



**IEEE Standard for  
Local and metropolitan area networks**

# **Part 16: Air Interface for Fixed and Mobile Broadband Wireless Access Systems**

**Amendment 2: Physical and Medium Access  
Control Layers for Combined Fixed and Mobile  
Operation in Licensed Bands**

*and*

**Corrigendum 1**

---

**IEEE Computer Society  
and the  
IEEE Microwave Theory and Techniques Society**

Sponsored by the  
LAN/MAN Standards Committee

---

IEEE  
3 Park Avenue  
New York, NY 10016-5997, USA  
28 February 2006

**IEEE Std 802.16e™-2005 and  
IEEE Std 802.16™-2004/Cor1-2005**  
(Amendment and Corrigendum to  
IEEE Std 802.16-2004)

TM  
802.16e

Authorized licensed use limited to: Fish & Richardson. Downloaded on April 11,2016 at 21:40:33 UTC from IEEE Xplore. Restrictions apply.

**IEEE Standard for  
Local and metropolitan area networks**

**Part 16: Air Interface for Fixed and Mobile  
Broadband Wireless Access Systems**

**Amendment 2: Physical and Medium Access  
Control Layers for Combined Fixed and Mobile  
Operation in Licensed Bands**

*and*

**Corrigendum 1**

Sponsor  
**LAN/MAN Standards Committee**  
of the  
**IEEE Computer Society**

and the  
**IEEE Microwave Theory and Techniques Society**



IEEE Std 802.16e-2005—Approved 7 December 2005  
IEEE Std 802.16-2004/Cor 1-2005—Approved 8 November 2005

**IEEE-SA Standards Board**

**Abstract:** This document updates and expands IEEE Std 802.16-2004 to allow for mobile subscriber stations.

**Keywords:** fixed broadband wireless access network, metropolitan area network, microwave, mobile broadband wireless access network, WirelessMAN® standards

---

The Institute of Electrical and Electronics Engineers, Inc.  
3 Park Avenue, New York, NY 10016-5997, USA

Copyright © 2006 by the Institute of Electrical and Electronics Engineers, Inc.  
All rights reserved. Published 28 February 2006. Printed in the United States of America.

IEEE and 802 and WirelessMan are registered trademarks in the U.S. Patent & Trademark Office, and owned by the Institute of Electrical and Electronics Engineers, Incorporated.

*CD-Rom:* ISBN 0-7381-4856-3 SE95394  
*PDF:* ISBN 0-7381-4857-1 SE95394

*No part of this publication may be reproduced in any form, in an electronic retrieval system or otherwise, without the prior written permission of the publisher.*

**IEEE Standards** documents are developed within the IEEE Societies and the Standards Coordinating Committees of the IEEE Standards Association (IEEE-SA) Standards Board. The IEEE develops its standards through a consensus development process, approved by the American National Standards Institute, which brings together volunteers representing varied viewpoints and interests to achieve the final product. Volunteers are not necessarily members of the Institute and serve without compensation. While the IEEE administers the process and establishes rules to promote fairness in the consensus development process, the IEEE does not independently evaluate, test, or verify the accuracy of any of the information contained in its standards.

Use of an IEEE Standard is wholly voluntary. The IEEE disclaims liability for any personal injury, property or other damage, of any nature whatsoever, whether special, indirect, consequential, or compensatory, directly or indirectly resulting from the publication, use of, or reliance upon this, or any other IEEE Standard document.

The IEEE does not warrant or represent the accuracy or content of the material contained herein, and expressly disclaims any express or implied warranty, including any implied warranty of merchantability or fitness for a specific purpose, or that the use of the material contained herein is free from patent infringement. IEEE Standards documents are supplied **“AS IS.”**

The existence of an IEEE Standard does not imply that there are no other ways to produce, test, measure, purchase, market, or provide other goods and services related to the scope of the IEEE Standard. Furthermore, the viewpoint expressed at the time a standard is approved and issued is subject to change brought about through developments in the state of the art and comments received from users of the standard. Every IEEE Standard is subjected to review at least every five years for revision or reaffirmation. When a document is more than five years old and has not been reaffirmed, it is reasonable to conclude that its contents, although still of some value, do not wholly reflect the present state of the art. Users are cautioned to check to determine that they have the latest edition of any IEEE Standard.

In publishing and making this document available, the IEEE is not suggesting or rendering professional or other services for, or on behalf of, any person or entity. Nor is the IEEE undertaking to perform any duty owed by any other person or entity to another. Any person utilizing this, and any other IEEE Standards document, should rely upon the advice of a competent professional in determining the exercise of reasonable care in any given circumstances.

Interpretations: Occasionally questions may arise regarding the meaning of portions of standards as they relate to specific applications. When the need for interpretations is brought to the attention of IEEE, the Institute will initiate action to prepare appropriate responses. Since IEEE Standards represent a consensus of concerned interests, it is important to ensure that any interpretation has also received the concurrence of a balance of interests. For this reason, IEEE and the members of its societies and Standards Coordinating Committees are not able to provide an instant response to interpretation requests except in those cases where the matter has previously received formal consideration.

Comments for revision of IEEE Standards are welcome from any interested party, regardless of membership affiliation with IEEE. Suggestions for changes in documents should be in the form of a proposed change of text, together with appropriate supporting comments. Comments on standards and requests for interpretations should be addressed to:

Secretary, IEEE-SA Standards Board  
445 Hoes Lane  
P.O. Box 1331  
Piscataway, NJ 08855-1331  
USA

Note: Attention is called to the possibility that implementation of this standard may require use of subject matter covered by patent rights. By publication of this standard, no position is taken with respect to the existence or validity of any patent rights in connection therewith. The IEEE shall not be responsible for identifying patents for which a license may be required by an IEEE standard or for conducting inquiries into the legal validity or scope of those patents that are brought to its attention.

Authorization to photocopy portions of any individual standard for internal or personal use is granted by the Institute of Electrical and Electronics Engineers, Inc., provided that the appropriate fee is paid to Copyright Clearance Center. To arrange for payment of licensing fee, please contact Copyright Clearance Center, Customer Service, 222 Rosewood Drive, Danvers, MA 01923 USA; +1 978 750 8400. Permission to photocopy portions of any individual standard for educational classroom use can also be obtained through the Copyright Clearance Center.

## Introduction

This introduction is not part of IEEE Std 802.16e-2005 and IEEE Std 802.16-2004/Cor 1-2005, IEEE Standard for Local and Metropolitan Area Networks Part 16: Air Interface for Fixed and Mobile Broadband Wireless Access Systems—Amendment 2: Physical and Medium Access Control Layers for Combined Fixed and Mobile Operation in Licensed Bands and Corrigendum.

This amendment updates and expands IEEE Std 802.16 to allow for mobile as well as fixed (stationary) subscriber stations. As of the publication date, the current applicable version of IEEE Std 802.16 is IEEE Std 802.16-2004, as amended by IEEE 802.16f-2005 and IEEE 802.16e-2005. The published amendment includes additional material developed not as part of the IEEE 802.16e project but instead as part of the corrigendum project IEEE 802.16-2004/Cor 1, applicable only to fixed systems. Because the work was completed at nearly the same time, the two approved documents were merged prior to publication. Additional standards projects to further develop IEEE Std 802.16 are underway.

## Conformance test methodology

The multipart conformance test documents for IEEE Std 802.16 by "IEEE Standard 802.16/ConformanceXX". For example, the first part of the conformance specification for IEEE 802.16 is designated "IEEE Standard 802.16/Conformance01."

## Notice to users

### Errata

Errata, if any, for this and all other standards can be accessed at the following URL: <http://standards.ieee.org/reading/ieee/updates/errata/index.html>. Users are encouraged to check this URL for errata periodically.

### Interpretations

Current interpretations can be accessed at the following URL: <http://standards.ieee.org/reading/ieee/interp/index.html>.

### Patents

Attention is called to the possibility that implementation of this standard may require use of subject matter covered by patent rights. By publication of this standard, no position is taken with respect to the existence or validity of any patent rights in connection therewith. The IEEE shall not be responsible for identifying patents or patent applications for which a license may be required to implement an IEEE standard or for conducting inquiries into the legal validity or scope of those patents that are brought to its attention.

## Participants

The amendment and corrigendum were developed by the IEEE 802.16 Working Group on Broadband Wireless Access, which develops the WirelessMAN™ Standard for Wireless Metropolitan Area Networks.

IEEE 802.16 Working Group Officers

**Roger B. Marks**, *Chair*  
**Ken Stanwood**, *Vice Chair*  
**Dean Chang**, *Secretary*

Primary development of the amendment was carried out by the Working Group's Task Group e (TGe):

TGe Officers

**Brian Kiernan**, *Chair*  
**Ron Murias**, *Chief Technical Editor*  
**Itzik Kitroser**, *Assistant Editor*  
**Jose Puthenkulam**, *Assistant Editor*

Primary development of the corrigendum was carried out by the Working Group's Maintenance Task Group:

Maintenance Officers

**Jonathan Labs**, *Chair*  
**Itzik Kitroser**, *Chief Technical Editor*  
**Ken Stanwood**, *Former Chair*

The following members of the IEEE 802.16 Working Group on Broadband Wireless Access participated in the Working Group Letter Ballot in which the draft of the amendment was prepared and finalized for IEEE Ballot:

Adivya Agrawal	Tal Kaitz	Greg Phillips
Baraa Al-Dabagh	Ofer Kelman	Kamlesh Rath
Mario Aliotta	Brian Kiernan	Gene Robinson
Eli Avivi	Itzik Kitroser	Randall Schwartz
Phillip Barber	Changhoi Koo	Yossi Segal
David Castelov	Jonathan Labs	Radu Selea
Dean Chang	Yigal Leiba	James Simkins
Naftali Chayat	Lingjie Li	Ken Stanwood
Rémi Chayer	John Liebetreu	Carl Stevenson
Brian Eidson	Hyoungsoo Lim	Shawn Taylor
Carl Eklund	Lars Lindh	David Trinkwon
Roger Eline	Heinz Lycklama	Rainer Ullmann
Avraham Freedman	Roger B. Marks	Eyal Verbin
Marianna Goldhammer	Russell McKown	Lei Wang
Zion Hadad	Andrew Middleton	Vladimir Yanover
David Johnston	Ron Murias	Choong-il Yeh
Panyuh Joo	Robert Nelson	Chulsik Yoon

The following participated as non-members in the Working Group Letter Ballot:

Chang-Jae Lee	Jeffrey Mandin	Jose Puthenkulam
---------------	----------------	------------------

The following members of the IEEE 802.16 Working Group on Broadband Wireless Access participated in the Working Group Letter Ballot in which the draft of the corrigendum was prepared and finalized for IEEE Ballot:

Ray Abrishami	Jaeho Jeon	Paul Odlyzko
Aditya Agrawal	Moo Ryong Jeong	Min Seok Oh
Baraa Al-Dabagh	Yong Seok Jin	Masoud Olfat
Mario Aliotta	Brian Johnson	Shlomo Ovadia
Dov Andelman	David Johnston	Joonho Park
Sanjeev Athalye	Panyuh Joo	Pyung-Su Park
Eli Avivi	Tal Kaitz	Youngsoo Park
Raja Banerjea	Ravi Kalavakunta	Trevor Pearman
Kevin Baum	Samuel Kang	Greg Phillips
Izhar Bentov	Ofer Kelman	Paul Piggip
Rajesh Bhalla	Adam Kerr	Ambroise Popper
Eckard Bogenfeld	Brian Kiernan	Jose Puthenkulam
Sean Cai	Beomjoon Kim	Kamlesh Rath
David Castelow	Bong Ho Kim	Anthony Reid
Giulio Cavalli	Chong-kwon Kim	Eric Reifsnider
Chan-Byoung Chae	Jaeyoel Kim	Russ Reynolds
Dean Chang	Jeong-Heon Kim	Maximilian Riegel
Jae Hwan Chang	Jeonghwi Kim	Chris Rogers
Sungcheol Chang	Jung Won Kim	Shane Rogers
Yong Chang	Min Sung Kim	Wonil Roh
Naftali Chayat	Ronny (Yong-Ho) Kim	Byung-Han Ryu
Rémi Chayer	Yong Bum Kim	Kiseon Ryu
Tao Chen	Young Kyun Kim	Andrew Sago
Yuehua (Lucy) Chen	Itzik Kitroser	Atul Salvekar
Aik Chindapol	Chris Knudsen	Randall Schwartz
Jaehee Cho	Changhoi Koo	Christian Seagren
Jaeweon Cho	Havish Koorapaty	Yossi Segal
Kihyoung Cho	Lalit Kotecha	Radu Selea
Seokheon Cho	Denesh Krishnasamy	N. K. Shankaranarayanan
Hyoung-Jin Choi	Dongseung Kwon	Eli Shasha
Joey Chou	Margaret LaBrecque	James Simkins
Jin Young Chun	Jonathan Labs	Jung Je Son
Jin Yong Chung	Jules Pierre Lamoureux	Yeong Moon Son
Kyuhyuk Chung	Chang-jae Lee	Ken Stanwood
José Costa	Jae Hak Lee	Shawn Taylor
Mark Cudak	Sungjin Lee	Wen Tong
Frank Draper	Yigal Leiba	Rainer Ullmann
Lester Eastwood	Barry Lewis	Mano Vafai
Carl Eklund	Jun Li	Eyal Verbin
Yigal Eliaspur	Xiaodong Li	Frederick Vook
Roger Eline	Geunhwi Lim	Arthur Wang
Torsten Fahldieck	Hyoung Kyu Lim	Guo Qiang Wang
Yonggang Fang	Hyoungsoo Lim	Irving Wang
Mo-Han Fong	Erik Lindskog	Jing Wang
Bogdan Franovici	Titus Lo	Lei Wang
Avraham Freedman	Hui-Ling Lou	Stanley Wang
Nikhil Goel	Heinz Lycklama	Alfred Wiczorek
Mariana Goldhamer	Michael Lynch	Geng Wu
Reza Golshan	Martin Lysejko	Jun Wu
Jin Guo	Seung Joo Maeng	Hassan Yaghoobi
Qiang Guo	David Maez	Ran Yaniv
Zion Hadad	Jeffrey Mandin	Vladimir Yanover
Yung Hahn	Roger Marks	Choong-Il Yeh
Jun Han	Russell McKown	Kunmin Yeo
Jeff Harrang	Scott Migaldi	Chulsik Yoon
Haixiang He	James Mollenauer	Wenzhong Zhang
Zhaoyun (Laura) Huang	Ollivier Mont-Reynaud	Keqiang Zhu
John Humbert	Ronald Murias	Peiyang Zhu
Seung Ku Hwang	K. S. Natarajan	
Jiho Jang	Gunnar Nitsche	



The following members of the individual balloting committee voted on this amendment. Balloters may have voted for approval, disapproval, or abstention.

Aditya Agrawal	David Hunter	Andrew Myles
Toru Aihara	Peeya Iwagoshi	Kadathur Natarajan
Thomas Alexander	Prakash Iyer	Robert Nelson
Gordon Antonello	Raj Jain	Paul Nikolich
Reza Arefi	Hamadi Jamali	Shlomo Ovadia
Eladio Arvelo	David James	Richard Pace
Raja Banerjea	Gilb James	Roger Pandanda
Phillip Barber	Jaeho Jeon	Yunsang Park
Victor Barinov	Brian Johnson	Girish Patel
John Barr	David Johnston	Greg Phillips
Rajesh Bhalla	Panyuh Joo	Subbu Ponnuswamy
David Castelow	Bobby Jose	Vikram Punj
Dean Chang	Avinash Joshi	Jose Puthenkulam
Jae Hwan Chang	Kevin Karcz	Oded Redlich
Yong Chang	Stuart Kerry	Maximilian Riegel
Naftali Chayat	Mika Kahola	Herbert Ruck
Remi Chayer	Tal Kaitz	Bong-Gee Song
Aik Chindapol	Dae-Hyun Kang	Tony Saboorian
Sunghyun Choi	Mika Kasslin	Atul Salvekar
Joey Chou	Ofer Kelman	Yossi Segal
Keith Chow	Brian Kiernan	N. Shankaranarayanan
Antonio M Cicu	Byoung-Jo Kim	Neil Shipp
Joseph Cleveland	Itzik Kitroser	Dorothy Stanley
Jose M. Costa	Dong Seung Kwon	Kenneth Stanwood
Steven Crowley	Margaret LaBrecque	Victor Stolpman
Mark Cudak	Jonathan Labs	Shawn Taylor
Thomas Dineen	Yigal Leiba	Lai King (Anna) Tee
Vern Dubendorf	Jun Li	David Thompson
Lester Eastwood	Jan-Ray Liao	Wen Tong
Donald Eidson	Hyoungsoo Lim	Mark-Rene Uchida
Carl Eklund	Randolph Little	Rainer Ullmann
Yigal Eliaspur	Guoliang Liu	Mini Vasudevan
Roger Eline	Aviram Lobel	Nico Van Waes
Darwin Engwer	William Lumpkins	Huaiyuan Wang
Yaacov Fenster	Gregory Luri	Lei Wang
Mo-Han Fong	Heinz Lycklama	Stanley Wang
Colin Frank	Michael Lynch	Joanne Wilson
Avraham Freedman	Jianglei Ma	Eric Woods
Ernesto Garcia	Seung Joo Maeng	Geng Wu
Mike Geipel	Jeff Mandin	Hassan Yaghoobi
Theodore Georgantas	Roger B. Marks	Vladimir Yanover
Mariana Goldhamer	Robert Matyas	Jung Yee
Jean-Denis Gorin	Ian McCallum	Choongil Yeh
Ronen Greenberg	Andy McGregor	Patrick Yu
Qiang Guo	Ingolf Meier	Oren Yuen
Zion Hadad	George Miao	Surong Zeng
Siamack Haghighi	Scott Migaldi	Hang Zhang
Yung Hahn	Yinghua Min	Peiying Zhu
John Haskin	Apurva Mody	Li Zhang
Haixiang He	Ron Murias	Yonatan Zvi

The following members of the individual balloting committee voted on this corrigendum that is incorporated into this amendment. Balloters may have voted for approval, disapproval, or abstention.

Osama Aboul-Magd	David Hunter	Ollivier Mont-Reynaud
Aditya Agrawal	Arshad Hussain	Jose Morales-Barroso
Toru Aihara	Atsushi Ito	Ron Murias
Dov Andelman	Raj Jain	Narayanan Murugesan
Danilo Antonelli	Hamadi Jamali	Michael Newman
Gordon Antonello	David James	Charles Ngethe
Mikio Aoki	Bilel Jamoussi	Shlomo Ovadia
Reza Arefi	David Johnston	Paul Odlyzko
William Byrd	Panyuh Joo	Chris Osterloh
Dale Baldwin	Bobby Jose	Satoshi Oyama
Phillip Barber	Joe Juisai	Paul Piggin
John Barnett	Ed Juskevicius	Subbu Ponnuswamy
Nick Baustert	Hyunjeong Kang	Ambroise Popper
Rajesh Bhalla	Mika Kasslin	Vikram Punj
Jan Boer	Ruediger Kays	Jose Puthenkulam
Gennaro Boggia	Ivy Kelly	Maximilian Riegel
Todor Cooklev	Ofer Kelman	Yousuf Saifullah
James Carlo	Stuart Kerry	Sundar Sankaran
David Castelow	Brian Kiernan	John Sargent
Jay Catelli	Kyunggho Kim	Stephen Schwarm
Dean Chang	Duncan Kitchin	Chris Seagren
Remi Chayer	Itzik Kitroser	Michael Seaman
Yi-Ming Chen	Chris Knudsen	Jack Sherman
Yung-Mu Chen	Kamal Koshy	Takashi Shono
Danila Chernetsov	Lalit Kotecha	Henry Simonds
Aik Chindapol	Thomas M. Kurihara	Rajnish Singh
Jaeweon Cho	Jeremy Landt	Jung Je Son
Yang-Seok Choi	Jonathan Labs	Yeongmoon Son
Keith Chow	Jules Pierre Lamoureux	Dorothy Stanley
José M. Costa	Gerald Lebizay	Thomas Starai
Mark Cudak	Yigal Leiba	Mark Sturza
Joel Demarty	Li Li	Joseph Tardo
Thomas Dineen	Qinghua Li	Wen Tong
Petar Djukic	Arthur Light	Mark-Rene Uchida
Carlo Donati	Hyoung-Kyu Lim	Rainer Ullmann
Lakshminath Dondeti	Hyoungsoo Lim	Guoqiang Wang
Francois Draper	Mark Lipford	Lei Wang
Sourav Dutta	William Lumpkins	Stanley Wang
Lester Eastwood	Gregory Luri	William Ward
Carl Eklund	Michael Lynch	Fujio Watanabe
Roger Eline	Jianglei Ma	Mattias Wennstrom
John Fendrich	Faramarz Maghsoodlou	Jason Wilden
Mo-Han Fong	Serge Manning	Joanne Wilson
Andre Fourmier	Ben Manny	Harry Worstell
Avi Freedman	Kevin Marquess	Ran Yaniv
Mike Geipel	Jon Martens	Vladimir Yanover
Theodore Georgantas	Kyle Maus	Hujun Yin
Pieter-Paul Giesberts	Jonathon McLendon	Patrick Yu
James Gilb	Ingolf Meier	Oren Yuen
Nikhil Goel	Tom Merkle	Hang Zhang
Mariana Goldhamer	Hakim Mesiwala	Jianzhong Zhang
Qiang Guo	Steve Methley	Peiying Zhu
Chris Guy	George Miao	ron greenthaler
Zion Hadad	Scott Migaldi	brian johnson
Siamack Haghighi	Robert Miller	atul salvekar
Haixiang He	Yinghua Min	Richard van Leeuwen
Shui Heung	William Mitchell	Nico van Waes
Zhaoyun Huang	Apurva Mody	Cor van de Water
John Humbert	James Mollenauer	Ilan Zohar

When the IEEE-SA Standards Board approved IEEE Std 802.16e-2005 on 7 December 2005 and IEEE Std 802.16-2004/Cor 1-2005 on 8 November 2005, it had the following membership:

**Steve M. Mills, *Chair***  
**Richard H. Hulett, *Vice Chair***  
**Don Wright, *Past Chair***  
**Judith Gorman, *Secretary***

Mark D. Bowman  
Dennis B. Brophy  
Joseph Bruder  
Richard Cox  
Bob Davis  
Julian Forster\*  
Joanna N. Guenin  
Mark S. Halpin  
Raymond Hapeman

William B. Hopf  
Lowell G. Johnson  
Herman Koch  
Joseph L. Koepfinger\*  
David J. Law  
Daleep C. Mohla  
Paul Nikolich

T. W. Olsen  
Glenn Parsons  
Ronald C. Petersen  
Gary S. Robinson  
Frank Stone  
Malcolm V. Thaden  
Richard L. Townsend  
Joe D. Watson  
Howard L. Wolfman

\*Member Emeritus

Also included are the following nonvoting IEEE-SA Standards Board liaisons:

Satish K. Aggarwal, *NRC Representative*  
Richard DeBlasio, *DOE Representative*  
Alan H. Cookson, *NIST Representative*

Michelle Turner  
*IEEE Standards Project Editor*

Authorized licensed use limited to: Fish & Richardson. Downloaded on April 11,2016 at 21:40:33 UTC from IEEE Xplore. Restrictions apply.

## Contents

1.Overview.....	1
1.1 Scope.....	1
1.2 Purpose.....	2
1.3 Frequency bands .....	2
1.3.3 License-exempt frequencies below 11 GHz (primarily 5–6 GHz) .....	2
1.3.4 Air interface nomenclature and PHY compliance .....	3
1.4 Reference model .....	3
1.4.1 Handover process.....	3
2.References.....	5
3.Definitions .....	7
4.Abbreviations and acronyms .....	11
5.Service-specific CS.....	13
5.1 ATM CS.....	13
5.1.2 Data/Control plane.....	13
5.1.2.2 Classification .....	13
5.1.2.2.1 VP-switched mode.....	13
5.1.2.2.2 VC-switched mode .....	13
5.2 Packet CS.....	13
5.2.2 Classification .....	13
5.2.3 PHS .....	13
5.2.3.1 PHS operation .....	13
5.2.3.2 PHS signaling .....	14
5.2.4 IEEE Std 802.3/Ethernet-specific part.....	14
5.2.4.1 IEEE Std 802.3/Ethernet CS PDU format .....	14
5.2.4.2 IEEE Std 802.3/Ethernet CS classifiers.....	14
5.2.5 IEEE Std 802.1Q-19982003 virtual local area network (VLAN) specific part.....	15
5.2.5.1 IEEE Std 802.1Q-19982003 VLAN CS PDU format.....	15
5.2.5.2 IEEE Std 802.1Q-19982003 CS classifiers .....	15
5.2.6 IP specific part .....	15
5.2.6.1 IP CS PDU format .....	15
5.2.7 IP-Header-compression-specific part .....	15
5.2.7.1 Compressed-IP-Header CS PDU .....	16
5.2.7.2 Compressed-IP-Header classifiers.....	16
6.MAC common part sublayer.....	17
6.1 PMP .....	17
6.3 Data/Control plane.....	17
6.3.1 Addressing and connections .....	17
6.3.1.1 PMP .....	17
6.3.2 MAC PDU formats.....	18
6.3.2.1 MAC header formats .....	18
6.3.2.1.1 Generic MAC header .....	19
6.3.2.1.2 MAC header without payload.....	21
6.3.2.2 MAC subheaders and special payloads .....	36
6.3.2.2.2 Grant Management subheader .....	37
6.3.2.2.3 Packing subheader .....	38

6.3.2.2.4	ARQ feedback.....	38
6.3.2.2.6	FAST-FEEDBACK allocation subheader .....	38
6.3.2.2.7	Extended subheader format .....	38
6.3.2.3	MAC Mmanagement messages .....	44
6.3.2.3.1	Downlink Channel Descriptor (DCD) message.....	47
6.3.2.3.2	Downlink map (DL-MAP) message .....	47
6.3.2.3.4	Uplink map (UL-MAP) message.....	49
6.3.2.3.5	Ranging request (RNG-REQ) message .....	50
6.3.2.3.6	Ranging Response (RNG-RSP) message .....	53
6.3.2.3.7	Registration request (REG-REQ) message.....	55
6.3.2.3.8	Registration Response (REG-RSP) message.....	56
6.3.2.3.9	Privacy key management (PKM) messages (PKM-REQ/PKM-RSP).....	58
6.3.2.3.10	DSA-REQ message.....	72
6.3.2.3.11	DSA-RSP message .....	72
6.3.2.3.12	DSA-ACK message .....	73
6.3.2.3.13	DSC Request (DSC-REQ) message .....	74
6.3.2.3.14	DSC Response (DSC-RSP) message .....	74
6.3.2.3.15	DSC Acknowledge (DSC-ACK) message.....	74
6.3.2.3.16	DSD-REQ message.....	74
6.3.2.3.17	DSD-RSP message .....	75
6.3.2.3.20	Downlink Burst Profile Change Request (DBPC-REQ) message.....	75
6.3.2.3.21	Downlink Burst Profile Change Response (DBPC-RSP) message .....	75
6.3.2.3.22	Reset Command (RES-CMD) message .....	75
6.3.2.3.23	SS basic capability request (SBC-REQ) message .....	75
6.3.2.3.24	SS basic capability response (SBC-RSP) message.....	76
6.3.2.3.26	De/Re-register command (DREG-CMD) message.....	76
6.3.2.3.28	Config File TFTP Complete (TFTP-CPLT) message.....	78
6.3.2.3.32	ARQ Reset message.....	78
6.3.2.3.33	Channel measurement Report Request/Response (REP-REQ/RSP) .....	79
6.3.2.3.34	Fast Power Control (FPC) message .....	80
6.3.2.3.41	AAS Beam Select message .....	80
6.3.2.3.42	SS De-registration Request (DREG-REQ) message .....	80
6.3.2.3.43	H-ARQ HARQ MAP message .....	82
6.3.2.3.44	Sleep Request message (MOB_SLP-REQ) .....	112
6.3.2.3.45	Sleep Response message (MOB_SLP-RSP).....	114
6.3.2.3.46	Traffic Indication message (MOB_TRF-IND) .....	118
6.3.2.3.47	Neighbor Advertisement (MOB_NBR-ADV) message .....	120
6.3.2.3.48	Scanning Interval Allocation Request (MOB_SCN-REQ) message .....	126
6.3.2.3.49	Scanning Interval Allocation Response (MOB_SCN-RSP) message .....	128
6.3.2.3.50	Scanning Result Report (MOB_SCN-REP) message.....	131
6.3.2.3.51	Association Result Report (MOB_ASC-REP) message.....	135
6.3.2.3.52	BS HO Request (MOB_BSHO-REQ) message.....	137
6.3.2.3.53	MS HO Request (MOB_MSHO-REQ) message .....	145
6.3.2.3.54	BS HO Response (MOB_BSHO-RSP) message .....	149
6.3.2.3.55	HO Indication (MOB_HO-IND) message .....	157
6.3.2.3.56	BS Broadcast Paging (MOB_PAG-ADV) message .....	160
6.3.2.3.57	Multicast Broadcast Service Map (MBS_MAP) message.....	161
6.3.2.3.58	Power control mode change request (PMC_REQ) message .....	166
6.3.2.3.59	Power control mode change response (PMC_RSP) message.....	167
6.3.2.3.60	OFDMA Sub downlink/uplink map (SUB-DL-UL-MAP) message .....	169
6.3.2.3.61	MIMO precoding setup/tear-down .....	172
6.3.3	Construction and transmission of MAC PDUs.....	172
6.3.3.3	Fragmentation .....	172
6.3.3.3.1	Non-ARQ Connections.....	173

6.3.3.4	Packing.....	173
6.3.3.4.2	Packing for ARQ-enabled connections.....	173
6.3.3.5	CRC calculation.....	173
6.3.3.5.1	CRC32 calculation for SC, SCa, and OFDM mode .....	173
6.3.3.5.2	CRC32 calculation for OFDMA mode.....	174
6.3.4	ARQ mechanism.....	175
6.3.4.2	ARQ Feedback IE format .....	175
6.3.4.3	ARQ parameters .....	176
6.3.4.3.4	ARQ_RETRY_TIMEOUT.....	176
6.3.4.6	ARQ operation.....	176
6.3.4.6.2	Transmitter state machine.....	176
6.3.4.6.3	Receiver state machine .....	179
6.3.5	Scheduling services.....	179
6.3.5.2	Uplink request/grant scheduling .....	182
6.3.5.2.1	UGS .....	182
6.3.5.2.2	rtPS.....	183
6.3.5.2.3	nrtPS.....	184
6.3.5.2.4	BE service.....	184
6.3.6	Bandwidth allocation and request mechanisms .....	184
6.3.6.1	Requests.....	184
6.3.6.3	Polling.....	185
6.3.6.3.1	Unicast.....	185
6.3.7	MAC support of PHY .....	185
6.3.7.4	UL-MAP .....	185
6.3.7.4.3	Uplink interval definition.....	185
6.3.7.5	Map relevance and synchronization .....	185
6.3.7.5.3	WirelessMAN-OFDM PHY .....	186
6.3.7.6	Optional MAC AAS Ssupport of WirelessMAN-SCa, OFDM, and OFDMA.....	186
6.3.7.6.1	AAS MAC services .....	186
6.3.7.6.4	Alerting the BS about presence of a new SS in an AAS system .....	186
6.3.8	Contention resolution.....	186
6.3.9	Network entry and initialization .....	186
6.3.9.1	Scanning and synchronization to the downlink .....	187
6.3.9.2	Obtain downlink parameters.....	187
6.3.9.3	Obtain uplink parameters.....	187
6.3.9.5	Initial ranging and automatic adjustments .....	188
6.3.9.5.1	Contention-based Initial ranging and automatic adjustments.....	188
6.3.9.6	Ranging parameter adjustment .....	189
6.3.9.7	Negotiate basic capabilities .....	192
6.3.9.8	SS authorization and key exchange .....	193
6.3.9.9	Registration.....	194
6.3.9.10	Establish IP connectivity .....	194
6.3.9.15	Forcing MSs to perform Network Entry at once .....	195
6.3.10	Ranging.....	195
6.3.10.1	Downlink burst profile management .....	195
6.3.10.2	Uplink periodic ranging.....	198
6.3.10.3	OFDMA-based ranging .....	200
6.3.10.3.1	Contention-based initial ranging and automatic adjustments .....	201
6.3.10.3.2	Periodic ranging and automatic adjustments .....	207
6.3.10.3.3	CDMA handover ranging and automatic adjustment .....	208
6.3.13	Establishment of multicast and broadcast transport connections .....	209
6.3.14	QoS .....	209
6.3.14.1	Theory of operation .....	209
6.3.14.2	Service flows.....	209

6.3.14.3	Object model.....	209
6.3.14.4	Service classes .....	211
6.3.14.4.1	Global service flows .....	211
6.3.14.7	Service Flow Creation .....	214
6.3.14.7.1	Dynamic service flow creation .....	214
6.3.14.9	Service flow management.....	214
6.3.14.9.2	Dynamic Service Flow state transitions.....	214
6.3.14.9.3	DSA .....	214
6.3.14.9.4	DSC.....	214
6.3.14.9.5	Connection release.....	215
6.3.15	DFS for license-exempt operation Procedures for shared frequency band usage .....	215
6.3.15.1	Introduction.....	215
6.3.15.2	Testing channels for primary other users (including specific spectrum users).....	216
6.3.15.3	Discontinuing operations after detecting primary specific spectrum users .....	217
6.3.15.4	Detecting primary specific spectrum users.....	217
6.3.15.5	Scheduling for channel testing.....	217
6.3.15.6	Requesting and reporting of measurements.....	217
6.3.15.7	Selecting and advertising a new channel .....	218
6.3.17	MAC support for H-ARQ HARQ.....	218
6.3.17.1	Subpacket generation.....	220
6.3.17.2	DL/UL ACK/NAK signaling.....	221
6.3.17.3	H-ARQ HARQ parameter signaling.....	221
6.3.18	DL CINR report operation.....	221
6.3.18.1	DL CINR report with REP-RSP MAC message .....	221
6.3.18.2	Periodic CINR report with fast-feedback (CQICH) channel.....	222
6.3.19	optional Band AMC operations using 6-bit CQICH encoding.....	224
6.3.19.1	Call flows for mode transitions between normal subchannel and band AMC .....	224
6.3.19.2	Conditions of transition triggering.....	225
6.3.20	Data delivery services for mobile network.....	225
6.3.20.1	Types of data delivery services.....	225
6.3.20.1.1	Unsolicited grant service (UGS).....	226
6.3.20.1.2	Real-Time Variable Rate (RT-VR) service .....	226
6.3.20.1.3	Non-Real-Time Variable Rate (NRT-VR) service .....	227
6.3.20.1.4	Best Effort (BE) service.....	227
6.3.20.1.5	Extended Real-Time Variable Rate (ERT-VR) service.....	227
6.3.21	Sleep mode for mobility-supporting MS .....	228
6.3.21.1	Introduction.....	228
6.3.21.2	Power Saving Classes of type I.....	230
6.3.21.3	Power Saving Classes of type II .....	231
6.3.21.4	Power Saving Classes of type III.....	232
6.3.21.5	Periodic Ranging in sleep mode .....	233
6.3.21.6	MDHO/FBSS Diversity Set Maintenance in sleep mode.....	234
6.3.22	MAC layer handover procedures.....	234
6.3.22.1	Network topology acquisition.....	234
6.3.22.1.1	Network topology advertisement.....	234
6.3.22.1.2	MS scanning of neighbor BSs .....	234
6.3.22.1.3	Association procedure.....	236
6.3.22.2	HO process.....	238
6.3.22.2.1	Cell reselection .....	241
6.3.22.2.2	HO decision and initiation .....	241
6.3.22.2.3	HO cancellation .....	243
6.3.22.2.4	Use of scanning and association results.....	243
6.3.22.2.5	Termination with the Serving BS .....	243
6.3.22.2.6	Drops during HO .....	244



6.3.22.2.7	Network entry/re-entry .....	244
6.3.22.2.8	MS-Assisted coordination of DL transmission at Target BS for HO .....	246
6.3.22.2.9	HO process.....	247
6.3.22.3	Macro diversity handover and fast BS switching .....	250
6.3.22.3.1	MDHO decision and initiation.....	251
6.3.22.3.2	FBSS decision and initiation.....	252
6.3.22.3.3	Diversity Set update for MDHO/FBSS .....	253
6.3.22.3.4	Anchor BS update for MDHO/FBSS.....	254
6.3.22.3.5	MS-Assisted coordination of DL transmission at new Anchor BS .....	256
6.3.23	Multicast and broadcast services (MBS) .....	257
6.3.23.1	Single-BS Access.....	257
6.3.23.2	Multi-BS Access .....	257
6.3.23.2.1	Establishment and maintenance of multicast and broadcast services .....	258
6.3.23.2.2	Performance enhancement with macro diversity.....	259
6.3.23.2.3	Power saving operation.....	259
6.3.23.2.4	Multicast and broadcast zone (MBS_Zone) .....	259
6.3.24	MS Idle Mode (optional) .....	259
6.3.24.1	MS Idle Mode Initiation .....	261
6.3.24.2	Cell selection.....	262
6.3.24.3	MS Broadcast Paging Message time synchronization .....	262
6.3.24.4	MS Paging Unavailable Interval.....	262
6.3.24.5	MS Paging Listening Interval .....	262
6.3.24.6	BS Broadcast Paging message .....	263
6.3.24.7	Paging Availability Mode termination .....	264
6.3.24.7.1	MS side .....	264
6.3.24.7.2	BS side .....	265
6.3.24.8	Location Update.....	265
6.3.24.8.1	Location Update conditions .....	265
6.3.24.8.2	Location Update Process .....	266
6.3.24.9	Network Re-Entry from Idle Mode .....	267
7.	Security sublayer.....	269
7.1	Architecture .....	269
7.1.1	Packet data encryption Secure encapsulation of MPDUs.....	270
7.1.2	Key management protocol .....	270
7.1.3	Authentication protocol .....	271
7.1.3.1	PKM RSA authentication .....	271
7.1.3.2	PKM EAP authentication.....	272
7.2	PKM protocol .....	272
7.2.1	PKM Version 1 .....	272
7.2.1.1	Security Associations.....	272
7.2.1.3	SS authorization and AK exchange overview .....	273
7.2.1.3.1	Authorization via RSA authentication protocol.....	273
7.2.1.4	TEK exchange overview.....	274
7.2.1.4.1	TEK exchange overview for PMP topology.....	274
7.2.1.4.2	TEK exchange overview for Mesh mode .....	274
7.2.1.5	Security capabilities selection.....	274
7.2.1.6	Authorization state machine .....	274
7.2.1.6.1	States .....	274
7.2.1.6.2	Messages .....	274
7.2.1.6.3	Events.....	274
7.2.1.6.4	Parameters.....	274
7.2.1.6.5	Actions .....	275

7.2.1.7	TEK state machine.....	275
7.2.1.7.1	States.....	275
7.2.1.7.2	Messages.....	275
7.2.1.7.3	Events.....	275
7.2.1.7.4	Parameters.....	275
7.2.1.7.5	Actions.....	275
7.2.2	PKM Version 2.....	275
7.2.2.1	TEK exchange overview for PMP topology.....	275
7.2.2.2	Key derivation.....	276
7.2.2.2.1	RSA-based authorization.....	276
7.2.2.2.2	EAP authentication.....	277
7.2.2.2.3	Authorization Key (AK) derivation.....	278
7.2.2.2.4	Key Encryption Key (KEK) derivation.....	279
7.2.2.2.5	Group Key Encryption Key (GKEK) derivation.....	279
7.2.2.2.6	Traffic Encryption Key (TEK).....	279
7.2.2.2.7	Group Traffic Encryption Key (GTEK).....	279
7.2.2.2.8	MBS Traffic Key (MTK).....	279
7.2.2.2.9	Message authentication keys (HMAC/CMAC) and KEK derivation.....	280
7.2.2.2.10	Key hierarchy.....	280
7.2.2.2.11	Maintenance of PMK and AK.....	285
7.2.2.2.12	PKMv2 PMK and AK switching methods.....	285
7.2.2.3	Associations.....	285
7.2.2.3.1	Security associations.....	285
7.2.2.3.2	Group Security Association.....	286
7.2.2.3.3	MBS Group Security Association.....	286
7.2.2.4	Security context.....	286
7.2.2.4.1	AK context.....	287
7.2.2.4.2	GKEK context.....	288
7.2.2.4.3	PMK context.....	288
7.2.2.4.4	PAK context.....	289
7.2.2.5	TEK state machine.....	289
7.2.2.5.1	States.....	291
7.2.2.5.2	Messages.....	292
7.2.2.5.3	Events.....	292
7.2.2.5.4	Parameters.....	293
7.2.2.5.5	Actions.....	293
7.3	Key Usage.....	296
7.5	Cryptographic methods.....	297
7.5.1	Data Encryption methods.....	297
7.5.1.1	Data encryption with DES in CBC mode.....	297
7.5.1.2	Data encryption with AES in CCM mode.....	298
7.5.1.2.1	PDU Ppayload Fformat.....	298
7.5.1.2.2	PN (Packet Number).....	298
7.5.1.2.3	CCM Aalgorithm.....	299
7.5.1.2.5	AES-CCM Mode example encrypted MPDUs.....	300
7.5.1.3	Data encryption with AES in CTR mode.....	301
7.5.1.3.1	Encrypted MBS PDU payload format.....	301
7.5.1.4	Data encryption with AES in CBC mode.....	302
7.5.1.4.1	CBC IV generation.....	302
7.5.1.2.4	Receive Processing Rules.....	304
7.5.2.4	Encryption of TEK-128 with AES Key Wrap.....	304
7.5.3	Calculation of HMAC-Digests.....	304
7.5.4	Derivation of TEKs, KEKs, and message authentication keys.....	304
7.5.4.2	3-DES KEKs.....	304

7.5.4.4	Cipher-based MAC (CMAC).....	305
7.5.4.4.1	Calculation of CMAC Value .....	305
7.5.4.5	Derivation of TEKs, KEKs, message authentication keys and GKEKs in PKMv2 ..	306
7.5.4.5.1	AES KEKs in PKMv2 .....	306
7.5.4.5.2	Encryption of GKEK in PKMv2 .....	306
7.5.4.6	Key derivation functions for PKMv2 .....	308
7.5.4.6.1	Dot16KDF for PKMv2 .....	308
7.6.1.4.3	BS certificate.....	309
7.6.1.6	tbsCertificate.issuerUniqueID and tbsCertificate.subjectUniqueID .....	309
7.7	Pre-Authentication .....	309
7.8	PKMv2.....	309
7.8.1	PKMv2 SA-TEK 3-way handshake.....	309
7.8.2	BS and SS RSA mutual authentication and AK exchange overview .....	311
7.8.3	Multicast Broadcast Service (MBS) support .....	312
7.8.3.1	MBS security associations .....	312
7.8.3.2	MBS Key Management .....	313
7.8.3.2.1	MBS Authorization Key (MAK) establishment .....	313
7.8.3.2.2	MGTEK establishment .....	313
7.8.3.2.3	MBS Traffic Key establishment .....	313
7.9	Optional multicast and broadcast rekeying algorithm (MBRA).....	313
7.9.1	MBRA flow .....	313
7.9.1.1	BS usage of GTEK .....	315
7.9.1.2	SS usage of GTEK.....	316
7.9.2	Messages.....	316
7.9.3	Encryption of GKEK .....	316
7.9.4	Message authentication keys for the Key Update Command message .....	316
8.PHY	.....	317
8.1	WirelessMAN-SC PHY specification .....	317
8.1.3	Duplexing techniques and PHY Type parameter encodings .....	317
8.1.3.2	TDD operation .....	317
8.1.3.2.1	TTG.....	317
8.1.3.2.2	RTG .....	317
8.1.4	Downlink PHY .....	317
8.1.4.1	Downlink subframe.....	317
8.1.4.1.2	Frame control section.....	317
8.1.9	Channel quality measurements .....	317
8.1.9.2	RSSI mean and standard deviation .....	317
8.2	WirelessMAN-SCa PHY .....	318
8.2.1	Transmit processing .....	318
8.2.1.5	Duplex framing.....	318
8.2.1.5.1	FDD .....	318
8.2.1.5.2	TDD .....	318
8.2.1.8	Compressed FCH maps .....	319
8.2.1.8.2	Compressed UL-MAP .....	319
8.2.1.9	MAP message fields and IEs .....	319
8.2.1.9.3	UL-MAP IE formats .....	319
8.2.2	Channel quality measurements .....	319
8.2.2.2	RSSI mean and standard deviation .....	319
8.3	WirelessMAN-OFDM PHY Layer.....	320
8.3.2	OFDM symbol parameters and transmitted signal .....	320
8.3.2.4	Parameters of transmitted signal .....	320
8.3.3	Channel coding .....	320

8.3.3.1	Randomization .....	320
8.3.3.2	FEC .....	321
8.3.3.2.1	Concatenated Reed–Solomon-convolutional code (RS-CC) .....	321
8.3.3.4	Modulation .....	322
8.3.3.4.2	Pilot modulation .....	322
8.3.3.5	Example OFDM uplink RS-CC encoding .....	322
8.3.3.5.3	Subchannelization (1 subchannel) .....	322
8.3.3.6	Preamble structure and modulation .....	323
8.3.5	Frame structure .....	323
8.3.5.1	PMP .....	323
8.3.5.1.1	PMP DL subchannelization zone .....	327
8.3.5.2	PMP-AAS Zone .....	329
8.3.5.5	Burst Pprofile format .....	331
8.3.6	MAP message fields and IEs .....	331
8.3.6.2	DL-MAP IE format .....	331
8.3.6.2.1	DIUC allocations .....	332
8.3.6.2.3	Channel measurement IE format .....	332
8.3.6.2.8	DL-MAP dummy IE format .....	332
8.3.6.2.9	DL SUBCH_IE format .....	333
8.3.6.3	UL-MAP IE format .....	333
8.3.6.3.1	UIUC allocations .....	333
8.3.6.3.3	Subchannelized network entry IE .....	333
8.3.6.3.5	UL-MAP power control IE format .....	334
8.3.6.3.7	UL-MAP Physical Modifier IE .....	334
8.3.6.3.8	UL-MAP dummy IE format .....	334
8.3.6.3.9	Fast_Ranging_IE .....	335
8.3.6.3.10	UL-MAP Fast tracking information element .....	335
8.3.6.6	Compressed private maps .....	336
8.3.6.6.1	Compressed private DL-MAP .....	337
8.3.6.6.2	Compressed Private UL-MAP .....	338
8.3.6.7	Reduced private maps .....	339
8.3.6.7.1	Reduced private DL-MAP .....	340
8.3.6.7.2	Reduced private UL-MAP .....	342
8.3.7	Control mechanisms .....	343
8.3.7.2	Ranging .....	343
8.3.7.2.1	Initial Ranging in AAS systems .....	345
8.3.7.3	Bandwidth requesting .....	346
8.3.7.3.2	Full Contention transmission .....	346
8.3.7.4	Power control .....	347
8.3.7.4.1	Closed loop power control mode .....	347
8.3.7.4.2	Open Loop Power Control Mode (Optional) .....	347
8.3.8	Transmit diversity: Sspace-Ttime Ccoding (optional) .....	349
8.3.9	Channel quality measurements .....	349
8.3.9.2	RSSI mean and standard deviation .....	349
8.3.9.3	CINR mean and standard deviation .....	350
8.3.10	Transmitter requirements .....	350
8.3.10.1	Transmit power level control .....	350
8.3.10.2	Transmitter spectral flatness .....	350
8.3.11	Receiver requirements .....	351
8.3.11.1	Receiver sensitivity .....	351
8.3.11.2	Receiver adjacent and alternate channel rejection .....	352
8.3.12	Frequency and timing requirements .....	352
8.4	WirelessMAN-OFDMA PHY layer .....	353
8.4.1	Introduction .....	353

8.4.2	OFDMA symbol description, symbol parameters and transmitted signal.....	353
8.4.2.3	Primitive parameters.....	353
8.4.3	OFDMA basic terms definition.....	353
8.4.3.1	Slot and Ddata Rregion.....	353
8.4.3.4	OFDMA data mapping.....	354
8.4.4	Frame structure.....	356
8.4.4.2	PMP frame structure.....	356
8.4.4.3	DL Fframe Pprefix.....	358
8.4.4.4	Allocation of subchannels for FCH and DL-MAP, and logical subchannel numbering.....	361
8.4.4.5	Uplink transmission allocations.....	361
8.4.4.6	Optional Diversity-Map ScanAAS support.....	363
8.4.4.6.1	AAS frame structure.....	363
8.4.4.6.2	AAS-DLFP Format Optional Diversity-Map scan.....	364
8.4.4.6.3	AAS Diversity-Scan Map network entry procedure.....	367
8.4.4.6.4	AAS preambles.....	367
8.4.4.7	Optional Direct Signaling Method.....	370
8.4.5	Map message fields and IEs.....	370
8.4.5.3	DL-MAP IE format.....	370
8.4.5.3.1	DIUC allocation.....	372
8.4.5.3.2	DL-MAP extended IE format.....	373
8.4.5.3.3	AAS downlink IE format.....	374
8.4.5.3.4	Transmit diversity (TD)Space-Time Coding (STC)/DL_Zone switch IE format.....	376
8.4.5.3.6	Data location in another BS IE.....	379
8.4.5.3.7	CID Switch IE.....	380
8.4.5.3.8	MIMO DL basic IE format.....	380
8.4.5.3.9	MIMO DL Eenhanced IE format.....	384
8.4.5.3.10	H-ARQ HARQ and Sub-MAP Pointer IE.....	386
8.4.5.3.11	DL-MAP Physical modifier IE.....	387
8.4.5.3.12	Multicast and Broadcast Service MAP IE (MBS_MAP_IE).....	389
8.4.5.3.13	DL PUSC Burst Allocation in Other Segment IE.....	391
8.4.5.3.14	HO anchor active DL MAP IE.....	392
8.4.5.3.15	HO active anchor DL MAP IE.....	393
8.4.5.3.16	HO CID Translation MAP IE.....	394
8.4.5.3.17	MIMO in another BS IE.....	395
8.4.5.3.18	Macro-MIMO DL Basic IE format.....	396
8.4.5.3.19	UL noise and interference level IE format.....	397
8.4.5.3.20	Dedicated DL control IE.....	399
8.4.5.3.21	HARQ DL MAP IE.....	403
8.4.5.3.22	DL HARQ ACK IE.....	419
8.4.5.3.23	Enhanced DL MAP IE.....	420
8.4.5.3.24	Closed-loop MIMO DL enhanced IE format.....	421
8.4.5.3.25	Broadcast Control Pointer IE.....	423
8.4.5.3.26	AAS_SDMA_DL_IE format.....	424
8.4.5.3.27	PUSC ASCA Allocation.....	427
8.4.5.4	UL-MAP IE format.....	428
8.4.5.4.1	UIUC Aallocation.....	430
8.4.5.4.2	PAPR reduction/Safety zone/Sounding zone allocation IE.....	431
8.4.5.4.3	CDMA allocation UL-MAP IE format.....	432
8.4.5.4.4	UL-MAP extended IE format.....	432
8.4.5.4.5	Power Control IE format.....	434
8.4.5.4.6	AAS uplink IE format.....	435
8.4.5.4.7	UL Zone switch IE format.....	436

8.4.5.4.8	Mini-subchannel allocation IE	437
8.4.5.4.9	FAST-FEEDBACK message mapping	438
8.4.5.4.10	FAST_FEEDBACK Fast-feedback channels	439
8.4.5.4.11	MIMO UL Basic IE format	466
8.4.5.4.12	CQICH Allocation IE Format	468
8.4.5.4.13	UL ACK channel	471
8.4.5.4.14	UL-MAP Physical Modifier IE	473
8.4.5.4.15	UL allocation start IE	475
8.4.5.4.16	CQICH Enhanced Allocation IE format	475
8.4.5.4.17	UL PUSC Burst Allocation in Other Segment IE	477
8.4.5.4.18	HO anchor active UL MAP IE	478
8.4.5.4.19	HO active anchor UL MAP IE	479
8.4.5.4.20	MIMO UL Enhanced IE format	479
8.4.5.4.21	OFDMA Fast_Ranging_IE format IE	480
8.4.5.4.22	UL-MAP_Fast_Tracking_IE	482
8.4.5.4.23	Anchor BS Switch IE	483
8.4.5.4.24	HARQ UL MAP IE	485
8.4.5.4.25	HARQ ACK Region Allocation IE	496
8.4.5.4.26	UL_Sounding_Command_IE	497
8.4.5.4.27	AAS_SDMA_UL_IE format	498
8.4.5.4.28	Feedback polling IE	500
8.4.5.5	Burst profile format	502
8.4.5.6	Compressed maps	503
8.4.5.6.1	Compressed DL-MAP	504
8.4.5.6.2	Compressed UL-MAP	505
8.4.5.7	AAS-FBCK-REQ/RSP message bodies	505
8.4.5.8	Reduced AAS private maps	506
8.4.5.8.1	Reduced AAS private DL-MAP	506
8.4.5.8.2	Reduced AAS private UL-MAP	510
8.4.6	OFDMA subcarrier allocations	513
8.4.6.1	Downlink	513
8.4.6.1.1	Preamble	513
8.4.6.1.2	Symbol structure	527
8.4.6.2	Uplink	539
8.4.6.2.1	Symbol structure for subchannel (PUSC)	541
8.4.6.2.2	Partitioning of subcarriers into subchannels in the uplink	541
8.4.6.2.3	Uplink permutation example	542
8.4.6.2.4	Partition a subchannel to mini-subchannels	542
8.4.6.2.5	Additional optional symbol structure for PUSC	543
8.4.6.2.6	Data subchannel rotation scheme	546
8.4.6.2.7	Optional uplink channel sounding in TDD systems	547
8.4.6.3	Optional adjacent subcarrier permutations for AAS and AMC	557
8.4.6.3.1	AMC optional permutation	560
8.4.6.3.2	Band-AMC operation in normal DL/UL-MAP	562
8.4.6.3.3	AMC support for SDMA	563
8.4.6.4	Optional permutations for PUSC	564
8.4.6.4.1	Optional permutation for PUSC adjacent subcarrier allocation (PUSC-ASCA)	564
8.4.6.4.1.2	Allocation using distributed clusters	566
8.4.6.4.1.2.1	Allocation of subcarriers to subchannels	566
8.4.6.8	Optional reduced AAS private maps	566
8.4.7	OFDMA ranging	567
8.4.7.1	Initial-ranging/handover-ranging transmissions	567
8.4.7.3	Ranging codes	569

8.4.7.4	Ranging and BW request opportunity size .....	570
8.4.8	Transmit diversitySpace-Time Coding (optional) .....	570
8.4.8.1	Transmit diversitySTC using two antennas .....	570
8.4.8.1.1	Multiple input single output channel estimation and synchronization .....	571
8.4.8.1.2	Space time coding using two antennas .....	571
8.4.8.1.3	Frequency hopping diversity coding (FHDC) .....	573
8.4.8.1.4	STC/FHDC configurations .....	573
8.4.8.1.5	Uplink using STC .....	573
8.4.8.2	Transmit diversitySTC for four antennas .....	575
8.4.8.2.1	STC for four antennas using PUSC .....	575
8.4.8.2.2	STC for four antennas using FUSC .....	576
8.4.8.2.3	STC configurations .....	577
8.4.8.2.4	MIMO Macro diversity handover based macro-diversity transmission .....	577
8.4.8.3	STC for the optional zones in the downlink .....	578
8.4.8.3.1	Symbol structure for optional AMC and optional FUSC .....	580
8.4.8.3.2	Symbol structure for the optional PUSC-ASCA .....	586
8.4.8.3.3	Transmission schemes for 2-antenna BS in DL.....	587
8.4.8.3.4	Transmission schemes for 3-antenna BS in DL.....	587
8.4.8.3.5	Transmission schemes for 4-antenna BS .....	591
8.4.8.3.6	MIMO precoding .....	596
8.4.8.4	STC for the optional zones in the uplink .....	597
8.4.8.4.1	Allocation of pilot subcarriers .....	598
8.4.8.4.2	Allocation of data subchannels .....	598
8.4.8.4.3	Transmission schemes for 2-antenna MS in UL.....	599
8.4.8.5	MIMO midamble .....	599
8.4.8.5.1	Midamble Sequence for PUSC .....	601
8.4.8.5.2	Midamble Sequence for FUSC and optional FUSC .....	601
8.4.8.9	STC subpacket combining .....	614
8.4.9	Channel coding .....	615
8.4.9.1	Randomization .....	616
8.4.9.2	Encoding .....	617
8.4.9.2.1	Convolutional coding (CC).....	617
8.4.9.2.2	Block Turbo Ccoding (optional).....	618
8.4.9.2.3	Convolutional turbo codes (optional) .....	619
8.4.9.2.5	Low Density Parity Check code (optional).....	626
8.4.9.3	Interleaving .....	631
8.4.9.3.1	Optional interleaver for CC .....	631
8.4.9.4	Modulation.....	631
8.4.9.4.1	Permutation definition Subcarrier randomization.....	631
8.4.9.4.2	Data modulation.....	632
8.4.9.4.3	Pilot modulation.....	633
8.4.9.5	Repetition .....	634
8.4.9.6	Zone boosting .....	634
8.4.9.7	Multiple HARQ (optional).....	634
8.4.9.7.1	Generic Chase HARQ.....	635
8.4.9.7.2	CC Incremental Redundancy HARQ.....	635
8.4.10	Control mechanisms .....	636
8.4.10.3	Power Ccontrol .....	636
8.4.10.3.1	Closed loop power control.....	637
8.4.10.3.2	Optional open loop power control .....	638
8.4.11	Channel quality measurements .....	640
8.4.11.2	RSSI mean and standard deviation .....	640
8.4.11.3	CINR mean and standard deviation .....	640
8.4.11.4	Optional Frequency Selectivity Characterization .....	642

8.4.12	Transmitter requirements .....	642
8.4.12.2	Transmitter spectral flatness .....	642
8.4.12.3	Transmitter constellation error and test method .....	643
8.4.12.3.1	RMS constellation error measurement for BS (downlink) .....	643
8.4.12.3.2	RMS constellation error measurement for SS .....	644
8.4.12.3.3	Calculation of RMS constellation error .....	644
8.4.12.3.4	Unmodulated subcarrier errors for SS .....	645
8.4.12.4	Transmitter reference timing accuracy .....	645
8.4.13	Receiver requirements .....	646
8.4.13.1	OFDMA PHY requirements for enhanced handover performance .....	646
8.4.13.1.1	Receiver sensitivity .....	646
8.4.13.1.2	MS uplink transmit time tracking accuracy .....	647
8.4.13.1.3	MS autonomous neighbor cell scanning .....	647
8.4.13.2	Receiver adjacent and alternatenon-adjacent channel rejection .....	647
8.4.13.3	Receiver maximum input signal .....	648
8.4.13.3.1	SS receiver maximum input signal .....	648
8.4.13.3.2	BS receiver maximum input signal .....	648
8.4.14	Frequency control requirements .....	648
8.4.14.1	Center frequency and symbol clock frequency tolerance .....	648
8.4.15	Optional HARQ support .....	648
8.4.15.1	Optional Chase HARQ support .....	649
8.4.15.1.1	HARQ Retransmission process .....	649
8.4.15.1.2	CRC .....	649
8.4.15.1.3	Concurrent transmission of UL HARQ bursts .....	649
8.4.15.1.4	Encoding .....	650
8.4.15.2	Optional IR HARQ for CC (convolutional code) .....	650
9.	Configuration .....	651
9.1	SS IP addressing used on secondary management connection .....	651
9.1.2	Mobile IP v4 fields used by the MS .....	651
10.	Parameters and constants .....	653
10.1	Global values .....	653
10.2	PKM parameter values .....	658
10.3	PHY-specific values .....	658
10.3.3	WirelessMAN-OFDM parameters and constant definitions .....	658
10.3.3.1	Uplink Allocation Start Time .....	658
10.3.4	WirelessMAN-OFDMA parameters and constant definitions .....	658
10.3.4.1	Uplink Allocation Start Time .....	658
10.4	Well-known addresses and identifiers .....	659
11.	TLV Encodings .....	661
11.1	Common encodings .....	661
11.1.1	Current transmit power .....	661
11.1.2	Authentication Tuples .....	661
11.1.2.1	HMAC Tuple .....	661
11.1.2.2	CMAC Tuple .....	661
11.1.2.3	Short-HMAC Tuple .....	662
11.1.3	MAC version encoding .....	663
11.1.5	Vendor ID encoding .....	663
11.1.6	Vendor-specific information .....	664
11.1.7	MOB-NBR-ADV message encodings .....	664



11.3 UCD management message encodings.....	665
11.3.1 UCD channel encodings .....	665
11.3.1.1 Uplink burst profile encodings .....	671
11.4 DCD management message encodings.....	672
11.4.1 DCD channel encodings .....	672
11.4.2 Downlink burst profile encodings.....	676
11.5 RNG-REQ message encodings.....	678
11.6 RNG-RSP management message encodings .....	679
11.6.1 SA Challenge Tuple.....	683
11.7 REG-REQ/RSP management message encodings.....	684
11.7.2 SS management support.....	685
11.7.6 Number of uplink CIDs supported.....	685
11.7.6.1 Number of uplink transport CIDs supported .....	685
11.7.6.2 Number of downlink transport CIDs supported .....	686
11.7.7 Convergence sublayer capabilities.....	686
11.7.7.1 Classification/PHS options and SDU encapsulation support .....	686
11.7.7.3 PHS support .....	686
11.7.8 SS capabilities encodings.....	687
11.7.8.10 Maximum MAC data per frame support.....	687
11.7.8.10.1 Maximum amount of MAC level data per DL frame .....	687
11.7.8.10.2 Maximum amount of MAC level data per UL frame .....	688
11.7.8.11 Packing support.....	688
11.7.8.12 MAC Extended rtPS support .....	688
11.7.8.13 Maximum number of bursts transmitted concurrently to the MS.....	688
11.7.9 SS MAC Address.....	689
11.7.10 CID update encodings.....	689
11.7.10.1 Compressed CID update encodings.....	690
11.7.11 Method for allocating IP address for the secondary management connection .....	690
11.7.12 Handover supported.....	690
11.7.13 HO Support.....	691
11.7.13.1 System Resource_Retain_Time.....	691
11.7.13.2 HO Process Optimization MS Timer.....	691
11.7.13.3 MS Handover Retransmission Timer .....	691
11.7.14 Mobility parameters support.....	692
11.7.14.1 Mobility features supported.....	692
11.7.15 Sleep mode recovery time.....	692
11.7.16 MS-PREV-IP-ADDR.....	692
11.7.17 SKIP-ADDR-ACQUISITION .....	693
11.7.18 SAID update encodings .....	693
11.7.19 Total number of provisioned service flow .....	693
11.7.20 Idle Mode.....	694
11.7.20.1 Idle Mode Timeout .....	694
11.7.20.2 Paging Interval Length.....	694
11.7.21 SA TEK Update .....	694
11.7.22 GKEK Parameters.....	695
11.7.23 ARQ-ACK Type.....	696
11.7.24 HO parameters processing time.....	696
11.7.25 MAC header and extended subheader support .....	696
11.7.26 SN Reporting Base.....	697
11.8 SBC-REQ/RSP management message encodings .....	698
11.8.2 Capabilities for construction and transmission of MAC PDUs.....	698
11.8.3 Physical parameters supported.....	698
11.8.3.6 WirelessMAN-OFDM specific parameters .....	698
11.8.3.6.2 OFDM SS demodulator .....	698

11.8.3.6.3	OFDM SS modulator .....	698
11.8.3.6.6	OFDM private map support .....	699
11.8.3.7	WirelessMAN-OFDMA specific parameters .....	699
11.8.3.7.1	OFDMA MS FFT sizes .....	699
11.8.3.7.2	OFDMA SS demodulator .....	699
11.8.3.7.3	OFDMA SS modulator .....	700
11.8.3.7.4	OFDMA SS Ppermutation support .....	700
11.8.3.7.5	OFDMA SS demodulator for MIMO support .....	701
11.8.3.7.6	OFDMA SS MIMO uplink support .....	702
11.8.3.7.7	OFDMA AAS private map support .....	702
11.8.3.7.8	OFDMA AAS capabilities .....	703
11.8.3.7.9	OFDMA SS CINR measurement capability .....	704
11.8.3.7.10	OFDM SS uplink power control support .....	704
11.8.3.7.11	OFDMA SS uplink power control support .....	704
11.8.3.7.12	OFDMA MAP Capability .....	704
11.8.3.7.13	Uplink control channel support .....	705
11.8.3.7.14	OFDMA MS CSIT capability .....	705
11.8.3.7.15	Maximum number of burst per frame capability in HARQ .....	706
11.8.3.7.16	OFDMA SS Modulator for MIMO Support .....	707
11.8.3.7.17	SDMA Pilot capability .....	707
11.8.3.7.18	OFDMA Multiple Downlink Burst Profile Capability .....	707
11.8.3.7.19	HARQ buffer capability .....	708
11.8.4	Security Negotiation Parameters .....	709
11.8.4.1	PKM Version Support .....	709
11.8.4.2	Authorization policy support .....	710
11.8.4.3	MAC (Message Authentication Code) Mode .....	711
11.8.4.4	PN window size .....	712
11.8.5	Power save class types capability .....	712
11.8.6	Extension capability .....	713
11.8.7	HO Trigger metric support .....	713
11.8.8	Association type support .....	713
11.9	PKM-REQ/RSP management message encodings .....	714
11.9.3	TEK .....	715
11.9.4	Key lifetime .....	715
11.9.5	Key-Sequence-Number .....	716
11.9.6	HMAC Digest .....	716
11.9.6.1	Short-HMAC Digest .....	716
11.9.7	SAID .....	716
11.9.8	TEK parameters .....	716
11.9.13	Security capabilities .....	717
11.9.14	Cryptographic suite .....	718
11.9.16	Version .....	719
11.9.17	SA-Descriptor .....	719
11.9.19	PKM configuration settings .....	720
11.9.20	Nonce .....	720
11.9.21	SS_RANDOM .....	720
11.9.22	BS_RANDOM .....	720
11.9.23	Pre-PAK .....	721
11.9.24	BS-Certificate .....	721
11.9.25	SigBS .....	721
11.9.26	MS-MAC address .....	722
11.9.27	CMAC Digest .....	722
11.9.28	Key Push Modes .....	723
11.9.29	Key Push Counter .....	724

11.9.30	GKEK (Group Key Encryption Key) .....	724
11.9.31	SigSS .....	724
11.9.32	AKID .....	724
11.9.33	EAP payload .....	725
11.9.34	Auth result code .....	725
11.9.35	SA service type .....	725
11.9.36	PKMv2 configuration settings .....	725
11.9.37	Frame number .....	726
11.11	REP-REQ management message encodings .....	726
11.12	REP-RSP management message encodings .....	728
11.13	Service flow management encodings .....	733
11.13.4	QoS parameter set type .....	735
11.13.5	Traffic priority .....	736
11.13.6	Maximum sustained traffic rate .....	736
11.13.8	Minimum reserved traffic rate .....	737
11.13.11	Service flow Uplink grant scheduling type .....	737
11.13.12	Request/transmission policy .....	738
11.13.14	Maximum latency .....	738
11.13.17	Target SAID .....	739
11.13.18	ARQ TLVs for ARQ-enabled connections .....	739
11.13.18.8	ARQ_BLOCK_SIZE .....	739
11.13.18.9	RECEIVER_ARQ_ACK_PROCESSING_TIME .....	739
11.13.19	CS specific service flow encodings .....	740
11.13.19.1	CS specification .....	740
11.13.19.2	CS parameter encoding rules .....	740
11.13.19.3	Packet CS encodings for configuration and MAC messaging .....	741
11.13.19.3.3	Classifier error parameter set .....	741
11.13.19.3.4	Packet classification rule .....	741
11.13.19.3.6	PHS error parameter set .....	744
11.13.19.3.8	IPv6 Flow label .....	744
11.13.19.4	ATM CS Encodings for Cconfiguration and MAC Mmessaging .....	745
11.13.19.4.2	ATM Classifier TLV .....	745
11.13.19.4.4	ATM Classifier Error Parameter Set .....	745
11.13.20	Unsolicited grant interval .....	745
11.13.21	Unsolicited polling interval .....	745
11.13.22	FSN size .....	746
11.13.23	MBS service .....	746
11.13.24	Global Service Class Name .....	746
11.13.25	Type of Data Delivery Services .....	747
11.13.26	SDU Inter-arrival Interval .....	747
11.13.27	Time Base .....	747
11.13.28	Traffic Indication Preference .....	747
11.13.29	MBS zone identifier assignment .....	748
11.13.30	Paging preference .....	748
11.13.31	SN Feedback Enabled .....	748
11.13.32	HARQ Service Flows .....	749
11.13.33	CID allocation for Active BSs .....	749
11.13.34	Authorization Token .....	749
11.13.35	HARQ Channel mapping .....	750
11.13.36	PDU SN extended subheader for HARQ reordering .....	750
11.13.37	MBS contents IDs .....	751
11.14	DREG-CMD/REQ message encodings .....	752
11.15	Handover management encodings .....	753
11.15.1	Resource_Retain_Time .....	753

11.16	Sleep mode management encodings .....	754
11.16.1	SLPID_Update .....	754
11.16.2	Next Periodic Ranging .....	754
11.17	MOB_PAG-ADV management message encodings .....	755
11.17.1	CDMA code and transmission opportunity assignment .....	755
11.17.2	Page-Response Window .....	755
11.17.3	Enabled-Action-Triggered .....	755
11.18	MOB_NBR-ADV management message encodings .....	756
11.18.1	PHY Mode ID .....	756
11.19	MOB_SCN-REP message encodings .....	758
12.	System profiles .....	759
12.1	WirelessMAN-SC (10–66 GHz) system profiles .....	759
12.1.1	WirelessMAN-SC MAC system profiles .....	759
12.1.1.3	Conventions for MAC Mmanagement messages for profiles profM1 and profM2 .....	759
12.1.1.4	MAC Management message Pparameter Ttransmission Oorder .....	759
12.1.1.4.3	UCD .....	759
12.1.1.4.7	REG-REQ .....	759
12.1.1.4.20	DSA-RSP—BS Initiated Sservice Aaddition .....	759
12.1.1.4.23	DSC-RSP—BS Initiated Sservice Cchange .....	760
12.1.1.6	Message parameters specific to profM2 .....	760
12.1.1.6.1	Packet CS Pparameters for DSA-REQ—BS Initiated .....	760
12.1.1.6.2	Packet CS Pparameters for DSA-RSP—BS Initiated .....	761
12.1.1.6.3	Packet CS Parameters for DSC-REQ—BS Initiated .....	761
12.1.1.6.4	Packet CS Parameters for DSC-RSP—BS Initiated .....	762
12.2	WirelessMAN-SCa and WirelessHUMAN(-SCa) system profiles .....	762
12.2.3	WirelessMAN-SCa Physical Layer (PHY) Profiles .....	762
12.2.3.2	Specific PHY profiles .....	762
12.2.3.2.3	WirelessHUMAN-specific PHY profile features .....	762
12.2.4	WirelessMAN-SCa RF profiles .....	762
12.2.4.3	RF profiles for 10 MHz channelization .....	762
12.3	WirelessMAN-OFDM and WirelessHUMAN(-OFDM) system profiles .....	762
12.3.1	WirelessMAN-OFDM and WirelessHUMAN(-OFDM) MAC profiles .....	762
12.3.1.1	ProfM3_PMP: Basic Packet PMP MAC System Profile .....	762
12.3.1.1.2	MAC Management Message Parameter Transmission Order .....	762
12.3.1.2	ProfM3_Mesh: Basic Packet Mesh MAC system profile .....	763
12.3.2	WirelessMAN-OFDM and WirelessHUMAN(-OFDM) Physical Layer Profiles .....	763
12.3.2.4	ProfP3_3: WirelessMAN-OFDM PHY profile for 3 MHz channelization .....	763
12.3.2.5	ProfP3_5.5: WirelessMAN-OFDM PHY profile for 5.5 MHz channelization .....	764
12.3.2.6	profP3_10: WirelessHUMAN(-OFDM) PHY profile for 10 MHz channelization ...	764
12.3.3	WirelessMAN-OFDM RF profiles .....	764
12.4	WirelessMAN-OFDMA and WirelessHUMAN(-OFDMA) system profiles .....	765
12.4.2	WirelessMAN-OFDMA and WirelessHUMAN(-OFDMA) MAC Pprofiles .....	765
12.4.2.1	Basic Ppacket PMP MAC Pprofile .....	765
12.4.2.1.1	Conventions for MAC Mmanagement Mmessages .....	765
12.4.2.1.2	MAC Mmanagement Mmessage Pparameter Ttransmission Oorder .....	765
12.4.3	WirelessMAN-OFDMA and WirelessHUMAN(-OFDMA) System PHY Pprofiles .....	766
12.4.3.1	Common Ffeatures of PHY Pprofiles .....	766
12.4.3.1.4	WirelessHUMAN PHY Pprofiles Ffeatures .....	766
12.4.3.1.5	Minimum performance requirements .....	766
12.4.3.2	WirelessMAN-OFDMA 1.25 MHz channel basic PHY Pprofile .....	768
12.4.3.3	WirelessMAN-OFDMA 3.5 MHz channel basic PHY Pprofile .....	769

12.4.3.4	WirelessMAN-OFDMA 7 MHz channel basic PHY Pprofile.....	769
12.4.3.5	WirelessMAN-OFDMA 8.75 MHz channel basic PHY Pprofile.....	770
12.4.3.6	WirelessMAN-OFDMA 14 MHz channel basic PHY Pprofile.....	770
12.4.3.7	WirelessMAN-OFDMA 17.5 MHz channel basic PHY Pprofile.....	771
12.4.3.8	WirelessMAN-OFDMA 28 MHz channel basic PHY Pprofile.....	771
12.4.3.9	WirelessHUMAN(-OFDMA) 10 MHz channel basic PHY Pprofile .....	771
12.4.3.10	WirelessHUMAN(-OFDMA) 20 MHz channel basic PHY Pprofile .....	771
12.4.4	WirelessMAN-OFDMA RF profiles .....	771
Annex A (informative) Bibliography .....		773
Annex B (informative) Supporting material for frequencies below 11 GHz.....		775
Annex C (informative) Example MAC common part sublayer service definition .....		777
Annex D (informative) Messages sequence charts (MSCs) .....		779
Annex E (informative) Block diagrams .....		789
Annex F (informative) Test vectors .....		795
Annex G (informative) Network model for mobile communications .....		815
Annex H (informative) LDPC direct encoding.....		819

Authorized licensed use limited to: Fish & Richardson. Downloaded on April 11,2016 at 21:40:33 UTC from IEEE Xplore. Restrictions apply.

## List of Figures

Figure 11—PHS signaling example .....	14
Figure 17a—IP CS PDU format with Compressed-IP-Header and without header suppression .....	16
Figure 17b—IP CS PDU format with both Compressed-IP-Header and header suppression .....	16
Figure 19—Generic MAC header format .....	19
Figure 19a—MAC signaling header type I format .....	21
Figure 20a—Bandwidth request and UL Tx Power Report header format .....	22
Figure 20b—Bandwidth request and CINR report .....	23
Figure 20c—CQICH allocation request .....	25
Figure 20d—PHY channel report header .....	26
Figure 20e—Bandwidth request and uplink sleep control header .....	27
Figure 20f—SN report header format .....	28
Figure 20g—MAC signaling header type II format .....	30
Figure 20h—Feedback header with CID field .....	31
Figure 20i—Feedback header without CID field .....	31
Figure 20j—MIMO Channel Feedback header with CID field .....	34
Figure 20k—MIMO Channel Feedback header without CID field .....	34
Figure 20l—Extended subheader group format .....	39
Figure 23a—Downlink HARQ subframe structure .....	94
Figure 23b—Sub-MAP Burst .....	169
Figure 34—ARQ Reset message dialog—transmitter initiated .....	177
Figure 35—ARQ Reset message dialog—receiver initiated .....	178
Figure 36—ARQ block reception .....	179
Figure 58—Obtaining uplink parameters .....	188
Figure 66—Wait for SBC-RSP—SS .....	192
Figure 67—Negotiate Basic Capabilities—BS .....	193
Figure 70—Registration—BS .....	194
Figure 79—Transition to a more robust operational burst profile .....	196
Figure 80—Transition to a less robust operational burst profile .....	196
Figure 80a—State transition diagram for downlink burst profile management—SS .....	197
Figure 80b—State transition diagram for downlink burst profile management—SS .....	199
Figure 82—Periodic Ranging receiver processing—BS .....	199
Figure 84—Periodic Ranging—SS .....	200
Figure 87—CDMA Initial Ranging—SS .....	206
Figure 90—Periodic CDMA ranging—SS .....	208
Figure 95—Theory of Operation Object Model .....	210
Figure 130—Construction of HARQ encoder packet .....	219
Figure 130a—Example of sleep mode operations with two power saving classes .....	230
Figure 130b—HO and initial network entry .....	240
Figure 130c—Example of cell selection with ranging .....	241
Figure 130d—MS initiating handover with the BS .....	247
Figure 130e—locally initiated transaction MOB_BSHO-RSP pending state flow diagram .....	248
Figure 130f—Typical MS listening state flow diagram .....	249
Figure 130g—locally initiated transaction MOB_BSHO-RSP pending state flow diagram .....	250
Figure 130h—Fast anchor BS selection mechanism .....	256
Figure 130i—Paging-groups example .....	260
Figure 130j—Security sublayer .....	270
Figure 130k—AK from PAK only (from RSA-based authorization) .....	281
Figure 130l—AK from PAK and PMK (RSA-based and EAP-based authorization) .....	282
Figure 130m—AK from PMK (from EAP-based authorization) .....	282
Figure 130n—AK with PMK and PMK2 (EAP-based authorization and Authenticated EAP-based authorization) .....	283
Figure 130o—HMAC/CMAC/KEK derivation from AK .....	283

Figure 130p—MTK key derivation from MAK .....	284
Figure 130q—HMAC/CMAC authentication key derivation from EIK .....	284
Figure 131—TEK state machine flow diagram .....	290
Figure 134—TEK management in BS and SS .....	297
Figure 135—Encrypted payload format in AES-CCM mode .....	298
Figure 135a—Nonce N Construction .....	299
Figure 136—Initial CCM Block $B_0$ .....	299
Figure 137—Construction of counter blocks $Ctr_j$ .....	300
Figure 137a—MBS MAC PDU Ciphertext payload format .....	301
Figure 137b—Residual termination block processing with CTS .....	302
Figure 137c—CBC IV generation .....	303
Figure 137d—MBRA management .....	315
Figure 197—PRBS generator for data randomization .....	320
Figure 198—OFDM randomizer downlink initialization vector for burst #2...N .....	321
Figure 199—OFDM randomizer uplink initialization vector .....	321
Figure 204—PRBS generator for pilot modulation .....	322
Figure 207—Example of OFDM frame structure with TDD .....	324
Figure 208—Example of OFDM frame structure with FDD .....	325
Figure 208a—Format of DL subchannelization zone .....	327
Figure 209—Structure of AAS Zone .....	330
Figure 210a—Subchannelized Initial Ranging—SS (part 1a) .....	344
Figure 210b—Subchannelized Initial Ranging —SS (part 1b) .....	345
Figure 216—Example of mapping OFDMA slots to subchannels and symbols in the downlink (in PUSC mode) .....	355
Figure 217—Example of mapping OFDMA slots to subchannels and symbols in the uplink .....	356
Figure 218—Example of an OFDMA frame (with only mandatory zone) in TDD mode .....	357
Figure 219—Illustration of OFDMA frame with multiple zones .....	358
Figure 222a—Example of rectangular allocation rules .....	362
Figure 224—AAS Diversity Map Frame Structure .....	364
Figure 224a—Example of UL AAS allocation with integer number of slots in duration .....	368
Figure 229a—Burst allocations in DL AAS Zone .....	376
Figure 230—Reduced CID decoding .....	402
Figure 229a—HARQ downlink allocation .....	404
Figure 230—Mapping order of FAST-FEEDBACK messages to the FAST-FEEDBACK region .....	438
Figure 230a—Post processed CINR for MIMO region .....	441
Figure 231a—Subcarrier mapping of Fast-feedback modulation symbols for PUSC .....	447
Figure 231b—Subcarrier mapping of Fast-feedback modulation symbols for optional PUSC .....	447
Figure 231c—Mapping of MIMO coefficients for quantized precoding weights for enhanced fast MIMO feedback payload bits .....	449
Figure 231d—Mapping of the payload bit sequence to a Fast-feedback channel .....	454
Figure 231e—Subcarrier mapping of Primary Fast-feedback modulation symbol for PUSC .....	455
Figure 231f—Subcarrier mapping of secondary Fast-feedback modulation symbols for PUSC .....	457
Figure 231a—Subcarrier mapping of UL ACK modulation symbols for PUSC .....	473
Figure 231b—Subcarrier mapping of UL ACK modulation symbols for optional PUSC .....	473
Figure 233a—Common SYNC symbol structure (frequency domain) .....	526
Figure 233b—Common SYNC symbol structure (time domain) .....	526
Figure 234—Cluster structure .....	529
Figure 238a—Pilot patterns for AAS mode in AMC zone .....	564
Figure 239—I-Initial-ranging/handover-ranging transmission for OFDMA .....	568
Figure 240—Initial-ranging handover-ranging transmission for OFDMA, using two consecutive initial ranging codes .....	568
Figure 243—PRBS generator for ranging code generation .....	569
Figure 243a—Ranging/BW request opportunities .....	570
Figure 245—Cluster structure for STC PUSC using 2 Antennas .....	572



Figure 247—STC usage with FUSC .....	573
Figure 249—Mapping of data subcarriers in STTD mode .....	574
Figure 249a—Pilot Patterns in UL PUSC tile .....	575
Figure 251—Cluster structure for STC PUSC using 4 antennas.....	576
Figure 251a—STC usage with FUSC.....	577
Figure 251a—Example of STC for optional zones in DL (matrix A for 2, 3, or 4 Tx and matrix B for 3 or 4 Tx).....	578
Figure 251b—Example of matrix B with horizontal encoding for 3 or 4 Tx BS for optional zones in DL .....	579
Figure 251c—Example of matrix C with vertical encoding for 2, 3, or 4 Tx BS for optional zones in DL .....	579
Figure 251d—Example of matrix C with horizontal encoding for 2, 3 or 4 Tx BS for optional zones in DL .....	580
Figure 251e—Pilot allocation for 2-antenna BS for the optional FUSC and the optional AMC zones.....	581
Figure 251f—Pilot allocation for 3-antenna BS for the optional FUSC and the optional AMC zones .....	581
Figure 251g—Pilot allocation for 4-antenna BS for the optional FUSC and the optional AMC zones.....	582
Figure 251h—Data mapping in the optional AMC Zone with 2 Tx antenna and matrix A .....	583
Figure 251i—Data mapping in the optional AMC zone with 2 Tx antenna and matrix B.....	584
Figure 251j—Data mapping with CC in the optional AMC Zone with 4 Tx antenna and Matrix A .....	585
Figure 251k—Uplink pilot allocation for 2-antenna MS for the optional PUSC zones.....	598
Figure 251l—Uplink data mapping for 2-antenna SS with matrix A for the optional PUSC permutation .....	599
Figure 251m—Midamble FUSC structure (frequency domain).....	600
Figure 251n—Midamble PUSC structure (frequency domain).....	600
Figure 252—Channel coding process for regular and repetition coding transmission.....	615
Figure 253—PRBS generator for data randomization.....	616
Figure 254a—Creation of the OFDMA randomizer initialization vector for HARQ .....	616
Figure 260—PRBS generator of the randomization.....	623
Figure 262—PRBS generator for pilot modulation .....	631
Figure D.1—Example Neighbor BS advertisement and scanning (without association) by MS request ...	780
Figure D.2—Example Neighbor BS advertisement and scanning (with non-coordinated association) by MS request .....	781
Figure D.3—Example Neighbor BS advertisement and scanning (without association) by BS request ....	782
Figure D.4—Example Neighbor BS advertisement and scanning (with association) by BS request .....	783
Figure D.5—Example Macro Diversity HO (Diversity Set Update: Add).....	784
Figure D.6—Example Macro Diversity HO (Diversity Set Update: Drop) .....	785
Figure D.7—Example sleep mode — MS initiated.....	786
Figure D.8—Example sleep mode — BS initiated.....	787
Figure D.9—Sleep mode—MS initiating awakening.....	788
Figure E.1—MS initiated HO process block diagram as seen by MS.....	790
Figure E.2—MS initiated HO process block diagram as seen by serving BS where final target BS is selected by serving BS .....	791
Figure E.3—BS Initiated HO process block diagram as seen by MS .....	792
Figure E.4—BS Initiated HO process block diagram as seen by serving BS .....	793
Figure G.1—Network model example.....	816
Figure G.2—Logical network reference model, control plane.....	816
Figure H.1—Block diagram of the encoder architecture for the block LDPC code.....	822

Authorized licensed use limited to: Fish & Richardson. Downloaded on April 11,2016 at 21:40:33 UTC from IEEE Xplore. Restrictions apply.

## List of Tables

Table 1—Air interface nomenclature .....	3
Table 4a—MAC Header HT and EC fields encoding .....	19
Table 5—Generic MAC header fields .....	20
Table 5a— Type field encodings for MAC signaling header Type I .....	20
Table 6—Type encodings .....	20
Table 7a—Description of fields BR and UL Tx Power Report header .....	23
Table 7b—Description of the fields of BR and CINR report header .....	24
Table 7c—Description of the fields of CQICH allocation request header .....	25
Table 7d—PHY channel report header fields .....	26
Table 7e—Bandwidth control and uplink sleep control header .....	28
Table 7f—SN report header fields .....	29
Table 7g—Type field encodings for MAC signaling header type II .....	30
Table 7h—Description of the fields of Feedback header .....	32
Table 7i—Feedback type and feedback content .....	32
Table 7j—Description of MIMO Channel Feedback header fields .....	34
Table 9—Grant Management subheader format .....	37
Table 10—Grant management subheader fields .....	37
Table 13a—Extended subheader group format .....	40
Table 13b—Description of extended subheaders types (DL) .....	40
Table 13c—Description of extended subheaders types (UL) .....	40
Table 13d—SDU SN extended subheader format .....	41
Table 13e—DL Sleep control extended subheader format .....	41
Table 13f—Feedback request extended subheader format .....	42
Table 13g—MIMO mode Feedback extended subheader format .....	42
Table 13h—UL Tx Power Report extended subheader format .....	43
Table 13i—Description of Mini-Feedback extended subheaders (UL) .....	43
Table 13j—Description of SN request extended subheader .....	43
Table 13k—PDU (short) SN extended subheader .....	44
Table 13l—PDU SN (long) extended subheader .....	44
Table 14—MAC Management messages .....	44
Table 15—DCD message format .....	47
Table 16—DL-MAP message format .....	48
Table 18—UL-MAP message format .....	49
Table 19—RNG-REQ message format .....	50
Table 26—PKM message codes .....	60
Table 37a— PKMv2 RSA-Request attributes .....	61
Table 37b— PKMv2 RSA-Reply attributes .....	62
Table 37c—PKMv2 RSA-Reject attributes .....	62
Table 37d—PKMv2 RSA-Acknowledgement attributes .....	63
Table 37e—EAP-Start attributes .....	63
Table 37f—PKMv2 EAP Transfer attributes .....	64
Table 37g—PKMv2 Authenticated EAP message attributes .....	64
Table 37h—PKMv2 SA-TEK-Challenge message attributes .....	65
Table 37i—PKMv2 SA-TEK-Request message attributes .....	66
Table 37j—PKMv2 SA-TEK-Response message attributes .....	66
Table 37k—PKMv2 Key Request attributes .....	67
Table 37l—PKMv2 Key-Reply attributes .....	68
Table 37m—PKMv2 Key-Reject attributes .....	69
Table 37n—PKMv2 SA-Addition attributes .....	69
Table 37o—PKMv2 TEK-Invalid attributes .....	70
Table 37p—PKMv2 Group Key update command attributes .....	70
Table 37q—PKMv2 EAP Complete attributes .....	72

Table 37r—PKMv2 Authenticated EAP Start attribute .....	72
Table 55—Action codes and actions .....	76
Table 61—ARQ Reset message format.....	78
Table 87—DREG-REQ message format .....	80
Table 91—Format configuration IE .....	82
Table 94—H-ARQHARQ_Control_IE format.....	85
Table 95—H-ARQCQICH_Control IE format.....	86
Table 95a—Threshold Values .....	87
Table 96—H-ARQHARQ Compact_DL-MAP IE format for normal subchannel .....	87
Table 97—H-ARQ HARQ Compact_DL-MAP IE format for band AMC.....	89
Table 98—HARQ Compact_DL-MAP IE format for safety.....	91
Table 99—H-ARQ HARQ Compact_DL-MAP IE format for DIUC subchannel.....	92
Table 101a—DL-MAP Subtypes.....	94
Table 101b—MIMO Compact_DL-MAP IE .....	95
Table 101c—SDMA Compact_DL-MAP IE format.....	99
Table 101d—HARQ Compact_DL-MAP IE format for switch HARQ mode .....	100
Table 101e—HARQ Compact MBS_MAP_IE format for extension .....	101
Table 102—H-ARQ HARQ Compact_UL-MAP IE format for normal subchannel .....	102
Table 103—H-ARQ HARQ Compact_UL-MAP IE format for band AMC.....	103
Table 104—H-ARQ HARQ Compact_UL-MAP IE format for safety .....	105
Table 105—H-ARQ Compact_UL-MAP IE format for UIUC subchannel .....	106
Table 108a—UL-MAP subtypes .....	108
Table 109—H-ARQ HARQ Compact_UL-MAP IE format for allocation start offset.....	109
Table 109a—MIMO Compact UL-MAP IE format .....	110
Table 109b—SDMA Compact UL-MAP IE format.....	111
Table 109c—Sleep-Request (MOB_SLP-REQ) message format .....	112
Table 109d—Sleep-Response (MOB_SLP-RSP) message format .....	114
Table 109e—Traffic-Indication (MOB_TRF-IND) message format .....	118
Table 109f—MOB_NBR-ADV message format .....	120
Table 109g—Bit-by-bit definition of PHY Profile ID of the BS .....	125
Table 109h—MOB_SCN-REQ message format.....	126
Table 109i—MOB_SCN-RSP message format.....	128
Table 109j—MOB_SCN-REP message format .....	132
Table 109k—MOB_ASC-REP message format.....	135
Table 109l—MOB_BSHO-REQ message format.....	137
Table 109m—MOB_MSHO-REQ message format .....	145
Table 109n—MOB_BSHO-RSP message format.....	149
Table 109o—MOB_HO-IND message format.....	157
Table 109p—BS Broadcast Paging (MOB_PAG-ADV) message format .....	160
Table 109q—MBS_MAP .....	161
Table 109r—MBS_MAP_Type.....	162
Table 109s—MBS_DATA_IE .....	163
Table 109t—Extended MBS_DATA_IE.....	164
Table 109u—MBS_DATA_Time_Diversity_IE.....	165
Table 109v—PMC_REQ message format.....	167
Table 109w—PMC_RSP message format.....	168
Table 109x—SUB-DL-UL-MAP message format.....	170
Table 109y—Setup/Tear-down of long-term MIMO precoding (PRC-LT-CTRL) message format .....	172
Table 111a—Example of QoS parameters providing a scheduling service to support real-time constant bit-rate data streams .....	180
Table 111b—Example of QoS parameters providing a scheduling service to support real-time variable-rate data streams .....	181
Table 111c—Example of QoS parameters providing a scheduling service to support delay-tolerant variable-rate data streams .....	181

Table 111d—Example of QoS parameters providing a scheduling service to support best-effort data streams .....	182
Table 121—CDMA initial Ranging and automatic adjustments procedure .....	201
Table 124a—Global service flow class name information field parameters .....	211
Table 124b—Traffic rate and burst values .....	212
Table 124c—Maximum latency values .....	213
Table 132a—Type of data delivery services .....	225
Table 132b—Unsolicited grant service parameters .....	226
Table 132c—Real-Time Variable Rate service parameters .....	226
Table 132d—Non Real-Time variable rate service parameters .....	227
Table 132e—Best Effort service parameters .....	227
Table 132f—Extended Real-Time Variable Rate service parameters .....	228
Table 133a—AK Context in PKMv2 .....	287
Table 133b—GKEK Context .....	288
Table 133c—PMK context .....	288
Table 133d—PAK context .....	289
Table 134—TEK FSM state transition matrix .....	291
Table 207a—SCa fast ranging extended IE format .....	319
Table 225—OFDM downlink frame prefix format .....	326
Table 225a—DL Subchannel index table .....	328
Table 225b—SBCH_DLFP .....	328
Table 225c—SBCH_DL_MAP_IE .....	329
Table 244—OFDM DL-MAP dummy IE format .....	332
Table 244a—DL SUBCH_IE format .....	333
Table 253—OFDM UL-MAP dummy IE format .....	334
Table 253a—OFDM Fast_Ranging_IE format .....	335
Table 253b—UL fast tracking information element .....	336
Table 258a—Compressed Private DL-MAP message format .....	337
Table 258b—Compressed Private UL-MAP message format .....	339
Table 258c—Reduced private DL-MAP message format .....	340
Table 258d—Reduced private UL-MAP message format .....	342
Table 260—OFDM SBCH_AAS_NW_ENTRY_REQ format .....	346
Table 262a—Normalized CINR per modulation (BER = 1e-6) .....	348
Table 263—Allowed relative constellation error versus data rate .....	350
Table 266—Receiver SNR assumptions .....	352
Table 268—OFDMA downlink Frame Prefix format for all FFT sizes except 128 .....	359
Table 268a—Subchannel index of the six subchannel groups .....	360
Table 268b—OFDMA downlink frame prefix format for 128 FFT .....	360
Table 269—AAS-DLFP Sstructure, Diversity-Map Sscan .....	365
Table 270—Structure of AAS_COMP_DL_IE () .....	366
Table 275—OFDMA DL-MAP_IE format .....	370
Table 276—OFDMA DIUC values .....	372
Table 277a—Extended DIUC Code Assignment for DIUC=15 .....	373
Table 277b—OFDMA DL-MAP extended-2 IE format .....	373
Table 277c—Extended-2 DIUC code assignment for DIUC=14 .....	374
Table 278—OFDMA downlink AAS downlink IE .....	375
Table 279—OFDMA downlink STC_DL_ZoneTD_ZONE IE format .....	377
Table 281—OFDMA Data location in another BS IE .....	379
Table 283—MIMO DL basic IE format .....	380
Table 283a—DL MIMO operation modes .....	382
Table 284—MIMO DL enhanced IE format .....	384
Table 285—H-ARQ HARQ MAP and Sub-MAP pointer IE format .....	386
Table 286—OFDMA DL-MAP Physical Modifier IE format .....	388
Table 286a—Multicast and Broadcast Service MAP IE .....	389

Table 286b—DL PUSC Burst Allocation in Other Segment IE .....	391
Table 286c—HO anchor active DL MAP IE.....	392
Table 286d—HO active anchor DL MAP IE .....	393
Table 286e—HO CID Translation MAP IE .....	394
Table 286f—MIMO in another BS IE.....	395
Table 286g—Macro MIMO DL Basic IE().....	396
Table 286h—UL interference and noise level extended IE.....	397
Table 286i—Dedicated DL control IE format.....	399
Table 286j—RCID_IE format .....	401
Table 286k—Skip IE .....	403
Table 286l—HARQ DL MAP IE format .....	404
Table 286m—DL HARQ Chase sub-burst IE format .....	406
Table 286n—DL HARQ IR CTC sub-burst IE format.....	408
Table 286o—DL HARQ IR CC sub-burst IE format .....	409
Table 286p—MIMO DL Chase HARQ sub-burst IE format .....	411
Table 286q—MIMO DL IR HARQ Sub-Burst IE format.....	412
Table 286r—MIMO DL IR HARQ for CC Sub-Burst IE format .....	414
Table 286s—MIMO DL STC HARQ Sub-Burst IE format.....	415
Table 286t—Dedicated MIMO DL Control IE format.....	416
Table 286u—HARQ_ACK IE.....	419
Table 286v—Enhanced DL MAP IE.....	420
Table 286w—Closed-loop MIMO DL enhanced IE .....	421
Table 286x—Broadcast Control Pointer IE format .....	423
Table 286y—AAS_SDMA_DL_IE.....	424
Table 286z—PUSC ASCA Allocation .....	427
Table 287—OFDMA UL-MAP IE format .....	428
Table 288—OFDMA UIUC values .....	430
Table 289—PAPR reduction, and safety zone, and sounding zone allocation IE format .....	431
Table 290—CDMA Allocation IE format .....	432
Table 290a—Extended UIUC Code Assignment for UIUC=15 .....	433
Table 290b—UL-MAP extended-2 IE format.....	433
Table 290c—Extended-2 UIUC Code Assignment for UIUC=11 .....	434
Table 292—OFDMA Power Control IE.....	434
Table 293—OFDMA uplink AAS uplink IE.....	435
Table 294—OFDMA uplink ZONE IE format.....	436
Table 295—Mini-subchannel allocation IE format .....	437
Table 295a—FAST-FEEDBACK allocation IE format .....	438
Table 298—Encoding of payload bits for Fast-feedback slot .....	442
Table 298a—Encoding of payload bits for secondary Fast-feedback slot .....	443
Table 298b—Effective CINR feedback encoding .....	443
Table 298c— 3-bit MIMO Fast-feedback channel subcarrier modulation.....	444
Table 298d—Enhanced Fast-feedback channel subcarrier modulation.....	445
Table 298e—Orthogonal Modulation Index in FAST_FEEDBACK Fast-feedback Cchannel .....	446
Table 298f—Encoding of payload bits for MIMO Mode Feedback with Enhanced Fast-feedback Channel.....	450
Table 298g—Interpretation of code words 0b101110-0b110110 in Table 298f in the case of using antenna grouping .....	451
Table 298h—Interpretation of code words 0b101110-0b110110 in Table 298f in the case of using antenna selection .....	451
Table 298j—Encoding of payload bits for Fast-feedback slot .....	452
Table 298i—Interpretation of code words 0b101110-0b110110 in Table 298f in the case of using reduced precoding matrix codebook .....	452
Table 298k—Secondary Fast-feedback channel subcarrier modulation with 4 bit .....	456
Table 298l—Orthogonal Modulation Index in Secondary Fast-feedback Channel.....	456

Table 298m—V(2,1,3).....	457
Table 298n—V(3,1,3).....	458
Table 298o—V(4,1,3).....	458
Table 298p—Generating parameters for V(3,1,6) and V(4,1,6).....	459
Table 298q—Operations to generate codebooks.....	460
Table 298r—3-bit 2x2 codebook V(2,2,3).....	460
Table 298s—3-bit 4x3 codebook V(4,3,3).....	461
Table 298t—3-bit 4x4 codebook V(4,4,3).....	462
Table 298u—6 bit, 3x1 Codebook V(3,1,6).....	463
Table 299—MIMO UL basic IE format.....	466
Table 299a—MIMO_UL_Basic_IE operation modes.....	468
Table 300—CQICH alloc IE format.....	468
Table 301—ACK channel subcarrier modulation.....	471
Table 301a—Orthogonal Modulation Index in UL ACK Channel.....	472
Table 302—OFDMA UL-MAP Physical Modifier IE format.....	474
Table 302a—UL allocation start IE format test.....	475
Table 302b—CQICH Enhanced allocation IE format.....	475
Table 302c—UL PUSC Burst Allocation in Other Segment IE.....	477
Table 302d—HO anchor active UL MAP IE.....	478
Table 302e—HO active anchor UL MAP IE.....	479
Table 302f—MIMO UL Enhanced IE.....	480
Table 302g—OFDMA Fast_Ranging_IE format IE.....	481
Table 302h—UL-MAP_Fast_Tracking_IE.....	482
Table 302i—Anchor_BS_switch_IE format.....	483
Table 302j—HARQ UL MAP IE.....	485
Table 302k—UL HARQ Chase sub-burst IE format.....	487
Table 302l—UL HARQ IR CTC sub-burst IE format.....	488
Table 302m—UL HARQ IR CC sub-burst IE format.....	489
Table 302n—MIMO UL Chase HARQ sub-burst IE format.....	490
Table 302o—MIMO UL IR HARQ sub-burst IE format.....	491
Table 302p—MIMO UL IR HARQ for CC sub-burst IE format.....	493
Table 302q—MIMO UL STC HARQ sub-burst IE format.....	494
Table 302r—Dedicated UL control IE format.....	495
Table 302s—Dedicated MIMO UL control IE format.....	496
Table 302t—HARQ ACKCH region allocation IE.....	497
Table 302u—AAS_SDMA_UL_IE.....	498
Table 302v—Feedback polling IE format.....	500
Table 304a—OFDMA Downlink_Burst_Profile TLV format for multiple FEC types.....	502
Table 304b—OFDMA Uplink_Burst_Profile TLV format for multiple FEC types.....	503
Table 305—Compressed DL-MAP message format.....	504
Table 308a—Reduced AAS private DL-MAP message format.....	507
Table 308b—Reduced AAS private UL-MAP message format.....	511
Table 309—Preamble modulation series per segment and IDcell for the 2k FFT mode.....	514
Table 309a—Preamble modulation series per segment and IDcell for the 1K FFT mode.....	515
Table 309b—Preamble modulation series per segment and IDcell for the 512 FFT mode.....	520
Table 309c—Preamble modulation series per segment and IDcell for the 128 FFT mode.....	524
Table 309d—Common SYNC sequence.....	527
Table 310—OFDMA downlink subcarrier allocations—PUSC.....	527
Table 310a—1024-FFT OFDMA downlink carrier allocations—PUSC.....	528
Table 310b—512-FFT OFDMA downlink carrier allocations—PUSC.....	528
Table 310c—128-FFT OFDMA downlink carrier allocations—PUSC.....	529
Table 311—OFDMA downlink subcarrier allocations.....	531
Table 311a—1024-FFT OFDMA downlink carrier allocations—FUSC.....	531
Table 311b—512-FFT OFDMA downlink carrier allocations—FUSC.....	533

Table 311c—128-FFT OFDMA downlink carrier allocations—FUSC .....	534
Table 312—OFDMA optional FUSC downlink subcarrier allocation .....	535
Table 312a—1024-FFT OFDMA downlink carrier allocations—Optional FUSC .....	536
Table 312b—512-FFT OFDMA downlink carrier allocations—Optional FUSC .....	536
Table 312c—128-FFT OFDMA downlink carrier allocations—Optional FUSC .....	537
Table 313a—Basic permutation sequences for diversity subcarrier allocations .....	538
Table 314a—1024-FFT OFDMA uplink subcarrier allocations for PUSC .....	540
Table 314b—512-FFT OFDMA uplink subcarrier allocations for PUSC .....	540
Table 314c—128-FFT OFDMA uplink subcarrier allocations for PUSC .....	541
Table 315—OFDMA uplink subcarrier allocations .....	543
Table 315a—Optional 1024-FFT OFDMA uplink subcarrier allocations .....	544
Table 315b—Optional 512-FFT OFDMA uplink subcarrier allocations .....	544
Table 315c—Optional 128-FFT OFDMA uplink subcarrier allocations .....	545
Table 315d—UL_Sounding_Command_IE() .....	548
Table 315e—Golay sequence of length 2048 bits .....	552
Table 315f—Length dependent offsets in the Golay sequence of Table 316b .....	553
Table 315g—Offsets for the decimated pilots method .....	554
Table 316—OFDMA AAS subcarrier allocations .....	559
Table 316a—1024-FFT OFDMA AMC subcarrier allocations .....	560
Table 316b—512-FFT OFDMA AMC subcarrier allocations .....	561
Table 316c—128-FFT OFDMA AMC subcarrier allocations .....	561
Table 316d—Allocation of subcarriers to subchannels .....	565
Table 316e—Cluster permutation base .....	565
Table 316f—Enhanced 3 Tx Matrix C with Antenna Grouping .....	591
Table 316g—Mapping of Pre-coding matrix and CQICH for 4 Tx Matrix C with Antenna Selection .....	595
Table 316h—Feedback for long-term precoding in MAC feedback header message .....	597
Table 316i—Feedback for life span of short-term precoding in MAC feedback header message 0b01001 .....	597
Table 316j—Nr [The length of sequence R(r)] .....	601
Table 316k—Permutation ( $l = 0, 1, 2, \dots, 127$ ) .....	602
Table 316l—PAPR reduction sequence for BS with 2 antennas (2048 point FFT) .....	603
Table 316m—PAPR reduction sequence for BS with 2 antennas (1024 point FFT) .....	605
Table 316n—PAPR reduction sequence for BS with 2 antennas (512 point FFT) .....	607
Table 316o—Permutation ( $l = 0, 1, 2, \dots, 47$ ) .....	608
Table 316p—PAPR Reduction Sequence for BS with 2 Antennas (128 point FFT) .....	609
Table 316q—Permutation ( $l = 0, 1, 2, \dots, 95$ ) .....	611
Table 316r—PAPR reduction sequence for BS with 3 or 4 antennas (512 point FFT) .....	611
Table 316s—Permutation ( $l = 0, 1, 2, \dots, 23$ ) .....	612
Table 316t—PAPR reduction sequence for BS with 3 or 4 antennas (128 point FFT) .....	613
Table 316u—STC subpacket combining (2-transmit antenna case) .....	614
Table 316v—STC subpacket combining (3-transmit antenna case) .....	614
Table 316w—STC subpacket combining (4-transmit antenna case) .....	615
Table 317—SubchannelSlots concatenation rule .....	617
Table 320a—Puncture pattern definition for HARQ .....	618
Table 322—Useful data payload for a subchannel .....	618
Table 323—Optional channel coding per modulation .....	618
Table 324—SubchannelSlots concatenation rule for CTC .....	620
Table 326—Optimal CTC channel coding per modulation .....	620
Table 327—Optimal CTC channel coding per modulation when supporting HARQ .....	620
Table 329—Parameters for the subblock interleavers .....	622
Table 331—Transmission format and modulation level for DL .....	624
Table 333—Transmission format and modulation level for UL .....	625
Table 333a—LDPC block sizes and code rates .....	629
Table 333b—Parameter ‘j’ for LDPC .....	630



Table 333c—HARQ Modes definition.....	634
Table 333d—Companded subchannels .....	635
Table 334—Normalized C/N per modulation .....	636
Table 336—Allowed relative constellation error versus data rate.....	643
Table 338—Receiver SNR and Eb/N0 assumptions .....	647
Table 342—Parameters and constants.....	653
Table 343—Operational ranges for privacy configuration settings.....	658
Table 345—CIDs.....	659
Table 348a—CMAC Tuple definition.....	662
Table 348b—CMAC Tuple definition.....	662
Table 348c—Short-HMAC Tuple definition.....	662
Table 348d—Short-HMAC Tuple definition .....	663
Table 348e—MOB-NBR-ADV encodings.....	664
Table 348f—Neighbor BS Trigger TLV description .....	665
Table 348g—Neighbor BS Trigger; Type/Function/Action.....	665
Table 349—UCD channel encodings .....	666
Table 353—UCD PHY-specific channel encodings—WirelessMAN-OFDMA .....	667
Table 357—UCD burst profile encodings WirelessMAN-OFDMA .....	671
Table 358—DCD channel encoding.....	672
Table 358—DCD channel encoding.....	673
Table 358a—Trigger TLV description .....	675
Table 358b—Trigger; Type/function/action description .....	676
Table 363—DCD burst profile encodings—WirelessMAN-OFDMA.....	677
Table 364—RNG-REQ message encodings.....	678
Table 364a—Power saving class parameters.....	679
Table 367—RNG-RSP message encodings.....	680
Table 367—RNG-RSP message encodings.....	680
Table 369a—REG-REQ/RSP management message encodings.....	684
Table 370—PKM attribute types.....	714
Table 371a—TEK encryption algorithm identifiers.....	715
Table 372—TEK-parameters subattributes .....	717
Table 374—Security-capabilities subattributes.....	717
Table 375—Data encryption algorithm identifiers.....	718
Table 376—Data authentication algorithm identifiers .....	718
Table 377—TEK encryption algorithm identifiers.....	718
Table 378—Allowed cryptographic suites .....	719
Table 383—SA-Descriptor subattributes.....	719
Table 383—Service flow encodings.....	734
Table 384a—Phy Mode ID fields description for OFDM PHY .....	756
Table 384b—Phy Mode ID fields description for OFDMA PHY.....	757
Table 402a—Optional feature requirements profM3_mesh.....	763
Table 404—Minimum Performance basic requirements.....	763
Table 408—Minimum Performance requirements for profP3_3 .....	763
Table 409—Minimum Performance requirements for profP3_5.5 .....	764
Table 410—Minimum Performance requirements for profP3_10 .....	764
Table 411—Profile definitions .....	765
Table 413—Minimum performance requirements for all profiles .....	766
Table 414—Minimum performance requirements for OFDMA_ProfP1 .....	768
Table 415—Minimum performance requirements for OFDMA_ProfP2 .....	769
Table 416—Minimum performance requirements for OFDMA_ProfP3 .....	769
Table 418—Minimum performance requirements for OFDMA_ProfP5 .....	770
Table G.1—Mobility related entities .....	815
Table G.2—Reference points at the control plane.....	817

Authorized licensed use limited to: Fish & Richardson. Downloaded on April 11,2016 at 21:40:33 UTC from IEEE Xplore. Restrictions apply.

**IEEE Standard for  
Local and metropolitan area networks**

**Part 16: Air Interface for Fixed and Mobile  
Broadband Wireless Access Systems**

**Amendment 2: Physical and Medium Access  
Control Layers for Combined Fixed and Mobile  
Operation in Licensed Bands**

*and*

**Corrigendum 1**

NOTE—The editing instructions contained in this amendment/corrigendum define how to merge the material contained herein into the existing base standard IEEE Std 802.16™-2004.

The editing instructions are shown *bold italic*. Four editing instructions are used: *change*, *delete*, *insert*, and *replace*. *Change* is used to make small corrections in existing text or tables. The editing instruction specifies the location of the change and describes what is being changed by using strike through (to remove old material) and underscore (to add new material). *Delete* removes existing material. *Insert* adds new material without disturbing the existing material. Insertions may require renumbering. If so, renumbering instructions are given in the editing instruction. *Replace* is used to make large changes in existing text, subclauses, tables, or figures by removing existing material and replacing it with new material. Editorial notes will not be carried over into future editions because the changes will be incorporated into the base standard.

**1. Overview**

**1.1 Scope**

This document provides enhancements to IEEE Std 802.16-2004 to support subscriber stations moving at vehicular speeds and thereby specifies a system for combined fixed and mobile broadband wireless access. Functions to support higher layer handover between base stations or sectors are specified. Operation is limited to licensed bands suitable for mobility below 6 GHz. Fixed IEEE 802.16 subscriber capabilities are not compromised. In addition to mobility enhancements, this document contains substantive corrections to IEEE 802.16-2004 regarding fixed operation

## 1.2 Purpose

This standard will increase the market for broadband wireless access solutions by taking advantage of the inherent mobility of wireless media. It will fill the gap between very high data rate wireless local area networks and very high mobility cellular systems. It will support fixed and mobile services for both enterprise and consumer markets.

## 1.3 Frequency bands

### 1.3.3 License-exempt frequencies below 11 GHz (primarily 5–6 GHz)

*Change the subclause as indicated:*

The physical environment for the license-exempt bands below 11 GHz is similar to that of the licensed bands in the same frequency range, as described in 1.3.2. However, the license-exempt nature introduces additional interference and co-existence issues, whereas regulatory constraints limit the allowed radiated power. In addition to the features described in 1.3.2, the PHY and MAC introduce mechanisms ~~such as dynamic frequency selection (DFS)~~ to facilitate the detection and avoidance of interference and the prevention of harmful interference into other users including specific spectrum users identified by regulation. This includes a mechanism for regulatory compliance called dynamic frequency selection (DFS).

It is recognized that some administrations require notification of terminal location for certain services in some license-exempt bands, which is a form of licensing. Conversely, it is possible to have uncoordinated usage within a licensed allocation. In these and other similar cases the pertinent issues for license-exempt usage remain as described in the preceding paragraph.

In the context of this standard, the use of the term “license-exempt frequencies” or “license-exempt bands” should be taken to mean the situation where licensing authorities do not coordinate individual assignments to operators, regardless of whether the spectrum in question has a particular regulatory status as license-exempt or licensed.

### 1.3.4 Air interface nomenclature and PHY compliance

*Delete the fourth column of Table 1 and make additional changes as indicated:*

**Table 1—Air interface nomenclature**

Designation	Applicability	PHY specification	Options	Duplexing alternative
WirelessMAN-SC <sup>TM</sup>	10–66 GHz	8.1	—	TDD FDD
WirelessMAN-SCa <sup>TM</sup>	Below 11 GHz licensed bands	8.2	AAS (6.3.7.6) ARQ (6.3.4) STC (8.2.1.4.3) <u>mobile</u>	TDD FDD
WirelessMAN-OFDM <sup>TM</sup>	Below 11 GHz licensed bands	8.3	AAS (6.3.7.6) ARQ (6.3.4) Mesh (6.3.6.6) STC (8.3.8) <u>mobile</u>	TDD FDD
WirelessMAN-OFDMA	Below 11 GHz licensed bands	8.4	AAS (6.3.7.6, <u>8.4.4.6</u> ) ARQ (6.3.4) <u>HARQ (6.3.17)</u> STC (8.4.8) <u>mobile</u>	TDD FDD
WirelessHUMAN <sup>TM</sup>	Below 11 GHz license-exempt bands	[8.2, 8.3 or 8.4] and 8.5	AAS (6.3.7.6) ARQ (6.3.4) Mesh (6.3.6.6) (with 8.3 only) STC (8.2.1.4.3/8.3.8/8.4.8)	TDD

*Change the last paragraph as indicated:*

Implementations of this standard for license-exempt frequencies below 11 GHz (such as those listed in B.1) shall comply with the WirelessMAN-SCa PHY as described in 8.2, the WirelessMAN-OFDM PHY as described in 8.3, or the WirelessMAN-OFDMA PHY as described in 8.4. They shall further comply with the DFS protocols (6.3.15) (where mandated by regulation) and with 8.5.

## 1.4 Reference model

*Insert the following new subclause into 1.4:*

### 1.4.1 Handover process

The handover (HO) process in which an MS migrates from the air-interface provided by one BS to the air-interface provided by another BS is defined in 6.3.22.2.

Authorized licensed use limited to: Fish & Richardson. Downloaded on April 11,2016 at 21:40:33 UTC from IEEE Xplore. Restrictions apply.

## 2. References

*Insert the following references:*

FIPS 197, Advanced Encryption Standard (AES).<sup>1</sup>

IEEE Std 802.16™-2004, IEEE Standard for Local and metropolitan area networks: Part 16: Air Interface for Fixed Broadband Wireless Access Systems.<sup>2,3</sup>

IETF RFC 2373, “IP Version 6 Addressing Architecture,” R. Hinden, S. Deering, July 1998. (<http://www.ietf.org/rfc/rfc2373.txt>)

IETF RFC 2462, “IPv6 Stateless Address Autoconfiguration,” S. Thomson, T. Narten, December 1998. (<http://www.ietf.org/rfc/rfc2462.txt>)

IETF RFC 2789, “Mail Monitoring MIB,” N. Freed, S. Kille, March 2000. (<http://www.ietf.org/rfc/rfc2789.txt>)

IETF RFC 3012, “Mobile IPv4 Challenge/Response Extensions,” C. Perkins, P. Calhoun, November 2000. (<http://www.ietf.org/rfc/rfc3012.txt>)

IETF RFC 3095, “RObust Header Compression (ROHC): Framework and four profiles: RTP, UDP, ESP, and uncompressed,” C. Bormann, et al, July 2001. (<http://www.ietf.org/rfc/rfc3095.txt>)

IETF RFC 3280, “Internet X.509 Public Key Infrastructure Certificate and Certificate Revocation List (CRL) Profile,” R. Housley, W. Polk, W. Ford, D. Solo, April 2002. (<http://www.ietf.org/rfc/rfc3280.txt>)

IETF RFC 3315, “Dynamic Host Configuration Protocol for IPv6 (DHCPv6),” R. Droms, et al, July 2003. (<http://www.ietf.org/rfc/rfc3315.txt>)

IETF RFC 3394, “Advanced Encryption Standard (AES) Key Wrap Algorithm,” J. Schaad, R. Housley, September 2002. (<http://www.ietf.org/rfc/rfc3394.txt>)

IETF RFC 3545, “Enhanced Compressed RTP (CRTP) for Links with High Delay, Packet Loss and Reordering,” T. Koren, S. Casner, J. Geevarghese, B. Thompson, P. Ruddy, July 2003. (<http://www.ietf.org/rfc/rfc3545.txt>)

IETF RFC 3748, “Extensible Authentication Protocol (EAP),” B. Aboba, L. Blunk, J. Vollbrecht, J. Carlson, H. Levkowetz, June 2004. (<http://www.ietf.org/rfc/rfc3748.txt>)

IETF RFC 3775, “Mobility Support in IPv6,” D. Johnson, C. Perkins, J. Arkko, June 2004 (<http://www.ietf.org/rfc/rfc3775.txt>)

ITU-T Recommendation X.25—Interface between Data Terminal Equipment (DTE) and Data Circuit-terminating Equipment (DCE) for terminals operating in the packet mode and connected to public data networks by dedicated circuit, October 1996.<sup>4</sup>

NIST Special Publication 800-38B—Recommendation for Block Cipher Modes of Operation: The CMAC Mode for Authentication.

---

<sup>1</sup>FIPS publications are available from the National Technical Information Service (NTIS), U. S. Dept. of Commerce, 5285 Port Royal Rd., Springfield, VA 22161 (<http://www.ntis.org/>).

<sup>2</sup>IEEE publications are available from the Institute of Electrical and Electronics Engineers, Inc., 445 Hoes Lane, Piscataway, NJ 08854, USA (<http://standards.ieee.org/>).

<sup>3</sup>The IEEE standards or products referred to in this clause are trademarks of the Institute of Electrical and Electronics Engineers, Inc.

<sup>4</sup>ITU-T publications are available from the International Telecommunications Union, Place des Nations, CH-1211, Geneva 20, Switzerland/Suisse (<http://www.itu.int/>).

Authorized licensed use limited to: Fish & Richardson. Downloaded on April 11,2016 at 21:40:33 UTC from IEEE Xplore. Restrictions apply.



### 3. Definitions

*Change the following definitions as indicated:*

**3.4 bandwidth stealing:** The use, by a subscriber station (SS), of a portion of the bandwidth allocated in response to a Bandwidth Request for a connection to send ~~another a Bandwidth Request rather than sending data~~ or data for any of its connections. *See also* 6.3.6.

**3.12 connection:** A unidirectional mapping between base station (BS) and subscriber station (SS) medium access control (MAC) peers ~~for the purpose of transporting a service flow's traffic~~. Connections are identified by a connection identifier (CID). ~~All traffic is carried on a connection, even for service flows that implement connectionless protocols, such as Internet Protocol (IP)~~The MAC defines two kinds of connections: management connections and transport connections. *See also:* **connection identifier**.

**3.13 connection identifier (CID):** A 16-bit value that identifies a transport connection or a uplink (UL)/downlink (DL) pair of associated management connections (i.e., belonging to the same subscriber station (SS)) to equivalent peers in the MAC of the base station (BS) and subscriber station (SS). The connection identifier (CID) address space is common (i.e., shared) between UL and DL and Table 345 specifies how it is partitioned among the different types of connections. ~~It maps to a service flow identifier (SFID), which defines the Quality of Service (QoS) parameters of the service flow associated with that connection.~~ Security associations (SAs) also exist between keying material and CIDs. *See also:* **connection service flow identifier**.

**3.21 dynamic frequency selection (DFS):** The ability of a system to switch to different physical RF channels ~~between transmit and receive activity~~ based on channel measurement criteria to conform to particular regulatory requirements.

**3.27 initial ranging connection identifier:** A management connection used by the subscriber station (SS) and the base station (BS) during the initial ranging process. The initial ranging connection is identified by a well-known connection identifier (CID) (see Table 345) ~~that is used by a subscriber station (SS) during the initial ranging process.~~ This CID is defined as constant value within the protocol since an SS has no addressing information available until the initial ranging process is complete.

**3.36 payload header suppression index (PHSI):** An 8-bit ~~mask that indicates which bytes in the Payload Header Suppression Field (PHSF) to suppress and which bytes to not suppress.~~ value that references the payload header suppression (PHS) Rule.

**3.45 BS receive/transmit transition gap (RTG):** A gap between the last sample of the uplink burst and the first sample of the subsequent downlink burst at the antenna port of the base station (BS) in a time division duplex (TDD) transceiver. This gap allows time for the base station (BS) to switch from receive to transmit mode ~~and SSs to switch from transmit to receive mode.~~ During this gap, the BS ~~and SS are~~ is not transmitting modulated data but simply allowing the BS transmitter carrier to ramp up; ~~and the transmit/receive (Tx/Rx) antenna switch to actuate, and the SS receiver sections to activate.~~ Not applicable for frequency division duplex (FDD) systems.

**3.60 transport connection:** A connection used to transport user data. It does not include any traffic over either the basic, primary or secondary management connections. A fragmentable transport connection is a connection that allows fragmentation of service data units (SDUs).

**3.61 transport connection identifier:** A unique identifier taken from the connection identifier (CID) address space that uniquely identifies the transport connection. All user data traffic is carried on transport connections, even for service flows that implement connectionless protocols, such as Internet Protocol (IP). An active or admitted service flow (identified by an service flow id (SFID)) maps to a transport connection identifier (transport CID) assigned by the BS.

**3.63 BS transmit/receive transition gap (TTG):** A gap between the last sample of the downlink burst and the first sample of the subsequent uplink burst at the antenna port of the base station (BS) in a time division duplex (TDD) transceiver. This gap allows time for the base station (BS) to switch from transmit to receive mode ~~and SSs to switch from receive to transmit mode~~. During this gap, the BS ~~and SS are~~ is not transmitting modulated data but simply allowing the BS transmitter carrier to ramp down, the transmit/receive (Tx/Rx) antenna switch to actuate, and the BS receiver section to activate. Not applicable for frequency division duplex (FDD) systems.

*Insert new subclauses under 3.5 as follows:*

**3.5 base station (BS):**

**3.5.1 neighbor BS:** For any mobile station (MS), a neighbor BS is a base station (BS) (other than the serving BS) whose downlink transmission can be received by the mobile station (MS).

**3.5.2 serving BS:** For any mobile station (MS), the serving BS is the base station (BS) with which the mobile station (MS) has most recently completed registration at initial network-entry or during a handover (HO).

**3.5.3 target BS:** The base station (BS) that a mobile station (MS) intends to be registered with at the end of a handover (HO).

**3.5.4 active BS:** An active BS is informed of the mobile station (MS) capabilities, security parameters, service flows and full MAC context information. For macro diversity handover (MDHO), the mobile station (MS) transmits/receives data to/from all active BSs in the diversity set.

*Insert new definitions as follows:*

**3.71 adjacent subcarrier allocation:** A permutation where the subcarriers are located adjacent to each other.

**3.72 anchor BS:** For macro diversity handover (MDHO) or fast BS switching (FBSS) supporting mobile station (MS)s, this is a base station (BS) where the mobile station (MS) is registered, synchronized, performs ranging and monitors the downlink (DL) for control information. For fast BS switching (FBSS) supporting mobile station (MS), this is the serving BS that is designated to transmit/receive data to/from the mobile station (MS) at a given frame.

**3.73 backbone network:** Communication mechanism by which two or more base station (BS)s communicate to each other, and may also include communication with other networks. The method of communication for backbone networks is outside the scope of this standard.

**3.74 broadcast connection:** The management connection used by the base station (BS) to send medium access control (MAC) management messages on a downlink to all subscriber station (SS). The broadcast connection is identified by a well-known connection identifier (CID) (see Table 345). A fragmentable broadcast connection is a connection that allows fragmentation of broadcast MAC management messages.

**3.75 diversity set:** The diversity set contains a list of active BSs to the mobile station (MS). The diversity set is managed by the mobile station (MS) and base station (BS). The diversity set is applicable to macro diversity handover (MDHO) and fast BS switching (FBSS).

**3.76 frequency assignment (FA) index:** A network specific logical frequency assignment (FA) index assignment. FA index assignment is used in combination with operator specific configuration information provided to the mobile station (MS) in a method outside the scope of this standard.

**3.77 fast BS switching (FBSS):** Base station (BS) switching that utilizes a fast switching mechanism to improve link quality. The mobile station (MS) is only transmitting/receiving data to/from one of the active BS (anchor BS) at any given frame. The anchor BS can change from frame to frame depending on the base station (BS) selection scheme.

**3.78 frequency assignment (FA):** A frequency assignment (FA) denotes a logical assignment of downlink (DL) center frequency and channel bandwidth programmed to the base station (BS).

**3.79 handover (HO):** The process in which an mobile station (MS) migrates from the air-interface provided by one base station (BS) to the air-interface provided by another base station (BS). Two HO variants are defined:

- 1) **break-before-make HO:** A HO where service with the target BS starts after a disconnection of service with the previous serving BS.
- 2) **make-before-break HO:** A HO where service with the target BS starts before disconnection of the service with the previous serving BS.

**3.80 group key encryption key (GKEK):** The GKEK is a random number generated by the base station (BS) or a network entity (for example, an ASA server) used to encrypt the GTEKs sent in multicast messages by the base station (BS) to mobile station (MS)s in the same multicast group.

**3.81 macro diversity handover (MDHO):** The process in which an mobile station (MS) migrates from the air-interface provided by one or more base station (BS)s to the air-interface provided by one or more other BSs. This process is accomplished in the downlink (DL) by having two or more BSs transmitting the same MAC/PHY protocol data unit (PDU) to the MS such that diversity combining can be performed by the MS. In the uplink (UL) it is accomplished by having two or more BSs receiving (demodulating, decoding) the same PDU from the MS, such that diversity combining of the received PDU can be performed among the BSs.

**3.82 management connection:** A connection used for the purpose of transporting medium access control (MAC) management messages (*see*: basic connection, primary management connection, broadcast connection, initial ranging connection) or standards-based messages (*see*: secondary management connection) required by the MAC layer.

NOTE—Table 14 specifies which MAC management message is transmitted on which of the management connections.<sup>5</sup>

**3.83 mobile station (MS):** A station in the mobile service intended to be used while in motion or during halts at unspecified points. An MS is always a subscriber station (SS) unless specifically excepted otherwise in the standard.

**3.84 multiple input multiple output (MIMO):** A system employing at least two transmit antennas and at least two receive antennas to improve the system capacity, coverage or throughput.

**3.85 orderly power down procedure:** The procedure that the mobile station (MS) performs when powering down as directed by (e.g., user input or prompted by a automatic power down mechanism).

**3.86 payload header suppression mask (PHSM):** A bit mask indicating which bytes in the payload header suppression field (PHSF) to suppress, and which bytes to not suppress.

**3.87 quality of service (QoS) parameter set:** Is associated with a service flow identifier (SFID). The contained traffic parameters define scheduling behavior of uplink or downlink flows associated with transport connections.

NOTE—See 6.3.14.1.

<sup>5</sup>Notes in text, tables, and figures are given for information only, and do not contain requirements needed to implement the standard.

**3.88 scanning interval:** A time period intended for the mobile station (MS) to monitor neighbor base stations (BSs) to determine the suitability of the BS as targets for handover (HO).

## 4. Abbreviations and acronyms

*Insert the following abbreviations:*

AES	advanced encryption standard
AMC	adaptive modulation and coding
ASA	authentication and service authorization
BWAA	bandwidth allocation/ access
CBC-MAC	cipher block chaining message authentication code
CCH	control subchannel
CCM	CTR mode with CBC-MAC
CQI	channel quality information
CQICH	channel quality information channel
CSIT	channel state information at the transmitter
CTC	convolutional turbo codes
CTR	counter mode encryption
dBi	decibels of gain relative to the zero dB gain of a free-space isotropic radiator
dBm	decibels relative to one milliwatt
DLFP	downlink frame prefix
EAP	extensible authentication protocol
FBSS	fast base station switching
FHDC	frequency hopping diversity coding
FUSC	full usage of subchannels
GKEK	group key encryption key
GMH	generic MAC header
GTEK	group traffic encryption key
HO	handover
MBS	multicast and broadcast services
MCS	modulation coding scheme
MDHO	macro diversity handover
MIMO	multiple input multiple output
MS	mobile station
PAK	primary authorization key
PAPR	peak to average power ratio
PMK	pairwise master key
PUSC	partial usage of subchannels
PUSC-ASCA	PUSC adjacent subcarrier allocation
SDMA	spatial division multiple access
SN	sequence number
SSID	subscriber station identification (MAC address)
STTD	space time transmit diversity
TUSC	tile usage of subchannels
UEP	unequal error protection

Authorized licensed use limited to: Fish & Richardson. Downloaded on April 11,2016 at 21:40:33 UTC from IEEE Xplore. Restrictions apply.

## 5. Service-specific CS

### 5.1 ATM CS

#### 5.1.2 Data/Control plane

##### 5.1.2.2 Classification

###### 5.1.2.2.1 VP-switched mode

*Change the first sentence of the first paragraph as indicated:*

For VP-switched mode, the VPI field, 12 bits for a network-to-network interface (NNI) ~~and/or~~ 8 bits for a user-to-network interface (UNI), is mapped to the 16-bit CID for the MAC connection on which it is transported.

###### 5.1.2.2.2 VC-switched mode

*Change the first sentence of the first paragraph as indicated:*

For VC-switched mode, the VPI and VCI fields, 28 bits total for an NNI ~~and/or~~ 24 bits total for a UNI, are mapped to the 16-bit CID for the MAC connection on which it is transported.

### 5.2 Packet CS

*Change the first paragraph of the subclause as indicated:*

The packet CS resides on top of the IEEE Std 802.16 MAC CPS. The CS performs the following functions, utilizing the services of the MAC:

- a) Classification of the higher-layer protocol PDU into the appropriate transport connection

*Change the last paragraph of the subclause as indicated:*

The packet CS is used for transport for all packet-based protocols ~~such as Internet Protocol (IP), Point-to-Point Protocol (PPP), and IEEE Std 802.3 (Ethernet)~~ as defined in 11.13.19.3.

#### 5.2.2 Classification

*Change the first paragraph of the subclause as indicated:*

Classification is the process by which a MAC SDU is mapped onto a particular transport connection for transmission between MAC peers. The mapping process associates a MAC SDU with a transport connection, which also creates an association with the service flow characteristics of that connection. This process facilitates the delivery of MAC SDUs with the appropriate QoS constraints.

#### 5.2.3 PHS

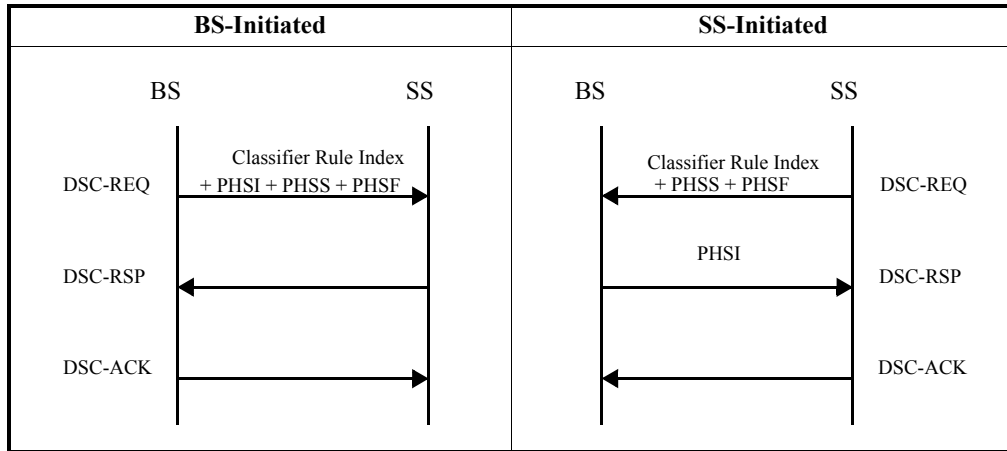
##### 5.2.3.1 PHS operation

*Change the second paragraph as indicated:*

A packet is submitted to the packet CS. The SS applies its list of Classifier rules. A match of the rule shall result in an Uplink Service Flow, CID, and may result in a PHS Rule.

**5.2.3.2 PHS signaling**

*Replace Figure 11 with the following figure:*



**Figure 11—PHS signaling example**

**5.2.4 IEEE Std 802.3/Ethernet-specific part**

**5.2.4.1 IEEE Std 802.3/Ethernet CS PDU format**

*Change the first paragraph as indicated:*

The IEEE Std 802.3/Ethernet PDUs are mapped to MAC SDUs according to Figure 12 (when header suppression is enabled at the connection, but not applied to the CS PDU) or Figure 13 (with header suppression). In the case where PHS is not enabled, PHSI field shall be omitted.

The IEEE Std 802.3/Ethernet PDU shall not include the Ethernet FCS when transmitted over this CS.

**5.2.4.2 IEEE Std 802.3/Ethernet CS classifiers**

*Change the second paragraph as indicated:*

Logical link control (LLC) IEEE Std 802.3/Ethernet header classification parameters—zero or more of the LLC IEEE Std 802.3/Ethernet header classification parameters (destination MAC address, source MAC address, Ethertype/SAP).

*Insert the following text at the end of subclause 5.2.4.2:*

Compressed-IP-Header IP over IEEE 802.3/Ethernet encapsulation exists to deal with the case where a IP compression function (i.e., ROHC or ECRTP) is performed on an IP packet carried in an IEEE 802.3/Ethernet frame before its ingress to the convergence sublayer (note that the compression function shall not operate on the IEEE 802.3/Ethernet frame header so that the Ethernet frame header remains intact).



For IP-header compressed IP over IEEE 802.3/Ethernet, IP header compression and VLAN headers may be included in the classification. In this case, only the IEEE 802.3/IEEE 802.1Q (11.13.19.3.4.8 through 11.13.19.3.4.12) and Compressed IP header (11.13.19.3.4.16, 11.13.19.3.4.18) classification parameters are allowed.

*Change the titles of subclauses 5.2.5 and 5.2.5.1 as indicated:*

## **5.2.5 IEEE Std 802.1Q-~~1998~~2003 virtual local area network (VLAN) specific part**

### **5.2.5.1 IEEE Std 802.1Q-~~1998~~2003 VLAN CS PDU format**

*Change the first paragraph as indicated:*

The format of the IEEE Std 802.1Q-~~1998~~2003 VLAN CS PDU shall be as shown in Figure 14 (when header suppression is enabled at the connection, but not applied to the CS PDU) or Figure 15 (with header suppression). In the case where PHS is not enabled, PHSI field shall be omitted.

### **5.2.5.2 IEEE Std 802.1Q-~~1998~~2003 CS classifiers**

*Change the subclause as indicated:*

The following parameters are relevant for IEEE Std 802.1Q-~~1998~~2003 CS classifiers:

~~IEEE Std 802.3/Ethernet header~~ classification parameters—zero or more of the ~~IEEE Std 802.3/Ethernet header~~ classification parameters (destination MAC address, source MAC address, Ethertype/SAP).

The IEEE Std 802.1Q-2003 VLAN PDU shall not include the FCS when transmitted over this CS.

IEEE Std 802.1D-~~1998~~2003 Parameters—zero or more of the IEEE classification parameters (IEEE Std 802.1D-~~1998~~2003 Priority Range, IEEE Std 802.1Q-~~1998~~2003 VLAN ID).

For IP over IEEE Std 802.1Q-~~1998~~2003 VLAN, IP headers may be included in classification. In this case, the IP classification parameters (11.13.19.3.4.2 through 11.13.19.3.4.7) are allowed.

## **5.2.6 IP specific part**

### **5.2.6.1 IP CS PDU format**

*Change the first paragraph as indicated:*

The format of the IP CS PDU shall be as shown in Figure 16 (when header suppression is enabled at the connection, but not applied to the CS PDU) or Figure 17 (with header suppression). In the case where PHS is not enabled, PHSI field shall be omitted.

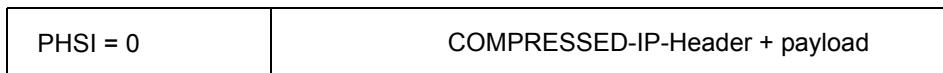
*Insert a new subclause 5.2.7:*

### **5.2.7 IP-Header-compression-specific part**

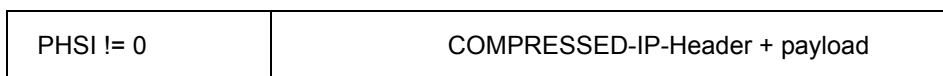
The Convergence sublayer supports SDUs in two formats that facilitate robust compression of IP and higher layer headers. These formats are ROHC (RFC 3095) and EC RTP (RFC 3545) and are referred to as the IP-header-compression CS PDU format.

### 5.2.7.1 Compressed-IP-Header CS PDU

The formats of the Compressed-IP-Header CS PDU are mapped to MAC SDUs according to Figure 17a (when header suppression is enabled at the connection, but not applied to the CS PDU) or Figure 17b (with header suppression).



**Figure 17a—IP CS PDU format with Compressed-IP-Header and without header suppression**



**Figure 17b—IP CS PDU format with both Compressed-IP-Header and header suppression**

### 5.2.7.2 Compressed-IP-Header classifiers

Compressed-IP-Header classifiers operate on the context fields of the ROHC- and ECRTTP-compressed packets. The IP header compression parameters (11.13.19.3.4.16, 11.13.19.3.4.18) may be used in Compressed-IP-Header classifiers.

## 6. MAC common part sublayer

### 6.1 PMP

*Change the subclause starting from the sixth paragraph as indicated:*

The MAC is connection-oriented. For the purposes of mapping to services on SSs and associating varying levels of QoS, all data communications are in the context of a transport connection. Service flows may be provisioned when an SS is installed in the system. Shortly after SS registration, transport connections are associated with these service flows (one connection per service flow) to provide a reference against which to request bandwidth. Additionally, new transport connections may be established when a customer's service needs change. A transport connection defines both the mapping between peer convergence processes that utilize the MAC and a service flow. The service flow defines the QoS parameters for the PDUs that are exchanged on the connection.

The concept of a service flow on a transport connection is central to the operation of the MAC protocol. Service flows provide a mechanism for uplink and downlink QoS management. In particular, they are integral to the bandwidth allocation process. An SS requests uplink bandwidth on a per connection basis (implicitly identifying the service flow). Bandwidth is granted by the BS to an SS as an aggregate of grants in response to per connection requests from the SS.

Transport connections, once established, may require active maintenance. The maintenance requirements vary depending upon the type of service connected. For example, unchannelized T1 services require virtually no connection maintenance since they have a constant bandwidth allocated ~~every frame~~ periodically. Channelized T1 services require some maintenance due to the dynamic (but relatively slowly changing) bandwidth requirements if compressed, coupled with the requirement that full bandwidth be available on demand. IP services may require a substantial amount of ongoing maintenance due to their bursty nature and due to the high possibility of fragmentation. As with connection establishment, modifiable connections may require maintenance due to stimulus from either the SS or the network side of the connection.

Finally, transport connections may be terminated. This generally occurs only when a customer's service requirements contract changes. The termination of a transport connection is stimulated by the BS or SS.

All three of these transport connection management functions are supported through the use of static configuration and dynamic addition, modification, and deletion of service flow~~connections~~.

### 6.3 Data/Control plane

#### 6.3.1 Addressing and connections

##### 6.3.1.1 PMP

*Change the subclause as indicated:*

Each air interface in SS shall have a 48-bit universal MAC address, as defined in IEEE Std 802<sup>®</sup>-2001. This address uniquely defines the air interface of the SS ~~from within the set of all possible vendors and equipment types~~. It is used during the initial ranging process to establish the appropriate connections for an SS. It is also used as part of the authentication process by which the BS and SS each verify the identity of the other.

Connections are identified by a 16-bit CID. At SS initialization, two pairs of management connections (uplink and downlink) shall be established between the SS and the BS and a third pair of management connections may be optionally generated. The three pairs of management connections reflect the fact that

there are inherently three different levels of QoS for management traffic between an SS and the BS. The basic connection is used by the BS MAC and SS MAC to exchange short, time-urgent MAC management messages. The primary management connection is used by the BS MAC and SS MAC to exchange longer, more delay-tolerant MAC management messages. Table 14 specifies which MAC Management messages are transferred on which of these two connections. In addition, it also specifies which MAC management messages are transported on the Broadcast Connection. Finally, the Secondary Management Connection is used by the BS and SS to transfer delay tolerant, standards-based [Dynamic Host Configuration Protocol (DHCP), Trivial File Transfer Protocol (TFTP), SNMP, etc.] messages. ~~These messages are carried in IP datagrams, as specified in 5.2.6.~~ Messages carried on the Secondary Management Connection may be packed and/or fragmented. For the SCA, OFDM, and OFDMA PHY layers, management messages shall have CRC. Use of the secondary management connection is required only for managed SS.

The CIDs for these connections shall be assigned in the RNG-RSP and REG-RSP messages. The message dialogs provide three CID values. The same CID value is assigned to both members (uplink and downlink) of each connection pair.

For bearer services, the BS initiates the set-up of service flow connections based upon the provisioning information distributed to the BS. The registration of an SS, or the modification of the services contracted at an SS, stimulates the higher layers of the BS to initiate the setup of the service flow connections. When admitted or active, service flows are uniquely associated with transport connections. MAC management messages shall never be transferred over transport connections. Bearer or data services shall never be transferred on the Basic, Primary, or Secondary Management connections.

~~The CID can be considered a connection identifier even for nominally connectionless traffic like IP, since it and serves as a pointer to destination and context information. The use of a 16-bit CID permits a total of 64K connections within each downlink and uplink channel.~~

### 6.3.2 MAC PDU formats

*Insert the following sentence to the last paragraph:*

All reserved fields shall be set to zero on transmission and ignored on reception.

#### 6.3.2.1 MAC header formats

*Change the existing text in the first paragraph of 6.3.2.1 as shown below:*

There is one defined DL MAC header that is the generic MAC header, which begins each MAC PDU containing either MAC management messages or CS data. Two MAC header formats are defined. The first is the generic MAC header that begins each MAC PDU containing either MAC management messages or CS data. The second is the bandwidth request header used to request additional bandwidth. The single-bit Header Type (HT) field distinguishes the generic MAC header and bandwidth request header formats. The HT field shall be set to zero for the Generic Header and to one for a bandwidth request header. There are two defined UL MAC header formats. The first is the generic MAC header that begins each MAC PDU containing either MAC management messages or CS data, where HT is set to 0 as shown in Table 4a. The second is the MAC header format without payload where HT is set to 1 as shown in Table 4a. For the latter format, the MAC header is not followed by any MAC PDU payload and CRC.

*Insert new table into 6.3.2.1 as follows:*

**Table 4a—MAC Header HT and EC fields encoding**

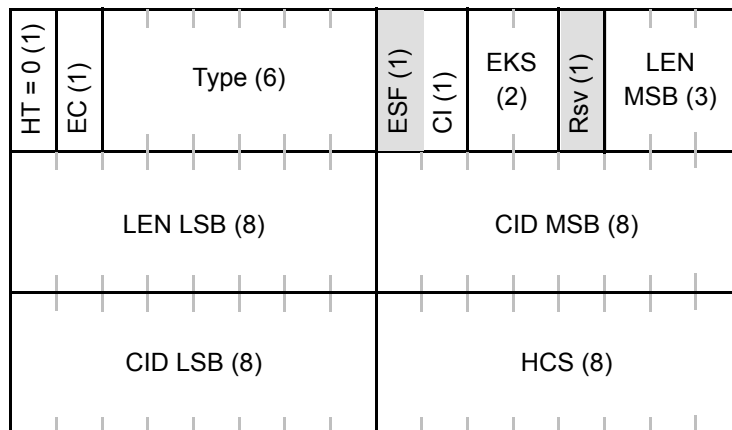
HT	EC <sup>a</sup>	MAC PDU type	Reference figure	Reference table
0	0	Generic MAC header for DL and UL. MAC PDU with data payload, no encryption, with a 6-bit type field, see Table 6 for its type field encodings.	19	5
0	1	Generic MAC header for DL and UL. MAC PDU with data payload, with encryption with a 6-bit type field, see Table 6 for its type field encodings.	19	5
1	0	DL: This encoding is not defined UL: MAC signaling header type I. MAC PDU without data payload, with a 3-bit type field, see Table 5a for type encoding definitions.	19a, 20, 20a-f	5a, 7, 7a-f
1	1	DL: Compressed/Reduced Private DL-MAP <sup>b</sup> UL: MAC signaling header type II. MAC PDU without data payload, with 1-bit type field, see Table 7g for type encoding definitions.	20g-i	7g, 7h

<sup>a</sup>Headers with HT=1 shall not be encrypted. Thus the EC field is used to distinguish between Feedback MAC header (UL) / Compress MAP (DL), and all other type headers.

<sup>b</sup>Compressed DL-MAP and Reduced Private MAP do not use MAC headers as defined in 6.3.2.1; however, the first two bits of these maps overlay with HT/EC fields and are always set to 0b11 to identify them as such (see 8.3.6.3, 8.3.6.7, 8.4.5.6, and 8.4.5.8).

**6.3.2.1.1 Generic MAC header**

*Replace Figure 19 in 6.3.2.1.1 with the following figure:*



**Figure 19—Generic MAC header format**

*Insert the following row into Table 5:*

**Table 5—Generic MAC header fields**

Name	Length (bits)	Description
ESF	1	<u>Extended subheader field. If ESF = 0, the extended subheader is absent. If ESF = 1, the extended subheader is present and will follow the GMH immediately. (See 6.3.2.2.7). The ESF is applicable both in the DL and in the UL.</u>

*Insert the following to the end of 6.3.2.1.1:*

The ESF bit in the Generic MAC header indicates that the extended subheader is present. Using this field, a number of additional subheaders can be used within a PDU. The extended subheader shall always appear immediately after the Generic MAC header and before all other subheaders. All extended subheaders are not encrypted. (See 6.3.2.2.7.)

**Table 5a— Type field encodings for MAC signaling header Type I**

Type field (3 bits)	MAC header type (with HT/EC=0b10)	Reference figure	Reference table
000	BR incremental	20	7
001	BR aggregate	20	7
010	PHY channel report	20d	7d
011	BR with UL Tx Power Report	20a	7a
100	Bandwidth request and CINR report	20b	7b
101	BR with UL sleep control	20e	7e
110	SN Report	20f	7f
111	CQICH allocation request	20c	7c

*Change the text in Table 6 as indicated:*

**Table 6—Type encodings**

Type bit	Value
#5 most significant bit (MSB)	Mesh subheader 1 = present, 0 = absent
#4	ARQ Feedback Payload 1 = present, 0 = absent
#3	Extended Type Indicates whether the present Packing or Fragmentation Subheaders, is <u>Extended, for non ARQ-enabled connections</u> 1 = Extended 0 = not Extended. <del>Applicable to connections where ARQ is not enabled</del> <u>For ARQ-enabled connections, this bit shall be set to 1.</u>

**Table 6—Type encodings (continued)**

Type bit	Value
#2	Fragmentation subheader 1 = present, 0 = absent
#1	Packing subheader 1 = present, 0 = absent
#0 least significant bit (LSB)	Downlink: FAST-FEEDBACK Allocation subheader Uplink: Grant Management subheader 1 = present, 0 = absent

*Renumber the current subclause 6.3.2.1.2 to 6.3.2.1.2.1.1. Insert the following text as the new subclause 6.3.2.1.2.*

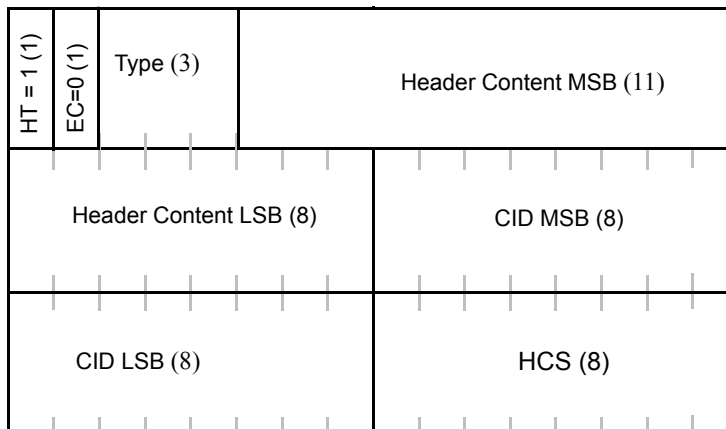
**6.3.2.1.2 MAC header without payload**

This MAC header format is applicable to UL only. The MAC header is not followed by any MAC PDU payload and CRC.

**6.3.2.1.2.1 MAC signaling header type I**

For this MAC header format, there is no payload following the MAC header. The MAC signaling header type I is illustrated in Figure 19a. Table 5a describes the encoding of the 3-bit type field following the EC field.

*Insert the following figure after Figure 19:*



**Figure 19a—MAC signaling header type I format**

*Change 6.3.2.1.2 as indicated:*

**6.3.2.1.2.1.1 Bandwidth request header**

The Bandwidth Request PDU shall consist of bandwidth request header alone and shall not contain a payload. The bandwidth request header is illustrated in Figure 20. An MS receiving a bandwidth request header on the downlink shall discard the PDU.

The ‘Bandwidth Request’ header shall have the following properties:

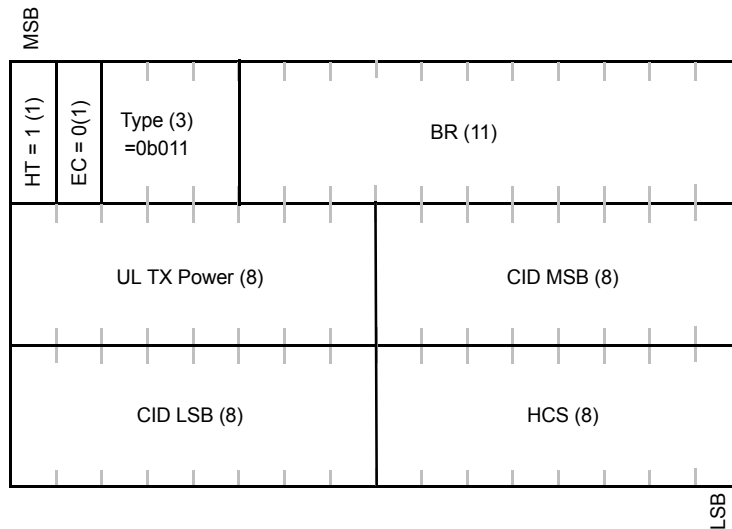
- a) ~~It is a MAC signaling header type I. The length of the header shall always be 6 bytes.~~
- b) ~~The EC field shall be set to 0, indicating no encryption.~~
- b) ~~e) The CID shall indicate the connection for which uplink bandwidth is requested.~~
- c) ~~The Bandwidth Request (BR) field shall indicate the number of bytes requested.~~
- e) ~~The allowed types for bandwidth requests are “000” for incremental and “001” for aggregate.~~
- d) The allowed types of bandwidth requests are defined in Table 5a.

The fields of the bandwidth request header are defined in Table 7. ~~Every header is encoded, starting with the HT and EC fields. The coding of these fields is such that the first byte of a MAC header shall never have the value of 0xFF. This prevents false detection of the stuff byte.~~

*Insert new subclause 6.3.2.1.2.1.2:*

**6.3.2.1.2.1.2 Bandwidth request and UL Tx Power Report header**

The Bandwidth Request and UL Tx Power Report PDU shall consist of bandwidth request and UL Tx Power Report header alone and shall not contain a payload. The bandwidth request and UL Tx Power Report header is illustrated in Figure 20a.



**Figure 20a—Bandwidth request and UL Tx Power Report header format**

The Bandwidth request and UL Tx Power Report header shall have the following properties:

- a) This is a MAC signaling header type I.
- b) The CID shall indicate the connection for which uplink bandwidth is requested.



- c) The allowed type for Bandwidth request and UL Tx Power Report is defined in Table 5a. The requested bandwidth is incremental.

The fields of the Bandwidth request UL Tx Power Report header are defined in Table 7a.

**Table 7a—Description of fields BR and UL Tx Power Report header**

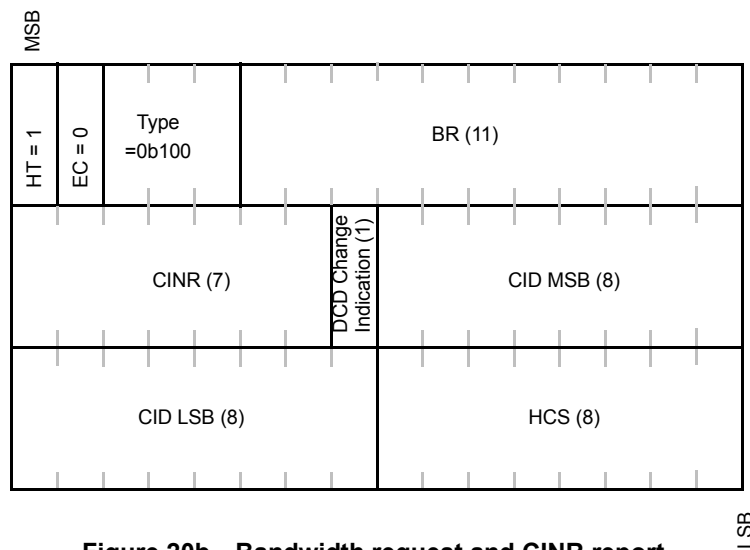
Name	Size	Description
Type	3 bits	The type of BR and UL Tx Power Report header is defined in Table 5a.
BR	11 bits	Bandwidth Request: The number of bytes of uplink bandwidth requested by the MS. The bandwidth request is for the CID. The request shall not include any PHY overhead. It is incremental BW request. In case of the Extended rtPS, if the MSB is 1, the BS changes its polling size into the size specified in the LSBs of the this field.
UL Tx power	8 bits	UL Tx power level in dBm for the burst that carries this header (as described in 11.1.1). The value shall be estimated and reported for the burst.
CID	16 bits	The CID shall indicate the connection for which uplink bandwidth is requested.
HCS	8 bits	Header Check Sequence (same usage as HCS entry in Table 5).

Support of this subheader shall be negotiated between the BS and MS as part of the registration dialog (REG-REQ/RSP).

*Insert new subclause 6.3.2.1.2.1.3:*

**6.3.2.1.2.1.3 Bandwidth request and CINR report header**

Bandwidth request and CINR report PDU shall consist of bandwidth request and CINR report header alone, and shall not contain a payload (see Figure 20b).



**Figure 20b—Bandwidth request and CINR report**

The Bandwidth request and CINR report header shall have the following properties:

- a) This is a MAC signaling header type I.
- b) The CID shall indicate the connection for which uplink bandwidth is requested.
- c) The allowed type for Bandwidth request and CINR report header is defined in Table 5a. The requested bandwidth is incremental.

The fields of the Bandwidth request and CINR report header are defined in Table 7b.

**Table 7b—Description of the fields of BR and CINR report header**

Name	Length (bits)	Description
Type	3	The type of Bandwidth request and CINR report header is defined in Table 5a.
BR	11	Bandwidth Request: The number of bytes of uplink bandwidth requested by the MS. The bandwidth request is for the CID. The request shall not include any PHY overhead. It is incremental BW request.
CINR	7	—
DCD Change Indications	1	—
CID	16	The CID shall indicate the connection for which uplink bandwidth is requested.
HCS	8	Header Check Sequence (same usage as HCS entry in Table 5).

**CINR**

This parameter indicates the CINR measured by the MS from the BS. It shall be interpreted as a single value from -16.0 dB to 47.5 dB in units of 0.5 dB.

**DCD Change Indication**

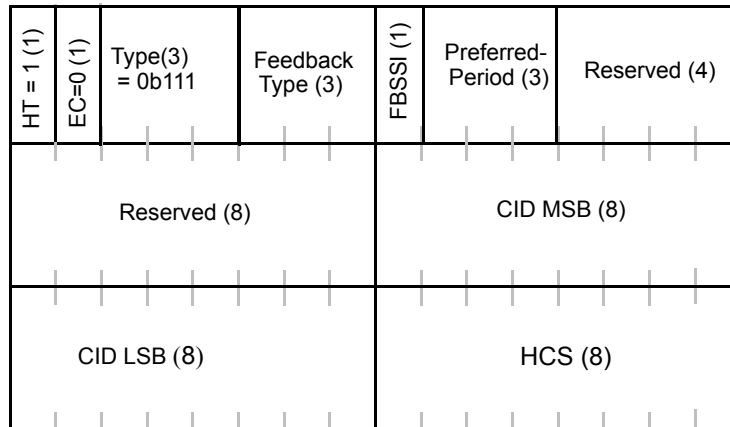
This parameter is set to 1 if the DCD change count stored at MS is not equal to that in the received DL-MAP message. Otherwise, it is set to 0.

Support of this subheader shall be negotiated between the BS and MS as part of the registration dialog (REG-REQ/RSP).

*Insert new subclause 6.3.2.1.2.1.4:*

**6.3.2.1.2.1.4 CQICH allocation request header**

The CQICH allocation request PDU shall consist of CQICH allocation request header alone and shall not contain a payload. This header is sent by MS to request the allocation of CQICH. The CQICH allocation request header is illustrated in Figure 20c.



**Figure 20c— CQICH allocation request**

The CQICH allocation request header shall have the following properties:

- a) This is a MAC signaling header type I.
- b) The CID shall indicate the MS basic CID.
- c) The allowed type for CQICH allocation request is defined in Table 5a.

The fields of the CQICH allocation request header are defined in Table 7c.

**Table 7c—Description of the fields of CQICH allocation request header**

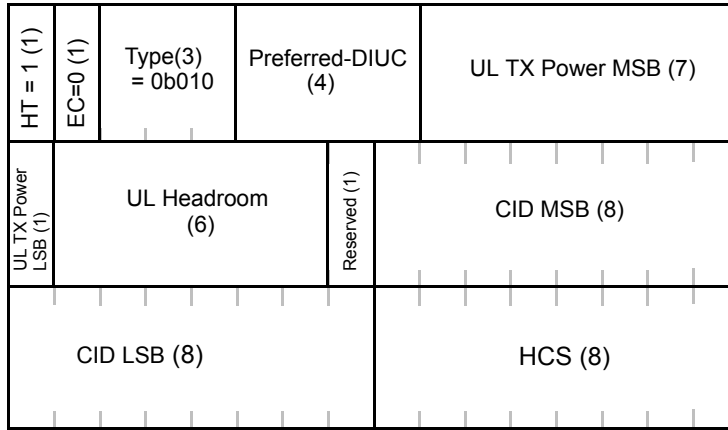
Name	Length (bits)	Description
Type	3	The type of CQICH allocation request header is defined in Table 5a.
Feedback Type	3	Set according to feedback type defined in Table 302a. When FBSSI is set to 1, this field is neglected.
FBSSI	1	FBSS Indicator: Set when MS request CQICH during FBSS handover.
Preferred-Period(=p)	3	CQICH allocation period MS prefers. The value is defined in units of frame. When FBSSI is set to 1, the value contained in this field shall be neglected.
<i>Reserved</i>	12	Shall be set to zero.
CID	16	MS basic CID.
HCS	8	Header Check Sequence (same usage as HCS entry in Table 5).

Support of this subheader shall be negotiated between the BS and MS as part of the registration dialog (REG-REQ/RSP).

*Insert new subclause 6.3.2.1.2.1.5:*

**6.3.2.1.2.1.5 PHY channel report header**

The PHY channel report PDU shall consist of a PHY channel report header alone and shall not contain a payload. The PHY channel report header is illustrated in Figure 20d.



**Figure 20d—PHY channel report header**

The PHY channel report shall have the following properties:

- a) This is a MAC signaling header type I.
- b) The CID shall indicate the MS basic CID.
- c) The allowed type for PHY channel report is defined in Table 5a.

An MS receiving a PHY channel report header on the downlink shall discard the PDU.

The fields of the PHY channel report header are defined in Table 7d.

**Table 7d—PHY channel report header fields**

Name	Length (bits)	Description
Type	3	The type of PHY channel report header is defined in Table 5a.
PREFERRED-DIUC	4	Index of the DIUC preferred by the MS.
UL-TX-POWER	8	UL Tx power level in dBm for the burst that carries this header (11.1.1). The value shall be estimated and reported for the burst.

**Table 7d—PHY channel report header fields (continued)**

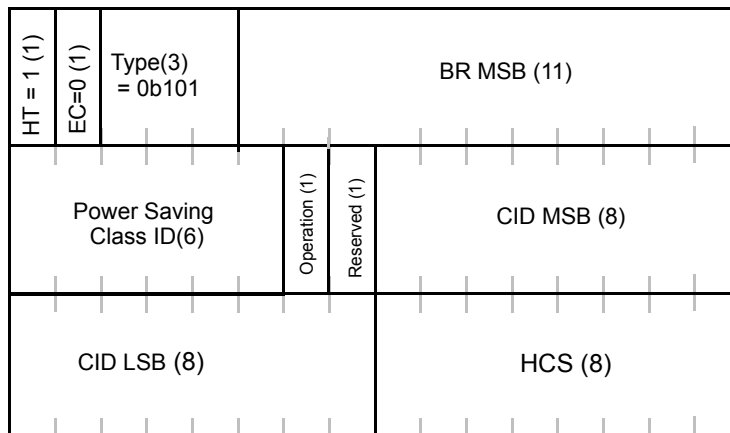
Name	Length (bits)	Description
UL-HEADROOM	6	Headroom to UL maximum power level in dB, for the burst that carries this Header, from 0 to 63 in 1 dB steps. Should the headroom exceed 63 dB, the value 63 shall be used. The minimum value is shall be reported for the burst.
<i>Reserved</i>	1	Set to zero.
CID	16	MS basic CID.
HCS	8	Header Check Sequence (same usage as HCS entry in Table 5).

Support of this subheader shall be negotiated between the BS and MS as part of the registration dialog (REG-REQ/RSP).

*Insert new subclause 6.3.2.1.2.1.6:*

**6.3.2.1.2.1.6 Bandwidth request and uplink sleep control header**

Bandwidth request and uplink sleep control header is sent by the MS to request activation/deactivation of certain Power Saving Class. The header also indicates incremental transmission demand. The Bandwidth request and uplink sleep control PDU shall consist of a Bandwidth request and uplink sleep control header alone and shall not contain a payload. The Bandwidth request and uplink sleep control header is illustrated in Figure 20e.



**Figure 20e—Bandwidth request and uplink sleep control header**

The Bandwidth request and uplink sleep control header shall have the following properties:

- a) This is a MAC signaling header type I.
- b) The CID shall indicate the MS basic CID.
- c) The allowed type for Bandwidth request and uplink sleep control is defined in Table 5a.

An MS receiving a Bandwidth request and uplink sleep control header on the downlink shall discard the PDU.

The fields of the Bandwidth request and uplink sleep control header are defined in Table 7e.

**Table 7e—Bandwidth control and uplink sleep control header**

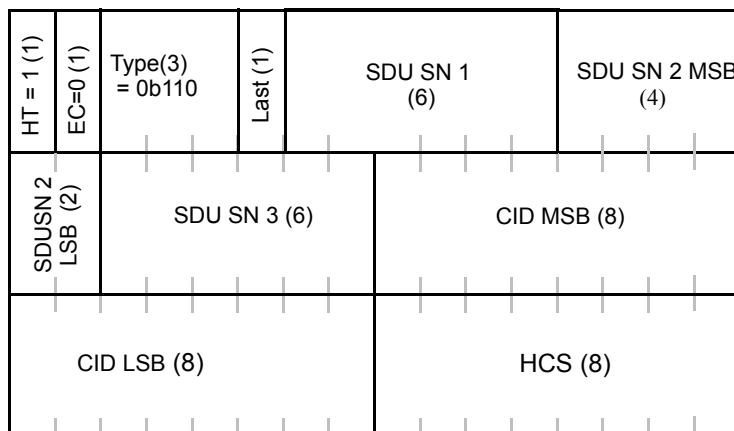
Name	Length (bits)	Description
Type	3	The type of Bandwidth request and uplink sleep control header is defined in Table 5a.
BR	11	Bandwidth Request: The number of bytes of uplink bandwidth requested by the MS. The bandwidth request is for the CID. The request shall not include any PHY overhead. It is incremental BW request.
Power_Saving_Class_ID	6	Power Saving Class ID.
Operation	1	1: to activate Power Saving Class. 0: to deactivate Power Saving Class.
Reserved	1	Shall be set to zero.
CID	16	Basic CID of the MS for which the bandwidth request and uplink sleep control header is sent.
HCS	8	Header Check Sequence (same usage as HCS entry in Table 5).

Support of this subheader shall be negotiated between the BS and MS as part of the registration dialog (REG-REQ/RSP).

*Insert new subclause 6.3.2.1.2.1.7:*

**6.3.2.1.2.1.7 SN report header**

The SN report header is sent by the MS to report the LSB of the next ARQ BSN or the virtual MAC SDU Sequence number for the active connections with SN Feedback enabled.



**Figure 20f—SN report header format**

The SN Report header shall be of the form illustrated in Figure 20f. The SN Report header shall have the following properties:

- a) This is a MAC signaling header type I.
- b) The CID shall indicate the basic connection of the MS for which the SN Report is being sent.
- c) The allowed type for SN report header is defined in Table 5a.
- d) The SDU SN field shall indicate the LSB of the next ARQ BSN or the virtual MAC SDU Sequence number for the active connections with SN Feedback enabled. The LSB of the ARQ BSN or virtual MAC SDU sequence number for each connection is provided. At most, three SNs can be provided in each SN report header in numerical ascending order of the SFID values of the connections with SN feedback enabled.
- e) The last field may be used to indicate whether the SN Report header is the last header, thus accommodating up to six active connections.

An MS receiving a SN report header on the downlink shall discard the PDU.

The fields of the SN report header are defined in Table 7f.

**Table 7f—SN report header fields**

Name	Length (bits)	Description
Type	3	Set to 0b110. Indicates that it is a SN Report header.
Last	1	If set to 0, this header contains the SDU or ARQ block sequence numbers of the first three connections with SN feedback enabled. If set to 1, this header contains the SDU or ARQ block sequence numbers of the fourth, fifth, and sixth connections with SN feedback enabled. SN feedback can be supported for up to six connections.
SDU SN 1	6	The ARQ BSN (LSB) or MAC SDU SN (LSB) for the first Service Flow addressed in this header. The order of reporting the sequence numbers, SNs, for the connections is predetermined as indicated in 6.3.22.3.4.1.
SDU SN 2	6	The ARQ BSN (LSB) or MAC SDU SN (LSB) for the second Service Flow addressed in this header.
SDU SN 3	6	The ARQ BSN (LSB) or MAC SDU SN (LSB) for the third Service Flow addressed in this header.
CID	16	Basic Connection Identifier.
HCS	8	Header Check Sequence.

Support of this subheader shall be negotiated between the BS and MS as part of the registration dialog (REG-REQ/RSP).

*Insert new subclause 6.3.2.1.2.2:*

#### **6.3.2.1.2.2 MAC signaling header type II**

This type of MAC header is UL specific. There is no payload following the MAC header. The MAC signaling header type II is illustrated in Figure 20g. Table 7g describes the encoding of the 1-bit type field following the EC field. The description of DL MAC header format with HT/EC = 0b11, defined as the Compressed DL-MAP, is not part of this subclause. The detailed description can be found in 8.4.5.6.1.

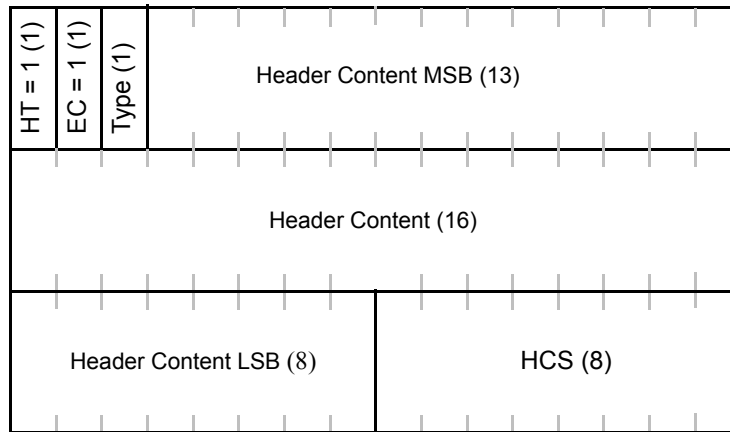


Figure 20g—MAC signaling header type II format

Table 7g—Type field encodings for MAC signaling header type II

Type field	MAC header Type (with HT/EC=0b11)	Reference figure	Reference table
0	Feedback header, with another 4-bit type field, see Table 7i for its type encodings.	20h, 20i	7h
1	<i>Reserved</i>	—	—

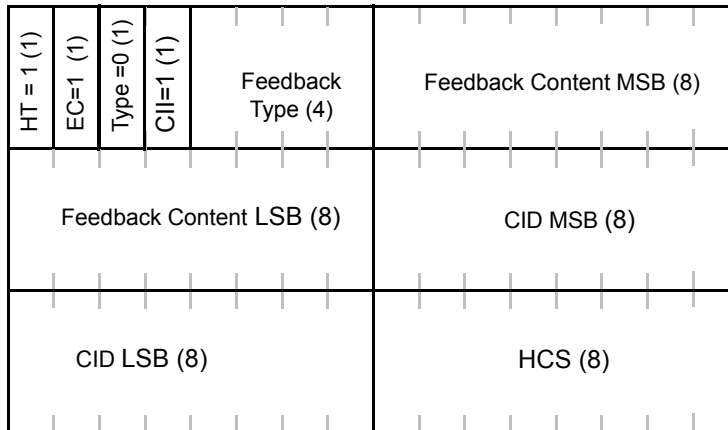
*Insert new subclause 6.3.2.1.2.2.1:*

**6.3.2.1.2.2.1 Feedback header**

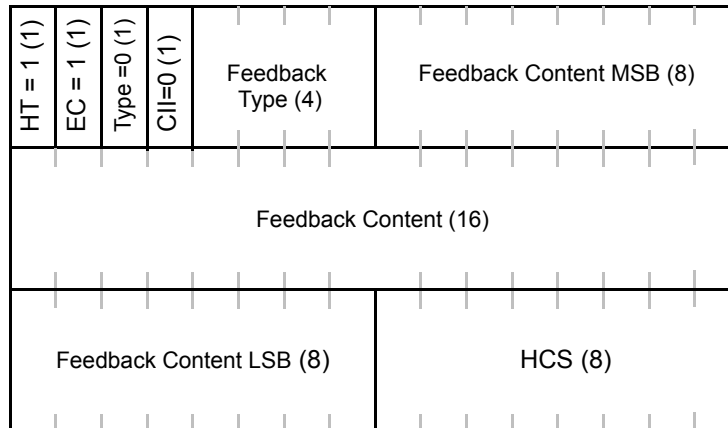
The Feedback header is sent by an MS either as a response to Feedback Polling IE (see 8.4.5.4.28), or the Feedback request extended subheader (see 6.3.2.2.7.3) or as an unsolicited feedback. When sent as a response to the Feedback Polling IE or the Feedback request extended subheader, the MS shall send a Feedback header using the assigned resource indicated in the Feedback Polling IE or the Feedback request extended subheader. When sent as an unsolicited feedback, the MS can either send the Feedback header on currently allocated UL resource, or request additional UL resource by sending Indication flag on the Fast-feedback channel or the Enhanced Fast-feedback channel (refer to 8.4.5.4.10.11) or sending BW request ranging code.

The Feedback PDU shall consist of the Feedback header alone and shall not contain a payload. The Feedback header with and without CID field are illustrated in Figure 20h and Figure 20i. The Feedback header with CID field shall be used when the UL resource used to send the Feedback header is requested through BW request ranging. Otherwise, the Feedback header without CID field shall be used.





**Figure 20h— Feedback header with CID field**



**Figure 20i—Feedback header without CID field**

The Feedback header shall have the following properties:

- a) This is a MAC signaling header type II. The length of the header shall always be 6 bytes.
- b) The allowed type for Feedback header is defined in Table 7g.
- c) The Feedback type field shall be set according to Table 7i.
- d) The CII field (CID Inclusion Indication) shall be set to 1 for the header with CID field and set to 0 for the header without CID field.
- e) The Feedback Content field shall be set accordingly based on the value of the feedback type field.

The Feedback header shall be used by the MS to provide its feedback(s). An MS receiving a Feedback header on the downlink shall discard the PDU.

The support of Feedback header is OFDMA PHY specific and shall be negotiated between the BS and the MS as part of the registration dialog (REG-REQ/RSP).

The fields of Feedback header are defined in Table 7h.

**Table 7h—Description of the fields of Feedback header**

Name	Length (bits)	Description
CII	1	CID Inclusion indication. Set to 1 for a Feedback header with CID field; set to 0 for a Feedback header without CID field.
Feedback Type	4	Set according to Table 7i.
Feedback Content	16 or 32	Set according to Table 7i. Length of 16 bits for a Feedback header with CID field and length of 32 bits for a Feedback header without CID field.
HCS	8	Header Check Sequence (same usage as HCS entry in Table 5).

**Table 7i—Feedback type and feedback content**

Feedback Type (binary)	Feedback contents	Description
0000	MIMO feedback type (3 bits) + feedback payload (6 bits)	CQI and MIMO feedback. The definition of MIMO feedback type (3 bits) and the corresponding feedback payload (6 bits) are the same as that defined in Table 302a and subclauses 8.4.5.4.10.4, 8.4.5.4.10.5, 8.4.5.4.10.6, 8.4.5.4.10.7, 8.4.5.4.10.8, 8.4.5.4.10.9, 8.4.5.4.10.10 for the Enhanced Fast-feedback channel.
0001	DL average CINR (5 bits)	DL average CINR of the serving or anchor BS (for the case of FBSS), with 5-bit payload encoding as defined in 8.4.5.4.12.
0010	Number of index, $L$ (2 bits) + $L$ occurrences of Antenna index (2 bits) + MIMO coefficients (5 bits, see definition in 8.4.5.4.10.7)	MIMO coefficients feedback for up to four antennas.
0011	Preferred-DIUC (4 bits) + DCD change count (4 bits)	Preferred DL channel DIUC feedback.
0100	UL-TX-Power (8 bits) (see Table 7a for definition)	UL transmission power.
0101	PREFERRED DIUC (4 bits) + UL TX-POWER (8 bits) + UL-HEADROOM (6 bits) (see Table 7d for definitions)	PHY channel feedback.
0110	AMC band indication bitmap (12 bits, see 6.3.2.3.43.2) + N CQI ( $N \times 5$ bits). N is the number of '1's in the AMC band indication bitmap.	CQIs of up to four best reception DL multiple AMC bands.

**Table 7i—Feedback type and feedback content (continued)**

Feedback Type (binary)	Feedback contents	Description
0111	Life span of short-term precoding feedback (4 bits) according to Table 316i.	The recommended number of frames for which the short-term precoding feedback can be used.
1000	Number of feedback types, $\theta$ (2 bits) + $\theta$ occurrences of 'feedback type (4 bits) + feedback content (variable)'	Multiple types of feedback.
1001	Feedback of index to long-term precoding matrix in codebook (6 bits), rank of precoding codebook (2 bits) and FEC and QAM feedback (6 bits) according to Table 316h.	Long-term precoding feedback.
1010	Combined DL average CINR of Active BSs (5 bits).	Combined DL average CINR of all Active BSs within the Diversity Set, with 5-bit payload encoding as defined in 8.4.5.4.15.
1011	MIMO channel feedback (see Table 7j for description of feedback content fields)	MIMO mode channel condition feedback.
1100	CINR Mean (8 bits) + CINR Standard Deviation (8 bits)	CINR Feedback (values and coding defined in 8.4.11.3).
1101	CL MIMO type (2 bits) If (CL MIMO type == 0b00 { Antenna grouping index (4 bits) + average CQI (5 bits) } Elseif ( CL MIMO type == 0b01 { Number of streams (2 bits) + Antennas selection option index (3 bits) + average CQI (5 bits) of the selected antennas } Elseif (CL MIMO type == 0b10) { Number of streams (2 bits)+Codebook index (6 bits) + average CQI (5 bits) }	Closed-loop MIMO feedback CL MIMO type: 0b00: antenna grouping 0b01: antenna selection 0b10: codebook 0b11: indication of transition from closed-loop MIMO to open-loop MIMO  Antenna grouping index: 0b0000~0b1001 = 0b101110 ~ 0b110110 in Table 298g Antenna selection option index: 0b000 ~ 0b010 = 0b110000 ~ 0b110010 in Table 316f for 3 Tx antenna 0b000~0b101 = 0b110000~0b110101 in Table 316g for 4 Tx antenna  Codebook index: (See 8.4.8.3.6.)
1100-1111	Reserved for future use	—

The feedback payload shall be placed at the first available bits of the feedback content field. Any unused bit in the content field shall be set to zero.

#### 6.3.2.1.2.2.1.1 MIMO Channel Feedback header

The MIMO Channel Feedback header is used for MS to provide DL MIMO channel quality feedback to the BS. The MIMO Channel Feedback header can be used to provide a single or composite channel feedback. The MIMO Channel Feedback header with or without basic CID field is illustrated in Figure 20j and Figure 20k respectively.

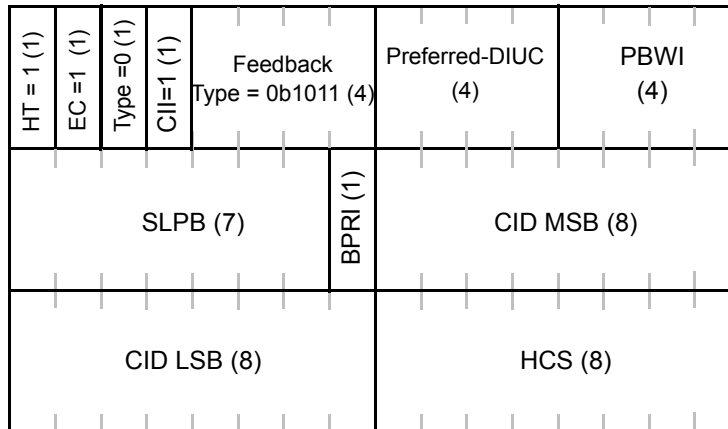


Figure 20j—MIMO Channel Feedback header with CID field

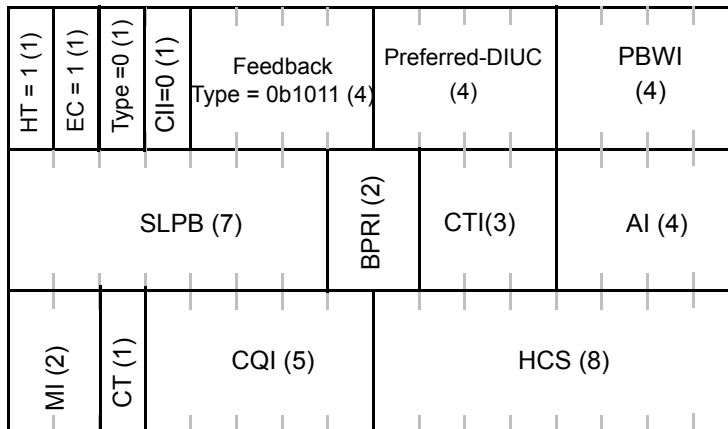


Figure 20k—MIMO Channel Feedback header without CID field

The fields of MIMO Channel Feedback header are defined in Table 7j.

Table 7j—Description of MIMO Channel Feedback header fields

Name	Length (bits)	Description
Feedback Type	4	Feedback Type of MIMO Channel Feedback header is defined in Table 7i.
PREFERRED-DIUC	4	Index of the preferred DIUC suggested by the MS.

**Table 7j—Description of MIMO Channel Feedback header fields (continued)**

PBWI	4	<p>This field provides the size of the preferred bandwidth, which can be used for DIUC transmission.</p> <p>The Preferred Bandwidth Index indicates the ratio of the preferred bandwidth over used channel bandwidth:</p> <p>0b0000: 1  0b0001: 3/4  0b0010: 2/3  0b0011: 1/2  0b0100: 1/3  0b0101: 1/4  0b0110: 1/5  0b0111: 1/6  0b1000: 1/8  0b1001: 1/10  0b1010: 1/12  0b1011: 1/16  0b1100: 1/24  0b1101: 1/32  0b1110: 1/48  0b1111: 1/64</p> <p>Where  Ratio = <math>BW_{\text{preferred}}/BW_{\text{used}}</math>,  <math>BW_{\text{preferred}}</math>: Preferred bandwidth for DIUC transmission,  <math>BW_{\text{used}}</math>: Actual used channel bandwidth (excluding guard bands).</p>
SLPB	7	<p>This field points to the starting preferred bandwidth location. Combining with PBWI field, BS knows the exact size and location of the preferred bandwidth in the channel.</p> <p>Starting Location of Preferred Bandwidth: 0-127</p> <p>The effective bandwidth (used bandwidth) is divided into 1/128 interval, from 0 to 127 representing from lower to higher band. SLPB indicates the starting location of preferred bandwidth for the DIUC burst profile.</p>
BPRI	1/2	<p>This field can be used to rank up to four preferred burst profiles within the DL channel.</p> <p>Burst Profile Ranking Indicator (without basic CID): BPRI indicates the ranking for DL channel condition of the preferred bandwidth as reported in the current header where 0 is the most preferred bandwidth)</p> <p>0b00: 1<sup>st</sup> preferred burst profile  0b10: 2<sup>nd</sup> preferred burst profile  0b01: 3<sup>rd</sup> preferred burst profile  0b11: 4<sup>th</sup> preferred burst profile</p> <p>Burst Profile Ranking Indicator (including basic CID):  0b0: 1<sup>st</sup> preferred burst profile  0b1: 2<sup>nd</sup> preferred burst profile</p> <p>This field is 1 bit when CII is set to 1; otherwise, this field is 2 bits.</p>
CTI	3	<p>This field provides coherent time information.</p> <p>Coherent Time Index: CTI indicates the estimated duration of the valid MIMO channel conditions</p> <p>0b000: Infinite  0b001: 1 frame  0b010: 2 frames  0b011: 3 frames  0b100: 4 frames  0b101: 8 frames  0b110: 14 frames  0b111: 24 frames</p> <p>This field is only present when CII is set to 0.</p>

**Table 7j—Description of MIMO Channel Feedback header fields (continued)**

AI	4	<p>This field is for Antenna Indication. It can support up to four antennas. This feedback header can report a composite channel condition, each bit represents for each antenna; “1” is applicable, “0” is not applicable.</p> <p>Antenna Index:                      Bit 0 (MSB)– Antenna 0                      Bit 1 – Antenna 1                      Bit 2 – Antenna 2                      Bit 3 (LSB) – Antenna 3</p> <p>This field is only present when CII is set to 0.</p>
MI	2	<p>This field suggests the preferred STC/MIMO Matrix for the MS Matrix Indicator:                      0b00: No STC                      0b01: Matrix A                      0b10: Matrix B                      0b11: Matrix C</p> <p>This field is only present when CII is set to 0.</p>
CT	1	<p>This field indicates the type of CQI feedback in the CQI field.                      CQI Type: The type of CQI feedback in the CQI field                      0: DL average CQI feedback                      1: CQI feedback for the preferred bandwidth indicated in the current header</p> <p>This field is only present when CII is set to 0.</p>
CQI	5	<p>CQI feedback</p> <p>This field is only present when CII is set to 0.</p>
CID	16	<p>MS basic CID</p> <p>This field is only present when CII is set to 1.</p>
HCS	8	Header Check Sequence (same usage as HCS entry in Table 5).

**6.3.2.2 MAC subheaders and special payloads**

*Replace the first paragraph of 6.3.2.2 with the following:*

Six types of subheaders may be present in a MAC PDU with generic MAC header. The per-PDU subheaders (i.e., extended subheader field, Mesh, Fragmentation, Fast-feedback allocation and Grant Management) may be inserted in MAC PDUs immediately following the Generic MAC header. If both the Fragmentation subheader and Grant Management subheader are indicated, the Grant Management subheader shall come first. If the Mesh subheader is indicated, it shall precede all other subheaders except for the extended subheader. In the downlink, the Fast-feedback allocation subheader shall always appear as the last per-PDU subheader. The ESF bit in the Generic MAC header indicates that the extended subheader is present. Using this field, a number of additional subheaders can be used within a PDU. The extended subheader shall always appear immediately after the Generic MAC header, and before all other subheaders. All extended subheaders are not encrypted. (See 6.3.2.2.7.)

**6.3.2.2.2 Grant Management subheader***Change Table 9 as indicated:***Table 9—Grant Management subheader format**

Syntax	Size	Notes
Grant Management Subheader {	—	—
if (scheduling service type == UGS) {	—	—
<b>SI</b>	1 bit	—
<b>PM</b>	1 bit	—
<b><u>FLI</u></b>	<u>1 bit</u>	—
<b><u>FL</u></b>	<u>4 bits</u>	—
<i>Reserved</i>	<u>149 bits</u>	Shall be set to zero
} else if (scheduling service type == Extended rtPS) {	—	—
<b><u>Extended piggyback request</u></b>	<u>11 bits</u>	—
<b><u>FLI</u></b>	<u>1 bit</u>	—
<b><u>FL</u></b>	<u>4 bits</u>	—
} else {	—	—
<b>Piggyback Request</b>	16 bits	—
}	—	—
}	—	—

*Insert the following new fields into Table 10:***Table 10—Grant management subheader fields**

Name	Size	Description
<b><u>FLI</u></b>	<u>1 bit</u>	<u>Frame latency indication</u> 0 = Frame latency field disabled for this grant 1 = Frame latency field enabled for this grant
<b><u>FL</u></b>	<u>4 bits</u>	<u>Frame latency</u> The number of frames previous to the current one in which the transmitted data was available. When the latency is greater than 15 then the FL field shall be set to 15.
<i>Reserved</i>	<u>9 bits</u>	
<b><u>Extended Piggyback Request</u></b>	<u>11 bits</u>	The number of bytes of uplink bandwidth requested by the MS. The bandwidth request is for the CID. The request shall not include any PHY overhead. The request shall be incremental. In case of the Extended rtPS, if the MSB is 1, the BS changes its polling size into the size specified in the LSBs of this field.

### 6.3.2.2.3 Packing subheader

*Insert the following text under the “Notes” column of the “Length” field:*

Length of the SDU fragment in bytes including the packing subheader.

*In Table 11, change the description of the 11-bit FSN in the Notes column as follows:*

Sequence number of the current SDU fragment. This field shall increment by one (modulo 2048) for each fragment, including unfragmented SDUs.

*In Table 11, change the description of the 3-bit FSN in the Notes column as follows:*

Sequence number of the current SDU fragment. This field shall increment by one (modulo 8) for each fragment, including unfragmented SDUs.

### 6.3.2.2.4 ARQ feedback

*Change the subclause as indicated:*

If the ARQ Feedback Payload bit in the MAC Type field (see Table 6) is set, the ARQ Feedback Payload shall be transported. If packing is used, it shall be transported as the first packed payload. See 6.3.3.4.3. Note that this bit does not address the ARQ Feedback payload contained inside an ARQ Feedback message.

### 6.3.2.2.6 FAST-FEEDBACK allocation subheader

*Change the description text of the “Allocation offset” field as indicated:*

#### **Allocation offset**

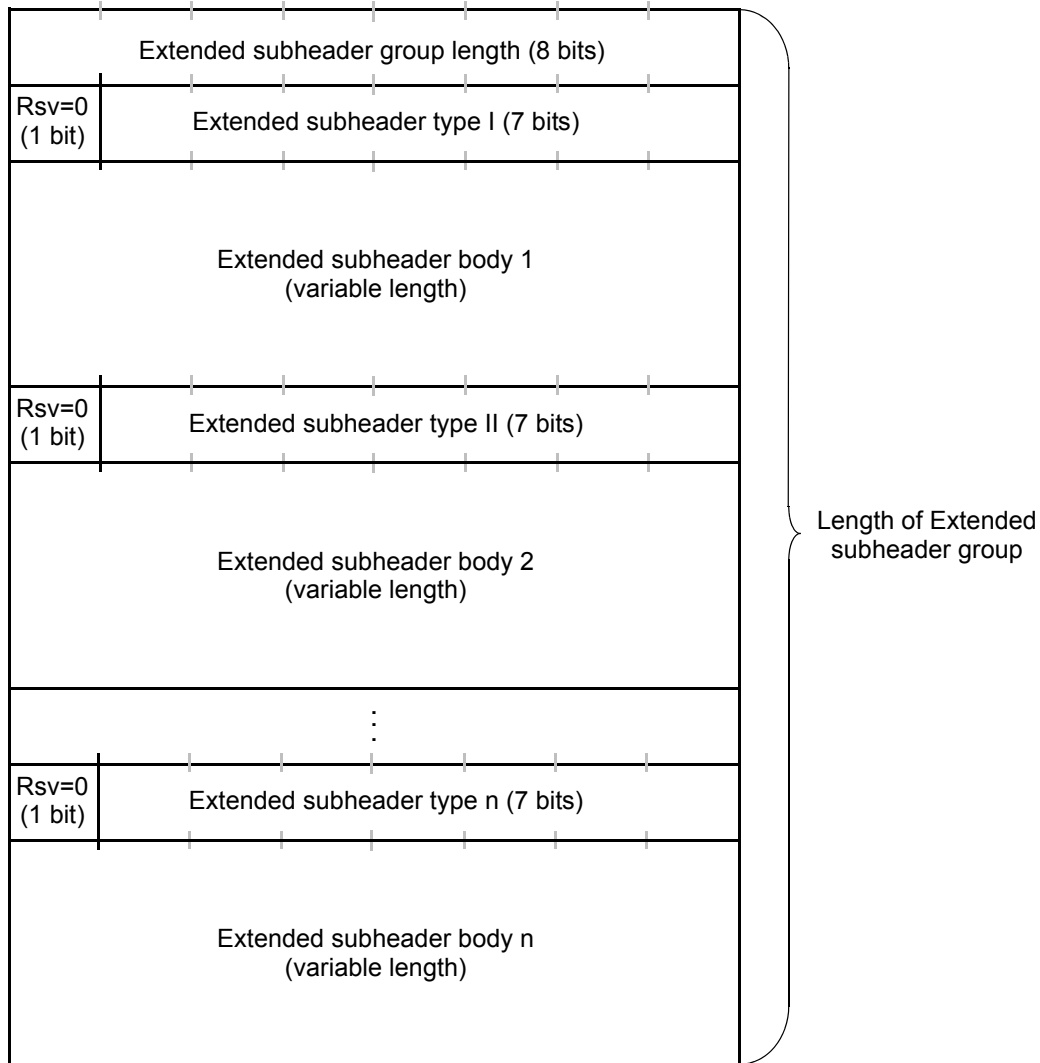
Defines the offset, in units of slots, from the beginning of the ~~FAST-FEEDBACK~~ FAST-FEEDBACK uplink bandwidth allocation (8.4.5.4.9), of the slot in which the SS servicing the CID appearing in the MAC generic header, must send an ~~FAST-FEEDBACK~~ FAST-FEEDBACK message ~~for the connection associated with the CID value~~. Range of values 0 to 63. The allocation applies to the UL subframe ~~of the next frame~~ two frames after the frame including the fast- feedback allocation subheader.

*Insert new subclause 6.3.2.2.7:*

### 6.3.2.2.7 Extended subheader format

The extended subheader group (see Figure 201), when used, shall always appear immediately after the Generic MAC header and before all subheaders, and PN number [if MAC PDU is protected (i.e., when EC=1)], as described in 6.3.2.2. The extended subheader group format is specified in Table 13a, Table 13b, and Table 13c. Extended subheaders shall not be encrypted.





**Figure 20I—Extended subheader group format**

The fields of the extended subheader group structure are described in Table 13a.

The extended subheader group starts with an 8-bit length field that is followed by one or multiple extended subheaders. The length field specifies the total length in bytes of the subheader group, including all the extended subheaders and the length byte. Each extended subheader consists of a reserved bit, a 7-bit extended subheader type field, and a variable size extended subheader body. The size of each extended subheader is determined by the extended subheader type as specified in Table 13b.

**Table 13a—Extended subheader group format**

Name	Size	Description
Extended subheader group length	8 bits	The extended subheader Group Length field indicates the total length of the subheader group, including all the extended subheaders and the length byte.
Reserved	1 bit	<i>Reserved</i> = 0
Extended subheader type	7 bits	Type of subheader as defined in Table 13b and Table 13c.
Extended subheader body	<i>variable</i>	The size of the extended subheader is determined by extended subheader type as specified in Table 13b and Table 13c. The size of the extended subheader body is byte aligned.

The list of defined extended subheaders is given in Table 13b for the DL and in Table 13c for the UL. The support of each extended subheader shall be negotiated between the BS and the MS as part of the registration dialog (REG-REQ/RSP).

**Table 13b—Description of extended subheaders types (DL)**

ES type	Name	ES body size	Description
0	SDU_SN extended subheader	1 byte	See 6.3.2.2.7.1
1	DL Sleep control extended subheader	3 bytes	See 6.3.2.2.7.2
2	Feedback request extended subheader	3 bytes	See 6.3.2.2.7.3
3	SN request extended subheader	1 byte	See 6.3.2.2.7.7
4	PDU SN(short) extended subheader	1 byte	See 6.3.2.2.7.8
5	PDU SN(long) extended subheader	2 bytes	See 6.3.2.2.7.8
6–127	<i>Reserved</i>	—	—

**Table 13c—Description of extended subheaders types (UL)**

ES type	Name	ES body size	Description
0	MIMO mode feedback extended subheader	1 byte	See 6.3.2.2.7.4
1	UL Tx Power Report extended subheader	1 byte	See 6.3.2.2.7.5
2	Mini-Feedback extended subheader	2 byte	See 6.3.2.2.7.6
3	PDU SN (short) extended subheader	1 byte	See 6.3.2.2.7.8
4	PDU SN (long) extended subheader	2 bytes	See 6.3.2.2.7.8
5–127	<i>Reserved</i>	—	—

*Insert new subclause 6.3.2.2.7.1:*

**6.3.2.2.7.1 SDU SN extended subheader**

The SDU SN extended subheader shall only be sent by the BS if SDU SN extended subheader capability is supported (negotiated through REG-REQ/RSP) and if SDU\_SN Feedback is enabled for a DL connection (negotiated through DSA-REQ/RSP). The SDU SN extended subheader shall contain the last virtual MAC SDU sequence number of current MAC PDU. The format of the SDU SN extended subheader is as described in Table 13d.

**Table 13d—SDU SN extended subheader format**

Name	Size	Description
SDU sequence number	8 bits	Last virtual MAC SDU sequence number in the current MAC PDU.

*Insert new subclause 6.3.2.2.7.2:*

**6.3.2.2.7.2 DL Sleep control extended subheader**

The DL Sleep control extended subheader is sent by the BS to activate/deactivate certain Power Saving Class. The requested operation is effective from the next frame after the one where the message was transmitted. The format of DL Sleep control extended subheader is as described in Table 13e.

**Table 13e—DL Sleep control extended subheader format**

Name	Size	Description
Power_Saving_Class_ID	6 bits	Indicates the Power Saving Class ID to which this command refers.
Operation	1 bit	1 = activate Power Saving Class 0 = de-activate Power Saving Class
Final_Sleep_Window_Exponent	3 bits	For Power Saving Class Type III only: assigned factor by which the final-sleep window base is multiplied in order to calculate the duration of single sleep window requested by the message.
Final_Sleep_Window_Base	10 bits	For Power Saving Class Type III only: the base for duration of single sleep window requested by the message.
<i>Reserved</i>	4 bits	—

*Insert new subclause 6.3.2.2.7.3:*

**6.3.2.2.7.3 Feedback request extended subheader**

Feedback request extended subheader shall only be sent by the BS to provide a UL allocation for a Fast-feedback channel transmission (see 8.4.5.4.10). The BS shall indicate in the FAST-FEEDBACK request subheader transmission the applied frame for the UL allocation.

The format of the Feedback request extended subheader is as described in Table 13f.

**Table 13f—Feedback request extended subheader format**

Name	Size	Description
UIUC	4 bits	—
Feedback type	4 bits	Shall be set according to Table 7i.
OFDMA Symbol offset	6 bits	The offset is relevant to the Allocation Start Time field given in the UL-MAP message.
Subchannel offset	6 bits	The lowest index subchannel used for carrying the burst, starting from Subchannel 0.
No. slot	3 bits	The number of slots allocated for the burst.
Frame offset (F)	1 bit	Indicate to start reporting at the frame. If F == 0, the allocation applies to the UL subframe two frames ahead of the current frame. If F==1, four frames ahead of the current frame.

*Insert new subclause 6.3.2.2.7.4:*

**6.3.2.2.7.4 MIMO mode Feedback extended subheader**

An MS uses the MIMO Feedback extended subheader to provide its feedback in terms of MIMO mode feedback. When there is an UL MAC PDU payload to be transmitted at the same time. The format of the MIMO mode Feedback extended subheader is as described in Table 13g.

**Table 13g—MIMO mode Feedback extended subheader format**

Name	Length	Description
Feedback type	2 bits	0b00: feedback type ‘0b000’ as defined in Table 302a 0b01: feedback type ‘0b001’ as defined in Table 302a 0b10: feedback type ‘0b010’ as defined in Table 302a 0b11: feedback type ‘0b011’ as defined in Table 302a
Feedback content	6 bits	Feedback contents and the corresponding feedback payload (6 bits) are the same as that defined in Table 302a and sub-clauses 8.4.5.4.10.4, 8.4.5.4.10.5, 8.4.5.4.10.6, 8.4.5.4.10.7, 8.4.5.4.10.8, 8.4.5.4.10.9, 8.4.5.4.10.10 for the Enhanced Fastfeedback channel

For each MS, if a MIMO mode Feedback extended subheader is present, it shall only appear in the first unicast PDU transmitted by that MS in that frame.

*Insert new subclause 6.3.2.2.7.5:*

**6.3.2.2.7.5 UL Tx Power Report extended subheader**

This subheader is sent from MS to BS to report the Tx power of the burst that carries this subheader. The format of the UL Tx Power Report extended subheader is as described in Table 13h.

**Table 13h—UL Tx Power Report extended subheader format**

Name	Size	Description
UL Tx Power	8 bits	Tx power level for the burst carries this header (11.1.1). The value shall be estimated and reported for the burst.

*Insert new subclause 6.3.2.2.7.6:*

**6.3.2.2.7.6 Mini-Feedback extended subheader**

The format of the mini-feedback extended subheader is shown in Table 13i.

**Table 13i—Description of Mini-Feedback extended subheaders (UL)**

Name	Size	Description
Feedback type	4 bits	Type of feedback: see Table 7i
Feedback content	12 bits	

*Insert new subclause 6.3.2.2.7.7:*

**6.3.2.2.7.7 SN request extended subheader**

The SN request extended subheader is sent by the BS to request the MS to send the SN report header. The fields of the SN request extended subheader are defined in Table 13j.

**Table 13j—Description of SN request extended subheader**

Name	Size	Description
SN report indication	2 bits	Bit #0: set to 1 to request transmission of the first SN report header Bit #1: set to 1 to request transmission of the second SN report header
<i>Reserved</i>	6 bits	Shall be set to zero

*Insert new subclause 6.3.2.2.7.8:*

**6.3.2.2.7.8 PDU SN extended subheader**

Specify the PDU sequence number in a monotonic increasing manner. The format of the PDU SN extended subheader is as described in Table 13k and Table 13l.

**Table 13k—PDU (short) SN extended subheader**

Name	Size	Description
PDU SN (short)	8 bits	Specify the PDU SN number

**Table 13l—PDU SN (long) extended subheader**

Name	Size	Description
PDU SN (long)	16 bits	Specify the PDU SN number

**6.3.2.3 MAC Mmanagement messages**

*Change the first paragraph as indicated:*

A set of MAC Mmanagement messages are defined. These messages shall be carried in the Payload of the MAC PDU. All MAC Mmanagement messages begin with a Management Message Type field and may contain additional fields. MAC Mmanagement messages on the Basic, Broadcast, and Initial Ranging connections shall neither be fragmented nor packed. MAC Mmanagement messages on the Primary Management Connection may be packed and/or fragmented. MAC management messages on the Fragmentable Broadcast connection may be fragmented. For the SCa, OFDM, and OFDMA PHY layers, management messages carried on the Initial Ranging, Broadcast, Fragmentable Broadcast, Basic, and Primary Management connections shall have CRC usage enabled. The format of the Mmanagement message is given in Figure 21. The encoding of the Management Message Type field is given in Table 14. MAC management messages shall not be carried on Transport Connections. MAC management messages that have a Type value specified in Table 14 as “Reserved,” or those not containing all required parameters or containing erroneously encoded parameters, shall be silently discarded.

*Change Table 14 as indicated:*

**Table 14—MAC Management messages**

Type	Message name	Message description	Connection
0	UCD	Uplink Channel Descriptor	<del>Broadcast</del> <u>Fragmentable Broadcast</u>
1	DCD	Downlink Channel Descriptor	<del>Broadcast</del> <u>Fragmentable Broadcast</u>
2	DL-MAP	Downlink Access Definition	Broadcast
3	UL-MAP	Uplink Access Definition	Broadcast
4	RNG-REQ	Ranging Request	Initial Ranging or Basic
5	RNG-RSP	Ranging Response	Initial Ranging or Basic

**Table 14—MAC Management messages (continued)**

Type	Message name	Message description	Connection
6	REG-REQ	Registration Request	Primary Management
7	REG-RSP	Registration Response	Primary Management
8	—	<i>Reserved</i>	—
9	PKM-REQ	Privacy Key Management Request	Primary Management
10	PKM-RSP	Privacy Key Management Response	Primary Management or Broadcast <sup>a</sup>
11	DSA-REQ	Dynamic Service Addition Request	Primary Management
12	DSA-RSP	Dynamic Service Addition Response	Primary Management
13	DSA-ACK	Dynamic Service Addition Acknowledge	Primary Management
14	DSC-REQ	Dynamic Service Change Request	Primary Management
15	DSC-RSP	Dynamic Service Change Response	Primary Management
16	DSC-ACK	Dynamic Service Change Acknowledge	Primary Management
17	DSD-REQ	Dynamic Service Deletion Request	Primary Management
18	DSD-RSP	Dynamic Service Deletion Response	Primary Management
19	—	<i>Reserved</i>	—
20	—	<i>Reserved</i>	—
21	MCA-REQ	Multicast Assignment Request	Primary Management
22	MCA-RSP	Multicast Assignment Response	Primary Management
23	DBPC-REQ	Downlink Burst Profile Change Request	Basic
24	DBPC-RSP	Downlink Burst Profile Change Response	Basic
25	RES-CMD	Reset Command	Basic
26	SBC-REQ	SS Basic Capability Request	Basic
27	SBC-RSP	SS Basic Capability Response	Basic
28	CLK-CMP	SS network clock comparison	Broadcast
29	DREG-CMD	De/Re-register Command	Basic
30	DSX-RVD	DSx Received Message	Primary Management
31	TFTP-CPLT	Config File TFTP Complete Message	Primary Management
32	TFTP-RSP	Config File TFTP Complete Response	Primary Management
33	ARQ-Feedback	Standalone ARQ Feedback	Basic
34	ARQ-Discard	ARQ Discard message	Basic
35	ARQ-Reset	ARQ Reset message	Basic
36	REP-REQ	Channel measurement Report Request	Basic
37	REP-RSP	Channel measurement Report Response	Basic
38	FPC	Fast Power Control	Broadcast

**Table 14—MAC Management messages (continued)**

Type	Message name	Message description	Connection
39	MSH-NCFG	Mesh Network Configuration	Broadcast
40	MSH-NENT	Mesh Network Entry	Basic
41	MSH-DSCH	Mesh Distributed Schedule	Broadcast
42	MSH-CSCH	Mesh Centralized Schedule	Broadcast
43	MSH-CSCF	Mesh Centralized Schedule Configuration	Broadcast
44	AAS-FBCK-REQ	AAS Feedback Request	Basic
45	AAS-FBCK-RSP	AAS Feedback Response	Basic
46	AAS_Beam_Select	AAS Beam Select message	Basic
47	AAS_BEAM_REQ	AAS Beam Request message	Basic
48	AAS_BEAM_RSP	AAS Beam Response message	Basic
49	DREG-REQ	SS De-registration message	Basic
<del>50–255</del>		<i>Reserved</i>	—
<u>50</u>	<u>MOB_SLP-REQ</u>	<u>sleep request message</u>	<u>basic</u>
<u>51</u>	<u>MOB_SLP-RSP</u>	<u>sleep response message</u>	<u>basic</u>
<u>52</u>	<u>MOB_TRF-IND</u>	<u>traffic indication message</u>	<u>broadcast</u>
<u>53</u>	<u>MOB_NBR-ADV</u>	<u>neighbor advertisement message</u>	<u>broadcast,</u> <u>primary management</u>
<u>54</u>	<u>MOB_SCN-REQ</u>	<u>scanning interval allocation request</u>	<u>basic</u>
<u>55</u>	<u>MOB_SCN-RSP</u>	<u>scanning interval allocation response</u>	<u>basic</u>
<u>56</u>	<u>MOB_BSHO-REQ</u>	<u>BS HO request message</u>	<u>basic</u>
<u>57</u>	<u>MOB_MSHO-REQ</u>	<u>MS HO request message</u>	<u>basic</u>
<u>58</u>	<u>MOB_BSHO-RSP</u>	<u>BS HO response message</u>	<u>basic</u>
<u>59</u>	<u>MOB_HO-IND</u>	<u>HO indication message</u>	<u>basic</u>
<u>60</u>	<u>MOB_SCN-REP</u>	<u>Scanning result report message</u>	<u>primary management</u>
<u>61</u>	<u>MOB_PAG-ADV</u>	<u>BS broadcast paging message</u>	<u>broadcast</u>
<u>62</u>	<u>MBS_MAP</u>	<u>MBS MAP message</u>	—
<u>63</u>	<u>PMC_REQ</u>	<u>Power control mode change request message</u>	<u>Basic</u>
<u>64</u>	<u>PMC_RSP</u>	<u>Power control mode change response message</u>	<u>Basic</u>
<u>65</u>	<u>PRC-LT-CTRL</u>	<u>Setup/Tear-down of long-term MIMO precoding</u>	<u>Basic</u>
<u>66</u>	<u>MOB_ASC-REP</u>	<u>Association result report message</u>	<u>primary management</u>
<u>67–255</u>		<i>Reserved</i>	—

<sup>3</sup>For subscribers and base stations that support PKMv2, PKM-RSP is sometimes transmitted on the broadcast connection.



*Change the text below Table 14 as indicated:*

In general, the PKM-RSP message is carried on the Primary Management connection. However, in order to send the PKM-RSP message in key push mode to MS for multicast service or broadcast service, it may be carried on the Broadcast connection.

During the adaptive antenna system (AAS) portion of the frame the DL-MAP, UL-MAP, DCD, UCD, MOB\_NBR-ADV, MOB\_TRF-IND, MOB\_PAG-ADV, and CLK-MAP messages may be sent using the basic CID.

### 6.3.2.3.1 Downlink Channel Descriptor (DCD) message

*Change the text as indicated:*

A DCD shall be transmitted by the BS at a periodic interval (Table 342) to define the characteristics of a downlink physical channel.

**Table 15—DCD message format**

Syntax	Size	Notes
DCD_Message_Format() {		
Management Message Type = 1	8 bits	
<del>Downlink channel ID</del> <i>Reserved</i>	8 bits	<u>Shall be set to zero</u>
Configuration Change Count	8 bits	
TLV Encoded information for the overall channel	<i>variable</i>	TLV specific
Begin PHY Specific Section {		See applicable PHY subclause
for (i = 1; i <= n; i++) {		For each downlink burst profile 1 to n
Downlink_Burst_Profile		PHY specific
}		
}		
}		

A BS shall generate DCDs in the format shown in Table 15, including all of the following parameters:

#### **Configuration Change Count**

Incremented by one (modulo 256) by the BS whenever any of the values of this channel descriptor change, except for the Frame Number for the OFDM PHY. If the value of this count in a subsequent DCD remains the same, the SS can quickly decide that the remaining fields have not changed and may be able to disregard the remainder of the message.

#### ~~**Downlink Channel ID**~~

~~The identifier of the downlink channel to which this message refers. This identifier is arbitrarily chosen by the BS and is unique only within the MAC domain. This acts as a local identifier for transactions such as ranging.~~

### 6.3.2.3.2 Downlink map (DL-MAP) message

*Change the second paragraph as indicated:*

A BS shall generate DL-MAP messages in the format shown in Table 16, including all of the following parameters:

**PHY Synchronization**

The PHY synchronization field is dependent on the PHY specification used. The encoding of this field is given in each PHY specification separately.

**DCD Count**

Matches the value of the configuration change count of the DCD, which describes the downlink burst profiles that apply to this map.

**Base Station ID**

The Base Station ID is a 48-bit long field identifying the BS. The Base Station ID shall be programmable. The most significant 24 bits shall be used as the operator ID. This is a network management hook that can be ~~combined with the Downlink Channel ID of the~~ sent with the DCD message for handling edge-of-sector and edge-of-cell situations.

*Change Table 16 as indicated:*

**Table 16—DL-MAP message format**

Syntax	Size	Notes
DL-MAP_Message_Format() {		
<b>Management Message Type = 2</b>	8 bits	
<b>PHY Synchronization Field</b>	<i>variable</i>	See appropriate PHY specification.
<b>DCD Count</b>	8 bits	
<b>Base Station ID</b>	48 bits	
Begin PHY Specific Section {		See applicable PHY subclause.
<u>if (WirelessMAN-OFDMA) {</u>		
<b><u>No. OFDMA symbols</u></b>	<u>8 bits</u>	<u>Number of OFDMA symbols in the DL subframe including all AAS/permutation zone.</u>
<u>}</u>		
for (i = 1; i <= n; i++) {		For each DL-MAP element 1 to n.
DL-MAP_IE()	<i>variable</i>	See corresponding PHY specification.
}		
}		
if !(byte boundary) {		
<b>Padding Nibble</b>	4 bits	Padding to reach byte boundary.
}		
}		

*Insert the following text at the end of the 6.3.2.3.2:*

The UL-MAP message (when present) shall be always transmitted in the first PDU on the burst described by the first DL-MAP\_IE of the DL-MAP (or, in the case of the OFDM PHY mode, of the DLFP).

The DL-MAP\_IEs in the DL-MAP shall be ordered in the increasing order of the transmission start time of the relevant PHY burst. The transmission start time is conveyed by the contents of the DL\_MAP\_IE in a manner that is PHY dependant.

The logical order in which MAC PDUs are mapped to the PHY layer bursts in the downlink is defined as the order of DL-MAP\_IEs in the DL-MAP message.

**6.3.2.3.4 Uplink map (UL-MAP) message**

*Change Table 18 as indicated:*

**Table 18—UL-MAP message format**

Syntax	Size	Notes
UL-MAP_Message_Format() {		
<b>Management Message Type = 3</b>	8 bits	
<del>Uplink Channel ID</del> <i>Reserved</i>	8 bits	<u>Shall be set to zero.</u>
<b>UCD Count</b>	8 bits	
<b>Allocation Start Time</b>	32 bits	
Begin PHY Specific Section {		See applicable PHY subclause.
if (WirelessMAN-OFDMA) {		
<b>No. OFDMA symbols</b>	8 bits	<u>Number of OFDMA symbols in the UL subframe</u>
↓		
for (i = 1; i <= n; i++) {		For each UL-MAP element 1 to n.
UL-MAP_IE()	<i>variable</i>	See corresponding PHY specification.
}		
}		
if !(byte boundary) {		
<b>Padding Nibble</b>	4 bits	Padding to reach byte boundary.
}		
}		

*Delete the ‘Uplink Channel ID’ description below Table 18:*

~~**Uplink Channel ID**~~

~~The identifier of the uplink channel to which this message refers.~~

*Change the third paragraph as indicated:*

IEs define uplink bandwidth allocations. Each UL-MAP message (except when the PHY layer is OFDMA PHY) shall contain at least one IE that marks the end of the last allocated burst. Ordering of IEs carried by the UL-MAP is PHY-specific.

*Insert the following text at the end of the subclause:*

For SC, SCa, and OFDMA PHYs, the UL-MAP message (if such exists) shall always be transmitted on the burst deccribed by the first DL\_MAP\_IE (and following the H-ARO\_MAP\_Pointer\_IE, if such exists in the

OFDMA PHY) of the DL-MAP message. If there are multiple PDUs in the burst described by the first DL\_MAP\_IE, the UL-MAP message shall be the first one.

The logical order in which MAC PDUs are mapped to the PHY layer bursts in the uplink is defined as the order of UL-MAP\_IEs in the UL-MAP message.

### 6.3.2.3.5 Ranging request (RNG-REQ) message

*Change 6.3.2.3.5 as indicated:*

An RNG-REQ shall be transmitted by the SS at initialization and periodically to determine network delay and to request power and/or downlink burst profile change. The format of the RNG-REQ message is shown in Table 19. The RNG-REQ message may be sent in Initial Ranging and data grant intervals.

**Table 19—RNG-REQ message format**

Syntax	Size	Notes
RNG-REQ_Message_Format() {		
<b>Management Message Type = 4</b>	8 bits	
<del>Downlink Channel ID</del> <i>Reserved</i>	8 bits	<u>Shall be set to zero</u>
<b>TLV Encoded Information</b>	<i>variable</i>	TLV specific
}		

The CID field in the MAC header shall assume the following values when sent in an Initial Ranging interval:

- a) Initial ranging CID if the SS is attempting to join the network.
- b) Initial ranging CID if the SS has not yet registered and is changing downlink (or both downlink and uplink) channels.
- c) In all other cases, the Basic CID is used as soon as one is assigned in the RNG-RSP message.

If sent in a data grant interval, the CID is always equal to the Basic CID.

An SS shall generate RNG-REQ messages in the format shown in Table 19, ~~including the following parameter:~~

**~~Downlink Channel ID~~**

~~The identifier of the downlink channel on which the SS received the UCD describing the uplink on which this ranging request message is to be transmitted. This is an 8-bit field.~~

All ~~other~~ parameters are coded as TLV tuples as defined in 11.5.

TLV message elements shall only be included in RNG-REQ messages of adequate UL bandwidth. In OFDMA, when the MS transmits the handover CDMA ranging code, the BS shall provide for initial UL bandwidth allocation of size at least sufficient for transmission of RNG-REQ message with MS MAC address TLV and Grant Management subheader. If required TLV message elements cannot be accommodated in the UL bandwidth of a current RNG-REQ message, after the MS obtains a Basic CID from the BS, the MS shall make UL BW request of sufficient size to conduct additional RNG-REQ including all required message elements, at the first available opportunity.

The following parameters shall be included in the RNG-REQ message when the SS is attempting ~~to join the network~~initial entry to the network:

**Requested Downlink Burst Profile****SS MAC Address**

The following parameter shall be included in the RNG-REQ message when transmitted during SS initial entry to the network. The parameter shall be sent on the SS's Basic connection or for OFDMA on the initial ranging connection:

**MAC Version (11.1.3)**

The following parameters may be included in the RNG-REQ message after the SS has received an RNG-RSP addressed to the SS:

**Requested Downlink Burst Profile****Ranging Anomalies**

The following parameter may be included in the RNG-REQ message:

**AAS broadcast capability**

The following parameter may be included in the RNG-REQ message when the MS is attempting to perform re-entry, association or handover:

**Requested Downlink Burst Profile**

The following parameter shall be included in the RNG-REQ message when the MS is attempting to perform re-entry, association or handover:

**Serving BSID**

The BSID of the BS to which the MS is currently connected (has completed the registration cycle and is in Normal Operation). The serving BSID shall not be included if the aging timer is timed-out (serving BSID AGINGTIMER, see Table 342). Inclusion of serving BSID in the RNG-REQ message signals to the target BS that the MS is currently connected to the network through the serving BS and is performing association or is in the process of handover network re-entry.

The following TLV parameter shall be included in the RNG-REQ message when the MS is attempting to perform re-entry, handover, or Location Update:

**Ranging Purpose Indication**

Presence of item in message indicates MS action as follows:

If Bit #0 is set to 1, in combination with serving BS ID BSID indicates the MS is currently attempting to HO; or in combination with Paging Controller ID the MS is attempting Network Re-entry from Idle Mode to the BS.

If Bit #1 is set to 1, indicates MS action of Idle Mode Location Update Process.

The following TLV parameter shall be included in the RNG-REQ message when the MS is attempting to perform re-entry:

**Paging Controller ID**

The Paging Controller ID is a logical network identifier for the serving BS or other network entity retaining MS service and operational information and/or administering paging activity for the MS while in Idle Mode.

The following TLV parameter may be included in RNG-REQ message when an MS is performing initial ranging to the selected target BS:

**HO\_ID**

Optional ID assigned for use in initial ranging to the target BS during HO once the BS is selected as the target BS (see 6.3.22.2.7).

The following parameter may be included in the RNG-REQ message when the MS is attempting to perform re-entry, association, or handover:

**MS MAC Address**

MS MAC Address shall be included if HO\_ID is omitted.

The following TLV parameter may be included in the RNG-REQ message when MS is attempting to perform Location Update:

**MAC Hash Skip Threshold**

Maximum number of successive MOB\_PAG-ADV messages that may be sent from a BS without individual notification for an MS, including MAC address hash of an MS for which Action Code is 00, 'No Action Required'.

The following TLV parameter shall be included in the RNG-REQ message when the MS is attempting to perform Location Update due to power down:

**Power Down Indicator**

Indicates the MS is currently attempting to perform Location Update due to power down.

The following parameter may be included in RNG-REQ message when the MS is attempting to perform handover and needs to inform target BS of its preference to continue in sleep mode after handover to target BS.

**Power Saving Class Parameters**

Compound TLV to specify Power Saving Class operation.

The following parameter may be included in the RNG-REQ message when the MS is attempting to perform network re-entry or handover and the MS has a valid HMAC/CMAC Tuple necessary to expedite security authentication.

**HMAC/CMAC Tuple (see 11.1.2)**

The HMAC/CMAC Tuple shall be the last attribute in the message.

**6.3.2.3.6 Ranging Response (RNG-RSP) message**

*Delete the third paragraph:*

A BS shall generate RNG-RSPs in the form shown in Table 20, including all of the following parameters:

**~~Uplink Channel ID~~**

~~The identifier of the uplink channel on which the BS received the RNG-REQ to which this response refers. This is an 8-bit quantity.~~

*Change the 'Uplink Channel ID' field in Table 20 as indicated:*

<del>Uplink Channel ID</del> <i>Reserved</i>	8 bits	<u>Shall be set to zero.</u>
--	--------	------------------------------

*Change the last paragraph as indicated:*

The following WirelessMAN-OFDMA PHY specific parameters shall be included in the RNG-RSP message when an initial or periodic ranging message based on code division multiple access (CDMA) is received, in which case the RNG-RSP shall use the initial ranging CID.

*Insert the following at the end of 6.3.2.3.6:*

The RNG-RSP is directed to the SS if it is sent on the Basic CID of the SS or if the RNG-RSP contains the MAC address of the SS, or, in the case of OFDMA, if the RNG-RSP contains CDMA-code parameters specifying the code sent by the SS.

When a BS sends a RNG-RSP message in response to a RNG-REQ message containing serving BSID, the BS may include the following TLV parameter in the RNG-RSP message:

**Service Level Prediction**—This value indicates the level of service the MS can expect from this BS. The following encodings apply:

- 0 = No service possible for this MS.
- 1 = Some service is available for one or several service flows authorized for the MS.
- 2 = For each authorized service flow, a MAC connection can be established with QoS specified by the AuthorizedQoSParamSet.
- 3 = No service level prediction available.

A Service Level Prediction may be accompanied by a number of service flow Encodings as specified in 11.13 sufficient to uniquely identify the AuthorizedQoSParamSet associated with the Service Level Prediction (SLP). If service flow encodings are included, then the SLP response is specific to the presented AuthorizedQoSParamSet defined by the associated encodings. Included service flow encodings are restricted to the following parameters only:

- Global Service Class Name.
- Service flow QoS parameter set encodings as defined in 11.13 such that the combination of Global Service Class Name and any service flow modifying parameters fully defines an AuthorizedQoSParamSet profile being assessed.
- Service flow Identifier.

If individual AuthorizedQoSParamSet profiles are provided for multiple Service Level Predictions, then each Service Level Prediction is specific to its associated AuthorizedQoSParamSet profile and shall include only response options 0 or 2.

When a BS sends a RNG-RSP message in response to a RNG-REQ message containing Paging Controller ID, the BS shall include the following TLV parameter in the RNG-RSP message:

**Location Update Response**

Response to Idle Mode LocationUpdate Request:

0b00=Failure of Idle Mode Location Update. The MS shall perform Network Re-entry from Idle Mode

0b01=Success of Idle Mode Location Update

0b10, 0b11: Reserved

**Paging Information**

New Paging Information assigned to MS. Paging Information shall only be included if Location Update Response = 0b01 and if Paging Information has changed.

**Paging Controller ID**

Paging Controller ID is a logical network identifier for the serving BS or other network entity retaining MS service and operational information and/or administering paging activity for the MS while in Idle Mode. Paging Controller ID shall only be included if Location Update Response = 0b01 and if Paging Controller ID has changed.

The following TLV parameter shall be included in the RNG-RSP message when the MS is attempting to perform network re-entry or handover and the target BS wishes to identify re-entry process management messages that may be omitted during the current HO attempt:

**HO Process Optimization**

Identifies re-entry process management messages that may be omitted during the current HO attempt due to the availability of MS service and operational context information obtained by means that are beyond the scope of this standard, and the MS service and operational status post-HO completion. The target BS may elect to use MS service and operational information obtained over the backbone network to build and send unsolicited SBC-RSP and/or REG-RSP management messages to update MS operational information. The MS shall not enter Normal Operation with Target BS until completing receiving all network re-entry, MAC management message responses as indicated in HO Process Optimization.

The following parameter may be included in RNG-RSP message transmitted in response to RNG-REQ message containing MAC Hash Skip Threshold:

**MAC Hash Skip Threshold**

Maximum number of successive MOB\_PAG-ADV messages that may be sent from a BS without individual notification for an MS, including MAC address hash of an MS for which Action Code for the MS is 00, 'No Action Required'.

The following TLV parameter shall be included in the RNG-RSP message when the periodic ranging in sleep operation completes and the serving BS decides to assign a new SLPID for the MS:

**SLPID\_Update (11.16.1)**

The SLPID\_Update is a compound TLV value that provides a shorthand method for changing the SLPID used by the MS during sleep mode operation. The SLPID\_Update TLV specifies new SLPID replacing old SLPID.

The following parameter may be included in RNG-RSP message by the BS to activate or deactivate Power Saving Class of type II and type III.

**Power\_Saving\_Class\_Parameters**

Compound TLV to specify Power Saving Class operation.



The following TLV parameter may be included in RNG-RSP message transmitted the BS permits an activation of Power Saving Class. This TLV indicates the enabled action that MS performs upon reaching trigger condition in sleep mode.

**Enabled-Action-Triggered**

Indicates possible action upon reaching trigger condition

The following TLV parameter shall be included in the RNG-RSP message when a BS sends RNG-RSP message as a reply to the RNG-REQ message from an MS which is performing initial ranging during HO and for which the BS has a current HO ID value:

**HO\_ID**

Optional ID assigned for use in initial ranging to the target BS once this BS is selected as the target BS (see 6.3.20.5).

The following TLV parameter shall be included for the BS to notify the MS of known future Next Periodic Ranging for the MS with its serving BS:

**Next Periodic Ranging**

Indicates the Frame Offset for the next periodic ranging opportunity. This value shall be set to zero to indicate that there has been DL traffic addressed to the MS.

The following parameter, necessary to expedite security authentication, shall be included in the RNG-RSP message when the BS notifies the MS through the HO Process Optimization TLV that the PKM-REQ/RSP sequence may be omitted for the current HO re-entry attempt, or when the BS wishes to acknowledge a valid HMAC/CMAC Tuple in the acknowledged RNG-REQ management message:

**HMAC/CMAC Tuple (see 11.1.2)**

The HMAC/CMAC Tuple shall be the last attribute in the message.

The following TLV parameter shall be included in the RNG-REQ message when a BS sends RNG-RSP message as a reply to the RNG-REQ message from an MS that is performing Location Update due to power down and:

**Power Down Response**

Indicates the MS's Power Down Location Update result.  
0x00= Failure of Power Down Information Update.  
0x01= Success of Power Down Information Update.

The following TLV may be present in RNG-RSP (see 7.8.1)

**PKMv2 SA-TEK-Challenge Tuple**

This carries the initial challenge of the 3-way handshake.

**6.3.2.3.7 Registration request (REG-REQ) message**

*Change the second paragraph below Table 21 as follows:*

The REG-REQ shall contain the following TLVs:

**Hashed Message Authentication Code (HMAC)/CMAC Tuple**

Shall be final attribute in the message's TLV attribute list (11.1.2).

In Mesh Mode, message digest is calculated using HMAC\_KEY\_U.

*Change the third paragraph below Table 21 as indicated:*

For PMP operation, the REG-REQ shall contain the following TLVs:

**~~Uplink~~ CID Support (11.7.6)**  
**SS management support (11.7.2)**  
**IP management mode (11.7.3)**

*Change the fourth paragraph below Table 21 as indicated:*

In Mesh Mode, the REG-REQ shall contain the following TLVs:

**SS MAC Address (11.7.9)**  
**MAC Version (11.1.3)**

*Insert the following text at the end of 6.3.2.3.7*

For an MS, the REG-REQ (on initial network entry) shall contain the following TLVs:

**Handover supported (11.7.12)**  
**Mobility parameters support (11.7.14)**

The REG-REQ may contain the following TLV:

**MAC header and extended subheader support (11.7.25).**

### **6.3.2.3.8 Registration Response (REG-RSP) message**

*Change the first paragraph below Table 22 as follows:*

The REG-RSP shall contain the following TLVs:

**SS management support (11.7.2)**

Response to REG-REQ indicating the mode of SS management operation.

**Secondary Management CID (11.7.5)**

Present only if the SS has indicated in the REG-REQ that it is a managed SS.

When the Secondary Management CID is present, the following uplink QoS parameters may be also included in the message:

Traffic priority (11.13.5)

Maximum sustained traffic rate (11.13.6)

Minimum reserved traffic rate (11.13.8)

Maximum latency (11.13.14)

**IP management mode (11.7.3)**

Response to REG-REQ indication of whether or not the requester wishes to accept IP-based traffic on the Secondary Management Connection, once the initialization process has completed.

**HMAC/CMAC Tuple (11.1.2)**

The HMAC/CMAC Tuple attribute shall be the final attribute in the message's TLV attribute list.

In Mesh Mode, message digest is calculated using HMAC\_KEY\_D.

***Change the end of the subclause as indicated:***

The REG-RSP may contain the following TLVs:

**SS Capabilities Encodings (11.7.8)**

Response to the capabilities of the requester provided in the REG-REQ. Included in the response if the request included capabilities information. The response indicates whether or not the capabilities may be used. If a capability is not recognized, the response indicates that this capability shall not be used by the requester. Capabilities returned in the REG-RSP shall not be set to require greater capability of the requester than is indicated in the REG-REQ.

**IP Version (11.7.4)****Vendor ID Encoding (of the responder; 11.1.5)****Vendor-specific information (11.1.6)**

Included if the RNG-REQ contained the Vendor ID Encoding of the requester.

**Convergence sublayer capabilities (11.7.7)**

Response to the capabilities of the requester provided in the REG-REQ. Included in the response if the request included Convergence Sublayer Capabilities information. The response indicates whether or not the capabilities may be used. If a capability is not recognized, the response indicates that this capability shall not be used by the requester. Capabilities returned in the REG-RSP shall not be set to require greater capability of the requester than is indicated in the REG-REQ.

**ARQ Parameters (11.7.1)**

ARQ and fragmentation parameters specified by the BS to complete ARQ parameter negotiation for the secondary management connection. This information is only included in the message if ARQ Parameters were supplied by the SS in the original REG-REQ message. For purposes of the parameter negotiation dialog, the parameters supplied in this message are equivalent to those supplied in the DSA-RSP message.

**~~IP management mode (11.7.3)~~**

~~Response to REG-REQ indication of whether or not the requester wishes to accept IP-based traffic on the Secondary Management Connection, once the initialization process has completed.~~

***Insert the following text at the end 6.3.2.3.8:***

For mobile stations, when the information is available to create CID update TLV, the target BS shall include the CID\_update and SAID\_update TLVs in the REG-RSP for an MS recognized by the target BS as performing HO or Network Re-entry from Idle Mode. BS may include the Compressed CID Update TLV instead of the CID\_update TLV in REG-RSP message if CID update procedure is required. The target BS recognizes an MS performing Network Re-entry from Idle Mode by the presence of a serving BSID or Paging Controller ID and Ranging Purpose Indication with Bit #0 set to 1 in the RNG-REQ message.

**CID\_update**

The CID\_update is a compound TLV value that provides a shorthand method for replacing the active connections used by the MS in its previous serving BS. Each CID\_update TLV specifies a CID in the target BS that shall replace a CID used in the previous serving BS. Multiple instances of CID\_update may occur in the REG-RSP to facilitate re-creating and re-assigning admitted or active service flows for the MS from its previous serving BS. If any of the service flow parameters change (including Target SAID, see 11.3.18), then those service flow parameter encoding TLVs that have changed will be added. If the BS cannot re-establish a particular service flow, it shall not include an instance of CID\_update for that service flow.

These TLVs enable the target BS to renew connections used in the previous serving BS, but with different QoS settings.

**Compressed CID\_update**

The Compressed CID\_update TLV also provides a method for replacing the active connections used by the MS in its previous serving BS as CID update TLV. It can diminish the length of

REG-RSP message. CID update and Compressed CID update TLVs shall be exclusively included in REG-RSP message. (See 11.7.10.1.)

#### **SAID\_update**

The SAID\_update is a compound TLV value that provides a shorthand method for renewing active SAs used by the MS in its previous serving BS. The TLVs specify SAID in the target BS that shall replace active SAID used in the previous serving BS. Multiple iterations of these TLVs may occur in the REG-RSP suitable to re-creating and re-assigning all active Security Associations for the MS from its previous serving BS including Primary, Dynamic and Static SAIDs. If any of the Security Associations parameters change, then those Security Associations parameters encoding TLVs that have changed will be added.

When a BS has multiple number Provisioned service flows to transmit to an MS, the BS may include:

#### **Total number of provisioned service flow TLV (11.7.19).**

The REG-RSP may contain the following TLV:

#### **MAC header and extended subheader support (11.7.25).**

For an MS, the REG-RSP (on initial network entry) shall contain the following TLVs:

#### **Handover supported (11.7.12).**

#### **Mobility parameters support (11.7.14).**

### **6.3.2.3.9 Privacy key management (PKM) messages (PKM-REQ/PKM-RSP)**

*Change the text directly below Table 24 as indicated:*

PKM protocol messages transmitted from the BS to the SS shall use the form shown in Table 25. They are transmitted on the SSs Primary Management Connection. When the BS sends PKM-RSP message in key push mode to MS for multicast service or broadcast service, it may be carried on the Broadcast connection.

*Change the text between Table 25 and Table 26 as indicated:*

The parameters shall be as follows:

#### **Code**

The Code is one byte and identifies the type of PKM packet. When a packet is received with an invalid Code, it shall be silently discarded. The code values are defined in Table 26.

#### **PKM Identifier**

The Identifier field is one byte. An SS uses the identifier to match a BS response to the SS requests. In the case of 3-way SA-TEK procedure, however, a BS uses it to match an SS response to the BS's challenges.

The SS shall increment (modulo 256) the Identifier field whenever it issues a new PKM message. In PKMv1, a "new" message is an Authorization Request or Key Request that is not a retransmission being sent in response to a Timeout event. In PKMv2, a PKMv2 RSA-Request, PKMv2 SA-TEK-Challenge, or PKMv2 Key-Request message is a "new" message. For retransmissions, the Identifier field shall remain unchanged.

The Identifier field in PKMv2 EAP-Transfer messages, PKMv2 Authenticated EAP messages, and ~~in~~ Authentication Information messages, which are informative and do not effect any response messaging, shall be set to zero. The Identifier field in a BS's PKM-RSP message shall match the Identifier field of the PKM-REQ message the BS is responding to. The Identifier field in TEK Invalid messages and PKMv2 TEK Invalid messages, which are not sent in response to PKM-REQs, shall be set to zero. The Identifier field in ~~PKMv2 Group~~ unsolicited Authorization Invalid messages shall be set to zero. The Identifier field in

PKMv2 Group-Key-Update-Command messages, which are used to distribute the updated GTEK and traffic keying material, shall be set to zero.

On reception of a PKM-RSP message, the SS associates the message with a particular state machine (the Authorization state machine in the case of Authorization Replies, Authorization Rejects, and Authorization Invalids for the PKMv1, PKMv2 RSA Reply, PKMv2 RSA Reject, PKMv2 EAP Transfer, PKMv2 SA-TEK-Challenge, SA-TEK-Request, PKMv2 SA-TEK-Response for the PKMv2; a particular TEK state machine in the case of Key Replies, Key Rejects, and TEK Invalids for the PKMv1, PKMv2-Key-Reply, PKMv2-Key-Reject, PKMv2 TEK-Invalids, and PKMv2 Group-Key-Update-Commands for the PKMv2).

In PKMv1, only SS shall keep track of the identifier of its latest.

An SS shall keep track of the identifier of its latest, pending Authorization Request. The SS shall discard Authorization Reply and Authorization Reject messages with Identifier fields not matching that of the pending Authorization Request.

An SS shall keep track of the identifiers of its latest, pending Key Request for each SA. The SS shall discard Key Reply and Key Reject messages with Identifier fields not matching those of the pending Key Request messages.

In PKMv2, both an SS and a BS shall keep track of the identifier of its latest.

An SS shall keep track of the identifier of its latest, pending PKMv2 RSA-Request. The SS shall discard PKMv2 RSA-Reply and PKMv2 RSA-Reject messages with Identifier fields not matching that of the pending PKMv2 RSA-Request. Moreover, a BS shall keep it, pending PKMv2 RSA-Reply. The BS shall discard PKMv2 RSA-Acknowledgement messages with identifier fields not matching that of the pending PKMv2 RSA-Reply.

A BS shall keep track of the identifier of its latest, pending PKMv2 SA-TEK-Challenge. The BS shall discard PKMv2 SA-TEK-Request messages with Identifier fields not matching that of the pending PKMv2 SA-TEK-Challenge. In addition, an SS shall keep it, pending PKMv2 SA-TEK-Request. The SS shall discard PKMv2 SA-TEK-Reply messages with identifier fields not matching that of the pending PKMv2 SA-TEK-Request.

An SS shall keep track of the identifier of its latest, pending PKMv2 Key-Request. The SS shall discard PKMv2 Key-Reply and PKMv2 Key-Reject messages with Identifier fields not matching that of the pending PKMv2 Key-Request.

### **Attributes**

PKM attributes carry the specific authentication, authorization, and key management data exchanged between client and server. Each PKM packet type has its own set of required and optional attributes. Unless explicitly stated, there are no requirements on the ordering of attributes within a PKM message. The end of the list of attributes is indicated by the LEN field of the MAC PDU header.

Change Table 26 as indicated:

**Table 26—PKM message codes**

Code	PKM message type	MAC Management message name
0-2	<i>Reserved</i>	—
3	SA Add	PKM-RSP
4	Auth Request	PKM-REQ
5	Auth Reply	PKM-RSP
6	Auth Reject	PKM-RSP
7	Key Request	PKM-REQ
8	Key Reply	PKM-RSP
9	Key Reject	PKM-RSP
10	Auth Invalid	PKM-RSP
11	TEK Invalid	PKM-RSP
12	Auth Info	PKM-REQ
<u>13</u>	<u>PKMv2 RSA-Request</u>	<u>PKM-REQ</u>
<u>14</u>	<u>PKMv2 RSA-Reply</u>	<u>PKM-RSP</u>
<u>15</u>	<u>PKMv2 RSA-Reject</u>	<u>PKM-RSP</u>
<u>16</u>	<u>PKMv2 RSA-Acknowledgement</u>	<u>PKM-REQ</u>
<u>17</u>	<u>PKMv2 EAP Start</u>	<u>PKM-REQ</u>
<u>18</u>	<u>PKMv2 EAP-Transfer</u>	<u>PKM-REQ/PKM-RSP</u>
<u>19</u>	<u>PKMv2 Authenticated EAP-Transfer</u>	<u>PKM-REQ/PKM-RSP</u>
<u>20</u>	<u>PKMv2 SA TEK Challenge</u>	<u>PKM-RSP</u>
<u>21</u>	<u>PKMv2 SA TEK Request</u>	<u>PKM-REQ</u>
<u>22</u>	<u>PKMv2 SA TEK Response</u>	<u>PKM-RSP</u>
<u>23</u>	<u>PKMv2 Key-Request</u>	<u>PKM-REQ</u>
<u>24</u>	<u>PKMv2 Key-Reply</u>	<u>PKM-RSP</u>
<u>25</u>	<u>PKMv2 Key-Reject</u>	<u>PKM-RSP</u>
<u>26</u>	<u>PKMv2 SA-Addition</u>	<u>PKM-RSP</u>
<u>27</u>	<u>PKMv2 TEK-Invalid</u>	<u>PKM-RSP</u>
<u>28</u>	<u>PKMv2 Group-Key-Update-Command</u>	<u>PKM-RSP</u>
<u>29</u>	<u>PKMv2 EAP Complete</u>	<u>PKM-RSP</u>
<u>30</u>	<u>PKMv2 Authenticate EAP Start</u>	<u>PKM-REQ</u>
<u>2943–255</u>	<i>Reserved</i>	—

Auth Invalid and Auth Info messages may be used in PKMv1 and PKMv2.

**6.3.2.3.9.2 Authorization Request (Auth Request) message**

*Change the last paragraph as indicated:*

An SAID attribute contains a ~~Privacy~~ Primary SAID. In this case, the provided SAID is the SS’s Basic CID, which is equal to the Basic CID assigned to the SS during initial ranging.

*Insert new subclause 6.3.2.3.9.11 at the end of 6.3.2.3.9:*

**6.3.2.3.9.11 PKMv2 RSA-Request message**

A client MS sends a PKMv2 RSA-Request message to the BS in order to request mutual authentication in the RSA-based authorization.

Code: 13

Attributes are shown in Table 37a.

**Table 37a— PKMv2 RSA-Request attributes**

Attribute	Contents
MS_Random	A 64-bit random number generated in the MS
MS_Certificate	Contains the MS’s X.509 user certificate
SAID	MS’s primary SAID equal to the Basic CID
SigSS	An RSA signature over all the other attributes in the message

The MS-certificate attribute contains an X.509 MS certificate (see 7.6) issued by the MS’s manufacturer. The MS’s X.509 certificate is as defined in 6.3.2.3.9.2.

The SigSS indicates an RSA signature over all the other attributes in this message, and the MS’s private key is used to make an RSA signature.

*Insert new subclause 6.3.2.3.9.12:*

**6.3.2.3.9.12 PKMv2 RSA-Reply message**

Sent by the BS to a client MS in response to a PKMv2 RSA-Request message, the PKMv2 RSA-Reply message contains an encrypted pre-PAK, the key’s lifetime, and the key’s sequence number. The pre-PAK shall be encrypted with the MS’s public key. The MS\_Random number is returned from the PKMv2 RSA-Request message, along with a random number supplied by the BS, thus enabling assurance of key liveness.

Code: 14

Attributes are shown in Table 37b.

**Table 37b— PKMv2 RSA-Reply attributes**

Attribute	Contents
MS_Random	A 64-bit random number generated in the MS
BS_Random	A 64-bit random number generated in the BS
Encrypted pre-PAK	RSA-OAEP-Encrypt(PubKey(MS), pre-PAK   MS MAC Address)
Key Lifetime	PAK Aging timer
Key Sequence Number	PAK sequence number
BS_Certificate	Contains the BS's X.509 certificate
SigBS	An RSA signature over all the other attributes in the message

The SigBS indicates an RSA signature over all the other attributes in this message, and the BS's private key is used to make an RSA signature.

*Insert new subclause 6.3.2.3.9.13:*

**6.3.2.3.9.13 PKMv2 RSA-Reject message**

The BS responds to an SS's authorization request with an PKMv2 RSA-Reject message if the BS rejects the SS's authorization request.

Code: 15

Attributes are shown in Table 37c.

**Table 37c—PKMv2 RSA-Reject attributes**

Attribute	Contents
MS_Random	A 64 bit random number generated in the MS
BS_Random	A 64 bit random number generated in the BS
Error-Code	Error code identifying reason for rejection of authorization request
BS_Certificate	Contains the BS's X.509 certificate
Display-String (optional)	Display string providing reason for rejection of authorization request
SigBS	An RSA signature over all the other attributes in the message

The Error-Code and Display-String attributes describe to the requesting MS the reason for the RSA-based authorization failure.

The SigBS indicates an RSA signature over all the other attributes in this message, and the BS's private key is used to make an RSA signature.



*Insert new subclause 6.3.2.3.9.14:*

#### **6.3.2.3.9.14 PKMv2 RSA-Acknowledgement message**

The MS sends the PKMv2 RSA-Acknowledgement message to BS in response to a PKMv2 RSA-Reply message or a PKMv2 RSA-Reject message. Only if the value of Auth Result Code is failure, then the Error-Code and Display-String can be included in this message.

Code: 16

Attributes are shown in Table 37d.

**Table 37d—PKMv2 RSA-Acknowledgement attributes**

Attribute	Contents
BS_Random	A 64-bit random number generated in the BS
Auth Result Code	Indicates result (Success or Failure) of authorization procedure
Error-Code	Error code identifying reason for rejection of authorization request
Display-String (optional)	Display string providing reason for rejection of authorization request
SigSS	An RSA signature over all the other attributes in the message

The SigSS indicates an RSA signature over all the other attributes in this message, and the SS's private key is used to make an RSA signature.

*Insert new subclause 6.3.2.3.9.15:*

#### **6.3.2.3.9.15 PKMv2 EAP Start message**

In the case of EAP re-authentication, “HMAC Digest/CMAC Digest” and “Key Sequence Number” attributes shall be included. At initial EAP authentication, these attributes are omitted.

Code: 17

Attributes are shown in Table 37e.

**Table 37e—EAP-Start attributes**

Attribute	Contents
Key Sequence Number	AK sequence number
HMAC Digest/CMAC Digest	Message digest calculated using AK

*Insert new subclause 6.3.2.3.9.16:*

**6.3.2.3.9.16 PKMv2 EAP Transfer message**

When an MS has an EAP payload received from an EAP method for transmission to the BS or when a BS has an EAP payload received from an EAP method for transmission to the MS, it encapsulates it in a PKMv2 EAP Transfer message. In the case of re-authentication, “HMAC Digest/CMAC Digest” and “Key Sequence Number” attributes shall be included.

Code: 18

Attributes are shown in Table 37f.

**Table 37f—PKMv2 EAP Transfer attributes**

Attribute	Contents
EAP Payload	Contains the EAP authentication data, not interpreted in the MAC
Key Sequence Number	AK sequence number
HMAC Digest/CMAC Digest	Message Digest calculated using AK

The EAP Payload field carries data in the format described in section 4 of RFC 3748.

*Insert new subclause 6.3.2.3.9.17:*

**6.3.2.3.9.17 PKMv2 Authenticated EAP Transfer messages**

This message is used for Authenticated EAP-based authorization (if this was specified by Authorization Policy Support negotiated in the SBC-REQ/RSP exchange). Specifically, when an MS or BS has an EAP payload received from an EAP method for transmission after an authentication established EIK, it encapsulates the EAP payload in a PKMv2 Authenticated EAP Transfer message.

Code: 19

Attributes are shown in Table 37g.

**Table 37g—PKMv2 Authenticated EAP message attributes**

Attribute	Contents
Key Sequence Number	PAK Sequence Number (optional)
EAP Payload	Contains the EAP authentication data, not interpreted in the MAC
HMAC/CMAC Digest	Message Digest calculated using EIK

The EAP Payload field carries EAP data in the format described in RFC 3748.

The CMAC-Digest’s or HMAC Digest’s attribute shall be the final attribute in the message’s attribute list.

Inclusion of the CMAC or HMAC Digest allows the MS and BS to cryptographically bind previous authorization and following EAP authentication by authenticating the EAP payload. The key for the CMAC Value or HMAC Digest is derived from the EIK.

PAK Sequence Number attribute carries PAK sequence number only if MS and BS negotiate “Authenticated EAP after RSA” mode.

***Insert new subclause 6.3.2.3.9.18:***

**6.3.2.3.9.18 PKMv2 SA-TEK-Challenge message**

The BS transmits the PKMv2 SA-TEK-Challenge message as a first step in the 3-way SA-TEK handshake at initial network entry and at reauthorization. The BS shall send this message to the MS after finishing authorization procedure(s) selected by the negotiated Authorization Policy Support included in the SBC-REQ/RSP messages. It identifies an AK to be used, and includes a random number challenge to be returned by the MS in the PKMv2 SA-TEK-Request message.

Code: 20

Attributes are shown in Table 37h.

**Table 37h—PKMv2 SA-TEK-Challenge message attributes**

Attribute	Contents
BS_Random	A freshly generated random number of 64 bits.
Key Sequence Number	AK sequence number.
AKID	AKID of the AK (this is the AKID of the <i>new</i> AK in the case of re-authentication).
Key lifetime	PMK lifetime, this attribute shall include only follows EAP-based authorization or EAP-based reauthorization procedures.
HMAC/CMAC Digest	Message authentication digest for this message.

The generation of the AK sequence number and the AKID is defined in 7.2.2.4.1.

The HMAC Digest attribute or the CMAC-Digest attribute shall be the final attribute in the message’s attribute list.

Inclusion of the HMAC Digest or the CMAC-Digest allows the MS and BS to authenticate a PKMv2 SA-TEK-Challenge message. The HMAC or the CMAC authentication keys are derived from the AK.

***Insert new subclause 6.3.2.3.9.19:***

**6.3.2.3.9.19 PKMv2 SA-TEK-Request message**

The MS transmits the PKMv2 SA-TEK-Request message after receipt and successful HMAC Digest or CMAC value verification of an SA-Challenge tuple or PKMv2 SA-TEK-Challenge message from the BS. The PKMv2 SA-TEK-Request proves liveness of the MS and its possession of the AK to the BS. If this

message is being generated during initial network entry, then it constitutes a request for SA-Descriptors identifying the primary and static SAs and GSAs the requesting MS is authorized to access and their particular properties (e.g., type, cryptographic suite).

If this message is being generated following HO, then it constitutes a request for establishment (in the target BS) of TEKs, GTEKs and GKEKs for the MS and renewal of active primary, static and dynamic SAs and associated SAIDs used by the MS in its previous serving BS.

Code: 21

Attributes are shown in Table 37i.

**Table 37i—PKMv2 SA-TEK-Request message attributes**

Attribute	Contents
MS_Random	A 64-bit number chosen by the MS freshly for every new handshake <sup>a</sup>
BS_Random	The 64-bit random number used in the PKMv2 SA-TEK-Challenge message or SA-Challenge Tuple
Key Sequence Number	AK sequence number
AKID	Identifies the AK that was used for protecting this message
Security-Capabilities	Describes requesting MS's security capabilities
Security Negotiation Parameters	Confirms requesting MS's security capabilities (see 11.8.4)
PKMv2 configuration settings	PKMv2 configuration defined in 11.9.36
HMAC/CMAC Digest	Message authentication digest for this message

<sup>a</sup>Receipt of a new BS Random value in SA-TEK-Challenge or SA-Challenge tuple indicates the beginning of a new handshake.

*Insert new subclause 6.3.2.3.9.20:*

**6.3.2.3.9.20 PKMv2 SA-TEK-Response message**

The BS transmits the PKMv2 SA-TEK-Response message as a final step in the 3-way SA-TEK handshake.

Code: 22

Attributes are shown in Table 37j.

**Table 37j—PKMv2 SA-TEK-Response message attributes**

Attribute	Contents
MS_Random	The number received from the MS.
BS_Random	The random number included in the PKMv2 SA-TEK-Challenge message or SA-Challenge TLV.
Key Sequence Number	AK sequence number.
AKID	This identifies the AK to the MS that was used for protecting this message.

**Table 37j—PKMv2 SA-TEK-Response message attributes (continued)**

Attribute	Contents
SA_TEK_Update	A compound TLV list each of which specifies an SA identifier (SAID) and additional properties of the SA that the MS is authorized to access. This compound field may be present at the reentry only. For each active SA in previous serving BS, corresponding TEK, GTEK and GKEK parameters are included.
Frame Number	An absolute frame number in which the old PMK and all its associate AKs should be discarded.
(one or more) SA-Descriptor(s)	Each compound SA-Descriptor attribute specifies an SA identifier (SAID) and additional properties of the SA. This attribute is present at the initial network entry only.
Security Negotiation Parameters	Confirms the authentication and message integrity parameters to be used (see 11.8.4).
HMAC Digest/CMAC Digest	Message authentication digest for this message.

*Insert new subclause 6.3.2.3.9.21:*

#### **6.3.2.3.9.21 PKMv2 Key-Request message**

An MS sends a PKMv2 Key-Request message to the BS to request new TEK and TEK-related parameters (GTEK and GTEK-related parameters for the multicast or broadcast service) or GKEK and GKEK-related parameters for the multicast or broadcast service.

Code: 23

Attributes are shown in Table 37k.

**Table 37k—PKMv2 Key Request attributes**

Attribute	Contents
Key Sequence Number	AK sequence number
SAID	Security association identifier —GSAID for multicast or broadcast service
Nonce	A random number generated in an MS
HMAC Digest/CMAC Digest	Message Digest calculated using AK

The HMAC Digest attribute or the CMAC-Digest attribute shall be the final attribute in the message's attribute list.

Inclusion of the HMAC Digest or the CMAC digest allows the MS and BS to authenticate the PKMv2 Key-Request message. The HMAC Digest or the CMAC-Digest's authentication key is derived from the AK.

*Insert new subclause 6.3.2.3.9.22:*

**6.3.2.3.9.22 PKMv2 Key-Reply message**

The BS responds to an MS’s PKMv2 Key-Request message with a PKMv2 Key-Reply message.

Code: 24

Attributes are shown in Table 371.

**Table 371—PKMv2 Key-Reply attributes**

Attribute	Contents
Key Sequence Number	AK sequence number.
SAID	Security association identifier — GSAID for multicast or broadcast service.
TEK-Parameters	“Older” generation of key parameters relevant to SAID — GTEK-Parameters for the multicast or broadcast service.
TEK-Parameters	“Newer” generation of key parameters relevant to SAID.
GKEK-Parameters	“Older” generation of GKEK-related parameters for multicast or broadcast service.
GKEK-Parameters	“Newer” generation of GKEK-related parameters for multicast or broadcast service.
Nonce	A same random number included in the PKMv2 Key Request message.
HMAC/CMAC Digest	Message Digest calculated using AK.

The TEK-Parameters and the SAID attributes are as defined in 6.3.2.3.9.5.

The GKEK-Parameters attribute is a compound attribute containing all of the GKEK-related parameters corresponding to a GSAID. This would include the GKEK, the GKEK’s remaining key lifetime, and the GKEK’s key sequence number. The older generation of GKEK-Parameters is valid within the current lifetime and the newer generation of GKEK-Parameters is valid within the next lifetime.

The HMAC Digest or the CMAC-Digest attribute shall be the final attribute in the message’s attribute list.

Inclusion of the HMAC Digest or the CMAC digest allows the MS and BS to authenticate the PKMv2 Key-Reply message. The HMAC Digest or the CMAC-Digest’s authentication key is derived from the AK.

*Insert new subclause 6.3.2.3.9.23:*

**6.3.2.3.9.23 PKMv2 Key-Reject message**

The BS responds to an MS’s PKMv2 Key-Request message with a PKMv2 Authorization-Reject message if the BS rejects the MS’s traffic keying material request.

Code: 25

Attributes are shown in Table 37m.

**Table 37m—PKMv2 Key-Reject attributes**

Attribute	Contents
Key Sequence Number	AK sequence number.
SAID	Security association identifier.
Error-Code	Error code identifying reason for rejection of the PKMv2 Key-Request message.
Display-String (optional)	Display string containing reason for the PKMv2 Key-Request message.
Nonce	A same random number included in the PKMv2 Key Request message.
HMAC/CMAC Digest	Message Digest calculated using AK.

The HMAC Digest or the CMAC-Digest attribute shall be the final attribute in the message's attribute list.

Inclusion of the HMAC Digest or the CMAC digest allows the MS and BS to authenticate the PKMv2 Key-Reject message. The HMAC Digest or the CMAC-Digest's authentication key is derived from the AK.

*Insert new subclause 6.3.2.3.9.24:*

**6.3.2.3.9.24 PKMv2 SA-Addition message**

This message is sent by the BS to the SS to establish one or more additional SAs.

Code: 26

Attributes are shown in Table 37n.

**Table 37n—PKMv2 SA-Addition attributes**

Attribute	Contents
Key Sequence Number	AK sequence number.
(one or more) SA-Descriptor(s)	Each compound SA-Descriptor attribute specifies an SA identifier (SAID) and additional properties of the SA.
HMAC/CMAC Digest	Message Digest calculated using AK.

The HMAC Digest or the CMAC-Digest attribute shall be the final attribute in the message's attribute list.

Inclusion of the HMAC Digest or the CMAC digest allows the MS and BS to authenticate the PKMv2 SA-Add message. The HMAC Digest or the CMAC-Digest's authentication key is derived from the AK.

*Insert new subclause 6.3.2.3.9.25:*

**6.3.2.3.9.25 PKMv2 TEK-Invalid message**

The BS sends a PKMv2 TEK-Invalid message to a client MS if the BS determines that the MS encrypted an uplink PDU with an invalid TEK (i.e., an SAID’s TEK key sequence number), contained within the received packet’s MAC header, is out of the BS’s range of known, valid sequence numbers for that SAID.

Code: 27

Attributes are shown in Table 37o.

**Table 37o—PKMv2 TEK-Invalid attributes**

Attribute	Contents
Key Sequence Number	AK sequence number
SAID	Security Association Identifier
Error-Code	Error code identifying reason for PKMv2 TEK-Invalid message
Display-String (optional)	Display string containing reason for the PKMv2 TEK-Invalid message
HMAC/CMAC Digest	Message Digest calculated using AK

The HMAC Digest or the CMAC-Digest attribute shall be the final attribute in the message’s attribute list.

Inclusion of the HMAC Digest or the CMAC digest allows the MS and BS to authenticate the PKMv2 SA-Add message. The HMAC Digest or the CMAC-Digest’s authentication key is derived from the AK.

*Insert new subclause 6.3.2.3.9.26:*

**6.3.2.3.9.26 PKMv2 Group-Key-Update-Command message**

This message is sent by BS to push the GTEK and/or GKEK parameters to MSs served with the specific multicast service or broadcast service.

Code: 28

Attributes are shown in Table 37p.

**Table 37p—PKMv2 Group Key update command attributes**

Attribute	Contents
Key-Sequence-Number	AK sequence number
GSAID	Security Association ID
Key Push Modes	Usage code of Key Update Command message.
Key Push Counter	Counter one greater than that of older generation.
GTEK-Parameters	“Newer” generation of GTEK-related parameters relevant to GSAID. The GTEK-Parameters is the TEK-Parameters for multi-cast or broadcast service.



**Table 37p—PKMv2 Group Key update command attributes (continued)**

Attribute	Contents
GKEK-Parameters	“Newer” generation of GKEK-related parameters for multicast or broadcast service.
HMAC/CMAC Digest	Message integrity code of this message.

Key Sequence Number is the sequence number of the synchronized AK (Authorization Key) between an MS and a BS.

GSAID is SAID for the multicast group or the broadcast group. The type and length of the GSAID is equal to ones of the SAID.

There are two types in a PKMv2 Group Key Update Command message, GKEK update mode and GTEK update mode. The former is used to update GKEK and the latter is used to update GTEK for the multicast service or the broadcast service. Key Push Modes indicates the usage code of a PKMv2 Group Key Update Command message. The PKMv2 Group Key Update Command message for the GKEK update mode is carried on the Primary Management connection, but one for the GTEK update mode is carried on the Broadcast connection. A few attributes in a PKMv2 Group Key Update Command message shall not be used according this Key Push Modes attribute’s value. See 11.9.33 for details.

Key Push Counter is used to protect for replay attack. This value is one greater than that of older generation.

A PKMv2 Group Key Update Command message contains only newer generation of key parameters, because this message inform an MS next traffic key material. The GTEK-Parameters attribute is a compound attribute containing all of the keying material corresponding to a newer generation of a GSAID’s GTEK. This would include the GTEK, the GTEK’s remaining key lifetime, the GTEK’s key sequence number, the associated GKEK sequence number, and the cipher block chaining (CBC) initialization vector. The GTEK is TEK for the multicast group or the broadcast group. The type and length of the GTEK is equal to ones of the TEK. The GKEK (Group Key Encryption Key) can be randomly generated from a BS or a certain network node (i.e., an ASA server). The GKEK should be identically shared within the same multicast group or the broadcast group. The GTEK is encrypted with GKEK for the multicast service or the broadcast service. GKEK parameters contain the GKEK encrypted by the KEK, GKEK sequence number, and GKEK lifetime. See 7.5.4.4 for details.

The HMAC/CMAC Digest attribute shall be the final attribute in the message’s attribute list. Inclusion of the keyed digest allows the receiving client to authenticate the Group Key Update Command message. The HMAC/CMAC Digest’s authentication key is derived from the AK for the GKEK update mode and GKEK for the GTEK update mode. See 7.5.4.3 for details.

***Insert new subclause 6.3.2.3.9.27:***

#### **6.3.2.3.9.27 PKMv2 EAP Complete**

In double EAP mode (EAP after EAP), BS sends the PKMv2 EAP Complete message to MS with EAP-Success to inform MS of completing the first EAP conversation.

This message is used only if MS and BS negotiate EAP in EAP mode.

The Key Sequence Number and HMAC/CMAC Digest attributes of this message appear only in re-authentication.

Code: 29

Attributes are shown in Table 37q.

**Table 37q—PKMv2 EAP Complete attributes**

Attribute	Contents
EAP Payload	Contains the EAP authentication data, not interpreted in the MAC layer
Key Sequence Number	AK sequence number appear only if AK is available from previous double EAP
HMAC Digest/CMAC Digest	Message Digest calculated using AK only if AK is available from previous double EAP Message Digest calculated using EIK when initial authentication

*Insert new subclause 6.3.2.3.9.28:*

**6.3.2.3.9.28 PKMv2 Authenticated EAP Start**

In double EAP mode (EAP after EAP), MS sends the PKMv2 EAP Authenticated EAP Start message to BS in order to initiate second round EAP. This message is signed by EIK, which is generated by 1st EAP.

This message is used only for initial authentication of double EAP.

Attributes are shown in Table 37r.

**Table 37r—PKMv2 Authenticated EAP Start attribute**

Attribute	Contents
MS_Random	Random number generated by MS
HMAC Digest/CMAC Digest	Message Digest calculated using EIK

**6.3.2.3.10 DSA-REQ message**

*Change the explanation text of the “HMAC” field as indicated:*

**HMAC/CMAC Tuple (see 11.1.2)**

The HMAC/CMAC Tuple attribute contains a keyed message digest (to authenticate the sender). The HMAC Tuple attribute shall be the final attribute in the DSx message’s attribute list.

**6.3.2.3.11 DSA-RSP message**

*Change the explanation text of the “Service Flow Parameters” field as indicated:*

**Service Flow Parameters** (see 11.13)

The complete specification of the service flow shall be included in the DSA-RSP if it includes a newly assigned CID or an expanded Service Class Name ~~or to point to specific parameter that caused rejection of connection creation (only in the case CC = “reject not supported parameter value” or “reject not supported parameter”).~~

*Delete the mandatory content of DSA-RSP in case of unsuccessful transaction and the explanation text of the “Service Flow Error Set” field:*

~~If the transaction is unsuccessful, the DSA-RSP shall include:~~

~~**Service Flow Error Set** (see 11.13)~~

~~A Service Flow Error Set and identifying service flow reference/SFID shall be included for every failed service flow in the corresponding DSA-REQ message. Every Service Flow Error Set shall include every specific failed QoS Parameter of the corresponding service flow (see 11.13). This parameter shall be omitted if the entire DSA-REQ is successful.~~

*Change the explanation text of the “HMAC” field as indicated:*

**HMAC/CMAC Tuple** (see 11.1.2)

The HMAC/CMAC Tuple attribute contains a keyed message digest (to authenticate the sender). The HMAC Tuple attribute shall be the final attribute in the DSx message’s attribute list.

**6.3.2.3.11.1 SS-Initiated DSA**

*Delete the last paragraph:*

~~If the transaction is unsuccessful, the DS shall use the original service flow reference to identify the failed parameters in the DSA-RSP.~~

*Delete subclause 6.3.2.3.11.2*

~~**6.3.2.3.11.2 BS-Initiated DSA**~~**6.3.2.3.12 DSA-ACK message**

*Delete the explanation text of the “Service Flow Error Set” field:*

~~**Service Flow Error Set** (see 11.13)~~

~~The Service Flow Error Set of the DSA-ACK message encodes specifics of any failed service flows in the DSA-RSP message. A Service Flow Error Set and identifying service flow reference shall be included for every failed QoS Parameter of every failed service flow in the corresponding DSA-REQ message (see 11.13). This parameter shall be omitted if the entire DSA-REQ is successful.~~

*Change the explanation text of the “HMAC” field as indicated:*

**HMAC/CMAC Tuple** (see 11.1.2)

The HMAC/CMAC Tuple attribute contains a keyed message digest (to authenticate the sender). The HMAC Tuple attribute shall be the final attribute in the DSx message’s attribute list.

### 6.3.2.3.13 DSC Request (DSC-REQ) message

*Change the explanation text of the “HMAC” field as indicated:*

#### **HMAC/CMAC Tuple (see 11.1.2)**

The HMAC/CMAC Tuple attribute contains a keyed message digest (to authenticate the sender). The HMAC Tuple attribute shall be the final attribute in the DSx message’s attribute list.

### 6.3.2.3.14 DSC Response (DSC-RSP) message

*Delete the mandatory content of DSC-RSP in case of unsuccessful transaction and the explanation text of the “Service Flow Error Set” field:*

If the transaction is unsuccessful, the DSC-RSP shall contain the following:

#### ~~Service Flow Error Set (see 11.13)~~

~~A Service Flow Error Set and identifying CID shall be included for every failed service flow in the corresponding DSC-REQ message. Every Service Flow Error Set shall include every specific failed QoS Parameter of the corresponding service flow (see 11.13). This parameter shall be omitted if the entire DSC-REQ is successful.~~

*Change the explanation text of the “HMAC” field as indicated:*

#### **HMAC/CMAC Tuple (see 11.1.2)**

The HMAC/CMAC Tuple attribute contains a keyed message digest (to authenticate the sender). The HMAC Tuple attribute shall be the final attribute in the DSx message’s attribute list.

### 6.3.2.3.15 DSC Acknowledge (DSC-ACK) message

*Delete the explanation text of the “Service Flow Error Set” field:*

#### ~~Service Flow Error Set (see 11.13)~~

~~The Service Flow Error Set of the DSC-ACK message encodes specifics of any failed service flows in the DSC-RSP message. A Service Flow Error Set and identifying SFID shall be included for every failed QoS Parameter of each failed service flow in the corresponding DSC-RSP message (see 11.13). This parameter shall be omitted if the entire DSC-RSP is successful.~~

*Change the explanation text of the “HMAC” field as indicated:*

#### **HMAC/CMAC Tuple (see 11.1.2)**

The HMAC/CMAC Tuple attribute contains a keyed message digest (to authenticate the sender). The HMAC Tuple attribute shall be the final attribute in the DSx message’s attribute list.

### 6.3.2.3.16 DSD-REQ message

*Change the explanation text of the “HMAC” field as indicated:*

#### **HMAC/CMAC Tuple (see 11.1.2)**

The HMAC/CMAC Tuple attribute contains a keyed message digest (to authenticate the sender). The HMAC Tuple attribute shall be the final attribute in the DSx message’s attribute list.

**6.3.2.3.17 DSD-RSP message**

*Change the explanation text of the “HMAC” field as indicated:*

**HMAC/CMAC Tuple (see 11.1.2)**

The HMAC/CMAC Tuple attribute contains a keyed message digest (to authenticate the sender). The HMAC Tuple attribute shall be the final attribute in the DSx message’s attribute list.

**6.3.2.3.20 Downlink Burst Profile Change Request (DBPC-REQ) message**

*Change the first paragraph as indicated:*

This message is not applicable to OFDMA PHY.

The DBPC-REQ message is sent by the SS to the BS on the SS’s Basic CID to request a change of the least robust downlink burst profile used by the BS to transport data to the SS (i.e., the Downlink Operational Burst Profile). Note that a change of downlink burst profile may also be requested by means of a RNG-REQ message as defined in 6.3.2.3.5.

*Change the second paragraph as indicated:*

The DBPC-REQ message shall be sent at the current operational Data Grant Burst Type for the SS. If the SS detects ~~fading~~ changes in the channel conditions on the downlink, the SS uses this message to request transition to a more appropriate Data Grant Burst Type ~~robust Data Grant Burst Type~~. The message format shall be as shown in Table 48.

**6.3.2.3.21 Downlink Burst Profile Change Response (DBPC-RSP) message**

*Insert the following sentence before the first paragraph:*

This message is not applicable to OFDMA PHY.

**6.3.2.3.22 Reset Command (RES-CMD) message**

*Change the explanation text of the “HMAC” field as indicated:*

**HMAC/CMAC Tuple (see 11.1.2)**

The HMAC/CMAC Tuple shall be the last attribute in the message.

**6.3.2.3.23 SS basic capability request (SBC-REQ) message**

*Change the last paragraph as indicated:*

Basic Capability Requests contain those SS Capabilities Encodings (~~41-7-8~~11.8) that are necessary for effective communication with the SS during the remainder of the initialization protocols. Only the following parameters shall be included in the Basic Capabilities Request:

**Physical Parameters Supported** (see 11.8.3)

**Bandwidth Allocation Support** (see 11.8.1)

The following parameters may be included:

**Capabilities for construction and transmission of MAC PDUs** (see 11.8.2)

- PKM flow control** (see 11.7.8.6)
- Authorization policy support** (see 11.8.4.2)
- Maximum number of supported security association** (see 11.7.8.8)

*Insert at the end of 6.3.2.3.23:*

Security Negotiation Parameters (see 11.8.4)

**HMAC/CMAC Tuple**

Either HMAC Tuple or CMAC Tuple shall be the final attribute in the message's TLV attribute list. This attribute should be included in the message during HO reentry (see 11.1.2).

**6.3.2.3.24 SS basic capability response (SBC-RSP) message**

*Insert at the end of 6.3.2.3.24:*

Security Negotiation Parameters (see 11.8.4)

**HMAC/CMAC Tuple**

Either HMAC Tuple or CMAC Tuple shall be the final attribute in the message's TLV attribute list. This attribute should be included in the message during HO reentry (see 11.1.2).

Capabilities for Construction and Transmission of MAC PDUs (see 11.8.2):

- PKM flow control** (see 11.8.4)
- Authorization Policy Support** (see 11.8.5)
- Maximum number of supported security association** (see 11.8.6)

**6.3.2.3.26 De/Re-register command (DREG-CMD) message**

*Change Table 55 as indicated:*

**Table 55—Action codes and actions**

Action code (hexadecimal)	Action
00	<del>SS shall leave the current channel and attempt to access another channel immediately terminate service with the BS and should attempt network entry at another BS.</del>
01	<del>SS shall listen to the current channel/BS but shall not transmit until an RES-CMD message or DREG-CMD with Action Code that allows transmission 02 or 03 is received.</del>
02	<del>SS shall listen to the current channel/BS but only transmit on the Basic; and Primary Management, and Secondary Management Connections.</del>
03	SS shall return to normal operation and may transmit on any of its active connections.
04	SS shall terminate current Normal Operations with the BS; the BS shall transmit this action code only in response to any SS DREG-REQ <u>message</u> .
<u>05</u>	<u>MS shall immediately begin de-registration from serving BS and request initiation of MS Idle Mode.</u>

**Table 55—Action codes and actions (continued)**

Action code (hexadecimal)	Action
06	<u>The MS may retransmit the DREG-REQ message after the time duration (REQ-duration) provided in the message.</u>
07	<u>The MS shall not retransmit the DREG-REQ message and shall wait the DREG-CMD message. BS transmittal of a subsequent DREG-CMD with Action Code 03 shall cancel this restriction.</u>
0508–FF	Reserved

*Change the first paragraph below Table 55 as follows:*

The DREG-CMD shall include the following parameters encoded as TLV tuples:

**HMAC/CMAC Tuple (see 11.1.2)**

The HMAC/CMAC Tuple shall be the last attribute in the message.

*Insert the following text after Table 55:*

When the DREG-CMD message is sent with Action Code = 0x05, the following TLVs shall be included:

**Paging Information (see 11.14)**

The Paging Information TLV defines the Paging Group ID and the PAGING\_CYCLE and PAGING\_OFFSET parameters to be used by the MS in IDLE mode

**Paging Controller ID**

The Paging Controller ID is a logical network identifier for the serving BS or other network entity retaining MS service and operational information and/or administering paging activity for the MS while in IDLE Model. Paging Controller ID shall be set to BSID when a BS is acting as Paging Controller.

**Idle Mode Retain Information**

Idle Mode Retain Information provided as part of this message is indicative only. Network Reentry from Idle Mode process requirements may change at time of actual re-entry. For each bit location, a value of 0 indicates the information for the associated re-entry management messages shall not be retained and managed, a value of 1 indicates the information for the associated reentry management message shall be retained and managed.

Bit #0: Retain MS service and operational information associated with SBC-REQ/RSP messages.

Bit #1: Retain MS service and operational information associated with PKM-REQ/RSP messages.

Bit #2: Retain MS service and operational information associated with REG-REQ/RSP messages.

Bit #3: Retain MS service and operational information associated with Network Address.

Bit #4: Retain MS service and operational information associated with Time of Day.

Bit #5: Retain MS service and operational information associated with TFTP messages.

Bit #6: Retain MS service and operation information associated with Full service (MAC state machines, CS classifier information, etc.). The information retained by setting Bit #6 does not include those information associated with SBC-REQ/RSP messages, PKM-REQ/RSP messages, REG-REQ/RSP messages, Network Address, Time of Day, and TFTP messages unless otherwise specified by setting one or more Bits #0–#5.

Bit #7: Consider Paging Preference of each Service Flow in resource retention. Bit #7 is meaningful when Bit #2 and Bit #6 have a value of 1. If Bit #2, Bit #6 and Bit #7 is 1, MS

service and operational information associated with Full service (MAC state machines, CS classifier information, etc.) are retained for Service Flows with positive Paging Preference. If Bit #2 and Bit #6 are 1 and Bit #7 is 0, MS service and operational information associated with Full service (MAC state machines, CS classifier information, etc.) are retained for all Service Flows.

When the DREG-CMD is sent with Action Code = 0x05, the following TLVs may be included:

**MAC Hash Skip Threshold**

Maximum number of successive MOB\_PAG-ADV messages that may be sent from a BS without individual notification for an MS, including MAC Address hash of an MS for which Action Code is 00, 'No Action Required'. If a BS receives the DREG-REQ message containing MAC Hash Skip Threshold TLV, the BS may include MAC Hash Skip Threshold TLV in the DREG-CMD message. If the value is set to 0xFF, a BS shall omit MAC Address hash of the MS with 'No Action Required' for every MOB\_PAG-ADV message. If the value is set to zero, BS shall include the MS MAC Address hash in every MOB\_PAG-ADV message.

The DREG-CMD message may include the following parameters encoded as TLV tuples:

**REQ-duration**

Waiting value for the DREG-REQ message re-transmission (measured in frames) If serving BS includes REQ-duration in a message including an Action Code = 0x05, the MS may initiate an Idle Mode request through a DREG-REQ with Action Code = 0x01, request for MS De-Registration from serving BS and initiation of MS Idle Mode, at REQ-duration expiration.

**6.3.2.3.28 Config File TFTP Complete (TFTP-CPLT) message**

*Change first paragraph as indicated:*

The Config File TFTP-CPLT message shall be generated by ~~the managed~~ SS when it has successfully retrieved its configuration file from the provisioning server (see 6.3.9.12). If the SS does not need a config file it shall send the TFTP-CPLT message to the BS anyway, to indicate that it has completed ~~secondary management connection~~ initialization and is ready to accept services. The format of the TFTP-CPLT shall be as shown in Table 57.

*Change the explanation text of the "HMAC" field as indicated:*

**HMAC/CMAC Tuple (see 11.1.2)**

The HMAC/CMAC Tuple shall be the last attribute in the message.

**6.3.2.3.32 ARQ Reset message**

*Change Table 61 as indicated:*

**Table 61—ARQ Reset message format**

Syntax	Size	Notes
ARQ_Reset_Message_Format() {		
<b>Management Message Type = 35</b>	8 bits	
<b>Connection ID</b>	16 bits	CID to which this message refers.



**Table 61—ARQ Reset message format (continued)**

Syntax	Size	Notes
Type	2 bits	0b00 = Original message from Initiator 0b01 = Acknowledgment from Responder 0b10 = Confirmation from Initiator 0b11 = Reserved
<u>Direction</u>	<u>2 bits</u>	0b00 = Uplink or downlink 0b01 = Uplink 0b10 = Downlink 0b11 = Reserved
Reserved	64 bits	Shall be set to zero.
}		

*Insert the following sentence below Table 61:*

For transport CIDs, the Direction bits shall be set to 0b00 on transmission, and ignored on reception. For secondary management CIDs, the Direction bits shall be set to 0b01 or 0b10 as appropriate and other values shall cause the message to be treated as invalid and discarded on reception.

**6.3.2.3.33 Channel measurement Report Request/Response (REP-REQ/RSP)**

*Change the first paragraph as indicated:*

If the BS, operating in bands below 11 GHz ~~or a DM-configured BS operating at any frequency~~, requires RSSI and CINR channel measurement reports, it shall send the channel measurements Report Request message. ~~In license-exempt bands, it~~ The Report Request message shall additionally be used to request the results of the DFS measurements the BS has previously scheduled. Table 62 shows the REP-REQ ~~message~~ message.

*Change the second paragraph as indicated:*

The REP-REQ message shall contain the following TLV encoded parameters:

**Report Request**

The channel measurement Report Response message shall be used by the SS to respond to the channel measurements listed in the received Report Requests. ~~In license-exempt bands~~ Where regulation mandates detection of specific signals by the SS, the SS shall also send a REP-RSP in an unsolicited fashion upon detecting a ~~Primary User~~ such signals on the channel it is operating in, if mandated by regulatory requirements. The SS may also send a REP-RSP containing channel measurement reports, in an unsolicited fashion, or when ~~non-primary user~~ other interference is detected above a threshold value. In cases where specific signal detection by an SS is not mandated by regulation, the SS may indicate ‘Unmeasured, Channel not measured’ (see 11.12) in the REP-RSP message when responding to the REP-REQ message from the BS. Table 63 shows the REP-RSP message.

*Insert the following sentence at the end of the subclause:*

Upon sending a REP-RSP message, an SS shall reset all its measurement counters for each channel on which it reported.

### 6.3.2.3.34 Fast Power Control (FPC) message

*Change first paragraph as indicated:*

Power control shall be effected by the use of periodic ranging. In addition, the BS may adjust the power levels of multiple subscribers simultaneously with the Fast Power Control (FPC) message. SSs shall apply the indicated change within the “~~SS downlink management message FPC processing time~~”. If the SS cannot apply the commanded power correction (SS is already at maximum or minimum power) the SS shall send a RNG-REQ message with “Ranging Anomalies” parameter. FPC shall be sent on the broadcast CID. This message shall only apply to SCa, OFDM, and OFDMA PHY specifications. See Table 64. Implementation of FPC message at BS is optional.

*Insert the following record into Table 64, after the ‘Number of Stations’ field:*

Power measurement frame	8 bits	
-------------------------	--------	--

*Insert the following text below Table 64:*

**Power measurement frame**

The 8 LSB of the frame number in which the BS measured the power corrections referred to in the message.

### 6.3.2.3.41 AAS Beam Select message

*Change the description of “AAS beam index” field below Table 86 as indicated:*

**AAS beam index**

This index shall correspond to the direction the AAS beam is pointing at during the ~~AAS\_DL\_Scan\_IE()~~ AAS\_DLFP() preferred by the SS (see 8.4.4.6).

*Insert the following text at the end of 6.3.2.3.41:*

For systems supporting mobility, the parameter “Allow AAS Beam Select Messages” in the UCD channel encoding TLV messages can be configured to indicate that these messages should not be sent by any MS, and the default value of “Allow AAS Beam Select Messages” is 1.

### 6.3.2.3.42 SS De-registration Request (DREG-REQ) message

*Change 6.3.2.3.42 as indicated:*

**Table 87—DREG-REQ message format**

Syntax	Size	Notes
DREG-REQ message format() {	—	—
<b>Management message type = 49</b>	8 bits	—
<b>De-Registration_Request_Code</b>	8 bits	0x00 = SS De-Registration request from BS 0x01 = <u>request for MS De-Registration from serving BS and initiation of MS Idle Mode</u> 0x02 = <u>Response for the Unsolicited MS De-Registration initiated by the BS.</u> 0x03-0xFF = <i>Reserved</i>

**Table 87—DREG-REQ message format (continued)**

Syntax	Size	Notes
TLV encoded parameters	variable	—
}	—	—

An SS shall generate SS DREG-REQs including the following parameters:

**De-Registration\_Request\_Code**

Request code identifying the type of De-Registration request:

- 0x00 = SS De-Registration request for de-registration from BS and network
- 0x01 = MS request for De-Registration from serving BS and initiation of Idle Mode
- 0x02 = MS response for the Unsolicited De-Registration initiated by BS
- 0x03-0xFF = Reserved

The DREG-REQ shall include the following parameters encoded as TLV tuples:

**HMAC/CMAC Tuple (see 11.1.2)**

The HMAC/CMAC Tuple shall be the last attribute in the message.

The MS shall include the following parameters in the DREG-REQ only if De-Registration\_Request\_Code = 0x01:

**Paging Cycle Request**

PAGING\_CYCLE requested by the MS

**Idle Mode Retain Information**

MS request for Paging Controller retention of network re-entry related MAC management message MS service and operational information to expedite future Network Re-entry from Idle Mode. For each Bit location, a value of 0 indicates the information associated with the specified MAC management message is not requested to be retained and managed, a value of 1 indicates the information is requested to be retained and managed.

Bit #0: Retain MS service and operational information associated with SBC-REQ/RSP messages.

Bit #1: Retain MS service and operational information associated with PKM-REQ/RSP messages.

Bit #2: Retain MS service and operational information associated with REG-REQ/RSP messages.

Bit #3: Retain MS service and operational information associated with Network Address.

Bit #4: Retain MS service and operational information associated with Time of Day.

Bit #5: Retain MS service and operational information associated with TFTP messages.

Bit #6: Retain MS service and operation information associated with Full service (MAC state machines, CS classifier information, etc.). The information retained by setting Bit #6 does not include those information associated with SBC-REQ/RSP messages, PKM-REQ/RSP messages, REG-REQ/RSP messages, Network Address, Time of Day, and TFTP messages unless otherwise specified by setting one or more Bits #0-#5.

Bit #7: Consider Paging Preference of each Service Flow in resource retention. Bit #7 is meaningful when Bit #2 and Bit #6 have a value of 1. If Bit #2, Bit #6 and Bit #7 is 1, MS service and operational information associated with Full service (MAC state machines, CS classifier information, etc.) are retained for Service Flows with positive Paging Preference. If Bit #2 and Bit #6 are 1 and Bit #7 is 0, MS service and operational information associated with Full service (MAC state machines, CS classifier information, etc.) are retained for all Service Flows.

The MS may include the following parameters in the DREG-REQ message only if DeRegistration\_Request\_Code = 0x01:

**MAC Hash Skip Threshold**

Maximum number of successive MOB\_PAG-ADV messages that may be sent from a BS individual notification for an MS, including MS MAC address hash of an MS for which Action Code is 0b00, 'No Action Required'.

*Change the title of 6.3.2.3.43 as indicated (note removal of hyphen in 'H-ARQ' throughout):*

**6.3.2.3.43 H-ARQ HARQ MAP message**

**6.3.2.3.43.1 H-ARQ HARQ message format**

*Change text in the second paragraph as indicated:*

BS may broadcast multiple ~~H-ARQ~~ HARQ MAP messages using multiple bursts after the MAP message. Each ~~H-ARQ~~ HARQ MAP message ~~should~~shall have a different modulation and coding rate. ~~If the frame contains DCD or UCD message following the MAP message, the H-ARQ MAP should follow DCD or UCD message.~~

*Change the second instance of 'Compact DL-MAP IE()' field in Table 88 to 'Compact UL-MAP IE()'*

*Change the text under the 'Syntax' column of the 'CRC appended' field in Table 88 from "CRC appended" to "Reserved" insert under the 'Notes' column of the same field the following sentence:*

Shall be set to zero

*Change the description of 'CRC appended' field below Table 88 as indicated:*

**CRC appended**

~~A value of one indicates a CRC-32 value is appended to the end of the compressed map(s) data. The CRC is computed across all bytes of the compressed map(s) starting with the byte containing the Compressed map indicator through the last byte of the map(s) as specified by the Map message length field. The CRC calculation is the same as that used for standard MAC messages. A value of zero indicates that no CRC is appended.~~

**6.3.2.3.43.2 Format configuration**

*Change Table 91 as indicated:*

**Table 91—Format configuration IE**

Syntax	Size	Notes
Compact_DL-MAP_IE() {		
DL-MAP IE Type = 4	3 bits	Format_Configuration_IE
New Format Indication	1 bit	0 = Use the format configured by the latest Format_Configuration_IE 1 = New format
if(New Format Indication == 1) {		

**Table 91—Format configuration IE (continued)**

Syntax	Size	Notes
<b>CID Type</b>	2 bits	<u>0b00</u> = Normal CID <u>0b01</u> = RCID11 (default) <u>0b10</u> = RCID7 <u>0b11</u> = RCID3
<b>Safety Pattern</b>	<del>40</del> 5 bits	
<b>Subchannel type for Band AMC</b>	2 bits	See Band AMC specification (8.4.6.3). <u>0b00</u> = Default type (default) <u>0b01</u> = 1 <u>bin</u> x6 <u>symbols</u> type <u>0b10</u> = 2 <u>bin</u> x3 <u>symbols</u> type <u>0b11</u> = 3 <u>bin</u> x2 <u>symbols</u> type
<b>Max Logical Bands</b>	2 bits	0 = 3 bands, 1 = 6 bands, 2 = 12 bands (default) 3 = 24 bands
<b>No. Symbols for Broadcast</b>	<del>4</del> 5 bits	No. Symbol, (default = 0)
<b>No. Symbols for DL Band AMC</b>	<del>4</del> 6 bits	No. Symbol, (default = 0)
<b>No. Symbols for UL Band AMC</b>	<del>4</del> 6 bits	No. Symbol, (default = 0)
}		
}		

*Change the description of the ‘New Format Indication’, ‘Safety Pattern’, ‘No. Symbols for Broadcast’, ‘No. Symbols for DL Band AMC’ and ‘No. Symbols for UL Band AMC’ fields below Table 91 as indicated:*

**New Format Indication**

If this value set to 0, the format should be configured by the latest Format Configuration\_IE in the previous frames. Otherwise, all parameters in Format Configuration IE ~~should~~shall be configured. The configured parameters are valid for the following Compact\_DL/UL\_MAP\_IE. At the start of each frame all parameters are set to default values.

**Safety Pattern**

If this value is less than 16, the number of safety bins is 12 and the indices of allocated bins for safety are  $16m+x$ , where  $x$  is the value of Safety Pattern and  $m = 0 \dots 11$ . If this value is ~~not less than~~from 16 to 31, the number of safety bins is 24 and the indices of allocated bins for safety are  $16m+x'$  and  $16m+(x'+8)$ , where  $x' = x - 16$  and  $m = 0 \dots 11$ . If the safety pattern exists, it should be always allocated first. The safety pattern is valid in the region of AMC zone only. If safety pattern is set to all ones, safety channel is disabled.

**No. Symbols for Broadcast**

~~This specifies the number of symbols allocated for Broadcast subchannel.~~This field specifies the number of symbols allocated for Broadcast symbol region. The Broadcast symbols shall be allocated at the end of the DL sub-frame. The number of symbols is counted from the last symbol of the DL sub-frame. The PermBase for this broadcast symbol region shall be set to 0.

**No. Symbols for DL Band AMC**

~~This specifies the number of symbols allocated for DL Band AMC subchannel-symbol region.~~The symbols for Band AMC shall be allocated before the broadcast symbol region. The other DL symbols excluding the symbols for Broadcast and DL Band are allocated for the DL Normal subchannel. PermBase for DL Band AMC is the same as one for normal subchannels region.

#### **No. Symbols for UL Band AMC**

This specifies the number of symbols allocated for UL Band AMC ~~subchannel~~ symbol region. The symbols for UL Band AMC shall be allocated at the end of the UL sub-frame and the number of symbols are counted from the last symbol of the UL sub-frame. The other UL symbols excluding the symbols for UL Band are allocated for the UL Normal subchannel. PermBase for UL Band AMC is the same as one for normal subchannels region.

*Insert the following text before Table 92:*

A logical band is a grouping of the AMC bands defined in 8.4.6.3. For example, three logical bands imply that logical band 0 is composed of AMC bands 0..15, logical band 1 is composed of AMC bands 16..31, and logical band 2 is composed of AMC bands 32..47. In general, if  $K = \text{Max Logical Bands}$ , then logical band  $J = 0 \dots (K-1)$  contains physical bands  $48/K \times J, 48/K \times J + 1, \dots, 48/K \times (J + 1) - 1$ .

#### **6.3.2.3.43.3 Reduced CID**

*Change the first paragraph as indicated:*

~~Figure 93~~ Table 93 presents the format of reduced CID. BS may use reduced CID instead of basic CID or multicast CID to reduce the size of HARQ MAP message. The type of reduced CID is determined by BS considering the range of basic CIDs of SS connected with the BS and specified by the RCID\_Type field of the Format Configuration IE.

*Change the second paragraph as indicated:*

The reduced CID is composed of 1 bit of prefix and n-bits of LSB of CID of SS. The prefix is set to 1 for the broadcast CID or multicast polling CID and set to 0 for basic CID. The reduced CID cannot be used instead of transport CID, primary management CID, or secondary management CID. An exception to the above is when the multicast polling RCID is used in DL. If a downlink CID decoded from a prefix 1 and RCID-11 is in the range of the Multicast polling CID (0xFF00–0xFFFD) then the DL CID should be interpreted as a DL transport CID by subtracting 0xFF (0xFFFD–0xFEFE).

*Change the third paragraph as indicated:*

Figure 22 shows the decoding of reduced CID when ~~the RCID\_Type is set to 3~~ RCID 11 is used.

*In Figure 22, replace all instances of “RDC11” with “RCID 11”.*

*Change the description of the ‘RCID n’ field below Table 93 as indicated:*

#### **RCID n**

n-bits LSB of CID. If the DL CID decoded from a prefix 1 and RCID-11 is in the range of the Multicast polling CID (0xFF00–0xFFFD) then the DL CID should be interpreted as a DL transport CID by subtracting 0xFF (0xFFFD–0xFEFE).

**6.3.2.3.43.4 H-ARQ HARQ control IE**

*Change 6.3.2.3.43.4 as indicated (note removal of hyphen in 'H-ARQ' throughout):*

The format of ~~H-ARQ~~HARQ\_Control\_IE, which includes encoding/decoding information for ~~H-ARQ~~HARQ enabled DL/UL bursts, is presented in the MAC frame. This IE shall be located in the compact DL/UL MAP\_IE.

**Table 94—~~H-ARQ~~HARQ\_Control\_IE format**

Syntax	Size	Notes
<del>H-ARQ</del> HARQ_Control_IE ()	—	—
<b>Prefix</b>	1 bit	0 = Temporary disable <del>H-ARQ</del> HARQ 1 = enable <del>H-ARQ</del> HARQ
if (Prefix == 1) {	—	—
<b>AI_SN</b>	1 bit	<del>H-ARQ</del> HARQ ID Seq. No
<b>SPID/Reserved</b>	2 bits	Subpacket ID when IR is defined by the FEC mode, otherwise reserved (encoded 0b00)
<b>ACID</b>	4 bits	<del>H-ARQ</del> HARQ CH ID
} else {	—	—
<b>Reserved</b>	3 bits	Shall be set to zero
}	—	—
}	—	—

**Prefix**

Indicates whether ~~H-ARQ~~HARQ is enabled or not.

**AI\_SN**

Defines ARQ Identifier Sequence Number. This is toggled between 0 and 1 on successfully transmitting each encoder packet with the same ARQ channel.

**SPID**

Defines SubPacket ID, which is used to identify the four subpackets generated from an encoder packet. The SPID field only applies to FEC modes supporting incremental redundancy.

**ACID**

Defines ~~H-ARQ~~HARQ Channel ID, which is used to identify ~~H-ARQ~~HARQ channels. Each connection can have multiple HARQ channels, each of which may have an encoder packet transaction pending.

**6.3.2.3.43.5 CQICH Control IE**

*Change the first paragraph as indicated:*

The format of CQICH Control IE is presented in Table 95. The specific reporting value shall follow the directions indicated in the latest CQICH allocation IE (8.4.5.4.12).

Change Table 95 as indicated:

**Table 95—H-ARQ CQICH Control IE format**

Syntax	Size	Notes
CQICH_Control_IE() {	—	—
<b>CQICH Indicator</b>	1 bit	If the indicator is set to 1, the CQICH_Control IE follows.
if (CQICH indicator == 1) {	—	—
<b>Allocation Index</b>	6 bits	Index to the channel in a frame the CQI report should be transmitted by the MS.
<b>Period (p)</b>	2 bits	A CQI feedback is transmitted on the CQI channels indexed by the (CQI Channel Index) by the MS in every 2 <sup>p</sup> frames.
<b>Frame offset</b>	3 bits	The MS starts reporting at the frame of which the number has the same 3 LSB as the specified frame offset. If the current frame is specified, the MS should start reporting in eight frames.
<b>Duration (d)</b>	4 bits	A CQI feedback is transmitted on the CQI channels indexed by the (CQI Channel Index) by the MS for 2 <sup>(d-1)</sup> frames. If d is 0b1111, the MS should report until the BS commands the MS to stop.
} else {	—	—
<del><b>Reserved COI reporting threshold</b></del>	3 bits	<del>Shall be set to zero. A threshold used by an MS to report its CINR using CQI channel; If 0b000, this threshold is neglected. SS shall treat these bits as reserved and shall be set to zero.</del>
}	—	—
}	—	—

Insert the following definition to the end of the subclause (following “Duration” definition):

**COI reporting threshold**

Used by the MS to determine whether it reports current channel measurement through COI channel if allocated in the future. If the value is set to 0b000, this threshold is inactive afterwards; otherwise it is activated. SS shall treat these bits as reserved and shall be set to zero.



*Insert the following new table:*

**Table 95a—Threshold Values**

Value (binary)	CINR (dB)
000	CQT inactivated
001	−6.0
010	−4.0
011	−2.0
100	−0.0
101	2.0
110	4.0
111	6.0

### 6.3.2.3.43.6 Compact\_DL-MAP IE

#### 6.3.2.3.43.6.1 Compact\_DL-MAP IE for normal subchannel

*Change the first paragraph as indicated:*

The format of Compact DL-MAP IE for normal subchannel is presented in Table 96. The direction of slot allocation for downlink is along with the subchannel index first and then the symbol index. The direction of data mapping shall be according to 8.4.3.4.

**Table 96—~~H-ARQ~~HARQ Compact\_DL-MAP IE format for normal subchannel**

Syntax	Size	Notes
Compact_DL-MAP_IE () {	—	—
<b>DL-MAP Type =0</b>	3 bits	—
<b>UL-MAP append</b>	1 bit	—
<b>RCID_IE</b>	<i>variable</i>	—
if (HARQ mode = 0) {	—	—
<b>N<sub>EP</sub> code</b>	4 bits	Code of encoder packet bits (see 8.4.9.2.3.5)
<b>N<sub>SCH</sub> code</b>	4 bits	Code of allocated subchannels (see 8.4.9.2.3.5)
} else if (HARQ mode = 1) {	—	—
<b><u>Shortened DIUC</u></b>	<u>3 bits</u>	<u>Shortened DIUC</u>
<b><u>Companded SC</u></b>	<u>5 bits</u>	<u>Code of allocated subchannels (see 8.4.9.5)</u>
}	—	—
<b><del>H-ARQ</del>HARQ_Control_IE</b>	<i>variable</i>	—

**Table 96—HARQ Compact\_DL-MAP IE format for normal subchannel (continued)**

Syntax	Size	Notes
<b>CQICH_Control_IE</b>	<i>variable</i>	—
if (UL-MAP append) {	—	—
if (HARQ mode = 0) {	—	<u>CTC IR</u>
$N_{EP}$ code for UL	4 bits	Code of encoder packet bits (see 8.4.9.2.3.5)
$N_{SCH}$ code for UL	4 bits	Code of allocated subchannels (see 8.4.9.2.3.5)
} else if (HARQ mode = 1) {	—	<u>Generic Chase</u>
<u>Shortened UIUC</u>	3 bits	<u>Shortened UIUC</u>
<u>Companded SC</u>	5 bits	<u>Code of allocated subchannels (see 8.4.9.5)</u>
}	—	—
<b>HARQ_Control_IE for UL</b>	<i>variable</i>	—
}	—	—
}	—	—

**DL-MAP Type**

The DL-MAP Type value specifies the type of the Compact\_DL-MAP IE. A value of 0 indicates the Normal Subchannel.

**UL-MAP append**

A value of 1 indicates the uplink access information is appended to the end of the DL-MAP IE.

**RCID\_IE**

Represent the assignment of the IE.

**$N_{EP}$  code,  $N_{SCH}$  code**

The combination of  $N_{EP}$  code and  $N_{SCH}$  code indicates the number of allocated subchannels and scheme of coding and modulation for the DL burst.

**Shortened DIUC**

A shortened version of the DIUC. The shortened DIUC takes on values 0..7 of the DIUC as defined in the DCD. See 8.4.5.3.1.

**Companded SC**

The Companded SC indicates the number of allocated subchannels.

**$N_{EP}$  code for UL,  $N_{SCH}$  code for UL**

The combination of  $N_{EP}$  code and  $N_{SCH}$  code indicates the number of allocated subchannels and scheme of coding and modulation for the UL burst.

**Shortened UIUC**

A shortened version of the UIUC. The shortened UIUC takes on values 1..8 of the UIUC as defined in the UCD. See 8.4.5.4.1.

**Companded SC**

The Companded SC indicates the number of allocated subchannels.

**6.3.2.3.43.6.2 Compact\_DL-MAP IE for Band AMC Subchannel**

*Change the first paragraph as indicated:*

Slots for downlink AMC zone are allocated along the subchannel index first within a band. The direction of data mapping for downlink AMC zone slots shall be frequency first (across bands when multiple bands are allocated). The format of Compact DL-MAP IE for Band AMC Subchannel is presented in Table 97.

**Table 97—~~HARQ~~ HARQ Compact\_DL-MAP IE format for band AMC**

Syntax	Size	Notes
Compact_DL-MAP_IE () {	—	—
<b>DL-MAP Type =1</b>	3 bits	—
<i>Reserved</i>	1 bit	Shall be set to zero
<b>RCID_IE</b>	<i>variable</i>	—
<u>if (HARQ mode = 0) {</u>	—	<u>CTC IR</u>
<b><i>N<sub>EP</sub></i> code</b>	4 bits	Code of encoder packet bits (see 8.4.9.2.3.5)
<b><i>N<sub>SCH</sub></i> code</b>	4 bits	Code of allocated subchannels (see 8.4.9.2.3.5)
<u>} else if (HARQ mode = 1) {</u>	—	<u>Generic Chase</u>
<b><u>Shortened DIUC</u></b>	<u>3 bits</u>	<u>Shortened DIUC</u>
<b><u>Companded SC</u></b>	<u>5 bits</u>	<u>Code of allocated subchannels (see 8.4.9.5)</u>
<u>}</u>	—	—
<b>Nband</b>	Nb-Band	Number of bands, 0 = use BITMAP instead
if (Nband == 0) {	—	—
<b>Band BITMAP</b>	Nb-BITMAP	<i>n</i> -th LSB is 1 if <i>n</i> -th band is selected
} else {	—	—
for (i=0;i< Nband ; i++)	—	—
<b>Band Index</b>	Nb-Index	Band selection.
}	—	—
<b>Allocation Mode</b>	2 bits	Indicates the subchannel allocation mode. 0b00 = same number of subchannels for the selected bands 0b01 = different number of subchannels for the selected bands 0b10 = total number of subchannels for the selected bands determined by <i>N<sub>SCH</sub></i> code and <i>N<sub>EP</sub></i> code 0b11 = <i>Reserved</i>
<i>Reserved</i>	2 bits	Shall be set to zero
if (Allocation Mode == 0b00){	—	—
<b>No. Subchannels</b>	8 bits	—
} else if (Allocation Mode == 0b01){	—	—
for (i=0;i< band count; i++)	—	If Nband is 0, band count is the number of 1 in Band BITMAP. Otherwise band count is Nband.

**Table 97—~~HARQ~~ HARQ Compact\_DL-MAP IE format for band AMC (continued)**

Syntax	Size	Notes
No. Subchannels	8 bits	—
}	—	—
HARQ_Control_IE	variable	—
CQICH_Control_IE	variable	—
}	—	—

**DL-MAP Type**

~~This~~ The DL-MAP Type value specifies the type of the Compact DL-MAP IE. A value of 1 indicates the Band AMC Subchannel.

**RCID\_IE**

Represent the assignment of the IE.

**$N_{EP}$  code,  $N_{SCH}$  code**

The combination of  $N_{EP}$  code and  $N_{SCH}$  code indicates the number of allocated subchannels and scheme of coding and modulation for the DL burst.

**Shortened DIUC**

A shortened version of the DIUC. The shortened DIUC takes on values 0..7 of the DIUC as defined in the DCD. See 8.4.5.3.1.

**Companded SC**

The Companded SC indicates the number of allocated subchannels.

**Nband**

Indicates the number of bands selected for the burst. If this value is set to 0, the Band BITMAP is used to indicate the number and the position of selected bands instead. The number of the maximum logical bands determines the length of this field.

**Band BITMAP**

~~This~~ The Band BITMAP is valid when Nband is 0. The  $n$ -th LSB of the Band BITMAP is set to 1 when the  $n$ -th logical band is selected for the burst. If the number of the maximum logical bands is 12 then the length of the Band BITMAP is 12 bits. The band count is set to the number of 1s in the Band BITMAP. The number of the maximum logical bands determines the length of this field.

**Band Index**

~~This~~ The Band Index value indexes the selected band offset and is valid when Nband is larger than 0. The number of the maximum logical bands determines the length of this field.

**Allocation Mode**

~~This~~ The Allocation Mode value indicates the subchannel allocation mode in the selected bands. The value is set to binary 00 0 when the same numbers of subchannels are allocated in the selected bands by the following field 'No. Subchannels'. The value is set to 0b01 when different numbers of subchannels are allocated in each of the selected bands by the following fields 'No. Subchannels'. The value is set to 0b10 when the total number of subchannels allocated in the selected bands is defined by  $N_{SCH}$  code and  $N_{EP}$  code. The subchannels fill from the bands with lowest index.

**No. Subchannels**

~~This~~ The No. Subchannels value indicates the number of subchannels allocated for this burst.

**Delete Figure 23—Subchannel allocation modes of Compact DL-MAP\_IE for Band AMC.**

**6.3.2.3.43.6.3 Compact\_DL-MAP IE for safety subchannel**

Change Table 98 as indicated:

**Table 98—HARQ Compact\_DL-MAP IE format for safety**

Syntax	Size	Notes
Compact_DL-MAP_IE () {	—	—
DL-MAP Type =2	3 bits	—
UL-MAP append	1 bit	—
RCID_IE	variable	—
if (HARQ mode = 0) {	—	<u>CTC IR</u>
NEP code	4 bits	Code of encoder packet bits (see 8.4.9.2.3.5)
NSCH code	4 bits	Code of allocated subchannels (see 8.4.9.2.3.5)
} else if (HARQ mode = 1) {	—	<u>Generic Chase</u>
Shortened DIUC	3 bits	<u>Shortened DIUC</u>
Companded SC	5 bits	<u>Code of allocated subchannels (see 8.4.9.5)</u>
}	—	—
BIN offset	8 bits	—
<del>HARQ</del> HARQ_Control_IE	variable	—
CQICH_Control_IE	variable	—
if (UL-MAP append) {	—	—
if (HARQ mode = “CTC IR”) {	—	—
NEP code for UL	4 bits	Code of encoder packet bits (see 8.4.9.2.3.5)
NSCH code for UL	4 bits	Code of allocated subchannels (see 8.4.9.2.3.5)
} else if (HARQ mode = “Generic”) {	—	—
Shortened UIUC	3 bits	<u>Shortened UIUC</u>
Companded SC	5 bits	<u>Code of allocated subchannels (see 8.4.9.5)</u>
}	—	—
BIN offset for UL	8 bits	—
<del>HARQ</del> HARQ_Control_IE for UL	variable	—
}	—	—
}	—	—

**DL-MAP Type**

This The DL-MAP Type value specifies the type of the Compact\_DL-MAP IE. A value of 2 indicates the Safety Subchannel.

**RCID\_IE**

Represent the assignment of the IE.

**$N_{EP}$  code,  $N_{SCH}$  code**

The combination of  $N_{EP}$  code and  $N_{SCH}$  code indicates the number of allocated subchannels and scheme of coding and modulation for the DL burst.

**Shortened DIUC**

A shortened version of the DIUC. The shortened DIUC takes on values 0..7 of the DIUC as defined in the DCD. See 8.4.5.3.1.

**Companded SC**

The Companded SC indicates the number of allocated subchannels.

**BIN Offset**

The offset of the BIN allocated for this DL burst. See appropriate specification.

**$N_{EP}$  code for UL,  $N_{SCH}$  code for UL**

The combination of  $N_{EP}$  code and  $N_{SCH}$  code indicates the number of allocated subchannels and scheme of coding and modulation for the UL burst.

**Shortened UIUC**

A shortened version of the UIUC. The shortened UIUC takes on values 1..8 of the UIUC as defined in the UCD. See 8.4.5.4.1.

**Companded SC**

The Companded SC indicates the number of allocated subchannels.

**BIN Offset for UL**

The offset of the BIN allocated for this UL burst. See appropriate specification.

**6.3.2.3.43.6.4 Compact DL-MAP IE for DIUC subchannel**

*Change Table 99 as indicated:*

**Table 99—~~H ARQ~~ HARQ Compact\_DL-MAP IE format for DIUC subchannel**

Syntax	Size	Notes
Compact_DL-MAP_IE () {		
<b>DL-MAP IE Type = 3</b>	3 bits	
<i>Reserved</i>	1 bit	Shall be set to zero
<b>DIUC</b>	4 bits	
<u>if (DIUC == 15) {</u>		
<b><u>Extended DIUC dependent IE()</u></b>	<u>variable</u>	
<u>} else {</u>		
<b>RCID_IE</b>	<i>variable</i>	
<b>No. Subchannels</b>	8 bits	The number of subchannels allocated by the IE
<b><u>Repetition coding indication</u></b>	<u>2 bits</u>	<u>0b00 – No repetition coding</u> <u>0b01 – Repetition coding of 2 used</u> <u>0b10 – Repetition coding of 4 used</u> <u>0b11 – Repetition coding of 6 used</u>
<i>Reserved</i>	<u>2 bits</u>	<u>Shall be set to zero</u>
<u>}</u>		

**Table 99—~~H-ARQ~~ HARQ Compact\_DL-MAP IE format for DIUC subchannel (continued)**

Syntax	Size	Notes
<b><u>H-ARQ_Control_IE</u></b>	<i>variable</i>	
<b><u>COICH_Control_IE</u></b>	<i>variable</i>	
}		

*Insert the following text below Table 99:*

**Repetition coding indication**

Indicates the repetition code used inside the allocated burst.

**6.3.2.3.43.6.5 Compact DL-MAP IE for HARQ ACK BITMAP**

*Change the second paragraph as indicated:*

For example, when an SS transmits a ~~H-ARQ~~ HARQ enabled burst at *i*-th frame and the burst is *j*-th ~~H-ARQ~~ HARQ enabled burst in the MAP, the SS should receive ~~H-ARQ~~ HARQ ACK at *j*-th LSB bit of the BITMAP, which is sent by the BS at *i*+(frame offset)-th frame. If the HARQ ACK BITMAP is omitted, the HARQ enabled SS shall retain the transmitted HARQ burst and retransmit it when the BS requests retransmission with HARQ Control IE.

*Change the description of the “BITMAP” field below Table 100 as indicated:*

**BITMAP**

Includes ~~H-ARQ~~ HARQ ACK information for ~~H-ARQ~~ HARQ enabled UL bursts. The size of BITMAP should be equal or larger than the number of ~~H-ARQ~~ HARQ enabled UL-bursts. The *j*-th HARQ enabled burst in the UL-MAP is corresponding to the *j*-th LSB in the BITMAP.

*Insert the following text at the end of 6.3.2.3.43.6.5:*

Whenever HARQ enabled UL-SDMA allocations are made within a frame, the ACK BITMAP Length shall be large enough to carry the ACKs for the both the SDMA and non-SDMA allocations. Also, the ACKs for the SDMA users allocated on the second layer shall be appended to the ACKs for the non-SDMA and first-layer SDMA users.

### 6.3.2.3.43.6.6 Compact DL-MAP IE for extension

Insert the following table at the end of 6.3.2.3.43.6.6:

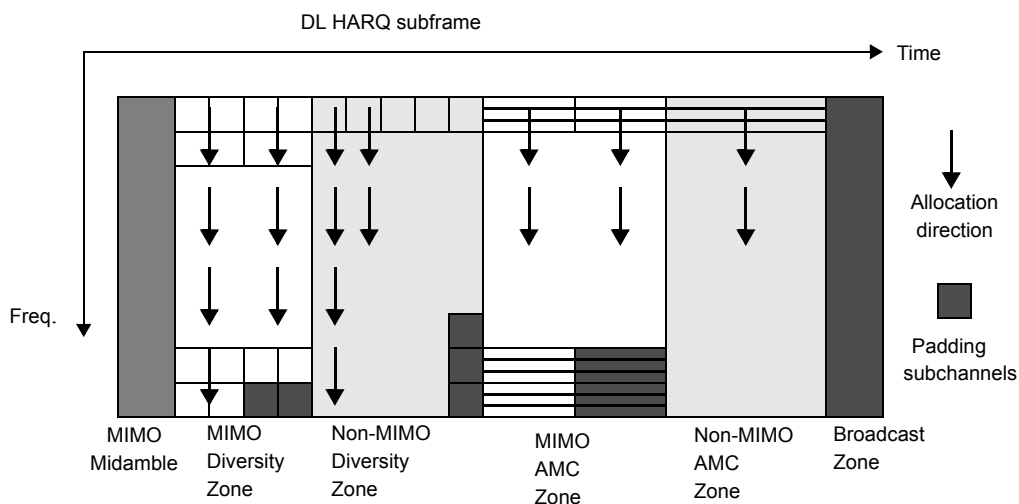
**Table 101a—DL-MAP Subtypes**

DL-MAP subtype	Description
0	TimeDiversity_MBS
1	HARQ mode switch
2–31	Reserved

Insert new subclause 6.3.2.3.43.6.7:

### 6.3.2.3.43.6.7 MIMO Compact\_DL-MAP IE format

When MIMO enabled DL burst are present within a frame, they shall be allocated before non-MIMO DL burst in both diversity and AMC zones. Figure 23a exemplifies the DL HARQ subframe structure, where the optional MIMO midamble is shown and 2x3 AMC type is depicted. Both MIMO diversity and MIMO AMC zones shall contain even number of symbols. For any remaining physical resources for each zone, padding subchannels shall be allocated to the region.



**Figure 23a—Downlink HARQ subframe structure**

Each MIMO enabled DL burst shall be first allocated by the regular Compact\_DL-MAP IE for diversity subchannels (see Table 94) and AMC subchannels (see Table 95), followed by the extended MIMO Compact\_DL-MAP IE. The format of MIMO Compact\_DL-MAP IE is presented in Table 101b. This extended IE shall follow right after the basic allocation IE for each MIMO enabled DL burst.



**Table 101b—MIMO Compact\_DL-MAP IE**

Syntax	Size	Notes
MIMO_Compact_DL-MAP_IE() {	—	—
<b>Compact DL-MAP Type</b>	3 bits	Type = 7
<b>DL-MAP Sub-type</b>	5 bits	MIMO = 0x01
<b>Length</b>	4 bits	Length of the IE in Bytes
<b>Mode Change</b>	1 bit	Indicates change of MIMO mode 0b0 = No change from previous allocation 0b1 = Change of MIMO mode
<b>Antenna Grouping/Selection</b>	1 bit	Application of antenna grouping/selection to the burst 0b0 = Not applied 0b1 = AG/AS applied
<b>Codebook based Precoding</b>	1 bit	Application of codebook based precoding to the burst 0b0 = Not applied 0b1 = Codebook based precoding applied
<b>N_layer</b>	2 bits	Number of multiple coding/modulation layers 0b00 – 1 layer 0b01 – 2 layers 0b10 – 3 layers 0b11 – 4 layers
if( Mode Change == 1){	—	—
<b>Mt</b>	2 bits	Indicates number of STC output streams 0b00 = 1 stream 0b01 = 2 streams 0b10 = 3 streams 0b11 = 4 streams
If (N_Layer == 0b00) {	—	—
If (Mt==0b01){	—	—
<b>Matrix</b>	2 bits	Indicates transmission matrix (See 8.4.8) 0b00 = Matrix A (Transmit Diversity) 0b01 = Matrix C (Vertical Encoding) 0b10–11 = <i>Reserved</i>
} elseif (Mt==0b10    Mt==10b1){	—	—
<b>Matrix</b>	2 bits	Indicates transmission matrix (See 8.4.8) 0b00 = Matrix A (Transmit Diversity) 0b01 = Matrix B (Vertical Encoding) 0b10 = Matrix C (Vertical Encoding) 0b11 = <i>Reserved</i>
}	—	—
} elseif(N_Layer == 0b01) {	—	—
If (Mt==01){	—	—
<b>Matrix</b>	2 bits	—
} elseif (Mt==10    Mt==11){	—	—

**Table 101b—MIMO Compact\_DL-MAP IE (continued)**

Syntax	Size	Notes
<b>Matrix</b>	2 bits	Indicates transmission matrix (See 8.4.8) 0b00 = Matrix B (Horizontal Encoding) 0b01–11 = <i>Reserved</i>
}	—	—
} elseif (N_Layer == 0b10) {	—	—
if (Mt==10   Mt==0b11){	—	—
<b>Matrix</b>	2 bits	Indicates transmission matrix (See 8.4.8) 0b00 = Matrix C (Horizontal Encoding) 0b01–11 = <i>Reserved</i>
}	—	—
} elseif (N_Layer == 0b11) {	—	—
if (Mt==0b11){	—	—
<b>Matrix</b>	2 bits	Indicates transmission matrix (See 8.4.8) 0b00 = Matrix C (Horizontal Encoding) 0b01–11 = <i>Reserved</i>
}	—	—
}	—	—
if (Antenna Grouping/Selection == 1) {	—	—
If (N_Layer == 0b00) {	—	—
If (Mt==0b10){	—	—
<b>Antenna Grouping/Selection Index</b>	4 bits	Indicates the index of antenna grouping/ selection. See 8.4.8.3.4 and 8.4.8.3.5 0b0000 = A1 0b0001 = A2 (Vertical Encoding) 0b0010 = A3 (Vertical Encoding) 0b0011 = B1 (Vertical Encoding) 0b0100 = B2 (Vertical Encoding) 0b0101 = B3 (Vertical Encoding) 0b0110–111 = <i>Reserved</i>
} elseif (Mt==11){	—	—
<b>Antenna Grouping/Selection Index</b>	4 bits	Indicates the index of antenna grouping/ selection. See 8.4.8.3.4 and 8.4.8.3.5 0b0000 = A1 0b0001 = A2 0b0010 = A3 0b0011 = B1 (Vertical Encoding) 0b0100 = B2 (Vertical Encoding) 0b0101 = B3 (Vertical Encoding) 0b0110 = B4 (Vertical Encoding) 0b0111 = B5 (Vertical Encoding) 0b1000 = B6 (Vertical Encoding) 0b1001–111 = <i>Reserved</i>
}	—	—
} elseif (N_Layer == 0b01) {	—	—
If (Mt==0b10){	—	—

**Table 101b—MIMO Compact\_DL-MAP IE (continued)**

Syntax	Size	Notes
<b>Antenna Grouping/Selection Index</b>	4 bits	Indicates the index of antenna grouping/selection. See 8.4.8.3.4 and 8.4.8.3.5 0b0000 = B1 (Horizontal Encoding) 0b0001 = B2 (Horizontal Encoding) 0b0010 = B3 (Horizontal Encoding) 0b0011–111 = <i>Reserved</i>
} elseif (Mt==0b11){	—	—
<b>Antenna Grouping/Selection Index</b>	4 bits	Indicates the index of antenna grouping/selection. See 8.4.8.3.4 and 8.4.8.3.5 0b0000 = B1 (Horizontal Encoding) 0b0001 = B2 (Horizontal Encoding) 0b0010 = B3 (Horizontal Encoding) 0b0011 = B4 (Horizontal Encoding) 0b0100 = B5 (Horizontal Encoding) 0b0101 = B6 (Horizontal Encoding) 0b0110–111 = <i>Reserved</i>
}	—	—
}	—	—
}	—	—
if (Codebook based precoding == 1) {	—	—
<b>Codebook based precoding Index</b>	6 bits	Indicates the index of precoding matrix W in the codebook. See 8.4.8.3.6
}	—	—
}	—	—
for (j=1;j<N_layer+1; j++) {	—	This loop specifies the N <sub>EP</sub> /DIUC for layers 2 and above when required for STC. The same N <sub>SCH</sub> and RCID applied for each layer
if (HARQ Mode =CTC Incremental Redundancy) {	4 bits	HARQ Mode is specified in the HARQ Compact_DL-MAP IE format for Switch HARQ Mode.\
<b>N<sub>EP</sub></b>	4 bits	—
} Else if (HARQ Mode = Generic Chase) {	—	—
<b>DIUC</b>	4 bits	—
}	—	—
if (CQICH indicator == 1) {	—	CQICH indicator comes from the preceding Compact DL-MAP IE
<b>Allocation Index<sup>1</sup></b>	6 bits	Index to CQICH assigned to this layer
}	—	—
}	—	—
if (CQICH indicator == 1) {	2 bits	The number of additional CQICHs allocated to this MS. (0 – 3)
<b>CQICH_Num</b>	2 bits	The number of additional CQICHs allocated to this MS. (0 – 3)

**Table 101b—MIMO Compact\_DL-MAP IE (continued)**

Syntax	Size	Notes
for (i=0; i<CQICH_Num; i++) {	—	—
<b>Feedback_type</b>	3 bits	Type of contents on the additional CQICH from MS 0b000 = Fast DL measurement/Default Feedback with antenna grouping 0b001 = Fast DL measurement/Default Feedback with antenna selection 0b010 = Fast DL measurement/Default Feedback with reduced codebook 0b011 = Quantized precoding weight feedback 0b100 = Index to precoding matrix in codebook 0b101 = Channel Matrix Information 0b101 = Per stream power control 0b110–0b111 = <i>Reserved</i>
<b>Allocation index</b>	6 bits	—
<b>CQICH Usage</b>	3 bits	Indicates the usage of this CQICH 0b000 = 6-bit CQI (default) 0b001 = <i>Reserved</i> 0b010 = 3-bit CQI (even) 0b011 = 3-bit CQI(odd) 0b100 = 6-bit CQI (primary) 0b101 = 6-bit CQI (secondary) 0b110–0b111 = <i>Reserved</i> .
}	—	—
}	—	—
<b>Padding</b>	<i>variable</i>	Padding to byte; shall be set to 0
}	—	—

**Matrix Indicator**

This field indicates MIMO matrix for the burst.

**Antenna Grouping/Selection Index**

The ‘Antenna Grouping/Selection Index’ field indicates antenna grouping/selection index for the current burst. For the actual description of the following matrices, see 8.4.8.3.4 and 8.4.8.3.5.

**Allocation Index<sup>1</sup>**

Indicates position from the start of the CQICH region.

The Feedback type of this CQICH shall be one of the three default types (type 0b000, 0b001, 0b010) according to the following rule:

Feedback type = 0b000 if ((Antenna Grouping/Selection == 1) and (matrix == A or B))

Feedback type = 0b001 if ((Antenna Grouping/Selection == 1) and (matrix == C))

Feedback type = 0b010 if ((Codebook based precoding == 1))

**Feedback Type**

Indicates the type of feedback content on the allocated CQICH from MS. Its mapping shall be

- 0b000 = Fast DL measurement/Default Feedback with antenna grouping
- 0b001 = Fast DL measurement/Default Feedback with antenna selection
- 0b010 = Fast DL measurement/Default Feedback with reduced codebook
- 0b011 = Quantized precoding weight feedback
- 0b100 = Index to precoding matrix in codebook
- 0b101 = Channel Matrix Information
- 0b110 ~ 0b111 = Reserved

When the feedback type is either 0b000, 0b001, or 0b010, the MS shall transmit either the regular S/N measurement using the formula in 8.4.5.4.10.5 in its lower 32 codewords in 8.4.5.4.10.4, or the MIMO mode feedback of the specified type in its upper 32 codewords according to Table 296d in 8.4.5.4.10.7.

For each layer, a codeword shall be constructed according to 8.4.9.2.3.5 with the  $N_{EP}$  and  $N_{SCH}$  combination and mapped onto the corresponding layer. Multiple codewords from multiple layers shall be interpreted as one HARQ channel whose parameters are given in the preceding Compact DL-MAP IE.

At the receiver, an ACK shall be transmitted only when there is no CRC error detected on every layer. Otherwise, a NACK shall be transmitted.

SDMA transmissions may be allocated on the downlink with the SDMA Compact DL-MAP IE (Table 101c). Num\_layer means the number of SDMA layers (2, 3, or 4) being allocated. For each SDMA layer, if the dedicated pilot bit is set to 1 in the STC\_ZONE IE (8.4.5.3.4) for the zone in which the SDMA allocations are being made, Num\_layer selects the pilot format for the burst by interpreting Num\_layer as the number of transmit antennas (as defined in 8.4.8), and the MS with the first RCID shall be assigned the pilot pattern corresponding to antenna 1, of 8.4.8, the second to the pilot pattern corresponding to antenna 2, and so on.

**Table 101c—SDMA Compact\_DL-MAP IE format**

Syntax	Size	Notes
SDMA_Compact_DL-MAP_IE() {	—	—
<b>Compact DL-MAP Type</b>	3 bits	Type = 7
<b>DL-MAP sub-type</b>	5 bits	SDMA = 0x03
<b>Length</b>	4 bits	Length of the IE in bytes
<b>Num_layers</b>	2 bits	Number of multiple coding/modulation layers: 0b00 = 1 layer 0b01 = 2 layers 0b10 = 3 layers 0b11 = 4 layers
<b>Padding</b>	2 bits	Shall be set to zero.
for (j=1; j<Num_layer; j++) {	—	This loop specifies the $N_{EP}$ for layers 2 and above when required for STC. The same $N_{SCH}$ and RCID applied for each layer
<b>RCID</b>	<i>variable</i>	MS identifier for the current layer of the SDMA allocation
<b>if (HARQ Mode = CTC Incremental Redundancy) { <math>N_{EP}</math> } elseif (HARQ Mode = Generic Chase) { DIUC }</b>	4 bits	HARQ Mode is specified in the HARQ Compact_DL-MAP IE format for Switch HARQ Mode

**Table 101c—SDMA Compact\_DL-MAP IE format (continued)**

Syntax	Size	Notes
<b>CQI Feedback_type</b>	3 bits	Type of contents on CQICH for this MS 0b000 = Default feedback 0b001 = Precoding weight matrix W 0b010 = Channel matrix H 0b011 = MIMO mode and permutation zone 0b100–0b111 = Reserved
<b>CQICH_Num</b>	2 bits	Total number of CQICHs assigned to this MS is (CQICH_Num +1)
<b>for (i=1;i&lt;CQICH_Num;i++) {</b>	—	—
<b>Allocation index</b>	6 bits	Index to uniquely identify the additional CQICH resources assigned to the MS
<b>}</b>	—	—
<b>Padding</b>	<i>variable</i>	The padding bits are used to ensure the contents within each layer loop are an integer number of bytes. Shall be set to zero
<b>}</b>	—	—
<b>}</b>	—	—

*Insert new subclause 6.3.2.3.43.6.8:*

**6.3.2.3.43.6.8 HARQ Compact\_DL-MAP IE format for Switch HARQ Mode**

In the HARQ-MAP, a BS may transmit DL-MAP Type = 7 with the Switch HARQ mode IE. Allocations subsequent to this IE shall be for the HARQ mode identified.

**Table 101d—HARQ Compact\_DL-MAP IE format for switch HARQ mode**

Syntax	Size	Notes
Compact_DL-MAP_IE () {	—	—
<b>DL-MAP Type = 7</b>	3 bits	—
<b>DL-MAP subtype</b>	5 bits	Extension subtype Value = 1
<b>Length</b>	4 bits	Length of the IE in Bytes
<b>HARQ mode</b>	4 bits	Subtype dependent payload
<b>}</b>	—	—

**DL-MAP Type**

The DL-MAP Type value specifies the type of the Compact\_DL-MAP IE. A value of 7 indicates the extension type.

**DL-MAP Subtype**

The DL-MAP Subtype value specifies the extended map type defined in Table 101a as HARQ mode switch.

**Length**

This indicates the length of this IE in Bytes. This is encoded as 2.

**HARQ mode**

The HARQ mode is a 4-bit value that specifies the HARQ mode for all subsequent Compact\_DL-MAP IEs to the end of the current HARQ map. See 8.4.9.5 for encoding of this value.

*Insert new subclause 6.3.2.3.43.6.9:*

**6.3.2.3.43.6.9 HARQ Compact MBS MAP IE****Table 101e—HARQ Compact MBS\_MAP\_IE format for extension**

Syntax	Size	Notes
Compact MBS_MAP_IE {	—	—
<b>DL_MAP Type = 3</b>	3 bits	—
<b>Multicast CID</b>	12 bits	12 LSBs of CID for multicast
<b>MBS Zone Identifier</b>	7 bits	—
<b>Macro diversity enhanced</b>	1 bit	—
If (macro diversity enhanced = 1){	—	—
<b>Permutation</b>	2 bits	—
<b>Idcell</b>	6 bits	—
<b>OFDMA Symbol Offset</b>	8 bits	OFDMA symbol offset with respect to start of the MBS portion
<b>N_EP code</b>	4 bits	The combination of N <sub>EP</sub> code and N <sub>SCH</sub> code indicates the number of allocated subchannels and scheme of coding and modulation for the MBS_MAP message in MBS portion
<b>N_SCH code</b>	4 bits	—
} else {	—	—
<b>N_EP</b>	4 bits	The combination of N <sub>EP</sub> code and N <sub>SCH</sub> code indicates the number of allocated subchannels and scheme of coding and modulation for the DL burst
<b>N_SCH code</b>	4 bits	—
<b>AI_SN</b>	1 bits	—
<b>SPID</b>	2 bits	—
<b>ACID</b>	4 bits	—
<b>Next MBS frame offset</b>	8 bits	The Next MBS frame offset value is lower 8 bits of the frame number in which the BS shall transmit the next MBS frame
<b>Next MBS OFDMA Symbol offset</b>	8 bits	The offset of the OFDMA symbol in which the next MBS portion starts, measured in OFDMA symbols from the beginning of the downlink frame in which the MBS_MAP is transmitted
}	—	—
if !(byte boundary) {	—	—

**Table 101e—HARQ Compact MBS\_MAP\_IE format for extension (continued)**

Syntax	Size	Notes
Padding Nibble	<i>variable</i>	Padding to reach byte boundary
}	—	—
}	—	—

**AI SN**

Defines ARQ Identifier Sequence Number. This is toggled between 0 and 1 on successfully transmitting each encoder packet with the same ARQ channel.

**SPID**

Defines SubPacket ID, which is used to identify the four subpackets generated from an encoder packet.

**ACID**

Defines ARQ Channel ID for TimeDiversity MBS packet. Each TimeDiversity MBS connection can have multiple ARQ channels, each of which may have an encoder packet transaction pending.

The MBS burst indicated by the HARQ Compact MBS\_MAP\_IE is encoded at the same way of HARQ. But it does not need the acknowledgement from MS.

**6.3.2.3.43.7 UL-MAP\_IE**

**6.3.2.3.43.7.1 Compact UL-MAP IE for normal subchannel**

*Change the first paragraph as indicated:*

The format of Compact UL-MAP IE for normal subchannel is presented in Table 102. The direction of slot allocation and the direction of data mapping for uplink shall be according to 8.4.3.4.

*Change Table 102 and the text that follows as indicated:*

**Table 102—~~HARQ~~ HARQ Compact\_UL-MAP IE format for normal subchannel**

Syntax	Size	Notes
Compact_UL-MAP_IE () {	—	—
<b>UL-MAP Type =0</b>	3 bits	—
<i>Reserved</i>	1 bit	Shall be set to zero
<b>RCID_IE</b>	<i>variable</i>	—
<u>if (HARQ mode = 0) {</u>	—	<u>CTC IR</u>
<b>N<sub>EP</sub> code</b>	4 bits	Code of encoder packet bits (see 8.4.9.2.3.5)
<b>N<sub>SCH</sub> code</b>	4 bits	Code of allocated subchannels (see 8.4.9.2.3.5)
<u>} else if (HARQ mode = 1) {</u>	—	<u>Generic Chase</u>
<b><u>Shortened UIUC</u></b>	<u>4 bits</u>	<u>Shortened UIUC</u>
<b><u>Companded SC</u></b>	<u>4 bits</u>	<u>Code of allocated subchannels (see 8.4.9.5)</u>



**Table 102—H-ARQ HARQ Compact\_UL-MAP IE format for normal subchannel (continued)**

Syntax	Size	Notes
{	—	—
<del>H-ARQ</del> HARQ_Control_IE	variable	—
}	—	—

**UL-MAP Type**

~~This~~ The UL-MAP Type value specifies the type of the compact UL-MAP IE. A value of 0 indicates the Normal Subchannel.

**RCID\_IE**

Represent the assignment of the IE.

**N<sub>EP</sub> code, N<sub>SCH</sub> code**

The combination of N<sub>EP</sub> code and N<sub>SCH</sub> code indicates the number of allocated subchannels and scheme of coding and modulation for the UL burst.

**Shortened UIUC**

A shortened version of the UIUC. The shortened UIUC takes on values 1..8 of the UIUC as defined in the UCD. See 8.4.5.4.1.

**Companded SC**

The Companded SC indicates the number of allocated subchannels.

**6.3.2.3.43.7.2 Compact UL-MAP IE for Band AMC Subchannel**

*Change the first paragraph as indicated:*

The format of Compact UL-MAP IE for Band AMC Subchannel is presented in Table 103. Slots for uplink AMC zone are allocated along the symbol index first within a band. The direction of data mapping for uplink AMC zone slots shall be frequency first (across bands when multiple bands are allocated).

*Change Table 103 and the text that follows as indicated:*

**Table 103—H-ARQ HARQ Compact\_UL-MAP IE format for band AMC**

Syntax	Size	Notes
Compact_UL-MAP_IE () {	—	—
<b>UL-MAP Type =band</b>	3 bits	—
<i>Reserved</i>	1 bit	Shall be set to zero
<b>RCID_IE</b>	variable	—
<u>if (HARQ mode = 0) {</u>	—	<u>CTC IR</u>
<i>N<sub>EP</sub> code</i>	4 bits	Code of encoder packet bits (see 8.4.9.2.3.5)
<i>N<sub>SCH</sub> code</i>	4 bits	Code of allocated subchannels (see 8.4.9.2.3.5)
<u>} else if (HARQ mode = 1) {</u>	—	<u>Generic Chase</u>
<b>Shortened UIUC</b>	<u>3 bits</u>	<u>Shortened UIUC</u>
<b>Companded SC</b>	<u>5 bits</u>	<u>Code of allocated subchannels (see 8.4.9.5)</u>

**Table 103—~~H-ARQ~~ HARQ Compact\_UL-MAP IE format for band AMC (continued)**

Syntax	Size	Notes
}	—	—
<b>Nband</b>	Nb-Band	Indicates the number of selected bands. 0 = BITMAP indicates the number and offset of selected bands
if (Nband == 0) {	—	—
<b>Band BITMAP</b>	Nb-BITMAP	<i>n</i> -th LSB is 1 if <i>n</i> -th band is selected
} else {	—	—
for (i=0;i< Nband ; i++)	—	—
<b>Band Index</b>	Nb-Index	Band selection.
}	—	—
<b>Allocation Mode</b>	2 bits	Indicates the subchannel allocation mode. 0b00 = same number of subchannels for the selected bands 0b01 = different number of subchannels for the selected bands 0b10 = total number of subchannels for the selected bands determined by $N_{SCH}$ code 0b11 = <i>Reserved</i>
<i>Reserved</i>	2 bits	Shall be set to zero
if (Allocation Mode == 0b00){	—	—
<b>No. Subchannels</b>	8 bits	—
} else if (Allocation Mode == 1){	—	—
for (i=0;i< band count; i++)	—	If Nband is 0, band count is the number of 1 in Band BITMAP. Otherwise band count is Nband.
<b>No. Subchannels</b>	8 bits	—
}	—	—
<del>H-ARQ</del> <b>HARQ_Control_IE</b>	<i>variable</i>	—
}	—	—

**UL-MAP Type**

~~This~~ The UL-MAP Type value specifies the type of the compact UL-MAP IE. A value of 1 indicates the Band AMC Subchannel.

**RCID\_IE**

Represent the assignment of the IE.

**$N_{EP}$  code,  $N_{SCH}$  code**

The combination of  $N_{EP}$  code and  $N_{SCH}$  code indicates the number of allocated subchannels and scheme of coding and modulation for the UL burst.

**Shortened UIUC**

A shortened version of the UIUC. The shortened UIUC takes on values 1..8 of the UIUC as defined in the UCD. See 8.4.5.4.1.

**Companded SC**

The Companded SC indicates the number of allocated subchannels.

**Nband**

Indicates the number of bands selected for the burst. If this value is set to 0, the Band BITMAP is used to indicate the number and the position of selected bands instead. The number of the maximum logical bands determines the length of this field.

**Band BITMAP**

The Band BITMAP is valid when Nband is 0. The *n*-th LSB of the Band BITMAP is set to 1 when the *n*-th logical band is selected for the burst. If the number of the maximum logical bands is 12 then the length of the Band BITMAP is 12 bits. The band count is set to the number of 1s in the Band BITMAP. The number of the maximum logical bands determines the length of this field.

**Band Index**

The Band Index value indexes the selected band offset and is valid when Nband is larger than 0. The number of the maximum logical bands determines the length of this field.

**Allocation Mode**

The Allocation Mode value indicates the subchannel allocation mode in the selected bands. The value is set to 0b00 when the same numbers of subchannels are allocated in the selected bands by the following field ‘No. Subchannels’. The value is set to 0b01 when different numbers of subchannels are allocated in each selected bands by the following fields “No. Subchannels”. The value is set to 0b10 when the total number of subchannels allocated in the selected bands is defined by  $N_{SCH}$  code and  $N_{EP}$  code. The subchannels fill from the bands with lowest index. The allocation mode variant is shown in Figure 23.

**No. Subchannels**

The No. Subchannels value indicates the number of subchannels allocated for this burst.

**6.3.2.3.43.7.3 Compact UL-MAP IE for safety subchannel**

Change the first paragraph as indicated:

The format of Compact UL-MAP IE for safety subchannel is presented in ~~Table 98~~ Table 104.

Change Table 104 and the text that follows as indicated:

**Table 104—~~H ARQ~~ HARQ Compact\_UL-MAP IE format for safety**

Syntax	Size	Notes
Compact_UL-MAP_IE () {	—	—
UL-MAP Type =2	3 bits	—
Reserved	1 bit	Shall be set to zero
RCID_IE	variable	—
if (HARQ mode = 0) {	—	<u>CTC IR</u>
$N_{EP}$ code	4 bits	Code of encoder packet bits (see 8.4.9.2.3.5)
$N_{SCH}$ code	4 bits	Code of allocated subchannels (see 8.4.9.2.3.5)
} else if (HARQ mode = 1) {	—	<u>Generic Chase</u>
Shortened UIUC	<u>3 bits</u>	<u>Shortened UIUC</u>

**Table 104—H-ARQ HARQ Compact\_UL-MAP IE format for safety (continued)**

Syntax	Size	Notes
<b>Companded SC</b>	5 bits	Code of allocated subchannels (see 8.4.9.5)
}	—	—
<b>BIN offset</b>	8 bits	—
<b>H-ARQHARQ_Control_IE</b>	variable	—
}	—	—

**UL-MAP Type**

The UL-MAP Type value specifies the type of the compact UL-MAP IE. A value of 2 indicates the Safety Subchannel.

**RCID\_IE**

Represent the assignment of the IE.

**N<sub>EP</sub> code, N<sub>SCH</sub> code**

The combination of N<sub>EP</sub> code and N<sub>SCH</sub> code indicates the number of allocated subchannels and scheme of coding and modulation for the UL burst.

**Shortened UIUC**

A shortened version of the UIUC. The shortened UIUC takes on values 1..8 of the UIUC as defined in the UCD. See 8.4.5.4.1.

**Companded SC**

The Companded SC indicates the number of allocated subchannels.

**BIN Offset**

The offset of the BIN allocated for this UL burst.

**6.3.2.3.43.7.4 Compact UL-MAP IE for UIUC subchannel**

Change Table 105 as indicated:

**Table 105—H-ARQ Compact\_UL-MAP IE format for UIUC subchannel**

Syntax	Size	Notes
Compact_UL-MAP_IE () {		
<b>UL-MAP Type =4</b>	3 bits	
<i>Reserved</i>	1 bit	Shall be set to zero
<b>UIUC</b>	4 bits	
<b>RCID_IE</b>	variable	
if (UIUC == 12) {		
<b>OFDMA symbol offset</b>	8 bits	
<b>Subchannel offset</b>	7 bits	
<b>No. OFDMA symbols</b>	7 bits	
<b>No. Subchannels</b>	7 bits	

**Table 105—H-ARQ Compact\_UL-MAP IE format for UIUC subchannel (continued)**

Syntax	Size	Notes
<b><u>Ranging method</u></b>	<u>2 bits</u>	<u>0b00 - Initial Ranging over two symbols</u> <u>0b01 - Initial Ranging over four symbols</u> <u>0b10 - BW Request/Periodic Ranging over one symbol</u> <u>0b11 - BW Request/Periodic Ranging over three symbols</u>
<i>Reserved</i>	<u>1 bit</u>	<u>Shall be set to zero</u>
<i>} else if (UIUC == 14) {</i>		
<b><u>CDMA_Allocation_IE()</u></b>	<u>32 bits</u>	
<i>}</i>		
<i>} else if (UIUC == 15) {</i>		
<b><u>Extended UIUC dependent IE()</u></b>	<i>variable</i>	
<i>} else {</i>		
<b>No. Subchannels</b>	8 bits	The number of subchannels allocated by the IE
<b><u>Repetition coding indication</u></b>	<u>2 bits</u>	<u>0b00 - No repetition coding</u> <u>0b01 - Repetition coding of 2 used</u> <u>0b10 - Repetition coding of 4 used</u> <u>0b11 - Repetition coding of 6 used</u>
<i>Reserved</i>	<u>2 bits</u>	<u>Shall be set to zero</u>
<i>}</i>		
<b><u>H-ARQ_Control_IE</u></b>	<i>variable</i>	
<i>}</i>		

*Insert the following text below Table 105:*

**Repetition coding indication**

Indicates the repetition code used inside the allocated burst.

**6.3.2.3.43.7.5 Compact UL-MAP IE for H-ARQ HARQ Region allocation**

*Insert the following paragraph at the beginning of the subclause:*

HARQ ACK Region shall reside in fast-feedback region. This means that when the Compact UL-MAP IE for HARQ ACK Region indicates a region within the region that is allocated for FAST FEEDBACK, then the region shall be used for HARQ ACK region.

*Change the third paragraph as indicated:*

The ~~H-ARQ~~ HARQ enabled SS that receives ~~H-ARQ~~ HARQ DL burst at  $i$ -th frame should transmit ACK signal through the half-subchannel in the ~~H-ARQ~~ HARQ region at  $(i+j)$ -th frame. The frame offset “ $j$ ” is defined by the “~~H-ARQ~~ HARQ ACK Delay for DL Burst” field in the UCD message. The half-subchannel offset in the ~~H-ARQ~~ HARQ Region is determined by the order of ~~H-ARQ~~ HARQ enabled DL burst in the ~~H-ARQ~~ HARQ MAP. For example, when an SS receives a ~~H-ARQ~~ HARQ enabled burst at  $i$ -th frame and the burst is  $n$ -th ~~H-ARQ~~ HARQ enabled burst in the ~~H-ARQ~~ HARQ MAP, the SS should transmit ~~H-ARQ~~ HARQ ACK at  $n$ -th half-subchannel in ~~H-ARQ~~ HARQ Region that is allocated by the BS at the  $(i+j)$ -th frame. The Compact MAP IE indexing HARQ burst should set the RCID field to basic CID of an SS, and the prefix field in the HARQ Control IE to 1. Otherwise, the MAP IE shall not be considered as HARQ enabled burst.

*Insert the following text at the end of 6.3.2.3.43.7.5:*

Whenever HARQ enabled DL-SDMA allocations are made within a frame, the ACKs for the SDMA users allocated on the second layer shall be appended to the ACKs for the non-SDMA and first-layer SDMA users.

**6.3.2.3.43.7.6 Compact UL-MAP IE for CQICH Region Allocation**

*Insert the following two paragraphs as the first paragraphs of the subclause:*

When there exist a need to allocate multiple CQICHs to an MS, the number of used subchannels for CQICH region shall be increased by the total number of additional CQICHs for all MS within the frame, and their positions shall be specified by Allocation Indices of their respective MIMO\_Compact\_DL-MAP IE.

HARQ CQICH region shall reside in fast-feedback region. This means that when the Compact UL-MAP IE for CQICH Region indicates a region within the region that is allocated for fast-feedback channel, then the region shall be used for HARQ CQICH region.

*Change the first paragraph as indicated:*

The CQI region information is delivered through the Compact\_UL-MAP\_IE as shown in Table 107. SS sends CQI report in CQI region. The CQICH control IE allocates a CQI channel in a CQICH region. When no CQICH Region allocation IE exists in HARQ MAP then fast-feedback region shall be used instead for CQICH region.

**6.3.2.3.43.7.7 Compact UL-MAP IE for extension**

*Insert the following at the end of 6.3.2.3.43.7.7:*

Table 108a represents the extended types of compact DL MAP.

**Table 108a—UL-MAP subtypes**

extended compact UL-MAP Type	Description
0	Switch HARQ Mode
1..7	Reserved

*Insert new subclause 6.3.2.3.43.7.8:*

**6.3.2.3.43.7.8 Compact UL-MAP IE for Allocation start offset**

The format of Compact UL-MAP IE for allocation start offset is presented in Table 109.

**Table 109—~~HARQ HARQ~~ Compact\_UL-MAP IE format for allocation start offset**

Syntax	Size	Notes
Compact_UL-MAP_IE () {		
<b>UL-MAP Type =7</b>	3 bits	
<b>UL-MAP subtype</b>	5 bits	Extension subtype
<b>Length = 2</b>	4 bits	Length of the IE in bytes
<b>Start symbol offset</b>	5 bits	Offset from the start of UL sub-frame
<b>Start subchannel offset</b>	8 bits	
}		

**UL-MAP Type**

Specifies the type of the compact UL-MAP IE. A value of 7 indicates the extension type.

**UL-MAP Subtype**

Specifies the subtype of the compact UL-MAP IE.

**Length**

Indicates the length of this IE in bytes. If an SS cannot recognize the UL-MAP Subtype, it skips the IE.

**Start symbol offset**

A subsequent HARQ UL data burst allocation shall start from the symbol specified in the value. However, this value does not affect to the ranging region, CQICH region, and HARQ ACK region.

**Start subchannel offset**

A subsequent HARQ UL data burst allocation shall start from the subchannel specified in the value. However, this value does not affect to the ranging region, CQICH region, and HARQ ACK region.

*Insert new subclause 6.3.2.3.43.7.9:*

**6.3.2.3.43.7.9 MIMO Compact UL MAP IE format**

When MIMO enabled UL burst are present within a frame, they shall be allocated before non-MIMO DL burst in both diversity and AMC zones. Figure 23a exemplifies the UL HARQ subframe structure, where the 1-by-6 AMC type is depicted.

Within the MIMO diversity zone, subchannels shall take the form of Mini-subchannel Type 0b01 in Table 312, which spans over six symbols. Within the MIMO AMC zone, subchannels shall take 1-by-6 AMC type. Both MIMO diversity and MIMO AMC zones shall contain multiples of six symbols.

Each MIMO enabled UL burst shall be first allocated by the regular Compact UL-MAP IE for diversity subchannels (see Table 100) and AMC subchannels (see Table 101), followed by the extended MIMO Compact UL-MAP IE. The indication of zone boundary shall be made by the presence of UL Zone IE in Table 292.

The format of MIMO Compact UL-MAP IE is presented in Table 109a. This extended IE shall follow right after the basic allocation IE for each MIMO enabled UL burst.

**Table 109a—MIMO Compact UL-MAP IE format**

Syntax	Size	Notes
MIMO Compact UL-MAP IE()	—	—
<b>Compact UL-MAP Type</b>	3 bits	Type = 7
<b>UL-MAP Subtype</b>	5 bits	MIMO = 0x01
<b>Length</b>	4 bits	Length of the IE in Bytes
<b>Matrix indicator</b>	1 bit	UL STC matrices (see 8.4.8.4) For 2-antenna MS, 0 = Matrix A 1 = Matrix B For Collaborative SM capable MS 0 = Pilot pattern A 1 = Pilot pattern B
<b>Num_layer</b>	1 bit	Number of multiple coding/modulation layers 0–1 layer 1–2 layers
for (j=1;j<Num_layer;j++) {	—	This loop specifies the $N_{EP}$ for layers 2 and above when required for STC. The same $N_{SCH}$ and RCID applied for each layer
if (HARQ Mode = CTC Incremental Redundancy) {	—	HARQ Mode is specified in the HARQ Compact UL-MAP IE format for Switch HARQ Mode.
<b><math>N_{EP}</math></b>	4 bits	—
} elseif (HARQ Mode = Generic Chase) {	—	—
<b>UIUC</b>	4 bits	—
}	—	—
}	—	—
<b>Padding</b>	<i>variable</i>	The padding bits are used to ensure the IE size is integer number of bytes
}	—	—

For each layer, a codeword shall be constructed according to 8.4.9.2.3.5 with the  $N_{EP}$  and  $N_{SCH}$  combination and mapped onto the corresponding layer. Multiple codewords from multiple layers shall be interpreted as one HARQ channel whose parameters are given in the preceding Compact UL-MAP IE.

At the receiver, an ACK shall be transmitted only when there is no CRC error detected on every layer. Otherwise, a NACK shall be transmitted.



*Insert new subclause 6.3.2.3.43.7.10:*

### 6.3.2.3.43.7.10 SDMA Compact UL-MAP IE format

SDMA transmissions may be allocated in the uplink with the SDMA Compact UL-MAP IE (Table 109b).

#### Num\_layer

The Num\_layer specifies the number of SDMA layers. It is interpreted as the number of transmit antennas (as defined in 8.4.8). The first layer/user shall use pilot pattern A and the second layer/user shall use pilot pattern B. The third layer/user shall use pilot pattern C and the fourth layer/user shall use pilot pattern D.

**Table 109b—SDMA Compact UL-MAP IE format**

Syntax	Size	Notes
SDMA_Compact_UL-MAP_IE() {	—	—
<b>Compact UL-MAP Type</b>	3 bits	Type = 7
<b>UL-MAP Sub-type</b>	5 bits	SDMA = 0x03
<b>Length</b>	4 bits	Length of the IE in Bytes
<b>Matrix indicator</b>	1 bit	UL STC matrices (see 8.4.8.4) For 2-antenna MS, 0 = Matrix A 1 = Matrix B
<b>Num_layer</b>	1 bit	Number of multiple coding/modulation layers: 0– 1 layer 1– 2 layers
<b>Padding</b>	2 bits	For byte alignment. Shall be set to zero.
For (j=1;j<Num_layer; j++) {		This loop specifies the $N_{EP}$ for layer 2 when required for STC.
<b>RCID</b>	<i>variable</i>	MS identifier for the current layer of the SDMA allocation
if (HARQ Mode =CTC Incremental Redundancy) {	—	HARQ Mode is specified in the HARQ Compact_UL-MAP IE format for Switch HARQ Mode.
<b><math>N_{EP}</math></b>	4 bits	—
} elseif (HARQ Mode = Generic Chase) {	—	—
<b>UIUC</b>	4 bits	—
}	—	—
<b>Padding</b>	<i>variable</i>	The padding bits are used to ensure the contents within the layer loop are an integer number of bytes. Shall be set to zero.
}	—	—
}	—	—

*Insert new subclause 6.3.2.3.44:*

**6.3.2.3.44 Sleep Request message (MOB\_SLP-REQ)**

An MS supporting sleep mode uses the MOB\_SLP-REQ message to request definition and/or activation of certain Power Save Classes of types 1, 2, and 3. The MOB\_SLP-REQ message is sent from the MS to the BS on the MS's basic CID. If Definition bit is set, the message contains suggested by the MS definition of new Power Saving Class.

**Table 109c—Sleep-Request (MOB\_SLP-REQ) message format**

Syntax	Size	Notes
MOB_SLP-REQ_Message_format() {	—	—
<b>Management message type = 50</b>	8 bits	—
<b>Number of Classes</b>	8 bits	Number of power saving classes.
for (i=0; i<Number of Classes; i++) {	—	—
<b>Definition</b>	1 bit	—
<b>Operation</b>	1 bit	—
<b>Power Saving Class ID</b>	6 bits	—
if (Operation = 1) {	—	—
<b>Start_frame_number</b>	6 bits	—
<b>Reserved</b>	2 bits	—
}	—	—
if (Definition = 1) {	—	—
<b>Power Saving Class Type</b>	2 bits	—
<b>Direction</b>	2 bits	—
<b>Traffic_triggered_wakening_flag</b>	1 bit	—
<b>Reserved</b>	3 bits	—
<b>initial-sleep window</b>	<del>6</del> 8 bits	—
<b>listening-window</b>	8 bits	—
<b>final-sleep window base</b>	10 bits	—
<b>final-sleep window exponent</b>	3 bits	—
<b>Number_of_Sleep_CIDs</b>	3 bits	—
for (i=0; i<Number_of_Sleep_CIDs; i++ {	—	—
<b>CID</b>	16 bits	—
}	—	—
}	—	—
<b>TLV encoded information</b>	<i>variable</i>	—
}	—	—

Parameters shall be as follows:

**Definition**

0 = Definition of Power Saving Class absent; in this case the message shall request activation or deactivation of Power Saving Class identified by Power\_Saving\_Class\_ID.

1 = Definition of Power Saving Class present.

**Operation**

0 = Deactivation of Power Saving Class (for types 1 and 2 only).

1 = Activation of Power Saving Class.

**Power\_Saving\_Class\_ID**

Assigned Power Saving Class identifier. The ID shall be unique within the group of Power Saving Classes associated with the MS. This ID may be used in further MOB\_SLP-REQ/RSP messages for activation / deactivation of Power Saving Class.

**Start\_frame\_number**

Start frame number for first sleep window.

**Direction**

Defined the directions of the class's CIDs.

0b00 = Unspecified. Each CID has its own direction assign in its connection creation. Can be DL, UL, or both (in the case of management connections).

0b01 = Downlink direction only.

0b10 = Uplink direction only.

0b11 = *Reserved*.

**Traffic\_triggered\_wakening\_flag (for Type I only)**

0 = Power Saving Class shall not be deactivated if traffic appears at the connection as described in 6.3.19.2.

1 = Power Saving Class shall be deactivated if traffic appears at the connection as described in 6.3.19.2.

**Listening window**

Assigned Duration of MS listening window (measured in frames). For Power Saving Class type III, it is not relevant and shall be encoded as 0.

**Initial-sleep window**

Assigned initial duration for the sleep window (measured in frames). For Power Saving Class type III, it is not relevant and shall be encoded as 0.

**Final-sleep window base**

Assigned final value for the sleep interval (measured in frames). For Power Saving Class type II, it is not relevant and must be encoded as 0. For Power Saving Class type III, it is the base for duration of single sleep window requested by the message.

**Final-sleep window exponent**

Assigned factor by which the final-sleep window base is multiplied in order to calculate the final-sleep window. The following formula is used:

$$\text{final-sleep window} = \text{final-sleep window base} \times 2^{(\text{final-sleep window exponent})}$$

For Power Saving Class type III, it is the exponent for the duration of single sleep window requested by the message.

**Number\_of\_CIDs**

If Number\_of\_CIDs = 0, it means that all unicast CIDs associated with the MS are requested for addition to the class.

**CID**

CIDs of unicast connections comprising the Power Saving Class. CID = 0 denotes set of all management connections associated with the MS.

The following TLV parameter may be included in MOB\_SLP-REQ message transmitted when requesting an activation of Power Saving Class. This TLV indicates the enabled action that MS performs upon reaching trigger condition in sleep mode.

**Enabled-Action-Triggered**

Indicates possible action upon reaching trigger condition.

The MOB\_SLP-REQ shall include the following parameters encoded as TLV tuples:

**HMAC/CMAC Tuple (see 11.1.2)**

The HMAC/CMAC Tuple shall be the last attribute in the message.

*Insert new subclause 6.3.2.3.45:*

**6.3.2.3.45 Sleep Response message (MOB\_SLP-RSP)**

The MOB\_SLP-RSP message shall be sent from BS to an MS on Broadcast CID or on the MS's basic CID in response to an MOB\_SLP-REQ message, or may be sent unsolicited. If Definition bit is set, the message contains the definition of a new Power Saving Class together with an assigned Power\_Saving\_Class\_ID that shall be unique per MS if only unicast traffic connections are included and unique per cell if only multicast connections are included. Mixture of multicast and unicast connections in a single class is not allowed.

After reception of the message, the MS shall assemble connections in Power Saving Classes and optionally activate them as requested in the message. If for certain class activation is deferred (Activation = 0), the BS may signal activation at later time in another unsolicited MOB\_SLP-RSP message (Table 109d).

**Table 109d—Sleep-Response (MOB\_SLP-RSP) message format**

Syntax	Size	Notes
MOB_SLP-RSP_Message_format() {	—	—
<b>Management message type = 51</b>	8 bits	—
<b>Number of Classes</b>	8 bits	Number of power saving classes.
for (i = 0; i < Number_of_Classes; i++) {	—	—
<b>Length of Data</b>	7 bits	—
<b>Sleep Approved</b>	1 bit	
<b>Definition</b>	1 bit	—
<b>Operation</b>	1 bit	—
<b>Power_Saving_Class_ID</b>	6 bits	—
if (Sleep Approved == 1) {	—	—
if (Operation = 1) {	—	—
<b>Start_frame_number</b>	6 bits	—
<i>Reserved</i>	2 bits	—
}	—	—
if (Definition = 1) {	—	—
<b>Power_Saving_Class_Type</b>	2 bits	—

**Table 109d—Sleep-Response (MOB\_SLP-RSP) message format (continued)**

Syntax	Size	Notes
<b>Direction</b>	2 bits	—
<b>initial-sleep window</b>	8 bits	—
<b>listening window</b>	8 bits	—
<b>final-sleep window base</b>	10 bits	—
<b>final-sleep window exponent</b>	3 bits	—
<b>TRF-IND required</b>	1 bit	—
<b>Traffic_triggered_wakening_flag</b>	1 bit	—
<i>Reserved</i>	1 bit	—
if (TRF-IND required) {	—	—
<b>SLPID</b>	10 bits	—
<i>Reserved</i>	2 bits	—
}	—	—
<b>Number_of_CIDs</b>	4 bits	—
for (i = 0; i < Number_of_CIDs; i++) {	—	—
<b>CID</b>	16 bits	—
}	—	—
if (MDHO or FBSS capability enabled) {	—	If MDHO or FBSS capability is enabled in the REG-REQ/RSP message exchange.
<b>Maintain Diversity Set and Anchor BS</b>	1 bit	—
if (Maintain Diversity Set and Anchor BS) {	—	—
<b>MDHO/FBSS duration (s)</b>	3 bits	—
}	—	—
}	—	—
}	—	—
<i>Padding</i>	<i>variable</i>	If needed for alignment to byte boundary
if (Operation = 1) {	—	—
<b>Power Saving Class TLV encoded information</b>	<i>variable</i>	—
}	—	—
} else {	—	In case Sleep Approved == 0
<b>REQ-duration</b>	8 bits	—
}	—	—
<b>TLV encoded information</b>	<i>variable</i>	—
}	—	—

Parameters shall be as follows:

**Length\_of\_Data**

Number of bytes in following specification of Power Saving Class.

**Sleep\_Approved**

1 = Indicates that BS approves the MS's Activation/Deactivation Request of the Power Saving Class.

0 = Indicates that BS disapproves the MS's Activation/Deactivation Request of the Power Saving Class.

For a MOB\_SLP-RSP transmitted in an unsolicited manner including Definition of one or more Power Saving Class IDs, the BS shall set Sleep Approved = 0 for each Power Saving Class ID defined in the message.

In case of the MOB\_SLP-RSP transmitted from the BS in an unsolicited manner, the BS shall set "Sleep approved" = 1 for each Power Saving Class ID that is not defined in the message.

**Definition**

1 = Definition of Power Saving Class present.

**Operation**

0 = Deactivation of Power Saving Class (for types 1 and 2 only; used only with Definition = 0).

1 = Activation of Power Saving Class.

**Power\_Saving\_Class\_ID**

Assigned Power Saving Class identifier. The ID shall be unique within the group of Power Saving Classes associated with the MS. This ID may be used in further MOB\_SLP-REQ/RSP messages for activation/deactivation of Power Saving Class.

**Start\_frame\_number**

Start frame number for first sleep window.

**REQ-duration**

Waiting value for the MOB\_SLP-REQ message re-transmission (measured in MAC frames): the MS may retransmit the MOB\_SLP-REQ message after the time duration (REQ-duration) provided in the message.

**Power\_Saving\_Class\_Type**

Requested Power Saving Class type

**Direction**

Defined the directions of the class's connections:

0b00 = Unspecified. Each connection has its own direction assigned during connection creation. Can be DL or UL.

0b10 = Uplink direction (for management connections only).

0b01 = Downlink direction (for management connections only).

0b11 = *Reserved*.

**Listening interval**

Assigned Duration of MS listening interval (measured in frames). For Power Saving Class type III, it is not relevant and must be encoded as 0.

**Initial-sleep window**

Assigned initial duration for the sleep window (measured in frames). For Power Saving Class type III, it is not relevant and must be encoded as 0.

**Final-sleep window base**

Assigned final value for the sleep interval (measured in frames). For Power Saving Class type II, it is not relevant and must be encoded as 0. For Power Saving Class type III, it is the base for duration of single sleep window requested by the message.

**Final-sleep window exponent**

Assigned factor by which the final-sleep window base is multiplied in order to calculate the final-sleep window. The following formula is used:

$$\text{final-sleep window} = \text{final-sleep window base} \times 2^{(\text{final-sleep window exponent})}$$

For Power Saving Class type II it is the exponent for the duration of single sleep window requested by the message.

**TRF-IND\_Required**

For Power Saving Class Type I only.

1 = BS shall transmit at least one TRF-IND message during each listening window of the Power Saving Class.

This bit shall be set to 0 for another types.

**Traffic\_triggered\_wakening\_flag** (for Type I only)

1 = Power Saving Class shall be deactivated if traffic appears at the connection as described in 6.3.19.2.

0 = Power Saving Class shall not be deactivated if traffic appears at the connection as described in 6.3.19.2.

**SLPID**

This is a number assigned by the BS whenever an MS is instructed to enter sleep mode. This number shall be unique in the sense that it is assigned to a single MS that is instructed to enter sleep mode. No other MS shall be assigned the same number while the first MS is still in sleep mode.

**Number\_of\_CIDs**

In case the message is sent on Basic connection of certain MS, Number\_of\_CIDs = 0 means that all CIDs associated with the MS are included into the class.

**CID**

CIDs of all connections comprising the Power Saving Class. This list shall contain either unicast connections or multicast connections or management connections, but not combination of connections of different types. If Basic CID is encoded, it means that all MS connections are included in a single class. CID = 0 is reserved for management operations. In case the message is sent on Basic connection of certain MS, CID = 0 denotes set of all management connections associated with the MS.

**Maintain Diversity Set and Anchor BS**

1: Diversity set and Anchor BS shall be maintained while in sleep mode for MDHO/FBSS duration.

0: Diversity set and Anchor BS shall not be maintained while in sleep mode.

**MDHO/FBSS duration (s)**

Diversity set and Anchor BS shall be maintained for  $10 \times 2^{\text{exp}(s)}$  frames after the Power Saving Class is activated.

**Power Saving Class TLV encoded information**

May contain the following TLVs:

**Next Periodic Ranging**

This value indicates the offset of frame in which MS shall be ready to perform a periodic ranging with respect to the frame where MOB\_SLP-RSP is transmitted.

The following TLV parameter may be included in MOB\_SLP-RSP message transmitted the BS permits an activation of Power Saving Class. This TLV indicates the enabled action that MS performs upon reaching trigger condition in sleep mode.

**Enabled-Action-Triggered**

Indicates possible action upon reaching trigger condition.

The MOB\_SLP-RSP shall include the following parameter encoded as TLV tuples:

**HMAC/CMAC Tuple (see 11.1.2)**

The HMAC/CMAC Tuple shall be the last attribute in the message.

*Insert new subclause 6.3.2.3.46:*

**6.3.2.3.46 Traffic Indication message (MOB\_TRF-IND)**

This message is sent from BS to MS on the broadcast CID or sleep mode multicast CID. The message is intended for MSs that are in sleep mode that have one or more Power Saving Class IDs defined of Power Saving Class type I, and is sent during those MS's listening-intervals. All MS with no Power Saving Class IDs defined of Power Saving Class type I shall ignore this message. The message indicates whether there has been traffic addressed to each MS that is in sleep mode. For an MS that is in sleep mode, during its listening-window the MS shall decode this message to seek an indication addressed to itself.

When an MS awakens, it will check the frame number to ensure that it did not lose frame synchronization with the BS and read the SLPID-Group Indication bit-map or Traffic Indication bit-map assigned to it and decide whether to continue in sleep mode or return to Normal Operation.

There are two formats for the MOB\_TRF-IND message, indicated by the FMT field. When FMT = 0, if the MS does not find its own SLPID-Group Indication bit-map or Traffic Indication bit-map to its SLPID in the MOB\_TRF-IND message, it will consider this as a negative indication and may continue its sleep mode. The MS shall update its SLPID if it finds its own Old\_New\_SLPID in SLPID\_Update TLV. When FMT = 1, if the MS does not find its own SLPID in the MOB\_TRF-IND message, it will consider this as a negative indication and may continue its sleep mode.

BS may arbitrarily include a positive indication for an MS in MOB\_TRF-IND message during listening-window if the MS's periodic ranging operation is scheduled to start sooner or later within next sleep-window, even if there is no DL Traffic to be sent to the MS.

**Table 109e—Traffic-Indication (MOB\_TRF-IND) message format**

Syntax	Size	Notes
MOB_TRF-IND_Message_format() {	—	—
<b>Management message type = 52</b>	8 bits	—
<b>FMT</b>	1 bit	—
if (FMT == 0) {	—	—
<b>SLPID Group Indication bit-map</b>	32 bits	<p><i>N</i>-th bit of SLPID-Group indication bit-map MSB corresponds to <math>N = 0</math>] is allocated to SLPID Group that includes MS with SLPID values from <math>N*32</math> to <math>N*32+31</math></p> <p>Meaning of this bit            0: There is no traffic for all the 32 MS that belong to the SLPID-Group            1: There is traffic for at least one MS in SLPID-Group.</p>



**Table 109e—Traffic-Indication (MOB\_TRF-IND) message format (continued)**

Syntax	Size	Notes
<b>Traffic Indication Bitmap</b>	<i>variable</i>	Traffic Indication bit map comprises the multiples of 32-bit long Traffic Indication unit. A Traffic Indication unit for 32 SLPIDs is added to MOB_TRF-IND message whenever its SLPID Group is set to 1 32 bits of Traffic Indication Unit (starting from MSB) are allocated to MS in the ascending order of their SLPID values: 0: Negative indication 1: Positive indication
} else {	—	—
<b>Num_Pos</b>	8 bits	Number of CIDs following
for (i=0; i<Num_Pos; i++) {	—	—
<b>SLPIDs</b>	10 bits	—
}	—	—
}	—	—
Padding	<i>variable</i>	If needed, for alignment to byte boundary.
<b>TLV encoded items</b>	<i>variable</i>	—
}	—	—

Parameters shall be as follows:

**FMT**

The FMT field indicates one of the SLPID bit-map based format and the Short Basic CID based format.

**SLPID-Group indication bit-map**

SLPIDs from 0 to 1023 are divided into 32 SLPID-Groups. Therefore, the respective SLPID-Group has the range as follows:

SLPID-Group#0 (MSB) corresponds to SLPID = 0...31.

SLPID-Group #1 corresponds to SLPID = 32...63.

...

SLPID-Group#31 corresponds to SLPID = 992...1023.

‘SLPID-Group Indication bit-map’ is a 32-bit-long field where each bit is assigned to the respective SLPID-Group. In other words, the most significant bit (MSB) in the field is assigned to SLPID-Group#0, and subsequent bit relates to SLPID-Group #1, etc.

The  $n$ -th bit ( $b_n$ ),  $n=0\sim31$ , of SLPID-Group Indication bit-map shall be interpreted in the following manner:

$b_n = 0$  means that there is no traffic for all the 32 MS belonging to SLPID-Group # $n$ . In this case, the MS in sleep mode belonging to SLPID-Group # $n$  may return to sleep mode.

$b_n = 1$  means that there exists traffic for one or more MS belonging to SLPID-Group # $n$ . In this case, the MS in sleep mode belonging to SLPID-Group # $n$  shall read its own Traffic Indication bit-map in MOB\_TRF-IND message.

**Traffic Indication bit-map**

Traffic Indication bit map comprises the multiples of 32-bit long Traffic Indication Unit for every SLPID-Group with SLPID-Group indication bit = 1. Bits in a 32-bit Traffic Indication unit (starting from MSB) are allocated to MS to in ascending order of SLPIDs. Each bit signals traffic information for the corresponding MS as follows:

- 0: Negative Indication
- 1: Positive Indication

**Num-pos**

The number of Positive indication.

**SLPID**

The SLPID for the Power\_Saving\_Class\_ID deactivated by this message and for MS to be transitioned into an awake mode.

When MOB\_TRF-IND message has FMT = 0, it may include the following TLV:

**SLPID\_Update (11.17.1)**

The SLPID\_Update is a compound TLV value that provides a shorthand method for changing the SLPID used by the MS in sleep mode operation. The SLPID\_Update TLV specifies a new SLPID that replaces an old SLPID. The SLPID\_Update TLV may contain multiple Old\_New\_SLPID values for the MS negatively indicated in MOB\_TRF-IND message.

*Insert new subclause 6.3.2.3.47:*

**6.3.2.3.47 Neighbor Advertisement (MOB\_NBR-ADV) message**

BSs supporting mobile functionality shall be capable of transmitting a MOB\_NBR-ADV management message at a periodic interval (MOB\_NBR-ADV interval, see Table 342a) to identify the network and define the characteristics of neighbor BS to potential MS seeking initial network entry or handover. For the compression of neighbor BSIDs using this message in MOB\_SCN-REP and MOB\_MSHO-REQ message, BSs shall keep mapping-tables of neighbor BS MAC addresses and neighbor BS indexes transmitted through MOB\_NBR-ADV message, for each Configuration Change Count. Using these mapping-tables, BSs can derive 48-bit neighbor BSID from neighbor BS index included in MOB\_SCN-REP or MOB\_MSHO-REQ message.

If neighbor information is not available, this message need not be transmitted.

**Table 109f—MOB\_NBR-ADV message format**

Syntax	Size	Notes
MOB_NBR-ADV_Message_format() {	—	—
<b>Management Message Type = 53</b>	8 bits	—

**Table 109f—MOB\_NBR-ADV message format (continued)**

<b>Skip-optional-fields bitmap</b>	8 bits	Bit [0]: if set to 1, omit Operator ID field. Bit [1]: if set to 1, omit NBR BS ID field. Bit [2]: if set to 1, omit HO process optimization field. Bit [3]: if set to 1, omit QoS related fields. Bit [4]–[7]: <i>Reserved</i> .
If (Skip-optional-fields-[0]=0) {	—	—
<b>Operator ID</b>	24 bits	Unique ID assigned to the operator.
}	—	—
<b>Configuration Change Count</b>	8 bits	Incremented each time the information for the associated neighbor BS has changed.
<b>Fragmentation Index</b>	4 bits	Indicates the current fragmentation index.
<b>Total Fragmentation</b>	4 bits	Indicates the total number of fragmentations.
<b>N_NEIGHBORS</b>	8 bits	—
For (j=0 ; j<N_NEIGHBORS ; j++) {	—	—
<b>Length</b>	8 bits	Length of message information within the iteration of N_NEIGHBOR in bytes.
<b>PHY Profile ID</b>	8 bits	Aggregated IDs of Co-located FA Indicator, FA Configuration Indicator, FFT size, Bandwidth, Operation Mode of the starting subchannelization of a frame, and Channel Number.
if (FA Index Indicator == 1) {	—	—
<b>FA Index</b>	8 bits	This field, Frequency Assignment Index, is present only the FA Index Indicator in PHY Profile ID is set. Otherwise, the neighbor BS has the same FA Index or the center frequency is indicated using the TLV encoded information.
}	—	—
if (BS EIRP Indicator == 1) {	—	—
<b>BS EIRP</b>	8 bits	Signed Integer from –128 to 127 in unit of dBm This field is present only if the BS EIRP indicator is set in PHY Profile ID. Otherwise, the BS has the same EIRP as the serving BS.
}	—	—
if (Skip-optional-fields[1]=0) {	—	—
<b>Neighbor BSID</b>	24 bits	This is an optional field for OFDMA PHY and it is omitted or skipped if Skip optional fields Flag = 1.
}	—	—
<b>Preamble Index/Subchannel Index</b>	8 bits	For the SCa and OFDMA PHY this parameter defines the PHY specific preamble. For the OFDM PHY, the 5 LSB contain the active DL subchannel index. The 3 MSB shall be <i>Reserved</i> and set to ‘0b000’.
if (Skip-optional-fields[2]=0) {	—	—

**Table 109f—MOB\_NBR-ADV message format (continued)**

<b>HO Process Optimization</b>	8 bits	HO Process Optimization is provided as part of this message is indicative only. HO process requirements may change at time of actual HO. For each Bit location, a value of '0' indicates the associated reentry management messages shall be required, a value of '1' indicates the reentry management message may be omitted. Regardless of the HO Process Optimization TLV settings, the target BS may send unsolicited SBC-RSP and/ or REG-RSP management messages Bit #0: Omit SBC-REQ/RSP management messages during re-entry processing Bit #1: Omit PKM Authentication phase except TEK phase during current re-entry processing Bit #2: Omit PKM TEK creation phase during reentry processing Bit #3: Omit REG-REQ/RSP management during current re-entry processing Bit #4: Omit Network Address Acquisition management messages during current reentry processing Bit #5: Omit Time of Day Acquisition management messages during current reentry processing Bit #6: Omit TFTP management messages during current re-entry processing Bit #7: Full service and operational state transfer or sharing between serving BS and target BS (ARQ, timers, counters, MAC state machines, etc...)
}	—	—
if (Skip-optional-fields-[3]=0) {	—	—
<b>Scheduling Service Supported</b>	8 bits	Bitmap to indicate if BS supports a particular scheduling service. 1 indicates support, 0 indicates not support: Bit #0: Unsolicited Grant Service (UGS) Bit #1: Real-time Polling Service (rtPS) Bit #2: Non-real-time Polling Service (nrtPS) Bit #3: Best Effort Bit #4: Extended real-time Polling Service (ertPS) If the value of bit 0 through bit 4 is 0b00000, it indicates no information on service available. Bits #5–7: <i>Reserved</i> ; shall be set to zero.
}	—	—
<b>DCD Configuration Change Count</b>	4 bits	This represents the 4 LSBs of the Neighbor BS current DCD configuration change count.
<b>UCD Configuration Change Count</b>	4 bits	This represents the 4 LSBs of the Neighbor BS current UCD configuration change count.
<b>TLV Encoded Neighbor information</b>	<i>variable</i>	TLV specific.
}	—	—
}	—	—

A BS shall generate MOB\_NBR-ADV messages in the format shown in Table 109f. The following parameters shall be included in the MOB\_NBR-ADV message unless otherwise noted as an optional item in which case they may be included:

**Operator ID**

The unique network ID shared by an association of BS. The 'Operator IE' field is present only if Bit #0 of Skip-optional-fields bitmap is 0.

**Configuration Change Count**

Incremented by one (modulo 256) whenever any of the values relating to any included data element changes, including DCD and UCD parameters. If the value of this count in a subsequent MOB\_NBR-ADV message remains the same, the MS can quickly disregard the entire message.

**Fragmentation Index**

The Fragmentation Index field indicates the current fragmentation index. The index for the first fragmentation is 0.

**Total Fragmentation**

The Total Fragmentation field set to 1 when the neighbor list is not fragmented. Otherwise, this field indicates the total number of fragments. When the neighbor list is fragmented, the N\_NEIGHBORS indicates the number of neighbor BSs in the current message.

**Skip-optional-fields Flag:**

The Skip-optional-fields Flag indicates whether some fields in MOB\_NBR-ADV message may be omitted in the MOB\_NBR-ADV message. The field is omitted if the bit is set to 1.

Bit #0: Omit Operator ID field

Bit #1: Omit NBR BS ID field

Bit #2: Omit HO process optimization field

Bit #3: Omit QoS related fields

**N\_NEIGHBORS**

The count of the unique combination of Neighbor BSID, Preamble Index, and DCD.

For each advertised neighbor, the following parameters shall be included:

**Length**

Length of message information within the iteration of N\_NEIGHBOR in bytes.

**Neighbor BSID**

The least significant 24 bits of the Base Station ID parameter in the DL-MAP message of the neighbor BS. The 'Neighbor BSID' field is present only if Bit #1 of Skip-optional-fields bitmap is 0.

**Preamble Index/Subchannel Index**

For the SCA and OFDMA PHY this parameter defines the PHY specific preamble. For the OFDM PHY the 5 LSB contain the DL subchannel index (as defined in Table 211) used in the advertised BS sector. The 3 MSB shall be Reserved and set to 0b000.

**PHY Profile ID**

The PHY Profile ID is the aggregate ID's including the Co-located FA Indicator bit, the FA Configuration indicator bit, Time/Frequency Synchronization Indicator, BS EIRP Indicator, DCD/UCD Reference Indicator, FA Index Indicator, and the FA (Frequency Assignment) number. For systems using OFDM or OFDMA, the bit-by-bit definition of the PHY Profile ID is shown in Table 109g. If the Co-located FA Indicator bit is set, the following field of the NBR-ADV element including Preamble Index, HO Process Optimization, DCD/UCD Configuration Change Count, and TLV Encoded Neighbor Information may be omitted.

**FA Index**

Only if the FA Index Indicator bit in the PHY Profile ID is set to 1, the FA Index follows the PHY Profile ID. In addition, if the FA Indicator is followed, the DL center frequency shall be omitted in the DCD/UCD difference TLV information. The bit-by-bit definition shall be determined by a service provider or a governmental body like FCC.

**BS EIRP**

The neighbor BS EIRP is listed in a signed integer form from -128 to 127 in units of dBm. The 'BS EIRP' field shall be omitted if the BS EIRP Indicator bit in PHY Profile ID is set zero.

### **HO Process Optimization**

HO Process Optimization is provided as part of this message is indicative only. HO process requirements may change at time of actual HO. For each Bit location, a value of '0' indicates the associated reentry management messages shall be required, a value of '1' indicates the reentry management message may be omitted. Regardless of the HO Process Optimization TLV settings, the target BS may send unsolicited SBC-RSP and/ or REG-RSP management messages:

- Bit #0: Omit SBC-REQ/RSP management messages during re-entry processing
- Bit #1: Omit PKM Authentication phase except TEK phase during current re-entry processing
- Bit #2: Omit PKM TEK creation phase during re-entry processing
- Bit #3: Omit REG-REQ/RSP management during current re-entry processing
- Bit #4: Omit Network Address Acquisition management messages during current reentry processing
- Bit #5: Omit Time of Day Acquisition management messages during current reentry processing
- Bit #6: Omit TFTP management messages during current re-entry processing
- Bit #7: Full service and operational state transfer or sharing between serving BS and target BS (ARQ, timers, counters, MAC state machines, etc...)

### **Scheduling Service Supported**

The Scheduling Service Supported field is present only if Bit #3 of Skip-optional-fields is 0. Bit-map to indicate if BS supports a particular scheduling service. 1 indicates support, 0 indicates not support:

- Bit #0: Unsolicited Grant Service (UGS)
  - Bit #1: Real-time Polling Service (rtPS)
  - Bit #2: Non-real-time Polling service (nrtPS)
  - Bit #3: Best Effort
  - Bit #4: Extended real-time Polling Service (ertPS)
- If the value of Bit #0 through #4 is 0b00000, it indicates no information on service available.

### **DCD Configuration Change Count**

Represents the 4 LSBs of the Neighbor BS current DCD configuration change count.

### **UCD Configuration Change Count**

Represents the 4 LSBs of the Neighbor BS current UCD configuration change count.

For each advertised Neighbor BS, the following TLV parameters may be included:

### **Mobility Feature Supported**

Same as in 11.7.14.1.

When Mobility Feature Supported bit indicate support for idle mode, following TLV parameters may be included:

### **Paging Group ID (16 bit)**

One or more logical affiliation groupings of BS

The following TLV parameters may be included.

### **DCD\_settings**

The DCD\_settings is a TLV value that encapsulates a DCD message (excluding the generic MAC header and CRC) that may be transmitted in the advertised BS downlink channel. This information is intended to enable fast synchronization of the MS with the advertised BS downlink. The DCD settings fields shall contain only neighbor's DCD TLV values that are different from the serving BS corresponding values. For values that are not included, the MS shall assume they are identical to the corresponding values of the serving BS. The duplicate TLV encoding parameters within a Neighbor BS shall not be included in DCD setting.

**UCD\_settings**

The UCD\_settings is a TLV value that encapsulates a UCD message (excluding the generic MAC header and CRC) that may be transmitted in the advertised BS downlink channel. This information is intended to enable fast synchronization of the MS with the advertised BS uplink. The UCD settings fields shall contain only neighbor’s UCD TLV values that are different from the serving BS’s corresponding values. For values that are not included, the MS shall assume they are identical to the serving BS’s corresponding values. The duplicate TLV encoding within a Neighbor BS shall not be included in UCD setting.

When the PHY parameters specified by the PHY Mode ID TLV are different than those of the serving BS, the following TLV shall be included:

**PHY Mode ID (see 11.19.1)**

a 16-bit value that specifies the PHY parameters, including channel bandwidth, FFT size, cyclic prefix, and frame duration.

**Table 109g—Bit-by-bit definition of PHY Profile ID of the BS**

Item	Size	Notes
<b>Co-located FA Indicator</b>	1 bit	If the BS (or FA) is co-located with the serving BS, this bit is set to 1.
<b>FA Configuration Indicator</b>	1 bit	If this bit is set 1, the BS has the same FA configuration (the same number of FAs as well as their frequencies) as the BS broadcasting the NBR-ADV.
<b>Time/Frequency Synchronization Indicator</b>	2 bits	0b00 = Unsynchronized 0b01 = Time synchronization 0b10 = Time and Frequency synchronization If time synchronization is indicated for the OFDMA PHY, then the downlink frames transmitted by the serving BS and the Neighbor BS shall be synchronized to a level of at least 1/8 cyclic prefix length. If frequency synchronization is indicated for the OFDMA PHY, then the BS reference clocks shall be synchronized to a level that yields RF center frequency offset of no more than 1% of the OFDMA carrier spacing of the Neighbor BS.
<b>BS EIRP Indicator</b>	1 bit	If this bit is set, the BS EIRP follows the PHY Profile ID.
<b>DCD/UCD Reference Indicator</b>	1 bit	1: The DCD/UCD settings of this neighbor BS are the same as those of the preceding neighbor BS unless the TLV information specifies. 0: The DCD/UCD settings of this neighbor BS are the same as those of the serving BS unless the TLV information specifies.
<b>FA Index Indicator</b>	1 bit	Only if this bit is set to 1, the FA Index follows the PHY Profile ID. In addition, if the FA Indicator is followed, the DL center frequency shall be omitted in the DCD/UCD difference TLV information.
<b>Trigger Reference Indicator</b>	1 bit	The Trigger Reference Indicator is related to the Neighbor BS trigger metric TLV information of this neighbor BS. 1: The trigger settings of this neighbor BS are the same as those of the preceding neighbor BS. 0: The trigger settings of this neighbor BS are the same as those provided by the serving BS (via DCD).If the TLV information is present, it overrides values inherited from preceding neighbor BS.

*Insert new subclause 6.3.2.3.48:*

**6.3.2.3.48 Scanning Interval Allocation Request (MOB\_SCN-REQ) message**

A MOB\_SCN-REQ message may be transmitted by an MS to request a scanning interval for the purpose of seeking available BSs and determining their suitability as targets for HO. An MS may request the scanning allocation to perform scanning or non-contention Association ranging.

An MS shall generate MOB\_SCN-REQ messages in the format shown in Table 109h.

**Table 109h—MOB\_SCN-REQ message format**

Syntax	Size	Notes
MOB_SCN-REQ_Message_format() {	—	—
<b>Management Message Type = 54</b>	8 bits	—
<b>Scan duration</b>	8 bits	Units are in frames.
<b>Interleaving interval</b>	8 bits	Units are frames.
<b>Scan Iteration</b>	8 bits	In frames
<b>N_Recommended_BS_Index</b>	8 bits	Number of neighboring BS to be scanned or associated, which are using BS index that corresponds to the position of BS in MOB_NBR-ADV message
If(N_Recommended_BS_Index!=0){		
<b>Configuration change count for MOB_NBR-ADV</b>	8 bits	Configuration Change Count value of referring MOB_NBR-ADV message
}	—	—
For(j=0;j<N_Recommended_BS_Index;j++){	—	—
<b>Neighbor_BS_Index</b>	8 bits	BS index corresponds to position of BS in MOB_NBR-ADV message
<b>Scanning type</b>	3 bits	0b000:Scanning without Association. 0b001:Scanning with Association level 0: association without coordination 0b010:Scanning with Association level 1: association with coordination. 0b011: Scanning with Association level 2: network assisted association 0b100–0b111: <i>Reserved</i>
}	—	—
<b>N_Recommended_BS_Full</b>	8 bits	Number of neighboring BS to be scanned or associated, which are using full 48 bits BS ID.
For(j=0;j<N_Recommended_BS_Full;j++){	—	—
<b>Recommended BS ID</b>	48 bits	—



**Table 109h—MOB\_SCN-REQ message format (continued)**

<b>Scanning type</b>	3 bits	0b000:Scanning without Association. 0b001:Scanning with Association level 0: association without coordination 0b010:Scanning with Association level 1: association with coordination. 0b011: Scanning with Association level 2: network assisted association 0b100–0b111: <i>Reserved</i>
}	—	—
<i>Padding</i>	<i>variable</i>	If needed for alignment to byte boundary.
<b>TLV encoded information</b>	<i>variable</i>	—
}	—	—

The following parameters shall be included in the MOB\_SCN-REQ message:

**Scan duration**

Duration (in units of frames) of the requested scanning period.

**Interleaving Interval**

The period of MS’s Normal Operation which is interleaved between Scanning Durations.

**Scan Iteration**

The requested number of iterating scanning interval by an MS.

**N\_Recommended\_BS\_Index**

Number of neighboring BS to be scanned or associated, which are included in MOB\_NBR-ADV message. The number could be larger than zero only when NBR\_BS\_Index\_Validity\_Time is larger than the difference of MOB\_SCN-REQ message transmitting time and MOB\_NBR-ADV message receiving time (MOB\_NBR-ADV message should be referred).

**Configuration Change Count for MOB\_NBR-ADV**

The value of Configuration Change Count in MOB\_NBR-ADV message referred in order to compress neighbor BSID.

**Neighbor\_BS\_Index**

BS index corresponds to position of BS in MOB\_NBR-ADV message.

**Scanning type**

Type of scanning or association to be used by the MS and coordinated by the Serving BS (if Association type >=0b011).

**N\_Recommended\_BS\_Full**

Number of neighboring BS to be scanned or associated, which are using full 48 bits BS ID.

**Recommended BS ID**

BS IDs of those BSs the MS plans to scan with or without association.

The MOB\_SCN-REQ message shall include the following parameters encoded as TLV tuples:

**HMAC/CMAC Tuple (See 11.1.2.)**

The HMAC/CMAC Tuple shall be the last attribute in the message.

*Insert new subclause 6.3.2.3.49:*

**6.3.2.3.49 Scanning Interval Allocation Response (MOB\_SCN-RSP) message**

A MOB\_SCN-RSP message shall be transmitted by the BS either unsolicited or in response to an MOB\_SCN-REQ message sent by an MS. A BS may transmit MOB\_SCN-RSP to start MS scan reporting with or without scanning allocation. A BS may allocate the scanning allocation for MS scanning with Scanning type = 0b000, or MS non-contention Association ranging with Scanning type = 0b010 or 0b011. The message shall be transmitted on the Basic CID.

If the Report mode is event-triggered, the MS shall respond once according to the trigger action specified in the MOB\_NBR-ADV (see 11.1.7) or the serving BS DCD (see 11.4.1). A subsequent MOB\_SCN RSP message may be sent to reset the trigger procedure.

The format of the MOB\_SCN-RSP message is depicted in Table 109i.

**Table 109i—MOB\_SCN-RSP message format**

Syntax	Size	Notes
MOB_SCN-RSP_Message_format() {	—	—
<b>Management Message Type = 55</b>	8 bits	—
<b>Scan duration</b>	8 bits	In units of frames. When Scan Duration is set to zero, no scanning parameters are specified in the message. When MOB_SCN-RSP is sent in response to MOB_SCN-REQ, setting Scan Duration to zero denies MOB_SCN-REQ.
<b>Report mode</b>	2 bits	0b00: No report 0b01: Periodic report 0b10: Event-triggered report 0b11: <i>Reserved</i>
<i>Reserved</i>	6 bits	Shall be set to zero.
<b>Report period</b>	8 bits	Available when the value of Report Mode is set to 0b01. Report period in frames.
<b>Report metric</b>	8 bits	Bitmap indicating metrics on which the corresponding triggers are based: Bit 0: BS CINR mean Bit 1: BS RSSI mean Bit 2: Relative delay Bit 3: BS RTD; this metric shall be only measured on serving BS/anchor BS. Bits 4–7: <i>Reserved</i> ; shall be set to zero.
if (Scan Duration !=0) {	—	—
<b>Start frame</b>	4 bits	—
<i>Reserved</i>	1 bit	Shall be set to zero.
<b>Interleaving interval</b>	8 bits	Duration in frames.
<b>Scan iteration</b>	8 bits	—
<i>padding</i>	3 bits	Shall be set to zero.

**Table 109i—MOB\_SCN-RSP message format (continued)**

<b>N_Recommended_BS_Index</b>	8 bits	Number of neighboring BS to be scanned or associated, which are using BS index that corresponds to the position of BS in MOB_NBR-ADV message.
<b>If(N_Recommended_BS_Index!=0){</b>		
<b>Configuration change count for MOB_NBR-ADV</b>	8 bits	Configuration Change Count value of referring MOB_NBR-ADV message.
<b>}</b>		
<b>For(j=0;j&lt;N_Recommended_BS_Index;j++){</b>		
<b>Neighbor_BS_Index</b>	8 bits	BS index corresponds to position of BS in MOB_NBR-ADV message.
<b>Scanning type</b>	3 bits	0b000: Scanning without Association 0b001: Scanning with Association level 0: association without coordination. 0b010: Scanning with Association level 1: association with coordination. 0b011: Scanning with Association level 2: network assisted association b100–0b111: <i>Reserved</i>
<b>If (Scanning type == 0b010) OR (Scanning type == 0b011) {</b>	—	—
<b>Rendezvous time</b>	8 bits	Units are frames.
<b>CDMA code</b>	8 bits	From initial ranging codeset.
<b>Transmission_opportunity_offset</b>	8 bits	Units are transmission opportunity.
<b>}</b>	—	—
<b>}</b>	—	—
<b>N_Recommended_BS_Full</b>	8 bits	Number of neighboring BS to be scanned or associated, which are using full 48 bits BS ID.
<b>For(j=0;j&lt;N_Recommended_BS_Full;j++){</b>	—	—
<b>Recommended BS ID</b>	48 bits	BS IDs of BSs that MS shall scan.
<b>Scanning type</b>	3 bits	0b000: Scanning without Association-Scanning 0b001: Scanning with Association level 0: association without coordination 0b010: Scanning with Association level 1: association with coordination 0b011: Scanning with Association level 2: network assisted association 0b100–0b111: <i>Reserved</i>
<b>If ( Scanning type == 0b010) OR ( Scanning type == 0b011) {</b>	—	—
<b>Rendezvous time</b>	8 bits	Units are frames.
<b>CDMA_code</b>	8 bits	From initial ranging codeset.
<b>Transmission_opportunity_offset</b>	8 bits	Units are transmission opportunity.

**Table 109i—MOB\_SCN-RSP message format (continued)**

}	—	—
}	—	—
<i>Padding</i>	<i>variable</i>	—
}	—	—
<b>TLV encoded information</b>	<i>variable</i>	—
}	—	—

The following parameters shall be included in the MOB\_SCN-RSP message:

**Scan duration**

Duration (in units of frames) where the MS may perform scanning or association for Available BSs. When MOB\_SCN-RSP is sent in response to MOB\_SCN-REQ, setting Scan duration to zero indicates the request for an allocation of scanning interval is denied.

**Report mode**

Action code for an MS's report of CINR measurement:

- 0b00: The MS measures channel quality of the Available BSs without reporting.
- 0b01: The MS reports the result of the measurement to Serving BS periodically. The period of reporting is different from that of scanning.
- 0b10: The MS reports the result of the measurement to Serving BS after each measurement.
- 0b11: *Reserved*

**Report period**

The period of MS's report of CINR measurement when the MS is required to report the value periodically.

**Report metric**

Bitmap indicator of trigger metrics that the serving BS requests the MS to report. Serving BS shall indicate only the trigger metrics agreed during SBC-REQ/RSP negotiation. Each bit indicates whether reports will be initiated by trigger based on the corresponding metric:

- Bit 0: BS CINR mean
- Bit 1: BS RSSI mean
- Bit 2: Relative delay
- Bit 3: BS RTD; this metric shall be only measured on serving BS/anchor BS
- Bits 4–7: *Reserved*; shall be set to zero

**Start Frame**

Measured from the frame in which this message was received. A value of zero means that first Scanning Interval starts in the next frame.

**Interleaving interval**

The period interleaved between Scanning Intervals when MS shall perform Normal Operation.

**Scan iteration**

The number of iterating scanning interval.

**Configuration Change Count for MOB\_NBR-ADV**

The value of Configuration Change Count in MOB\_NBR-ADV message referred in order to compress neighbor BSID

**N\_Recommended\_BS\_Index**

Number of neighboring BS to be scanned or associated, which are included in MOB\_NBR-ADV message. The number could be larger than zero only when NBR\_BS\_Index\_Validity\_Time is larger than the difference of MOB\_SCN-RSP message

transmitting time and MOB\_NBR-ADV message receiving time (MOB\_NBR-ADV message should be referred).

**Neighbor\_BS\_Index**

BS index corresponds to position of BS in MOB\_NBR-ADV message

**Scanning type**

Type of scanning or association used by the MS and coordinated by the Serving BS (if scanning type  $\geq 0b010$ ).

**N\_Recommended\_BS\_Full**

Number of neighboring BS to be scanned or associated that are using full 48 bits BS ID.

**Recommended BS ID**

Recommended BS ID list for scan with or without association.

If Scanning type  $> 0b001$  then Serving BS may request, over the backbone, from Recommended BS allocation of non-contention-based ranging opportunity for MS association activity. When conducting initial ranging to Recommended BS, MS shall use allocated non-contention-based ranging opportunity, if available.

**Rendezvous time**

This is offset, measured in units of frame duration (of Serving BS), when the corresponding Recommended BS is expected to provide non-contention-based ranging opportunity for the MS. The offset is calculated from the frame where MOB\_SCN-RSP message is transmitted. In case Scanning type =  $0b000$  or  $0b001$  the parameter is not applicable and shall be encoded as 0. The Recommended BS is expected to provide non-contention-based Ranging opportunity at the frame specified by Rendezvous time parameter.

**CDMA code**

A unique code assigned to the MS, to be used for association with the neighbor BS. Code is from the initial ranging codeset.

**Transmission opportunity offset**

A unique transmission opportunity assigned to the MS, to be used for association with the Target BS in units of symbol duration.

The MOB\_SCN-RSP message shall include the following parameters encoded as TLV tuples:

**HMAC/CMAC Tuple (See 11.1.2.)**

The HMAC/CMAC Tuple shall be the last attribute in the message.

*Insert new subclause 6.3.2.3.50:*

**6.3.2.3.50 Scanning Result Report (MOB\_SCN-REP) message**

When the Report Mode is  $0b10$  (i.e., event triggered) in the most recently received MOB\_SCN-RSP, the MS shall transmit a MOB\_SCN-REP message to report the scanning results to its servicing BS after each scanning period at the time indicated in the MOB\_SCN-RSP message. The MS may transmit a MOB\_SCN-REP message to report the scanning results to its serving BS at anytime. The message shall be transmitted on the Primary Management CID. (See Table 109j.)

**Table 109j—MOB\_SCN-REP message format**

Syntax	Size	Notes
MOB_SCN-REP_Message_format() {	—	—
<b>Management Message Type = 60</b>	8 bits	—
<b>Report Mode</b>	1 bit	0: Event-triggered report 1: Periodic report
<b>Comp_NBR_BSID_IND</b>	1 bit	—
<b>N_current_BSs</b>	3 bits	When FBSS/MDHO is supported, N_current_BSs is the number of BSs currently in the diversity set; When FBSS/MDHO is not supported or the MS has an empty diversity set, N_current_BSs is set to 1.
<i>Reserved</i>	3 bits	
<b>Report metric</b>	8 bits	Bitmap indicating presence of certain metrics (threshold values) on which the corresponding triggers are based: Bit 0: BS CINR mean Bit 1: BS RSSI mean Bit 2: Relative delay Bit 3: BS RTD; this metric shall be only measured on serving BS/anchor BS Bits 4–7: <i>Reserved</i> ; shall be set to zero
For (j=0; j<N_current_BSs; j++) {		
<b>Temp BSID</b>	4 bits	Diversity set member ID assigned to this BS. When the MS has an empty diversity set or FBSS/MDHO is not supported, Temp BSID shall be set to 0.
<i>Reserved</i>	4 bits	Shall be set to zero.
If (Report metric[Bit 0]==1)	—	—
<b>BS CINR mean</b>	8 bits	—
If (Report metric[Bit 1]==1)	—	—
<b>BS RSSI mean</b>	8 bits	—
If (Report metric[Bit 2]==1)	—	—
<b>Relative delay</b>	8 bits	In case FBSS/MDHO is in progress, this field shall include the relative delay of BSs currently in the diversity set, except for that of the Anchor BS.
If (Report metric[Bit 3]==1)	—	—
<b>BS RTD</b>	8 bits	This field shall include the RTD of the serving BS/anchor BS.
}	—	—
<b>N_Neighbor_BS_Index</b>	8 bits	Number of neighboring BS that are included in MOB_NBR-ADV message.
If (N_Neighbor_BS_Index!=0){	—	—

**Table 109j—MOB\_SCN-REP message format (continued)**

Syntax	Size	Notes
<b>Configuration change count for MOB_NBR-ADV</b>	8 bits	Configuration Change Count value of referring MOB_NBR-ADV message
}	—	—
For(j=0;j<N_Neighbor_BS_Index;j++) {	—	—
<b>Neighbor_BS_Index</b>	8 bits	BS index corresponds to position of BS in MOB_NBR-ADV message
If(Report metric[Bit 0]==1)	—	—
<b>BS CINR mean</b>	8 bits	—
If(Report metric[Bit 1]==1)	—	—
<b>BS RSSI mean</b>	8 bits	—
If(Report metric[Bit 2]==1)	—	—
<b>Relative delay</b>	8 bits	—
}	—	—
<b>N_Neighbor_BS_Full</b>	8 bits	Number of neighboring BS that are using full 48 bits BS ID.
For(j=0;j<N_Neighbor_BS_Full;j++) {	—	—
<b>Neighbor BSID</b>	48 bits	—
If(Report metric[Bit 0]==1)	—	—
<b>BS CINR mean</b>	8 bits	—
If(Report metric[Bit 1]==1)	—	—
<b>BS RSSI mean</b>	8 bits	—
If(Report metric[Bit 2]==1)	—	—
<b>Relative delay</b>	8 bits	—
}	—	—
<b>TLV encoded information</b>	<i>variable</i>	Optional
}	—	—

An MS shall generate MOB\_SCN-REP messages in the format shown in Table 109j. The following parameters shall be included in the MOB\_SCN-REP message:

**Report mode**

Action code for an MS's scan report of its measurement:

0: Event triggered report

1: Periodic report according to Scan report period of MOB\_SCN-RSP

**Report metric**

Bitmap indicator of trigger metrics that the serving BS requests the MS to report. Serving BS shall indicate only the trigger metrics agreed during SBC-REQ/RSP negotiation. For each bit location, a value of '0' indicates the trigger metric is not included, while a value of '1' indicates the trigger metric is included in the message. The bitmap interpretation for the metrics shall be:

- Bit 0: BS CINR mean
- Bit 1: BS RSSI mean
- Bit 2: Relative delay
- Bit 3: BS RTD; this metric shall be only measured on serving BS/anchor BS
- Bits 4–7: *Reserved*; shall be set to zero

**N\_current\_Bs**

When FBSS/MDHO is supported, N\_current\_Bs is the number of BSs currently in the diversity set; when FBSS/MDHO is not supported or the MS has an empty diversity set, N\_current\_Bs is set to 1 (= serving /anchor BS).

**Temp BSID**

Diversity set member ID assigned to this BS. When the MS has an empty diversity set or FBSS/MDHO is not supported, Temp BSID shall be set to 0.

**N\_Neighbor\_BS\_Index**

Number of neighboring BS reported in this message and which are included in MOB\_NBR-ADV message. The number could be larger than zero only when NBR\_BS\_Index\_Validity\_Time is larger than the difference of MOB\_SCN-REP message transmitting time and MOB\_NBR-ADV message receiving time (MOB\_NBR-ADV message should be referred).

**N\_Neighbor\_BS\_Full**

Number of neighboring BS reported in this message that are using full 48 bits BS ID.

For each neighbor BS included in this message, the following parameters shall be included:

**Configuration Change Count for MOB\_NBR-ADV**

The value of Configuration Change Count in MOB\_NBR-ADV message referred in order to compress neighbor BSID.

**Neighbor\_BS\_Index**

BS index corresponds to position of BS in MOB\_NBR-ADV message.

**Neighbor BSID**

Same as the Base Station ID parameter in the DL-MAP message of neighbor BS.

According to Report metric that MS indicates, the MOB\_SCN-REP message may include the following parameters:

**BS CINR mean**

The BS CINR mean parameter indicates the CINR measured by the MS from the particular BS. The value shall be interpreted as a signed byte with units of 0.5 dB. The measurement shall be performed on the subcarriers of the frame preamble that are active in the particular BS's segment and averaged over the measurement period.

**BS RSSI mean**

The BS RSSI mean parameter indicates the Received Signal Strength measured by the MS from the particular BS. The value shall be interpreted as an unsigned byte with units of 0.25 dB, such that 0x00 is interpreted as -103.75 dBm, an MS shall be able to report values in the range -103.75 dBm to -40 dBm. The measurement shall be performed on the frame preamble and averaged over the measurement period.

**Relative delay**

This parameter indicates the delay of neighbor DL signals relative to the serving BS, as measured by the MS for the particular BS. The value shall be interpreted as a signed integer in units of samples.

**BS RTD**

The BS RTD parameter indicates the round trip delay (RTD) measured by the MS from the serving BS. RTD can be given by the latest time advance taken by MS. The value shall be interpreted as an unsigned byte with units of 1/Fs (see 10.3.4.3). This parameter shall be only measured on serving BS/anchor BS.



TLV tuples specified in 11.19 may be included into MOB\_SCN-REP message. Information provided by  $N$ -th TLV of this type is related to  $N$ -th BS listed in the message.

The MOB\_SCN-REP message shall include the following parameters encoded as TLV tuples:

#### HMAC/CMAC Tuple (See 11.1.2.)

The HMAC/CMAC Tuple shall be the last attribute in the message.

*Insert new subclause 6.3.2.3.51:*

#### 6.3.2.3.51 Association Result Report (MOB\_ASC-REP) message

When association level 2 is used, the MS does not have to wait for RNG-RSP from the Target BS after sending RNG-REQ or ranging code to the Target BS. Instead, the RNG-RSP info may be sent by each Target BS to the Serving BS (over the backbone). The Serving BS may aggregate all the RNG-RSP messages to a single MOB\_ASC-REP message, which the Serving BS then sends to the MS. This message is transmitted using the primary management CID (Table 109k).

**Table 109k—MOB\_ASC-REP message format**

Syntax	Type	Size	Notes
MOB_ASC_REPORT_Message_format() {	—	—	—
<b>Management Message Type = 66</b>	—	8 bits	—
<b>N_Recommended_BS_Index</b>	—	8 bits	Number of neighboring BS, which are using BS index that corresponds to the position of BS in MOB_NBR-ADV message
If(N_Recommended_BS_Index!=0){	—	—	—
<b>Configuration change count for MOB_NBR-ADV</b>	—	—	Configuration Change Count value of referring MOB_NBR-ADV message
}	—	—	—
For(j=0;j<N_Recommended_BS_Index;j++){	—	—	—
<b>Neighbor_BS_Index</b>	—	8 bits	—
<b>Timing adjust</b>	1	32 bits	—
<b>Power level adjust</b>	2	8 bits	—
<b>Offset frequency adjust</b>	3	32 bits	—
<b>Ranging status</b>	4	8 bits	—
<b>Service level prediction</b>	5	8 bits	—
}	—	—	—
<b>N_Recommended_BS_Full</b>	—	8 bits	Number of neighboring BS that are using full 48 bits BS ID.
For(j=0;j<N_Recommended_BS_Full;j++){	—	—	—
<b>Neighbor_BS_ID</b>	—	48 bits	—
<b>Timing adjust</b>	1	32 bits	—

**Table 109k—MOB\_ASC-REP message format (continued)**

Syntax	Type	Size	Notes
<b>Power level adjust</b>	2	8 bits	—
<b>Offset frequency adjust</b>	3	32 bits	—
<b>Ranging status</b>	4	8 bits	—
<b>Service level prediction</b>	5	8 bits	—
}	—	—	—
}	—	—	—

The following parameters shall be included in the MOB\_ASC-REP message:

**N\_Recommended\_BS\_Index**

Number of neighboring BSs reported in this message and which are included in MOB\_NBR-ADV message. The number could be larger than zero only when NBR\_BS\_Index\_Validity\_Time is larger than the difference of MOB\_ASC-REP message transmitting time and MOB\_NBR-ADV message receiving time (MOB\_NBR-ADV message should be referred).

**Configuration Change Count for MOB\_NBR-ADV**

The value of Configuration Change Count in MOB\_NBR-ADV message referred in order to compress neighbor BSID.

**Neighbor\_BS\_Index**

BS index corresponds to position of BS in MOB\_NBR-ADV message.

**N\_Recommended\_BS\_Full**

Number of neighboring BSs reported in this message that are using full 48 bits BS ID.

**Neighbor\_BS\_ID**

BS\_ID of the neighboring BS with which the MS is associated.

**Timing adjust**

The time required to advance MS transmissions so frames arrive at the expected time instance at the neighbor BS.

**Power level adjust**

The power level offset adjustment required so that MS transmissions arrive at the desired level at the neighbor BS.

**Offset frequency adjust**

The relative frequency adjustment required so that MS transmissions arrive at the desired frequency at the neighbor BS.

**Ranging status**

Used to indicate whether MS ranging attempt is within acceptable limits of the neighbor BS.

**Service level prediction**

The service level prediction value indicates the level of service the MS can expect from this neighbor BS. The following encodings apply:

- 0 = No service possible for this MS
- 1 = Some service is available for one or several service flows authorized for the MS.
- 2 = For each authorized service flow, a MAC connection can be established with QoS specified by the AuthorizedQoSParamSet.
- 3 = No service level prediction available.

*Insert new subclause 6.3.2.3.52:*

### 6.3.2.3.52 BS HO Request (MOB\_BSHO-REQ) message

The BS may transmit a MOB\_BSHO-REQ message when it wants to initiate an HO. An MS receiving this message may scan recommended neighbor BSs in this message. The message shall be transmitted on the basic CID.

**Table 109I—MOB\_BSHO-REQ message format**

Syntax	Size	Notes
MOB_BSHO-REQ_Message_format() {	—	—
<b>Management Message Type = 56</b>	8 bits	—
<b>Network Assisted HO supported</b>	1 bit	Indicates that the serving BS supports Network Assisted HO
<b>Mode</b>	3 bits	0b000: HO request 0b001: MDHO/FBSS request: Anchor BS update with CID update 0b010: MDHO/FBSS request: Anchor BS update without CID update 0b011: MDHO/FBSS request: Diversity Set update with CID update 0b100: MDHO/FBSS request: Diversity Set update without CID update 0b101: MDHO/FBSS request: Diversity Set update with CID update for newly added BS 0b110: MDHO/FBSS request: Diversity Set update with CID update and CQICH allocation for newly added BS 0b111: <i>Reserved</i>
<i>Padding</i>	4 bits	Shall be set to zero.
If (Mode == 0b000) {	—	—
<b>HO operation mode</b>	1 bit	0: Recommended HO request. 1: Mandatory HO request.
<b>N_Recommended</b>	8 bits	—
<b>Resource Retain Flag</b>	1 bit	0: MS resource release. 1: MS resource retain.
<i>Padding</i>	6 bits	Shall be set to zero.
for (j=0 ; j<N_Recommended ; j++) {	—	N_Recommended can be derived from the known length of the message.
<b>Neighbor BSID</b>	48 bits	—
<b>Service level prediction</b>	8 bits	—
<b>Preamble index/Subchannel Index</b>	8 bits	
<b>HO process optimization</b>	8 bits	
<b>Network Assisted HO supported</b>	1 bit	Indicates that the BS supports Network Assisted HO.
<b>HO_ID_included_indicator</b>	1 bit	To indicate if the field HO_IND is included.

**Table 109I—MOB\_BSHO-REQ message format (continued)**

Syntax	Size	Notes
<b>HO_authorization_policy_indicator</b>	1 bit	To indicate if authorization negotiation is used in HO procedure. 0: EAP authorization and the value of the MAC mode field in the current BS (default) 1: The authorization policy for the target BS is negotiated.
<i>Padding</i>	1 bit	To ensure nibble alignment.
If (HO_ID_included_indicator == 1) {	—	—
<b>HO_ID</b>	8 bits	ID assigned for use in initial ranging to the target BS once this BS is selected as the target BS (see 6.3.20.5).
}	—	—
If (HO_authorization_policy_indicator == 1) {	—	—
<b>HO_authorization_policy_support</b>	8 bits	Bit #0: RSA authorization Bit #1: EAP authorization Bit #2: Authenticated-EAP authorization Bit #3: HMAC supported Bit #4: CMAC supported Bit #5: 64-bit Short-HMAC Bit #6: 80-bit Short-HMAC Bit #7: 96-bit Short-HMAC
}	—	—
}	—	—
}	—	—
else if (Mode == 0b001) {	—	—
<b>TEMP_BSID</b>	3 bits	TEMP_BS_ID of the recommended Anchor BS.
<b>AK Change Indicator</b>	1 bit	To indicate whether the AK being used should change when switching to a new Anchor BS. If set to 0, the MS should continue to use the AK currently in use. If set to 1, the MS should use the AK derived for use with the new Anchor BS.
<b>N_CIDs</b>	8 bits	Number of CIDs that need to be reassigned. For MDHO, N_CIDs shall be set to zero.
for (i= 0; i<N_CIDs; i++) {	—	—
<b>New CID</b>	16 bits	New CID to be used after Diversity Set is updated.
}	—	—
<b>N_SAIDs</b>	8 bits	Number of SAIDs that need to be reassigned.
For(i=0; i<N_SAIDs; i++){	—	—
<b>New SAID</b>	16 bits	New SAID to be used after Anchor BS is updated.
}	—	—

**Table 109I—MOB\_BSHO-REQ message format (continued)**

Syntax	Size	Notes
}	—	—
else if (Mode == 0b010) {	—	—
<b>TEMP_BS_ID</b>	3 bits	TEMP_BS_ID of the recommended Anchor BS.
<b>AK Change Indicator</b>	1 bit	To indicate whether the AK being used should change when switching to a new Anchor BS. If set to 0, the MS should continue to use the AK currently in use. If set to 1, the MS should use the AK derived for use with the new Anchor BS.
}	—	—
else if (Mode == 0b011) {	—	—
<b>N_new_BSs</b>	3 bits	Number of new BSs that are recommended to be added to the Diversity Set of the MS.
for (j=0 ; j<N_new_BSs ; j++) {	—	—
<b>Neighbor BSID</b>	48 bits	—
<b>Temp BSID</b>	3 bits	Diversity Set member ID assigned to this BS.
}	—	—
<b>N_current_BSs</b>	3 bits	Number of BSs currently in the Diversity Set of the MS, which are recommended to be remained in the Diversity Set.
for (j=0 ; j<N_current_BSs ; j++) {	—	—
<b>Temp BSID</b>	3 bits	Diversity Set member ID assigned to this BS.
}	—	—
<b>TEMP_BS_ID_Anchor</b>	3 bits	Temp BSID for Anchor BS.
<b>AK Change Indicator</b>	1 bit	To indicate whether the AK being used should change when switching to a new Anchor BS. If set to 0, the MS should continue to use the AK currently in use. If set to 1, the MS should use the AK derived for use with the new Anchor BS.
<b>N_CIDs</b>	8 bits	Number of CIDs that need to be reassigned
for (j=0 ; j<N_CIDs ; j++) {	—	—
<b>New_CID</b>	16 bits	New CID to be used after Diversity Set is updated
}	—	—
<b>N_SAIDs</b>	8 bits	Number of SAIDs that need to be reassigned.
For(i=0; i<N_SAIDs; i++){	—	—
<b>New SAID</b>	16 bits	New SAID to be used after Diversity Set is updated.
}	—	—
}	—	—

**Table 109I—MOB\_BSHO-REQ message format (continued)**

Syntax	Size	Notes
else if (Mode == 0b100) {	—	—
<b>N_new_BSs</b>	3 bits	Number of new BSs that are recommended to be added to the Diversity Set of the MS.
for (j=0 ; j<N_new_BSs ; j++) {	—	—
<b>Neighbor BSID</b>	48 bits	—
<b>Temp BSID</b>	3 bits	Diversity Set member ID assigned to this BS.
}	—	—
<b>N_current_BSs</b>	3 bits	Number of BSs currently in the Diversity Set of the MS, which are recommended to be remained in the Diversity Set.
for (j=0 ; j<N_current_BSs ; j++) {	—	—
<b>Temp_BSID</b>	3 bits	Diversity Set member ID assigned to this BS.
}	—	—
<b>TEMP_BS_ID_Anchor</b>	3 bits	Temp_BSID for Anchor BS
<b>AK Change Indicator</b>	1 bit	To indicate whether the AK being used should change when switching to a new Anchor BS. If set to 0, the MS should continue to use the AK currently in use. If set to 1, the MS should use the AK derived for use with the new Anchor BS.
}	—	—
else if (Mode == 0b101) {	—	—
<b>N_new_BSs</b>	3 bits	Number of new BSs that are recommended to be added to the Diversity Set of the MS.
<b>N_CIDs</b>	8 bits	Number of CIDs that need to be reassigned
<b>N_SAIDs</b>	8 bits	Number of SAIDs that need to be reassigned.
for ( i= 0; i < N_new_BSs; i++) {	—	—
<b>Neighbor BS_ID</b>	48 bits	—
<b>TEMP_BS_ID</b>	3 bits	Diversity Set member ID assigned to this BS.
for (j= 0;j<N_CIDs;j++) {	—	—
<b>New CID for BS_i</b>	16 bits	New CID to be used for new BS_i.
}	—	—
For(i=0; i<N_SAIDs; i++){	—	—
<b>New SAID for BS_i</b>	16 bits	New SAID to be used for new BS_i.
}	—	—
}	—	—

**Table 109I—MOB\_BSHO-REQ message format (continued)**

Syntax	Size	Notes
<b>N_current_BSSs</b>	3 bits	Number of BSSs currently in the Diversity Set of the MS, which are recommended to be remained in the Diversity Set.
for (i=0; i < N_current_BSSs; i++) {	—	—
<b>TEMP_BS-ID</b>	3 bits	Diversity Set member ID assigned to this BS.
}	—	—
<b>TEMP_BS-ID_Anchor</b>	3 bits	Temp_BSID for Anchor BS.
<b>AK Change Indicator</b>	1 bit	To indicate whether the AK being used should change when switching to a new Anchor BS. If set to 0, the MS should continue to use the AK currently in use. If set to 1, the MS should use the AK derived for use with the new Anchor BS.
}	—	—
else if (Mode == 0b110) {	—	—
<b>N_new_BSSs</b>	3 bits	Number of new BSSs that are recommended to be added to the Diversity Set of the MS.
<b>N_CIDs</b>	8 bits	Number of CIDs that need to be allocated.
<b>N_SAIDs</b>	8 bits	Number of SAIDs that need to be reassigned.
for ( i= 0; i < N_new_BSSs; i++) {	—	—
<b>Neighbor BS_ID</b>	48 bits	—
<b>TEMP_BS-ID</b>	3 bits	Diversity Set member ID assigned to this BS.
for (j= 0; j < N_CIDs; j++) {	—	—
<b>New CID for BS_i</b>	16 bits	New CID to be used for new BS_i.
}	—	—
for(i=0; i < N_SAIDs; i++){	—	—
<b>New SAID for BS_i</b>	16 bits	New SAID to be used for new BS_i.
}	—	—
<b>CQICH_ID</b>	<i>variable</i>	Index to uniquely identify the CQICH resource assigned to the MS after the MS switched to the new anchor BS.
<b>Feedback channel offset</b>	6 bits	Index to the fast-feedback channel region of the new Anchor BS marked by UIUC.
<b>Period (p)</b>	2 bits	A CQI feedback is transmitted on the CQICH every 2 <sup>p</sup> frames.
<b>Frame offset</b>	3 bits	The MS starts reporting at the frame of which the number has the same 3 LSB as the specified frame offset. If the current frame is specified, the MS should start reporting in eight frames.

**Table 109I—MOB\_BSHO-REQ message format (continued)**

Syntax	Size	Notes
<b>Duration (<i>d</i>)</b>	3 bits	A CQI feedback is transmitted on the CQI channels indexed by the CQICH_ID for $10 \times 2^d$ frames. If $d == 0b000$ , the CQI-CH is de-allocated. If $d == 0b111$ , the MS should report until the BS command for the MS to stop.
<b>MIMO_permutation_feedback_cycle</b>	2 bits	0b00 = No MIMO and permutation mode feedback 0b01 = the MIMO and permutation mode indication shall be transmitted on the CQICH indexed by the CQICH_ID every 4 CQICH transmission opportunities allocated to the MS in this message. The first indication is sent on the 4 <sup>th</sup> CQICH transmission opportunity allocated to the MS in this message. 0b10 = the MIMO mode and permutation mode indication shall be transmitted on the CQICH indexed by the CQICH_ID every 8 CQICH transmission opportunities allocated to the MS in this message. The first indication is sent on the 8 <sup>th</sup> CQICH transmission opportunity allocated to the MS in this message. 0b11 = the MIMO mode and permutation mode indication shall be transmitted on the CQICH indexed by the CQICH_ID every 16 CQICH transmission opportunities allocated to the MS in this message. The first indication is sent on the 16 <sup>th</sup> CQICH transmission opportunity allocated to the MS in this message.
}	—	—
<b>N_current_BSSs</b>	3 bits	Number of BSs currently in the Diversity Set of the MS, which are recommended to be remained in the Diversity Set.
for (i=0;i<N_current_BSSs;i++) {	—	—
<b>TEMP_BS_ID</b>	3 bits	Diversity Set member ID assigned to this BS.
}	—	—
<b>TEMP_BS_ID_Anchor</b>	3 bits	Temp BSID for Anchor BS.
<b>AK Change Indicator</b>	1 bit	To indicate whether the AK being used should change when switching to a new Anchor BS. If set to 0, the MS should continue to use the AK currently in use. If set to 1, the MS should use the AK derived for use with the new Anchor BS.
}	—	—
<b>Action time</b>	7 bits	—
<i>padding</i>	<i>variable</i>	Padding bits to ensure byte aligned.
TLV encoded information	<i>variable</i>	TLV specific.
}	—	—



A BS shall generate MOB\_BSHO-REQ messages in the format shown in Table 109I. The following parameters shall be included in the MOB\_BSHO-REQ message:

#### **Mode**

Indicates which HO mode is for this handover request.

- 0b000: HO request
- 0b001: MDHO/FBSS request: Anchor BS update with CID update
- 0b010: MDHO/FBSS request: Anchor BS update without CID update
- 0b011: MDHO/FBSS request: Diversity Set update with CID update
- 0b100: MDHO/FBSS request: Diversity Set update without CID update
- 0b101: MDHO/FBSS request: Diversity Set update with CID update for newly added BS
- 0b110: MDHO/FBSS request: Diversity Set update with CID update and CQICH allocation for newly added BS
- 0b111: *Reserved*

#### **HO operation mode**

Indicate the operation mode of this HO request as initiated and prescribed by BS.

- 0: Recommended HO request
- 1: Mandatory HO request. If HO operation mode is set to 1, BS shall include at least one recommended BS in the message ( $N\_Recommended \geq 1$ ).

#### **Resource Retain Flag**

The Resource Retain Flag indicates whether the serving BS will retain or delete the connection information of the MS upon receiving MOB\_HO-IND with HO\_IND\_type=0b00. If the flag is set to 1, the serving BS will retain the MS's connection information during the time in Resource Retain Time field. If Resource Retain Flag=1 and Resource Retain Time is not included as a TLV item in the message, then the serving BS and MS shall use the System Resource Retain Time timer. If the flag is set to 0, the serving BS will discard the MS's connection information.

#### **Action Time**

For HO, this value is defined as number of frames until the Target BS allocates a dedicated transmission opportunity for RNG-REQ message to be transmitted by the MS using Fast\_Ranging\_IE. Dedicated allocation for transmission of RNG-REQ means that channel parameters learned by the MS during Association of that BS stay valid and can be reused during actual Network Re-entry without preceding CDMA-based Initial Ranging. This parameter is decided by the Serving BS based on the information obtained from potential Target BSs over the backbone.

For MDHO/FBSS, this is the time of update of Anchor BS and/or Diversity Set. A value of zero in this parameter signifies that this parameter should be ignored.

For Mode=0b00, for each recommended neighbor BS, the following parameters shall be included:

#### **Network Assisted HO supported**

Indicates that the BS supports Network Assisted HO, 1=supported, 0=not supported

#### **Neighbor BSID**

Same as the Base Station ID parameter in the DL-MAP message of neighbor BS. This may include the serving BS.

#### **Preamble index/ Subchannel Index**

For the SCa and OFDMA PHY this parameter defines the PHY specific preamble for the neighbor BS. For the OFDM PHY the 5 LSB contain the DL subchannel index (as defined in Table 211) used in the Neighbor BS' sector. The 3 MSB shall be Reserved and set to 0b000.

#### **Service level prediction**

The service level prediction value indicates the level of service the MS can expect from this BS. The following encodings apply:

- 0 = No service possible for this MS
- 1 = Some service is available for one or several service flows authorized for the MS.

- 2 = For each authorized service flow, a MAC connection can be established with QoS specified by the AuthorizedQoSParamSet.
- 3 = No service level prediction available.

#### **HO process optimization**

HO Process Optimization is provided as part of this message is indicative only. HO process requirements may change at time of actual HO. For each Bit location, a value of '0' indicates the associated reentry management messages shall be required, a value of '1' indicates the reentry management message may be omitted. Regardless of the HO Process Optimization TLV settings, the target BS may send unsolicited SBC-RSP and/ or REG-RSP management messages:

- Bit #0: Omit SBC-REQ/RSP management messages during re-entry processing
- Bit #1: Omit PKM Authentication phase except TEK phase during current re-entry processing
- Bit #2: Omit PKM TEK creation phase during re-entry processing
- Bit #3: Omit REG-REQ/RSP management during current re-entry processing
- Bit #4: Omit Network Address Acquisition management messages during current re-entry processing
- Bit #5: Omit Time of Day Acquisition management messages during current reentry processing
- Bit #6: Omit TFTP management messages during current re-entry processing
- Bit #7: Full service and operational state transfer or sharing between serving BS and target BS (ARQ, timers, counters, MAC state machines, etc...)

For Mode != 0b000, the following parameters shall be included:

#### **N\_new\_Bs**

Number of new BSs that are recommended to be added to the Diversity Set of the MS.

#### **N\_CID**

Number of CIDs that need to be allocated.

#### **TEMP BSID**

Index to diversity set for active BS ranging from 0 to 7.

#### **New CID**

The New CIDs shall be set according to the followings: the first CID in the list shall be basic CID; the second CID in the list shall be primary management CID, the third CID in the list shall be Secondary Management CID if secondary management connection is established for the MS at the current serving BS. The remaining CIDs shall be transport CIDs, multicast CIDs are enumerated by the ascending order of corresponding current SFIDs. The MS shall store the CIDs associated with the newly added BS and using the CIDs when the newly added BS becomes the anchor BS.

#### **N\_SAIDs**

Number of SAIDs that need to be assigned.

#### **New SAID**

New SAIDs are enumerated by the ascending order of corresponding current SAIDs. The MS shall store the SAIDs associated with the newly added BS and using the SAIDs when the newly added BS becomes the anchor BS.

#### **HO\_ID included indicator**

Indicates whether HO\_ID is included or not in this message.

#### **HO\_ID**

ID assigned for use in initial ranging to the target BS once this BS is selected as the target BS (see 6.3.20.5).

#### **AK Change Indicator**

Indicates whether the AK being used should change when switching to a new Anchor BS. If set to 0, the MS should continue to use the AK currently in use; if set to 1, the MS should use the AK derived for use with the new Anchor BS.

The MOB\_BSHO-REQ may contain the following TLV:

**Resource Retain Time (see 11.15.1)**

The MOB\_BSHO-REQ message shall include the following parameter encoded as TLV tuples:

**HMAC/CMAC Tuple (see 11.1.2)**

The HMAC/CMAC Tuple shall be the last attribute in the message.

*Insert new subclause 6.3.2.3.53:*

**6.3.2.3.53 MS HO Request (MOB\_MSHO-REQ) message**

The MS may transmit an MOB\_MSHO-REQ message when it wants to initiate an HO. The message shall be transmitted on the basic CID (Table 109m).

**Table 109m—MOB\_MSHO-REQ message format**

Syntax	Size	Notes
MOB_MSHO-REQ_Message_format() {	—	—
<b>Management Message Type = 57</b>	8 bits	—
<b>Report metric</b>	8 bits	Bitmap indicating presence of metric in message Bit #0: BS CINR mean Bit #1: BS RSSI mean Bit #2: Relative delay Bit #3: BS RTD; this metric shall be only measured on serving BS/anchor BS. Bits #4–7: <i>Reserved</i> ; shall be set to zero.
<b>N_New_BS_Index</b>	8 bits	Number of new recommended BSs which are included in MOB_NBR-ADV message.
If(N_New_BS_Index!=0){		
<b>Configuration change count for MOB_NBR-ADV</b>	8 bits	Configuration Change Count value of referring MOB_NBR-ADV message.
}		
For(j=0;j<N_New_BS_Index;j++){		
<b>Neighbor_BS_Index</b>	8 bits	
<b>Preamble index/ Preamble Present and Subchannel Index</b>	8 bits	For the SCa and OFDMA PHY this parameter defines the PHY specific preamble for the neighbor BS. For the OFDM PHY the 5 LSB contain the active DL subchannel index for the neighbor BS. The 3 MSB shall be <i>Reserved</i> and set to '0b000'.
If(Report metric[Bit#0]==1)		
<b>BS CINR mean</b>	8 bits	
If(Report metric[Bit#1]==1)		

**Table 109m—MOB\_MSHO-REQ message format (continued)**

Syntax	Size	Notes
<b>BS RSSI mean</b>	8 bits	
If(Report metric[Bit#2]==1)		
<b>Relative delay</b>	8 bits	
<b>Service level prediction</b>	3 bits	
<b>Arrival Time Difference Indication</b>	1 bit	If the MS is transmitting this message to request HO or MDHO/FBSS is not supported by either BS or MS, this bit shall be set to 0.
If (Arrival Time Difference Indication == 1) {		
<b>Arrival Time Difference (t)</b>	4 bits	Relative difference in arrival time between the neighbor BS and the anchor BS, in terms of fraction of CP.
}		
}		
<b>N_New_BS_Full</b>		
For(j=0;j< N_New_BS_Full;j++){		
<b>Neighbor_BS_ID</b>	8 bits	
<b>Preamble index/ Preamble Present and Sub-channel Index</b>	8 bits	For the SCa and OFDMA PHY this parameter defines the PHY specific preamble for the neighbor BS. For the OFDM PHY the 5 LSB contain the active DL subchannel index for the neighbor BS. The 3 MSB shall be Reserved and set to '0b000'.
If (Report metric [Bit#0] == 1)	—	—
<b>BS CINR mean</b>	8 bits	—
If(Report metric[Bit#1]==1)	—	—
<b>BS RSSI mean</b>	8 bits	—
If(Report metric[Bit#2]==1)	—	—
<b>Relative delay</b>	8 bits	—
<b>Service level prediction</b>	3 bits	—
<b>Arrival Time Difference Indication</b>	1 bit	If the MS is transmitting this message to request HO or MDHO/FBSS is not supported by either BS or MS, this bit shall be set to 0.
If (Arrival Time Difference Indication == 1) {	—	—
<b>Arrival Time Difference (t)</b>	4 bits	Relative difference in arrival time between the neighbor BS and the anchor BS, in terms of fraction of CP.
}	—	—
}	—	—

**Table 109m—MOB\_MSHO-REQ message format (continued)**

Syntax	Size	Notes
<b>N_current_BSSs</b>	3 bits	When FBSS/MDHO is supported and the MS has non-empty diversity set, N_current_BSSs is the number of BSSs that are currently in the Diversity Set of the MS. When FBSS/MDHO is not supported or the MS has an empty diversity set, N_current_BSSs is set to 1.
<b>Padding</b>	1 bit	Shall be set to zero.
For (j=0 ; j<N_current_BSSs ; j++) {	—	—
<b>Temp BSID</b>	4 bits	Diversity Set member ID assigned to this BS. When the MS has an empty diversity set or FBSS/MDHO is not supported, Temp BSID shall be set to 0.
If(Report metric[Bit#0]==1)	—	—
<b>BS CINR mean</b>	8 bits	—
If(Report metric[Bit#1]==1)	—	—
<b>BS RSSI mean</b>	8 bits	—
If(Report metric[Bit#2]==1)	—	—
<b>Relative delay</b>	8 bits	Only when FBSS/MDHO is in progress, this field will include the relative delay of BSSs currently in the diversity set, except anchor BS.
If(Report metric[Bit#3]==1)	—	—
<b>BS RTD</b>	8 bits	This field will include the RTD of the serving BS/anchor BS.
}	—	—
<i>Padding</i>	<i>variable</i>	Padding bits to ensure byte aligned.
<b>TLV encoded information</b>	<i>variable</i>	
}	—	—

An MS shall generate MOB\_MSHO-REQ messages in the format shown in Table 109m. The following parameters shall be included in the MOB\_MSHO-REQ message:

#### Report metric

Bitmap indicator of trigger metrics that the MS reports in this message. MS shall indicate only the trigger metrics agreed during SBC-REQ/RSP negotiation. For each bit location, a value of '0' indicates the trigger metric should not be included, while a value of '1' indicates the trigger metric should be included in the message. The bitmap interpretation for the metrics shall be:

Bit 0: BS CINR mean

Bit 1: BS RSSI mean

Bit 2: Relative delay

Bit 3: BS RTD; this metric shall be only measured on serving BS/anchor BS

Bits 4–7: *Reserved*; shall be set to zero

**N\_New\_BS\_Index**

Number of neighboring BSs to be considered for handover, which are included in MOB\_NBR-ADV message. The number could be larger than zero only when NBR\_BS\_Index\_Validity\_Time is larger than the difference of MOB\_MSHO-REQ message transmitting time and MOB\_NBR-ADV message receiving time (MOB\_NBR-ADV message should be referred).

**N\_New\_BS\_Full**

Number of neighboring BSs to be scanned or associated, which are not included in MOB\_NBR-ADV message.

For each recommended neighbor BS, the following parameters shall be included,

**Configuration Change Count for MOB\_NBR-ADV**

The value of Configuration Change Count in MOB\_NBR-ADV message referred in order to compress neighbor BSID.

**Neighbor\_BS\_Index**

BS index corresponds to position of BS in MOB\_NBR-ADV message.

**Neighbor BSID**

Same as the Base Station ID parameter in the DL-MAP message of the Neighbor BS.

**Preamble index/ Subchannel Index**

For the SCa and OFDMA PHY this parameter defines the PHY specific preamble for the neighbor BS. For the OFDM PHY the 5 LSB contain the DL subchannel index (as defined in Table 211) used in the Neighbor BS' sector. The 3 MSB shall be Reserved and set to 0.

According to Report metric that MS indicates, the MOB\_MSHO-REQ message includes the following parameters:

**BS CINR mean**

The BS CINR mean parameter indicates the CINR in dB measured at the MS on the downlink signal of a particular BS. The value shall be interpreted as a signed byte with the resolution of 0.5 dB. The measurement shall be performed on the subcarriers of the frame preamble that are active in the particular BS's segment and averaged over the measurement period.

**BS RSSI mean**

The BS RSSI mean parameter indicates the Received Signal Strength measured by the MS from the particular BS. The value shall be interpreted as an unsigned byte with units of 0.25 dB, such that 0x00 is interpreted as -103.75 dBm, an MS shall be able to report values in the range -103.75 dBm to -40 dBm. The measurement shall be performed on the frame preamble and averaged over the measurement period.

**Relative delay**

This parameter indicates the delay of neighbor DL signals relative to the serving BS, as measured by the MS for the particular BS. The value shall be interpreted as a signed integer in units of samples.

**BS RTD**

The BS RTD parameter indicates the round trip delay (RTD) measured by the MS from the serving BS. RTD can be given by the latest time advance taken by MS. The value shall be interpreted as an unsigned byte with units of 1/Fs (see 10.3.4.3). This parameter shall be only measured on serving BS/anchor BS.

**Service level prediction**

The service level prediction value indicates the level of service the MS can expect from this BS. The following encodings apply:

0 = No service possible for this MS

1 = Some service is available for one or several service flows authorized for the MS

- 2 = For each authorized service flow, a MAC connection can be established with QoS specified by the AuthorizedQoSParamSet.
- 3 = No service level prediction available.

**Arrival Time Difference**

The Arrival Time Difference parameter indicates the delay of downlink signal relative to the serving BS, as measured by the MS for the neighbor BS. For SCa PHY mode, this value shall be interpreted as a signed byte with the resolution of PS. For OFDM and OFDMA PHY mode, this value shall be interpreted as a signed fraction with a range of +7/8 to -1 one cyclic prefix time of the serving BS. A positive value indicates that the signal of the neighbor BS arrived after that of the serving BS (for example, the value of 0x02 indicates that the neighbor signal is delayed by 25% ±6.25% of the CP).

When the MS supports FBSS/MDHO and has a non-empty diversity set, the MS shall include the following parameters for each active BS. When the MS does not support FBSS/MDHO or has an empty active, the MS shall include the following parameters for the current serving BS.

**Temp BSID**

When the MS support FBSS/MDHO and has a non-empty diversity set, Temp BSID is the diversity set member ID. When the MS does not support FBSS/MDHO or has an empty diversity set, Temp BSID shall be set to 0.

**BS CINR mean**

The BS CINR mean parameter indicates the CINR in dB measured at the MS on the downlink signal of a particular BS. The value shall be interpreted as a signed byte with the resolution of 0.5 dB. The measurement shall be performed on the frame preamble and averaged over the measurement period.

The MOB\_MSHO-REQ message shall include the following parameters encoded as TLV tuples:

**HMAC/CMAC Tuple (See 11.1.2.)**

The HMAC/CMAC Tuple shall be the last attribute in the message.

*Insert new subclause 6.3.2.3.54:*

**6.3.2.3.54 BS HO Response (MOB\_BSHO-RSP) message**

The BS shall transmit an MOB\_BSHO-RSP message upon reception of MOB\_MSHO-REQ message. The message shall be transmitted on the basic CID.

**Table 109n—MOB\_BSHO-RSP message format**

Syntax	Size	Notes
MOB_BSHO-RSP_Message_format() {	—	—
<b>Management Message Type = 58</b>	8 bits	—

**Table 109n—MOB\_BSHO-RSP message format (continued)**

Syntax	Size	Notes
<b>Mode</b>	3 bits	0b000: HO request 0b001: MDHO/FBSS request: Anchor BS update with CID update 0b010: MDHO/FBSS request: Anchor BS update without CID update 0b011: MDHO/FBSS request: Diversity Set update with CID update 0b100: MDHO/FBSS request: Diversity Set update without CID update 0b101: MDHO/FBSS request: Diversity Set update with CID update for newly added BS 0b110: MDHO/FBSS request: Diversity Set update with CID update and CQICH allocation for newly added BS 0b111: MS handover request not recommended (BS in list unavailable)
<i>Reserved</i>	5 bits	Shall be set to zero.
If (Mode == 0b000) {	—	—
<b>HO operation mode</b>	1 bit	0: Recommended HO response. 1: Mandatory HO response.
<b>N_Recommended</b>	8 bits	—
<b>Resource Retain Flag</b>	1 bit	0: Release connection information. 1: Retain connection information.
<i>Reserved</i>	7 bits	Shall be set to zero.
For (j=0 ; j<N_Recommended ; j++) {	—	Neighbor base stations shall be presented in an order such that the first presented is the one most recommended and the last presented is the least recommended.
<b>Neighbor BSID</b>	48 bits	—
<b>Preamble index/ Preamble Present and Sub-channel Index</b>	8 bits	For the SCa and OFDMA PHY this parameter defines the PHY specific preamble for the neighbor BS. For the OFDM PHY the 5 LSB contain the active DL subchannel index for the neighbor BS. The 3 MSB shall be Reserved and set to '0b000'.
<b>Service level prediction</b>	8 bits	—
<b>HO process optimization</b>	8 bits	—
<b>Network Assisted HO supported</b>	1 bit	Indicates that the BS supports Network Assisted HO.
<b>HO_ID_included_indicator</b>	1 bit	Indicates if the field HO_IND is included.
If (HO_ID_included_indicator == 1) {	—	—
<b>HO_ID</b>	8 bits	ID assigned for use in initial ranging to the target BS once this BS is selected as the target BS.
}	—	—



**Table 109n—MOB\_BSHO-RSP message format (continued)**

Syntax	Size	Notes
<b>HO_authorization policy indicator</b>	1 bit	To indicate if authorization negotiation is used in HO procedure. 0: EAP authorization and the value of the MAC mode field in the current BS (default) 1: The authorization policy for the target BS is negotiated.
<i>Reserved</i>	4 bits	Shall be set to zero.
If (HO_authorization policy indicator == 1) {	—	—
<b>HO_authorization_policy_support</b>	8 bits	Bit #0: RSA authorization Bit #1: EAP authorization Bit #2: Authenticated-EAP authorization Bit #3: HMAC supported Bit #4: CMAC supported Bit #5: 64-bit Short-HMAC Bit #6: 80-bit Short-HMAC Bit #7: 96-bit Short-HMAC
}	—	—
}	—	—
}	—	—
else if (Mode == 0b001) {	—	—
<b>Temp BSID</b>	3 bits	TEMP_BSID of the recommended Anchor BS.
<b>AK Change Indicator</b>	1 bit	To indicate whether the AK being used should change when switching to a new Anchor BS. If set to 0, the MS should continue to use the AK currently in use. If set to 1, the MS should use the AK derived for use with the new Anchor BS.
<b>N_CIDs</b>	8 bits	Number of CIDs that need to be reassigned. For MDHO, N_CIDs shall be set to zero.
For (i= 0;i<N_CIDs;i++) {	—	—
<b>New CID</b>	16 bits	New CID to be used after Diversity Set is updated.
}	—	—
<b>N_SAIDs</b>	8 bits	Number of SAIDs that need to be reassigned.
For(i=0; i<N_SAIDs; i++){	—	—
<b>New SAID</b>	16 bits	New SAID to be used after Anchor BS is updated.
}	—	—
}	—	—
else if (Mode == 0b010) {	—	—
<b>Temp BSID</b>	3 bits	TEMP_BSID of the recommended Anchor BS.

**Table 109n—MOB\_BSHO-RSP message format (continued)**

Syntax	Size	Notes
<b>AK Change Indicator</b>	1 bit	To indicate whether the AK being used should change when switching to a new Anchor BS. If set to 0, the MS should continue to use the AK currently in use. If set to 1, the MS should use the AK derived for use with the new Anchor BS.
}	—	—
else if (Mode == 0b011) {	—	—
<b>N_new_BSs</b>	3 bits	Number of new BSs that are recommended to be added to the Diversity Set of the MS.
For (j=0 ; j<N_new_BSs ; j++) {	—	—
<b>Neighbor BSID</b>	48 bits	—
<b>Temp BSID</b>	3 bits	Diversity Set member ID assigned to this BS
}	—	—
<b>N_current_BSs</b>	3 bits	Number of BSs currently in the Diversity Set of the MS that are recommended to remain in the Diversity Set
For (j=0 ; j<N_current_BSs ; j++) {	—	—
<b>Temp BSID</b>	3 bits	Diversity Set member ID assigned to this BS.
}	—	—
<b>TEMP_BS_ID_Anchor</b>	3 bits	Temp BSID for Anchor BS
<b>AK Change Indicator</b>	1 bit	To indicate whether the AK being used should change when switching to a new Anchor BS. If set to 0, the MS should continue to use the AK currently in use. If set to 1, the MS should use the AK derived for use with the new Anchor BS.
<b>N_CIDs</b>	8 bits	Number of CIDs that need to be reassigned.
For (j=0 ; j<N_CIDs ; j++) {	—	—
<b>New_CID</b>	16 bits	New CID to be used after Diversity Set is updated.
}	—	—
<b>N_SAIDs</b>	8 bits	Number of SAIDs that need to be reassigned.
For(i=0; i<N_SAIDs; i++){		
<b>New SAID</b>	16 bits	New SAID to be used after Diversity Set is updated.
}	—	—
}	—	—
else if (Mode == 0b100) {	—	—
<b>N_new_BSs</b>	3 bits	Number of new BSs that are recommended to be added to the Diversity Set of the MS.
For (j=0 ; j<N_new_BSs ; j++) {	—	—

**Table 109n—MOB\_BSHO-RSP message format (continued)**

Syntax	Size	Notes
<b>Neighbor BSID</b>	48 bits	—
<b>Temp BSID</b>	3 bits	Diversity Set member ID assigned to this BS.
}	—	—
<b>N_current_BSSs</b>	3 bits	Number of BSs currently in the Diversity Set of the MS, which are recommended to be remained in the Diversity Set.
For (j=0 ; j<N_current_BSSs ; j++) {	—	—
<b>Temp BSID</b>	3 bits	Diversity Set member ID assigned to this BS.
}	—	—
<b>TEMP_BSID_Anchor</b>	3 bits	Temp BSID for Anchor BS.
<b>AK Change Indicator</b>	1 bit	To indicate whether the AK being used should change when switching to a new Anchor BS. If set to 0, the MS should continue to use the AK currently in use. If set to 1, the MS should use the AK derived for use with the new Anchor BS.
}	—	—
else if (Mode == 0b101) {	—	—
<b>N_new_BSSs</b>	3 bits	Number of new BSs that are recommended to be added to the Diversity Set of the MS.
<b>N_CIDs</b>	8 bits	Number of CIDs that need to be reassigned.
for ( i= 0; i < N_new_BSSs; i++) {	—	—
<b>Neighbor BSID</b>	48 bits	—
<b>TEMP_BSID</b>	3 bits	Diversity Set member ID assigned to this BS.
for (j= 0;j<N_CIDs;j++) {	—	—
<b>New CID for BS_i</b>	16 bits	New CID to be used for new BS_i.
}	—	—
}	—	—
<b>N_current_BSSs</b>	3 bits	Number of BSs currently in the Diversity Set of the MS that are recommended to remain in the Diversity Set.
for (i=0;i<N_current_BSSs;i++) {	—	—
<b>TEMP_BSID</b>	3 bits	Diversity Set member ID assigned to this BS.
}	—	—
<b>TEMP_BSID_Anchor</b>	3 bits	Temp BSID for Anchor BS.
<b>AK Change Indicator</b>	1 bit	To indicate whether the AK being used should change when switching to a new Anchor BS. If set to 0, the MS should continue to use the AK currently in use. If set to 1, the MS should use the AK derived for use with the new Anchor BS.
}	—	—

**Table 109n—MOB\_BSHO-RSP message format (continued)**

Syntax	Size	Notes
else if (Mode == 0b110) {	—	—
<b>N_new_BSs</b>	3 bits	Number of new BSs that are recommended to be added to the Diversity Set of the MS.
<b>N_CIDs</b>	8 bits	Number of CIDs that need to be reassigned.
<b>N_SAIDs</b>	8 bits	Number of SAIDs need to be reassigned..
for ( i= 0; i < N_new_BSs; i++) {	—	—
<b>Neighbor BSID</b>	48 bits	—
<b>TEMP_BSID</b>	3 bits	Diversity Set member ID assigned to this BS.
for (j= 0;j<N_CIDs;j++) {	—	—
<b>New CID for BS_i</b>	16 bits	New CID to be used for new BS_i.
}	—	—
For(i=0; i<N_SAIDs; i++){	—	—
<b>New SAID for BS_i</b>	16 bits	New SAID to be used for new BS_i.
}	—	—
<b>CQICH_ID</b>	<i>variable</i>	Index to uniquely identify the CQICH resource assigned to the MS after the MS switched to the new anchor BS.
<b>Feedback channel offset</b>	6 bits	Index to the fast-feedback channel region of the new Anchor BS marked by UIUC.
<b>Period (=p)</b>	2 bits	A CQI feedback is transmitted on the CQICH every 2 <sup>p</sup> frames.
<b>Frame offset</b>	3 bits	The MS starts reporting at the frame of which the number has the same 3 LSB as the specified frame offset. If the current frame is specified, the MS should start reporting in eight frames.
<b>Duration (=d)</b>	3 bits	A CQI feedback is transmitted on the CQI channels indexed by the CQICH_ID for 10×2 <sup>d</sup> frames. If d == 0b000, the CQI-CH is de-allocated. If d == 0b111, the MS should report until the BS command for the MS to stop.

**Table 109n—MOB\_BSHO-RSP message format (continued)**

Syntax	Size	Notes
<b>MIMO_permutation_feedback_cycle</b>	2 bits	0b00 = No MIMO and permutation mode feedback 0b01 = the MIMO and permutation mode indication shall be transmitted on the CQICH indexed by the CQICH_ID every four CQICH transmission opportunities allocated to the MS in this message. The first indication is sent on the 4 <sup>th</sup> CQICH transmission opportunity allocated to the MS in this message. 0b10 = the MIMO mode and permutation mode indication shall be transmitted on the CQICH indexed by the CQICH_ID every eight CQICH transmission opportunities allocated to the MS in this message. The first indication is sent on the 8 <sup>th</sup> CQICH transmission opportunity allocated to the MS in this message. 0b11 = the MIMO mode and permutation mode indication shall be transmitted on the CQICH indexed by the CQICH_ID every 16 CQICH transmission opportunities allocated to the MS in this message. The first indication is sent on the 16 <sup>th</sup> CQICH transmission opportunity allocated to the MS in this message.
}	—	—
<b>N_current_BSSs</b>	3 bits	Number of BSSs currently in the Diversity Set of the MS that are recommended to remain in the Diversity Set.
for (i=0;i<N_current_BSSs;i++) {	—	—
<b>TEMP_BSSID</b>	3 bits	Diversity Set member ID assigned to this BS.
}	—	—
<b>TEMP_BSSID_Anchor</b>	3 bits	Temp BSSID for Anchor BS.
<b>AK Change Indicator</b>	1 bit	To indicate whether the AK being used should change when switching to a new Anchor BS. If set to 0, the MS should continue to use the AK currently in use. If set to 1, the MS should use the AK derived for use with the new Anchor BS.
}	—	—
<b>Action time</b>	8 bits	—
<i>padding</i>	<i>variable</i>	Padding bits to ensure byte aligned.
<b>TLV encoded information</b>	2 bits	TLV specific See 11.16.1.
}		

A BS shall generate MOB\_BSHO-RSP messages in the format shown in Table 109n. The following parameters shall be included in the MOB\_BSHO-RSP message:

#### **HO operation mode**

Indicate the operation mode of this HO response as prescribed by BS.

0: Recommended HO response.

1: Mandatory HO response. If HO operation mode is set to 1, BS shall include at least one recommended BS in the message ( $N_{\text{Recommended}} \geq 1$ ).

#### **Action Time**

For HO, this value is defined as number of frames until the Target BS allocates a dedicated transmission opportunity for RNG-REQ message to be transmitted by the MS using Fast Ranging IE. Non-zero value of this parameter means that potential Target BS estimates that channel parameters learned by the MS during Association of that BS stay valid and can be reused during actual Network Re-entry without preceding CDMA-based Initial Ranging. This parameter is decided by the Serving BS based on the information obtained from potential Target BSs over the backbone.

For MDHO/FBSS, this is the time of update of Anchor BS and/or Diversity Set. A value of zero in this parameter signifies that this parameter should be ignored.

For MS handover request not recommended (Mode == 0b111), Action Time is the number of frames that the BS suggests MS wait before transmitting a next MOB\_MSHO-REQ or MOB\_HO-IND. If the action timer is equal to 0, MS may transmit a revised MOB\_MSHO-REQ or MOB\_HO-IND immediately.

#### **Resource Retain Flag**

The Resource Retain Flag indicates whether the serving BS will retain or delete the connection information of the MS upon receiving MOB\_HO-IND with HO\_IND\_type=0b00. If the flag is set to 1, the serving BS will retain the MS's connection information during the time in Resource Retain Time field. If Resource Retain Flag=01 then the serving BS and MS shall use the System Resource Retain Time timer. If the flag is set to 0, the serving BS will discard the MS's connection information.

For Mode=0b000 for each recommended neighbor BS, the following parameters shall be included,

#### **NeighborBSID**

Same as the **Base Station ID** parameter in the DL-MAP message of neighbor BS. This may include the serving BS.

#### **Preamble index/ Subchannel Index**

For the SCa and OFDMA PHY this parameter defines the PHY specific preamble for the neighbor BS. For the OFDM PHY the 5 LSB contain the DL subchannel index (as defined in Table 211) used in the Neighbor BS' sector. The 3 MSB shall be Reserved and set to 0.

#### **Service level prediction**

The service level prediction value indicates the level of service the MS can expect from this BS. The following encodings apply:

0 = No service possible for this MS

1 = Some service is available for one or several service flows authorized for the MS.

2 = For each authorized service flow, a MAC connection can be established with QoS specified by the AuthorizedQoSParamSet.

3 = No service level prediction available.

#### **HO process optimization**

HO Process Optimization is provided as part of this message is indicative only. HO process requirements may change at time of actual HO. For each Bit location, a value of '0' indicates the associated reentry management messages shall be required, a value of '1' indicates the reentry management message may be omitted. Regardless of the HO Process Optimization TLV settings, the target BS may send unsolicited SBC-RSP and/ or REG-RSP management messages:

Bit #0: Omit SBC-REQ/RSP management messages during re-entry processing

- Bit #1: Omit PKM Authentication phase except TEK phase during current re-entry processing
- Bit #2: Omit PKM TEK creation phase during re-entry processing
- Bit #3: Omit REG-REQ/RSP management during current re-entry processing
- Bit #4: Omit Network Address Acquisition management messages during current reentry processing
- Bit #5: Omit Time of Day Acquisition management messages during current reentry processing
- Bit #6: Omit TFTP management messages during current re-entry processing
- Bit #7: Full service and operational state transfer or sharing between serving BS and target BS (ARQ, timers, counters, MAC state machines, etc...)

**HO\_ID\_included\_indicator**

Indicates whether HO\_ID is included or not in this message.

The MOB\_BSHO-RSP may contain the following TLV:

**Resource Retain Time (See 11.15.1.)**

The MOB\_BSHO-RSP message shall include the following parameter encoded as TLV tuples:

**HMAC/CMAC Tuple (See 11.1.2.)**

The HMAC/CMAC Tuple shall be the last attribute in the message.

For Mode != 0b000, the following parameter shall be included:

**AK Change Indicator**

Indicates whether the AK being used should change when switching to a new Anchor BS. If set to 0, the MS should continue to use the AK currently in use; if set to 1, the MS should use the AK derived for use with the new Anchor BS.

*Insert new subclause 6.3.2.3.55:*

**6.3.2.3.55 HO Indication (MOB\_HO-IND) message**

An MS shall transmit a MOB\_HO-IND message for final indication that it is about to perform a HO. When the MS cancels or rejects the HO, the MS shall transmit a MOB\_HO-IND message with appropriate HO\_IND\_type field. The message shall be transmitted on the basic CID.

**Table 109o—MOB\_HO-IND message format**

Syntax	Size	Notes
MOB_HO-IND_Message_format() {	—	—
<b>Management Message Type = 59</b>	8 bits	—
<i>Reserved</i>	6 bits	<i>Reserved</i> ; shall be set to zero
<b>Mode</b>	2 bits	0b00: HO 0b01: MDHO/FBSS: Anchor BS update 0b10: MDHO/FBSS: Diversity Set update 0b11: <i>Reserved</i>
if (Mode == 0b00) {	—	—

**Table 109o—MOB\_HO-IND message format (continued)**

<b>HO_IND_type</b>	2 bits	0b00: serving BS release 0b01: HO cancel 0b10: HO reject 0b11: <i>Reserved</i>
<b>Ranging_Params_valid_indication</b>	2 bits	0b00: No indication. BS ignores this field (Default) 0b01: MS ranging parameters for Target BS, which is specified in this message are valid 0b10: MS has no valid ranging parameters for Target BS, which is specified in this message 0b11: <i>Reserved</i>
<b>Reserved</b>	4 bits	Shall be set to zero.
if (HO_IND_type == 0b00) {	—	—
<b>Target_BS_ID</b>	48 bits	Applicable only when HO_IND_type is set to 0b00.
}	—	—
}	—	—
if (Mode == 0b01) {	—	—
<b>MDHOFBSS_IND_Type</b>	2 bits	0b00: Confirms Anchor BS update 0b01: Anchor BS update cancel 0b10: Anchor BS update reject 0b11: <i>Reserved</i>
if (MDHOFBSS_IND_Type == 0b00) {	—	—
<b>Anchor BSID</b>	3 bits	TEMP_BSID of the Anchor BS
<b>Action time</b>	8 bits	Action time when the Anchor BS shall be updated.
}	—	—
}	—	—
if (Mode == 0b10) {	—	—
<b>MDHOFBSS_IND_Type</b>	2 bits	0b00: Confirms Diversity Set update 0b01: Diversity Set update cancel 0b10: Diversity set update reject 0b11: <i>Reserved</i>
if (MDHOFBSS_IND_Type == 0b00) {	—	—
<b>Diversity Set Included Indicator</b>	1 bit	1: Final decision of Diversity Set members included in the message 0: Diversity Set members are as specified in MOB_BSHO_RSP message. No Diversity Set information included in this message.
if (Diversity Set Included Indicator == 1) {	3 bits	—
<b>Anchor BSID</b>	3 bits	TEMP_BSID of the Anchor BS.
<b>N_BSs</b>	3 bits	Number of BS in the Diversity Set, excluding the Anchor BS.
For (j=0 ; j<N_BSs ; j++) {	—	—



**Table 109o—MOB\_HO-IND message format (continued)**

<b>Temp BSID</b>	3 bits	Diversity Set member ID assigned.
}	—	—
}	8 bits	—
<b>Action time</b>	8 bits	Action time when the Anchor BS shall be updated.
}	—	—
}	—	—
<b>Preamble index/ Subchannel Index</b>	8 bits	For the SCa and OFDMA PHY this parameter defines the PHY specific preamble for the target BS. For the OFDM PHY the 5 LSB contain the active DL subchannel index for the target BS. The 3 MSB shall be Reserved and set to '0b000'.
<i>Padding</i>	<i>variable</i>	Padding bits to ensure byte aligned. Shall be set to zero.
<b>TLV encoded information</b>	<i>variable</i>	—
}	—	—

The MS shall use the handover mode signaled by the BS in the previous MOB\_BSHO-REQ or MOB\_BSHO-RSP message to perform handover.

An MS shall generate MOB\_HO-IND messages in the format shown in Table 109o. The following parameters shall be included in the message:

**Ranging Params valid indication**

Indicator that shows whether ranging parameters acquired by the MS during preceding Association with selected Target BS are still valid. This indicator may be used by Target BS in decision to allocate dedicated transmission opportunity by Fast Ranging IE.

0b00: No indication. BS ignores this field (Default)

0b01: MS ranging parameters for Target BS, which is specified in this message are valid

0b10: MS has no valid ranging parameters for Target BS, which is specified in this message

0b11: *Reserved*

**Target\_BS\_ID**

Same as the Base Station ID parameter in the DL-MAP message of target BS.

**Preamble Index/ Subchannel Index**

For the SCa and OFDMA PHY this parameter defines the PHY specific preamble for the target BS. For the OFDM PHY the 5 LSB contain the DL subchannel index (as defined in Table 211) used in the target BS sector. The 3 MSB shall be Reserved and set to 0.

The MOB\_HO-IND message shall include the following parameter encoded as TLV tuples:

**HMAC/CMAC Tuple (See 11.1.2.)**

The HMAC/CMAC Tuple shall be the last attribute in the message.

*Insert new subclause 6.3.2.3.56:*

**6.3.2.3.56 BS Broadcast Paging (MOB\_PAG-ADV) message**

The MOB\_PAG-ADV message shall be sent on the Broadcast CID or Idle mode multicast CID during the BS Paging Interval.

The MAC Management Message Type for this message is given in Table 14. The format of the message is shown in Table 109p.

**Table 109p—BS Broadcast Paging (MOB\_PAG-ADV) message format**

Syntax	Size	Notes
MOB_PAG-ADV_Message_format() {	—	—
Management Message Type=62	8 bits	—
Num_Paging_Group_IDs	16 bits	Number of Paging Group IDs in this message
For (i=0; i<Num_Paging_Group_IDs; i++) {	—	—
Paging Group ID	16 bits	—
}	—	—
Num_MACs	8 bits	Number of MS MAC addresses
For (j=0; j<Num_MACs; j++) {	—	—
MS MAC Address hash	24 bits	The hash is obtained by computing a CRC24 on the MS 48-bit MAC address. The polynomial for the calculation is 0x1864CFB
Action Code	2 bits	Paging action instruction to MS 0b00=No Action Required 0b01=Perform Ranging to establish location and acknowledge message 0b10=Enter Network 0b11=Reserved
Reserved	6 bits	—
}	—	—
<i>padding</i>	<i>variable</i>	Padding bits to ensure octet aligned
TLV Encoded Information	<i>variable</i>	TLV specific
}	—	—

A BS shall generate MOB\_PAG-ADV including the following parameters:

**Paging Group ID (16 bit)**

One or more logical affiliation groupings of BS.

**MS MAC Address hash**

This is a 24-bit field used to hash the MS 48-bit MAC address. The hash value shall be the remainder of the division (Modulo 2) of the 48-bit MAC address multiplied by the polynomial D24 with the generator polynomial

$g(D) = D^{24} + D^{23} + D^{18} + D^{17} + D^{14} + D^{11} + D^{10} + D^7 + D^6 + D^5 + D^4 + D^3 + D + 1$  (hex=1864cfb) (Example: [MS 48-bit MAC address]= 00:D0:59:0F:E2:2E, hash should then be set to 0x51efe3).

**Action Code**

- Paging action instruction to the MS to perform the following action:
- 0b00=No Action Required
- 0b01=Perform Ranging to establish location and acknowledge message
- 0b10=Enter Network
- 0b11=Reserved

For OFDMA PHY, when a BS pages multiple MSs, the BS may assign dedicated CDMA codes to one or more MS being paged. The BS shall first list the MAC Address Hash of those MSs that are assigned dedicated CDMA codes, followed by the MSs that are not assigned dedicated CDMA codes.

For OFDMA PHY, the following TLV may be included in the MOB\_PAG-ADV management message:

**CDMA code and transmission opportunity assignment (11.17.1)**

OFDMA-PHY specific parameter used to indicate CDMA code and transmission opportunity assigned to one or more MSs being paged in this message. One CDMA code and transmission opportunity assignment in the TLV corresponds to one MS paged. The order of the assignments is the same as the order of appearance of MS MAC address hash except with action code “No Action Required” in this message.

For OFDMA PHY, the following TLV may be included in the MOB\_PAG-ADV management message. If a CDMA code assignment TLV is included, the Page-Response window TLV shall be included. There shall be no more than one occurrence of the Page-Response window TLV.

**Page-Response window (11.17.2)**

OFDMA-PHY specific parameter used to indicate the time window (in unit of frames) during which the MS shall transmit the CDMA code at the transmission opportunity assigned in the CDMA code and transmission opportunity assignment TLV. The start of the window is the next frame after receiving the MOB\_PAG-ADV.

*Insert new subclause 6.3.2.3.56:*

**6.3.2.3.57 Multicast Broadcast Service Map (MBS\_MAP) message**

The BS may send an MBS\_MAP message on an MBS portion to describe the MBS connections serviced by the MBS portion. When a MBS\_MAP is sent, the connections need be described in the DL-MAP, but a MBS\_MAP\_IE() shall be substituted instead. The MBS MAP message format is presented in Table 109q. This message includes the MBS\_DATA\_IE and Extended\_MBS\_DATA\_IE, which define the access information for the downlink and uplink MBS burst.

**Table 109q—MBS\_MAP**

Syntax	Size	Notes
MBS_MAP Message format () {	—	—
Management Message Type =	4 bits	62
Frame number	4 bits	The frame number is identical to the 4 LSBs of the frame number in the DL-MAP
MBS_DIUC_Change_Count	8 bits	—
#MBS_DATA_IE	4 bits	The number of included MBS_DATA_IE

**Table 109q—MBS\_MAP (continued)**

For (i = 0; i < n; i++) {	—	$n = \#MBS\_DATA\_IE$
<b>MBS_DATA_IE</b>	<i>variable</i>	—
}	—	—
<b>#Extended_MBS_DATA_IE</b>	—	The number of included Extended_MBS_DATA_IE
For(i=0; i<n; i++) {	—	$n = \#Extended\_MBS\_DATA\_IE$
<b>Extended_MBS_DATA_IE()</b>	<i>variable</i>	—
}	—	—
<b>#MBS_DATA_Time_Diversity_IE</b>	4 bits	The number of included MBS_DATA_Time_Diversity_IE
For(i=0; i<m; i++) {	—	$m = \#MBS\_DATA\_Time\ diversity\_IE$
<b>MBS_DATA_Time_Diversity_IE()</b>	<i>variable</i>	—
}	—	—
If(!byte boundary) {	—	—
<b>Padding Nibble</b>	4 bits	—
}	—	—
<b>TLV encoding element</b>	—	—
}	—	—

**MBS DIUC Change Count**

It is used to notify the Burst Profile used for Multi-BS-MBS data has been changed. If MBS\_DIUC\_Change\_Count change, MS should wait until receiving DCD message unless Downlink Burst Profile TLV is included in MBS\_MAP message.

The following TLV may be included in MBS\_MAP message.

**Downlink Burst Profile**

Downlink Burst Profile is used for the definition of MBS DIUC.

**Table 109r—MBS\_MAP\_Type**

<b>MBS_MAP_Type</b>	<b>Description</b>
0	MBS_DATA_IE
1	MBS_DATA_Time_Diversity_IE
2	Extended MBS_DATA_IE
3~255	<i>Reserved</i>

**Table 109s—MBS\_DATA\_IE**

Syntax	Size	Notes
MBS_DATA_IE{	—	—
<b>MBS_MAP Type = 0</b>	2 bits	MBS_DATA_IE
<b>MBS Burst Frame Offset</b>	2 bits	This indicates the burst located by this IE will be shown after MBS Burst Frame Offset + 2 frames.
<b>Next MBS MAP change indication</b>	1 bit	This indicates whether the size of MBS MAP message of next MBS frame for these Multicast CIDs included this IE will be different from the size of this MBS MAP message.
<b>No. of Multicast CID</b>	3 bits	—
For(i=0; i< No. of Multicast CID; i++){	—	—
<b>Multicast CID</b>	12 bits	12 LSBs of CID for multicast.
}	—	—
<b>MBS DIUC</b>	4 bits	—
<b>OFDMA Symbol Offset</b>	8 bits	OFDMA symbol offset with respect to start of next (MBS Burst Frame offset + 2)th frame.
<b>Subchannel offset</b>	6 bits	OFDMA subchannel offset with respect to start of the next (MBS Burst Frame offset + 2)th frame.
<b>Boosting</b>	3 bits	Refer to Table 273.
<b>No. OFDMA Symbols</b>	7 bits	The size of MBS data.
<b>No. Subchannels</b>	6 bits	—
<b>Repetition Coding Indication</b>	2 bits	0b00 - No repetition coding 0b01 - Repetition coding of 2 used 0b10 - Repetition coding of 4 used 0b11 - Repetition coding of 6 used
<b>Next MBS frame offset</b>	8 bits	The Next MBS frame offset value is lower 8 bits of the frame number in which the BS shall transmit the next MBS frame.
<b>Next MBS OFDMA Symbol offset</b>	8 bits	The offset of the OFDMA symbol in which the next MBS portion starts, measured in OFDMA symbols from the beginning of the downlink frame in which the MBS_MAP is transmitted.
If (Next MBS MAP change indication=1){	—	—
<b>Next MBS No. OFDMA symbols</b>	2 bits	It is to indicate the size of MBS_MAP message in Next MBS portion where the BS shall transmit the next MBS frame for multicast CIDs in this IE.
<b>Next MBS No. OFDMA subchannels</b>	6 bits	It is to indicate the size of MBS_MAP message in Next MBS portion where the BS shall transmit the next MBS frame for multicast CIDs in this IE.
}	—	—
}	—	—

**Table 109t—Extended\_MBS\_DATA\_IE**

Syntax	Size	Notes
MBS_DATA_IE() {	—	—
<b>MBS MAP Type = 2</b>	2 bits	MBS_DATA_IE
<b>MBS_Burst_Frame_Offset</b>	2 bits	This indicates the burst indicated by this IE will be shown after MBS Burst Frame offset + 2 frames.
<b>Next MBS MAP change indication</b>	1 bit	This indicates whether the size of MBS MAP message of next MBS frame for these multicast CIDs included this IE will be different from the size of this MBS MAP message.
<b>No. of Multicast CID</b>	3 bits	—
For(i=0; i<No. of Multicast CIDs; i++) {	—	—
<b>Multicast CID</b>	12 bits	12 LSBs of CID for multicast.
<b>No. of Logical Channel ID</b>	4 bits	—
For(j=0; j<No. of Logical Channel ID; j++) {	—	—
<b>Logical Channel ID</b>	8 bits	—
}	—	—
}	—	—
<b>MBS DIUC</b>	4 bits	—
<b>OFDMA symbol offset</b>	8 bits	OFDMA symbol offset with respect to start of the next (MBS_Burst_Frame_offset + 2)-th frame.
<b>Subchannel offset</b>	6 bits	OFDMA subchannel offset with respect to start of the next (MBS_Burst_Frame_offset + 2)-th frame.
<b>Boosting</b>	3 bits	—
<b>No. OFDMA symbols</b>	7 bits	The size of MBS data.
<b>No. subchannels</b>	6 bits	—
<b>Repetition coding indication</b>	2 bits	0b00 = No repetition coding 0b01 = Repetition coding of 2 used 0b10 = Repetition coding of 4 used 0b11 = Repetition coding of 6 used
<b>Next MBS frame offset</b>	8 bits	The Next MBS frame offset value is lower 8 bits of the frame number in which the BS shall transmit the next MBS frame.
<b>Next MBS OFDMA symbol offset</b>	8 bits	The offset of the OFDMA symbol in which the next MBS portion starts, measured in OFDMA symbols from the beginning of the downlink frame in which the MBS_MAP is transmitted.
If (Next MBS MAP change indication = 1){	—	—

**Table 109t—Extended\_MBS\_DATA\_IE (continued)**

Syntax	Size	Notes
<b>Next MBS No. OFDMA symbols</b>	2 bits	It is to indicate the size of MBS_MAP message in Next MBS portion where the BS shall transmit the next MBS frame for multicast CIDs in this IE.
<b>Next MBS No. OFDMA subchannels</b>	6 bits	It is to indicate the size of MBS_MAP message in Next MBS portion where the BS shall transmit the next MBS frame for multicast CIDs in this IE.
}	—	—
}	—	—

**Multicast CID**

CID that is used for MBS connections

**Logical Channel ID**

This field is used to distinguish logical MBS connections which belong to the same Multicast CID. It is allocated to each logical MBS connection (i.e., MBS contents) in DSA-RSP message during Dynamic Service Addition procedure as described in 11.13.36.

**Table 109u—MBS\_DATA\_Time\_Diversity\_IE**

Syntax	Size	Notes
MBS_DATA_Time_Diversity_IE() {	—	—
<b>MBS_MAP Type = 1</b>	2 bits	—
<b>MBS Burst Frame Offset</b>	2 bits	This indicates the burst located by this IE will be shown after MBS Burst Frame offset + 2 frames
<b>Multicast CID</b>	12 bits	12 LSBs of CID for multicast.
<b>OFDMA symbol offset</b>	8 bits	This indicates starting position of the region of MBS Bursts with respect to start of the next (MBS Burst Frame offset + 2)-th frame.
<b>N_EP code</b>	4 bits	—
<b>N_SCH code</b>	4 bits	—
<b>AI_SN</b>	1 bit	—
<b>SPID</b>	2 bits	—
<b>ACID</b>	4 bits	—
<b>Next MBS MAP change indication</b>	1 bit	This indicates whether the size of MBS MAP message of next MBS frame for these multicast CIDs included this IE will be different from the size of this MBS MAP message.
<b>Next MBS frame offset</b>	8 bits	—
<b>Next MBS OFDMA Symbol offset</b>	8 bits	—
If (Next MBS MAP change indication = 1) {	—	—

**Table 109u—MBS\_DATA\_Time\_Diversity\_IE (continued)**

Syntax	Size	Notes
Next MBS No. OFDMA symbols	2 bits	It is to indicate the size of MBS_MAP message in Next MBS portion where the BS shall transmit the next MBS frame for multicast CIDs in this IE.
Next MBS No. OFDMA subchannels	6 bits	It is to indicate the size of MBS_MAP message in Next MBS portion where the BS shall transmit the next MBS frame for multicast CIDs in this IE.
}	—	—
}	—	—

**OFDMA symbol offset**

This indicates starting position of the region for MBS Bursts at the next (MBS\_Burst\_Frame\_offset + 2)-th frame. The region begins from the first subchannel of the OFDM symbol and in this region, MBS bursts, indicated by MBS\_DATA\_Time\_Diversity\_IE at the same MBS\_MAP message, are allocated in a one-dimensional way in the order of MBS\_DATA\_Time\_Diversity\_IE at a MBS\_MAP message.

**N<sub>EP</sub> code, N<sub>SCH</sub> code**

The combination of N<sub>EP</sub> code and N<sub>SCH</sub> code indicates the number of allocated subchannels and scheme of coding and modulation for the DL burst.

**AI\_SN**

Defines ARQ Identifier Sequence Number. This is toggled between 0 and 1 on successfully transmitting each encoder packet with the same ARQ channel.

**SPID**

Defines SubPacket ID, which is used to identify the four subpackets generated from an encoder packet.

**ACID**

Defines ARQ Channel ID for TimeDiversity MBS packet. Each TimeDiversity MBS connection can have multiple ARQ channels, each of which may have an encoder packet transaction pending.

MBS\_DATA\_Time\_Diversity\_IE presents when MBS only for HARQ enabled MS is provided.

The MBS burst indicated by the MBS\_DATA\_Time\_Diversity\_IE is encoded at the same way of HARQ. But it does not need the acknowledgement from MS.

**Insert new subclause 6.3.2.3.58:**

**6.3.2.3.58 Power control mode change request (PMC\_REQ) message**

This subclause is applicable to the OFDM and OFDMA PHY modes. The decision of the change of the power control mode between the open loop power control and closed loop power control is done at BS and the decision is indicated by the PMC\_RSP MAC message. Before the frame start specified in PMC\_RSP, the MS shall transmit PMC\_REQ in response to receipt of an PMC\_RSP from the BS directing a change to uplink power control mode. Further, PMC\_REQ can be used to request to change the power control mode. On the receipt of the PMC\_REQ from MS, BS may send PMC\_RSP in T47. The closed and open loop power control schemes are described in 8.3.7.4 (for OFDM) and 8.4.10.3 (for OFDMA). Before the first PMC\_RSP message from BS, the default power control mode shall be the closed power control scheme.



**Table 109v—PMC\_REQ message format**

Syntax	Size	Notes
PMC_REQ message format {	—	—
<b>Management Message Type = 63</b>	8 bits	Type = 63
<b>Power control mode change</b>	2 bits	0b00: Closed loop power control mode 0b01: <i>Reserved</i> 0b10: Open loop power control passive mode 0b11: Open loop power control active mode
<b>UL Tx power</b>	8 bits	UL Tx power level for the burst that carries this header (11.1.1). When the Tx power is different from slot to slot, the maximum value is reported.
<b>Confirmation</b>	1 bit	0: Request 1: Confirmation
<i>Reserved</i>	5 bits	Shall be set to zero
}	—	—

CID shall be the basic CID of MS. MS shall generate the PMC\_REQ message including the following parameters:

**Power control mode change**

- 0: Closed loop power control mode
- 1: Open loop power control mode

**UL Tx power**

UL Tx power level for the burst that carries this header (11.1.1). When the Tx power is different from slot to slot, the maximum value is reported.

**Confirmation**

- 0: MS requests to change the power control mode.
- 1: MS confirms the receipt of PMC\_RSP from BS.

*Insert new subclause 6.3.2.3.58:*

**6.3.2.3.59 Power control mode change response (PMC\_RSP) message**

For OFDM and OFDMA PHY modes, PMC\_RSP is sent from BS as a confirmation of MS's uplink power control change intention with PMC\_REQ message or it is sent unsolicited manner to command MS to change the uplink power control mode as indicated in the PMC\_RSP. When the open loop power control is indicated,  $\text{Offset\_BS}_{\text{perMS}}$  is included. When the closed loop power control is indicated, power adjust can be signaled. Before the first PMC\_RSP message from BS, the default power control mode shall be the closed power control scheme (Table 109w).

**Table 109w—PMC\_RSP message format**

Syntax	Size	Notes
PMC_RSP message format {	—	—
<b>Management Message Type = 64</b>	8 bits	Type = 64
<b>Power control mode change</b>	2 bits	0b00: Closed loop power control mode 0b01: Reserved 0b10: Open loop power control passive mode 0b11: Open loop power control active mode
<b>Start frame</b>	6 bits	6 LSBs of frame number when the indicated power control mode is activated. When it is same with the current frame number, the mode change shall be applied from the current frame.
If (Power control mode change==0) {	—	—
<b>Power adjust</b>	8 bits	Signed integer, which expresses the change in power level (in multiples of 0.25 dB) that the MS shall apply to its current transmission power. When subchannelization is employed, the subscriber shall interpret the power offset adjustment as a required change to the transmitted power density.
} else {	—	—
<b>Offset_BS<sub>perMS</sub></b>	8 bits	Signed integer, which expresses the change in power level (in multiples of 0.25 dB) that the MS shall apply to the open loop power control formula in 8.4.10.3.2.
}	—	—
}	—	—

CID shall be the basic CID of MS. MS shall generate the PMC\_RSP message including the following parameters:

**Power control mode change**

- 0b00: Closed loop power control mode
- 0b01: Reserved
- 0b10: Open loop power control passive mode
- 0b11: Open loop power control active mode

**Start frame**

6 LSBs of frame number when the indicated power control mode is activated. When it is same with the current frame number, the mode change shall be applied from the current frame.

**Power adjust**

Signed integer, which expresses the change in power level (in multiples of 0.25 dB) that the MS shall apply to its current transmission power. When subchannelization is employed, the subscriber shall interpret the power offset adjustment as a required change to the transmitted power density.

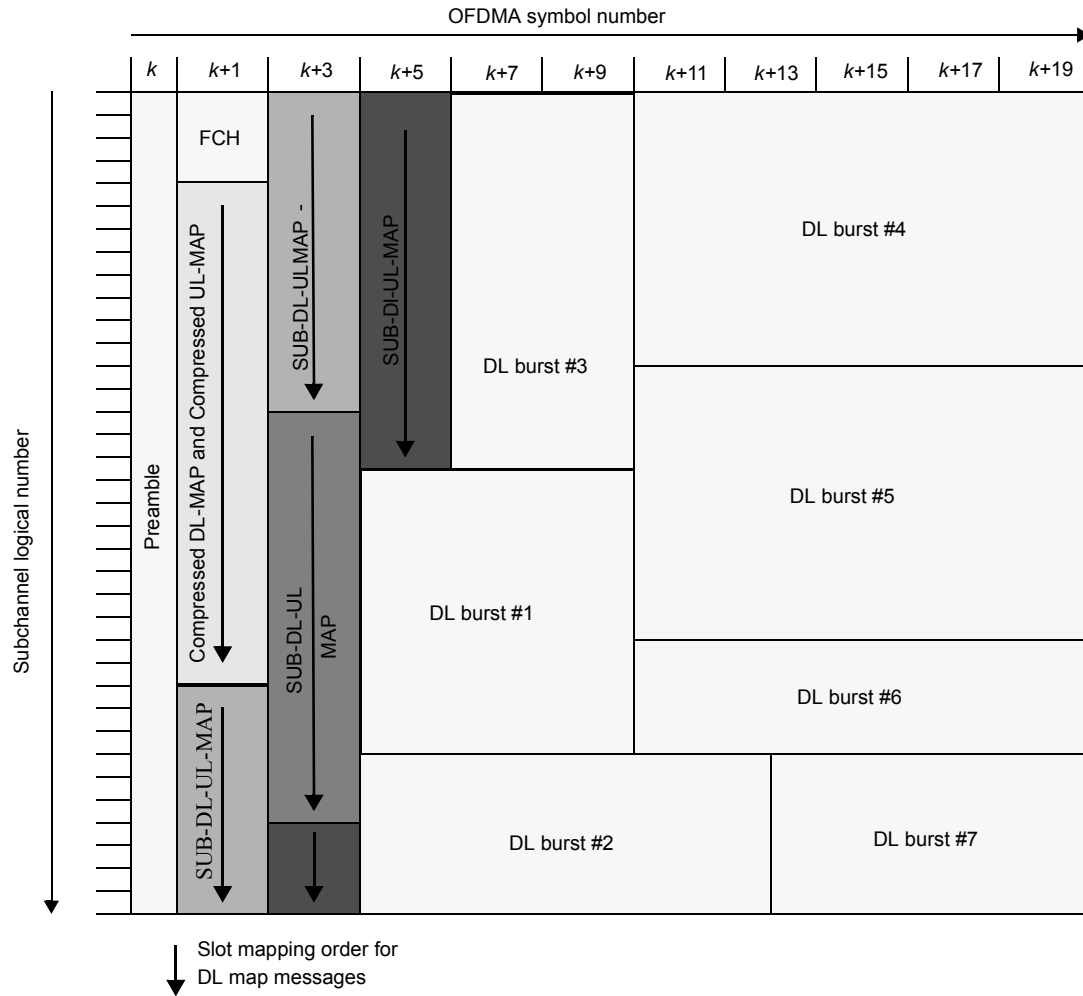
**Offset\_BS<sub>perMS</sub>**

Signed integer, which expresses the change in power level (in multiples of 0.25 dB) that the MS shall apply to the open loop power control formula in 8.4.10.3.2.

*Insert new subclause 6.3.2.3.60:*

**6.3.2.3.60 OFDMA Sub downlink/uplink map (SUB-DL-UL-MAP) message**

The placement of SUB-DL-UL-MAP messages within a frame is shown in Figure 23b.



**Figure 23b—Sub-MAP Burst**

This message shall only apply to OFDMA PHY.

The SUB-DL-UL-MAP message shall appear in a compressed form, in which the generic MAC header is omitted. This is indicated by setting the two most significant bits of the first data byte in the message’s PHY burst to 1 (an invalid combination for a generic MAC header).

The SUB-DL-UL-MAP format is presented in Table 109x.

**Table 109x—SUB-DL-UL-MAP message format**

Syntax	Size	Notes
SUB-DL-UL-MAP() {	—	—
<b>Compressed map indicator</b>	3 bits	Set to 0b111
<b>Map message length</b>	10 bits	—
<b>RCID_Type</b>	2 bits	0b00 = Normal CID 0b01 = RCID11 0b10 = RCID7 0b11 = RCID3
<b>HARQ ACK offset indicator</b>	1 bit	—
If (HARQ ACK offset indicator == 1){	—	—
<b>DL HARQ ACK offset</b>	8 bits	—
<b>UL HARQ ACK offset</b>	8 bits	—
}	—	—
<b>DL IE Count</b>	8 bits	—
For (i=1; i <= DL IE Count; i++)	—	—
<b>DL-MAP_IE()</b>	<i>variable</i>	—
}	—	—
<b>OFDMA Symbol offset</b>	8 bits	This value indicates start Symbol offset of subsequent sub-bursts in this UL Allocation start IE
<b>Subchannel offset</b>	7 bits	This value indicates start Subchannel offset of subsequent sub-bursts in this UL Allocation start IE
<i>Reserved</i>	1 bit	Shall be set to 0
while (map data remains){	—	—
<b>UL-MAP_IE()</b>	<i>variable</i>	—
}	—	—
If !(byte boundary) {	—	—
<b>Padding Nibble</b>	<i>variable</i>	Padding to reach byte boundary
}	—	—
}	—	—

**Map message length**

The length of the submap message in bytes including the compressed map indicator and the CRC.

**HARQ ACK offset indicator**

A field that indicates the inclusion of HARQ offsets. If this field is 0, then the ACK offsets shall be follow the last allocation made by previous maps. An MS that failed to decode any of the previous maps shall disregard all HARQ allocations made by this map, if HARQ ACK offset indicator is 0.

**DL HARQ ACK offset**

Indicates the ACK channel in the ACKCH Region that corresponds to the first HARQ enabled downlink burst specified in this map message.

**UL HARQ ACK offset**

Indicates the ACK bit index in the DL HARQ ACK IE that corresponds to the first HARQ enabled uplink burst specified in this map message.

**RCID\_TYPE**

The RCID type used for RCID\_IEs specified in DL-MAP\_IEs that are described in this SUB-DL-UL-MAP.

**DL IE Count**

The number of DL-MAP\_IE-s.

A CCITT CRC 16 value is appended to the end of the burst. The CRC is computed across all bytes of the SUB-DL-UL-MAP message.

SUB-DL-UL-MAP message shall be pointed only through compressed DL MAP and appended compressed UL MAP.

The order of DL-MAP\_IEs in the SUB-DL-UL-MAP message shall conform to the order defined for the DL-MAP message in 6.3.2.3.2

The logical order in which MAC PDUs are mapped to the PHY layer bursts in the downlink is defined as the order of increasing start time of all PHY bursts in the frame regardless of the MAP message in which they are described. If two or more PHY bursts have the same start time, the logical order is determined according to the order of appearance in the concatenation of DL-MAP and all SUB-DL-UL-MAP messages.

The logical order in which MAC PDUs are mapped to the PHY layer bursts in the uplink is defined as the order of UL-MAP\_IEs in the SUB-DL-UL-MAP message.

The SUB-DL-UL-MAP message can be located in the first zone of the frame or in any of the zones within the frame. The sub-map capability for the first zone or other zones are specified and negotiated using SBC-REQ/RSP messages. In each zone, the SUB-DL-UL-MAP messages shall be allocated consecutively using the same uni-dimensional frequency-first slot mapping order used for the DL-MAP and HARQ MAP bursts. For the first zone in the frame, the first burst containing a SUB-DL-UL-MAP message shall be allocated immediately following the bursts containing HARQ MAP messages, or following the DL-MAP if no HARQ MAPs exist in the frame. For all subsequent zones, the first burst containing a SUB-DL-UL-MAP message shall be allocated starting at the first subchannel of the first OFDMA symbol in the zone. DL-MAP\_IEs that appear in an SUB-DL-UL-MAP message shall only describe allocations whose starting OFDMA symbol is equal to or later than the first OFDMA symbol of the zone in which the SUB-DL-UL-MAP message is located. The bursts containing the SUB-DL-UL-MAP messages shall only be described by a SUB-MAP Pointer IE. This IE (if exists) shall immediately follow a STC\_Zone\_IE to describe SUB-DL-UL-MAP messages that are located in that zone.

The INC\_CID flag shall be reset to 0 in the beginning of each SUB-DL-UL-MAP message.

The physical modifier (PHY-MOD) shall be reset at the beginning of each SUB-DL-UL-MAP message and before the first UL-MAP\_IE.

All DL and UL zone switch IEs (Extended DIUC 0x01, Extended UIUC 0x04) shall be defined in the main DL and UL MAPs. SUB-DL-UL-MAP shall comply with the main DL and UL MAP zone switch. The SUB-DL-UL-MAP shall not include the downlink zone switch IE. Instead, the zone shall be identified by the symbol number (indicated in DL-MAP\_IE and other IE-s defining allocations).

The zone in which an UL allocation occurs is identified by the “OFDMA Symbol Offset” field in the SUB-DL-UL-MAP or the UL\_Allocation\_start\_IE (see 8.4.5.4.26). Allocations within a non-AAS zone shall start at the subchannel/symbol offset defined by the SUB-DL-UL-MAP or UL\_Allocation\_start\_IE. Allocations made in an UL AAS zone shall be defined by the slot offset field of the UL-MAP\_IE referenced to the start of the AAS zone. In this case, the subchannel/symbol offset is only used to specify that the allocation occurs in the AAS zone and is not used as a starting point for the UL allocation.

The DL-MAP\_IEs in the SUB-DL-UL-MAP shall be ordered in the increasing order of the transmission start time of the relevant PHY burst/allocation. The uplink allocations in the SUB-DL-UL-MAP shall be ordered in increasing order of zones

The maximum number of SUB-DL-UL-MAP messages per frame is three.

SUB-DL-UL-MAP message shall be used only with compressed DL and appended UL MAP structure.

*Insert new subclause 6.3.2.3.61:*

**6.3.2.3.61 MIMO precoding setup/tear-down**

The BS can setup long-term precoding with feedback from a particular MS by sending the MAC-manage message PRC-LT-CTRL to the MS. The BS can also use the same MAC-management message to tear-down the long-term precoding with feedback.

The precoding feedback delay of the base station, in number of frames, should be signaled from the BS to the MS in the PRC-LT-CTRL MAC-management message.

**Table 109y—Setup/Tear-down of long-term MIMO precoding (PRC-LT-CTRL) message format**

Syntax	Size	Notes
PRC-LT-CTRLformat(){	—	—
Management message type = 65	8 bits	—
Setup/Tear-down long-term precoding with feedback	1 bit	0=Turn off 1=Turn on
BS precoding application delay	2 bits	<i>k</i> , delay in number of frames beyond the minimal delay of 1 frame for when precoding information fed back from the MS to the BS can or will be applied.
}	—	—

**6.3.3 Construction and transmission of MAC PDUs**

**6.3.3.3 Fragmentation**

*Change the first sentence of the first paragraph as indicated:*

Fragmentation is the process by which a MAC SDU (or MAC Management message) is divided into one or more MAC PDUs.

***Insert new text after the second paragraph:***

The size of the FSN field in fragmentation subheaders is fixed per connection. The fragmentable broadcast connection shall use 11-bit FSN. BS and SS shall support 11-bit FSN. BS and SS may support 3-bit FSN. All management connections shall use 11-bit FSN. The size of the FSN used on non-ARQ fragmentable transport connections is determined during connection set-up (see 11.13.22).

**6.3.3.3.1 Non-ARQ Connections*****Change the second sentence of the first paragraph as indicated:***

The sequence number assigned to each fragment allows the receiver to recreate the original payload and to detect the loss of any intermediate ~~packets~~fragments.

**6.3.3.4 Packing****6.3.3.4.2 Packing for ARQ-enabled connections*****Change the second paragraph as indicated:***

The packing of variable-length MAC SDUs for the ARQ-enabled connections is similar to that of non-ARQ connections, when fragmentation is enabled. The BSN of the Packing subheader shall be used by the ARQ protocol to identify and retransmit ~~lost fragments~~ARQ blocks.

**6.3.3.5 CRC calculation*****Change the subclause as indicated:***

A service flow may require that a CRC be added to each MAC PDU carrying data for that service flow (11.13.12). In this case, for each MAC PDU with HT = 0, a CRC~~32~~ (as defined in ~~IEEE Std 802.36.3.3.5.1 for SC, SCa and OFDM mode and 6.3.3.5.2 for OFDMA mode~~), shall be appended to the payload of the MAC PDU; i.e., request MAC PDUs are unprotected. The CRC shall cover the generic MAC header and the Payload of the MAC PDU. The CRC shall be calculated after encryption; i.e., the CRC protects the Generic Header and the ciphered Payload.

***Insert new subclause 6.3.3.5.1:*****6.3.3.5.1 CRC32 calculation for SC, SCa, and OFDM mode**

The data (input) bytes shall be flipped (for each byte exchange bit0 ↔ bit7, bit1 ↔ bit6, bit2 ↔ bit5, and bit3 ↔ bit4)

The CRC32 shall be calculated using the following standard generator polynomial of degree 32:

$$G(x) = x^{32} + x^{26} + x^{23} + x^{22} + x^{16} + x^{12} + x^{11} + x^{10} + x^8 + x^7 + x^5 + x^4 + x^2 + x + 1$$

(where, the hexadecimal representation of truncated  $G(x)$  is "0x04c11db7")

The CRC32 is the 1's complement of the sum (modulo 2) of the following:

- 1) The remainder of  $x^k (x^{31} + x^{30} + x^{29} + \dots + x^2 + x + 1)$  divided (modulo 2) by  $G(x)$ , where  $k$  is the number of bits in the input data, and
- 2) The remainder after multiplication of the bit-flipped input data (treated as a polynomial) by  $x^{32}$  and then division by  $G(x)$ .

The CRC32 field shall then be transmitted bit-flipped commencing with the most significant byte. (The first transmitted byte will have in its bit 7 the coefficient of  $x^{24}$  and in bit 0 the coefficient of  $x^{31}$ .) The fourth byte will have the coefficient of  $x^0$  in bit 7 and the coefficient of  $x^7$  in bit 0).

As a typical implementation, at the transmitter, the initial remainder of the division is preset to all 1's and is then modified by division of the bit-flipped data by the generator polynomial  $G(x)$ . The 1's complement of this remainder is then bit flipped byte after byte when transmitted, with the most significant byte first.

At the receiver, the initial remainder is preset to all 1's and the input bytes shall be flipped first and then treated as coefficient of a polynomial. When divided by  $G(x)$ , this polynomial shall result in the absence of transmission errors, in a unique nonzero remainder value. The unique remainder value is the polynomial:

$$x^{31} + x^{30} + x^{26} + x^{25} + x^{24} + x^{18} + x^{15} + x^{14} + x^{12} + x^{11} + x^{10} + x^8 + x^6 + x^5 + x^4 + x^3 + x + 1$$

(or as its hexadecimal representation 0xC704DD7B)

*Insert new subclause 6.3.3.5.1.1:*

#### **6.3.3.5.1.1 CRC32 test vectors for SC, SCa, and OFDM mode**

The following is an example of CRC calculation in SC, SCa and OFDM mode:

Generic MAC Header (Hex) = 40 40 1A 06 C4 5A  
 Payload (Hex) = BC F6 57 21 E7 55 36 C8 27 A8 D7 1B 43 2C A5 48  
 CRC32 for SC, SCa and OFDM mode (Hex) = CB B6 5F 48

*Insert new subclause 6.3.3.5.2:*

#### **6.3.3.5.2 CRC32 calculation for OFDMA mode**

The data (input) bytes shall not be flipped as in OFDM mode.

The CRC32 shall be calculated using the following standard generator polynomial of degree 32:

$$G(x) = x^{32} + x^{26} + x^{23} + x^{22} + x^{16} + x^{12} + x^{11} + x^{10} + x^8 + x^7 + x^5 + x^4 + x^2 + x + 1$$

(where, the hexadecimal representation of truncated  $G(x)$  is "0x04c11db7")

At the transmitter, the following procedure is applied;

- 1) First 32 bits are complemented, which is equivalent to setting the initial value of the CRC register as 0xFFFFFFFF.
- 2) The first bit of the first field (MSB of the first byte of the MAC header) corresponds to the  $x^{n-1}$  term and the last bit of the last field corresponds to the  $x^0$  term, where  $n$  is the number of bits in the input data sequence.
- 3) The resulting polynomial multiplied by  $x^{32}$  is divided by  $G(x)$ .
- 4) The remainder bit sequence is complemented.
- 5) The 32 bits of the CRC value are placed in the CRC field so that the  $x^{31}$  term is the left-most bit of the first byte, and the  $x^0$  term is the right most bit of the last byte.
- 6) The resulting CRC field is sent MSB first (6.3.3.1).



At the receiver, the initial remainder is preset to all 1's and the input bytes shall be fed into the CRC engine MSB first. When divided by  $G(x)$ , this polynomial shall result in the absence of transmission errors, in a unique nonzero remainder value. The unique remainder value is the polynomial:

$$x^{31} + x^{30} + x^{26} + x^{25} + x^{24} + x^{18} + x^{15} + x^{14} + x^{12} + x^{11} + x^{10} + x^8 + x^6 + x^5 + x^4 + x^3 + x + 1$$

(or as its hexadecimal representation 0xC704DD7B)

*Insert new subclause 6.3.3.5.2.1:*

#### **6.3.3.5.2.1 CRC32 test vectors for OFDMA mode**

The following is an example of CRC calculation in OFDMA mode:

Generic MAC Header (Hex) = 40 40 1A 06 C4 5A  
 Payload (Hex) = BC F6 57 21 E7 55 36 C8 27 A8 D7 1B 43 2C A5 48  
 CRC32 for OFDMA mode (Hex) = 1B D1 BA 21

### **6.3.4 ARQ mechanism**

*Change the last paragraph of the subclause as indicated:*

The ARQ feedback information can be sent as a standalone MAC management message on the appropriate basic management connection, or piggybacked on an existing connection. ARQ feedback cannot be fragmented. ~~The implementation of ARQ is optional.~~

#### **6.3.4.2 ARQ Feedback IE format**

*Change the description of "BSN" field below Table 111 as indicated:*

##### **BSN**

If (ACK Type == 0x0): BSN value corresponds to the most significant bit of the first 16-bit ARQ ACK map and follows an MSB first approach with the BSN incremented by 1 for each bit in the ARQ ACK map, following through for the subsequent ARQ ACK maps.

If (ACK Type == 0x1): BSN value indicates that its corresponding block and all blocks with lesser (see 6.3.4.6.1) values within the transmission window have been successfully received.

If (ACK Type == 0x2): Combines the functionality of types 0x0 and 0x1.

If (ACK Type == 0x3): Combines the functionality of type 0x1 with the ability to acknowledge reception of ARQ blocks in terms of block sequences. A block sequence is defined as a set of ARQ blocks with consecutive BSN values. With this option, members of block sequences are identified and associated with the same reception status indication.

### 6.3.4.3 ARQ parameters

*Change subclause 6.3.4.3.4 as indicated:*

#### 6.3.4.3.4 ARQ\_RETRY\_TIMEOUT

ARQ\_RETRY\_TIMEOUT is the minimum time interval a transmitter shall wait before retransmission of an unacknowledged block for retransmission. The interval begins when the ARQ block was last transmitted. On connections that use both HARQ and ARQ, the ARQ\_RETRY\_TIMEOUT value shall be set accordingly to allow HARQ retransmission operation of the ARQ block to be completed before ARQ retransmission occurs. An ARQ block is unacknowledged if it has been transmitted but no acknowledgment has been received.

### 6.3.4.6 ARQ operation

#### 6.3.4.6.2 Transmitter state machine

*Change the first paragraph as indicated:*

An ARQ block may be in one of the following four states—~~not-sent~~, outstanding, discarded, and waiting-for-retransmission. Any ARQ block begins as ~~not-sent~~. After it is sent it becomes outstanding for a period of time termed ~~ACK~~ARQ\_RETRY\_TIMEOUT. While a block is in outstanding state, it is either acknowledged and discarded, or transitions to waiting-for-retransmission after ~~ACK~~ARQ\_RETRY\_TIMEOUT or NACK. An ARQ block can become waiting-for-retransmission before the ~~ACK~~ARQ\_RETRY\_TIMEOUT period expires if it is negatively acknowledged. An ARQ block may also change from waiting-for-retransmission to discarded when an ACK message for it is received or after a timeout ARQ\_BLOCK\_LIFETIME.

*Change the ninth paragraph as indicated:*

A bitmap entry not indicating acknowledgement shall be considered a NACK for the corresponding blocks.

NOTE—Selective ACK bit-maps are referenced to a specific BSN, which indicates to absolute number of the block referenced by the first bit in the bit-map. It is the responsibility of the ARQ feedback sender to assign the BSN such that all bits in the bit define either ACK or NAK for a specific ARO block. This can be achieved by assigning the BSN number low enough (modulo  $2^{11}$ ), such that every bit in the bit map provides correct feedback information.

*Change the thirteenth paragraph as indicated:*

The actions to be taken by the transmitter state machine when it wants to initiate a reset of the receiver ARQ state machine are provided in Figure 34. The actions to be taken by the ~~transmitter~~ receiver state machine when it ~~initiates~~ an ARQ Reset message ~~is received~~ are also provided in ~~Figure 34~~ Figure 35.

Replace Figure 34 with the following figure:

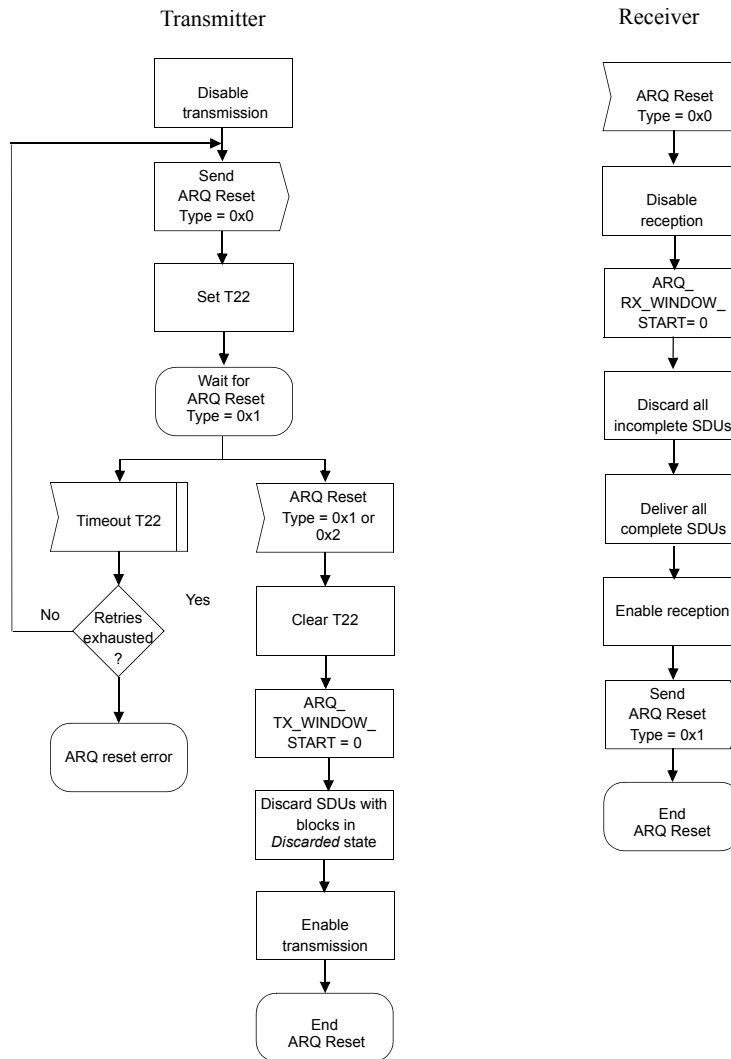


Figure 34—ARQ Reset message dialog—transmitter initiated

Change the last sentence of the paragraph below Figure 34 as indicated:

When the timer exceeds the value of ARQ\_SYNC\_LOSS\_TIMEOUT, the transmitter state machine shall initiate a reset of the connection's state machines as described in Figure 3534.

Replace Figure 35 with the following figure:

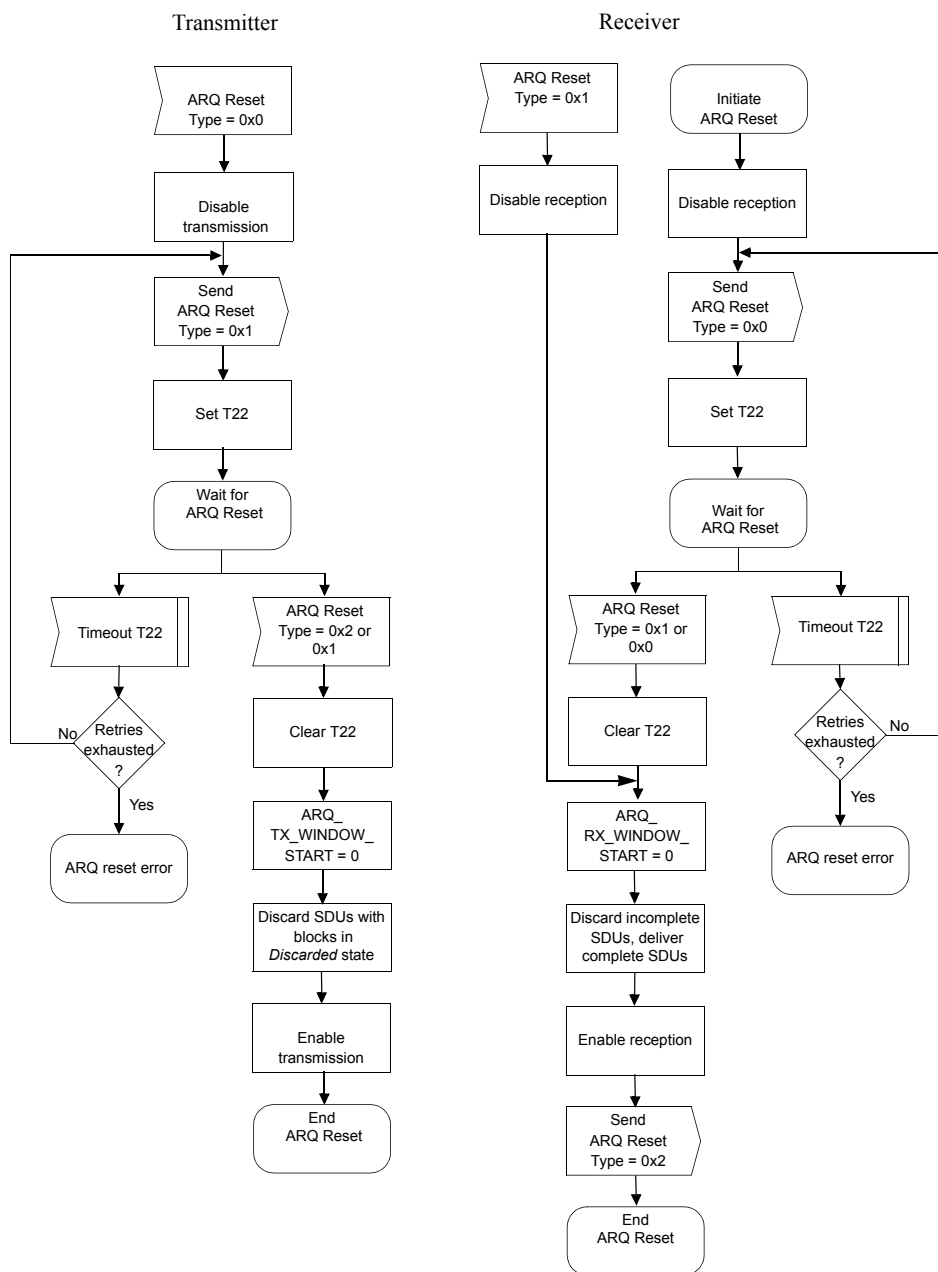


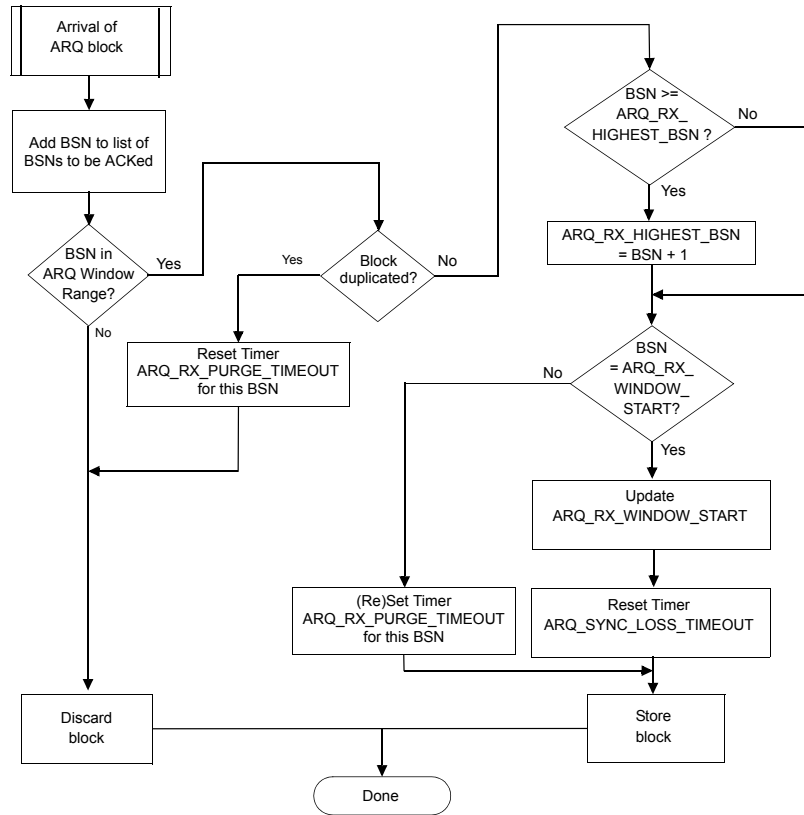
Figure 35—ARQ Reset message dialog—receiver initiated

Insert the following sentence below Figure 35:

When in ARQ reset error state in Figure 34 and Figure 35, the SS shall re-initialize its MAC, the behaviour for BS is implementation dependant.

**6.3.4.6.3 Receiver state machine**

Replace Figure 36 with the following figure:



**Figure 36—ARQ block reception**

Change the first sentence of second paragraph below Figure 36 as indicated:

As each block is received, a timer is started for that block. When a block does not result in an advance of the ARQ\_RX\_WINDOW\_START the ARQ\_RX\_PURGE\_TIMEOUT for that block shall be started.

**6.3.5 Scheduling services**

Change the first paragraph as indicated:

Scheduling services represent the data handling mechanisms supported by the MAC scheduler for data transport on a connection. Each connection is associated with a single data scheduling service. ~~Each data A scheduling service is associated with~~ determined by a set of QoS parameters that quantify aspects of its behavior. These parameters are managed using the DSA and DSC message dialogs. ~~Four services (11.13.11)~~ are supported: Unsolicited Grant Service (UGS), Real time Polling Service (rtPS), Non real time Polling Service (nrtPS), and Best Effort (BE). The following text provides a brief description of each of the supported scheduling services, including the mandatory QoS parameters that shall be included in the service flow definition when the scheduling service is enabled for a service flow. A detailed description of each QoS parameter is provided in 11.13.

*Change the second paragraph as indicated:*

Well-known scheduling services can be implemented by specifying a specific set of QoS parameters:

~~The UGS is designed Table 111a describes the QoS parameters that would provide a scheduling service to support real-time data streams consisting of fixed-size data packets issued at periodic intervals, such as T1/E1 and Voice over IP without silence suppression. The mandatory QoS service flow parameters for this scheduling service are Maximum Sustained Traffic Rate (11.13.6), Maximum Latency (11.13.14), Tolerated Jitter (11.13.13), and Request/Transmission Policy (11.13.12). If present, the Minimum Reserved Traffic Rate parameter (11.13.8) shall have the same value as the Maximum Sustained Traffic Rate parameter.~~

*Insert new Table 111a:*

**Table 111a—Example of QoS parameters providing a scheduling service to support real-time constant bit-rate data streams**

Parameter	Meaning
<b>Tolerated jitter</b>	As in 11.13.13
If (Fixed length SDU) {	
<b>SDU size</b>	As in 11.13.16
}	
<b>Minimum reserved traffic rate</b>	As in 11.13.8
<b>Maximum Latency</b>	As in 11.13.14
<b>Request/Transmission Policy</b>	As in 11.13.12
If (uplink service flow){	
<b>Grant Scheduling Type</b>	UGS as specified in 6.3.5.2.1
<b>Unsolicited Grant Interval</b>	As in 11.13.20
}	

*Change the third paragraph as indicated:*

~~The rPS is designed Table 111b describes the QoS parameters that would provide a scheduling service to support real-time data streams consisting of variable-sized data packets that are issued at periodic intervals, such as moving pictures experts group (MPEG) video. The mandatory QoS service flow parameters for this scheduling service are Minimum Reserved Traffic Rate (11.13.8), Maximum Sustained Traffic Rate (11.13.6), Maximum Latency (11.13.14), and Request/Transmission Policy (11.13.12).~~

*Insert new Table 111b:*

**Table 111b—Example of QoS parameters providing a scheduling service to support real-time variable-rate data streams**

Parameter	Meaning
Maximum Latency	As in 11.13.14
Minimum Reserved Traffic Rate	As in 11.13.8
Maximum Sustained Traffic Rate	Optional. As in 11.13.6
Traffic Priority	As in 11.13.5
Request/Transmission Policy	As in 11.13.12
If (uplink service flow){	
Scheduling Type	rtPS as in 6.3.5.2.2
Unsolicited Polling Interval	As in 11.13.21
}	

*Change the fourth paragraph as indicated:*

The nrtPS is designed ~~Table 111c describes the QoS parameters that would provide a scheduling service to support delay-tolerant data streams consisting of variable-sized data packets for which a minimum data rate is required, such as FTP. The mandatory QoS service flow parameters for this scheduling service are Minimum Reserved Traffic Rate (11.13.8), Maximum Sustained Traffic Rate (11.13.6), Traffic Priority (11.13.5), and Request/Transmission Policy (11.13.12).~~

*Insert new Table 111c:*

**Table 111c—Example of QoS parameters providing a scheduling service to support delay-tolerant variable-rate data streams**

Parameter	Meaning
Minimum Reserved Traffic Rate	As in 11.13.8
Maximum Sustained Traffic Rate	Optional. As in 11.13.8
Traffic Priority	As in 11.13.5
Request/Transmission Policy	As in 11.13.12
If (uplink service flow){	
Scheduling Type	nrtPS as in 6.3.5.2.3
}	

***Change the fifth paragraph as indicated:***

~~The BE service is designed Table 111d describes the QoS parameters that would provide a scheduling service to support data streams for which no minimum service level is required and therefore may be handled on a space-available basis. The mandatory QoS service flow parameters for this scheduling service are Maximum Sustained Traffic Rate (11.13.6), Traffic Priority (11.13.5), and Request/Transmission Policy (11.13.12).~~

***Insert new Table 111d:***

**Table 111d—Example of QoS parameters providing a scheduling service to support best-effort data streams**

Parameter	Meaning
Maximum Sustained Traffic Rate	Optional. As in 11.13.8
Request/Transmission Policy	As in 11.13.12
If (uplink service flow){	
Scheduling Type	BE as in 6.3.5.2.4
}	

**6.3.5.2 Uplink request/grant scheduling**

***Change the first paragraph as indicated:***

Uplink request/grant scheduling is performed by the BS with the intent of providing each subordinate SS with bandwidth for uplink transmissions or opportunities to request bandwidth. By specifying a scheduling ~~service type~~ and its associated QoS parameters, the BS scheduler can anticipate the throughput and latency needs of the uplink traffic and provide polls and/or grants at the appropriate times.

***Change the second paragraph as indicated:***

Table 112 summarizes the scheduling ~~services types~~ and the poll/grant options available for each. The following subclauses define service flow scheduling services for uplink operations.

**6.3.5.2.1 UGS**

***Change the first paragraph as indicated:***

The UGS is designed to support real-time uplink service flows that ~~generate transport~~ fixed-size data packets on a periodic basis, such as T1/E1 and Voice over IP without silence suppression. The service offers fixed-size grants on a real-time periodic basis, which eliminate the overhead and latency of SS requests and assure that grants are available to meet the flow's real-time needs. The BS shall provide Data Grant Burst IEs to the SS at periodic intervals based upon the Maximum Sustained Traffic Rate of the service flow. The size of these grants shall be sufficient to hold the fixed-length data associated with the service flow (with associated generic MAC header and Grant management subheader) but may be larger at the discretion of the BS scheduler. In order for this service to work correctly, the Request/Transmission Policy (see 11.13.12) setting shall be such that the SS is prohibited from using any contention request opportunities for this connection. The mandatory QoS parameters are Maximum Sustained Traffic Rate (11.13.6), Maximum Latency (11.13.14), Tolerated Jitter (11.13.13), Uplink Grant Scheduling Type (11.13.11) and Request/Transmission Policy



~~(11.13.12). If present, the Minimum Reserved Traffic Rate parameter (11.13.8) shall have the same value as the Maximum Sustained Traffic Rate parameter. The key service IEs are the Maximum Sustained Traffic, Maximum Latency, the Tolerated Jitter, and the Request/Transmission Policy. If present, the Minimum Reserved Traffic Rate parameter shall have the same value as the Maximum Sustained Traffic Rate parameter.~~

***Insert at the end of 6.3.5.2.1***

The FL and FLI fields may be used to provide the BS with information on the synchronization of the MS application that is generating periodic data for UGS/Extended rtPS Service Flows.

The MS may use these fields to detect whether latency experienced by this service flow at the MS exceeds a certain limit, e.g., a single frame duration. If the FL indicates inordinate latency, the BS may shift scheduled grants earlier for this service flow [taking into account the Frame Latency (FL)].

**6.3.5.2.2 rtPS**

***Change the first paragraph as indicated:***

The rtPS is designed to support real-time uplink service flows that ~~generate transport~~ variable size data packets on a periodic basis, such as moving pictures experts group (MPEG) video. The service offers real-time, periodic, unicast request opportunities, which meet the flow's real-time needs and allow the SS to specify the size of the desired grant. This service requires more request overhead than UGS, but supports variable grant sizes for optimum data transport efficiency.

***Change the second paragraph as indicated:***

The BS shall provide periodic unicast request opportunities. In order for this service to work correctly, the Request/Transmission Policy setting (see 11.13.12) shall be such that the SS is prohibited from using any contention request opportunities for that connection. The BS may issue unicast request opportunities as prescribed by this service even if prior requests are currently unfulfilled. This results in the SS using only unicast request opportunities and data transmission opportunities in order to obtain uplink transmission opportunities ~~(the SS could still use unsolicited Data Grant Burst Types for uplink transmission as well)~~. All other bits of the Request/Transmission Policy are irrelevant to the fundamental operation of this scheduling service and should be set according to network policy. The mandatory QoS parameters are Minimum Reserved Traffic Rate (11.13.8), Maximum Sustained Traffic Rate (11.13.6), Maximum Latency (11.13.14), Uplink Grant Scheduling Type (11.13.11) and Request/Transmission Policy (11.13.12). ~~The key service IEs are the Maximum Sustained Traffic Rate, the Minimum Reserved Traffic Rate, the Maximum Latency and the Request/Transmission Policy.~~

***Insert new subclause 6.3.5.2.2.1:***

**6.3.5.2.2.1 Extended rtPS**

Extended rtPS is a scheduling mechanism which builds on the efficiency of both UGS and rtPS. The BS shall provide unicast grants in an unsolicited manner like in UGS, thus saving the latency of a bandwidth request. However, whereas UGS allocations are fixed in size, ertPS allocations are dynamic.

The BS may provide periodic UL allocations that may be used for requesting the bandwidth as well as for data transfer. By default, size of allocations corresponds to current value of Maximum Sustained Traffic Rate at the connection. The MS may request changing the size of the UL allocation by either using an extended piggyback request field of the Grant Management subheader or using BR field of the MAC signaling headers as described in Table 5a, or sending a codeword (defined in 8.4.5.4.10.13) over CQICH. The BS shall not change the size of UL allocations until receiving another bandwidth change request from the MS.

When the bandwidth request size is set to zero, the BS may provide allocations for only bandwidth request header or no allocations at all. In case that no unicast bandwidth request opportunities are available, the MS may use contention request opportunities for that connection, or send the CQICH codeword to inform the BS of its having the data to send. If the BS receives the CQICH codeword, the BS shall start allocating the UL grant corresponding to the current Maximum Sustained Traffic Rate value.

The key service IEs are the Maximum Sustained Traffic Rate, the Minimum Reserved Traffic Rate, the Maximum Latency, and the Request/Transmission Policy.

The Extended rtPS is designed to support real-time service flows that generate variable size data packets on a periodic basis, such as Voice over IP services with silence suppression.

#### **6.3.5.2.3 nrtPS**

*Change the first paragraph as indicated:*

The nrtPS offers unicast polls on a regular basis, which assures that the uplink service flow receives request opportunities even during network congestion. The BS typically polls nrtPS CIDs on an interval on the order of one second or less.

*Change the second paragraph as indicated:*

The BS shall provide timely unicast request opportunities. In order for this service to work correctly, the Request/Transmission Policy setting (see 11.13.12) shall be set such that the SS is allowed to use contention request opportunities. This results in the SS using contention request opportunities as well as unicast request opportunities and ~~unsolicited Data Grant Burst Types~~data transmission opportunities. All other bits of the Request/Transmission Policy are irrelevant to the fundamental operation of this scheduling service and should be set according to network policy. The mandatory QoS parameters for this scheduling service are Minimum Reserved Traffic Rate (11.13.8), Maximum Sustained Traffic Rate (11.13.6), Traffic Priority (11.13.5), Uplink Grant Scheduling Type (11.13.11), and Request/Transmission Policy (11.13.12).

#### **6.3.5.2.4 BE service**

*Change the subclause as indicated:*

The intent of the BE ~~service~~ grant scheduling type is to provide efficient service for best effort traffic in the uplink. In order for this service to work correctly, the Request/Transmission Policy setting shall be set such that the SS is allowed to use contention request opportunities. This results in the SS using contention request opportunities as well as unicast request opportunities and ~~unsolicited Data Grant Burst Types~~data transmission opportunities. All other bits of the Request/Transmission Policy are irrelevant to the fundamental operation of this scheduling service and should be set according to network policy.

### **6.3.6 Bandwidth allocation and request mechanisms**

#### **6.3.6.1 Requests**

*Change the second paragraph as indicated:*

Because the uplink burst profile can change dynamically, all requests for bandwidth shall be made in terms of the number of bytes needed to carry the MAC header and payload, but not the PHY overhead. The Bandwidth Request message may be transmitted during any uplink allocation, except during any initial ranging interval. An SS shall not request bandwidth for a connection if it has no PDU to transmit on that connection.

*Change the last three sentences of the third paragraph as indicated:*

The self-correcting nature of the request/grant protocol requires that SSs ~~shall~~may periodically use aggregate Bandwidth Requests. ~~The period may be~~a function of the QoS of a service and of the link quality. Due to the possibility of collisions, contention-based Bandwidth Requests ~~transmitted in broadcast or multicast Request IEs should~~shall be aggregate requests.

*Insert the following paragraph as the end of the subclause:*

Capability of incremental Bandwidth Requests is optional for the SS and mandatory for the BS. Capability of aggregate Bandwidth Requests is mandatory for SS and BS.

### 6.3.6.3 Polling

#### 6.3.6.3.1 Unicast

*Change the box with the text “Process UL-MAP and assign bandwidth to the outstanding requests” in Figure 37 to read “Process UL-MAP and assign bandwidth”.*

*Change the decision box with the text “Timer for aggregate requests expired?” in Figure 37 to read “Aggregate requests needed?”*

### 6.3.7 MAC support of PHY

#### 6.3.7.4 UL-MAP

##### 6.3.7.4.3 Uplink interval definition

###### 6.3.7.4.3.1 Request IE

*Insert the following sentence at the end of the subclause:*

This subclause does not apply to the OFDMA PHY.

###### 6.3.7.4.3.2 Initial Ranging IE

*Insert the following sentence at the end of the subclause:*

This subclause does not apply to the OFDMA PHY, in which CDMA-based ranging is used, as described in 6.3.10.3.

###### 6.3.7.4.3.4 End of map IE

*Insert the following sentence at the end of the subclause:*

This IE is not used in OFDMA PHY.

#### 6.3.7.5 Map relevance and synchronization

*Change the second paragraph as indicated:*

Information in the DL-MAP pertains to the current frame (the frame in which the message was received). Information carried in the UL-MAP pertains to a time interval starting at the Allocation Start Time measured from the beginning of the current frame and ending after the last specified allocation. For the OFDM PHY

with an UL-MAP sent in AAS zone, the allocation start time shall be measured from the start of the AAS zone in which the UL MAP was sent. This timing holds for both the TDD and FDD variants of operation. The TDD variant is shown in Figure 46 and Figure 47. The FDD variant is shown in Figure 48 and Figure 49.

### 6.3.7.5.3 WirelessMAN-OFDM PHY

*Change the second bullet of the subclause as indicated:*

- For TDD, the Allocation Start Time value shall be either the ATDD split, or the ATDD split +  $T_f$ ; and the allocation shall be within a single frame. The allocation start time shall be no smaller than the round trip delay +  $T_{proc}$ .

*Change the title of subclause 6.3.7.6 as indicated:*

### 6.3.7.6 Optional MAC AAS ~~S~~support of WirelessMAN-SCa, OFDM, and OFDMA

#### 6.3.7.6.1 AAS MAC services

*Change the fifth paragraph as indicated:*

For SC, SCa and OFDM systems, the AAS part of the DL frame begins with an AAS specific Preamble, see Figure 52 and Figure 53. Note that this DL preamble does not apply to the OFDMA PHY.

#### 6.3.7.6.4 Alerting the BS about presence of a new SS in an AAS system

*Change the second paragraph as indicated:*

Alternatively, for SC, SCa and OFDM systems, an AAS SS may use the following procedure to alert the BS to its presence, so the BS can adapt its antenna array to the SS position.

### 6.3.8 Contention resolution

*Change the seventh paragraph as indicated:*

The SS shall consider the contention transmission lost if no data grant has been given within  $T_1$  received in the number of subsequent UL-MAP messages specified by the parameter Contention-based reservation timeout (or no response within  $T_3$  for initial ranging). The SS shall now increase its backoff window by a factor of two, as long as it is less than the maximum backoff window. The SS shall randomly select a number within its new backoff window and repeat the deferring process described above.

### 6.3.9 Network entry and initialization

*Change the second paragraph below Figure 55 as indicated:*

Implementation of phase e) is optional. This phase shall be performed if both SS and BS support Authorization Policy. Implementation of phases g), h), and i) at the SS is optional. These phases shall only be performed if the SS has indicated in the REG-REQ message that it is a managed SS.

### 6.3.9.1 Scanning and synchronization to the downlink

*Change the first paragraph as indicated:*

On initialization or after signal loss, the SS shall acquire a downlink channel. The SS shall have nonvolatile storage in which the last operational parameters are stored and ~~shall~~may first try to reacquire this downlink channel. If this fails, it shall begin to ~~continuously~~ scan the possible channels of the downlink frequency band of operation until it finds a valid downlink signal.

### 6.3.9.2 Obtain downlink parameters

*Change the first paragraph as indicated:*

The MAC shall search for the DL-MAP MAC management messages. The SS achieves MAC synchronization once it has received at least one DL-MAP message and is able to decode the DL-Burst Profiles contained therein. An SS MAC remains in synchronization as long as it continues to successfully receive the DL-MAP and DCD messages for its Channel. If the Lost DL-MAP Interval (Table 342) has elapsed without a valid DL-MAP message or the T1 interval (Table 342) has elapsed without a valid DCD message, an SS shall try to reestablish synchronization. The process of acquiring synchronization is illustrated in Figure 56. The process of maintaining synchronization is illustrated in Figure 57.

### 6.3.9.3 Obtain uplink parameters

*Change the third paragraph as indicated:*

The SS shall determine from the channel description parameters whether it may use the uplink channel. If the channel is not suitable, then the SS shall continue scanning to find another downlink channel. If the channel is suitable, the SS shall extract the parameters for this uplink from the UCD. ~~It then shall wait for the next DL-MAP message and extract the time synchronization from this message.~~ Then, the SS shall wait for a bandwidth allocation map for the selected channel. It may begin transmitting uplink in accordance with the MAC operation and the bandwidth allocation mechanism.

*Replace Figure 58 with the following figure:*

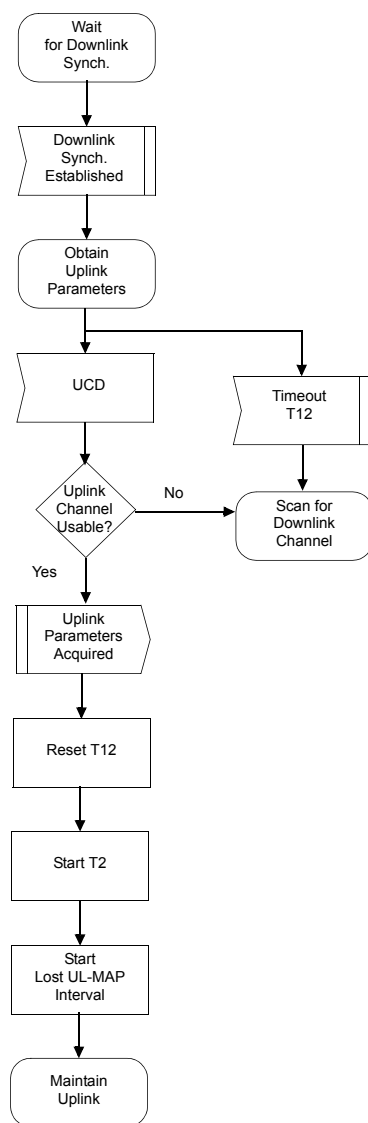


Figure 58—Obtaining uplink parameters

### 6.3.9.5 Initial ranging and automatic adjustments

*Change the title of 6.3.9.5.1 as indicated:*

#### 6.3.9.5.1 Contention-based initial ranging and automatic adjustments

*Change the second paragraph as indicated:*

For SC, SCa, and OFDM PHY, the SS shall put together a RNG-REQ message to be sent in an Initial Ranging Interval. The duration of the burst carrying the RNG-REQ message shall be as specified in the “Ranging

Request Burst Size” TLV (see 11.3.1). The CID field shall be set to the non initialized SS value (zero). For the OFDM PHY, the initial ranging process may include a subchannelized mechanism specified in 8.3.7.2. For the OFDMA PHY, the initial ranging process shall begin by sending initial-ranging CDMA codes on the UL allocation dedicated for that purpose (for more details see 6.3.10.3), instead of RNG-REQ messages sent on contention slots.

***Change the seventh paragraph as indicated:***

In the case that the  $EIR \times P_{IR,max}$  and/or BS\_EIRP are/is not known, the SS shall start from ~~the~~<sup>its</sup> minimum transmit power level ~~defined by the BS.~~

***Change the ninth paragraph as indicated:***

For SC, SCa, and OFDM PHY, the SS shall send the RNG-REQ at a power level below  $P_{TX\_IR\_MAX}$ , measured at the antenna connector. If the SS does not receive a response, the SS shall resend the RNG-REQ at the next appropriate Initial Ranging transmission opportunity ~~at one step higher and adjust its~~ power level. If the SS receives a response containing the frame number in which the RNG-REQ was transmitted, it shall consider the transmission attempt unsuccessful but implement the corrections specified in the RNG-RSP and issue another RNG-REQ message after the appropriate backoff delay. If the SS receives a response containing its MAC Address, it shall consider the RNG\_RSP reception successful. If the SS does not receive a response, the SS shall resend the RNG-REQ at the next appropriate Initial Ranging transmission opportunity and adjust its power level.

***Change the second sentence of the eleventh paragraph as indicated:***

If the SS does not receive a response, the SS shall send a new CDMA code at the next appropriate Initial Ranging transmission opportunity ~~at one step higher and adjust its~~ power level.

***Change the third paragraph below Table 115 as indicated:***

On receiving a RNG-RSP instruction to move to a new downlink frequency ~~and/or uplink channel ID~~, the SS shall consider any previously assigned Basic, Primary Management, and Secondary Management CIDs to be deassigned, and shall obtain new Basic, Primary Management, and Secondary Management CIDs via initial ranging and registration.

***Insert the following text at the end of 6.3.9.5.1:***

For MS that are employing the optional association procedure, and to which the MS and BS are currently Associated, the MS may use its un-expired, previously obtained and retained associated Ranging transmit parameters to set initial ranging values including  $P_{TX\_IR\_MAX}$  power levels.

### **6.3.9.6 Ranging parameter adjustment**

***Replace Figure 60 with the following figure:***

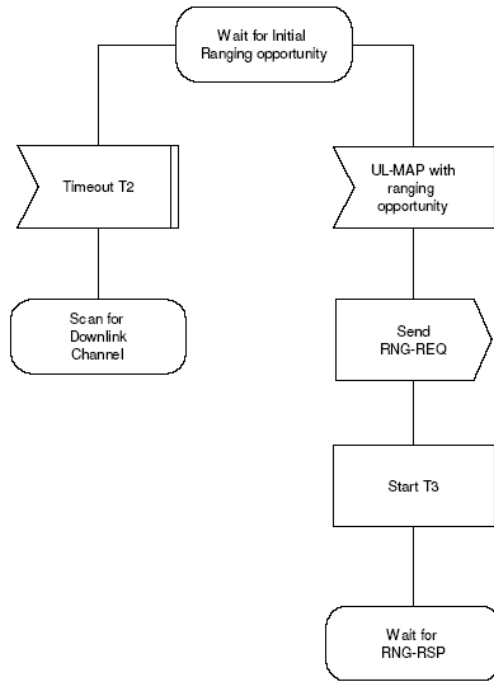


Figure 60 – Initial Ranging – SS (part 1)



Replace Figure 61 with the following figure:

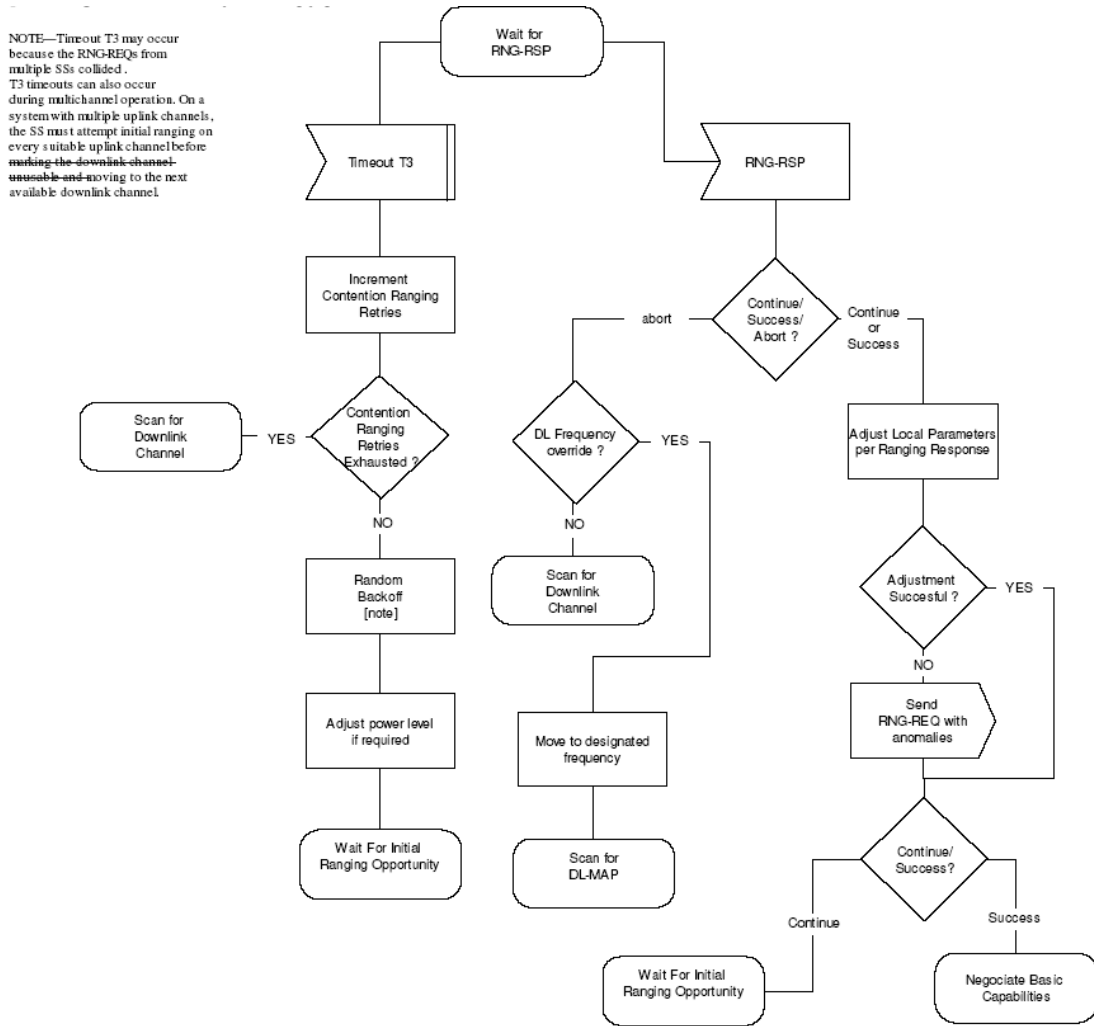


Figure 61 – Initial Ranging – SS (part 2)

Change the text of the “send RNG-RSP (rerange) with Frame Number (and Opportunity)” box of Figure 64 as follows:

Send RNG-RSP (~~rerange~~continue) with Frame Number (and Opportunity).

### 6.3.9.7 Negotiate basic capabilities

Replace Figure 66 with the following figure:

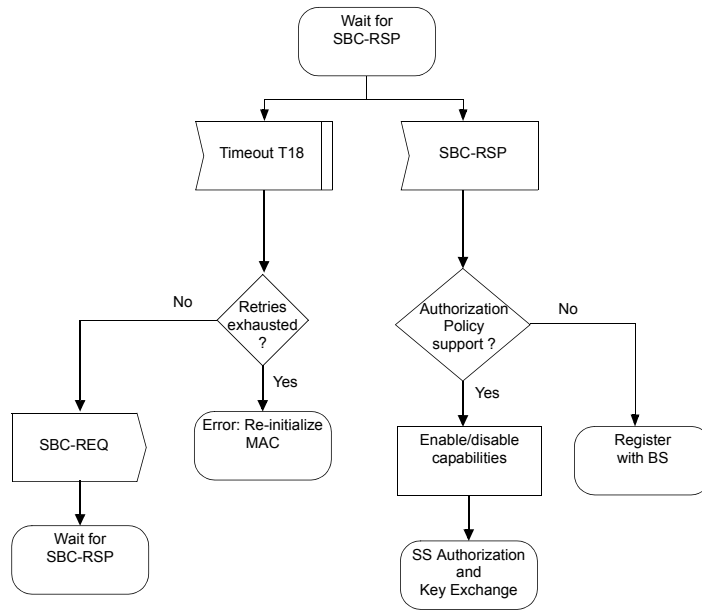
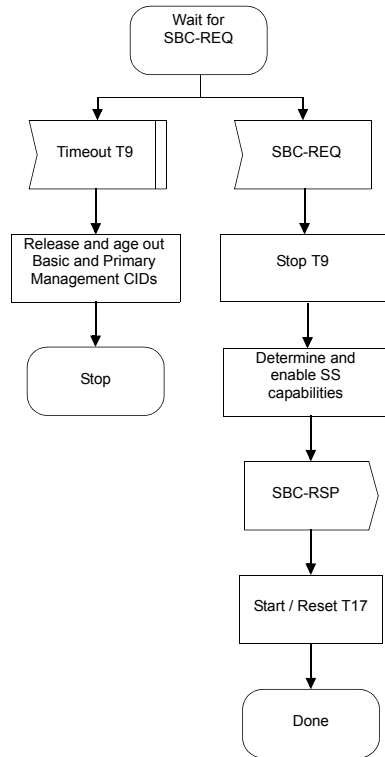


Figure 66—Wait for SBC-RSP—SS

*Replace Figure 67 with the following figure:*



**Figure 67—Negotiate Basic Capabilities—BS**

**6.3.9.8 SS authorization and key exchange**

*Change the first paragraph as indicated:*

If PKM is enabled (see 11.7.8.7), ¶the BS and SS shall perform authorization and key exchange as described in 7.2.

### 6.3.9.9 Registration

Replace Figure 70 with the following figure:

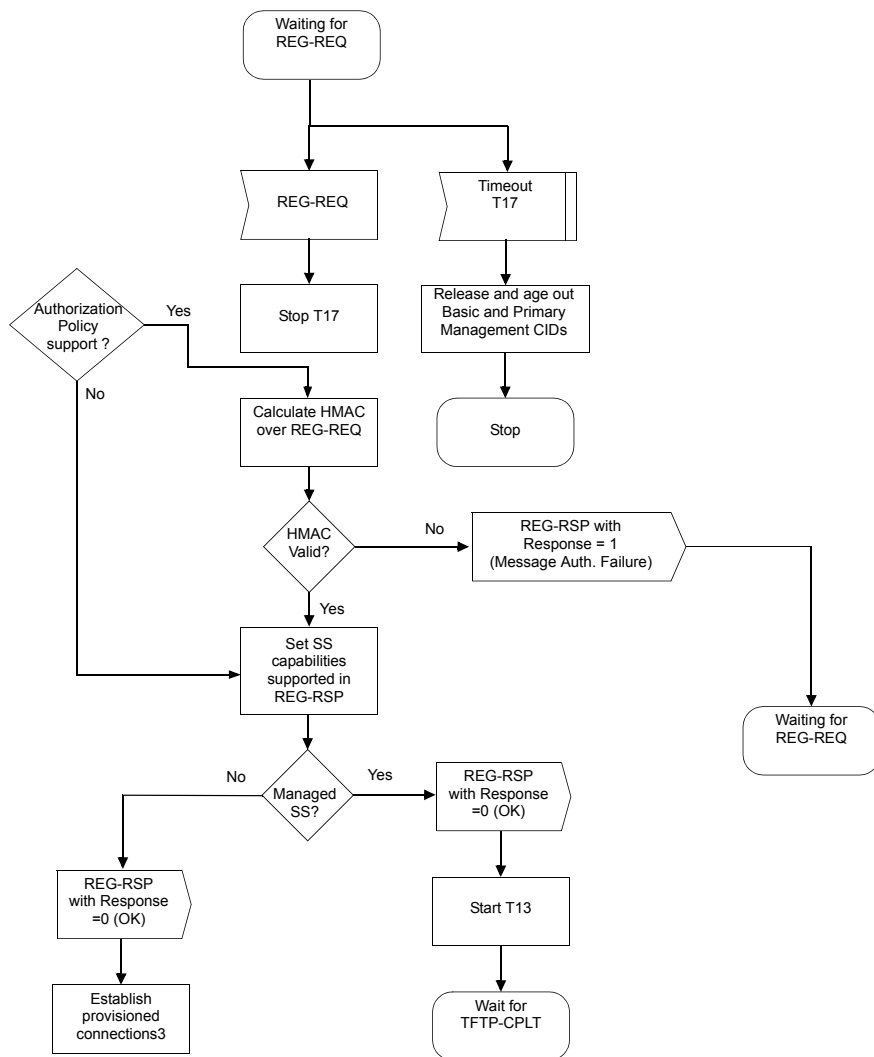


Figure 70—Registration—BS

### 6.3.9.10 Establish IP connectivity

Replace the first paragraph in 6.3.9.10 with the following:

For an MS, if mobile IP is being used, the MS may secure its address on the secondary management connection using mobile IP.

Otherwise, for all SS and for MS using IPv4 and not using mobile IP, they shall invoke DHCP mechanisms [IETF RFC 2131] in order to obtain an IP address and any other parameters needed to establish IP connectivity. If the SS has a configuration file, the DHCP response shall contain the name of a file that contains further configuration parameters. For SS using IPv6, they shall either invoke DHCPv6 [IETF RFC 3315] or

IPv6 Stateless Address Autoconfiguration [IETF RFC 2462] based on the value of a TLV tuple in REG-RSP. Establishment of IP connectivity shall be performed on the SS's Secondary Management Connection (see Table 110).

The IP version parameter shall be included in the TLV described in 11.4.2.7.

*Insert new subclause 6.3.9.15:*

### **6.3.9.15 Forcing MSs to perform Network Entry at once**

A BS may restart due to a critical error or an operator's intention. The BS has the restart count as the number of times in which the BS restarts. This restart count is incremented by one whenever BS restarts. The restart count as TLV encoding is included in DCD message (refer to Table 358). The BS may intentionally increment the restart count to be included in DCD message for the purpose of forcing all MSs to perform the Network Entry due to some problem at the BS or an operator's purpose.

After the BS restarts, it shall inform the MSs of its restart through the incremented restart count in DCD message. The restart count, which BS sent via DCD message, is saved in MS in order to recognize whether BS restarts or not.

Restart count is updated by every BS Restart Count TLV encoding in DCD message sent by BS. In other words, whenever MS receives DCD message, it shall compare the restart count in DCD message with the old one saved in it. If MS detects the restart count in DCD message different from old one save in MS, it shall perform Network Entry.

MOB\_NBR-ADV message shall also include the BS Restart Count TLV for neighbor BS in each DCD\_settings of DCD message. MS shall save the restart count of each neighbor BS for HO procedure. MS during HO shall compare the restart count of Target BS through DCD message with the restart count of Target BS saved in MS. As a result, if MS detects the restart of Target BS, it shall perform the Network Entry.

## **6.3.10 Ranging**

### **6.3.10.1 Downlink burst profile management**

*Insert the following sentence at beginning of the subclause*

This mechanism is not applicable to OFDMA PHY.

*Change the first paragraph as indicated:*

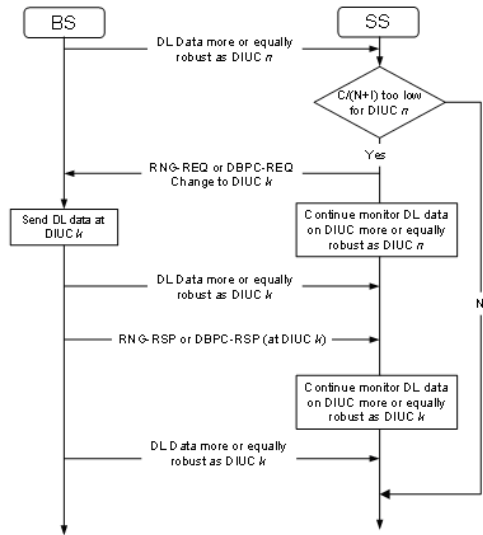
The downlink operational burst profile is determined by the BS according to the quality of the signal that is received by each SS. To reduce the volume of uplink traffic, the SS monitors the CINR and compares the average value against the allowed range of operation. This region is bounded by threshold levels. If the received CINR goes outside of the allowed operating region for the downlink operational profile, the SS requests a change to a new operational burst profile using one of two methods. In the first method the SS uses an allocated data grant to send a DBPC-REQ. In the second method the SS uses the initial ranging interval to send a RNG-REQ. The second method can only be used in context with a request to change to a more robust profile. The SS determines the optimal method. If the first method is used and the SS has been granted uplink bandwidth (a data grant allocation to the SS's Basic CID), the SS shall send a DBPC-REQ message in that allocation. The BS responds with a DBPC-RSP message. If a grant is not available the second method is used and the SS requires a more robust burst profile on the downlink, the SS shall send a RNG-REQ message in an Initial Ranging interval. With either method, the message is sent using the Basic CID of the SS. The coordination of message transmit and receipt relative to actual change of ~~modulation~~ operational burst profile is different depending upon whether an SS is transitioning to a more or less robust

burst profile. Figure 79 shows the case where an SS is transitioning to a more robust type. Figure 80 shows transition to a less robust burst profile.

*Change the second paragraph as indicated:*

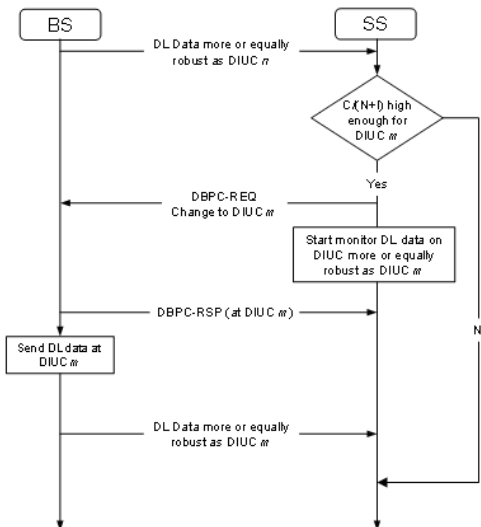
The SS applies an algorithm has full responsibility to determine its optimal burst profile in accordance with the threshold parameters established in the DCD message in accordance with Figure 81.

*Replace Figure 79 with the following figure:*



**Figure 79—Transition to a more robust operational burst profile**

*Replace Figure 80 with the following figure:*



**Figure 80—Transition to a less robust operational burst profile**

Insert new Figure 80a:

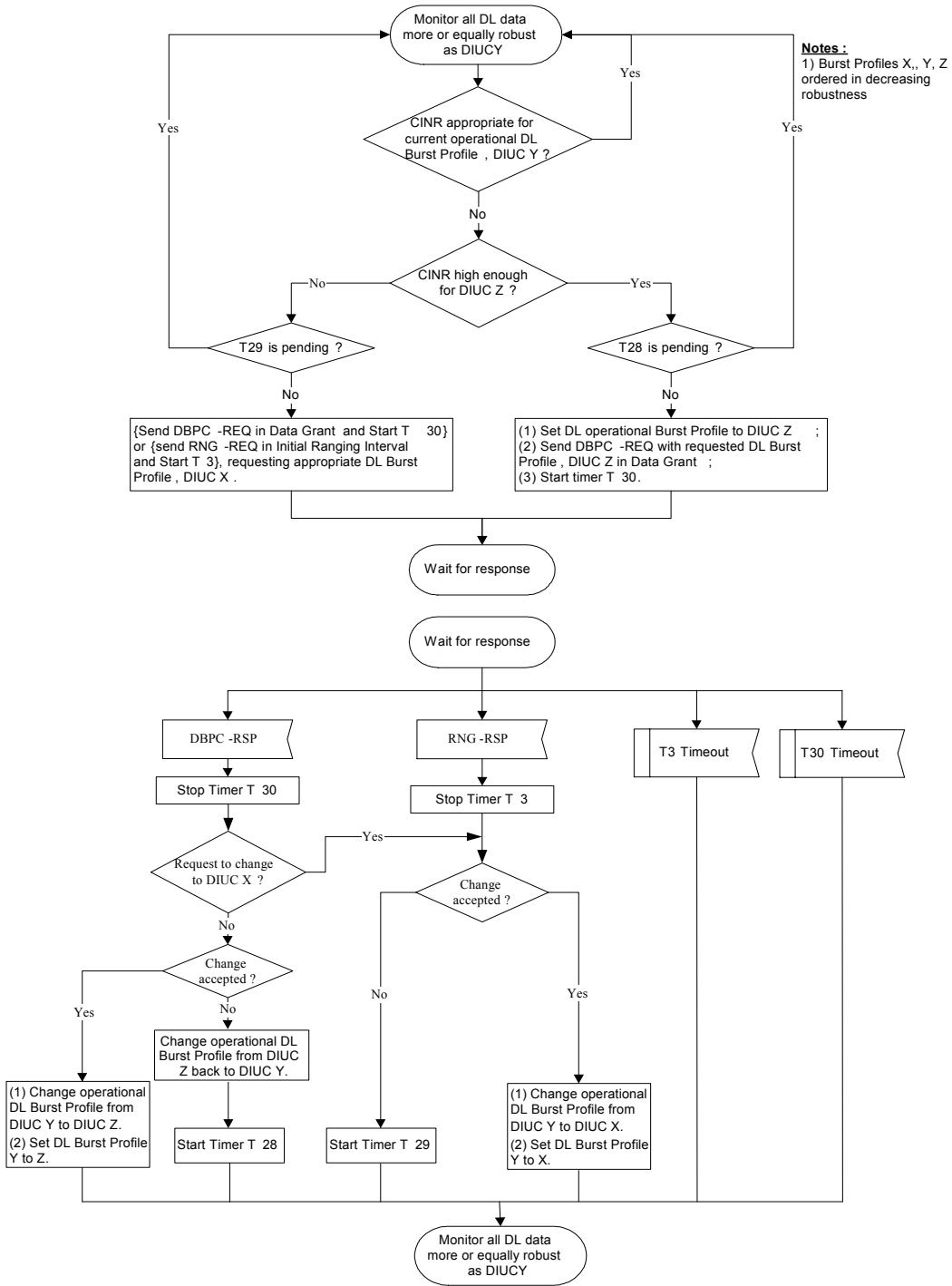


Figure 80a—State transition diagram for downlink burst profile management—SS

*Delete Figure 81.*

### **6.3.10.2 Uplink periodic ranging**

*Change the first and sixth enumerated item of the second paragraph as indicated:*

- 1) For each SS, the BS shall maintain a T27 timer. At each expiration of the timer, the BS shall grant bandwidth to the SS for an uplink transmission in the form of a data grant or an invited ranging opportunity. The timer is restarted each time a unicast grant is made to the SS. As a result, as long as the SS remains active, the BS does not specifically grant bandwidth to the SS for a ranging opportunity.
- 6) ~~The SS shall respond to each uplink bandwidth grant addressed to it. When the status of the last RNG-RSP message received is *continue*, the RNG-REQ message shall be included in the transmitted burst.~~ the SS shall not use the data grant to service its uplink connections except to transmit a RNG-REQ message. ~~When the status of the last RNG-RSP message received is *success*, the SS shall use the grant to service its pending uplink data queues. If no data is pending, the SS shall respond to the grant by transmitting a block of padded data.~~

*Insert new enumerated item to the second paragraph*

- 7) When the SS cannot apply a correction, it shall send a RNG-REQ reporting the anomaly in the next data grant or invited ranging opportunity.



Replace Figure 82 with the following figure:

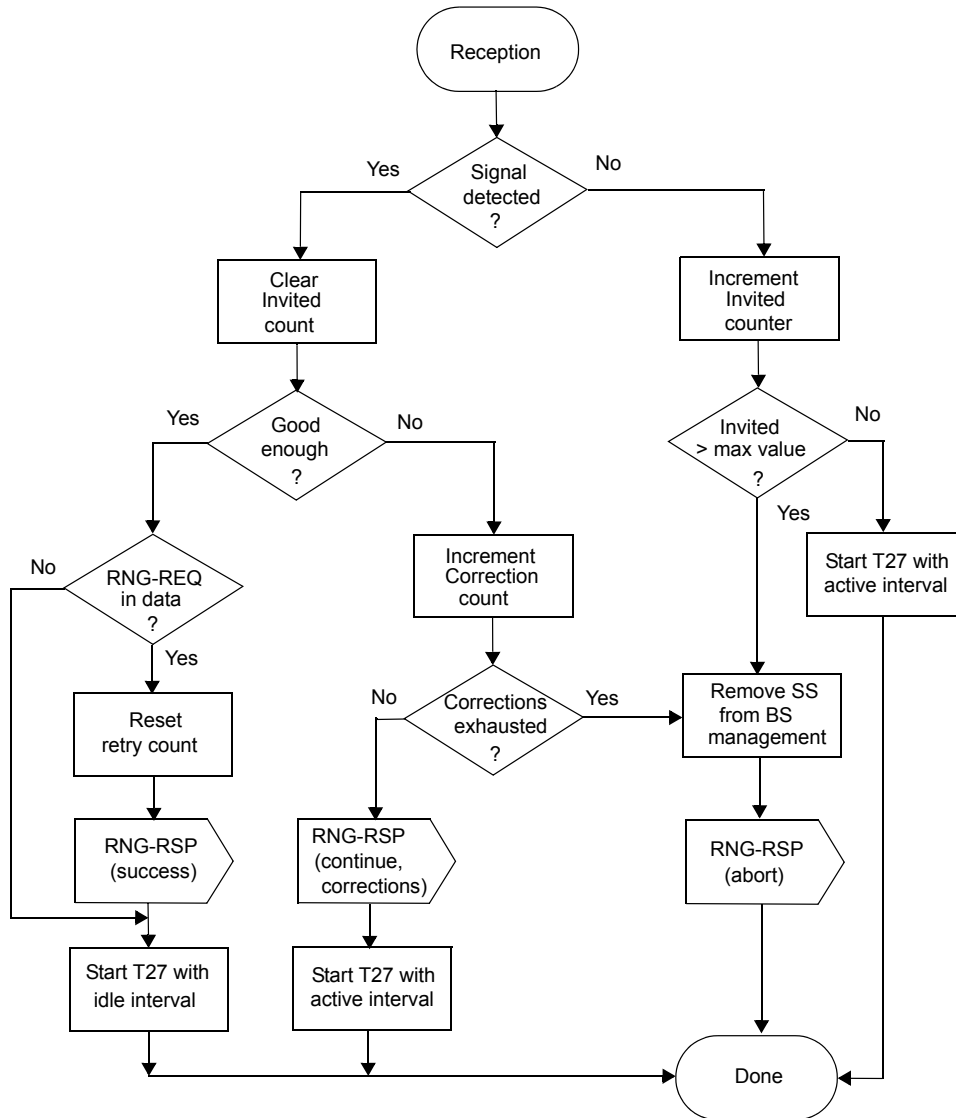


Figure 82—Periodic Ranging receiver processing—BS

Replace Figure 84 with the following figure:

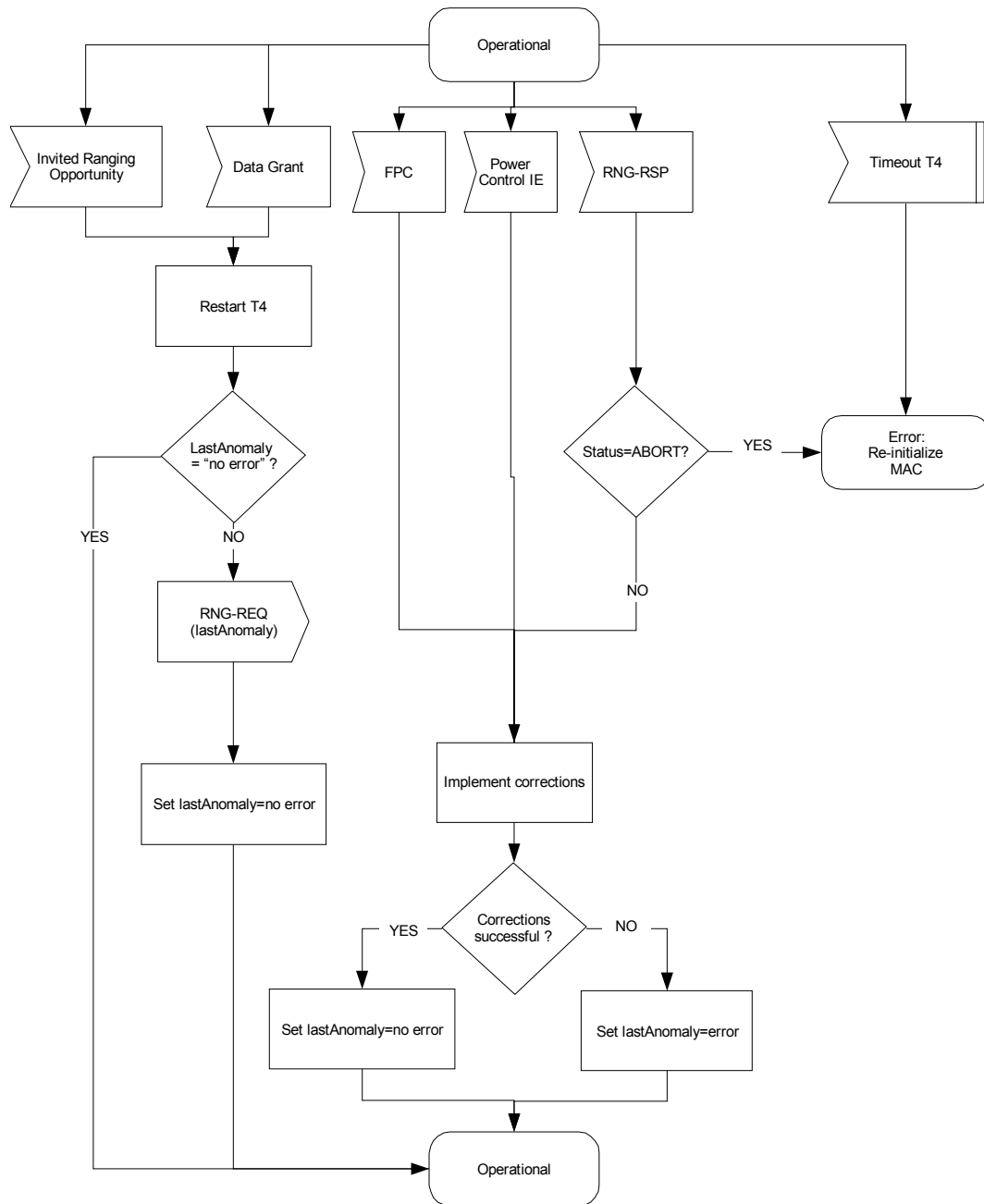


Figure 84—Periodic Ranging—SS

### 6.3.10.3 OFDMA-based ranging

Insert the following sentence at the end of the subclause:

For OFDMA PHY the allocation of ranging opportunity inside a ranging allocation is defined in 8.4.7.4.

**6.3.10.3.1 Contention-based initial ranging and automatic adjustments**

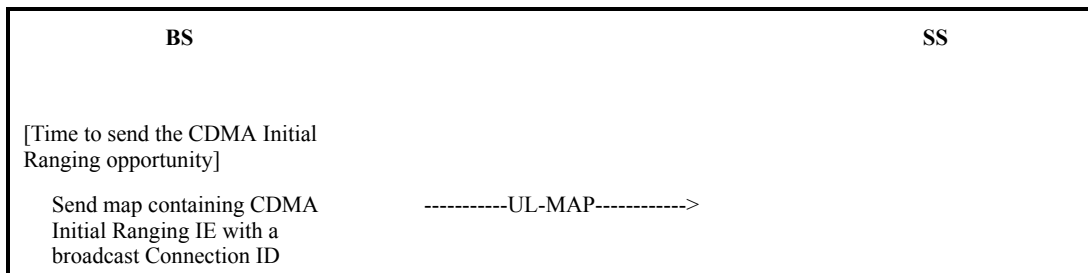
*Change the text as indicated:*

- The SS, after acquiring downlink synchronization and uplink transmission parameters, shall choose randomly a Ranging Slot (with the use of a binary truncated exponent algorithm to avoid possible re-collisions) at the time to perform the ranging, then it chooses randomly a Ranging Code (from the Initial Ranging domain) and sends it to the BS (as a CDMA code).
- The BS cannot tell which SS sent the CDMA ranging request; therefore, upon successfully receiving a CDMA Ranging Code, the BS broadcasts a Ranging Response message that advertises the received Ranging Code as well as the ranging slot (OFDMA symbol number, subchannel, etc.) where the CDMA Ranging code has been identified. This information is used by the SS that sent the CDMA ranging code to identify the Ranging Response message that corresponds to its ranging request. The Ranging Response message contains all the needed adjustment (e.g., time, power, and possibly frequency corrections) and a status notification.
- Upon receiving a Ranging Response message with continue status, the SS shall continue the ranging process as done on the first entry with ranging codes randomly chosen from the Initial Ranging domain sent on the Periodic Ranging region.
- When the BS receives an initial-ranging CDMA code that results in sending an RNG-RSP message with success status, the BS shall provide BW allocation for the SS using the CDMA\_Allocation\_IE to send an RNG-REQ message.
- Initial ranging process is over after receiving RNG-RSP message, which includes a valid basic CID (following a RNG-REQ transmission on a CDMA\_Allocation\_IE). If this RNG-RSP message includes 'continue' indication, the ranging process should be continued using the periodic ranging mechanisms.
- The timeout required for SS to wait for RNG-RSP, following or not following CDMA Allocation IE, is defined by T3.
- ~~Upon receiving a Ranging Response message with continue status, the SS shall continue the ranging process as done on the first entry with ranging codes randomly chosen from the Periodic Ranging domain.~~
- Using the OFDMA ranging mechanism, the periodic ranging timer is controlled by the SS, not the BS.

The message sequence chart (Table 121) and flow charts (Figure 85, Figure 86, Figure 86a, and Figure 87) on the following pages define the CDMA initial ranging and adjustment process that shall be followed by compliant SSs and BSs.

*Change Table 121 as indicated:*

**Table 121—CDMA initial Ranging and automatic adjustments procedure**



**Table 121—CDMA initial Ranging and automatic adjustments procedure (continued)**

BS		SS
	<-----Ranging Code----->	Transmit randomly selected Initial Ranging code in a randomly selected Ranging Slot from available Ranging Region
[Receive Ranging Code]		
Send RNG-RSP with Time and Power Corrections and original Ranging Code and Ranging Slot	-----RNG-RSP----->	
Status = Continue		Receive RNG-RSP message with Ranging Code and Ranging Slot matching sent values Adjust Time and Power parameters
[Time to send the CDMA Initial Ranging opportunity]		
Send map containing CDMA Initial Ranging IE with a broadcast Connection ID	-----UL-MAP----->	
	<-----Ranging Code----->	Transmit randomly selected <del>Periodic</del> Initial Ranging code in a randomly selected Ranging Slot from available <u>Periodic</u> Ranging Region
[Receive Ranging Code]		
Send RNG-RSP with Time and Power Corrections and original Ranging Code and Ranging Slot	-----RNG-RSP----->	
Status = Success		Receive RNG-RSP message with Ranging Code and Ranging Slot matching sent values Adjust Time and Power parameters
[Time to send the next map]		
Send map containing anonymous BW allocation with original Ranging Code and Ranging Slot	-----UL-MAP----->	
	<-----RNG-REQ----->	Transmit RNG-REQ and continue with regular Initial network entry

*Replace Figure 85 with the following figure:*

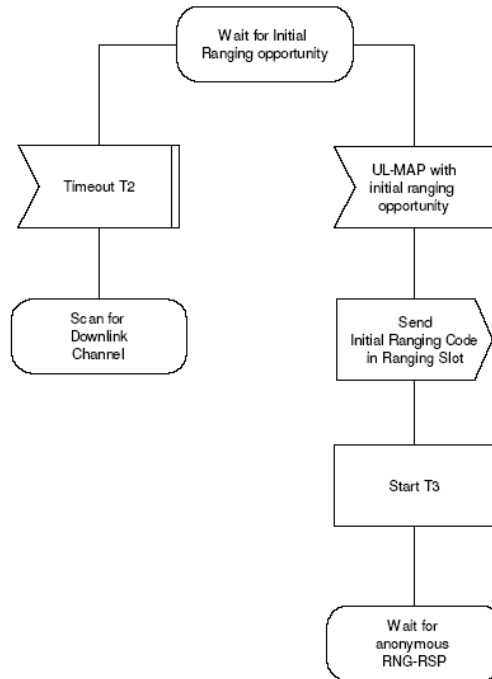


Figure 85 – CDMA Initial Ranging – SS (part 1)

Replace Figure 86 with the following figure:

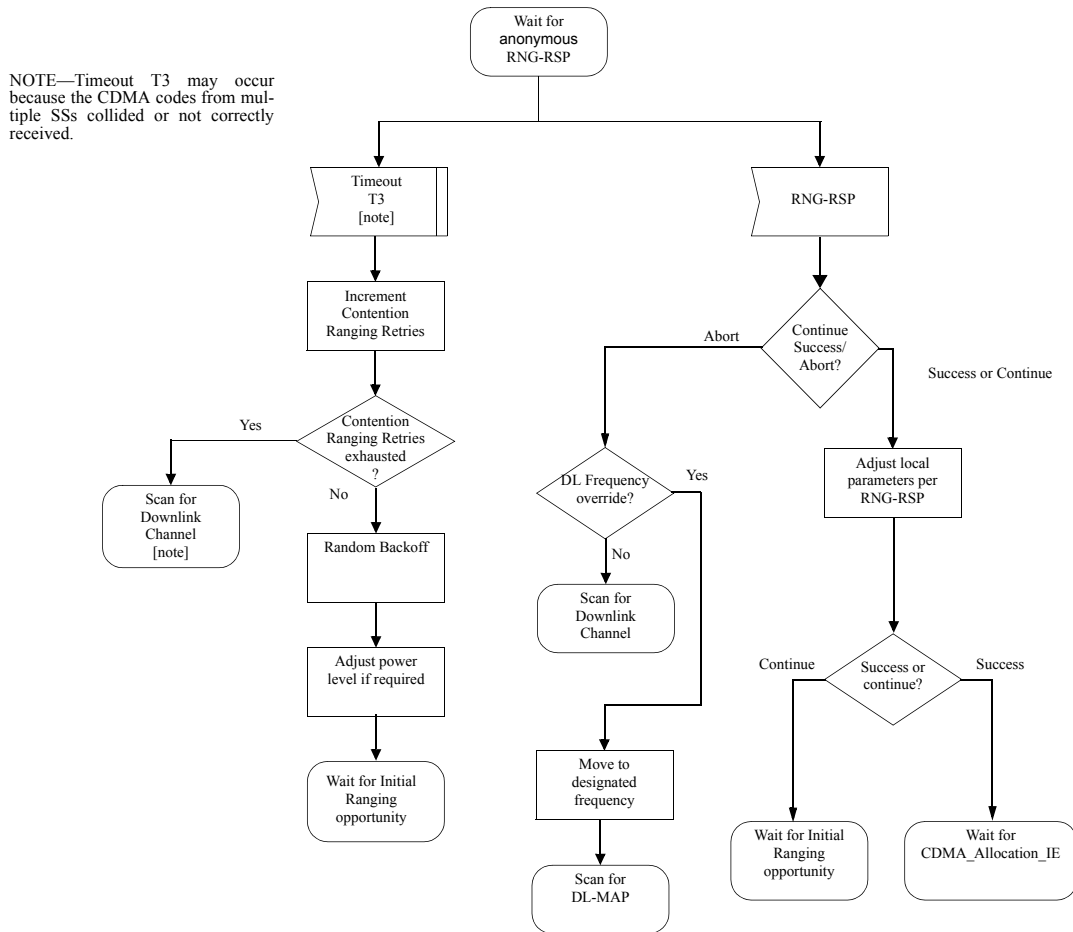


Figure 86—CDMA Initial Ranging—SS (part 2)

*Insert the following figure:*

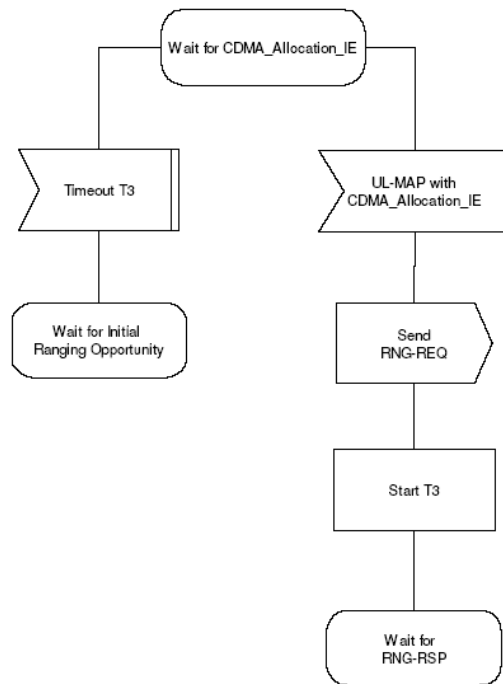
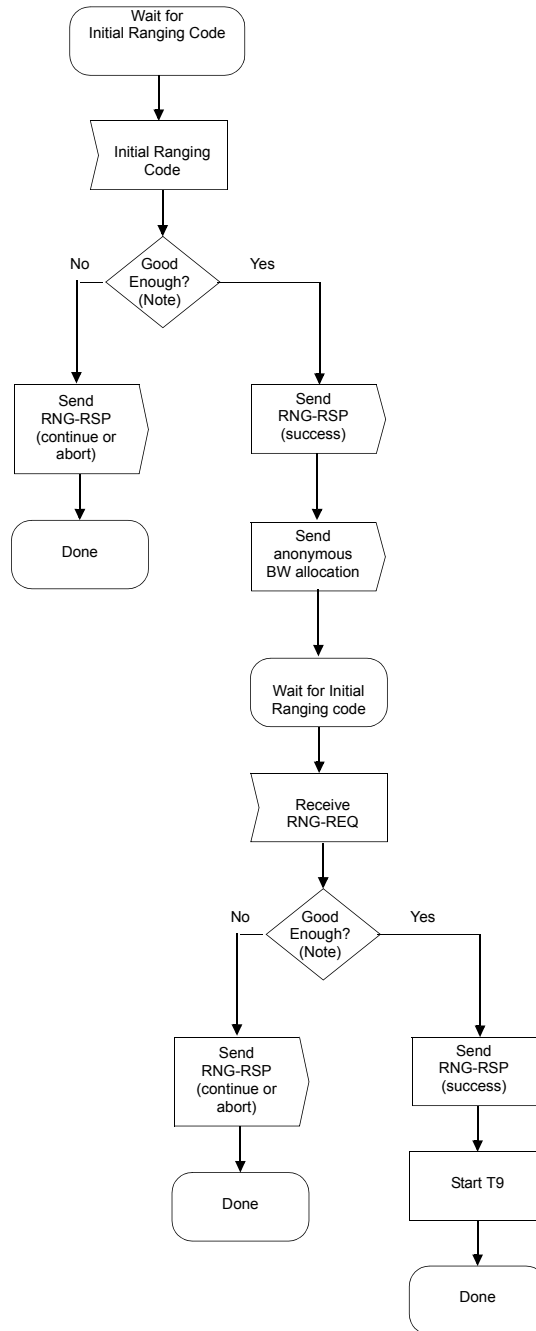


Figure 86a – CDMA Initial Ranging – SS (part 3)

Replace Figure 87 with the following figure:



NOTE—Means ranging is within the tolerable limits of the BS.

Figure 87—CDMA Initial Ranging—SS



*Change subclause 6.3.10.3.2 as indicated:*

### **6.3.10.3.2 Periodic ranging and automatic adjustments**

An SS that wishes to perform periodic ranging shall take the following steps:

- The SS, shall choose randomly a Ranging Slot (with the use of a binary truncated exponent algorithm to avoid possible re-collisions) at the time to perform the ranging, then it chooses randomly a Periodic Ranging Code (~~from the Periodic Ranging domain~~) and sends it to the BS (as a CDMA code).
- If the MS does not receive a response, the MS may send a new CDMA code at the next appropriate periodic Ranging transmission opportunity and adjust its power level up to PTX\_IR\_MAX (6.3.9.5.1).
- The BS cannot tell which SS sent the CDMA ranging request; therefore, upon successfully receiving a CDMA Periodic Ranging Code, the BS broadcasts a Ranging Response message that advertises the received Periodic Ranging Code as well as the ranging slot (OFDMA symbol number, subchannel, etc.) where the CDMA Periodic Ranging code has been identified. This information is used by the SS that sent the CDMA Periodic ranging code to identify the Ranging Response message that corresponds to its ranging request. The Ranging Response message contains all the needed adjustment (e.g., time, power, and possibly frequency corrections) and a status notification.
- Upon receiving a Ranging Response message with continue status, the SS shall continue the ranging process with further periodic ranging codes randomly chosen ~~from the Periodic Ranging domain~~.
- Using the OFDMA ranging mechanism, the periodic ranging timer is controlled by the SS, not the BS.
- The BS may send an unsolicited RNG-RSP as a response to a CDMA-based bandwidth-request or any other data transmission from the SS.

Replace Figure 90 with the following figure:

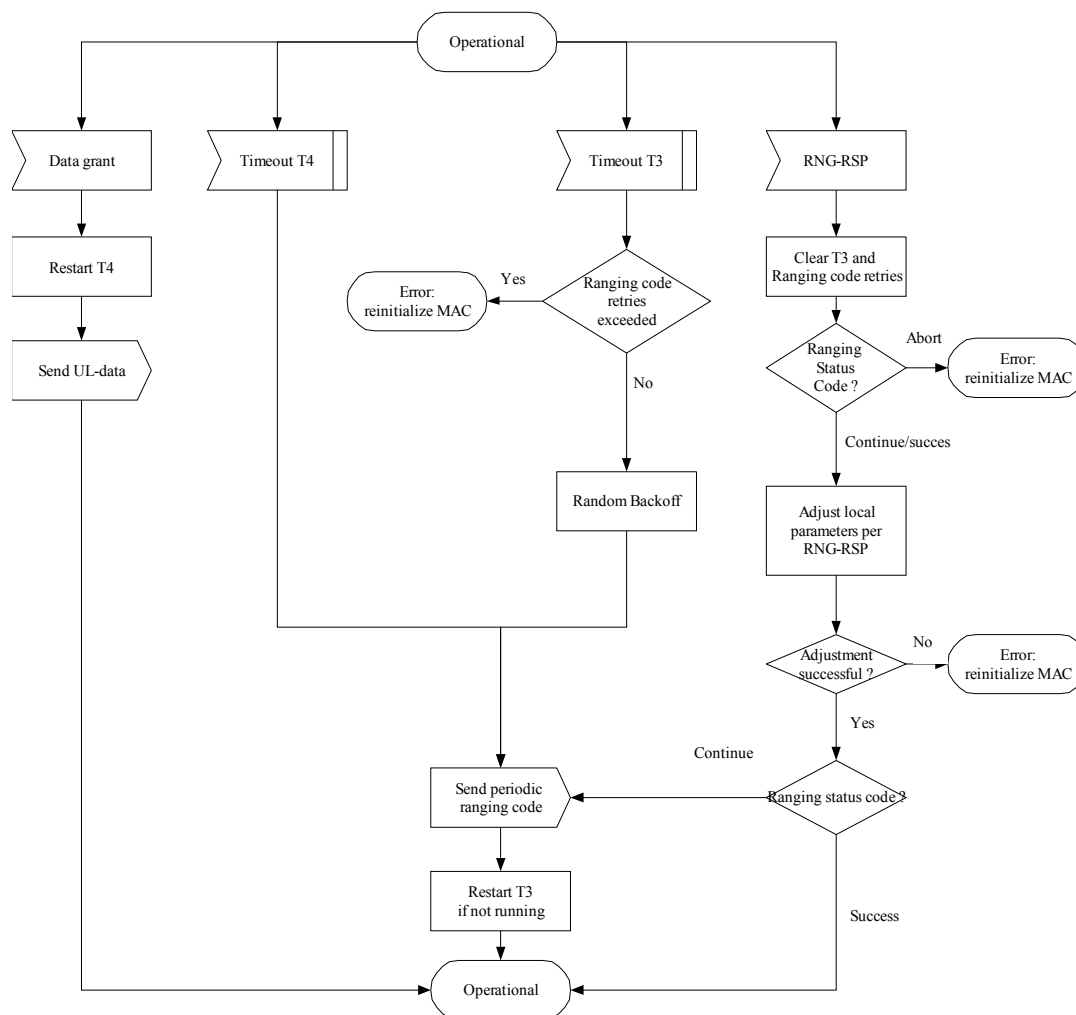


Figure 90—Periodic CDMA ranging—SS

Insert new subclause 6.3.10.3.3:

**6.3.10.3.3 CDMA handover ranging and automatic adjustment**

An MS that wishes to perform handover ranging shall take a process similar to that defined in the initial ranging section with the following modifications.

In CDMA handover ranging process, the CDMA handover ranging code is used instead of the initial ranging code. The code is selected from the handover-ranging domain as defined in 8.4.7.3.

Alternatively, if the BS is pre-notified for the upcoming handover MS, it may provide BW allocation information to the MS using Fast\_Ranging\_IE to send an RNG-REQ message.

**6.3.13 Establishment of multicast and broadcast transport connections**

*Change the subclause title and the first paragraph as indicated:*

The BS may establish a downlink multicast or broadcast service by creating a connection with each SS to be associated with the service. Any available traffic CID value may be used for the service (i.e., there are no dedicated CIDs for multicast transport connections). To ensure proper multicast operation, the CID used for the service is the same for all SSs on the same channel that participate in the connection. The SSs need not be aware that the connection is a multicast or broadcast transport connection. The data transmitted on the connection with the given CID shall be received and processed by the MAC of each involved SS. Thus, each multicast or broadcast SDU is transmitted only once per BS channel. Since a multicast or broadcast transport connection is associated with a service flow, it is associated with the QoS and traffic parameters for that service flow.

**6.3.14 QoS****6.3.14.1 Theory of operation**

*Change the third paragraph as indicated:*

The principal mechanism for providing QoS is to associate packets traversing the MAC interface into a service flow as identified by the transport CID. A service flow is a unidirectional flow of packets that is provided a particular QoS. The SS and BS provide this QoS according to the QoS Parameter Set defined for the service flow.

**6.3.14.2 Service flows**

*Change items (a) and (b) of the second paragraph as indicated:*

- a) *Service Flow ID:* An SFID is assigned to each existing service flow. The SFID serves as the principal identifier for the service flow in the network between a BS and an SS. A service flow has at least an SFID and an associated direction.
- b) *CID:* The connection ID of the transport connection Mapping to an SFID that exists only when the service flow is connection has an admitted or active service flow. The relationship between SFID and transport CID, when present, is unique. An SFID shall never be associated with more than one transport CID, and a transport CID shall never be associated with more than one SFID.

*Change footnote 14 as indicated:*

To say that QoS Parameter Set A is a subset of QoS Parameter Set B the following shall be true for all QoS Parameters in A and B:

- if (a smaller QoS parameter value indicates less resources, e.g., Maximum Traffic Rate)  
A is a subset of B if the parameter in A is less than or equal to the same parameter in B
- if (a larger QoS parameter value indicates less resources, e.g., Tolerated Grant Jitter)  
A is a subset of B if the parameter in A is greater than or equal to the same parameter in B
- if (the QoS parameter is not quantitative, e.g., ~~Service Flow Scheduling Type~~)  
A is a subset of B if the parameter in A is equal to the same parameter in B

**6.3.14.3 Object model**

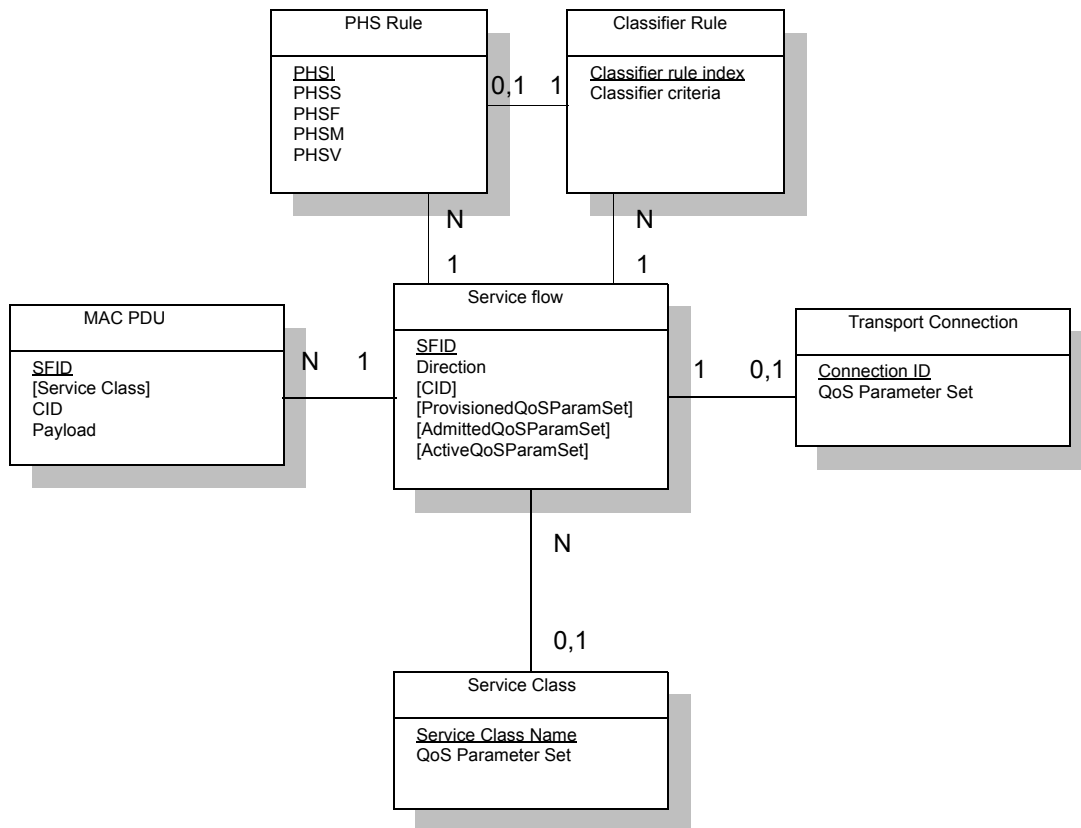
*Change the subclause as indicated:*

The major objects of the architecture are represented by named rectangles in Figure 95. Each object has a number of attributes; the attribute names that uniquely identify it are underlined. Optional attributes are denoted with brackets. The relationship between the number of objects is marked at each end of the association line between the objects. For example, a service flow may be associated with from 0 to *N* (many) PDUs, but a PDU is associated with exactly one service flow. The service flow is the central concept of the MAC protocol. It is uniquely identified by a 32-bit (SFID). Service flows may be in either the uplink or downlink direction. There is a one-to-one mapping between admitted and active service flows (32-bit SFID) and transport connections (16-bit CID). Admitted and active service flows are mapped to a 16-bit CID.

Outgoing user data is submitted to the MAC SAP by a CS process for transmission on the MAC interface. The information delivered to the MAC SAP includes the CID identifying the transport connection across which the information is delivered. The service flow for the connection is mapped to MAC transport connection identified by the CID.

A Classifier Rule uniquely maps a packet to its transport connection. The Classifier Rule is associated to zero or one PHS Rules. When creating a PHS Rule the associated Classifier Rule Index is used as a reference. A PHS Rule is associated to a single service flow. PHS Rules associated to the same service flow are uniquely identified by their PHSI. The Classifier Rule uniquely maps packets to its associated PHS Rule.

*Replace Figure 95 with the following figure:*



**Figure 95—Theory of Operation Object Model**

### 6.3.14.4 Service classes

*Insert new subclause 6.3.14.4.1:*

#### 6.3.14.4.1 Global service flows

Mobile networks require common definitions of service class names and associated AuthorizedQoSParamSets in order to facilitate operation across a distributed topology. Global service class names shall be supported to enable operation in this context.

In operation, global service class names are employed as a baseline convention for communicating AuthorizedQoSParamSet or AdmittedQoSParamSet. Global service class name is similar in function to service class name except that 1) Global service class name use may not be modified by a BS, 2) Global service class names remain consistent among all BS, and 3) Global service class names are a rules-based naming system whereby the global service class name itself contains referential QoS Parameter codes. In practice, global service class names are intended to be accompanied by extending or modifying QoS Param Set defining parameters, as needed, to provide a complete and expedited method for transferring Authorized- or AdmittedQoSParamSet information.

**Global service class name**—A rules-based, composite name parsed in eight information fields of format ISBRLSPTR, elements reference extensible look-up tables. Each information field placeholder must be an expressed value obtained from Table 124a, as part of the name, and may not be omitted.

**Table 124a—Global service flow class name information field parameters**

Position	Name	Size (bits)	Value
I	Uplink/Downlink indicator	1	0 or 1: 0=uplink; 1=downlink
S	Maximum sustained traffic rate	6	Extensible look-up Table (value 0b111111 indicates TLV to follow)
T	Traffic indication preference	1	0 or 1: 0=No traffic indication; 1=Traffic indication
B	Maximum traffic burst	6	Extensible look-up Table (value 0b111111 indicates TLV to follow)
R	Minimum reserved traffic rate	6	Extensible look-up Table (value 0b111111 indicates TLV to follow)
L	Maximum latency	6	Extensible look-up Table 124c (value 0b111111 indicates TLV to follow)
S	Fixed-length versus variable-length SDU indicator	1	0 or 1: 0=variable length; 1=fixed length
P	Paging preference	1	0 or 1: 0 = No paging generation 1 = Paging generation
R	<i>Reserved</i>	4	Shall be set to 0b0000

**Global service flow class name parameters**

**Uplink/Downlink indicator**

The Uplink/Downlink indicator parameter identifies the defined service flow direction from the originating entity.

**Maximum sustained traffic rate**

A parameter that defines the peak information rate of the service. The rate is expressed in bits per second and pertains to the service data units (SDUs) at the input to the system. Explicitly, this parameter does not include transport, protocol, or network overhead such as MAC headers or CRCs, or non-payload session maintenance overhead like SIP, MGCP, H.323 administration, etc. This parameter does not limit the instantaneous rate of the service since this is governed by the physical attributes of the ingress port. However, at the destination network interface in the uplink direction, the service shall be policed to conform to this parameter, on the average, over time. On the network in the downlink direction, it may be assumed that the service was already policed at the ingress to the network. If this parameter is set to zero, then there is no explicitly mandated maximum rate. The maximum sustained traffic rate field specifies only a bound, not a guarantee that the rate is available. The algorithm for policing this parameter is left to vendor differentiation and is outside the scope of the standard.

**Table 124b—Traffic rate and burst values**

6-bit Code (binary)	Traffic rate (bits/s)	Burst values (bits)	6-bit Code (binary)	Traffic rate (bits/s)	Burst values (bits)
000000	No requirement	No requirement	010000	192000	192000
000001	1200	1200	010001	256000	256000
000010	2400	2400	010010	384000	384000
000011	4800	4800	010011	512000	512000
000100	9600	9600	010100	768000	768000
000101	14400	14400	010101	1024000	1024000
000110	19200	19200	010110	1536000	1536000
000111	24000	24000	010111	1921000	1921000
001000	26400	26400	011000-111110	<i>Reserved</i>	<i>Reserved</i>
001001	28000	28000			
001010	36000	36000	111111	TLV follows	TLV follows
001011	44000	44000			
001100	48000	48000			
001101	56000	56000			
001110	64000	64000			
001111	128000	128000			

**Traffic Indication Preference**

This parameter is a single bit indicator of an MS's preference for the reception of Traffic Indication messages during sleep mode. When set it indicates that the BS may present Traffic

Indication messages to the MS when data SDUs bound for the MS are present while the MS is in sleep mode.

**Maximum traffic burst**

The Maximum traffic burst parameter defines the maximum burst size that must be accommodated for the service. Since the physical speed of ingress/egress ports, any air interface, and the backhaul will in general be greater than the maximum sustained traffic rate parameter for a service, this parameter describes the maximum continuous burst the system should accommodate for the service assuming the service is not currently using any of its available resources. Maximum traffic burst set to zero shall mean no Maximum traffic burst reservation requirement.

**Minimum reserved traffic rate**

The Minimum reserved traffic rate parameter specifies the minimum rate, in bits per second, reserved for this service flow. The BS shall be able to satisfy bandwidth requests for a connection up to its minimum reserved traffic rate. If less bandwidth than its Minimum reserved traffic rate is requested for a connection, the BS may reallocate the excess reserved bandwidth for other purposes. The value of this parameter is calculated excluding MAC overhead. Minimum reserved traffic set to zero shall mean no minimum reserved traffic rate requirement.

**Maximum latency**

The value of this parameter specifies the maximum interval between the reception of a packet at CS of BS or SS and the arrival of the packet to the peer device. If defined, this parameter represents a service commitment and shall be guaranteed. A value of zero for Maximum latency shall be interpreted as no commitment.

**Table 124c—Maximum latency values**

6-bit Code (binary)	Value (ms)	6-bit Code (binary)	Value (ms)	6-bit Code (binary)	Value (ms)
000000	No requirement	001000	50	010000	10000
000001	1	001001	100	010001 - 111110	<i>Reserved</i>
000010	2	001010	150		
000011	5	001011	200	111111	TLV follows
000100	10	001100	500		
000101	20	001101	1000		
000110	30	001110	2000		
000111	40	001111	5000		

**SDU indicator**

The value of this parameter specifies whether the SDUs on the service flow are fixed-length or variable-length.

**Paging Preference**

This parameter is a single bit indicator of an MS’s preference for the reception of paging advisory messages during idle mode. When set, it indicates that the BS may present paging advisory messages or other indicative messages to the MS when data SDUs bound for the MS are present while the MS is in Idle Mode.

### 6.3.14.7 Service Flow Creation

#### 6.3.14.7.1 Dynamic service flow creation

##### 6.3.14.7.1.1 Dynamic service flow creation—SS-initiated

*Change the third paragraph as indicated:*

A DSA-REQ from an SS contains a ~~service flow reference~~ and QoS Parameter set (marked either for admission-only or for admission and activation).

### 6.3.14.9 Service flow management

#### 6.3.14.9.2 Dynamic Service Flow state transitions

*Change the first paragraph as indicated:*

The Dynamic Service Flow state transition diagram (Figure 99) is the top-level state diagram and controls the general service flow state. As needed, it creates transactions, each represented by a Transaction state transition diagram, to provide the DSA, DSC, and DSD signaling. Each Transaction state transition diagram communicates only with the parent Dynamic Service Flow state transition diagram. The top-level state transition diagram filters DSx messages and passes them to the appropriate transaction based on SFID, ~~service flow reference number~~, and Transaction ID.

*Change Figure 101 on the transition line between “Holding Down” to “End” as indicated:*

(Timeout T~~8~~10 / DSA Ended)

(SF-Change~~Delete~~-Remote / DSA Ended)

#### 6.3.14.9.3 DSA

##### 6.3.14.9.3.1 SS-initiated DSA

*Change the following text in Table 125:*

If ActiveQoSParamSet is non-null, Enable transmission ~~and~~ or reception of data on new service flow.

##### 6.3.14.9.3.3 DSA state transition diagrams

*In Figure 111, change the box of “[BS only] DSX-RVD” to a “send” symbol.*

#### 6.3.14.9.4 DSC

*Change the first paragraph as indicated:*

The DSC set of messages is used to modify the flow parameters associated with a service flow. Specifically, DSC can modify the service flow Specification. Implementation of dynamic service change initiated by BS is mandatory. Implementation of dynamic service change initiated by SS is optional.

*Change the eighth paragraph as indicated:*

Any service flow can be deactivated with a DSC command by sending a DSC-REQ message, referencing the SFID, and including a null ActiveQoSParamSet. ~~However, if a Basic, Primary Management, or~~



~~Secondary Management Connection of an SS is deactivated, that SS is deregistered and shall re-register. Therefore, care should be taken before deactivating such service flows. If a service flow that was provisioned is deactivated, the provisioning information for that service flow shall be maintained until the service flow is reactivated.~~

***Change the eleventh paragraph as indicated:***

The following service flow parameters may not be changed, and shall not be present in the DSC-REQ or DSC-RSP messages:

- Service Flow Scheduling Type
- Request/Transmission Policy
- Convergence Sublayer Specification
- Fixed-Length versus Variable-Length SDU Indicator
- SDU Size
- ATM switching (ATM Services only)
- ARQ parameters, in accordance with individual TLV definitions
- FSN Size

#### **6.3.14.9.4.3 DSC state transition diagrams**

*In Figure 120, change the box of “[BS only] DSX-RVD” to a “send” symbol.*

*In Figure 121, Change the fourth box from “SF Delete-Remote” to “SF Delete-Remote, SF Change-Local”.*

*In Figure 122, Change first box from “SF Changed, SF Deleted, SF Delete-Remote” to “SF Changed, SF Deleted, SF Delete-Remote, SF Change-Local”.*

*In Figure 123, Change first Box from “SF Deleted, SF Delete-Remote” to “SF Deleted, SF Delete-Remote, SF Change-Local”.*

#### **6.3.14.9.5 Connection release**

*Change the subclause as indicated:*

Any service flow can be deleted with the DSD messages. When a service flow is deleted, all resources associated with it are released. If a service flow for a provisioned service is deleted, the ability to re-establish the service flow for that service is network management dependent. Therefore, care should be taken before deleting such service flows. ~~However, the deletion of a provisioned service flow shall not cause an SS to reinitialize.~~ Implementation of dynamic Service deletion initiated by BS is mandatory. Implementation of dynamic service deletion initiated by SS is optional

#### **6.3.15 DFS for license exempt operation-Procedures for shared frequency band usage**

*Change the title of 6.3.15 and the subclauses 6.3.15.1 to 6.3.15.7 as indicated:*

##### **6.3.15.1 Introduction**

Procedures are defined in this subclause that may be used when the IEEE 802.16 system is sharing a frequency band with another system or service, either for the reduction of interference to and from other systems, to facilitate coexistence of systems or for other reasons. These procedures generally involve mechanisms to facilitate the detection of other users, and the avoidance and prevention of harmful interference into other users. Included within these procedures for certain sharing scenarios, regulatory

requirements specify that DFS (as defined by ITU-R in M.1652 [new reference B11]) shall be used to facilitate sharing with specific spectrum users identified by regulation. A specific spectrum user is a user from a service specifically identified in regulation as requiring protection from harmful interference. In the case DFS is mandated by regulatory requirements, then it shall be implemented according to this specification.

~~DFS is mandatory for license-exempt operation. Systems should detect and avoid primary users. Further, the use of a channel selection algorithms is may be required, which results in uniform channel spreading across a minimum number of channels. This specification is intended to be compliant with the regulatory requirements set forth in such as ERC/DEC/(99)23 [B10]. The timing and threshold parameters used for DFS are specified by each regulatory administration.~~

The ~~DFS~~ procedures specified in this subclause provide for:

- Testing channels for primary other users including specific spectrum users (6.3.15.2)
- Discontinuing operations after detecting primary other users including specific spectrum users (6.3.15.3)
- Detecting primary other users including specific spectrum users (6.3.15.4)
- Scheduling for channel testing (6.3.15.5).
- Requesting and reporting of measurements (6.3.15.6)
- Selecting and advertising a new channel (6.3.15.7)

*Change the title of subclause 6.3.15.2 as indicated:*

#### **6.3.15.2 Testing channels for primary other users (including specific spectrum users)**

*Change the subclause as indicated:*

A BS or SS implementing these procedures shall not use a channel that it knows contains primary other users or has not been tested recently for the presence of primary other users. A BS shall test for the presence of primary other users based on timing parameters and values that may be set locally, or in the case of DFS and the detection of specific spectrum users, they may be defined in regulation. Timing parameters include: ~~for at least the following:~~

- **Startup Test Period** before operating in a new channel if the channel has not been tested for primary other users for at least **Startup Test Period** during the last **Startup Test Valid**.
- **Startup Test Period** before operating in a new channel if a channel was previously determined to contain primary other users during the last **Startup Test Valid**.
- **Operating Test Period** (where the period is only accumulated during testing) of each **Operating Test Cycle period** while operating in a channel. Testing may occur in quiet periods or during normal operation.

An SS may start operating in a new channel without following the above start-up testing procedures if:

- The SS moves to the channel as a result of the receipt of a Channel Switch Announcement from the BS.
- The SS is initializing with a BS that is not currently advertising, using the Channel Switch Announcement that it is about to move to a new channel.

A BS may start operating in a new channel without following the above start-up testing procedures if it has learned from another BS device by means outside the scope of this standard that it is usable.

*Change the title of subclause 6.3.15.3 as indicated:*

### 6.3.15.3 Discontinuing operations after detecting primary specific spectrum users

*Change the subclause as indicated:*

If a BS or an SS is operating in a channel and detects primary specific spectrum users, ~~which interference might be caused in the channel,~~ it shall discontinue any transmission of the following:

- MAC PDUs carrying data within **Max Data Operations Period**.
- MAC PDUs carrying MAC Management messages within **Management Operations Period**.

The values of the above parameters may be set locally, or in the case of DFS they may be defined in regulation.

*Change the title of subclause 6.3.15.4 as indicated:*

### 6.3.15.4 Detecting primary specific spectrum users

*Change the subclause as indicated:*

Each BS and SS shall use a method to detect primary specific spectrum users operating in a channel that satisfies the regulatory requirements, where applicable. The particular method used to perform the ~~primary user~~ detection is outside the scope of this ~~specification~~ standard.

### 6.3.15.5 Scheduling for channel testing

*Change the subclause as indicated:*

A BS may measure one or more channels itself and may request any SS to measure one or more channels on its behalf, either in a quiet period or during normal operation.

To request the SSs to measure one channel, the BS shall include in the DL-MAP a ~~Report Channel~~ Channel Measurement IE as specified in 8.3.6.2.3. The BS that requests the SSs to perform a measurement shall not transmit MAC PDUs to any SS during the measurement interval. If the channel measured is the operational channel, the BS shall not schedule any uplink transmissions from SSs to take place during the measurement period.

Upon receiving a DL-MAP with the ~~DFS~~ Channel Measurement IE, an SS shall start to measure the indicated channel no later than **Max. Channel Switch Time** after the start of the measurement period. An SS may stop the measurement no sooner than **Max. Channel Switch Time** before the expected start of the next frame or the next scheduled uplink transmission (of any SS). If the channel to be measured is the operating channel, **Max. Channel Switch Time** shall be equal to the value of RTG, as specified in Table 358. ~~Max. Channel Switch Time shall not exceed 2 ms, or in the case of DFS Max. Channel Switch Time may be defined in regulation.~~

### 6.3.15.6 Requesting and reporting of measurements

*Change the subclause as indicated:*

The SS shall, for each measured channel, keep track of the following information:

- Frame Number of the frame during which the first measurement was made
- Accumulated time measured

- Existence of a ~~Primary User~~ specific spectrum user on the channel
- Whether a WirelessHUMAN using the same PHY system was detected on the measured channel
- Whether unknown transmissions [such as radio local area network (RLAN) transmissions] were detected on the channel

The BS may request a measurement report by sending a REP-REQ message. This is typically done after the aggregated measurement time for one or more channels exceeds the regulatory required measurement time. Upon receiving a REP-REQ the SS shall reply with a REP-RSP message and reset its measurement counters for each channel on which it reported.

If the SS detects a ~~primary~~ specific spectrum user on the channel it is operating during a measurement interval or during normal operation it shall immediately cease to send any user data if so mandated by regulatory requirements and send at the earliest possible opportunity an unsolicited REP-RSP. The BS shall provide transmission opportunities for sending an unsolicited REP-RSP frequently enough to meet regulatory requirements, where applicable. The SS may also send, in an unsolicited fashion, a REP-RSP when ~~non-primary~~ other user interference is detected above a threshold value.

### 6.3.15.7 Selecting and advertising a new channel

*Change the second paragraph as indicated:*

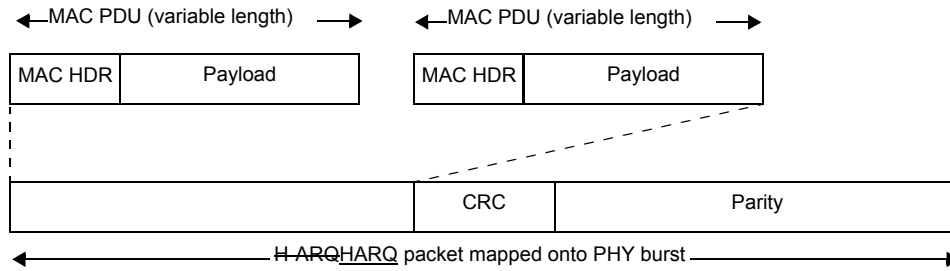
A BS may use a variety of information, including information learned during SS initialization and information gathered from measurements undertaken by the BS and the SSs, to assist in the selection of the new channel. The algorithm to choose a new channel is not standardized but in the case of DFS shall satisfy any regulatory requirements, including uniform spreading rules and channel testing rules. If a BS would like to move to a new channel, a channel supported by all SSs in the sector should be selected.

*Change 6.3.17 as indicated:*

### 6.3.17 MAC support for ~~H-ARQ~~ HARQ

Hybrid automatic repeat request (~~H-ARQ~~HARQ) scheme is an optional part of the MAC ~~and can be enabled on a per terminal basis~~. ~~H-ARQ~~HARQ may be supported only for the OFDMA PHY. ~~The per terminal H-ARQ~~HARQ and associated parameters shall be specified and negotiated using SBC-REQ/RSP messages during initialization network entry or re-entry procedure. The utilization of HARQ is on a per-connection basis, that is, it can be enabled on a per CID basis by using the DSA/DSC messages. Two implementations of HARQ are supported: 1) per-terminal, that is, HARQ is enabled for all active CIDs for a terminal, and 2) per-connection, that is, it can be enabled on a per CID basis by using the DSA/DSC messages. The two implementation methods shall not be employed simultaneously on any terminal. If HARQ is supported, SS shall support per-terminal implementation. If HARQ is supported, MS shall support per-connection implementation. A burst cannot have a mixture of ~~H-ARQ~~HARQ and non-~~H-ARQ~~HARQ traffic.

One or more MAC PDUs can be concatenated and an ~~H-ARQ~~HARQ packet formed by adding a CRC to the PHY burst. Figure 130 shows how the ~~H-ARQ~~HARQ encoder packet is constructed.



**Figure 130—Construction of HARQ encoder packet**

Each H-ARQ packet is encoded according to the PHY specification, and four subpackets are generated from the encoded result. A subpacket identifier (SPID) is used to distinguish the four subpackets. In case of downlink communication, a BS can send one of the subpackets in a burst transmission. Because of the redundancy among the subpackets, SS can correctly decode the original encoder packet even before it receives all four subpackets. Whenever receiving the first subpacket, the SS attempts to decode the original encoder packet from it. If it succeeds, the SS sends an ACK to the BS, so that the BS stops sending additional subpackets of the encoder packet. Otherwise, the SS sends a NAK, which causes the BS to transmit one subpacket selected from the four. These procedures go on until the SS successfully decodes the encoder packet. When the SS receives more than one subpacket, it tries to decode the encoder packet from ever-received subpackets.

The rule of subpacket transmission is as follows,

- 1) At the first transmission, BS shall send the subpacket labeled '00'.
- 2) BS may send one among subpackets labeled '00', '01', '10', or '11' in any order.
- 3) BS can send more than one copy of any subpacket, and can omit any subpacket except the subpacket labeled '00'.

In order to specify the start of a new transmission, one-bit H-ARQ HARQ identifier sequence number (AI\_SN) is toggled on every successful transmission of an encoder packet on the same H-ARQ HARQ channel. If the AI\_SN changes, the receiver treats the corresponding subpacket as a subpacket belongs to a new encoder packet, and discards ever-received subpackets with the same ARQ identifier.

The H-ARQ HARQ scheme is basically a stop-and-wait protocol. The ACK is sent by the SS after a fixed delay (synchronous ACK) defined by H-ARQ HARQ DL ACK delay offset for DL burst, which is specified in DLCD message. Timing of retransmission, however, is flexible and corresponds to the asynchronous part of the H-ARQ HARQ. The ACK/NAK is sent by the BS using the H-ARQ HARQ Bitmap IE, and sent by an SS using the fast feedback UL subchannel.

The H-ARQ HARQ scheme supports multiple H-ARQ HARQ channels per a connection, each of which may have an encoder packet transaction pending. The number of H-ARQ HARQ channels in use per connection is determined through DSA-REQ/DSA-RSP handshake, or REG-REQ/REG-RSP handshake by BS. The total number of HARQ channels in use per terminal is determined through capability negotiation using SBC-REQ/SBC-RSP handshake. These HARQ channels are distinguished by an H-ARQ HARQ channel identifier (ACID). The ACID for any subpackets can be uniquely identified by the control information carried in the MAPs.

H-ARQ HARQ can be used to mitigate the effect of channel and interference fluctuation. H-ARQ HARQ renders performance improvement due to SNR gain and time diversity achieved by combining previously erroneously decoded packet and retransmitted packet, and due to additional coding gain by IR (Incremental Redundancy).

HARQ is enabled on a CID basis.

To deal with ordering implication of HARQ, each connection may enable ARQ or PDU SN mechanisms on top of the enabled HARQ connection.

Time stamp of first HARQ burst transmission is used as the time relevance for all MAC specific Management messages and subheaders (such as BW requests, Fast feedback, ARQ feedbacks etc.) that have been transmitted in this burst.

*Change 6.3.17.1 as indicated:*

### **6.3.17.1 Subpacket generation**

Two main variants of HARQ are supported—Chase Combining and Incremental Redundancy (IR). SS may support IR. MS may support either Chase Combining or IR. For IR, the PHY layer will encode the HARQ packet generating several versions of encoded subpackets. Each subpacket shall be uniquely identified using a subpacket identifier (SPID). For Chase Combining, the PHY layer shall encode the HARQ packet generating only one version of the encoded packet. As a result, no SPID is required for Chase Combining.

For downlink HARQ operation, the BS will send a version of the encoded HARQ packet. The SS will attempt to decode the encoded packet on this first HARQ attempt. If the decoding succeeds, the SS will send an ACK to the BS. If the decoding fails, the SS will send a NAK to the BS. In response, the BS will send another HARQ attempt. The BS may continue to send HARQ attempts until the SS successfully decodes the packet and sends an acknowledgement.

For IR, each HARQ attempt may have a uniquely encoded subpacket. The rule of subpacket transmission is as follows:

- 1) At the first transmission, BS the transmitting side shall send the subpacket labeled 0b00.
- 2) BS the transmitting side may send one among subpackets labeled 0b00, 0b01, 0b10, or 0b11 in any order.
- 3) BS the transmitting side can send more than one copy of any subpacket, and can omit any subpacket except the subpacket labeled 0b00.

In order to specify the start of a new transmission, one-bit HARQ identifier sequence number (AI\_SN) is toggled on every successful transmission of an encoder packet HARQ retransmission attempt on the same HARQ channel. If the AI\_SN changes, the receiver treats the corresponding subpacket as a subpacket belongs HARQ attempt as belonging to a new encoder packet, and discards ~~ever received subpackets~~ previous HARQ attempt with the same ARQ identifier.

The HARQ HARQ scheme is basically a stop-and-wait protocol where the retransmissions are only sent after receiving a NACK signal for the previous transmission or the ACK has not been received within the duration defined by HARQ ACK Delay for UL burst (i.e., HARQ data sent by SS) or by HARQ ACK delay for DL burst (i.e., HARQ data sent by BS). As acknowledgement of DL HARQ burst sent by the BS, the ACK is sent by the SS after a fixed delay (synchronous ACK) defined by HARQ ACK Delay for DL Burst ~~DL ACK delay offset~~ which is specified in the DCD UCD message (see Table 353). As acknowledgement of UL HARQ burst sent by the SS, the ACK is sent by the BS after a fixed delay (synchronous ACK) defined by HARQ ACK delay for UL Burst which is specified in DCD message (see Table 358). Timing of retransmission is, however, flexible and corresponds to the asynchronous part of the HARQ HARQ. The ACK/NAK is sent by the BS using the HARQ HARQ Bitmap IE, and sent by an SS using the fast feedback UL subchannel.

**6.3.17.2 DL/UL ACK/NAK signaling**

*Change the subclause as indicated:*

For DL ~~H-ARQ HARQ~~ HARQ, fast ACK/NAK signaling is necessary. For the fast ACK/NAK signaling of DL ~~H-ARQ HARQ~~ HARQ channel, a dedicated PHY layer ACK/NAK channel is designed in UL. For the fast ACK/NAK signaling of UL fast feedback, ~~H-ARQ HARQ~~ HARQ ACK message is designed. The HARQ ACK/NAK message for UL HARQ may be omitted.

**6.3.17.3 ~~H-ARQ HARQ~~ parameter signaling**

*Change the last paragraph as indicated:*

For the signaling of those parameters, ~~H-ARQ HARQ AllocationControl~~ HARQ AllocationControl IE is defined and the IE is to be placed in a ~~DL MAP or UL MAP for Compact MAP~~ Compact MAP IE which allocates a data burst where H-ARQ is used.

*Renumber subclause 6.3.17.4 as 6.3.18 and change the title of the subclause as indicated:*

**6.3.18 DL CINR report operation**

*Change the subclause as indicated:*

This subclause applies to OFDMA mode only. The SS transmits either a physical CINR metric or an effective CINR metric using the REP-RSP MAC message or fast-feedback (COICH) channel.

The physical CINR is defined in 8.4.11.3. The effective CINR is a function of physical CINR, varying channel conditions and implementation margin. The exact measurement method used to derive the effective CINR is implementation specific. The reported effective CINR feedback shall correspond to the MCS in Table 298a with which the expected block error rate, assuming a specific block length, is closest to, but does not exceed, a specific target average error rate. The target average error rate and assumed block length are defined in profiles. When HARQ is employed, the computed block error rate shall only pertain to the first HARQ transmission.

The metric can be reported for either the preamble or a permutation zone. The manner in which the metric is derived for a permutation zone is in general implementation specific; however, the BS may explicitly instruct the SS to report the metric based on measurements from data or pilots.

The SS shall implement at least one measurement scheme and negotiate its capability.

**6.3.18.1 DL CINR report with REP-RSP MAC message**

The REP-RSP message shall be sent by the SS in response to a REP-REQ message from the BS to report estimation of DL physical CINR or effective CINR.

REP-REQ shall indicate whether the reported metric shall apply to the preamble or to a specific permutation zone. For the report on the preamble, BS can request SS to report the CINR based on the measurement from the preamble for the different frequency reuse factors or band AMC configuration. For report on a specific permutation zone, the REP-REQ indicates the report type configuration, which includes the zone for which the CINR is to be estimated. The zone is identified by its permutation type (PUSC with 'use all SC = 0', PUSC with 'use all SC = 1', FUSC, Optional FUSC, AMC zone, Safety channel), and PRBS ID. Also, the same permutation and PRBS ID can be differentiated by the STC or AAS indication. The SS shall not perform a measurement in a frame in which the specified zone is not allocated, and shall retain the previous measurement. For PUSC permutation zones, the SS may be instructed to report CINR estimate for only a subset of the major groups. The SS may send a REP-RSP message in an unsolicited fashion.

In the case where the requested report configuration does not differ from the previous REP-REQ message in which CINR report was requested, the SS is required to send its response within three frames. A REP-REQ message shall not contain more than one TLV requesting any type of CINR report.

For the Band-AMC differential CINR reports, the effective CINR metric shall not be used.

If the BS instructs CINR reporting on an AAS zone, then the SS shall report the estimate of the physical or effective CINR measured from dedicated AAS preamble/pilot or data subcarriers that belong to slots allocated to it. For DL-PUSC in AAS mode, if major-group indication has been specified in the measurement configuration then the reported CINR shall be measured on all indicated major groups rather than on slots allocated to the SS.

*Change 6.3.18.2 as indicated:*

### **6.3.18.2 Periodic CINR report with fast-feedback (CQICH) channel**

~~This subclause describes the operation scenarios and requirements of CQICH, which is designed for HARQ enabled SS. After an SS turns on its power, the only appropriate subchannels that can be allocated to the MSS are normal subchannels all subchannels the SS can support except the band AMC subchannel. To determine the M/C level of normal subchannels, the average CINR measurement is enough for the BS to determine the M/C levels of uplink and downlink. As soon as the BS and the SS know the capabilities of both entities modulation and coding, the BS may allocate a CQICH subchannel using a CQICH Control IE (CQICH allocation IE or CQICH Control IE) for periodic CINR reports (physical CINR or effective CINR). Then, the MSS reports the average CINR of the BS preamble. From then on, the BS is able to determine the M/C level. A CINR measurement is quantized into 32 levels and encoded into 5 four information bits.~~

CQICH Allocation IE may indicate whether the reported metric shall apply to preamble or to a specific permutation zone. For the report on the preamble, BS can request SS to report the CINR based on the measurement from the preamble for the different frequency reuse factors. For the report on the specific permutation zones, the CQICH Allocation IE indicates the report type configuration, which includes the zone for which the CINR is to be estimated. The zone is identified by its permutation type (PUSC with 'use all SC = 0', PUSC with 'use all SC = 1', AMC AAS zone, FUSC, Optional FUSC, Safety channel), and PRBS ID. Also, the same permutation and PRBS ID can be differentiated by the STC or AAS indication. The SS shall not perform a measurement in a frame in which the specified zone is not allocated, and shall retain the previous measurement. For PUSC permutation zones, the SS may be instructed to report an estimate for only a subset of the major groups. The first CQICH Allocation IE sent to the SS shall indicate the report type configuration. Only a subsequent CQICH Allocation IE may update the report type configuration for COI channel based reports. See 8.4.5.4.12 and 8.4.11.3. CQICH allocated through CQICH Control IE shall use the measurement configuration defined in the latest CQICH allocation IE. The quantization and encoding of physical CINR and effective CINR onto the Fast-Feedback channel is defined in 8.4.5.4.10.

A effective CINR reported on the COI is interpreted as the SS's recommendation that best meets the specified target error rate for the duration remaining until the next scheduled COI report.

The SS may send an unsolicited REP-REQ message if it decides that the last effective CINR report is no longer appropriate for the duration remaining until the next periodic COI transmission. The message is used to specify the new effective CINR for the COI channel. The COI channel is identified by its CQICH ID or by the SS's CID if the COI channel is allocated without a CQICH ID. The SS shall not send an unsolicited update to the effective CINR of a COI channel if 'triggered update' is disabled in the CQICH Allocation IE that allocated the COI channel.



An SS may support two concurrent CQI channels (not necessarily being scheduled in the same frame)—one for effective CINR reports and one for physical CINR reports—both of which refer to the same zone. In such a case, both reported values shall be derived from the same underlying set of measurements. The CQI channel is identified by the CQICH\_ID field in the CQICH Allocation IE. Support for more than one concurrent CQI channel is optional and negotiated in 11.8.3.7.9.

For the BandAMC differential CINR reports, the effective CINR scheme shall not be used.

If the BS instructs CINR reporting on an AAS zone, then the SS shall report the estimate of the physical or effective CINR measured from dedicated AAS preamble/pilot or data subcarriers that belong to slots allocated to it. For DL-PUSC in AAS mode, if major-group indication has been specified in the measurement configuration, then the reported CINR shall be measured on all indicated major groups rather than on slots allocated to the SS.

The SS sends the REP-RSP message in an unsolicited fashion to BS to trigger Band AMC operation. The triggering conditions are given by TLV encodings in UCD messages. For SS, the REP-RSP (see 11.12 for the TLV encodings) includes the CINR measurements of five four best bands. For MS, the REP-RSP (see 11.12 for the TLV encodings) includes the CINR measurements of four or five selected best bands (see 8.4.6.3.2). Only when an SS reports its BS the CINR measurements of Band AMC channels, its logical definition is made differently, as follows. If the number of bands is 48 (2048 FFT in 20 MHz), the two contiguous bands are paired and renumbered the same as a 24 band system. Then, if the LSB of an SS MAC address is 1, it only uses the odd-numbered bands. If not, it only uses the even-numbered bands. Hence, for example, the LSB of an SS MAC address is 1,  $(4m+2, 4m+3)$  bands are paired and the paired band is the  $m$ -th band of the SS. Similarly, for an even-numbered SS,  $(4m, 4m+1)$  bands are paired and the paired band is the  $m$ -th band of the SS. If the number of bands is 24, the two contiguous bands are just paired and renumbered the same as a 12 band system. If the original number of band is equal to or less than 12, the logical definition is not necessary.

At any time, the BS may de-allocate the SS' CQICH by putting another CQICH ~~Control~~ IE with Duration  $d = 0000$ . Before the CQICH life timer (which is set at the receipt of the CQICH ~~Control~~ IE) expires) sending another CQICH ~~Control~~ IE overwrites all the information related to the CQICH such as Allocation Index, Period, Frame offset, and Duration. Hence, unless the BS refreshes the timer, the SS should stop reporting as soon as the timer expires. However, in case of sending the MAP IE for re-allocation or deallocation, the BS should make sure if the previous CQICH is released before it is re-allocated to another SS.

The BS acknowledges the trigger from SS by allocating Band AMC subchannels sending a unicast MAC PDU to the SS using Band AMC subchannels. From the next frame when the SS sent the REP-RSP, the SS starts reporting the differential of CINR from preamble for fivefour selected bands (increment: 1 and decrement: 0 with a step of 1 dB) on its CQICH. The CQICH shall then be used for differential Band-AMC reports, regardless of the report configuration specified in the CQICH IE that allocated the current CQI channel. If the BS does ~~not allocate the Band AMC subchannels~~ send a unicast MAC PDU to the SS using Band AMC subchannels or send REP-REQ to indicate reporting Band AMC CINR within the specified delay (CQICH Band AMC Transition Delay) in the UCD message, the SS ~~reports the updated average CINR of the preamble for normal subchannel allocations~~ shall resume to report CINR according to the report configuration specified in the latest CQICH Allocation IE. In addition, if the BS sends a unicast MAC PDU to the SS using non-Band AMC subchannels, or the CQICH allocation IE indicates to report CINR on a zone other than Band AMC zone, the SS shall resume to report CINR according to the report configuration specified in the latest CQICH Allocation IE.

When the BS wants to trigger the transition to Band AMC mode or update the CINR reports, it sends the REP-REQ message (see 11.11 for the TLV encodings). When the SS receives the message, it replies with REP-RSP. ~~When the BS receives the REP-RSP, it should synchronize the selection of bands reported and their CINR. Unless the BS allocates normal subchannels, the SS reports the differential increment compared~~

~~to the most up-to-date report from the next CQI reporting frame. After BS receives the REP-RSP, the same procedure shall be used as in the triggering by the SS.~~

The transition of the CQICH reporting scheme from Band AMC to non-Band AMC mode can be made by SS and BS. At any time, SS can send REP-RSP of reporting CINR of the non-Band AMC mode to trigger a transition of the CQICH reporting scheme to the non-Band AMC mode. When BS receives the REP-RSP, BS may send CQICH allocation IE to the SS to direct the non-Band AMC reporting scheme. When BS does not send the CQICH allocation IE and/or SS does not receive the CQICH allocation IE, SS shall keep reporting the differential CINR through CQICH. At any time, BS can send CQICH allocation IE to trigger a transition of the CQICH reporting scheme to the non-Band AMC mode.

#### Conditions of transition triggering

a) Normal subchannel -> AMC transition

If the maximum of the standard deviations of the individual band's CINR measurements is lower than 'Band AMC Allocation Threshold' and the average CINR of the whole bandwidth is larger than 'Band AMC Entry Average CINR' for at least 'Band AMC Allocation Timer' frames, SS using normal subchannels sends an unsolicited REP\_RSP to request mode transition. REP\_RSP message contains band bitmap indicating the best four bands and their CINR measurements. The standard deviation of the individual band's CINR measurement shall be measured over time.

b) AMC -> Normal subchannel transition

If the maximum of the standard deviations of the individual band's CINR measurements for at least 'Band AMC Release Timer' frames is higher than 'Band AMC Release Threshold', SS in Band AMC mode may trigger mode transition from Band AMC to normal subchannel. The standard deviation of the individual band's CINR measurement shall be measured over time.

c) Band Change

If the CINR of any one band excluding the best four bands previously selected for band AMC allocations is greater than the average CINR of the AMC reporting bands for at least 'Band AMC Allocation Timer', SS sends an unsolicited REP\_RSP that contains band bitmap indicating the best four bands and their CINR measurements.

*Insert new subclause 6.3.19:*

### **6.3.19 optional Band AMC operations using 6-bit CQICH encoding**

*Insert new subclause 6.3.19.1:*

#### **6.3.19.1 Call flows for mode transitions between normal subchannel and band AMC**

Three allocated CQICH codewords are allocated for indicating the transitions. Let the first codeword be C1 (the 62<sup>nd</sup> codeword in Table 296b: 0b111101), the second one C2 (the 63<sup>rd</sup> codeword: 0b111110), and the third one C3 (the 64<sup>th</sup> codeword: 0b111111).

a) Normal -> Band AMC

The MS transmits C1, and the BS that receives the codeword transmits REP-REQ. The MS replies with REP-RSP having the CINR measurements of the five best bands at the same frame or after transmitting C2. From the next frame after transmitting REP-RSP, the MS reports the Band AMC differential CQI of the selected bands.

b) Band AMC -> Normal

The MS transmits C3. The MS reports the regular CQI of the whole bandwidth. Until the BS allocates normal subchannels, the MS repeats this process. In other words, the MS transmits the C3 and the regular CQI alternately until the normal subchannel is allocated to it.

c) Band change

The MS and its BS follows the same procedure of the transition from normal subchannel to Band AMC.

- d) Refreshing the CINR of the four best bands without band changes  
The MS transmits an unsolicited REP-RSP at the same frame or after transmitting C2.

*Insert new subclause 6.3.19.2:*

**6.3.19.2 Conditions of transition triggering**

- a) Normal subchannel -> AMC transition  
If the maximum of the standard deviations of the individual band’s CINR measurements is lower than ‘Band AMC Allocation Threshold’ and the average CINR of the whole bandwidth is larger than ‘Band AMC Entry Average CINR’ for at least ‘Band AMC Allocation Timer’ frames, MS using normal subchannels sends an unsolicited request mode transition and transmits a special code-word on its CQICH to inform its BS of its request of mode transition. REP-RSP message contains band bitmap indicating the best five bands and their CINR measurements.
- b) AMC -> Normal subchannel transition  
If the maximum of the standard deviations of the individual band’s CINR measurements for at least ‘Band AMC Release Timer’ frames is higher than ‘Band AMC Release Threshold’, MS in Band AMC mode may trigger mode transition from Band AMC to normal subchannel.
- c) Band Change  
If the CINR of any one band excluding the best five bands previously selected for band AMC allocations is greater than the average CINR of the AMC reporting bands for at least Band AMC Allocation Timer, the AMC allocation bands should be changed by following the procedure given above.

*Insert new subclause 6.3.20:*

**6.3.20 Data delivery services for mobile network**

Data delivery service is associated with certain predefined set of QoS-related service flow parameters. Note that definition of Data Delivery Service does not include assignment of specific values to the parameters.

*Insert new subclause 6.3.20.1:*

**6.3.20.1 Types of data delivery services**

Type of Data Delivery Service identifies specific set of QoS parameters—see Table 132a.

**Table 132a—Type of data delivery services**

Type	Symbolic name of service type	Meaning
0	UGS	Unsolicited Grant Service For UL connections should be supported by UGS Scheduling Service
1	RT-VR	Real-Time Variable Rate Service For UL connections should be supported by rtPS Scheduling Service
2	NRT-VR	Non-Real-Time Variable Rate service For UL connections should be supported by nrtPS Scheduling Service
3	BE	Best Efforts Service For UL connections should be supported by BE Scheduling Service
4	ERT-VR	Extended Real-Time Variable Rate Service. For UL connections should be supported by ertPS Scheduling Service.

See the subclauses that follow for detailed definitions for the data delivery services of different types.

*Insert new subclause 6.3.20.1.1:*

**6.3.20.1.1 Unsolicited grant service (UGS)**

This type of service is to support real-time applications generating fixed-rate data. This data can be provided as either fixed or variable length PDUs. The following are the parameters of the service specified in Table 132b:

**Table 132b—Unsolicited grant service parameters**

Parameter	Meaning
<b>Tolerated jitter</b>	According to 11.13.13
if (Fixed length SDU){	—
<b>SDU size</b>	According to 11.13.16
}	—
<b>Minimum reserved traffic rate</b>	According to 11.13.8
<b>Maximum Latency</b>	According to 11.13.14
<b>Request/Transmission Policy</b>	According to 11.13.12
<b>Unsolicited Grant Interval</b>	<u>As in 11.13.20</u>

*Insert new subclause 6.3.20.1.2:*

**6.3.20.1.2 Real-Time Variable Rate (RT-VR) service**

This service is to support real-time data applications with variable bit rates which require guaranteed data rate and delay. The following are the parameters of the service in Table 132c:

**Table 132c—Real-Time Variable Rate service parameters**

Parameter	Meaning
Maximum Latency	As specified in 11.13.14
Minimum Reserved Traffic Rate	As defined in 11.13.8 with averaging over time.
Maximum Sustained Traffic Rate	Optional, if absent defaulting to Minimum Reserved Traffic Rate. As specified in 11.13.8, with averaging over time. This value shall be bigger than Minimum Reserved Traffic Rate.
Traffic priority	According to 11.13.5
Request/Transmission policy	According to 11.13.12
Unsolicited Polling Interval	As in 11.13.21

**Description of the service**

Let  $S$  denote the amount of data arrived to the transmitter’s MAC SAP, during time interval  $T = \text{Time Base}$ ; and let  $R = \text{Minimum Reserved Traffic Rate}$ . Then the BS is supposed, during each time interval of the length (Time Base), to allocate to the connection resources sufficient for transferring an amount of data according to the value of Minimum Reserved Traffic Rate (11.13.8) i.e., at least  $\min \{S, R * T\}$ . Any SDU should be delivered within a time interval  $D = \text{Maximum Latency}$ . In the case when the amount of data submitted to the transmitter’s MAC SAP exceeds (Minimum Reserved Traffic Rate) \*  $T$ , delivery of each specific SDU is not guaranteed.

*Insert new subclause 6.3.20.1.3:*

**6.3.20.1.3 Non-Real-Time Variable Rate (NRT-VR) service**

This QoS profile shall support applications that require a guaranteed data rate but are insensitive to delays. It is desirable in certain cases to limit the data rate of these services to some maximum rate. The QoS profile is defined by the parameters defined in Table 132d:

**Table 132d—Non Real-Time variable rate service parameters**

<b>Parameter</b>	<b>Meaning</b>
<u>Minimum Reserved Traffic Rate</u>	<u>As defined in 11.13.8 with averaging over time.</u>
<u>Maximum Sustained Traffic Rate</u>	<u>Optional, if absent defaulting to Minimum Reserved Traffic Rate. As specified in 11.13.8, with averaging over time. This value shall be bigger than Minimum Reserved Traffic Rate.</u>
<u>Traffic priority</u>	<u>According to 11.13.5.</u>
<u>Request/Transmission policy</u>	<u>According to 11.13.12.</u>

**Description of the service**

Let  $S$  denote the amount of data arrived to the transmitter’s MAC SAP, during time interval  $T = \text{Time Base}$ ;  $R = \text{Minimum Reserved Traffic Rate}$ . Then the BS is supposed during each time interval of the length (Time Base) to allocate to the connection resources sufficient for transferring amount of data according to the value of Minimum Reserved Traffic Rate (11.13.8) i.e., at least  $\min \{S, R * T\}$ . In the case when the amount of data submitted to the transmitter’s MAC SAP exceeds (Maximum Sustained Traffic Rate) \*  $T$ , delivery of each specific SDU is not guaranteed

*Insert new subclause 6.3.20.1.4:*

**6.3.20.1.4 Best Effort (BE) service**

This service is for applications with no rate or delay requirements. The parameters of the service are shown in Table 132e.

**Table 132e—Best Effort service parameters**

<b>Parameter</b>	<b>Meaning</b>
Maximum Sustained Traffic Rate	As specified in 11.13.6
Traffic priority	According to 11.13.5
Request/Transmission policy	According to 11.13.12

*Insert new subclause 6.3.20.1.5:*

**6.3.20.1.5 Extended Real-Time Variable Rate (ERT-VR) service**

This service is to support real-time applications with variable data-rates, which require guaranteed data and delay, for example VoIP with silence suppression. The parameters required for this service are in Table 132f.

**Table 132f—Extended Real-Time Variable Rate service parameters**

Parameter	Meaning
Maximum Latency	As specified in 11.13.14
Tolerated Jitter	As specified in 11.13.13
Minimum Reserved Traffic Rate	As specified in 11.13.8
Maximum Sustained Traffic Rate	As specified in 11.13.6
Traffic Priority	As specified in 11.13.5
Request/Transmission Policy	As specified in 11.13.12
Unsolicited Grant Interval	As specified in 11.13.20

*Insert new subclause 6.3.21:*

**6.3.21 Sleep mode for mobility-supporting MS**

*Insert new subclause 6.3.21.1:*

**6.3.21.1 Introduction**

Sleep mode is a state in which an MS conducts pre-negotiated periods of absence from the Serving BS air interface. These periods are characterized by the unavailability of the MS, as observed from the Serving BS, to DL or UL traffic. Sleep mode is intended to minimize MS power usage and decrease usage of Serving BS air interface resources. Implementation of sleep mode is optional for the MS and mandatory for the BS.

For each involved MS, the BS keeps one or several contexts, each one related to certain Power Saving Class. Power Saving Class is a group of connections that have common demand properties. For example, all BE and NRT-VR connections may be marked as belonging to a single class while two UGS connections may belong to two different classes in case they have different intervals between consequent allocations. Power Saving class may be repeatedly activated and deactivated. Activation of certain Power Saving Class means starting sleep/listening windows sequence associated with this class. Algorithm of choosing Power Saving Class type for certain connections is outside of the scope of the standard.

There are three types of Power Saving Classes, which differ by their parameter sets, procedures of activation/deactivation, and policies of MS availability for data transmission.

Unavailability interval is a time interval that does not overlap with any listening window of any active Power Saving Class

Availability interval is a time interval that does not overlap with any Unavailability interval

During Unavailability interval the BS shall not transmit to the MS, so the MS may power down one or more physical operation components or perform other activities that do not require communication with the BS—scanning neighbor BSs, associating with neighbor BSs, etc. If there is a connection at the MS, which is not associated with any active Power Saving Class, the MS shall be considered available on permanent basis.

During Availability interval the MS is expected to receive all DL transmissions same way as in the state of normal operations (no sleep). In addition, the MS shall examine the DCD and UCD change counts and the frame number of the DL-MAP PHY Synchronization field to verify synchronization with the BS. Upon detecting a changed DCD and/or UCD count in the DL MAP, unless using the Broadcast Control Pointer IE

for tracking and updating DCD and/or UCD changes, the MS shall continue reception until receiving the corresponding updated message.

- If the BS transmits the Broadcast Control Pointer IE, the MS shall read and react to this message according to the following:
  - 1) If the DCD\_UCD Configuration Change Counter has changed since MS last decoding of this IE, even if scheduled to be in a sleep interval the MS shall awaken at DCD\_UCD Transmission Frame in time to synchronize to the DL and decode the DCD and UCD message in the frame, if present. If the MS fails to decode one or both of DCD and UCD, or no DCD or UCD was transmitted by the BS, the MS shall continue decoding all subsequent frames until it has acquired both updated DCD and UCD. Upon successful completion of DCD and UCD decoding, the MS shall immediately return to regular sleep mode operation.
  - 2) If Skip Broadcast\_System\_Update is set to '0', even if scheduled to be in a sleep interval, the MS shall awaken at Broadcast\_System\_Update\_Transmission\_Frame in time to synchronize to the DL and decode and read the DL-MAP and any message, if present. Upon completion, the MS shall immediately return to regular sleep mode operation.

During Unavailability intervals for MS, the BS may buffer (or it may drop) MAC SDUs addressed to unicast connections bound to an MS. The BS may choose to delay transmission of SDUs addressed to multicast connections until the following Availability Interval, common for all MSs participating in the multicast connection.

An MS performing handover may include Power\_Saving\_Class\_Parameters in RNG-REQ message to indicate its preference to enter sleep mode after the handover. In this case, the BS shall transmit unsolicited MOB\_SLP-RSP message to the MS after handover.

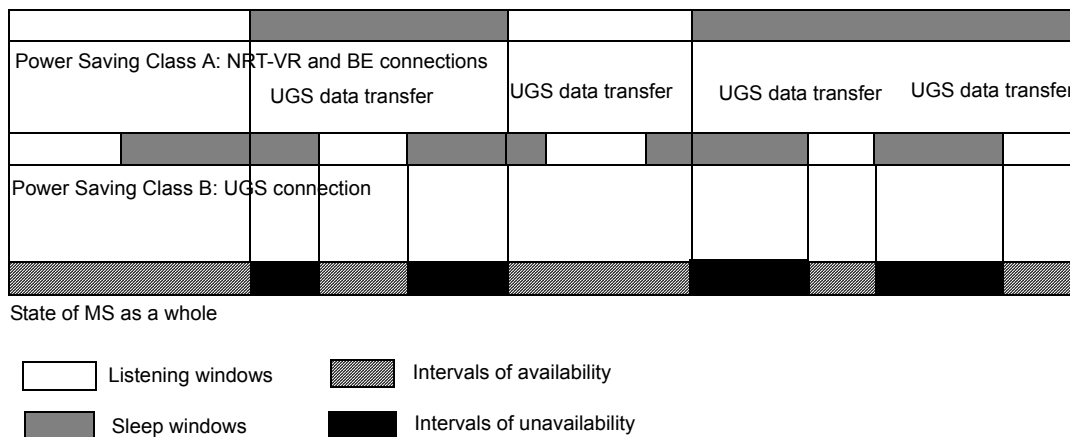
In MOB\_TRF-IND message with negative indication for the MS, the BS may include an updated SLPID for an MS by appending SLPID\_Update TLV in the MOB\_TRF-IND message. When the received MOB\_TRF-IND message includes a SLPID\_Update TLV, the MS shall decode the TLV and, if addressed, update its SLPID to the new one. The MS shall identify if the SLPID\_Update TLV addresses it by searching through the SLPID\_Update TLV and determining if the MS's current SLPID matches the Old\_SLPID in the SLPID\_Update TLV. If they match, then the MS shall set its SLPID to the New\_SLPID provided in the SLPID\_Update TLV. For an example of sleep mode operation, see Annex D.

MS in sleep mode may participate in periodic ranging. The procedure includes Serving BS allocation of UL transmission opportunity for periodic ranging in which the MS shall transmit RNG-REQ message. After transmittal of the RNG-REQ, the MS shall wait for the RNG-RSP message. Participation in the periodic ranging procedure does not change state of Power Saving Classes not associated with Ranging procedure.

MS in sleep mode may maintain triggers to perform event-based actions based on TLV encodings for CINR, RSSI, and RTD trigger (see Table 358.) received in DCD message or the TLV encodings for Neighbor BS CINR and Neighbor BS RSSI trigger (see Table 348e.) received in MOB\_NBR-ADV message. For this purpose, MS may include Enabled-Action-Triggered TLV in RNG-REQ or MOB\_SLP-REQ message requesting to associate specific actions with certain triggers. In response to the RNG-REQ or MOB\_SLP-REQ message, BS shall transmit RNG-RSP or MOB\_SLP-RSP message including Enabled-Action-Triggered TLV provided that it allows to activate the requested type of Power Saving Class. After receiving RNG-RSP or MOB\_SLP-RSP message including the Enabled-Action-Triggered TLV, MS shall perform the action indicated in the Enabled-Action-Triggered TLV following function/action specified in DCD or MOB\_NBR-ADV message. If MS does not include Enabled-Action-Triggered TLV in the RNG-REQ or MOB\_SLP-REQ message, BS shall not include Enabled-Action-Triggered TLV in the RNG-RSP or MOB\_SLP-RSP message. In this case, MS shall not perform and BS shall not expect the event-triggered action while the MS is in sleep mode. For the action indicated in the Enabled-Action-Triggered TLV, MS may transmit MOB\_SCN-REPORT or MOB\_SCN-REQ message and perform scanning and/or association without deactivating any Power Saving Class.

The Serving BS may verify MS exit from sleep mode by making a UL allocation for MS at any time subsequent to supposed waking event (for example, positive indication in MOB\_TRF-IND message) by transmitting at least BR message (if there is no data to transmit, BR field of the BR PDU shall be set to 0).

Figure 130a describes example of behavior of MS with two Power Saving Classes: Class A contains several connections of BE and NRT-VR type, Class B contains a single connection of UGS type. Then for Class A the BS allocates sequence of listening window of constant size and doubling sleep window. For Class B the BS allocates sequence of listening window of constant size and sleep window of constant size. The MS is considered unavailable (and may power down) within windows of unavailability, which are intersections of sleep windows of A and B.



**Figure 130a—Example of sleep mode operations with two power saving classes**

*Insert new subclause 6.3.21.2:*

**6.3.21.2 Power Saving Classes of type I**

Power Saving Class of this type is recommended for connections of BE, NRT-VR type.

For definition and/or activation of one or several Power Saving Classes of type I the MS shall send MOB\_SLP-REQ or Bandwidth request and uplink sleep control header (for activation only); the BS shall respond with an MOB\_SLP-RSP message or DL Sleep control extended subheader. The MS may retransmit MOB\_SLP-REQ message if it does not receive the MOB\_SLP-RSP message within the T43 timer.

Alternatively Power Saving Class may be defined/activated/deactivated by TLVs transmitted in RNG-RSP message.

The following are relevant parameters:

- Initial-sleep window
- Final-sleep window base
- Listening window



- Final-sleep window exponent
- Start frame number for first sleep window
- Traffic triggered waking flag

Power Saving Class becomes active at the frame specified as Start frame number for first sleep window. Each next sleep window is twice the size of the previous one, but not greater than specified final value.

$Sleep\ window = \min(2 * (Previous\ sleep\ window), Final\text{-}sleep\ window\ base * 2^{(Final\text{-}sleep\ window\ exponent)})$

$sleepWin = \min(2 \cdot prevSleepWin, finalSleepWinBase \cdot 2^{finalSlpWinExp}),$

where

*sleepWin* is the sleep window,  
*prevSleepWin* is the previous sleep window,  
*finalSleepWinBase* is the Final-sleep window base, and  
*finalSlpWinExp* is the Final-sleep window exponent.

Sleep windows are interleaved with listening windows of fixed duration. The BS terminates active state of Power Saving Class by sending MOB\_TRF-IND message. A traffic indication (MOB\_TRF-IND) message shall be sent by the BS on broadcast CID or Sleep mode multicast CID during listening window to alert MS of appearance of DL traffic demand at the corresponding connections.

When an MS receives an UL allocation after receiving a positive MOB\_TRF-IND message indication, the MS shall transmit at least BR message (if there is no data to transmit, BR field of the BR PDU shall be set to 0).

During active state of Power Saving Class of type I the MS is not expected to send or receive any MAC SDUs or their fragments or to send bandwidth requests at connections that belong to the Power Saving Class.

Power Saving Class is deactivated either by MOB\_SLP-REQ/Bandwidth request and uplink sleep control header or MOB\_SLP-RSP/DL Sleep control extended subheader messages or (if Traffic triggered waking flag = 1) after one of following events:

- BS transmits (during availability window) a MAC SDU or fragment thereof over connection belonging to the Power Saving Class
- MS transmits a bandwidth request with respect to connection belonging to the Power Saving Class
- MS receives MOB\_TRF-IND message indicating presence of buffered traffic addressed to the MS

Assuming TRF-IND\_Required flag was set in MOB\_SLP-REQ, Power Saving Class shall be deactivated if MS failed to receive MOB\_TRF-IND message during availability window.

During listening windows the MS is expected to receive all DL transmissions same way as in the state of normal operations (no sleep).

***Insert new subclause 6.3.21.3:***

### **6.3.21.3 Power Saving Classes of type II**

Power Saving Class of this type is recommended for connections of UGS, RT-VR type. The following are relevant parameters:

- Initial-sleep window

- Listening window
- Start frame number for first sleep window

Power Saving Class becomes active at the frame specified as “Start frame number for first sleep window”. All sleep windows are of the same size as initial window. Sleep windows are interleaved with listening windows of fixed duration. Power Saving Classes of this type are defined/activated/deactivated by MOB\_SLP-REQ/MOB\_SLP-RSP or Bandwidth request and uplink sleep control header/DL Sleep control extended subheader transaction. The MS may retransmit MOB\_SLP-REQ message or Bandwidth request and uplink sleep control header if it does not receive the MOB\_SLP-RSP message or DL Sleep control extended subheader within the T43 timer. The BS may send unsolicited MOB\_SLP-RSP or DL Sleep control extended subheader to initiate activation of Power Saving Class. Once started, the active state continues until explicit termination by MOB\_SLP-REQ/MOB\_SLP-RSP messages or Bandwidth request and uplink sleep control header/DL Sleep control extended subheader. BS may send unsolicited MOB\_SLP-RSP message or DL Sleep control extended subheader to deactivate Power Saving Class. Alternatively Power Saving Class of type II may be defined and/or activated /deactivated by TLVs transmitted in RNG-REQ and RNG-RSP message.

As opposite to Power Saving Class type I, during listening windows of Power Saving Class type II the MS may send or receive any MAC SDUs or their fragments at connections comprising the Power Saving Class as well as acknowledgements to them. The MS shall not receive or transmit MAC SDUs during sleep windows.

*Insert new subclause 6.3.21.4:*

#### **6.3.21.4 Power Saving Classes of type III**

Power Saving Class of this type is recommended for multicast connections as well as for management operations, for example, Periodic Ranging, DSx operations, MOB\_NBR-ADV etc. Power Saving Classes of this type are defined/activated by MOB\_SLP-REQ/MOB\_SLP-RSP or Bandwidth request and uplink sleep control header/DL Sleep control extended subheader transaction. The MS may retransmit MOB\_SLP-REQ message (or Bandwidth request and uplink sleep control header) if it does not receive the MOB\_SLP-RSP message (or DL Sleep control extended subheader) within the T43 timer. The BS may send unsolicited MOB\_SLP-RSP or DL Sleep control extended subheader to initiate activation of Power Saving Class. Deactivation of Power Saving Class occurs automatically after expiration of sleep window.

Alternatively Power Saving Class of type III may be defined/activated by TLV encodings in RNG-RSP message. For periodic ranging Next Periodic Ranging TLV encoding may be used. It activates special Power Saving Classes of type III associated with periodic ranging procedure. In this case the sleep window of the class starts in the next frame after RNG-RSP transmitted and ends in the previous frame, which Next Periodic Ranging TLV indicates.

If Next Periodic Ranging TLV encoding is included in MOB\_SLP-RSP, this activates Power Saving Class of type III for periodic ranging and BS can continue to activate the Power Saving Class using Next Periodic Ranging TLV encoding in RNG-RSP message with ranging status set to success.

The following are relevant parameters:

- Final-sleep window base
- Final-sleep window exponent
- Start frame number for sleep window

Power Saving Class becomes active at the frame specified as “Start frame number for first sleep window”. Duration of sleep window is specified as base/exponent. After the expiration of the sleep window Power Saving Class automatically becomes inactive.

For multicast service Base Station may guess when the next portion of data will appear. Then the BS allocates sleep window for all time when it does not expect the multicast traffic to arrive. After expiration of the sleep window multicast data, if already available, may be transmitted to relevant MSs. After that the BS may decide to re-activate Power Saving Class.

As an example, Power Saving Class of type III may include Basic connection to serve needs of Periodic Ranging. In this case, duration (base/exponent) of sleep window shall be equal to time interval needed before next Periodic ranging transaction. Then the MS, after the specified time interval, shall be available to DL transmission and BS may either allocate an UL transmission opportunity for RNG-REQ or send unsolicited RNG-RSP. Re-activation of the Power Saving Class may be achieved using, for example, TLVs included into RNG-REQ/RSP.

Alternatively, Power Saving Class of type III may be activated /deactivated by TLVs transmitted in RNG-RSP messages.

*Insert new subclause 6.3.21.5:*

### **6.3.21.5 Periodic Ranging in sleep mode**

For each MS in sleep mode, during its listening-window, BS may allocate an UL transmission opportunity for periodic ranging. Alternatively, BS may return the MS to Normal Operation by deactivation of at least one Power Saving Class to keep it in active state until assignment of a UL transmission opportunity for periodic ranging, or let the MS know when the periodic ranging opportunity shall occur with Next Periodic Ranging TLV in last successful RNG-RSP.

During periodic ranging or negotiation of sleep mode, after RNG-REQ (or MOB\_SLP-REQ) reception, BS may send RNG-RSP (or MOB\_SLP-RSP, respectively) including Next Periodic Ranging TLV so that MS shall know when to perform periodic ranging as described in more details in 6.3.19.4. In the frame specified by Next Periodic Ranging TLV, the MS shall decode all consequent UL-MAP messages waiting for a UL unicast transmission opportunity for periodic ranging. When such an opportunity occurs, the MS shall transmit a RNG-REQ message to the BS and then perform the regular procedure for periodic ranging. A successful periodic ranging procedure does not deactivate another Power Save Classes. In the case where periodic ranging procedure fails, the MS shall perform Initial Ranging procedure or handover to another BS.

When the periodic ranging operation between MS and BS successfully processes, the BS may inform the MS of the frame number in which the next periodic ranging operation is expected to start. For that, BS shall append a Next Periodic Ranging TLV encoding to the RNG-RSP message. BS also may inform MS of the existence of DL Traffic addressed to MS. For that, BS shall include the Next Periodic Ranging TLV with a value set to zero. This deactivates all Power Saving Classes at the MS. If an MS receives the RNG-RSP message with this indication from the BS, then the MS shall immediately resume Normal Operation with the BS.

The BS may include a SLPID\_Update TLV item in a RNG-RSP message for an MS in sleep mode. If the serving BS receives a RNG-REQ message from an MS in sleep mode and there is any need to update SLPID assigned to the MS, the BS shall append a SLPID\_Update TLV to the RNG-RSP message only for a RNG-RSP message with ranging status flag set to 'success'. When the received RNG-RSP message with ranging status flag set to 'success' includes a SLPID\_Update TLV, the MS shall decode the TLV and update its SLPID to the new one. The MS shall identify if the SLPID\_Update TLV addresses it by searching through the SLPID\_Update TLV and determining if the MS's current SLPID matches the Old\_SLPID in the SLPID\_Update TLV. If they match, then the MS shall set its SLPID to the New\_SLPID provided in the SLPID\_Update TLV.

*Insert new subclause 6.3.21.6:*

**6.3.21.6 MDHO/FBSS Diversity Set Maintenance in sleep mode**

An MS in Sleep mode shall maintain the Diversity set and Anchor BS if at least one active Power Saving Class has the Maintain Diversity Set and Anchor BSID set to 1 and the MDHO/FBSS duration as specified in the MOB\_SLP-RSP message has not expired. Before the MDHO/FBSS duration expires, the MS shall continue to monitor the signal strength of neighbor BS and initiate deactivation of at least one Power Saving Class to keep in normal mode to perform Diversity Set update procedure (defined in 6.3.22.3.3) or Anchor BS update procedure (defined in 6.3.22.3.4).

*Insert new subclause 6.3.22:*

**6.3.22 MAC layer handover procedures**

This subclause contains the procedures performed during handover (HO).

An MS shall be capable of performing handover using the procedures defined in 6.3.22.2.

The handover process defined in this subclause may be used in a number of situations. Some examples are as follows:

- When the MS moves and (due to signal fading, interference levels, etc.) needs to change the BS to which it is connected in order to provide a higher signal quality;
- When the MS can be serviced with higher QoS at another BS.

The handover decision algorithm is beyond the scope of the standard.

*Insert new subclause 6.3.22.1:*

**6.3.22.1 Network topology acquisition**

*Insert new subclause 6.3.22.1.1:*

**6.3.22.1.1 Network topology advertisement**

A BS shall broadcast information about the network topology using the MOB\_NBR-ADV message. The message provides channel information for neighboring base stations normally provided by each BS's own DCD/UCD message transmissions. A BS may obtain that information over the backbone. Availability of this information facilitates MS synchronization with neighboring BS by removing the need to monitor transmission from the neighboring BS for DCD/UCD broadcasts.

*Insert new subclause 6.3.22.1.2:*

**6.3.22.1.2 MS scanning of neighbor BSs**

A BS may allocate time intervals to MS for the purpose of MS seeking and monitoring suitability of neighbor BSs as targets for HO. The time during which the MS scans for available BS will be referred to as a scanning interval.

An MS may request an allocation of a group of scanning intervals with interleaving intervals of normal operation using the MOB\_SCN-REQ message for the purpose of reducing the number of MOB\_SCN-REQ and MOB\_SCN-RSP messages required to create multiple scanning opportunities when frequent scanning is required. The MS indicates in this message the estimated duration of time it requires for the scan.

Scanning interval and interleaving interval repeat with the number of Scan iteration.

When the Trigger Action in the DCD message is encoded as 0x3, the MS shall send the MOB\_SCN-REQ message to the BS to begin the neighbor BS scanning process when the trigger condition is met. In the MOB\_SCN-REQ message the MS (the MOB\_SCN-RSP message the BS) shall indicate group of neighbor BSs for which only Scanning or Scanning with Association are requested by MS (recommended by BS). Presence of those BSs for which Association is requested (recommended) is indicated by encoding of Scanning type = 0b001. The BS may negotiate over the backbone with a BS Recommended for Association allocation unicast ranging opportunities. Then the MS will be informed on Rendezvous time to conduct Association ranging with the Recommended BS. When conducting initial ranging to a BS recommended for Association, MS shall use allocated unicast ranging opportunity, if available. Regardless of the presence of Recommended BS IDs, MS may determine and perform any scanning or Association activities during scanning interval at its own discretion. When the Report Mode is 0b10 in the MOB\_SCN-RSP message, the MS shall scan all BSs within the Recommended BS list of the message and then report the scanning result with the MOB\_SCN-REP message as conditioned by specified trigger event. Particularly if the Trigger Function in the most recently-received DCD channel encoding is 0x5 or 0x6, the MS shall include all recommended BSs of the MOB\_SCN RSP within the MOB\_SCN-REP. Otherwise, the MS shall add only the BSs that met the Trigger Function conditions within the MOB\_SCN-REP message. The scanning duration performed by the MS on all neighbor BSs shall be no longer than the parameter Max\_Dir\_Scan\_Time (as specified in 10.1) to limit the time before a report is sent to the BS. If the trigger type, trigger function and trigger action for a particular neighbor BS as defined in MOB\_NBR-ADV are the same as the neighbor BS trigger type, trigger function and trigger action defined in the serving BS DCD, the trigger value and trigger averaging duration defined in the MOB\_NBR-ADV shall take precedence.

Upon reception of the MOB\_SCN-REQ message, the BS shall respond with a MOB\_SCN-RSP message. The MS may retransmit the MOB\_SCN-REQ message if it does not receive the MOB-SCN-RSP message within the T44 timer. The MOB\_SCN-RSP message shall either grant the requesting MS a scanning interval that is at least as long as requested by that MS, or deny the request. A value of zero for Scan duration in MOB\_SCN-RSP shall indicate the request for an allocation of scanning interval is denied. The MOB\_SCN-RSP message shall either grant the requesting MS a scanning interval that is at least as long as requested by that MS, or deny the request. A value of zero for Duration in MOB\_SCN-RSP shall indicate the request for an allocation of scanning interval is denied. The serving BS may also send MOB\_SCN-RSP message unsolicited. For unsolicited MOB\_SCN-RSP message, a value of zero for Scan duration is used to trigger MS to report scanning result, without explicitly assigning scanning intervals to the MS. In this case, the MS shall only update Report Mode, Report Period and Report Metric based on the information received in MOB\_SCN-RSP message.

Following reception of a MOB\_SCN-RSP message granting the request, beginning at Start frame an MS may scan for one or more BS during the time interval allocated in the message. When a BS is identified through scanning, the MS may attempt to synchronize with its downlink transmissions, and estimate the quality of the PHY channel.

The serving BS may buffer incoming data addressed to the MS during the scanning interval and transmit that data after the scanning interval during any interleaving interval or after exit of the Scanning mode.

An MS may terminate scanning and return to Normal Operation anytime that may be indicated to the BS by sending a MAC PDU (for example, Bandwidth request) during any scanning interval. If a serving BS receives a MAC PDU message during any scanning interval from an MS that is supposed to be in Scanning Mode, the BS shall assume that the MS is no longer in Scanning Mode. The group of intervals is terminated at any time if the MS sends MOB\_SCN-REQ message or serving BS sends MOB\_SCN-RSP message during any interleaving interval with Scan Duration set to zero.

*Insert new subclause 6.3.22.1.3:*

**6.3.22.1.3 Association procedure**

Association is an optional initial ranging procedure occurring during scanning interval with respect to one of the neighbor BSs. The function of Association is to enable the MS to acquire and record ranging parameters and service availability information for the purpose of proper selection of HO target and/or expediting a potential future handover to a target BS. Recorded ranging parameters of an Associated BS may be further used for setting initial ranging values in future ranging events during actual handover.

There are three levels of association as follows:

- Association Level 0: Scan / Association without coordination
- Association Level 1: Association with coordination
- Association Level 2: Network assisted association reporting

Upon completion of a successful MS initial-ranging of a BS, if the RNG-RSP message contains a Service Level Prediction parameter set to 2, the MS may mark the BS as Associated in its MS local Association table of identities, recording elements of the RNG-RSP to the MS local Association table, and setting an appropriate aging timer (see Table 342). Association state in the MS local Association table shall be aged-out after ASC-AGING-TIMER timeout and the Association entry removed.

The BS may direct the MS to associate with recommended BSs by setting scanning type to 0b010 or 0b011 in MOB\_SCN-RSP. If the MS supports directed association, it shall perform association as directed by the serving BS. If MS does not support directed association, it may ignore this message. The support of directed association shall be negotiated as part of SBC-REQ and SBC-RSP MAC management message dialog.

*Insert new subclause 6.3.22.1.3.1:*

**6.3.22.1.3.1 Association Level 0—Scan / Association without coordination**

When this association level is chosen by the network, the Serving BS and the MS negotiate about the association duration and intervals (via MOB\_SCN-REQ with scanning type = 0b001 and MOB\_SCN-RSP). The Serving BS allocates periodic intervals where the MS may range neighboring BSs; however, the Target BS has no knowledge of the MS and provides only contention-based ranging allocations. An MS chooses randomly a ranging code from the initial ranging domain of the Target BS and transmits it in the contention-based ranging interval of the Target BS.

After the BS successfully receives ranging code and sends RNG-RSP message with ranging status ‘success’, it will provide uplink allocation of adequate size for the MS to transmit RNG-REQ message with TLV parameters (Serving BS ID, MS MAC address) related to the association ranging.

*Insert new subclause 6.3.22.1.3.2:*

**6.3.22.1.3.2 Association Level 1—Association with coordination**

When this association level is chosen, the Serving BS provides association parameters to the MS and coordinates association between the MS and neighboring BSs.

The MS may request to perform association with coordination by sending the MOB\_SCN-REQ message to the Serving BS with scanning type = 0b010. This message will include a list of neighboring BSs with which the MS wishes to perform association. The serving BS may also arrange for this type of association unilaterally by sending unsolicited MOB\_SCN-RSP.

The Serving BS will then coordinate the association procedure with the requested neighboring BSs.

Each neighboring BS will provide a ranging region for association at a predefined “rendezvous time”, in terms of relative frame number. The neighboring BS will also assign:

- A unique code number (from within the initial ranging codeset)
- A transmission opportunity within the allocated region (in terms of offset from the start of the region)

The neighboring BS may assign the same code or transmission opportunity to more than one MS, but not both. In case all allocated transmission opportunities in current region are different, there is no potential for collision of transmissions from different MSs. In case the Serving BS allocates the same transmission opportunity to several MSs, there is some probability of collision and then neighbor BS may fail to identify transmitted codes.

The Serving BS (of the associating MS), will coordinate to assure that the neighboring BSs do not assign overlapping or too close in time to each other ranging regions.

The Serving BS will provide the pre-assigned association ranging info via the MOB\_SCN-RSP message.

When the Dedicated ranging indicator is set to 1, the ranging region will be allocated via UIUC=12 in the UL-MAP.

When “Dedicated ranging indicator” is set to 1, then the ranging region and ranging method defined could be used for the purpose of ranging using dedicated CDMA code and transmit opportunity assigned in the MOB\_PAG-ADV message (for location update in idle mode) or in the MOB\_SCN-RSP message (for coordinated association).

MSs registered to this BS are prohibited from use of the named ranging region.

Upon receiving the MOB\_SCN-RSP message, the MS should interpret the provided “rendezvous time”, dedicated code, and transmission opportunity as follows:

- “Rendezvous time” specifies the frame in which the neighbor BS will transmit a UL-MAP containing the definition of the dedicated ranging region where the MS can use the assigned CDMA ranging code. Rendezvous time is provided in units of frames, beginning at the frame where the MOB\_SCN-RSP message is transmitted.
- The MS shall synchronize to the neighbor BS at the first frame immediately following the rendezvous time, read the UL-MAP transmitted at this frame, and extract the description of the dedicated ranging region (ranging region with “Dedicated ranging indicator” bit set to 1). The MS shall determine the specific region it should use for transmission of the dedicated CDMA code by applying the offset defined by the “transmission opportunity offset” field in MOB\_SCN-RSP, which was received from the serving BS, to the dedicated ranging region definition in the UL-MAP of the neighbor BS. In case the neighbor BS decides to provide a regular (non-dedicated) ranging region with Dedicated ranging indicator set to 0, the MS may transmit the allocated CDMA code in the regular ranging region.
- If the MS could not obtain UL\_MAP at the first frame immediately following the rendezvous time, it shall abort the Level 1 association process it’s attempting with the current BS. The MS may perform the Level 0 association with this BS as defined in 6.3.22.1.3.1 after it aborts the Level 1 association process.

*Insert new subclause 6.3.22.1.3.3:*

**6.3.22.1.3.3 Association Level 2—Network Assisted Association Reporting**

The MS may request to perform association with network assisted association reporting by sending the MOB\_SCN-REQ message to the Serving BS with scanning type = 0b011. This message will include a list of neighboring BSs with which the MS wishes to perform association. The serving BS may also request this type of association unilaterally by sending the MOB\_SCN-RSP message.

The Serving BS will then coordinate the association procedure with the requested neighboring BSs in a fashion similar to association Level 1. However, when using this association type, the MS is required only to transmit the CDMA ranging code at the neighbor BS. Then the MS does not have to wait for RNG-RSP from the neighbor BS. Instead, the RNG-RSP information on PHY offsets will be sent by each neighbor BS to the Serving BS (over the backbone). The Serving BS may aggregate all ranging related information into a single MOB\_ASC\_REPORT message.

When receiving this message, the MS updates its association database (PHY offsets and CIDs) and timers for each associated BS.

If no ranging region exists with “Dedicated ranging indicator” set to 1 but a regular (non-dedicated) ranging region is allocated by the BS at the rendezvous time, then MS may use this allocation for the coordination process. In this case, the MS may transmit the allocated CDMA code in the region defined via UL-MAP\_IE with UIUC=12 (i.e., the regular ranging region). The MS shall also in this case ignore the value of the “transmission opportunity offset” field of the MOB\_SCN-RSP message it received from the serving BS during the association negotiation. The neighbor BS that decides to provide a regular (non-dedicated) ranging region instead of a ranging region with Dedicated ranging indicator set to 1, should expect to receive the allocated CDMA code in the regular (non-dedicated) ranging region. If the MS could not obtain UL\_MAP at the first frame immediately following the rendezvous time, it shall abort the Level 2 association process its attempting with the current BS. The MS may perform the Level 0 association with this BS as defined in 6.3.22.1.3.1 after it aborts the Level 2 association process.

*Insert new subclause 6.3.22.2:*

**6.3.22.2 HO process**

The subclause defines the HO process in which an MS migrates from the air-interface provided by one BS to the air-interface provided by another BS. The HO process consists of the following stages:

- Cell reselection—MS may use Neighbor BS information acquired from a decoded MOB\_NBR-ADV message, or may make a request to schedule scanning intervals or sleep-intervals to scan, and possibly range, Neighbor BS for the purpose of evaluating MS interest in handover to potential target BS. The cell reselection process need not occur in conjunction with any specific, contemplated HO Decision.
- HO Decision and Initiation—A handover begins with a decision for an MS to handover from a serving BS to a target BS. The decision may originate either at the MS or the serving BS. The HO Decision consummates with a notification of MS intent to handover through MOB\_MSHO-REQ or MOB\_BSHO-REQ message.
- Synchronization to Target BS downlink—MS shall synchronize to downlink transmissions of Target BS and obtain DL and UL transmission parameters. If MS had previously received a MOB\_NBR-ADV message including target BSID, Physical Frequency, DCD and UCD, this process may be shortened. If the target BS had previously received HO notification from serving BS over the backbone, then target BS may allocate a non-contention-based Initial Ranging opportunities.



- Ranging—MS and target BS shall conduct Initial Ranging per 6.3.9.5 or Handover Ranging per 6.3.10.3.3. If MS RNG-REQ includes serving BSID, then target BS may make a request to serving BS for information on the MS over the backbone network and serving BS may respond. Regardless of having received MS information from serving BS, target BS may request MS information from the backbone network. Network re-entry proceeds per 6.3.9.5 except as may be shortened by target BS possession of MS information obtained from serving BS over the backbone network. Depending on the amount of that information Target BS may decide to skip one or several of the following Network Entry steps:
  - 1) Negotiate basic capabilities (Bit #0 in HO Process Optimization TLV in RNG-RSP is set)
  - 2) PKM Authentication phase (Bit #1 in HO Process Optimization TLV is set)
  - 3) TEK establishment phase (Bit #2 in HO Process Optimization TLV is set)
  - 4) Send REG-REQ (Bit #9 in HO Process Optimization TLV is set)
  - 5) BS may send unsolicited REG-RSP message with updated capabilities information or skip REG-RSP message when no TLV information to be updated (Bit #10 in HO Process Optimization TLV is set)

In case Bit #6 in HO Process Optimization TLV is set, full service and operational state transfer or sharing between Serving BS and Target BS is assumed (ARQ state, all timers, counters, MAC state machines, CIDs, Service Flows information and other connection information), so BS and MS do not exchange network re-entry messages after ranging before resuming normal operations.

A full list of optimization capabilities is provided in definition of HO Process Optimization TLV (Table 367).

In case Network Re-entry includes Key Request/Reply handshake, the BS shall provide sufficient time to the MS to process received TEK information before moving to next step as specified by HO TEK processing time TLV.

If TLVs for re-establishment of connections (11.7.9) appear in RNG-RSP (REG-RSP), DSA-REQ/RSP procedure shall not be used for this purpose. In this case, re-establishment of connections starts immediately after RNG-RSP (REG-RSP); the BS shall provide sufficient time to the MS to process connections information as specified by MS HO connections parameters processing time TLV.

In case Key Request/Key Reply handshake is not omitted, BS shall send REG-RSP, solicited or not. If REG-RSP is not omitted, network re-entry process completes with REG-RSP message.

- Termination of MS Context—The final step in handover. Termination of MS Context is defined as serving BS termination of context of all connections belonging to the MS and the context associated with them (i.e., information in queues, ARQ state-machine, counters, timers, header suppression information, etc. is discarded).
- HO Cancellation—An MS may cancel HO at any time prior to expiration of Resource\_Retain\_Time interval after transmission of MOB\_HO-IND message.

The HO process, and its similarity to the initial network entry process, is depicted in Figure 130b.

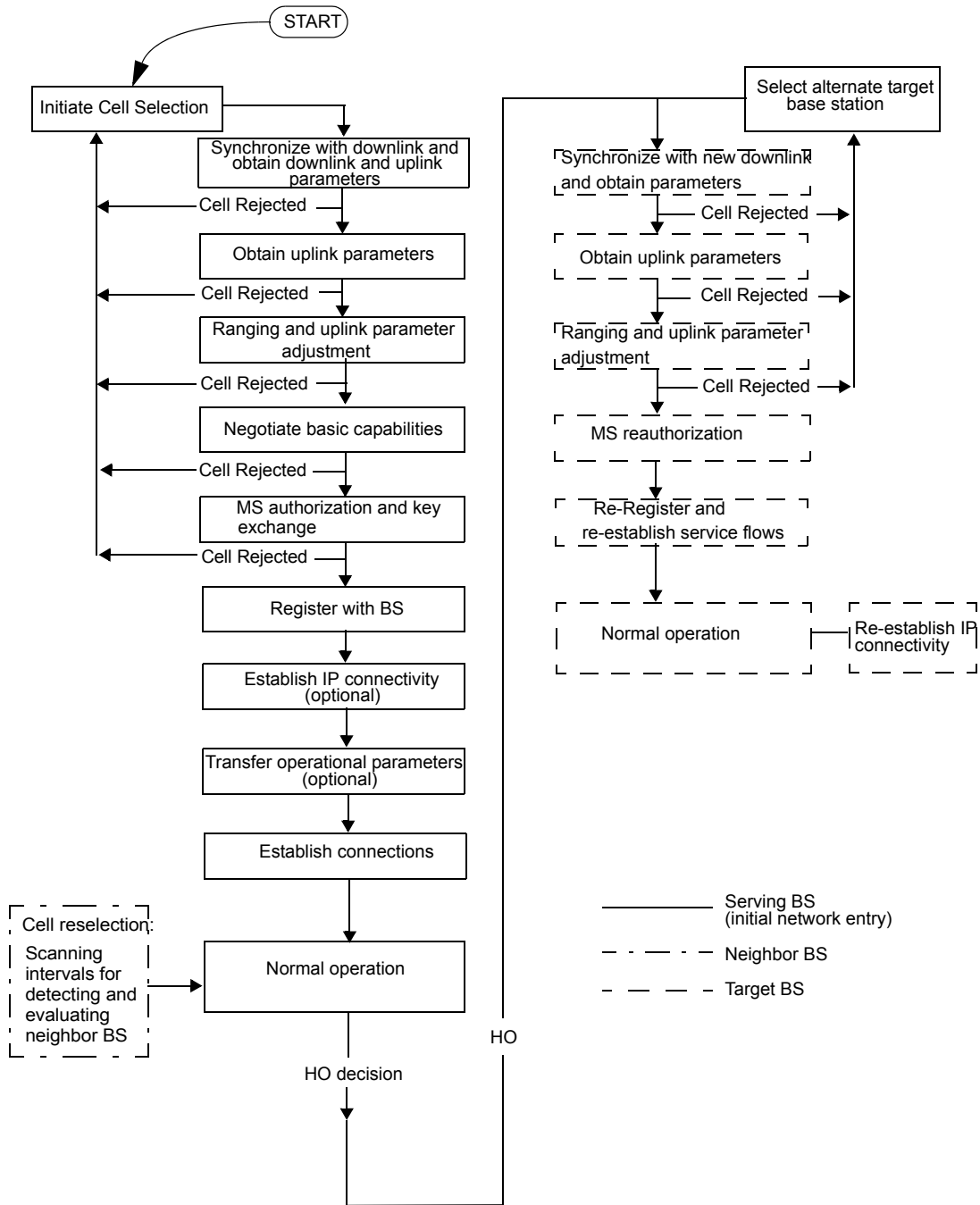
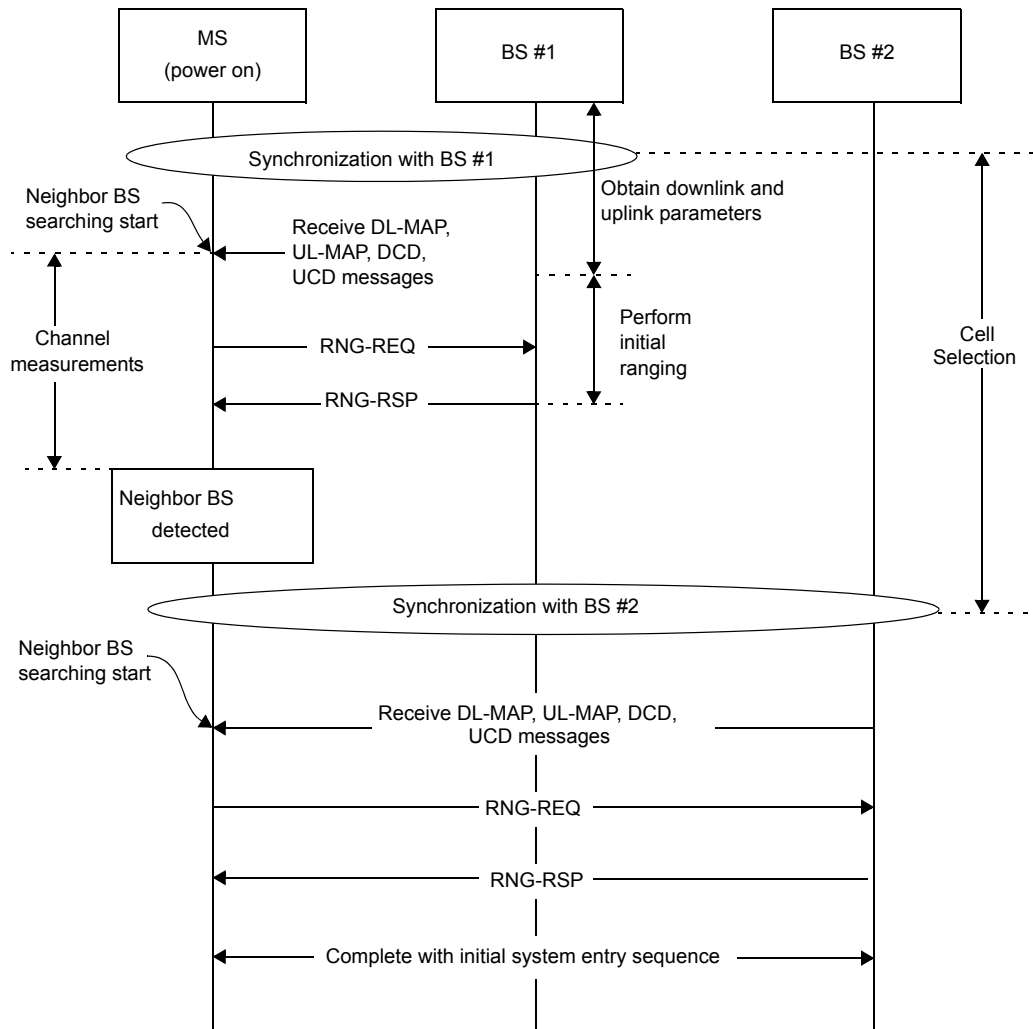


Figure 130b—HO and initial network entry

*Insert new subclause 6.3.22.2.1:*

**6.3.22.2.1 Cell reselection**

Cell reselection refers to the process of an MS Scanning and/or Association with one or more BS in order to determine their suitability, along with other performance considerations as a handover target. The MS may incorporate information acquired from a MOB\_NBR-ADV message to give insight into available Neighbor BSs for cell reselection consideration. Serving BS may schedule scanning intervals or sleep-intervals to conduct cell reselection activity. Such a procedure does not involve termination of existing connection to a serving BS. (See Figure 130c.)



**Figure 130c—Example of cell selection with ranging**

*Insert new subclause 6.3.22.2.2:*

**6.3.22.2.2 HO decision and initiation**

A handover begins with a decision for an MS to handover from a serving BS to a target BS. The decision may originate either at the MS, the serving BS, or on the network. The HO may proceed with a notification

through either MOB\_MSHO-REQ or MOB\_BSHO-REQ messages. The HO notification is recommended, but not required. Acknowledgement of MOB\_MSHO-REQ with MOB\_BSHO-RSP is required. After MS transmits MOB\_MSHO-REQ, MS shall not transmit any MOB\_MSHO-REQ prior to expiration of timer MS\_handover\_retransmission\_timer. MS shall deactivate timer MS handover retransmission timer on MS transmit of MOB\_HO-IND or MS receipt of MOB\_BSHO-RSP.

If an MS that transmitted a MOB\_MSHO-REQ message detects an incoming MOB\_BSHO-REQ message, it shall ignore that MOB\_BSHO-REQ message. A BS that transmitted a MOB\_BSHO-REQ message and detects an incoming MOB\_MSHO-REQ message from the same MS shall ignore its MOB\_BSHO-REQ. A BS that transmitted a MOB\_BSHO-REQ message and detects an incoming MOB\_HO-IND message from the same MS shall ignore its own previous request.

When MOB\_MSHO-REQ is sent by an MS, the MS may indicate one or more possible target BS. When MOB\_BSHO-REQ is sent by a BS, the BS may indicate one or more possible target BSs. MS may evaluate possible target BS(s) through previously performed scanning and Association activity.

Serving BS criteria for recommendation of target BS may include factors such as expected MS performance at potential target BS and MS QoS requirements. Serving BS may obtain expected MS performance at potential target BS through the exchange of backbone messages with that BS. Serving BS may negotiate location of common time interval where dedicated initial ranging transmission opportunity for the MS will be provided by all potential target BSs. This information may be included into MOB\_BSHO-RSP message.

Dedicated allocation for transmission of RNG-REQ means that channel parameters learned by the MS during Association of that BS are considered valid during sufficient time and can be reused for actual Network Re-entry without preceding CDMA Ranging. Information such as indicators of link quality in the UL direction learned by the MS during Association may be provided to the Serving BS over the backbone.

If Network Assisted HO supported flag is set to "1" in MOB\_BSHO-REQ message, MS may perform a handover to any BS among the recommended BSs in MOB\_BSHO-REQ without notifying the serving BS of a selected target BS. As an acknowledgement to the MOB\_BSHO-REQ message, the MS may send a MOB\_HO-IND message with its target BSID set to "0x00000000".

When the serving BS, transmitted MOB\_BSHO-REQ with Network Assisted HO supported flag = "1", receive MOB\_HO-IND with target BS ID = "0x00000000", it may neglect target BS ID included in MOB\_HO-IND message.

MS actual pursuit of handover to one of BSs specified in MOB\_BSHO-RSP is recommended, but not required. MS may decide to attempt handover to a different BS that may or may not have been included in MOB\_BSHO-RSP. If the MS signals rejection of serving BS instruction to HO through HO\_IND\_type field in the MOB\_HO-IND set value of 0b10 (HO reject option), the BS may reconfigure the neighbor BS list and retransmit MOB\_BSHO-RSP message including a new neighbor BS list.

In some instances, the BS may need to force the MS to conduct handover. The BS shall include a value of HO operation mode = 1 in either the MOB\_BSHO-REQ or MOB\_BSHO-RSP to signal to the MS that the MS must conduct handover. Upon receiving a message with HO operation mode = 1, the MS should treat the handover request as required and shall respond with a HO-IND. MS should send HO-IND with option HO\_IND\_type = 0b00 indicating commitment to HO unless MS is unable to handover to any of the recommended BSs in the message, in which case MS may respond with HO-IND with option HO\_IND\_type=0b10 indicating HO reject. An MS required to conduct handover is not restricted to conducting handover to those BS included in the notifying message. In other words, the MS may attempt handover to a different BS that may or may not have been included in either the MOB\_BSHO-REQ or MOB\_BSHO-RSP.

Serving BS may notify one or more potential target BS over the backbone network of MS intent to handover. Serving BS may also send MS information to potential target BS over the backbone to expedite handover.

The MS that sent MOB\_HO-IND with option HO\_IND\_type = 0b00 indicating commitment to HO and intent to release the serving BS, shall not be expected to monitor serving BS DL traffic after expiration of Resource retain timer.

*Insert new subclause 6.3.22.2.3:*

#### **6.3.22.2.3 HO cancellation**

After an MS or BS has initiated an HO using either MOB\_MSHO-REQ or MOB\_BSHO-REQ message, the MS may cancel HO at any time.

The cancellation shall be made through transmission of a MOB\_HO-IND messages the HO cancel option (HO\_IND\_type=0b01).

When MS transmits and serving BS receives MOB\_HO-IND message with the HO cancel option (HO\_IND\_type=0b01) during Resource Retain Time (when Resource Retain Flag=1), regardless of MS attempt at HO, the MS and serving BS shall resume Normal Operation communication.

*Insert new subclause 6.3.22.2.4:*

#### **6.3.22.2.4 Use of scanning and association results**

MS may scan target neighbor BSs and optionally try association. If the target BS had previously received HO notification from serving BS over the backbone, then target BS may place a Fast\_Ranging\_IE() (see 8.2.1.9.3.6, 8.3.6.3.9, and 8.4.5.4.21. Fast ranging Information Element) in the UL-MAP to allocate a non-contention-based Initial Ranging opportunity. MS shall scan target BS for UL-MAP that includes either a contention- or non-contention-based MS Initial Ranging opportunity.

*Insert new subclause 6.3.22.2.5:*

#### **6.3.22.2.5 Termination with the Serving BS**

After the handover request/response handshake has completed, the MS may begin the actual HO. At some stage during the HO process, the MS terminates service with the serving BS. This is accomplished by sending a MOB\_HO-IND message with the HO\_IND\_type value indicating serving BS release.

If the HO\_IND\_type field specifies serving BS release, the BS shall start the Resource retain timer from value Resource\_Retain\_Time provided by BS in REG-RSP, BSHO-REQ, or BSHO-RSP messages. The serving BS shall retain the connections, MAC state machine, and PDUs associated with the MS for service continuation until the expiration of Resource retain timer. Regardless of Resource retain timer, the serving BS shall remove MAC context and MAC PDUs associated with the MS upon reception of a backbone message from the target BS indicating MS Network Attachment at target BS.

If the serving BS determines to retain the connection information of an MS that has sent MOB\_HO-IND with HO\_IND\_type=0b00 and begun the actual HO, this connection information may be used by the MS in order to perform an expedited re-entry operation with target BS or the serving BS. The serving BS shall notify the MS of retention of MS connection information through Resource Retain Flag in MOB\_BSHO-RSP message or MOB\_BSHO-REQ message during handover request/response handshake operation. If Resource Retain Flag = 1 and Resource Retain Time is not included as a TLV item in the message, then the serving BS and MS shall use the System Resource Retain Time timer.

*Insert new subclause 6.3.22.2.6:*

**6.3.22.2.6 Drops during HO**

A drop is defined as the situation where an MS has stopped communication with its serving BS (either in the downlink or in the uplink) before the normal HO sequence outlined in Cell Selection and Termination with the serving BS has been completed.

An MS can detect a drop by its failure to demodulate the downlink, or by exceeding the RNG-REQ retries limit allowed for the periodic ranging mechanism. A BS can detect a drop when the Number of retries limit allowed on inviting Ranging Requests for the periodic ranging mechanism is exceeded.

When the MS has detected a drop during network re-entry with a target BS, it may attempt network re-entry with its preferred target BS as through Cell Reselection (see 6.3.22.2.1), and may include resuming communication with the Serving BS by sending MOB\_HO-IND message with HO\_IND type = 0b01 (HO cancel). If the MS fails network re-entry with its preferred Target BS, the MS shall perform initial entry procedure.

MS shall perform CDMA ranging with Target BS using codes from HO codes domain.

Upon Target BS sending RNG-RSP with 'ranging status' = success, Target BS shall provide CDMA\_ALLOC\_IE with appropriate UL allocation for RNG-REQ from MS. MS shall send RNG-REQ with MAC address and HMAC/CMAC. Target BS may now identify that HO attempt by MS was not coordinated with Serving BS and may request all relevant MS context from Serving BS. Using this info Target BS shall now send RNG-RSP with 'HO process optimization' bitmap and network re-entry may continue as in the typical, non-drop case.

When the serving BS has detected a drop, it shall react as if a MOB\_HO-IND message has been received with HO\_IND\_type indicating serving BS release.

*Insert new subclause 6.3.22.2.7:*

**6.3.22.2.7 Network entry/re-entry**

Unless otherwise indicated in this subclause, MS mobile network entry/re-entry is processed according to 6.3.9.

An MS and a target BS shall conduct Ranging per 6.3.9.5 except when dedicated Ranging opportunity is available, in which case, the procedure described in 6.3.22.2.4 shall be employed. For identification of the MS, RNG-REQ message may include MS MAC Address or HO\_ID (if assigned in MOB\_BSHO-REQ or MOB\_BSHO-RSP). The target BS shall assign to the MS Basic CID and Primary CID in the RNG-RSP management message.

The MS shall signal the target BS of a current HO attempt by including a serving BSID TLV and Ranging Purpose Indication TLV with Bit #0 set to 1 in the RNG-REQ management message. The MS shall not include a Ranging Purpose Indication TLV in the RNG-REQ management message unless actually in the process of conducting an HO, location update, or Network Re-entry from Idle Mode attempt.

If an MS RNG-REQ includes a serving BSID and Ranging Purpose Indication TLV with Bit #0 set to 1, and the target BS had not previously received MS information over the backbone, then the target BS may make an MS information request of the serving BS over the backbone network and the serving BS may respond. Regardless of having received MS information from the serving BS, the target BS may request MS information from another network entity via the backbone network.

Network re-entry proceeds per 6.3.9, except as may be shortened by the target BS's possession of MS information obtained from the serving BS over the backbone network, and except 6.3.9.10 to 6.3.9.12, which may be postponed until after the MS re-enters the network.

To notify an MS seeking HO of possible omission of re-entry process management messages during the current HO attempt (due to the availability of MS service and operational context information obtained over the backbone network), the target BS shall place in RNG-RSP an HO Process Optimization TLV indicating which re-entry management messages may be omitted. The MS shall complete the processing of all indicated messages before entering Normal Operation with target BS.

As indicated in the HO Process Optimization TLV settings, the target BS may elect to use MS service and operational information obtained over the backbone network to build and send unsolicited SBC-RSP and/or REG-RSP management messages to update MS operational information, or to include this information into TLV items in the RNG-RSP. If the target BS sends an unsolicited SBC-RSP or unsolicited REG-RSP message and the MS sends the corresponding SBC-REQ (REG-REQ) message, the BS may ignore only the first corresponding REQ management message received. The MS is not required to send the complimentary REQ management message if it receives an unsolicited SBC-RSP or unsolicited REG-RSP management message prior to MS attempt to send the corresponding REQ management message. Target BS re-entry unsolicited response management messages may be grouped into the same DL frame transmission with the RNG-RSP. However, unsolicited SBC-RSP and unsolicited REG-RSP may not be grouped together into the same DL frame transmission when the PKM-REQ/RSP management message process is required. For a security keying process that has not been determined to be omitted in the HO Process Optimization TLV settings, if MS RNG-REQ includes a serving BSID and Ranging Purpose Indication TLV with Bit #0 set to 1, and target BS has received a backbone message containing MS information, MS and target BS shall use the embedded TLV PKM-REQ information and the reauthorization process as defined in 7.2.

If the MS finishes the re-entry registration procedure by successfully receiving either an unsolicited REG-RSP message or a RNG-RSP message including REG-RSP specific TLV items, the MS shall send a Bandwidth Request header with zero BR field when Bit #12 of the HO Process Optimization TLV in the RNG-RSP message is set to one. If the BS receives a Bandwidth Request header with zero BR after sending either the unsolicited REG-RSP message or the RNG-RSP message including REG-RSP specific TLV items, the BS regards the Bandwidth Request header as a notification of MS's successful re-entry registration.

When, during capabilities negotiation, MS specifies that it supports IEEE 802.16 security, if the normal PKM initial network entry process as defined in 7.2 is to be abridged or omitted, then the MS shall include the HMAC/CMAC Tuple as the last message item in the RNG-REQ management message using the Authorization Key and Key Sequence Number derived for use on the target BS. If the required HMAC/CMAC Tuple is invalid or omitted in the RNG-REQ management message, then the full PKM REQ/RSP sequence must be completed and cannot be omitted. The target BS shall include a valid HMAC/CMAC Tuple as the last message item in the RNG-RSP if it instructs the MS, through the HO Process Optimization TLV, that the PKM-REQ/RSP sequence may be omitted.

If MS RNG-REQ includes a serving BSID and Ranging Purpose Indication TLV with Bit #0 set to 1, and target BS has received a backbone message containing MS information, the target BS may use MS service and operational information obtained over the backbone network to build and send a REG-RSP management message that includes service flow remapping information in SFID, New\_CID and Connection\_Info TLVs.

During HO, the target BS may notify the MS, through the Bit #7 MS DL data pending element of the HO Process Optimization TLV item in RNG-RSP, of post-HO re-entry MS DL data pending. Upon MS successful re-entry at the target BS, now the new serving BS, the new serving BS can transmit forwarded data (called "pre-HO pending MS DL data") to the MS. After completing reception of any HO pending MS DL data retained and forwarded, the MS may re-establish IP connectivity and the new serving BS may send a backbone message to request the old serving BS or other network entity to stop forwarding pre-HO pending MS DL data.

Network entry/re-entry process completes with establishment /re-establishment of provisioned connections.

When the target BS has detected a failed HO entry/re-entry attempt, it may inform the serving BS of HO failure through a backbone message indicating Handover Failure.

*Insert new subclause 6.3.22.2.8:*

#### **6.3.22.2.8 MS-Assisted coordination of DL transmission at Target BS for HO**

If both the Serving BS and the Target BS involved in the HO process can support continuity of ARQ or SDU\_SN enabled connections, the BSs and the MS may perform MS-Assisted coordination of DL transmission during HO as described in this subclause. Target BS may signal to the MS on the intention to apply this procedure using Bit #11 of ‘HO Process Optimization’ flag in the RNG-RSP message.

Once the MS has successfully completed handover to the Target BS (now new Serving BS), to maintain continuity of transmission to the MS between the old and new Serving BSs, the last successfully received information unit needs to be identified to the new Serving BS. Depending on whether the connection is ARQ enabled or ARQ disabled, the identity of the next information unit can be given by the ARQ block sequence number or the MAC SDU sequence number respectively.

MS can optionally support the feedback of the ARQ block sequence number or the virtual MAC SDU sequence number after the MS has successfully completed handover to the Target BS. The capability and the support for each connection are defined in the REG-REQ/RSP and DSA-REQ/RSP TLVs respectively.

- For ARQ enabled, the ARQ block sequence number is already available at the MS.
- For ARQ disabled, the following procedures shall be performed by the BS and the MS: the old Serving BS shall include a SDU SN extended subheader at least once every  $2^p$  MAC PDUs, where  $p$  is specified in the SN Feedback support TLV (11.7.8.9). Upon transmitting MOB\_BSHO-RSP (in response to receiving MOB\_MSHO-REQ, in case of MS initiated HO) or upon transmitting MOB\_BSHO-REQ (in case of BS initiated HO), if the old serving BS continues transmission of data to the MS, it shall include SDU SN extended subheader in MAC PDU at least once before “Estimated HO time” (the first time that MS is expected to communicate with the Target BS). The MS shall maintain MAC SDU sequence number based on the information received from the BS. When the MS receives a MAC PDU without SDU SN extended subheader, the MS shall increment the MAC SDU sequence number by one for every SDU received. When the MS receives MAC SDU sequence number from the BS, it shall reset the MAC SDU sequence number to the value included in SDU SN extended subheader.

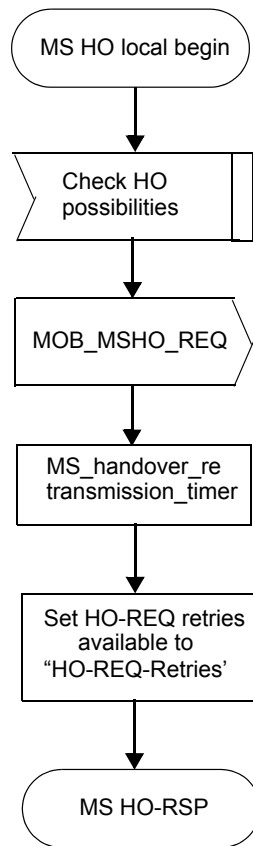
Upon completion of network re-entry, the Target BS (now new Serving BS) should provide UL allocation for the MS sufficient for transmission of SN Report MAC header with LSBs of the sequence number(s) of ARQ block or virtual MAC SDU number. After reception of SN Report MAC header, the BS shall resume transmission of the data of the corresponding DL Service Flow starting from MAC SDUs pointed by the sequence number. At the completion of network re-entry, the MS shall send SN Report MAC headers (as described in 6.3.2.1.2.1.7) that include the next ARQ Block (or virtual MAC SDU) sequence number that it is expecting for each of its connections that have SN feedback enabled. The MS shall send the sequence number in numerical ascending order of the values of the SFIDs values. The new Serving BS may send the SN request extended subheader to explicitly request an MS to send additional SN report header. After receiving the SN request extended subheader, the MS shall send the requested SN report header. The new Serving BS provides allocation through UL-MAP\_IE for the MS to send the additional SN report header.



*Insert new subclause 6.3.22.2.9:*

**6.3.22.2.9 HO process**

Figure 130d shows the process of an MS initiating handover with the BS.



**Figure 130d—MS initiating handover with the BS**

Figure 130e shows the process of an MS waiting for a response from the BS; in addition, it presents the case in which the MS has decided to stop the handover in the middle of the process.

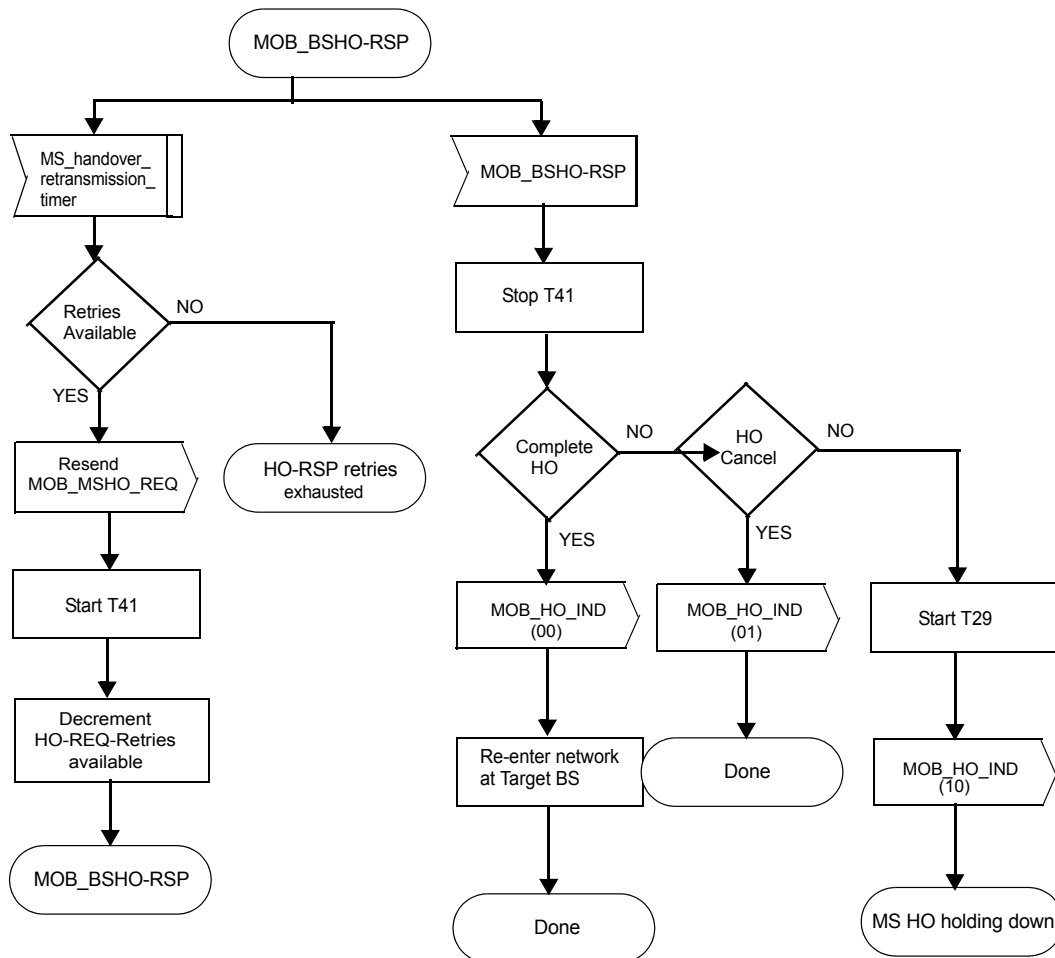


Figure 130e—locally initiated transaction MOB\_BSHO-RSP pending state flow diagram

Figure 130f shows the process of an MS following a canceling of the handover and ensuring that the MOB\_HO-IND message was received by the BS (by expiration of T42 timeout). While waiting, if new handover process is required, the MS shall stop T42 timer without waiting.

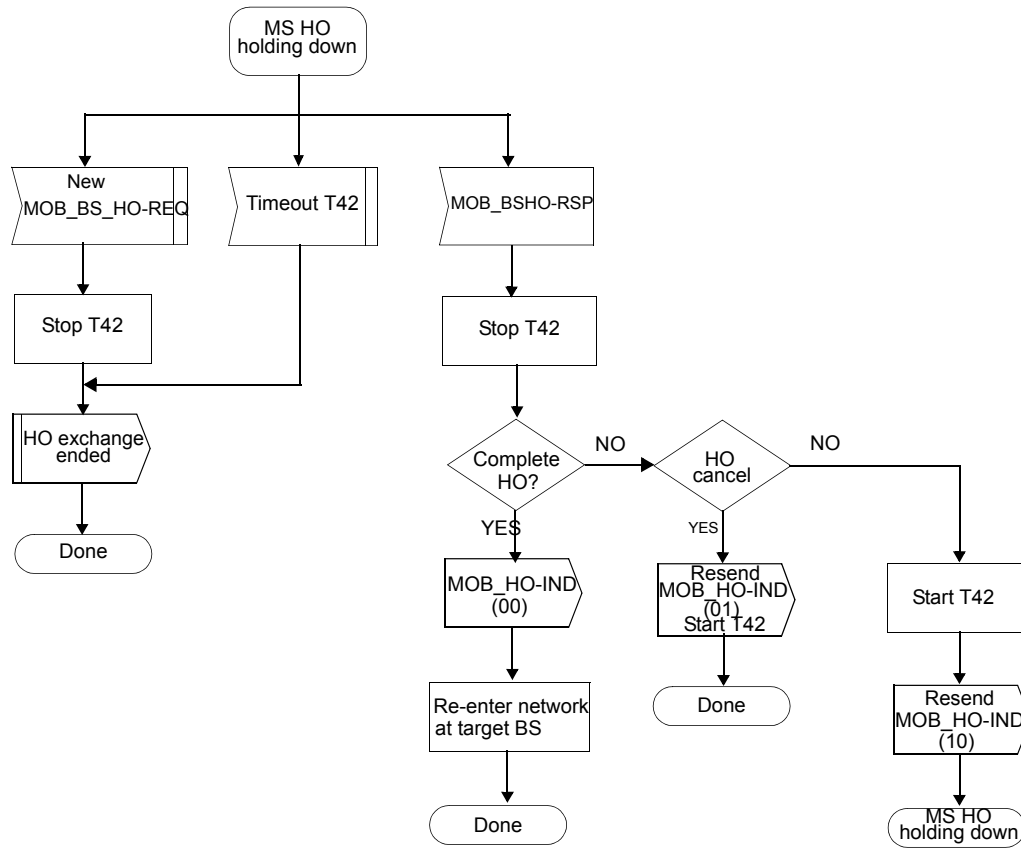


Figure 130f—Typical MS listening state flow diagram

Figure 130g shows the process of an MS receiving a MOB\_BSHO-REQ message from the BS; in addition, it presents the case in which the MS has decided to stop the handover in the middle of the process.

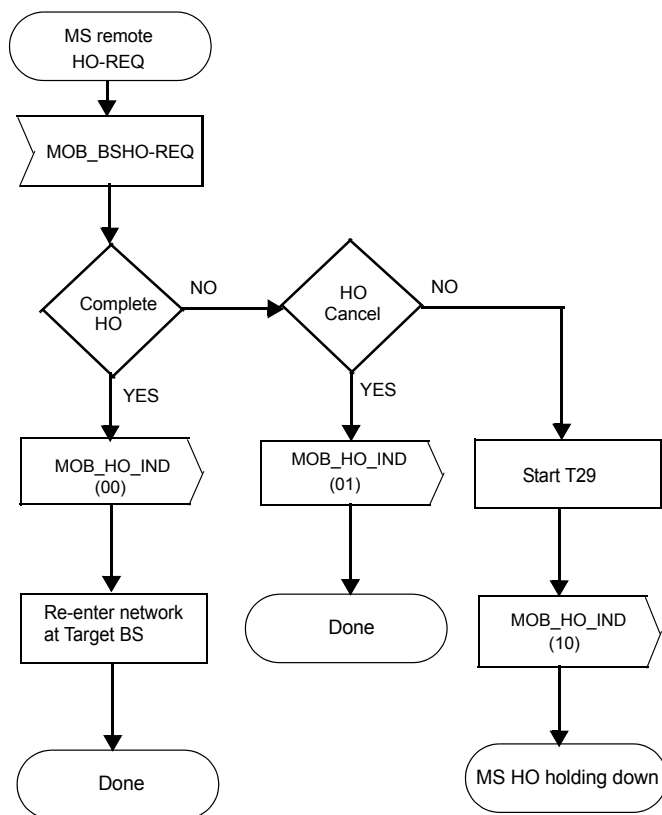


Figure 130g—locally initiated transaction MOB\_BSHO-RSP pending state flow diagram

*Insert new subclause 6.3.22.3:*

**6.3.22.3 Macro diversity handover and fast BS switching**

In addition to the HO procedures previously discussed, there are two optional HO modes, MDHO and FBSS. The MDHO or FBSS capability can be enabled or disabled in the REG-REQ/RSP message exchange. With MDHO or FBSS enabled, the MS shall perform the following stages:

- MDHO Decision: A MDHO begins with a decision for an MS to transmit to and receive from multiple BSs at the same time. A MDHO can start with either MOB\_MSHO-REQ or MOB\_BSHO-REQ messages.
- FBSS HO Decision: A FBSS handover begins with a decision for an MS to receive/transmit data from/to the Anchor BS that may change within the Diversity Set. A FBSS handover can be triggered by either MOB\_MSHO-REQ or MOB\_BSHO-REQ messages.

- Diversity Set Selection/Update: An MS may scan the neighbor BS and select BSs that are suitable to be included in the diversity set. The MS shall report the selected BSs and the diversity set update procedure shall be performed by the BS and the MS.
- Anchor BS Selection/Update: An MS is required to continuously monitor the signal strength of the BSs that are included in the diversity set. The MS shall select one BS from its current Diversity Set to be the Anchor BS and reports the selected Anchor BS on CQICH or MOB\_MSHO-REQ message.

If MOB\_BSHO-RSP specifies another HO type value than requested by MOB\_MSHO-REQ (for example, the MS requested HO and the BS prescribes MDHO/FBSS), then the MS should perform the procedure specified by the BS.

The MS should perform the procedure specified by the BS in HO Type field of MOB\_BSHO-REQ.

When a Diversity Set and an Anchor BS are maintained at the MS and the BS, the BS can decide to put the MS MDHO or FBSS on a per burst allocation basis, based on factors such as QoS of a particular service flow being transmitted.

*Insert new subclause 6.3.22.3.1:*

#### **6.3.22.3.1 MDHO decision and initiation**

Support of MDHO or FBSS is optional for both the MS and the BS.

For an MS and a BS that support MDHO, the MS and the BS shall maintain a list of BSs that are involved in MDHO with the MS. The list is called the Diversity Set. Among the BSs in the Diversity Set, an Anchor BS is defined. Regular operation when MS is registered at a single BS is a particular case of MDHO with Diversity Set consisting of single BS, which in this case shall be the Anchor BS. When operating in MDHO, the MS communicates with all BSs in the Diversity Set for UL and DL unicast messages and traffic.

There are two methods for the MS to monitor DL control information (i.e., DL-MAP, UL-MAP, and FCH) and DL broadcast messages. The first method is the MS monitors only the Anchor BS for DL control information and DL broadcast messages. In this case, the DL-MAP and UL-MAP of the Anchor BS may contain burst allocation information for the non-Anchor Active BS. The second method is the MS monitors all the BSs in the Diversity Set for DL control information and DL broadcast messages. In this case, the DL-MAP and UL-MAP of any Active BS may contain burst allocation information for the other Active BSs. The method to be used by MS is defined during the REG-REQ and REG-RSP handshake.

A MDHO begins with a decision for an MS to transmit/receive unicast messages and traffic from multiple BSs at the same time interval. For DL MDHO, two or more BSs provide synchronized transmission of MS downlink data such that diversity combining can be performed by the MS. For UL MDHO, the transmission from an MS is received by multiple BSs such that selection diversity of the information received by multiple BSs can be performed.

The BS supporting MDHO or FBSS shall broadcast the DCD message that includes the H\_Add Threshold and H\_Delete Threshold. These thresholds are used by the FBSS/MDHO capable MS to determine if MOB\_MSHO-REQ should be sent. When long-term CINR of a serving BS is less than H\_Delete Threshold, the MS shall send MOB\_MSHO-REQ to requires dropping this serving BS from the diversity set; when long-term CINR of a neighbor BS is higher than H\_Add Threshold, the MS shall send MOB\_MSHO-REQ to require adding this neighbor BS to the diversity set.

The decision to update the Diversity Set begins with a notification by the MS through the MOB\_MSHO-REQ message or by the BS through the MOB\_BSHO-REQ management message. The process of Anchor BS update may begin with MOB\_MSHO-REQ from MS or MOB\_BSHO-REQ from the Anchor BS.

Acknowledgement with MOB\_BSHO-RSP of a notification is required. After MS transmits MOB\_MSHO-REQ, MS shall not transmit any MOB\_MSHO-REQ prior to expiration of timer MS\_handover\_retransmission\_timer. MS shall deactivate timer MS\_handover\_retransmission\_timer on MS transmit of MOB\_HO-IND or MS receipt of MOB\_BSHO-RSP. Process of Anchor BS update may also begin with Anchor switching indication via fast-feedback channel.

If an MS that transmitted a MOB\_MSHO-REQ message detects an incoming MOB\_BSHO-REQ message, it shall ignore that MOB\_BSHO-REQ message. A BS that transmitted a MOB\_BSHO-REQ message and detects an incoming MOB\_MSHO-REQ or MOB\_HO-IND message from the same MS shall ignore its own previous request.

The BSs involving in MDHO with an MS shall use the same set of CIDs for the connections that are established with the MS. The BS may assign a new set of CIDs to the MS during Diversity Set update through MOB\_BSHO-REQ message and MOB\_BSHO-RSP message.

There are several conditions that are required to enable macro diversity handover and or Fast BS Switching handover between MS and a group of BSs. These conditions are listed below:

- The BSs involving in MDHO are synchronized based on a common time source.
- The frames sent by the BSs involving in MDHO at a given frame time arrive at the MS within the prefix interval.
- BSs involving in MDHO have synchronized frame structure.
- BSs involving in MDHO have the same frequency assignment.
- BSs involving in MDHO shall use the same set of CIDs for the connections that are established with the MS.
- The same MAC/PHY PDUs shall be sent by all the BSs involving in MDHO to the MS.
- BSs involved in MDHO are also required to share or transfer MAC context. Such context includes all information the MS and BS normally exchange during Network Entry, particularly authentication state, so that an MS authenticated/registered with one of BSs from diversity set BSs is automatically authenticated/registered with other BSs from the same diversity set. The context also includes a set of Service Flows and corresponding mapping to connections associated with MS, current authentication, and encryption keys associated with the connections.

*Insert new subclause 6.3.22.3.2:*

#### **6.3.22.3.2 FBSS decision and initiation**

Support of FBSS is optional for both MS and BS.

For MS and BS that support FBSS, the MS and the BS shall maintain a list of BSs that are involved in FBSS with the MS. The list is called the Diversity Set. Among the BSs in the Diversity Set, an Anchor BS is defined. Regular operation when MS is registered at a single BS is a particular case of FBSS with Diversity Set consisting of single BS, which in this case shall be the Anchor BS. When operating in FBSS, the MS only communicates with the Anchor BS for UL and DL messages including management and traffic connections. Transition from one Anchor BS to another (“switching”) is performed without invocation of HO procedure described in 6.3.22.2. Anchor update procedure is defined in 6.3.22.3.4.

The BS supporting FBSS shall broadcast the DCD message that includes the H\_Add Threshold and H\_Delete Threshold. These thresholds may be used by the FBSS capable MS to determine if MOB\_MSHO-REQ should be sent to request switching to another Anchor BS or changing Diversity Set. When mean CINR of a BS is less than H\_Delete Threshold, the MS may send MOB\_MSHO-REQ to request dropping this BS from the diversity set; when mean CINR of a neighbor BS is higher than H\_Add Threshold, the MS

may send MOB\_MSHO-REQ to request adding this neighbor BS to the diversity set. In each case, Anchor BS responds with MOB\_BSHO-RSP with updated Diversity Set.

The process of Anchor BS update may begin with MOB\_MSHO-REQ from MS or MOB\_BSHO-REQ from the Anchor BS. Acknowledgement of MOB\_MSHO-REQ with MOB\_BSHO-RSP is required. After MS transmits MOB\_MSHO-REQ, MS shall not transmit any MOB\_MSHO-REQ prior to expiration of timer MS\_handover\_retransmission\_timer. The MS shall deactivate the timer MS handover retransmission timer upon MS transmit of MOB\_HO-IND or upon MS receipt of MOB\_BSHO-RSP. The process of Anchor BS update may also begin with Anchor switching indication via fast-feedback channel.

If an MS that transmitted a MOB\_MSHO-REQ message detects an incoming MOB\_BSHO-REQ message, it shall ignore that MOB\_BSHO-REQ message. A BS that transmitted a MOB\_BSHO-REQ message and detects an incoming MOB\_MSHO-REQ or MOB\_HO-IND message from the same MS shall ignore its own previous request.

There are several conditions that are required to enable Fast BS Switching handover between MS and a group of BSs. These conditions are listed below:

- BSs involving in FBSS are synchronized based on a common time source
- The frames sent by the BSs from Diversity Set arrive at the MS within the prefix interval
- BSs involving in FBSS have synchronized frames
- BSs involving in FBSS operate at same frequency channel
- BSs involving in FBSS are also required to share or transfer MAC context. Such context includes all information MS and BS normally exchange during Network Entry, particularly authentication state, so that an MS authenticated/registered with one of BSs from diversity set BSs is automatically authenticated/registered with other BSs from the same diversity set. The context also includes a set of Service Flows and corresponding mapping to connections associated with MS, current authentication, and encryption keys associated with the connections.

*Insert new subclause 6.3.22.3.3:*

### **6.3.22.3.3 Diversity Set update for MDHO/FBSS**

When MOB\_MSHO-REQ is sent by an MS, the MS may provide a possible list of BSs to be included in the MS' Diversity Set. The MS may evaluate the possible list of BSs through the received MOB\_NBR-ADV message, and previously performed signal strength measurement, propagation delay measurement, scanning, ranging, and association activity. When MOB\_BSHO-RSP is sent by the Anchor BS or BSs in the MS' current Diversity Set, the BSs may provide a list of BSs recommended for incorporation into the MS' Diversity Set.

When MOB\_BSHO-REQ is sent by the Anchor BS or BSs in the MS' current Diversity Set, the BSs may provide a recommended list of BSs to be included in the MS' Diversity Set. The criteria for the recommendation may be based on expected QoS performance to MS requirements and list of BSs that can be involved in MDHO/FBSS as broadcast in MOB\_NBR-ADV.

MS actual update of Diversity Set is recommended, but not required. However, the actual Diversity Set chosen by the MS shall be a subset of those listed in MOB\_BSHO-RSP or in MOB\_BSHO-REQ and shall be indicated in MOB\_HO-IND, with MDHOFBSS\_IND\_type field in MOB\_HO-IND set to 0b00 (confirm Diversity Set update). The MS may reject the Diversity Set recommended by the Anchor BS by setting the MDHOFBSS\_IND\_type field in MOB\_HO-IND to 0b10 (Diversity Set update reject). The BS may reconfigure the Diversity Set list and retransmit MOB\_BSHO-RSP message to the MS.

After an MS or BS has initiated an Diversity Set update using MOB\_MSHO/BSHO-REQ, the MS may cancel the Diversity Set update at any time. The cancellation shall be made through transmission of a MOB\_HO-IND with MDHOFBSS\_IND\_type field set to 0b01.

If the MS is operating in FBSS, when adding a new BS to the MS' Diversity Set, the MS may initiate ranging with newly added BS.

*Insert new subclause 6.3.22.3.4:*

#### **6.3.22.3.4 Anchor BS update for MDHO/FBSS**

There are two mechanisms for the MS and BS to perform Anchor BS update. The first mechanism is by using the HO messages. The second mechanism is by using the fast Anchor BS selection feedback. The preferred Anchor BSs shall be within the current Diversity Set of the MS. The MS may select the preferred Anchor BS through the previously performed signal strength measurement. The BS decides the target Anchor BS based on the MS report. MS and BS supporting MDHO or FBSS shall implement one of the two mechanisms to perform Anchor BS update.

*Insert new subclause 6.3.22.3.4.1:*

##### **6.3.22.3.4.1 HO MAC management message method**

For the method using MAC management message, the MS reports the preferred Anchor BS by using the MOB\_MSHO-REQ message. The BS informs the MS of the Anchor BS update through MOB\_BSHO-REQ or MOB\_BSHO-RSP message with the estimated switching time. The MS shall update its Anchor BS based on the information received in MOB\_BSHO-REQ or MOB\_BSHO-RSP. The MS also shall indicate its acceptance of the new anchor BS through MOB\_HO-IND, with MDHOFBSS\_IND\_type field set to 0b00. The MS may reject the Anchor BS update instruction by the BS, by setting the MDHOFBSS\_IND\_type field in MOB\_HO-IND to 0b10 (Anchor BS update reject). The BS may reconfigure the Anchor BS list and retransmit MOB\_BSHO-RSP or MOB\_BSHO-REQ message to the MS. After an MS or BS has initiated an Anchor BS update using MOB\_MSHO/BSHO-REQ, the MS may cancel Anchor BS update at any time. The cancellation shall be made through transmission of a MOB\_HO-IND with MDHOFBSS\_IND\_type field set to 0b01.

When switching to a new Anchor BS within the MS' Diversity Set, the network entry procedures, as depicted in Figure 130b, are not required and shall not be performed by the MS.

*Insert new subclause 6.3.22.3.4.2:*

##### **6.3.22.3.4.2 Fast Anchor BS selection feedback mechanism**

For MS and BS using the Fast-feedback method to update Diversity Set, when the MS has more than one BS in its Diversity Set, the MS shall transmit fast Anchor BS selection information to the current Anchor BS using Fast-feedback channel. If the MS needs to transmit Anchor BS selection information, it transmits the codeword corresponding to the selected Anchor BS via its Fast-feedback channel. The codeword is identified by TEMP\_BSID assigned to the BSs in an diversity set.

Fast-feedback channel shall be allocated by one of the following three methods:

- a) Pre-allocated by MOB\_BSHO-RSP or MOB\_BSHO-REQ when a BS is added to the diversity set.
- b) Allocated through Anchor\_Switch\_IE during anchor switching operation.
- c) Allocated by UL-MAP of the new anchor BS after the switching period.



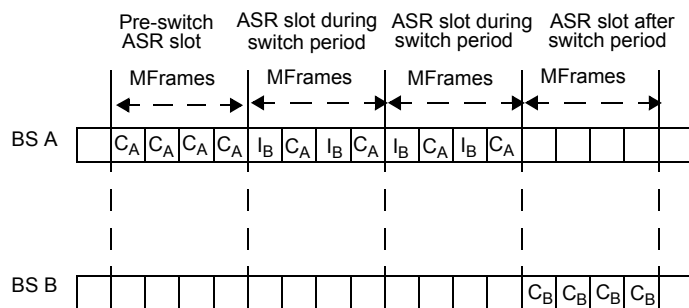
For FBSS operation, the time axis is slotted by an ASR (Anchor Switch Reporting) slot that is  $M$  frame long. If the current frame number is  $N$ , then the ASR slot number shall be the integer quotient of  $N$  divided by  $M$ . The ASR slot shall start at the frame where frame number modulus  $M$  equals to zero.  $M$  shall be configured by the DCD. A switching period is introduced whose duration is equals to  $L$  ASR slots.  $L$  shall be configured by the DCD to be long enough such that certain process (e.g., HARQ transmission, backhaul context transfer) can be completed at the current anchor BS before the MS switches to the new anchor BS.

The switching operation for  $L = 2$  is illustrated in Figure 130h. In the first ASR slot, the MS detects the signal strength from a BS in the diversity set (e.g., BS B) is better than that of the current anchor BS (e.g., BS A) such that a switch to the new anchor BS is desired. The MS transmits the anchor BS switch indicator at the beginning of the next ASR slot. At the start of the second ASR slot, the MS shall start a switching timer with value equals to the switching period. Starting from the second ASR slot and for the subsequent ASR slots prior to the expiry of the switching timer, the MS shall transmit the anchor switch indicator through CQICH allocated by the current Anchor BS (e.g., BS A).

The current anchor BS may send the `Anchor_Switch_IE` prior to the expiry of the switching timer to do one of the following: 1) acknowledge the MS's switch indication and/or assign a CQICH at the new Anchor BS (BS B), and/or specify a new action time when the switch shall occur, and/or specify a new anchor BS to switch to; 2) cancel the MS switching event. If the MS does not receive an `Anchor_BS_switch_IE` prior to the expiry of the switching timer, the MS shall switch to the new Anchor BS after the expiry of the switching timer. If the MS receives an `Anchor_BS_Switch_IE` prior to the expiry of the switching timer with no cancellation and no new action time specified, the MS shall switch to the new Anchor BS after the expiry of the switching timer. If the MS receives an `Anchor_BS_Switch_IE` prior to the expiry of the switching timer with new action time specified, the MS shall switch to the new Anchor BS at the action time specified. If the MS receives an `Anchor_BS_Switch_IE` with cancellation prior to the expiry of the switching timer, the MS shall cancel the switching operation. If the MS successfully decodes an `Anchor_BS_Switch_IE`, the MS shall acknowledge the reception of the IE using the allocated codeword over the CQICH.

Prior to the expiry of the switching timer, the MS shall report CQI of the current anchor BS (e.g., BS A) and anchor switch indication on alternate frames. If the MS started the switching operation by indicating a BS within the diversity set (e.g., BS B) as the new anchor BS, the MS shall not indicate another new anchor BS prior to the expiry of the switching timer. Prior to the expiry of the switching timer, if the MS has intention to cancel the switching due to factors such as the signal strength of the new anchor BS (e.g., BS B) is no longer higher than that of the current anchor BS (e.g., BS A) by a certain threshold, the MS shall continue to indicate BS B in the CQICH during the switching period. However, the MS can initiate the cancellation of the anchor BS switch if, and only if, no `Anchor_BS_Switch_IE` with cancellation flag disabled is received prior to the expiry of the switching timer. In such case, after the expiry of the switching timer, the MS shall stay with BS A and shall transmit the CQI on the same CQICH allocated by BS A in the same fashion as prior to the switch operation starts. On the BS side, after the expiry of the switching timer, the BS A shall continue to monitor the same CQICH allocated to the MS for an implementation dependent duration. If CQI transmission is detected, the BS A shall assume that the MS has cancelled the switch. The MS shall not initiate cancellation of the switch if `Anchor_BS_Switch_IE` with cancellation flag disabled is received prior to the expiry of the switching timer.

If no cancellation occurs, after the expiry of the switching timer, the MS shall switch to the new anchor BS (e.g., BS B) and monitor the downlink of BS B. If the BS B has already pre-allocated a CQICH to the MS (this can be done using `MOB-_BSHO-RSP` or `Anchor_Switch_IE`), the MS reports the CQI using the allocated CQICH and may begin the normal communication with the new anchor BS (e.g., BS B) starting from the first frame after the expiry of the switching timer. If CQICH is not pre-allocated to the MS prior to the switch, the MS shall monitor the MAP from the new anchor BS (e.g., BS B) and wait for the CQICH allocation after the switch. If after the switch, the MS does not receive a CQICH allocation within duration equals to the switching period, the MS requests the new anchor BS (e.g., BS B) to allocate CQICH channel by transmitting CQICH allocation request header. If the new anchor BS (e.g., BS B) receives CQICH allocation request header, the BS shall allocate a CQICH for the MS.



**Figure 130h—Fast anchor BS selection mechanism**

If MDHO support is negotiated, the BS may assign UL resource to the MS to send combined CQI of active BSs using the Feedback header. The BS may also assign fast-feedback channel or Enhanced fast-feedback channel for CQI feedback. When such a channel is assigned, the MS shall report the CQI of the Anchor BS on the channel.

*Insert new subclause 6.3.22.3.5:*

**6.3.22.3.5 MS-Assisted coordination of DL transmission at new Anchor BS**

The following procedure shall only be supported for FBSS.

Once the MS has successfully switched to the new anchor BS, to maintain continuity of transmission to the MS between the old and new anchor BSs, the last successfully received information unit needs to be identified to the new anchor BS. Depending on whether the connection is ARQ enabled or ARQ disabled, the identity of the next information unit can be given by the ARQ block sequence number or the MAC SDU sequence number respectively.

MS can optionally support the feedback of ARQ block sequence number or the virtual MAC SDU sequence number after the MS has successfully switched to the new anchor BS. The capability and the support for each connection are defined in the REG-REQ/RSP and DSA-REQ/RSP TLVs respectively.

For the connections that have SN Feedback enabled, the following procedures shall be performed by the BS and the MS:

- For ARQ disabled with SN feedback enabled, the BS shall include a SDU SN extended subheader at least once every  $2^p$  MAC PDUs, where p is specified in the MAC header and extended subheader support TLV (11.7.25). Upon receiving anchor BS switching request from the MS, the old anchor BS shall include SDU SN extended subheader in MAC PDU at least once before the expiration of the switching timer. The MS shall maintain MAC SDU sequence number based on the information received from the BS. When the MS receives a MAC PDU without SDU SN extended subheader, the MS shall increment the MAC SDU sequence number by one for every SDU received. When the MS receives MAC SDU sequence number from the BS, it shall reset the MAC SDU sequence number based on the value included in SDU SN extended subheader.
- At the expiration of the Anchor switch timer, the new anchor BS should assign UL resource through UL-MAP\_IE for the MS to transmit the LSB of the sequence number(s) of ARQ block or virtual MAC SDU on the SN Report MAC header (6.3.2.1.6). At the expiration of the Anchor switch timer,

- the MS shall send up to two SN Report MAC headers (with Last = 0 and Last = 1 as described in 6.3.2.1.2.1.7) that include the next ARQ Block (or virtual MAC SDU) sequence number that it is expecting for each of its connections that have SN feedback enabled. The MS shall send the sequence number in numerical ascending order of the values of the SFIDs values. The new anchor BS may send the SN request extended subheader to explicitly request an MS to send additional SN report header. After receiving the SN request extended subheader, the MS shall send the requested SN report header. The new anchor BS may assign UL resource through UL-MAP\_IE for the MS to send the additional SN report header.
- Once the handover to the new anchor BS has been completed, acknowledgement and/or retransmission of any outstanding ARQ blocks is handled per the ARQ mechanism defined in 6.3.4.

*Insert new subclause 6.3.23:*

### **6.3.23 Multicast and broadcast services (MBS)**

Some globally defined service flows may carry broadcast or multicast information that should be delivered to a plurality of SS or MS. Such service flows have certain QoS parameters and may require encryption performed using a globally defined sequence of TEKs. Since a multicast or broadcast transport connection is associated with a service flow, it is associated with the QoS and traffic parameters for that service flow. Some MS are registered to certain BS while some are in Idle mode and not currently served by any specific BS.

Two types of access to multicast and broadcast services (MBS) may be supported: single-BS access and multi-BS access. Single-BS access is implemented over multicast and broadcast transport connections within one BS, while multi-BS access is implemented by transmitting data from Service Flow(s) over multiple BS. MS may support both Single-BS and Multi-BS access. ARQ is not applicable to either single-BS-MBS or multi-BS-MBS. Initiation of MBS with respect to specific MS is always performed in registered state by creation of multicast connection carrying MBS data. During such initiation the MS learns the Service Flow ID that identifies the service. For multi-BS-MBS, each BS capable of providing MBS belongs to a certain MBS Zone, which is a set of BSs where the same CID and same SA is used for transmitting content of certain Service Flow(s). MBS Zone is identified by a unique MBS\_ZONE identifier.

*Insert new subclause 6.3.23.1:*

#### **6.3.23.1 Single-BS Access**

The BS may provide the MS with single-BS access by creating a multicast traffic connection with each MS to be associated with the service or a broadcast transport connection. Any available traffic CID value may be used for the single-BS-MBS service. The CID used for the service is the same for all MS on the same channel that participate in the connection. The data transmitted on the connection with the given CID shall be received and processed by the MAC of each involved MS. Thus, each multicast MAC SDU is transmitted only once per BS channel.

If a downlink multicast connection is to be encrypted, each MS participating in the connection shall have an additional security association (SA), allowing that connection to be encrypted using certain keys that are independent of those used for other encrypted transmissions between the MS and BS.

*Insert new subclause 6.3.23.2:*

#### **6.3.23.2 Multi-BS Access**

Multi-BS-MBS is defined as a kind of service that all MSs successfully registered to the specific Multi-BS-MBS connection (each MS needs register to MBS service at the network level simultaneously) can receive

on the cell the encrypted MAC PDUs of the multicast and broadcast content that multiple BSs transmit anywhere under the given time period. It requires the multiple BS participating in same Multi-BS-MBS service to be synchronized in the transmissions of common multicast/broadcast data. To ensure proper multicast operation on networks of BS employing synchronized transmissions of common multicast data, the CID used for a multi-BS-MBS connection shall be the same for all BS and MSs on the same channel that participate in the connection.

Multicast service synchronized across multiple BS enables an MS to receive the multicast or broadcast transmission from multiple BS, and thereby improve the reliability of reception. In contrast to Single-BS access, Multi-BS access does not require that the MS be registered to the BS from which it receives the transmission, or to any other BS. In this case, transmitted MAC PDUs shall use the same CID, and transport the same data synchronized across the group of BS across the group of BS. A multicast and broadcast zone identifier (MBS\_ZONE) is used to indicate the group of BS through which a CID and SA for a broadcast and multicast service flow are valid.

During a Dynamic Service Addition procedure, an MBS connection for multiple MBS contents can be established by using an MBS Contents Identifier TLV encoding in DSA-REQ or DSA-RSP message sent by the BS as described in 11.13.36. In other words, when the MS sends DSA-REQ message with the MBS service request as described in 11.13.23, the BS may respond to it with DSA-RSP message including an MBS Contents Identifier TLV encoding. The BS may also send the MS a DSA-REQ message including an MBS Contents Identifier TLV encoding in order to make an establishment of an MBS connection. Logical Channel ID, which pairs with Multicast CID in MBS\_DATA\_IE, is allocated to each MBS Contents IDs in the order that it is included in TLV value. As a result, an MS can receive multiple MBS messages for an MBS connection with different MBS contents distinguished by Logical Channel ID belonging to a Multicast CID. BS shall allocate MBS PDUs in the order that the combination of Multicast CID and Logical Channel ID is defined in Extended\_MBS\_DATA\_IE.

*Insert new subclause 6.3.23.2.1:*

#### **6.3.23.2.1 Establishment and maintenance of multicast and broadcast services**

Establishment of MBS with respect to certain Service Flow is always performed when MS is registered to certain BS. Such establishment is specified in 6.3.23.1.

Multicast and broadcast services are associated with multicast and broadcast service flows. Multicast and broadcast service flows are not dedicated to the specific MS and are maintained even though the MS is either in awake/sleep mode or in the idle mode. When an MS is registered at a BS for receiving multicast and broadcast service, multicast and broadcast service flows shall be instantiated as multicast connections. Data of multicast and broadcast service flows may be transmitted from BS and received at MS also regardless of what mode the MS is currently in. The BS may establish a downlink multicast and broadcast service by creating a multicast and broadcast service flows when the service commences.

Mapping of multicast and broadcast service flow IDs to CIDs shall be known to all BSs belong to the same multicast and broadcast service zone.

When the MS is being registered at BS for receiving multicast and broadcast services, it shall initiate DSA procedure with respect to multicast and broadcast connections to inform the BS that the MS is a consumer of certain multicast/broadcast services. Such knowledge may be used to initiate bi-directional upper layers communication between the MS and the network for the purpose of configuration of multicast/broadcast service. After the successful configuration, the MS may reuse the same configuration when it moves to another BS without re-configuration.

During communication to the BS the MS may learn MBS\_ZONE identifier. If MS acquired MBS\_ZONE and goes to Idle Mode, then the MS may continue receiving MBS content from any BS that advertises the

same MBS\_ZONE. By doing this, the MS uses the same CID and SA that were used in registered state. In case MS, still in Idle state, migrates to BS advertising another MBS\_ZONE, it is expected to register at that BS and to acquire a new CID and SA for further reception of MBS content.

Multicast and broadcast service flows are encrypted at the application layer or MAC layer or both. Upper layer encryption may be employed to prevent non-authorized access to multicast and broadcast content. Multicast and broadcast service may provide access control against theft of service by enforcing data encryption based on AES-CTR defined in NIST Special Publication 800-38A, FIPS 197. Details of MBS Security is defined in 7.8.3.

*Insert new subclause 6.3.23.2.2:*

#### **6.3.23.2.2 Performance enhancement with macro diversity**

To increase the receiving performance, MBS transmission in a group of BS should be synchronized. In such case, each BS shall transmit the same PDUs, using the same transmission mechanism (symbol, subchannel, modulation, and etc.) at the same time. The way that multiple BSs accomplish the synchronized transmission (which implies performing functions like classification, fragmentation, scheduling at a centralized point called the MBS Server) is outside the scope of the standard. In order to indicate the allocation of MBS data, MBS MAP shall denote corresponding bursts with multicast CIDs associated with certain Service Flows within given MBS Zone.

*Insert new subclause 6.3.23.2.3:*

#### **6.3.23.2.3 Power saving operation**

To facilitate power efficient reception of MBS data, an MBS\_MAP\_IE may be placed in the DL-MAP to point to the location of a dedicated MBS allocation in the DL subframe. The purpose of this IE is to do the initial direction of the MS to the MBS allocation, and to redirect MS that lost synchronization with MBS allocations back to the next MBS allocation.

*Insert new subclause 6.3.23.2.4:*

#### **6.3.23.2.4 Multicast and broadcast zone (MBS\_Zone)**

Different CIDs or different SAs may be used in different regions for the same multicast and broadcast service flow. A multicast and broadcast zone identifier (MBS\_ZONE) is used to indicate a region through which a CID and SA for a broadcast and multicast service flow are valid. BS may advertise MBS\_ZONE in DCD message. In case BS sends DSA for establishment of connection for MBS, MBS\_ZONE shall be encoded in the DSA message. If an MS in Idle mode moves into BSs in the same MBS zone, the MS does not have to re-enter the network and to re-establish a connection or a connection defined by MBS Contents Identifier to monitor the multicast and broadcast service flow. However, if an MS moves into a different MBS zone, the MS may need to re-establish a connection or a virtual connection for the multicast and broadcast service flow.

One BS may have multiple MBS zone identifiers.

*Insert new subclause 6.3.24:*

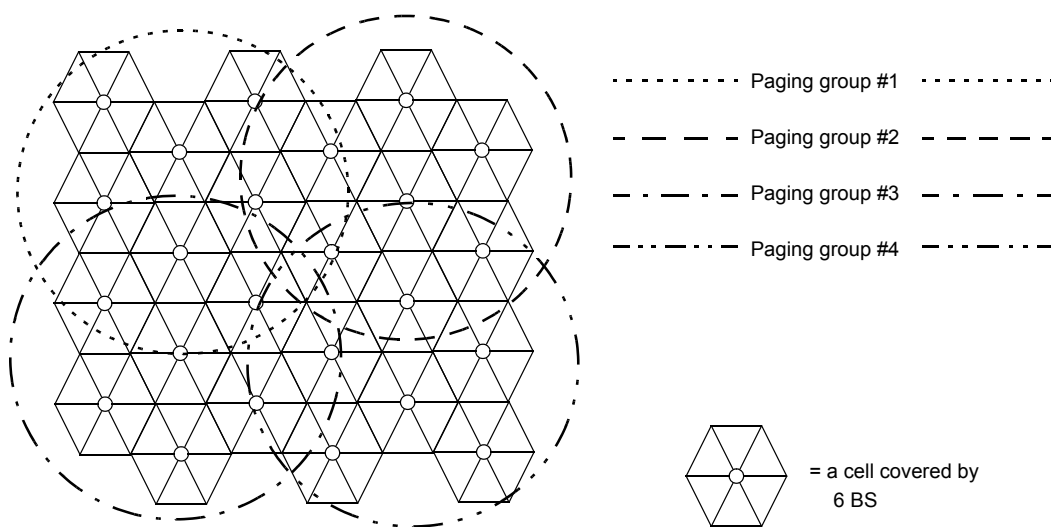
#### **6.3.24 MS Idle Mode (optional)**

Idle Mode is intended as a mechanism to allow the MS to become periodically available for DL broadcast traffic messaging without registration at a specific BS as the MS traverses an air link environment populated by multiple BSs, typically over a large geographic area. Idle Mode benefits MS by removing the active

requirement for HO, and all Normal Operation requirements. By restricting MS activity to scanning at discrete intervals, Idle Mode allows the MS to conserve power and operational resources.

Idle Mode benefits the network and BS by providing a simple and timely method for alerting the MS to pending DL traffic directed toward the MS, and by eliminating air interface and network HO traffic from essentially inactive MS.

The BSs are divided into logical groups called paging groups. The purpose of these groups is to offer a contiguous coverage region in which the MS does not need to transmit in the UL, yet can be paged in the DL if there is traffic targeted at it. The paging groups should be large enough so that most MSs will remain within the same paging group most of the time, and small enough such that the paging overhead is reasonable. Figure 130i shows an example of four paging groups defined over multiple BS arranged in a hexagonal grid. A BS may be a member of one or more Paging Groups.



**Figure 130i—Paging-groups example**

The paging-groups are defined in the management system. One possible method of definition is by using the paging-group-action backbone message. Another backbone message, paging-announce, is used to manage the list of MS in idle mode and initiate paging of the MS on all BS belonging to the paging group.

Idle is comprised of the following activities/stages:

- MS Idle Mode Initiation
- Cell Selection
- MS Broadcast Paging Message time synchronization
- MS Paging Unavailable Interval
- MS Paging Listening Interval
- BS Paging Interval
- BS Broadcast Paging message
- Paging Availability Mode Termination

***Insert new subclause 6.3.24.1:*****6.3.24.1 MS Idle Mode Initiation**

Idle Mode Initiation may begin after MS De-Registration. During Normal Operation with its serving BS, an MS may signal intent to begin Idle Mode by sending a DREG-REQ with a De-Registration\_Request\_Code = 0x01; request for MS De-Registration from serving BS and initiation of MS Idle Mode. If the MS does not receive the DREG-CMD message within T45 timer expiry after it sends the DREG-REQ message to the BS, the MS shall retransmit the DREG-REQ message as long as DREG Request Retry Count has not been exhausted. Otherwise, the MS shall re-initialize MAC. Also, the BS shall start Management\_Resource\_Holding\_Timer to maintain connection information with the MS as soon as it sends the DREG-CMD message to the MS. If Management\_Resource\_Holding\_Timer has been expired, the BS shall release connection information with the MS. Similarly, a serving BS may signal for an MS to begin Idle Mode by sending a DREG-CMD with an Action Code = 0x05 in unsolicited manner. In this case of BS initiated Idle Mode, the serving BS shall start T46 timer as well as Management\_Resource\_Holding\_Timer at the same time. If the BS does not receive the DREG-REQ message with De-Registration\_Request\_Code = 0x02 from the MS in response to the unsolicited DREG-CMD with Action Code = 0x05 within T46 timer expiry, the BS shall retransmit the DREG-CMD message with Action Code = 0x05 in unsolicited manner as long as DREG Command Retry Count has not been exhausted. MS shall enter Idle Mode after it sends DREG-REQ message with De-Registration\_Request Code = 0x02 in response to the unsolicited DREG-CMD with Action Code = 0x05.

As another case of BS initiated Idle Mode, the serving BS may also include a REQ-duration TLV with an Action Code = 0x05 in the DREG-CMD, signaling for an MS to initiate an Idle Mode request through a DREG-REQ with Action Code = 0x01, request for MS De-Registration from serving BS and initiation of MS Idle Mode, at REQ-duration expiration. In this case, BS shall not start T46 timer. MS may include Idle Mode Retain Information TLV with in DREG-REQ message with Action Code=0x01 transmitted at the REQ-duration expiration. In this case, BS shall transmit another DREG-CMD message with Action Code=0x05 including Idle Mode Retain Information TLV.

At the expiration of T46 timer due to no reception of DREG-REQ. BS shall retransmit the unsolicited DREG-CMD message, reset Management Resource Holding Timer, and increment DREG Command Retry Count. These operations may go on until BS receives the DREG-REQ message from MS. If DREG Command Retry Count is exhausted, BS shall not retransmit DREG-CMD message any more. On the contrary, if BS receives DREG-REQ message De-Registration\_Request\_Code = 0x02 as long as DREG Command Retry Count is not exhausted, BS regards MS as entering Idle Mode normally and deletes the MS's connection information at expiration of Management Resource Holding Timer.

For MS terminating Normal Operation with the serving BS and entering Idle Mode, the Paging Controller—the serving BS or other network entity administering Idle Mode activity for the MS—may retain certain MS service and operational information useful for expediting a future MS network re-entry from Idle Mode. The MS may request Paging Controller retention of specific MS service and operational information for Idle Mode management purposes through inclusion of the Idle Mode Retain Information element in the DREG-REQ management message. The serving BS shall report the likely effect on expedited future MS network re-entry due to Paging Controller retention of MS service and operational context by reporting the indicative Idle Mode Retain Information in DREG-CMD. Similarly, the BS may also include Idle Mode Retain Information element in the unsolicited DREG-CMD message.

The MS shall maintain an Idle Mode Timer and Paging Controller shall maintain an Idle Mode System Timer to provide an interval timer to prompt MS Idle Mode Location Update activity and demonstrate MS continued network presence to re-validate Paging Controller retention of MS service and operational information. Idle Mode Timer and Idle Mode System Timer shall start on serving BS transmission of DREG-CMD directing MS transition to Idle Mode. Idle Mode Timer and Idle Mode System Timer shall recycle on any successful MS network Idle Mode Location Update. On expiration of Idle Mode System Timer or on

MS network entry/reentry and resumption of Normal Operation, the Paging Controller shall discard all MS service and operational information retained for Idle Mode management purposes. On expiration of Idle Mode Timer, the MS shall consider that Paging Controller has discarded all MS service and operational information retained for Idle Mode management purposes. If the MS intends to retain the MS service and operational information, the MS should avoid Idle Mode Timer and Idle Mode System Timer expiration, by performing location update operation sufficiently ahead of the time expiration of the Idle Mode Timer and Idle Mode System Timer.

When MS enters idle mode, ARQ state information and parameters between MS and BS are removed and ARQ is reset when connection is setup during network re-entry after idle mode.

The MS may request BS inclusion of MS MAC Address Hash in MOB\_PAG-ADV message at regular intervals, regardless of need for notification, by including 'MAC Hash Skip Threshold' in DREG-REQ with Action Code=0x01. The value of MAC Hash Skip Threshold specifies the maximum number of successive MOB\_PAG-ADV messages that may be sent from a BS without individual notification for an MS, including MAC Address Hash of an MS for which Action Code is 00, 'No Action Required'. Provided the BS approves the MS deregistration with initiation of Idle Mode and elects MAC Hash Skip Threshold function, the BS shall respond by sending DREG-CMD message with Action Code=0x05 and including the MAC Hash Skip Threshold TLV.

*Insert new subclause 6.3.24.2:*

#### **6.3.24.2 Cell selection**

At MS Idle Mode Initiation, an MS may engage in cell selection to obtain a new Preferred BS. A Preferred BS is a Neighbor BS that the MS evaluates and selects as the BS with the best air interface DL properties. The Preferred BS may be the MS's previous Serving BS. In all other respects, cell selection is similar to 6.3.22.2.1.

*Insert new subclause 6.3.24.3:*

#### **6.3.24.3 MS Broadcast Paging Message time synchronization**

At evaluation and selection of the Preferred BS, the MS shall synchronize and decode the DCD and DL-MAP for the Preferred BS, extracting the frame size and frame number. The MS shall evaluate the frame size and frame number and use them to determine time until next regular BS Paging Interval for the Preferred BS. The calculated time until the next regular BS Paging Interval, less any MS DL scanning, decoding, and synchronization time requirements, shall be the MS Paging Unavailable Interval.

*Insert new subclause 6.3.24.4:*

#### **6.3.24.4 MS Paging Unavailable Interval**

During MS Paging Unavailable Interval, the MS may power down, scan Neighbor BSs, re-select a Preferred BS, conduct ranging, or perform other activities for which the MS will not guarantee availability to any BS for DL traffic. Should the MS re-select a Preferred BS during the MS Paging Unavailable Interval, then the MS shall return to the MS Broadcast Paging Message time synchronization stage.

*Insert new subclause 6.3.24.5:*

#### **6.3.24.5 MS Paging Listening Interval**

The MS shall scan, decode the DCD and DL-MAP, and synchronize on the DL for the Preferred BS in time for the MS to begin decoding any BS Broadcast Paging message during the entire BS Paging Interval. At the



end of MS Paging Listening Interval, providing that the MS does not elect to terminate the MS Idle Mode, the MS may return to MS Paging Unavailable Interval.

If the BS transmits the Broadcast Control Pointer IE, the MS shall read and react to this message as follows:

- a) If the DCD\_UCD Configuration Change Counter has changed since MS last decoding of this IE, even if scheduled to be in a paging unavailable interval the MS shall awaken at DCD\_UCD Transmission Frame in time to synchronize to the DL and decode the DCD and UCD message in the frame, if present. If the MS fails to decode one or both of DCD and UCD, or no DCD or UCD was transmitted by the BS, the MS shall continue decoding all subsequent frames until it has acquired both updated DCD and UCD. Upon successful completion of DCD and UCD decoding, the MS shall immediately return to regular Idle Mode operation.
- b) If Skip Broadcast\_System\_Update is set to '0', even if scheduled to be in a paging unavailable interval, the MS shall awaken at Broadcast\_System\_Update\_Transmission\_Frame in time to synchronize to the DL and decode the DL-MAP and any message, if present. Upon completion, the MS shall immediately return to regular Idle Mode operation.

A BS Paging Interval shall occur during the N frames beginning with the frame whose frame number,  $N_{\text{frame}}$ , meets the condition

$$N_{\text{frame}} \text{ modulo } \text{PAGING\_CYCLE} == \text{PAGING\_OFFSET}$$

on each BS, where N is Paging Interval Length. The BS receives notification of active PAGING\_CYCLES through backbone messages. A BS may broadcast one or more BS Broadcast Paging messages during the MS Paging Listening Interval. Different BSs may synchronize their MS Paging Listening Intervals.

***Insert new subclause 6.3.24.6:***

#### **6.3.24.6 BS Broadcast Paging message**

A BS Broadcast Paging message is an MS notification message indicating either the presence of DL traffic pending, through the BS or some network entity, for the specified MS or to poll the MS and request a location update without requiring a full network entry. The BS Broadcast Paging message shall be sent on the Broadcast CID or Idle Mode Multicast CID (defined in Table 345 of 10.4) during the BS Paging Interval if there is some MSs that need paging. If there is no MS that needs paging to corresponding frame, the BS may not broadcast BS Broadcast Paging message. A paging message shall be transmitted during the MS Paging Listening Interval if there is any MS that need paging.

The BS Broadcast Paging message shall include one or more Paging Group IDs identifying the logical affiliations of the transmitting BS.

MSs are identified in the BS Broadcast Paging message by their MS MAC Address hash. A single BS Broadcast Paging message may include multiple MAC Addresses. For a given BS Broadcast Paging message in a specific BS Paging Interval, the BS shall include only those MS MAC Address hash particular to the PAGING\_CYCLE.

The BS Broadcast Paging message shall also include an Action Code directing each MS notified via the inclusion of its MS MAC Address hash to either:

- 0b00: no action required
- 0b01: perform Ranging to establish location and acknowledge message
- 0b10: perform initial network entry
- 0b11: Reserved

When MAC Hash Skip Threshold set to 0xFF is included in DREG-CMD message at MS Idle Mode Initiation, MAC Address Hash of an MS shall be omitted in every MOB\_PAG-ADV message for which the MS need not be paged, and as would result in MOB\_PAG-ADV notification of the MS with Action Code=0b00, No Action Required. MS shall maintain an MS MAC Hash Skip Counter and BS shall independently maintain a BS MAC Hash Skip Counter for count of successive MOB\_PAG-ADV messages that omit individual MS MAC Address Hash and any Action Code. BS shall maintain one such respective BS MAC Hash Skip Counter for each MS Idle Mode Initiation and for which BS is currently serving as Preferred BS. MS and BS shall reset their respective MAC Hash Skip Counter when BS transmits MOB\_PAG-ADV including MS MAC Address Hash and Action Code.

After transmitting the Broadcast Paging message with Action Code 'Perform Ranging' or 'Enter Network', if the BS does not receive RNG-REQ from the MS paged until the next MS Paging Listening Interval, the BS shall retransmit the Broadcast Paging message. Every time the BS retransmits the Broadcast Paging message, it decreases the predefined 'Paging Retry Count' by one. If the BS does not receive RNG-REQ from the MS until the 'Paging Retry Count' decreases to zero, the BS determines that the MS is unavailable, and shall send a backbone message to indicate that the list of MSs in Idle Mode shall be updated in all BSs that belong to the same paging group.

For a BS Broadcast Paging message to be transmitted to indicate the presence of DL traffic pending, there shall be at least a packet in the DL traffic whose Paging Preference indicates paging generation.

*Insert new subclause 6.3.24.7:*

#### **6.3.24.7 Paging Availability Mode termination**

Idle Mode may only be terminated through:

- MS re-entry to the network
- Paging Controller detection of MS unavailability through repeated, unanswered paging messages
- Expiration of the Idle Mode System Timer

*Insert new subclause 6.3.24.7.1:*

##### **6.3.24.7.1 MS side**

An MS may terminate MS Idle Mode at any time.

An MS shall terminate Idle Mode and re-enter the network if it decodes a BS Broadcast Paging message that contains the MS own MS MAC Address hash and an Action Code of 0b10, enter network. In the event that an MS decodes a BS Broadcast Paging message that contains the MS own MS MAC Address hash and an Action Code of 0b01, Perform Ranging, the MS shall conduct and complete Idle Mode Location Update to establish location to the network and acknowledge message decoding. In both cases for the OFDMA PHY, if a PHY specific ranging code and transmission opportunity is assigned to the MS in the MOB\_PAG-ADV message, the MS shall perform network re-entry or Idle Mode Location Update by transmitting the code at the transmission opportunity assigned in the MOB\_PAG-ADV message on the dedicated ranging region assigned in the UL-MAP-IE (UIUC = 12 and dedicated ranging indicator bit set to 1).

The procedure for PHY specific ranging code operation is described as follows:

- After receiving the MOB\_PAG-ADV and within the Page-Response window, the MS shall transmit the assigned ranging code at the transmission opportunity in the frames where dedicated ranging regions are assigned in the UL-MAP-IE (UIUC = 12 and dedicated ranging indicator bit set to 1). The assigned ranging code transmission can be terminated early if the MS receives a RNG-RSP message with 'success' status before the end of the Page-Response window.

- In the case where RNG-RSP message with ‘continue’ status is received and within the Page-Response window, the MS shall transmit the assigned ranging code at the transmission opportunity in the next frame where the dedicated ranging region is assigned.
- In the case where RNG-RSP message with ‘success’ status is not received within the Page-Response window, the MS shall continue with the normal initial ranging procedure for Network Re-entry from Idle (6.3.22.10) or Idle Mode Location Update (6.3.24.8.2).
- In the case where no RNG-RSP message is received or no dedicated ranging region is assigned within the Page-Response window to the MS, the MS shall continue with the normal initial ranging procedure for Network Re-entry from Idle (6.3.24.9) or Idle Mode Location Update (6.3.24.8.2).
- In all other cases, the MS shall use normal network re-entry or Idle Mode Location Update procedure, as described in 6.3.24.8.2

To prevent collisions from multiple MSs trying to wake from Idle mode at the same time, the MS shall use the Initial\_ranging\_backoff\_start and Initial\_ranging\_backoff\_end described in Table 349.

*Insert new subclause 6.3.24.7.2:*

#### **6.3.24.7.2 BS side**

The BS at which the MS re-entered the network shall inform the appropriate element in the network of the re-entry of the MS. The means by which the BS accomplishes this is outside the scope of this standard.

*Insert new subclause 6.3.24.8:*

#### **6.3.24.8 Location Update**

Location Update is comprised of condition evaluation and update processing.

*Insert new subclause 6.3.24.8.1:*

##### **6.3.24.8.1 Location Update conditions**

An MS in Idle mode shall perform a Location Update process operation if any Location Update condition is met. There are four location update evaluation conditions: Paging Group Update, Timer Update, Power Down Update, and MAC Hash Skip Threshold Update. MS may also perform Location Update process at will.

*Insert new subclause 6.3.24.8.1.1:*

##### **6.3.24.8.1.1 Paging Group update**

The MS shall perform Location Update process when the MS detects a change in paging group. The MS shall detect the change of paging group by monitoring the paging group identifier, PG\_ID, which is transmitted by the Preferred BS in the DCD message or MOB\_PAG-ADV broadcast message during the MS Paging Listening Interval. If the PG\_ID detected does not match the Paging Group to which the MS belongs, the MS shall determine that paging group has changed.

*Insert new subclause 6.3.24.8.1.2:*

##### **6.3.24.8.1.2 Timer update**

The MS shall periodically perform Location Update process prior to the expiration of the Idle Mode Timer.

*Insert new subclause 6.3.24.8.1.3:*

#### **6.3.24.8.1.3 Power Down update**

The MS shall attempt to complete a Location Update once as part of its orderly power-down procedure. This mechanism enables the Paging Controller to update the MS's exact status and to delete all information for the MS and discontinue Idle Mode Paging Control for the MS at the time of power down. At the time of successful Power Down Location Update, the Paging Controller shall release all Idle Mode retaining information related to the MS. In case of 'Failure of Power Down Information Update', the Paging Controller shall perform availability check using Location Update polling. Unavailability of MS shall be determined and the Paging Controller shall delete all Idle Mode retaining information if the MS does not answer for the BS's Location Update polling up to 'Paging Retry Count'.

*Insert new subclause 6.3.24.8.1.4:*

#### **6.3.24.8.1.4 MAC Hash Skip Threshold update**

The MS shall perform Location Update process when the MS MAC Hash Skip Counter exceeds MAC Hash Skip Threshold successively. After successful Location Update, the BS and MS shall re-initialize their respective MAC Hash Skip Counters.

*Insert new subclause 6.3.24.8.2:*

#### **6.3.24.8.2 Location Update Process**

If an MS in Idle Mode determines or elects to update its location, depending on the security association the MS shares with the target BS, the MS shall use one of two processes: Secure Location Update Process or Unsecure Location Update Process. For purposes of Location Update Process, the target BS shall be the Preferred BS.

*Insert new subclause 6.3.24.8.2.1:*

##### **6.3.24.8.2.1 Secure Location Update process**

If the MS shares a valid security context with the target BS such that the MS may include a valid HMAC/CMAC Tuple in the RNG-REQ, then the MS shall conduct initial ranging with the target BS by sending a RNG-REQ including Ranging Purpose Indication TLV with Bit #1 set to 1, Location Update Request and Paging Controller ID TLVs and HMAC/CMAC Tuple. If the target BS evaluates the HMAC/CMAC Tuple as valid and can supply a corresponding authenticating HMAC/CMAC Tuple, then the target BS shall reply with a RNG-RSP including the Location Update Response TLV and HMAC/CMAC Tuple completing the Location Update process. If Paging Group ID has changed, then target BS shall include Paging Group ID TLV in the RNG-RSP. If the target BS responds with a successful Location Update Response=0x01, Success of Location Update, the target BS shall notify the Paging Controller via the backbone of the MS new location information, the MS shall assume the Paging Group ID of the target BS, and the Paging Controller may send a backbone message to inform the BS at which the MS entered Idle Mode that the MS has transitioned to a different Paging Group. If the target BS evaluates the HMAC/CMAC Tuple as invalid, cannot supply a corresponding authenticating HMAC/CMAC Tuple, or otherwise elects to direct the MS to use Unsecure Location Update, then the target BS shall instruct the MS to continue network re-entry using the Unsecure Location Update process by inclusion of Location Update Response TLV in RNG-RSP with a value of 0x00= Failure of Location Update.

*Insert new subclause 6.3.24.8.2.2:*

#### **6.3.24.8.2.2 Unsecure Location Update process**

For an MS and target BS that do not share current, valid security context, they shall process Location Update using the Network Re-Entry from Idle Mode method.

*Insert new subclause 6.3.24.9:*

#### **6.3.24.9 Network Re-Entry from Idle Mode**

For the Network Re-Entry from Idle Mode method, the MS shall initiate network re-entry with the target BS by sending a RNG-REQ including Ranging Purpose Indication TLV with Bit #0 set to 1 and Paging Controller ID TLVs.

If the MS shares a valid security context with the target BS such that the MS may include a valid HMAC/CMAC Tuple in the RNG-REQ, then the MS shall conduct initial ranging with the target BS by sending a RNG-REQ including HMAC/CMAC Tuple.

If MS RNG-REQ includes an Ranging Purpose Indication TLV with Bit #0 set to 1 and Paging Controller ID TLVs, and target BS had not previously received MS information over the backbone, then target BS may make an MS information request of Paging Controller over the backbone network and Paging Controller may respond. Regardless of having received MS information from Paging Controller, target BS may request MS information from another network management entity via the backbone network.

Network re-entry proceeds per 6.3.9.5 except as may be shortened by target BS possession of MS information obtained from Paging Controller or other network entity over the backbone network.

For the target BS to notify an MS seeking Network Re-entry from Idle Mode of re-entry process management messages that may be omitted during the current re-entry attempt due to the availability of MS service and operational context information obtained over the backbone network, the target BS shall place an HO Process Optimization TLV in the RNG-RSP indicating which re-entry management messages may be omitted. The target BS shall not direct the omission of any re-entry process management messages that would compromise the security or integrity of Normal Operation of the communications as established through an unabridged Initial Entry.

If the target BS evaluates a HMAC/CMAC Tuple included in the RNG-REQ as valid and can supply a corresponding authenticating HMAC/CMAC Tuple, then the target BS may reply with a RNG-RSP including the valid HMAC/CMAC Tuple. The target BS shall not indicate through the HO Process Optimization TLV that the PKM-REQ/RSP management messages may be omitted in the current re-entry attempt without inclusion of a valid HMAC/CMAC Tuple. If an MS detects an invalid HMAC/CMAC Tuple included as part of a RNG-RSP during Network Re-entry from Idle Mode, the MS shall continue with network re-entry but shall process full PKM security re-keying regardless of HO Process Optimization TLV settings.

Regardless of the HO Process Optimization TLV settings, the target BS may elect to use MS service and operational information obtained over the backbone network to build and send unsolicited SBC-RSP and/or REG-RSP management messages to update MS operational information, or to include 11.7 REG-RSP specific or 11.8 SBC-RSP specific message items as TLV items in the RNG-RSP. Target BS may ignore only the first corresponding REQ management message received if it sends an unsolicited SBC-RSP or unsolicited REG-RSP message. MS is not required to send the complimentary REQ management message if it receives an unsolicited SBC-RSP or unsolicited REG-RSP management message prior to MS attempt to send the corresponding REQ management message. Target BS re-entry unsolicited response management messages may be grouped into the same DL frame transmission and may be grouped into the same DL frame transmission with the RNG-RSP. However, unsolicited SBC-RSP and unsolicited REG-RSP may not be

grouped together into the same DL frame transmission when the PKM-REQ/RSP management message process is required.

For a security keying process that has not been determined to be omitted in the HO Process Optimization TLV settings, if MS RNG-REQ includes Ranging Purpose Indication TLV with Bit #0 set to 1 and Paging Controller ID TLVs, and target BS has keying material for the MS, the MS and target BS shall use the RNG-RSP SA Challenge Tuple information to initiate the 3-way handshake reauthorization process as defined in 7.8.1.

If MS RNG-REQ includes Ranging Purpose Indication TLV with Bit #0 set to 1 and Paging Controller ID TLVs, and target BS has received a backbone message containing MS information, the target BS may use MS service and operational information obtained over the backbone network to build and send a REG-RSP management message that includes service flow remapping information in SFID, New\_CID, and Connection\_Info TLVs.

During network re-entry, the target BS may notify the MS, through the Bit #7 MS DL data pending element of the HO Process Optimization TLV item in RNG-RSP, of post-network reentry MS DL data pending. Upon MS successful re-entry at target BS, now new serving BS, and new serving BS completing reception of any network re-entry pending MS DL data retained and forwarded, MS may re-establish IP connectivity and the new serving BS may send a backbone message to request the old serving BS or other network entity to stop forwarding pre-HO pending MS DL data.

Network entry/re-entry process completes with establishment of Normal Operations.

The target BS shall notify the Paging Controller via the backbone of MS successful network re-entry and the Paging Controller may send a backbone message to inform the BS at which the MS entered Idle Mode that the MS has resumed Normal Operations at the new serving BS.

## 7. Security sublayer

*Change Clause 7 as indicated:*

The ~~S~~security sublayer provides subscribers with privacy, authentication, or confidentiality<sup>6</sup> across the ~~fixed~~ broadband wireless network. It does this by applying cryptographic transforms to MPDUs carried across ~~between~~ connections between SS and BS.

In addition, the security sublayer provides operators with strong protection from theft of service. The BS protects against unauthorized access to these data transport services by securing ~~enforcing encryption of~~ the associated service flows across the network. ~~The S~~Security sublayer employs an authenticated client/server key management protocol in which the BS, the server, controls distribution of keying material to client SS. Additionally, the basic security transport connection security mechanisms are strengthened by adding digital-certificate-based SS device-authentication to ~~its~~the key management protocol.

*Change 7.1 as indicated:*

### 7.1 Architecture

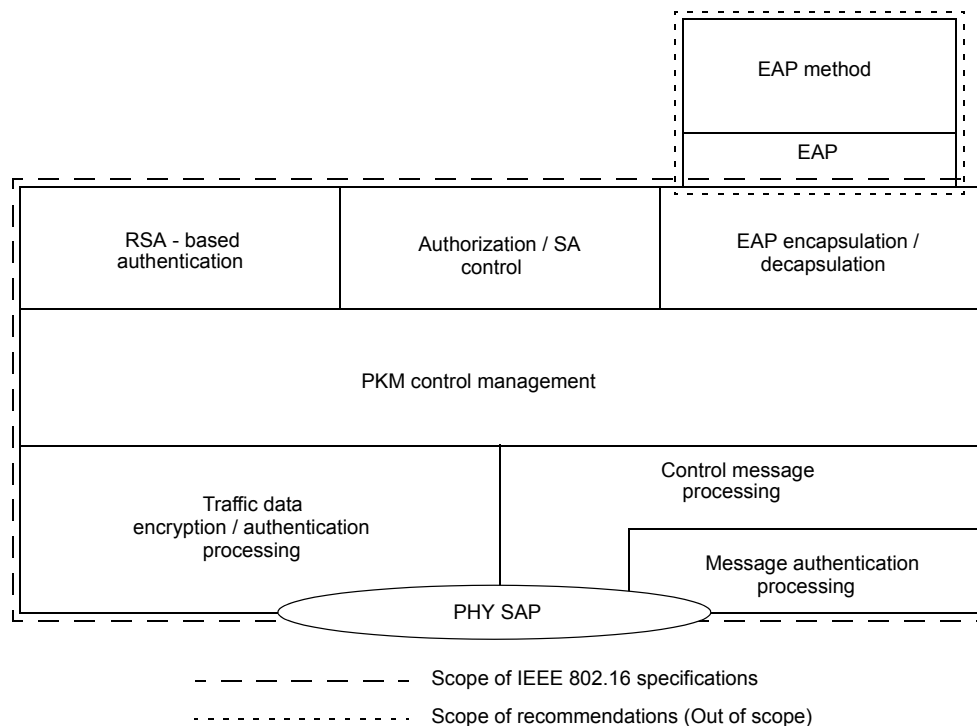
Security has two component protocols as follows:

- a) An encapsulation protocol for ~~securing~~encrypting packet data across the ~~fixed~~ BWA network. This protocol defines (1) a set of supported *cryptographic suites*, i.e., pairings of data encryption and authentication algorithms, and (2) the rules for applying those algorithms to a MAC PDU payload.
- b) A key management protocol (PKM) providing the secure distribution of keying data from the BS to the SS. Through this key management protocol, SS and BS synchronize keying data; in addition, the BS uses the protocol to enforce conditional access to network services.

The protocol stack for the security components of the system are shown in Figure 130j.

<sup>6</sup>In security parlance, confidentiality = privacy + authenticity.

*Insert new figure:*



**Figure 130j—Security sublayer**

*Change 7.1.1 as indicated:*

**7.1.1 Packet data encryption Secure encapsulation of MPDUs**

Encryption services are defined as a set of capabilities within the MAC Security Sublayer. MAC Header information specific to encryption is allocated in the generic MAC header format.

Encryption is applied to the MAC PDU payload when required by the selected ciphersuite; the generic MAC header is not encrypted. All MAC management messages ~~described in subclause 6.4.2.3~~ shall be sent in the clear to facilitate registration, ranging, and normal operation of the MAC.

*Replace 7.1.2 with the following:*

**7.1.2 Key management protocol**

The PKM protocol allows for both mutual authentication and unilateral authentication (e.g., where the BS authenticates SS, but not vice versa). It also supports periodic reauthentication/reauthorization and key refresh. The key management protocol uses either EAP [IETF RFC 3748], or X.509 digital certificates [IETF RFC 3280] together with RSA public-key encryption algorithm [PKCS #1] or a sequence starting with RSA authentication and followed by EAP authentication. It uses strong encryption algorithms to perform key exchanges between an SS and BS.

The PKM’s authentication protocol establishes a shared secret (called an Authorization Key (AK)) between the SS and the BS. The shared secret is then used to secure subsequent PKM exchanges of TEKs. This



two-tiered mechanism for key distribution permits refreshing of TEKs without incurring the overhead of computation-intensive operations.

A BS authenticates a client SS during the initial authorization exchange. Each SS presents its credentials, which will be a unique X.509 digital certificate issued by the SS's manufacturer (in the case of RSA authentication) or a operator-specified credential (in the case of EAP-based authentication).

The BS associates an SS's authenticated identity to a paying subscriber, and hence to the data services that subscriber is authorized to access. Thus, with the AK exchange, the BS determines the authenticated identity of a client SS and the services (i.e., specific TEKs) the SS is authorized to access.

Since the BS authenticates the SS, it may protect against an attacker employing a cloned SS, masquerading as a legitimate subscriber's SS.

The traffic-key management portion of the PKM protocol adheres to a client/server model, where the SS (a PKM "client") requests keying material, and the BS (a PKM "server") responds to those requests, ensuring that individual SS clients receive only keying material for which they are authorized.

The PKM protocol uses MAC management messaging, i.e., PKM-REQ and PKM-RSP messages defined in 6.3.2.3. The PKM protocol is defined in detail in 7.2.

***Replace 7.1.3 with the following:***

### **7.1.3 Authentication protocol**

An SS uses the PKM protocol to obtain authorization and traffic keying material from the BS, and to support periodic reauthorization and key refresh.

PKM supports two distinct authentication protocol mechanisms:

- RSA protocol [PKCS #1 v2.1 with SHA-1(FIPS 186-2)] (support is mandatory in PKMv1, support is optional in PKMv2)
- Extensible Authentication Protocol (optional unless specifically required)

***Insert new subclause 7.1.3.1:***

#### **7.1.3.1 PKM RSA authentication**

The PKM RSA authentication protocol uses X.509 digital certificates [IETF RFC 3280], the RSA public-key encryption algorithm [PKCS #1] that binds public RSA encryption keys to MAC addresses of SSs.

A BS authenticates a client SS during the initial authorization exchange. Each SS carries a unique X.509 digital certificate issued by the SS's manufacturer. The digital certificate contains the SS's Public Key and SS MAC address. When requesting an AK, an SS presents its digital certificate to the BS. The BS verifies the digital certificate, and then uses the verified Public Key to encrypt an AK, which the BS then sends back to the requesting SS.

All SSs using RSA authentication shall have factory-installed RSA private/public key pairs or provide an internal algorithm to generate such key pairs dynamically. If an SS relies on an internal algorithm to generate its RSA key pair, the SS shall generate the key pair prior to its first AK exchange, described in 7.2.1. All SSs with factory-installed RSA key pairs shall also have factory-installed X.509 certificates. All SSs that rely on internal algorithms to generate an RSA key pair shall support a mechanism for installing a manufacturer-issued X.509 certificate following key generation.

*Insert new subclause 7.1.3.2:*

### **7.1.3.2 PKM EAP authentication**

PKM EAP Authentication uses Extensible Authentication Protocol [IETF RFC 3748] in conjunction with an operator-selected EAP Method (e.g. EAP-TLS [IETF RFC 2716]). The EAP method will use a particular kind of credential – such as an X.509 certificate in the case of EAP-TLS, or a Subscriber Identity Module in the case of EAP-SIM.

The particular credentials and EAP methods that are to be used are outside of the scope of this specification. However, the EAP method selected should fulfill the “mandatory criteria” listed in section 2.2 of RFC 4017. Use of an EAP method not meeting these criteria may lead to security vulnerabilities.

During re-authentication, the EAP transfer messages are protected with an HMAC/CMAC tuple. The BS and SS must discard unprotected EAP transfer messages, or EAP transfer messages with invalid HMAC/CMAC digests during re-authentication.

*Replace 7.2 and all its subclauses with a new 7.2 and the following subclauses as indicated:*

## **7.2 PKM protocol**

There are two Privacy Key Management Protocols supported in IEEE Std 802.16e. PKM version 1 and PKMv2 with more enhanced features such as new key hierarchy, AES-CMAC, AES-key-wraps, and MBS.

### **7.2.1 PKM Version 1**

#### **7.2.1.1 Security Associations**

A *Security Association (SA)* is the set of security information a BS and one or more of its client SSs share in order to support secure communications across the IEEE 802.16 network. Three types of SAs are defined: *Primary, Static, and Dynamic*. Each SS establishes a primary security association during the SS initialization process. Static SAs are provisioned within the BS. Dynamic SAs are established and eliminated, on the fly, in response to the initiation and termination of specific service flows. Both Static and Dynamic SAs may be shared by multiple SSs.

An SA's shared information shall include the Cryptographic Suite employed within the SA. The shared information may include TEKs and Initialization Vectors. The exact content of the SA is dependent on the SA's Cryptographic Suite.

SAs are identified using SAIDs.

Each SS shall establish an exclusive Primary SA with its BS. The SAID of any SS's Primary SA shall be equal to the Basic CID of that SS.

Using the PKM protocol, an SS requests from its BS an SA's keying material. The BS shall ensure that each client SS only has access to the SAs it is authorized to access.

An SA's keying material [e.g., Data Encryption Standard (DES) key and CBC Initialization Vector] has a limited lifetime. When the BS delivers SA keying material to an SS, it also provides the SS with that material's remaining lifetime. It is the responsibility of the SS to request new keying material from the BS before the set of keying material that the SS currently holds expires at the BS. Should the current keying material expire before a new set of keying material is received, the SS shall perform network entry as described in 6.3.9.

In certain Cryptographic Suites, key lifetime may be limited by the exhaustion rate of a number space [e.g., the PN (Packet Number) in AES-CCM mode]. In this case, the key ends either at the expiry of the key lifetime or the exhaustion of the number space, whichever is earliest. Note that in this case, security is not determined by the key lifetime.

### 7.2.1.3 SS authorization and AK exchange overview

SS authorization, controlled by the Authorization state machine, is the process of the BS authenticating a client SS's identity:

- a) The BS and SS establishing a shared AK by RSA, from which a key encryption key (KEK) and message authentication keys are derived.
- b) The BS providing the authenticated SS with the identities (i.e., the SAIDs) and properties of primary and static SAs the SS is authorized to obtain keying information for.

After achieving initial authorization, an SS periodically reauthorizes with the BS; reauthorization is also managed by the SS's Authorization state machine. TEK state machines manage the refreshing of TEKs.

#### 7.2.1.3.1 Authorization via RSA authentication protocol

An SS begins authorization by sending an Authentication Information message to its BS. The Authentication Information message contains the SS manufacturer's X.509 certificate, issued by the manufacturer itself or by an external authority. The Authentication Information message is strictly informative; i.e., the BS may choose to ignore it. However, it does provide a mechanism for a BS to learn the manufacturer certificates of its client SS.

The SS sends an Authorization Request message to its BS immediately after sending the Authentication Information message. This is a request for an AK, as well as for the SAIDs identifying any Static Security SAs the SS is authorized to participate in. The Authorization Request includes:

- a) A manufacturer-issued X.509 certificate.
- b) A description of the cryptographic algorithms the requesting SS supports; an SS's cryptographic capabilities are presented to the BS as a list of cryptographic suite identifiers, each indicating a particular pairing of packet data encryption and packet data authentication algorithms the SS supports.
- c) The SS's Basic CID. The Basic CID is the first static CID the BS assigns to an SS during initial ranging—the primary SAID is equal to the Basic CID.

In response to an Authorization Request message, a BS validates the requesting SS's identity, determines the encryption algorithm and protocol support it shares with the SS, activates an AK for the SS, encrypts it with the SS's public key, and sends it back to the SS in an Authorization Reply message. The authorization reply includes:

- An AK encrypted with the SS's public key.
- A 4-bit key sequence number, used to distinguish between successive generations of AKs.
- A key lifetime.
- The identities (i.e., the SAIDs) and properties of the single primary and zero or more static SAs the SS is authorized to obtain keying information for.

While the Authorization Reply shall identify Static SAs in addition to the Primary SA whose SAID matches the requesting SS's Basic CID, the Authorization Reply shall not identify any Dynamic SAs.

The BS, in responding to an SS's Authorization Request, shall determine whether the requesting SS, whose identity can be verified via the X.509 digital certificate, is authorized for basic unicast services, and what additional statically provisioned services (i.e., Static SAIDs) the SS's user has subscribed for. Note that the protected services a BS makes available to a client SS can depend upon the particular cryptographic suites SS and BS share support for.

An SS shall periodically refresh its AK by reissuing an Authorization Request to the BS. Reauthorization is identical to authorization with the exception that the SS does not send Authentication Information messages during reauthorization cycles. The description of the authorization state machine in 7.2.1.6 clearly indicates when Authentication Information messages are sent.

To avoid service interruptions during reauthorization, successive generations of the SS's AKs have overlapping lifetimes. Both the SS and BS shall be able to support up to two simultaneously active AKs during these transition periods. The operation of the Authorization state machine's Authorization Request scheduling algorithm, combined with the BS's regimen for updating and using a client SS's AKs (see 7.3), ensures that the SS can refresh.

#### **7.2.1.4 TEK exchange overview**

*Relocate text of 7.2.2 to here and renumber subclause 7.2.1.4.*

##### **7.2.1.4.1 TEK exchange overview for PMP topology**

*Relocate text of 7.2.2.1 to here and renumber subclause 7.2.1.4.1.*

##### **7.2.1.4.2 TEK exchange overview for Mesh mode**

*Relocate text of 7.2.2.2 to here and renumber subclause 7.2.1.4.2.*

#### **7.2.1.5 Security capabilities selection**

*Relocate text of 7.2.3 to here and renumber subclause 7.2.1.5.*

#### **7.2.1.6 Authorization state machine**

*Relocate text of 7.2.4 to here and renumber subclause 7.2.1.6.*

##### **7.2.1.6.1 States**

*Relocate text of 7.2.4.1 to here and renumber subclause 7.2.1.6.1.*

##### **7.2.1.6.2 Messages**

*Relocate text of 7.2.4.2 to here and renumber as subclause 7.2.1.6.2.*

##### **7.2.1.6.3 Events**

*Relocate text of 7.2.4.3 to here and renumber as subclause 7.2.1.6.3.*

##### **7.2.1.6.4 Parameters**

*Relocate text of 7.2.4.4 to here and renumber as subclause 7.2.1.6.4.*

**7.2.1.6.5 Actions**

*Relocate text of 7.2.4.5 to here and renumber as subclause 7.2.1.6.5.*

**7.2.1.7 TEK state machine**

*Relocate text of 7.2.5 here and renumber as subclause 7.2.1.7.*

**7.2.1.7.1 States**

*Relocate text of 7.2.5.1 here and renumber as subclause 7.2.1.7.1.*

**7.2.1.7.2 Messages**

*Relocate text of 7.2.5.2 here and renumber as subclause 7.2.1.7.2.*

**7.2.1.7.3 Events**

*Relocate text of 7.2.5.3 here and renumber as subclause 7.2.1.7.3.*

**7.2.1.7.4 Parameters**

*Relocate text of 7.2.5.4 here and renumber as subclause 7.2.1.7.4.*

**7.2.1.7.5 Actions**

*Relocate text of 7.2.5.5 here and renumber as subclause 7.2.1.7.5.*

**7.2.2 PKM Version 2****7.2.2.1 TEK exchange overview for PMP topology**

If the SS and BS decide “No authorization” as their authorization policy, the SS and BS shall perform neither SA-TEK handshake nor Key Request/Key Reply handshake. In this case, target SAID value, which may be included in DSA-REQ/RSP messages, shall be Null SAID.

Upon achieving authorization, an SS starts a separate TEK state machine for each of the SAIDs identified in the Authorization Reply or PKMv2 SA-TEK-RSP message, if data traffic encryption is provisioned for one or more service flows. Each TEK state machine operating within the SS is responsible for managing the keying material associated with its respective SAID. TEK state machines periodically send Key Request messages to the BS, requesting a refresh of keying material for their respective SAIDs.

The BS responds to a Key Request with a Key Reply message, containing the BS’s active keying material for a specific SAID.

TEKs and KEKs may be either 64 bits or 128 bits long. SAs employing any ciphersuite with a basic block size of 128 bits shall use 128-bit TEKs and KEKs. Otherwise 64-bit TEKs and KEKs shall be used. The name TEK-64 is used to denote a 64-bit TEK and TEK-128 is used to denote a 128-bit TEK. Similarly, KEK-64 is used to denote a 64-bit KEK and KEK-128 is used to denote a 128-bit KEK.

For SAs using a ciphersuite employing DES-CBC, the TEK in the Key Reply is triple DES (3-DES) (encrypt-decrypt-encrypt or EDE mode) encrypted, using a two-key, 3-DES KEK derived from the AK.

For SAs using a ciphersuite employing 128 bits keys, such as AES-CCM mode, the TEK in the key Reply is AES encrypted using a 128-bit key derived from the AK and a 128-bit block size.

Note that at all times the BS maintains two diversity sets of keying material per SAID. The lifetimes of the two generations overlap such that each generation becomes active halfway through the life of its predecessor and expires halfway through the life of its successor. A BS includes in its Key Replies both of an SAID's active generations of keying material.

For SAs using a ciphersuite employing CBC mode encryption the Key Reply provides the requesting SS, in addition to the TEK and CBC initialization vector, the remaining lifetime of each of the two sets of keying material. For SAs using a ciphersuite employing AES-CCM mode, the Key Reply provides the requesting SS, in addition to the TEK, the remaining lifetime of each of the two sets of keying material. The receiving SS uses these remaining lifetimes to estimate when the BS will invalidate a particular TEK, and therefore when to schedule future Key Requests such that the SS requests and receives new keying material before the BS expires the keying material the SS currently holds. For AES-CCM mode, when more than half the available PN numbers in the 31-bit PN number space are exhausted, the SS shall schedule a future Key Request in the same fashion as if the key lifetime was approaching expiry. The operation of the TEK state machine's Key Request scheduling algorithm, combined with the BS's regimen for updating and using an SAID's keying material (see 7.3), ensures that the SS will be able to continually exchange encrypted traffic with the BS.

A TEK state machine remains active as long as

- a) The SS is authorized to operate in the BS's security domain, i.e., it has a valid AK, and
- b) The SS is authorized to participate in that particular SA, i.e., the BS continues to provide fresh keying material during rekey cycles.

MAC PDUs sent on connections that belong to an SA that includes data encryption, shall be encrypted. A MAC PDU received on such connections, with the EC bit not set, shall be discarded.

### 7.2.2.2 Key derivation

The PKMv2 key hierarchy defines what keys are present in the system and how the keys are generated.

Since there are two authentication schemes, one based on RSA and one based on EAP, there are two primary sources of keying material.

The keys used to protect management message integrity and transport the traffic encryption keys are derived from source key material generated by the authentication and authorization processes. The RSA-based authorization process yields the pre-Primary AK (pre-PAK) and the EAP based authentication process yields the MSK. Keys used to protect MBS traffic are derived from the MBSAK, which is supplied by means outside the scope of this specification. These keys form the roots of the key hierarchy.

All PKMv2 key derivations are based on the Dot16KDF algorithm as defined in 7.5.4.6.1.

The MSK is the shared "master key" that is derived by the two sides in the course of executing the EAP inner method. The authentication part of the authorization flow (and the involvement of the generic EAP layer) is now complete.

#### 7.2.2.2.1 RSA-based authorization

When the RSA-based authorization is negotiated as authorization policy, the PKMv2 RSA-Request, the PKMv2 RSA-Reply, the PKMv2 RSA-Reject, and the PKMv2 RSA-Acknowledgement messages are used to share the pre-PAK (Primary Authorization Key).

The pre-PAK is sent by the BS to the SS encrypted with the public key of the SS certificate. Pre-PAK is mainly used to generate the PAK. The optional EIK for transmitting authenticated EAP payload (see 7.2.2.2.2) are also generated from pre-PAK:

$$\text{EIK} \mid \text{PAK} = \text{Dot16KDF}(\text{pre-PAK}, \text{SS MAC Address} \mid \text{BSID} \mid \text{"EIK+PAK"}, 320)$$

PAK will be used to generate the AK (see 7.2.2.2.3) if RSA authorization was used. PAK is 160 bits long.

#### 7.2.2.2.2 EAP authentication

If a RSA mutual authorization took place before the EAP exchange or if the first EAP took place during EAP-in-EAP mode, the EAP messages may be protected using EIK-EAP Integrity Key derived from pre-PAK (see 7.2.2.2.1). EIK is 160 bits long.

The product of the EAP exchange that is transferred to IEEE 802.16 layer is the Master Session Key (MSK), which is 512 bits in length. This key is derived [or may be equivalent to the 512-bits Master Session Key (MSK)]. This key is known to the AAA server, to the Authenticator (transferred from AAA server) and to the SS. The SS and the authenticator derive a PMK (Pairwise Master Key) and optional EIK by truncating the MSK to 320 bits.

The PMK derivation from the MSK is as follows:

The PMK and EIK derivation from the MSK during first EAP method is as follows:

$$\text{EIK} \mid \text{PMK} \leftarrow \text{truncate}(\text{MSK}, 320)$$

The PMK2 derivation from the MSK2 during second EAP method is as follows:

$$\text{PMK2} \leftarrow \text{truncate}(\text{MSK2}, 160)$$

If more keying material is needed for future link ciphers, the key length of the PMK may be increased.

After successful EAP based authorization, if the SS or BS negotiates authorization policy as "Authenticated EAP after EAP" mode, the authenticated EAP messages shall carry second EAP message. It shall cryptographically bind previous EAP authentication and following EAP authentication session, while protecting second EAP messages. In order to prevent "man-in-the-middle attack", the first and second EAP method should fulfill the "mandatory criteria" listed in section 2.2 of RFC 4017 such as EAP-PSK, EAP-AKA.

If SS and BS negotiate double EAP mode (a.k.a. Authenticated EAP after EAP), SS and BS perform two rounds of EAP as follows:

- 1) In order to initiate first round EAP of double EAP, SS may send PKMv2 EAP Start message with no attribute.
- 2) SS and BS shall perform first round EAP conversation with PKMv2 EAP Transfer message without HMAC/CMAC Digest.
- 3) During first EAP conversation, if BS has to send EAP-Success, BS shall send EAP payload to SS with PKMv2 EAP Complete message signed by newly generated EIK. BS shall re-send the PKMv2 EAP\_Complete message by Second\_EAP\_Timeout. Total number of sending PKMv2 EAP\_Complete message is EAP\_Complete\_Resend. After SS receives the PKMv2 EAP\_Complete message which includes EAP-Success payload, SS can possess EIK and PMK. In this case, SS can validate the message. Otherwise, if SS receives EAP-Failure or cannot validate the message, SS fails in authentication. After BS transfers the PKMv2 EAP Complete message to SS, BS activates the Second\_EAP\_Timeout in order to wait PKMv2 Authenticated EAP Start message. When the timer expires, BS shall regard the authentication as failure.

- 4) After the successful first round EAP, SS shall send PKMv2 EAP Start message signed by EIK to initiates second round EAP conversation. If BS validates the PKMv2 EAP Start message by EIK, BS shall initiate second EAP by sending PKMv2 Authenticated EAP message including EAP-Identity/Request to SS. If BS cannot validate the PKMv2 Authenticated EAP Start message, BS shall regard the authentication as failure.
- 5) SS and BS shall perform second EAP conversation with PKMv2 Authenticated EAP message signed by EIK.
- 6) If second round EAP succeeds, both SS and authenticator generate AK from PMK and PMK2. SS and BS shall perform SA-TEK 3-way handshake.

After the successful initial authentication, SS and BS shall perform reauthentication by PMK/PMK2 lifetime. In performing reauthentication, SS and BS perform double EAP just like initial authentication. Otherwise, SS and BS can perform EAP once.

When SS and BS perform reauthentication with double EAP also, the following procedure shall be performed as follows:

- In order to initiate reauthentication, SS may send PKMv2 EAP Start message signed by H/CMAC\_KEY\_U derived from AK.
- SS and BS shall use PKMv2 EAP Transfer message to carry first round EAP conversation.
- BS shall carry EAP-Success or EAP-Failure message with PKMv2 EAP Complete message signed by AK generated from the previous double EAP.
- After successful first round EAP, SS shall initiate second round EAP by sending PKMv2 EAP Start message signed by H/CMAC\_KEY\_U generated from AK (previous double EAP generated this key).
- SS and BS shall perform second round EAP conversation with PKMv2 EAP Transfer message signed by AK which is generated by previous double EAP.
- SS and BS shall perform SA-TEK 3-way handshake.

When SS and BS perform reauthentication with double EAP, SS and BS can perform EAP once as follows:

- In order to initiate reauthentication, SS may send PKMv2 EAP Start message signed by H/CMAC\_KEY\_U derived from AK.
- SS and BS shall use PKMv2 EAP Transfer message to carry first round EAP conversation.
- BS shall carry EAP-Success or EAP-Failure message with PKMv2 EAP Transfer instead of sending PKMv2 EAP Complete signed by AK. It means that BS does not want to run second round EAP.

#### 7.2.2.2.3 Authorization Key (AK) derivation

The AK will be derived by the BS and the SS from the PMK (from EAP-based authorization procedure) and/or the PAK (from RSA-based authorization procedure). Note that PAK and/or PMK can be used according to the value of Authorization Policy Support field included in the SBC-REQ/RSP messages.

The exclusive-or (XOR:  $\oplus$ ) value of PAK and PMK is mainly used to generate the AK.

If (PAK and PMK)

$$AK \leftarrow \text{Dot16KDF}(\text{PAK} \oplus \text{PMK}, \text{SS MAC Address} \mid \text{BSID} \mid \text{PAK} \mid \text{"AK"}, 160)$$

Else If (PMK and PMK2)

$$AK \leftarrow \text{Dot16KDF}(\text{PMK} \oplus \text{PMK2}, \text{SS MAC Address} \mid \text{BSID} \mid \text{"AK"}, 160)$$

Else



If (PAK)

$$AK \leftarrow \text{Dot16KDF}(\text{PAK}, \text{SS MAC Address} \mid \text{BSID} \mid \text{PAK} \mid \text{“AK”}, 160)$$

Else // PMK only

$$AK \leftarrow \text{Dot16KDF}(\text{PMK}, \text{SS MAC Address} \mid \text{BSID} \mid \text{“AK”}, 160);$$

Endif

Endif

#### 7.2.2.2.4 Key Encryption Key (KEK) derivation

The Key Encryption Key or KEK is derived directly from the AK. The KEK is defined in 7.2.2.2.9 with the HMAC/CMAC definition. It is used to encrypt the TEKs, GKEK and all other keys sent by the BS to SS in unicast message.

#### 7.2.2.2.5 Group Key Encryption Key (GKEK) derivation

GKEK is randomly generated at the BS and transmitted to the SS encrypted with the KEK. There is one GKEK per Group Security Association. GKEK is used to encrypt the GTEKs sent in multicast messages by the BS to the SSs in the same multicast group.

#### 7.2.2.2.6 Traffic Encryption Key (TEK)

The TEK is generated as a random number in the BS and is encrypted using the corresponding TEK encryption algorithm (e.g., AES\_KEY\_WRAP for SAs with TEK encryption algorithm identifier in the cryptographic suite is equal to 0x04), keyed with the KEK and transferred between BS and SS in the TEK exchange.

#### 7.2.2.2.7 Group Traffic Encryption Key (GTEK)

The GTEK is used to encrypt multicast data packets and it is shared among all SSs that belongs to the multicast group. There are two GTEKs per GSA.

The GTEK is randomly generated at the BS or at certain network node and is encrypted using same algorithms applied to encryption for TEK and transmitted to the SS in multicast or unicast messages. The GTEK in a PKMv2 Key-Request and PKMv2 Key-Reply messages will be encrypted by the KEK. Also, the GTEK in a PKMv2 Group Key Update Command message will be encrypted by the GKEK.

#### 7.2.2.2.8 MBS Traffic Key (MTK)

The generation and transport of the MAK (MBS AK) is outside the scope of the IEEE 802.16 standard. It is provided through means defined at higher layers. However, the key such as the MTK is used in the link cipher; therefore, its existence needs to be defined in layer 2.

The MTK is used to encrypt the MBS traffic data. It is defined as follows:

$$\text{MTK} \leftarrow \text{Dot16KDF}(\text{MAK}, \text{MGTEK} \mid \text{“MTK”}, 128)$$

The MGTEK is the GTEK for the MBS. An SS can get the GTEK by exchanging the PKMv2 Key Request message and the PKMv2 Key Reply message with a BS or by receiving the PKMv2 Group Key Update Command message from a BS. The generation and transport of the GTEK is defined as in 6.3.2.3.9 and 7.9.

### 7.2.2.2.9 Message authentication keys (HMAC/CMAC) and KEK derivation

MAC (message authentication code) keys are used to sign management messages in order to validate the authenticity of these messages. The MAC to be used is negotiated at SS Basic Capabilities negotiation.

There is a different key for UL and DL messages. Also, a different message authentication key is generated for a multicast message (this is DL direction only) and for a unicast message.

In general, the message authentication keys used to generate the CMAC value and the HMAC-Digest are derived from the AK.

The keys used for CMAC key and for KEK are as follows:

$$\text{CMAC\_KEY\_U} \mid \text{CMAC\_KEY\_D} \mid \text{KEK} \Leftarrow \text{Dot16KDF}(\text{AK}, \text{SS MAC Address} \mid \text{BSID} \mid \text{"CMAC\_KEYS+KEK"}, 384)$$
$$\text{CMAC\_KEY\_GD} \Leftarrow \text{Dot16KDF}(\text{GKEK}, \text{"GROUP CMAC KEY"}, 128) \text{ (Used for multicast MAC message such as a PKMv2 Group-Key-Update-Command message)}$$

The keys used for HMAC key and for KEK are as follows:

$$\text{HMAC\_KEY\_U} \mid \text{HMAC\_KEY\_D} \mid \text{KEK} \Leftarrow \text{Dot16KDF}(\text{AK}, \text{SS MAC Address} \mid \text{BSID} \mid \text{"HMAC\_KEYS+KEK"}, 448)$$
$$\text{HMAC\_KEY\_GD} \Leftarrow \text{Dot16KDF}(\text{GKEK}, \text{"GROUP HMAC KEY"}, 160) \text{ (Used for multicast MAC message such as a PKMv2 Group-Key-Update-Command message)}$$

Exceptionally, the message authentication keys for the HMAC/CMAC Digest included in a PKMv2 Authenticated-EAP-Transfer message are derived from the EIK instead of the AK.

The keys used for CMAC key and for KEK are as follows:

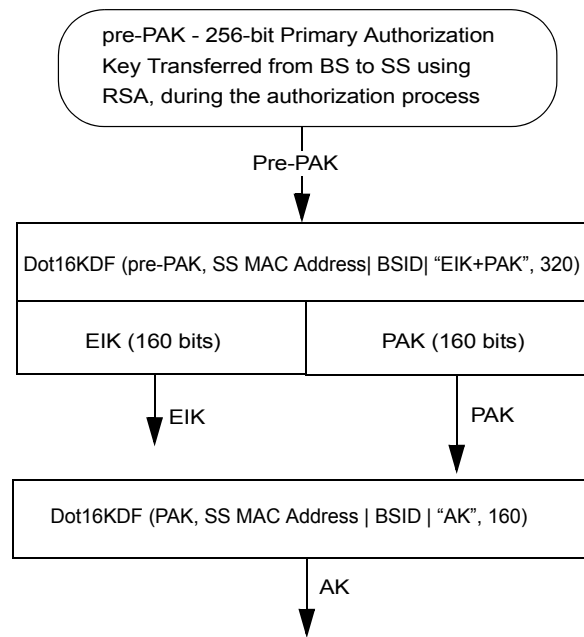
$$\text{CMAC\_KEY\_U} \mid \text{CMAC\_KEY\_D} \Leftarrow \text{Dot16KDF}(\text{EIK}, \text{SS MAC Address} \mid \text{BSID} \mid \text{"CMAC\_KEYS"}, 256)$$

The keys used for HMAC key and for KEK are as follows:

$$\text{HMAC\_KEY\_U} \mid \text{HMAC\_KEY\_D} \Leftarrow \text{Dot16KDF}(\text{EIK}, \text{SS MAC Address} \mid \text{BSID} \mid \text{"HMAC\_KEYS"}, 320)$$

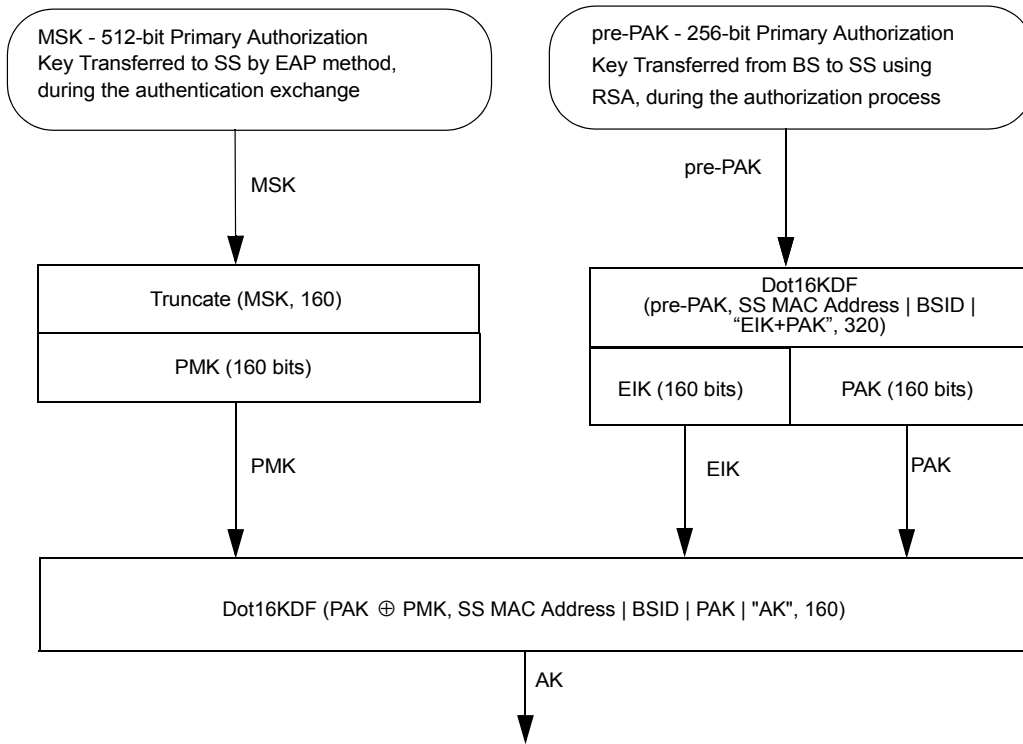
### 7.2.2.2.10 Key hierarchy

Figure 130k outlines the process to calculate the AK when the RSA-based authorization process has taken place, but where the EAP based authentication process has not taken place, or the EAP method used has not yielded an MSK.



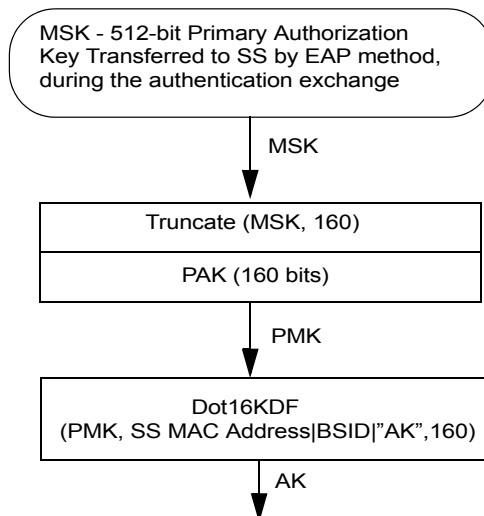
**Figure 130k—AK from PAK only (from RSA-based authorization)**

Figure 130l outlines the process to calculate the AK when both the RSA-based authorization exchange has taken place, yielding a PAK and the EAP based authentication exchange has taken place, yielding an MSK.



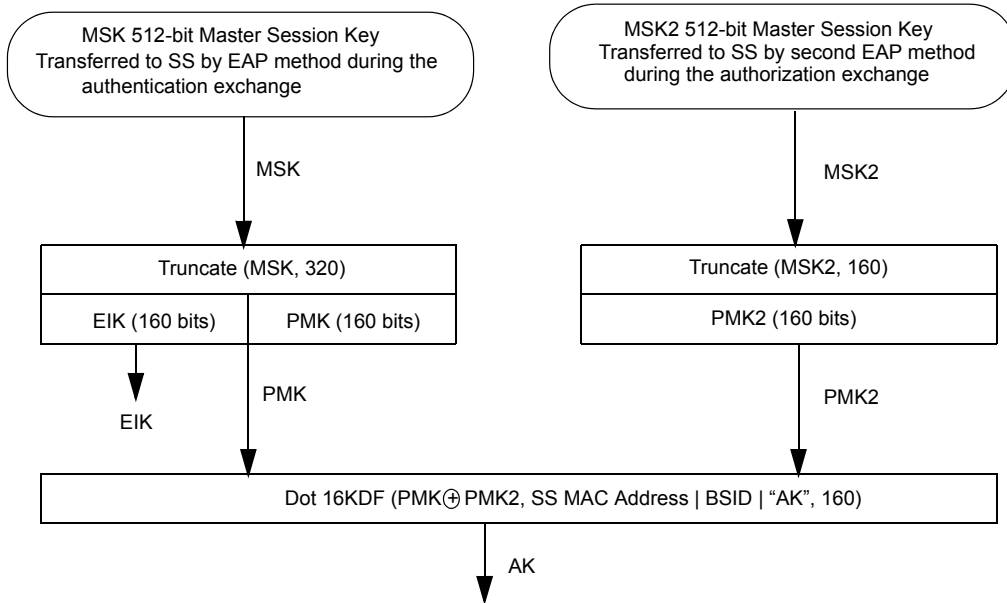
**Figure 130l—AK from PAK and PMK (RSA-based and EAP-based authorization)**

Figure 130m outlines the process to calculate the AK when only the EAP based authentication exchange has taken place, yielding an MSK:



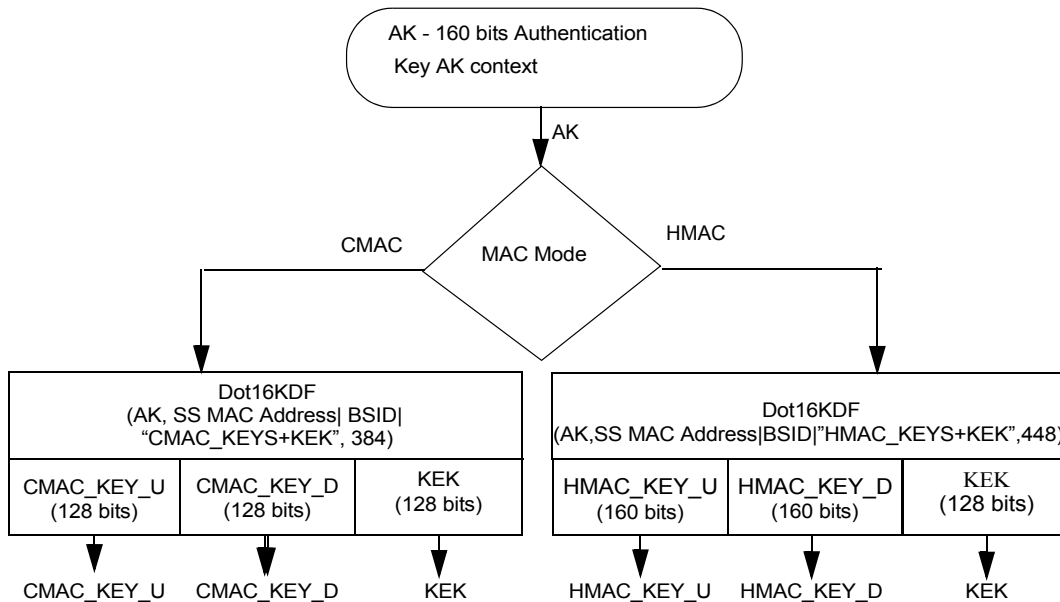
**Figure 130m—AK from PMK (from EAP-based authorization)**

Figure 130n outlines the process to calculate the AK when EAP in EAP mode authentication exchange has taken place, first EAP yielding EIK and MSK and second EAP yielding MSK2.



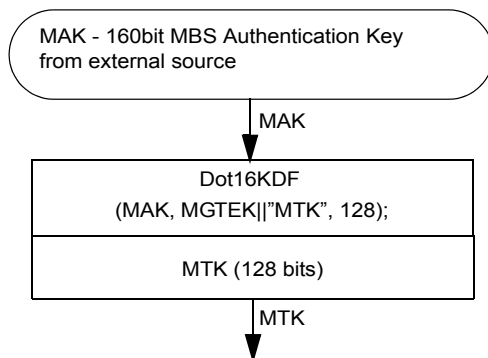
**Figure 130n—AK with PMK and PMK2 (EAP-based authorization and Authenticated EAP-based authorization)**

Figure 130o outlines the unicast key hierarchy starting from the AK.



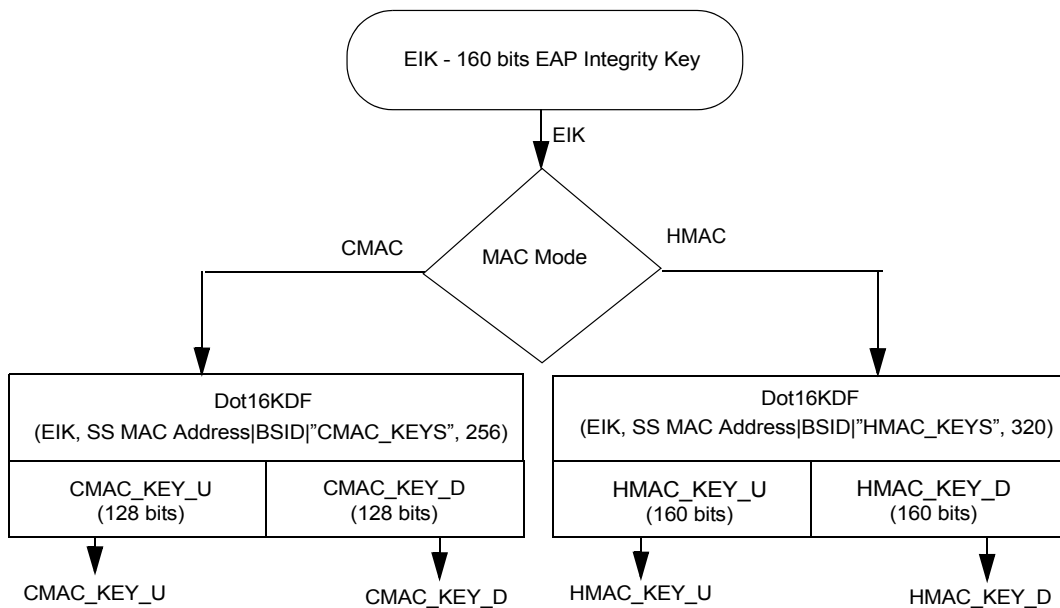
**Figure 130o—HMAC/CMAC/KEK derivation from AK**

Figure 130p outlines the MBS key hierarchies starting from the MAK.



**Figure 130p—MTK key derivation from MAK**

Figure 130q outlines the process to calculate message authentication keys derived from the EIK. The message authentication keys are used to generate the CMAC value or the HMAC-Digest included in a PKMv2 Authenticated-EAP-Transfer message.



**Figure 130q—HMAC/CMAC authentication key derivation from EIK**

### 7.2.2.2.11 Maintenance of PMK and AK

The BS and SS maintain cached PMK and AK as follows:

a) PMK caching

An SS caches a PMK upon successful EAP authentication. An Authenticator caches a PMK upon its receipt via the AAA protocol. Upon caching a new PMK for a particular SS, an Authenticator shall delete any PMK for that SS (as well as all associated AKs).

For the case of reauthentication, deletion of old PMKs at Authenticator and SS is accomplished via the switchover mechanism described in this subclause using the messages in 6.3.2.3.9.20.

The Authenticator and SS will additionally delete PMKs and/or associated AKs in various situations—including lifetime expiration, reauthentication, and reclamation of memory resources, or as the result of other mechanisms beyond the scope of this specification.

In the case of re-authentication, the older PMK and its AKs shall be deleted by the SS after verifying the HMAC or CMAC of the PKMv2 SA-TEK challenge message and the BS after verifying the HMAC/CMAC of the PKMv2 SA-TEK request message.

b) AK activation and deactivation

Successful completion of the 3-way SA-TEK handshake causes the activation of all the AKs associated with the new PMK (i.e., all AKs on BSs associated with the current authenticator will be active).

If the packet counter belonging to a short HMAC or a CMAC key reaches its maximum value, the associated AK becomes permanently deactivated.

The BS and SS must maintain the AK context (i.e., replay counters etc.) as long as they retain the AK.

### 7.2.2.2.12 PKMv2 PMK and AK switching methods

Once the PKMv2 SA-TEK 3-way handshake begins, the BS and SS shall use the new AK matching the new PMK context for the 3-way handshake messages. Other messages shall continue to use the old AK until the 3-way handshake completes successfully. Upon successful completion of the 3-way handshake, all messages shall use the new AK.

The old AK matching the old PMK context may be used for receiving packets before the “frame number” attribute specified in PKMv2 SA-TEK-response message.

### 7.2.2.3 Associations

Keying material is held within associations. There are three types of association: The security associations (SA) that maintain keying material for unicast connections; group security associations (GSA) that hold keying material for multicast groups; and MBSGSAs that hold keying material for MBS services.

If SS and BS decide “No authorization” as their authorization policy, they do not have any security association. In this case, Null SAID shall be used as the target SAID field in DSA-REQ/RSP messages.

#### 7.2.2.3.1 Security associations

A security association contains keying material that is used to protect unicast connections. The contents of an SA are as follows:

The SAID, a 16-bit identifier for the SA. The SAID shall be unique within a BS.

The KEK, a 128-bit key encryption key, derived from the AK.

TEK0 and TEK1, 128-bit traffic encryption keys, generated within the BS and transferred from the BS to the SS using a secure key exchange.

The TEK Lifetimes TEK0 and TEK1, a key aging lifetime value.

PN0 and PN1, 32-bit packet numbers for use by the link cipher.

RxPN0 and RxPN1, 32-bit receive sequence counter, for use by the link cipher.

A security association is shared between an SS and a BS or, in case of ongoing MDHO(FBSS) between MS and BSs from Diversity Set.

#### **7.2.2.3.2 Group Security Association**

The Group Security Association (GSA) contains keying material used to secure multicast groups. These are defined separately from SAs since GSA offer a lower security bound than unicast security associations, since keying material is shared between all members of the group, allowing any member of the group to forge traffic as if it came from any other member of the group.

The contents of a GSA are as follows:

The Group Key Encryption Key (GKEK). Serves the same function as an SA KEK but for a GSA.

The Group Traffic Encryption Key (GTEK). Served the same function as an SA TEK but for a GSA.

#### **7.2.2.3.3 MBS Group Security Association**

The primary keying material in the MBS Group Security Association is the MAK. The MAK is provisioned by an external entity, such as an MBS server. The MAK may be common among members of an MBS group.

The contents of an MBSGSA are as follows:

The MAK, a 160-bit MBS AK, serves the same function as the AK but local to the MBSGSA.

The MGTEK, a 128-bit MBS Group Traffic Encryption Key, used indirectly to protect MBS traffic. It is updated more frequently than the MAK.

The MTK (MBS Traffic Key) a 128-bit key used to protect MBS traffic, derived from the MAK and MGTEK.

The MGTEK is a random number provisioned by the access network such as a BS as an access network authorization key. It is only used for generating MTK together with MAK.

In MBS Group Security Association, the usage of MGTEK is same as that of GTEK.

Key encryption algorithm and key transport mechanism of GTEK shall be also applied for MGTEK.

#### **7.2.2.4 Security context**

The security context is a set of parameters linked to a key in each hierarchy that defines the scope while the key usage is considered to be secure.

Examples of these parameters are key lifetime and counters ensuring the same encryption will not be used more than once. When the context of the key expires, a new key should be obtained to continue working.



The purpose of this subclause is to define the context that belongs to each key, how it is obtained and the scope of its usage.

#### 7.2.2.4.1 AK context

The PMK key has two phases of lifetime: the first begins at PMK creation and the second begins after validation by the 3-way handshake.

The phases ensure that when the PMK is created it will be defined with the PMK or PAK pre-handshake lifetime and after successful 3-way handshake, this lifetime may be enlarged using the PMK lifetime TLV within the 3-way handshake.

If the cached AK and associated context is lost by either BS or SS, no new AKs can be derived from this PMK on handover.

Cached AKs that were derived from the PMK can continue to be used in HO.

Reauthentication is required to obtain a new PMK so as to derive new AKs.

The AK context is described in Table 133a.

**Table 133a—AK Context in PKMv2**

Parameter	Size (bits)	Usage
AK	160	The authorization key, calculated as defined in 7.2.2.2.3.
AKID	64	AKID = Dot16KDF(AK, AK SN SS MAC Address BSID "AK", 64) The AK_SN in the Dot16KDF function is an 8-bit number which consists of leading 4 zero bits and appending 4-bit AK_SN in MSB first order.
AK Sequence Number	4	Sequence number of root keys (PAK and PMK) for the AK. This value is the most significant 2-bit of PAK sequence number concatenated with the least significant 2-bit of PMK sequence number. If AK = f (PAK and PMK), then AK SN = PAK SN + PMK SN If AK = f (PAK), then AK SN = PAK SN If AK = f (PMK), then AK SN = PMK SN
AK Lifetime	—	This is the time this key is valid; it is calculated AK lifetime = MIN(PAK lifetime, PMK lifetime)—when this expires, re-authentication is needed.
PMK Sequence Number	4	The sequence number of the PMK from which this AK is derived.
HMAC/CMAC_KEY_U	160/128	The key which is used for signing UL management messages.
HMAC/CMAC_PN_U	32	Used to avoid UL replay attack on the management connection—when this expires re-authentication is needed.
HMAC/CMAC_KEY_D	160/128	The key which is used for signing DL management messages.
HMAC/CMAC_PN_D	32	Used to avoid DL reply attack on the management connection—when this expires re-authentication is needed.
KEK	160	Used to encrypt transport keys from the BS to the SS.
EIK	160	EAP Integrity Key for authenticating Authenticated EAP message.

**7.2.2.4.2 GKEK context**

The GKEK is the head of the group key hierarchy. There is a separate GKEK for each group (each GSA). This key is randomly generated by the BS and transferred to the SS encrypted with KEK. It is used to encrypt group TEKs (GTEK) when broadcasting them to all SSs. The GKEK context is described in Table 133b.

**Table 133b—GKEK Context**

Parameter	Size (bits)	Usage
GKEK	128	Randomly generated by BS and transmitted to SS under KEK.
GKEKID	64	Arrives from BS with GKEK.
GKEK lifetime	—	Arrives from BS with GKEK; when this expires a new GKEK should be obtained.
HMAC_KEY_G/ CMAC_KEY_G	160 or 128	The key which is used for signing group DL GTEK update messages, calculated by $KDF(CMAC\_PAD, GKEK)$ .
HMAC_PN_G/ CMAC_PN_G	32	Used to avoid DL replay attack on management. When this expires a new GKEK should be obtained.
H/CMAC_KEY_U	160 or 128	The key that is used for signing UL management messages.

GKEK or KEK can be used for encrypting MGTEK for MBS GSA.

*Insert new subclause 7.2.2.4.3:*

**7.2.2.4.3 PMK context**

The PMK context includes all parameters associated with the PMK. This context is created when EAP Authentication completes.

The PMK context is described in Table 133c.

**Table 133c—PMK context**

Parameter	Size (bits)	Usage
PMK	160	A key yielded from the EAP-based authentication.
PMK sequence number	4	PMK sequence number, when the EAP-based authorization is achieved and a key is generated. The least significant 2 bits are the sequence counter. And the most significant 2 bits set to 0.

#### 7.2.2.4.4 PAK context

The PAK context includes all parameters associated with the PAK. This context is created when RSA Authentication completes.

The PAK context is described in Table 133d.

**Table 133d—PAK context**

Parameter	Size (bits)	Usage
PAK	160	A key yielded from the EAP-based authentication.
PAK Lifetime	4	PAK lifetime, from when the RSA-based authorization is achieved. The value of PAK lifetime is initially set to a default value. The 3-way handshake may subsequently change this value.
PAK sequence number	4	PAK sequence number, when the RSA-based authorization is achieved and a key is generated. The most significant 2 bits are the sequence counter. And the least significant 2 bits set to 0.

#### 7.2.2.5 TEK state machine

The TEK state machine consists of seven states and eleven events (including receipt of messages) that may trigger state transitions. Like the Authorization state machine, the TEK state machine is presented in both a state flow diagram (Figure 134) and a state transition matrix (Table 134). As was the case for the Authorization state machine, the state transition matrix shall be used as the definitive specification of protocol actions associated with each state transition.

Shaded states in Figure 131 (Operational, Rekey Wait, Rekey Reauthorize Wait, and M&B Rekey Interim Wait) have valid keying material and encrypted traffic may be sent.

The SAID may be replaced by the GSAID for the multicast service or the broadcast service. And, the TEK may be also replaced by the GTEK for the multicast service or the broadcast service.

The Authorization state machine starts an independent TEK state machine for each of its authorized SAIDs. As mentioned in 7.2.2, the BS maintains two active TEKs per SAID.

For the unicast service, the BS includes in its Key Replies both of these TEKs, along with their remaining lifetimes. The BS encrypts downlink traffic with the older of its two TEKs and decrypts uplink traffic with either the older or newer TEK, depending upon which of the two keys the SS was using at the time. The SS encrypts uplink traffic with the newer of its two TEKs and decrypts downlink traffic with either the older or newer TEK, depending upon which of the two keys the BS was using at the time. See 7.3 for details on SS and BS key usage requirements.

For the multicast service or the broadcast service, the BS may include both of GTEKs in its Key Reply messages, when an SS request traffic keying material. And, the BS may include the newer GTEK in the Key Update Command message, when the BS transmits the new traffic keying material in key push mode. The BS encrypts downlink traffic with current GTEK. The SS decrypts downlink traffic with either the older or

newer GTEK, depending upon which of the two keys the BS is using at the time. See 7.9 for details on SS and BS key usage requirements.

Through operation of a TEK state machine, the SS attempts to keep its copies of an SAID's TEKs synchronized with those of its BS. A TEK state machine issues Key Requests to refresh copies of its SAID's keying material soon after the scheduled expiration time of the older of its two TEKs and before the expiration of its newer TEK. To accommodate for SS/BS clock skew and other system processing and transmission delays, the SS schedules its Key Requests a configurable number of seconds before the newer TEK's estimated expiration in the BS. With the receipt of the Key Reply, the SS shall always update its records with the TEK Parameters from both TEKs contained in the Key Reply message. TEK Parameters contained in the two Key Update Command messages for the multicast service or the broadcast service.

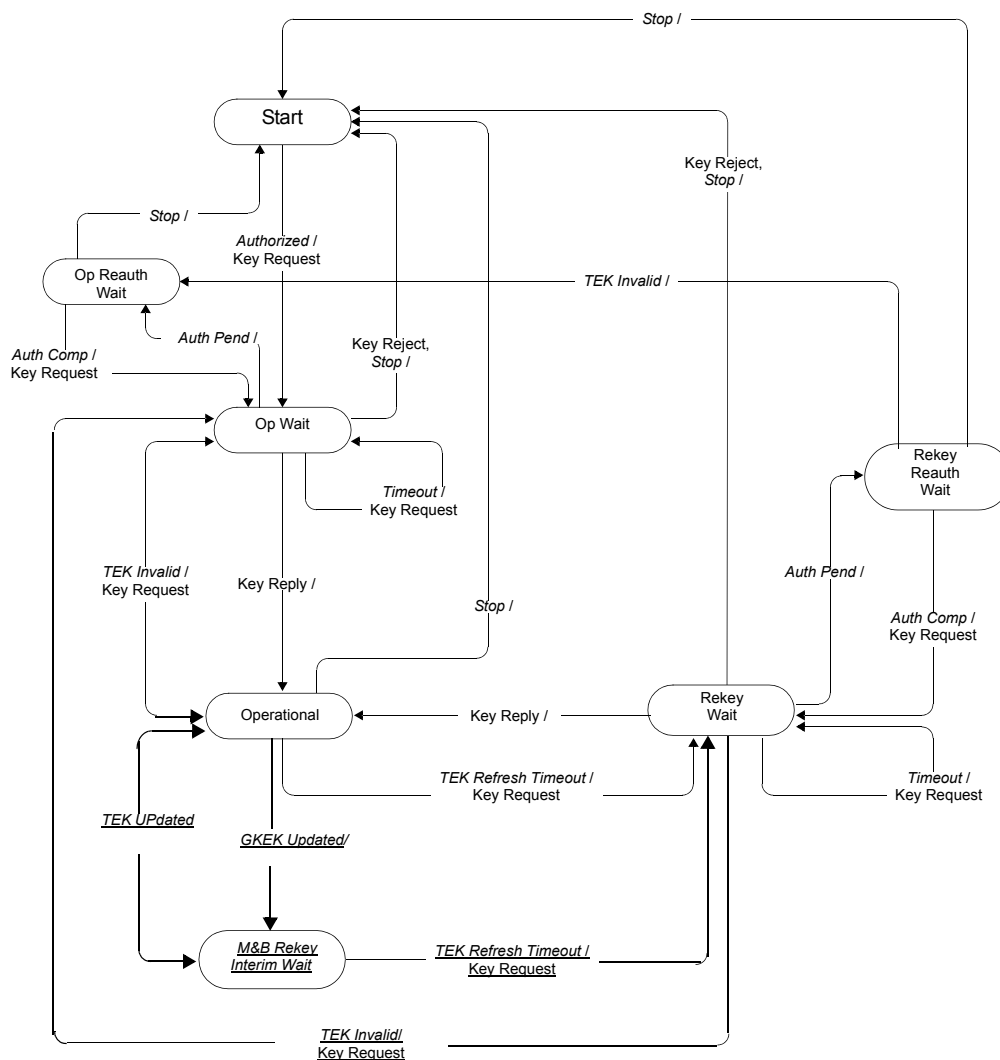


Figure 131—TEK state machine flow diagram

**Table 134—TEK FSM state transition matrix**

State Event or Rcvd Message	(A) Start	(B) Op Wait	(C) Op Reauth Wait	(D) Op	(E) Rekey Wait	(F) Rekey Reauth Wait	(G) <u>M&amp;B</u> <u>Rekey</u> <u>Interim</u> <u>Wait</u>
(1) <i>Stop</i>		Start	Start	Start	Start	Start	
(2) <i>Authorized</i>	Op Wait						
(3) <i>Auth Pend</i>		Op Reauth Wait			Rekey Reauth Wait		
(4) <i>Auth Comp</i>			Op Wait			Rekey Wait	
(5) <i>TEK Invalid</i>				Op Wait	Op Wait	Op Reauth Wait	
(6) <i>Timeout</i>		Op Wait			Rekey Wait		
(7) <i>TEK Refresh Timeout</i>				Rekey Wait			<u>Rekey Wait</u>
(8) <i>Key Reply</i>		Operational			Operational		
(9) <i>Key Reject</i>		Start			Start		
(10) <u>GKEK</u> <u>Updated</u>				<u>M&amp;B</u> <u>Rekey</u> <u>Interim</u> <u>Wait</u>			
(11) <u>GTEK</u> <u>Updated</u>							<u>Operational</u>

**7.2.2.5.1 States**

*Start:* This is the initial state of the FSM. No resources are assigned to or used by the FSM in this state—e.g., all timers are off, and no processing is scheduled.

*Operational Wait (Op Wait):* The TEK state machine has sent its initial request (Key Request) for its SAID’s keying material (TEK and CBC initialization vector), and is waiting for a reply from the BS.

*Operational Reauthorize Wait (Op Reauth Wait):* The wait state the TEK state machine is placed in if it does not have valid keying material while the Authorization state machine is in the middle of a reauthorization cycle.

*Operational:* The SS has valid keying material for the associated SAID.

*Rekey Wait*: The TEK Refresh Timer has expired and the SS has requested a key update for this SAID. Note that the newer of its two TEKs has not expired and may still be used for both encrypting and decrypting data traffic.

*Rekey Reauthorize Wait (Rekey Reauth Wait)*: The wait state the TEK state machine is placed in if the TEK state machine has valid traffic keying material, has an outstanding request for the latest keying material, and the Authorization state machine initiates a reauthorization cycle.

*M&B Rekey Interim Wait (Multicast & Broadcast Rekey Interim Wait)*: This state is defined only for the multicast service or the broadcast service. This state is the wait state the TEK state machine is placed in if the TEK state machine has valid traffic keying material and receives the new GKEK from the BS.

### 7.2.2.5.2 Messages

Note that the message formats are defined in detail in 6.3.2.3.9.

*Key Request*: Request a TEK for this SAID. Sent by the SS to the BS and authenticated with keyed message digest. The message authentication key is derived from the AK.

*Key Reply*: Response from the BS carrying the two diversity sets of traffic keying material for this SAID. Sent by the BS to the SS, it includes the SAID's TEKs, encrypted with a KEK derived from the AK or the GSAID's GTEK, encrypted with a GKEK randomly generated from the BS or the ASA server. The Key Reply message is authenticated with a keyed message digest; the authentication key is derived from the AK.

*Key Reject*: Response from the BS to the SS to indicate this SAID is no longer valid and no key will be sent. The Key Reject message is authenticated with a keyed message digest; the authentication key is derived from the AK.

*TEK Invalid*: The BS sends an SS this message if it determines that the SS encrypted an uplink PDU with an invalid TEK, i.e., an SAID's TEK key sequence number, contained within the received PDU's MAC Header, is out of the BS's range of known, valid sequence numbers for that SAID.

*Key Update Command*: Push a GTEK for this GSAID for the multicast service or the broadcast service. Sent by the BS to the SS and authenticate with keyed message digest. The message authentication key is derived from the AK in the Key Update Command message for the GKEK update mode. The message authentication key is derived from the GKEK in the Key Update Command message for the GTEK update mode.

### 7.2.2.5.3 Events

*Stop*: Sent by the Authorization FSM to an active (non-START state) TEK FSM to terminate TEK FSM and remove the corresponding SAID's keying material from the SS's key table. See Figure 130k.

*Authorized*: Sent by the Authorization FSM to a non-active (START state) TEK FSM to notify TEK FSM of successful authorization. See Figure 130k.

*Authorization Pending (Auth Pend)*: Sent by the Authorization FSM to TEK FSM to place TEK FSM in a wait state while Authorization FSM completes reauthorization. See Figure 130k.

*Authorization Complete (Auth Comp)*: Sent by the Authorization FSM to a TEK FSM in the Operational Reauthorize Wait or Rekey Reauthorize Wait states to clear the wait state begun by the prior Authorization Pending event. See Figure 130k.

*TEK Invalid*: This event is triggered by either an SS's data packet decryption logic or by the receipt of a TEK Invalid message from the BS.

An SS's data packet decryption logic triggers a TEK Invalid event if it recognizes a loss of TEK key synchronization between itself and the encrypting BS. For example, an SAID's TEK key sequence number, contained within the received downlink MAC PDU header, is out of the SS's range of known sequence numbers for that SAID.

A BS sends an SS a TEK Invalid message, triggering a TEK Invalid event within the SS, if the BS's decryption logic recognizes a loss of TEK key synchronization between itself and the SS.

*Timeout:* A retry timer timeout. Generally, the particular request is retransmitted.

*TEK Refresh Timeout:* The TEK refresh timer timed out. This timer event signals the TEK state machine to issue a new Key Request in order to refresh its keying material. The refresh timer is set to fire a configurable duration of time (*TEK Grace Time*) before the expiration of the newer TEK the SS currently holds. This is configured via the BS to occur after the scheduled expiration of the older of the two TEKs.

*GKEK Updated:* This event is triggered when the SS receives the new GKEK through the Key Update Command message for the GKEK update mode.

*GTEK Updated:* This event is triggered when the SS receives the new GTEK and traffic keying material through the Key Update Command message for the GTEK update mode.

#### 7.2.2.5.4 Parameters

All configuration parameter values take the default values from Table 343 or may be specified in Auth Reply message.

*Operational Wait Timeout:* Timeout period between sending of Key Request messages from the Op Wait state (see 11.9.19.4).

*Rekey Wait Timeout:* Timeout period between sending of Key Request messages from the Rekey Wait state (see 11.9.19.5).

*TEK Grace Time:* Time interval, in seconds, before the estimated expiration of a TEK that the SS starts rekeying for a new TEK. TEK Grace Time takes the default value from Table 343 or may be specified in a configuration setting within the Auth Reply message and is the same across all SAIDs (see 11.9.19.6).

*M&B TEK Grace Time (Multicast & Broadcast TEK Grace Time):* Time interval, in seconds, before the estimated expiration of an old distributed GTEK.

#### 7.2.2.5.5 Actions

Actions taken in association with state transitions are listed by <event> (<rcvd message>) --> <state>:

1-B Op Wait (*Stop*) → Start

- a) Clear Key Request retry timer
- b) Terminate TEK FSM

1-C Op Reauth Wait (*Stop*) → Start

- a) Terminate TEK FSM

1-D Operational (*Stop*) → Start

- a) Clear TEK refresh timer, which is timer set to go off “*TEK Grace Time*” seconds prior to the TEK’s scheduled expiration time
  - b) Terminate TEK FSM
  - c) Remove SAID keying material from key table
- 1-E Rekey Wait (*Stop*) → Start
- a) Clear Key Request retry timer
  - b) Terminate TEK FSM
  - c) Remove SAID keying material from key table
- 1-F Rekey Reauth Wait (*Stop*) → Start
- a) Terminate TEK FSM
  - b) Remove SAID keying material from key table
- 2-A Start (*Authorized*) → Op Wait
- a) Send Key Request message to BS
  - b) Set Key Request retry timer to Operational Wait Timeout
- 3-B Op Wait (*Auth Pend*) → Op Reauth Wait
- a) Clear Key Request retry timer
- 3-E Rekey Wait (*Auth Pend*) → Rekey Reauth Wait
- a) Clear Key Request retry timer
- 4-C Op Reauth Wait (*Auth Comp*) → Op Wait
- a) Send Key Request message to BS
  - b) Set Key Request retry timer to Operational Wait Timeout
- 4-F Rekey Reauth Wait (*Auth Comp*) → Rekey Wait
- a) Send Key Request message to BS
  - b) Set Key Request retry timer to Rekey Wait Timeout
- 5-D Operational (*TEK Invalid*) → Op Wait
- a) Clear TEK refresh timer
  - b) Send Key Request message to BS
  - c) Set Key Request retry timer to Operational Wait Timeout
  - d) Remove SAID keying material from key table



- 5-E Rekey Wait (*TEK Invalid*) → Op Wait
- Clear TEK refresh timer
  - Send Key Request message to BS
  - Set Key Request retry timer to Operational Wait Timeout
  - Remove SAID keying material from key table
- 5-F Rekey Reauth Wait (*TEK Invalid*) → Op Reauth Wait
- Remove SAID keying material from key table
- 6-B Op Wait (*Timeout*) → Op Wait
- Send Key Request message to BS
  - Set Key Request retry timer to Operational Wait Timeout
- 6-E Rekey Wait (*Timeout*) → Rekey Wait
- Send Key Request message to BS
  - Set Key Request retry timer to Rekey Wait Timeout
- 7-D Operational (*TEK Refresh Timeout*) → Rekey Wait
- Send Key Request message to BS
  - Set Key Request retry timer to Rekey Wait Timeout
- 7-G M&B Rekey Interim Wait (*TEK Refresh Timeout*) → Rekey Wait
- Send Key Request message to BS
  - Set Key Request retry timer to Rekey Wait Timeout
- 8-B Op Wait (Key Reply) → Operational
- Clear Key Request retry timer
  - Process contents of Key Reply message and incorporate new keying material into key database
  - Set the TEK refresh timer to go off “TEK Grace Time” seconds prior to the newer key’s scheduled expiration
- 8-E Rekey Wait (Key Reply) → Operational
- Clear Key Request retry timer
  - Process contents of Key Reply message and incorporate new keying material into key database
  - Set the TEK refresh timer to go off “TEK Grace Time” seconds prior to the newer key’s scheduled expiration

- 9-B Op Wait (Key Reject) → Start
- a) Clear Key Request retry timer
  - b) Terminate TEK FSM
- 9-E Rekey Wait (Key Reject) → Start
- a) Clear Key Request retry timer
  - b) Terminate TEK FSM
  - c) Remove SAID keying material from key table
- 10-D Operational (*GKEK Updated*) → M&B Rekey Interim Wait
- a) Process contents of Key Update Command message for the GKEK update mode and incorporate new GKEK into key database
- 11-G M&B Rekey Interim Wait (*GTEK Updated*) → Operational
- a) Clear Key Request retry timer
  - b) Process contents of Key Update Command message for the GTEK update mode and incorporate new traffic keying material into key database
  - c) Set the TEK refresh timer to go off “TEK Grace Time” seconds prior to the key’s scheduled expiration

### 7.3 Key Usage

*Replace Figure 134 TEK Management in BS and SS with the following figure:*

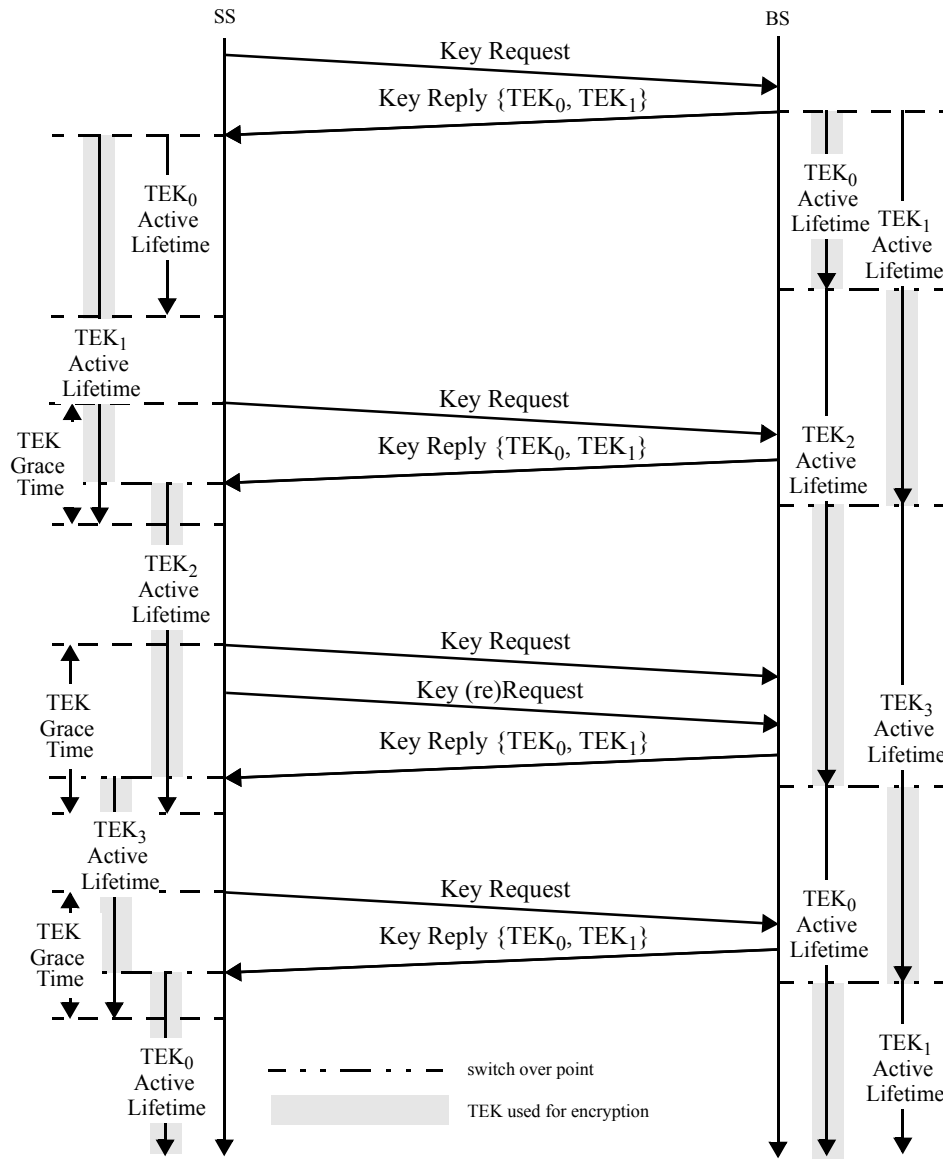


Figure 134—TEK management in BS and SS

## 7.5 Cryptographic methods

### 7.5.1 Data Encryption methods

#### 7.5.1.1 Data encryption with DES in CBC mode

*Change the second paragraph as indicated:*

The CBC IV shall be calculated as follows: in the downlink, the CBC shall be initialized with the exclusive-or (XOR) of (1) the IV parameter included in the TEK keying information, and (2) the ~~content of the PHY Synchronization field~~ current Frame Number (right justified) of the latest DL-MAP. In the uplink, the CBC shall be initialized with the XOR of (1) the IV parameter included in the TEK keying information, and (2) the ~~content of the PHY Synchronization field of the DL-MAP that is in effect when the UL-MAP for the uplink transmission is created/received~~ Frame Number of the frame where the relevant UL-MAP was transmitted.

**7.5.1.2 Data encryption with AES in CCM mode**

*Change the title of 7.5.1.2.1 as indicated:*

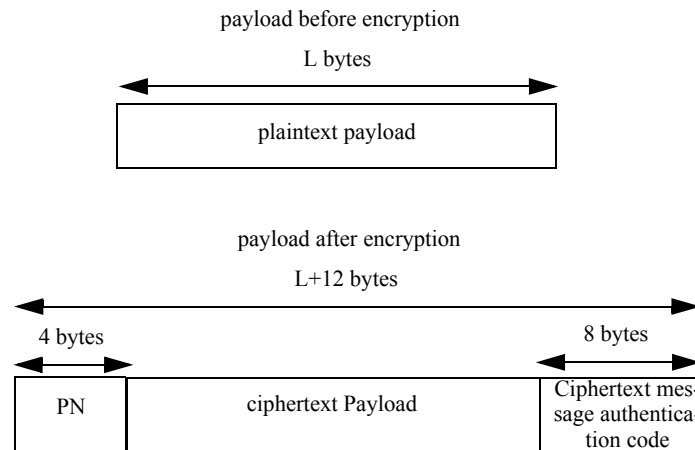
**7.5.1.2.1 PDU Payload Format**

*Change the first and third paragraph as indicated:*

The PDU payload shall be prepended with a 4-byte PN (Packet Number). The PN shall be transmitted ~~in little-endian byte order~~ LSB first. The PN shall not be encrypted.

The ciphertext ~~ICV~~ Message Authentication Code is transmitted such that byte index 0 (as enumerated in the NIST AES Specification) is transmitted first and byte index 7 is transmitted last (i.e., LSB First) ~~in little-endian byte order~~.

*Replace Figure 135 with the following figure:*



**Figure 135—Encrypted payload format in AES-CCM mode**

**7.5.1.2.2 PN (Packet Number)**

*Change the first paragraph as indicated:*

The PN associated with an SA shall be set to 1 when the SA is established and when a new TEK is installed. ~~The PN shall be transmitted little-endian order in the MAC PDU as described in 7.5.1.2.1.~~ After each PDU transmission, the PN shall be incremented by 1. On uplink connections, the PN shall be XORed with 0x80000000 prior to encryption and transmission. On downlink connections, the PN shall be used without such modification.

*Change the title of 7.5.1.2.3 as indicated:*

**7.5.1.2.3 CCM Algorithm**

*Change this subclause as indicated:*

The NIST CCM specification defines a number of algorithm parameters. These parameters shall be fixed to specific values when used in SAs with a data encryption algorithm identifier of 0x02.

~~The 'tlen' shall equal 64 and t shall equal 8, meaning, the number of octets bytes in the Message Authentication field authentication field M shall be set to 8. Consistent with the CCM specification the 3-bit binary encoding [(t-2)/2]<sub>3</sub> of M bits 5, 4, and 3 of the 'Flags' byte in B<sub>0</sub> shall be 011.~~

The size q of the length field Q shall be set to 2. Consistent with the CCM specification, the 3-bit binary encoding [q-1]<sub>3</sub> of the q DLEN size field in bits 2, 1 and 0 of the 'Flags' byte in B<sub>0</sub> shall be 001.

The length a of the ~~additional authenticated~~ associated data string A (a) shall be set to 0.

The nonce shall be 13 bytes long ~~as shown in Figure 135a. Bytes 0 through 4 + through 5 shall be set to the first five bytes of the Generic MAC header GMH (thus excluding the HCS). The HCS of the Generic MAC header is not included in the nonce since it is redundant. Bytes 5 through 8 Bytes 6 through 9 are reserved and shall be set to 0x00000000. Bytes 9 through 12 +0 through 13 shall be set to the value of the PN. The PN Bytes shall be ordered such that Byte 9 +0 shall take the least significant byte and byte 12 +3 shall take the most significant byte.~~

Byte number	0	4	5	8	9	12
Field	Generic MAC header		<i>Reserved</i>		PN	
Contents	Generic MAC header omitting HCS		0x00000000		packet number field from payload	

**Figure 135a—Nonce N Construction**

Consistent with the CCM specification, the initial block B<sub>0</sub> is formatted as shown in Figure 136.

*Replace Figure 136 with the following figure.:*

Byte number	0	1	13	14	15
Byte significance:				MSB	LSB
Number of bytes	1	13			2
Field	Flag	Nonce			L
Contents	0x19	As specified in Figure 135a			Length of plain text payload

**Figure 136—Initial CCM Block B<sub>0</sub>**

Note the ~~big-endian~~ ordering of the DLEN value is MSB first, consistent opposite that of the normal little endian representation. This is to remain compliant with the letter of the NIST CCM specification.

~~The sixth byte of the GMH is not included in the nonce since it is redundant.~~

Consistent with the NIST CCM specification the counter blocks Ctr<sub>i</sub> A<sub>i</sub> are formatted as shown in Figure 137.

**Replace Figure 137 with the following figure:**

Byte number	0	1	13	14	15
Byte significance:				MSB	LSB
Number of bytes	1	13		2	
Field	Flag	Nonce		Counter	
Contents	0x1	As specified in Figure 135a		i	

**Figure 137—Construction of counter blocks Ctr<sub>j</sub>**

**Insert a new subclause 7.5.1.2.5:**

**7.5.1.2.5 AES-CCM Mode example encrypted MPDUs**

The following two examples show MPDUs in both plaintext and enciphered form in transmission order. In addition, the post-decryption plaintext of the Message Authentication Code is shown.

Example AES-CCM PDU #1 (Hex)

**Plaintext PDU**

Generic MAC header = 00 40 0A 06 C4 30  
 Payload = 00 01 02 03

**Ciphertext PDU where TEK = 0xD50E18A844AC5BF38E4CD72D9B0942E5  
 and PN=0x2157F6BC**

Generic MAC header = 40 40 1A 06 C4 5A  
 PN field = BC F6 57 21  
 Encrypted payload = E7 55 36 C8  
 Encrypted message authentication code = 27 A8 D7 1B 43 2C A5 48  
 CRC32 for SC, SCa, and OFDM mode = CB B6 5F 48  
 CRC32 for OFDMA mode = 1B D1 BA 21

**After decryption**

Plaintext message authentication code = 01 59 09 A0 ED CC 21 D3

Example AES-CCM PDU #2 (Hex)

**Plaintext PDU**

Generic MAC header = 00 40 27 7E B2 AD  
 Payload = 00 01 02 03 04 05 06 07 08 09 0A 0B 0C 0D 0E 0F  
 10 11 12 13 14 15 16 17 18 19 1A 1B 1C 1D 1E 1F  
 20

**Ciphertext PDU where TEK = 0xB74EB0E4F81AD63D121B7E9AECCD268F  
 and PN=0x78D07D08**

Generic MAC header = 40 40 37 7E B2 C7  
 PN field = 08 7D D0 78  
 Encrypted payload = 71 3F B1 22 B9 73 4F DB FD 68 2E AD 9D CA 9F 44  
 1F 62 FE 0F 4A 2C 45 B5 53 17 3D 66 5B 2D 53 C1  
 B3  
 Encrypted message authentication code = E7 E4 8D 2D B7 61 CF 94  
 CRC32 for SC, SCa, and OFDM mode = 92 1B 32 41  
 CRC32 for OFDMA mode = FD 03 7B 1D

**After decryption**

Plaintext message authentication code = 0B DB 85 3C 0A CA E6 5F

*Insert new subclause 7.5.1.3:*

**7.5.1.3 Data encryption with AES in CTR mode**

If the data encryption algorithm identifier in the cryptographic suite of an MBS GSA equals 0x80, data on connections associated with that SA shall use the CTR mode of the US Advanced Encryption Standard (AES) algorithm [NIST Special Publication 800-38A, FIPS 197, RFC 3686] to encrypt the MAC PDU payloads. In MBS, the AES block size and cipher counter block are 128 bits.

**7.5.1.3.1 Encrypted MBS PDU payload format**

Counter mode requires unique initial counter and key pair across all messages. This subclause describes the initialization of the 128-bit initial counter, constructed from the 24-bit PHY synchronization field or frame number and a new 8-bit Rollover counter (ROC).

NOTE—When we start to deal with a new PDU we have a new frame number and therefore re-initialize the counter. When the frame number reaches 0x000000 (from 0xFFFFF), we increment ROC.

The PDU payload for AES-CTR encryption shall be prepended with the 8-bit ROC, i.e., the ROC is the 8 MSBs of the 32-bit nonce. The ROC shall not be encrypted.

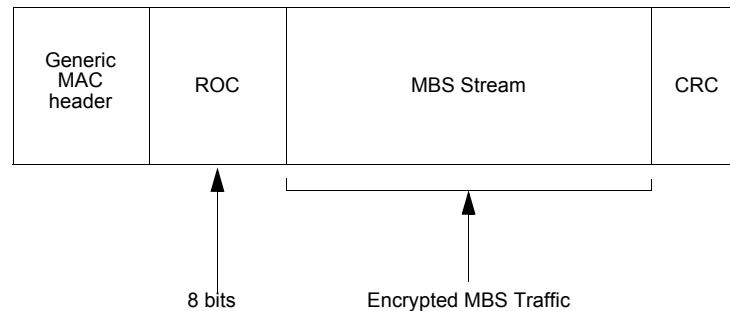
Any tuple value of {AES Counter, KEY} shall not be used more than once for the purposes of encrypting a block. SS and BS shall ensure that a new MGTEK is requested and transferred before the ROC reaches 0xFF.

A 32-bit nonce NONCE = n0 | n1 | n2 | n3 (n0 being the MSByte and n3 the LSByte) is made of ROC and 24 bits frame number in the following way: n0=ROC and n1, n2, n3 are the byte representation of frame-number in MSB first order. NONCE shall be repeated four times to construct the 128-bit counter block required by the AES-128 cipher. (initial counter = NONCE|NONCE|NONCE|NONCE). When incremented, this 16-byte counter will be treated as a Big Endian number.

This mechanism can reduce per-PDU overhead of transmitting the full counter. At the most 2<sup>32</sup> PDUs can be encrypted with a single MTK.

The plaintext PDU shall be encrypted using the active MBS\_Traffic\_key (MTK) derived from MAK and MGTEK, according to CTR mode specification. A different 128-bit counter value is used to encrypt each 128-bit block within a PDU.

The processing yields a payload that is 8 bits longer than the plaintext payload.



**Figure 137a—MBS MAC PDU Ciphertext payload format**

### 7.5.1.4 Data encryption with AES in CBC mode

If the data encryption algorithm identifier in the cryptographic suite of an SA equals 0x03, data on connections associated with that SA shall use the CBC mode of the US Advanced Encryption Standard (AES) algorithm [NIST Special Publication 800-38A, FIPS 197] to encrypt the MAC PDU payloads.

Residual termination block processing shall be used to encrypt the final block of plaintext when the final block is less than the cipher block size. Given a final block having  $n$  bits, where  $n$  is less than the cipher block size  $m$ , the next-to-last ciphertext block shall be divided into two parts. One of the two parts is  $n$  bits, the other part is  $m-n$  bits. The former will be sent to receiver as the final block ciphertext. Padding the final short block to obtain a complete plaintext block, then encrypt it with AES algorithm in CBC mode. The encryption and decryption procedure is depicted in Figure 137b.

In the special case when the payload portion of the MAC PDU is less than the cipher block size, the most significant  $n$  bits of the generated CBC-IV, corresponding to the number of bits of the payload, shall be XORed with the  $n$  bits of the payload to generate the short cipher block.

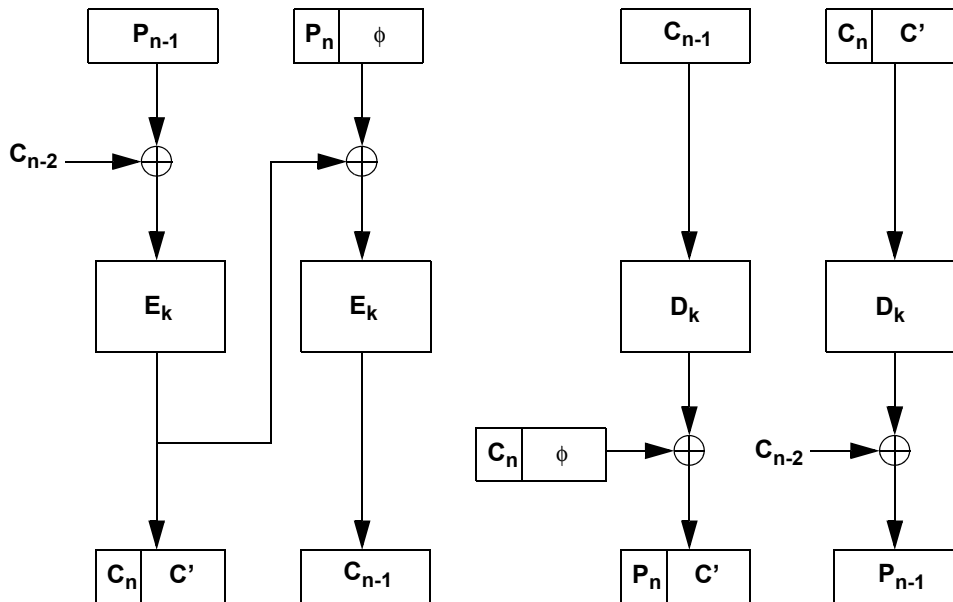


Figure 137b—Residual termination block processing with CTS

#### 7.5.1.4.1 CBC IV generation

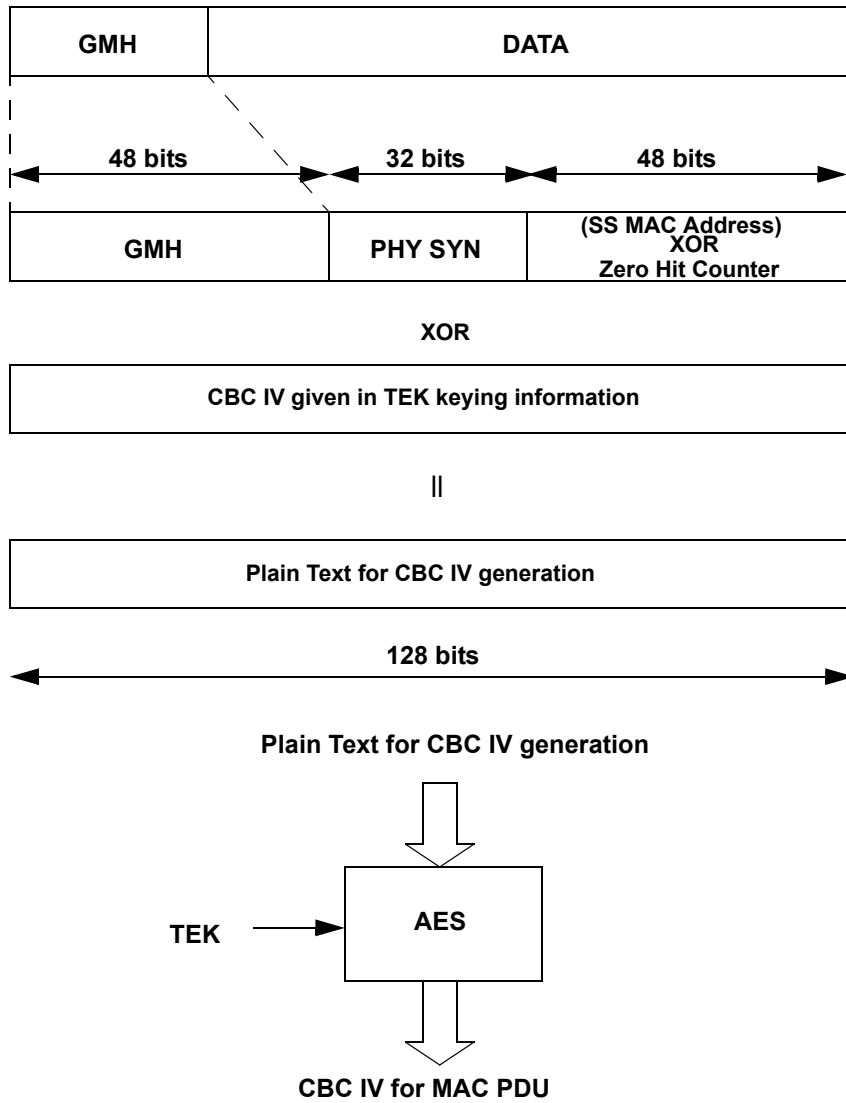
The Zero Hit Counter is initialized into zero when the Key Reply message is received, and updates whenever either the PHY Frame number is zero or MAC PDU is received in a frame. The Zero Hit Counter increases by one if the previous PHY Frame number is equal to or greater than the current PHY Frame number.

The CBC IV is generated as the result of the AES block ciphering algorithm with the key of TEK. Its plain text for the CBC IV generation is calculated with the exclusive-or (XOR) of (1) the CBC IV parameter value included in the TEK keying information, and (2) the 128-bits content which is a concatenation of the 48-bit



MAC PDU header, the 32-bit PHY Synchronization value of the MAP that a data transmission occurs, and the XOR value of the 48-bit SS MAC address and the Zero Hit Counter.

The CBC IV shall be updated every MAC PDUs.



**Figure 137c—CBC IV generation**

If the MAC PDU is decoded from several channel coded blocks transmitted at different frames in HARQ operation, the MAC PDU payload must be decrypted with the CBC IV value which are generated from the PHY Synchronization value of the MAP when spid = 0.

#### 7.5.1.2.4 Receive Processing Rules

*Insert at the end of 7.5.1.2.4:*

The receiver shall maintain a PN window whose size is specified by the PN\_WINDOW\_SIZE parameter for SAs and management connections as defined in 11.9.36. Any received PDU with a PN lower than the beginning of the PN window shall be discarded as a replay attempt. The receiver shall track PNs within the PN window. Any PN that is received more than once shall be discarded as a replay attempt. Upon reception of a PN, which is greater than the end of the PN window, the PN window shall be advanced to cover this PN.

*Insert new subclause 7.5.2.4*

#### 7.5.2.4 Encryption of TEK-128 with AES Key Wrap

This method of encrypting the TEK-128 shall be used for SAs with the TEK encryption algorithm identifier in the cryptographic suite equal to 0x04.

The BS encrypts the value fields of the TEK-128 in the Key Reply messages it sends to client SS. This field is encrypted using the AES Key Wrap Algorithm.

encryption:  $C, I = Ek[P]$   
decryption:  $P, I = Dk[C]$   
P = Plaintext 128-bit TEK  
C = Ciphertext 128-bit TEK  
I = Integrity Check Value  
k = the 128-bit KEK  
 $Ek[ ]$  = AES Key Wrap encryption with key k  
 $Dk[ ]$  = AES Key Wrap decryption with key k

The AES key wrap encryption algorithm accepts both a ciphertext and an integrity check value. The decryption algorithm returns a plaintext key and the integrity check value. The default integrity check value in the NIST AES Key Wrap algorithm shall be used.

#### 7.5.3 Calculation of HMAC-Digests

*Replace the last sentence of the subclause with the following sentence:*

~~The digest shall be calculated over the entire MAC Management message with the exception of the HMAC-Digest and HMAC Tuple attributes.~~

The HMAC sequence number in the HMAC tuple or Short-HMAC tuple shall be equal to the AK sequence number of the AK from which the HMAC\_KEY\_x was derived.

In the case of PKMv2, Short-HMAC Digest Calculations shall include the HMAC\_PN\_\* that should be concatenated after the MAC Management message.

#### 7.5.4 Derivation of TEKs, KEKs, and message authentication keys

*Change the title of subclause 7.5.4.2 as indicated:*

##### 7.5.4.2 ~~3-DES~~ KEKs

*Insert the following paragraph at the end of the subclause:*

The construction of the KEK for use with TEK-128 keys shall be the same as for 3-DES KEKs except that the full 128 bits of the KEK are used directly as the 128-bit AES key, instead of the KEK being split into two 64-bit DES keys.

*Insert new subclause 7.5.4.4 as follows:*

#### **7.5.4.4 Cipher-based MAC (CMAC)**

A BS or SS may support management message integrity protection based on Cipher-based MAC—together with the AES block cipher. The CMAC construction as specified in Special Publication 800-38B—Recommendation for Block Cipher Modes of Operation: the CMAC Mode for Authentication: May 2005 shall be used.

##### **7.5.4.4.1 Calculation of CMAC Value**

The calculation of the keyed hash value contained in the CMAC-Digest attribute and the CMAC Tuple shall use the CMAC Algorithm with AES. The downlink authentication key CMAC\_KEY\_D shall be used for authenticating messages in the downlink direction. The uplink authentication key CMAC\_KEY\_U shall be used for authenticating messages in the uplink direction. Uplink and downlink message authentication keys are derived from the AK (see 7.5.4 below for details).

For authentication multicast messages (in the DL only) a CMAC\_KEY\_GD shall be used (one for each group), group authentication key is derived from GKEK

The CMAC-Digest and CMAC Tuple attributes shall be only applicable to the PKM version 2. In the PKM version 2 protocol, the ~~AKID CMAC key sequence number used in the computation of the CMAC value tuple shall be the 64 bit AKID equal to the 4 bit AK sequence number~~ of the AK from which the CMAC\_KEY\_x was derived. See 6.3.2.3.9.18 for the SA-TEK-Challenge message attributes in which the mapping between the AK Sequence number and the AKID is communicated and see 7.2.2.4.1 for a description of the AK context that contains the AK and AKID.

The CMAC Packet Number Counter (CMAC\_PN\_\*) is a 4-byte sequential counter that is incremented in the context of UL messages by the SS, and in the context of DL messages by the BS,. The BS will also maintain a separate CMAC\_PN\_\* for multicast packets per each GSA and increment that counter in the context of each multicast packet from the group. For MAC messages that have no CID e.g., RNG-REQ message, the CMAC\_PN\_\* context will be the same as used on the basic CID. If basic CID is unknown (e.g., in network reentry situation) then CID 0 should be used.

The CMAC Packet Number Counter, CMAC\_PN\_\*, is part of the CMAC security context and must be unique for each MAC management message with the CMAC tuple or digest. Any tuple value of {CMAC\_PN\_\*, AK} shall not be used more than once. The reauthentication process should be initiated (by BS or SS) to establish a new AK before the CMAC\_PN\_\* reaches the end of its number space.

The digest shall be calculated over a field consisting of the ~~AKID CMAC key sequence number~~ followed by the CMAC Packet Number Counter, expressed as an unsigned 32-bit number, followed by the 16-bit Connection ID on which the message is sent, followed by 16-bit of zero padding (for the header to be aligned with AES block size) and followed by the entire MAC management message with the exception of the CMAC-TLV.

The least significant bits of the digest shall be truncated to yield a 64-bit length digest. ~~The CMAC key sequence number shall be equal to the 4 bit AK sequence number of the AK from which the CMAC\_KEY\_x was derived.~~

i.e.,:

CMAC value  $\leq$  Truncate64 (CMAC (CMAC\_KEY\_\*, ~~AKID~~ ~~CMAC-key-sequence-number~~ | CMAC\_PN | CID | 16-bit zero padding | MAC\_Management\_Message))

If the digest is included in an MPDU that has no CID, e.g., A RNG-REQ message, the CID used shall take the value of the basic CID. If basic CID is unknown (e.g., in network reentry situation) then CID 0 should be used.

*Insert new subclause 7.5.4.5:*

#### **7.5.4.5 Derivation of TEKs, KEKs, message authentication keys and GKEKs in PKMv2**

*Insert new subclause 7.5.4.5.1:*

##### **7.5.4.5.1 AES KEKs in PKMv2**

The construction of the KEK for use with TEK-128 keys shall be the same as for 3-DES KEKs as described in 7.5.4.2 except that the full 128 bits of the KEK are used directly as the 128-bit AES key, instead of the KEK being split into two 64-bit DES keys.

*Insert new subclause 7.5.4.5.2:*

##### **7.5.4.5.2 Encryption of GKEK in PKMv2**

The BS encrypts the value fields of the GKEK in the Key Update Command message for the GKEK update mode and sends the encrypted GKEK to each SS served with the specific multicast service or the broadcast service. The following options for encryption of GKEK may be used. The encryption algorithm is determined according to the value of cryptographic suite. Also, the value of cryptographic suite for GKEK encryption is identical to the one for GTEK encryption.

*Insert new subclause 7.5.4.5.2.1:*

###### **7.5.4.5.2.1 Encryption of GKEK with 3-DES in PKMv2**

This method of encrypting the GKEK shall be used for SAs with the TEK (or GTEK) encryption algorithm identifier in the cryptographic suite equal to 0x01.

The BS encrypts the value fields of the GKEK in the Key Update Command messages (for the GKEK update mode) it sends to client SS. This field is encrypted using two-key 3-DES in the EDE mode:

Encryption:  $C = Ek_1[Dk_2[Ek_1[P]]]$

Decryption:  $P = Dk_1[Ek_2[Dk_1[C]]]$

P = Plaintext 128-bit GKEK

C = Ciphertext 128-bit GKEK

k1 = leftmost 64 bits of the 128-bit KEK

k2 = rightmost 64 bits of the 128-bit KEK

E [ ] = 56-bit DES ECB mode encryption

D [ ] = 56-bit DES ECB mode decryption

***Insert new subclause 7.5.4.5.2.2:*****7.5.4.5.2.2 Encryption of GKEK with RSA in PKMv2**

The RSA method of encrypting the GKEK (PKCS #1 v2.1, RSA Cryptography Standard, RSA Laboratories, June 2002) shall be used for SAs with the TEK (or GTEK) encryption algorithm identifier in the cryptographic suite equal to 0x02.

***Insert new subclause 7.5.4.5.2.3:*****7.5.4.5.2.3 Encryption of GKEK with ECB mode AES in PKMv2**

This method of encrypting the GKEK shall be used for SAs with the TEK (or GTEK) encryption algorithm identifier in the cryptographic suite equal to 0x03.

The BS encrypts the value fields of the GKEK in the Key Update Command messages (for the GKEK update mode) it sends to client SS. This field is encrypted using 128-bit AES in ECB mode.

Encryption:  $C = Ek1[P]$

Decryption:  $P = Dk1[C]$

P = Plaintext 128-bit GKEK

C = Ciphertext 128-bit GKEK

k1 = the 128-bit KEK

E [ ] = 128-bit AES ECB mode encryption

D [ ] = 128-bit AES ECB mode decryption

***Insert new subclause 7.5.4.5.2.4:*****7.5.4.5.2.4 Encryption of GKEK with AES Key Wrap in PKMv2**

This method of encrypting the GKEK shall be used for SAs with the TEK (or GTEK) encryption algorithm identifier in the cryptographic suite equal to 0x04.

The BS encrypts the value fields of the GKEK in the Key Update Command messages (for the GKEK update mode) it sends to client SS. This field is encrypted using 128-bit AES Key Wrap Algorithm. This 128-bit AES Key Wrap Algorithm is defined only for PKM version 2.

Encryption:  $C,I = Ek[P]$

Decryption:  $P,I = Dk[C]$

P = Plaintext 128-bit GKEK

C = Ciphertext 128-bit GKEK

k = the 128-bit KEK derived from the AK

Ek [ ] = AES Key Wrap encryption with key k

$Dk[ ]$  = AES Key Wrap decryption with key  $k$

*Insert new subclause 7.5.4.6:*

#### **7.5.4.6 Key derivation functions for PKMv2**

##### **7.5.4.6.1 Dot16KDF for PKMv2**

The Dot16KDF algorithm is a CTR mode construction that may be used to derive an arbitrary amount of keying material from source keying material.

In the case that the HMAC/CMAC setting in the MAC (Message Authentication Code) mode is set to CMAC, the algorithm is defined as:

Dot16KDF(key, astring, keylength)

```
{  
  
    result = null;  
  
    Kin = Truncate (key, 128);  
  
    for (i = 0; i <= int((keylength-1)/128); i++) {  
  
        result = result | CMAC(Kin, i | astring | keylength);  
  
    }  
  
    return Truncate (result, keylength);  
  
}
```

In the case that the HMAC/CMAC setting in the authentication policy bits is set to HMAC, the algorithm is defined as:

Dot16KDF(key, astring, keylength)

```
{  
  
    result = null;  
  
    Kin = Truncate (key, 160);  
  
    For (i=0; i <= int( (keylength-1)/160 ); i++) {  
  
        result = result | SHA-1( i | astring | keylength | Kin);  
  
    }  
  
    return Truncate (result, keylength);  
  
}
```

The key is a cryptographic key that is used by the underlying digest algorithm (SHA-1 or CMAC-AES). ‘astring’ is an octet string used to alter the output of the algorithm. ‘keylength’ is used to determine the length of key material to generate and is used in the digest input data to prevent extension attacks.  $\text{Truncate}(x, y)$  is the rightmost  $y$  bits of a value  $x$  only if  $y \leq x$ .

***Insert new subclause 7.6.1.4.3:***

**7.6.1.4.3 BS certificate**

```
countryName=<Country of Operation>
organizationName=< Name of Infrastructure Operator>
organizationalUnitName=<WirelessMAN>
commonName=<Serial Number>
commonName=<BS Id>
```

The BS Id field shall contain the operator-defined BSId.<sup>7</sup> It is expressed as six pairs of hexadecimal digits separated by colons (:), e.g., “00:60:21:A5:0A:23.” The Alpha HEX characters (A-F) shall be expressed as uppercase letters.

The attributes listed above shall be included.

***Change 7.6.1.6 as follows:***

**7.6.1.6 tbsCertificate.issuerUniqueID and tbsCertificate.subjectUniqueID**

The issuerUniqueID and subjectUniqueID fields shall be omitted for all both of the PKM’s certificate types.

***Insert new subclause 7.7:***

**7.7 Pre-Authentication**

In anticipation of a handover, an MS may seek to use pre-authentication to facilitate an accelerated reentry at a particular target BS.

Pre-authentication results in establishment of an Authorization Key (with a unique AK Name) in the MS and target BS. The specific mechanism for Pre-authentication is out of the scope of this specification.

***Insert new subclause 7.8 and its subclauses:***

**7.8 PKMv2**

**7.8.1 PKMv2 SA-TEK 3-way handshake**

The AK can be derived in one of three different ways depending on the authentication scheme used as documented in 7.2.2.2.3. Before the 3-way handshake begins, the BS and SS shall both derive a shared KEK and HMAC/CMAC keys as per 7.2.2.2.

The PKMv2 SA-TEK 3-way handshake sequence proceeds as follows:

<sup>7</sup>The BSId is an operator-defined value, consequently the BS certificate is typically issued by the Operator, who must ensure that the BS ID is unique within the operator’s network.

- 1) During initial network entry or reauthorization, the BS shall send PKMv2 SA-TEK-Challenge (including a random number BS\_Random) to the SS after protecting it with the HMAC/CMAC Tuple. If the BS does not receive PKMv2 SA-TEK-Request from the SS within SACHallengeTimer, it shall resend the previous PKMv2 SA-TEK-Challenge up to SACHallengeMaxResends times. If the BS reaches its maximum number of resends, it shall initiate another full authentication or drop the SS.
- 2) If HO Process Optimization Bit #1 is set indicating that PKM Authentication phase is omitted during network re-entry or handover, the BS begins the 3-way-handshake by appending the SA Challenge Tuple TLV to the RNG-RSP. If the BS does not receive PKMv2 SA-TEK-Request from the MS within SaChallengeTimer (suggested to be several times greater than the length of SaChallengeTimer), it may initiate full re-authentication or drop the MS. If the BS receives an initial RNG-REQ during the period that PKMv2 SA-TEK-Request is expected, it shall send a new RNG-RSP with another SaChallenge TLV.
- 3) The SS shall send PKMv2 SA-TEK-Request to the BS after protecting it with the HMAC/CMAC. If the SS does not receive PKMv2 SA-TEK-Response from the BS within SATEKTimer, it shall resend the request. The SS may resend the PKMv2 SA-TEK-Request up to SATEKRequestMaxResends times. If the SS reaches its maximum number of resends, it shall initiate another full authentication or attempt to connect to another BS. The SS shall include, through the Security Negotiation Parameters attribute, the security capabilities that it included in the SBC-REQ message during the basic capabilities negotiation phase.
- 4) Upon receipt of PKMv2 SA-TEK-Request, a BS shall confirm that the supplied AKID refers to an AK that it has available. If the AKID is unrecognized, the BS shall ignore the message. The BS shall verify the HMAC/CMAC. If the HMAC/CMAC is invalid, the BS shall ignore the message. The BS shall verify that the BS\_Random in the SA TEK Request matches the value provided by the BS in the SA Challenge message. If the BS\_Random value does not match, the BS shall ignore the message. In addition, the BS must verify the SS's security capabilities encoded in the Security Negotiation Parameters attribute against the security capabilities provided by the SS through the SBC-REQ message. If security negotiation parameters do not match, the BS should report the discrepancy to higher layers.
- 5) Upon successful validation of the PKMv2 SA-TEK-Request, the BS shall send PKMv2 SA-TEK-Response back to the SS. The message shall include a compound TLV list each of which identifies the Primary and static SAs, their SA identifiers (SAID) and additional properties of the SA (e.g., type, cryptographic suite) that the SS is authorized to access. In case of HO, the details of any Dynamic SAs that the requesting MS was authorized in the previous serving BS are also included. In addition, the BS must include, through the Security Negotiation Parameters attribute, the security capabilities that it wishes to specify for the session with the SS (these will generally be the same as the ones insecurely negotiated in SBC-REQ/RSP).

Additionally, in case of HO, for each active SA in previous serving BS, corresponding TEK, GTEK and GKEK parameters are also included. Thus, SA\_TEK\_Update provides a shorthand method for renewing active SAs used by the MS in its previous serving BS. The TLVs specify SAID in the target BS that shall replace active SAID used in the previous serving BS and also "older" TEK-Parameters and "newer" TEK-Parameters relevant to the active SAIDs. The update may also include multicast/broadcast Group SAIDs (GSAIDs) and associated GTEK-Parameters pairs.

In case of unicast SAs, the TEK-Parameters attribute contains all of the keying material corresponding to a particular generation of an SAID's TEK. This would include the TEK, the TEK's remaining key lifetime, its key sequence number and the cipher block chaining (CBC) initialization vector. The TEKs are encrypted with KEK.

In case of group or multicast SAs, the TEK-Parameters attribute contains all of the keying material corresponding to a particular generation of a GSAID's GTEK. This would include the



GTEK, the GKEK, the GTEK's remaining key lifetime, the GTEK's key sequence number, and the cipher block chaining (CBC) initialization vector. The type and length of the GTEK is equal to ones of the TEK. The GKEK should be identically shared within the same multicast group or the broadcast group. Contrary Key-Update Command, the GTEKs and GKEKs are encrypted with KEK because they are transmitted as a unicast here.

Multiple iterations of these TLVs may occur suitable to re-creating and re-assigning all active SAs and their (G)TEK pairs for the SS from its previous serving BS. If any of the Security Associations parameters change, then those Security Associations parameters encoding TLVs that have changed will be added.

The HMAC/CMAC shall be the final attribute in the message's attribute list.

- 6) Upon receipt of PKMv2 SA-TEK-Response, an SS shall verify the HMAC/CMAC. If the HMAC/CMAC is invalid, the SS shall ignore the message. Upon successful validation of the received PKMv2 SA-TEK-Response, the SS shall install the received TEKs and associated parameters appropriately. Verification of HMAC/CMAC is done as per subclauses 7.5.3 and 7.5.4.4.

The SS also must verify the BS's security negotiation parameters TLV encoded in the Security Negotiation Parameters attribute against the security negotiation parameters TLV provided by the BS through the SBC-RSP message. If security capabilities do not match, the SS should report the discrepancy to upper layers. The SS may choose to continue the communication with the BS. In this case, the SS may adopt the security negotiation parameters encoded in SA-TEK-Response message.

### 7.8.2 BS and SS RSA mutual authentication and AK exchange overview

The BS mutual authentication can take place in one of two modes of operation. In one mode, only mutual authentication is used. In the other mode, the mutual authentication is followed by EAP authentication. In this second mode, the mutual authentication is performed only for initial network entry and only EAP authentication is performed in the case that authentication is needed in re-entry.

SS mutual authorization, controlled by the PKMv2 Authorization state machine, is the process of

- a) The BS authenticating a client SS's identity.
- b) The SS authenticating the BS's identity.
- c) The BS providing the authenticated SS with an AK, from which a key encryption key (KEK) and message authentication keys are derived.
- d) The BS providing the authenticated SS with the identities (i.e., the SAIDs) and properties of primary and static SAs the SS is authorized to obtain keying information for.

After achieving initial authorization, an SS periodically seeks reauthorization with the BS; reauthorization is also managed by the SS's PKMv2 Authorization state machine. An SS must maintain its authorization status with the BS in order to be able to refresh aging TEKs and GTEKs. TEK state machines manage the refreshing of TEKs. The SS or BS may run optional authenticated EAP messages for additional authentication.

The SS sends an Authorization Request message to its BS immediately after sending the Authentication Information message. This is a request for an AK, as well as for the SAIDs identifying any Static Security SAs the SS is authorized to participate in. The Authorization Request includes (see 6.3.2.3.9.19):

- A manufacturer-issued X.509 certificate.

- A description of the cryptographic algorithms the requesting SS supports; an SS's cryptographic capabilities are presented to the BS as a list of cryptographic suite identifiers, each indicating a particular pairing of packet data encryption and packet data authentication algorithms the SS supports.
- The SS's Basic CID. The Basic CID is the first static CID the BS assigns to an SS during initial ranging—the primary SAID is equal to the Basic CID.
- A 64-bit random number generated in the SS.

In response to an Authorization Request message, a BS validates the requesting SS's identity, determines the encryption algorithm and protocol support it shares with the SS, activates an AK for the SS, encrypts it with the SS's public key, and sends it back to the SS in an Authorization Reply message. Random numbers are included in the exchange to ensure liveness. The Authorization Reply includes (see 6.3.2.3.9.20)

- The BS's X.509 certificate, used to verify the BS's identity.
- A pre-PAK encrypted with the SS's public key.
- A 4-bit PAK sequence number, used to distinguish between successive generations of AKs.
- A PAK lifetime.
- The identities (i.e., the SAIDs) and properties of the single primary and zero or more static SAs the SS is authorized to obtain keying information for.
- The 64-bit random number generated in the SS.
- A 64-bit random number generated in the BS, used to ensure key of liveness along with the random number of SS.
- The RSA signature over all the other attributes in the auth-reply message by BS, used to assure the the authenticity of the above PKMv2 RSA-Reply messages.

An SS shall periodically refresh its AK by reissuing an Authorization Request to the BS. Reauthorization is identical to authorization. To avoid service interruptions during reauthorization, successive generations of the SS's AKs have overlapping lifetimes. Both SS and BS shall be able to support up to two simultaneously active AKs during these transition periods. The operation of the Authorization state machine's Authorization Request scheduling algorithm, combined with the BS's regimen for updating and using a client SS's AKs (see 7.4), ensures that the SS can refresh TEK keying information without interruption over the course of the SS's reauthorization periods.

After successful RSA based authorization either EAP based authorization or Authenticated EAP based authorization maybe supported according to the value of Authorization policy negotiated in the SBC-REQ/RSP messages. It shall cryptographically bind RSA and further EAP authentication.

### **7.8.3 Multicast Broadcast Service (MBS) support**

MBS is an efficient and power saving mechanism that requires PKMv2 to send multimedia broadcast information. It provides subscribers with strong protection from theft of service across broadband wireless mobile network by encrypting broadcast connections between SSs and BSs.

#### **7.8.3.1 MBS security associations**

In addition to existing three Security Association, MBS requires a MBS Group Security Association. It is the set of security information that multiple BS and one or more of its client SSs share but not bound to any MS authorization state in order to support secure and access controlled MBS content reception across the IEEE 802.16 network. Each MBS capable MS may establish a MBS security association during the MS initialization process. MBS GSAs shall be provisioned within the BS. A MBS GSA's shared information shall include the Cryptographic Suite employed within the GSA and key material information such as MAKs (MBS Authorization Key) and MGTEKs (MBS Group Traffic Encryption Key). The exact content of the

MGSA is dependent on the MGSA's Cryptographic Suite. As like any other Unicast SAs, MBS GSA is also identified using 16bits SAIDs. Each MS shall establish one or more MBS GSA with its serving BS.

Using the PKMv2 protocol, an MS receives or establishes an MBS GSA's keying material. The BS and MBS content server shall ensure that each client MS only has access to the MGSAs it is authorized to access.

An SA's keying material (e.g., MAK and MGTEK) has a limited lifetime. When the MBS content server or BS delivers MBS SA keying material to an MS, it also provides the MS with that material's remaining lifetime. It is the responsibility of the MS to request new keying material from the MBS server or BS before the set of keying material that the MS currently holds expires at the MBS Server or BS.

### **7.8.3.2 MBS Key Management**

#### **7.8.3.2.1 MBS Authorization Key (MAK) establishment**

The MAK establishment procedure in MS and BS is outside of scope of this specification.

#### **7.8.3.2.2 MGTEK establishment**

See 7.2.2.3.3 MBS Group Security Association and PKMv2 Key Derivation (7.2.2.2).

#### **7.8.3.2.3 MBS Traffic Key establishment**

See 7.2.2.2 PKMv2 Key Derivation.

*Insert new subclause 7.9:*

### **7.9 Optional multicast and broadcast rekeying algorithm (MBRA)**

When MBRA is supported, the MBRA shall be used to refresh traffic keying material efficiently not for the unicast service, but for the multicast service or the broadcast service.

#### **7.9.1 MBRA flow**

The MBRA overall flow is shown in the Figure 137d.

An SS may get the traffic keying material before an SS is served with the specific multicast service or the broadcast service. The initial GTEK request exchange procedure is executed by using the Key Request and Key Reply messages that are carried on the Primary Management connection. The GTEK (Group Traffic Encryption Key) is the TEK for multicast or broadcast service. Once an SS shares the traffic keying material with a BS, an SS does not need to request the new traffic keying material. A BS updates and distributes the traffic keying material periodically by sending two Key Update Command messages.

A BS manages the M&B (Multicast & Broadcast) TEK Grace Time for the respective GSA-ID in itself. The GSA-ID (Group Security Association Identifier) is the SA-ID for multicast or broadcast service. This M&B TEK Grace Time is defined only for the multicast service or the broadcast service. This parameter means time interval (in seconds), before the estimated expiration of an old distributed GTEK. In addition, the M&B TEK Grace Time is longer than the TEK Grace Time managed in an SS.

A BS distributes updated traffic keying material by sending two Key Update Command messages before old distributed GTEK is expired. The usage type of these messages is distinguished according to the Key Push Modes included in the Key Update Command message.

A BS transmits the PKMv2 Group Key Update Command message for the GKEK update mode to each SS served with the specific multicast service or the broadcast service before the M&B TEK Grace Time starts. The purpose of the Key Update Command message for the GKEK update mode is to distribute the GKEK (Group Key Encryption Key). The Key Update Command message for the GKEK update mode is carried on the Primary Management connection. A BS intermittently transmits the Key Update Command message for the GKEK update mode to each SS in order to reduce the BS's load in refreshing traffic key material. The GKEK is needed to encrypt the new GTEK. The GKEK may be randomly generated in a BS or an ASA server.

A BS transmits the PKMv2 Group Key Update Command message for the GTEK update mode carried on the broadcast connection after the M&B TEK Grace Time starts. The aim of the Key Update Command message for the GTEK update mode is to distribute new GTEK and the other traffic keying material to all SSSs served with the specific multicast service or the broadcast service. This GTEK is encrypted with already transmitted GKEK.

An SS shall be capable of maintaining two successive sets of traffic keying material per authorized GSA-ID. Through operation of its GTEK state machines, an SS shall check whether it receives new traffic keying material or not. If an SS gets new traffic keying material, then its TEK Grace Time is not operated. However, if it does not have that, then an SS shall request a new set of traffic keying material a configurable amount of time, the TEK Grace Time, before the SS's latest GTEK is scheduled to expire.

If an SS receives the valid two Key Update Command messages and shares new valid GKEK and GTEK with a BS, then that SS does not need to request a new set of traffic keying material.

If an SS does not receive at least one of two Key Update Command messages, then that SS sends the Key Request message to get a new traffic keying material. A BS responds to the Key Request message with the Key Reply message. In other words, if an SS does not get valid new GKEK or GTEK, then the GTEK request exchange procedure initiated by an SS is executed.

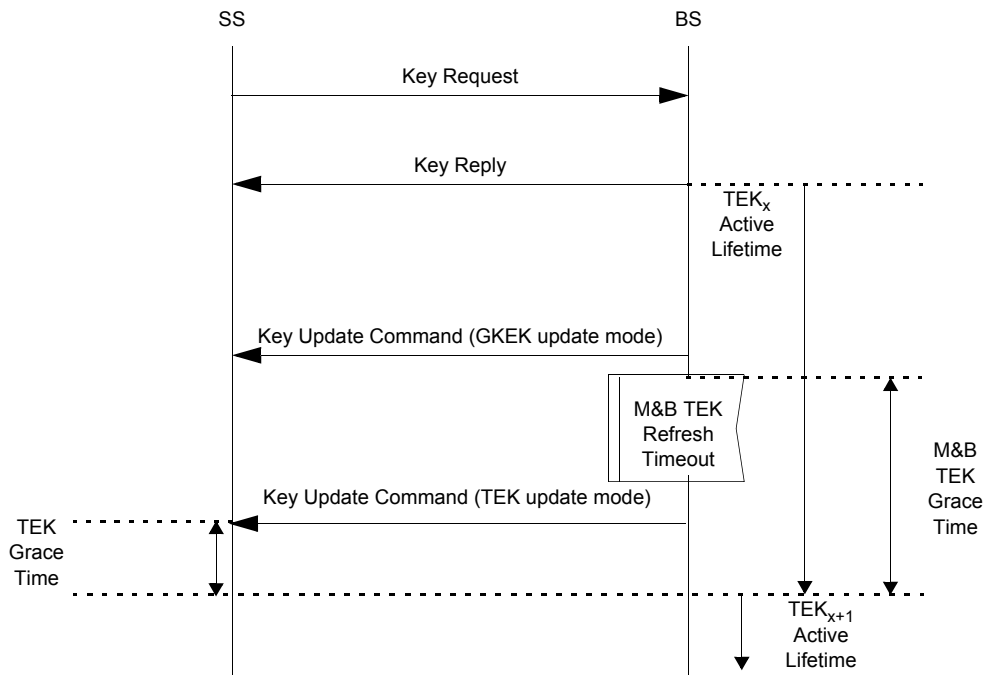


Figure 137d—MBRA management

7.9.1.1 BS usage of GTEK

An SS tries to get the GTEK before an SS is served with the specific service. The initial GTEK request exchange procedure is executed by using the Key Request and Key Reply messages that are carried on the primary management connection.

A BS shall be capable of maintaining two successive sets of traffic keying material per authorized GSAID. That is, when GKEK has been changed a BS manages the M&B (Multicast & Broadcast) TEK Grace Time for the respective GSA-ID in itself. Through operation of its M&B TEK Grace Time, a BS shall push a new set of traffic keying material. This M&B TEK Grace Time is defined only for the multicast service or the broadcast service in a BS. This parameter means time interval (in seconds) before the estimated expiration of an old distributed GTEK. That is, the M&B TEK Grace Time is longer than the TEK Grace Time managed in an SS.

A BS distributes updated GTEK by using two Key Update Command messages when the GKEK has been changed, or by using one (the second) Key Update Command message otherwise, around the M&B TEK Grace Time, before the already distributed GTEK is expired. Those messages are distinguished according to a parameter included in that message, “Key Push Modes.”

A BS transmits the first Key Update Command message to each SS served with the specific service before the M&B TEK Grace Time. The first Key Update Command message is carried on the primary management connection. A BS intermittently transmits the first Key Update Command message to each SS in order to reduce the BS’s load for key refreshment. The purpose of the first Key Update Command message is to distribute the GKEK (Group Key Encryption Key). This GKEK is needed to encrypt the updated GTEK. The GKEK is also encrypted with the SS’s KEK. The GKEK may be randomly generated in a BS or an ASA server.

A BS transmits the PKMv2 Group Key Update Command message carried on the broadcast connection after the M&B TEK Grace Time. The aim of the second Key Update Command message is to distribute the GTEK to the specific service group. This GTEK is encrypted with transmitted GKEK before the M&B TEK Grace Time.

### 7.9.1.2 SS usage of GTEK

An SS shall be also capable of maintaining two successive sets of traffic keying material per authorized GSAID. Through operation of its GTEK state machines, an SS shall check whether it receives new traffic keying material or not. If an SS get new traffic keying material, then its TEK Grace Time is not operated. However, if it does not have that, then an SS shall request a new set of traffic keying material a configurable amount of time, the TEK Grace Time, before the SS's latest GTEK is scheduled to expire.

## 7.9.2 Messages

Messages used in the MBRA are the Key Request, Key Reply, and Key Update Command messages.

- **Key Request**  
An SS may request the traffic keying material with the Key Request message in the initial GTEK request exchange procedure or the GTEK refresh procedure. Refer to 6.3.2.3.9.5.
- **Key Reply**  
A BS responds to the Key Request message with the Key Reply message including the traffic keying material. Key Reply message includes GKEK as well as GTEK. The GTEK is the TEK for the multicast or broadcast service. GKEK and GTEK are encrypted to safely distribute to an SS. GTEK is encrypted with the GKEK for the multicast service or the broadcast service. The GKEK is encrypted with the KEK. See 7.5.4.5.2 and 7.9.3 for details. This message is carried on the primary management connection. Refer to 6.3.2.3.9.6.
- **Key Update Command**  
A BS transmits Key Update Command message to initiate and push newly updated GKEK and GTEK to every SSs served with the specific multicast or broadcast service.

## 7.9.3 Encryption of GKEK

The BS encrypts the value fields of the GKEK in the Key Update Command message for the GKEK update mode and sends the encrypted GKEK to each SS served with the specific multicast service or the broadcast service. This field is encrypted using several algorithms. See 7.5.4.5.2 for details.

## 7.9.4 Message authentication keys for the Key Update Command message

One of the HMAC-Digest attribute or the CMAC-Digest attribute is used for Key Update Command message authentication.

Input key used to generate HMAC authentication keys of Key Update Command message is different according to the value field of the Key Push Modes. The AK shall be used for generation of HMAC-Digest included in the Key Update Command message for the GKEK update mode and the GTEK shall be used for generation of HMAC-Digest included in the Key Update Command message for the GTEK update mode. See 7.2.2.2.9 for details. The CMAC\_KEY\_GD and HMAC\_KEY\_GD should be recomputed when a new GKEK is used.

## 8. PHY

### 8.1 WirelessMAN-SC PHY specification

#### 8.1.3 Duplexing techniques and PHY Type parameter encodings

##### 8.1.3.2 TDD operation

###### 8.1.3.2.1 TTG

*Change the second and third sentences of the subclause as indicated:*

This gap allows time for the BS to switch from transmit to receive mode and SSs to switch from receive to transmit mode. During this gap, the BS and SS are not transmitting modulated data but simply allowing the BS transmitter carrier to ramp down, the transmit/receive (Tx/Rx) antenna switch to actuate, and the BS receiver section to activate.

###### 8.1.3.2.2 RTG

*Change the second and third sentences of the subclause as indicated:*

This gap allows time for the BS to switch from receive to transmit mode and SSs to switch from transmit to receive mode. During this gap, the BS and SS are not transmitting modulated data but simply allowing the BS transmitter carrier to ramp up and the Tx/Rx antenna switch to actuate, and the SS receiver sections to activate.

### 8.1.4 Downlink PHY

#### 8.1.4.1 Downlink subframe

##### 8.1.4.1.2 Frame control section

###### 8.1.4.1.2.5 Downlink\_Burst\_Profile

*Change the first paragraph as indicated:*

Each Downlink\_Burst\_Profile in the DCD message (6.3.2.3.1) shall include the following parameters:

- Modulation type
- FEC Code Type
- Last codeword length
- ~~DIUC mandatory exit threshold~~
- ~~DIUC minimum entry threshold~~
- Preamble Presence

### 8.1.9 Channel quality measurements

#### 8.1.9.2 RSSI mean and standard deviation

*Change the second paragraph as indicated:*

Mean and standard deviation statistics shall be reported in units of dBm and dB, respectively. To prepare such reports, statistics shall be quantized in 1 dB increments, ranging from -40 dBm (encoded 0x53) to -123 dBm (encoded 0x00). Values outside this range shall be assigned the closest extreme value within the scale. The standard deviation shall be quantized in 0.5 dB increments (i.e., standard deviation < 0.5 dB encoded 0x00, 0.5 dB ≤ standard deviation < 1.0dB encoded 0x01).

## 8.2 WirelessMAN-SCa PHY

### 8.2.1 Transmit processing

#### 8.2.1.5 Duplex framing

##### 8.2.1.5.1 FDD

###### 8.2.1.5.1.3 FDD Channel and Burst Descriptor field definitions

*Change the second paragraph as indicated:*

###### DL Burst Descriptor Parameters

Each DCD message burst descriptor shall include the following TLV encodings:

- Modulation type
- RS information bytes
- RS parity bytes
- ~~DIUC mandatory exit threshold~~
- ~~DIUC minimum entry threshold~~
- CC/CTC-specific parameters

Each DCD message burst descriptor may include the following additional TLV encodings:

- Block interleaver depth
- BTC code selector
- Spreading parameters
- CID\_In\_DL\_IE

##### 8.2.1.5.2 TDD

###### 8.2.1.5.2.1 TDD Channel Descriptor field definitions

*Change the second paragraph as indicated:*

###### DL Burst Descriptor Parameters

Each DCD message burst descriptor shall include the following TLV encodings:

- Modulation type
- RS information bytes
- RS parity bytes
- ~~DIUC mandatory exit threshold~~
- ~~DIUC minimum entry threshold~~
- CC/CTC-specific parameters

Each DCD message burst descriptor may include the following additional TLV encodings:

- Block interleaver depth
- BTC code selector
- Spreading parameters
- CID\_In\_DL\_IE



**8.2.1.8 Compressed FCH maps**

**8.2.1.8.2 Compressed UL-MAP**

*Change the first paragraph as indicated:*

The compressed UL-MAP format is presented in Table 190. The message may only appear after a compressed DL-MAP message to which it shall be appended. The message presents the same information as the standard format with one exception. The Uplink Channel ID is omitted. A value of zero shall be assigned to this parameter.

**8.2.1.9 MAP message fields and IEs**

**8.2.1.9.3 UL-MAP IE formats**

*Delete the extra period above Table 202.*

*Insert new subclause 8.2.1.9.3.6:*

**8.2.1.9.3.6 Fast\_Ranging\_IE**

A fast ranging extended IE may be placed in a UL-MAP message by a BS to provide an MS with a contentionless initial ranging opportunity. The value of the subcode assigned to this function is 1. The CID value in the UL-MAP\_IE() shall be set to 0. The format of the extended IE is presented in Table 207a.

**Table 207a—SCa fast ranging extended IE format**

Syntax	Size	Notes
Fast_Ranging_IE(){	—	—
Subcode	4 bits	FRNG=0x01
Length	4 bits	Length = 8
MAC address	48 bits	MS's MAC address as provided on the RNG-REQ message on initial system entry
Offset	12 bits	Indicates the start time, in units of minislots, of the burst relative to the Allocation Start Time given in the UL-MAP message. The time instants indicated by offsets are the transmission times of the first symbol of the burst including preamble.
Reserved	4 bits	—
}	—	—

**8.2.2 Channel quality measurements**

**8.2.2.2 RSSI mean and standard deviation**

*Change the second paragraph as indicated:*

Mean and standard deviation statistics shall be reported in units of dBm and dB, respectively. To prepare such reports, statistics shall be quantized in 1 dB increments, ranging from -40 dBm (encoded 0x53) to -123 dBm (encoded 0x00). Values outside this range shall be assigned the closest extreme value within the scale.

The standard deviation shall be quantized in 0.5dB increments (i.e., standard deviation < 0.5dB encoded 0x00, 0.5dB ≤ standard deviation < 1.0dB encoded 0x01).

### 8.3 WirelessMAN-OFDM PHY Layer

#### 8.3.2 OFDM symbol parameters and transmitted signal

##### 8.3.2.4 Parameters of transmitted signal

*Change in Table 213 “{-84:-82, -47:-45, 17: 19, 54:56}” to “{-84:-82, -47:-45, 17: 19, 54:56}”.*

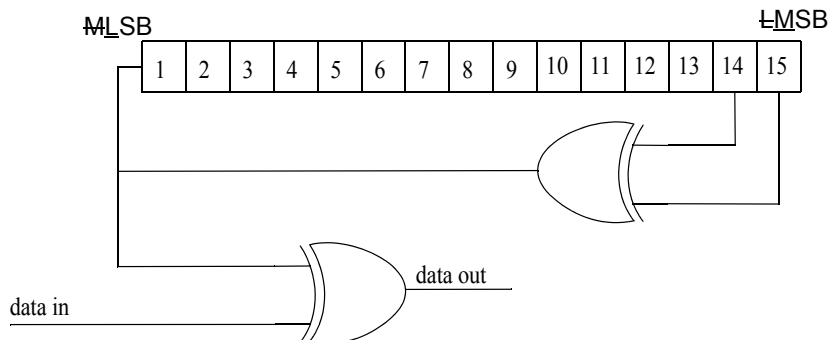
#### 8.3.3 Channel coding

*Change the first paragraph as indicated:*

##### 8.3.3.1 Randomization

Data randomization is performed on each burst of data on the downlink and uplink. The randomization is performed on each allocation (downlink or uplink), which means that for each allocation of a data block (subchannels on the frequency domain and OFDM symbols on the time domain) the randomizer shall be used independently. If the amount of data to transmit does not fit exactly the amount of data allocated, padding of 0xFF (“1” only) shall be added to the end of the transmission block for the unused integer bytes. For RS-CC and CC encoded data (see 8.3.3.2.1), padding will be added to the end of the transmission block, up to the amount of data allocated minus one byte, which shall be reserved for the introduction of a 0x00 tail byte by the FEC. For BTC (8.3.3.2.2) and CTC (8.3.3.2.3), if implemented, padding will be added to the end of the transmission block, up to the amount of data allocated.

*Change Figure 197 as indicated:*



**Figure 197—PRBS generator for data randomization**

*Change the first two sentences of the second paragraph below Figure 197 as indicated:*

On the downlink, the randomizer shall be re-initialized at the start of each frame, and at the start of the STC zone only in the case a FCH-STC is present, with the sequence: 1 0 0 1 0 1 0 1 0 0 0 0 0 0. The randomizer shall not be reset at the start of the burst #1 immediately following FCH or FCH-STC.

*Insert new text immediately before Figure 198 in 8.3.3.1:*

For a DL subchannelization zone (refer to 8.3.5.1.1) the randomizer is initialized in an equivalent manner. At the start of the DL subchannelized zone, the randomizer shall be re-initialized to the sequence 1 0 0 1 0 1 0 1 0 0 0 0 0 0. The randomizer shall not be reset at the start of the first burst in the CCH. At the start of

subsequent bursts, the randomizer shall be initialized with the vector shown in Figure 198. The frame number used for initialization refers to the frame in which the subchannelized burst is transmitted and can be obtained from the SBCH\_DLFP (refer to Table 225b).

Replace Figure 198 and Figure 199 with the following figures:

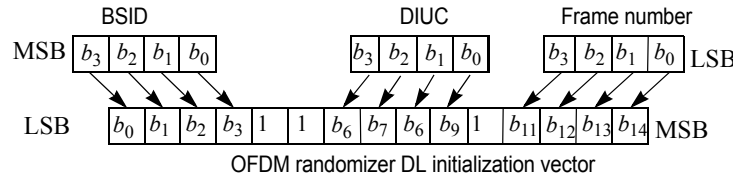


Figure 198—OFDM randomizer downlink initialization vector for burst #2...N

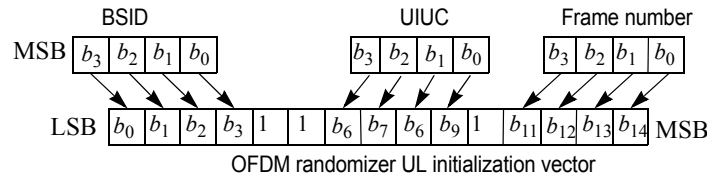


Figure 199—OFDM randomizer uplink initialization vector

### 8.3.3.2 FEC

Change the third sentence of the first paragraph as indicated:

The ~~Reed–Solomon–Convolutional coding rate 1/2~~most robust burst profile shall always be used as the coding mode when requesting access to the network ~~(except in subchannelization modes, which uses only convolutional coding 1/2)~~ and in the FCH burst.

#### 8.3.3.2.1 Concatenated Reed–Solomon-convolutional code (RS-CC)

Change the two paragraphs below Table 214 as indicated:

~~RS-CC rate 1/2 shall always be used as the coding mode when requesting access to the network.~~

The encoding is performed by first passing the data in block format through the RS encoder and then passing it through a convolutional encoder. A single 0x00 tail byte is appended to the end of each burst. This tail byte shall be appended after randomization. In the RS encoder, the redundant bits are sent before the input bits, keeping the 0x00 tail byte at the end of the allocation. ~~When the total number of data bits in a burst is not an integer number of bytes, zero pad bits are added after the zero tail bits.~~ To ensure that the number of bits after the convolutional encoder is divisible by  $N_{cbps}$ , as specified in Table 223, zero (0b0) pad bits are added after the zero tail bits before the encoder. The zero pad bits are not randomized. Note that this situation can occur only in subchannelization. In this case, the RS encoding is not employed.

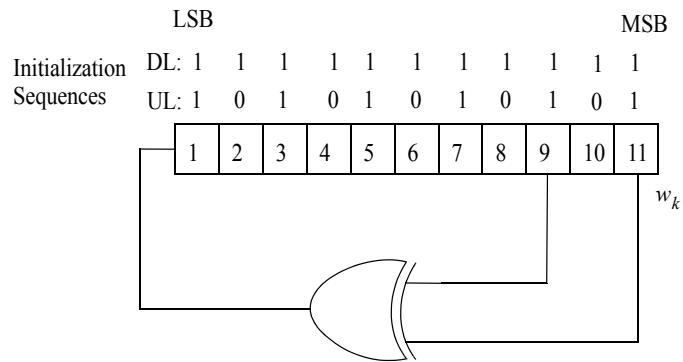
*Change the second to last paragraph in 8.3.3.2.1 as indicated:*

When subchannelization is applied in the uplink, the FEC shall bypass the RS encoder and use the Overall Coding Rate as indicated in Table 215 as CC Code Rate. The uncoded Block Size and Coded Block size may be computed by multiplying the values listed in Table 215 by the number of allocated subchannels divided by 16.

### 8.3.3.4 Modulation

#### 8.3.3.4.2 Pilot modulation

*Replace Figure 204 with the following figure:*



**Figure 204—PRBS generator for pilot modulation**

*Change the second paragraph in 8.3.3.4.2 as indicated:*

The value of the pilot modulation for OFDM symbol  $k$  is derived from  $w_k$ . On the downlink the index  $k$  represents the symbol index relative to the beginning of the downlink subframe. For bursts contained in the STC zone when the FCH-STC is present, index  $k$  represents the symbol index relative to the beginning of the STC zone. In the DL Subchannelization Zone, the index  $k$  represents the symbol index relative to the beginning of the burst. On the uplink the index  $k$  represents the symbol index relative to the beginning of the burst. On both uplink and downlink, the first symbol of the preamble is denoted by  $k=0$ . The initialization sequences that shall be used on the downlink and uplink are shown in Figure 204. On the downlink, this shall result in the sequence 111111111100000000110... where the 3<sup>rd</sup> 1, i.e.,  $w_2=1$ , shall be used in the first OFDM downlink symbol following the frame preamble. For each pilot (indicated by frequency offset index), the BPSK modulation shall be derived as follows:

### 8.3.3.5 Example OFDM uplink RS-CC encoding

#### 8.3.3.5.3 Subchannelization (1 subchannel)

*Change the third paragraph as indicated:*

Randomized Data (Hex)

D4 BA A1 12 F2 74 96 30 27 D4 00 00

NOTE—The last hex value represents two bits only.

### 8.3.3.6 Preamble structure and modulation

*Change the first sentence of the first paragraph as indicated:*

All preambles are structured as either one ~~of~~ or two OFDM symbols.

*Change the last sentence of the paragraph below Equation (79) as indicated:*

This preamble ~~shall also precede all allocations during the AAS portion of a frame and~~ shall be used as burst preamble on the downlink bursts when indicated in the DL-MAP\_IE.

### 8.3.5 Frame structure

#### 8.3.5.1 PMP

*Change the first sentence of the fifth paragraph as indicated:*

The FCH is followed by one or multiple downlink bursts, ~~each transmitted with different burst profile.~~

*Change the seventh paragraph as indicated:*

The STC zone starts from a preamble. The BS can choose between the following two modes of operation:

- 1) No FCH-STC Present: If the regular DL-MAP describes allocations in the STC zone, then the STC zone shall start with an STC preamble that may be immediately followed by encoded PHY bursts, with no FCH-STC present.
- 2) FCH-STC Present: If the DL-MAP does not describe allocations in the STC zone, then the STC zone shall start with an STC preamble that is immediately followed by ~~and~~ an STC encoded FCH-STC burst, which is one symbol with the same payload format as specified in ~~Table 24~~ Table 225. The FCH-STC burst is transmitted at BPSK rate  $\frac{1}{2}$ . It is followed by one or several STC encoded PHY bursts. The first burst in the STC zone may contain a DL-MAP applicable only to the STC zone, in which the DL IEs start time refer to the beginning of the STC zone, including preamble. If DL-MAP is present, it shall be the first MAC PDU in the payload of the burst. The STC zone may also contain an UL-MAP, as well as DCD and UCD messages. The UL-MAP, if present, shall not duplicate or overlap any unicast allocations made in the regular UL-MAP, and the allocation start time shall refer to the beginning of the STC zone. The UL-MAP if present shall not contain duplicate or overlapping unicast allocations (defined within same or any other UL-MAP). Contention region allocations may be duplicated, in which case, they shall fully overlap. The randomizer and pilot modulation shall be reinitialized at the beginning of the STC zone.

The SS will be able to determine that there is no STC data allocation in frame K-1 STC Zone by determining that there has been no STC zone in the previous frame K-2.

*Add a new sentence above the eighth paragraph as indicated:*

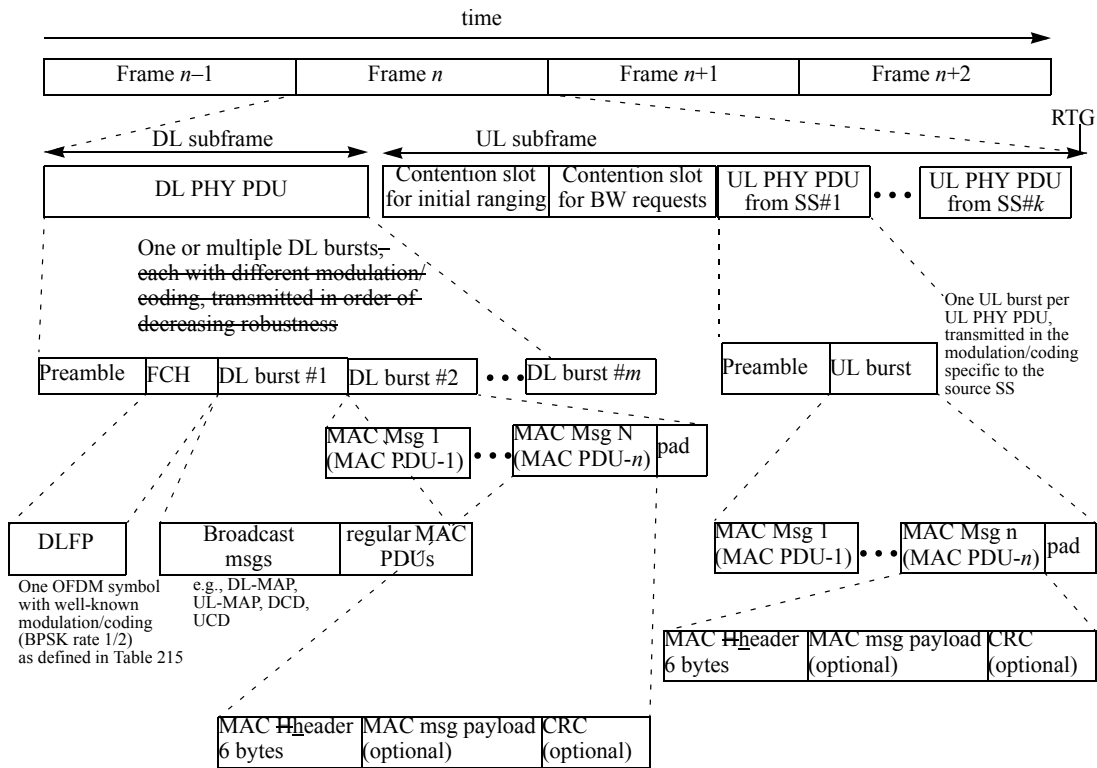
The DL subframe may optionally contain a DL subchannelization zone as described in 8.3.5.1.1 PMP DL subchannelization zone.

*Change the eighth paragraph as indicated:*

With the OFDM PHY, a PHY burst, either a downlink PHY burst or an uplink PHY burst, consists of an integer number of OFDM symbols, carrying MAC messages, i.e., MAC PDUs. To form an integer number

of OFDM symbols, unused bytes in the burst payload may be padded by the bytes 0xFF. Then the payload should be randomized, encoded, and modulated using the burst PHY parameters specified by this standard. If an SS does not have any data to be transmitted in an UL allocation, the SS shall transmit an UL PHY burst (as specified in 6.3.3.7) that may contain a bandwidth request header as defined in Figure 20, with BR = 0 and its basic CID. If the allocation is large enough, an AAS enabled SS may also provide an AAS Feedback Response (AAS-FBCK-RSP) message (6.3.2.3.40). An SS shall transmit during the entirety of all of its UL allocations, using the standard padding mechanism (6.3.3.7) to fill allocations if necessary.

**Change Figure 207 as indicated:**



**Figure 207—Example of OFDM frame structure with TDD**

**Change the paragraph above Figure 208 as indicated:**

In TDD and H-FDD systems, subscriber station allowances must be made by a transmit-receive turnaround gap SSTTG and by a receive-transmit turnaround gap SSRTG. ~~The BS shall not transmit downlink information to a station later than (SSRTG+RTD) before its scheduled uplink allocation, and shall not transmit downlink information to it earlier than (SSTTG-RTD) after the end of scheduled uplink allocation, where RTD denotes Round-Trip Delay. The BS shall transmit DL bursts intended for an SS such that the end of any DL burst shall not be transmitted to the SS later than (SSRTG+RTD) before its scheduled uplink allocation and the beginning of any DL burst to the SS shall not be transmitted to the SS earlier than (SSTTG-RTD) after the end of its scheduled uplink allocation, where RTD denotes Round-Trip Delay.~~ The parameters SSRTG and SSTTG are capabilities provided by the SS to BS upon request during network entry (see 11.8.3.1).

Change Figure 208 as indicated:

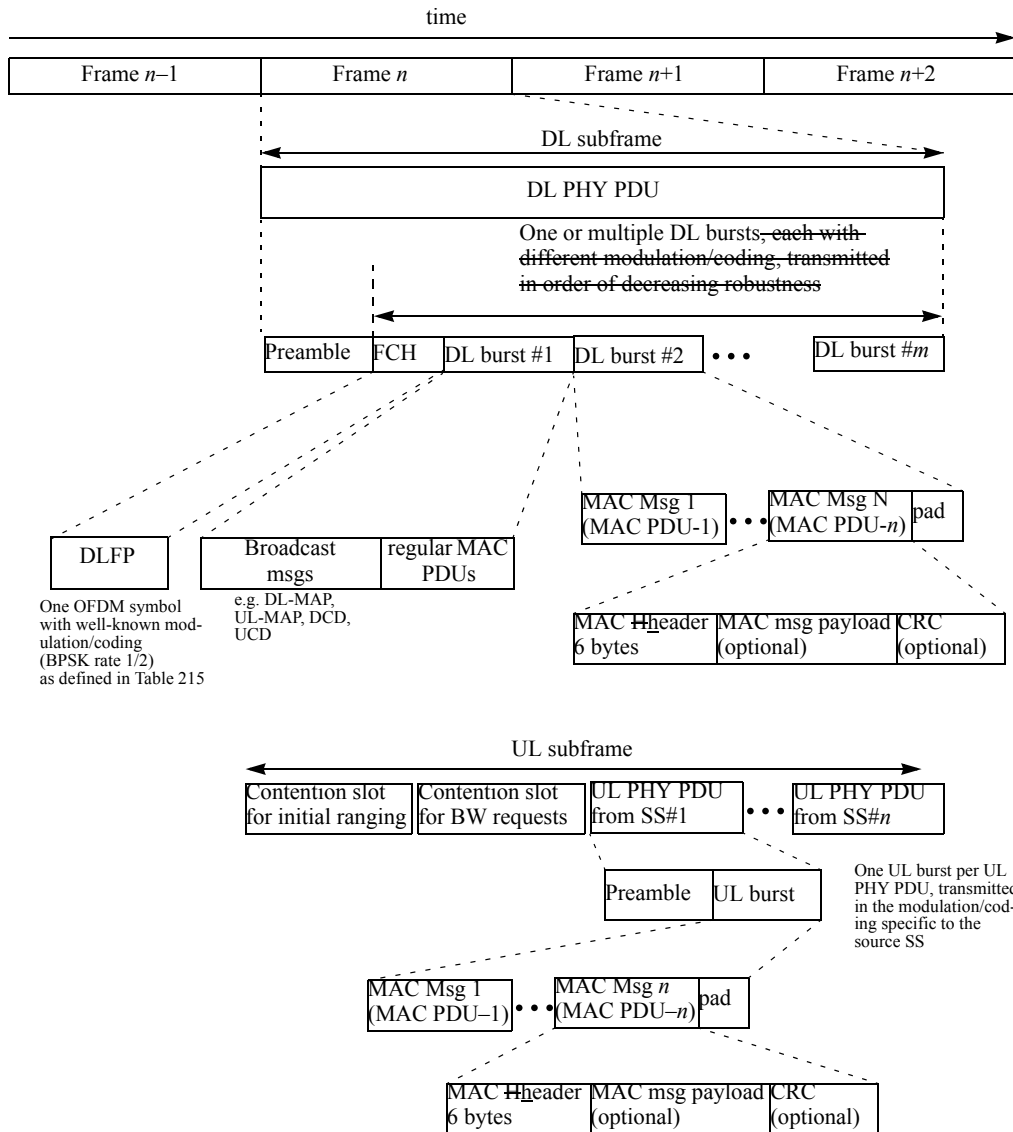


Figure 208—Example of OFDM frame structure with FDD

Insert the following paragraph above Table 225:

Because the optional STC and AAS zones may contain UL-MAPs, along with the UL-MAP transmitted in the mandatory part of the frame, and because the allocation start time for frames may vary from one frame to the next, there is a possibility that UL-MAPs from two frames, or from different zones, may describe overlapping time intervals. Where MAP IEs (contained in either a AAS-DLFP or a UL-MAP) describe overlapping time intervals with MAP IEs from another UL-MAP (or AAS-DLFP) then an SS shall interpret and use those from the most recently received map. MAP IEs that do not conflict with MAP IEs received in earlier UL-MAPs (or AAS-DLFP) shall augment the uplink map.

Change Table 225 and the HCS field description as indicated:

**Table 225—OFDM downlink frame prefix format**

Syntax	Size	Notes
DL_Frame_Prefix_Format() {		
<b>Base_Station_ID</b>	4 bits	4 LSBs of BS ID. <u>Prior to completion of network entry, the SS shall ignore this field and decode all bursts specified by the DLFP. Upon completion of network entry, the SS shall validate these bits with those of the BS on which it is registered.</u> The burst specified by the DLFP shall not be decoded if these bits do not match those of the BS on which it is registered.
<b>Frame_Number</b>	4 bits	4 LSB of the Frame Number of <u>current frame</u> <del>DCD Channel Encoding as specified in Table 358.</del>
<b>Configuration_Change_Count</b>	4 bits	4 LSB of Change Count value as specified in 6.3.2.3.1.
<i>Reserved</i>	4 bits	Shall be set to zero.
<b><u>Rate_ID</u></b>	<u>4 bits</u>	<u>Encoded according to the Table 224.</u>
<i>Reserved</i>	<u>1 bit</u>	<u>Shall be set to zero.</u>
<b><u>Length</u></b>	<u>11 bits</u>	<u>Number of OFDM symbols in the first burst.</u>
for (n=0; n < <del>43</del> ; n++) {		
DL_Frame_Prefix_IE() {		
<del>Rate_ID</del> DIUC	4 bits	<del>For the first information element it shall be Rate_ID encoded according to the Table 224. For following IEs this field is DIUC that</del> Defines the burst profile of the corresponding burst.
if (DIUC != 0){		
<b>Preamble present</b>	1 bits	If “1,” preamble is placed <del>before as the first symbol in</del> the burst.
<b>Length</b>	11 bits	Number of OFDM symbols in the burst; <u>including preamble if present.</u>
} else {		
<b>Start Time</b>	12 bits	Start time of STC zone in units of symbol duration counted from the beginning of the frame.
}		
}		
}		
}		
<b>HCS</b>	8 bits	An 8-bit Header Check Sequence; calculated as specified in Table 5.
}		



**HCS**

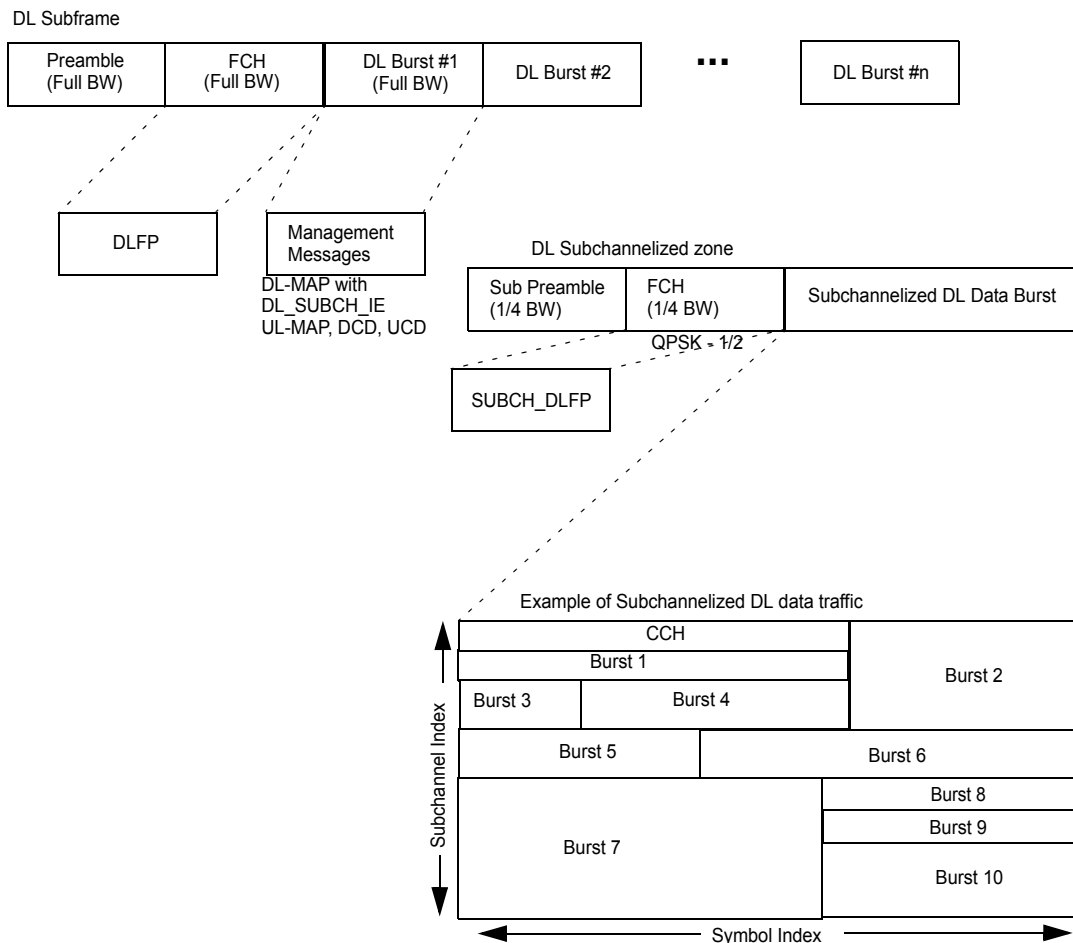
An 8-bit Header Check Sequence used to detect errors in the DL Frame Prefix. The generator polynomial is  $g(D) = D^8 + D^2 + D + 1$ . The transmitter shall take all the bytes in the DL Frame Prefix except the byte reserved for the HCS and divide them by  $g(x)$  and use the remainder as HCS code. At the receiver, dividing the DL\_Frame\_Prefix by  $g(x)$  then gives the remainder 0 if correct. (Example: BS\_ID=0x0319B812A9B8 (4LSB=0x8), Frame\_Number=187662 (4LSB=0xE), Configuration\_Change\_Count=159 (4LSB=0xF), Reserved=0xF0, Rate\_ID=1 (0x1), Length=204 (0x0CC), DLFP\_IE(1) DIUC=1 (0x1), DLFP\_IE(1) Midamble Present = 1 / Burst\_Length=50 (0x832), all following DLFP\_IEs=0 (82 times 0x0000). Encode byte sequence [0x8EFF010CC18320000000] and obtain 0x9930 as the HCS byte.)

*Insert new subclause 8.3.5.1.1:*

**8.3.5.1.1 PMP DL subchannelization zone**

The DL subframe may optionally contain a DL subchannelization zone. This zone is marked by a DL\_SUBCH\_IE in the DL Map.

The DL subchannelization zone is shown in Figure 208a.



**Figure 208a—Format of DL subchannelization zone**

The zone commences with a subchannelized preamble followed by a subchannelized FCH burst. The FCH is transmitted using QPSK  $\frac{1}{2}$ . The FCH is transmitted over 1/4 of the bandwidth. The carrier allocation is as given in Table 211 (OFDM symbol parameters).

The subchannel index of the FCH shall be one of the codes 0b00100, 0b01100, 0b10100, or 0b11100. The subchannel index should preferably be provisioned by the operator to avoid illumination of an area by base stations using the same frequency channel with the same subchannel index. If not provisioned, the subchannel index shall, by default, be derived from the 2 LSBs of the BSID as in Table 225a.

**Table 225a—DL Subchannel index table**

2 LSBs of BSID (binary)	Subchannel index according to Table 211 (binary)
00	00100
01	01100
10	10100
11	11100

The FCH contains the SBCH\_DLFP, which points to the control subchannel (CCH), and contains the profile and length of the first burst in it. The SBCH\_DLFP is shown in Table 225b.

**Table 225b—SBCH\_DLFP**

Field	Size	Comments
SBCH_DL_Frame_Prefix_format() {	—	—
<b>Base_Station_ID</b>	4 bits	4 LSBs of BS ID. The burst specified by the DFLP shall not be decoded if these bits do not match those of the BS on which it is registered.
<b>Frame_Number</b>	4 bits	4 LSBs of Frame Number field as specified in Table 214.
<b>Configuration_Change_Count</b>	4 bits	4 LSBs of Change Count value as specified in 6.3.2.3.1.
<b>CCH_Rate ID</b>	4 bits	The Rate ID, according to Table 222 of the first burst of the CCH.
<b>CCH duration</b>	8 bits	The duration of the first burst in the CCH.
<b>Reserved</b>	1 bit	Shall be set to zero.
<b>CCH subchannel index</b>	5 bits	The subchannel index in which the CCH is transmitted. See Table 211.
<b>CCH midamble repetition</b>	2 bits	The midamble repetition rate of the first burst of the CCH: 0b00: Preamble only 0b01: Midamble after every 4 data symbols 0b10: Midamble after every 8 data symbols 0b11: Midamble after every 16 data symbols

**Table 225b—SBCH\_DLFP (continued)**

Field	Size	Comments
<b>HCS</b>	8 bits	An 8-bit header Check Sequence; calculated as specified in Table 5.
}	—	—

The FCH is followed by subchannelized traffic on allocated subchannels. The subcarrier allocation of the subchannels is given in Table 211. Bursts in the DL subchannelized zone shall contain midambles when indicated in the midamble repetition field.

The CCH may carry UL and DL maps. UL maps shall use the format of UL-MAP\_IE as in Table 243 (UL map IE). DL maps shall use the format of SBCH\_DL\_MAP\_IE as in Table 225c.

**Table 225c—SBCH\_DL\_MAP\_IE**

Syntax	Size	Notes
SBCH_DL_MAP_IE() {	—	—
<b>CID</b>	16 bits	—
<b>Start Time</b>	11 bits	—
<b>Subchannel Index</b>	5 bits	—
<b>DIUC</b>	4 bits	—
<b>Duration</b>	10 bits	In OFDM symbols
<b>Midamble repetition interval</b>	2 bits	0b00: Preamble only 0b01: Midamble after every 4 data symbols 0b10: Midamble after every 8 data symbols 0b11: Midamble after every 16 data symbols
}	—	—

**Start Time**

This field indicates the start time in units of symbol duration, relative to the beginning of the subsequent DL subchannelized zone (including preamble).

A BS shall assume that the MS is not capable of receiving more than one burst in a single frame. Therefore downlink allocations contained in SBCH\_DL\_MAP\_IEs in the CCH shall point to future frames. When an allocation is present for a given MS, the BS shall assume that the MS may not be capable of demodulating the CCH in that frame, and therefore not include any SBCH\_DL\_MAP\_IEs or UL-MAP\_IEs for that MS.

**8.3.5.2 PMP-AAS Zone**

*Change all instances to FCH to AAS-FCH.*

*Change the second sentence of the first paragraph as indicated:*

The first fraction of the transmission consists of one or several repetitions of a short preamble followed by AAS-FCH symbol (Figure 3209).

***Insert the following text below the first paragraph:***

The randomizer shall be reinitialized with the sequence 1 0 0 1 0 1 0 1 0 0 0 0 0 0 0 for all the AAS-FCH bursts, and not initialized for the first burst of the body. It is then reinitialized as specified in Figure 198 for subsequent bursts.

***Change the third paragraph as indicated:***

AAS\_DLFP contains information (DL IEs or UL IEs) on location and transmission rate of PHY bursts. There is a possibility of more than one concatenated DL PHY bursts, each one described by a DL IE. UL IEs specify either UL PHY burst (a single burst per SS) or contention region for initial ranging or bandwidth requesting. The DL IEs and UL IEs in each AAS\_DLFP shall appear in the same order as the allocations to which they refer. The DL IEs and UL IEs described in the AAS portion of the zone shall not be described in the broadcast DL-MAP and UL-MAP.

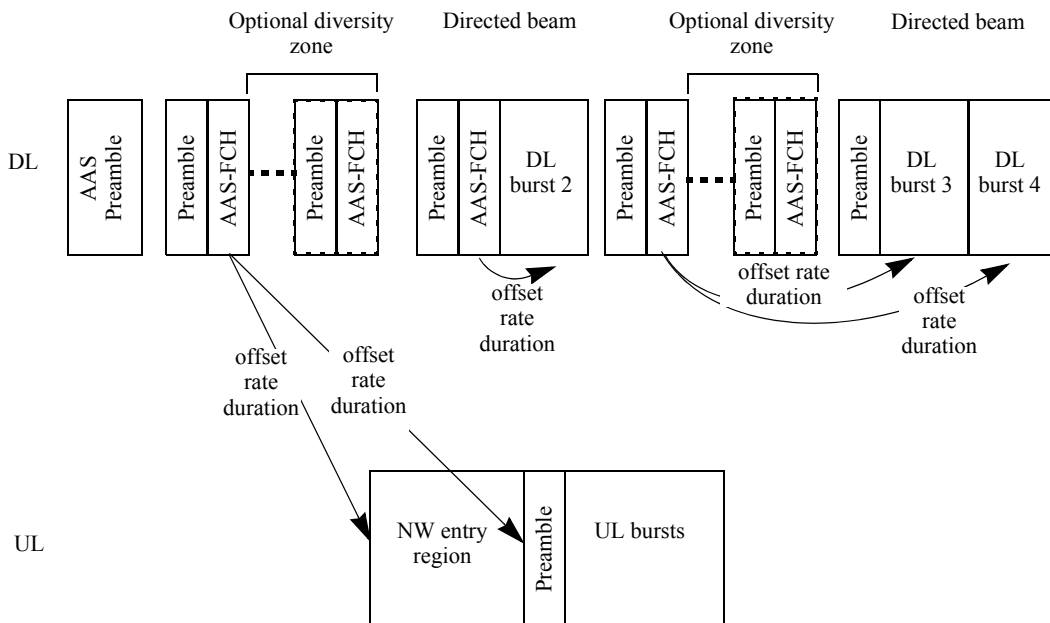
***Change the fifth paragraph as indicated:***

Alternatively, AAS\_DLFP may contain UL IEs. There are two options as follows:

- 1) A single UL IE.
- 2) “Compressed” UL IE, which contains a network entry allocation and a regular allocation.

The minimum time between an UL IE and the corresponding UL burst shall be equal to the relevance time of an UL-MAP as described in subclause 6.3.7.5.

***Replace Figure 209 with the following figure:***



**Figure 209—Structure of AAS Zone**

*Change the relevant fields in Table 228 as indicated:*

} else If (UIUC == 34) {		
<b>Midamble repetition interval</b>	2 bits	0b00: Preamble only 0b01: <u>Interval 5</u> : Midamble after every <u>84</u> data symbols 0b10: <u>Interval 9</u> : Midamble after every <u>168</u> data symbols 0b11: <u>Interval 17</u> : Midamble after every <u>3216</u> data symbols
<b>Duration</b>	<u>912</u> bits	In OFDM symbols.

*Change the relevant fields in Table 229 as indicated:*

} else If (UIUC == 34) {		
<b>Duration</b>	<u>129</u> bits	Duration of regular allocation in OFDM symbols.

*In Table 230, replace “Burst Profiles” by “Burst Profiles (Data Grant Burst Type)”*

*Change the title of subclause 8.3.5.5 as indicated:*

**8.3.5.5 Burst Pprofile format**

*Change the second sentence of the first paragraph as indicated:*

The DIUC field is associated with the Downlink Burst Profile ~~and Thresholds~~.

*Change the third sentence of the paragraph below Table 233 as indicated:*

The UIUC field is associated with the Uplink Burst Profile ~~and Thresholds~~.

**8.3.6 MAP message fields and IEs**

**8.3.6.2 DL-MAP IE format**

*Change 8.3.6.2 as indicated:*

**Connection Identifier (CID)**

Represents the assignment of the IE to a broadcast, multicast or unicast address.  
If the broadcast or multicast CID is used then it is possible to concatenate unicast MAC PDUs (with different CIDs) into a single DL burst. During a broadcast or multicast DL burst it is the responsibility of the BS to ensure that any ~~MAC PDUs~~ bursts sent to an HFDD SS do not overlap (in time; taking SSTG and SSRTG into account) any UL allocations for that SS. An HFDD SS for which a DL MAP IE and UL MAP IE overlap in time shall use the UL allocation and discard DL traffic during the overlapping period.

**Start Time**

If transmitted in a private map (for compressed private map see 8.3.6.6, for reduced private map see 8.3.6.7) within an AAS zone, this field indicates the start time, in units of symbol duration, relative to the start of the first symbol of the PHY PDU beginning of the subsequent AAS zone (including preamble) where the DL-MAP message is transmitted. If transmitted in a compressed private map (see 8.3.6.6), this field indicates the start time, in units of symbol duration, relative to the beginning of the subsequent downlink frame (including preamble). For a DL-MAP in the STC zone, indicates the start time in units of symbol duration, relative to the start of the first symbol of the STC zone (including preamble). The end of the last allocated burst is indicated by allocating an End of Map burst (DIUC = 14) with zero duration. The time instants indicated by the Start Time values are the transmission times of the first symbol of the burst including preamble (if present) any preamble.

**8.3.6.2.1 DIUC allocations**

*Insert the following text below Table 237:*

The Gap Downlink Burst Profile (DIUC = 13) indicates that the Base Station does not transmit (a silent interval in downlink transmission) and the SS shall ignore the received signal.

**8.3.6.2.3 Channel measurement IE format**

*Change the first sentence of the first paragraph as indicated:*

An extended IE with an extended DIUC value of 0x00 is issued by the BS to request a channel measurement report (see 6.3.2.3.33).

**8.3.6.2.8 DL-MAP dummy IE format**

*Change Table 244 as indicated:*

**Table 244—OFDM DL-MAP dummy IE format**

Syntax	Size	Notes
Dummy_IE() {	—	—
Extended DIUC	4 bits	0x0506 .. 0x0F
Length	4 bits	0..15
Unspecified data	variable	The “Length” field specifies the size of this field in bytes.
}	—	—

*Insert new subclause 8.3.6.2.9:*

**8.3.6.2.9 DL SUBCH\_IE format**

In the DL-MAP a DL subchannelization enabled BS (see 8.3.5.3) may transmit an extended IE with a DUIC value of 0x05 to indicate that subsequent allocations use DL subchannelization. The extended IE conforms to the structure in Table 244a.

**Table 244a—DL SUBCH\_IE format**

Syntax	Size	Comments
DL_SUBCH_IE {	—	—
Extended DUIC	4 bits	DL SUBCH = 0x05
Length	4 bits	Length = 0x00
}	—	—

**8.3.6.3 UL-MAP IE format**

*Change the ‘Midamble repetition interval’ in Table 245 as indicated:*

<b>Midamble repetition interval</b>	2 bits	0b00: Preamble only 0b01: <u>Interval 5</u> : Midamble after every <u>84</u> data symbols 0b10: <u>Interval 9</u> : Midamble after every <u>468</u> data symbols 0b11: <u>Interval 17</u> : Midamble after every <u>3216</u> data symbols
-------------------------------------	--------	--

*Change the description of the ‘Midamble Repetition Interval’ field below Table 245 as indicated:*

**Midamble Repetition Interval**

Indicates the preamble repetition interval in OFDM symbols. When the last section of ~~symbol~~ ~~burst~~ after the last ~~preamble~~ midamble is higher than half the midamble repetition interval (i.e., more than 42, 84, 468 for 0b01, 0b10, 0b11) a postamble shall be added at the end of the ~~allocation~~ ~~burst~~.

**8.3.6.3.1 UIUC allocations**

*In Table 246, replace “Burst Profiles” by “Burst Profiles (Data Grant Burst Type)”.*

**8.3.6.3.3 Subchannelized network entry IE**

*Change the last sentence of first paragraph as indicated:*

An SS responding to a bandwidth allocation using the Subchannelized Network entry IE shall start its burst with a ~~short~~ ~~subchannelization~~ preamble (see 8.3.3.6) and use only the most robust mandatory burst profile in that burst.

*Insert the following sentence to the definition of the ‘Transmit opportunity index’ field below Table 248:*

The transmit opportunities are numbered from 0x00 to 0x0F, where transmit opportunity 0x00 indicates the first transmit opportunity in the frame pointed by the frame number index.

**8.3.6.3.5 UL-MAP power control IE format**

*Change the first paragraph as indicated:*

When a power change for the SS is needed, UIUC = 15 is used with extended UIUC set to 0x00 and with 8-bit Power control value as shown in Table 250. The power control value is an 8-bit signed integer expressing the change in power level (in 0.25 dB units) that the SS ~~should~~shall apply to correct ~~its~~its current transmission power. If the SS cannot apply the commanded power correction (SS is already at maximum or minimum power) the SS shall send a RNG-REQ message with “Ranging Anomalies” parameter.

**8.3.6.3.7 UL-MAP Physical Modifier IE**

*Change the second paragraph as indicated:*

Cyclically delaying the preambles and midambles is an optional feature. The PHYMOD\_UL\_IE can appear anywhere in the UL map, and it shall remain in effect until another PHYMOD\_UL\_IE is encountered, or until the end of the UL map.

**8.3.6.3.8 UL-MAP dummy IE format**

*Change Table 253 as follows:*

**Table 253—OFDM UL-MAP dummy IE format**

Syntax	Size	Notes
Dummy_IE() {	—	—
<b>Extended UIUC</b>	4 bits	0x0 <del>3</del> <u>4</u> ..0x0F
<b>Length</b>	4 bits	0..15
<b>Unspecified data</b>	<i>variable</i>	The “Length” field specifies the size of this field in bytes
}	—	—



*Insert new subclause 8.3.6.3.9:***8.3.6.3.9 Fast\_Ranging\_IE**

A Fast\_Ranging\_IE may be placed in the UL-MAP message by a BS to provide a non-contention-based initial-ranging opportunity. The Fast\_Ranging\_IE shall be placed in the extend UIUC (extension code = 0x03) within a UL-MAP IE. The Fast\_Ranging\_IE shall be assigned to the initial ranging CID=0x0000.

**Table 253a—OFDM Fast\_Ranging\_IE format**

Syntax	Size	Notes
Fast_Ranging_IE {	—	—
Extended UIUC	4 bits	= 0x03
Length	4 bits	= 0x8
MAC address	48 bits	MS's MAC address as provided on the RNG-REQ message on initial system entry
UIUC	4 bits	UIUC ≠ 15. UIUC ≠ 4. A code used to define the type of uplink access and the burst type associated with that access.
Duration	12 bits	The length, in units of OFDM symbols, of the allocation. The start time of the first allocation shall be the Allocation Start Time given in the UL-MAP message.
}	—	—

BS may assign subchannel indices other than 0b10000, only to the MS that entered the network using the subchannelized network entry (see 8.3.6.3.3).

*Insert new subclause 8.3.6.3.10:***8.3.6.3.10 UL-MAP Fast tracking information element**

The UL-MAP Fast tracking information element in an UL-MAP entry is used to provide fast power, time and frequency indications/corrections to MS's that have transmitted in the previous frame.

The extended UIUC=15 shall be used for this IE with sub-code 0x04.

The CID used in the Information Element shall be a broadcast CID.

**Table 253b—UL fast tracking information element**

Syntax	Size	Notes
UL_Fast_tracking_IE()	—	—
<b>extended UIUC</b>	4 bits	Fast-Indication = 0x04
<b>Number of Length</b>	4 bits	Variable
for (i=1; i<n; i++) {	—	For each Fast Indication bytes 1 to n (n = Length)
<b>Power correction</b>	2 bits	Power correction indication: 0b00: no change; 0b01: +2 dB; 0b10: -1 dB; 0b11: -2 dB;
<b>Frequency correction</b>	4 bits	The correction is 0.1% of the carrier spacing multiplied by the 4-bit number interpreted as a signed integer (i.e., 0b1000: -8; ... 0b0000: 0; ... 0b0111: 7)
<b>Time correction</b>	2 bits	The correction is floor(2 / Fs) multiplied by: 0b00: 0; 0b01: 1; 0b10: -1; 0b11: Not used
}	—	—
}	—	—

The UL Fast tracking IE is an optional field in the UL-MAP. When this IE is sent, it provides an indication about corrections that should be applied by MS's that have transmitted in the previous UL frame. Each indication byte shall correspond to one unicast allocation-IE that has indicated an UL burst allocation in the previous UL-MAP. The order of the indication bytes shall be the same as the order of the unicast allocation-IE in the UL-MAP.

The response time for corrections following receipt of this IE shall be equal to "Ranging Response Processing Time" as defined in 10.1.

*Insert new subclause 8.3.6.6:*

**8.3.6.6 Compressed private maps**

The presence of the compressed private DL-MAP format is indicated by the contents of the most significant two bits of the first data byte. These bits overlay the HT and EC bits of a generic MAC header. When these bits are both set to 1 (an invalid combination for a standard header), the compressed private DL-MAP format is present. A compressed private UL-MAP shall only appear immediately after a compressed private DL-MAP. The presence of a compressed private UL-MAP is indicated by a bit in the compressed private DL-MAP data structure.

A broadcast map, an AAS-DLFP message, a SBCH\_DL\_MAP\_IE, or another private map in a previous frame can point to the compressed private map. Other restrictions of compressed private maps include:

- The private map must be the first message in a PHY burst.

- Private maps shall only be used in the AAS portion of the subframe or within the DL subchannelization zone.
- Private maps are only allowed to use unicast CID values.
- Private maps shall only describe allocations within the AAS portion of the subframe or within the DL subchannelization zone.
- Both UL and DL allocations included in the private map are relative to the next frame.

A modification to the ‘Preamble Time Shift’ (as defined in 8.3.6.2.7 and 8.3.6.3.7) shall also apply to allocations in subsequent private maps in the private map chain, until modified again or until the end of the private map chain.

The compressed private map is an optional feature that can be negotiated between the SS and BS.

*Insert new subclause 8.3.6.6.1:*

**8.3.6.6.1 Compressed private DL-MAP**

The compressed private DL-MAP format is presented in Table 258a. The message presents the same information as the standard format with one exception. In place of the DL-MAP’s 48-bit Base Station ID, the compressed format provides a subset of the full value. When the compressed format is used, the full 48-bit Base Station ID shall be present in the DCD.

**Table 258a—Compressed Private DL-MAP message format**

Syntax	Size	Notes
Compressed_Private_DL-MAP() {	—	—
<b>Compressed map indicator</b>	2 bits	Set to 0b11 for compressed format
<i>Reserved</i>	1 bit	Shall be set to zero
<b>UL-MAP appended</b>	1 bit	—
<b>Compressed Map Type</b>	1 bit	Shall be set to 0 for compressed private map
<b>Map message length</b>	11 bits	—
<b>DCD Count</b>	8 bits	—
<b>Base Station ID</b>	4 bits	4 LSBs of BSID. The burst specified by the DLFP shall not be decoded if these bits do not match those of the BS on which it is registered
<b>DL IE Count</b>	8 bits	—
for (i=1;i<=DL IE count;i++){	—	—
<b>SBCH_DLP_MAP_IE()</b>	<i>variable</i>	—
}	—	—
if !(byte boundary) {	—	—
<b>Padding Nibble</b>	4 bits	Padding to reach byte boundary
}	—	—
if (UL-MAP appended) {	—	—
<b>Compressed_Private_UL-MAP()</b>	<i>variable</i>	

**Table 258a—Compressed Private DL-MAP message format (continued)**

Syntax	Size	Notes
}		
<b>HCS</b>	8 bits	—
}	—	—

**Compressed map indicator**

A value of 0b11 in this field indicates the map message conforms to the compressed format described here. A value of 0b00 in this field indicates the map message conforms to the standard format described in 6.3.2.3.2. Any other value is in error.

**UL-MAP appended**

A value of 1 indicates a compressed UL-MAP (see 8.3.6.6.2) is appended to the current compressed DL-MAP data structure.

**Map message length**

This value specifies the length of the compressed map message(s) beginning with the byte containing the Compressed map indicator and ending with the last byte of the compressed DL-MAP message if the UL-MAP appended bit is not set or the last byte of the UL-MAP compressed message if the UL-MAP appended bit is set. The length includes the computed 8-bit HCS value.

**DCD Count**

Matches the value of the configuration change count of the DCD, which describes the downlink burst profiles that apply to this map.

**DL IE count**

A field that holds the number of CID entries in the following list of DL-MAP IEs.

**HCS**

A HCS value, as defined in 6.3.2.1.1, is appended to the compressed private DL-MAP.

The HCS is computed across all bytes of the compressed map(s) starting with the byte containing the Compressed map indicator and including appended Compressed Private UL-MAP, if present.

*Insert new subclause 8.3.6.6.2:*

**8.3.6.6.2 Compressed Private UL-MAP**

The compressed private UL-MAP format is presented in Table 258b. The message may only appear after a compressed private DL-MAP message to which it shall be appended. The message presents the same information as the standard format with the exception that the Generic MAC header and the Uplink Channel ID are omitted. The HCS is computed across all bytes of the compressed map(s) starting with the byte containing the Compressed map indicator and including appended UL-MAP, if present.

**Table 258b —Compressed Private UL-MAP message format**

Syntax	Size	Notes
Compressed_Private_UL-MAP() {	—	—
<b>UCD Count</b>	8 bits	—
<b>Allocation Start Time</b>	32 bits	—
while (map data remains) {	—	—
<b>UL-MAP_IE()</b>	<i>variable</i>	—
}	—	—
if !(byte boundary) {	—	—
<b>Padding Nibble</b>	4 bits	Padding to reach byte boundary
}	—	—
}	—	—

**UCD Count**

Matches the value of the Configuration Change Count of the UCD, which describes the uplink burst profiles that apply to this map.

**Allocation Start Time**

Effective start time of the uplink allocation defined by the UL-MAP.

*Insert new subclause 8.3.6.7:*

**8.3.6.7 Reduced private maps**

Reduced private maps are based upon the compressed map format; however, they are specifically designed to support a single unicast ID per map. Their use is identical to standard compressed private maps. However, fields have been removed that are not required to support a single ID. The reduced private map will be pointed to by a broadcast map or private compressed map, which will define the values of several fields that will be constant for the duration of the private map chain. The behavior of the compressed map fields that are not present in the reduced private map are described in the following list:

- 1) DCD Count—Optionally included. Only required if DCD count changes.
- 2) Base Station ID—Acquired by the map that initiated the private map chain. Assumed constant for the duration of the private map chain.
- 3) CID—Only required in first map of private map chain.
- 4) UCD Count—Optionally included. Only required in first UL map of private map chain.
- 5) Allocation Start Time—UL start time relative to TTG plus an integer number of symbol times.

*Insert new subclause 8.3.6.7.1:*

**8.3.6.7.1 Reduced private DL-MAP**

The Reduced private DL-MAP format is presented in Table 258c. The reduced private DL-MAP message eliminates the fields that are not relevant since the message is targeted to a single CID.

**Table 258c—Reduced private DL-MAP message format**

Syntax	Size	Notes
Reduced Private DL_MAP()	—	—
<b>Compressed map indicator</b>	2 bits	Set to 0b11 for compressed format
<i>Reserved</i>	1 bit	Shall be set to zero
<b>UL-MAP appended</b>	1 bit	—
<b>Compressed Map Type</b>	1 bit	Shall be set to 1 for reduced private map
<b>CID Included</b>	1 bit	1 = CID included. The CID shall be included in the first compressed private MAP if it was pointed to by a DL-MAP IE with a multicast CID
<b>DCD Count Included</b>	1 bit	1 = DCD Count included. The DCD count is expected to be the same as in the broadcast map that initiated the private map chain. The DCD count can be included in the private map if it changes
<b>PHY modification Included</b>	1 bit	1 = included.
<i>Reserved</i>	1 bit	Shall be set to zero
Map message length	11 bits	—
if (CID Included) {	—	—
<b>CID</b>	16 bits	—
}	—	—
if (DCD Count Included) {	—	—
<b>DCD Count</b>	8 bits	—
}	—	—
if (PHY modification Included) {	—	—
<b>Preamble Time Shift</b>	8 bits	Updated preamble time shift to be used starting with the next frame
}	—	—
<b>Preamble Present</b>	1 bit	—
<b>Start Time</b>	11 bits	—
<b>Duration</b>	10 bits	—
<b>Subchannel Index</b>	5 bits	—
<i>Reserved</i>	1 bit	Shall be set to zero
If (UL-MAP appended) {	—	For the AMC permutation (2 x 3 type)

**Table 258c—Reduced private DL-MAP message format (continued)**

Syntax	Size	Notes
<b>Reduced Private UL-MAP()</b>	<i>variable</i>	—
}	—	—
<b>HCS</b>	8 bits	
}	—	—

**Map message length**

Specifies the length of the reduced map message(s) beginning with the byte containing the Compressed map indicator, including the Reduced Private UL maps if present, and ending with the last byte of the Reduced Private DL-MAP message, the computed 8-bit HCS value.

**Compressed map indicator**

A value of 0b11 in this field indicates the presence of a compressed map.

**UL-MAP appended**

A value of 1 indicates a reduced compressed private UL-MAP (see 8.3.6.7.2) is appended to the current private DL-MAP data structure.

**CID Included**

Specifies if a CID is included. The CID shall be included in the first compressed private MAP if it was pointed to by a DL-MAP IE with a multicast CID.

**DCD Count Included**

Specifies if a DCD count is included. DCD Count is only required if the DCD count is changed.

**PHY Modification Included**

Indicates if a preamble modifier is included.

**Connection Identifier (CID)**

Represents the assignment of the IE to a unicast address.

**Preamble Time Shift**

The preamble time shift for subsequent DL allocations, as defined in 8.6.3.3.7.

**DCD Count**

Matches the value of the configuration change count of the DCD, which describes the downlink burst profiles that apply to this map.

**DIUC**

DIUC used for the burst.

**Preamble Present**

If set, the indicated burst shall start with the short preamble.

**Start Time**

Indicates the start time, in units of symbol duration, relative to the beginning of the next downlink frame (including preamble). The time instants indicated by the Start Time values are the transmission times of the first symbol of the burst including preamble (if present).

**Duration**

Indicates the duration, in units of OFDM symbols, of the allocation. The duration is inclusive of the preamble contained in the allocation.

**HCS**

An HCS value, as defined in 6.3.2.1.1, is appended to the end of the reduced map(s) data. The HCS is computed across all bytes of the reduced map(s) starting with the byte containing the Compressed map indicator and including appended Reduced Private UL-MAP(s), if present.

*Insert new subclause 8.3.6.7.2:*

**8.3.6.7.2 Reduced private UL-MAP**

The Reduced private UL-MAP format is presented in Table 258d. The message may only appear after a Reduced private DL-MAP message to which it shall be appended.

**Table 258d—Reduced private UL-MAP message format**

Syntax	Size	Notes
Reduced Private UL-MAP()	—	—
<b>UCD Count Included</b>	1 bit	1 = UCD Count Included. The UCS count should be included in the first allocation of a private map chain.
<b>PHY modification Included</b>	1 bit	1 = Preamble time shift included.
<b>Power Control Included</b>	1 bit	1 = Power control value included.
if (UCD Count Included) {	—	—
<b>UCD Count</b>	8 bits	—
}	—	—
if (PHY modification Included) {	—	—
<b>Preamble Time Shift</b>	8 bits	Updated preamble time shift to be used starting with the next frame.
}	—	—
if (Power Control Included) {	—	—
<b>Power Control</b>	8 bits	Signed integer in 0.25 dB units.
}	—	—
<b>UIUC</b>	4 bits	—
<b>Start Time</b>	11 bits	—
<b>Duration</b>	10 bits	—
<b>Subchannel Index</b>	5 bits	—
<b>Midamble Repetition Interval</b>	2 bits	—
<i>Reserved</i>	5 bits	Set to zero.
}	—	—

**UCD Count Included**

Indicates if UCD Count is included. This should be included in the first UL map of a private map chain.

**Phy Modification Included**

Indicates if a preamble modifier is included.



**Power Control Included**

Indicates if an SS power control byte is included.

**Preamble Time Shift**

The preamble time shift for subsequent UL allocations, as defined in 8.6.3.3.7.

**Power Control**

The change in transmit power level that the SS should apply starting on the next frame.

**UCD Count**

Matches the value of the configuration change count of the UCD, which describes the uplink burst profiles that apply to this map.

**UIUC**

UIUC used for the burst.

**Start Time**

Indicates the start time of the allocation, in units of symbol duration, referenced to the beginning of the next frame and consists of an integer symbol offset specified here, as well as the addition of the TTG known from DCD messages. If TTG is not present in the DCD (for FDD) it is assume to be zero.

**Duration**

Indicates the duration, in units of OFDM symbols, of the allocation. The duration is inclusive of the preamble contained in the allocation.

**Subchannel Index**

See Table 211.

**Midamble Repetition Interval**

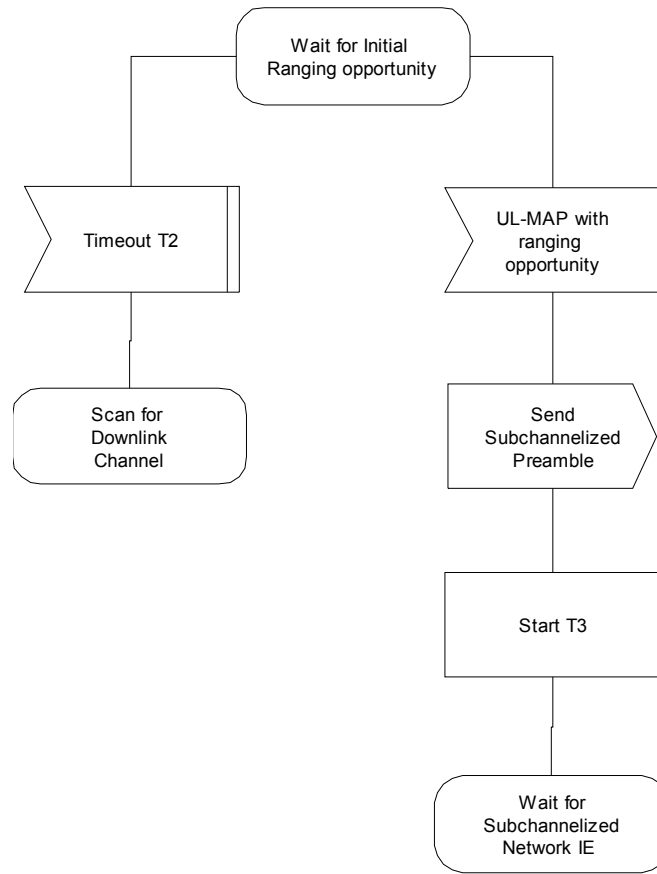
Indicates the preamble repetition interval in OFDM symbols, as defined in 8.3.6.3.

**8.3.7 Control mechanisms****8.3.7.2 Ranging**

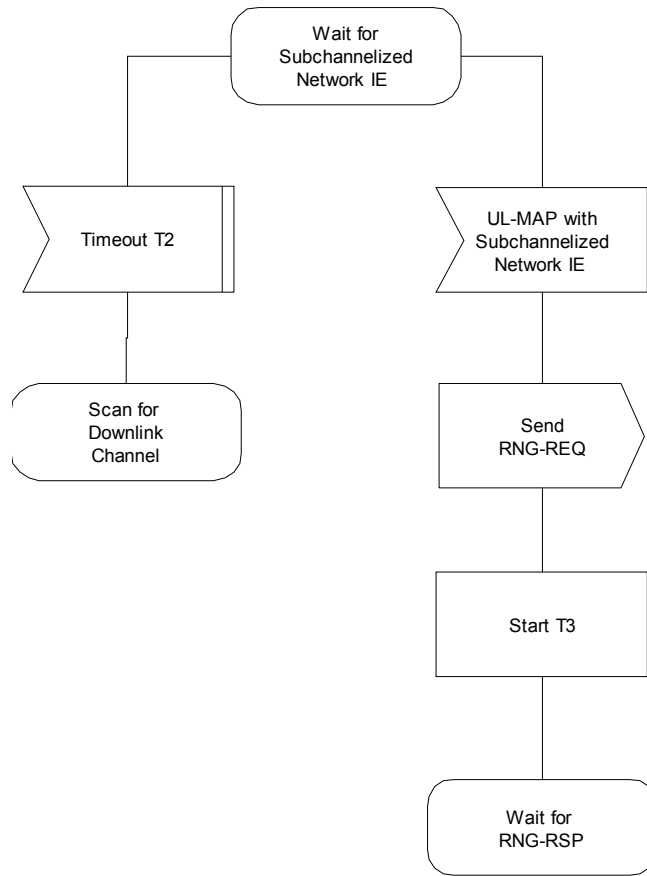
*Change the fifth paragraph as indicated:*

SSs that compute their  $P_{TX\_IR\_max}$  to exceed their maximum power level and SSs that have attempted initial ranging with the maximum power level using RNG-REQ may, if the BS supports subchannelization, attempt initial ranging in an initial ranging slot using the following burst format, to be referred to as the Subchannelized Initial Ranging Signal and as indicated in Figure 210a and Figure 210b.

*Insert the following new figures (Figure 210a and Figure 210b) into the subclause:*



**Figure 210a—Subchannelized Initial Ranging—SS (part 1a)**



**Figure 210b—Subchannelized Initial Ranging —SS (part 1b)**

*Change the eighth paragraph as indicated:*

The BS need only detect that energy is sent on a single subchannel and may respond by allocating a single subchannel identifying the SS by the Transmit Opportunity, Frame Number and ranging subchannel in which the transmission was received. The allocation is accomplished by sending an UL-MAP IE containing a Subchannelized\_Network\_Entry\_IE (see 8.3.6.3.3) and transmitted using the Initial Ranging CID, as shown in Figure 210b. The allocated bandwidth shall be big enough as to contain at least one RNG-REQ message.

**8.3.7.2.1 Initial Ranging in AAS systems**

*Change the last sentence of the first paragraph as indicated:*

This burst shall use the most robust mandatory ~~rate~~ coding method (BPSK-1/2).

*Insert the following sentence under the Notes column for the HCS field in Table 259:*

An 8-bit Header Check Sequence, calculated as specified in Table 5.

*Change Table 260 as indicated:*

**Table 260—OFDM SBCH\_AAS\_NW\_ENTRY\_REQ format**

Syntax	Size	Notes
SBCH_AAS_NW_ENTRY_REQ(){		
<b>Network entry code</b>	4 bits	A randomly selected code.
<b>Phase offset 1</b>	4 bits	The mean phase offset of beam 1 relative to beam 0. 4-bit signed number, in units of $360^\circ/16$ .
<b>Phase offset 2</b>	4 bits	The mean phase offset of beam 2 relative to beam 0. 4-bit signed number, in units of $360^\circ/16$ .
<b>Phase offset 3</b>	4 bits	The mean phase offset of beam 3 relative to beam 0. 4-bit signed number, in units of $360^\circ/16$ .
<b>Measurement frame index</b>	1 bit	0: Phase information corresponds to beams in previous frame 1: Phase information corresponds to beams in one before previous frame.
<b>RSSI mean value</b>	5 bits	
<b><u>Reserved</u></b>	<u>2 bits</u>	<u>Shall be set to zero</u>
<b><u>HCS</u></b>	<u>8 bits</u>	<u>An 8-bit Header Check Sequence; calculated as specified in Table 5.</u>
}		

### 8.3.7.3 Bandwidth requesting

*Change the first sentence of the second paragraph as indicated:*

In a REQ Region-Full, when subchannelization is not active, each Transmit Opportunity shall consist of a short preamble and one OFDM symbol using the most robust mandatory ~~burst profile~~ coding method (BPSK-1/2).

*Change the last sentence of the second paragraph as indicated:*

The transmission of an SS shall contain a subchannelized preamble corresponding to the TO chosen, followed by data OFDM symbols using the most robust mandatory ~~burst profile~~ coding method (BPSK-1/2).

#### 8.3.7.3.2 Full Contention transmission

*Change the second paragraph as indicated:*

If the Full Contention allocation appears in subchannelized region, the allocation is partitioned into transmission opportunities (TOs) both in frequency and in time. The width (in subchannels) and length (in OFDM symbols) of each transmission opportunity is defined in the UCD message ~~defining UIUC = 2~~. The transmission of an SS shall contain a subchannelized preamble corresponding to the TO chosen, followed by data OFDM symbols using the most robust mandatory ~~burst profile~~ coding method (BPSK-1/2).

### 8.3.7.4 Power control

*Change the last sentence of the second paragraph as indicated:*

Subscriber stations shall report the maximum available power, and the ~~normalized~~ current average transmitted power.

Explicitly, let PSDref be the reference level of power spectrum density of the SS. This can only be changed by power control messages. The transmit power of the SS is defined as current tx power = min((number used subchannels) × PSDref, maximum available power). Thus, in the case of saturation, the reference level of power spectrum density shall not be changed.

*Insert a new subheading 8.3.7.4.1 Closed loop power control mode:*

#### 8.3.7.4.1 Closed loop power control mode

*Change the second paragraph in 8.3.7.4 as indicated:*

When subchannelization is employed in the uplink, the SS shall maintain the same transmitted power density unless the maximum power level is reached. That is, when the number of active subchannels allocated to a user is reduced, the total transmitted power shall be reduced proportionally by the SS, without additional power control messages. When the number of subchannels is increased the total transmitted power shall also be increased proportionally. However, the transmitted power level shall not exceed the maximum levels dictated by signal integrity considerations and regulatory requirements. Subscriber stations shall report the maximum available power, and the normalized transmitted power.

*Insert the following text between the second and third paragraph in 8.3.7.4:*

When subchannelization is employed in the downlink, the BS may vary the power of individual subchannelized allocations to improve the link budget to particular MS's. The transmitted power level shall not exceed the maximum levels dictated by signal integrity considerations and regulatory requirements. Within a given DL subchannelized allocation the spectral flatness requirement as specified in 8.3.10.1.1 applies to all the energized subcarriers.

*Insert a new subclause 8.3.7.4.2:*

#### 8.3.7.4.2 Open Loop Power Control Mode (Optional)

When the open loop power control is supported and the uplink power control mode is changed to open loop power control by PMC\_RSP, the power per a subcarrier shall be maintained for the UL transmission as follows.

This open loop power control shall be applied for all the uplink bursts.

$$P_{EIRP}(dBm) = PL + CNR + R + (N + I) + 10 \log_{10}(BW_{sch}) + Offset_{SS_{perSS}} + Offset_{BS_{perSS}} \quad (84a)$$

where

$P_{EIRP}$  is the Tx effective isotropic radiated power (EIRP) level, expressed in dBm, per subcarrier for the current transmission. It includes the MS Tx antenna gain and its related coupling losses.

$PL$  is the estimated average current UL path loss.

- CNR** is the normalized Carrier to Noise Ratio (per subcarrier) for the given modulation, FEC and the related Convolutional Coding scheme used for the current transmission as presented in Table 262a. The normalized Carrier to Noise Ratio can be modified by UCD (Normalized C/N override).
- R** is the number of repetitive sequences used by the receiving circuitry employed to determine the path losses.
- BW<sub>sch</sub>** is the bandwidth occupied by an OFDM subcarrier, expressed in Hz.
- N+I** is the estimated normalized average power level (dBm) of the noise and interference per subcarrier at the Rx antenna port of the receiving side (BS), for BW=1 Hz. It does not include the equivalent gain of the Rx antenna and its related coupling losses.
- Offset<sub>MS\_UL</sub>** represents the correction term for SS-specific power offset. Practically it amounts to the desired Fade Margin for the respective UL link. It is controlled by the MS and initially is set to zero.
- Offset<sub>BS\_UL</sub>** represents the MS-specific power offset, controlled by the BS through the power control messages. When Offset<sub>BS\_UL</sub> is set through the PMC\_RSP message, it shall include the equivalent BS Rx antenna gain, including its related coupling losses, measured at the antenna port of the equipment.

**Table 262a—Normalized CINR per modulation (BER = 1e-6)**

Modulation/FEC-CC Rate	Normalized CNR (dB)
BPSK 1/2	13.9
QPSK 1/2	16.9
QPSK 3/4	18.65
16QAM 1/2	23.7
16QAM 3/4	25.45
QAM64 1/2	29.7
QAM64 3/4	31.45

The normalized CNR is calculated based on Noise Figure = 7 dB and MIL (Modulation Implementation Losses = 5 dB).

The estimated average current UL propagation loss,  $PL_{UL}$ , shall be calculated based on the total power received on the active subcarriers of the frame preamble, referenced to the  $BS\_EIRP$  parameter sent by the BS.

Table 262a returns the default normalized CNR values per modulation. The operating parameters  $BS\_EIRP$  and  $NI$  are signaled by a DCD message (Table 358—DCD channel encoding).

Additionally, the BS controls the  $Offset\_BS_{perSS}$  using PMC\_RSP message (6.3.2.3.58) to override the  $Offset\_BS_{perSS}$  value or using RNG-RSP (6.3.2.3.6), Fast Power Control (FPC) message (6.3.2.3.34), Power Control IE (8.3.6.3.5) to adjust the  $Offset\_BS_{perSS}$  value. The accumulated power control value shall be used for  $Offset\_BS_{perSS}$ .

The  $Offset\_BS_{perSS}$  can be updated using relative or fixed form (as a function of the relevant adjustment commands used). Fixed form is used when the parameter is obtained from a PMC\_RSP message. In this case, the MS should replace the old  $Offset\_SS_{perSS}$  value by the new  $Offset\_SS_{perSS}$  sent by the BS. With all

other messages mentioned in the previous paragraph, relative form is used. In this case, MS should increase and decrease the  $Offset\_SS_{perSS}$  according to the offset value sent by BS.

The actual power setting shall be quantized to the nearest implementable value, subject to the specification. For each transmission, the SS shall limit the power, as required to satisfy the spectral masks and EVM requirements.

**Passive Uplink open loop power control**

In passive Uplink open loop power control the MS will set  $Offset\_SS_{perSS}$  to zero and modify the TX power value using Equation (84a).

**Active Uplink open loop power control**

An alternative way is that the SS may adjust  $Offset\_SS_{perSS}$  value within a range.

$$Offset\_Bound_{lower} \leq Offset_{perSS} \leq Offset\_Bound_{upper}, \tag{84b}$$

where

$Offset\_Bound_{upper}$  is the upper bound of  $Offset\_SS_{perSS}$   
 $Offset\_Bound_{lower}$  is the lower bound of  $Offset\_SS_{perSS}$

*Change the title of subclause 8.3.8 as indicated:*

**8.3.8 Transmit diversity: ~~Space-Time Coding~~ (optional)**

*Change the first paragraph as indicated:*

STC (~~see Alamouti [B1]~~, in some cases also termed STTD), may be used on the downlink to provide ~~second~~higher order (Space) transmit diversity.

**8.3.9 Channel quality measurements**

**8.3.9.2 RSSI mean and standard deviation**

*Change the first sentence of first paragraph as indicated:*

When collection of RSSI measurements is mandated by the BS, an SS shall obtain an RSSI measurement from the OFDM downlink long preambles.

*Change the first sentence of the third paragraph as indicated:*

The method used to estimate ~~the a single~~ RSSI ~~of a single message measurement~~ is left to individual implementation, but the relative accuracy of a single signal strength measurement, taken from a single message, shall be  $\pm 2$  dB, with an absolute accuracy of  $\pm 4$  dB.

*Replace Equation (90) and Equation (91) with the following equations:*

$$\hat{x}_{RSSI}^2[k] = \begin{cases} |R[0]|^2 & k = 0 \\ (1 - \alpha_{avg})\hat{x}_{RSSI}^2[k - 1] + \alpha_{avg}|R[k]|^2 & k > 0 \end{cases} \quad (mW)^2 \tag{90}$$

$$\hat{\sigma}_{RSSI\ dB} = 5 \log \left( \left| x_{RSSI}^2[k] - (\hat{\mu}_{RSSI}[k])^2 \right| \right) \quad dBm \quad (91)$$

### 8.3.9.3 CINR mean and standard deviation

*Change the second sentence of the third paragraph as indicated:*

The specified accuracy shall apply to the range of CINR values starting from ~~3 dB below~~ the SNR of the most robust rate, to ~~+0.3 dB~~ above the SNR of the least robust rate.

### 8.3.10 Transmitter requirements

*Insert the following paragraph:*

All requirements on the transmitter apply to the RF output connector of the equipment. For equipment with integral antenna only, a reference antenna with 0 dBi gain shall be assumed.

#### 8.3.10.1 Transmit power level control

*Change the subclause as indicated:*

For an SS not supporting subchannelization, the transmitter shall support a monotonic power level control of 30 dB minimum. For an SS supporting subchannelization, the transmitter shall support a monotonic power level control of 50 dB minimum. The minimum step size shall be no more than 1 dB. The relative accuracy of the power control mechanism is  $\pm 1.5$  dB for step sizes not exceeding ~~30~~ 15 dB, and  $\pm 3$  dB for step sizes from 15 dB to 30 dB and  $\pm 5$  dB for step size greater than 30 dB. For a BS, the transmitter shall support a monotonic power level control of 10 dB minimum.

*Renumber subclause 8.3.10.1.1 as 8.3.10.2*

#### 8.3.10.2 Transmitter spectral flatness

*Insert the following sentence after Table 263:*

The power transmitted at spectral line 0 shall not exceed  $-15$  dB relative to total transmitted power.

*Renumber subclause 8.3.10.1.2 as 8.3.10.3*

*Change Table 264 as indicated:*

**Table 263—Allowed relative constellation error versus data rate**

Burst type	Relative constellation error for SS (dB)	Relative constellation error for BS (dB)
BPSK-1/2	-13.0	<u>-13.0</u>
QPSK-1/2	-16.0	<u>-16.0</u>
QPSK-3/4	-18.5	<u>-18.5</u>
16-QAM-1/2	-21.5	<u>-21.5</u>



**Table 263—Allowed relative constellation error versus data rate (continued)**

Burst type	Relative constellation error for SS (dB)	Relative constellation error for BS (dB)
16-QAM-3/4	-25.0	<u>-25.0</u>
64-QAM-2/3	<del>-28.5</del> <u>-29.0</u>	<u>-29.0</u>
64-QAM-3/4	<del>-31.0</del> <u>-30.0</u>	<u>-31.0</u>

*Renumber subclause 8.3.10.2 as 8.3.10.4*

**8.3.11 Receiver requirements**

*Insert the following paragraph:*

All requirements on the receiver apply to the RF input connector of the equipment. For equipment with integral antenna only, a reference antenna with 0 dBi gain shall be assumed.

**8.3.11.1 Receiver sensitivity**

*Delete the first bullet of the first paragraph:*

- ~~— At the antenna connector or through a calibrated radiated test environment,~~

*Change the second paragraph as indicated:*

The receiver minimum input level sensitivity ( $R_{SS}$ ) shall be (assuming a 5 dB implementation margin and a 7 ~~8~~ dB Noise Figure):

*Replace Equation (98) with the following equation:*

$$R_{SS} = -101 + SNR_{Rx} + 10 \cdot \log\left(F_S \cdot \frac{N_{used}}{N_{FFT}} \cdot \frac{N_{subchannels}}{16}\right) \tag{98}$$

where

- $SNR_{Rx}$  the receiver SNR as per Table 266 in dB,
- $F_S$  sampling frequency in MHz as defined in 8.3.2.2,
- $N_{subchannels}$  the number of allocated subchannels (default 16 if no subchannelization is used).

*Change Table 266 as indicated:*

**Table 266—Receiver SNR assumptions**

Modulation	Coding rate	Receiver SNR (dB)
BPSK	1/2	<del>6.4</del> <u>3.0</u>
QPSK	1/2	<del>9.4</del> <u>6.0</u>
	3/4	<del>11.2</del> <u>8.5</u>
16-QAM	1/2	<del>16.4</del> <u>11.5</u>
	3/4	<del>18.2</del> <u>15.0</u>
64-QAM	2/3	<del>22.7</del> <u>19.0</u>
	3/4	<del>24.4</del> <u>21.0</u>

*Change the paragraph below Table 266 as indicated:*

Note that these SNR values are derived in an AWGN environment, and assume that Reed-Solomon convolutional coding (RS-CC) is used.

Test messages for measuring Receiver Sensitivity shall be based on a continuous stream of MAC PDUs, each with a payload ~~consisting of~~ containing an  $R$  times repeated sequence  $S_{modulation}$ . For each modulation, a different sequence applies:

*Change the second paragraph below Table 266 as indicated:*

For each mandatory test message, the  $(R, S_{modulation})$  tuples that shall apply are:

- Short length test message payload (288 data bytes):  $(144, S_{BPSK})$ ,  $(72, S_{QPSK})$ ,  $(36, S_{16QAM})$ ,  $(6, S_{64QAM})$
- Mid length test message payload (864 data bytes):  $(432, S_{BPSK})$ ,  $(216, S_{QPSK})$ ,  $(108, S_{16QAM})$ ,  $(18, S_{64QAM})$
- Long length test message payload ~~(1536~~1488 data bytes):  ~~$(768, S_{BPSK})$ ,  $(384, S_{QPSK})$ ,  $(192, S_{16QAM})$ ,  $(32, S_{64QAM})$~~

### 8.3.11.2 Receiver adjacent and alternate channel rejection

*In the second paragraph, change the reference 8.3.10.3 to 8.3.11.3.*

### 8.3.12 Frequency and timing requirements

*Change the second paragraph as indicated:*

At the SS, both the transmitted center frequency and the ~~symbol~~sampling clock frequency shall be synchronized and locked to the BS with a tolerance of maximum 2% of the subcarrier spacing for the transmitted center frequency, and 5 ppm for the sampling clock frequency. In the case of subchannelization, the tolerance for transmitted center frequency shall be maximum 1% of the subcarrier spacing.

## 8.4 WirelessMAN-OFDMA PHY layer

### 8.4.1 Introduction

*Insert the following text at the end of 8.4.1*

The OFDMA PHY mode based on at least one of the FFT sizes 2048 (backward compatible to IEEE Std 802.16-2004), 1024, 512 and 128 shall be supported. This facilitates support of the various channel bandwidths.

The MS may implement a scanning and search mechanism to detect the DL signal when performing initial network entry and this may include dynamic detection of the FFT size and the channel bandwidth employed by the BS.

### 8.4.2 OFDMA symbol description, symbol parameters and transmitted signal

#### 8.4.2.3 Primitive parameters

*Change this subclause as indicated:*

The following four primitive parameters characterize the OFDMA symbol:

- *BW*: This is the nominal channel bandwidth.
- $N_{\text{used}}$ : Number of used subcarriers (which includes the DC subcarrier).
- $n$ : Sampling factor. This parameter, in conjunction with *BW* and  $N_{\text{used}}$  determines the subcarrier spacing, and the useful symbol time. This value is set ~~to 8/7~~ as follows: for channel bandwidths that are a multiple of 1.75 MHz then  $n = 8/7$  else for channel bandwidths that are a multiple of any of 1.25, 1.5, 2 or 2.75 MHz then  $n = 28/25$  else for channel bandwidths not otherwise specified then  $n = 8/7$ .
- $G$ : This is the ratio of CP time to “useful” time. The following values shall be supported: 1/32, 1/16, 1/8, and 1/4.

#### 8.4.3 OFDMA basic terms definition

*Change the title of subclause 8.4.3.1 as indicated:*

##### 8.4.3.1 Slot and ~~D~~data ~~R~~region

*Change the text in 8.4.3.1 as indicated:*

The definition of an OFDMA slot depends on the OFDMA symbol structure, which varies for uplink and downlink, for FUSC and PUSC, and for the distributed subcarrier permutations and the adjacent subcarrier permutation.

- For downlink FUSC (defined in 8.4.6.1.2.2) and downlink optional FUSC (defined in 8.4.6.1.2.3) using the distributed subcarrier permutation (~~defined in 8.4.6.1.2.2 and 8.4.6.1.2.3~~), one slot is one subchannel by one OFDMA symbol.
- For downlink PUSC using the distributed subcarrier permutation (defined in 8.4.6.1.2.1), one slot is one subchannel by two OFDMA symbols.
- For uplink PUSC using either of the distributed subcarrier permutations (defined in 8.4.6.2.1 and 8.4.6.2.5), and for downlink TUSC1 and TUSC2 (defined in 8.4.6.1.2.4 and 8.4.6.1.2.5), one slot is one subchannel by three OFDMA symbols.
- For ~~uplink and downlink~~ using the adjacent subcarrier permutation (defined in 8.4.6.3), one slot is one subchannel by ~~one, two, three, or six~~ two, three, or six OFDMA symbols.

*Change the paragraph above Figure 215 as indicated:*

In OFDMA, a Data Region is a two-dimensional allocation of a group of contiguous subchannels, in a group of contiguous OFDMA symbols. All the allocations refer to logical subchannels. This two dimensional allocation may be visualized as a rectangle, such as the 4 × 3 rectangle shown in Figure 215.

#### 8.4.3.4 OFDMA data mapping

*Change the second and third paragraphs as indicated:*

Downlink:

- 1) Segment the data after the modulation block into blocks sized to fit into one OFDMA slot.
- 2) Each slot shall span one ~~or more~~ subchannels in the subchannel axis and ~~two~~ one or more OFDMA symbols in the time axis, as per the slot definition in 8.4.3.1 (see Figure 2167 for an example). Map the slots such that the lowest numbered slot occupies the lowest numbered subchannel in the lowest numbered OFDMA symbol.
- 3) Continue the mapping such that the OFDMA ~~symbol~~ subchannel index is increased. When the edge of the Data Region is reached, continue the mapping from the lowest numbered OFDMA ~~symbol~~ subchannel in the next ~~subchannel~~ available symbol.

Uplink:

The UL mapping consists of two steps. In the first step, the OFDMA slots allocated to each burst are selected. In the second step, the allocated slots are mapped.

##### Step 1—Allocate OFDMA slots to bursts

- 1) Segment the data into blocks sized to fit into one OFDMA slot.
- 2) Each slot shall span one or more subchannels in the subchannel axis and ~~three~~ one or more OFDMA symbols in the time axis, as per the slot definition in 8.4.3.1 (see Figure 217 for an example). Map the slots such that the lowest numbered slot occupies the lowest numbered subchannel in the lowest numbered OFDMA symbol.
- 3) Continue the mapping such that the OFDMA symbol index is increased (skipping allocations made with UIUC=0,12,13, see 8.4.5.4). When the edge of the UL zone (which is marked with Zone\_switch\_IE) is reached, continue the mapping from the lowest numbered OFDMA symbol in the next available subchannel.
- 4) An UL allocation is created by selecting an integer number of contiguous slots, according to the ordering of steps 1–3. This results in the general Burst structure shown by the gray area in Figure 217.

##### Step 2—Map OFDMA slots within the UL allocation.

- 1) Map the slots such that the lowest numbered slot occupies the lowest numbered subchannel in the lowest numbered OFDMA symbol.
- 2) Continue the mapping such that the Subchannel index is increased. When the last subchannel is reached, continue the mapping from the lowest numbered subchannel in the next OFDMA symbol that belongs to the UL allocation. The resulting order is shown by the arrows in Figure 217.

The subchannels referred to in this subclause are logical subchannels, before subchannel renumbering in the downlink, and before applying the rotation scheme (8.4.6.2.6) and the mapping indicated by UL allocated subchannels bitmap in UCD for the uplink.

Replace Figure 216 and Figure 217 with the following figures:

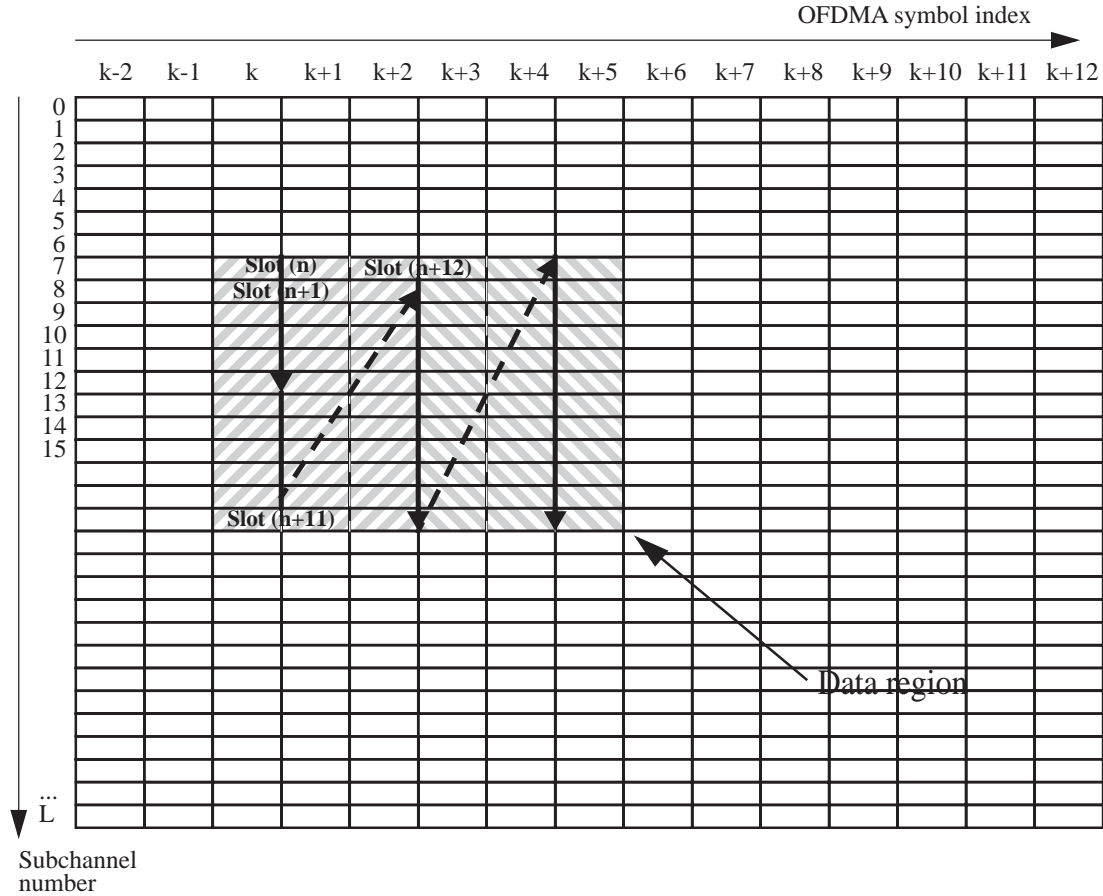


Figure 216—Example of mapping OFDMA slots to subchannels and symbols in the downlink (in PUSC mode)

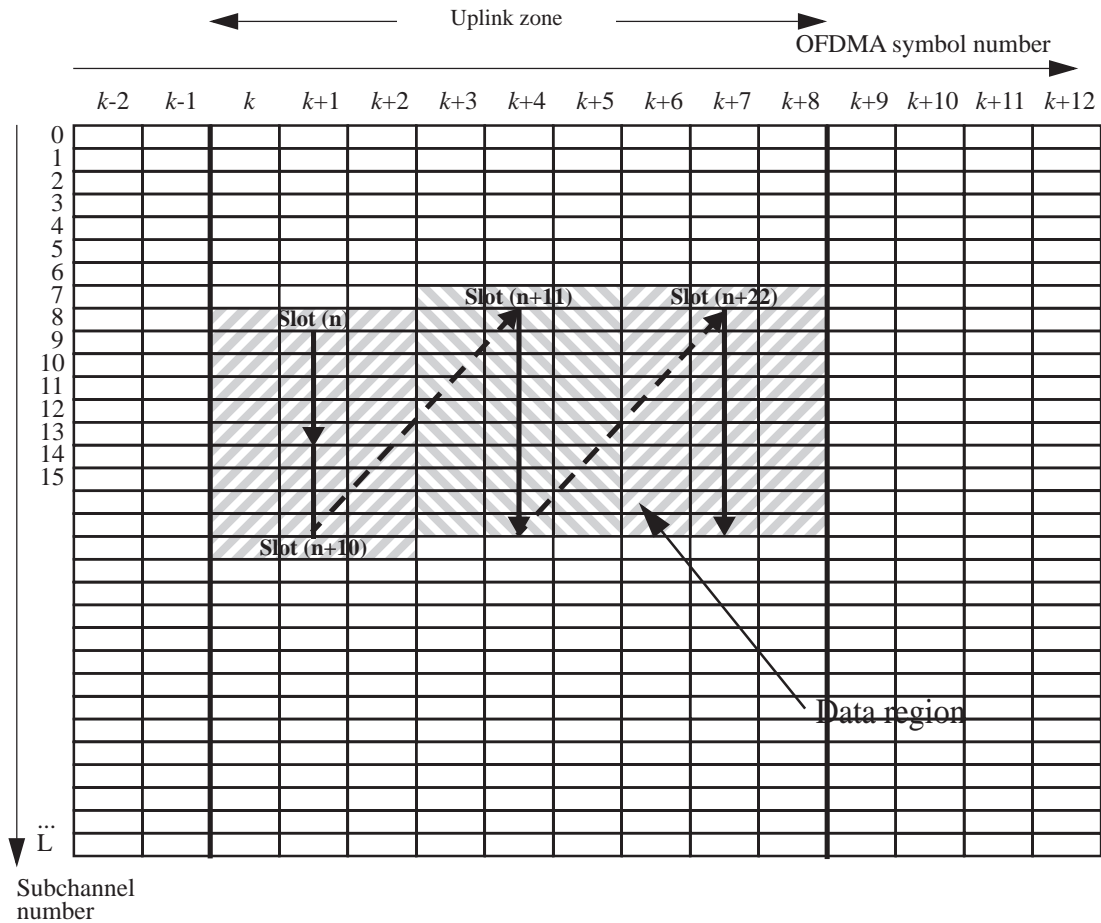


Figure 217—Example of mapping OFDMA slots to subchannels and symbols in the uplink

#### 8.4.4 Frame structure

##### 8.4.4.2 PMP frame structure

*Change the second paragraph as indicated:*

In TDD and H-FDD systems, subscriber station allowances must be made by a SSRTG and by a SSTTG. The BS shall not transmit downlink information to a station later than (SSRTG+RTD) before the beginning of its first scheduled uplink allocation in any UL-subframe, and shall not transmit downlink information to it earlier than (SSTTG-RTD) after the end of the last scheduled uplink allocation, where RTD denotes Round-Trip Delay. In addition the SS should be allowed to receive the downlink preamble for each frame that contains DL data for it, by assuring the period specified above does not overlap with the preamble. The parameters SSRTG and SSTTG are capabilities provided by the SS to BS upon request during network entry (see 11.8.3.1).

Replace Figure 218 with the following figure:

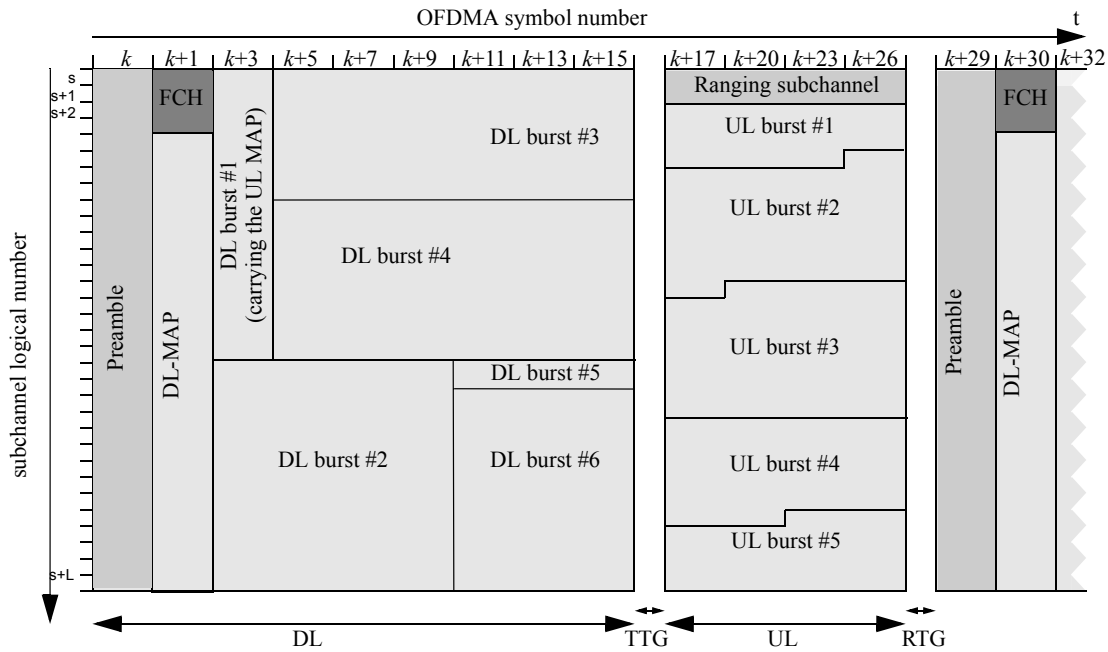


Figure 218—Example of an OFDMA frame (with only mandatory zone) in TDD mode

Change the third through fifth paragraphs as indicated:

Subchannel allocation in the downlink may be performed in the following ways: partial usage of subchannels (PUSC) where some of the subchannels are allocated to the transmitter, and full usage of the subchannels (FUSC) where all subchannels are allocated to the transmitter. ~~The first two transmitted subchannels in the first data symbol of the downlink is called FCH.~~ The FCH shall be transmitted using QPSK rate 1/2 with four repetitions using the mandatory coding scheme (e.g. i.e., the FCH information will be sent on four adjacent subchannels with successive logical subchannel numbers) in a PUSC zone. The FCH contains the DL\_Frame Prefix as described in 8.4.4.3, and specifies the length of the DL-MAP message that immediately follows the DL\_Frame\_Prefix and the repetition coding used for the DL-MAP message.

The transitions between modulations and coding take place on ~~OFDMA symbolslot~~ boundaries in time domain (except in AAS zone) and on subchannels within an OFDMA symbol in frequency domain.

The OFDMA frame may include multiple zones (such as PUSC, FUSC, PUSC with all subchannels, optional FUSC, AMC, TUSC1, and TUSC2 and ~~optional FUSC with all subchannels~~), the transition between zones is indicated in the DL-Map by the STC\_DL\_Zone\_Zone\_switch IE (see 8.4.5.3.4) or AAS\_DL\_IE (see 8.4.5.3.3). No DL-MAP or UL-MAP allocations can span over multiple zones. Figure 219 depicts the OFDMA frame with multiple zones.

The PHY parameters (such as channel state and interference levels) may change from one zone to the next.

Replace Figure 219 with the following figure:

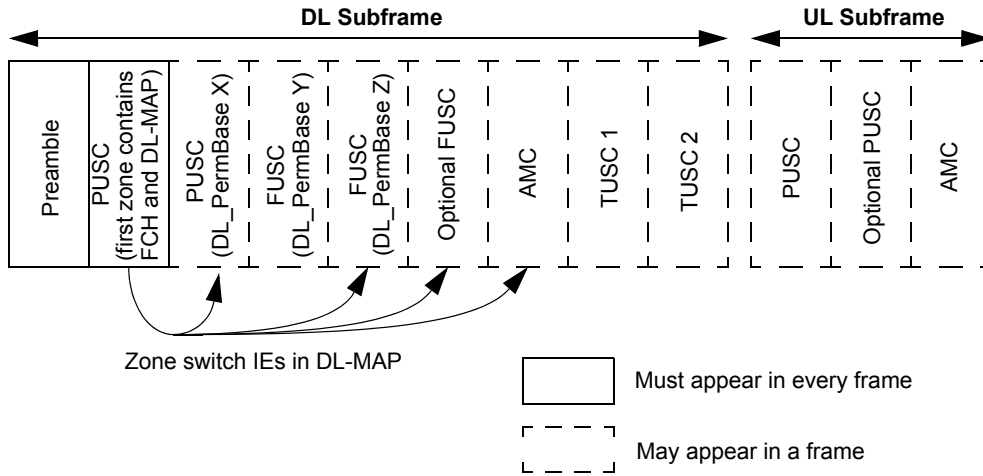


Figure 219—Illustration of OFDMA frame with multiple zones

Insert the following text in 8.4.4.2 after Figure 219:

The following restrictions apply to downlink allocations:

- a) The maximum number of downlink zones is 8 in one downlink subframe.
- b) For each SS, the maximum number of bursts to decode in one downlink subframe is 64. This includes all bursts without CID or with CIDs matching the SS's CIDs.
- c) For each MS, the maximum number of bursts transmitted concurrently and directed to the MS is limited by the value specified in Max\_Num\_Bursts TLV (including all bursts without CID or with CIDs matching the MSs CIDs). Bursts transmitted concurrently are bursts that share the same OFDMA symbol. Before the MS completed capability exchange BS shall transmit data to the MS in the first concurrent data burst per symbol.

If the BS allocates more bursts or zones, then the SS is required to decode the first bursts/zones until the limit is reached.

Change the title of subclause 8.4.4.3 as indicated:

**8.4.4.3 DL Fframe Pprefix**



Change Table 268 as indicated:

**Table 268—OFDMA downlink Frame Prefix format for all FFT sizes except 128**

Syntax	Size	Notes
DL_Frame_Prefix_Format() {	—	—
Used subchannel bitmap	6 bits	Bit #0: Subchannels 0-11 are used Subchannel group 0 Bit #1: Subchannels 12-19 are used Subchannel group 1 Bit #2: Subchannels 20-31 are used Subchannel group 2 Bit #3: Subchannels 32-39 are used Subchannel group 3 Bit #4: Subchannels 40-51 are used Subchannel group 4 Bit #5: Subchannels 52-59 are used Subchannel group 5
<del>Ranging_Change_Indication</del> <del>Reserved</del>	1 bit	Shall be set to zero
Repetition_Coding_Indication	2 bits	0b00: No repetition coding on DL-MAP 0b01: Repetition coding of 2 used on DL-MAP 0b10: Repetition coding of 4 used on DL-MAP 0b11: Repetition coding of 6 used on DL-MAP
Coding_Indication	3 bits	0b000: CC encoding used on DL-MAP 0b001: BTC encoding used on DL-MAP 0b010: CTC encoding used on DL-MAP 0b011: ZT CC encoding used on DL-MAP 0b100: CC encoding with optional interleaver 0b101: LDPC encoding used on DL-MAP <del>0b10+ 0b110</del> to 0b111 -Reserved
DL-MAP_Length	8 bits	—
Reserved	4 bits	Shall be set to zero.
}	—	—

Change paragraph below Table 268 as indicated:

**Used subchannel bitmap**

A bitmap indicating which groups of subchannel are used on the first\_PUSC zone and on PUSC zones in which ‘use all SC’ indicator is set to ‘0’ in STC\_DL\_Zone\_IE(). Value of ‘1’ means used by this segment and ‘0’ means not used by this segment.

~~**Ranging\_Change\_Indication**~~

~~A flag that indicates whether this frame contains a change of the allocation of Periodic Ranging/BW Request uplink regions comparing to the previous frame. A value of “1” means that a change has occurred, and value of “0” means that the allocations of Periodic Ranging/BW Request regions in the current frame are the same as in the previous frame.~~

**Repetition\_Coding\_Indication**

Indicates the repetition code used for the DL-MAP. Repetition code may be 0 (no additional repetition), 1 (one additional repetition), 2 (three additional repetitions) or 3 (five additional repetitions).

**Coding\_Indication**

Indicates the FEC encoding code used for the DL-MAP. The DL-MAP shall be transmitted with QPSK modulation at FEC rate 1/2. ~~Note that~~ The BS ~~must~~ shall ensure that DL-MAP (and other MAC messages required for SS operation) are sent with the mandatory coding scheme often enough to ensure uninterrupted operation of SS supporting only the mandatory coding scheme.

**DL-Map\_Length**

Defines the length in slots of the DL-MAP message that follows immediately the DL\_Frame\_Prefix, after repetition code is applied.

*Insert new Table 268a following Table 268:*

**Table 268a—Subchannel index of the six subchannel groups**

FFT size	Subchannel group	# Subchannel range	FFT size	Subchannel group	# Subchannel range
2048	0	0-11	512	0	0-4
	1	12-19		1	N/A
	2	20-31		2	5-9
	3	32-39		3	N/A
	4	40-51		4	10-14
	5	52-59		5	N/A
1024	0	0-5	128	0	0
	1	6-9		1	N/A
	2	10-15		2	1
	3	16-19		3	N/A
	4	20-25		4	2
	5	26-29		5	N/A

*Insert new text and table:*

For the case of 128 FFT, the following compressed format shall be used for FCH.

**Table 268b—OFDMA downlink frame prefix format for 128 FFT**

Syntax	Size	Notes
DL_Frame_Prefix_format() {	—	—
<b>Used subchannel indicator</b>	1 bit	0: Subchannel 0 is used for segment 0, Subchannel 1 is used for segment 1, Subchannel 2 is used for segment 2,  1: Use all subchannels
<i>Reserved</i>	1 bit	Shall be set to zero
<b>Repetition_Coding_Indication</b>	2 bits	0b00 - No repetition coding on DL-MAP 0b01 - Repetition coding of 2 used on DL-MAP 0b10 - Repetition coding of 4 used on DL-MAP 0b11 - Repetition coding of 6 used on DL-MAP
<b>Coding_Indication</b>	3 bits	0b000 - CC encoding used on DL-MAP 0b001 - BTC encoding used on DL-MAP 0b010 - CTC encoding used on DL-MAP 0b011 - ZT CC encoding used on DL-MAP 0b100 - LDPC encoding used on DL-MAP 0b101 ~ 0b111 - <i>Reserved</i>
<b>DL-Map_Length</b>	5 bits	—
}	—	—

Before being mapped to the FCH, the 12-bit DL Frame Prefix shall be repeated four times to form a 48-bit block, which is the minimal FEC block size.

*Change the title of 8.4.4.4 to read:*

#### **8.4.4.4 Allocation of subchannels for FCH and DL-MAP, and logical subchannel numbering**

*Change the first paragraph of 8.4.4.4 as indicated:*

In PUSC, any segment used shall be allocated at least ~~12 subchannels~~ the same number of subchannels as in subchannel group #0. For FFT sizes other than 128, ~~the first 4 slots in the downlink part of the segment contain the FCH as defined in 8.4.4.2. These slots contain 48 bits modulated by QPSK with coding rate 1/2 and repetition coding of 4. For FFT-128, the first slot in the downlink part of the segment is dedicated to FCH and repetition is not applied.~~ The basic allocated subchannel sets for Segments 0, 1, and 2 are Subchannel Group #0, #2, #4 ~~Subchannel Group #0, #2, #4~~ respectively. Figure 220 depicts this structure.

*Change the paragraph below Figure 220 as indicated:*

After decoding the DL\_Frame\_Prefix message within the FCH, the SS has the knowledge of how many and which subchannels are allocated to the PUSC segment. In order to observe the allocation of the subchannels in the downlink as a contiguous allocation block, the subchannels shall be renumbered. The renumbering, for the first PUSC zone, shall start from the FCH subchannels (renumbered to values 0...11), then continue numbering the subchannels in a cyclic manner to the last allocated subchannel and from the first allocated subchannel to the FCH subchannels. Figure 221 gives an example of such renumbering for segment 1. For other PUSC zones, in which use all SC indicator is set to '1' or which are defined by AAS\_DL\_IE(), renumbering shall be performed starting from subchannel  $(N_{subchannels}/3)*PRBS\_ID$ , where PRBS\_ID is specified in the STC\_DL\_Zone\_IE or AAS\_DL\_IE(). For other PUSC zones, in which use all SC indicator is set to '0', the renumbering shall be the same as in the first PUSC zone.

For uplink, in order to observe the allocation of the subchannels as a contiguous allocation block, the subchannels shall be renumbered, the renumbering shall start from the lowest numbered allocated subchannel (renumbered to value 0), up to the highest numbered allocated subchannel, skipping non-allocated subchannels. Figure 222 gives an example of such renumbering for segment 1.

*Insert the following text at the end of the subclause:*

The DL-MAP of each segment shall be mapped to the slots allocated to the segment in a frequency first order, starting from the slot after the FCH (subchannel 4 in the first symbol, after renumbering), and continuing to the next symbols if necessary. The FCH of segments that have no subchannels allocated (unused segments) will not be transmitted, and the respective slots may be used for transmission of MAP/data of other segments.

#### **8.4.4.5 Uplink transmission allocations**

*Change 8.4.4.5 as follows:*

The allocation for a user uplink transmission is a number of subchannels over a number of OFDMA symbols. ~~The number of symbols shall be equal to  $3*N$ , where  $N$  is a positive integer. The basic allocation structure is a slot, as defined in 8.4.3.1.~~

~~The basic allocation structure is one subchannel for a duration of 3 times the OFDMA symbol duration  $T_s$ ,  $(N-1)$ . Larger allocation are repetitions of the basic structure  $(N-k)$ , for a positive integer  $k$ .~~

The framing structure used for the uplink includes an allocation for ranging and an allocation for data transmission. The MAC layer sets the length of the uplink framing and the uplink mapping.

***Insert the following text at the end of the subclause:***

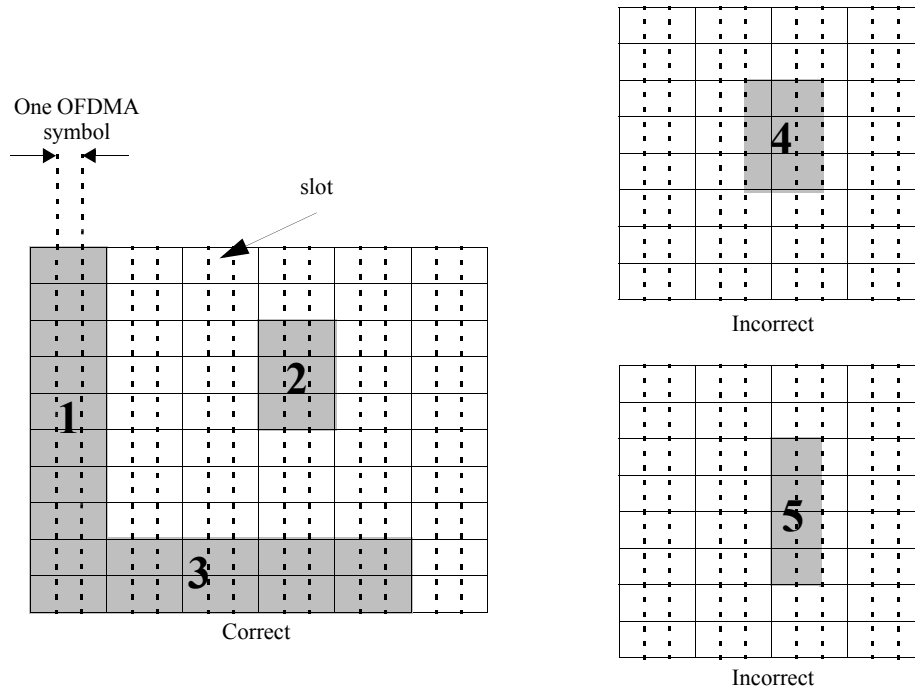
In the uplink, the BS shall not allocate to any SS more than one UL-MAP\_IE with data burst profile UIUC (1-10) in a single frame. In the uplink, the BS shall not allocate to any MS more than one Mini-subchannel allocation in a single frame. These limitations do not apply to HARQ data allocation regions.

The BS shall not allocate more than three ranging allocation IEs (UIUC 12) per frame, one for initial ranging/handover ranging (Dedicated ranging indicator bit in UL-MAP IE is set to 0 and Ranging Method is set to 0b00 or 0b01), one for bandwidth request/periodic ranging (Dedicated ranging indicator bit in UL-MAP IE is set to 0 and Ranging Method is set to 0b10 or 0b11), and one for initial ranging for the paged MS and/or coordinated association (Dedicated ranging indicator bit in UL-MAP IE is set to 1).

Rectangular allocations made with UIUC = 0,12,13 shall not break the UL tile structure, shall not span over multiple zones and conform to the following rules:

- 1) In each subchannel, the size of each continuous group of OFDMA symbols remaining after allocation of UIUC = 0,12,13 regions shall be a multiple of 3 OFDMA symbols.
- 2) The slot boundaries in all subchannels shall be aligned, i.e., if a slot starts in symbol  $k + 1$ ,  $k + 2$  at any other subchannel.
- 3) The number of UL symbols (excluding AAS preambles) per zone shall be an integer multiple of slot duration. Data symbols shall always start on a slot boundary.

Figure 222a depicts examples of correct and incorrect allocations of regions with UIUC = 0,12,13. Each rectangle is an UL-subframe (or zone). Regions 1,2,3 are correct allocations, while 4 and 5 are incorrect allocations.



**Figure 222a—Example of rectangular allocation rules**

*Change the title of subclause 8.4.4.6 as indicated:*

#### **8.4.4.6 Optional Diversity-Map ~~Scan~~AAS support**

##### **8.4.4.6.1 AAS frame structure**

*Change the subclause as indicated:*

An AAS DL Zone begins on the specified symbol boundary and consists of all subchannels until the start of the next Zone or end of frame. The two highest numbered subchannels of the DL frame may be dedicated at the discretion of the BS for the AAS Diversity-Map Zone in PUSC, FUSC, and optional FUSC permutation.

The AAS Diversity-Map Zone shall only be used with FFT sizes greater than or equal to 512.

In the AMC permutation, the fourth and (N-4)th subchannels of the total N subchannels first and last subchannels of the DL frame AAS DL Zone may be dedicated at the discretion of the BS for the AAS Diversity-Map Zone. For AMC permutation, each subchannel for the AAS diversity MAP consists of 3 bins by 2 symbols. When these subchannels are used for this purpose a Diversity-Map zone, they shall not be allocated in the normal DL-MAP message and shall be used only on the AAS portion of the DL subframe. These subchannels will be used to transmit the AAS-DLFP() whose physical construction is shown in Figure 223. In the case that the AAS Diversity-Map zone is not included in the AAS zone, these subchannels may be used for ordinary traffic and may be allocated in DL MAP messages.

A 2 bin by 3 symbol tile structure shall be used for all AMC permutations in an AAS zone, including the optional AAS Diversity-Map zone.

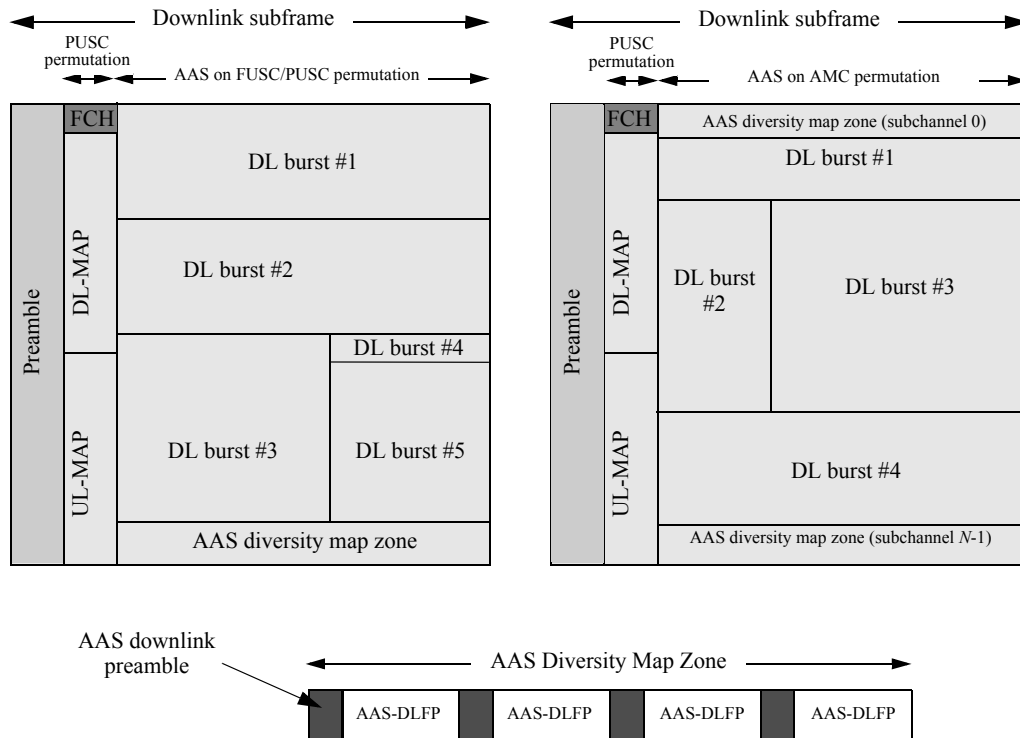
In the AAS zone, the same antenna beam pattern shall be used for all pilot subcarriers and data subcarriers in a given AMC subchannel.

In an AAS zone defined with the PUSC permutation, the SS may assume that the entire major group is beamformed such that the channel may vary slowly within the major group over the entire duration of the zone.

*Change the caption of Figure 223 as indicated:*

Example of allocation for ~~AAS\_DL\_Scan~~ AAS-DLFP

*Replace Figure 224 with the following figure:*



**Figure 224—AAS Diversity Map Frame Structure**

*Change the title of subclause 8.4.4.6.2 as indicated:*

**8.4.4.6.2 AAS-DLFP Format Optional Diversity-Map scan**

*Change the subclause as indicated:*

The purpose of the AAS-DLFP is to provide a robust transmission of the required base station parameters to enable SS initial ranging, as well as SS paging and access allocation. This is achieved through using a highly robust form of modulation and coding (namely QPSK-1/2 rate with 2 repetitions). The start of an AAS-DLFP is marked by an AAS DL preamble. The AAS-DLFPs transmitted within the AAS Diversity Map Zone may, but need not carry the same information. Different beams may be used within the AAS Diversity Map Zone; however, each AAS Downlink Preamble and associated AAS-DLFP must be transmitted on the same beam.

The UL and DL AAS Zones are defined by the uplink and downlink extended AAS-IE in the broadcast map. In the case that an SS cannot successfully decode the broadcast maps, the SS will scan for the DLFP messages and utilize private maps within the AAS zone. It is assumed that all AAS subscribers will be able to determine the IDcell used in the selection of the DL preamble at the beginning of the DL frame. This IDcell shall be used as the DL\_PermBase for the AAS zone. The UL\_PermBase for the UL zone referred to by the initial ranging allocation in the AAS-DLFP shall be that provided in the UCD message. For AAS subscribers that cannot detect the AAS\_DL\_IE transmitted in the DL-MAP, which specifies the boundaries and permutation of AAS DL zones, they must search over the possible permutations (PUSC/FUSC/AMC) and

starting symbol to detect the AAS-DLFP. The permutation for the AAS UL Zone is specified by a field in the AAS-DLFP.

The AAS-DLFP supports the ability to transmit a ~~MAP IE that carries a~~ compressed DL-MAP IE. This allocation message can point to a broadcast DL-MAP that is beamformed or can be used to “page” a specific SS that cannot receive the normal DL-MAP. Once the initial allocations are provided to the user, private DL-MAPs and UL-MAPs can be sent on a beamformed transmission to the user at the highest modulation and ~~lowest~~highest coding rate that can be supported by the link. The AAS-DLFP also has an uplink initial ranging allocation for AAS subscribers. The AAS-DLFP is not randomized.

The preamble length specified by the Downlink\_preamble\_config field should be limited to an integer number of slot durations for the DL PUSC permutation. Further, this field determines the preamble duration for the allocation pointed to by the DL Comp IE in the AAS-DLFP, and must be consistent with the preamble lengths described in the AAS\_DL\_IE messages.

The contents of the AAS-DLFP() payload is described by Table 269.

**Table 269—AAS-DLFP Structure, Diversity-Map Scan**

Syntax	Size	Notes
AAS-DLFP() {		
<b>AAS beam index</b>	64 bits	This index is the index referred to by the AAS_Beam_Select message (see 6.3.2.3.41).  <u>This field also defines the preamble frequency/time shift. For frequency shifted preambles, this value is used for the value of <math>K</math> in Equation (103). For time shifted preambles, the value of <math>K</math> in Equation (102) is given by:</u> <u>For PUSC,</u> $K = [AAS\_beam\_index \pmod{14}] * N_{FH} / 14$ <u>For AMC,</u> $K = [AAS\_beam\_index \pmod{9}] * N_{FH} / 9$
<b>Preamble select</b>	1 bit	0 – Frequency shifted Preamble 1 – Time shifted Preamble
<b>Uplink_Preamble_Config</b>	2 bits	0b00 – 0 symbols 0b01 – 1 symbols 0b10 – 2 symbols 0b11 – 3 symbols
<b>Downlink_Preamble_Config</b>	2 bits	0b00 – 0 symbols 0b01 – 1 symbols 0b10 – 2 symbols 0b11 – 3 symbols
<b><u>AAS_UL_Zone_Permutation</u></b>	<u>2 bits</u>	<u>This field describes the permutation used by the allocation pointed to by the AAS_ranging_allocation_IE.</u> <u>0b00 = PUSC permutation</u> <u>0b01 = Optional PUSC permutation</u> <u>0b10 = adjacent-subcarrier permutation</u> <u>0b11 = Reserved</u>
<del>Initial</del> AAS_Ranging_Allocation_IE(){		

**Table 269—AAS-DLFP Structure, Diversity-Map Scan (continued)**

Syntax	Size	Notes
<b>OFDMA Symbol Offset</b>	8 bits	<u>The offset to the starting location of the ranging allocation is referenced to the DL preamble of the subsequent frame, and consists of an integer symbol offset specified here, as well as the addition of the TTG known from DCD messages. If TTG is not present in the DCD (for FDD) it is assumed to be zero.</u>
<b>Subchannel offset</b>	<del>67</del> bits	
<b>No of OFDMA Symbols</b>	<del>74</del> bits	
<b>No of Subchannels</b>	<del>64</del> bits	
<b>Ranging Method</b>	2 bits	0b00 – Initial Ranging over two symbols 0b01 – Initial Ranging over four symbols 0b10 – BW Request/Periodic Ranging over one symbol 0b11 – BW Request/Periodic Ranging over three symbols
}		
<b>AAS_Comp_DL_IE()</b>	<del>502</del> bits	
<b>HCS</b>	8 bits	
}		

**Table 270—Structure of AAS\_COMP\_DL\_IE ()**

Syntax	Size	Notes
AAS_COMP_DL_IE()		
<b>CID</b>	16 bits	
<b>DIUC</b>	4 bits	Set DIUC =15 to indicate the well known modulation of QPSK, encoded with the mandatory CC at rate 1/2
<b>OFDMA Symbol Offset</b>	8 bits	<u>Referenced to the DL frame start preamble of the next frame.</u>
<b>Subchannel offset</b>	<del>68</del> bits	
<b>No of OFDMA Symbols</b>	7 bits	
<b>No of Subchannels</b>	6 bits	
<del><b>Boosting</b></del>	<del>3</del> bits	
<b><u>Repetition Coding Indication</u></b>	<u>2</u> bits	<u>As specified in 8.4.5.3</u>
<i><u>Reserved</u></i>	<u>1</u> bit	<u>Shall be set to zero</u>
}		



*Insert a new subclause 8.4.4.6.3 and renumber all subsequent subclauses accordingly:*

#### **8.4.4.6.3 AAS Diversity-Scan Map network entry procedure**

The AAS network entry utilizing the DLFP involves the following procedure:

- The AAS-SS synchronizes frame timing and frequency to the frame-start DL preamble.
- For AAS-SS at cell edge, which cannot decode the FCH or broadcast DL-MAP and UL-MAP messages, they will search for the AAS-DLFP on the AAS Diversity Map Zone. This search will need to span the possible subchannel permutations.
- The AAS-SS may receive necessary messages such as the DCD and UCD pointed to by allocations made from the AAS-DLFP using the broadcast CID. These messages may be transmitted using beam-pattern diversity to increase the link budget.
- Once the AAS-SS decodes the DCD and UCD it should perform initial ranging on the interval pointed to by the best-received AAS-DLFP.
- The AAS-SS may receive a ranging response message through a DL-MAP allocation pointed to by an AAS-DLFP with the broadcast CID.
- The AAS-SS may receive initial downlink allocations through a DL-MAP allocation pointed to by the AAS-DLFP with either broadcast CID or specific CID.
- Subsequent allocations can be managed with private DL-MAP and UL-MAP allocations.

*Replace subclauses 8.4.4.6.3 and 8.4.4.6.4 with the following subclauses and renumber them from 8.4.4.6.4:*

#### **8.4.4.6.4 AAS preambles**

AAS preambles are used to provide training information in both UL and DL AAS zones. All data allocations (UIUC 1-10, DIUC 0-12) and the optional AAS DLFP in an AAS zone are preceded by an AAS preamble.

UL and DL allocations are made exclusive of the AAS preamble. In the DL, a 2D allocation burst is preceded by the appropriate DL AAS preamble. In the UL, a 1D allocation is preceded by the appropriate AAS preamble. The absolute slot offset for the UL AAS allocation indicates the first data slot, which is preceded by the appropriate AAS preamble. If an UL allocation wraps at the end of the AAS zone, the data allocation does not include the symbols required for the initial AAS zone preambles.

In case the UL AAS zone length is equal to the number of symbols assigned to the AAS preamble, then no data slots are transmitted in the zone. In this case, the ‘slot offset’ field in the UL\_MAP\_IE shall be interpreted as the logical subchannel from which to start transmitting preambles. The ‘duration’ field in the UL\_MAP\_IE shall be interpreted as the number of subchannels on which to send the preamble.

The optional AAS -DLFP is preceded by an AAS downlink preamble of one symbol duration. All other DL bursts with DIUC 0-12 within an AAS DL zone have a preamble whose duration is specified by the “Downlink\_preamble\_config” fields of the AAS\_DL\_IE. This field shall be consistent with the same field of the AAS\_DLFP if present. In the case the AAS DL Zone is using the PUSC permutation, the “Downlink\_preamble\_config” shall always be set to an integer number of slot durations (i.e., 0 or 2 symbols).

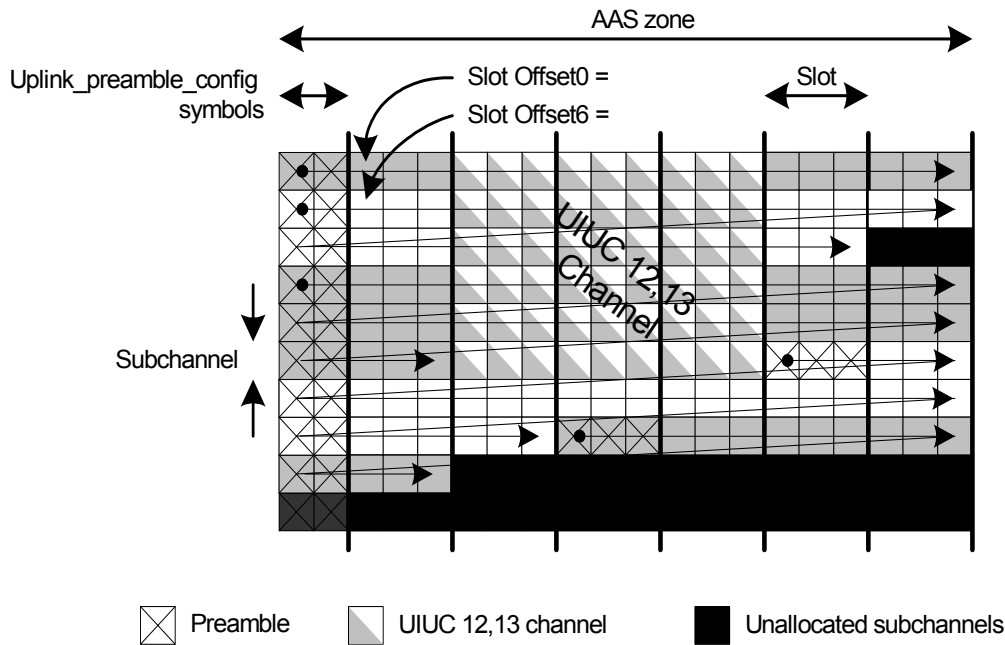
An UL preamble is inserted at the start of an UL data allocation with UIUC 1–10 and whenever such an UL allocation wraps from the end of an AAS zone to the beginning. The first Uplink\_preamble\_config symbols of the UL AAS zone are reserved for UL AAS preambles. On a given subchannel, an UL AAS preamble will be inserted into these symbols by the SS devices who is allocated the slot following the preamble (or following a UIUC 0,12,13 region if it directly follows the preamble). Any UL preamble inserted in an AAS zone in a location other than the first Uplink\_preamble\_config symbols shall be 3 symbols in duration.

The absolute slot offset field in the UL map IE corresponds to the first data slot of an allocation, which is preceded by the appropriate number of symbols for the UL AAS preamble. The absolute slot offset will count from the first subchannel slot, counting all slots in an AAS zone including any UIUC 0,12,13 regions. The slot offset will not include the first “Uplink\_preamble\_config” preamble symbols at the start of the AAS zone.

The duration of an UL AAS zone minus the reserved uplink preamble symbols and any UIUC 0,12,13 allocations shall be an integer number of slots. To insure that UL tile structures are not broken due to an allocation wrapping, the following restrictions hold:

- When used in an AAS zone, a UIUC 0,12,13 region shall be a multiple of three symbols in duration.
- An UL AAS Zone shall consist of an integer number of slots plus the number of UL AAS preamble symbols as defined in by the “Uplink\_preamble\_config” field of the UL\_AAS\_IE and AAS\_DLFP.
- UL AAS Zone Duration =  $N*3 + \text{Uplink\_preamble\_config}$  symbols.
- Fast-feedback channels shall be allocated an integer number of slots.

Figure 224a shows a legal UL AAS zone with an UIUC 12,13 allocation that is an integer number of slots in duration.



**Figure 224a—Example of UL AAS allocation with integer number of slots in duration**

The structure of the preambles is as specified in 8.4.4.6.4.1 and 8.4.4.6.4.2 for the downlink and uplink, respectively. The preamble may be either time or frequency shifted according to a preamble shift index as defined in 8.4.5.3.11 and 8.4.5.4.14. The preamble shift index shall be set by the PHY\_MOD\_DL\_IE and PHY\_MOD\_UL\_IE, for downlink and uplink, respectively. The preamble shift index shall also be set by the AAS beam index carried by the AAS -DLFP(), in which case it shall apply to all subsequent downlink allocations until a PHY\_MOD\_DL\_IE is received. The BS shall ensure that all shift index specifications for an allocation (in private maps, AAS -DLFP, broadcast maps, etc.) are consistent. When using the cyclic time / frequency shifted preamble defined in 8.4.5.3.11 and 8.4.5.4.14, beams that use the same subchannels at the same time instance shall be configured to use a different preamble shift index.

**8.4.4.6.4.1 AAS Downlink Preamble**

A basic AAS downlink preamble is formed by concatenating the sequences from the three carrier sets defined in 8.4.6.1.1. Let the PN sequence for the  $m$ -th preamble carrier set ( $m = 0,1,2$ ) defined in 8.4.6.1.1 have length  $N$  bits. The  $k$ -th bit of the basic AAS preamble sequence  $P$  is given by:

$$P_k = W_n(m \bmod 3) \quad (100a)$$

where

$$m = \left\lfloor \frac{k}{N} \right\rfloor \bmod 3,$$

$$n = k \bmod N,$$

$W_n(m)$  is the  $n$ -th bit of the PN sequence for the  $m$ -th preamble carrier-set defined in 8.4.6.1.1.

The preamble sequence will correspond to a IDcell equal to  $(ID_c + 16) \bmod 32$  (where  $ID_c$  is the IDcell determined from the DL preamble). The bits  $P_k$  shall be mapped to values consistent with the specification in 8.4.6.1.1 (0 mapped to +1, 1 mapped to -1).

The AAS preamble sequence length is  $N_{used}$  bits and it shall be mapped starting from the first usable subcarrier, according to the permutation. The DC carrier shall not be modulated and the corresponding bit in the constructed preamble sequence shall be discarded.

The AAS preamble used for the burst shall be a subset of this basic preamble sequence corresponding to the subcarriers used by the burst's subchannels. In the AMC allocation, the basic AAS preamble occupies nine subcarriers in each bin of the subchannels. The number of symbols occupied by the preamble is set by the 'Downlink preamble\_config' field in the AAS\_DL\_IE(). The AAS preamble is formed by copying the basic preamble onto the consecutive preamble symbols. The AAS preamble shall be placed, for each subchannel, starting from the first OFDMA symbol for that subchannel that belongs to the burst.

Downlink pilot locations are shifted forward with the burst allocation in time in the AMC zone with the following rules: pilot index =  $9k + 3m + 1$  where  $k$  is a bin index and  $m = \text{symbol index} \bmod 3$ . The symbol index starts at zero for each AAS zone and corresponds to the first symbol in the AAS zone (if AAS preamble is not present) or the first symbol following the AAS preamble (if AAS preamble is present).

**8.4.4.6.4.2 AAS uplink preamble**

The basic AAS uplink preamble is formed by the method defined in 8.4.4.6.4.1 using the IDcell (as determined from the preamble). This subset shall correspond to the subcarriers used by the burst's subchannels. In the AMC allocation, the basic AAS preamble occupies nine subcarriers in each bin of the subchannels. The number of symbols occupied by the preamble is set by the 'Uplink preamble\_config' field in the AAS\_UL\_IE(). The AAS preamble is formed by copying the basic preamble onto the consecutive preamble symbols. The AAS preamble shall be placed, for each subchannel, starting from the first OFDMA symbol for that subchannel that belongs to the burst.

Any UL allocation that wraps from the last OFDMA symbol of the AAS zone to the first OFDMA symbol shall have a preamble inserted in the first  $N$  OFDMA symbols of the AAS zone, where  $N$  is the number of AAS preamble symbols for the burst defined by the Uplink\_Preamble\_Config field of either the AAS\_UL\_IE or the AAS\_DLFP.

The transmit power level of uplink AAS preamble is equal to that of data subcarrier determined by Equation (135) in 8.4.10.3 when the required (C/N) value of the current transmission, excluding code repetition factor, is between the predefined lower bound and the predetermined upper bound. Otherwise, the transmit power

level of uplink AAS preamble is boosted or reduced. The predefined  $LowerBound_{AAS\_PREAMBLE}$  and  $UpperBound_{AAS\_PREAMBLE}$  are broadcast in the UCD TLV. Thus, transmit power level of AAS preamble can be determined as follows:

$$\left( \begin{array}{l} P_{AAS\_PREAMBLE} = P_{Data} - (C/N) + 10 \cdot \log 10(R) + LowerBound_{AAS\_PREAMBLE}, \\ \quad \text{if } (C/N) - 10 \cdot \log 10(R) < LowerBound_{AAS\_PREAMBLE} \\ P_{AAS\_PREAMBLE} = P_{Data} - (C/N) + 10 \cdot \log 10(R) + UpperBound_{AAS\_PREAMBLE}, \\ \quad \text{if } (C/N) - 10 \cdot \log 10(R) \geq UpperBound_{AAS\_PREAMBLE} \\ P_{AAS\_PREAMBLE} = P_{Data}, \\ \quad \text{elsewhere} \end{array} \right. \quad (100b)$$

where

**PData**

Tx power level (dBm) per subcarrier for current data transmission determined by Equation (135) in 8.4.10.3.

**(C/N)**

Required normalized C/N of the modulation/FEC rate for the current transmission in Table 332.

**R**

Number of repetitions for the modulation/FEC rate.

When SS does not have enough power to boost up AAS preamble, the power of AAS preamble is set equal to data symbol power. The power control of the uplink AAS preamble is normally disabled by setting the initial values of  $LowerBound_{AAS\_PREAMBLE}$  and  $UpperBound_{AAS\_PREAMBLE}$  equal to  $-32$  dB,  $31.75$  dB, respectively. The SS that does not support preamble power control set the AAS preamble power equal to that of data symbols.

**8.4.4.7 Optional Direct Signaling Method**

*Delete 8.4.4.7 and all of its subclauses.*

**8.4.5 Map message fields and IEs**

**8.4.5.3 DL-MAP IE format**

*Change Table 275 as indicated:*

**Table 275—OFDMA DL-MAP\_IE format**

Syntax	Size	Notes
DL_MAP_IE() {	—	—
DIUC	4 bits	—
if (DIUC == 14) {	—	—
<b>Extended-2 DIUC dependent IE</b>	—	—
} Else if (DIUC == 15) {	—	—
<b>Extended DIUC dependent IE</b>	variable	See subclauses following 8.4.5.3.1.
} else {	—	—

Table 275—OFDMA DL-MAP\_IE format (continued)

Syntax	Size	Notes
if (INC_CID == 1) {	—	The DL-MAP starts with INC_CID = 0. INC_CID is toggled between 0 and 1 by the CID-SWITCH_IE() (8.4.5.3.7)
<b>N_CID</b>	8 bits	Number of CIDs assigned for this IE
for ( $n=0$ ; $n < N\_CID$ ; $n++$ ) {	—	—
<u>If ( included in SUB-DL-UL-MAP) {</u>	—	—
<b><u>RCID_IE()</u></b>	—	<u>For SUB-DL-UL-MAP, reduced CID format is used</u>
} else {	—	—
<b>CID</b>	16 bits	—
}	—	—
}	—	—
<b>OFDMA Symbol offset</b>	8 bits	—
<u>if (Permutation = 0b11 and (AMC type is 2x3 or 1x6)) {</u>	—	—
<b><u>Subchannel offset</u></b>	<u>8 bits</u>	—
<b><u>Boosting</u></b>	<u>3 bits</u>	<u>000: normal (not boosted); 001: +6dB; 010: -6dB; 011: +9dB; 100: +3dB; 101: -3dB; 110: -9dB; 111: -12dB;</u>
<b><u>No. OFDMA triple symbol</u></b>	<u>5 bits</u>	<u>Number of OFDMA symbols is given in multiples of 3 symbols</u>
<b><u>No. Subchannels</u></b>	<u>6 bits</u>	—
} else {	—	—
<b>Subchannel offset</b>	6 bits	—
<b>Boosting</b>	3 bits	000: normal (not boosted); 001: +6dB; 010: -6dB; 011: +9dB; 100: +3dB; 101: -3dB; 110: -9dB; 111: -12dB;
<b>No. OFDMA Symbols</b>	7 bits	—
<b>No. Subchannels</b>	6 bits	—
}	—	—
<b>Repetition Coding Indication</b>	2 bits	0b00 – No repetition coding 0b01 – Repetition coding of 2 used 0b10 – Repetition coding of 4 used 0b11 – Repetition coding of 6 used
}	—	—
}	—	—

**Change the following text in 8.4.5.3**

**OFDMA Symbol offset**

The offset of the OFDMA symbol in which the burst starts, measured in OFDMA symbols from ~~beginning of the downlink frame~~ symbol in which the DL-MAP preamble is transmitted with the symbol immediately following the preamble being offset 1. The symbol offset shall follow the normal slot allocation within a zone so that difference between OFDMA Symbol offsets for all bursts within a zone is a multiple of the slot length in symbols.

**Boosting**

Power boost applied to the allocation's data subcarriers. Indication whether the subcarriers for this allocation are power boosted. The field shall be zero in AAS zone with AMC permutation, or in a zone with AMC or PUSC-ASCA permutation using 'Dedicated Pilots'.

**Repetition coding Indication**

Indicates the repetition code used inside the allocated burst. Repetition shall be used only for DIUC indicating QPSK modulation.

**No. OFDMA Symbols**

The number of OFDMA symbols that are used (fully or partially) to carry the downlink PHY Burst. The value of the field shall be a multiple of the slot length in symbols.

**Insert the following sentence at the end of the subclause:**

The subchannels offsets referred to in all formats of DL-MAP\_IE are logical subchannels, before subchannel renumbering in the downlink.

**8.4.5.3.1 DIUC allocation**

**Change Table 276 as indicated:**

**Table 276—OFDMA DIUC values**

DIUC	Usage
0–12	Different burst profiles
13	Gap/PAPR reduction
14	<del>End of map</del> <u>Extended-2 DIUC IE</u>
15	Extended DIUC

**Insert the following sentence at the end of the subclause:**

The SS shall ignore the received signal in the GAP/PAPR reduction region.

**8.4.5.3.2 DL-MAP extended IE format**

*Insert new subclause 8.4.5.3.2.1:*

**8.4.5.3.2.1 DL-MAP extended IE format**

Table 277a defines the encoding for Extended DIUC that shall be used by DL-MAP Extended IEs.

**Table 277a—Extended DIUC Code Assignment for DIUC=15**

Extended DIUC (hexadecimal)	Usage
00	Channel_Measurement_IE
01	STC_Zone_IE
02	AAS_DL_IE
03	Data_location_in_another_BS_IE
04	CID_Switch_IE
05	MIMO_DL_Basic_IE
06	MIMO_DL_Enhanced_IE
07	HARQ_Map_Pointer_IE
08	PHYMOD_DL_IE
09-0A	<i>Reserved</i>
0B	DL PUSC Burst Allocation in Other Segment
0C-0E	<i>Reserved</i>
0F	UL_interference_and_noise_level_IE

*Insert new subclause 8.4.5.3.2.2:*

**8.4.5.3.2.2 DL-MAP extended-2 IE format**

A DL-MAP IE entry with a DIUC value of 14, indicates that the IE carries special information and conforms to the structure shown in Table 277b. A station shall ignore an extended-2 IE entry with an extended-2 DIUC value for which the station has no knowledge. In the case of a known extended-2 DIUC value but with a length field longer than expected, the station shall process information up to the known length and ignore the remainder of the IE.

**Table 277b—OFDMA DL-MAP extended-2 IE format**

Syntax	Size	Notes
DL_extended-2_IE {	—	—
<b>Extended-2 DIUC</b>	4 bits	0x00 ... 0x0F
<b>Length</b>	8 bits	Length in bytes of Unspecified data field
<b>Unspecified data</b>	<i>variable</i>	—
}	—	—

Table 277c defines the encoding for Extended-2 DIUC that shall be used by DL-MAP extended-2 IEs.

**Table 277c—Extended-2 DIUC code assignment for DIUC=14**

Extended-2 DIUC (hexadecimal)	Usage
00	MBS_MAP_IE
01	HO_Anchor_Active_DL_MAP_IE
02	HO_Active_Anchor_DL_MAP_IE
03	HO_CID_Translation_MAP_IE
04	MIMO_in_another_BS_IE
05	Macro-MIMO_DL_Basic_IE
06	Skip_IE
07	HARQ DL MAP IE
08	HARQ ACK IE
09	Enhanced DL MAP IE
0A	Closed-loop MIMO DL Enhanced IE
0B-0D	<i>Reserved</i>
0E	AAS_SDMA_DL_IE
0F	<i>Reserved</i>

*Change the title of subclause 8.4.5.3.3 as indicated:*

**8.4.5.3.3 AAS downlink IE format**

*Change the subclause as indicated:*

Within a frame, the switch from non-AAS to AAS-enabled traffic is marked by using the extended DIUC = 15 with the AAS\_DL\_IE() to indicate that the subsequent allocations, until the start of the first UL MAP allocation using TDD, and until the end of the frame using FDD shall be for AAS traffic. The AAS\_DL\_IE defines a DL AAS Zone that spans continuous OFDMA symbols until terminated by a Zone Switch IE, another AAS\_DL\_IE or the end of the DL frame. Multiple AAS zones can exist within the same frame. For the HARQ MAP, the last AAS\_IE is relevant until the beginning of the broadcast region if defined in HARQ format configuration IE. When used, the CID in the DL-MAP\_IE() shall be set to the broadcast CID. All DL bursts in the AAS portion of the frame may be preceded by an AAS\_preamble based on the indication “Downlink\_preamble\_config” field in the AAS\_DL\_IE(). The preamble is defined in 8.4.4.6.4.1. The preamble is defined in 8.4.6.1.1, and shall be selected to have the same segment number as the DL frame preamble, and the cell ID shall equal to  $(DL\_Preamble\_ID_{cell} + 16) \bmod 32$ . The preamble shall exist only on those subchannels used by the DL burst.



**Table 278—OFDMA ~~downlink~~ AAS downlink IE**

Syntax	Size	Notes
AAS_DL_IE() {		
<b>Extended DIUC</b>	4 bits	AAS = 0x02
<b>Length</b>	4 bits	Length = 0x03
<b><u>OFDMA symbol offset</u></b>	<u>8 bits</u>	<u>Denotes the start of the zone (counting from the frame preamble and starting from 0)</u>
<b>Permutation</b>	<u>23 bits</u>	0b000 = PUSC permutation 0b001 = FUSC permutation 0b010 = Optional FUSC permutation <del>0b011 = adjacent subcarrier permutation</del> 0b011 = AMC 0b100 = TUSC1 0b101 = TUSC2 <del>0b100-0b111 = Reserved</del> 0b110-0b111 = <i>Reserved</i>
<b><u>DL_PermBase</u></b>	<u>6 bits</u>	
<b><del>Preamble indication</del> <u>Downlink preamble config</u></b>	2 bits	0b00 = No preamble 0b01 = Preamble used <del>0b10-0b11 = Reserved</del> 0b00 - 0 symbols 0b01 - 1 symbols 0b10 - 2 symbols 0b11 - 3 symbols
<b><del>First bin index</del></b>	6 bits	When Permutation=0b10, this indicates the index of the first band allocated to this AMC segment
<b><del>Last bin index</del></b>	6 bits	When Permutation=0b10, this indicates the index of the last band allocated to this AMC segment
<b><u>Preamble type</u></b>	<u>1 bit</u>	0 – Frequency shifted preamble is used in this DL AAS zone. 1 – Time shifted preamble is used in this DL AAS zone
<b><u>PRBS_ID</u></b>	<u>2 bits</u>	Values: 0..2. Refer to 8.4.9.4.1
<b><u>Diversity Map</u></b>	<u>1 bit</u>	0: Not Supported in this AAS zone 1: Supported in this AAS zone
<i>Reserved</i>	<u>1 bit</u>	<u>Shall be set to zero</u>
}		

**Permutation**

Defines the permutation used within the DL AAS Zone.

**DL\_PermBase**

Permutation Base for specified DL AAS Zone.

**OFDMA Symbol offset**

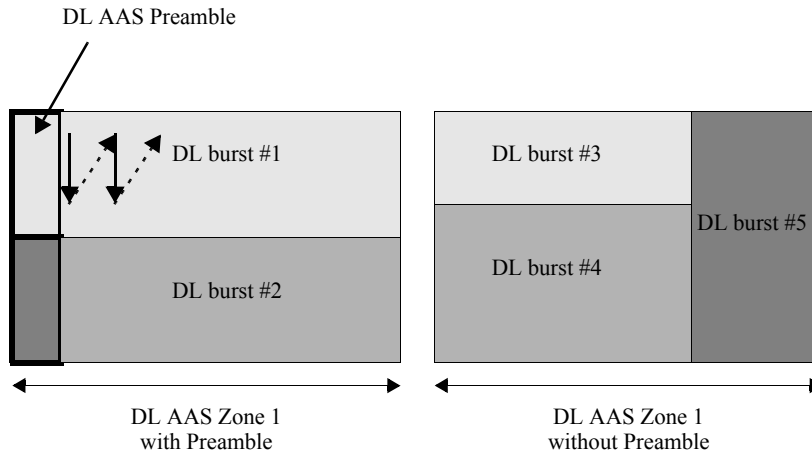
The offset of the OFDMA symbol in which the AAS Zone starts, measured in OFDMA symbols from beginning of the current downlink frame.

**Downlink\_preamble\_config**

Defines the number of DL AAS preambles to be used before each DL burst in the AAS Zone.

Following AAS\_IE indicating AMC permutation the AMC type shall be 2x3 (2 bins by 3 symbols).

*Insert new Figure 229a:*



**Figure 229a—Burst allocations in DL AAS Zone**

*Change the title of subclause 8.4.5.3.4*

**8.4.5.3.4 ~~Transmit diversity (TD)~~Space-Time Coding (STC)/DL\_Zone switch IE format**

*Change 8.4.5.3.4 as indicated:*

In the DL-MAP, a BS may transmit DIUC=15 with the STC\_DL\_ZONE\_IE() to indicate that the subsequent allocations shall use a specific permutation, and/or be STC transmit diversity encoded use a specific transmit diversity mode. The downlink frame shall start in PUSC mode with ~~IE=0 and~~ no transmit diversity. Allocations subsequent to this IE shall use the permutation and transmit diversity mode it instructs, until the next STC\_DL Zone IE or AAS\_DL\_IE. Allocation for a STC capable SS shall be done through either DL\_MAP\_IE() or any one of MIMO related IEs (MIMO\_DL\_Basic\_IE() or MIMO\_DL\_Enhanced\_IE()). If DL\_MAP\_IE() is used, the matrix indicator in STC\_DL\_Zone\_IE() shall be used for the allocation. If any one of MIMO related IEs is used, the matrix indicator in these IEs shall override the matrix indicator in STC\_DL\_Zone\_IE().

Replace Table 279 with the following table:

**Table 279—OFDMA downlink STC\_DL\_ZONE ~~TD\_ZONE~~ IE format**

Syntax	Size	Notes
STC_DL_ZONE_IE() {	—	—
<b>Extended DIUC</b>	4 bits	STC/DL_ZONE_SWITCH = 0x01
<b>Length</b>	4 bits	Length = 0x04
<b>OFDMA symbol offset</b>	8 bits	Denotes the start of the zone (counting from the frame preamble and starting from 0)
<b>Permutation</b>	2 bits	0b00 = PUSC permutation 0b01 = FUSC permutation 0b10 = Optional FUSC permutation 0b11 = Optional adjacent subcarrier permutation
<b>Use All SC indicator</b>	1 bit	0 = Do not use all subchannels 1 = Use all subchannels
<b>STC</b>	2 bits	0b00 = No STC 0b01 = STC using 2/3 antennas 0b10 = STC using 4 antennas 0b11 = FHDC using 2 antennas
<b>Matrix indicator</b>	2 bits	STC matrix (see 8.4.8.1.4) if (STC == 0b01 or STC == 0b10) { 0b00 = Matrix A 0b01 = Matrix B 0b10 = Matrix C 0b11 = <i>Reserved</i> } else if (STC == 0b11) { 0b00 = Matrix A 0b01 = Matrix B 0b10-11 = <i>Reserved</i> }
<b>DL_PermBase</b>	5 bits	—
<b>PRBS_ID</b>	2 bits	Values: 0..2. Refer to 8.4.9.4.1
<b>AMC type</b>	2 bits	Indicates the AMC type in case permutation type = 0b11, otherwise shall be set to 0. AMC type (NxM = N bins by M symbols): 0b00 - 1x6 0b01 - 2x3 0b10 - 3x2 0b11 - <i>Reserved</i> Note that only 2x3 Band AMC subchannel type (AMC Type = 0b01) is supported by MS.
<b>Midamble presence</b>	1 bit	0 = not present 1 = present at the first symbol in STC zone
<b>Midamble boosting</b>	1 bit	0 = no boost 1 = Boosting (3 dB)

**Table 279—OFDMA downlink ~~STC\_DL\_Zone~~~~TD\_ZONE~~ IE format (continued)**

Syntax	Size	Notes
<b>2/3 antennas select</b>	1 bit	0 = STC using 2 antennas 1 = STC using 3 antennas Selects 2/3 antennas when STC = 0b01
<b>Dedicated Pilots</b>	1 bit	0 = Pilot symbols are broadcast 1 = Pilot symbols are dedicated. An MS should use only pilots specific to its burst for channel estimation
<i>Reserved</i>	84 bits	Shall be set to zero
}	—	—

Change the text in subclause 8.4.5.3.4 as indicated:

**~~STC~~Transmit Diversity**

Indicates the ~~STC~~Transmit Diversity mode that shall be used by the transmitter for allocations following this IE (see 8.4.8). All allocations ~~without STC~~Transmit Diversity with STC='0b00' shall be transmitted ~~only from one antenna (antenna 0) with non-STC pilot pattern.~~ All allocations with ~~STC-Transmit Diversity~~ the BS shall transmit from both its antennas ~~not setting to '0b00'~~ shall be transmitted with the corresponding pilot pattern in 8.4.8. The STC mode change is allowed only on a zone boundary.

**Dedicated Pilots**

The optional fields Dedicated Pilots are used to support the use of open loop precoding or closed-loop transmissions in which the MS has no knowledge of the precoding/beamforming matrix. When the data allocations are precoded/beamformed, then setting the Dedicated Pilots bit to 1 means the pilot symbols are precoded/beamformed in the same way as are the corresponding data subcarriers. In this case, an MS should use only the pilots that are specific to its allocation for channel estimations.

For the PUSC permutation, the pilot symbols belonging to a major group must be precoded/beamformed along with all of the data allocations made within the major group. For the FUSC or Optional FUSC permutation, all of the pilot symbols and data subcarriers within an OFDM symbol shall be precoded/beamformed.

For backward compatibility, for the FUSC or Optional FUSC permutation, multiple legacy (revD) SS units must not be allocated in TD Zones in which pilots are dedicated. However, a single legacy SS unit can be allocated to a TD Zone in which the pilots are dedicated as long as no other SS units are also allocated to that TD Zone. For the PUSC permutation, only a single legacy SS can be allocated to one or more major groups and only when the major groups extends across the entire zone.

This IE should not be used within SUB-DL-UL-MAP.

**8.4.5.3.6 Data location in another BS IE**

*Change the text in 8.4.5.3.6 as indicated:*

In the DL-MAP, a BS may transmit DIUC=15 with the Data\_location\_in\_another\_BS\_IE() to indicate that data is transmitted to the SS through another BS. This IE shall be sent right after the IE defining the same data received in the current BS, but it may be sent alone without the IE defining the same data received in the current BS only if the data is to be transmitted in the current frame.

**Table 281—OFDMA Data location in another BS IE**

Syntax	Size	Notes
Data_location_in_another_BS_IE() {		
<b>Extended DIUC</b>	4 bits	Data_location_in_another_BS = 0x3
<b>Length</b>	4 bits	Length = 0x0A9
<i>Reserved</i>	<del>6 bits</del>	<del>Shall be set to zero</del>
<b>Segment</b>	2 bits	Segment number
<b>Used subchannels</b>	6 bits	Used subchannels <u>groups</u> at other BS Bit #0: <del>0-11</del> <u>Subchannel group 0</u> Bit #1: <del>12-19</del> <u>Subchannel group 1</u> Bit #2: <del>20-31</del> <u>Subchannel group 2</u> Bit #3: <del>32-39</del> <u>Subchannel group 3</u> Bit #4: <del>40-51</del> <u>Subchannel group 4</u> Bit #5: <del>52-59</del> <u>Subchannel group 5</u>
<del>Cell</del>	<del>5 bits</del>	<del>Cell ID of other BS</del>
<b>DIUC</b>	4 bits	<u>DIUC used for the burst in the other BS</u>
<b>Frame Advance</b>	3 bits	The number of frames offset from the <del>current</del> <u>next</u> frame where the data will be transmitted (0 = Next frame)
<i>Reserved</i>	<u>1 bit</u>	<u>Shall be set to zero</u>
<b>OFDMA Symbol offset</b>	8 bits	
<b>Subchannel offset</b>	6 bits	
<b>Boosting</b>	3 bits	000: normal (not boosted); 001: +6dB; 010: -6dB; 011: +9dB; 100: +3dB; 101: -3dB; 110: -9dB; 111: -12dB;
<b>Preamble index</b>	7 bits	<u>Preamble index of the other BS</u>
<b>No. OFDM Symbols</b>	8 bits	
<b>No. Subchannels</b>	6 bits	

**Table 281—OFDMA Data location in another BS IE (continued)**

Syntax	Size	Notes
<b>Repetition Coding Indication</b>	2 bits	00 – No repetition coding 01 – Repetition coding of 2 used 10 – Repetition coding of 4 used 11 – Repetition coding of 6 used
<b>CID</b>	<u>16 bits</u>	
}		

**8.4.5.3.7 CID Switch IE**

*Change 8.4.5.3.7 as indicated:*

In the DL-MAP, a BS may transmit DIUC=15 with the CID-Switch\_IE() to toggle the inclusion of the CID parameter in DL-MAP allocations. The DL-MAP and Sub-DL-UL-MAP shall begin in the mode where CIDs are not included. The first appearance of the CID-Switch\_IE() shall toggle the DL-MAP mode to include CIDs. Any subsequent appearance of the CID-Switch\_IE() shall toggle the DL-MAP CID inclusion mode.

**8.4.5.3.8 MIMO DL basic IE format**

*Change the first paragraph of 8.4.5.3.8 as indicated:*

In the DL-MAP, a MIMO-enabled BS may transmit DIUC = 15 with the MIMO\_DL\_Basic\_IE() to indicate the MIMO configuration of the subsequent downlink allocation to a specific MIMO-enabled SS CID describe downlink allocations assigned to MIMO-enabled SSs. The MIMO mode indicated in the MIMO\_DL\_Basic\_IE() shall only apply to the subsequent downlink allocations until the end of frames indicated in the IE. The allowed combinations of number of antennas, matrices, number of encoded streams, and CIDs are listed in Table 283a.

*Change Table 283 as indicated:*

**Table 283—MIMO DL basic IE format**

Syntax	Size	Notes
MIMO_DL_Basic_IE () {		
<b>Extended DIUC</b>	4 bits	MIMO = 0x05
<b>Length</b>	4 bits	Length of the message in bytes (variable)
<b>Num_Region</b>	4 bits	
for ( i = 0; i < Num_Region; i++) {		
<b>OFDMA Symbol offset</b>	<del>408</del> bits	
<u>If (Permutation = 0b11 and (AMC type is 2x3 or 1x6)) {</u>		
<b>Subchannel offset</b>	<u>8 bits</u>	

**Table 283—MIMO DL basic IE format (continued)**

Syntax	Size	Notes
<b>Boosting</b>	<u>3</u> bits	
<b>No. OFDMA Symbols</b>	<u>5</u> bits	
<b>No. subchannels</b>	<u>6</u> bits	
Else {		
<b>Subchannel offset</b>	<u>56</u> bits	
<b>Boosting</b>	3 bits	
<b>No. OFDMA Symbols</b>	<u>97</u> bits	
<b>No. subchannels</b>	<u>56</u> bits	
}		
<b>Matrix_indicator</b>	2 bits	<p>STC matrix (see 8.4.8)                      STC = STC mode indicated in the latest                      STC_DL_Zone_IE().                      if (STC == 0b01)                      †                          00 = Matrix A                          01 = Matrix B                          10-11 = Reserved                      †                      else if (STC == 0b10)                      †                          00 = Matrix A                          01 = Matrix B                          10 = Matrix C                          11 = Reserved                      †                      STC matrix (see 8.4.8.1.4)                      if (STC == 0b01 or STC == 0b10)                      †                          0b00 = Matrix A                          0b01 = Matrix B                          0b10 = Matrix C                          0b11 = Reserved                      †                      else if (STC == 0b11)                      †                          0b00 = Matrix A                          0b01 = Matrix B                          0b10-11 = Reserved                      †</p>
<b>Num_layers</b>	2 bits	
<i>Reserved</i>	<u>1</u> bit	Shall be set to zero
for ( $j = 0; j < \text{Num\_layers}; j++$ ) {		
if (INC_CID == 1) {		
<b>CID</b>	16 bits	
}		
}		

**Table 283—MIMO DL basic IE format (continued)**

Syntax	Size	Notes
<b>Layer_index</b>	2 bits	
<b>DIUC</b>	4 bits	
}		
}		
<i>padding</i>	<i>variable</i>	Number of bits required to align to byte length, shall be set to zero.
}		

*Change the following text below Table 283:*

**Num\_layers**

~~The value of these 2 bits plus one indicate the number of MIMO transmission layers. Number of individually encoded streams allocated in the region. The layer is defined as a separate coding/modulation path.~~

*Insert the following text at the end of the subclause:*

Table 283a defines the modes of operation specified by MIMO\_DL\_Basic IE() and MIMO\_DL\_Enhanced IE(). For each it details: the number of antennas (as indicated by the latest STC\_DL\_ZONE IE()), the type of matrix, the number of encoded streams, (i.e., the number of different CIDs stated in the Num\_layers 'for' loop in Table 283); the implicit type and rate of coding. The cases of either broadcast CID or (INC\_CID == 0), correspond to 'Single CID' rows, but should be decoded by all SSs on a best effort basis. An SS that does not support decoding of multiple overlapping bursts shall attempt to decode the first burst relevant to it, according to the stream ordering.

**Table 283a—DL MIMO operation modes**

Number of transmit antennas	Matrix indicator	Num_layers	Number of different SSs	Encoding type	Rate	Mapping of encoded stream to matrix entries	Remark
2	A	1	1	STTD	1	Encoded stream #0: S1, S2	
2	B	1	1	Vertical encoding	2	Encoded stream #0: S1, S2	
2	B	2	1	Horizontal encoding for a single SS	2	Encoded stream #0: S1 Encoded stream #1: S2	Two overlapping layers
2	B	2	2	Horizontal encoding for two different SSs	2	Encoded stream #0: S1 Encoded stream #1: S2	Two overlapping layers



**Table 283a—DL MIMO operation modes (continued)**

Number of transmit antennas	Matrix indicator	Num_layers	Number of different SSs	Encoding type	Rate	Mapping of encoded stream to matrix entries	Remark
4	A	1	1	STTD	1	Encoded stream #0: S1, S2, S3, S4	
4	B	1	1	Vertical encoding	2	Encoded stream #0: S1, S2, S3, S4	
4	B	2	1	Horizontal encoding for a single SS	2	Encoded stream #0: S1, S2, S5, S7 Encoded stream #1: S3, S4, S6, S8	Two overlapping layers
4	B	2	2	Horizontal encoding for two different SSs	2	Encoded stream #0: S1, S2, S5, S7 Encoded stream #1: S3, S4, S6, S8	Two overlapping layers
4	C	1	1	Vertical encoding	4	Encoded stream #0: S1, S2, S3, S4	
4	C	4	1	Horizontal encoding for a single SS	2	Encoded stream #0: S1 Encoded stream #1: S2 Encoded stream #2: S3 Encoded stream #3: S4	Four overlapping layers
4	C	4	> 1	Horizontal encoding for two or more different SSs	4	Encoded stream #0: S1 Encoded stream #1: S2 Encoded stream #2: S3 Encoded stream #3: S4	Four overlapping layers

**Vertical encoding**

Indicates transmitting a single FEC encoded stream over multiple antennas. The number of encoded streams is always 1.

**Horizontal encoding**

Indicates transmitting multiple separately FEC encoded streams over multiple antennas. The number of encoded streams is more than 1.

**Rate**

The number of QAM symbols signaled per array channel use.

### 8.4.5.3.9 MIMO DL Enhanced IE format

*Change the subclause as indicated:*

In the DL-MAP, a MIMO-enabled BS may transmit DIUC = 15 with the MIMO\_DL\_Enhanced\_IE(), as shown in Table 284, to indicate the MIMO mode of the subsequent downlink allocation to a specific MIMO-enabled SS describe downlink allocations assigned to MIMO-enabled SSs, each identified by the CQICH\_ID previously assigned to the SS. The MIMO mode indicated in the MIMO\_DL\_Enhanced\_IE() shall only apply to the subsequent downlink allocations until the end of frames indicated in the IE. The allowed combinations of number of antennas, matrices, number of encoded streams, and CIDs are listed in Table 283a.

**Table 284—MIMO DL enhanced IE format**

Syntax	Size	Notes
MIMO_DL_Enhanced_IE() {		
<b>Extended DIUC</b>	4 bits	EN_MIMO = 0x06
<b>Length</b>	4 bits	<del>Length of the message in bytes (variable)</del>
<b>Num_Region</b>	4 bits	
for ( <i>i</i> = 0; <i>i</i> < Num_Region; <i>i</i> ++) {		
<b>OFDMA Symbol offset</b>	<del>10</del> 8 bits	
If (Permutation = 0b11 and (AMC type is 2x3 or 1x6)) {		
<b>Subchannel offset</b>	8 bits	
<b>Boosting</b>	3 bits	
<b>No. OFDMA Symbols</b>	5 bits	
<b>No. subchannels</b>	6 bits	
Else {		
<b>Subchannel offset</b>	<del>5</del> 6 bits	
<b>Boosting</b>	3 bits	
<b>No. OFDMA Symbols</b>	<del>9</del> 7 bits	
<b>No. subchannels</b>	<del>5</del> 6 bits	
}		

**Table 284—MIMO DL enhanced IE format (continued)**

Syntax	Size	Notes
<b>Matrix_indicator</b>	2 bits	<p>STC matrix (see 8.4.8)</p> <p>STC = STC mode indicated in the latest STC_DL_Zone_IE().</p> <p>if (STC == 0b01)</p> <p>†</p> <p>00 = Matrix A</p> <p>01 = Matrix B</p> <p>10-11 = Reserved</p> <p>‡</p> <p>else if (STC == 0b10)</p> <p>†</p> <p>00 = Matrix A</p> <p>01 = Matrix B</p> <p>10 = Matrix C</p> <p>11 = Reserved</p> <p>‡</p> <p>STC matrix (see 8.4.8.1.4)</p> <p>if (STC == 0b01 or STC == 0b10)</p> <p>†</p> <p>0b00 = Matrix A</p> <p>0b01 = Matrix B</p> <p>0b10 = Matrix C</p> <p>0b11 = Reserved</p> <p>‡</p> <p>else if (STC == 0b11)</p> <p>†</p> <p>0b00 = Matrix A</p> <p>0b01 = Matrix B</p> <p>0b10-11 = Reserved</p> <p>‡</p>
<b>Num_layers</b>	2 bits	
<i>Reserved</i>	<u>1 bit</u>	<u>Shall be set to zero</u>
for ( $j = 0; j < \text{Num\_layers}; j++$ ) {		
if (INC_CID == 1) {		
<b>CQICH_ID</b>	<i>variable</i>	Index to uniquely identify the CQICH resource assigned to the SS. The size of this field is dependent on system parameter defined in $\text{DUCD}$ (see Table 353).
}		
<b>Layer_index</b>	2 bits	
<b>DIUC</b>	4 bits	
}		
<i>padding</i>	<i>variable</i>	Number of bits required to align to byte length, shall be set to zero.
}		

**Num\_Region**

This field indicates the number of the regions defined by OFDMA\_Symbol\_offset, Subchannel\_offset, Boosting, No.\_OFDMA\_Symbols and No.\_subchannels in this IE.

**Matrix\_indicator**

The values of these two bits indicate the STC matrix (see 8.4.8.1.4).

**CQICH\_ID**

This is the CQICH\_ID assigned to an SS in the CQICH\_Alloc\_IE(). The CQICH\_ID is used to uniquely identify an SS that is assigned a CQICH.

**Num\_layers**

~~The value of these 2 bits plus one indicate the number of MIMO transmission layers. Number of individually encoded streams allocated in the region. The layer is defined as a separate coding/modulation path.~~

**LayerBurst\_index**

This field specifies the ~~layerburst~~ index.

*Change 8.4.5.3.10 as indicated:*

**8.4.5.3.10 H-ARQ HARQ and Sub-MAP Pointer IE**

*Change the first paragraph as indicated:*

This IE shall only be used by a BS supporting ~~H-ARQ~~HARQ, for MSS supporting ~~H-ARQ~~HARQ. There shall be at most 4 HARQ MAP Pointer IE in the DL-MAP.

*Change Table 285 as indicated:*

**Table 285—H-ARQ HARQ MAP and Sub-MAP pointer IE format**

Syntax	Size	Notes
<del>H-ARQ_MAP_Pointer_IE() {</del> <del>HARQ and Sub-MAP_Pointer_IE() {</del>	—	—
<b>Extended DIUC</b>	4 bits	HARQ_P = 0x07
<b>Length</b>	4 bits	<del>Length = 0x02</del>
<del>While (data remains) {</del>	—	—
<b>DIUC</b>	4 bits	Indicates the AMC level of the burst containing an HARQ MAP message.
<b>No. Slots</b>	8 bits	The number of slots allocated for the burst containing an HARQ MAP message.
<i>Reserved</i>	4 bits	<del>Shall be set to zero</del>
<b>Repetition Coding Indication</b>	<u>2 bits</u>	<u>0b00 - No repetition coding</u> <u>0b01 - Repetition coding of 2 used</u> <u>0b10 - Repetition coding of 4 used</u> <u>0b10 - Repetition coding of 6 used</u>
<b>MAP Version</b>	<u>2 bits</u>	<u>0b00 - HARQ MAPv1</u> <u>0b01 - Sub-MAP</u> <u>0b10 - Sub-MAP with CID Mask included</u> <u>0b11 - Reserved</u>
<del>If (MAP Version == 0b10) {</del>	—	—
<b>Idle users</b>	<u>1 bit</u>	<u>Bursts for Idle users included in the Sub MAP</u>
<b>Sleep users</b>	<u>1 bit</u>	<u>Bursts for Sleep users included in the Sub MAP</u>

**Table 285—~~HARQ~~ HARQ MAP and Sub-MAP pointer IE format (continued)**

Syntax	Size	Notes
<b><u>CID Mask Length</u></b>	<u>2 bits</u>	0b00: 12 bits 0b01: 20 bits 0b10: 36 bits 0b11: 52 bits
<b><u>CID mask</u></b>	<u>n bits</u>	<u>n</u> = The number of bits of CID mask is determined by CID Mask Length. When the MAP message pointed by this pointer IE includes any MAP IE for an awake mode MS, the bit index corresponding to ((Basic CID of the MS) MOD n) in this CID mask field shall be set to 1. Otherwise, it may be set to 0.
<u>}</u>	—	—
<u>Reserved</u>	<u>0 or 4 bits</u>	For a byte alignment of IE, Shall be set to zero
<u>}</u>	—	—

Insert the following text to the end of the subclause:

**Repetition coding Indication**

Indicates the repetition code used inside the allocated burst.

**MAP Version**

Indicates the version the HARQ MAP.

**8.4.5.3.11 DL-MAP Physical modifier IE**

Change the first two paragraphs as indicated:

The Physical Modifier Information Element indicates that the subsequent allocations shall utilize a preamble, which is either cyclically delayed in time or cyclically rotated in frequency. This IE applies to operation in AAS mode.

In the case when the preamble is cyclically delayed in time by  $K$  samples, the preamble will contribute a component  $s'(t)$  to the transmitted waveform as defined in Equation (104). This IE applies to operation in AAS mode.

Replace Equation (104) with the following equation:

$$s'(t) = \text{Re} \left\{ e^{2j\pi f_c t} \sum_{m = -(N_{used} - 1)/2}^{(N_{used} - 1)/2} c_m \times e^{2j\pi m \Delta f (t - T_g - K/F_s)} \right\} \quad (104)$$

Change the first sentence of the paragraph below Equation (104) as indicated:

where  $c_{km}$  are the preamble tone values, and  $t$  is the time, elapsed since the beginning of the OFDMA symbol, with  $0 < t < T_s$ .

Replace Equation (105) with the following equation:

$$C_{New,K} = (C_{Original} + 5 \cdot K) \text{ mod } N_{Used} \quad (105)$$

Change the first sentence of the paragraph below Equation (105) as indicated:

Where  $C_{New,K}$  is the new subcarrier index and  $C_{Original}$  is the original subcarrier index, and  $K$  is the frequency shift index indicated in the PHYMOD\_DL\_IE.

Change Table 286 as indicated:

**Table 286—OFDMA DL-MAP Physical Modifier IE format**

Syntax	Size	Notes
PHYMOD_DL_IE() {		
Extended DIUC	4 bits	PHYMOD = 0x08
Length	4 bits	Length = 0x03
Preamble Modifier Type	1 bit	0 – <del>Randomized preamble</del> <u>frequency shifted preamble</u> 1 – <del>Cyclically shifted Preamble</del> <u>time shifted Preamble</u>
if (Preamble Modifier Type == 0) {		
Preamble frequency shift index	4 bits	Indicates the value of $K$ in Equation (105)
} else {		
<del>Time index shift type</del>	<del>1 bit</del>	<del>0 – Rounded down shift</del> <del>1 – Exact shift</del>
if ( <del>Time index shift type == 0</del> ) {		
Preamble Time Shift Index	4 bits	<u>Specifies the cyclic time shift in Equation (104):</u> For PUSC, 0 – 0 sample cyclic shift 1 – $\text{floor}(N_{FFT}/14)$ sample cyclic shift .... 13 – $\text{floor}(N_{FFT}/14*13)$ sample cyclic shift 14-15 – Reserved  For AMC permutation, 0 – 0 sample cyclic shift 1 – $\text{floor}(N_{FFT}/9)$ sample cyclic shift .... 8 – $\text{floor}(N_{FFT}/9*8)$ sample cyclic shift 9-15 – Reserved
} else {		

**Table 286—OFDMA DL-MAP Physical Modifier IE format (continued)**

Syntax	Size	Notes
<del>Preamble Time Shift Index</del>	4 bits	For PUSC, 0—0 sample cyclic shift 1— $\text{floor}(N_{FFT}/14)$ sample cyclic shift ... 13— $\text{floor}(N_{FFT}/14*13)$ sample cyclic shift 14-15—Reserved  For AMC permutation, 0—0 sample cyclic shift 1— $\text{floor}(N_{FFT}/9)$ sample cyclic shift ... 8— $\text{floor}(N_{FFT}/9*8)$ sample cyclic shift 9-15—Reserved
}		
}		
<b>Pilot Pattern Modifier</b>	1 bit	0: Not applied, 1: Applied
<b>Pilot Pattern Index</b>	2 bits	Pilot pattern used for this allocation [see 8.4.6.3.3 (AMC), 8.4.6.1.2.6 (TUSC)]; 0b00—Pilot Pattern #A 0b01—Pilot Pattern #B 0b10—Pilot Pattern #C 0b11—Pilot Pattern #D
<i>Reserved</i>	23 bits	Shall be set to zero
}		

*Insert new subclause 8.4.5.3.12:*

**8.4.5.3.12 Multicast and Broadcast Service MAP IE (MBS\_MAP\_IE)**

In the DL-MAP, a BS may transmit DIUC=14 with the MBS\_MAP\_IE() to indicate when the next data for a multicast and broadcast service flow will be transmitted. The offset value is associated with a CID value, and indicates the frame that the next data will be transmitted in by using the CID value. (See Table 286a.)

**Table 286a—Multicast and Broadcast Service MAP IE**

Syntax	Size	Notes
MBS_MAP_IE() {	—	—
Extended-2 DIUC	4 bits	MBS_MAP_IE() = 0x00
Length	8 bits	—
MBS Zone identifier	7 bits	MBS Zone identifier corresponds to the identifier provided by the BS at connection initiation

**Table 286a—Multicast and Broadcast Service MAP IE (continued)**

Syntax	Size	Notes
<b>Macro diversity enhanced</b>	1 bit	0 = Non Macro-Diversity enhanced zone; 1 = Macro-Diversity enhanced zone
If(Macro diversity enhanced = 1){	—	—
<b>Permutation</b>	2 bits	0b00 = PUSC permutation 0b01 = FUSC permutation 0b10 = Optional FUSC permutation 0b11 = Adjacent subcarrier permutation
<b>DL_PermBase</b>	5 bits	—
<b>PRBS_ID</b>	2 bits	—
<b>OFDMA Symbol Offset</b>	7 bits	The offset of the OFDMA symbol measured in OFDMA symbols from beginning of the downlink frame in which the DL-MAP is transmitted. Counting from the frame preamble and starting from 0
<b>DIUC change indication</b>	1 bit	Used to indicate DIUC change is included
<i>Reserved</i>	3 bits	Shall be set to zero
if (DIUC change indication = 1) {	—	—
<b>Reserved</b>	3 bits	—
<b>Boosting</b>	3 bits	Refer to Table 273
<b>DIUC</b>	4 bits	—
<b>No. Subchannels</b>	6 bits	Indication of burst size of MBS MAP message with the number of subchannels
<b>NO. OFDMA symbols</b>	6 bits	Indication of burst size of MBS MAP message with the number of OFDMA symbols
<b>Repetition Coding Indication</b>	2 bits	0b00—No repetition coding 0b01—Repetition coding of 2 used 0b10—Repetition coding of 4 used 0b11—Repetition coding of 6 used
}	—	—
} else {	—	—
<b>DIUC</b>	4 bits	—
<b>CID</b>	16 bits	CID for Single BS MBS service
<b>OFDMA Symbol Offset</b>	8 bits	The offset of the OFDMA symbol in which the burst starts, measured in OFDMA symbols from beginning of the downlink frame in which the DL-MAP is transmitted.
<b>Subchannel offset</b>	6 bits	The lowest index OFDMA subchannel used for carrying the burst, starting from subchannel 0.
<b>Boosting</b>	3 bits	Refer to Table 273
<b>SLC_3_indication</b>	1 bit	Used to notify sleep mode class 3 is used for single BS MBS service



**Table 286a—Multicast and Broadcast Service MAP IE (continued)**

Syntax	Size	Notes
<b>NO. OFDMA Symbols</b>	6 bits	—
<b>NO. Subchannels</b>	6 bits	—
<b>Repetition Coding Indication</b>	2 bits	0b00—No repetition coding 0b01—Repetition coding of 2 used 0b10—Repetition coding of 4 used 0b11—Repetition coding of 6 used
if (SLC 3_indication = 1) {	—	—
<b>Next MBS_MAP_IE frame offset</b>	8 bits	The Next MBS_MAP_IE frame offset value is lower 8 bits of the frame number in which the BS shall transmit the next MBS_MAP_IE frame.
}	—	—
}	—	—
if !(byte boundary) {	—	—
<b>Padding Nibble</b>	<i>variable</i>	Padding to reach byte boundary
}	—	—
}	—	—

**Next MBS\_MAP\_IE frame offset**

The Next MBS\_MAP\_IE frame offset value is lower 8 bits of the frame number in which the BS shall transmit the next MBS\_MAP\_IE frame.

At the MBS region, MBS MAP message are located from the first subchannel and first OFDMA symbol of MBS region.

*Insert new subclause 8.4.5.3.13:*

**8.4.5.3.13 DL PUSC Burst Allocation in Other Segment IE**

In the DL-MAP, a BS may transmit DIUC=15 with the DL PUSC Burst Allocation in Other Segment IE () to indicate that data is transmitted to the MS in other segment through other BS. (See Table 286b.)

**Table 286b—DL PUSC Burst Allocation in Other Segment IE**

Syntax	Size	Notes
DL PUSC Burst Allocation in Other Segment IE() {	—	—
<b>Extended DIUC</b>	4 bits	DL PUSC Burst Allocation in Other Segment IE () = 0x0B
<b>Length</b>	4 bits	Length = 0x09
<b>CID</b>	16 bits	—
<b>DIUC</b>	4 bits	—

**Table 286b—DL PUSC Burst Allocation in Other Segment IE (continued)**

Syntax	Size	Notes
<b>Segment</b>	2 bits	Segment number for other BS's sector
<b>Boosting</b>	3 bits	Refer to Table 273.
<b>IDcell</b>	5 bits	Cell ID for other BS's sector
<b>DL_PermBase</b>	5 bits	—
<b>PRBS_ID</b>	2 bits	—
<b>Repetition coding indication</b>	2 bits	0b00: No repetition coding 0b01: Repetition coding of 2 used 0b10: Repetition coding of 4 used 0b11: Repetition coding of 6 used
<b>Used Subchannels</b>	6 bits	Used subchannels groups at other BS's sector: Bit #0: Subchannel group 0 Bit #1: Subchannel group 1 Bit #2: Subchannel group 2 Bit #3: Subchannel group 3 Bit #4: Subchannel group 4 Bit #5: Subchannel group 5
<b>OFDMA symbol offset</b>	8 bits	—
<i>Reserved</i>	1 bit	Shall be set to zero.
<b># OFDMA symbols</b>	7 bits	—
<b>Subchannel offset</b>	6 bits	—
<b># subchannels</b>	6 bits	—
<i>Reserved</i>	7 bits	Shall be set to zero
}	—	—

*Insert new subclause 8.4.5.3.14:*

**8.4.5.3.14 HO anchor active DL MAP IE**

This MAP IE is in the DL-MAP of active non-anchor BS and indicates the burst from Anchor BS. When an MS receives a HO Anchor Active DL-MAP IE on DL-MAP message from an active non-anchor BS, it can decode a data burst transmitted from Anchor BS by using the 'Anchor Preamble' in HO Anchor Active DL-MAP IE. (See Table 286c.)

**Table 286c—HO anchor active DL MAP IE**

Syntax	Size	Notes
<b>HO Anchor_Active DL MAP IE () {</b>	—	—
<b>Extended-2 DIUC</b>	4 bits	HO Anchor_Active MAP IE = 0x02
<b>Length</b>	8 bits	<i>variable</i>
for (each bursts) {	—	—

**Table 286c—HO anchor active DL MAP IE (continued)**

Syntax	Size	Notes
<b>Anchor Preamble</b>	8 bits	Preamble of anchor BS
<b>Anchor CID</b>	16 bits	Basic CID in anchor BS
<b>DIUC</b>	4 bits	—
<b>OFDMA symbol offset</b>	8 bits	—
<b>Subchannel offset</b>	6 bits	—
<b>Repetition coding indication</b>	2 bits	0b00—No repetition coding 0b01—Repetition coding of 2 used 0b10—Repetition coding of 4 used 0b11—Repetition coding of 6 used
}	—	—
<i>padding nibble</i>	0 or 4 bits	Shall be set to zero.
}	—	—

*Insert new subclause 8.4.5.3.15:*

#### **8.4.5.3.15 HO active anchor DL MAP IE**

This MAP IE is in the DL-MAP of the anchor BS and indicates the burst from active non-anchor BS. When an MS receives a HO Active Anchor DL-MAP IE on DL-MAP message from an Anchor BS, it can decode a data burst transmitted from the active non-anchor BS by using the ‘Active Preamble’ in HO Active Anchor DL-MAP IE.(See Table 286d.)

**Table 286d—HO active anchor DL MAP IE**

Syntax	Size	Notes
HOActive_Anchor DL MAP IE() {	—	—
<b>Extended-2 DIUC</b>	4 bits	HO Active_Anchor MAP IE = 0x01
<b>Length</b>	8 bits	<i>variable</i>
for (each bursts) {	—	—
<b>Active Preamble</b>	8 bits	Preamble of active BS
<b>Anchor CID</b>	16 bits	Basic CID in anchor BS
<b>DIUC</b>	4 bits	—
<b>OFDMA symbol offset</b>	8 bits	—
<b>Repetition coding indication</b>	2 bits	0b00: No repetition coding 0b01: Repetition coding of 2 used 0b10: Repetition coding of 4 used 0b11: Repetition coding of 6 used
<b>Subchannel offset</b>	6 bits	—

**Table 286d—HO active anchor DL MAP IE (continued)**

Syntax	Size	Notes
# OFDMA symbols	7 bits	—
# subchannels	6 bits	—
Boosting	3 bits	Refer to Table 273.
}	—	—
<i>padding nibble</i>	0 or 4 bits	Shall be set to zero.
}	—	—

*Insert new subclause 8.4.5.3.16:*

**8.4.5.3.16 HO CID Translation MAP IE**

The HO burst from active non-anchor BS is indicated by the MAP IE in DL-MAP of that BS with an Active CID. The Active CID is the CID assigned by the active non-anchor BS to translate the CID given by the Anchor BS.

Because the CID is different from the anchor CID, the CID Translation MAP IE should provide translation of the Active CID into the Anchor CID. This translation IE is transmitted by Active non-anchor BS and applied on both DL and UL IEs. The translation is valid only in the current frame. (See Table 286e.)

**Table 286e—HO CID Translation MAP IE**

Syntax	Size	Notes
HO CID Translation MAP IE() {	—	—
Extended-2 DIUC	4 bits	CID Translation MAP IE = 0x03
Length	8 bits	<i>variable</i>
for (each bursts) {	—	—
Anchor Preamble	8 bits	Preamble of anchor BS
Anchor CID	16 bits	Basic CID in anchor BS
Active CID	16 bits	—
}	—	—
}	—	—

*Insert new subclause 8.4.5.3.17:*

#### 8.4.5.3.17 MIMO in another BS IE

In the DL-MAP, a BS may transmit MIMO\_in\_another\_BS\_IE () to indicate that data is transmitted to the MS through other BS at the same frame. This IE shall be right after the IE defining the same data or data region received in the anchor BS. (See Table 286f.)

**Table 286f—MIMO in another BS IE**

Syntax	Size	Notes
MIMO_in_another_BS_IE () {	—	—
<b>Extended-2 DIUC</b>	4 bits	MIMO in another BS IE = 0x04
<b>Length</b>	8 bits	<i>variable</i>
<b>Segment</b>	2 bits	Segment number
<b>Used subchannels</b>	6 bits	Used subchannels at other BS Bit #0: 0-11 Bit #1: 12-19 Bit #2: 20-31 Bit #3: 32-39 Bit #4: 40-51 Bit #5: 52-59
<b>IDCell</b>	5 bits	Cell ID of other BS
<b>Num_Region</b>	4 bits	—
<i>Reserved</i>	3 bits	Shall be set to zero.
for ( i = 0; i < Num_Region; i++) {	—	—
<b>Matrix_indicator</b>	2 bits	See matrix indicator defined in STC_DL_Zone_IE
<b>OFDMA Symbol offset</b>	8 bits	—
<b>Subchannel offset</b>	6 bits	—
<b>Boosting</b>	3 bits	Refer to Table 273.
<b>No. OFDMA Symbols</b>	7 bits	—
<b>No. subchannels</b>	6 bits	—
<b>Num_layer</b>	2 bits	—
<i>Reserved</i>	2 bits	Shall be set to zero.
for (j = 0; j < Num_layer; j++) {	—	—
if (INC_CID == 1) {	—	—
<b>CID</b>	16 bits	—
}	—	—
<b>Layer_index</b>	2 bits	—
<b>DIUC</b>	4 bits	0-11 burst profiles.

**Table 286f—MIMO in another BS IE (continued)**

Syntax	Size	Notes
<i>Reserved</i>	2 bits	Shall be set to zero.
}	—	—
}	—	—
<b>Padding</b>	<i>variable</i>	Padding to byte; shall be set to 0.
}	—	—

*Insert new subclause 8.4.5.3.18:*

**8.4.5.3.18 Macro-MIMO DL Basic IE format**

Table 286g specifies DL-MAP IE for Macro-MIMO in MDHO Mode, which benefits from a combination of RF, diversity combining, and soft data combining.

**Table 286g—Macro MIMO DL Basic IE()**

Syntax	Size	Notes
Macro_MIMO_DL_Basic_IE() {	—	—
<b>Extended-2 DIUC</b>	4 bits	Macro MIMO DL Basic IE = 0x05
<b>Length</b>	8 bits	<i>variable</i>
<b>Segment</b>	2 bits	Segment number
<b>Used subchannels</b>	6 bits	Used subchannels groups at other BS's sector: Bit #0: Subchannel group 0 Bit #1: Subchannel group 1 Bit #2: Subchannel group 2 Bit #3: Subchannel group 3 Bit #4: Subchannel group 4 Bit #5: 9 Subchannel group 5
<b>Num_Region</b>	4 bits	—
For (i=0; i<Num_Region; i++) {	—	—
<b>OFDMA Symbol offset</b>	8 bits	—
<b>Subchannel offset</b>	6 bits	—
<b>Boosting</b>	3 bits	Refer to Table 273
<b>No. OFDMA symbols</b>	7 bits	—
<b>No. Subchannels</b>	6 bits	—
<b>Packet index</b>	4 bits	Packet index for each region
<b>Matrix indicator</b>	2 bits	See matrix indicator defined in STC_DL_Zone_IE
<b>Num_layer</b>	2 bits	—

**Table 286g—Macro MIMO DL Basic IE() (continued)**

Syntax	Size	Notes
<i>Reserved</i>	2 bits	Shall be set to zero
for (j=0; j<Num_layer; j++) {	—	—
if (INC_CID == 1) {	—	—
<b>CID</b>	16 bits	—
}	—	—
<b>Layer_index</b>	2 bits	—
<b>DIUC</b>	4 bits	0-11 burst profiles
<i>Reserved</i>	2 bits	Shall be set to zero
}	—	—
}	—	—
<b>Padding</b>	<i>variable</i>	Padding to byte; shall be set to zero
}	—	—

**Packet Index**

Indicates the packet index for the particular region. The regions with the same packet index shall be diversity combined at MS.

*Insert new subclause 8.4.5.3.19:*

**8.4.5.3.19 UL noise and interference level IE format**

For the open loop power control, UL interference and noise level shall be broadcast to MSs in the given BS coverage by BS. UL interference and noise level IE broadcast the UL interference and noise level (dBm) estimated in BS. All the UL interference and noise level are quantized in 0.5 dBm steps from –150 dBm (encoded 0x00) to –22.5 dBm (encoded 0xFF). (See Table 286h.)

**Table 286h—UL interference and noise level extended IE**

Syntax	Size	Notes
UL interference and noise level_IE {	—	—
<b>Extended DIUC</b>	4 bits	UL_NI = 0xF
<b>Length</b>	4 bits	Length = variable

**Table 286h—UL interference and noise level extended IE (continued)**

Syntax	Size	Notes
<b>Bitmap</b>	8 bits	LSB indicates the there exists a 'CQI/ACK/Periodic Ranging region NI' field (1). Otherwise, it is 0. The 2 <sup>nd</sup> LSB indicates the there exists a 'PUSC region NI' field (1). Otherwise, it is 0. The 3 <sup>rd</sup> LSB indicates the there exists a 'Optional PUSC region NI' field (1). Otherwise, it is 0. The 4 <sup>th</sup> LSB indicates the there exists an 'AMC region NI' field (1). Otherwise, it is 0. The 5 <sup>th</sup> LSB indicates the there exists 'AAS region NI' field (1). Otherwise, it is 0. The 6 <sup>th</sup> LSB indicates the there exists "Periodic ranging region NI" field (1). Otherwise, it is '0' The 7 <sup>th</sup> LSB indicates the there exists 'Sounding region NI' field (1). Otherwise, it is '0' The 8 <sup>th</sup> LSB indicates the there exists 'MIMO region NI' field (1). Otherwise, it is '0'
if (LSB of Bitmap = 1) {	—	—
<b>CQI/ACK/Periodic Ranging region NI</b>	8 bits	Estimated average power level (dBm) per a subcarrier in CQI/ACK/Periodic Ranging region.
}	—	—
if (The 2 <sup>nd</sup> LSB of Bitmap = 1) {	—	—
<b>PUSC region NI</b>	8 bits	Estimated average power level (dBm) per a subcarrier in PUSC region.
}	—	—
if (The 3 <sup>rd</sup> LSB of Bitmap = 1) {	—	—
<b>Optional PUSC region NI</b>	8 bits	Estimated average power level (dBm) per a subcarrier in optional PUSC region.
}	—	—
if (The 4 <sup>th</sup> LSB of Bitmap = 1) {	—	—
<b>AMC region NI</b>	8 bits	Estimated average power level (dBm) per a subcarrier in AMC region.
}	—	—
if (The 5 <sup>th</sup> LSB of Bitmap = 1) {	—	—
<b>AAS region NI</b>	8 bits	Estimated average power level (dBm) per a subcarrier in AAS region. The interference and noise level shall be estimated before the beam forming.
}	—	—
if (The 6 <sup>th</sup> LSB of Bitmap = 1) {	—	—



**Table 286h—UL interference and noise level extended IE (continued)**

Syntax	Size	Notes
<b>Periodic ranging region NI</b>	8 bits	Estimated average power level (dBm) per a subcarrier in Periodic ranging region. The interference and noise level shall be estimated before the beam forming. When this field is present, the value for the periodic ranging region indicated in CQI/ACK/Periodic Ranging region NI shall be ignored. Instead, the value of this field shall be used for NI level of the periodic ranging region.
}	—	—
if (The 7th LSB of Bitmap = 1) {	—	—
<b>Sounding region NI</b>	8 bits	Estimated average power level (dBm) per a subcarrier in sounding region.
}	—	—
if (The 8th LSB of Bitmap = 1) {	—	—
<b>MIMO region NI</b>	8 bits	Estimated average power level (dBm) per a subcarrier in MIMO region.
}	—	—
}	—	—

The UL interference and noise level that is indicated in the latest IE shall be used if necessary. MS shall not transmit any UL burst in open loop power control mode until it receives any UL noise and interference level IE.

*Insert new subclause 8.4.5.3.20:*

**8.4.5.3.20 Dedicated DL control IE**

Dedicated DL Control IE contains additional control information for each sub-burst in the Table 286l. Because each sub-burst may have its own control information format dependent on the MS capability, the length of the Dedicated DL Control IE is variable.(See Table 286i.)

**Table 286i—Dedicated DL control IE format**

Syntax	Size	Notes
Dedicated DL control IE() {	—	—
<b>Length</b>	4 bits	Length of following control information in Nibble.
<b>Control header</b>	4 bits	Bit #0: SDMA Control InfoBit Bits #1-3: Reserved
If ( SDMA Control Info Bit == 1){	—	—
<b>Num SDMA layers</b>	2 bits	This value plus one indicates the total number of SDMA layers associated with the HARQ DL MAP IE.

**Table 286i—Dedicated DL control IE format (continued)**

Syntax	Size	Notes
}	—	—
<b>Padding bits</b>	<i>variable</i>	—
}	—	—

**SDMA Control Info**

The Dedicated DL Control IE with SDMA Control Info =1 shall be present within the first sub-burst allocation of each layer of SDMA allocations (including the first layer). Each SDMA layer has its own pilot pattern (layer *n* uses the pilot pattern defined for antenna *n*, see 8.4.8). When the SDMA control info is present, the OFDMA Symbol offset and Subchannel offset shall be reset to the beginning of the two dimensional data region defined in the HARQ DL MAP IE.

For allocations specified in an AAS zone with PUSC permutation, the ‘Num SDMA layers’ value shall be identical in all Dedicated DL Control IEs that describe allocations in the same major group.

***Insert new subclause 8.4.5.3.20.1:***

**8.4.5.3.20.1 Reduced CID IE**

Table 286j presents the format of reduced CID. BS may use reduced CID instead of basic CID or multicast CID to reduce the size of HARQ MAP message. The type of reduced CID is determined by BS considering the range of basic CIDs of SS connected with the BS and specified by the RCID\_Type field of the Format Configuration IE.

The reduced CID is composed of 1 bit of prefix and *n*-bits of LSB of CID of SS. The prefix is set to 1 for the broadcast CID or multicast CID and set to 0 for basic CID. The reduced CID cannot be used instead of transport CID, primary management CID or secondary management CID.

Figure 229 shows the decoding of reduced CID when the RCID\_Type is set to 3.

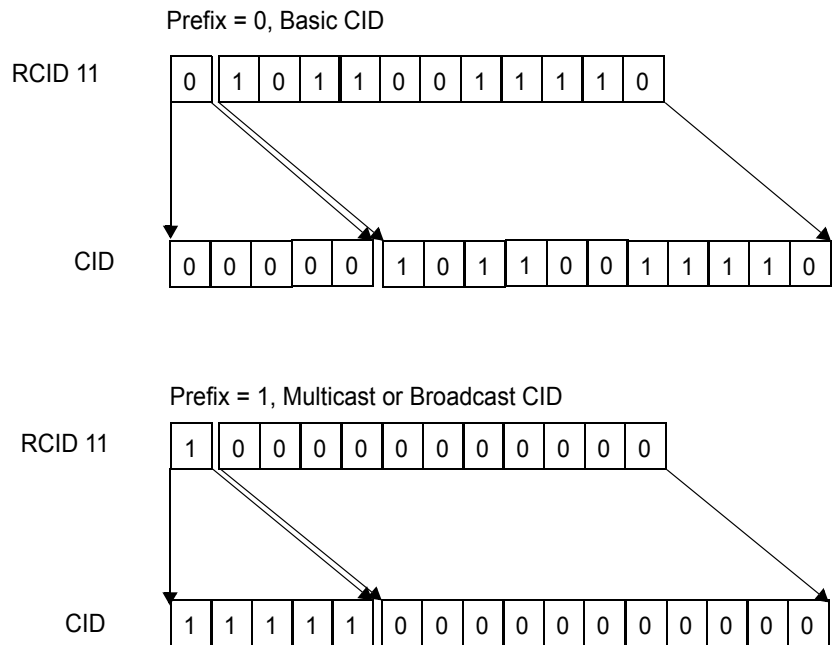
**Table 286j—RCID\_IE format**

Syntax	Size	Notes
RCID_IE ( ) {	—	—
if (RCID_Type == 0){	—	—
<b>CID</b>	16 bits	Normal CID
}else{	—	—
<b>Prefix</b>	1 bit	For multicast, AAS, Padding and broadcast burst temporary disable RCID
if ( Prefix == 1){	—	—
<b>RCID 11</b>	11 bits	11 LSB of multicast, AAS or broadcast CID
}else{	—	—
if (RCID_Type == 1){	—	—
<b>RCID 11</b>	11 bits	11 LSB of basic CID
} else if (RCID_Type == 2){	—	—
<b>RCID 7</b>	7 bits	7 LSB of basic CID
} else if (RCID_Type == 3){	—	—
<b>RCID 3</b>	3 bits	3 LSB of basic CID
}	—	—
}	—	—
}	—	—

**CID**  
Normal 16 bits CID

**Prefix**  
A value of one indicates that 11 bits RCID for broadcast and multicast follows the prefix. Otherwise, the *n*-bits RCID for basic CID follows the prefix. The value of *n* is determined by the RCID\_Type field in Format\_Configuration\_IE.

**RCID n**  
*n*-bits LSB of CID



**Figure 229b—Reduced CID decoding**

*Insert new subclause 8.4.5.3.20.2:*

**8.4.5.3.20.2 Skip IE**

This IE may be sent by BS in the mandatory DL-MAP as a broadcast IE. This IE is used to indicate to mobility enabled MS (negotiated through capability exchange in REG-REQ and REG-RSP, defined in 11.7.13.1) whether to process subsequent IEs following the Skip\_IE. There are two modes of operation. At the beginning of each DL-MAP, the processing of IEs is always enabled. When a Skip\_IE is encountered, and if Mode is set to 1, the mobility enabled MS may skip the processing of all subsequent IEs in the DL-MAP. However, when a Skip\_IE with Mode set to 0 is encountered, the mobility enabled MS may disable the processing of subsequent IEs until the next Skip\_IE is encountered in the DL-MAP. When the next Skip\_IE with Mode set to 0 is encountered, the MS shall enable the processing of subsequent IEs. This process continues until the end of the DL-MAP.

**Table 286k—Skip IE**

Syntax	Size	Notes
Skip_IE() {	—	—
<b>Extended-2 DIUC</b>	4 bits	SkipIE () = 0x06
<b>Length</b>	8 bits	Length in bytes
<b>Mode</b>	1 bit	If set to 1, the MS can skip the processing of all subsequent IEs in the DL-MAP If set to 0, the MS toggle the enabling and disabling of processing of IEs following the Skip_IE, until the next Skip_IE is encountered.
<i>Reserved</i>	7 bits	—
}	—	—

*Insert new subclause 8.4.5.3.21:*

#### **8.4.5.3.21 HARQ DL MAP IE**

The following modes of HARQ shall be supported by the HARQ DL MAP IE:

- a) Chase combining HARQ for all FEC types (HARQ Chase). In this mode the burst profile is indicated by a DIUC.
- b) Incremental redundancy HARQ with CTC (HARQ IR). In this mode the burst profile is indicated by the parameters  $N_{EP}$ ,  $N_{SCH}$ .
- c) Incremental redundancy HARQ for convolutional code (HARQ CC-IR).

The IE may also be used to indicate a non-HARQ transmission.

The HARQ DL MAP IE defines one or more two-dimensional data regions (a number of symbols by a number of subchannels). These allocations are further partitioned into bursts, termed sub-bursts, by allocating a specified number of slots to each burst. All sub-bursts of a data region shall only support one of the HARQ modes. The number of slots is indicated by duration or  $N_{SCH}$  fields. The slots are allocated in a frequency-first order, starting from the slot with the smallest symbol number and smallest subchannel, and continuing to slots with increasing subchannel number. When the edge of the allocation is reached, the symbol number is increased by a slot duration, as depicted in Figure 229c. Each sub-burst is separately encoded.

The enhanced feedback 6-bit channel type or mandatory feedback channel type shall be used for CQI channels allocated through any of the DL HARQ sub-burst IEs.

Each HARQ Map IE and sub-burst IE shall be nibble-aligned. When there is an if-else clause, regardless of whether the 'if' clause or the 'else' clause is executed, the resulting Map IE shall be nibble-aligned. When there is a loop, nibble-alignment shall be required before the loop starts and inside the loop.

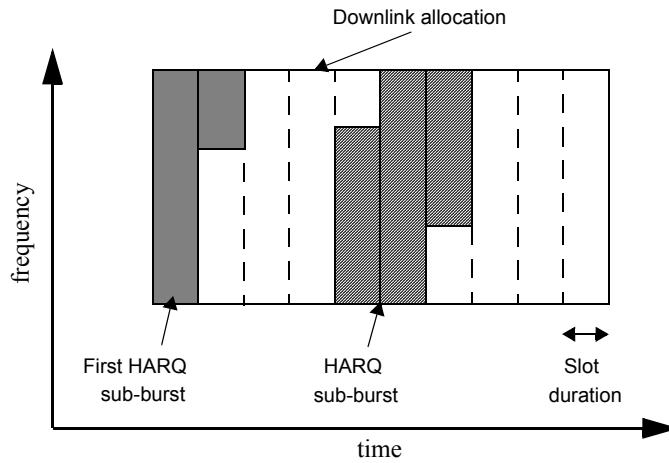


Figure 229c—HARQ downlink allocation

Table 286l—HARQ DL MAP IE format

Syntax	Size	Notes
HARQ DL MAP IE {	—	—
<b>Extended-2 DIUC</b>	4 bits	HARQ_DL_MAP_IE() = 0x07
<b>Length</b>	8 bits	Length in bytes
<b>RCID_Type</b>	2 bits	0b00 = Normal CID 0b01 = RCID11 0b10 = RCID7 0b11 = RCID3
<i>Reserved</i>	2 bits	
While (data remains) {	—	—
<b>Boosting</b>	3 bits	0b000: normal (not boosted) 0b001: +6dB 0b010: -6dB 0b011: +9dB 0b100: +3dB 0b101: -3dB 0b110: -9dB 0b111: -12dB;
<b>Region_ID use indicator</b>	1 bit	0: not use Region_ID 1: use Region_ID
If (Region_ID use indicator == 0) {		
<b>OFDMA symbol offset</b>	8 bits	Offset from the start symbol of DL subframe
<b>Subchannel offset</b>	7 bits	—
<b>Number of OFDMA symbols</b>	7 bits	—

**Table 286I—HARQ DL MAP IE format (continued)**

Syntax	Size	Notes
<b>Number of subchannels</b>	7 bits	—
<i>Reserved</i>	3 bits	—
} else {	—	—
<b>Region_ID</b>	8 bits	Index to the DL region defined in DL region definition TLV in DCD
}	—	—
<b>Mode</b>	4 bits	Indicates the mode of this HARQ region 0b0000 = Chase HARQ 0b0001 = Incremental redundancy HARQ for CTC 0b0010 = Incremental redundancy HARQ for Convolutional Code 0b0011 = MIMO Chase HARQ 0b0100 = MIMO IR HARQ 0b0101 = MIMO IR HARQ for Convolutional Code 0b0110 = MIMO STC HARQ 0b0111-0b1111 <i>Reserved</i>
<b>Sub-burst IE Length</b>	8 bits	Length, in nibbles, to indicate the size of the sub-burst IE in this HARQ mode. The MS may skip DL HARQ sub-burst IE if it does not support the HARQ Mode. However, the MS shall decode NACK Channel field from each DL HARQ sub-burst IE to determine the UL ACK channel it shall use for its DL HARQ burst.
If (Mode == 0b0000) {	—	—
<b>DL HARQ Chase sub-burst IE()</b>	<i>variable</i>	—
} else if (Mode == 0b0001) {	—	—
<b>DL HARQ IR CTC sub-burst IE()</b>	<i>variable</i>	—
} else if (Mode == 0b0010) {	—	—
<b>DL HARQ IR CC sub-burst IE() {</b>	<i>variable</i>	—
} else if (Mode==0b0011) {	—	—
<b>MIMO DL Chase HARQ Sub-Burst IE ()</b>	<i>variable</i>	—
} else if (Mode==0b0100) {	—	—
<b>MIMO DL IR HARQ Sub-Burst IE ()</b>	<i>variable</i>	—
} else if (Mode==0b0101) {	—	—
<b>MIMO DL IR HARQ for CC Sub-Burst IE ()</b>	<i>variable</i>	—
} else if (Mode == 0b0110) {	—	—

**Table 286i—HARQ DL MAP IE format (continued)**

Syntax	Size	Notes
<b>MIMO DL STC HARQ Sub-Burst IE</b> {	<i>variable</i>	—
}	—	—
}	—	—
<b>Padding</b>	<i>variable</i>	Padding to byte; shall be set to 0
}	—	—

**Table 286m—DL HARQ Chase sub-burst IE format**

Syntax	Size	Notes
DL HARQ Chase sub-burst IE() {	—	—
<b>N sub burst[ISI]</b>	4 bits	Number of sub-bursts in the 2D region
<b>N ACK channel</b>	4 bits	Number of HARQ ACK enabled sub-bursts in the 2D region.
For (j=0; j< N sub burst; j++){	—	—
<b>RCID_IE()</b>	<i>variable</i>	—
<b>Duration</b>	10 bits	Duration in slots
<b>Sub-Burst DIUC Indicator</b>	1 bit	If Sub-Burst DIUC Indicator is 1, it indicates that DIUC is explicitly assigned for this sub-burst. Otherwise, the this sub-burst will use the same DIUC as the previous sub-burst If j is 0 then this indicator shall be 1.
<i>Reserved</i>	1 bit	Shall be set to zero.
If( Sub-Burst DIUC Indicator == 1){	—	—
<b>DIUC</b>	4 bits	—
<b>Repetition Coding Indication</b>	2 bits	0b00 – No repetition coding 0b01 – Repetition coding of 2 used 0b10 – Repetition coding of 4 used 0b11 – Repetition coding of 6 used
<i>Reserved</i>	2 bits	Shall be set to zero.
}	—	—
<b>ACID</b>	4 bits	—
<b>AI_SN</b>	1 bit	—



**Table 286m—DL HARQ Chase sub-burst IE format (continued)**

Syntax	Size	Notes
<b>ACK disable</b>	1 bit	When 'ACK Disable' == 1, the allocated sub-burst does not require an ACK to be transmitted by the SS in the ACKCH Region (see 8.4.5.4.24). In this case, no ACK channel is allocated for the sub-burst in the ACKCH Region. For the burst, BS shall not perform HARQ retransmission and MS shall ignore ACID, AI_SN and SPID, which shall be set to '0' by BS if they exist.
<b>Dedicated DL Control Indicator</b>	2 bits	LSB #0 indicates inclusion of CQI control LSB #1 indicates inclusion of Dedicated DL Control IE.
If{ LSB #0 of Dedicated DL Control Indicator == 1}{	—	—
<b>Duration (d)</b>	4 bits	A CQI feedback is transmitted on the CQI channels indexed by the (CQI Channel Index) by the SS for 2 <sup>(d-1)</sup> frames. If d is 0b0000, deallocates all CQI feedback when the current ACID is completed successfully. If d is 0b1111, the MS should report until the BS command for the MS to stop.
If (Duration != 0b0000){	—	—
<b>Allocation Index</b>	6 bits	Index to the channel in a frame the CQI report should be transmitted by the SS.
<b>Period (p)</b>	3 bits	A CQI feedback is transmitted on the CQI channels indexed by the (CQI Channel Index) by the SS in every 2 <sup>p</sup> frames.
<b>Frame offset</b>	3 bits	The MS starts reporting at the frame of which the number has the same 3 LSB as the specified frame offset. If the current frame is specified, the MS should start reporting in eight frames.
}	—	—
}	—	—
If (LSB #1 of Dedicated DL Control Indicator == 1) {	—	—
<b>Dedicated DL Control IE ()</b>	<i>variable</i>	—
}	—	—
}	—	—
}	—	—

A non-HARQ MS is required to decode DL HARQ Chase sub-burst IEs with “ACK disabled” = 1 if the MS has the capability to decode the extended HARQ IEs. (See Table 286n.)

**Table 286n—DL HARQ IR CTC sub-burst IE format**

Syntax	Size	Notes
DL HARQ IR CTC sub-burst IE() {	—	—
<b>N sub burst</b>	4 bits	—
<b>N ACK channel</b>	4 bits	Number of HARQ ACK enabled sub-bursts in the 2D region
For (j=0; j< N sub burst; j++){	—	—
<b>RCID_IE()</b>	<i>variable</i>	—
<b>N<sub>EP</sub></b>	4 bits	—
<b>N<sub>SCH</sub></b>	4 bits	—
<b>SPID</b>	2 bits	—
<b>ACID</b>	4 bits	—
<b>AI_SN</b>	1 bit	—
<b>ACK disable</b>	1 bit	When ‘ACK Disable’ == 1, the allocated sub-burst does not require an ACK to be transmitted by the SS in the ACKCH Region (see 8.4.5.4.24). In this case, no ACK channel is allocated for the sub-burst in the ACKCH Region. For the burst, BS shall not perform HARQ retransmission and MS shall ignore ACID, AI_SN and SPID, which shall be set to ‘0’ by BS if they exist.
<i>Reserved</i>	2 bits	Shall be set to zero
<b>Dedicated DL Control Indicator</b>	2 bits	LSB #0 indicates inclusion of CQI control LSB #1 indicates inclusion of Dedicated DL Control IE
If( LSB #0 of Dedicated DL Control Indicator == 1){	—	—
<b>Duration (d)</b>	4 bits	A CQI feedback is transmitted on the CQI channels indexed by the (CQI Channel Index) by the SS for 2 <sup>(d-1)</sup> frames. If d is 0b0000, deallocates all CQI feedback when the current ACID is completed successfully. If d is 0b1111, the MS should report until the BS command for the MS to stop
If (Duration != 0b0000){	—	—
<b>Allocation index</b>	6 bits	Index to the channel in a frame the CQI report should be transmitted by the SS
<b>Period(p)</b>	3 bits	A CQI feedback is transmitted on the CQI channels indexed by the (CQI Channel Index) by the SS in every 2 <sup>p</sup> frames.

**Table 286n—DL HARQ IR CTC sub-burst IE format (continued)**

Syntax	Size	Notes
<b>Frame offset</b>	3 bits	The MS starts reporting at the frame of which the number has the same 3 LSB as the specified frame offset. If the current frame is specified, the MS should start reporting in eight frames.
}	—	—
}	—	—
If (LSB #1 of Dedicated DL Control Indicator ==1) {	—	—
<b>Dedicated DL Control IE ()</b>	<i>variable</i>	—
}	—	—
}	—	—
}	—	—

**Table 286o—DL HARQ IR CC sub-burst IE format**

Syntax	Size	Notes
DL HARQ IR CC sub-burst IE() {	—	—
<b>N sub burst</b>	4 bits	—
<b>N ACK channel</b>	4 bits	Number of HARQ ACK enabled sub-bursts in the 2D region
For (j=0; j< N sub burst; j++) {	—	—
<b>RCID_IE()</b>	<i>variable</i>	—
<b>Duration</b>	10 bits	—
<b>Sub-Burst DIUC Indicator</b>	1 bit	If Sub-Burst DIUC Indicator is 1, it indicates that DIUC is explicitly assigned for this sub-burst. Otherwise, the this sub-burst will use the same DIUC as the previous sub-burst If <i>j</i> is 0 then this indicator shall be 1.
<i>Reserved</i>	1 bit	—
If( Sub-Burst DIUC Indicator == 1){	—	—
<b>DIUC</b>	4 bits	—
<b>Repetition Coding Indication</b>	2 bits	0b00 – No repetition coding 0b01 – Repetition coding of 2 used 0b10 – Repetition coding of 4 used 0b11 – Repetition coding of 6 used
<i>Reserved</i>	2 bits	—
}	—	—
<b>ACID</b>	4 bits	—
<b>AI_SN</b>	1 bit	—

**Table 286o—DL HARQ IR CC sub-burst IE format (continued)**

Syntax	Size	Notes
<b>SPID</b>	2 bits	—
<b>ACK disable</b>	1 bit	When ‘ACK Disable’ == 1, the allocated sub-burst does not require an ACK to be transmitted by the SS in the ACKCH Region (see 8.4.5.4.24). In this case, no ACK channel is allocated for the sub-burst in the ACKCH Region. For the burst, BS shall not perform HARQ retransmission and MS shall ignore ACID, AI_SN and SPID, which shall be set to ‘0’ by BS if they exist.
<b>Dedicated DL Control Indicator</b>	2 bits	LSB #0 indicates inclusion of CQI control LSB #1 indicates inclusion of Dedicated DL Control IE
<i>Reserved</i>	2 bits	Shall be set to zero.
If (LSB #0 of Dedicated DL Control Indicator == 1) {	—	—
<b>Duration (d)</b>	4 bits	A CQI feedback is transmitted on the CQI channels indexed by the (CQI Channel Index) by the SS for $2^{(d-1)}$ frames. If d is 0b0000, deallocates all CQI feedback when the current ACID is completed successfully. If d is 0b1111, the MS should report until the BS command for the MS to stop
If (Duration != 0b0000){	—	—
<b>Allocation index</b>	6 bits	Index to the channel in a frame the CQI report should be transmitted by the SS
<b>Period(p)</b>	3 bits	A CQI feedback is transmitted on the CQI channels indexed by the (CQI Channel Index) by the SS in every $2^p$ frames.
<b>Frame offset</b>	3 bits	The MS starts reporting at the frame of which the number has the same 3 LSB as the specified frame offset. If the current frame is specified, the MS should start reporting in eight frames.
}	—	—
}	—	—
If ((LSB #1 of Dedicated DL Control Indicator == 1) {	—	—
<b>Dedicated DL Control IE ()</b>	<i>variable</i>	—
}	—	—
}	—	—
}	—	—

**Table 286p—MIMO DL Chase HARQ sub-burst IE format**

Syntax	Size	Notes
MIMO_DL_Chase_HARQ_Sub-Burst_IE() {	—	—
<b>N sub burst</b>	4 bits	Number of sub-bursts in the 2D region
<b>N ACK channel</b>	6 bits	Number of HARQ ACK enabled sub-bursts in the 2D region
For (j=0; j<N sub burst; j++){	—	—
<b>MU Indicator</b>	1 bit	Indicates whether this DL burst is intended for multiple SS
<b>Dedicated MIMO DL Control Indicator</b>	1 bit	—
<b>ACK Disable</b>	1 bit	When 'ACK Disable' == 1, the allocated sub-burst does not require an ACK to be transmitted by the SS in the ACKCH Region (see 8.4.5.4.24). In this case, no ACK channel is allocated for the sub-burst in the ACKCH Region. For the burst, BS shall not perform HARQ retransmission and MS shall ignore ACID, AI_SN and SPID, which shall be set to '0' by BS if they exist.
If (MU indicator == 0) {	—	—
<b>RCID IE()</b>	<i>variable</i>	—
}	—	—
If (Dedicated MIMO DL Control Indicator ==1) {	—	—
<b>Dedicated MIMO DL Control IE ()</b>	<i>variable</i>	—
}	—	—
<b>Duration</b>	10 bits	—
For (i=0; i<N_layer; i++) {	—	—
if (MU indicator == 1) {	—	—
<b>RCID IE()</b>	<i>variable</i>	—
}	—	—
<b>DIUC</b>	4 bits	—
<b>Repetition Coding Indication</b>	2 bits	0b00 – No repetition coding 0b01 – Repetition coding of 2 used 0b10 – Repetition coding of 4 used 0b11 – Repetition coding of 6 used
If (ACK Disable ==0) {	—	—
<b>ACID</b>	4 bits	—

**Table 286p—MIMO DL Chase HARQ sub-burst IE format (continued)**

Syntax	Size	Notes
AI_SN	1 bit	—
}	—	—
}	—	—
}	—	—
}	—	—

When an MS receives a MIMO HARQ burst allocation with Dedicated MIMO DL Control Indicator set to '1', the MS shall store the information in Dedicated MIMO DL Control IE. When an MS receives a MIMO HARQ burst allocation with Dedicated MIMO DL Control Indicator is set to '0', the MS shall use the stored Dedicated MIMO DL Control information from the last burst allocation where this information was included.

For MIMO HARQ allocation specified in the MIMO DL Chase HARQ Sub-Burst IE, MIMO DL IR HARQ Sub-Burst IE, or the MIMO DL IR HARQ for CC Sub-Burst IE, each layer shall be allocated its associated ACK channel. The number of ACK channels associated with the sub-burst IE may be greater than N\_sub\_burst.

For each multi SS sub-burst (MU Indicator = 1), if the dedicated pilot bit is set to 1 in the STC\_ZONE IE (8.4.5.3.4) for the zone in which the sub-burst allocations are being made, N\_layer for this sub-burst selects the pilot format for the sub-burst by interpreting N\_layer as the number of transmit antennas (as defined in 8.4.8), and the SS with the first RCID shall be assigned the pilot pattern corresponding to antenna 1, of 8.4.8, the second to the pilot pattern corresponding to antenna 2, and so on.

**Table 286q—MIMO DL IR HARQ Sub-Burst IE format**

Syntax	Size	Notes
MIMO DL IR HARQ Sub-Burst IE {	—	—
N sub burst	4 bits	Number of sub-bursts in the 2D region
N ACK channel	6 bits	Number of HARQ ACK enabled sub-bursts in the 2D region
For (j=0; j< N sub burst; j++){	—	—
MU Indicator	1 bit	Indicates whether this DL burst is intended for multiple SS
Dedicated MIMO DL Control Indicator	1 bit	—

**Table 286q—MIMO DL IR HARQ Sub-Burst IE format (continued)**

Syntax	Size	Notes
<b>ACK Disable</b>	1 bit	When ‘ACK Disable’ == 1, the allocated sub-burst does not require an ACK to be transmitted by the SS in the ACKCH Region (see 8.4.5.4.24). In this case, no ACK channel is allocated for the sub-burst in the ACKCH Region. For the burst, BS shall not perform HARQ retransmission and MS shall ignore ACID, AI_SN and SPID, which shall be set to ‘0’ by BS if they exist.
If (MU indicator == 0) {	—	—
<b>RCID IE()</b>	<i>variable</i>	—
}	—	—
If (Dedicated MIMO DL Control Indicator ==1) {	—	—
<b>Dedicated MIMO DL Control IE ()</b>	<i>variable</i>	—
}	—	—
<b>N<sub>SCH</sub></b>	4 bits	—
For (i=0;i<N_layer;i++) {	—	—
if (MU indicator == 1) {	—	—
<b>RCID IE()</b>	<i>variable</i>	—
}	—	—
<b>N<sub>EP</sub></b>	4 bits	—
If (ACK Disable ==0) {	—	—
<b>SPID</b>	2 bits	—
<b>ACID</b>	4 bits	—
<b>AI_SN</b>	1 bit	—
}	—	—
}	—	—
}	—	—
}	—	—
}	—	—

**Table 286r—MIMO DL IR HARQ for CC Sub-Burst IE format**

Syntax	Size	Notes
MIMO DL IR HARQ for CC Sub-Burst IE {	—	—
<b>N sub burst</b>	4 bits	Number of sub-bursts in the 2D region
<b>N ACK channel</b>	6 bits	Number of HARQ ACK enabled sub-bursts in the 2D region
For (j=0; j< N sub burst; j++){	—	—
<b>MU Indicator</b>	1 bit	Indicates whether this DL burst is intended for multiple SS
<b>Dedicated MIMO DL Control Indicator</b>	1 bit	—
<b>ACK Disable</b>	1 bit	When ‘ACK Disable’ == 1, the allocated sub-burst does not require an ACK to be transmitted by the SS in the ACKCH Region (see 8.4.5.4.24). In this case, no ACK channel is allocated for the sub-burst in the ACKCH Region. For the burst, BS shall not perform HARQ retransmission and MS shall ignore ACID, AI_SN and SPID, which shall be set to ‘0’ by BS if they exist.
If (MU indicator == 0) {	—	—
<b>RCID IE()</b>	<i>variable</i>	—
}	—	—
If (Dedicated MIMO DL Control Indicator ==1) {	—	—
<b>Dedicated MIMO DL Control IE ()</b>	<i>variable</i>	—
}	—	—
<b>Duration</b>	10 bits	—
For (i=0; i<N_layer; i++) {	—	—
if (MU indicator == 1) {	—	—
<b>RCID IE()</b>	<i>variable</i>	—
}	—	—
<b>DIUC</b>	4 bits	—
<b>Repetition Coding Indication</b>	2 bits	0b00 – No repetition coding 0b01 – Repetition coding of 2 used 0b10 – Repetition coding of 4 used 0b11 – Repetition coding of 6 used
If (ACK Disable ==0) {	—	—
<b>ACID</b>	4 bits	—
<b>AI_SN</b>	1 bit	—
<b>SPID</b>	2 bits	—



**Table 286r—MIMO DL IR HARQ for CC Sub-Burst IE format (continued)**

Syntax	Size	Notes
}	—	—
}	—	—
}	—	—
}	—	—

**Table 286s—MIMO DL STC HARQ Sub-Burst IE format**

Syntax	Size	Notes
MIMO DL STC HARQ Sub-Burst IE {	—	—
<b>N sub burst</b>	4 bits	Number of sub-bursts in the 2D region
<b>N ACK channel</b>	6 bits	Number of HARQ ACK enabled sub-bursts in the 2D region
For (j=0; j< N sub burst; j++){	—	—
<b>Tx count</b>	2 bits	0b00: initial transmission 0b01: odd retransmission 0b10: even retransmission 0b11: Reserved
<b>Duration</b>	10 bits	—
<b>Sub-burst offset indication</b>	1 bit	Indicates the inclusion of sub-burst offset
<i>Reserved</i>	3 bits	—
If (Sub-burst offset indication == 1) {	—	—
<b>Sub-burst offset</b>	8 bits	Offset in slots with respect to the previous sub-burst defined in this data region. If this is the first subburst within the data region, this offset is with respect to slot 0 of the data region.
}	—	—
<b>RCID IE()</b>	<i>variable</i>	—
<b>ACK Disable</b>	1 bit	When 'ACK Disable' == 1, the allocated sub-burst does not require an ACK to be transmitted by the SS in the ACKCH Region (see 8.4.5.4.24). In this case, no ACK channel is allocated for the sub-burst in the ACKCH Region. For the burst, BS shall not perform HARQ retransmission and MS shall ignore ACID, AI_SN, and SPID, which shall be set to '0' by BS if they exist.
if (Tx count ==0) {	—	—
<b>Dedicated MIMO DL Control Indicator</b>	1 bit	

**Table 286s—MIMO DL STC HARQ Sub-Burst IE format (continued)**

Syntax	Size	Notes
If (Dedicated MIMO DL Control Indicator ==1) {	—	—
<b>Dedicated MIMO DL Control IE ()</b>	<i>variable</i>	—
}	—	—
<b>DIUC</b>	4 bits	—
<b>Repetition Coding Indication</b>	2 bits	0b00 – No repetition coding 0b01 – Repetition coding of 2 used 0b10 – Repetition coding of 4 used 0b11 – Repetition coding of 6 used
}	—	—
If (ACK Disable ==0) {	—	—
<b>ACID</b>	4 bits	—
}	—	—
}	—	—
}	—	—

This IE is used to support the STC subpacket retransmission.

*Insert new subclause 8.4.5.3.21.1:*

**8.4.5.3.21.1 Dedicated MIMO DL Control IE format**

Dedicated DL Control IE for MIMO contains additional control information for each sub-burst. Because each sub-burst may have its own control information format dependent on the MS capability, the length of the Dedicated DL Control IE for MIMO is variable.

**Table 286t—Dedicated MIMO DL Control IE format**

Syntax	Size	Notes
Dedicated MIMO DL Control IE() {	—	—
<b>Length</b>	5 bits	Length of following control information in Nibble.
<b>Control header</b>	3 bits	Bit #0: MIMO Control Info Bit #1: CQI Control Info Bit #2: Closed MIMO Control Info
<b>N_layer</b>	2 bits	Number of coding/modulation layers 0b00 = 1 layer 0b01 = 2 layers 0b10 = 3 layers 0b11 = 4 layers
if( MIMO Control Info == 1){	—	—

**Table 286t—Dedicated MIMO DL Control IE format (continued)**

Syntax	Size	Notes
<b>Matrix</b>	2 bits	Indicates transmission matrix (See 8.4.8) 0b00 = Matrix A 0b01 = Matrix B 0b10 = Matrix C 0b11 = Codebook
if (Dedicated Pilots == 1) {	—	Dedicated Pilots field in STC_Zone_IE()
<b>Num_Beamformed_Streams</b>	2 bits	Indicates the number of beamformed streams which is equal to the number of pilot patterns 0b00 = 1 stream 0b01 = 2 streams 0b10 = 3 streams 0b11 = 4 streams
}	—	—
}	—	—
If (CQICH Control Info == 1){	—	—
<b>Period</b>	3 bits	Period (in frame) = 2 <sup>period</sup>
<b>Frame offset</b>	3 bits	—
<b>Duration</b>	4 bits	A CQI feedback is transmitted on the CQI channels indexed by the Allocation index for 10 × 2 <sup>d</sup> frames.
For (j=0;N_layer+1;j++) {	—	—
<b>Allocation index</b> <sup>1</sup>	6 bits	Index to CQICH assigned to this layer.
}	—	—
<b>CQICH_Num</b>	2 bits	Number of additional CQICHs assigned to this SS (0–3)
for (i=0; i<CQICH_Num; i++) {	—	—
<b>Feedback type</b>	3 bits	Type of feedback on this CQICH
<b>Allocation index</b>	6 bits	—
}	—	—
}	—	—
if (Closed MIMO Control Info == 1){	—	—
if (MIMO Control Info==1) {	—	—
<b>MIMO mode = Matrix</b>	—	—
} Else {	—	—
<b>MIMO mode = Matrix in STC_Zone_IE()</b>	—	—
}	—	—
If (MIMO mode == 00 or 01) {	—	—

**Table 286t—Dedicated MIMO DL Control IE format (continued)**

Syntax	Size	Notes
<b>Antenna Grouping Index</b>	3 bits	Indicates the index of antenna grouping. See 8.4.8.3.4 and 8.4.8.3.5 If(Matrix_indicator == 00) 000~010 = 0b101110~0b110000 in Table 298d else 000~101 = 0b110001~0b110110 in Table 298d
} elseif (MIMO mode == 10) {		
<b>Num_stream</b>	2 bits	Indicates the number of streams in Table 316f for 3 Tx and Table 316g for 4 Tx.
<b>Antenna Selection Index</b>	3 bits	Indicates the index of antenna selection. See 8.4.8.3.4 and 8.4.8.3.5 000~110 = 0b110000~0b110101 in Table 298e
} elseif (MIMO mode == 11) {		
<b>Num_stream</b>	2 bits	Indicates number of streams
<b>Codebook Precoding Index</b>	6 bits	Indicates the index of precoding matrix W in the codebook (see 8.4.8.3.6).
}		
}		
<i>Padding</i>	<i>variable</i>	Padding to Nibble; shall be set to 0
}	—	—

**Control header**

Four bits are used to indicate the following control information. If the first bit is set to 1, this means that MIMO Control information follows. If the second bit is set to 1, this IE shall contain CQI control information. Other bits are reserved for future extension.

**N\_layer**

Specifies the number of layers contained in this burst. The layer is defined as a separate coding/modulation path.

**Matrix Indicator**

This field indicates MIMO matrix for the burst.

**Period**

Informs the SS of the period of CQI reports. A CQI feedback is transmitted on the CQICH every  $2^p$  frames.

**Frame Offset**

Informs the SS when to start transmitting reports. The SS starts reporting at the frame number which has the same 3 LSBs as the specified Frame Offset. If the current frame is specified, the SS shall start reporting in eight frames.

**Duration**

Indicates when the SS should stop reporting unless the CQICH allocation is refreshed beforehand. If Duration is set to 0b0000, the BS shall de-allocate the CQICH. If Duration is set to 0b1111, the CQICH is allocated indefinitely and the SS should report until it receives another MAP\_IE with Duration set to 0b0000.

**Allocation Index<sup>1</sup>**

Indicates position from the start of the CQICH region.

**Feedback Type**

Indicates the type of feedback content on the allocated CQICH from SS. Its mapping shall be

- 0b000 = Fast DL measurement/Default Feedback with antenna grouping
- 0b001 = Fast DL measurement/Default Feedback with antenna selection
- 0b010 = Fast DL measurement/Default Feedback with reduced codebook
- 0b011 = Quantized precoding weight feedback
- 0b100 = Index to precoding matrix in codebook
- 0b101 = Channel Matrix Information
- 0b110–0b111 = *Reserved*

*Insert new subclause 8.4.5.3.22:*

**8.4.5.3.22 DL HARQ ACK IE**

The DL HARQ ACK IE is used by BS to send HARQ acknowledgment to UL HARQ enabled traffic. The bit position in the bitmap is determined by the order of the HARQ enabled UL bursts in the UL-MAP. The frame offset  $j$  between the UL burst and the HARQ ACK-BITMAP is specified by “HARQ\_ACK\_Delay\_for UL Burst” field in the DCD message. For example, when an MS transmits a HARQ enabled burst at frame  $i$  and the burst is the  $n$ -th HARQ enabled burst in the MAP, the MS should receive HARQ ACK at  $n$ -th bit of the BITMAP which is sent by the BS at frame  $(i+j)$ .

The existence of this IE shall be optional.

If the HARQ ACK BITMAP is omitted, the HARQ MS should retain the transmitted HARQ burst and retransmit it when the BS request retransmission with AI\_SN. This IE may only be exist in the DL-MAP message.

**Table 286u—HARQ\_ACK IE**

Syntax	Size	Notes
HARQ_ACK_IE() {	—	—
<b>Extended-2 DIUC</b>	4 bits	HARQ_ACK_IE () = 0x08
<b>Length</b>	8 bits	Length in bytes
<b>Bitmap</b>	<i>variable</i>	Bitmap size is determined by Length field
}	—	—

**Bitmap**

Includes HARQ ACK information for HARQ enabled UL bursts. The size of BITMAP should be equal or larger than the number of HARQ enabled UL-bursts. Each byte carries 8 ACK indications ordered from LSB (smallest index ACK channel) to MSB. An acknowledgement bit shall be 0 (ACK) if the corresponding uplink packet has been successfully received; otherwise, it shall be 1 (NAK).

*Insert new subclause 8.4.5.3.23:*

**8.4.5.3.23 Enhanced DL MAP IE**

The Enhanced DL Map IE may be used for BS to indicate to the MS the DL resource allocation based on the channel definition specified in the DL channel definition TLV in the DCD. (See Table 286v.)

**Table 286v—Enhanced DL MAP IE**

Syntax	Size	Notes
Enhanced_DL_MAP_IE() {	—	—
<b>Extended-2 DIUC</b>	4 bits	Enhanced_DL_MAP_IE () = 0x09
<b>Length</b>	8 bits	Length in bytes
<b>Num_Assignment</b>	4 bits	Number of assignments in this IE
For (i=0; i<Num_Assignment; i++) {	—	—
if (INC_CID == 1) {	—	The DL-MAP starts with INC_CID =0. INC_CID is toggled between 0 and 1 by the CID-SWITCH_IE() (8.4.5.3.7)
<b>N_CID</b>	8 bits	Number of CIDs
For (n=0; n<N_CID; n++) {	—	—
<b>CID</b>	16 bits	—
}	—	—
}	—	—
<b>DIUC</b>	4 bits	—
<b>Boosting</b>	3 bits	Refer to Table 273
<b>Repetition Coding Indication</b>	2 bits	—
<b>Region_ID</b>	8 bits	Index to the DL region defined in DL channel definition TLV in DCD
<i>Reserved</i>	3 bits	Shall be set to zero
}	—	—
}	—	—

**Num\_Assignment**

Number of assignments in this IE

**Region\_ID**

Index to the DL region defined in DL channel definition TLV in DCD message

*Insert new subclause 8.4.5.3.24:*

**8.4.5.3.24 Closed-loop MIMO DL enhanced IE format**

The Closed-loop MIMO DL enhanced IE may be used by BS to assign resource to close loop MIMO enabled MSs. (See Table 286w.)

**Table 286w—Closed-loop MIMO DL enhanced IE**

Syntax	Size	Notes
CL_MIMO_DL_Enhanced_IE () {	—	—
<b>Extended-2 DIUC</b>	4 bits	CL_MIMO_DL_enhanced_IE () = 0x0A
<b>Length</b>	8 bits	Length in bytes
<b>Num_Region</b>	4 bits	—
for ( i = 0; i < Num_Region; i++) {	—	—
<b>OFDMA Symbol offset</b>	8 bits	—
<b>Subchannel offset</b>	6 bits	—
<b>Boosting</b>	3 bits	Refer to Table 273.
<b>No. OFDMA Symbols</b>	7 bits	—
<b>No. subchannels</b>	6 bits	—
<b>Matrix_indicator</b>	2 bits	Indicates transmission matrix (see 8.4.8) 0b00 = Matrix A (Transmission diversity) 0b01 = Matrix B (Hybrid Scheme) 0b10 = Matrix C (Spatial Multiplexing) 0b11 = Codebook
if ( Matrix_indicator != 0b10) {	—	—
<b>RCID_IE</b>	<i>variable</i>	—
<b>DIUC</b>	4 bits	—
<b>Repetition_Coding_indication</b>	2 bits	—
If (Matrix indicator == 0b00 or 0b01)	—	—
<b>Antenna Grouping Index</b>	3 bits	Indicating the index of the antenna grouping index If ((Matrix_indicator == 0b00) 0b000~0b010 = 0b101110~0b110000 in Table 298d else 0b000~0b101 = 0b110001~0b110110 in Table 298d
<i>Reserved</i>	3 bits	Shall be set to zero.
Elseif (Matrix_indicator == 0b11) {	—	—
<b>Num stream</b>	2 bits	Indicates number of streams
<b>Codebook Precoding Index</b>	6 bits	Indicate the index of the precoding matrix in the codebook
<i>Reserved</i>	2 bits	Shall be set to zero.

**Table 286w—Closed-loop MIMO DL enhanced IE (continued)**

Syntax	Size	Notes
}Else {	—	—
<b>Num_MS</b>	2 bits	Number of MSs who are assigned DL resource when antenna selection is used
<i>Reserved</i>	2 bits	Shall be set to zero.
for (i = 0;i<Num_MS;i++) {	—	—
<b>RCID_IE</b>	<i>variable</i>	—
<b>DIUC</b>	4 bits	—
<b>Repetition_Coding_indication</b>	2 bits	—
<b>Num_stream</b>	2 bits	Indicates the number of streams in Table 316f for 3 Tx antenna and Table 316g for 4 Tx antenna
<b>Antenna Selection index</b>	3 bits	Indicates the index of antenna selection See 8.4.8.3.4 and 8.4.8.3.5 0b000~0b010 = 0b110000~0b110010 in Table 316f 0b000~0b101 = 0b110000 ~ 0b 110101 in Table 316g
<i>Reserved</i>	1 bit	Shall be set to zero.
}	—	—
}	—	—
}	—	—
<b>Padding</b>	<i>variable</i>	Padding to byte; shall be set to zero.
}	—	—

**Num\_Region:**

A field that indicates the number of the regions defined by OFDMA\_Symbol\_offset, Subchannel\_offset, Boosting, No.\_OFDMA\_Symbols and No.\_subchannels in this IE

**Matrix\_indicator:**

The values of these two bits indicate the STC matrix (see 8.4.8)

**Antenna Grouping Index:**

A field that indicates the index of the antenna grouping index

**Antenna Selection Index:**

A field that indicates the index of the selected antenna

**Codebook Precoding Index:**

A field that indicates the index of the precoding matrix in the codebook

**Num\_stream:**

The value of these 2 bits plus one indicate the number of MIMO transmission streams

**Stream\_index:**

A field that specifies the stream index



*Insert new subclause 8.4.5.3.25:*

**8.4.5.3.25 Broadcast Control Pointer IE**

The structure of this IE is captured in Table 286x.

**Table 286x—Broadcast Control Pointer IE format**

Syntax	Size	Notes
Broadcast Control Pointer IE() {	—	—
<b>Extended DIUC</b>	4 bits	FDN = 0x0A
<b>Length</b>	4 bits	Length in bytes
<b>DCD_UCD Configuration Change Counter</b>	4 bits	A composite configuration change counter incremented for each change in either DCD or UCD
<b>DCD_UCD Transmission Frame</b>	8 bits	The least significant eight bits of the frame number of the next DCD and/or UCD transmission.
<b>Skip Broadcast_System_Update</b>	1 bit	—
If (Skip Broadcast_System_Update == 0) {	—	—
<b>Broadcast_System_Update_Type</b>	3 bits	Shows the type of Broadcast_System_Update 0b000: For MOB_NBR-ADV Update 0b001: For Emergency Services Message 0b010 – 0b111: <i>Reserved</i>
<b>Broadcast_System_Update_Transmission_Frame</b>	8 bits	The least significant eight bits of the frame number of the next Broadcast_System_Update transmission.
} else {	—	—
<i>Reserved</i>	3 bits	Shall be set to zero.
}	—	—
}	—	—

*Insert new subclause 8.4.5.3.26:*

**8.4.5.3.26 AAS\_SDMA\_DL\_IE format**

**Table 286y—AAS\_SDMA\_DL\_IE**

Syntax	Size	Notes
AAS_SDMA_DL_IE(){	—	—
<b>Extended-2 DIUC</b>	4 bits	AAS_SDMA_DL_IE = 0x0E
<b>Length</b>	8 bits	<i>variable</i>
<b>RCID_Type</b>	2 bits	0b00 = Normal CID 0b01 = RCID11 0b10 = RCID7 0b11 = RCID3
<b>Num Burst Region</b>	4 bits	—
<i>Reserved</i>	2 bits	Shall be set to zero.
For (ii = 1: Num Region) {	—	—
<b>OFDMA symbol offset</b>	8 bits	Starting symbol offset referenced to DL preamble of the downlink frame specified by the Frame Offset
If (Zone Permutation is AMC, TUSC1, or TUSC2) {	—	—
<b>Subchannel offset</b>	8 bits	—
<b>No. OFDMA triple symbols</b>	5 bits	Number of OFDMA symbols is given in multiples of 3
<b>No. subchannels</b>	6 bits	—
} Else {	—	—
<b>Subchannel offset</b>	6 bits	—
<b>No. OFDMA symbols</b>	7 bits	—
<b>No. subchannels</b>	6 bits	—
}	—	—
<b>Number of Users</b>	3 bits	SDMA users for the assigned region
<i>Reserved</i>	2 bits	Shall be set to zero
For (jj = 1: Num_Users) {	—	—
<b>RCID_IE()</b>	<i>variable</i>	—
<b>Encoding Mode</b>	2 bits	0b00: No HARQ 0b01: HARQ Chase Combining 0b10: HARQ Incremental Redundancy 0b11: HARQ Conv. Code Incremental Redundancy
<b>CQICH Allocation</b>	1 bit	0: Not Included 1: Included
<b>ACKCH Allocation</b>	1 bit	0: Not Included 1: Optionally included for HARQ users
<b>Pilot Pattern Modifier</b>	1 bit	0: Not Applied 1: Applied Shall be set to 0 if PUSC AAS zone
If (AAS DL Preamble Used) {	—	—

Table 286y—AAS\_SDMA\_DL\_IE (continued)

Syntax	Size	Notes
<b>Preamble Modifier Index</b>	4 bits	Preamble Modifier Index
}	—	—
If (Pilot Pattern Modifier) {	—	—
<b>Pilot Pattern</b>	2 bits	See 8.4.6.3.3.3 (AMC), 8.4.6.1.2.6 (TUSC) 0b00: Pattern #A 0b01: Pattern #B 0b10: Pattern #C 0b11: Pattern #D
<i>Reserved</i>	1 bit	Shall be set to zero
} Else {	—	—
<i>Reserved</i>	3 bits	Shall be set to zero
}	—	—
If (Encoding Mode == 00) {	—	No HARQ
<b>DIUC</b>	4 bits	—
<b>Repetition Coding Indication</b>	2 bits	0b00: No repetition 0b01: Repetition of 2 0b10: Repetition of 4 0b11: Repetition of 6
<i>Reserved</i>	2 bits	Shall be set to zero.
}	—	—
If (Encoding Mode == 01) {	—	HARQ Chase Combining
If (ACKCH Allocation) {	—	—
<b>ACK CH Index</b>	5 bits	—
} Else {	—	—
<i>Reserved</i>	1 bit	Shall be set to zero
}	—	—
<b>DIUC</b>	4 bits	—
<b>Repetition Coding Indication</b>	2 bits	0b00: No repetition 0b01: Repetition of 2 0b10: Repetition of 4 0b11: Repetition of 6
<b>ACID</b>	4 bits	—
<b>AI_SN</b>	1 bit	—
}	—	—
If (Encoding Mode == 10) {	—	HARQ Incremental Redundancy
If (ACKCH Allocation) {	—	—
<b>ACK CH Index</b>	5 bits	See DL Ack channel index in 8.4.5.4.24
} Else {	—	—
<i>Reserved</i>	1 bit	Shall be set to zero.
}	—	—
<b>N<sub>EP</sub></b>	4 bits	—

**Table 286y—AAS\_SDMA\_DL\_IE (continued)**

Syntax	Size	Notes
$N_{SCH}$	4 bits	Indicator for the number of first slots used for data encoding in this SDMA allocation region
<b>SPID</b>	2 bits	—
<b>ACID</b>	4 bits	—
<b>AI_SN</b>	1 bit	—
}	—	—
If (Encoding Mode = 11) {	—	HARQ Conv. Code Incremental Redundancy
If (ACKCH Allocation) {	—	—
<b>ACK CH Index</b>	5 bits	See DL Ack channel index in 8.4.5.4.24
<i>Reserved</i>	2 bits	Shall be set to zero.
} Else {	—	—
<i>Reserved</i>	3 bits	Shall be set to zero
}	—	—
<b>DIUC</b>	4 bits	—
<b>Repetition Coding Indication</b>	2 bits	0b00: No repetition 0b01: Repetition of 2 0b10: Repetition of 4 0b11: Repetition of 6
<b>SPID</b>	2 bits	—
<b>ACID</b>	4 bits	—
<b>AI_SN</b>	1 bit	—
}	—	—
If (CQICH Allocation Included) {	—	—
<b>Allocation Index</b>	6 bits	Index to the channel in a frame the CQI report should be transmitted by the SS
<b>Period (p)</b>	3 bits	A CQI feedback is transmitted on the CQI channels indexed by the (CQI Channel Index) by the SS in every $2^p$ frames
<b>Frame offset</b>	3 bits	The MS starts reporting at the frame of which the number has the same 3 LSB as the specified frame offset. If the current frame is specified, the MS should start reporting in eight frames
<b>Duration (d)</b>	4 bits	A CQI feedback is transmitted on the CQI channels indexed by the (CQI Channel Index) by the SS for $2^{(d-1)}$ frames. If d is 0b0000, the CQICH is de-allocated. If d is 0b1111, the MS should report until the BS command for the MS to stop.
}	—	—
}	—	End of User loop
}	—	End of Burst Region Loop
<b>Padding</b>	<i>variable</i>	—
}	—	—

In an AAS zone with PUSC permutation, all AAS\_SDMA\_DL\_IEs that define allocations in a given major group shall contain the same value for the ‘Number of users’ field. In AAS zone with PUSC, user #*n* uses the pilot pattern as defined for antenna #*n* in 8.4.8.

*Insert a new subclause 8.4.5.3.27:*

#### 8.4.5.3.27 PUSC ASCA Allocation

In the DL-MAP, a BS may transmit DIUC = 15 with the PUSC\_ASCA\_IE() to indicate that data is transmitted to a PUSC-ASCA supporting MS using the PUSC-ASCA permutation. (See Table 286z.)

**Table 286z—PUSC ASCA Allocation**

Syntax	Size	Notes
PUSC_ASCA_Alloc_IE {	—	—
<b>Extended DIUC</b>	4 bits	—
<b>Length</b>	4 bits	Length = 0x06
<b>DIUC</b>	4 bits	—
<b>Short Basic CID</b>	12 bits	12 least significant bits of the Basic CID
<b>OFDMA Symbol offset</b>	8 bits	—
<b>Subchannel offset</b>	6 bits	—
<b>No. OFDMA Symbols</b>	7 bits	—
<b>No. Subchannels</b>	6 bits	—
<b>Repetition Coding Information</b>	2 bits	0b00 = No repetition coding 0b01 = Repetition coding of 2 used 0b10 = Repetition coding of 4 used 0b11 = Repetition coding of 6 used
<b>Permutation ID</b>	4 bits	—
<i>Reserved</i>	7 bits	Shall be set to zero.
}	—	—

#### **DIUC**

DIUC used for the burst.

#### **Short Basic CID**

12 least significant bits of the Basic CID.

#### **OFDMA Symbol offset**

The offset of the OFDMA symbol in which the burst starts, measured in OFDMA symbols from beginning of the downlink frame in which the DL-MAP is transmitted.

#### **Subchannel offset**

The lowest index OFDMA subchannel used for carrying the burst, starting from subchannel 0.

#### **No. OFDMA Symbols**

The number of OFDMA symbols that are used (fully or partially) to carry the downlink PHY Burst.

#### **No. of subchannels**

The number of subchannels with subsequent indexes, used to carry the burst.

#### **Repetition coding Indication**

Indicates the repetition code used inside the allocated burst.

#### **Permutation ID**

Identifies the PUSC ASCA permutation used to carry the burst.

#### 8.4.5.4 UL-MAP IE format

*Change 8.4.5.4 as indicated:*

The OFDMA UL-MAP IE defines uplink bandwidth allocations. Uplink bandwidth allocations are specified either as block allocations (subchannel by symbol) with an absolute offset, or as an allocation with duration in slots with either a relative or absolute slot offset. Block allocations are used for fast feedback (UIUC=0), CDMA ranging and BW request allocations (UIUC=12) as well as PAPR/Safety zone allocations (UIUC=13). Slot allocations are used for all other UL bandwidth allocations. For UL allocations in non-AAS zones, the starting position for the allocation is determined considering the prior allocations appearing in the UL-MAP. For UL allocations in an AAS UL Zone, the starting position is included in the UL IE indicating an absolute slot offset from the beginning of the AAS zone. If an OFDMA UL-MAP IE with UIUC = 0 or UIUC = 12 or UIUC = 13 exists, they ~~must be~~ shall always be allocated first.

~~For the first~~ For the first OFDMA UL-MAP IE, with UIUC other than 0, 12 or 13, the allocation shall start at the lowest numbered non-allocated subchannel on the first non-allocated OFDMA symbol defined by the allocation start time field of the UL-MAP message that is not allocated with UIUC = 0 or UIUC = 12 or UIUC = 13 (See Figure 217 for an example). These IEs shall represent the number of slots provided for the allocation. For allocations not in an AAS zone, Each allocation IE shall start immediately following the previous allocation and shall advance in the time domain axis. If the end of the UL frame zone has been reached, the allocation shall continue at the next subchannel at first OFDMA symbol (define by the allocation start time field) allocated to that zone that is not allocated with UIUC = 0 or UIUC = 12 or UIUC = 13. The CID represents the assignment of the IE to either a unicast, multicast, or broadcast address. A UIUC shall be used to define the type of uplink access and the burst type associated with that access. A Burst Descriptor shall be specified in the UCD for each UIUC to be used in the UL-MAP. For further details on allocations in an UL AAS zone, see 8.4.4.6.

The format of the UL-MAP IE is defined in Table 287.

*Change Table 287 and the text that follows as indicated:*

**Table 287—OFDMA UL-MAP IE format**

Syntax	Size	Notes
UL-MAP_IE() {	—	—
<b>CID</b>	16 bits	—
<b>UIUC</b>	4 bits	—
if (UIUC == 11) {		
<b><u>Extended UIUC 2 dependent IE</u></b>	<i>variable</i>	See 8.4.5.4.4.2
}		
elseif (UIUC == 12) {	—	—
<b>OFDMA symbol offset</b>	8 bits	—
<b>Subchannel offset</b>	7 bits	—
<b>No. OFDMA symbols</b>	7 bits	—
<b>No. subchannels</b>	7 bits	—

**Table 287—OFDMA UL-MAP IE format (continued)**

Syntax	Size	Notes
<b>Ranging method</b>	2 bits	0b00 – Initial Ranging/ <u>Handover Ranging</u> over two symbols 0b01 – Initial Ranging/ <u>Handover Ranging</u> over four symbols 0b10 – BW Request/Periodic Ranging over one symbol 0b11 – BW Request/Periodic Ranging over three symbols
<del>Reserved</del> <u>Dedicated ranging indicator</u>	1 bit	<del>shall be set to zero</del> <u>0: the OFDMA region and Ranging Method defined are used for the purpose of normal ranging</u> <u>1: the OFDMA region and Ranging Method defined are used for the purpose of ranging using dedicated CDMA code and transmission opportunities assigned in the MOB_PAG-ADV message or in the MOB_SCN-RSP message.</u>
<del>} else if (UIUC == 13) {</del>	<del>=</del>	<del>—</del>
<u>PAPR Reduction and Safety Zone Allocation IE</u>	<u>32 bits</u>	—
<del>} else if (UIUC == 14) {</del>	<del>—</del>	<del>—</del>
<u>CDMA_Allocation_IE()</u>	32 bits	—
<del>} else if (UIUC == 15) {</del>	<del>—</del>	<del>—</del>
<b>Extended UIUC dependent IE</b>	<i>variable</i>	See subclauses following 8.4.5.4.3
<del>} else if (UIUC == 0) {</del>	<del>=</del>	<del>=</del>
<u>FAST-FEEDBACK_Allocation_IE()</u>	<u>32 bits</u>	<u>=</u>
<del>} else {</del>	<del>—</del>	<del>—</del>
<b>Duration</b>	10 bits	In OFDMA slots (see 8.4.3.1)
<b>Repetition coding indication</b>	2 bits	0b00 – No repetition coding 0b01 – Repetition coding of 2 used 0b10 – Repetition coding of 4 used 0b11 – Repetition coding of 6 used
<u>if (AAS or AMC UL Zone) {</u>	<u>=</u>	<u>AAS/AMC Allocations include absolute slot offset.</u>
<u>Slot offset</u>	<u>12 bits</u>	<u>Offset from start of the AAS or AMC zone for this allocation, specified in slots.</u>
<del>}</del>	<del>—</del>	<del>—</del>
<del>}</del>	<del>—</del>	<del>—</del>
<del>Padding nibble, if needed</del>	<del>4 bits</del>	<del>Completing to nearest byte, shall be set to 0.</del>
<del>}</del>	<del>—</del>	<del>—</del>

**CID**

Represents the assignment of the IE to which the IE is assigned.

**UIUC**

UIUC used for the burst.

**OFDMA Symbol offset**

The offset of the OFDMA symbol in which the burst starts, the offset value is defined in units of OFDMA symbols and is relevant to the Allocation Start Time field given in the UL-MAP message.

**Subchannel offset**

The lowest index subchannel used for carrying the burst, starting from subchannel 0. ~~When allocation of mini-subchannels is used, this offset will always be even numbered and will point to the first subchannel of the couple splitted into mini-subchannels and used in the allocation.~~

**No. OFDMA Symbols**

The number of OFDMA symbols that are used to carry the uplink Burst.

**No. subchannels**

The number of subchannels with subsequent indices.

**Duration**

Indicates the duration, in units of OFDMA slots, of the allocation.

**Repetition coding indication**

Indicates the repetition code used inside the allocated burst. Repetition shall be used only for UIUC indicating QPSK modulation.

When a ranging allocation (UIUC = 12) is present in the UL-MAP, and the SS is in ranging backoff state, it shall count the ranging opportunities present in the ranging region. Only ranging allocations allocated in permutation zones supported by the SS, and matching the type of backoff the SS (ranging or BW request) shall be considered as containing relevant ranging opportunities.

The subchannel offsets in all formats of UL-MAP\_IE are referred to logical subchannels before applying the mapping indicated by UL subchannels bitmap in UCD and rotation scheme (see 8.4.6.2.6) for the uplink.

For Sub-UL-DL-MAPs, the current UL zone is automatically reset to the first UL zone at the beginning of a new Sub-MAP. The current UL zone is thereafter updated whenever an UL-MAP IE contains an explicit OFDMA symbol offset.

*Change the title of 8.4.5.4.1 as indicated:*

**8.4.5.4.1 UIUC Allocation**

*Change the second sentence of the first paragraph as indicated:*

~~These tones~~ The data subcarriers within these subchannels may be used by all SSs to reduce PAPR of their transmissions.

*Change Table 288 as indicated:*

**Table 288—OFDMA UIUC values**

UIUC	Usage
0	FAST-FEEDBACK Channel
1–10	Different burst profiles ( <u>Data Grant Burst Type</u> )
11	<del>End of Map IE</del> <u>Extended UIUC 2 IE</u>
12	CDMA Bandwidth Request, CDMA Ranging
13	PAPR reduction allocation, Safety zone
14	CDMA Allocation IE
15	Extended UIUC



*Insert the following sentence at the beginning of the paragraph below Table 288:*

The UIUC=0 is used for allocation of FAST-FEEDBACK channel region. There shall not be more than one UL-MAP\_IE with UIUC = 0 for a UL frame.

*Change the last paragraph from Note style to normative text style.*

*Change subclause 8.4.5.4.2 title as indicated:*

**8.4.5.4.2 PAPR reduction/Safety zone/Sounding zone allocation IE**

*Change Table 289 as indicated:*

**Table 289—PAPR reduction, and safety zone, and sounding zone  
allocation IE format**

Syntax	Size	Notes
PAPR_Reduction_and_Safety_Sounding_Zone_Allocation_IE() {	—	—
<b>OFDMA symbol offset</b>	8 bits	—
<b>Subchannel offset</b>	7 bits	—
<b>No. OFDMA symbols</b>	7 bits	—
<b>No. subchannels</b>	7 bits	—
<b>PAPR Reduction/Safety Zone</b>	1 bit	0 = PAPR reduction allocation 1 = Safety zone allocation
<b><u>Sounding Zone</u></b>	<u>1 bit</u>	<u>0 = PAPR/Safety Zone</u> <u>1 = Sounding Zone Allocation</u>
<i>Reserved</i>	<u>21 bit</u>	Shall be set to zero
}	—	—

*Change the fields descriptions below Table 289:*

**OFDMA ~~S~~symbol offset**

The offset of the OFDMA symbol in which the ~~burst~~PAPR-reduction/safety-zone starts, the offset value is defined in units of OFDMA symbols and is relevant to the Allocation Start Time field given in the UL-MAP message.

**Subchannel offset**

The lowest index subchannel that are used for ~~carrying~~ the ~~burst~~PAPR-reduction/safety-zone, starting from subchannel 0.

**No. OFDMA ~~S~~ymbols**

The number of OFDMA symbols that are used ~~to carry~~for the uplink ~~Burst~~PAPR-reduction/safety-zone.

**Number of subchannels**

The number of subchannels with subsequent indexes that are used ~~to carry~~for the ~~burst~~PAPR-reduction/safety-zone.

### 8.4.5.4.3 CDMA allocation UL-MAP IE format

*Change Table 290 as indicated:*

**Table 290—CDMA Allocation IE format**

Syntax	Size	Notes
CDMA_Allocation_IE() {		
<b>Duration</b>	6 bits	
<b><u>UIUC</u></b>	<u>4 bits</u>	<u>UIUC for transmission</u>
<b>Repetition Coding Indication</b>	2 bits	0b00 – No repetition coding 0b01 – Repetition coding of 2 used 0b10 – Repetition coding of 4 used 0b11 – Repetition coding of 6 used
<b><u>Frame Number Index</u></b>	<u>4 bits</u>	<u>LSBs of relevant frame number</u>
<b>Ranging Code</b>	8 bits	
<b>Ranging Symbol</b>	8 bits	
<b>Ranging subchannel</b>	7 bits	
<b>BW request mandatory</b>	1 bit	1= yes, 0= no
}		

*Insert the following text below Table 290:*

**Frame Number Index**

Identifies the frame in which the CDMA code, which this message responds to, was transmitted. The four least significant bits of the frame number are used as the frame number index.

### 8.4.5.4.4 UL-MAP extended IE format

*Insert new subclause 8.4.5.4.4.1, containing the text currently in 8.4.5.4.4.*

#### 8.4.5.4.4.1 UL-MAP extended IE format

*Insert the following text and table at the end of the new 8.4.5.4.4.1:*

Table 290a defined the encoding for Extended UIUC that shall be used by UL-MAP extended IEs.

**Table 290a—Extended UIUC Code Assignment for UIUC=15**

Extended UIUC (hexadecimal)	Usage
00	Power_control_IE
01	Mini-subchannel_allocation_IE
02	AAS_UL_IE
03	CQICH_Alloc_IE
04	UL Zone IE
05	PHYMOD_UL_IE
06	MIMO_UL_Basic_IE
07	UL-MAP_Fast_Tracking_IE
08	UL_PUSC_Burst_Allocation_in_Other_Segment_IE
09	Fast_Ranging_IE
0A	UL Allocation Start IE
0B ... 0F	<i>Reserved</i>

*Insert new subclause 8.4.5.4.4.2:*

**8.4.5.4.4.2 UL-MAP extended-2 IE format**

A UL-MAP IE entry with a UIUC value of 11, indicates that the IE carries special information and conforms to the structure shown in Table 290b. A station shall ignore an extended-2 IE entry with an extended-2 UIUC value for which the station has no knowledge. In the case of a known extended-2 UIUC value but with a length field longer than expected, the station shall process information up to the known length and ignore the remainder of the IE.

**Table 290b—UL-MAP extended-2 IE format**

Syntax	Size	Note
UL_extended-2_IE() {	—	—
<b>Extended-2 UIUC</b>	4 bits	0x00 ... 0x0F
<b>Length</b>	8 bits	Length in bytes of Unspecified data field
<b>Unspecified Data</b>	<i>variable</i>	—
}	—	—

Table 290c defines the encoding for Extended-2 UIUC that shall be used by UL-MAP extended-2 IEs.

**Table 290c—Extended-2 UIUC Code Assignment for UIUC=11**

Extended-2 Type (hexadecimal)	Usage
00	CQICH_Enhanced Allocation_IE
01	HO_Anchor_Active_UL-MAP_IE
02	HO_Active Anchor UL MAP
03	Anchor_BS_switch_IE
04	UL_sounding_command_IE
05	<i>Reserved</i>
06	MIMO UL Enhanced IE
07	HARQ UL MAP IE
08	HARQ ACKCH Region Allocation IE
09 ... 0D	<i>Reserved</i>
0E	AAS_SDMA_UL_IE
0F	Feedback_polling_IE

**8.4.5.4.5 Power Control IE format**

*Change Table 292 as indicated:*

**Table 292—OFDMA Power Control IE**

Syntax	Size	Notes
Power_Control_IE() {		
<b>Extended UIUC</b>	4 bits	Fast power control = 0x00
<b>Length</b>	4 bits	Length = 0x0+ <u>2</u>
<b>Power control</b>	8 bits	Signed integer, which expresses the change in power level (in 0.25 dB units) that the SS should apply to correct its current transmission power.
<b><u>Power measurement frame</u></b>	<u>8 bits</u>	
}		

*Insert the following text below Table 292:*

**Power measurement frame**

The 8 LSB of the frame number in which the BS measured the power corrections referred to in the message.

Change the title of 8.4.5.4.6 as indicated:

**8.4.5.4.6 AAS uplink IE format**

Change the subclause as indicated:

Within a frame, the switch from non-AAS to AAS-enabled traffic is marked by using the extended UIUC = 15 with the AAS\_UL\_IE() to indicate that the subsequent allocation ~~until the end of the frame~~ shall be for AAS traffic. The AAS\_UL\_IE defines a UL AAS Zone that spans continuous OFDMA symbols of length defined by the AAS zone length field. Multiple UL AAS Zones can exist within the same frame. When used, the CID in the UL-MAP\_IE() shall be set to the broadcast CID. All UL bursts in the AAS portion of the frame may be preceded by an AAS preamble based on the indication in the AAS\_UL\_IE(). The preamble is defined in 8.4.9.4.3-18.4.4.6.4.2.

**Table 293—OFDMA uplink AAS uplink IE**

Syntax	Size	Notes
AAS_UL_IE() {		
<b>Extended UIUC</b>	4 bits	AAS = 0x02
<b>Length</b>	4 bits	Length = 0x034
<b>Permutation</b>	2 bits	0b00 = PUSC permutation 0b01 = Optional PUSC permutation 0b10 = adjacent-subcarrier permutation 0b11 = <i>Reserved</i>
<b><u>UL PermBase</u></b>	<u>7 bits</u>	
<b>OFDMA symbol offset</b>	8 bits	
<b><u>AAS zone length</u></b>	<u>8 bits</u>	<u>Number of OFDMA symbols in AAS zone</u>
<b><u>Preamble indication- Uplink preamble config</u></b>	2 bits	0b00 = No preamble 0b01 = Preamble used 0b10-0b11 = <i>Reserved</i> <u>0b00 - 0 symbols</u> <u>0b01 - 1 symbols</u> <u>0b10 - 2 symbols</u> <u>0b11 - 3 symbols</u>
<b><u>Preamble type</u></b>	<u>1 bit</u>	<u>0 – Frequency shifted preamble is used in this UL AAS zone</u> <u>1 – Time shifted preamble is used in this UL AAS zone</u>
<b><u>First bin index</u></b>	6 bits	When Permutation = 0b10, this indicates the index of the first band allocated to this AMC segment
<b><u>Last bin index</u></b>	6 bits	When Permutation = 0b10, this indicates the index of the last band allocated to this AMC segment
<i>Reserved</i>	4 bits	<u>Shall be set to zero</u>
}		

**Permutation**

Defines the permutation used within the UL AAS Zone

**UL PermBase**

Permutation Base for specified UL AAS Zone

**OFDMA Symbol offset**

The symbol offset of the UL AAS Zone. This is referenced to the ‘Allocation Start Time’ field in the UL-MAP.

**Uplink preamble config**

Defines the number of UL AAS preambles to be used before each UL burst in the AAS Zone.

Following AAS\_IE indicating AMC permutation, the AMC type shall be 2x3 (2 bins by 3 symbols).

**8.4.5.4.7 UL Zone switch IE format**

*Change the first paragraph as indicated:*

In the UL-MAP, a BS may transmit UIUC = 15 with the UL\_ZONE\_IE() to indicate that the subsequent allocations shall use a specific permutation. UL\_Zone\_IE() may appear ahead of all uplink allocation IE and indicate the permutation of the first and the following slots. If UL\_Zone\_IE() does not appear ahead of all uplink allocation IEs, the uplink frame shall start in PUSC mode with UL\_HoehHPermBase as indicated in the UCD message. Allocations subsequent to this IE shall use the permutation it instructs. No burst allocation or ranging channel allocation shall span multiple zones.

*Change Table 294 as indicated:*

**Table 294—OFDMA uplink ZONE IE format**

Syntax	Size	Notes
<u>UL_ZONE_IE()</u> {		
<b>Extended UIUC</b>	4 bits	<u>UL_ZONE</u> = 0x04
<b>Length</b>	4 bits	Length = 0x03
<b>OFDMA symbol offset</b>	7 bits	
<b>Permutation</b>	2 bits	0b00 = PUSC permutation <del>0b01 = PUSC permutation</del> <del>0b10 = Optional PUSC permutation</del> 0b01 = Optional PUSC permutation <del>0b11 = Adjacent subcarrier permutation</del> <u>0b11 = Reserved</u>
<del>PUSC</del> <u>UL_HoehHPermBase</u>	7 bits	
<b><u>AMC type</u></b>	<u>2 bits</u>	<u>Indicates the AMC type in case permutation type = 0b10, otherwise shall be set to 0.</u>  <u>AMC type (NxM = N bins by M symbols):</u> <u>0b00 - 1x6</u> <u>0b01 - 2x3</u> <u>0b10 - 3x2</u> <u>0b11 - Reserved</u>
<b><u>Use All SC indicator</u></b>	<u>1 bit</u>	<u>0 = Do not use all subchannels</u> <u>1 = Use all subchannels</u>
<i>Reserved</i>	<u>5 bits</u>	<u>Shall be set to zero</u>
}		

*Insert the following at the end of 8.4.5.4.7*

This IE should not be used within SUB-DL-UL-MAP.

*Change the definition of ‘Permutation’ field below Table 294 as indicated:*

**Permutation**

Indicates the permutation that shall be used by the transmitter for allocations following this IE. Permutation changes are only allowed on a zone boundary. The UL ~~Depth~~PermBase indicated by the IE shall be used as the basis of the permutation (see 8.4.6.2.2, 8.4.6.2.3).

*Insert the following text after the end of Table 294:*

**Use all SC indicator**

When the ‘Use All SC indicator’ is set to 0, subchannels indicated by allocated subchannel bit-map in UCD shall be used. Otherwise, all subchannels shall be used.

**8.4.5.4.8 Mini-subchannel allocation IE**

*Change Table 295 as indicated:*

**Table 295—Mini-subchannel allocation IE format**

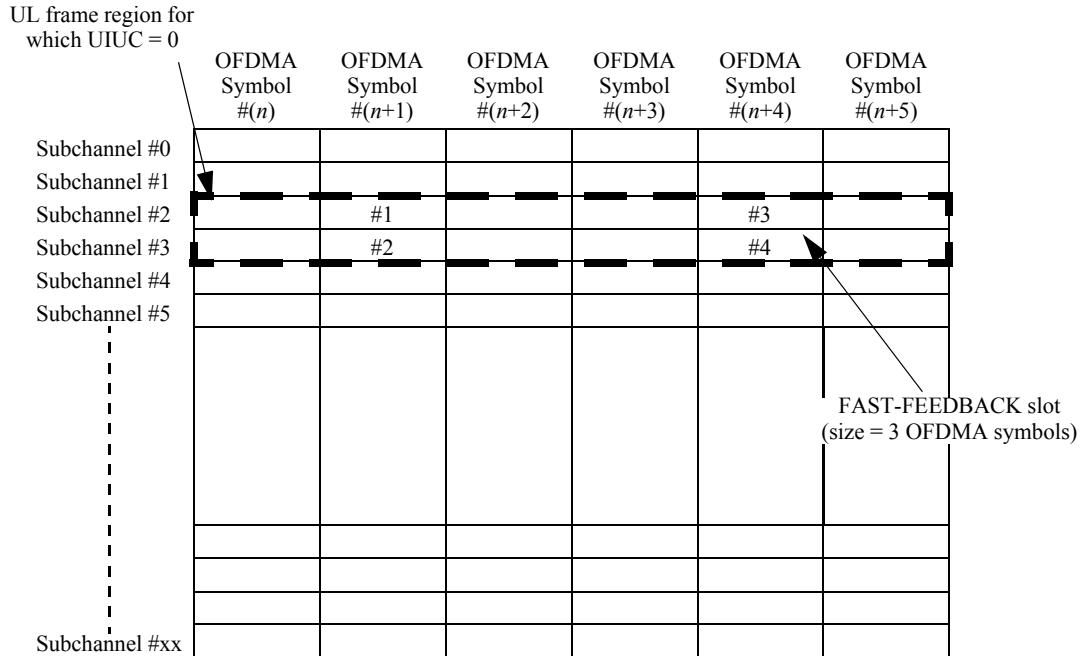
Syntax	Size	Notes
Mini_subchannel_allocation_IE() {		
<b>Extended <del>DU</del>UIUC</b>	4 bits	Mini_subchannel_allocation = 0x01
<b>Length</b>	4 bits	Length(M) = 0x037 if M=2 0x049 if M=3 0x06f if M=6
<b>CType</b>	2 bits	0b00 – 2 mini-subchannels (defines M=2) 0b01 – 2 mini-subchannels (defines M=2) 0b10 – 3 mini-subchannels (defines M=3) 0b11 – 6 mini-subchannels (defines M=6)
<b>Duration</b>	<del>406</del> bits	In OFDMA slots
For (j=0; j<M; j++) {		
<b>CID(j)</b>	16 bits	
<b>UIUC(j)</b>	4 bits	Allowed values are 1–10
<b>Repetition(j)</b>	2 bits	Indicates the repetition code used inside the allocated burst for minisubchannel with index j 0b00 – No repetition coding 0b01 – Repetition coding of 2 used 0b10 – Repetition coding of 4 used 0b11 – Repetition coding of 6 used  <u>Repetition shall be used only for M=2 or M=3</u>
}		
<b>Padding</b>	n bits	Padding bits shall be set to zero n = 0 if M=2 24 if M=3 0 if M=6
}		

### 8.4.5.4.9 FAST-FEEDBACK message mapping

*Change the subclause as indicated:*

Each FAST-FEEDBACK message occupies one UL slot. FAST-FEEDBACK messages are mapped in to the region marked by UIUC=0 in the UL-MAP, in a ~~time~~frequency-first order, as shown in Figure 230.

*Replace Figure 230 with the following figure:*



**Figure 230—Mapping order of FAST-FEEDBACK messages to the FAST-FEEDBACK region**

*Insert the following text at the end of the subclause:*

The FAST-FEEDBACK region shall be allocated using the FAST-FEEDBACK allocation IE as defined in [Table 295a](#).

**Table 295a—FAST-FEEDBACK allocation IE format**

Syntax	Size	Notes
FASTFEEDBACK_allocation_IE() {		
<b>OFDMA symbol offset</b>	8 bits	
<b>Subchannel offset</b>	7 bits	
<b>No. OFDMA symbols</b>	7 bits	
<b>No subchannels</b>	7 bits	
<i>Reserved</i>	3 bits	
}		



*Change the title of 8.4.5.4.10 as indicated:*

#### **8.4.5.4.10 FAST\_FEEDBACK Fast-feedback channels**

*Change the second sentence of the first paragraph as indicated:*

The allocations are done in unicast manner through the FAST\_FEEDBACK MAC subheader (see 6.3.2.2.6), COICH Control IE (see 6.3.2.3.43.5) or COICH Allocation IE (see 8.4.5.4.12), and the transmission takes place in a specific UL region designated by UIUC = 0.

*Change the paragraph below Table 296 as indicated:*

The fast-feedback code words used in Table 296 belong to a set of orthogonal vectors and are mapped directly to the data subcarriers of a tile in frequency first order starting from the first OFDMA symbol (see 8.4.9.4.2), where subcarriers(0) is the lowest numbered data subcarrier in the tile, and the tile indices are defined in Equation (113) for PUSC and Equation (115) for optional PUSC by the permutation (see 8.4.6.2). The vectors are defined in Table 297.

*Replace Equation (106) with the following equation:*

$$\begin{aligned}
 P0 &= \exp\left(j \cdot \frac{\pi}{4}\right) \\
 P1 &= \exp\left(j \cdot \frac{3\pi}{4}\right) \\
 P2 &= \exp\left(-j \cdot \frac{3\pi}{4}\right) \\
 P3 &= \exp\left(-j \cdot \frac{\pi}{4}\right)
 \end{aligned} \tag{106}$$

*Change the last paragraph as indicated:*

The fast feedback slot includes 4 bits of payload data, whose encoding depended on the instruction given in the FAST\_FEEDBACK subheader, COICH Control IE and COICH Allocation IE. The following subclauses define these encodings.

##### **8.4.5.4.10.1 Fast DL measurement feedback**

*Insert the following text at the beginning of subclause 8.4.5.4.10.1:*

MIMO capable MS shall measure post processing CINR for each individual layers as shown in Figure 230a. When the FAST\_FEEDBACK subheader Feedback Type field is "00", the MS shall report the post processing average CINR (Avg\_CINR) as defined in Equation (106a). When BS requests MS feedback through COICH\_Alloc\_IE() or COICH\_Enhanced\_Alloc\_IE() with '00' feedback\_type field, MS shall report Avg\_CINR or individual layer CINR as described in 8.4.5.4.12 and 8.4.5.4.16.

For vertically encoded MIMO system, defined the averaged CINR (Avg\_CINR) as :

$$\underline{Avg\_CINR = e^{C(d,y|H)} - 1} \tag{106a}$$

where  $C(d,y|H)$  is the receiver-constrained mutual information conditioned on knowing the channel knowledge. Note that  $d$  is the transmitted signal,  $y$  is the post-processing receive signal and  $H$  is the channel matrix

between transmit and receive antennas. For LMMSE receiver, the individual post-detector-processing signal to noise ratios are given as  $CINR_1, \dots, CINR_N$ , as shown in Figure 230a and in Equation (106b).

$$C(d, y|H) = \frac{1}{N} \sum_{n=1}^N \log(1 + CINR_n) \quad (106b)$$

In this case,

$$Avg\_CINR = \left( \prod_{n=1}^N (1 + CINR_n) \right)^{1/N} - 1 \quad (106c)$$

when the individual post-detector processing CINR is high, the average CINR is

$$Avg\_CINR \approx \frac{1}{N} \sum_{n=1}^N CINR_n \text{ (in dB)} \quad (106d)$$

For ML MIMO detectors case,

$$C(d, y|H) = \frac{1}{N} \log \det(I_N + H^H R^{-1} H) \quad (106e)$$

where

$I_N$  is an  $N$  by  $N$  identity matrix.

$R$  is the correlation matrix of interference plus noise measured at MS.

**Change 8.4.5.4.10.1 as indicated:**

~~When the FAST\_FEEDBACK subheader Feedback Type field is “00” the SS shall report the S/N it measures on the DL. Equation (107) shall be used:~~

$$\text{Payload bits nibble} = \begin{cases} 0, & S/N < -2dB \\ n, & 2 \cdot n - 4 < S/N < 2 \cdot n - 2, \quad 0 < n < 15 \\ 15, & S/N > 26dB \end{cases} \quad (107)$$

When the Feedback type field in CQICH\_Enhanced\_Alloc\_IE() is 0b000 with CQICH type 0b101, Equation (107) shall be used:

$$\text{Payload bits nibble} = \begin{cases} 0, & S/N \leq 1 - B \\ n, & (2n - 1 - B) < S/N \leq (2n + 1 - B), \quad 0 < n < 15 \\ 15, & S/N > 29 - B \end{cases} \quad (107)$$

where B is the positive integer value indicated in the SN Reporting Base TLV (see 11.7.26). B shall default to “3” if the SN Reporting Base TLV was not included in the REG-RSP.

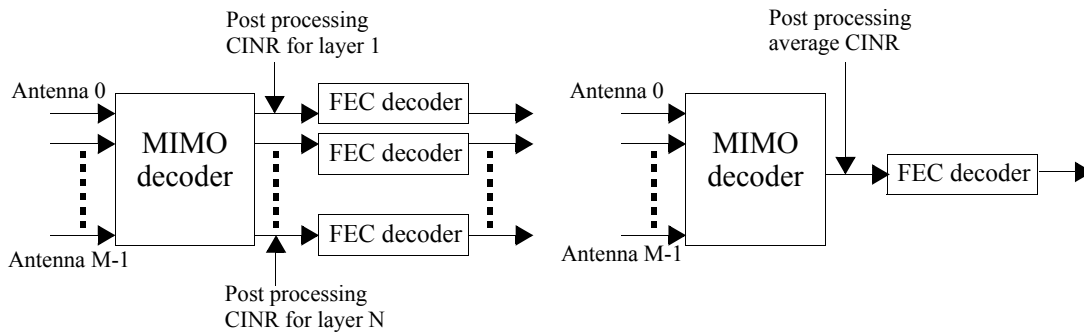
**Insert the following at the end of 8.4.5.4.10.1:**

For an MS that supports the feedback method by using Feedback header, if  $M$  is defined as the indication flag in UCD, the MS shall set the payload bits nibble as  $M-1$  instead of  $M$ , if the outcome of payload bits nibble calculation based on Equation (107) is  $M$ .

For band AMC operation, the SS shall report differential of CINR of four selected bands (increment: 1 and decrement: 0 with a step of 1 dB) on its fast-feedback channel.

MIMO capable SS shall measure post processing CINR for each individual layers as shown in Figure 230a. The SS shall report the post processing CINR averaged over layers. When the BS requests SS feedback through CQICH Alloc IE() SS shall report average CINR or individual layer CINR as described in 8.4.5.4.12. The layer is defined as a separate coding/modulation path.

**Insert new Figure 230a:**



**Figure 230a—Post processed CINR for MIMO region**

For SS with more than one receive antennas, Equation (107a) shall be used:

$$\text{Payload bits Nibble} = \begin{cases} 0 & \text{CINR} < (-2 - \Delta\text{dB}) \\ n & 2n - 2 - \Delta\text{dB} < \text{CINR} < (2n - 2 - \Delta\text{dB}) \quad 0 < n < 15 \\ 15 & \text{CINR} > 26 - \Delta\text{dB} \end{cases} \quad (107a)$$

where

$\Delta = 10 \log(Nr)$  for the cases of single transmit antenna BS or 2 and 4 transmit antenna BS using matrix A transmission format.

$\Delta = 10 \log(Nr/2)$  for the case of 2 and 4 transmit antennas BS using matrix B transmission format.  $Nr$  is the number of receive antennas.

**8.4.5.4.10.2 Fast MIMO feedback**

**Insert the following text at the end of 8.4.5.4.10.2:**

When CQI Feedback Type field in CQICH\_Enhanced\_Alloc\_IE() (see 8.4.5.4.15) is 0b011 and CQICH type is 0b101, the MS shall report the MIMO coefficient the BS should use for best DL reception. The mapping for the complex weights is shown in Figure 231. For this type of feedback, if  $N$  is the number of BS transmit antennas, then  $(N-1)$  CQICH shall be allocated to the MS and MS shall report the desired antenna weights of antenna 1 through  $N-1$  based on antenna 0.

### 8.4.5.4.10.3 Mode Selection Feedback

*Change the first sentence of the first paragraph as indicated:*

For an SS that supports the STC option (see 8.4.8), ~~W~~hen the FAST-FEEDBACK subheader Feedback Type field is “11” or at a specific frame indicated in the CQICH\_Alloc\_IE(), the SS shall send its selection in terms of MIMO mode (STTD versus SM) or permutation mode on the assigned FAST-FEEDBACK channel.

*Change Table 298 as indicated:*

**Table 298—Encoding of payload bits for Fast-feedback slot**

Value (binary)	Description
0b0000	STTD and PUSC/FUSC permutation
0b0001	STTD and adjacent-subcarrier permutation
0b0010	SM and PUSC/FUSC permutation
0b0011	SM and adjacent-subcarrier permutation
<u>0b0100</u>	<u>Closed-loop SM and PUSC/FUSC permutation</u>
<u>0b0101</u>	<u>Closed-loop SM and adjacent-subcarrier permutation</u>
<u>0b0110</u>	<u>Closed-loop SM + Beamforming and adjacent-subcarrier permutation</u>
<u>0b0111</u>	<u>Antenna Group A1 for rate 1</u> <u>For 3-antenna BS, See 8.4.8.3.4.1</u> <u>For 4-antenna BS, See 8.4.8.3.5.1</u>
<u>0b1000</u>	<u>Antenna Group A2 for rate 1</u>
<u>0b1001</u>	<u>Antenna Group A3 for rate 1</u>
<u>0b1010</u>	<u>Antenna Group B1 for rate 2</u> <u>For 3-antenna BS, see 8.4.8.3.4.2</u> <u>For 4-antenna BS, see 8.4.8.3.5.2</u>
<u>0b1011</u>	<u>Antenna Group B2 for rate 2</u>
<u>0b1100</u>	<u>Antenna Group B3 for rate 2</u>
<u>0b1101</u>	<u>Antenna Group B4 for rate 2 (only for 4-antenna BS)</u>
<u>0b1110</u>	<u>Antenna Group B5 for rate 2 (only for 4-antenna BS)</u>
<u>0b1111</u>	<u>Antenna Group B6 for rate 2 (only for 4-antenna BS)</u>

*Insert new table at the end of 8.4.5.4.10.3:*

**Table 298a—Encoding of payload bits for secondary Fast-feedback slot**

Value (binary)	Description
0000	Antenna selection option 0 (see Table 316f for 3 Tx and Table 316g for 4Tx)
0001	Antenna selection option 1 (see Table 316f for 3 Tx and Table 316g for 4Tx)
0010	Antenna selection option 2 (see Table 316f for 3 Tx and Table 316g for 4Tx)
0011	Antenna selection option 3 (see Table 316f for 3 Tx and Table 316g for 4Tx)
0100	Antenna selection option 4 (see Table 316f for 3 Tx and Table 316g for 4Tx)
0101	Antenna selection option 5 (see Table 316f for 3 Tx and Table 316g for 4Tx)
0110	Antenna selection option 6 (see Table 316f for 3 Tx and Table 316g for 4Tx)
0111	Antenna selection option 7 (see Table 316f for 3 Tx and Table 316g for 4Tx)
1000	Reduced Precoding matrix codebook entry 0
1001	Reduced Precoding matrix codebook entry 1
1010	Reduced Precoding matrix codebook entry 2
1011	Reduced Precoding matrix codebook entry 3
1100	Reduced Precoding matrix codebook entry 4
1101	Reduced Precoding matrix codebook entry 5
1110	Reduced Precoding matrix codebook entry 6
1111	Reduced Precoding matrix codebook entry 7

*Insert new subclause 8.4.5.4.10.4:*

**8.4.5.4.10.4 Effective CINR feedback for fast-feedback channel**

When the feedback type field in the CQICH\_IE() is 0b01 or the effective CINR report is request by REP-REQ, the SS shall report the effective CINR, as defined in 6.3.18, according to Table 298b. To avoid ambiguity, both the BS and the SS must know the FEC type assumed for this report. The FEC type assumed for the MCS column is the first FEC type in the table in 11.8.3.7.2 for which the SS and BS have successfully negotiated the capability exchange. If none of the FEC types in 11.8.3.7.2 have been successfully negotiated, then the mandatory FEC type shall be assumed.

**Table 298b—Effective CINR feedback encoding**

Label	Encoding	MCS
0	0b0000	QPSK 1/2, repetition 6
1	0b0001	QPSK 1/2, repetition 4
2	0b0010	QPSK 1/2, repetition 2
3	0b0011	QPSK 1/2

**Table 298b—Effective CINR feedback encoding (continued)**

Label	Encoding	MCS
4	0b0100	QPSK 3/4
5	0b0101	16-QAM 1/2
6	0b0110	16-QAM 3/4
7	0b0111	64-QAM 1/2
8	0b1000	64-QAM 2/3
9	0b1001	64-QAM 3/4
10	0b1010	64-QAM 5/6
11	0b1011	A decrease in CQICH duration is recommended (effective CINR has not changed from previous CQICH slot). This encoding shall not be repeated over consecutive CQI slots.
12-15	0b1100-0b1111	Reserved

*Insert new subclause 8.4.5.4.10.5*

**8.4.5.4.10.5 Enhanced Fast-feedback channels**

Enhanced Fast-feedback slots may be individually allocated to an MS for transmission of PHY related information that requires fast response from the MS. The allocations are done either in a unicast manner through the Fast-feedback allocation subheader (see 6.3.2.2.6), or through the CQICH\_Control IE() (see 6.3.2.3.43.5), or through the CQICH\_Alloc\_IE() (see 8.4.5.4.12), or through the CQICH\_Enhanced\_Alloc\_IE() (see 8.4.5.4.16), or through the MIMO Compact DL-MAP IE() (see 6.3.2.3.43.6.7), Dedicated MIMO DL Control IE (8.4.5.3.21.1), AAS\_SDMA\_DL\_IE (8.4.5.4.26). The transmission takes place in a specific UL region designated by UIUC = 0.

Each 3-bit MIMO Fast-feedback slot consists of 1/2 OFDMA slots mapped in a manner similar to the mapping of ACK Channel. An Enhanced Fast-feedback slot uses QPSK modulation on the 24 data subcarriers it contains, and can carry a data payload of 3 bits. Table 298c defines the mapping between the payload bit sequences and the subcarriers modulation.

**Table 298c— 3-bit MIMO Fast-feedback channel subcarrier modulation**

3-bit payload (binary)	Fast Feedback vector indices per Tile Even = {Tile(0), Tile(2), Tile(4)} or Odd = {Tile(1), Tile(3), Tile(5)}
000	0,0,0
001	1,1,1
010	2,2,2
011	3,3,3
100	4,4,4
101	5,5,5
110	6,6,6
111	7,7,7

Each Enhanced Fast-feedback slot consists of 1 OFDMA slots mapped in a manner similar to the mapping of normal uplink data. An Enhanced Fast-feedback slot uses QPSK modulation on the 48 data subcarriers it contains and can carry a data payload of 6 bits. Table 298d defines the mapping between the payload bit sequences and the subcarriers modulation.

**Table 298d—Enhanced Fast-feedback channel subcarrier modulation**

6-bit Payload (binary)	Fast-feedback vector indices per Tile Tile(0), Tile(1), ... Tile(5)	6-bit Payload (binary)	Fast-feedback vector indices per Tile Tile(0), Tile(1), ... Tile(5)
000000	0,0,0,0,0,0	100000	6,7,5,1,2,4
000001	1,1,1,1,1,1	100001	7,6,4,0,3,5
000010	2,2,2,2,2,2	100010	4,5,7,3,0,6
000011	3,3,3,3,3,3	100011	5,4,6,2,1,7
000100	4,4,4,4,4,4	100100	2,3,1,5,6,0
000101	5,5,5,5,5,5	100101	3,2,0,4,7,1
000110	6,6,6,6,6,6	100110	0,1,3,7,4,2
000111	7,7,7,7,7,7	100111	1,0,2,6,5,3
001000	2,4,3,6,7,5	101000	7,5,1,2,4,3
001001	3,5,2,7,6,4	101001	6,4,0,3,5,2
001010	0,6,1,4,5,7	101010	5,7,3,0,6,1
001011	1,7,0,5,4,6	101011	4,6,2,1,7,0
001100	6,0,7,2,3,1	101100	3,1,5,6,0,7
001101	7,1,6,3,2,0	101101	2,0,4,7,1,6
001110	4,2,5,0,1,3	101110	1,3,7,4,2,5
001111	5,3,4,1,0,2	101111	0,2,6,5,3,4
010000	4,3,6,7,5,1	110000	5,1,2,4,3,6
010001	5,2,7,6,4,0	110001	4,0,3,5,2,7
010010	6,1,4,5,7,3	110010	7,3,0,6,1,4
010011	7,0,5,4,6,2	110011	6,2,1,7,0,5
010100	0,7,2,3,1,5	110100	1,5,6,0,7,2
010101	1,6,3,2,0,4	110101	0,4,7,1,6,3
010110	2,5,0,1,3,7	110110	3,7,4,2,5,0
010111	3,4,1,0,2,6	110111	2,6,5,3,4,1
011000	3,6,7,5,1,2	111000	1,2,4,3,6,7
011001	2,7,6,4,0,3	111001	0,3,5,2,7,6
011010	1,4,5,7,3,0	111010	3,0,6,1,4,5

**Table 298d—Enhanced Fast-feedback channel subcarrier modulation (continued)**

6-bit Payload (binary)	Fast-feedback vector indices per Tile Tile(0), Tile(1), ... Tile(5)	6-bit Payload (binary)	Fast-feedback vector indices per Tile Tile(0), Tile(1), ... Tile(5)
011011	0,5,4,6,2,1	111011	2,1,7,0,5,4
011100	7,2,3,1,5,6	111100	5,6,0,7,2,3
011101	6,3,2,0,4,7	111101	4,7,1,6,3,2
011110	5,0,1,3,7,4	111110	7,4,2,5,0,1
011111	4,1,0,2,6,5	111111	6,5,3,4,1,0

The Fast-feedback channel is orthogonally modulated with QPSK symbols. Let  $M_{n,8m+k}$  ( $0 \leq k \leq 7$ ) be the modulation symbol index of the  $k$ -th modulation symbol in the  $m$ -th uplink tile of the  $n$ -th Fast-feedback channel. The possible modulation patterns composed of  $M_{n,8m}, M_{n,8m+1}, \dots, M_{n,8m+7}$  the  $m$ -th tile of the  $n$ -th Fast-feedback channel are defined in Table 298e.

**Table 298e—Orthogonal Modulation Index in ~~FAST\_FEEDBACK~~ Fast-feedback Channel**

Vector index	$M_{n,8m}, M_{n,8m+1}, \dots, M_{n,8m+7}$
0	P0, P1, P2, P3, P0, P1, P2, P3
1	P0, P3, P2, P1, P0, P3, P2, P1
2	P0, P0, P1, P1, P2, P2, P3, P3
3	P0, P0, P3, P3, P2, P2, P1, P1
4	P0, P0, P0, P0, P0, P0, P0, P0
5	P0, P2, P0, P2, P0, P2, P0, P2
6	P0, P2, P0, P2, P2, P0, P2, P0
7	P0, P2, P2, P0, P2, P0, P0, P2

where

$$P0 = \exp\left(j \cdot \frac{\pi}{4}\right)$$

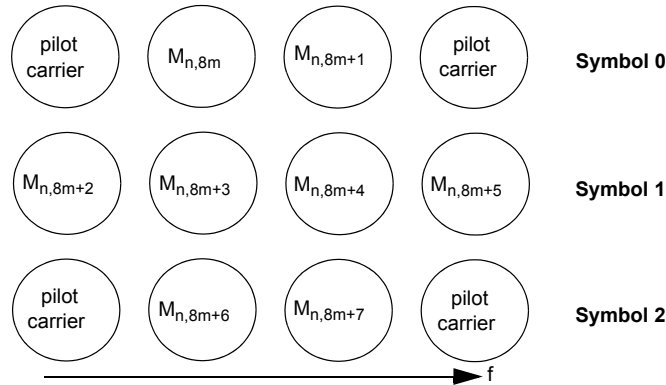
$$P1 = \exp\left(j \cdot \frac{3\pi}{4}\right)$$

$$P2 = \exp\left(-j \cdot \frac{3\pi}{4}\right)$$

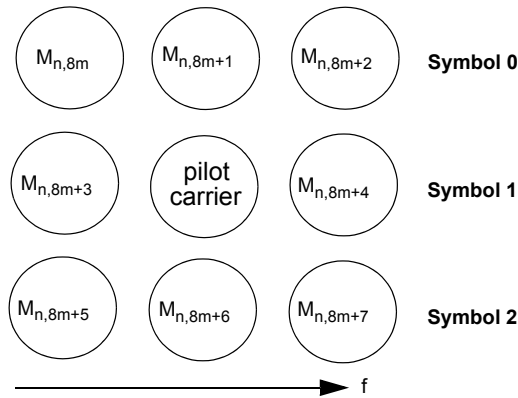
$$P3 = \exp\left(-j \cdot \frac{\pi}{4}\right)$$

$M_{n,8m+k}$  is mapped to a Fast-feedback channel tile, as shown in Figure 231a, for PUSC uplink subchannel, and in Figure 231b, for optional PUSC uplink subchannel. A Fast-feedback channel is mapped to one sub-channel composed of six tiles.





**Figure 231a—Subcarrier mapping of Fast-feedback modulation symbols for PUSC**



**Figure 231b—Subcarrier mapping of Fast-feedback modulation symbols for optional PUSC**

The Enhanced Fast-feedback slot includes 6 bits of payload data, whose encoding depends on the instruction given in the Fast-feedback subheader, the CQICH\_Control IE(), the CQICH\_Alloc\_IE(), or through the CQICH\_Enhanced\_Alloc\_IE(). The following subclauses define these encodings.

*Insert new subclause 8.4.5.4.10.6:*

**8.4.5.4.10.6 Fast DL measurement feedback for Enhanced Fast-feedback channel**

When the Fast-feedback allocation subheader Feedback Type field is 0b00 or the feedback is requested through CQICH\_Alloc\_IE (see 8.4.5.4.12), or the Feedback\_type field in CQICH\_Enhanced\_Alloc\_IE() is 0b000-0b010 with CQICH type 0b000 or 0b100 (see 8.4.5.4.15), the MS shall report the SNR it measures on the DL. Equation (107b) shall be used.

$$\text{Payload bits} = \begin{cases} 0, & S/N \leq -B \\ n, & (n-1-B) < (S/N) \leq (n-B), 0 < n < 31 \\ 31, & S/N > 30-B \end{cases} \quad (107b)$$

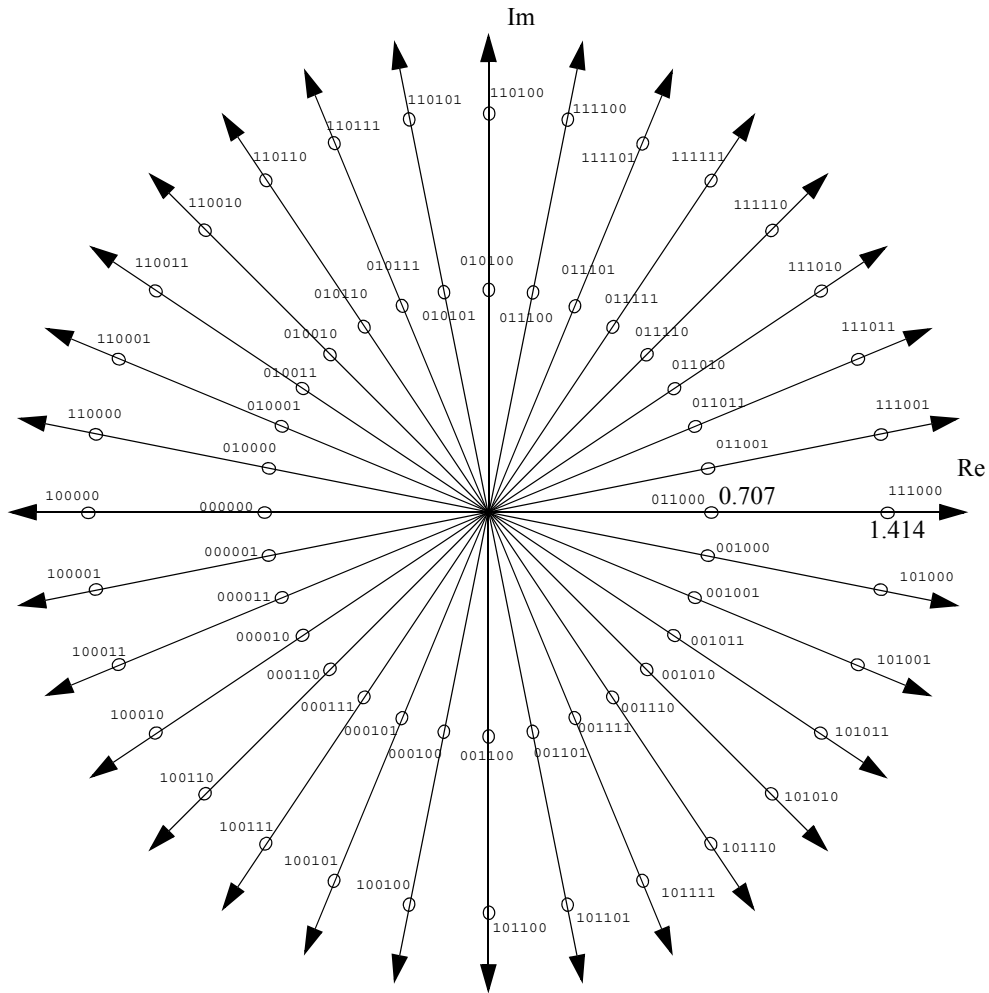
where B is the positive integer value indicated in the SN Reporting Base TLV (see 11.7.26). B shall default to “3” if the SN Reporting Base TLV was not included in the REG-RSP.

For MIMO capable MSs, if the BS allocates a single CQICH to the MS in UL-MAP (CQICH\_Num = 0) for the purposes of Fast DL Measurement, the MS shall report the effective post processing SNR Eff\_SNR as defined in 8.4.5.4.10.1. Otherwise, if the BS allocate multiple CQICHs to the MS in UL-MAP (CQICH\_Num > 0) for the purposes of Fast DL Measurement, the MS shall report post processing S/N of individual layers in order of layer indices.

*Insert new subclause 8.4.5.4.10.7*

#### **8.4.5.4.10.7 Fast MIMO feedback of Quantized Precoding Weight for Enhanced Fast-feedback channel**

When the Fast-feedback allocation subheader Feedback Type field is 0b01 or 0b10, or the CQI Type field in the MIMO Compact DL-MAP IE() (see 6.3.2.3.43.6.7) is 0b01, or the Feedback Type field in CQICH\_Enhanced\_Alloc\_IE() (see 8.4.5.4.15) is 0b011 with CQICH type 0b000 or 0b100, the MS shall report the MIMO coefficient the BS should use for best DL reception. The mapping for the complex weights is shown in Figure 231c. For this type of feedback, if  $N$  is the number of BS transmit antennas, then  $(N-1)$  CQICH shall be allocated to the SS and SS shall report the desired antenna weights of antenna 1 through  $N-1$  based on antenna 0.



**Figure 231c—Mapping of MIMO coefficients for quantized precoding weights for enhanced fast MIMO feedback payload bits**

*Insert new subclause 8.4.5.4.10.8:*

**8.4.5.4.10.8 MIMO Mode Feedback for Enhanced Fast-feedback channel**

When the Enhanced Fast-feedback channel is employed, the SS may report the MIMO mode feedback on the assigned CQICH when the Fast-feedback allocation subheader Feedback Type field is 0b00; or the Feedback Type field in the MIMO Compact DL-MAP IE() (see 6.3.2.3.43.6.7) is 0b000, 0b001, or 0b010; or the Feedback Type field in CQICH\_Enhanced\_Alloc\_IE() (see 8.4.5.4.15) is 0b000, 0b001, or 0b010 with CQICH type 0b000 or 0b100. The encoding of payload bits is shown in Table 298f.

**Table 298f—Encoding of payload bits for MIMO Mode Feedback with Enhanced Fast-feedback Channel**

<b>Value (binary)</b>	<b>Description</b>
101000	STTD and PUSC/FUSC permutation
101001	STTD and adjacent-subcarrier permutation
101010	SM and PUSC/FUSC permutation
101011	SM and adjacent-subcarrier permutation
101100	Hybrid and PUSC/FUSC permutation
101101	Hybrid and adjacent-subcarrier permutation
101110–110110	Interpretation according to Table 298g, Table 298h or Table 298i, depending on if antenna grouping, antenna selection or a reduced precoding matrix codebook is used.
110111	Closed loop precoding with 1 stream.
111000	Closed loop precoding with 2 streams.
111001	Closed loop precoding with 3 streams.
111010	Closed loop precoding with 4 streams.
111011–111111	<i>Reserved</i>

**Clarification of streams concept:**

The number of streams is the number of outputs from the space-time code.

**Table 298g—Interpretation of code words 0b101110-0b110110 in Table 298f in the case of using antenna grouping**

Value (binary) 6-bit/3-bit	Description
101110/000	Antenna Group A1 for rate 1 For 3-antenna BS, See 8.4.8.3.4.1 For 4-antenna BS, See 8.4.8.3.5.1
101111/001	Antenna Group A2 for rate 1
110000/010	Antenna Group A3 for rate 1
110001/000	Antenna Group B1 for rate 2 For 3-antenna BS, See 8.4.8.3.4.2 For 4-antenna BS, See 8.4.8.3.5.2
110010/001	Antenna Group B2 for rate 2
110011/010	Antenna Group B3 for rate 2
110100/011	Antenna Group B4 for rate 2 (only for 4-antenna BS)
110101/100	Antenna Group B5 for rate 2 (only for 4-antenna BS)
110110/101	Antenna Group B6 for rate 2 (only for 4-antenna BS)

**Table 298h—Interpretation of code words 0b101110-0b110110 in Table 298f in the case of using antenna selection**

Value (binary) 6-bit/3-bit	Description
101110/000	Antenna selection option 0 (see Table 316f for 3 Tx and Table 316g for 4Tx)
101111/001	Antenna selection option 1 (see Table 316f for 3 Tx and Table 316g for 4Tx)
110000/010	Antenna selection option 2 (see Table 316f for 3 Tx and Table 316g for 4Tx)
110001/011	Antenna selection option 3 (see Table 316f for 3 Tx and Table 316g for 4Tx)
110010/100	Antenna selection option 4 (see Table 316f for 3 Tx and Table 316g for 4Tx)
110011/101	Antenna selection option 5 (see Table 316f for 3 Tx and Table 316g for 4Tx)
110100/110	Antenna selection option 6 (see Table 316f for 3 Tx and Table 316g for 4Tx)
110101/111	Antenna selection option 7 (see Table 316f for 3 Tx and Table 316g for 4Tx)
110110	<i>Reserved</i>

**Table 298i—Interpretation of code words 0b101110-0b110110 in Table 298f in the case of using reduced precoding matrix codebook**

Value (binary) 6-bit/3-bit	Description
101110/000	Reduced Precoding matrix codebook entry 0
101111/001	Reduced Precoding matrix codebook entry 1
110000/010	Reduced Precoding matrix codebook entry 2
110001/011	Reduced Precoding matrix codebook entry 3
110010/100	Reduced Precoding matrix codebook entry 4
110011/101	Reduced Precoding matrix codebook entry 5
110100/110	Reduced Precoding matrix codebook entry 6
110101/111	Reduced Precoding matrix codebook entry 7
110110	<i>Reserved</i>

*Insert new subclause 8.4.5.4.10.9:*

**8.4.5.4.10.9 Anchor BS report**

The MS may send its Anchor BS selection using the 8 codewords numbered from 32 to 39. Table 298j shows the encoding of payload bits for the Fast-feedback slot (see 8.4.5.4.9).

**Table 298j—Encoding of payload bits for Fast-feedback slot**

Value (binary)	Description
100000	Anchor BS for TEMP_BS_ID=0b000
100001	Anchor BS for TEMP_BS_ID=0b001
100010	Anchor BS for TEMP_BS_ID=0b010
100011	Anchor BS for TEMP_BS_ID=0b011
100100	Anchor BS for TEMP_BS_ID=0b100
100101	Anchor BS for TEMP_BS_ID=0b101
100110	Anchor BS for TEMP_BS_ID=0b110
100111	Anchor BS for TEMP_BS_ID=0b111

Also, the 40th codeword (i.e., 0b101000) is used as an acknowledgement for the Anchor\_BS\_Switch\_IE.

When the 4-by-3 uplink tile structure is used (see 8.4.6.2.1), the number of tiles in a channel,  $N$ , is 6 and the number of subcarriers in a tile,  $L$ , is 12. When the 3-by-3 uplink tile structure is used (see 8.4.6.5.1),  $N = 6$  and  $L = 9$ .

When the MS reports the measured S/N, each payload bit is repeated according to the predefined UEP ratio  $R_0:R_1:R_2:R_3$ , where  $R_0, R_1, R_2$ , and  $R_3$  represent the repetition number for the first payload bit  $b_0$  (MSB), the second payload bit  $b_1$ , the third payload bit  $b_2$ , and the fourth payload bit  $b_3$  (LSB), respectively. In case of the 4-bit CQI payload, a ratio of  $R_0:R_1:R_2:R_3 = 26:19:14:7$  is used for the 4-by-3 uplink tile structure, and  $R_0:R_1:R_2:R_3 = 19:14:10:5$  is used for the 3-by-3 uplink tile structure.

The repeated bit sequence is interleaved according to Equation (107c) before binary DPSK modulation.

$$y = ((xR)/N) \bmod(R) + \lfloor x/N \rfloor, \quad (107c)$$

where

$y$  denotes the bit index in the interleaved bit sequence ( $y = 0, 1, 2, \dots, R-1$ ),  
 $x$  denotes bit index in the repeated bit sequence ( $x = 0, 1, 2, \dots, R-1$ ).

The length of the repeated bit sequence is  $R = R_0 + R_1 + R_2 + R_3 = N(L-1) = 66$  for the 4-bit CQI. The interleaved bit sequence is divided into  $N$  groups and each group has  $L-1$  bits. The  $n$ -th group ( $n=0, 1, \dots, N-1$ ) is used for binary DPSK modulation on the subcarriers in the  $n$ -th uplink tile, as shown in the Figure 208b. The first subcarrier in each tile is used as a phase reference. The  $L-1$  bits in the  $n$ -th<sup>h</sup> group are mapped to  $L$  DPSK symbols for the  $n$ -th tile as follows:

$$C_{n,k}^{CQI} = \begin{cases} 1 & (k=0) \\ C_{n,k-1}^{CQI} & k > 0 \text{ and } (B_{n,k-1}^{CQI} = 0) \\ -C_{n,k-1}^{CQI} & k > 0 \text{ and } (B_{n,k-1}^{CQI} = 1) \end{cases} \quad (107d)$$

where

$C_{n,k}^{CQI}$  mapping symbol of the  $k$ -th subcarrier of the  $n$ -th tile ( $k=0, 1, \dots, L-1$ ),  
 $B_{n,k}^{CQI}$   $k$ -th bit of  $n$ -th group in the interleaved bit sequence ( $k=0, 1, \dots, L-2$ ).

***Insert new subclause 8.4.5.4.10.10:***

#### **8.4.5.4.10.10 UEP fast-feedback**

When the UEP fast-feedback is employed and the Fast-feedback allocation subheader Feedback type field is '00' or the BS requests the feedback through CQICH\_Alloc\_IE() or CQICH\_Control IE(), the MS may report the feedback payload on the assigned CQICH by using the following UEP fast-feedback method. The UEP fast-feedback provides the payload bits carried by the fast-feedback channel with the unequal error protection (UEP) capability. The UEP fast-feedback repeats each payload bit according to a predefined repetition ratio, as illustrated in Figure 231d. The repeated bit sequence is interleaved and used for binary DPSK modulation on the subcarriers for the fast-feedback channel.

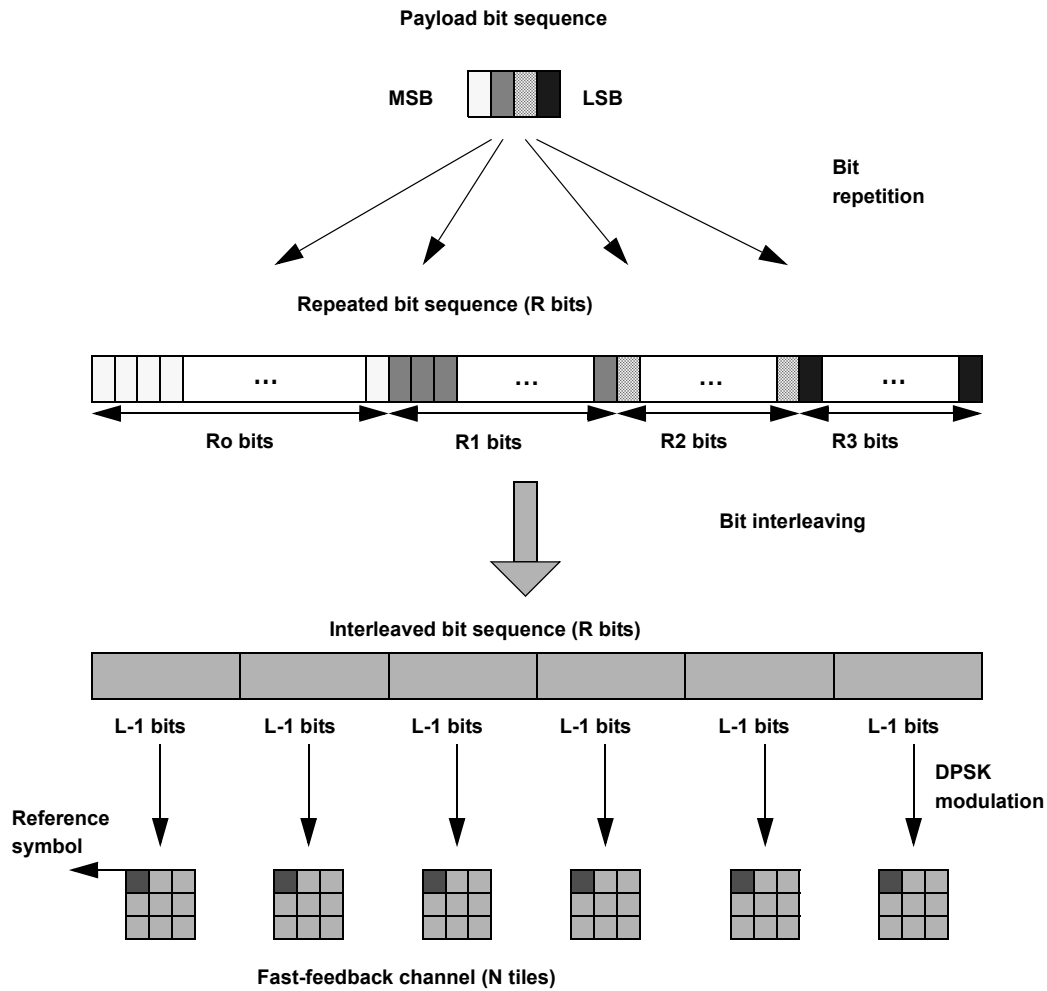


Figure 231d—Mapping of the payload bit sequence to a Fast-feedback channel

*Insert new subclause 8.4.5.4.10.11:*

**8.4.5.4.10.11 Band AMC differential CINR feedback for Enhanced Fast-feedback channel**

When the Band AMC operation is triggered, the SS shall report the differential of CINR for five selected bands (increment: 1 and decrement: 0 with a step of 1 dB) on its enhanced or primary fast-feedback channel. The first 32 codewords with MSB of 0 are used.

*Insert new subclause 8.4.5.4.10.12*

**8.4.5.4.10.12 Indication Flag Feedback**

For an MS that supports the feedback method using the Feedback header, the MS can send an indication flag on the Fast-feedback channel, the Enhanced Fast-feedback channel, or the primary/secondary Fast-feedback channel. The indication flag is a specific encoding of the payload bits on the Fast-feedback channel or the Enhanced Fast-feedback channel. The indication flag is used by the MS to indicate to the BS its intention to transmit a Feedback header or a Bandwidth Request header without the need to perform bandwidth request



ranging. After receiving the indication flag from the MS, the BS may allocate the required UL resource to the MS.

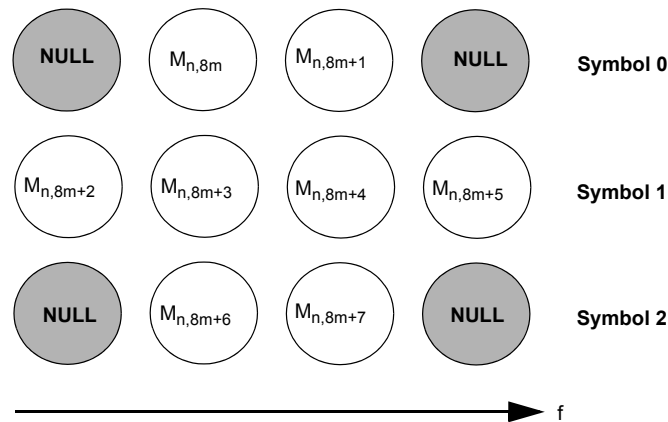
For the case of Fast-feedback channel or secondary Fast-feedback channel the Indication Flag feedback operation is enabled, the specific encoding of the payload bits is defined in the Use CQICH indication flag TLV. This specific encoding is reserved for the purpose of indication flag and shall not be used to send other feedback information (see 8.4.5.4.10.1).

For the case of Enhanced Fast-feedback channel or primary Fast-feedback channel, the encoding of 0b111100 shall be used as the indication flag.

*Insert new subclause 8.4.5.4.10.13*

**8.4.5.4.10.13 Primary and secondary Fast-feedback channels**

A primary Fast-feedback slot consists of 1 OFDMA slots mapped in a manner similar to the mapping of normal uplink data. A primary Fast-feedback slot uses QPSK modulation on the 48 data subcarriers of UL PUSC tiles it contains, and can carry a data payload of 6 bits. The primary Fast-feedback slot has identical mapping between the payload bit sequences and the subcarriers modulation as the Enhanced Fast-feedback 6-bit payload slot except null pilot subcarriers within the slot. (See Figure 231e.)



**Figure 231e—Subcarrier mapping of Primary Fast-feedback modulation symbol for PUSC**

A secondary Fast-feedback slot consists of 1 OFDMA slot mapped in a manner similar to the mapping of normal uplink data. A secondary Fast-feedback slot uses QPSK modulation on the 24 pilot subcarriers of UL PUSC tiles it contains, and can carry a data payload of 4 bits. Table 298k defines the mapping between the payload bit sequences and the subcarriers modulation.

**Table 298k—Secondary Fast-feedback channel subcarrier modulation with 4 bit**

Four-bit payload (binary)	Vector indices per tile Tile(0), Tile(1), Tile(2), Tile(3), Tile(4), Tile(5)	Four-bit payload (binary)	Vector indices per tile Tile(0), Tile(1), Tile(2), Tile(3), Tile(4), Tile(5)
0000	0,0,0,1,1,1	1000	0,0,1,3,2,2
0001	1,1,1,0,0,0	1001	1,3,2,2,3,1
0010	2,2,2,3,3,3	1010	2,2,3,1,0,0
0011	3,3,3,2,2,2	1011	3,3,1,0,1,1
0100	0,1,2,3,0,1	1100	0,0,3,2,0,3
0101	1,2,3,0,1,3	1101	1,2,0,2,2,0
0110	2,3,0,1,2,3	1110	2,1,3,3,1,2
0111	3,0,1,2,3,0	1111	3,2,2,1,1,2

The secondary Fast-feedback channel is orthogonally modulated with QPSK symbols. Let  $M_{n,4m+k}$  ( $0 \leq k \leq 3$ ) be the modulation symbol index of the  $k$ -th modulation symbol in the  $m$ -th uplink PUSC tile of the  $n$ -th secondary Fast-feedback channel. The possible modulation patterns composed of  $M_{n,4m+k}$  in the  $m$ -th tile of the  $n$ -th secondary Fast-feedback channel are defined in Table 298l.

**Table 298l—Orthogonal Modulation Index in Secondary Fast-feedback Channel**

Vector index	$M_{n,4m}, M_{n,4m+1}, M_{n,4m+2}, M_{n,4m+3}$
0	P0, P0, P0, P0
1	P0, P2, P0, P2
2	P0, P1, P2, P3
3	P1, P0, P3, P2

where

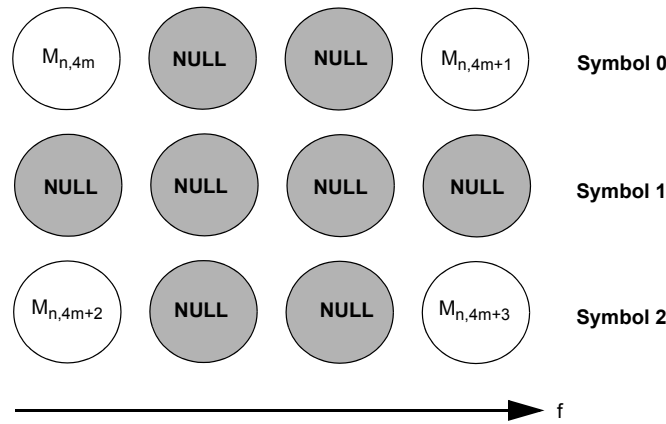
$$P_0 = \exp\left(j\frac{\pi}{4}\right),$$

$$P_1 = \exp\left(j\frac{3\pi}{4}\right),$$

$$P_2 = \exp\left(-j\frac{3\pi}{4}\right),$$

$$P_3 = \exp\left(-j\frac{\pi}{4}\right).$$

$M_{n,4m+k}$  are mapped to secondary Fast-feedback channel tile as shown in Figure 231f for PUSC uplink sub-channel. A secondary Fast-feedback channel is mapped to one subchannel composed of six tiles.



**Figure 231f—Subcarrier mapping of secondary Fast-feedback modulation symbols for PUSC**

*Insert new subclause 8.4.5.4.10.14:*

**8.4.5.4.10.14 Extended rtPS bandwidth request**

In the case of Extended rtPS service, the MS may request bandwidth allocation, which is defined as the Maximum Sustained Traffic Rate in service flow encodings. The codeword 0b111011 is used for that purpose.

*Insert new subclause 8.4.5.4.10.15*

**8.4.5.4.10.15 MIMO feedback for transmit beamforming**

Codebooks are defined for the feedback of MIMO transmit beamforming, whose codeword may be employed as the beamforming matrix in MIMO precoding in 8.4.8.3.6. The vector codebooks for 2x1, 3x1, and 4x1 with 3-bit feedback index are listed in Table 298m, Table 298n, and Table 298o. The notation  $V(N_p, S, L)$  denotes the vector codebook, which consists of  $2^L$  complex, unit vectors of a dimension  $N_p$ , and  $S$  denotes the number of streams. The integer  $L$  is the number of bits required for the index that can indicate any vector in the codebook.

**Table 298m— $V(2,1,3)$**

Vector index	1	2	3	4	5	6	7	8
v1	1	0.7940	0.7940	0.7941	0.7941	0.3289	0.5112	0.3289
v2	0	$-0.5801 + j0.1818$	$0.0576 + j0.6051$	$-0.2978 - j0.5298$	$0.6038 + j0.0689$	$0.6614 + j0.6740$	$0.4754 - j0.7160$	$-0.8779 - j0.3481$

**Table 298n— $V(3,1,3)$**

Vector index	1	2	3	4	5	6	7	8
v1	1	0.500	0.500	0.500	0.500	0.4954	0.500	0.500
v2	0	$-0.7201 - j0.3126$	$-0.0659 + j0.1371$	$-0.0063 + j0.6527$	$0.7171 + j0.3202$	$0.4819 - j0.4517$	$0.0686 - j0.1386$	$-0.0054 - j0.6540$
v3	0	$0.2483 - j0.2684$	$-0.6283 - j0.5763$	$0.4621 - j0.3321$	$-0.2533 + j0.2626$	$0.2963 - j0.4801$	$0.6200 + j0.5845$	$-0.4566 + j0.3374$

**Table 298o— $V(4,1,3)$**

Vector index	1	2	3	4	5	6	7	8
v1	1	0.3780	0.3780	0.3780	0.3780	0.3780	0.3780	0.3780
v2	0	$-0.2698 - j0.5668$	$-0.7103 + j0.1326$	$0.2830 - j0.0940$	$-0.0841 + j0.6478$	$0.5247 + j0.3532$	$0.2058 - j0.1369$	$0.0618 - j0.3332$
v3	0	$0.5957 + j0.1578$	$-0.2350 - j0.1467$	$0.0702 - j0.8261$	$0.0184 + j0.0490$	$0.4115 + j0.1825$	$-0.5211 + j0.0833$	$-0.3456 + j0.5029$
v4	0	$0.1587 - j0.2411$	$0.1371 + j0.4893$	$-0.2801 + j0.0491$	$-0.3272 - j0.5662$	$0.2639 + j0.4299$	$0.6136 - j0.3755$	$-0.5704 + j0.2113$

The codebooks in Table 298m, Table 298n, and Table 298o are produced by generating expressions one per table. These tables are optimized for generation efficiency and storage memory.

Three operations are employed and they employs floating point arithmetic in IEEE Std 754, whose final results are rounded to four decimal places. The first operation generates a unitary  $N \times N$  matrix  $H(v)$  using an  $N$  vector  $v$  as:

$$H(v) = \begin{cases} \mathbf{I}, & v = e_1 \\ \mathbf{I} - p\mathbf{w}\mathbf{w}^H, & \text{otherwise} \end{cases}, \quad (107e)$$

where

$$\mathbf{w} = v - e_1 \text{ and } e_1 = [1 \ 0 \ \dots \ 0];$$

$$p = \frac{2}{\|\mathbf{w}^H \mathbf{w}\|};$$

$\mathbf{I}$  is the  $N \times N$  identity matrix;

$()^H$  denotes the conjugate transpose operation.

Two vector codebooks  $V(3,1,6)$  and  $V(4,1,6)$  are generated as follows. All the vector codewords  $v_i$ ,  $i = 2, \dots, 2^L$  are derived from the first codeword  $v_1$  as:

$$\tilde{v}_i = H(s)Q^i(\mathbf{u})H^H(s)v_i, \text{ for } i = 2, \dots, 2^L, \quad v_i = \tilde{v}_i e^{-j\phi_1}, \text{ for } i = 2, \dots, 2^L,$$

where

$$Q^i(\mathbf{u}) = \text{diag} \left( e^{j \cdot \frac{2\pi}{2^L} \cdot u_1 \cdot i}, \dots, e^{j \cdot \frac{2\pi}{2^L} \cdot u_{N_t} \cdot i} \right) \text{ is a diagonal matrix;}$$

$$\mathbf{u} = \begin{bmatrix} u_1 & \dots & u_{N_t} \end{bmatrix} \text{ is an integer vector;}$$

$$\mathbf{v}_1 = \frac{1}{\sqrt{N_t}} \begin{bmatrix} 1 & e^{j \cdot \frac{2\pi}{N_t}} & \dots & e^{j \cdot \frac{2\pi}{N_t} \cdot (N_t-1)} \end{bmatrix}^T ;$$

$\phi_i$  is the phase of the first entry of  $\tilde{\mathbf{v}}_i$ .

The parameters for the generation of  $V(3,1,6)$  and  $V(4,1,6)$  are listed in Table 298p.

**Table 298p—Generating parameters for  $V(3,1,6)$  and  $V(4,1,6)$**

$N_t$	$L$	$\mathbf{u}$ in $Q^i(\mathbf{u})$	$\mathbf{s}$ in $\mathbf{H}(\mathbf{s})$
3	6	[1 26 57]	[1.2518-j0.6409, -0.4570-j0.4974, 0.1177+j0.2360]
4	6	[1 45 22 49]	[1.3954-j0.0738, 0.0206+j0.4326, -0.1658-j0.5445, 0.5487-j0.1599] <sup>T</sup>

The second operation generates an  $N$  by  $M + 1$  unitary matrix from a unit  $N$  vector and a unitary  $N - 1$  by  $M$  matrix as:

$$HC(\mathbf{v}_N, \mathbf{A}_{(N-1)M}) = H(\mathbf{v}_N) \begin{bmatrix} 1 & 0 & \dots & 0 \\ 0 & & & \\ \dots & & & \\ 0 & & & \mathbf{A}_{(N-1)M} \end{bmatrix} \tag{107f}$$

where

$$N - 1 \geq M; \text{ the } N - 1 \text{ by } M \text{ unitary matrix has property } \mathbf{A}^H \mathbf{A} = \mathbf{I}.$$

The third operation generates an  $N$  by  $M$  matrix from a unit  $N$  vector,  $\mathbf{v}_N$ , by taking the last  $N - 1$  columns of  $\mathbf{H}(\mathbf{v}_N)$  as:

$$HE(\mathbf{v}_N) = H(\mathbf{v}_N)_{:,2:N} \tag{107g}$$

The three operations jointly generate eleven matrix codebooks from vector codebooks as shown in Table 298q, where each entry is the generating operation of one codebook.

Table 298q contains operations to generate codebooks  $V(N_t, S, L)$  for  $N_t = 2, 3, 4$ ,  $S = 2, 3, 4$ , and  $L = 3$  and 6:

**Table 298q—Operations to generate codebooks**

$N_t, L \setminus S$	2	3	4
2, 3	$H(V(2,1,3))$	—	—
3, 3	$HE(V(3,1,3))$	$H(V(3,1,3))$	—
4, 3	—	$HE(V(4,1,3))$	$H(V(4,1,3))$
2, 6	$H(V(2,1,6))$	—	—
3, 6	$HC(V(3,1,3),V(2,1,3))$	$HC(V(3,1,3),H(V(2,1,3)))$	—
4, 6	$HC(V(4,1,3),H(V(3,1,3)))$	$HE(V(4,1,6))$	$H(V(4,1,6))$

The set notation  $V(N_t, 1, L)$  in the input arguments of the operations denotes that each vector in the codebook  $V(N_t, 1, L)$  is sequentially taken as an input to the operations. The output of the operation with one or more codebooks as input arguments is also a codebook. For example, in  $HC(V(3,1,3),H(V(2,1,3)))$  has two codebooks as input. The first is  $V(3,1,3)$  with 8 vectors and the second is  $H(V(2,1,3))$  with 8 2x2 matrices, which are computed from  $V(2,1,3)$ . The feedback index is constructed by sequentially concatenating all the indexes of the input argument vector codebooks in binary format. For example, the feedback index of  $HC(V(3,1,3),H(V(2,1,3)))$  is constructed as  $i_2 j_2$ , where  $i_2$  and  $j_2$  are the indexes of the vectors in codebooks  $V(3,1,3)$  and  $V(2,1,3)$  in binary format respectively.

Table 298r, Table 298s, Table 298t are included to illustrate codebooks generated using the rules defined above.

**Table 298r—3-bit 2x2 codebook  $V(2,2,3)$**

Matrix index (binary)	Column1	Column2	Matrix index (binary)	Column1	Column2
000	1	0	100	0.7941	$0.6038 - j0.0689$
	0	1		$0.6038 + j0.0689$	-0.7941
001	0.7940	$-0.5801 - j0.1818$	101	0.3289	$0.6614 - j0.6740$
	$-0.5801 + j0.1818$	-0.7940		$0.6614 + j0.6740$	-0.3289
010	0.7940	$0.0576 - j0.6051$	110	0.5112	$0.4754 + j0.7160$
	$0.0576 + j0.6051$	-0.7940		$0.4754 - j0.7160$	-0.5112
011	0.7941	$-0.2978 + j0.5298$	111	0.3289	$-0.8779 + j0.3481$
	$-0.2978 - j0.5298$	-0.7941		$-0.8779 - j0.3481$	-0.3289

**Table 298s—3-bit 4x3 codebook V(4,3,3)**

<b>Matrix index (binary)</b>	<b>Column1</b>	<b>Column2</b>	<b>Column3</b>
000	0	0	0
	1	0	0
	0	1	0
	0	0	1
001	$-0.2698 + j0.5668$	$0.5957 - j0.1578$	$0.1587 + j0.2411$
	0.3665	$0.4022 + j0.4743$	$-0.1509 + j0.2492$
	$0.4022 - j0.4743$	0.3894	$-0.0908 - j0.2712$
	$-0.1509 - j0.2492$	$-0.0908 + j0.2712$	0.8660
010	$-0.7103 - j0.1326$	$-0.2350 + j0.1467$	$0.1371 - j0.4893$
	0.1606	$-0.2371 + j0.2176$	$0.0522 - j0.5880$
	$-0.2371 - j0.2176$	0.8766	$0.1672 - j0.1525$
	$0.0522 + j0.5880$	$0.1672 + j0.1525$	0.5848
011	$0.2830 + j0.0940$	$0.0702 + j0.8261$	$-0.2801 - j0.0491$
	0.8570	$-0.1568 - j0.3653$	$0.1349 - j0.0200$
	$-0.1568 + j0.3653$	-0.1050	$0.0968 - j0.3665$
	$0.1349 + j0.0200$	$0.0968 + j0.3665$	0.8700
100	$-0.0841 - j0.6478$	$0.0184 - j0.0490$	$-0.3272 + j0.5662$
	0.3140	$-0.0485 - j0.0258$	$0.5454 + j0.4174$
	$-0.0485 + j0.0258$	0.9956	$0.0543 + j0.0090$
	$0.5454 - j0.4174$	$0.0543 - j0.0090$	0.3125
101	$0.5247 - j0.3532$	$0.4115 - j0.1825$	$0.2639 - j0.4299$
	0.3569	$-0.4508 - j0.0797$	$-0.4667 + j0.2128$
	$-0.4508 + j0.0797$	0.6742	$-0.3007 + j0.2070$
	$-0.4667 - j0.2128$	$-0.3007 - j0.2070$	0.5910
110	$0.2058 + j0.1369$	$-0.5211 - j0.0833$	$0.6136 + j0.3755$
	0.9018	$0.1908 - j0.0871$	$-0.2857 + j0.0108$
	$0.1908 + j0.0871$	0.5522	$0.5644 + j0.2324$
	$-0.2857 - j0.0108$	$0.5644 - j0.2324$	0.1680
111	$0.0618 + j0.3332$	$-0.3456 - j0.5029$	$-0.5704 - j0.2113$
	0.8154	$0.3037 - j0.1352$	$0.1698 - j0.2845$
	$0.3037 + j0.1352$	0.4015	$-0.4877 + j0.3437$
	$0.1698 + j0.2845$	$-0.4877 - j0.3437$	0.4052

**Table 298t—3-bit 4x4 codebook V(4,4,3)**

Matrix index (binary)	Column1	Column2	Column3	Column4
000	1	0	0	0
	0	1	0	0
	0	0	1	0
	0	0	0	1
001	0.3780	$-0.2698 + j0.5668$	$0.5957 - j0.1578$	$0.1587 + j0.2411$
	$-0.2698 - j0.5668$	0.3665	$0.4022 + j0.4743$	$-0.1509 + j0.2492$
	$0.5957 + j0.1578$	$0.4022 - j0.4743$	0.3894	$-0.0908 - j0.2712$
	$0.1587 - j0.2411$	$-0.1509 - j0.2492$	$-0.0908 + j0.2712$	0.8660
010	0.3780	$-0.7103 - j0.1326$	$-0.2350 + j0.1467$	$0.1371 - j0.4893$
	$-0.7103 + j0.1326$	0.1606	$-0.2371 + j0.2176$	$0.0522 - j0.5880$
	$-0.2350 - j0.1467$	$-0.2371 - j0.2176$	0.8766	$0.1672 - j0.1525$
	$0.1371 + j0.4893$	$0.0522 + j0.5880$	$0.1672 + j0.1525$	0.5848
011	0.3780	$0.2830 + j0.0940$	$0.0702 + j0.8261$	$-0.2801 - j0.0491$
	$0.2830 - j0.0940$	0.8570	$-0.1568 - j0.3653$	$0.1349 - j0.0200$
	$0.0702 - j0.8261$	$-0.1568 + j0.3653$	-0.1050	$0.0968 - j0.3665$
	$-0.2801 + j0.0491$	$0.1349 + j0.0200$	$0.0968 + j0.3665$	0.8700
100	0.3780	$-0.0841 - j0.6478$	$0.0184 - j0.0490$	$-0.3272 + j0.5662$
	$-0.0841 + j0.6478$	0.3140	$-0.0485 - j0.0258$	$0.5454 + j0.4174$
	$0.0184 + j0.0490$	$-0.0485 + j0.0258$	0.9956	$0.0543 + j0.0090$
	$-0.3272 - j0.5662$	$0.5454 - j0.4174$	$0.0543 - j0.0090$	0.3125
101	0.3780	$0.5247 - j0.3532$	$0.4115 - j0.1825$	$0.2639 - j0.4299$
	$0.5247 + j0.3532$	0.3569	$-0.4508 - j0.0797$	$-0.4667 + j0.2128$
	$0.4115 + j0.1825$	$-0.4508 + j0.0797$	0.6742	$-0.3007 + j0.2070$
	$0.2639 + j0.4299$	$-0.4667 - j0.2128$	$-0.3007 - j0.2070$	0.5910



**Table 298t—3-bit 4x4 codebook V(4,4,3) (continued)**

110	0.3780	0.2058 + j0.1369	-0.5211 - j0.0833	0.6136 + j0.3755
	0.2058 - j0.1369	0.9018	0.1908 - j0.0871	-0.2857 + j0.0108
	-0.5211 + j0.0833	0.1908 + j0.0871	0.5522	0.5644 + j0.2324
	0.6136 - j0.3755	-0.2857 - j0.0108	0.5644 - j0.2324	0.1680
111	0.3780	0.0618 + j0.3332	-0.3456 - j0.5029	-0.5704 - j0.2113
	0.0618 - j0.3332	0.8154	0.3037 - j0.1352	0.1698 - j0.2845
	-0.3456 + j0.5029	0.3037 + j0.1352	0.4015	-0.4877 + j0.3437
	-0.5704 + j0.2113	0.1698 + j0.2845	-0.4877 - j0.3437	0.4052

**Table 298u—6 bit, 3x1 Codebook V(3,1,6)**

Matrix index (binary)	Column1	Matrix index (binary)	Column1
000000	0.5774	100000	0.5437
	-0.2887 + j0.5000		-0.1363 - j0.4648
	-0.2887 - j0.5000		0.4162 + j0.5446
000001	0.5466	100001	0.5579
	0.2895 - j0.5522		-0.6391 + j0.3224
	0.2440 + j0.5030		-0.2285 - j0.3523
000010	0.5246	100010	0.5649
	-0.7973 - j0.0214		0.6592 - j0.3268
	-0.2517 - j0.1590		0.1231 + j0.3526
000011	0.5973	100011	0.484
	0.7734 + j0.0785		-0.6914 - j0.3911
	0.1208 + j0.1559		-0.3669 + j0.0096
000100	0.4462	100100	0.6348
	-0.3483 - j0.6123		0.5910 + j0.4415
	-0.5457 + j0.0829		0.2296 - j0.0034
000101	0.6662	100101	0.4209
	0.2182 + j0.5942		0.0760 - j0.5484
	0.3876 - j0.0721		-0.7180 + j0.0283
000110	0.412	100110	0.6833
	0.3538 - j0.2134		-0.1769 + j0.4784
	-0.8046 - j0.1101		0.5208 - j0.0412

**Table 298u—6 bit, 3x1 Codebook V(3,1,6) (continued)**

000111	0.684	100111	0.4149
	$-0.4292 + j0.1401$		$0.3501 + j0.2162$
	$0.5698 + j0.0605$		$-0.7772 - j0.2335$
001000	0.4201	101000	0.6726
	$0.1033 + j0.5446$		$-0.4225 - j0.2866$
	$-0.6685 - j0.2632$		$0.5061 + j0.1754$
001001	0.6591	101001	0.419
	$-0.1405 - j0.6096$		$-0.2524 + j0.6679$
	$0.3470 + j0.2319$		$-0.5320 - j0.1779$
001010	0.407	101010	0.6547
	$-0.5776 + j0.5744$		$0.2890 - j0.6562$
	$-0.4133 + j0.0006$		$0.1615 + j0.1765$
001011	0.6659	101011	0.3843
	$0.6320 - j0.3939$		$-0.7637 + j0.3120$
	$0.0417 + j0.0157$		$-0.3465 + j0.2272$
001100	0.355	101100	0.69
	$-0.7412 - j0.0290$		$0.6998 + j0.0252$
	$-0.3542 + j0.4454$		$0.0406 - j0.1786$
001101	0.7173	101101	0.3263
	$0.4710 + j0.3756$		$-0.4920 - j0.3199$
	$0.1394 - j0.3211$		$-0.4413 + j0.5954$
001110	0.307	101110	0.7365
	$-0.0852 - j0.4143$		$0.0693 + j0.4971$
	$-0.5749 + j0.6295$		$0.2728 - j0.3623$
001111	0.74	101111	0.3038
	$-0.3257 + j0.3461$		$0.3052 - j0.2326$
	$0.3689 - j0.3007$		$-0.6770 + j0.5496$
010000	0.3169	110000	0.727
	$0.4970 + j0.1434$		$-0.5479 - j0.0130$
	$-0.6723 + j0.4243$		$0.3750 - j0.1748$
010001	0.7031	110001	0.3401
	$-0.4939 - j0.4297$		$0.4380 + j0.5298$
	$0.2729 - j0.0509$		$-0.5470 + j0.3356$

**Table 298u—6 bit, 3x1 Codebook V(3,1,6) (continued)**

010010	0.3649	110010	0.6791
	$0.1983 + j0.7795$		$-0.1741 - j0.7073$
	$-0.3404 + j0.3224$		$0.0909 - j0.0028$
010011	0.6658	110011	0.3844
	$0.2561 - j0.6902$		$-0.1123 + j0.8251$
	$-0.0958 - j0.0746$		$-0.1082 + j0.3836$
010100	0.3942	110100	0.6683
	$-0.3862 + j0.6614$		$0.5567 - j0.3796$
	$0.0940 + j0.4992$		$-0.2017 - j0.2423$
010101	0.6825	110101	0.394
	$0.5632 + j0.0490$		$-0.5255 + j0.3339$
	$-0.1901 - j0.4225$		$0.2176 + j0.6401$
010110	0.3873	110110	0.6976
	$-0.4531 - j0.0567$		$0.2872 + j0.3740$
	$0.2298 + j0.7672$		$-0.0927 - j0.5314$
010111	0.7029	110111	0.3819
	$-0.1291 + j0.4563$		$-0.1507 - j0.3542$
	$0.0228 - j0.5296$		$0.1342 + j0.8294$
011000	0.387	111000	0.6922
	$0.2812 - j0.3980$		$-0.5051 + j0.2745$
	$-0.0077 + j0.7828$		$0.0904 - j0.4269$
011001	0.6658	111001	0.4083
	$-0.6858 - j0.0919$		$0.6327 - j0.1488$
	$0.0666 - j0.2711$		$-0.0942 + j0.6341$
011010	0.4436	111010	0.6306
	$0.7305 + j0.2507$		$-0.5866 - j0.4869$
	$-0.0580 + j0.4511$		$-0.0583 - j0.1337$
011011	0.5972	111011	0.4841
	$-0.2385 - j0.7188$		$0.5572 + j0.5926$
	$-0.2493 - j0.0873$		$0.0898 + j0.3096$
011100	0.5198	111100	0.5761
	$0.2157 + j0.7332$		$0.1868 - j0.6492$
	$0.2877 + j0.2509$		$-0.4292 - j0.1659$

**Table 298u—6 bit, 3x1 Codebook V(3,1,6) (continued)**

011101	0.571	111101	0.5431
	$0.4513 - j0.3043$		$-0.1479 + j0.6238$
	$-0.5190 - j0.3292$		$0.4646 + j0.2796$
011110	0.5517	111110	0.5764
	$-0.3892 + j0.3011$		$0.4156 + j0.1263$
	$0.5611 + j0.3724$		$-0.4947 - j0.4840$
011111	0.5818	111111	0.549
	$0.1190 + j0.4328$		$-0.3963 - j0.1208$
	$-0.3964 - j0.5504$		$0.5426 + j0.4822$

#### 8.4.5.4.11 MIMO UL Basic IE format

*Change 8.4.5.4.11 as indicated:*

In the UL-MAP, a MIMO-enabled BS may transmit  $UIUC = 15$  with the `MIMO_UL_Basic_IE()` to indicate the MIMO mode of the ~~subsequent~~ uplink allocations described in this IE to a specific MIMO-enabled SS ~~CID~~. The MIMO mode indicated in the `MIMO_UL_Basic_IE()` shall only apply to the ~~subsequent~~ uplink allocation within the IE until the end of frame (see Table 299). This IE may be used either for a MIMO enabled SS or for an SS that supports only collaborative SM. The IE may also be used to assign allocations in AAS zones to AAS enabled SSs that are capable of collaborative SM.

**Table 299—MIMO UL basic IE format**

Syntax	Size	Notes
<code>MIMO_UL_Basic_IE () {</code>		
<b>Extended <del>UIUC</del></b>	4 bits	$MIMO = 0x026$
<b>Length</b>	4 bits	<del>Length of the message in bytes (variable)</del>
<b>Num_Assign</b>	4 bits	Number of burst assignment
For ( $j=0; j<Num\_assign; j++$ ) {		
<b><u>Collaborative SM Indication</u></b>	1 bit	0: Non collaborative SM (Vertical coding assignment to a MIMO capable SS) 1: Collaborative SM (assignment to 2 collaborative SM capable SSs)
If ( <u>Collaborative SM Indication == 0</u> ) {		
<b>CID</b>	16 bits	SS basic CID
<b>UIUC</b>	4 bits	

**Table 299—MIMO UL basic IE format (continued)**

Syntax	Size	Notes
<b>MIMO_Control</b>	1 bit	For dual transmission capable SS 0: STTD 1: SM For Collaborative SM capable SS 0: pilot pattern A 1: pilot pattern B
<b>} Else {</b>		
<b><u>CID_A</u></b>	<u>16 bits</u>	<u>Basic CID of SS that shall use pilot pattern A</u>
<b><u>UIUC_A</u></b>	<u>4 bits</u>	<u>UIUC used for the allocation that uses pilot pattern A</u>
<b><u>CID_B</u></b>	<u>16 bits</u>	<u>Basic CID of SS that shall use pilot pattern B</u>
<b><u>UIUC_B</u></b>	<u>4 bits</u>	<u>UIUC used for the allocation that uses pilot pattern B</u>
<b>}</b>		
<b>Duration</b>	10 bits	In OFDMA slots (see 8.4.3.1)
<b>}</b>		
<i>padding</i>	<i>variable</i>	Number of bits required to align to byte length, shall be set to zero.
<b>}</b>		

**Num\_assign**

This field specifies the number of assignments in this IE.

**MIMO\_Control**

MIMO\_Control field specifies the MIMO mode of the corresponding UL burst. ~~For a dual transmission capable SS, the value of 0 indicates STTD mode, the value of 1 indicates SM mode. For a collaborative SM capable SS, the value of 0 indicates pilot pattern A, the value of 1 indicates pilot pattern B.~~

*Insert new text and Table 299a as shown:*

Table 299a summarizes the modes of operation specified by MIMO\_UL\_Basic\_IE(). For each it details the following:

- == Number of antennas;
- == Values of Collaborative SM indication and MIMO control;
- == Number of different CID's stated in the appropriate case of the "if" statement;
- == Implicit type and rate of coding.

**Table 299a—MIMO UL Basic IE operation modes**

<u>Mode</u>	<u>Number of Tx antennas per SS</u>	<u>Collaborative SM Indication</u>	<u>MIMO control</u>	<u>CIDs</u>	<u>Coding Type</u>	<u>Rate</u>
<u>Collaborative MIMO, 2 SSs</u>	<u>1</u>	<u>1</u>	<u>N/A</u>	<u>CID_A != CID_B</u>	<u>Two SS, each transmits from antenna #0</u>	<u>1 per SS</u>
<u>Spatial Multiplexing, Vertical coding</u>	<u>2</u>	<u>0</u>	<u>1</u>	<u>Single CID</u>	<u>SM with Vertical coding for Single user</u>	<u>2</u>
<u>STTD</u>	<u>2</u>	<u>0</u>	<u>0</u>	<u>Single CID</u>	<u>STTD</u>	<u>1</u>

**Vertical coding**

Indicates transmitting the same coded stream over multiple antennas.

**Rate**

The number of QAM symbols signaled per array channel use.

**8.4.5.4.12 CQICH Allocation IE Format**

*Change the first sentence as indicated:*

CQICH\_Alloc\_IE(), is introduced to dynamically allocate or de-allocate a CQICH to an SS. Once allocated, the SS transmit channel quality information on the assigned CQICH on every subsequent frames, until the SS receives a CQICH\_Alloc\_IE() to de-allocate the assigned CQICH.

*Change Table 300 as indicated:*

**Table 300—CQICH alloc IE format**

<u>Syntax</u>	<u>Size</u>	<u>Notes</u>
<u>CQICH_Alloc_IE() {}</u>		
<u>Extended <del>DU</del>UIUC</u>	<u>4 bits</u>	<u>CQICH = 0x03</u>
<u>Length</u>	<u>4 bits</u>	<u>Length of the message in bytes (variable).</u>
<u>CQICH_ID</u>	<u>variable</u>	<u>Index to uniquely identify the CQICH resource assigned to the SS. The size of this field is dependent on system parameter defined in <del>DU</del>UCD.</u>
<u>Allocation offset</u>	<u>6 bits</u>	<u>Index to the fast-feedback channel region marked by UIUC = 0.</u>
<u>Period (p)</u>	<u>2 bits</u>	<u>A CQI feedback is transmitted on the CQICH every <del>2p</del>2<sup>p</sup> frames.</u>
<u>Frame offset</u>	<u>3 bits</u>	<u>The SS starts reporting at the frame of which the number has the same 3 LSB as the specified frame offset. If the current frame is specified, the SS should start reporting in eight frames.</u>

**Table 300—CQICH alloc IE format (continued)**

Syntax	Size	Notes
<b>Duration (d)</b>	3 bits	A CQI feedback is transmitted on the CQI channels indexed by the CQICH_ID for $10 \times 2^d$ frames. If $d = 0$ , the CQI-CH is deallocated. If $d = 0b111$ , the SS should report until the BS command for the SS to stop.
<b>Report configuration included</b>	1 bits	<u>Update to CINR report configuration is included.</u>
<u>If (report configuration included == 1) {</u>		
<b>Feedback Type</b>	2 bits	<u>0b00 = physical CINR feedback</u> <u>0b01 = effective CINR feedback</u> <u>0b10–0b11 = Reserved</u>
<b>Report type</b>	1 bit	<u>0: Report for preamble</u> <u>1: Report for specific permutation zone</u>
<u>If (Report type == 0) {</u>		
<b>CINR preamble report type</b>	1 bit	<u>The type of preamble-based CINR report</u> <u>0: Frequency reuse factor=1 configuration.</u> <u>1: Frequency reuse factor=3 configuration.</u>
<u>}</u>		
<u>Else {</u>		<u>report for permutation zone.</u>
<b>Zone permutation</b>	3 bits	<u>The type of zone for which to report</u> <u>0b000 – PUSC with 'use all SC = 0'</u> <u>0b001 – PUSC with 'use all SC = 1'</u> <u>0b010 – FUSC</u> <u>0b011 – Optional FUSC</u> <u>0b100 – Safety Channel region</u> <u>0b101 – AMC zone (only applicable to AAS mode)</u> <u>0b110–111 – Reserved</u>
<b>Zone type</b>	2 bits	<u>0b00 – Non-STC zone</u> <u>0b01 – STC zone</u> <u>0b10 – AAS zone</u> <u>0b11 – Reserved</u>
<b>Zone PRBS_ID</b>	2 bits	<u>The PRBS_ID of the zone on which to report</u>
<u>If (Zone type == 0b000 or 0b001) {</u>		
<b>Major group indication</b>	1 bit	<u>If '0' then the report may refer to any subchannel in the PUSC zone.</u>
<u>If (Major group indication == 1) {</u>		
<b>PUSC Major group bitmap</b>	6 bits	<u>Reported CINR shall only apply to the subchannels of PUSC major groups for which the corresponding bit is set.</u> <u>Bit #k refers to major group k.</u>
<u>}</u>		
<u>}</u>		
<b>CINR zone measurement type</b>	1 bit	<u>0: measurement from pilot subcarriers and, if AAS zone, from AAS preamble.</u> <u>1: measurement from data subcarriers</u>

**Table 300—CQICH alloc IE format (continued)**

Syntax	Size	Notes
}		
If (feedback type == 0b00) {		<u>Physical CINR feedback</u>
<b><u>Averaging parameter included</u></b>	<u>1 bit</u>	
<u>If (Averaging parameter included == 1) {</u>		
<b><u>Averaging parameter</u></b>	<u>4 bits</u>	<u>Averaging parameter <math>\alpha_{avg}</math> used for deriving physical CINR estimates reported through CQICH. This value is given in multiples of 1/16 in the range of [1/16..16/16] in increasing order.</u>
}		
}		
}		
<b>MIMO_permutation_feedback_cycle</b>	2 bits	0b00 = No MIMO and permutation mode feedback 0b01 = The MIMO and permutation mode indication shall be transmitted on the CQICH indexed by the CQICH_ID every four <del>frames allocated CQICH transmission opportunity</del> . The first indication is sent on the <del>eight</del> fourth allocated CQICH <del>frame transmission opportunity</del> . 0b10 = The MIMO mode and permutation mode indication shall be transmitted on the CQICH indexed by the CQICH_ID every eight <del>frames allocated CQICH transmission opportunity</del> . The first indication is sent on the eighth allocated CQICH <del>frame transmission opportunity</del> . 0b11 = The MIMO mode and permutation mode indication shall be transmitted on the CQICH indexed by the CQICH_ID every 16 <del>frames allocated CQICH transmission opportunity</del> . The first indication is sent on the 16th allocated CQICH <del>frame transmission opportunity</del> .
<b>Padding</b>	variable	<del>The padding bits is used to ensure the IE size is integer number of bytes. Number of bits required to align to byte length, shall be set to zero.</del>
}		

*Change the description of 'MIMO\_permutation\_feedback\_Cycle' field below Table 300 as indicated:*

**MIMO\_permutation\_feedback\_Cycle**

This field specifies the MIMO and permutation mode fast feedback cycle. See ~~8.4.5.4.10.28~~4.5.4.10.3 for fast-feedback channel payload encoding for MIMO and permutation feedback. When MIMO\_permutation\_feedback\_cycle is not equal to 0b00, the MIMO and permutation mode indication shall transmitted at certain CQICH frames instead of the normal CQI value.



*Insert the following fields description below Table 300:*

**Report configuration included**

Indicates whether an update to the report configuration exists in the IE. A value of ‘0’ indicates that the SS shall use the configuration defined in the last received CQI configuration.

**Report type**

Indicates whether the CINR metric shall be reported on the preamble (‘0’) or on a permutation zone (‘1’).

**Averaging parameter included**

Indicate whether a new averaging parameter  $\alpha_{avg}$  for physical CINR reports exists in the IE. A value of ‘0’ indicates that the SS shall perform physical CINR measurements using the last known averaging parameter.

*Insert the following paragraph at the end of the subclause:*

For MIMO capable SSs, BS may allocate one or multiple CQICH channels to the SS in UL\_MAP. If one CQICH channel is allocated, SS shall report the average post processing S/R. If multiple CQICH channels are allocated, SS shall report post processing SNR of individual layers, the order of CQICH channel allocation shall match the order of layer index.

#### 8.4.5.4.13 UL ACK channel

*Replace the contents of the subclause with the following text:*

The uplink ACK (Acknowledgement) provides feedback for Downlink Hybrid ARQ. This channel shall only be supported by SS supporting HARQ. The SS transmits ACK or NAK feedback for Downlink packet data. One ACK channel occupies a half subchannel, which is three pieces of 3×3 uplink tile in the case of optional PUSC or three pieces of 4×3 uplink tile in the case of PUSC. The even half subchannel consists of Tile(0), Tile(2), and Tile(4). The odd half subchannel consists of Tile(1), Tile(3), and Tile(5).

The acknowledgement bit of the  $n$ -th ACK channel shall be ‘0’ (ACK) if the corresponding downlink packet has been successfully received; otherwise, it shall be ‘1’ (NAK). This 1 bit is encoded into a length 3 code-word over 8-ary alphabet for the error protection as shown in Table 301.

**Table 301—ACK channel subcarrier modulation**

ACK 1-bit symbol	Vector Indices per Tile Tile(0), Tile(1), Tile(2)
0	0, 0, 0
1	4, 7, 2

The UL ACK channel is orthogonally modulated with QPSK symbols. Let  $M_{n,8m+k}$  ( $0 \leq k \leq 7$ ) be the modulation symbol index of the  $k$ -th modulation symbol in the  $m$ -th uplink tile of the  $n$ -th UL ACK channel. The possible modulation patterns composed of  $M_{n,8m}, M_{n,8m+1}, \dots, M_{n,8m+7}$  in the  $m$ -th tile of the  $n$ -th UL ACK channel are defined in Table 301a.

**Table 301a—Orthogonal Modulation Index in UL ACK Channel**

Vector index	$M_{n,8m}, M_{n,8m+1}, \dots, M_{n,8m+7}$
0	P0, P1, P2, P3, P0, P1, P2, P3
1	P0, P3, P2, P1, P0, P3, P2, P1
2	P0, P0, P1, P1, P2, P2, P3, P3
3	P0, P0, P3, P3, P2, P2, P1, P1
4	P0, P0, P0, P0, P0, P0, P0, P0
5	P0, P2, P0, P2, P0, P2, P0, P2
6	P0, P2, P0, P2, P2, P0, P2, P0
7	P0, P2, P2, P0, P2, P0, P0, P2

where

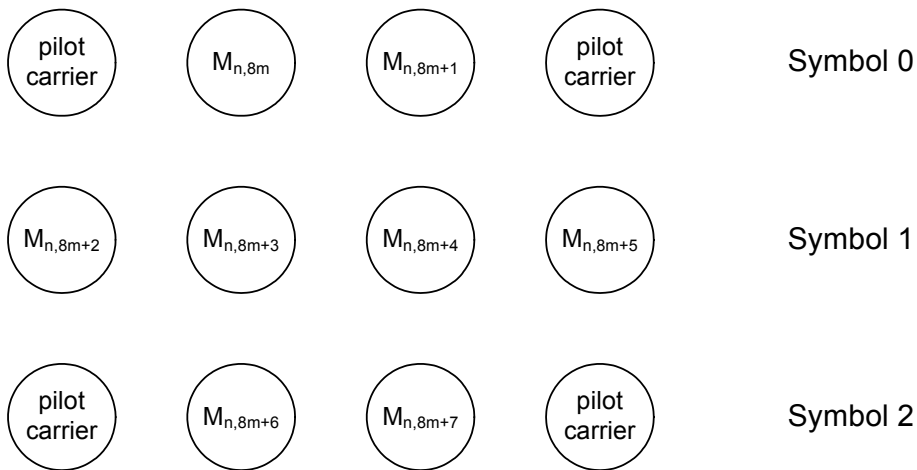
$$P0 = \exp\left(j \cdot \frac{\pi}{4}\right)$$

$$P1 = \exp\left(j \cdot \frac{3\pi}{4}\right)$$

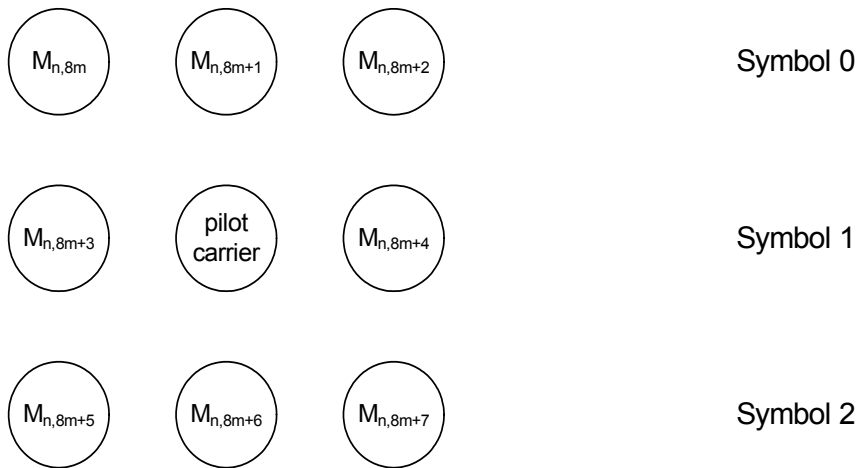
$$P2 = \exp\left(-j \cdot \frac{3\pi}{4}\right)$$

$$P3 = \exp\left(-j \cdot \frac{\pi}{4}\right)$$

$M_{n,8m+k}$  is mapped to UL ACK channel tile as shown in Figure 231a for PUSC uplink subchannel and in Figure 231b for optional PUSC uplink subchannel. An UL ACK channel is mapped to half sub-channel composed of 3 tiles. In the figures, subcarrier index increases from left to right.



**Figure 231g—Subcarrier mapping of UL ACK modulation symbols for PUSC**



**Figure 231h—Subcarrier mapping of UL ACK modulation symbols for optional PUSC**

**8.4.5.4.14 UL-MAP Physical Modifier IE**

*Change the first paragraph as indicated:*

For an SS that supports the AAS option (see 8.4.4.6), the Physical Modifier Information Element indicates that the subsequent allocations shall utilize a preamble, which is either cyclically rotated in frequency or cyclically delayed [see Equation (104) and Equation (105)]. The PHYMOD\_UL\_IE can appear anywhere in the UL map, and it shall remain in effect until another PHYMOD\_UL\_IE is encountered, or until the end of the UL map. When BS schedules more than one UL transmission for an SS it shall guarantee that the preamble modifier is the same for all UL bursts of the SS.

Change Table 302 as indicated:

**Table 302—OFDMA UL-MAP Physical Modifier IE format**

Syntax	Size	Notes
PHYMOD_UL_IE() {		
Extended UIUC	4 bits	PHYMOD = 0x05
Length	4 bits	Length = 0x03 <sub>L</sub>
Preamble Modifier Type	1 bit	0 – <del>Randomized preamble</del> <u>frequency shifted preamble</u> 1 – <del>Cyclically shifted Preamble</del> <u>time shifted Preamble</u>
if (Preamble Modifier Type == 0) {		
Preamble frequency shift index	4 bits	Indicates the value of $K$ in Equation (105)
} else {		
Preamble Time Shift Index	4 bits	<del>Indicates the value of <math>K</math> in equation (1)</del> <u>Specifies the cyclic time shift in equation (100):</u> For PUSC, 0 – 0 sample cyclic shift 1 – $\text{floor}(N_{FFT}/4)$ sample cyclic shift .... 3 – <del><math>\text{floor}(N_{FFT}/4*3)</math></del> $\text{floor}(N_{FFT}/4*3)$ sample cyclic shift 4–15 – Reserved  For optional PUSC, 0 – 0 sample cyclic shift 1 – $\text{floor}(N_{FFT}/3)$ sample cyclic shift 2 – $\text{floor}(N_{FFT}/3*2)$ sample cyclic shift 3–15 – Reserved  For AMC permutation, 0 – 0 sample cyclic shift 1 – $\text{floor}(N_{FFT}/9)$ sample cyclic shift .... 8 – <del><math>\text{floor}(N_{FFT}/9*8)</math></del> $\text{floor}(N_{FFT}/9*8)$ sample cyclic shift 9–15 – Reserved
}		
Pilot Pattern Modifier	1 bits	0: Not applied, 1: Applied
Pilot Pattern Index	2 bits	Pilot pattern used for this allocation (see 8.4.8.1.5 (Figure 249) and 8.4.6.3.3): 0b00 – Pilot Pattern #A 0b01 – Pilot Pattern #B 0b10 – Pilot Pattern #C 0b11 – Pilot Pattern #D
Reserved	7 bits	Shall be set to zero
}		

*Insert new subclause 8.4.5.4.15:*

**8.4.5.4.15 UL allocation start IE**

The UL Allocation start IE indicates the start offset of all subsequent UL allocation including allocation done by UL-MAP\_IE and extended UL-MAP\_IE. When this IE is included in UL-MAP or SUB-DL-UL-MAP, an SS shall determine all subsequent UL allocations based on the start offset defined in this IE except when the UL allocation already specified a start offset. This IE shall be supported by all SS.

**Table 302a—UL allocation start IE format test**

Syntax	Size	Notes
UL Allocation start IE() {	—	—
<b>Extended UIUC</b>	4 bits	UL_Allocation_start_IE() = 0x0A
<b>Length</b>	4 bits	Length = 0x02
<b>OFDMA symbol offset</b>	8 bits	This value indicates start symbol offset of all subsequent UL allocations in this UL_MAP message (UL-MAP or SUB-UL-DL-MAP).
<b>Subchannel offset</b>	7 bits	This value indicates start subchannel offset of all subsequent UL data burst allocations in this message (UL-MAP or SUB-UL-DL-MAP).
<i>Reserved</i>	1 bit	Shall be set to zero.
}	—	—

*Insert new subclause 8.4.5.4.16:*

**8.4.5.4.16 CQICH Enhanced Allocation IE format**

CQICH\_Enhanced\_Alloc\_IE(), is introduced to dynamically allocate or de-allocate a CQICH to an SS. This IE shall only be used with Enhanced Fast-feedback channel in 8.4.5.4.10.4 and primary/secondary Fast-feedback channel in 8.4.5.4.10.12. Once allocated, the SS transmit feedback information of the specified type on the assigned CQICH with the determined period, until the SS receives a CQICH\_Enhanced\_Alloc\_IE() to de-allocate the assigned CQICH.

**Table 302b—CQICH Enhanced allocation IE format**

Syntax	Size	Notes
CQICH_Enhanced_Alloc_IE() {	—	—
<b>Extended-2 UIUC</b>	4 bits	CQICH Enhance Alloc IE()=0x00
<b>Length</b>	8 bits	Length in bytes of following fields
<b>CQICH_ID</b>	<i>variable</i>	Index to uniquely identify the CQICH resource assigned to the MS
<b>Period (=p)</b>	3 bits	A CQI feedback is transmitted on the CQICH every 2 <sup>p</sup> frames

**Table 302b—CQICH Enhanced allocation IE format (continued)**

Syntax	Size	Notes
<b>Frame offset</b>	3 bits	The MS starts reporting at the frame of which the number has the same 3 LSB as the specified frame offset. If the current frame is specified, the MS should start reporting in eight frames
<b>Duration (=d)</b>	3 bits	A CQI feedback is transmitted on the CQI channels indexed by the CQICH_ID for $10 \times 2^d$ frames. If $d=0b000$ , the CQICH is deallocated. If $d=0b111$ , the MS should report until the BS command for the MS to stop.
<b>CQICH_Num</b>	4 bits	Number of CQICHs assigned to this CQICH_ID is (CQICH_Num + 1)
for (i=0;i<CQICH_Num+1;i++) {	—	—
<b>Feedback Type</b>	3 bits	0b000 - 0b010 = Fast DL measurement/Default Feedback depending on CQICH types 0b011 = Quantized precoding weight feedback 0b100 = Index to precoding matrix in codebook 0b101 = Channel Matrix Information 0b110-0b111 = Reserved
<b>Allocation index</b>	6 bits	Index to the Fast-feedback channel region marked by UIUC=0
<b>CQICH Type</b>	3 bits	0b000 = 6-bit CQI, 0b001 = Reserved, 0b010 = 3-bit CQI (even) 0b011 = 3-bit CQI(odd) 0b100 = 6-bit CQI (primary) 0b101 = 4-bit CQI (secondary) 0b110-0b111 = Reserved
<b>STTD indication</b>	1 bit	When CQICH type=000, 0 = Reserved 1 = use STTD in PUSC only (see Figure 249)
}	—	—
<b>Band_AMC_Precoding_Mode</b>	1 bit	0 = One common precoder for all bands. 1 = Distinct precoders for the bands with the highest S/N values, up to the number of short-term precoders fed back as specified by Nr_Precoders_feedback
If (Band_AMC_Precoding_Mode =1) { Nr_Precoders_feedback (=N) }	3 bits	Nr of precoders feedback = N
<b>Padding</b>	<i>variable</i>	The padding bits are used to ensure the IE size is integer number of bytes.
}	—	—

**Feedback Type**

For CQICH type=0b000, 0b001 or 0b100:

- 0b000 = Fast DL measurement/Default Feedback with antenna grouping
- 0b001 = Fast DL measurement/Default Feedback with antenna selection

0b010 = Fast DL measurement/Default Feedback with reduced codebook  
When the MS transmits the feedback of S/N using 5 LSBs of 6 bits on its assigned CQICH, the MSB is set to 0 (see 8.4.5.4.10.5). MS may transmit, on its assigned CQICH, the feedback information specified in 8.4.5.4.10.7

For CQICH type= 0b010 or 0b011:

0b000 = Antenna grouping (see Table 298d of 8.4.5.4.10.7)

0b001 = Antenna selection (see Table 298e of 8.4.5.4.10.7)

0b010 = Reduced codebook (see Table 298f of 8.4.5.4.10.7)

For CQICH type= 0b101:

0b000 = Fast DL measurement (see 8.4.5.4.10.1 and 8.4.5.4.10.5)

0b001 = Default Feedback with antenna grouping (see Table 298 of 8.4.5.4.10.3)

0b010 = Antenna selection and reduced codebook (see Table 298a of 8.4.5.4.10.3)

0b011 = Quantized precoding weight feedback (see Figure 231 of 8.4.5.4.10.2)

*Insert new subclause 8.4.5.4.17:*

**8.4.5.4.17 UL PUSC Burst Allocation in Other Segment IE**

In the UL-MAP, a BS may transmit UIUC=15 with the UL PUSC Burst Allocation in Other Segment IE () to define uplink bandwidth allocation in other segment. (See Table 302c.)

**Table 302c—UL PUSC Burst Allocation in Other Segment IE**

Syntax	Size	Notes
UL PUSC Burst Allocation in Other Segment IE () {	—	—
<b>Extended UIUC</b>	4 bits	UL PUSC Burst Allocation in Other Segment IE () = 0x08
<b>Length</b>	4 bits	Length=0x08
<b>UIUC</b>	4 bits	—
<b>Segment</b>	2 bits	Segment number for other BS' sector
<b>UL_Permbase</b>	7 bits	UL Permbase for other BS' sector
<b>OFDMA symbol offset</b>	8 bits	—
<b>Subchannel offset</b>	6 bits	—
<b>Duration</b>	10 bits	—
<b>Repetition coding indication</b>	2 bits	0b00 – No repetition coding 0b01 – Repetition coding of 2 used 0b10 – Repetition coding of 4 used 0b11 – Repetition coding of 6 used
<i>Reserved</i>	1 bit	Shall be set to zero
}	—	—

*Insert new subclause 8.4.5.4.18:*

**8.4.5.4.18 HO anchor active UL MAP IE**

This MAP IE is in the UL-MAP of an active non-anchor BS and indicates the burst from the Anchor BS. When an MS receives a HO Anchor Active UL-MAP IE on UL-MAP message from an active non-anchor BS, it can send a data burst to the Anchor BS by using the ‘Anchor Preamble’ in HO Anchor Active UL-MAP IE. (See Table 302d.)

**Table 302d—HO anchor active UL MAP IE**

Syntax	Size	Notes
HO Anchor Active UL MAP IE () {	—	—
<b>Extended-2 UIUC</b>	4 bits	HO Anchor Active MAP IE() = 0x01
<b>Length</b>	8 bits	—
for (each bursts) {	—	—
<b>Anchor Preamble</b>	16 bits	Preamble of anchor BS
<b>Anchor CID</b>	16 bits	Basic CID in anchor BS
<b>Start subchannel offset</b>	12 bits	—
<b>UIUC</b>	4 bits	—
<b>Duration</b>	10 bits	—
<b>Repetition coding indication</b>	2 bits	0b00 – No repetition coding 0b01 – Repetition coding of 2 used 0b10 – Repetition coding of 4 used 0b11 – Repetition coding of 6 used
}	—	—
<i>padding nibble</i>	0 or 4 bits	Shall be set to zero.
}	—	—



*Insert new subclause 8.4.5.4.19:*

**8.4.5.4.19 HO active anchor UL MAP IE**

This MAP IE is in the UL-MAP of the anchor BS and indicates the burst from active non-anchor BS. When an MS receives a HO Active Anchor UL-MAP IE on UL-MAP message from an Anchor BS, it can send a data burst to the active non-anchor BS by using the ‘Active Preamble’ in HO Active Anchor UL-MAP IE. (See Table 302e.)

**Table 302e—HO active anchor UL MAP IE**

Syntax	Size	Notes
<b>HO Active_Anchor UL MAP IE () {</b>	—	—
<b>Extended-2 UIUC</b>	4 bits	HO Active_Anchor MAP IE() = 0x02
<b>Length</b>	8 bits	—
for (each bursts) {	—	—
<b>Active Preamble</b>	16 bits	Preamble of active BS
<b>Anchor CID</b>	16 bits	Basic CID in anchor BS
<b>Start subchannel offset</b>	12 bits	—
<b>UIUC</b>	4 bits	—
<b>Duration</b>	10 bits	—
<b>Repetition coding indication</b>	2 bits	0b00 – No repetition coding 0b01 – Repetition coding of 2 used 0b10 – Repetition coding of 4 used 0b11 – Repetition coding of 6 used
}	—	—
<i>padding nibble</i>	0 or 4 bits	Shall be set to zero.
}	—	—

*Insert new subclause 8.4.5.4.20:*

**8.4.5.4.20 MIMO UL Enhanced IE format**

In the UL-MAP, a MIMO-enabled BS may transmit MIMO\_UL\_Enhanced\_IE() to indicate the MIMO configuration and pilot patterns of the subsequent uplink allocation to a specific MIMO-enabled MS CID. The MIMO mode indicated in the MIMO\_UL\_Basic\_IE() shall only apply to the uplink allocation within the IE. (See Table 302f.)

**Table 302f—MIMO UL Enhanced IE**

Syntax	Size	Notes
MIMO_UL_Enhanced_IE () {	—	—
<b>Extended-2 UIUC</b>	4 bits	MIMO_UL_enhanced_IE=0x06
<b>Length</b>	8 bits	Length in bytes
<b>Num_Assign</b>	4 bits	Number of burst assignment
For (j=0; j< Num_assign; j++){	—	—
<b>Num_CID</b>	2 bits	—
For ( i=0; i <Num_CID; i++){	—	—
<b>CID</b>	16 bits	MS basic CID
<b>UIUC</b>	4 bits	—
<b>Matrix_Indicator</b>	1 bit	For MS with dual antenna 0: Matrix A (STTD, see 8.4.8.4.3) 1: Matrix B (SM, see 8.4.8.4.3) For MS with single antenna, skip this field.
<b>Pilot Pattern Indicator</b>	1 bit	For MS with single antenna 0: pilot pattern A 1: pilot pattern B For MS with dual antenna (for PUSC only) 0: pilot pattern A/B 1: pilot pattern C/D
<i>Reserved</i>	2 bits	Shall be set to zero.
}	—	—
<b>Duration</b>	10 bits	In OFDMA slots (see 8.4.3.1)
}	—	—
<i>Padding</i>	<i>variable</i>	Shall be set to zero.
}	—	—

**Num\_Assign**

A field that specifies the number of assignments in this IE.

**Matrix\_Indicator**

A field that specifies the MIMO mode of UL burst. For MS with dual antenna it indicates STC Matrix and for MS with single antenna it is skipped.

**Pilot Pattern Indicator**

A field that indicates pilot patterns to MS with single antenna or to MS with dual antenna (see 8.4.8.1.5).

*Insert new subclause 8.4.5.4.21:*

**8.4.5.4.21 OFDMA Fast\_Ranging\_IE format IE**

A Fast\_Ranging\_IE may be placed in the UL-MAP message by a BS to provide a non-contention-based initial-ranging opportunity. The Fast\_Ranging\_IE shall be placed in the extended UIUC within a UL-MAP IE.

The format of the IE is PHY dependent as shown in Table 302g.

**Table 302g—OFDMA Fast\_Ranging\_IE format IE**

Syntax	Size	Notes
Fast_Ranging_IE {	—	—
<b>Extended UIUC</b>	4 bits	Fast_Ranging_IE() = 0x09
<b>Length</b>	4 bits	Length = 0x0B
<b>HO ID indicator</b>	1 bit	0: MAC Address is present 1: HO ID is present
<i>Reserved</i>	3 bits	Shall be set to zero
if (HO ID indicator == 1) {	—	—
<b>HO ID</b>	8 bits	—
<i>Reserved</i>	40 bits	Shall be set to zero
} else {	—	—
<b>MAC address</b>	48 bits	MS MAC address as provided on the RNG-REQ message on initial system entry
}	—	—
<b>UIUC</b>	4 bits	UIUC ≠ 15. A four-bit code used to define the type of uplink access and the burst type associated with that access.
<b>Duration</b>	10 bits	In OFDMA slots (see 8.4.3.1)
<b>Repetition coding indication</b>	2 bits	0b00 – No repetition coding 0b01 – Repetition coding of 2 used 0b10 – Repetition coding of 4 used 0b11 – Repetition coding of 6 used
}	—	—

#### **UIUC**

UIUC used for the burst.

#### **Duration**

Indicates the duration, in units of OFDMA slots, of the allocation.

#### **Repetition coding indication**

Indicates the repetition code used inside the allocated burst.

#### **HO ID indicator**

An indicator to indicate whether HO ID or MAC Address is being used to identify an MS during HO.

#### **HO ID**

An identifier assigned to an MS for use during initial ranging to the selected target BS.

*Insert new subclause 8.4.5.4.22:*

**8.4.5.4.22 UL-MAP\_Fast\_Tracking\_IE**

In the UL-MAP, a BS may transmit UIUC = 15 with the UL-MAP\_Fast\_Tracking\_IE() to provide fast power, time and frequency indications/corrections to MSs that have transmitted in the frame before the previous frame.

The CID used in the Information Element shall be a broadcast CID.

**Table 302h—UL-MAP\_Fast\_Tracking\_IE**

Syntax	Size	Notes
UL-MAP_Fast_Tracking_IE() {	—	—
<b>extended UIUC</b>	4 bits	Fast Tracking_IE() = 0x07
<b>Length</b>	4 bits	<i>Variable</i>
<b>Map Index</b>	2 bits	Index of SUB-DL-UL-MAP to which this IE refers, or zero if this IE refers to the mandatory UL-MAP. Shall be set to zero.
<i>Reserved</i>	6 bits	Shall be set to zero.
for ( <i>i</i> = 1; <i>i</i> <= <i>n</i> ; <i>i</i> ++) {	—	For each Fast Indication bytes 1 to <i>n</i> ( <i>n</i> =Length)
<b>Power correction</b>	3 bits	Power correction indication: 0b000: no change; 0b001: +2 dB 0b010: -1 dB 0b011: -2 dB 0b100: -4 dB 0b101: -6 dB 0b110: +4 dB 0b111: +6 dB
<b>Frequency correction</b>	3 bits	The correction is 0.1% of the carrier spacing multiplied by the 3-bit number interpreted as a signed integer (i.e., 0b100: -4; ... 0b000: 0; ... 0b011: 3)
<b>Time correction</b>	2 bits	The correction is floor(2 / $F_s$ ) multiplied by: 0b00: 0; 0b01: 1; 0b10: -1; 0b11: <i>Reserved</i>
}	—	—
}	—	—

The UL Fast tracking IE is an optional field in the UL-MAP. When this IE is sent it provides an indication about corrections that should be applied by MSs that have transmitted in the pervious UL frame. Each Indication byte shall correspond to one unicast allocation-IE that has indicated an allocation of an uplink transmission slot in the previous UL-MAP. The order of the indication bytes shall be the same as the order of the unicast allocation-IE in the UL-MAP.

The response time for corrections following receipt of this IE shall be equal to “Ranging Response Processing Time” as defined in 10.1.

*Insert new subclause 8.4.5.4.23:*

#### 8.4.5.4.23 Anchor BS Switch IE

The Anchor\_BS\_switch\_IE may be sent by a BS to indicate to one or more MS(s) to switch to a new specified Anchor BS at specific action time, or to cancel the switch. The Anchor\_BS\_switch\_IE can also be used to allocate CQICH at the new Anchor BS.

**Table 302i—Anchor\_BS\_switch\_IE format**

Syntax	Size	Notes
Anchor_BS_switch_IE() {	—	—
<b>Extended UIUC2</b>	4 bits	Anchor_BS_switch_IE() = 0x03
<b>Length</b>	8 bits	Length of the message in bytes
<b>N_Anchor_BS_switch</b>	4 bits	Number of Anchor BS switching indicated in this IE
for (i = 0; i < N_Anchor_BS_switch; i++) {	—	—
<b>Reduced CID</b>	12 bits	LSB 12 bits of basic CID of an MS whose anchor BS switching is indicated in this IE
<b>Action code</b>	2 bits	0b00 – The MS shall switch to the Anchor BS specified in the fast Anchor BS selection information in the Fast-feedback channel, at the default time specified by the switching period defined in the DCD. 0b01 – The MS shall switch to the Anchor BS specified in this IE and at the action time specified in this IE. 0b10 – The MS shall cancel all anchor switching procedure, stop switching timer and remain on the current anchor BS; 0b11 – <i>Reserved</i>
If (Action code == 01) {	—	—
<b>Action time (A)</b>	3 bits	In units of frames. 0b000 means the MS shall switch at the default time specified by the switching period defined in the DCD
<b>TEMP_BS_ID</b>	3 bits	TEMP_BS_ID of the anchor BS to switch to. (TEMP_BS_ID is the assigned ID to the BS when it was added to the diversity set of an MS)
<b>Reserved</b>	2 bits	—
}	—	—
If ( Action code == 00    Action code == 01 ) {	—	—
<b>CQICH Allocation Indicator</b>	2 bits	To indicate if CQICH allocation at the new Anchor BS is included in this IE.
If (CQICH_Allocation_Indicator == 1) {	—	—
<b>CQICH_ID</b>	<i>variable</i>	Index to uniquely identify the CQICH resource assigned to the MS after the MS switched to the new anchor BS

**Table 302i—Anchor\_BS\_switch\_IE format (continued)**

Syntax	Size	Notes
<b>Feedback channel offset</b>	6 bits	Index to the Fast-feedback channel region of the new Anchor BS marked by UIUC=0
<b>Period (=p)</b>	2 bits	A CQI feedback is transmitted on the CQICH every $2^p$ frames.
<b>Frame offset</b>	3 bits	The MS starts reporting at the frame of which the number has the same 3 LSB as the specified frame offset. If the current frame is specified, the MS should start reporting in eight frames
<b>Duration (=d)</b>	3 bits	A CQI feedback is transmitted on the CQI channels indexed by the CQICH_ID for $10 \times 2^d$ frames. If $d = 0b000$ , the CQI-CH is de-allocated. If $d = 0b111$ , the MS should report until the BS command for the MS to stop.
<b>MIMO_permutation_feedback_cycle</b>	2 bits	0b00 = No MIMO and permutation mode feedback 0b01 = the MIMO and permutation mode indication shall be transmitted on the CQICH indexed by the CQICH_ID every 4 allocated CQICH transmission opportunity. The first indication is sent on the 4th allocated CQICH transmission opportunity. 0b10 = the MIMO mode and permutation mode indication shall be transmitted on the CQICH indexed by the CQICH_ID every 8 allocated CQICH transmission opportunity. The first indication is sent on the 8th allocated CQICH transmission opportunity. 0b11 = the MIMO mode and permutation mode indication shall be transmitted on the CQICH indexed by the CQICH_ID every 16 allocated CQICH transmission opportunity. The first indication is sent on the 16th CQICH allocated CQICH transmission opportunity.
<b>Reserved</b>	<i>variable</i>	Number of bits required to align to byte length from CQICH Allocation Indicator bit field. Shall be set to zero.
}	—	—
}else{	—	—
<i>Reserved</i>	2 bits	—
}	—	—
}	—	—
<i>Reserved</i>	4 bits	—
}	—	—

*Insert new subclause 8.4.5.4.24:*

#### 8.4.5.4.24 HARQ UL MAP IE

The following modes of HARQ shall be supported by the HARQ UL MAP IE:

- 1) Chase combining HARQ for all FEC types (HARQ Chase). In this mode, the burst profile is indicated by a DIUC.
- 2) Incremental redundancy HARQ for CTC (HARQ IR). In this mode, the burst profile is indicated by the parameters  $N_{EP}$ ,  $N_{SCH}$ .
- 3) Incremental redundancy HARQ for convolutional code (HARQ CC-IR).

The IE may also be used to indicate also a non-HARQ transmission.

The HARQ UL MAP IE defines one or more bursts. Each burst is separately encoded.

When Allocation Start Indication is 1, the HARQ UL MAP IE indicates the starting symbol and subchannel of the allocation. The starting symbol and subchannel shall indicate a valid slot location in the uplink subframe. The slots are allocated in a time-first order (as specified in 8.4.5.4). The starting symbol and subchannel are relevant only in the context of the HARQ UL MAP IE in which they appear. Allocations made without an Allocation Start Indication (such as HARQ UL MAP IE with Allocation Start Indication 0, or regular UL-MAP\_IE), shall be based on the global slot index, each of these allocations shall follow the last allocation which did not contain Allocation Start indication.

**Table 302j—HARQ UL MAP IE**

Syntax	Size	Notes
HARQ UL MAP IE() {	—	—
<b>Extended-2 UIUC</b>	4 bits	HARQ_UL-MAP_IE () = 0x07
<b>Length</b>	8 bits	Length in bytes
<b>RCID_Type</b>	2 bits	0b00 = Normal CID 0b01 = RCID11 0b10 = RCID7 0b11 = RCID3
Reserved	2 bits	
while (data remains) {	—	—
<b>Mode</b>	3 bits	Indicates the mode of this IE 0b000 = Chase HARQ 0b001 = Incremental redundancy HARQ for CTC 0b010 = Incremental redundancy HARQ for convolutional code 0b011 = MIMO Chase HARQ 0b100 = MIMO IR HARQ 0b101 = MIMO IR HARQ for Convolutional Code 0b110 = MIMO STC HARQ 0b111 = <i>Reserved</i>
<b>Allocation Start Indication</b>	1 bit	0: No allocation start information 1: Allocation start information follows

**Table 302j—HARQ UL MAP IE (continued)**

Syntax	Size	Notes
If (Allocation Start Indication == 1) {	—	—
<b>OFDMA Symbol offset</b>	8 bits	This value indicates start Symbol offset of subsequent sub-bursts in this HARQ UL MAP IE
<b>Subchannel offset</b>	7 bits	This value indicates start Subchannel offset of subsequent sub-bursts in this HARQ UL MAP IE
<i>Reserved</i>	1 bit	Shall be set to zero.
}	—	—
<b>N sub Burst</b>	4 bits	Indicates the number of bursts in this UL MAP IE
For (i = 0 ; i < N Sub-burst; i++){		
If (Mode == 000) {		
<b>UL HARQ Chase Sub-Burst IE ()</b>		
} else if (Mode == 001) {		
<b>UL HARQ IR CTC Sub-Burst IE ()</b>		
} else if (Mode == 010) {		
<b>UL HARQ IR CC Sub-Burst IE ()</b>		
} else if (Mode == 011) {		
<b>MIMO UL Chase HARQ Sub-Burst IE ()</b>		
} else if (Mode == 100) {		
<b>MIMO UL IR HARQ Sub-Burst IE ()</b>		
} else if (Mode == 101) {		
<b>MIMO UL IR HARQ for CC Sub-Burst IE ()</b>		
} else if (Mode == 110) {		
<b>MIMO UL STC HARQ Sub-Burst IE ()</b>		
}		
}		
}	—	—
<b>Padding</b>	<i>variable</i>	Padding to byte; shall be set to 0
}	—	—



**Table 302k—UL HARQ Chase sub-burst IE format**

Syntax	Size	Notes
HARQ Chase UL Sub-Burst IE {	—	—
<b>RCID IE()</b>	<i>variable</i>	—
<b>Dedicated UL Control Indicator</b>	1 bit	—
If (Dedicated UL Control Indicator == 1) {	—	—
<b>Dedicated UL Control IE ()</b>	<i>variable</i>	—
}	—	—
<b>UIUC</b>	4 bits	—
<b>Repetition Coding Indication</b>	2 bits	0b00 – No repetition coding 0b01 – Repetition coding of 2 used 0b10 – Repetition coding of 4 used 0b11 – Repetition coding of 6 used
<b>Duration</b>	10 bits	—
<b>ACID</b>	4 bits	—
<b>AI_SN</b>	1 bit	—
<b>ACK disable</b>	1 bit	When ‘ACK Disable’ == 1, the allocated sub-burst does not require an ACK to be transmitted by the BS in the HARQ ACK BITMAP (see 8.4.5.3.22). In this case, no bit position is allocated for the sub-burst in the HARQ ACK BITMAP. For the burst, MS shall not perform HARQ retransmission and ignore ACID, AI_SN and SPID, which shall be set to ‘0’ by BS if they exist.
<i>Reserved</i>	1 bit	—
}	—	—

**Table 302I—UL HARQ IR CTC sub-burst IE format**

Syntax	Size	Notes
HARQ IR CTC UL Sub-Burst IE {	—	—
<b>RCID IE()</b>	<i>variable</i>	—
<b>Dedicated UL Control Indicator</b>	1 bit	—
If (Dedicated UL Control Indicator ==1) {	—	—
<b>Dedicated UL Control IE ()</b>	<i>variable</i>	—
}	—	—
<b>N<sub>EP</sub></b>	4 bits	—
<b>N<sub>SCH</sub></b>	4 bits	—
<b>SPID</b>	2 bits	—
<b>ACID</b>	4 bits	—
<b>AI_SN</b>	1 bit	—
<b>ACK disable</b>	1 bit	When 'ACK Disable' == 1, the allocated sub-burst does not require an ACK to be transmitted by the BS in the HARQ ACK BITMAP (see 8.4.5.3.22). In this case, no bit position is allocated for the sub-burst in the HARQ ACK BITMAP. For the burst, MS shall not perform HARQ retransmission and ignore ACID, AI_SN and SPID, which shall be set to '0' by BS if they exist.
<i>Reserved</i>	3 bits	—
}	—	—

**Table 302m—UL HARQ IR CC sub-burst IE format**

Syntax	Size	Notes
HARQ IR CC UL Sub-Burst IE {	—	—
<b>RCID IE()</b>	<i>variable</i>	—
<b>Dedicated UL Control Indicator</b>	1 bit	—
If (Dedicated UL Control Indicator == 1) {	—	—
<b>Dedicated UL Control IE ()</b>	<i>variable</i>	—
}	—	—
<b>UIUC</b>	4 bits	—
<b>Repetition Coding Information</b>	2 bits	0b00 – No repetition coding 0b01 – Repetition coding of 2 used 0b10 – Repetition coding of 4 used 0b11 – Repetition coding of 6 used
<b>Duration</b>	10 bits	—
<b>SPID</b>	2 bits	—
<b>ACID</b>	4 bits	—
<b>AI_SN</b>	1 bit	—
<b>ACK disable</b>	1 bit	When ‘ACK Disable’ == 1, the allocated sub-burst does not require an ACK to be transmitted by the BS in the HARQ ACK BITMAP (see 8.4.5.3.22). In this case, no bit position is allocated for the sub-burst in the HARQ ACK BITMAP. For the burst, MS shall not perform HARQ retransmission and ignore ACID, AI_SN and SPID, which shall be set to ‘0’ by BS if they exist.
<i>Reserved</i>	3 bits	—
}	—	—

**Table 302n—MIMO UL Chase HARQ sub-burst IE format**

Syntax	Size	Notes
MIMO UL Chase HARQ Sub-Burst IE {	—	—
<b>MU Indicator</b>	1 bit	Indicates whether this UL burst is intended for multiple SS
<b>Dedicated MIMO UL Control Indicator</b>	1 bit	—
<b>ACK Disable</b>	1 bit	When ‘ACK Disable’== 1, the allocated sub-burst does not require an ACK to be transmitted by the BS in the HARQ ACK BITMAP (see 8.4.5.3.22). In this case, no bit position is allocated for the sub-burst in the HARQ ACK BITMAP. For the burst, MS shall not perform HARQ retransmission and ignore ACID, AI_SN and SPID, which shall be set to ‘0’ by BS if they exist.
if (MU indicator == 0) {	—	—
<b>RCID IE()</b>	<i>variable</i>	—
If (Dedicated MIMO UL Control Indicator ==1) {	—	—
<b>Dedicated MIMO UL Control IE ()</b>	<i>variable</i>	—
}	—	—
} else {	—	—
<b>Matrix</b>	1 bit	Indicates transmission matrix (see 8.4.8) for MS with dual Tx antennas 0 = Matrix A 1 = Matrix B Ignored by MS with single Tx antenna
}	—	—
<b>Duration</b>	10 bits	—
For (i=0;i<N_layer;i++) {	—	—
if (MU indicator == 1) {	—	—
<b>RCID IE()</b>	<i>variable</i>	—
}	—	—
<b>UIUC</b>	4 bits	—
<b>Repetition Coding Indication</b>	2 bits	0b00 – No repetition coding 0b01 – Repetition coding of 2 used 0b10 – Repetition coding of 4 used 0b11 – Repetition coding of 6 used
If (ACK Disable ==0) {	—	—
<b>ACID</b>	4 bits	—

**Table 302n—MIMO UL Chase HARQ sub-burst IE format (continued)**

Syntax	Size	Notes
AI_SN	1 bit	—
}	—	—
}	—	—
}	—	—

When an MS receives a MIMO HARQ burst allocation with Dedicated MIMO UL Control Indicator set to '1', the MS shall store the information in Dedicated MIMO UL Control IE. When an MS receives a MIMO HARQ burst allocation with Dedicated MIMO UL Control Indicator is set to '0', the MS shall use the stored Dedicated MIMO UL Control information from the last burst allocation where this information was included.

For MIMO HARQ allocation specified in the MIMO UL Chase HARQ Sub-Burst IE, MIMO UL IR HARQ Sub-Burst IE, or the MIMO UL IR HARQ for CC Sub-Burst IE, each layer shall be allocated its associated bit position in the ACK channel bitmap. The number of bits in the ACK channel bitmap associated with the sub-burst IE may be greater than N\_sub\_burst.

For each single MS sub-burst (MU indicator = 0) matrix and layer information shall be read from Dedicated MIMO UL Control IE, if set by the indicator bit, and be applied to the burst accordingly. For each multiple-SS sub-burst (MU Indicator = 1), N\_layer for this sub-burst shall be set to 2 and the first SS with the first RCID shall use the pilot pattern A for single antenna MS or the pilot pattern A/B for dual antenna MS in 8.4.8.1.5 and the first UIUC; whereas, the second MS with the second RCID shall use the pilot pattern B for single antenna MS or the pilot pattern C/D for dual antenna MS and the second UIUC.

**Table 302o—MIMO UL IR HARQ sub-burst IE format**

Syntax	Size	Notes
MIMO UL IR HARQ Sub-Burst IE {	—	—
<b>MU Indicator</b>	1 bit	Indicates whether this UL burst is intended for multiple SSS
<b>Dedicated MIMO UL Control Indicator</b>	1 bit	—
<b>ACK Disable</b>	1 bit	When 'ACK Disable' == 1, the allocated sub-burst does not require an ACK to be transmitted by the BS in the HARQ ACK BITMAP (see 8.4.5.3.22). In this case, no bit position is allocated for the sub-burst in the HARQ ACK BITMAP. For the burst, MS shall not perform HARQ retransmission and ignore ACID, AI_SN and SPID, which shall be set to '0' by BS if they exist.
if (MU indicator == 0) {	—	—
<b>RCID IE()</b>	<i>variable</i>	—
If (Dedicated MIMO UL Control Indicator == 1) {	—	—

**Table 302o—MIMO UL IR HARQ sub-burst IE format**

Syntax	Size	Notes
<b>Dedicated MIMO UL Control IE ()</b>	<i>variable</i>	—
}	—	—
} else {	—	—
<b>Matrix</b>	1 bit	Indicates transmission matrix (see 8.4.8) for MS with dual Tx antennas 0 = Matrix A 1 = Matrix B Ignored by MS with single Tx antenna
}	—	—
<b>N<sub>SCH</sub></b>	4 bits	—
For (i=0;i<N_layer;i++) {	—	—
if (MU indicator == 1) {	—	—
<b>RCID IE()</b>	<i>variable</i>	—
}	—	—
<b>N<sub>EP</sub></b>	4 bits	—
If (ACK Disable ==0) {	—	—
<b>SPID</b>	2 bits	—
<b>ACID</b>	4 bits	—
<b>AI_SN</b>	1 bit	—
}	—	—
}	—	—
}	—	—

**Table 302p—MIMO UL IR HARQ for CC sub-burst IE format**

Syntax	Size	Notes
MIMO UL IR HARQ for CC Sub-Burst IE {	—	—
<b>MU Indicator</b>	1 bit	Indicates whether this UL burst is intended for multiple SS
<b>Dedicated MIMO UL Control Indicator</b>	1 bit	—
<b>ACK Disable</b>	1 bit	When 'ACK Disable' == 1, the allocated sub-burst does not require an ACK to be transmitted by the BS in the HARQ ACK BITMAP (see 8.4.5.3.22). In this case, no bit position is allocated for the sub-burst in the HARQ ACK BITMAP. For the burst, MS shall not perform HARQ retransmission and ignore ACID, AI_SN and SPID, which shall be set to '0' by BS if they exist.
if (MU indicator == 0) {	—	—
<b>RCID IE()</b>	<i>variable</i>	—
If (Dedicated MIMO UL Control Indicator == 1) {	—	—
<b>Dedicated MIMO UL Control IE ()</b>	<i>variable</i>	—
}	—	—
} else {	—	—
<b>Matrix</b>	1 bit	Indicates transmission matrix (See 8.4.8) for MS with dual Tx antennas 0 = Matrix A 1 = Matrix B Ignored by MS with single Tx antenna
}	—	—
<b>Duration</b>	10 bits	—
For (i=0;i<N_layer;i++) {	—	—
if (MU indicator == 1) {	—	—
<b>RCID IE()</b>	<i>variable</i>	—
}	—	—
<b>UIUC</b>	4 bits	—
<b>Repetition Coding Indication</b>	2 bits	0b00 – No repetition coding 0b01 – Repetition coding of 2 used 0b10 – Repetition coding of 4 used 0b11 – Repetition coding of 6 used
If (ACK Disable == 0) {	—	—
<b>ACID</b>	4 bits	—
<b>AI_SN</b>	1 bit	—

**Table 302p—MIMO UL IR HARQ for CC sub-burst IE format (continued)**

Syntax	Size	Notes
<b>SPID</b>	2 bits	—
}	—	—
}	—	—
}	—	—

**Table 302q—MIMO UL STC HARQ sub-burst IE format**

Syntax	Size	Notes
MIMO UL STC HARQ Sub-Burst IE {	—	—
<b>Tx count</b>	2 bits	0b00: Initial transmission 0b01: Odd retransmission 0b10: Even retransmission 0b11: <i>Reserved</i>
<b>Duration</b>	10 bits	—
<b>Sub-burst offset indication</b>	1 bit	Indicates the inclusion of sub-burst offset.
<i>Reserved</i>	—	Shall be set to zero
<b>If (Sub-burst offset indication ==1) {</b>	—	—
<b>Sub-burst offset</b>	8 bits	Offset in slots with respect to the previous sub-burst defined in this data region. If this is the first sub-burst within the data region, this off-set is with respect to slot 0 of the data region.
}	—	—
<b>RCI_D_IE()</b>	<i>Variable</i>	—
<b>ACK Disable</b>	1 bit	When 'ACK Disable' == 1, the allocated sub-burst does not require an ACK to be transmitted by the BS in the HARQ ACK BITMAP (see 8.4.5.3.22). In this case, no bit position is allocated for the sub-burst in the HARQ ACK BITMAP. For the burst, MS shall not perform HARQ retransmission and ignore ACID, AI_SN and SPID, which shall be set to '0' by BS if they exist.
<b>If (Tx count == 00) {</b>	—	—
<b>UIUC</b>	4 bits	—



**Table 302q—MIMO UL STC HARQ sub-burst IE format (continued)**

Syntax	Size	Notes
<b>Repetition Coding Information</b>	2 bits	0b00 – No repetition coding 0b01 – Repetition coding of 2 used 0b10 – Repetition coding of 4 used 0b11 – Repetition coding of 6 used
}	—	—
If (ACK Disable == 0) {	—	—
<b>ACID</b>	4 bits	—
}	—	—
}	—	—

*Insert new subclause 8.4.5.4.24.1:*

#### 8.4.5.4.24.1 Dedicated UL Control IE

**Table 302r—Dedicated UL control IE format**

Syntax	Size	Notes
Dedicated UL control IE() {	—	—
<b>Length</b>	4 bits	Length of following control information in Nibble.
<b>Control header</b>	4 bits	Bit #0: SDMA Control Info Bit #1–3: Reserved
If (SDMA Control Info Bit == 1){	—	—
<b>Num SDMA layers</b>	2 bits	This value plus one indicates the total number of SDMA layers associated with the HARQ UL MAP IE
<b>Pilot pattern</b>	2 bits	0b00 = pattern A 0b01 = pattern B 0b10 = pattern C 0b11 = pattern D
}	—	—
}	—	—

#### **Length**

A field that indicates the following control information.

#### **Control Information**

Variable size control information.

#### **SDMA control information**

The Dedicated UL Control IE with SDMA Control Info = 1 shall be present within the first sub-burst allocation of each layer of SDMA allocations. When the SDMA control info is present, the OFDMA Symbol offset and Subchannel offset shall be reset to the Start OFDMA

Symbol offset and Start Subchannel offset of the HARQ UL MAP IE. The specified pilot pattern (see 8.4.8.1.5) is used for all sub-burst allocations until the next occurrence of SDMA Control Info or until the end of the current HARQ UL MAP IE. The information specified in this SDMA control info is first applied to the same sub-burst allocation that contains the Dedicated UL Control IE.

*Insert new subclause 8.4.5.4.24.2:*

**8.4.5.4.24.2 Dedicated MIMO UL control IE format**

Dedicated UL Control IE for MIMO contains additional control information for each sub-burst. (See Table 302s.)

**Table 302s—Dedicated MIMO UL control IE format**

Syntax	Size	Notes
Dedicated MIMO UL Control IE() {	—	—
<b>Matrix</b>	2 bits	Indicates transmission matrix (see 8.4.8) 0b00 = Matrix A (Transmit Diversity) 0b01 = Matrix B (Spatial Multiplexing) 0b10–0b11 = Reserved
<b>N_layer</b>	2 bits	Number of coding/modulation layers 0b00 = 1 layer 0b01 = 2 layers 0b10–0b11 = Reserved
}	—	—

*Insert new subclause 8.4.5.4.25:*

**8.4.5.4.25 HARQ ACK Region Allocation IE**

This IE may be used by the BS to define a UL region to include one or more ACK channel(s) for HARQ supporting MS. The IE format is shown in Table 302t. The slots in the ACKCH region are divided into two half-slots. The first half-slot is composed of tiles 0,2,4; the second half-slot is composed of tiles 1,3,5. In the ACKCH Region, ACK channel  $2n$  is the first half of slot  $n$ ; ACK channel  $(2n+1)$  is the second half of slot  $n$ . The slot number  $n$  is increased first along the subchannel axis until the end of the ACKCH region, and then along the time axis.

The HARQ enabled MS that receives HARQ DL burst at frame  $i$  should transmit the ACK signal through the ACK channel in the ACKCH region at frame  $(i+j)$ . The frame offset  $j$  is defined by the “HARQ ACK Delay for DL Burst” field in the UCD message.

The half-subchannel offset in the ACKCH Region is determined by the order of HARQ enabled DL burst in the DL MAP. For example, when an MS receives a HARQ enabled burst at frame  $i$ , and the burst is the  $n$ -th HARQ enabled burst among the HARQ related IEs, the MS should transmit HARQ ACK at  $n$ -th half-subchannel in ACKCH Region that is allocated by the BS at frame  $(i+j)$ .

Each SS should specify support of “UL ACK” channel (see 11.8.3.7.13).

When the “ACK disable” bit is set (in DL HARQ IR CTC Sub-Burst IE format), no ACK channel is allocated for the sub-burst.

**Table 302t—HARQ ACKCH region allocation IE**

Syntax	Size	Notes
HARQ ACKCH_Region_IE() {	—	—
<b>Extended-2 UIUC</b>	4 bits	HARQ_ACKCH_region_IE () = 0x08
<b>Length</b>	8 bits	Length in bytes
<b>OFDMA Symbol offset</b>	8 bits	—
<b>Subchannel offset</b>	7 bits	—
<b>No. OFDMA symbols</b>	5 bits	—
<b>No. subchannels</b>	4 bits	—
}	—	—

**OFDMA Symbol offset**

**Subchannel offset**

**No. OFDMA Symbols**

**No. Subchannels**

Specify the start symbol offset, the start subchannel offset, the number of allocated symbols, and the number of subchannels for the HARQ acknowledgement region respectively.

HARQ ACK Region Allocation IE may override Fast-feedback Region. This means that when the HARQ ACK Region Allocation IE indicates the same region that is allocated for CQICH, then the region shall be used for HARQ ACK region.

*Insert new subclause 8.4.5.4.26:*

**8.4.5.4.26 UL\_Sounding\_Command\_IE**

UL\_Sounding\_Command\_IE is defined in 8.4.6.2.7.1, Table 316a.

*Insert new subclause 8.4.5.4.27:*

**8.4.5.4.27 AAS\_SDMA\_UL\_IE format**

**Table 302u—AAS\_SDMA\_UL\_IE**

Syntax	Size	Notes
AAS_SDMA_UL_IE() {	—	—
<b>Extended-2 UIUC</b>	4 bits	AAS_SDMA_UL_IE = 0x0E
<b>Length</b>	8 bits	<i>variable</i>
<b>RCID_Type</b>	2 bits	0b00 = Normal CID 0b01 = RCID11 0b10 = RCID7 0b11 = RCID3
<b>Num Burst Region</b>	4 bits	—
<i>Reserved</i>	2 bits	Shall be set to zero.
For (ii = 1: Num Region) {	—	—
<b>Slot offset</b>	12 bits	Starting slot offset in AAS zone referenced to right after UL AAS preamble
<b>Slot duration</b>	10 bits	—
<b>Number of Users</b>	3 bits	SDMA users for the assigned region
<i>Reserved</i>	3 bits	Shall be set to zero.
For (jj = 1: Num_Users) {	—	—
<b>RCID_IE()</b>	<i>variable</i>	—
<b>Encoding Mode</b>	2 bits	0b00: No HARQ 0b01: HARQ Chase Combining 0b10: HARQ Incremental Redundancy 0b11: HARQ Conv. Code Incremental Redundancy
<b>Power Adjust</b>	1 bit	0: Not Included 1: Included; Signed integer in 0.25 dB Unit
<b>Pilot Pattern Modifier</b>	1 bit	0: Not Applied 1: Applied
If (AAS UL Preamble Used) {	—	—
<b>Preamble Modifier Index</b>	4 bits	Preamble Modifier Index
}	—	—
If (Pilot Pattern Modifier) {	—	Pilots per beam
<b>Pilot Pattern</b>	2 bits	See 8.4.8.1.5 (Figure 249) and 8.4.6.3.3 0b00: Pattern #A 0b01: Pattern #B 0b10: Pattern #C 0b11: Pattern #D
<i>Reserved</i>	2 bits	Shall be set to zero.
}	—	—

Table 302u—AAS\_SDMA\_UL\_IE (continued)

Syntax	Size	Notes
If (Encoding Mode == 0b00) {	—	—
<b>DIUC</b>	4 bits	—
<b>Repetition Coding Indication</b>	2 bits	0b00: No repetition 0b01: Repetition of 2 0b10: Repetition of 4 0b11: Repetition of 6
<i>Reserved</i>	2 bits	Shall be set to zero.
}	—	—
If (Encoding Mode == 0b01) {	—	HARQ Chase Combining
<b>DIUC</b>	4 bits	—
<b>Repetition Coding Indication</b>	2 bits	0b00: No repetition 0b01: Repetition of 2 0b10: Repetition of 4 0b11: Repetition of 6
<b>ACID</b>	4 bits	—
<b>AI_SN</b>	1 bit	—
<i>Reserved</i>	1 bit	Shall be set to zero.
}	—	—
If (Encoding Mode == 0b10) {	—	—
<b>N<sub>EP</sub></b>	4 bits	—
<b>N<sub>SCH</sub></b>	4 bits	Indicator for the number of first slots used for data encoding in this SDMA allocation region
<b>SPID</b>	2 bits	—
<b>ACID</b>	4 bits	—
<b>AI_SN</b>	1 bit	—
<i>Reserved</i>	1 bit	Shall be set to zero.
}	—	—
If (Encoding Mode == 0b11) {	—	HARQ Conv. Code Incremental Redundancy
<b>DIUC</b>	4 bits	—
<b>Repetition Coding Indication</b>	2 bits	0b00: No repetition 0b01: Repetition of 2 0b10: Repetition of 4 0b11: Repetition of 6
<b>SPID</b>	2 bits	—
<b>ACID</b>	4 bits	—
<b>AI_SN</b>	1 bit	—
<i>Reserved</i>	3 bits	Shall be set to zero.
}	—	—

**Table 302u—AAS\_SDMA\_UL\_IE (continued)**

Syntax	Size	Notes
If (Power Adjust Included) {	—	—
<b>Power adjustment</b>	8 bits	Signed integer in 0.25 dB Unit
}	—	—
}	—	End of User loop
}	—	End of Burst Region Loop
<b>Padding</b>	<i>variable</i>	Shall be set to zero.
}	—	—

*Insert new subclause 8.4.5.4.28:*

**8.4.5.4.28 Feedback polling IE**

This IE may be used by BS to schedule Feedback header transmission by the MS. When the Dedicated UL Allocation bit is set to 1, a dedicated UL allocation shall be included in this IE. The dedicated UL allocation shall be used by the MS to transmit Feedback header at the designated Feedback header transmission frame defined by this IE. When the Dedicated UL Allocation bit is set to 0, no dedicated UL allocation shall be included. Instead, at the designated transmission frame defined by this IE, the MS shall compose the Feedback header and the BS shall include a dedicated UL allocation for the transmission using normal UL MAP IE. (See Table 302v.)

**Table 302v—Feedback polling IE format**

Syntax	Size	Notes
Feedback polling IE () {	—	—
<b>Extended-2 UIUC</b>	4 bits	0x0F
<b>Length</b>	8 bits	Length in bytes of following fields
<b>Num_Allocations</b>	4 bits	
<b>Dedicated UL Allocation Included</b>	1 bit	0: No dedicated UL resource is allocated in this feedback polling IE. BS shall provide UL allocation for the Feedback header transmission through UL-MAP at each designated transmitting frame defined by this IE 1: Dedicated UL resource is included
<b>Reserved</b>	3 bits	Shall be set to zero.
For (i=0; i < Num Allocations; i++) {	—	—
<b>Basic CID</b>	16 bits	—
<b>Allocation Duration (d)</b>	3 bits	The allocation is valid for $4^{(d-1)}$ frame starting from the frame defined by Frame_offset If d == 0b000, the pre-scheduled Feedback header transmission is released If d == 0b111, the pre-scheduled Feedback header transmission shall be valid until the BS commands to release it.

**Table 302v—Feedback polling IE format (continued)**

Syntax	Size	Notes
If (d != 0b000) {	—	—
<b>Feedback type</b>	4 bits	See Table 7i
<b>Frame Offset</b>	3 bits	The offset (in units of frames) from the current frame in which the first UL feedback header shall be transmitted on the allocated UL resource. The start value of frame offset shall be 1.
<b>Period (p)</b>	2 bits	The UL resource region is dedicated to the MS in every 2 <sup>p</sup> frame.
If (Dedicated UL Allocation Included == 1) {	—	—
<b>UIUC</b>	4 bits	—
<b>OFDMA symbol offset</b>	8 bits	—
<b>Subchannel offset</b>	7 bits	—
<b>Duration</b>	3 bits	In OFDMA Slots
<b>Repetition coding indication</b>	2 bits	0b00 – No repetition coding 0b01 – Repetition coding of 2 used 0b10 – Repetition coding of 4 used 0b11 – Repetition coding of 6 used
}	—	—
}	—	—
}	—	—
<i>Padding bits</i>	<i>variable</i>	To align octet boundary
}	—	—

**Feedback type**

See Table 7i.

**Duration**

In OFDMA slots (see 8.4.3.1).

**Period (p)**The UL resource region is dedicated to an MS in every 2<sup>p</sup> frame.**Dedicated UL Allocation**

0: No dedicated UL resource is allocated in feedback polling IE. BS shall provide UL allocation for the Feedback header transmission at each designated transmitting frame defined by this IE.

1: Dedicated UL resource is included.

**OFDMA symbol offset**

The offset of OFDMA symbol in which the burst starts, measured in OFDMA symbols from beginning of the designated transmission uplink frame for feedback header.

**Subchannel offset**

The lowest index OFDMA subchannel used for carrying the burst, starting from subchannel 0.

**Allocation Duration (d)**

The allocation is valid for 4<sup>(d-1)</sup> frame starting from the frame defined by Frame offset  
If d == 0b000, the dedicated allocation is de-allocated.

If  $d = 0b111$ , the dedicated resource shall be valid until the BS commands to de-allocate the dedicated allocation.

*Insert the following text and tables at the end of 8.4.5.5:*

**8.4.5.5 Burst profile format**

Table 304a defines the format of the Downlink Burst Profile with type=153, which is used in the DCD message (6.3.2.3.1) for MS only. The DIUC field is associated with the Downlink Burst Profile and Thresholds. The DIUC value is used in the DL-MAP message to specify the Burst Profile to be used for a specific downlink burst.

**Table 304a—OFDMA Downlink\_Burst\_Profile TLV format for multiple FEC types**

Syntax	Size	Notes
Downlink burst profile {	—	—
<b>Type = 153</b>	8 bits	—
<b>Length</b>	8 bits	—
<i>Reserved</i>	2 bits	Shall be set to zero
<b>Coding Type</b>	2 bits	0b00: BTC 0b01: CTC 0b10: ZT CC 0b11: LDPC
<b>DIUC</b>	4 bits	—
<b>TLV encoded information</b>	<i>variable</i>	—
}	—	—

Table 304b defines the format of the Uplink Burst Profile with type=13, which is used in the UCD message (6.3.2.3.3) for MS only. The UIUC field is associated with the Uplink Burst Profile and Thresholds. The UIUC value is used in the UL-MAP message to specify the Burst Profile to be used for a specific uplink burst.



**Table 304b—OFDMA Uplink\_Burst\_Profile TLV format for multiple FEC types**

Syntax	Size	Notes
Uplink burst profile {	—	—
<b>Type = 13</b>	8 bits	—
<b>Length</b>	8 bits	—
<i>Reserved</i>	2 bits	Shall be set to zero
<b>Coding Type</b>	2 bits	0b00: BTC 0b01: CTC 0b10: ZT CC 0b11: LDPC
<b>UIUC</b>	4 bits	—
<b>TLV encoded information</b>	<i>variable</i>	—
}	—	—

DIUC/UIUC for mandatory CC shall be referred to Downlink/Uplink burst profile with type=1. If there is no Downlink(Uplink) burst profile with type of 153(13), MSs shall refer to Downlink(Uplink) burst profile with type of 1. The burst transmitted without CID in the DL-MAP IE shall be encoded using DIUC specified in the downlink burst profile with type of 1. This capability is determined by SBC-REQ/RSP (see 11.8.3.7.16).

MAP IEs that do not contain a CID or that contain broadcast/multicast CIDs shall always use type 1 DIUC (see Table 303).

#### 8.4.5.6 Compressed maps

*Change the subclause as indicated:*

In addition to the standard DL-MAP and UL-MAP formats described in 6.3.2.3.2 and 6.3.2.3.4, the DL-MAP and UL-MAP may conform to the format presented in the following subclauses. The presence of the compressed DL-MAP format is indicated by the contents of the most significant two bits of the first data byte ~~following the DL Frame Prefix~~. These bytes overlay the HT and EC bits of a generic MAC header. When these bits are both set to 1 (an invalid combination for a standard header), the compressed DL-MAP format is present. A compressed UL-MAP shall only appear after a compressed DL-MAP. The presence of a compressed UL-MAP is indicated by a bit in the compressed DL-MAP data structure.

The compressed map must occur directly after the DL Frame Prefix, or can be used as a private map in an AAS zone. When located in an AAS zone, the private map can be pointed to by a broadcast map, the AAS DLFP message, or another private map in a previous frame. Other restrictions of private maps include:

- The private map must be the first message in a PHY burst.
- Private maps are only allowed to use unicast CID values.
- Allocations pointed to by a private map must occur within the same AAS zone as the private map.
- Both UL and DL allocations included in the private map are relative to the next frame + frame offset value negotiated with the SS (see 11.8.3.7.6).

When a private map chain is started that has UL IE, an AAS\_UL\_IE must be included in the first UL map so the AAS zone information is known by the SS. This information only needs to be included in the first private map of a private map chain, or after any parameters in the AAS zone is changed. The DL zone information is expected to be static for the duration of the private map chain; however, a AAS\_DL\_IE can be included to change the DL AAS zone parameters. The private map is an optional feature that can be negotiated between the SS and BS. In addition, there is a capability bit to indicate if an SS can support private map chains. This is to support applications that utilize private maps but do not require chains.

#### 8.4.5.6.1 Compressed DL-MAP

Change Table 305 as indicated:

**Table 305—Compressed DL-MAP message format**

Syntax	Size	Notes
Compressed_DL-MAP() {		
<b>Compressed map indicator</b>	<del>23</del> bits	Set to binary 110 <del>for</del> to indicate a compressed map format
<i>Reserved</i>	<del>1</del> bit	<del>Shall be set to zero</del>
<b>UL-MAP appended</b>	1 bit	
<del>CRC appended</del> <i>Reserved</i>	1 bit	<u>Shall be set to zero</u>
<b>Map message length</b>	11 <u>bits</u>	
<b>PHY Synchronization Field</b>	32 bits	
<b>DCD Count</b>	8 bits	
<b>Operator ID</b>	8 bits	
<b>Sector ID</b>	8 bits	
<b><u>No. OFDMA symbols</u></b>	<u>8 bits</u>	<u>Number of OFDMA symbols in the DL subframe including all AAS/permutation zone.</u>
<b>DL IE count</b>	8 bits	
for ( $i = 1; i \leq \text{DL IE count}; i++$ ) {		
<b>DL-MAP_IE()</b>	<i>variable</i>	
}		
if !(byte boundary) {		
<b>Padding Nibble</b>	4 bits	Padding to reach byte boundary
}		
}		

*Change the description of ‘UL-MAP appended’ and ‘CRC appended’ field below Table 305 as indicated:*

**UL-MAP appended**

A value of 1 indicates a compressed UL-MAP (see ~~8.5.5.2.4.28.4.5.6.2~~) is appended to the current compressed DL-MAP data structure.

~~**CRC appended**~~

~~A value of one indicates a CRC-32 value is shall be~~ appended to the end of the compressed map(s) data. The CRC is computed across all bytes of the compressed map(s) starting with the byte containing the Compressed map indicator through the last byte of the map(s) as specified by the Map message length field. The CRC calculation is the same as that used for standard MAC messages. ~~A value of zero indicates that no CRC is appended.~~

*Insert the following text at the end of the subclause:*

In case the UL-MAP is not appended to the DL-MAP, the UL-MAP (if such exists) message shall be always transmitted on the burst described by the first DL-MAP IE of the DL-MAP.

**8.4.5.6.2 Compressed UL-MAP**

*Change the second sentence of the first paragraph as indicated:*

The message presents the same information as the standard format with the exception that the Generic MAC header ~~and the Uplink Channel ID are~~ omitted.

*Insert the following field after the ‘Allocation Start Time’ field in Table 306:*

No. OFDMA symbols	8 bits	Number of OFDMA symbols in the UL subframe.
-------------------	--------	---

**8.4.5.7 AAS-FBCK-REQ/RSP message bodies**

*Change field ‘Frequency measurement resolution’ in Table 307 as indicated:*

Frequency measurement resolution	2 bits	<u>if Measurement Data Type = 0 {</u> 0b00 = 32 subcarriers 0b01 = 64 subcarriers 0b10 = 128 subcarriers 0b11 = 256 subcarriers } <u>if Measurement Data Type = 1 {</u> 0b00 = 1 subcarrier 0b01 = 4 subcarriers 0b10 = 8 subcarriers 0b11 = 16 subcarriers }
----------------------------------	--------	--

*Insert the following description after the description of ‘Number of Frames’ field below Table 307 as indicated:*

**Measurement Data Type**

Indicates the type of data on which the measurement is carried out. If the ‘Measurement Data Type’ field entry is set to ‘1’ the measurement is carried out over all DL bursts for this SS during the period, that is indicated by Frame Number and Number of Frames. The measurement, thereby, extends over the DL bursts as a whole, including AAS DL preambles.

*Change the description of ‘Frequency measurement resolution’ below Table 307 as indicated:*

**Frequency measurement resolution**

Indicates the frequency measurement points to report on. Measurement points shall be on the frequencies corresponding to the negative subcarrier offset indices  $-N_{used}/2 + n$  times the indicated subcarrier resolution and corresponding to the positive subcarrier offset indices  $N_{used}/2 - n \times$  times the indicated subcarrier resolution where  $n$  is a positive integer. In case of measurement on the downlink data (value ‘1’ of the ‘Measurement Data Type’ field) only the frequencies occurring in the allocations of the addressed SS shall be reported.

*Change the description of ‘CINR mean value’ field below Table 308 as indicated:*

**CINR mean value**

The mean CINR as measured on the element pointed to by data measurement type, frame number, and number of frames in the corresponding request. The ~~RSSICINR~~ is quantized as described in 8.3.9.2. When the AAS feedback response is unsolicited, this value corresponds to preceding frame.

*Change the description of the ‘Re(Frequency\_value[i]) and Im(Frequency\_value[i])’ field below Table 308 as indicated:*

**Re( Frequency\_value[i] ) and Im( Frequency\_value[i] )**

The real (Re) and imaginary (Im) part of the mean measured complex amplitude on the frequency measurement point (low to high frequency) in signed integer fixed point format ([±][2 bits].[5 bits]).

**8.4.5.8 Reduced AAS private maps**

*Insert new subclause 8.4.5.8.1:*

**8.4.5.8.1 Reduced AAS private DL-MAP**

The reduced AAS private DL-MAP format is presented in Table 308a. The reduced AAS private DL-MAP message eliminates the fields that are not relevant since the message is targeted to a single CID. The DL\_PermBase of the zone containing the assigned DL allocation is assumed to have the same value as the zone in which the compressed private DL-MAP message is located.

**Table 308a—Reduced AAS-private DL-MAP message format**

Syntax	Size	Notes
Reduced_AAS_Private_DL-MAP() {	—	—
<b>Compressed map indicator</b>	3 bits	Set to 0b110 for compressed format
<b>UL-MAP appended</b>	1 bit	1 = reduced UL Private map is appended
<b>Compressed Map Type</b>	2 bits	Shall be set to 0b11 for reduced private map
<b>Multiple IE</b>	1 bit	1 = Multiple IE Mode
<i>Reserved</i>	1 bit	Shall be set to zero
if (Multiple IE) {	—	—
<b>NUM IE</b>	8 bits	—
}	—	—
for (ii=1:NUM IE) {	—	—
<b>Periodicity</b>	2 bits	00 = single command, not periodic, or terminate periodicity. Otherwise, repeat DL and UL allocations once per $r$ frames, where $r = 2^{(n-1)}$ , where $n$ is the decimal equivalent of the periodicity field.
<b>CID Included</b>	1 bit	1 = CID included. The CID shall be included in the first compressed private MAP if it was pointed to by a DL-MAP IE with INC_CID==0 or by a DL-MAP IE with a multicast CID.
<b>DCD Count Included</b>	1 bit	1 = DCD Count included. The DCD count is expected to be the same as in the broadcast map that initiated the private map chain. The DCD count can be included in the private map if it changes.
<b>PHY modification Included</b>	1 bit	1 = included.
<b>CQICH Control Indicator</b>	1 bit	1 = CQICH control information included.
<b>Encoding Mode</b>	2 bits	Encoding for DL traffic burst 0b00: No HARQ 0b01: Chase Combining HARQ 0b10: Incremental Redundancy HARQ 0b11: Conv. Code Incremental Redundancy
<b>Separate MCS Enabled</b>	1 bit	Separate coding applied for reduced AAS_Private_MAP and DL data burst
If (Separate MCS Enabled) {	—	Specifies coding for the next private map in the allocation specified by this private map
<b>Duration</b>	10 bits	Slot duration for reduced AAS Private Map
<b>DIUC</b>	4 bits	Modulation and Coding Level

**Table 308a—Reduced AAS-private DL-MAP message format (continued)**

Syntax	Size	Notes
<b>Repetition Coding Indication</b>	2 bits	0b00: No repetition 0b01: Repetition of 2 0b10: Repetition of 4 0b11: Repetition of 6
}	—	—
if (CID Included) {	—	—
<b>CID</b>	16 bits	Must be a unicast CID
}	—	—
If (CQICH Control Indicator == 1) {	—	—
<b>Allocation Index</b>	6 bits	CQICH subchannel index within Fast-feed-back region marked with UIUC = 0
<b>Report Period</b>	3 bits	Reporting period indicator (in frames)
<b>Frame offset</b>	3 bits	Start frame offset for initial reporting
<b>Report Duration</b>	4 bits	Reporting duration indicator
<b>CQI Measurement Type</b>	2 bits	0b00 – CINR measurement based upon DL allocation 0b01 – CINR measurement based upon DL frame preamble 0b10, 0b11 – <i>Reserved</i>
<i>Reserved</i>	2 bits	Shall be set to zero
}	—	—
if (DCD Count Included) {	—	—
<b>DCD Count</b>	8 bits	Matches the value of the configuration change count of the DCD, which describes the down-link burst profiles that apply to this map
}	—	—
if (PHY modification Included) {	—	—
<b>Preamble Select</b>	1 bit	0 = Frequency shifted preamble 1 = Time shifted preamble
<b>Preamble Shift Index</b>	4 bits	Updated preamble shift index to be used starting with the frame specified by the Frame Offset
<b>Pilot Pattern Modifier</b>	1 bit	0: Not Applied, 1: Applied Shall be set to 0 if PUSC AAS zone
<b>Pilot Pattern Index</b>	2 bits	pilot pattern used for this allocation [see 8.4.6.3.3 (AMC), 8.4.6.1.2.6 (TUSC)]: 0b00 – Pilot pattern #A 0b01 – Pilot pattern #B 0b10 – Pilot pattern #C 0b11 – Pilot pattern #D
}	—	—

**Table 308a—Reduced AAS-private DL-MAP message format (continued)**

Syntax	Size	Notes
<b>DL Frame Offset</b>	3 bits	Defines the frame in which the burst is located. A value of zero indicates an allocation in the subsequent frame
if (current zone permutation is FUSC or optional FUSC) {	—	—
<b>Zone symbol offset</b>	8 bits	The offset of the OFDMA symbol in which the zone containing the burst starts, measured in OFDMA symbols from beginning of the downlink frame referred to by the Frame Offset
}	—	—
<b>OFDMA Symbol Offset</b>	8 bits	Starting symbol offset referenced to DL preamble of the downlink frame specified by the Frame Offset
If (current zone permutation is AMC, TUSC1 or TUSC2) {		AMC (2 x 3 type), TUSC1 and TUSC2 all have triple symbol slot lengths
<b>Subchannel offset</b>	8 bits	—
<b>No. OFDMA triple symbol</b>	5 bits	Number of OFDMA symbols is given in multiples of three symbols
<b>No. subchannels</b>	6 bits	—
} Else {		—
<b>Subchannel offset</b>	6 bits	—
<b>No. OFDMA Symbols</b>	7 bits	—
<b>No. subchannels</b>	6 bits	—
}		—
<b>DIUC/N<sub>EP</sub></b>	4 bits	DIUC for Encoding Mode 0b00, 0b01, 0b11 N <sub>EP</sub> for Encoding Mode 0b10
If (HARQ Enabled) {	—	Encoding Mode 0b01, 0b10, 0b11
<b>DL HARQ ACK bitmap</b>	1 bit	HARQ ACK for previous UL burst
<b>ACK Allocation Index</b>	6 bits	ACK channel index within HARQ ACK region
<b>ACID</b>	4 bits	HARQ channel ID
<b>AI_SN</b>	1 bit	HARQ Sequence Number Indicator
If (IR Type) {		Incremental Redundancy
<b>N<sub>SCH</sub></b>	4 bits	Applied for Encoding Mode 0b10
<b>SPID</b>	2 bits	Applied for Encoding Mode 0b10 and 0b11
<i>Reserved</i>	2 bits	—
}	—	—

**Table 308a—Reduced AAS-private DL-MAP message format (continued)**

Syntax	Size	Notes
}	—	—
<b>Repetition Coding Indication</b>	2 bits	0b00 – No repetition coding 0b01 – Repetition coding of 2 used 0b10 – Repetition coding of 4 used 0b11 – Repetition coding of 6 used
If (UL-MAP appended) {	—	—
<b>Reduced_AAS_Private_UL-MAP()</b>	<i>variable</i>	—
}	—	—
<i>Reserved</i>	3 bits	—
}	—	—
<b>Nibble Padding</b>	<i>variable</i>	Padding depends upon HARQ options
<b>CRC-16</b>	16 bits	—
}	—	—

A CRC 16-CCITT, as defined in ITU-T Recommendation X.25, shall be included at the end of each reduced private map. The CRC is computed across all bytes of the reduced map, including the appended UL map if included, starting with the byte containing the ‘compressed map indicator’ through the last byte of the map including padding.

The “DL Frame Offset” and “UL Frame Offset” fields define the latency between the Reduced Private Map and the DL or UL allocation made by the Reduced Private Map. This is valid for all values of the “Periodicity” field. A Reduced Private Map with “Periodicity = 00” indicates single allocation or termination of a periodic chain of private map allocations if such chain is established.

***Insert new subclause 8.4.5.8.2:***

**8.4.5.8.2 Reduced AAS private UL-MAP**

The reduced AAS private UL-MAP format is presented in Table 308b. The message may only appear after a reduced AAS private DL-MAP message to which it shall be appended.



**Table 308b—Reduced AAS private UL-MAP message format**

Syntax	Size	Notes
Reduced_AAS_Private_UL-MAP() {	—	—
<b>AAS zone configuration Included</b>	1 bit	1 = AAS zone configuration included. AAS configuration should be included in the first UL map of a private map chain to define the UL AAS Zone.
<b>AAS zone position Included</b>	1 bit	1 = AAS zone position included. AAS zone position should be included in the first UL map of a private map chain to define the UL AAS Zone and any time the UL AAS zone is changed.
<b>UL MAP Information Included</b>	1 bit	1 = UL Map Information is included (UCD Count and Private Map Allocation Start Time). These fields should be included in the first allocation of a private map chain.
<b>PHY modification Included</b>	1 bit	1 = Preamble shift index included.
<b>Power Control Included</b>	1 bit	1 = Power control value included.
<b>Include Feedback header</b>	2 bits	0b00 = No feedback 0b01 = MS shall transmit a CINR feedback header (type 0b1011) based upon the DL allocation 0b10 = MS shall transmit a CINR feedback header (type 0b1011) based upon the DL frame preamble 0b11 = <i>Reserved</i>
<b>Encoding Mode</b>	2 bits	Encoding for UL traffic burst 0b00: No HARQ 0b01: Chase Combining HARQ 0b10: Incremental Redundancy HARQ 0b11: Conv. Code Incremental Redundancy
if (AAS Zone Config Included) {	—	—
<b>Permutation</b>	2 bits	0b00 = PUSC permutation 0b01 = Optional PUSC permutation 0b10 = AMC permutation 0b11 = <i>Reserved</i>
<b>UL_PermBase</b>	7 bits	—
<b>Preamble Indication</b>	2 bits	0b00 = 0 symbols 0b01 = 1 symbol 0b10 = 2 symbols 0b11 = 3 symbols
<i>Padding</i>	5 bits	—
}	—	—
if (AAS Zone Position Included) {	—	—
<b>Zone Symbol Offset</b>	8 bits	The symbol offset of the UL AAS Zone referenced to the start of the UL subframe in the frame specified by the UL frame offset.

**Table 308b—Reduced AAS private UL-MAP message format (continued)**

Syntax	Size	Notes
<b>Zone Length</b>	8 bits	The duration of the UL AAS Zone, specified in number of OFDMA symbols.
}	—	—
if (UL MAP Information Included) {	—	—
<b>UCD Count</b>	8 bits	Matches the value of the configuration change count of the UCD, which describes the uplink burst profiles that apply to this map.
<b>Private Map Allocation Start Time</b>	32 bits	Defines the start of the UL subframe relative to the start of the frame pointed to by the UL frame offset. This is defined in units of PS, and restricted to be less than $T_f$
}	—	—
if (PHY modification included) {	—	—
<b>Preamble Select</b>	1 bit	0 = Frequency shifted preamble 1 = Time shifted preamble
<b>Preamble Shift Index</b>	4 bits	—
<b>Pilot Pattern Modifier</b>	1 bit	0: Not Applied 1: Applied
<b>Pilot Pattern Index</b>	2 bits	See 8.4.8.1.5 (Figure 249) and 8.4.6.3.3: 0b00 – Pilot pattern #A 0b01 – Pilot pattern #B 0b10 – Pilot pattern #C 0b11 – Pilot pattern #D
}	—	—
if (Power Control Included) {	—	—
<b>Power control</b>	8 bits	Signed integer in 0.25 dB units
}	—	—
<b>UL Frame Offset</b>	3 bits	Defines the frame in which the burst is located. A value of zero indicates an allocation in the subsequent frame
<b>Slot Offset</b>	12 bits	The offset to the starting location of the uplink burst from the beginning of the UL AAS zone in slots
<b>Slot Duration</b>	10 bits	The duration of the UL burst, specified in slots
<b>UIUC / N<sub>EP</sub></b>	4 bits	UIUC for Encoding Mode 0b00, 0b01, 0b11 N <sub>EP</sub> for Encoding Mode 0b10
if (HARQ Enabled) {	—	Encoding Mode 0b01, 0b10, 0b11
<b>ACID</b>	4 bits	HARQ channel ID

**Table 308b—Reduced AAS private UL-MAP message format (continued)**

Syntax	Size	Notes
AI_SN	1 bit	HARQ Seq. Number Indicator
<i>Reserved</i>	3 bits	Shall be set to zero
If (IR Type) {	—	Incremental Redundancy
N <sub>SCH</sub>	4 bits	Applied for Encoding Mode 0b10
SPID	2 bits	Applied for Encoding Mode 0b10 and 0b11
<i>Reserved</i>	2 bits	Shall be set to zero
}	—	—
}	—	—
<b>Repetition coding Indication</b>	2 bits	Applied for Encoding Mode 0b00 and 0b01 0b00 – No repetition coding 0b01 – Repetition coding of 2 used 0b10 – Repetition coding of 4 used 0b11 – Repetition coding of 6 used
}	—	—

#### 8.4.6 OFDMA subcarrier allocations

*Change the subclause as indicated:*

For OFDMA,  $F_s = \text{floor}(8/7 \cdot BW/8000) \cdot 8000$ . Subtracting the guard tones from  $N_{FFT}$ , one obtains the set of “used” subcarriers  $N_{\text{used}}$ . For both uplink and downlink, these used subcarriers are allocated to pilot subcarriers and data subcarriers. However, there is a difference between the different possible zones. For FUSC and PUSC, in the downlink, the pilot tones are allocated first; what remains are data subcarriers, which are divided into subchannels that are used exclusively for data. For PUSC ~~in the downlink or~~ in the uplink, the set of used subcarriers is first partitioned into subchannels, and then the pilot subcarriers are allocated from within each subchannel. Thus, in FUSC, there is one set of common pilot subcarriers, and in PUSC of the downlink, there is one set of common pilot subcarriers in each major group, but in PUSC of the uplink, each subchannel contains its own set of pilot subcarriers.

##### 8.4.6.1 Downlink

###### 8.4.6.1.1 Preamble

*Change the first paragraph as indicated:*

The first symbol of the downlink transmission is the preamble; there are ~~six~~three types of preamble carrier-sets, those are defined by allocation of different subcarriers for each one of them; those subcarriers are modulated using a boosted BPSK modulation with a specific Pseudo-Noise (PN) code.

***Change the third and fourth paragraphs as indicated:***

Each segment uses ~~two~~one types of preamble out of the ~~six~~three sets in the following manner:

Each segment uses a preamble composed of a carrier-set out of the three available carrier-sets in the following manner: (In the case of segment ~~4~~0, the DC carrier will not be modulated at all and the appropriate PN will be discarded; therefore, DC carrier shall always be zeroed. ~~For segment 2, the last carrier shall not be modulated, for the preamble symbol there will be 172 guard band subcarriers on the left side and the right side of the spectrum).~~

***Change the description of the 'k' variable below Equation (109) as indicated:***

$k$  is a running index 0...~~576~~567.

***Change the paragraph above Figure 233 as indicated:***

Therefore, each segment eventually modulates each third subcarrier. As an example, Figure 233 depicts the preamble of segment 1 (in this figure subcarrier 0 corresponds to the first subcarrier used on the preamble symbol).

***Change the first sentence of the paragraph below Figure 233 as indicated:***

The PN series modulating the ~~pilots~~ preamble carrier-set are defined in Table 309.

***Insert the following text immediately before Table 309:***

For 1024 FFT size the PN series modulating the preamble carrier-set are defined in Table 309a (in case of segment 0, the DC carrier will not be modulated at all and the appropriate PN will be discarded; therefore, DC carrier shall always be zeroed, for the preamble symbol there will be 86 guard band subcarriers on the Left side and the right side of the spectrum).

For 512 FFT size the PN series modulating the preamble carrier-set are defined in Table 309b (in case of segment 1, the DC carrier will not be modulated at all and the appropriate PN will be discarded; therefore, DC carrier shall always be zeroed, for the preamble symbol there will be 42 guard band subcarriers on the Left side and 41 guard band subcarriers on the right side of the spectrum).

For 128 FFT size the PN series modulating the preamble carrier-set are defined in Table 309c (in case of segment 0, the DC carrier will not be modulated at all and the appropriate PN will be discarded; therefore, DC carrier shall always be zeroed, for the preamble symbol there will be 10 guard band subcarriers on the Left side and the right side of the spectrum).

***Change the title of Table 309 as indicated:***

**Table 309—Preamble modulation series per segment and IDcell for the 2k FFT mode**

***In Table 309, add '0x' before the text under the column 'Series to modulate ( $W_k$ )' at the 11th row.***

*Insert Table 309a through Table 309c:*

**Table 309a—Preamble modulation series per segment and IDcell for the 1K FFT mode**

Index	IDcell	Segment	Series to modulate (in hexadecimal format)
0	0	0	0xA6F294537B285E1844677D133E4D53CCB1F182DE00489E53E6B6E77065C7EE7D0ADBEAF
1	1	0	0x668321CBBE7F462E6C2A07E8BBDA2C7F7946D5F69E35AC8ACF7D64AB4A33C467001F3B2
2	2	0	0x1C75D30B2DF72CEC9117A0BD8EAF8E0502461FC07456AC906ADE03E9B5AB5E1D3F98C6E
3	3	0	0x5F9A2E5CA7CC69A5227104FB1CC2262809F3B10D0542B9BDFDA4A73A7046096DF0E8D3D
4	4	0	0x82F8A0AB918138D84BB86224F6C342D81BC8BFE791CA9EB54096159D672E91C6E13032F
5	5	0	0xEE27E59B84CCF15BB1565EF90D478CD2C49EE8A70DE368EED7C9420B0C6FFAF9AF035FC
6	6	0	0xC1DF5AE28D1CA6A8917BCDAF4E73BD93F931C44F93C3F12F0132FB643EFD5885C8B2BCB
7	7	0	0xFCA36CCCF7F3E0602696DF745A68DB948C57DFA9575BEA1F05725C42155898F0A63A248
8	8	0	0x024B0718DE6474473A08C8B151AED124798F15D1FFCCD0DE574C5D2C52A42EEF858DBA5
9	9	0	0xD4EBFCC3F5A0332BEA5B309ACB04685B8D1BB4CB49F9251461B4ABA255897148F0FF238
10	10	0	0xEEA213F429EB926D1BDEC03ABB67D1DE47B4738F3E929854F83D18B216095E6F546DADE
11	11	0	0xC03036FA9F253045DF6C0889A8B83BAEFCF90EB993C2D79BD911CA84075061AA43DA471
12	12	0	0x1E68EC22E5E2947FB0A29E4CC70597254B36C60331EACF779FE752D3F55DC41ABFC7DC9
13	13	0	0x63A57E75A0434F035AAC4504B265081D497F10C77928B71797C5D6C6824DC0F23BE34EE
14	14	0	0xC57C4612816DE981C58FD6F8DE9DD41F2422ADBC522B0CE31F9A6D5F2A126DC08F69FB1
15	15	0	0x978256AF184E7ED17789B33D324C711B36BFBCCE5446EB03687E9A0A839C7CE156104D2
16	16	0	0x011EC823157DD73150640CEB7DDB0A1F8F91E09599A851D5C7CAF687CFB752D297D82FC
17	17	0	0xC6DE82BEB7F57B9120E8A376D85C8F70FDC65BC660402DAC4AE6002EA2740C4F9E5973C
18	18	0	0x4C74929D6F9FAB9E5BB761026038E076F6824295E0AF397806ECEBC6DC713F03ACDC27C

**Table 309a—Preamble modulation series per segment and IDcell  
 for the 1K FFT mode (continued)**

Index	IDcell	Segment	Series to modulate (in hexadecimal format)
19	19	0	0x13E1E85C2234D0F3418001A35F135E10C6C918C36BC659FDA9D655D288A0BDAA8BF489D
20	20	0	0xFD4AF2D8F4F08F1A7DF59291C9AEE788F641B8231CFB813376E0BEB68DFCFCBBE552445
21	21	0	0xEBBC77A493AA0C62C62F25EE5E8D0701F50386F49026FA31487C9FD5C5206CE4EB00576
22	22	0	0x134F936F9E875842587ADCA92187F2FC6D62FFC3A833D8CDE465F9972ABAA83763AAEB7
23	23	0	0x3CD1DA70670BC73363D1B4A66D280FF6AA7636D07ECF32BA26101E5EBA1594FB8A0420A
24	24	0	0x918296B2937C2B6F73CF98F85A81B723D1C69DBDF3E019749C582DA22E789562729D475
25	25	0	0xC323981B8B2240865F48D61AE1B3B61D88522B7358952F949D4308CA15D1EE8FDFA683F
26	26	0	0x7514A6FA5FBB250C5C8CE96F791D676036C344A44B24284477B44CB3E758F8BCD58F05B
27	27	0	0x84C7FEC6E977FA1EC0C7CC9E0D067C73D8F846F82ABB3456D2104E1448D5A58D5975152
28	28	0	0x4841AFC277B86A0E067AF319422F501C87ACBFBDD66BFEA3644F879AE98BA8C5D605123
29	29	0	0xF35EA87318E459138A2CE69169AD5FD9F30B62DA04ED21320A9F59893F0D176752152FD
30	30	0	0xA0C5F35C5971CD3DC55D7D2B9FD27AA17A198583F580EB0800744EE5B6B3648DEA95840
31	31	0	0xA6D3D33AD9B56862DBF076E3ACE6A3150510CCC8BE77DE4E6E10EB5FE163765647D07DF
32	0	1	0x52849D8F020EA6583032917F36E8B62DFD18AD4D77A7D2D8EC2D4F20CC0C75B7D4DF708
33	1	1	0xCC53A152209DEC7E61A06195E3FA633076F7AE1BAFFE83CE565087C0507BA596E0BD990
34	2	1	0x17D98A7E32CCA9B142FE32DB37B2BF726E25AA7A557FFB5C400B47A38B16CF18E1EDE63
35	3	1	0xA5BA8C7E2C795C9F84EBBD425992766BDE5549A7A9F7EF7E44AFD941C6084568638FE84
36	4	1	0x33E57E78A5696255CA61AE36027036DA619E493A0A8F95D9915C6E61F3006CB9706BEBA
37	5	1	0x09961E7309A9B7F3929C370C51910EBAB1B4F409FA976AE8679F354C84C4051F371F902
38	6	1	0x508A9EBAEF3C7E09CFCFC0B6F444A09B45A130EFC8C5B22BCE87213854E7C9D329C9ADC
39	7	1	0xAACEEF9BCDC82E4AD525185B07CBABCB74861D16F7C25CFBA917B05463AD65391AF840D

**Table 309a—Preamble modulation series per segment and IDcell for the 1K FFT mode (continued)**

Index	IDcell	Segment	Series to modulate (in hexadecimal format)
40	8	1	0x23060ACC5A125DAB207EEEE47B4EEE1E8466BD17DDA2EB3CD90D2AB7A758C213E6D7FE5
41	9	1	0xCA55521667BDA8B6F1B205201A51B3A0C05DE9EA06BC73268730A81A992777021F46055
42	10	1	0x05ADFC A2F8207DC6FF8D1A85A1DD4694D4C48A838C4F833C532710021AC448A7B62B8DD
43	11	1	0x218C951223D7B712DC98F8B5217388A830003C5F2A00F232DD3475D2FC78C25B8D88FF9
44	12	1	0x79B94D24D721121EF678B7156F8D2666DE712BBF3837C85A9518781903146A7B4D42A28
45	13	1	0x58AABEF6A6BDE4011CAC583C5104B2C6FC5A2980F856373E5931A3C690245327581FA13
46	14	1	0x427D1AD18E338E16FCE6E23B4AD6D82A2144D53048F2665AA94577AFABD26889FCB1F9F
47	15	1	0x337FE0E4C15A22471AE0F6B6F91161A7DE2E1403D73587D5C8355105D2F70642B2CE425
48	16	1	0xA3FCAA311B536AC9DB39FED9F4E996506B3181C58D6B7E04157A3FD463F60468765BCFD
49	17	1	0xF484FD1F57F53A4A749B86148E0B1D0653667CE1393198875DDB0AE9179BBBDAAD53A11
50	18	1	0xA3E9ECF1E6048562BC89DB6168E708855F0D4AD29F859EF36C9160DF407D85426233632
51	19	1	0x890519376D1FFAA2894EABCD6663B0A3C2411982C17B01270E0FB0B289D4BC8C3B83DA9
52	20	1	0x09847B6187BB5F6F6728B4ED610088FAD9DADFC00748E9DCD8A0CE320D6C991654ABE05
53	21	1	0x3285AE0A3D196313659C37BE1C94D61D20F11FD49D9FDF9D1026FF5763F02CB78AE135C
54	22	1	0x0069D3F34D0D455AFB45FEFDF716333B785C6BDA90DA23F1CC68BC6A1DBC916C595DA3E
55	23	1	0xAA977A8BCA39381E7C35A1ACC7C4F60421C0862BFD6106C7C025B0676EA0EF68972DD8F
56	24	1	0xF310745C497094ABE56E0490C0800319DBE290553E696B6859635AF03B121F79D925D19
57	25	1	0x964DFD350B9C7DFDC7F6F7C43283A76F0D613E48A5520D1DAF761C6F47E389B43A023F5
58	26	1	0x6D767B88D28A455CC3B56C942BAFD8E465A50FD2C22FE6162E03A9AAC3C1CC899800610
59	27	1	0xC5491C6CA3D998906EC1482F815B74B7C2E3816B682ACC6009AB7EFF34BF0E9CE59C754
60	28	1	0x6D8EE32D30E19D93A0E5AD8226BAE9CF6FCBA17CF6E67FDC5A15A81ECB8908BEDD77C80

**Table 309a—Preamble modulation series per segment and IDcell  
 for the 1K FFT mode (continued)**

Index	IDcell	Segment	Series to modulate (in hexadecimal format)
61	29	1	0x98F8BFD774C7A249418E6FF4723D6E6AB2F091CDE4DE1CE11D 3BD463B509FB716940FD
62	30	1	0x65300BAD8FFA21BC7DC2C1F79FA97A9F469CCC9E270A61759F34 D6276F57CBEB009CD21
63	31	1	0x6F36BB6D5A7DC4FB720439E91FF0DE86DD6C4B93CFC4271F2BC C6169616E3AEAA19E360
64	0	± 2	0xD27B00C70A8AA2C036ADD4E99D047A376B363FEDC287B8FD1A 7794818C5873ECD0D3D56
65	1	2	0xE7FDDCCEED8D31B2C0752D976DE92BEA241A713CF818C274AA1 C2E3862C7EB7023AF35D4
66	2	2	0x87BF4954022D30549DF7348477EACB97AC3565B838460CC62F242 883313B15C31370335
67	3	2	0x82DD830BEDE4F13C76E4CF9AEF5E42609F0BDDCB000A742B637 2DD5225B0C3114494746
68	4	2	0x4E06E4CF46E1F5691938D7F40179D8F79A85216775384BD97966DB 4BBF49FB6FAB8F945
69	5	2	0x64164534569A5E670FDB390D09C04802DD6A16B022CADC77EDD 7464AFED43C773A8DC76
70	6	2	0xFB8769A81AA9DB607F14A6A95948401F83057CDC9C9C3996BA58 21403A49F00A4E35191
71	7	2	0x77710D6F40B4F79CC63F678551C3EC18FA9DF2C82E6C8F415DAD FD63264B7513180070E
72	8	2	0x503F196BBF93C238BFD5E735E5AE52E0DAE64F5E2F4C3B92E553 F51303C4A64C4403BF3
73	9	2	0x5FD4A6894566678C95B9D5A59DDE5366799045FEB03A2BAA7409 4140E9068C61C2E972C
74	10	2	0x95B584DC40C8B5DEAD63D48FCE65B1E61BAB4C597D921DB126 77141E2FFE7C0AA3DA0D5
75	11	2	0x985763AB6CC8934DB8A0BE738A7AF1D1FA3958C1F9E2D6A51A1 63E47A0A6E5FEB759FDD
76	12	2	0xFD8D45F00D943AD986BD353D61C6746DBF8A309B6AE1C173B88 0D957B76DC031A957E8D
77	13	2	0xAE4323534F6EFB1A20169328417885EF304FA220389FA9C2607E5A 406F4CE4A7498A39F
78	14	2	0xE5205579893BE184CB9948C28E2F9AAF699D47B6E5E0B219CBEA FE4BEC8D561BD809E34
79	15	2	0xAB11D6941478D36D5695CE813070DC1E32122A39083E53FE37366 0AEB125D83383FBDC A
80	16	2	0x188A09C46F1F11206FF9F15CFB5F6CD2F26C4BF485EE37D3650A5 95064F76CE34E40EAD
81	17	2	0x4B1CDE25539A56CEDC45FE7F54C38CF155F4FB1AE868F6C3952D 07014BF828E810BDE2D



**Table 309a—Preamble modulation series per segment and IDcell for the 1K FFT mode (continued)**

Index	IDcell	Segment	Series to modulate (in hexadecimal format)
82	18	2	0x16CA8F8C6A879E865E3611EAC389D56AFA3E4E84CDBB73567BA4A160249C4B680A7D9BC
83	19	2	0x39D2B08AA0E2E8781476027B41AD72F8D9838B7001AADFD33A92D81E56ECBB2C9378D58
84	20	2	0x8C258BC80D4AD125F335A5151EDF9E9A463E06C5C8D046F82E5DC3D73EF4D2231C5D14F
85	21	2	0x41A029C6356C825585179C5348EDF07A3AC2022539AC28DC4CD3C1DFADC8EE9644CD939
86	22	2	0x0D70A77CBE9804913BFBE4FBF917C5CD3580F6062BBAD3F99ECEBB4A9EBB87523AB722
87	23	2	0x6A00A30901F9FDE44B4F1ECED44E0BCB943B29519F313BE4496D34F39B154FC2384CB75
88	24	2	0x95351107A8BE6ABFC24C1292FE1A0FE677CBFD04F2E81178CAA9D294730EF9C946F676E
89	25	2	0x01F21470FD9B1E0B3C6B2F7C0412A15764C277D61BA2EE3B3769DE7ADACB2BB29918FB7
90	26	2	0xA578ABFE155369440FA3D4DF757CCA596469B80A0E56BFE6010DD63E67CEDB86BB1EF39
91	27	2	0x1E1CFFAB031836777DE5D168A9246C559574C74CCC06405EB406B8DDB7C9A6EF54A66A5
92	28	2	0x354149C2CA19A735F9CD04AF4922E8ECE6509B978B951F946FD4AD36C7F9C83624205E7
93	29	2	0x5A27E60DEA547D0D41897A03199F28A967AC51728E3B38325B4FBECF1B85A7EE9B04182
94	30	2	0x784DA3B16B810FE3B851060AD7BD27D9D9457F6C8899A13D311E531B855C15ECE6D3A2F
95	31	2	0xD7DFBC65797633A8C13D3EEC781D48952338136063B579D69437B28B744B5A4BE18AFA9
96	0	0	0x61AF26BD39A9FFF52826625E04ADA299385A373FA946D837D754E6CFEBB26F5C03B87CF
97	1	1	0xD77D97CDB93DBEAA65CAFA146F40D72B5E80944F750E07325DC164ED60F32434BC7187D
98	2	2	0x4529D9CA65AF49C1C39BDC18CFAB87E03FE4DAFC0A48FF1457D46B0DF66B414A23ACDDB
99	3	0	0x33AC0261DAA57C1D611EBA1C730D50AFEE5BE3E849030A4E891BC8C5F4C78DCDDFEA263
100	4	1	0xBED48C704F02A84F03BCD299D919DA56F7B71EDF8A0F8A25E8F8496F95A44CE2B9F74C9
101	5	2	0x0ECCBE0902EBF4B4C29506014A3706622784B7B2D5153E10AD3112DC5E45277A32E79DE
102	6	0	0x7CB4937889C7DFD9AA2D37235E06F993D3D4F5D515B39CA652F62397C08457D66BC5A36

**Table 309a—Preamble modulation series per segment and IDcell for the 1K FFT mode (continued)**

Index	IDcell	Segment	Series to modulate (in hexadecimal format)
103	7	1	0x43F23F6CAC6C43896B3EDBF00E1CBD42E2CC75E2A996448F0FC F17F6779DD6E356FED11
104	8	2	0x72C8A209FBC4A568BEF03BCFE1B0D959F977B0963780B4E54E2B 9A1016344ACB7EE3E3A
105	9	0	0x77AEB9E50DC3727849A94FBFFCDB5B9589AF50ABD8A58808B96 63058E17A2EBC496DF43
106	10	1	0x667123C89077FE4AAAEF15C635E976C6811682D478FFC7B721A76 B5A38697DF4FB7D2CE
107	11	2	0xCBD6C5C9BE55B0BE76AD03392E8A8AB9A86063DB31B79280B44 7980BB841FD7E9DC6B9B
108	12	0	0xC7D7DEF8B3C9C8667D8D65063B4DAD1FF69445C87CA71DA955 D0CA23970E988A6EA4C83
109	13	1	0xFB246ABD92F9E560CB2BEC2317204C9CE22AD3BD19EA02E90F5 F3B7F4F65538D8ED098E
110	14	2	0x29E74579472FDD8FFC2700B2BF33C649989DD8153093A7CA08B50 F7A5E4BAED108A0F0D
111	15	0	0xA27F29D8D6CCD7EB4BBE303C3E9E95802DB98BFD5B8ED03B88 304359D92E3EC108CA3C8
112	16	1	0x3FE70E26FA00327FE3B2BE6BC5D5014F588F09C17D222C146DD6 8B4824692A651888C76
113	17	2	0x41E91307EC58801CFF2C7E9CFEFBEB71681FAE2BEAEC72D4E455 6E99345D3BA4B369B59

**Table 309b—Preamble modulation series per segment and IDcell for the 512 FFT mode**

Index	IDcell	Segment	Series to modulate (in hexadecimal format)
0	0	0	0x66C9CB4D1C8F31D60F5795886EE02FFF6BE4
1	1	0	0xD8C30DA58B5ED71056C5D79032B80E05522C
2	2	0	0x8EB62664E3B2C5222DE18E9000561F25AAFC
3	3	0	0x3B32299087C257CD31C67E4AA5DD697B0E08
4	4	0	0xC07E0B0C5DB44071EE6CEC40CA3135CB5DB8
5	5	0	0x89B08CD299A8AC757DB59107AF4E1EF1EE1C
6	6	0	0x1B72E8C0ECFAABF050091382B411B45A718C
7	7	0	0x5B33ED5A6303397EC3CCC35C8203A5A05178
8	8	0	0xAD1173C461254BF9181238319F93F86AF964
9	9	0	0x51E2005BBA69C858BCC741D84990B657271C
10	10	0	0x21A03B607DD96F270CBC759B2A9BD6A84A34

**Table 309b—Preamble modulation series per segment and IDcell  
for the 512 FFT mode (continued)**

Index	IDcell	Segment	Series to modulate (in hexadecimal format)
11	11	0	0x4518EC4C7AD645D24AD949B42A7881403C7C
12	12	0	0xF8B70C595A37315D301D378A4D2848C821D4
13	13	0	0xFF42582005F8382C5CC6298D757155B36B24
14	14	0	0x599EF40107CBB3B30AF945365494A0D60570
15	15	0	0xC6D6BE87F0D88458ABD22DE822B64E450738
16	16	0	0xE043896829F236B10A35014D9E4F26ECB95C
17	17	0	0x2347472A610FC084C71460393AEF36CBE928
18	18	0	0x5F4D880DC516DC0B3860DA948225D2BC6770
19	19	0	0x9EFEEA99631FAF0D9589E9640BCD56C5FF08
20	20	0	0xFE792EF83B235B3D4A6447BED27035454BC0
21	21	0	0xB3B1B868C121C4555A64161B654A4FE81D70
22	22	0	0xB7C2D44078510ADD2447D93E8A1231AE3910
23	23	0	0x16A9D8F71CC1CD0EFA0008AA343A7A4ADA4C
24	24	0	0x7389FDE96166E7E40F7A6778AA02944937A4
25	25	0	0xA0598A0907798B3465DD8CBD08565F0FB5B8
26	26	0	0x0E75B3C128085C954A25E5808FC5833A8FB0
27	27	0	0xBBCDA362265B4D4D2BEE80F635E638316280
28	28	0	0x660047B06A1B5FAE6A9F0679DBCA9B1A2DF4
29	29	0	0x2594AE119CB87E802D67EF7EE0EAE99474CC
30	30	0	0x8FB3FA462D2CFAF842BB5319D9786A997C10
31	31	0	0x599E199B609C0C654DB053E8C94F343AAFF8
32	0	1	0xE0187D89220D11B5F60DAC078A5E2EED6EF0
33	1	1	0x69F57E074F14A10FEC6144C26E98C4688330
34	2	1	0xD2C4067132528AA41BBE61A9C171A382F768
35	3	1	0xB027CB82594D3900700B541A99CCD5FD5870
36	4	1	0xE9B565C61F73EC6633A1F2D96EC409495B80
37	5	1	0xEBD7E29110582C5951233AB22B03DE709698
38	6	1	0x0CCA91DA1B42B0B55C924F32B08B1FAE0E18
39	7	1	0xA4213FFB85B56E27C74FC6ECBA359875438C
40	8	1	0x1A37F92589686CFE5E4D4BFD8E2BC63AA8CC
41	9	1	0x31531C7B2F7518BF59ACFB216FC74D09F2F4
42	10	1	0xCE026112DF00BB74E1B1F43B595112B16344

**Table 309b—Preamble modulation series per segment and IDcell for the 512 FFT mode (continued)**

Index	IDcell	Segment	Series to modulate (in hexadecimal format)
43	11	1	0x503494DE054AE395883AEDD8CC7801B8F124
44	12	1	0x8447E25CA9A0EE1CFB9FADB6C42B8F565B3C
45	13	1	0x757C45DA8F140FB6E71024294B2439CDACFC
46	14	1	0xF2A59A32B51CE505E45E9B5C7C7DBE880DF4
47	15	1	0x8DFBF09479BC91E466A539E077D2B26A8B2C
48	16	1	0x1C6FB87D76DB82FFA1E492166684CACEE560
49	17	1	0xA32CF584137FDF1D4CCE6A1CF40FEC1F4AE0
50	18	1	0xEC4D3AC52136FA468F28777078C8A82C0808
51	19	1	0x30CABB208C9D6C774814A163765E4ACBC540
52	20	1	0xCA3448C6716F6F8D15D7372A3A4F6E825A14
53	21	1	0xABD1526F4A510F820B689F30C1E7B88C8848
54	22	1	0x94E4E2AE2C4E47FD7D0A154C25BF40F759E0
55	23	1	0x43BFFD566D85BE162650670BE1A3CA523284
56	24	1	0xD7644475A2E5EDAD1AD184242E3C841A03E0
57	25	1	0xA61DDBA416D1D14358647C4ACEF2503001E4
58	26	1	0x1F9047A8651D4D4A7C582469DC8C41B68E08
59	27	1	0xE0EAC02D975263F36D4BEF70669CBDEE658C
60	28	1	0xDFAE7334BD2B8FF1D2C7CB5922823B03F744
61	29	1	0xD44B2AD5842F1EEA1A39DBC64EC064FCCFBC
62	30	1	0x08AD296C8D17ABD021E02E20DACC247673EC
63	31	1	0x2FE66830D806B3F8DD38D5FE1CF12DEB9774
64	0	2	0xC6325F42597BD48A8914944C7DB973D83E64
65	1	2	0xE04B98E9254434D3F765A621752C0F1FEC54
66	2	2	0xA74B60D84CCB156B1B8AE015B8CE980868EC
67	3	2	0x78E7405DCFDA1DFCDA6E54B3794B49A0F8B0
68	4	2	F32F4CA1A154E746FE1C2D1E4A1251779804
69	5	2	0x5A2905A1CF5D06444C880ADC07EB3889E71C
70	6	2	0x74290661C664DEB829569B7C4E6C32B2BE00
71	7	2	0xEBB53241F5D9CD87A612C0774ED2FED4679C
72	8	2	0xE33B89ABA4ED020D558B833AF74072922164
73	9	2	0x3B7D2DEEF829E230718AA7996CD814A4DD88
74	10	2	0x373861E8993FC22E176F6DA6A46A10158EF4

**Table 309b—Preamble modulation series per segment and IDcell for the 512 FFT mode (continued)**

Index	IDcell	Segment	Series to modulate (in hexadecimal format)
75	11	2	0x2BEA329B65DE1CD26ECDD382915AC40B1D0C
76	12	2	0x7A8B131BD5D1270C30003DA472DD81D9A434
77	13	2	0x9D6A237940057479D30BE19AD719F8F9B47C
78	14	2	0xC1FB9C3811B349E9F793A14C8AE8425A6218
79	15	2	0xDFFDE03D8C717A346B4B1D3C02693330A9B4
80	16	2	0x76254DEF89683CD7210898069E2CDA0EE144
81	17	2	0x09B9B69C132C4E2DC16A1438828147D65F94
82	18	2	0xB1CCE0D47DF246E9059CBC970168518206AC
83	19	2	0x1017669D7990F3AB4378924C69E442F2BAD0
84	20	2	0x772407B19C5FA41D542C8A2DC9ADD2C2943C
85	21	2	0x7A38C2889EB10D93F23EC75B212D327D18A8
86	22	2	0xD25A195D899BF6F531F5ECC228BE0678A438
87	23	2	0xA83FD1C33F4C6CAA5A0E8B062937AC310034
88	24	2	0xAA6DDD1A05ADF49F615BE9F9EBCA6630E440
89	25	2	0xB14990574937763EEBD71A12FEB0C673F878
90	26	2	0xDDF013D74BDDE5FBB621A32B54DE24AA1D60
91	27	2	0xD814295D387D2EE33F90C07CA493062B3054
92	28	2	0x89B93046231A786C3D74ABAEC6AFF42D037C
93	29	2	0x5680E918BA19199E841B4D6A7D1DD1420E78
94	30	2	0x639CC821373B332F975817C0A1AC16A48150
95	31	2	0x06711D78BD8978D82DA58B7E494DDF77E994
96	0	0	0xC882DD8DBD23C796A1389DA4EAA9A4138640
97	1	1	0x038086D70895496BCABC404B1EC999F67AC0
98	2	2	0x8203073A335DB9E57B0CA2F07D5958176B50
99	3	0	0x3FF1CD3638EE6469A4A482AF834EF56A2340
100	4	1	0x69EA7871159D5099F900C6133C07DABF56F0
101	5	2	0x4D88ABB17FF855393EDBC070CF0439D5E94C
102	6	0	0x01EFD43C87362B00E376A728BC597BEED978
103	7	1	0x7AE20D16F3CC6F947413518FDF6E1FCCDE8

**Table 309b—Preamble modulation series per segment and IDcell for the 512 FFT mode (continued)**

Index	IDcell	Segment	Series to modulate (in hexadecimal format)
104	8	2	0xBB852F9A90B0DE260BB67F45491B31DE3A74
105	9	0	0x088627544BDF971C1AC4F86F05A212EE9634
106	10	1	0x0C8A08A37C2B9D3C1812E9C116B4E6A6285C
107	11	2	0xE74775CADD0D2D808FE7FC1C177489284
108	12	0	0xE81ECC6AC393294E9B549A8B2BADE7FFF904
109	13	1	0x1C5FAE8CACE7A2CD13CAF4A34A440E909BF8
110	14	2	0x6EE7E42A292BDACC5C79B81CA6598274C940
111	15	0	0x407547BC0C961D9E9ADDE010F4990724E8DC
112	16	1	0x46CE626ACD894F9650E6B7C3F9E3BFAE5B08
113	17	2	0xC59B894FBF170F44F4816750280AB8CB4E48

**Table 309c—Preamble modulation series per segment and IDcell for the 128 FFT mode**

Index	IDcell	Segment	Series to modulate (hexadecimal)	Index	IDcell	Segment	Series to modulate (hexadecimal)	Index	IDcell	Segment	Series to modulate (hexadecimal)
0	0	0	0x01E52A9B3	38	6	1	0xD2DD02238	76	12	2	0xF69E451B1
1	1	0	0xC96FF8AB1	39	7	1	0xFEAF63CB2	77	13	2	0x91BC72EBF
2	2	0	0xA1F5CE648	40	8	1	0x8CE0D5FB6	78	14	2	0xF964A5447
3	3	0	0x1E2BF6919	41	9	1	0xCC25D7A7E	79	15	2	0xF8CD36F4A
4	4	0	0x051798B72	42	10	1	0x7019D3A92	80	16	2	0x726A3C802
5	5	0	0x932D7FA8E	43	11	1	0x784CF7EAB	81	17	2	0x118D1B682
6	6	0	0x2CBD50F73	44	12	1	0x07085DAC8	82	18	2	0xDEDE9E703A
7	7	0	0xF86F6A451	45	13	1	0x4CEEB5E1F	83	19	2	0x3E8929773
8	8	0	0x2BA44F7E7	46	14	1	0x9E5CD5B80	84	20	2	0x2C64AA7F9
9	9	0	0xEEFA172C3	47	15	1	0x63A76FD05	85	21	2	0x2249CEA0F
10	10	0	0xFF46C729A	48	16	1	0xAA276F96F	86	22	2	0x01363A94E
11	11	0	0x0362D5C61	49	17	1	0x3370F5082	87	23	2	0x69D77721F
12	12	0	0x27DDC7CA5	50	18	1	0x35A644170	88	24	2	0xAE103C9B9
13	13	0	0x17EAEDAC6	51	19	1	0x16FD73B8B	89	25	2	0x89E2A6940
14	14	0	0x94ACD9E03	52	20	1	0xEEE990E94	90	26	2	0xA7BC42645
15	15	0	0x1A1AC22DD	53	21	1	0x28A3120FC	91	27	2	0xBBB6B9C0F
16	16	0	0xFD5E18DA6	54	22	1	0xC2FBC2993	92	28	2	0x5BF7598F8

**Table 309c—Preamble modulation series per segment and IDcell for the 128 FFT mode (continued)**

Index	IDcell	Segment	Series to modulate (hexadecimal)	Index	IDcell	Segment	Series to modulate (hexadecimal)	Index	IDcell	Segment	Series to modulate (hexadecimal)
17	17	0	0x35DEB6E0E	55	23	1	0x880BCACD3	93	29	2	0x4AE4C79FE
18	18	0	0xA0185E326	56	24	1	0xAFA4DB918	94	30	2	0x1FDC748C9
19	19	0	0x93B3F9C75	57	25	1	0xAE1E49884	95	31	2	0x877D5E6E4
20	20	0	0x632481EA8	58	26	1	0xF7945E264	96	0	0	0x0FE322452
21	21	0	0x8BB8104A5	59	27	1	0x38374CA42	97	1	1	0x4DC778B5F
22	22	0	0x87C89EF75	60	28	1	0x5AAE39B00	98	2	2	0xADD9E3F88
23	23	0	0x207AA794C	61	29	1	0x138069E54	99	3	0	0x2C1C857DC
24	24	0	0x6A4D1C403	62	30	1	0x966707005	100	4	1	0xCFB4B5503
25	25	0	0x7761B4BD7	63	31	1	0xA5037759E	101	5	2	0xCD8505E21
26	26	0	0x31ABBF06D	64	0	2	0x3FE158D96	102	6	0	0x82892F4CE
27	27	0	0x69C6E455F	65	1	2	0xAED3B839F	103	7	1	0x3979FD176
28	28	0	0xAB3B3CFF0	66	2	2	0xF5AE23268	104	8	2	0x5FA49C311
29	29	0	0x731412685	67	3	2	0x1895E68BE	105	9	0	0xBA7857B19
30	30	0	0xA3135C034	68	4	2	0x1443C94EC	106	10	1	0xBC030C4CA
31	31	0	0xFECCB2B85	69	5	2	0x929547307	107	11	2	0x517F3CBD6
32	0	1	0xAA37BDA7C	70	6	2	0xA17D3230C	108	12	0	0x7E545BE73
33	1	1	0x90955CE1F	71	7	2	0xD54FC0C33	109	13	1	0xDDCA69C3F
34	2	1	0xADBC1B844	72	8	2	0xAB77F079C	110	14	2	0xA01A2C8C7
35	3	1	0xA04A3B197	73	9	2	0xC3CA00A66	111	15	0	0x1C0B64435
36	4	1	0x015E56CB3	74	10	2	0x025519879	112	16	1	0x330282DF2
37	5	1	0x64D6F4038	75	11	2	0x6CF39F815	113	17	2	0x147FCCF4B

*Insert new subclause 8.4.6.1.1.1:*

**8.4.6.1.1.1 Common SYNC symbol (optional)**

In every fourth downlink transmission frame, the last OFDM symbol is the common SYNC symbol; it can be transmitted by the BSs in the 1024/512/128 FFT modes by antenna 0. The mapping of the common SYNC sequence to the common SYNC symbol subcarrier is defined by using the following formula:

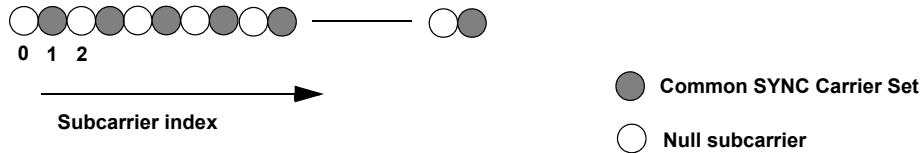
$$Common\_SYNC\_Carrier\_Set = N_{LEFT-FFT} + 2k - 1$$

where

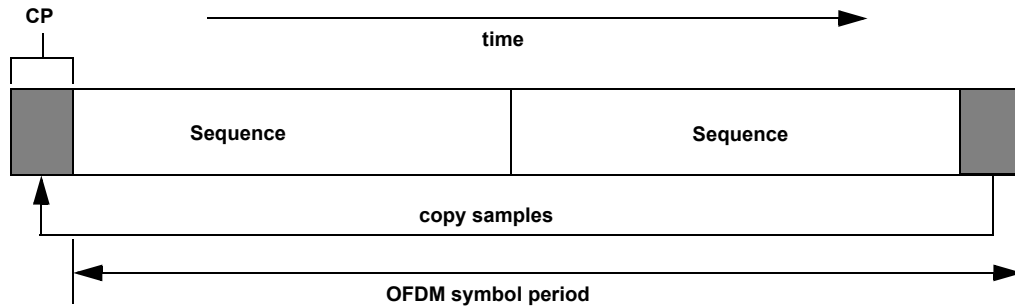
$k$  is the number of the running index  $1 \dots [(N_{FFT} - N_{LEFT-FFT} - N_{RIGHT-FFT} - 1)/2]$ , where  $[x]$  denotes the smallest integer number greater than  $x$ .

$N_{LEFT-FFT}$  and  $N_{RIGHT-FFT}$  are the numbers of guard subcarriers of the left band and right band of FFT size  $N_{FFT}$ , respectively. The values of  $N_{LEFT-FFT}$  and  $N_{RIGHT-FFT}$  for 1024/512/128 FFT modes are listed in Table 309a, Table 309b, and Table 309c, and the DC carrier shall always be zeroed.

The common SYNC symbol is defined by frequency domain as shown in Figure 233a, the time domain illustration is shown in Figure 233b.



**Figure 233a—Common SYNC symbol structure (frequency domain)**



**Figure 233b—Common SYNC symbol structure (time domain)**

The same common SYNC symbol is transmitted by all BSs across the network synchronously.

*Insert new subclause 8.4.6.1.1.2:*

**8.4.6.1.1.2 Common SYNC symbol sequence**

The common SYNC sequences are listed in Table 309d. The defined sequences shall be mapped onto the common SYNC symbol subcarriers in ascending order. The sequences in Table 309a are in an hexadecimal format, and the value of the sequences should be converted to binary sequences (0 mapped to +1 and 1 mapped to -1). The converted binary sequences are mapped onto the corresponding subcarriers from the MSB to the LSB.



**Table 309d—Common SYNC sequence**

$N_{FFT}$	Sequence	PAPR (dB)	$N_{LEFT-FFT}$	$N_{RIGHT-FFT}$
1024	0x473A0B21CE9537F3A0B20316AC873A0B21CE95378C5F4DFCE9537F3A0B21CE9537F3A0B20316AC80C5F4DE316AC873A0B20316AC800	3.32	87	86
512	0x5642862D90FE75642862A6F018B642862D90FE749BD79D590FE740	3.17	43	43
128	0x590A18B643F9D0	2.89	11	11

**8.4.6.1.2 Symbol structure**

**8.4.6.1.2.1 Symbol structure for PUSC**

*Change Table 310 as indicated:*

**Table 310—OFDMA downlink subcarrier allocations—PUSC**

Parameter	Value	Comments
Number of DC subcarriers	1	Index 1024 ( <u>counting from 0</u> )
Number of Guard subcarriers, Left	184	
Number of Guard subcarriers, Right	183	
Number of used subcarriers ( $N_{used}$ )	1681	Number of all subcarriers used within a symbol, including all possible allocated pilots and the DC carrier.
Number of subcarriers per cluster	14	
Number of clusters	120	
Renumbering sequence	1	Used to renumber clusters before allocation to subchannels:  6, 108, 37, 81, 31, 100, 42, 116, 32, 107, 30, 93, 54, 78, 10, 75, 50, 111, 58, 106, 23, 105, 16, 117, 39, 95, 7, 115, 25, 119, 53, 71, 22, 98, 28, 79, 17, 63, 27, 72, 29, 86, 5, 101, 49, 104, 9, 68, 1, 73, 36, 74, 43, 62, 20, 84, 52, 64, 34, 60, 66, 48, 97, 21, 91, 40, 102, 56, 92, 47, 90, 33, 114, 18, 70, 15, 110, 51, 118, 46, 83, 45, 76, 57, 99, 35, 67, 55, 85, 59, 113, 11, 82, 38, 88, 19, 77, 3, 87, 12, 89, 26, 65, 41, 109, 44, 69, 8, 61, 13, 96, 14, 103, 2, 80, 24, 112, 4, 94, 0
Number of data subcarriers in each symbol per subchannel	24	
Number of subchannels	60	
<del>PermutationBase12</del> Basic permutation sequence 12 (for 12 subchannels)		6,9,4,8,10,11,5,2,7,3,1,0
<del>PermutationBase8</del> Basic permutation sequence 8 (for 8 subchannels)	4	7,4,0,2,1,5,3,6

*Insert the following tables into 8.4.6.1.2.1:*

**Table 310a—1024-FFT OFDMA downlink carrier allocations—PUSC**

Parameter	Value	Comments
Number of DC Subcarriers	1	Index 512
Number of Guard Subcarriers, Left	<del>9</del> 92	—
Number of Guard Subcarriers, Right	<del>92</del> 91	—
Number of Used Subcarriers ( $N_{used}$ ) including all possible allocated pilots and the DC subcarrier.	841	Number of all subcarriers used within a symbol.
renumbering sequence	6, 48, 37, 21, 31, 40, 42, 56, 32, 47, 30, 33, 54, 18, 10, 15, 50, 51, 58, 46, 23, 45, 16, 57, 39, 35, 7, 55, 25, 59, 53, 11, 22, 38, 28, 19, 17, 3, 27, 12, 29, 26, 5, 41, 49, 44, 9, 8, 1, 13, 36, 14, 43, 2, 20, 24, 52, 4, 34, 0	Used to renumber clusters before allocation to subchannels.
Number of carriers per cluster	14	—
Number of clusters	60	—
Number of data subcarriers in each symbol per subchannel	24	—
Number of subchannels	30	—
PermutationBase6 (for 6 subchannels)	3,2,0,4,5,1	—
PermutationBase4 (for 4 subchannels)	3,0,2,1	—

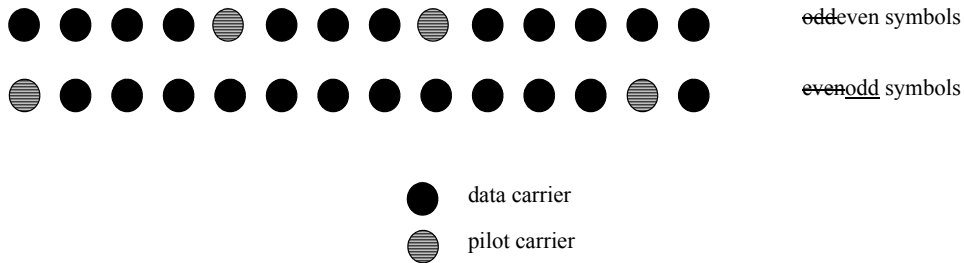
**Table 310b—512-FFT OFDMA downlink carrier allocations—PUSC**

Parameter	Value	Comments
Number of DC Subcarriers	1	Index 256
Number of Guard Subcarriers, Left	46	—
Number of Guard Subcarriers, Right	45	—
Number of Used Subcarriers ( $N_{used}$ ) including all possible allocated pilots and the DC subcarrier.	421	Number of all subcarriers used within a symbol.
renumbering sequence	12, 13, 26, 9, 5, 15, 21, 6, 28, 4, 2, 7, 10, 18, 29, 17, 16, 3, 20, 24, 14, 8, 23, 1, 25, 27, 22, 19, 11, 0	Used to renumber clusters before allocation to subchannels.
Number of carriers per cluster	14	—
Number of clusters	30	—
Number of data subcarriers in each symbol per subchannel	24	—
Number of subchannels	15	—
PermutationBase5 (for 5 subchannels)	4,2,3,1,0	—

**Table 310c—128-FFT OFDMA downlink carrier allocations—PUSC**

Parameter	Value	Comments
Number of DC Subcarriers	1	Index 64
Number of Guard Subcarriers, Left	22	—
Number of Guard Subcarriers, Right	21	—
Number of Used Subcarriers ( $N_{used}$ ) including all possible allocated pilots and the DC subcarrier.	85	Number of all subcarriers used within a symbol.
renumbering sequence	2, 3, 1, 5, 0, 4	Used to renumber clusters before allocation to subchannels.
Number of carriers per cluster	14	—
Number of clusters	6	—
Number of data subcarriers in each symbol per subchannel	24	—
Number of subchannels	3	—

*Change Figure 234 as indicated:*



**Figure 234—Cluster structure**

*Insert the following sentence below Figure 234:*

Figure 234 shows subcarriers from left to right in order of increasing subcarrier index. For the purpose of determining PUSC pilot location, odd and even symbols are counted from the beginning of the current zone. The first symbol in the zone is even. The preamble shall not be counted as part of the first zone.

**8.4.6.1.2.1.1 Downlink subchannels subcarrier allocation in PUSC**

*Replace 8.4.6.1.2.1.1 with the following text:*

The carrier allocation to subchannels is performed using the following procedure:

- 1) Dividing the subcarriers into the number of clusters ( $N_{clusters}$ ) physical clusters containing 14 adjacent subcarriers each (starting from carrier 0). The number of clusters,  $N_{clusters}$ , varies with FFT sizes. See Table 310, Table 310a, Table 310b and Table 310c for details.

- 2) Renumbering the physical clusters into logical clusters using the following formula:

$$\begin{aligned}
 & \text{LogicalCluster} \\
 & = \begin{cases} \text{RenumberingSequence(PhysicalCluster)} & \text{First DL zone, or Use All SC indicator} = 0 \\ & \text{inSTC\_DL\_Zone\_IE} \\ \text{RenumberingSequence((PhysicalCluster) + 13 \cdot DL\_PermBase) mod Nclusters} & \text{otherwise} \end{cases}
 \end{aligned}$$

In the first PUSC zone of the downlink (first downlink zone) and in a PUSC zone defined by STC\_DL\_ZONE\_IE() with ‘use all SC indicator = 0’, the default re-numbering sequence is used for logical cluster definition. For All other cases DL\_PermBase parameter in the STC\_DL\_Zone\_IE() or AAS\_DL\_IE() shall be used.

- 3) Allocate logical clusters to groups. The allocation algorithm varies with FFT sizes.

For FFT size=2048:

Dividing the clusters into six major groups. Group 0 includes clusters 0-23, group 1 includes clusters 24-39, group 2 includes clusters 40-63, group 3 includes clusters 64-79, group 4 includes clusters 80-103, group 5 includes clusters 104-119. These groups may be allocated to segments, if a segment is being used, then at least one group shall be allocated to it (by default group 0 is allocated to sector 0, group 2 is allocated to sector 1, and group 4 to is allocated sector 2).

For FFT size=1024:

Dividing the clusters into six major groups. Group 0 includes clusters 0-11, group 1 includes clusters 12-19, group 2 includes clusters 20-31, group 3 includes clusters 32-39, group 4 includes clusters 40-51, group 5 includes clusters 52-59. These groups may be allocated to segments, if a segment is being used, then at least one group shall be allocated to it (by default group 0 is allocated to sector 0, group 2 is allocated to sector 1, and group 4 to is allocated sector 2).

For FFT size=512:

Dividing the clusters into six major groups. Group 0 includes clusters 0-9, group 2 includes clusters 10-19, group 4 includes clusters 20-29. These groups may be allocated to segments, if a segment is being used, then at least one group shall be allocated to it (by default group 0 is allocated to sector 0, group 2 is allocated to sector 1, and group 4 to is allocated sector 2).

For FFT size=128:

Dividing the clusters into six major groups. Group 0 includes clusters 0-1, group 2 includes clusters 2-3, group 4 includes clusters 4-5. These groups may be allocated to segments, if a segment is being used, then at least one group shall be allocated to it (by default group 0 is allocated to sector 0, group 2 is allocated to sector 1, and group 4 to is allocated sector 2).

- 4) Allocating subcarriers to subchannel in each major group is performed separately for each OFDMA symbol by first allocating the pilot carriers within each cluster, and then taking all remaining data carriers within the symbol and using the same procedure described in 8.4.6.1.2.2.2. The parameters vary with FFT sizes.

For FFT size=2048:

Use the parameters from Table 310, with basic permutation sequence 12 for even numbered major groups, and basic permutation sequence 8 for odd numbered major groups, to partition the subcarriers into subchannels containing 24 data subcarriers in each symbol.

For FFT size=1024:

Use the parameters from Table 310a, with basic permutation sequence 6 for even numbered major groups, and basic permutation sequence 4 for odd numbered major groups, to partition the subcarriers into subchannels containing 24 data subcarriers in each symbol.

For FFT size=512:

Use the parameters from Table 310b, with basic permutation sequence 5 for even numbered major groups, to partition the subcarriers into subchannels containing 24 data subcarriers in each symbol.

For FFT size=128:

Use the parameters from Table 310c to partition the subcarriers into subchannels containing 24 data subcarriers in each symbol.

Note that the preamble IDcell is used for the first PUSC zone in Equation (111). Otherwise the DL\_PermBase parameter in the STC\_DL\_Zone\_IE() or AAS\_DL\_IE() shall be used in the equation. The subcarrier indexing within each group shall start from 0, where 0 is the lowest number subcarrier in the lowest numbered logical cluster belonging to the group.

**8.4.6.1.2.2 Symbol structure for FUSC**

*Change the relevant entries and title of Table 311 as indicated:*

**Table 311—OFDMA downlink subcarrier allocations**

Parameter	Value	Comments
Number of DC Subcarriers	1	Index 1024 (counting from 0)
VariableSet #0	<del>2471</del>	0,72,144,216,288,360,432,504,576,648,720,792,864,936,1008,1080,1152,1224,1296,1368,1440,1512,1584,1656,48,120,192,264,336,408,480,552,624,696,768,840,912,984,1056,1128,1200,1272,1344,1416,1488,1560,1632,24,96,168,240,312,384,456,528,600,672,744,816,888,960,1032,1104,1176,1248,1320,1392,1464,1536,1608,1680
ConstantSet #0	412	<del>39,645,1017,1407,330,726,1155,1461,351,855,1185,1545,153,297,441,585,729,873,1017,1161,1305,1449,1593,</del>
VariableSet #1	<del>2471</del>	36,108,180,252,324,396,468,540,612,684,756,828,900,972,1044,1116,1188,1260,1332,1404,1476,1548,1620,1692,12,84,156,228,300,372,444,516,588,660,732,804,876,948,1020,1092,1164,1236,1308,1380,1452,1524,1596,1668,60,132,204,276,348,420,492,564,636,708,780,852,924,996,1068,1140,1212,1284,1356,1428,1500,1572,1644
ConstantSet #1	412	<del>261,651,1143,1419,342,849,1158,1530,522,918,1206,1701,81,225,369,513,657,801,945,1089,1233,1377,1521,1665</del>
<u>PermutationBase</u> <u>sequence</u>	Basic permutation	3, 18, 2, 8, 16, 10, 11, 15, 26, 22, 6, 9, 27, 20, 25, 1, 29, 7, 21, 5, 28, 31, 23, 17, 4, 24, 0, 13, 12, 19, 14, 30

*Insert the following Tables into 8.4.6.1.2.2:*

**Table 311a—1024-FFT OFDMA downlink carrier allocations—FUSC**

Parameter	Value	Comments
Number of DC Subcarriers	1	Index 512
Number of Guard Subcarriers, Left	87	—

**Table 311a—1024-FFT OFDMA downlink carrier allocations—FUSC**

Parameter	Value	Comments
Number of Guard Subcarriers, Right	86	—
Number of Used Subcarriers ( $N_{used}$ )	851	Number of all subcarriers used within a symbol, including all possible allocated pilots and the DC subcarrier.
Pilots	—	—
VariableSet #0	12	0,24,48,72,96,120,144,168,192,216,240,264,288,312,336,360,384,408,432,456,480,504,528,552,576,600,624,648,672,696,720,744,768,792,816,840
ConstantSet #0	2	$72*(2*n + k) + 9$ when $k=0$ and $n=0..5$ DC subcarrier shall be included when the pilot subcarrier index is calculated by the equation.
VariableSet #1	12	36,108,180,252,324,396,468,540,612,684,756,828,900,972,1044,1116,1188,1260,1332,1404,1476,1548,1620,1692,1764,1836,1908,1980,2052,2124,2196,2268,2340,2412,2484,2556,2628,2700,2772,2844,2916,2988,3060,3132,3204,3276,3348,3420,3492,3564,3636,3708,3780
ConstantSet #1	2	$72*(2*n + k) + 9$ when $k=1$ and $n=0..4$ DC subcarrier shall be included when the pilot subcarrier index is calculated by the equation.
Number of data subcarriers	768	—
Number of data subcarriers per sub-channel	48	—
Number of Subchannels	16	—
PermutationBase	—	6, 14, 2, 3, 10, 8, 11, 15, 9, 1, 13, 12, 5, 7, 4, 0

**Table 311b—512-FFT OFDMA downlink carrier allocations—FUSC**

Parameter	Value	Comments
Number of DC Subcarriers	1	Index 256
Number of Guard Subcarriers, Left	43	—
Number of Guard Subcarriers, Right	42	—
Number of Used Subcarriers ( $N_{used}$ )	427	Number of all subcarriers used within a symbol, including all possible allocated pilots and the DC subcarrier.
Pilots	—	—
VariableSet #0	18	0,24,48,72,96,120,144,168,192,216,240,264,288,312,336,360,384,408
ConstantSet #0	3	$72*(2*n + k) + 9$ when $k=0$ and $n=0..2$ DC subcarrier shall be included when the pilot subcarrier index is calculated by the equation.
VariableSet #1	18	12,36,60,84,108,132,156,180,204,228,252,276,300,324,348,372,396, 420
ConstantSet #1	3	$72*(2*n + k) + 9$ when $k=1$ and $n=0..2$ DC subcarrier shall be included when the pilot subcarrier index is calculated by the equation.
Number of subcarriers	384	—
Number of data subcarriers per subchannel	48	—
Number of Subchannels	8	—
PermutationBase	—	2,0,1,6,4,3,5,7

**Table 311c—128-FFT OFDMA downlink carrier allocations—FUSC**

Parameter	Value	Comments
Number of DC Subcarriers	1	Index 64
Number of Guard Subcarriers, Left	11	—
Number of Guard Subcarriers, Right	10	—
Number of Used Subcarriers ( $N_{used}$ )	107	Number of all subcarriers used within a symbol, including all allocated pilots and the DC subcarrier.
Pilots	4	—
VariableSet #0	5	0 24, 48, 72, 96
VariableSet #1	4	12, 36, 60, 84
ConstantSet #0	1	39 DC subcarrier shall be included when the pilot subcarrier index is calculated by the equation.
ConstantSet #1	0	N/A DC subcarrier shall be included when the pilot subcarrier index is calculated by the equation.
Number of data subcarriers	96	—
Number of data subcarriers per subchannel	48	—
Number of Subchannels	2	—
PermutationBase	—	1, 0

*Change the sentence below Equation (110) as indicated:*

where  $FUSC\_SymbolNumber$  counts the FUSC symbols used in the ~~transmission~~current zone starting from 0.

*Change the text above Figure 235 as indicated:*

Figure 235 depicts as an example of the symbol allocation for segment 0 on ~~symbol number 1~~the first symbol.

*Change the caption of Figure 235 to read:*

Downlink symbol structure for segment 0 on ~~symbol number 1~~the first symbol using FUSC.

#### 8.4.6.1.2.2.1 Downlink subchannels subcarrier allocation

*Change the second sentence of the first paragraph as indicated:*

The subchannel indices are formulated using a ~~RS~~Reed-Solomon series, and is allocated out of the data subcarriers domain.



**8.4.6.1.2.2.2 Partitioning of data subcarriers into subchannels in downlink FUSC**

Replace Equation (111) with the following equation:

$$subcarrier(k, s) = N_{subchannels} \cdot n_k + \{p_s[n_k \bmod N_{subchannels}] + DL\_PermBase\} \bmod N_{subchannels} \quad (111)$$

Change the text of ‘IDcell’, ‘X<sub>mod(k)</sub>’, ‘p<sub>s</sub>[j]’ and ‘N<sub>subchannels</sub>’ parameters and insert new parameter ‘N<sub>subcarriers</sub>’ below Equation (111) as indicated:

- $\frac{N_{subchannel}}{s} N_{subchannels}$  is the number of subchannels (for PUSC use number of subchannels in the currently partitioned Major group).
- $p_s[j]$  is the series obtained by rotating ~~{PermutationBase<sub>0</sub>}~~ basic permutation sequence cyclically to the left  $s$  times,
- $N_{subcarriers}$  number of data subcarriers allocated to a subchannel in each OFDMA symbol.
- ~~IDcell~~  $DL\_PermBase$  is an integer ranging from 0 to 31, which identifies the particular BS segment and is specified by MAC layer, which is set to preamble IDCell in the first zone and determined by the DL-MAP for other zones.
- $X_{mod(k)}$  is the remainder of the quotient  $X/k$  (which is at most  $k-1$ ).

**8.4.6.1.2.3 Additional optional symbol structure for FUSC**

Insert the following paragraph at the beginning of the subclause:

The additional optional subchannel structure in the downlink supports 32 subchannels where each transmission uses 48 data carriers symbols as their minimal block of processing. In the downlink, all the pilot carriers are allocated first, and then the remaining carriers are used exclusively for data transmission.  $N_{used}$  subcarriers except the DC subcarrier are divided into 9 contiguous subcarriers in which one pilot carrier is allocated. The position of the pilot carrier in 9 contiguous subcarriers varies according to the index of OFDMA symbol which contains the subcarriers. If the 9 contiguous subcarriers indexed as 0...8, the index of the pilot carrier shall be  $3 \times l + 1$  where  $l = m \bmod 3$  ( $m$  is the symbol index).

Change Table 312 as indicated:

**Table 312—OFDMA optional FUSC downlink subcarrier allocation**

Parameter	Value	Comments
Number of DC subcarriers	1	<u>Index 1024 (counting from 0)</u>
$N_{used}$	<u>47281729</u>	<u>Number of all subcarriers used within a symbol, including all possible allocated pilots and the DC carrier.</u>
Guard subcarriers: Left, Right	<del>159, 160</del> <u>160, 159</u>	
Number of Pilot Subcarriers	192	
Pilot subcarrier index	$9k + 3m + 1$ , for $k = 0, \dots, 191$ and $m = [symbol\ index] \bmod 3$	<u>Symbol of index 0 in pilot subcarrier index is shall be the first symbol from which the diversity subchannelization is applied of the current zone.</u>
Number of Data Subcarriers	1536	

*Insert the following Tables at the end of 8.4.6.1.2.3:*

**Table 312a—1024-FFT OFDMA downlink carrier allocations—Optional FUSC**

Parameters	Value	Comments
Number of DC Subcarriers	1	—
Number of Guard Subcarriers, Left	80	—
Number of Guard Subcarriers, Right	79	—
Number of Used Subcarriers ( $N_{used}$ ) (including all possible allocated pilots and the DC subcarrier).	865	—
Number of Pilot Subcarriers	96	—
Pilot Subcarrier Index	$9k+3m+1$ for $k=0,1,\dots,95$ , and $m=[\text{symbol index}] \bmod 3$	Symbol of index 0 in pilot subcarrier index should be the first symbol of the current zone. $m$ is incremented only for data symbols. DC subcarrier is excluded when the pilot subcarrier index is calculated by the equation.
Number of Data Subcarriers	768	—
Number of Data Subcarriers per subchannel	48	—

**Table 312b—512-FFT OFDMA downlink carrier allocations—Optional FUSC**

Parameters	Value	Comments
Number of DC Subcarriers	1	—
Number of Guard Subcarriers, Left	40	—
Number of Guard Subcarriers, Right	39	—
Number of Used Subcarriers ( $N_{used}$ ) (including all possible allocated pilots and the DC subcarrier).	433	—
Number of Pilot Subcarriers	48	—
Pilot Subcarrier Index	$9k+3m+1$ for $k=0,1,\dots,47$ , and $m=[\text{symbol index}] \bmod 3$	Symbol of index 0 in pilot subcarrier index should be the first symbol of the current zone. $m$ is incremented only for data symbols. DC subcarrier is excluded when the pilot subcarrier index is calculated by the equation.
Number of Data Subcarriers	384	—
Number of Data Subcarriers per subchannel	48	—

**Table 312c—128-FFT OFDMA downlink carrier allocations—Optional FUSC**

Parameters	Value	Comments
Number of DC Subcarriers	1	—
Number of Guard Subcarriers, Left	10	—
Number of Guard Subcarriers, Right	9	—
Number of Used Subcarriers ( $N_{used}$ ) (including all possible allocated pilots and the DC subcarrier).	109	—
Number of Pilot Subcarriers	12	—
Pilot Subcarrier Index	$9k+3m+1$ for $k=0,1,\dots,11$ , and $m=[\text{symbol index}] \bmod 3$	Symbol of index 0 in pilot subcarrier index should be the first symbol of the current zone. $m$ is incremented only for data symbols. DC subcarrier is excluded when the pilot subcarrier index is calculated by the equation.
Number of Data Subcarriers	96	—
Number of Data Subcarriers per subchannel	48	—

NOTE— A “data symbol” is a symbol in which overlaps with at least one data slot (whether or not data is allocated on that slot).

In Equation (112),  $P_1, P_2$ -permutation sequences shall be taken from Table 312d.  $k'$  shall be calculated as follows:  $k' = k \bmod(\text{length of permutation sequence})$ .

**8.4.6.1.2.3.1 Downlink subchannels subcarrier allocation**

**8.4.6.1.2.3.1 Downlink subchannels subcarrier allocation**

*Replace the contents of 8.4.6.1.2.3.1 with the following text:*

To allocate the subchannels, the whole data tones in a symbol are partitioned into groups of contiguous data subcarriers. Each subchannel consists of one subcarrier from each of these groups. The number of groups is therefore equal to number of data subcarriers per subchannel, and its value is 48. The number of the subcarriers in a group is equal to the number of subchannels, say  $N_s$ . As shown in Table 313a,  $N_s$  is determined by FFT size. The exact partitioning into subchannels is according to Equation (112), called DL permutation formula.

$$\text{Carriers}(s, m) = \begin{cases} N_s \times k + [s + P_{1, c_1}(k') + P_{2, c_2}(k')], & 0 < c_1, c_2 < N_s \\ N_s \times k + [s + P_{1, c_1}(k')], & c_1 \neq 0, c_2 = 0 \\ N_s \times k + [s + P_{2, c_2}(k')], & c_1 = 0, c_2 \neq 0 \\ N_s \times k + s, & c_1 = 0, c_2 = 0 \end{cases} \tag{112}$$

where

$Carriers(s, m)$  = subcarrier index of  $m$ -th subcarrier in subchannel  $s$

$$k=(m+s*23)mod\ 48, k'=k\ mod(N_s-1)$$

$m$  = subcarrier-in-subchannel index from the set [0~47]

$s$  = index number of a subchannel from the set [0~ $N_s-1$ ]

$P_{1,c_1}(j)$  =  $j$ -th element of the sequence obtained by rotating basic permutation sequence  $P_1$  cyclically to the left  $c_1$  times. See Table 312d.

$P_{2,c_2}(j)$  =  $j$ -th element of the sequence obtained by rotating basic permutation sequence  $P_2$  cyclically to the left  $c_2$  times. See Table 312d.

$$c_1 = DL\_PermBase\ mod\ N_s, c_2 = floor(DL\_PermBase / N_s)$$

In Equation (112), the operation in [ ] is done over GF( $N_s$ ). In GF( $2^n$ ), addition is binary XOR operation. For example,  $13 + 4$  in GF( $2^n$ ) is  $[(1101)_2\ XOR\ (0100)_2] = (1001)_2 = 9$ , where  $(x)_2$  represents binary expansion of  $x$ .

**Table 312d—Basic permutation sequences for diversity subcarrier allocations**

FFT size	$N_s$	Basic permutation sequences		
128	2	GF(2)	$P_1$	1
			$P_2$	1
512	8	GF(8)	$P_1$	1, 2, 4, 3, 6, 7, 5
			$P_2$	1, 4, 6, 5, 2, 3, 7
1024	16	GF(16)	$P_1$	1, 2, 4, 8, 3, 6, 12, 11, 5, 10, 7, 14, 15, 13, 9
			$P_2$	1, 4, 3, 12, 5, 7, 15, 9, 2, 8, 6, 11, 10, 14, 13
2048	32	GF(32)	$P_1$	1, 2, 4, 8, 16, 5, 10, 20, 13, 26, 17, 7, 14, 28, 29, 31, 27, 19, 3, 6, 12, 24, 21, 15, 30, 25, 23, 11, 22, 9, 18
			$P_2$	1, 4, 16, 10, 13, 17, 14, 29, 27, 3, 12, 21, 30, 23, 22, 18, 2, 8, 5, 20, 26, 7, 28, 31, 19, 6, 24, 15, 25, 11, 9

**Insert new subclause 8.4.6.1.2.4:**

**8.4.6.1.2.4 Optional downlink tile usage of subchannels—TUSC1**

The optional downlink TUSC1 is similar in structure to the uplink PUSC structure defined in 8.4.6.2. Each transmission uses 48 data subcarriers as the minimal block of processing. The permutation properties are given in Table 313, Table 313a, Table 313b, and Table 313c. The active subchannels in the TUSC1 zone, as defined in the DCD message (see Table 356 in 11.4.1), shall be renumbered consecutively starting from 0.

The pilots in the TUSC1 permutation are regarded as part of the allocation, and as such shall be beamformed in a way that is consistent with the transmission of the allocation’s data subcarriers.

The TUSC1 permutation shall only be used within an AAS zone.

*Insert new subclause 8.4.6.1.2.4.1:*

#### **8.4.6.1.2.4.1 Symbol structure for TUSC1 subchannels**

The TUSC1 symbol structure corresponds to that of the uplink PUSC structure as defined in 8.4.6.2.1.

*Insert new subclause 8.4.6.1.2.4.2:*

#### **8.4.6.1.2.4.2 Partitioning of subcarriers into TUSC1 subchannels**

The partitioning of subcarriers into tiles and tiles into subchannels corresponds to the definitions for the uplink PUSC structure as defined in 8.4.6.2.2 with *UL\_Permbase* replaced by *IDcell*.

*Insert new subclause 8.4.6.1.2.5:*

#### **8.4.6.1.2.5 Optional downlink tile usage of subchannels—TUSC2**

The TUSC2 is similar in structure to the uplink PUSC structure defined in 8.4.6.2.5. Each transmission uses 48 data subcarriers as the minimal block of processing. The permutation properties are given in Table 315, Table 315a, Table 315b, and Table 315c. The active subchannels in the TUSC2 zone, as defined in the DCD message (see Table 356 in 11.4.1), shall be renumbered consecutively starting from 0.

The pilots in the TUSC2 permutation are regarded as part of the allocation, and as such shall be beamformed in a way that is consistent with the transmission of the allocation's data subcarriers

The TUSC2 permutation shall only be used within an AAS zone.

*Insert new subclause 8.4.6.1.2.5.1:*

#### **8.4.6.1.2.5.1 Symbol structure for TUSC2 subchannels**

The TUSC2 symbol structure corresponds to that of the uplink optional PUSC structure as defined in 8.4.6.2.5.1.

*Insert new subclause 8.4.6.1.2.5.2:*

#### **8.4.6.1.2.5.2 Partitioning of subcarriers into TUSC2 subchannels**

The partitioning of subcarriers into tiles and tiles into subchannels corresponds to the definitions for the uplink optional PUSC structure as defined in 8.4.6.2.5.2.

*Insert new subclause 8.4.6.1.2.6*

#### **8.4.6.1.2.6 TUSC1/TUSC2 support for SDMA**

The pilots in an AAS zone with TUSC1 or TUSC2 permutation are regarded as part of the allocation, and as such shall be beamformed in a way that is consistent with the transmission of the allocation's data subcarriers. In an SDMA region, the pilots of each allocation may correspond to a different pilot pattern. The pilot patterns for TUSC1 permutation are as depicted in Figure 249, and the patterns for the TUSC2 permutation are as depicted in Figure 251i.

### **8.4.6.2 Uplink**

*Change the second paragraph as indicated:*

The uplink supports 70 subchannels for PUSC permutation, and 96 subchannels for optional PUSC permutation. Each transmission uses 48 data carriers as the minimal block of processing. Each new transmission for the uplink commences with the parameters as given in Table 313 for PUSC permutation, and with the parameters as given in Table 315 for optional PUSC permutation.

*Change the text under the ‘Value’ column of the ‘Number of DC subcarriers’ field in Table 313 as indicated: “1 (Index 1024, counting from 0)”.*

*Insert the following tables at the end of 8.4.6.2, immediately before 8.4.6.2.1:*

**Table 313a—1024-FFT OFDMA uplink subcarrier allocations for PUSC**

Parameter	Value	Notes
Number of DC subcarriers	1	Index 512
$N_{\text{used}}$	841	Number of all subcarriers used within a symbol
Guard subcarriers: left, right	92, 91	—
TilePermutation	11,19,12,32,33,9,30,7,4,2,13,8,17,23,27,5,15,34,22,14,21,1,0,24,3,26,29,31,20,25,16,10,6,28,18	Used to allocate tiles to subchannels
$N_{\text{subchannels}}$	35	—
$N_{\text{tiles}}$	210	—
Number of subcarriers per tile	4	Number of all subcarriers used within tile
Tiles per subchannel	6	—

**Table 313b—512-FFT OFDMA uplink subcarrier allocations for PUSC**

Parameter	Value	Notes
Number of DC subcarriers	1	Index 256
$N_{\text{used}}$	409	Number of all subcarriers used within a symbol
Guard subcarriers: left, right	52, 51	—
TilePermutation	11,15,10,2,12,9,8,14,16,4,0,5,13,3,6,7,1	Used to allocate tiles to subchannels
$N_{\text{subchannels}}$	17	—
$N_{\text{tiles}}$	102	—
Number of subcarriers per tile	4	Number of all subcarriers used within tile
Tiles per subchannel	6	—

**Table 313c—128-FFT OFDMA uplink subcarrier allocations for PUSC**

Parameter	Value	Notes
Number of DC subchannel	1	Index 64
$N_{used}$	97	Number of all subcarriers used within a symbol
Guard subcarriers: left, right	16, 15	—
PermutationBase0	2, 0, 3, 1	Used to allocate tiles to subchannels
$N_{subchannels}$	4	—
$N_{tiles}$	24	—
Number of subcarriers per tile	4	Number of all subcarriers used within tile
Tiles per subchannel	6	—

**8.4.6.2.1 Symbol structure for subchannel (PUSC)**

*Change the first and second paragraphs as indicated:*

A ~~burst~~slot in the uplink is composed of three ~~time~~OFDMA symbols and one subchannel, within each ~~burst~~slot, there are 48 data subcarriers and 24 fixed-location pilots ~~subcarrier~~ as shown in Table 313.

The subchannel is constructed from six uplink tiles, each tile has four successive active subcarriers and its configuration is illustrated in Figure 236.

**8.4.6.2.2 Partitioning of subcarriers into subchannels in the uplink**

*Replace the contents of the subclause with the following text:*

The usable subcarriers in the allocated frequency band shall be divided into  $N_{tiles}$  physical tiles as defined in Figure 236 with parameters from Table 314. The allocation of physical tiles to logical tiles in subchannels is performed in the following manner:

Logical tiles are mapped to physical tiles in the FFT using Equation (113); for an example refer to 8.4.6.2.3.

$$Tiles(s, n) = N_{subchannels} \cdot n + (Pt[(s + n) \bmod N_{subchannels}] + UL\_PermBase) \bmod N_{subchannels} \quad (113)$$

where

- $Tiles(s,n)$  is the physical tile index in the FFT with tiles being ordered consecutively from the most negative to the most positive used subcarrier (0 is the starting tile index)
- $n$  is the tile index 0...5 in a subchannel
- $Pt$  is the tile permutation
- $s$  is the subchannel number in the range 0... $N_{subchannels}-1$
- UL\_PermBase is an integer value in the range 0...69, which is assigned by a management entity
- $N_{subchannels}$  is the number of subchannels for the FFT size given in Table 313a, Table 313b, and Table 313c.

After mapping the physical tiles in the FFT to logical tiles for each subchannel, the data subcarriers per slot are enumerated by the following process:

- 1) After allocating the pilot carriers within each tile, indexing of the data subcarriers within each slot is performed starting from the first symbol at the lowest indexed subcarrier of the lowest indexed tile and continuing in an ascending manner through the subcarriers in the same symbol, then going to the next symbol at the lowest indexed data subcarrier, and so on. Data subcarriers shall be indexed from 0 to 47.
- 2) The mapping of data onto the subcarriers will follow Equation (114). This equation calculates the subcarrier index (as assigned in item 1) to which the data constellation point is to be mapped.

$$Subcarrier(n, s) = (n + 13 \cdot s) \bmod N_{subcarriers} \quad (114)$$

where

$Subcarrier(n, s)$  is the permuted subcarrier index corresponding to data subcarrier  $n$  is subchannel  $s$ ,  
 $n$  is a running index 0...47, indicating the data constellation point,  
 $s$  is the subchannel number,  
 $N_{subcarriers}$  is the number of subcarriers per slot.

For example, for subchannel 1 ( $s = 1$ ), the first data constellation point ( $n = 0$ ) is mapped onto subcarrier (0,1) = 13, where 13 is the subcarrier with index 13 according to item 1) above. Considering the PUSC tile structure, it can be seen that this is the second indexed subcarrier on the second symbol within the slot. Similarly, for subchannel 3, the ninth data constellation point ( $n = 8$ ) is mapped onto subcarrier (8, 3) = 47. According to item 1), this is the last indexed subcarrier of the third symbol within the slot.

Subcarrier enumeration shall not be applied to the slots in the UL-MAP indicated by either UIUC = 0 or UIUC = 12.

#### 8.4.6.2.3 Uplink permutation example

*Change the second paragraph as indicated:*

The tiles used for subchannel  $s = 3$  in  $UL\_HDeellPermBase = 2$  are computed.

*Change the third paragraph as indicated:*

The relevant parameters characterizing the uplink are therefore taken from Table 313.

- Number of subchannels:  $N_{subchannels} = 70$
- Number of subcarriers in each OFDMA symbol:  $N_{subcarriers} = 24$
- Number of data subcarriers in each subchannel:  $N_{subcarriers} = 48$
- TilePermutation = {6, 48, 58, 57, 50, 1, 13, 26, 46, 44, 30, 3, 27, 53, 22, 18, 61, 7, 55, 36, 45, 37, 52, 15, 40, 2, 20, 4, 34, 31, 10, 5, 41, 9, 69, 63, 21, 11, 12, 19, 68, 56, 43, 23, 25, 39, 66, 42, 16, 47, 51, 8, 62, 14, 33, 24, 32, 17, 54, 29, 67, 49, 65, 35, 38, 59, 64, 28, 60, 0}

*Change the third bullet of the last paragraph as indicated:*

- 3) Take the first six numbers, add the  $UL\_HDeellPermBase$  (perform modulo operation if needed):  
 {59, 52, 3, 15, 28, 48}

#### 8.4.6.2.4 Partition a subchannel to mini-subchannels

*Change every instance of “subchannel”, including Table 314, to “slot” in the subclause.*

*Change the first sentence of the first paragraph as indicated:*



Mini-subchannels can be applied to PUSC or optional-PUSC uplink permutations, in which an ~~An~~ uplink subchannel is composed of six tiles.

**Replace the paragraph below Table 314 with the following text:**

When mini subchannels of order  $M$  are indicated in the map, the allocation shall be a multiple of  $M$  slots, and shall not exceed one full subchannel, i.e., at most one slot will be allocated in each OFDMA symbol.

Allocating tiles to mini-subchannels shall be done as follows: The slots in the allocation shall be numbered in time-first order in the same order as the slots are allocated in the map. The number of slot modulu  $M$  is used as index to Table 314, and determines which tiles are allocated to the SS.

Mapping data to mini-subchannels shall be done as follows: The FEC, repetition and constellation mapping shall be applied as if the allocation was of duration/ $M$  slots (where duration is the number of slots specified in the map). The resulting data subcarriers shall be enumerated in the tiles allocated to each SS in a frequency-first order beginning from the tile with the smallest symbol number and smallest frequency. The sub-carrier rotation defined in Equation (114) [item 2) of 8.4.6.2.2] shall not be applied to mini-subchannels, instead enumeration of the data subcarriers shall be performed as indicated by Equation (114a) which sets the order to which the mapping of the data onto the subcarriers shall be performed:

$$P(n) = \left( n + 13 \cdot \left\lfloor \frac{n}{48} \right\rfloor \right) \bmod 48 + 48 \cdot \left\lfloor \frac{n}{48} \right\rfloor \tag{114a}$$

where

$P(n)$       physical data subcarrier index ( $n$ ).  
 $n$             is a running index 0... used data subcarriers, which represents the logical subcarrier index.

**8.4.6.2.5 Additional optional symbol structure for PUSC**

**Change Table 315 as indicated:**

**Table 315—OFDMA uplink subcarrier allocations**

Parameter	Value
Number of DC subcarriers	1 (Index 1024, counting from 0)
$N_{used}$	<del>4728</del> 1729
Guard subcarriers: Left, Right	<del>159, 160</del> 160, 159
$N_{subchannels}$	96
$N_{tiles}$	576
Number of subcarriers per tile	3
Tiles per subchannel	6
Number of data subcarriers per subchannel	48

*Insert the following tables at the end of 8.4.6.2.5:*

**Table 315a—Optional 1024-FFT OFDMA uplink subcarrier allocations**

Parameters	Value	Notes
Number of DC subcarriers	1	—
Number of guard subcarriers, left	80	—
Number of guard subcarriers, right	79	—
Number of used subcarriers ( $N_{used}$ ) (including all possible allocated pilots and the DC subcarrier)	865	—
Number of subchannels ( $N_{subchannels}$ )	48	—
Number of tiles ( $N_{tiles}$ )	288	—
Number of subcarriers per tile	3	—
Tiles per subchannel	6	—
Number of data subcarriers per subchannel	48	—

**Table 315b—Optional 512-FFT OFDMA uplink subcarrier allocations**

Parameters	Value	Notes
Number of DC subcarriers	1	—
Number of guard subcarriers, left	40	—
Number of guard subcarriers, right	39	—
Number of used subcarriers ( $N_{used}$ ) (including all possible allocated pilots and the DC subcarrier)	433	—
Number of subchannels ( $N_{subchannels}$ )	24	—
Number of tiles ( $N_{tiles}$ )	144	—
Number of subcarriers per tile	3	—
Tiles per subchannel	6	—
Number of data subcarriers per subchannel	48	—

**Table 315c—Optional 128-FFT OFDMA uplink subcarrier allocations**

Parameters	Value	Notes
Number of DC subcarriers	1	—
Number of guard subcarriers, left	10	—
Number of guard subcarriers, right	9	—
Number of used subcarriers ( $N_{used}$ ) (including all possible allocated pilots and the DC subcarrier)	109	—
Number of subchannels ( $N_{subchannels}$ )	6	—
Number of tiles ( $N_{tiles}$ )	36	—
Number of subcarriers per tile	3	—
Tiles per subchannel	6	—
Number of data subcarriers per subchannel	48	—

#### 8.4.6.2.5.1 Symbol structure for subchannel

*Change the first paragraph as indicated:*

A ~~burst slot~~ in the uplink is composed of three ~~time~~OFDMA symbols and one subchannel, within each ~~burst slot~~, there are 48 data subcarriers and six fixed-location pilots ~~subcarrier~~. The subchannel is constructed from six uplink tiles. ~~Each tile has three successive active subcarriers, and its configuration is illustrated in Figure 237.~~

#### 8.4.6.2.5.2 Partitioning of subcarriers into subchannels in the uplink

*Change 8.4.6.2.5.2 as indicated:*

To allocate the subchannels,  $N_{used}$  subcarriers ~~excluding DC subcarrier~~ are partitioned into tiles, which is 3x3 frequency-time block containing 9 tones (1 pilot tones and 8 data tones). The whole frequency bands ~~are~~ is partitioned into groups of contiguous tiles. Each subchannel consists of 6 tiles each of which is chosen from different groups. ~~The value of  $N_s$  is equal to  $N_{tiles}/18$ .  $N_{tiles}$  is the number of tiles in the whole frequency band for each FFT size, which is specified in Table 315, Table 315a, Table 315b, and Table 315c.~~

~~For the parameters defined in Table 313, the number of tiles in a group is 32 and there are 18 groups in the whole frequency band. Since a subchannel consists of 6 tiles, 6 groups at equal distance (3 groups away from each) are chosen and each tile is selected from each group.~~

~~The exact partitioning into subchannels is according to Equation (111), called UL permutation formula.~~

*Delete Equation (115) and the variable descriptions below it. Replace with the following:*

There are 18 groups in the whole frequency band and the number of tiles in a group is  $N_s$ . In order to make a subchannel, 6 groups at equal distance (3 groups away from each) are chosen and each of 6 tiles is selected from each group.

The exact partitioning into subchannels is according to Equation (115), called UL permutation formula.

***Insert the following new formula 115:***

$$Tiles(s, m) = \begin{cases} 3N_s \cdot m + N_s \cdot S + \lfloor s' + P_{1, c_1}(m') + P_{2, c_2}(m') \rfloor, & 0 < c_1, c_2 < N_s \\ 3N_s \cdot m + N_s \cdot S + \lfloor s' + P_{1, c_1}(m') \rfloor, & c_1 \neq 0, c_2 = 0 \\ 3N_s \cdot m + N_s \cdot S + \lfloor s' + P_{2, c_2}(m') \rfloor, & c_1 = 0, c_2 \neq 0 \\ 3N_s \cdot m + N_s \cdot S + s', & c_1=0, c_2=0 \end{cases} \quad (115)$$

where

$Tiles(s, m)$  = tile index of the  $m$ -th tile in subchannel  $s$ .

$S = \lfloor s/N_s \rfloor, s' = s \cdot \text{mod}(N_s)$

$m$  = tile-in-subchannel index from the set  $[0 \sim 5], m' = m \text{ mod}(N_s - 1)$

$s$  = index number of a subchannel from the set  $[0 \sim 3N_s - 1]$

$P_{1, c_1}(j)$  =  $j$ -th element of the sequence obtained by rotating basic permutation sequence  $P_1$  cyclically to the left  $c_1$  times. See Table 313a.

$P_{2, c_2}(j)$  =  $j$ -th element of the sequence obtained by rotating basic permutation sequence  $P_2$  cyclically to the left  $c_2$  times. See Table 313a.

$c_1 = UL\_PermBase \text{ mod}(N_s), c_2 = \lfloor UL\_PermBase/N_s \rfloor$

In Equation (115), the operation in  $\lfloor \ ]$  is over  $GF(2^n)$ . In  $GF(2^n)$ , addition is binary XOR operation. For example,  $13 + 4$  in  $GF(2^4)$  is  $[(1101)_2 \text{ XOR } (0100)_2] = (1001)_2 = 9$ , where  $(x)_2$  represents binary expansion of  $x$ .

After allocating the tiles for each subchannel the data subcarriers of each subchannel are enumerated by the same procedure used for UL PUSC in 8.4.6.2.2.

#### **8.4.6.2.6 Data subchannel rotation scheme**

***Change the first paragraph as indicated:***

A rotation scheme shall be applied per each OFDMA slot-duration in any zone, except zones marked as AAS zone, optional PUSC zone (8.4.6.2.5) or zone using the adjacent-subcarriers permutations (8.4.6.3). Slot-duration is defined in 8.4.3.1. On each slot-duration, the rotation scheme shall be applied to all UL subchannels that belong to the segment (see 8.4.4.5), except those subchannels indicated in the UL-MAP by UIUC = 0, UIUC = 13 or UIUC = 12. The rotation scheme is defined by applying the following rules:

***Change the first, third, and last items of the numerated list following the first paragraph as indicated:***

- 1) Per OFDMA slot duration, pick only subchannels that are not indicated by either UIUC = 0, UIUC = 12 or UIUC = 13 (as defined above). Renumber these subchannels contiguously, such that the lowest numbered physical subchannel is renumbered with 0. The total number of subchannels picked shall be designated  $N_{subchn}$ .
- 3) Mark the first UL OFDMA slot-duration for each permutation zone with the slot index  $S_{idx} = 0$ . Within the permutation zone, increase  $S_{idx}$  by 1 in every slot duration, such that subsequent slots are numbered 1,2,3... etc.
- 6) For subchannels in the UL-MAP indicated by either UIUC = 0, UIUC=12, or UIUC=13,  
 $new\_subchannel\_number = old\_subchannel\_number$

***Insert new numerated item 7):***

- 7) The *new\_subchannel\_number* will replace the *old\_subchannel\_number* in each allocation defined by 8.4.3.4. Where the *new\_subchannel\_number* is the output of the rotation scheme, and the *old\_subchannel\_number* is the input of the rotation scheme.

***Insert new subclause 8.4.6.2.7:*****8.4.6.2.7 Optional uplink channel sounding in TDD systems*****Insert new subclause 8.4.6.2.7.1:*****8.4.6.2.7.1 Channel sounding**

This subclause describes a signaling mechanism where an MS transmits channel sounding waveforms on the uplink to enable the BS to determine the BS-to-MS channel response under the assumption of TDD reciprocity. Only CSIT capable MSs (as indicated by the SBC-REQ message, see 11.8.3.7.6) shall support this signaling. This signaling methodology enables the use of closed-loop transmission strategies. Closed-Loop transmission strategies use knowledge of the channel at the transmitter to improve link performance, reliability, and range. This methodology also provides a means for the BS to determine the quality of the channel response across the signal bandwidth for the purpose of selecting the best portion of the band on which to transmit. The signaling described in this subclause enables the BS to measure the uplink channel response and translate the measured uplink channel response to an estimated downlink channel response when the transmit and receive hardware are appropriately calibrated. To support downlink channel estimation in a mobile environment, an MS may be instructed to transmit sounding signals periodically. The first sounding symbol is transmitted in the frame containing the relevant sounding instruction if Sounding\_Relevance is set to 0. The Sounding\_Relevance\_Flag indicates whether the Sounding relevance applies to all CIDs in the sounding command or whether a different Sounding Relevance can be applied individually for each CID in the sounding command. For each sounding assignment being made in this IE, the Sounding Relevance cannot be set to 0 unless the respective SS has a sounding response time capability less than or equal to the time between the completion of the transmission of the UL\_Sounding\_Command\_IE and the beginning of its respective sounding assignment.

In order to enable uplink sounding, in UL-MAP, a BS transmits UIUC=13 with the PAPR\_Reduction\_Safety\_and\_Sounding\_Zone\_Allocation\_IE() (see Table 287) to indicate the allocation of an UL sounding zone within the frame. The Sounding Zone is a region of one or more OFDMA symbol intervals in the UL frame that is used by the MS to transmit sounding signals to enable the BS to rapidly determine the channel response between the BS and the MS. The BS may command an MS to transmit a sounding signal (defined below) at one or more OFDMA symbols within the sounding zone by transmitting the UL-MAP message UL\_Sounding\_Command\_IE() to provide detailed sounding instructions to the MS. If periodic sounding is instructed by the BS, it is the responsibility of the BS to continue to signal the PAPR\_Reduction\_Safety\_and\_Sounding\_Zone\_Allocation\_IE() in every appropriate frame. The UL\_Sounding\_Command\_IE() of type A instructs the MS to transmit the specific sounding signal(s) at one or more specific symbol interval(s) within the sounding zone and specifies the specific sounding frequency band(s) to be occupied within each of these sounding symbol(s). The UL\_Sounding\_Command\_IE() of type B is similar to the UL\_Sounding\_Command\_IE() of type A except the frequency band(s) are allocated according to a specified downlink subcarrier permutation.

For the purposes of sounding the uplink of a CSIT capable MS of type A, the OFDMA frequency bandwidth within the Sounding Zone is partitioned into non-overlapping sounding frequency bands, where each sounding frequency band contains 18 consecutive OFDMA subcarriers. For the 2048 FFT size, the Sounding Zone, therefore, contains maximum of  $1728/18=96$  sounding frequency bands, where 1728 is the number of usable subcarriers ( $N_{used}$ ). For other FFT sizes, the sounding bands are also 18 subcarriers wide, and the number of possible sounding bands across the signal bandwidth varies accordingly.

As shown in Table 316a, the sounding instructions for CSIT type A include an assigned set of contiguous sounding frequency bands (called the sounding allocation). The sounding frequency bands are non-distributed for CSIT capability type A and are distributed according to a specified downlink permutation (for example, PUSC) for CSIT capability type B. For CSIT capability B, distributing the sounding frequency bands according to the optional FUSC is supported only for MSs that support the optional FUSC permutation.

Additionally, for CSIT capability A, the sounding instructions in UL\_Sounding\_Command\_IE() contain two alternate methods of maintaining signal orthogonality between multiple multiplexed MS sounding transmissions. The first methodology is called “cyclic shift separability” and involves the MS occupying all subcarriers within the sounding allocation. With this methodology, multiple MSs use the same sounding sequence (defined below), but each uses a different frequency-domain phase shift to multiply that underlying sounding sequence. In the second methodology, the MS occupies a decimated set of subcarriers (e.g., every 16th subcarrier). Multiple MSs can occupy the same sounding allocation, but each MS would use a set of non-overlapping subcarriers within the sounding allocation.

The sounding instructions in UL\_Sounding\_Command\_IE() of type B does not allow for multiplexing of sounding transmissions of multiple MSs over the same bands.

**Table 315d—UL\_Sounding\_Command\_IE()**

Syntax	Size	Notes
UL_Sounding_Command_IE(){	—	—
<b>Extended-2 UIUC</b>	4 bits	UL_sounding_command_IE()=0x04
<b>Length</b>	8 bits	<i>variable</i>
<b>Sounding_Type</b>	1 bit	0 = Type A 1 = Type B
<b>Send Sounding Report Flag</b>	1 bit	—
<b>Sounding_Relevance_Flag</b>	1 bit	0 = Sounding relevance is the same for all CIDs 1 = Sounding relevance is specified for each CID
if(Sounding_Relevance_Flag==0) {	—	—
<b>Sounding_Relevance</b>	1 bit	0 = All CIDs respond in the frame carrying the instruction 1 = All CIDs respond in next frame
<i>Reserved</i>	2 bits	Shall be set to zero.
} else {	—	—
<i>Reserved</i>	3 bits	Shall be set to zero.
}	—	—
<b>Include additional feedback</b>	2 bits	0b00 = No additional feedback 0b01 = include channel coefficients (see 8.4.6.2.7.3) 0b10 = include received pilot coefficients 0b11 = include feedback message
if (Sounding_Type == 0) {	—	—
<b>Num_Sounding_symbols</b>	3 bits	Total number of sounding symbols being allocated, from 1 (0b000) to $2^3=8$ (0b111)

**Table 315d—UL\_Sounding\_Command\_IE() (continued)**

Syntax	Size	Notes
<b>Separability Type</b>	1 bit	0: occupy all subcarriers in the assigned bands; 1: occupy decimated subcarriers
if (Separability type==0) {	—	(using cyclic shift separability)
<b>Max Cyclic Shift Index P</b>	3 bits	0b000: P=4; 0b001: P=8; 0b010: P=16, 0b011: P=32 0b100: P=9; 0b101: P=18; 0b110-0b111: <i>Reserved</i>
<i>Reserved</i>	1 bit	Shall be set to zero.
} else {	—	(using decimation separability)
<b>Decimation Value D</b>	3 bits	Sound every $D^{\text{th}}$ subcarrier within the sounding allocation. Decimation value $D$ is 2 to the power of (1 plus this value), hence 2,4,8,... up to maximum of 128, and 0b111 means decimation of 5.
<b>Decimation offset randomization</b>	1 bit	0= no randomization of decimation offset 1= decimation offset pseudo-randomly determined
}	—	—
for (i=0;i<Num_Sounding_symbols;i++){	—	—
<b>Sounding symbol index</b>	3 bits	Symbol index within the Sounding Zone, from 1 (value 0b000) to $2^3=8$ (value 0b111)
<b>Number of CIDs</b>	6 bits	Number of CIDs sharing this sounding allocation
<i>Reserved</i>	3 bits	Shall be set to zero.
for (j = 0; j<Num. of CIDs; j++) {	—	—
<b>Shorted basic CID</b>	12 bits	12 LSBs of the MS basic CID value
<b>Power Assignment Method</b>	2 bits	0b00 = equal power; 0b01 = Reserved; 0b10 = Interference dependent. Per subcarrier power limit; 0b11 = Interference dependent. Total power limit.
<b>Power boost</b>	1 bit	0 = no power boost 1 = power boost
<b>Multi-Antenna Flag</b>	1 bit	0 = MS sounds first antenna only 1 = MS sounds all antennas
<b>Allocation Mode</b>	1 bit	0: Normal 1: Band AMC
If (Allocation Mode == 1) {	—	—
<b>Band bit Map</b>	12 bits	See logical band defined in 6.3.18.
<i>Reserved</i>	2 bits	Shall be set to zero.
} Else {	—	—

**Table 315d—UL\_Sounding\_Command\_IE() (continued)**

Syntax	Size	Notes
<b>Starting Frequency Band</b>	7 bits	Out of 96 bands at most (FFT size dependent)
<b>Number of frequency bands</b>	7 bits	Contiguous bands used for sounding
}	—	—
If (Sounding Relevance Flag == 1) {	—	—
<b>Sounding_Relevance</b>	1 bit	—
} else {	—	—
<i>Reserved</i>	1 bit	Shall be set to zero
}	—	—
if (Separability Type==0) {	—	—
<b>Cyclic time shift index m</b>	5 bits	Cyclically shifts the time domain symbol by multiples (from 0 to P-1) of N/P where N=FFT size, and P=Max Cyclic Shift Index.
} else {	—	—
<b>Decimation Offset d</b>	6 bits	Relative starting offset position for the first sounding occupied subcarrier in the sounding allocation
If (Include additional feedback == 0b01) {	—	—
<b>Use same symbol for additional feedback</b>	1 bit	0 = the additional feedback is sent in the symbol(s) following the allocated sounding symbol 1 = the additional feedback is sent in the same symbol as the allocated sounding symbol
<i>Reserved</i>	2 bits	Shall be set to zero
} else {	—	—
<i>Reserved</i>	3 bits	Shall be set to zero.
}	—	—
}	—	—
<b>Periodicity</b>	3 bits	0b000 = single command, not periodic, or terminate periodicity. Otherwise, repeat sounding once per $r$ frames, where $r = 2^{(n-1)}$ , where $n$ is the decimal equivalent of the periodicity field
}	—	—
}	—	—
} else {	—	—
<b>Permutation</b>	3 bits	0b000 = PUSC perm. 0b001 = FUSC perm 0b010 = Optional FUSC perm. 0b011 = PUSC-ASCA 0b100 = TUSC1 0b101 = TUSC2 0b110 = AMC (2x3) 0b111 = <i>Reserved</i>



**Table 315d—UL\_Sounding\_Command\_IE() (continued)**

Syntax	Size	Notes
<b>DL_PermBase</b>	6 bits	—
<b>Num_Sounding_symbols</b>	3 bits	—
for (i=0; i<Num_Sounding_symbols; i++){	—	—
<b>Number of CIDs</b>	7 bits	—
<i>Reserved</i>	1 bit	Shall be set to zero.
for (j=0; j<Number of CIDs; j++) {	—	—
<b>Shortened basic CID</b>	12 bits	12 LSBs of the MS basic CID value
If(Sounding_Relevance_Flag==1){	—	—
<b>Sounding_Relevance</b>	1 bit	0 = Respond in the frame carrying the instruction 1 = Respond in next frame
<i>Reserved</i>	3 bits	Shall be set to zero
}	—	—
<b>Subchannel offset</b>	7 bits	The lowest index subchannel used for carrying the burst, starting from subchannel 0
<b>Power boost</b>	1 bit	0 = no power boost 1 = power boost
<b>Number of subchannels</b>	3 bits	The number subchannels with subsequent indexes, used to carry the burst.
<b>Periodicity</b>	3 bits	0b000 = single command, not periodic, or terminate periodicity. Otherwise, repeat sounding once per $r$ frames, where $r = 2^{(n-1)}$ , where $n$ is the decimal equivalent of the periodicity field
<b>Power Assignment Method</b>	2 bits	0b00 = equal power; 0b01 = <i>Reserved</i> ; 0b10 = Interference dependent. Per subcarrier power limit; 0b11 = Interference dependent. Total power limit.
}	—	—
}	—	—
}	—	—
<i>Padding</i>	<i>variable</i>	Pad IE to octet boundary. Bits shall be set to 0
}	—	—

If the field “Include Channel Coefficients” is enabled, then the UL Sounding Command IE() enables the MS to perform the direct transmission of DL channel coefficients to the BS along with the UL sounding waveform. For the description of the direct channel coefficient encoding method, see 8.4.6.2.7.3.

For CSIT capability A, the indices  $d$  or  $m$  are associated with the first antenna of the MS. If Multi-Antenna Flag equals 1 then the  $i$ -th antenna of the MS corresponds to index  $d + i - 1$  or to  $m + i - 1$  respectively. If Multi-Antenna Flag equals 0 then only the first antenna performs sounding. The BS shall assign indices to

different CIDs such that overlapping of indices is avoided. Optional permutations for AAS and AMC subchannels

For CSIT capability A, if the separability type is zero, then the sequence used by a transmit device (MS or MS antenna) associated with the  $n$ -th index is determined according to:

$$s_{un}(k) = s_u(k)e^{-j\frac{2\pi kn}{P}}$$

where

- $k$  is the index of the occupied subcarrier ( $0 \leq k \leq L_s - 1$ ,  $L_s$  is the number of occupied subcarriers),
- $P$  is the max cyclic shift index (from the sounding instructions),
- $n$  is the assigned cyclic time shift index (also from the sounding instructions), which ranges from 0 to  $P-1$ .

The sequence  $s_u(k)$  whose length is equal to  $L_s$  (a multiple of 18), is obtained as a cyclic shift of the sequence  $S(k)$  by an offset equal to  $u$  such that the variable  $u$  stands for the decimal value of the number represented by the binary digits  $b_5 \dots b_0$  and

- $b_5..b_3$  = three least significant bits of UL\_Permbase,
- $b_2..b_0$  = three least significant bits of the frame number.

The sequence  $s(k)$  is the binary subsequence of the Golay sequence given in Table 316b, starting from location  $Offset(L_s)$ , the latter given by Table 316c. The PAPR for any of these subsequences is approximately 5 dB.

**Table 315e—Golay sequence of length 2048 bits**

0xdc5, 0xda3b, 0xdc5, 0x25c5, 0xdc5, 0xda3b, 0x243b, 0xda3b, 0xdc5, 0xda3b, 0xdc5, 0x25c5, 0x243b, 0x25c5, 0xdc5, 0x25c5, 0xdc5, 0xda3b, 0xdc5, 0x25c5, 0xdc5, 0xda3b, 0x243b, 0xda3b, 0x243b, 0x25c5, 0x243b, 0xda3b, 0xdc5, 0xda3b, 0x243b, 0xda3b, 0xdc5, 0xda3b, 0xdc5, 0x25c5, 0xdc5, 0xda3b, 0x243b, 0xda3b, 0xdc5, 0xda3b, 0xdc5, 0x25c5, 0x243b, 0x25c5, 0xdc5, 0x25c5, 0x243b, 0x25c5, 0x243b, 0xda3b, 0x243b, 0x25c5, 0xdc5, 0x25c5, 0xdc5, 0xda3b, 0xdc5, 0x25c5, 0x243b, 0x25c5, 0xdc5, 0x25c5, 0xdc5, 0xda3b, 0x243b, 0x25c5, 0x243b, 0xda3b, 0xdc5, 0xda3b, 0x243b, 0xda3b, 0x243b, 0x25c5, 0x243b, 0xda3b, 0x243b, 0x25c5, 0xdc5, 0x25c5, 0x243b, 0x25c5, 0x243b, 0xda3b, 0xdc5, 0xda3b, 0x243b, 0xda3b, 0xdc5, 0xda3b, 0xdc5, 0x25c5, 0xdc5, 0xda3b, 0x243b, 0xda3b, 0x243b, 0x25c5, 0x243b, 0xda3b, 0xdc5, 0xda3b, 0x243b, 0xda3b
---

**Table 315f—Length dependent offsets in the Golay sequence of Table 316b**

Length	Offset	Length	Offset	Length	Offset	Length	Offset	Length	Offset	Length	Offset
18	44	306	1512	594	264	882	1426	1170	961	1458	352
36	119	324	446	612	767	900	639	1188	542	1476	369
54	140	342	424	630	423	918	314	1206	1727	1494	354
72	3	360	1502	648	1667	936	313	1224	1720	1512	342
90	376	378	340	666	1171	954	561	1242	1541	1530	1350
108	478	396	799	684	1154	972	1170	1260	1537	1548	1343
126	32	414	1473	702	1153	990	1557	1278	384	1566	1344
144	478	432	96	720	1151	1008	1295	1296	882	1584	1347
162	102	450	28	738	1135	1026	509	1314	800	1602	1342
180	191	468	1423	756	682	1044	377	1332	442	1620	1322
198	744	486	587	774	671	1062	1264	1350	407	1638	1300
216	764	504	519	792	671	1080	1270	1368	406	1656	1289
234	98	522	1536	810	641	1098	1183	1386	410	1674	1277
252	324	540	187	828	640	1116	164	1404	387	1692	1279
270	505	558	1510	846	639	1134	959	1422	376	1710	1261
288	16	576	736	864	1407	1152	1537	1440	367	1728	1600

For CSIT type A, if the separability type is one, then a spacing of  $D$  subcarriers (where  $D$  is the Decimation value) is maintained between every two occupied subcarriers associated with the same transmit device. The occupied subcarriers for each transmit device shall be modulated by BPSK symbols in the same manner as done in 8.4.9.4.3, Equation (130). The relevant value of  $w_k$  is taken from the Golay sequence in Table 316b with offset given according to Table 316d. Let  $\hat{d}$  be the value of the decimation offset  $d$  plus the relative offset according to the MS antenna number (when Multi-Antenna Flag equals 0, then only the first antenna does sounding). If Decimation Offset Randomization equals 0, then  $g = \hat{d}$ , otherwise  $g = ((p((baseID + Frame Number) \bmod 32) + \hat{d}) \bmod D)$ , where  $p(x)$  is the value in PermutationBase as defined by Table 311 (“OFDMA downlink carrier allocations for FUSC in 2048 FFT mode”) at the location  $x$ . The first subcarrier to be occupied is located at the  $g^{th}$  subcarrier. The pseudo-random cyclic shift of the decimation offset may be used to combat inter-cell interference. On the other hand, when this pseudo-random cyclic shift is not used, then an alternative strategy for combating inter-cell interference involves assigning each neighboring cell/sector a set of decimation offsets that is different from those used by neighboring cells/sectors.

**Table 315g—Offsets for the decimated pilots method**

FFT size	Offset	PAPR
2048	1922	6.3
1024	393	6.1
512	140	5.8
128	15	5.1

The two periodicity bits indicate whether the MS is to periodically repeat the sounding waveforms in subsequent sounding zone without having to receive a subsequent UL\_Sounding\_Command\_IE(). Setting the periodicity bits to 0b00 has two meanings: Ordinarily, the 0b00 setting means a single sounding command with no periodicity. However, if periodic sounding is being performed by a specified MS, then the 0b00 setting means the specified MS must stop all sounding over the specified OFDMA symbol.

When the MS is sounding with CSIT capability B, the pilot subcarriers shall be BPSK modulated with their values corresponding to the sequence  $s_u(k)$ , where  $k=0$  is associated with the first occupied subcarrier.

Sequence to subcarrier mapping is done in physical order after collecting all subcarrier index belonging to the allocated subchannels.

If Send Sounding Report Flag is set to one, then any sounding IE (type A or B) encompasses an additional implicit instruction, according to which the MS shall report the average of the downlink SINR at the neighborhood of the pilot subcarriers. This instruction is equivalent to a Report command with parameter Channel Type request equal to 0b11. A CSIT capable MS (of type A or type B) shall respond with the appropriate REP-RSP() message on the uplink (see also 11.11 and 11.12) within the same frame used to convey the relevant sounding IE. It is the responsibility of the BS to allocate enough bandwidth to support the proper transmission of this REP-RSP() message. In case a periodic sounding is required, a periodic REP-RSP() shall be sent.

For each occupied subcarrier in a sounding symbol, the SINR at the MS is estimated based on a non-beamformed transmission that corresponds to the downlink preamble at the first symbol of the frame. The average SINR reported is the average of those estimates. An MS that transmits over multiple sounding symbols shall address the last symbol in the region for that matter.

If Send Sounding Report Flag is set to zero, then no reports are required to be sent by the specified MSs.

***Insert new subclause 8.4.6.2.7.2:***

**8.4.6.2.7.2 Power assignment**

If inside UL\_Sounding\_Command\_IE() the power assignment method field is set to 0b00 then the mobile shall transmit all pilots with equal power. In general, the transmission power is according to previous commands of the power control mechanism (see 8.4.10.3).

If the power assignment method is 0b10, then the power allocated to each pilot shall be proportional to

$$Q = \frac{1}{\sigma_k^2}$$

where  $\sigma_k^2$  is the estimated absolute interference level at the vicinity of the  $k$ -th pilot subcarrier

(without normalization to received signal strength at each OFDMA tone). The transmit power shall be

normalized so that the maximal power over all tones is the same as the power density of regular data transmission.

If the power assignment method is set to 0b11, then the power allocated to each pilot is set proportional to

$$Q = \max\{10, \min\{0.1, \frac{\hat{\sigma}^2}{\sigma_k^2}\}\} \text{ where } \hat{\sigma}^2 \text{ is the average interference level over the entire spectrum associated}$$

with the channel sounding command. The transmit power shall be normalized so that the average power per tone is the same as the power density of regular data.

In both cases, an additional power boost of 3 dB will be applied if the field power boost is set on.

***Insert new subclause 8.4.6.2.7.3:***

#### **8.4.6.2.7.3 Direct transmission of DL channel coefficients**

If the “Include additional feedback” field is set to 0b01, then the UL Sounding Command IE() enables the MS to perform the direct transmission of DL channel coefficients to the BS along with the UL sounding waveform. This functionality provides downlink channel state information to the BS in both FDD systems and TDD systems in which BS array transceiver calibration is not implemented. With this functionality enabled, DL channel coefficients are encoded as described below and are transmitted in one or more sounding zone symbols that immediately follow each symbol being used to transmit UL sounding waveforms. In this case, the UL sounding waveform is used by the BS to estimate the UL channel so that the DL channel coefficients transmitted by the MSs can be estimated by the BS. The channel coefficients can then be used to enable closed-loop transmission on the downlink.

There are two cases depending on the value of the separability type field. First, if separability type is 0 (cyclic shift separability in the sounding waveform), then a single additional symbol follows each sounding symbol being allocated with the UL\_Sounding\_command\_IE(). In that additional symbol, an MS antenna that transmits sounding in the sounding symbol will transmit an encoded channel coefficient waveform that occupies the same sounding bands allocated for the sounding waveform. The encoded waveform for the  $u^{\text{th}}$  MS (where  $u$  is the cyclic shift index in the UL Sounding Command) is defined for two cases: The first case is for where the MS has a single transmit antenna, but multiple receive antennas, and is told with the sounding command IE to sound all antennas (multi-antenna flag set to 1). In this case, the single transmit antenna transmits the sounding waveform appropriate for the single transmit antenna on the sounding symbol and transmits the following encoded waveform in the next symbol interval:

$$Z_u(k) = \beta_u \cdot \sum_{l=1}^{M_b} \sum_{m=1}^{M_{m,u}} \hat{H}_{u,m,l}(k) \cdot s_{p(u)}(k) \cdot \exp\{-j2\pi k((m-1) + (l-1) \cdot M_{m,u})/\alpha_u\} \quad (115a)$$

where

$\tilde{H}_{u,m,l}(k)$  is the estimated DL channel coefficient between the  $l^{\text{th}}$  BS transmit antenna and the  $m^{\text{th}}$  receive antenna of the  $u^{\text{th}}$  MS for subcarrier  $k$ ,

$\beta_u$  is a scaling to make the average transmit power of the feedback waveform (averaged across all frequency) of  $Z_u(k)$  be one,

$s_{p(u)}(k)$  is the sounding sequence of 8.4.6.2.7.1,

$M_{m,u}$  is the number of receive antennas on the  $u^{\text{th}}$  MS,

$\alpha_u$  is  $M_{m,u}M_b$ ,  
 $M_b$  is the number of BS transmit antennas,  
 $p(u)$  in  $s_{p(u)}(k)$  is equal to  $u-j$ , where  $u$  is formed from the UL\_Permbase and frame number as described in 8.4.6.2.7.1 and  $j$  is the CID loop index.

The second case for a separability type of 0 is for when the MS has a number of transmit antennas equal to the number of receive antennas. In this case, if the multi-antenna flag is false, then the first antenna of the MS shall transmit the waveform of the preceding equation. If the multi-antenna flag is true, then the encoded waveform to be transmitted by the MS antenna assigned to cyclic shift index of  $u$  in the UL Sounding Command is

$$Z_u(k) = \beta_u \cdot \sum_{l=1}^{M_b} \hat{H}_{u,l}(k) \cdot s_{p(u)}(k) \cdot \exp\{-j2\pi k(l-1)/\alpha_u\} \quad (115b)$$

where

$\hat{H}_{u,l}(k)$  is the estimated DL channel coefficient between the  $l^{th}$  BS transmit antenna and the MS antenna assigned to the cyclic shift index of  $u$  in the UL Sounding Command for subcarrier  $k$ ,  
 $\beta_u$  is a scaling to make the average transmit power of the feedback waveform (averaged across all frequency) of  $Z_u(k)$  be one,  
 $s_{p(u)}(k)$  is the sounding sequence of 8.4.6.2.7.1,  
 $\alpha_u$  is  $M_b$ ,  
 $M_b$  is the number of BS transmit antennas,  
 $p(u)$  in  $s_{p(u)}(k)$  is equal to  $u-j$ , where  $u$  is formed from the UL\_Permbase and frame number as described in 8.4.6.2.7.1 and  $j$  is the CID loop index.

When separability type is 1 in the UL Sounding Command (decimation separability in the sounding waveform), then the “use same symbol for additional feedback” bit specifies whether the additional feedback is sent in the symbol(s) following the allocated sounding symbol, or in the same symbol as the allocated sounding symbol. These two cases are described as follows. If separability type is 1 and “use same symbol for additional feedback bit” is true, then a number of additional sequential decimation offset indices equal to the number of MS receive antennas is used for the encoded feedback waveform (e.g., if a decimation offset of 1 is used for the uplink sounding, then decimation offsets 2 and 3 are the additional decimation offsets used for the additional feedback for a two receive antenna MS). On the  $i$ -th additional decimation offset, the first MS transmit antenna transmits the following waveform:

$$Z_l(k) = \beta_u \cdot \sum_{l=1}^{M_b} \hat{H}_{i,l}(k) \cdot s_{p(u)}(k) \cdot \exp\{-j2\pi k(l-1)/\alpha_u\} \quad (115c)$$

where

$\hat{H}_{i,l}(k)$  is the estimated DL channel coefficient between the  $l^{th}$  BS transmit antenna and the  $i^{th}$  receive MS antenna,  
 $\beta_u$  is a scaling to make the average transmit power of the feedback waveform (averaged across all frequency) of  $Z_u(k)$  be one,

$s_{p(u)}(k)$  is the sounding sequence of 8.4.6.2.7.1,  
 $\alpha_u$  is  $M_b$ ,  
 $M_b$  is the number of BS transmit antennas,  
 $p(u)$  in  $s_{p(u)}(k)$  is equal to  $u-j$ , where  $u$  is formed from the UL\_Permbase and frame number as described in 8.4.6.2.7.1 and  $j$  is the CID loop index.

For this type of feedback, the multi-antenna flag in the sounding command should be set to zero so that only the first antenna of the MS transmits the required sounding waveform and only the first antenna of the MS transmits the feedback waveform.

If separability type is 1 and “use same symbol for additional feedback bit” is false, then every allocated sounding symbol is followed by a number of additional symbols equal to the number of BS antennas. When an MS has a number of receive antennas equal to its number of transmit antennas, then an MS antenna that transmits on subcarrier  $k$  of the sounding symbol shall transmit the DL channel coefficient for the  $i$ -th base antenna to the corresponding MS receive antenna for the  $k$ -th subcarrier on subcarrier  $k$  of the  $i$ -th additional symbol following the allocated sounding symbol. In equation form, the MS that transmits a sounding signal on subcarrier  $k$  of the sounding symbol shall transmit  $H_l(k)$  on the  $l$ -th symbol following the sounding symbol, where  $\hat{H}_l(k)$  is the DL channel coefficient from the  $l$ -th BS antenna to the corresponding MS receive antenna. When the MS has a single transmit antenna and multiple receive antennas, then the first MS transmit antenna transmits any sounding and feedback requested in the sounding command.

*Insert new subclause 8.4.6.2.7.4:*

#### **8.4.6.2.7.4 Feedback of Received Pilot Coefficients**

If the “Include additional feedback” field is set to 0b10, the UL Sounding Command IE() enables the MS to transmit additional feedback based on the downlink received pilot signal values in the frequency domain. In this case, a single additional symbol is used to transmit a subset of the received pilot values back to the BS. For the case of a MIMO midamble being used as the source of the received pilots, the midamble received by each SS antenna is decimated in a blockwise fashion, block interlaced to reconstruct the feedback symbol, and sent back on the additional symbol interval. (Blockwise decimation by  $p$  with a block size of  $q$  means to retain one block of  $q$  consecutive samples out of every  $pq$  consecutive samples, and a block decimation offset of  $r$  means that the  $r^{\text{th}}$  block of length  $q$  is the first one to be retained.) For the received MIMO midamble, the blockwise decimation factor  $p$  shall be set equal to the number of SS receive antennas, the block size  $q$  shall be set equal to the number of BS antennas, and the blockwise decimation offset value depends on the receive antenna number of the SS. The blockwise decimation offset for SS receive antenna  $m$  ( $m = 1, 2, \dots$ ) is  $m-1$ . Before being transmitted, the power of this additional symbol shall be normalized to the same level as the sounding symbol that precedes it.

*Change the title of 8.4.6.3 as indicated:*

#### **8.4.6.3 Optional adjacent subcarrier permutations for ~~AAS~~ and AMC**

*Change the second sentence of the first paragraph as indicated:*

Alternatively, the adjacent subcarrier permutation can be used to take advantage of the structure of the adjacent subcarrier permutation in parts of DL subframe that are indicated accordingly by the DL-MAP and UL sub-frame that are indicated accordingly by the UL-MAP.

*Delete the second and third paragraphs as indicated:*

~~While the BS does not have any SSSs registered that are not capable of using the adjacent subcarrier permutation selected by the BS, the BS may employ the AAS superframe structure. Otherwise, it shall always return to the distributed subcarrier permutation at the end of each frame and provision broadcast traffic at the start of each frame.~~

The AAS superframe shall have the following structure:

- 1) ~~The BS shall start each superframe with no less than 20 consecutive frames, which contain both downlink and uplink broadcast OFDMA symbols. Each of these frames shall provision DCD, UCD, DL-MAP, and UL-MAP messages, and at least one initial ranging opportunity. The frame duration code in each frame (except the last one) shall be set to the actual frame duration used. The frame duration code in the last frame shall be set to 0x00.~~
- 2) ~~Subsequently, the BS shall transmit up to 200 ms of AAS only frames, followed by a minimum of one frame containing at least one downlink broadcast OFDMA symbol, which shall provision DCD, UCD, and DL-MAP messages. The frame duration code shall be set to 0x00.~~
- 3) ~~The BS shall repeat Step 2) of this subclause, up to the AAS superframe duration, which shall be no more than 1 s.~~

***Change the fourth paragraph as indicated:***

With the adjacent subcarrier permutation, symbol data within a subchannel is assigned to adjacent subcarriers and the pilot and data subcarriers are assigned fixed positions in the frequency domain within an OFDMA symbol. This permutation is the same for both uplink and downlink. Within each frame, the BS shall indicate the switch to the optional permutation in the AAS\_DL\_IE() and AAS\_UL\_IE() when switching to AAS traffic. (See 8.4.5.3 and 8.4.5.4.) using one of the zone switch IEs specified in 8.4.5.3.3, 8.4.5.3.4, 8.4.5.4.6 and 8.4.5.4.7. To define adjacent subcarrier permutation, a bin, which is ~~the~~ set of nine contiguous subcarriers within an OFDMA symbol, is a basic allocation unit both in downlink and uplink. A bin structure is shown in Figure 238.

***Change the paragraph below Figure 238 as indicated:***

AMC allocations can be made by two mechanisms—by subchannel index reference in UL-MAP and DL-MAP, or by subchannel allocation in a band using HARQ map (defined in 6.3.2.3.43). Each UL or DL zone may include allocations from HARQ and normal map. For regular AMC allocations made by the DL-MAP or UL-MAP, an AMC subchannel of type  $N \times M$  (where  $N \times M = 6$ ) is defined as six contiguous bins (a slot consists of  $N$  bins by  $M$  symbols). The subchannels are numbered from the lowest (0) to the highest frequency, such that subchannel  $k$  ( $k = 0 - 192/N$ ) consists of bins  $N \times k$  to  $N \times k + N - 1$ .

A group of four rows of bins is called a physical band. AMC subchannel consists of six contiguous bins in a same band. For band-AMC allocations made by HARQ map message, an AMC slot consists of six contiguous bins in a same logical band defined in format configuration IE (6.3.2.3.43.2). There are four types of AMC subchannels which are different in the collection of six bins in a band. In the first type (default type), the available bins in a band are enumerated by starting from the lowest bin in the first symbol to the last bin in the symbol and then going to the lowest bin in the next symbol and so on. In the first type of AMC subchannel, a slot consists of six consecutive bins in this enumeration. In the second type of AMC subchannel, a slot is defined as two bins by three symbols. In the third type, a slot is defined as three bins by two symbols and in the fourth type a slot is defined as one bin by six symbols. In the last three types of AMC subchannel, enumeration of bins in a slot is the same as in the first type.



*Change Table 316 as indicated:*

**Table 316—OFDMA AAS subcarrier allocations**

Parameter	Value
Number of DC subcarriers	1 ( <u>Index 1024, counting from 0</u> )
Number of guard subcarriers, left	160
Number of guard subcarriers, right	159
$N_{used}$ , Number of used subcarriers (which includes the DC subcarrier)	1729
Total number of subcarriers	2048
Number of pilots	192
Number of data subcarriers	1536
Number of <u>physical</u> bands	48
Number of bins per <u>physical</u> band	4
Number of data subcarriers per <u>subchannel slot</u>	48

*Change the paragraph below Table 316 as indicated:*

Let the index of the traffic subcarriers be numbered from 0 to 47 within an AMC subchannel slot. The index of first traffic subcarrier in the first bin is ~~10~~, next one is ~~21~~ and so on. The index of the subcarriers increases along the subcarriers first, then the bin. The  $j$ -th symbol of the 48 symbols where a band AMC subchannel slot is allocated is mapped onto the  $(S_{per}^{off}(j) - 1)$ -th subcarrier of a subchannel slot.  $j$  is [0, 47].

*Change the definition of the ‘off’ and ‘per’ parameters below Equation (116) as indicated:*

$$\begin{aligned}
 per &= \text{IDcell} \# \text{PermBase} \bmod 48, \\
 off &= -(\text{IDcell} \div 48) \bmod 49 - (\lfloor \text{PermBase} / 48 \rfloor) \bmod 49. \text{ This field is an element of GF}(7^2).
 \end{aligned}$$

*Insert the following sentence at the end of the subclause:*

In the downlink, PermBase shall be set to DL\_PermBase specified in preceding STC\_DL\_Zone IE and in the uplink, it shall be set to UL\_PermBase specified in preceding UL\_Zone IE.

*Insert new subclause 8.4.6.3.1:*

**8.4.6.3.1 AMC optional permutation**

**Table 316a—1024-FFT OFDMA AMC subcarrier allocations**

Parameter	Value	Notes
Number of DC Subcarriers	1	—
Number of Guard Subcarriers, Left	80	—
Number of Guard Subcarriers, Right	79	—
Number of Used Subcarriers ( $N_{used}$ ) (including all possible allocated pilots and the DC subcarrier)	865	—
Number of Pilot Subcarriers	96	—
Pilot Subcarrier Index	$9k+3m+1$ , for $k=0,1\dots95$ , and $m=[\text{symbol index}] \bmod 3$	Symbol of index 0 in pilot subcarrier index should be the first symbol of the current zone. $m$ is incremented only for data symbols, excluding preambles, Safety zones, Sounding symbols, midambles, etc. DC subcarrier is excluded when the pilot subcarrier index is calculated by the equation.
Number of Data Subcarriers	768	—
Number of Bands	24	—
Number of Bins per Band	4	—
Number of Data Subcarriers per Subchannel	48	—

**Table 316b—512-FFT OFDMA AMC subcarrier allocations**

Parameter	Value	Notes
Number of DC Subcarriers	1	—
Number of Guard Subcarriers, Left	40	—
Number of Guard Subcarriers, Right	39	—
Number of Used Subcarriers ( $N_{used}$ ) (including all possible allocated pilots and the DC subcarrier)	433	—
Number of Pilot Subcarriers	48	—
Pilot Subcarrier Index	$9k+3m+1$ , for $k=0,1\dots47$ , and $m=[\text{symbol index}] \bmod 3$	Symbol of index 0 in pilot subcarrier index should be the first symbol of the current zone. $m$ is incremented only for data symbols, excluding preambles, Safety zones, Sounding symbols, midambles, etc. DC subcarrier is excluded when the pilot subcarrier index is calculated by the equation.
Number of Data Subcarriers	384	—
Number of Bands	12	—
Number of Bins per Band	4	—
Number of Data Subcarriers per Subchannel	48	—

**Table 316c—128-FFT OFDMA AMC subcarrier allocations**

Parameter	Value	Notes
Number of DC Subcarriers	1	—
Number of Guard Subcarriers, Left	10	—
Number of Guard Subcarriers, Right	9	—
Number of Used Subcarriers ( $N_{used}$ ) (including all possible allocated pilots and the DC subcarrier)	109	—
Number of Pilot Subcarriers	12	—
Pilot Subcarrier Index	$9k+3m+1$ , for $k=0,1\dots11$ and $m=[\text{symbol index}] \bmod 3$	Symbol of index 0 in pilot subcarrier index should be the first symbol of the current zone. $m$ is incremented only for data symbols, excluding preambles, Safety zones, Sounding symbols, midambles, etc.
Number of Data Subcarriers	96	—
Number of Bands	3	—
Number of Bins per Band	4	—
Number of Data Subcarriers per Subchannel	48	—

NOTE—A “data symbol” is a symbol in which overlaps with at least one data slot (whether or not data is allocated on that slot).

In the region mapped according to HARQ MAP in 6.3.2.3.43, there are four types of AMC subchannels which are different in the collection of six bins in a band. In the first type (default type), the available bins in a band are enumerated by starting from the lowest bin in the first symbol to the last bin in the symbol and then going to the lowest bin in the next symbol and so on. A subchannel consists of six consecutive bins in this enumeration. The second type is two bins by three symbols, the third type is three bins by two symbols and the last type is one bin by six symbols. In the last three types, enumeration of bins in a subchannel is the same as in the first type.

In the region mapped according to normal DL/UL-MAP in 8.4.5.3 and 8.4.5.4, there is only one type of AMC subchannel, which consists of two bins by three symbols.

In all the types, data mapping follows 8.4.3.4 except for region mapped according to 6.3.2.3.43. Slots for downlink AMC zone in a region mapped according to 6.3.2.3.43 are allocated along the subchannel index first within a band. The direction of data mapping for downlink AMC slots shall be frequency first (across bands when multiple bands are allocated).

Slots for uplink AMC zone in a region mapped according to 6.3.2.3.43 are allocated along the symbol index first within a band. The direction of data mapping for uplink AMC slots shall be frequency first (across bands when multiple bands are allocated).

***Insert new subclause 8.4.6.3.2:***

**8.4.6.3.2 Band-AMC operation in normal DL/UL-MAP**

This subclause describes the band-AMC operation, which is designed for band-AMC enabled SS using normal DL/UL-MAP. The SS sends the REP-RSP message in an unsolicited fashion to BS to trigger Band AMC operation. The triggering conditions are given by TLV encodings in UCD messages. The REP-RSP (see 11.12 for the TLV encodings) includes the CINR measurements of five best bands.

For FFT sizes of 2048 and 1024, the number of Max Logical Bands is defined as 12. For FFT sizes of 512 and 128, the number of Max Logical Bands is the same as the number of physical AMC bands defined in 8.4.6.3. A logical band is a grouping of the physical AMC bands. For example, 12 logical bands for 1024-FFT imply that logical band 0 is composed of AMC bands (0,1), logical band 1 is composed of AMC bands (2,3), and logical band 2 is composed of AMC bands (4,5). In general, if  $K = \text{Max Logical Bands}$ , then logical band  $J = [0 \dots (K-1)]$  contains physical bands  $M/K * J, M/K * J + 1, \dots, M/K * (J+1) - 1$ , where  $M$  is the number of physical AMC bands.

The BS acknowledges the trigger by allocating Band AMC subchannels. From the next frame when the SS/MS sends the REP-RSP, the SS starts reporting the differential of CINR for four selected bands, and the MS starts reporting the differential of CINR for four or five selected bands (increment: 1 and decrement: 0 with a step of 1 dB) on its allocated fast-feedback channel (CQICH). If the BS does not allocate the Band AMC subchannels within the specified delay (CQICH Band AMC Transition Delay) in the UCD message, the SS reports the updated average CINR for the allocation of subchannel with distributed subcarrier permutation.

When the BS wants to trigger the transition to Band AMC mode or update the CINR reports, it sends the REP-REQ message (see 11.11 for the TLV encodings). When the SS receives the message, it replies with REP-RSP. When the BS receives the REP-RSP, it should synchronize the selection of bands reported and their CINR. Unless the BS allocates subchannels with distributed subcarrier permutation, the SS reports the differential increment/decrement compared to the most up-to-date report from the next CQI reporting frame.

*Insert new subclause 8.4.6.3.3:*

#### **8.4.6.3.3 AMC support for SDMA**

The pilots in an AMC AAS zone are regarded as part of the allocation, and as such shall be beamformed in a way that is consistent with the transmission of the allocation's data subcarriers. In an SDMA region, the pilots of each allocation may correspond to a different pilot pattern. A pilot pattern consists of location and polarity. The pilot patterns are depicted in Figure 238a. Data subcarriers shall be punctured to obtain patterns #2 and #3. Subcarriers shall only be punctured if there is an allocation associated with the corresponding pattern, as described in the `AAS_SDMA_DL_IE()`, `AAS_SDMA_UL_IE()`, `PHYMOD_DL_IE()`, `PHYMOD_UL_IE()`, `Reduced_AAS_Private_DL-MAP()` or `Reduced_AAS_Private_UL-MAP()`. Only MSs that support all four pilot patterns, as indicated by their capability in 11.8.3.7.16, shall be assigned allocations in an SDMA region where pilot patterns #2 and #3 are used. Data subcarriers shall be punctured after constellation mapping in the case of CC encoding, and prior to constellation mapping in the case of CTC encoding. In the latter case, the FEC block shall be truncated to accommodate the punctured subchannel structure, and the data subcarrier enumeration of Equation (116) shall not be applied. Instead, data subcarriers within a slot shall be enumerated starting from the first OFDMA symbol at the data subcarrier that is lowest in frequency, continuing in ascending frequency order throughout the slot's subcarriers in the same symbol, then going to the next symbol at the subcarrier lowest in frequency, and so on.

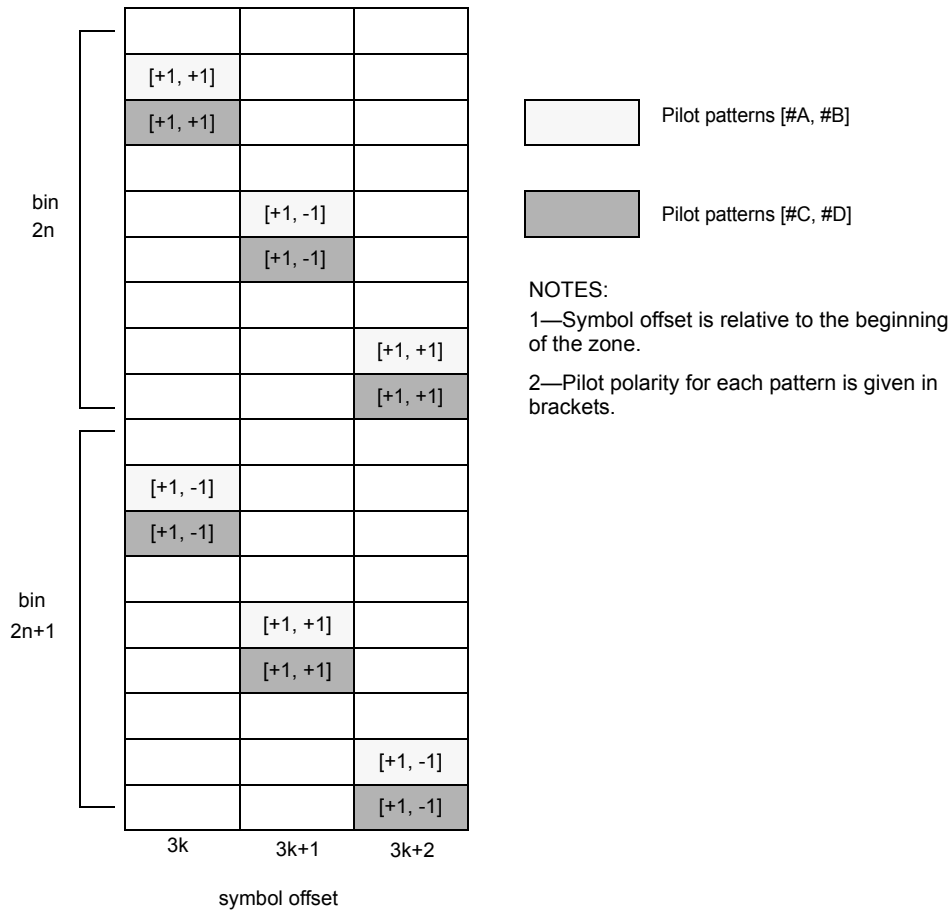


Figure 238a—Pilot patterns for AAS mode in AMC zone

*Insert new subclause 8.4.6.4:*

**8.4.6.4 Optional permutations for PUSC**

*Insert new subclause 8.4.6.4.1:*

**8.4.6.4.1 Optional permutation for PUSC adjacent subcarrier allocation (PUSC-ASCA)**

The following subclause defines two ways to use an adjacent subcarrier allocation for the PUSC mode.

*Insert new subclause 8.4.6.4.1.1:*

**8.4.6.4.1.1 Allocation using adjacent clusters**

The following definition will allow defining an adjacent subcarrier allocation using adjacent clusters for the PUSC mode.

Symbol structure shall use the parameters from Table 310, Table 310a, Table 310b, and Table 310c (as the regular PUSC), the same cluster structure shall be maintained.

*Insert new subclause 8.4.6.4.1.1.1:*

**8.4.6.4.1.1.1 Allocation of subcarriers to subchannels**

Allocation of subcarriers to subchannels shall be performed in the following manner:

- 1) Dividing the subcarriers into physical clusters each containing 14 adjacent subcarriers (starting from data subcarrier 0), number of clusters are defined in Table 308.
- 2) Clusters to be used for a specific DL allocation shall be the first  $2 \times (\text{Allocated Subchannels})$  after the first  $2 \times (\text{SubchannelOffset})$
- 3) Concatenate the clusters into blocks using the rules from Table 316d
  - $n$ : number of allocated subchannels
  - $k$ : floor ( $n / 12$ )
  - $m$ :  $n$  modulo 12

**Table 316d—Allocation of subcarriers to subchannels**

Number of subchannels	Clusters concatenated
$n \leq 12$	1 block of $2 \times n$ clusters
$n = 12 \times k$	$k$ blocks of 24 clusters
$n > 12, n \neq 12 \times k$	$(k-1)$ blocks of 24 clusters 1 block of $2 \times \text{ceil}((m+12)/2)$ clusters 1 block of $2 \times \text{floor}((m+12)/2)$ clusters

- 4) Per block, remove from the clusters associated with the section the pilot carriers, take the remaining data subcarriers and using the same procedure described in 8.4.6.1.2.2.2 (with the parameter  $N_{\text{subcarriers}} = 24$ ,  $\text{PermutationBase}$  taken from Table 317e and  $\text{Cell\_Id}$  as defined in message PUSC\_Directed\_MIMO\_Alloc\_IE) partition the subcarriers into subchannels containing 24 data subcarriers in each OFDMA symbol.

**Table 316e—Cluster permutation base**

Permutation ID	Number of clusters in the section	Permutation Base
12	24	[6,9,4,8,10,11,5,2,7,3,1,0]
11	22	[6,9,2,8,10,5,0,4,3,1,7]
10	20	[6,4,1,2,9,3,5,8,7,0]
9	18	[7,4,0,2,1,5,3,8,6]
8	16	[7,4,0,2,1,5,3,6]
7	14	[2,1,5,3,4,6,0]
6	12	[2,1,5,3,4,0]
5	10	[4,2,3,1,0]

**Table 316e—Cluster permutation base (continued)**

Permutation ID	Number of clusters in the section	Permutation Base
4	8	[2,3,1,0]
3	6	[2,0,1]
2	4	[0,1]
1	2	[0]

*Insert new subclause 8.4.6.4.1.2:*

**8.4.6.4.1.2 Allocation using distributed clusters**

The following definition will allow defining an adjacent subcarrier allocation using distributed clusters for the PUSC mode.

Symbol structure shall use the parameters from Table 308 (as the regular PUSC), the same cluster structure shall be maintained.

*Insert new subclause 8.4.6.4.1.2.1:*

**8.4.6.4.1.2.1 Allocation of subcarriers to subchannels**

- 1) Dividing the subcarriers into 120 physical clusters containing 14 adjunct subcarriers each (starting from carrier 0).
- 2) Renumbering the physical clusters into logical clusters using the following formula:  
 $LogicalCluster = RenumberingSequence(PhysicalCluster + 13 * ID_{cell}) \bmod 120$ .
- 3) Dividing the clusters into six major groups (number of clusters per Major group is set using parameters from Table 308).
- 4) Allocating carriers to subchannel in each major group depends on the specific allocation performed. per major group determine the number of clusters which are to be used in the specific allocation (clusters to be used for a specific DL allocation shall be the first  $2 * (Allocated\ Subchannels)$  after the first  $2 * (SubchannelOffset)$ ), determine the number of clusters to be used in every major group. Per major group (which includes allocated clusters) remove from the associated clusters the pilot carriers, take the remaining data subcarriers and using the same procedure described in 8.4.6.1.2.2.2 (with the parameter  $N_{subcarriers} = 24$ ,  $PermutationBase$  taken from Table 317e and  $Cell\_Id$  as defined in message PUSC\_Directed\_MIMO\_Alloc\_IE) partition the subcarriers into subchannels containing 24 data subcarriers in each OFDMA symbol.

*Insert new subclause 8.4.6.8:*

**8.4.6.8 Optional reduced AAS private maps**

Reduced AAS private maps are based upon the compressed map format, however they are specifically designed to support a single unicast IE per map. Their use is identical to compressed private maps, however, fields have been removed that are not require to support a single IE. The reduced AAS private map will be pointed to by a broadcast map or private compressed map, which will define the values of several fields that will be constant for the duration of the private map chain. The behavior of the compressed map fields that are not present in the reduced AAS private map are described below:



- 1) Frame Duration – Acquired by the map that initiated the private map chain. Assumed constant for the duration of the private map chain.
- 2) Frame Number – Acquired by the map that initiated the private map chain. Counted by the SS for the duration of the private map chain.
- 3) DCD Count – Optionally included. Only required if DCD count changes
- 4) Operator ID – Acquired by the map that initiated the private map chain. Assumed constant for the duration of the private map chain.
- 5) Sector ID – Acquired by the map that initiated the private map chain. Assumed constant for the duration of the private map chain.
- 6) CID – Only required in first map of private map chain.
- 7) UCD Count – Optionally included. May be sent in the first UL map of private map chain. If not included, the last received UCD Count shall be used.
- 8) Allocation Start Time – Optionally defined by Private Map Allocation Start Time which may be sent in the first UL map of private map chain. If not included, the UL subframe start time is assumed to be static and defined by the last received Allocation Start Time in an UL map.

#### 8.4.7 OFDMA ranging

*Change the first paragraph as indicated:*

~~When used with the WirelessMAN OFDMA PHY, the MAC layer shall define a single ranging channel. This A ranging channel is composed of one or more groups of six adjacent subchannels, using the symbol structure defined in 8.4.6.2.1, where the groups are defined starting from the first subchannel. Optionally, ranging channel can be composed of one or more groups of eight adjacent subchannels using the symbol structure defined in 8.4.6.2.5 or 8.4.6.3. Subchannels are considered adjacent if they have successive logical subchannel numbers.~~ The indices of the subchannels that compose the ranging channel are specified in the UL-MAP message. Users are allowed to collide on this ranging channel. To effect a ranging transmission, each user randomly chooses one ranging code from a bank of specified binary codes. These codes are then BPSK modulated onto the subcarriers in the ranging channel, one bit per subcarrier (subcarriers used for ranging shall be modulated with the waveform specified in 8.4.7.1/8.4.7.2 and are not restricted to any time grid specified for the data subchannels).

*Insert the following text immediately after the paragraph in 8.4.7:*

An MS at some circumstance such as trying network re-entry to another new BS in the drop situation, location update in idle mode or fast call recovery (which needs more UL resources for RNG-REQ because of additional 21 bytes long HMAC Tuple) may use the HO ranging code. The BS receiving HO ranging code shall allocate more bandwidth to the MS, enough to send RNG-REQ with HMAC Tuple.

For the 128-point and 512-point FFT, the BS may allocate less than 6 (or 8 in case of optional PUSC or AMC) subchannels for a ranging/BW-request allocation. In this case the MS shall produce the ranging code as defined below (as if 6/8 subchannels were allocated), but modulate only the tones in the subchannels allocated (so that the last bits of the ranging code are not transmitted). For the 512-point FFT, the minimum allocation shall be 5 subchannels (or 7 for the optional PUSC).

*Change the title of subclause 8.4.7.1 as indicated:*

##### 8.4.7.1 Initial-ranging/handover-ranging transmissions

*Change the text in 8.4.7.1 as indicated:*

The initial ranging transmission shall be used by any SS that wants to synchronize to the system channel for the first time. The initial ranging codes shall be used for initial network entry and association. Handover ranging codes shall be used for ranging against a Target BS during handover. An initial-ranging transmission shall be performed during two or four consecutive symbols. The same ranging code is transmitted on the ranging channel during each symbol, with no phase discontinuity between the two symbols. A time-domain illustration of the initial-ranging/handover-ranging transmission is shown in Figure 239.

Replace Figure 239 with the following figure:

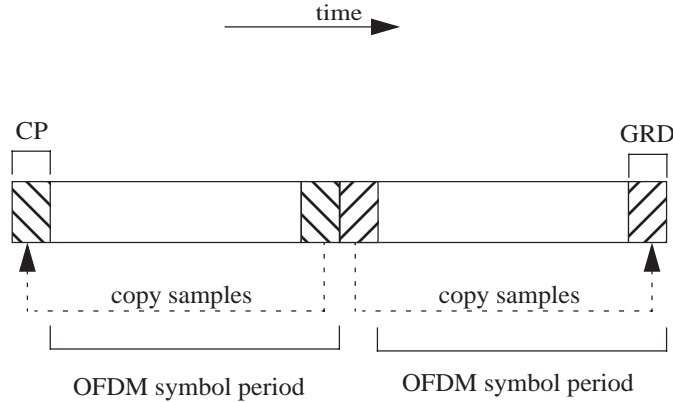


Figure 239—Initial-ranging/handover-ranging transmission for OFDMA

Insert the following sentence below Figure 239:

The transmitted signal is according to 8.4.2.5, Equation (100), except that  $0 \leq t \leq 2T_s$ .

Change the text above Figure 240 as indicated:

The BS can allocate two consecutive initial-ranging/handover-ranging slots, onto those the MS shall transmit the two consecutive initial-ranging/handover-ranging codes (starting code shall always be a multiple of 2), as illustrated in Figure 240:

Replace Figure 240 with the following figure:

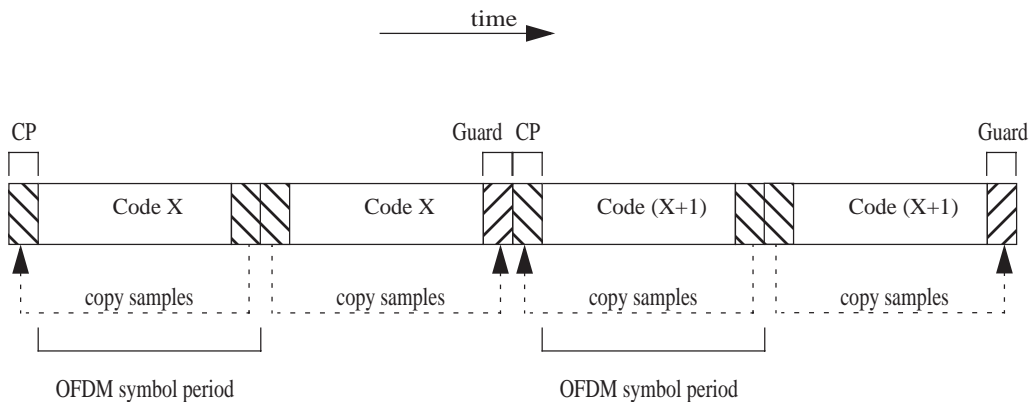


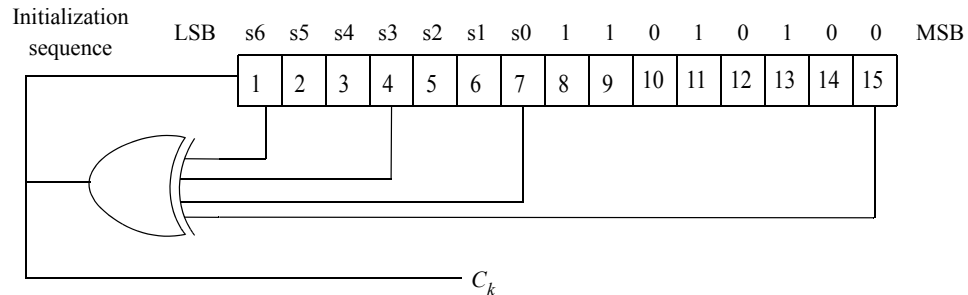
Figure 240—Initial-ranging/handover-ranging transmission for OFDMA, using two consecutive initial ranging codes

**8.4.7.3 Ranging codes**

*Change the second sentence of the first paragraph as indicated:*

The PRBS generator shall be initialized by the seed  ~~$b_{15}b_{14}...b_0 = 0,0,1,0,1,0,1,1,s_0,s_1,s_2,s_3,s_4,s_5,s_6$~~  where  ~~$s_6$  is the MSB~~ LSB of the PRBS seed, and  ~~$s_6:s_0 = UL\_IDcellPermBase$~~ , where  ~~$s_6$  is the MSB of~~ UL\_IDcellPermBase.

*Replace Figure 243 with the following figure:*



**Figure 243—PRBS generator for ranging code generation**

*Change the second paragraph as indicated:*

The binary ranging codes are subsequences of the pseudonoise sequence appearing at its output  $C_k$ . The length of each ranging code is 144 bits. These bits are used to modulate the subcarriers in a group of six (eight for the permutation defined in 8.4.6.2.5 or 8.4.6.3) adjacent subchannels, where subchannels are considered adjacent if they have successive logical subchannel numbers. The bits are mapped to the subcarriers in increasing frequency order of the subcarriers, such that the lowest indexed bit modulates the subcarrier with the lowest frequency index and the highest indexed bit modulates the subcarrier with the highest frequency index. The index of the lowest numbered subchannel in the six (eight for the permutation defined in 8.4.6.2.5 or 8.4.6.3) shall be an integer multiple of six (eight for the permutation defined in 8.4.6.2.5 or 8.4.6.3). The six (eight for the permutation defined in 8.4.6.2.5 or 8.4.6.3) subchannels are called a ranging subchannel. The ranging subchannel is referenced in the ranging and Bandwidth Request messages by the index of lowest numbered subchannel.

*Change the third and fourth paragraphs as indicated:*

For example, the first 144 bit code obtained by clocking the PN generator as specified, with  ~~$UL\_IDcellPermBase = 0$~~ , the first code shall be  ~~$011110000011111...00110000010001...$~~ . The next ranging code is produced by taking the output of the 145th to 288th clock of the PRBS generator, etc.

The number of available codes is 256, numbered 0..255. Each BS uses a subgroup of these codes, where the subgroup is defined by a number  $S$ ,  $0 \leq S \leq 255$ . The group of codes will be between  $S$  and  ~~$((S+Q+N+M+L) \bmod 256)$~~ .

- The first  $N$  codes produced are for initial-ranging. ~~For example, for the default case of two subchannels in the ranging channel, e~~ Clock the PRBS ~~generator~~  ~~$120144 \times (S \bmod 256)$~~  times to  ~~$120144 \times ((S + N) \bmod 256) - 1$~~  times.
- The next  $M$  codes produced are for periodic-ranging. ~~For example, for the default case of two subchannels in the ranging channel, e~~ Clock the PRBS ~~generator~~  ~~$120144 \times ((N + S) \bmod 256)$~~  times to  ~~$120144 \times ((N + M + S) \bmod 256) - 1$~~  times.

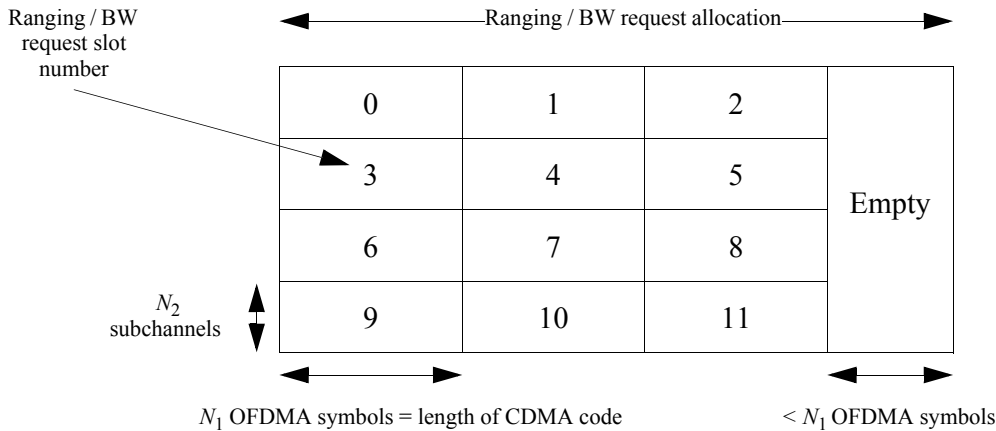
- The next  $L$  codes produced are for bandwidth-requests. ~~For example, for the default case of two subchannels in the ranging channel, e~~Clock the PRBS generator  ~~$+20144 \times ((N + M + S) \bmod 256)$~~  times to  ~~$+20144 \times ((N + M + L + S) \bmod 256) - 1$~~  times.
- The next  $O$  codes produced are for handover-ranging. Clock the PRBS generator  $144 \times ((N + M + L + S) \bmod 256)$  times to  $144 \times ((N + M + L + O + S) \bmod 256) - 1$  times.

**Insert new subclause 8.4.7.4:**

**8.4.7.4 Ranging and BW request opportunity size**

For CDMA ranging and BW request, the ranging opportunity size is the number of symbols required to transmit the appropriate ranging/BW request code (1,2,3 or 4 symbols), and is denoted  $N_1$ .  $N_2$  denotes the number of subchannels required to transmit a ranging code (6 or 8, see 8.3.7.3). In each ranging/BW request allocation, the opportunity size ( $N_1$ ) is fixed and conveyed by the corresponding UL\_MAP\_IE that defines the allocation.

The ranging allocation is subdivided into slots of  $N_1$  OFDMA symbols by  $N_2$  subchannels, in a time first order, i.e. the first opportunity begins on the first symbol of the first subchannel of the ranging allocation, the next opportunities appear in ascending order in the same subchannel, until the end of the ranging/BW request allocation (or until there are less than  $N_1$  symbols in the current subchannel), and then the number of subchannel is incremented by  $N_2$ . The ranging allocation is not required to be a whole multiple of  $N_1$  symbols, so a gap may be formed (that can be used to mitigate interference between ranging and data transmissions). Each CDMA code will be transmitted at the beginning of the corresponding slot. See Figure 243a.



**Figure 243a—Ranging/BW request opportunities**

*Change the title of 8.4.8 as indicated:*

**8.4.8 ~~Transmit diversity~~Space-Time Coding (optional)**

*Change the title of 8.4.8.1 as indicated:*

**8.4.8.1 ~~Transmit diversity~~STC using two antennas**

***Change the first paragraph as indicated:***

Space Time Coding (STC) (see Alamouti [B1]) STC [B1] (in some cases also termed STTD) or frequency hopping diversity coding (FHDC) may be used on the downlink to provide ~~second~~ higher order (Space) transmit diversity.

***Change the last paragraph as indicated:***

The regular subchannel and preamble transmission in the downlink shall be performed from only one antenna (Antenna 0) while the transmit diversity Subchannels transmission shall be performed from both antennas obeying the formulas in 8.4.8.1.2.1 ~~and 8.4.8.1.2.1.~~

**8.4.8.1.1 Multiple input single output channel estimation and synchronization*****Change the last sentence of the paragraph as indicated:***

The scheme requires multiple input single output channel estimation, which is allowed by splitting some pilots between the 2 Tx antennas, as described in 8.4.8.1.2.1 ~~and 8.4.8.1.2.1.~~

**8.4.8.1.2 Space time coding using two antennas****8.4.8.1.2.1 STC encoding*****Insert the following text at the beginning of the subclause:***

Two antenna rate 1 scheme is a basic STC scheme, enabled by matrix A as defined in 8.4.8.1.4. Other STC schemes are defined in a matrix notation in 8.4.8.1.4.

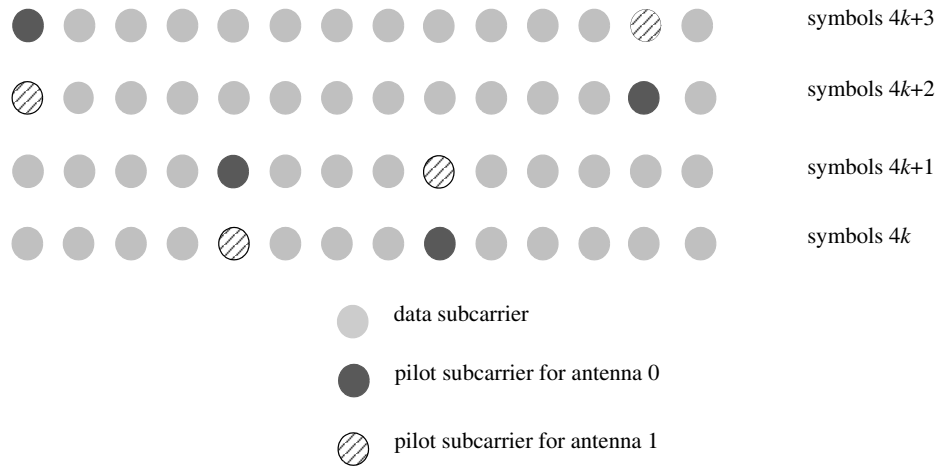
***Insert the following text before the last paragraph:***

STC rate 1 encoding shall be performed after constellation mapping and before subcarrier randomization defined in 8.4.9.4.1.  $s_1$  and  $s_2$  represent two subcarriers at the same frequency in two consecutive OFDMA symbols (each OFDMA subcarrier is referred to as a channel use). The STC rate 1 coding is done on all data subcarriers that belong to an STC coded burst in the two OFDMA symbols. Pilot subcarriers are not encoded and are transmitted from either antenna 0 or antenna 1.

**8.4.8.1.2.1.1 STC using two antennas in PUSC*****Replace the second paragraph with the following paragraph***

Figure 245 replaces Figure 234 in the definition of PUSC permutation when STC is enabled. The pilot locations change in period of 4 symbols.

*Replace Figure 245 with the following figure:*



**Figure 245—Cluster structure for STC PUSC using 2 Antennas**

*Insert the following sentence below Figure 245:*

Symbols are counted from the beginning of the current zone. The first symbol in the zone is even. STC encoding is done on each pair of symbols  $2n, 2n+1$  ( $n = 0,1,\dots$ ).

*Delete Figure 246.*

*Change the title of subclause 8.4.8.1.2.1.2 as indicated:*

**8.4.8.1.2.1.2 STC using using two antennas in FUSC**

*Change the first paragraph as indicated:*

~~In FUSC, all subchannels shall be used for STC transmission. The pilots within the symbols shall be divided between the antennas—antenna 0 uses VariableSet#0 and ConstantSet#0 for even symbols while antenna 1 uses VariableSet#1 and ConstantSet#1 for even symbols, antenna 0 uses VariableSet#1 and ConstantSet#0 for odd symbols while antenna 1 uses VariableSet#0 and ConstantSet#1 for odd symbols (symbol counting starts at the starting point of the relevant STC zone), defined in 8.4.6.1.2.2. In STC transmission, the  $FUSC\_SymbolNumber$  in Equation (110) is replaced with  $\text{floor}(FUSC\_SymbolNumber/2)$ , so that variable pilots shall move every second symbol.~~ The transmission of the data shall be performed in pairs of symbols as illustrated in Figure 247.

Replace Figure 247 with the following figure:

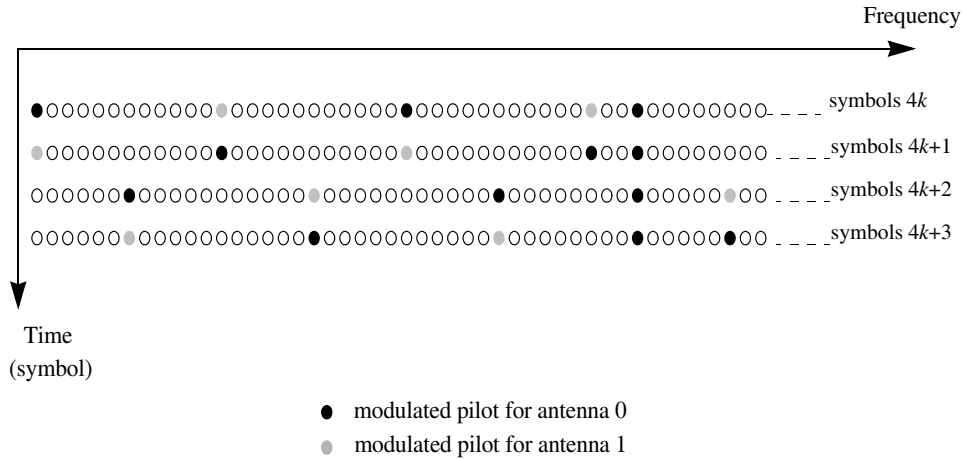


Figure 247—STC usage with FUSC

#### 8.4.8.1.3 Frequency hopping diversity coding (FHDC)

Change the second sentence of the first paragraph below Equation (119) as indicated:

The downlink preamble ~~will~~shall be transmitted for the duration of one OFDMA symbol from ~~both antennas~~Antenna 0 as shown in Figure 248, and subchannels used for FHDC are transmitted in adjunct pairs of subchannels.

#### 8.4.8.1.4 STC/FHDC configurations

Change the second sentence of the first paragraph as indicated:

The following matrices defines the transmission format with the row index indicating the antenna number and column index indicating the ~~subchannel-symbol time (two symbols per entry)~~ OFDMA symbol.

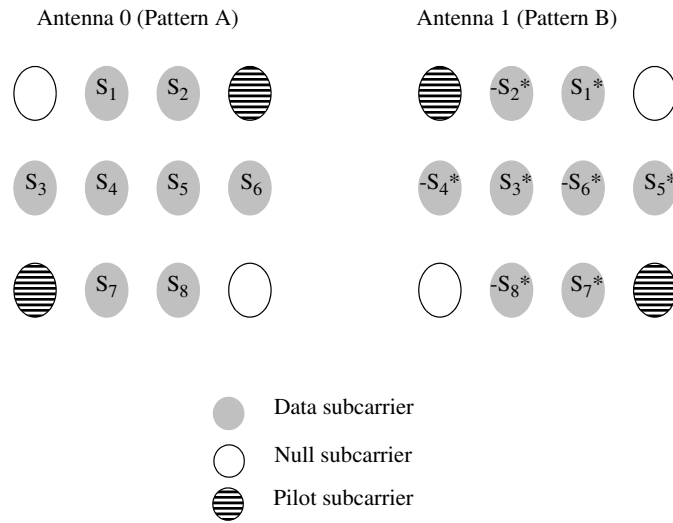
#### 8.4.8.1.5 Uplink using STC

Change the subclause as indicated:

A user-supporting transmission using STC configuration in the uplink, shall use a modified uplink tile, 2-transmit diversity data ('STTD mode'), or 2-transmit spatial multiplexing ('SM mode') data that can be mapped onto each subcarrier. The mandatory tile shall be modified to accommodate those configurations. ~~Figure 249 depicts the UL tile for STC transmission.~~

In STTD mode, the tiles shall be allocated to subchannels and the data subcarriers enumerated as defined in 8.4.6.2. The pilots in each tile shall be split between the two antennas and the data subcarriers shall be encoded in pairs after constellation mapping, as depicted in Figure 249. The data subcarriers transmitted from Antenna #0 follow the original mapping defined in 8.4.6.2.

Replace Figure 249 with the following figure:



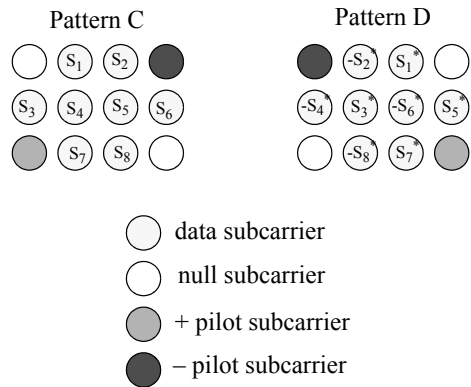
**Figure 249—Mapping of data subcarriers in STTD mode**

Two single transmit antenna SS's can perform collaborative spatial multiplexing onto the same subcarrier. In this case, ~~the~~ one SS ~~should~~ shall use the uplink tile with pattern-A, and the other SS ~~should~~ shall use the uplink tile with pattern-B. The pilot patterns are depicted in Figure 249. Transmit data shall be coded, interleaved, modulated and mapped to time/frequency as in the non-MIMO case. A single user having two antennas may do UL spatial multiplexing either using horizontal coding or vertical coding. For horizontal coding two bursts are first individually modulated, and then transmitted one per antenna (first burst on antenna #0, the second burst on antenna #1). For vertical coding a single burst is modulated and then transmitted according to the mapping order defined in 8.4.3.4 with the modification that on each subchannel, 2 consecutive slots are mapped instead of a single slot. The first slot of each slot pair is transmitted using antenna #0, while the second slot is transmitted using antenna #1.

To do spatial multiplexing with either vertical or horizontal coding a subscriber needs to signal both its antennas. In order to signal both antennas, the subscriber uses both pilot patterns A and B. Antenna #0 shall be signaled using pattern A and antenna #1 using pattern B. For non-MIMO transmissions, only antenna #0 shall be used.



*Insert Figure 249a and the included text at the end of 8.4.8.1.5:*



**Figure 249a—Pilot Patterns in UL PUSC tile**

Two single transmit antenna SS's can perform collaborative spatial multiplexing onto the same subchannel. In this case, the one SS should use the uplink tile with pattern-A and the other SS should use the uplink tile with pattern-B. Also, two dual transmit antenna SS's can perform collaborative spatial multiplexing onto the same subchannel. In this case, the one SS should use the uplink tile with the pilot pattern A, B and the other SS should use the uplink tile with the pilot pattern C, D through MIMO\_UL\_Enhanced\_IE. Pilot patterns are illustrated in the Figure 249 and Figure 249a.

*Change the title of subclause 8.4.8.2 as indicated:*

**8.4.8.2 ~~Transmit diversity~~STC for four antennas**

*Change the first sentence of the paragraph as indicated:*

The ~~Transmit diversity~~STC schemes could be further enhanced by using four antennas at the transmission site.

**8.4.8.2.1 STC for four antennas using PUSC**

*Change the subclause as indicated:*

For this configuration, the basic cluster structure is changed (as indicated in Figure 251) to accommodate the transmission from four antennas. (Pilots for antennas 2/3 override data subcarriers, ~~in the even symbols. Switching and erasing of the data subcarriers shall be performed after constellation mapping; therefore, maintaining all the encoding scheme and the subchannel allocation scheme~~ The data puncturing for CC or the data truncation for CTC shall be performed after STC encoding and before IFFT packet mapping).

Replace Figure 251 with the following figure:

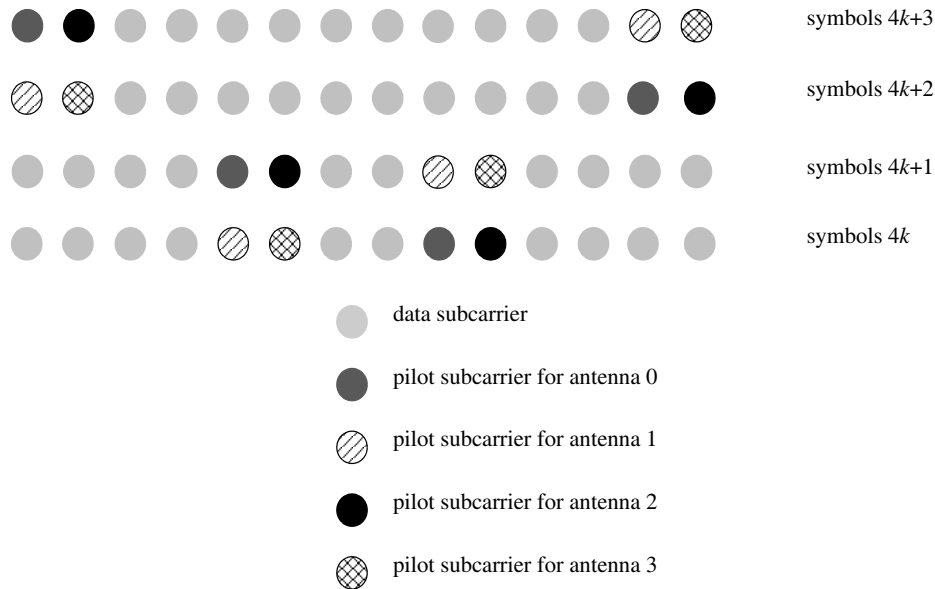


Figure 251—Cluster structure for STC PUSC using 4 antennas

#### 8.4.8.2.2 STC for four antennas using FUSC

Change the subclause as indicated:

For the FUSC configuration, the pilots embedded within the symbol shall be further divided. The pilots shall be transmitted with a structure including four time symbols (repeating itself every four symbols) as follows:

Even Symbols 0: antenna 0 uses VariableSet#0 and ConstantSet#0, antenna 1 uses VariableSet#1 and ConstantSet#1, antenna 2 uses indices of (VariableSet#0+1), antenna 3 uses indices of (VariableSet#1+1)

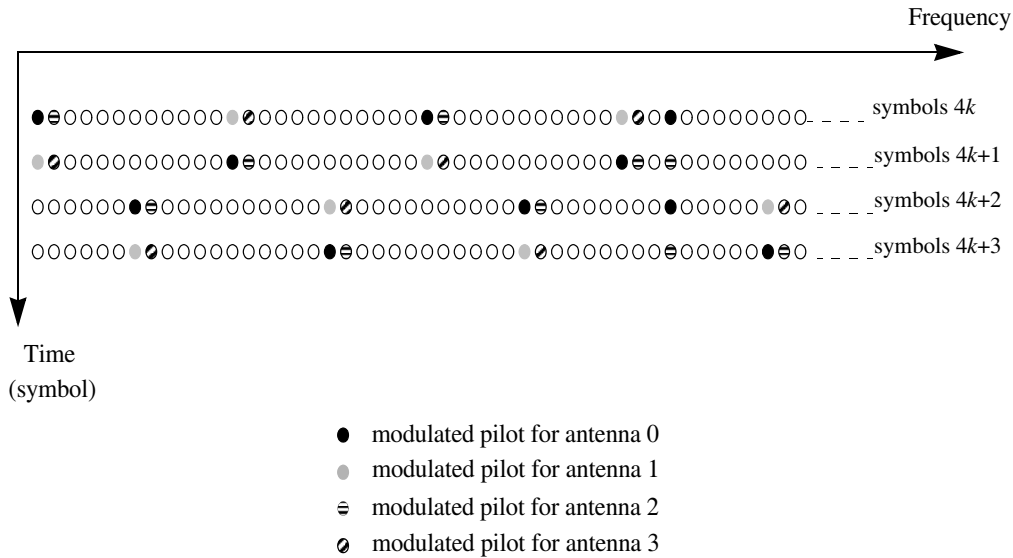
Symbol 1: antenna 2 uses VariableSet#0 and ConstantSet#0, antenna 3 uses VariableSet#1 and ConstantSet#1

Odd Symbols 2: antenna 0 uses VariableSet#1 and ConstantSet#0, antenna 1 uses VariableSet#0 and ConstantSet#1, antenna 2 uses indices of (VariableSet#1+1) and (ConstantSet#0), antenna 3 uses indices of (VariableSet#0+1) and (ConstantSet#1)

Symbol 3: antenna 2 uses VariableSet#1 and ConstantSet#0, antenna 3 uses VariableSet#0 and ConstantSet#1

In STC transmission the *FUSC\_SymbolNumber* in Equation (110) is replaced with  $\text{floor}(FUSC\_SymbolNumber/2)$ , so that variable pilots shall move every second symbol. The FUSC permutation is performed on the data subcarriers remaining after allocating the pilots for antennas 0,1 and the Constant pilots. The data subcarriers which that overlap with variable pilots allocated to antennas 2,3 are punctured replaced with pilots. The data puncturing for CC or the data truncation for CTC shall be performed after STC encoding and before IFFT subcarrier mapping.

*Insert new Figure 251a:*



**Figure 251a—STC usage with FUSC**

**8.4.8.2.3 STC configurations**

*Change first sentence of the second paragraph as indicated:*

The following matrices define the transmission format with the row index indicating the antenna number and column index indicating the ~~subchannel symbol time (two symbols per entry)~~ OFDMA symbol.

*Insert new subclause 8.4.8.2.4:*

**8.4.8.2.4 MIMO Macro diversity handover based macro-diversity transmission**

A macro diversity handover (MDHO) zone may be defined by the OFDMA downlink STC\_ZONE\_IE by setting the ID<sub>cell</sub>=0. For the MDHO-BSs joint transmission, for the STC capable MS, the total *N* antennas of MDHO-BSs constitute an antenna pool. A pre-determined antenna selection formula can be used. The MIMO transmit formats are specified in 8.4.8.1.4 for two-transmit-antenna case and 8.4.8.2.3 for four-transmit-antenna case. The MIMO pilot transmission is two-antenna transmission for PUSC and FUSC will follow the arrangement of the Figure 245 and 8.4.8.1.2.1.2 respectively (see Figure 207 for the optional FUSC and AMC permutations). The MIMO pilot transmission is four-antenna transmission for PUSC and FUSC will follow the arrangement of the Figure 251 and 8.4.8.2.2 respectively (see Figure 208 for the optional FUSC and AMC permutations). The un-selected antennas are set to the null transmission.

MS shall demodulate signal in the same procedure as in non-MDHO mode if it does not receive MIMO\_in\_another\_BS\_IE() or Macro\_MIMO DL Basic IE(). The same data are transmitted from multiple BSs in the same data regions. MS performs RF or diversity combining.

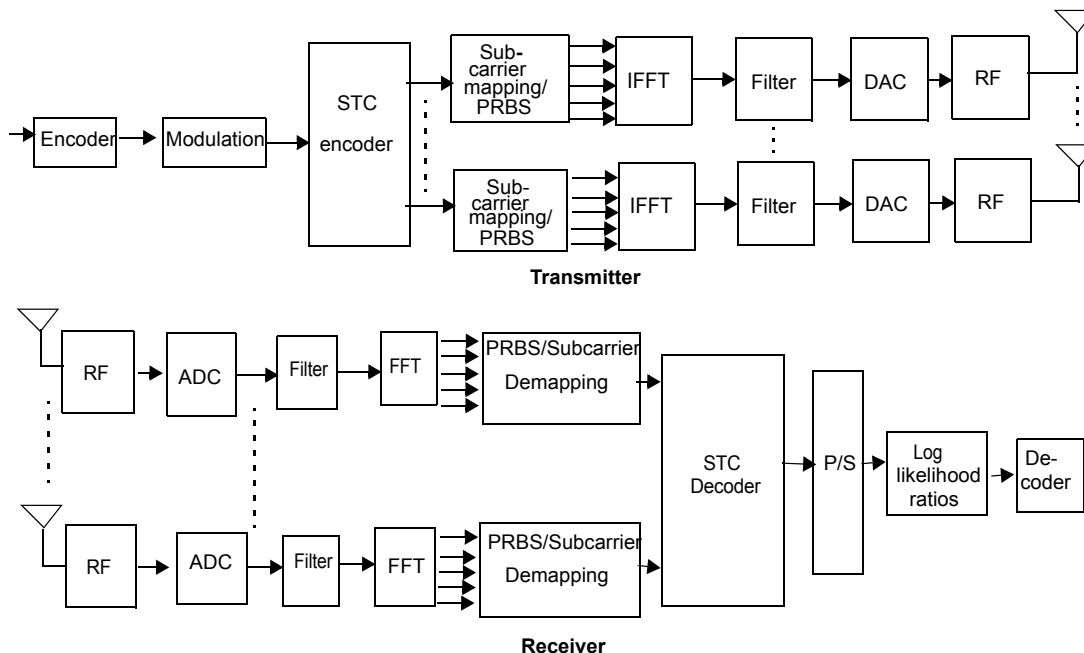
MS shall perform soft data combining when it receives MIMO\_in\_another\_BS\_IE(). In this case, the same data are transmitted in the same or different data region.

MS will demodulate signal in the same procedure as in non-MDHO mode, then it will perform soft combining for those data regions with the same packet index when it receives Macro\_MIMO DL Basic IE(). This scheme benefits from combination of RF, diversity combining, and soft data combining.

*Insert new subclause 8.4.8.3:*

**8.4.8.3 STC for the optional zones in the downlink**

Three optional zones for the downlink—the optional FUSC, optional AMC, and the optional PUSC-ASCA zones—are described in 8.4.6.1.2.3, 8.4.6.3, and 8.4.6.4.1, respectively. STC may be used to improve system performance for these zones and an example of transmit diversity (TD) with multiple transmitters and multiple receivers is shown in Figure 251b.

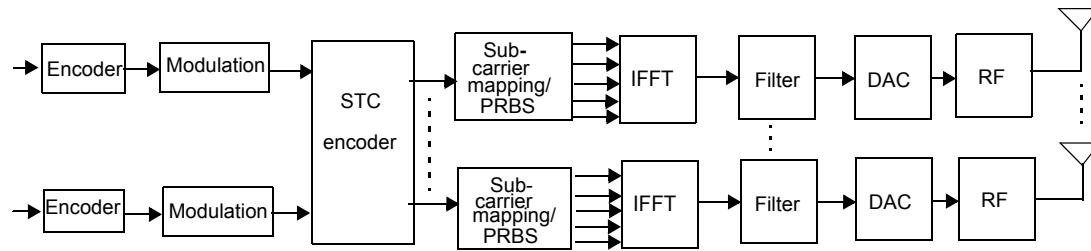


**Figure 251b—Example of STC for optional zones in DL (matrix A for 2, 3, or 4 Tx and matrix B for 3 or 4 Tx)**

In Figure 251b, the STC encoder operates on input data symbols sequentially and distributes the antenna specific data symbols to each antenna path. The block of subcarrier mapping and PRBS function denotes data truncation or puncturing, if needed, pilot insertion, IFFT input packing and each subcarrier multiplied by the factor  $2*(1/2-w_k)$  according to the subcarrier index  $k$  in 8.4.9.4.1. The data truncation for CTC or the puncturing of CC encoder shall be required for 3 Tx and 4 Tx BS for the optional AMC and the optional FUSC zones in the downlink, and required for 2 Tx for the optional PUSC in the uplink.

This figure also represents the usage of matrix B with vertical encoding for 3 or 4 Tx BS.

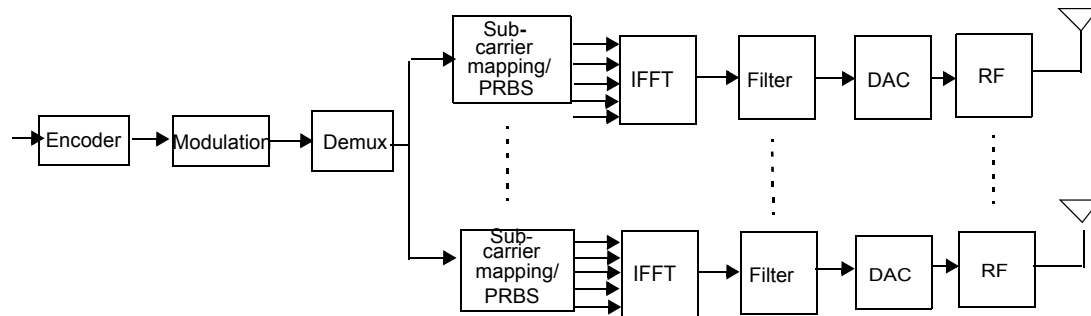
For the usage of matrix B with horizontal encoding for 3 or 4 Tx BS, an exemplary figure is shown in Figure 251c.



**Figure 251c—Example of matrix B with horizontal encoding for 3 or 4 Tx BS for optional zones in DL**

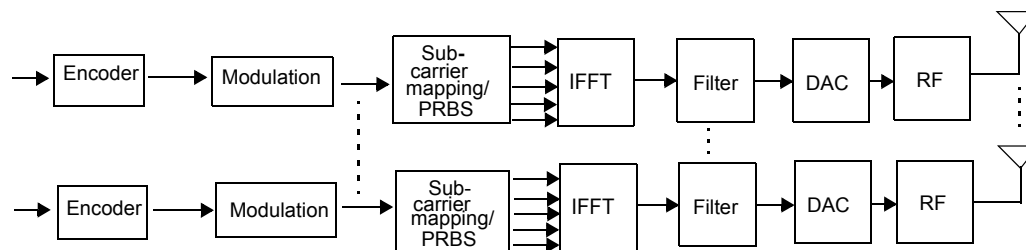
Figure 251d illustrates the usage of matrix C with vertical encoding. The modulated symbols are distributed sequentially from the top to the bottom output paths.

A “layer” is defined as an information path fed to the STC encoder as an input, and a “Stream” is defined as each information path encoded by the STC encoder that is passed to subcarrier mapping and sent through one antenna, or passed to the beamformer. Therefore, the number of layers in a system with vertical encoding is one, but in case of horizontal encoding it depends on the number of encoding/modulation paths. The number of streams in both vertical and horizontal encoding systems is the same as the number of output paths of the STC encoder.



**Figure 251d—Example of matrix C with vertical encoding for 2, 3, or 4 Tx BS for optional zones in DL**

An exemplary figure for matrix C with horizontal encoding is provided in Figure 251e.



**Figure 251e—Example of matrix C with horizontal encoding for 2, 3 or 4 Tx BS for optional zones in DL**

*Insert new subclause 8.4.8.3.1:*

**8.4.8.3.1 Symbol structure for optional AMC and optional FUSC**

*Insert new subclause 8.4.8.3.1.1:*

**8.4.8.3.1.1 Allocation of pilot subcarriers**

For 2-antenna BS, all pilots in the even symbols shall be allocated for antenna 0; whereas, all pilots in the odd symbols shall be allocated for antenna 1. The positions of pilots in the odd symbols are further switched with those of data subcarriers whose locations coincide with pilots in the previous symbol. This is shown in Figure 251f.

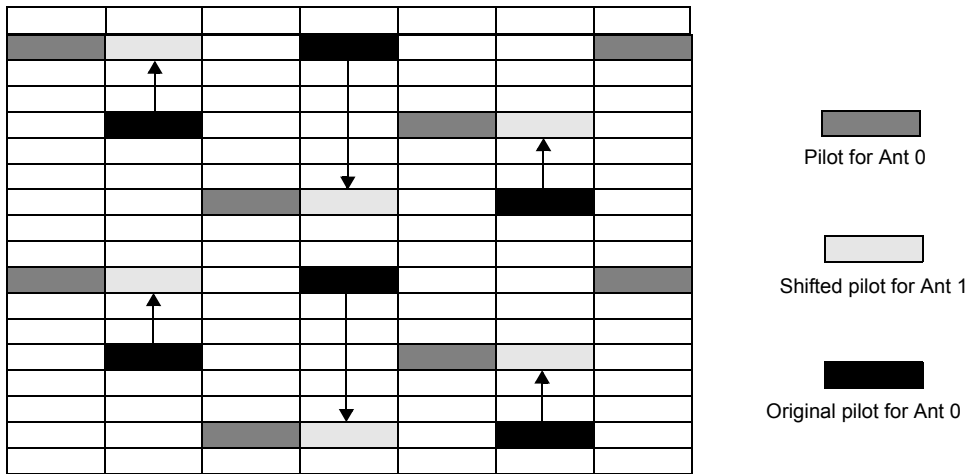
$$\text{Pilot Location for Antenna \#0} = 9k + 3[m \bmod 3] + 1 \quad (m = \text{even})$$

$$\text{Pilot Location for Antenna \#1} = 9k + 3[(m-1) \bmod 3] + 1 \quad (m = \text{odd})$$

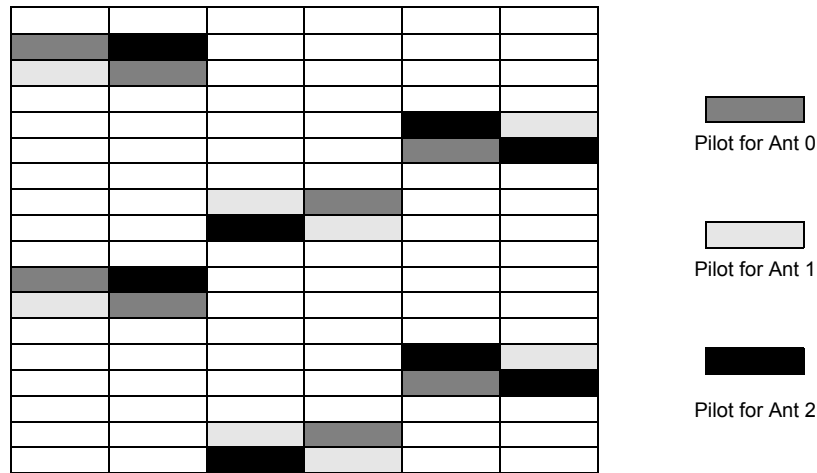
for  $m = [\text{symbol index}]$ , symbol index 0 is the first symbol (except midamble) in which the STC Zone is applied,  $k$  is defined in 8.4.6.1.2.3.

In other words, symbol index shall be reset to ‘0’ when a new STC Zone is applied.

For 3-antenna BS, pilot allocation pattern shall first be changed as in the 2-antenna BS case, and then the neighboring two subcarriers shall be further allocated as pilots. This is shown in Figure 251g.



**Figure 251f—Pilot allocation for 2-antenna BS for the optional FUSC and the optional AMC zones**



**Figure 251g—Pilot allocation for 3-antenna BS for the optional FUSC and the optional AMC zones**

For 4-antenna BS, pilot pattern shall first be changed as in the 2-antenna BS case, and then the neighboring two subcarriers shall be further punctured for antenna 2 and 3 as is shown in Figure 251h.

$$\text{Pilot Location for Antenna \#0} = 9k + 3[m \bmod 3] + 1 \quad (m = \text{even})$$

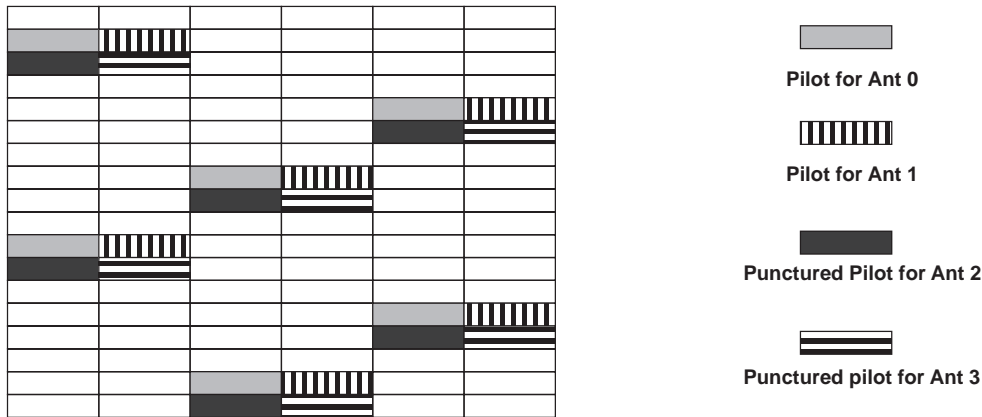
$$\text{Pilot Location for Antenna \#1} = 9k + 3[(m-1) \bmod 3] + 1 \quad (m = \text{odd})$$

$$\text{Pilot Location for Antenna \#2} = 9k + 3[m \bmod 3] + 2 \quad (m = \text{even})$$

$$\text{Pilot Location for Antenna \#3} = 9k + 3[(m-1) \bmod 3] + 2 \quad (m = \text{odd})$$

for  $m = [\text{symbol index}]$ , symbol index 0 is the first symbol (except midamble) in which the STC Zone is applied,  $k$  is defined in 8.4.6.1.2.3.

In other words, symbol index shall be reset to '0' when a new STC Zone is applied



**Figure 251h—Pilot allocation for 4-antenna BS for the optional FUSC and the optional AMC zones**

*Insert new subclause 8.4.8.3.1.2:*

**8.4.8.3.1.2 Allocation of data subchannels**

**8.4.8.3.1.2.1 STC Mapping for optional AMC permutation**

For the optional AMC permutation in STC zone, the data subchannels shall take 2x6 (2 bins for 6 symbols) format. The subcarrier permutation represented by Equation (112) in 8.4.6.3 shall not be applied for the optional AMC permutation within STC zones.

For 2-antenna matrix A in 8.4.8.3.3, STC encoded data symbols shall be time mapped starting over the first 2 OFDMA symbols. The mapping starts at the lowest numbered subcarriers of lowest slot and continues in an ascending manner in subchannels first and then proceeds to the next two symbols in time. An illustration of the mapping rule for the antenna #0 is shown in Figure 251i, assuming 2 Tx with Matrix A for a block of 2 slots.



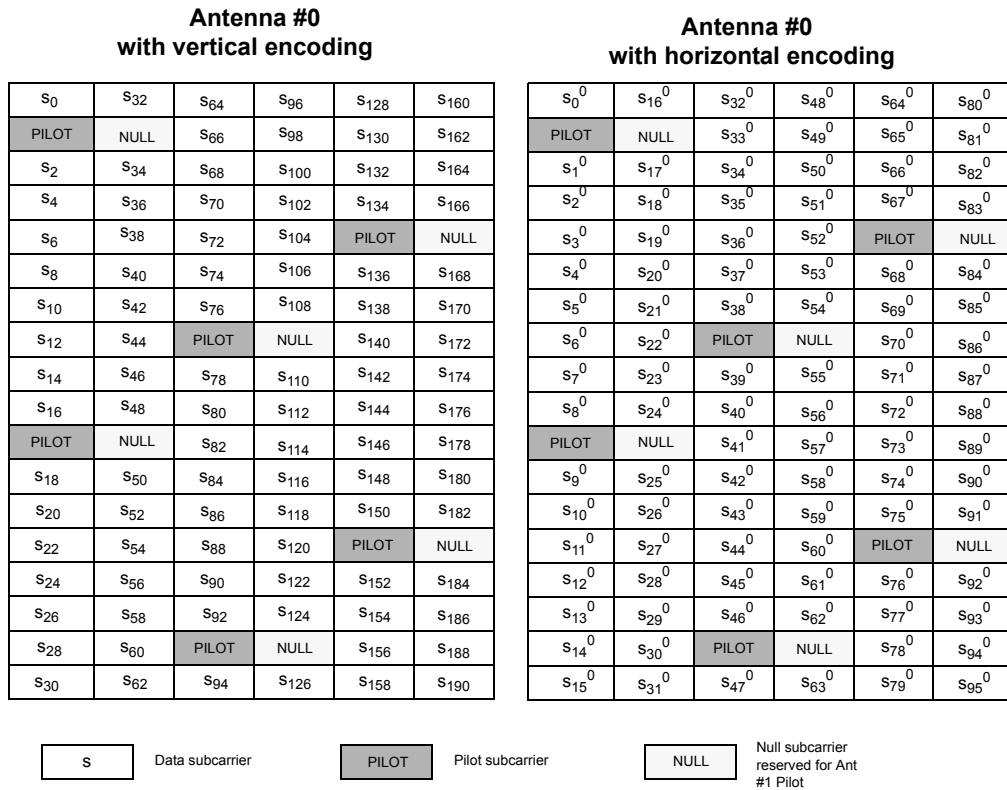
**Antenna #0**

S <sub>0</sub>	-S <sub>1</sub> *	S <sub>32</sub>	-S <sub>33</sub> *	S <sub>64</sub>	-S <sub>65</sub> *
PILOT	NULL	S <sub>34</sub>	-S <sub>35</sub> *	S <sub>66</sub>	-S <sub>67</sub> *
S <sub>2</sub>	-S <sub>3</sub> *	S <sub>36</sub>	-S <sub>37</sub> *	S <sub>68</sub>	-S <sub>69</sub> *
S <sub>4</sub>	-S <sub>5</sub> *	S <sub>38</sub>	-S <sub>39</sub> *	S <sub>70</sub>	-S <sub>71</sub> *
S <sub>6</sub>	-S <sub>7</sub> *	S <sub>40</sub>	-S <sub>41</sub> *	PILOT	NULL
S <sub>8</sub>	-S <sub>9</sub> *	S <sub>42</sub>	-S <sub>43</sub> *	S <sub>72</sub>	-S <sub>73</sub> *
S <sub>10</sub>	-S <sub>11</sub> *	S <sub>44</sub>	-S <sub>45</sub> *	S <sub>74</sub>	-S <sub>75</sub> *
S <sub>12</sub>	-S <sub>13</sub> *	PILOT	NULL	S <sub>76</sub>	-S <sub>77</sub> *
S <sub>14</sub>	-S <sub>15</sub> *	S <sub>46</sub>	-S <sub>47</sub> *	S <sub>78</sub>	-S <sub>79</sub> *
S <sub>16</sub>	-S <sub>17</sub> *	S <sub>48</sub>	-S <sub>49</sub> *	S <sub>80</sub>	-S <sub>81</sub> *
PILOT	NULL	S <sub>50</sub>	-S <sub>51</sub> *	S <sub>82</sub>	-S <sub>83</sub> *
S <sub>18</sub>	-S <sub>19</sub> *	S <sub>52</sub>	-S <sub>53</sub> *	S <sub>84</sub>	-S <sub>85</sub> *
S <sub>20</sub>	-S <sub>21</sub> *	S <sub>54</sub>	-S <sub>55</sub> *	S <sub>86</sub>	-S <sub>87</sub> *
S <sub>22</sub>	-S <sub>23</sub> *	S <sub>56</sub>	-S <sub>57</sub> *	PILOT	NULL
S <sub>24</sub>	-S <sub>25</sub> *	S <sub>58</sub>	-S <sub>59</sub> *	S <sub>88</sub>	-S <sub>89</sub> *
S <sub>26</sub>	-S <sub>27</sub> *	S <sub>60</sub>	-S <sub>61</sub> *	S <sub>90</sub>	-S <sub>91</sub> *
S <sub>28</sub>	-S <sub>29</sub> *	PILOT	NULL	S <sub>92</sub>	-S <sub>93</sub> *
S <sub>30</sub>	-S <sub>31</sub> *	S <sub>62</sub>	-S <sub>63</sub> *	S <sub>94</sub>	-S <sub>95</sub> *

s	Data subcarrier
PILOT	Pilot subcarrier
NULL	Null subcarrier reserved for Ant #1 Pilot

**Figure 251i—Data mapping in the optional AMC Zone with 2 Tx antenna and matrix A**

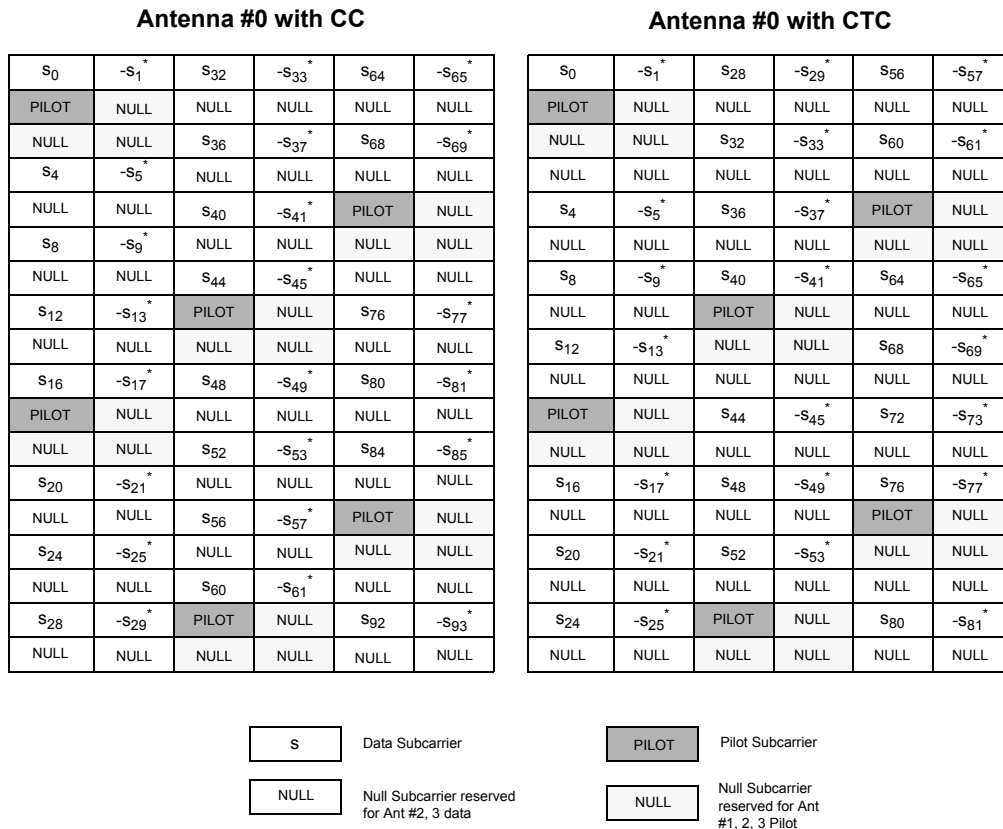
For 2-antenna vertically encoded matrix B in the optional AMC permutation, modulated data symbols shall be sequentially mapped for two transmit antennas along the subcarriers of the first symbol. The mapping continues in an ascending manner in subchannels first and then proceeds to the next symbol in time. An illustration of the mapping rule for the antenna #0 is shown in Figure 251j, assuming 2 Tx with vertically encoded matrix B for a block of 2 slots. Figure 251j also shows the mapping rule for 2-antenna horizontally encoded matrix B in the optional AMC permutation, where each encoded stream is separately mapped to the corresponding antenna.



**Figure 251j—Data mapping in the optional AMC zone with 2 Tx antenna and matrix B**

For a 3- or 4-antenna matrix A and matrix B in 8.4.8.3.4 and 8.4.8.3.5, STC encoded data symbols shall be mapped at two adjacent subcarriers over two OFDMA symbols. When the subcarrier pair (over two symbols) at frequency  $k+1$  is allocated to pilots for antenna #0 or #1 and the pair at frequency  $k+2$  is allocated to pilots for antenna #2 or #3, then the pair at frequency  $k+3$  shall be jointly encoded with the pair at frequency  $k$ . This is illustrated in Figure 251k, where blocks of 2 convolutional coded (CC) slots and convolutional turbo coded (CTC) slots are separately shown. The mapping starts at the lowest numbered subcarriers of the lowest slot and continues in an ascending manner in subchannels first and then proceeds to the next two symbols in time.

For a 3- and 4-antenna vertically/horizontally encoded matrix C in the optional AMC permutation, the same mapping rule for 2-antenna vertically/horizontally encoded matrix B shall be applied on the same frequency-time block with the 3- or 4-antenna pilot pattern.



**Figure 251k—Data mapping with CC in the optional AMC Zone with 4 Tx antenna and Matrix A**

**8.4.8.3.1.2.2 STC Mapping for optional FUSC permutation**

For the optional FUSC permutation in STC zone, the data subchannels shall be allocated for two consecutive OFDMA symbols. For a 2-antenna matrix A in 8.4.8.3.3, STC encoded data symbols shall be time mapped over two OFDMA symbols. The mapping starts at the lowest numbered subcarriers of lowest slot and continues in an ascending manner in subchannels first and then, if needed, proceeds to the next two symbols in time.

For a 2-antenna vertically encoded matrix B in 8.4.8.3.3 for the optional FUSC permutation, the data subchannels shall be allocated for two consecutive OFDMA symbols and the modulated data symbols shall be sequentially mapped for two transmit antennas along the subcarriers in the symbol. The mapping continues in an ascending manner in subchannels first and then proceeds to the next symbol in time. For a 2-antenna horizontally encoded matrix B in 8.4.8.3.3 each encoded stream is separately mapped to the corresponding antenna.

For a 3- and 4-antenna matrix A and matrix B in 8.4.8.3.4 and 8.4.8.3.4 for the optional FUSC permutation, STC encoded data symbols shall be mapped at two logical subcarriers over two OFDMA symbols. When the subcarrier pair (over two symbols) at logical frequency  $k+1$  is allocated to pilots for antenna #0 or #1 and the pair at logical frequency  $k+2$  is allocated to pilots for antenna #2 or #3, then the pair at logical frequency  $k+3$  shall be jointly encoded with the pair at logical frequency  $k$ . The mapping starts at the lowest numbered subcarriers of the lowest slot and continues in an ascending manner in subchannels first and then proceeds to the

next two symbols in time if needed. Data puncturing for CC or truncation for CTC shall be performed in a similar manner as in the optional AMC zone.

For 3- and 4-antenna vertically/horizontally encoded matrix C in the optional FUSC permutation, the same mapping rule for 2-antenna vertically/horizontally encoded matrix B shall be applied on the same frequency-time block with the 3- or 4-antenna pilot pattern.

A mapping example of a downlink burst for the optional FUSC using 4-antenna transmission is provided in the following:

Parameters are:

ID\_CELL = 1, Symbol index  $m=0$  (first symbol in STC zone), subchannel index = 0, The number of sub-channels = 1, 1024 FFT,

The indices of 48 data subcarriers in subchannel #0 for the optional FUSC are as follows:

3	23	46	58	79	104	121	132	156	170	196	215	231	245
254	273	293	316	328	349	374	391	402	426	440	466	485	501
515	524	543	563	586	598	619	644	661	672	696	710	736	755
771	785	794	813	833	856								

If Convolutional Coding is used for 4 Tx antennas, data tones at subcarrier indices = {245,254,515,524,785,794} shall be punctured for additional pilots. If Convolutional Turbo Coding is used for 4 Tx antennas, the last 6 of 48 data tones shall be first truncated and the remaining 42 data tones shall be mapped at the following indices:

3	23	46	58	79	104	121	132	156	170	196	215	231	273
293	316	328	349	374	391	402	426	440	466	485	501	543	563
586	598	619	644	661	672	696	710	736	755	771	813	833	856

#### 8.4.8.3.1.2.3 Burst packing of spatial multiplexed streams with CTC HARQ

For multiple spatial rate transmission and HARQ CTC, the packet shall be formed by concatenating multiple  $N_{EP}/N_{SCH}$  FEC codewords together. For the case of vertical encoding (number of layers=1), there shall be only 1 CRC check at the end of the last codeword. The first block is of size  $N_{EP}$  and the second block of size  $N_{EP}-16$  bits. For the case of horizontal encoding (number of layers >1), each burst shall be a separate  $N_{EP}/N_{SCH}$  pair with separate CRC. The randomization seed shall be reset for all of the  $N_{EP}/N_{SCH}$  pairs in the combined codeword. Figure 251j shows an example of vertically encoded rate 2 with CTC HARQ transmission.

*Insert new subclause 8.4.8.3.2:*

#### 8.4.8.3.2 Symbol structure for the optional PUSC-ASCA

Symbol structure is defined in 8.4.6.3.1, pilots division between antennas per cluster for the STC/MIMO operation shall follow the division in the PUSC mode as defined in 8.4.8.1 and 8.4.8.2. Pilots may optionally be beamformed or precoded.

**Insert new subclause 8.4.8.3.3:****8.4.8.3.3 Transmission schemes for 2-antenna BS in DL**

The following matrices define the transmission format with the row index indicating antenna number and column index indicating OFDMA symbol time. For both DL permutation zones with 2-antenna BS, one of the following three transmission matrices shall be used:

$$A = \begin{bmatrix} S_i & -S_{i+1}^* \\ S_{i+1} & S_i^* \end{bmatrix}$$

$$B = \begin{bmatrix} S_i \\ S_{i+1} \end{bmatrix}$$

$$C = \frac{1}{\sqrt{1+r^2}} \begin{pmatrix} S_i + jr \cdot S_{i+3} & r \cdot S_{i+1} + S_{i+2} \\ S_{i+1} - r \cdot S_{i+2} & jr \cdot S_i + S_{i+3} \end{pmatrix}, r = \frac{-1 + \sqrt{5}}{2}$$

where  $S_i$  and  $S_{i+1}$  in  $B$  may be encoded in different rates.

**Insert new subclause 8.4.8.3.4:****8.4.8.3.4 Transmission schemes for 3-antenna BS in DL**

The following definitions are applicable to modes that support STC for 3-antenna Tx.

For 3-antenna BS, one of the three transmission matrices A, B, or C, shall be used:

Let the complex symbols to be transmitted be  $x_1, x_2, x_3, x_4$ , which take values from a square QAM constellation; let  $s_i = x_i e^{j\theta}$  for  $i=1, 2, \dots, 8$ , where  $\theta = \tan^{-1}\left(\frac{1}{3}\right)$ ; and let

$$\tilde{s}_1 = s_{1I} + js_{3Q}; \tilde{s}_2 = s_{2I} + js_{4Q}; \tilde{s}_3 = s_{3I} + js_{1Q}; \tilde{s}_4 = s_{4I} + js_{2Q} \text{ where } s_i = s_{iI} + js_{iQ}.$$

The proposed Space-Time-Frequency code (over two OFDMA symbols and two subcarriers) for 3Tx-Rate 1 configuration with diversity order 3 is given in three permuted versions:

$$\begin{aligned}
 A_1 &= \begin{bmatrix} \tilde{S}_1 & -\tilde{S}_2^* & 0 & 0 \\ \tilde{S}_2 & \tilde{S}_1^* & \tilde{S}_3 & -\tilde{S}_4^* \\ 0 & 0 & \tilde{S}_4 & \tilde{S}_3^* \end{bmatrix} \\
 A_2 &= \begin{bmatrix} \tilde{S}_1 & -\tilde{S}_2^* & \tilde{S}_3 & -\tilde{S}_4^* \\ \tilde{S}_2 & \tilde{S}_1^* & 0 & 0 \\ 0 & 0 & \tilde{S}_4 & \tilde{S}_3^* \end{bmatrix} \\
 A_3 &= \begin{bmatrix} \tilde{S}_1 & -\tilde{S}_2^* & 0 & 0 \\ 0 & 0 & \tilde{S}_3 & -\tilde{S}_4^* \\ \tilde{S}_2 & \tilde{S}_1^* & \tilde{S}_4 & \tilde{S}_3^* \end{bmatrix}
 \end{aligned} \tag{124a}$$

where the ML decoding can be achieved by symbol-by-symbol decoding.

The matrix B is

$$B_1 = \begin{bmatrix} \sqrt{\frac{3}{4}} & 0 & 0 \\ 0 & \sqrt{\frac{3}{4}} & 0 \\ 0 & 0 & \sqrt{\frac{3}{2}} \end{bmatrix} \begin{bmatrix} \tilde{S}_1 & -\tilde{S}_2^* & \tilde{S}_5 & -\tilde{S}_6^* \\ \tilde{S}_2 & \tilde{S}_1^* & \tilde{S}_6 & \tilde{S}_5^* \\ \tilde{S}_7 & -\tilde{S}_8^* & \tilde{S}_3 & -\tilde{S}_4^* \end{bmatrix} \tag{124b}$$

$$B_2 = \begin{bmatrix} 0 & 1 & 0 \\ 0 & 0 & 1 \\ 1 & 0 & 0 \end{bmatrix} B_1$$

$$B_3 = \begin{bmatrix} 0 & 0 & 1 \\ 1 & 0 & 0 \\ 0 & 1 & 0 \end{bmatrix} B_1$$

where the definition for the remaining variables are as follows:

$$\tilde{s}_5 = s_{5I} + js_{7Q}; \quad \tilde{s}_6 = s_{6I} + js_{8Q}; \quad \tilde{s}_7 = s_{7I} + js_{5Q}; \quad \tilde{s}_8 = s_{8I} + js_{6Q} \tag{124c}$$

The matrix C is used for spatial multiplexing.

$$C = \begin{bmatrix} S_1 \\ S_2 \\ S_3 \end{bmatrix} \tag{124d}$$

The index,  $k$ , of the permuted version of Matrix A and Matrix B to use for a particular deployment is given by:  $k = \text{mod}(\text{floor}(\text{logical\_data\_subcarrier\_number\_for\_first\_tone\_of\_code-1})/2, 3) + 1$ , where  $\text{logical\_data\_subcarrier\_number\_for\_first\_tone\_of\_code} = 1, 2, 3, \dots$ , Total # of data subcarriers.

**Insert new subclause 8.4.8.3.4.1:**

**8.4.8.3.4.1 Enhanced 3 Tx Matrix A with Antenna Grouping**

For 3-Tx-antenna BS, transmission matrix A in 8.4.8.3.4 may be employed with adaptive antenna grouping, which is fed back from MS.

When MS reports 0b000, 0b0111 or 0b101110 on its CQICH (See 8.4.5.4.10.3 and 8.4.5.4.10.7), then BS shall group antenna 0 and 1 for the first subcarrier and antenna 1 and 2 for the second subcarrier. In matrix form, it shall be read as

$$A_1 = \begin{bmatrix} \tilde{s}_1 & \tilde{s}_2^* & 0 & 0 \\ \tilde{s}_2 & \tilde{s}_1 & \tilde{s}_3 & -\tilde{s}_4 \\ 0 & 0 & \tilde{s}_4 & \tilde{s}_3 \end{bmatrix} \tag{124e}$$

When MS reports 0b001, 0b1000 or 0b101111 on its CQICH, then BS shall group antenna 0 and 1 for the first subcarrier and antenna 0 and 2 for the second subcarrier. In matrix form, it shall be read as

$$A_2 = \begin{bmatrix} \tilde{s}_1 & \tilde{s}_2^* & \tilde{s}_3 & -\tilde{s}_4 \\ \tilde{s}_2 & \tilde{s}_1 & 0 & 0 \\ 0 & 0 & \tilde{s}_4 & \tilde{s}_3 \end{bmatrix} \tag{124f}$$

When MS reports 0b010, 0b1001 or 0b110000 on its CQICH, then BS shall group antenna 0 and 2 for the first subcarrier and antenna 1 and 2 for the second subcarrier. In matrix form, it shall be read as

$$A_3 = \begin{bmatrix} \tilde{s}_1 & \tilde{s}_2^* & 0 & 0 \\ 0 & 0 & \tilde{s}_3 & -\tilde{s}_4 \\ \tilde{s}_2 & \tilde{s}_1 & \tilde{s}_4 & \tilde{s}_3 \end{bmatrix} \tag{124g}$$

**Insert new subclause 8.4.8.3.4.1:**

**8.4.8.3.4.2 Enhanced 3 Tx Matrix B with Antenna Grouping**

For 3 Tx antenna BS, transmission matrix B for rate 2 may be employed with antenna grouping information that is fed back on a CQICH from MS.

When MS reports 0b000, 0b1010, or 0b110001 on its allocated CQICH, then BS shall transmit in the following transmission matrix:

$$B_1 = \begin{bmatrix} \sim & \sim & \sim & \sim & \sim \\ s_7 & -s_8 & s_3 & -s_4 & \sim \\ \sim & \sim & \sim & \sim & \sim \\ s_1 & -s_2 & s_5 & -s_6 & \sim \\ \sim & \sim & \sim & \sim & \sim \\ s_2 & s_1 & s_6 & s_5 & \sim \end{bmatrix} \quad (124h)$$

When MS reports 0b001, 0b1011, or b110010 on its allocated CQICH, then BS shall transmit in the following transmission matrix:

$$B_2 = \begin{bmatrix} \sim & \sim & \sim & \sim & \sim \\ s_1 & -s_2 & s_5 & -s_6 & \sim \\ \sim & \sim & \sim & \sim & \sim \\ s_7 & -s_8 & s_3 & -s_4 & \sim \\ \sim & \sim & \sim & \sim & \sim \\ s_2 & s_1 & s_6 & s_5 & \sim \end{bmatrix} \quad (124i)$$

When MS reports 0b010, 0b1100, or 0b110011 on its allocated CQICH, then BS shall transmit in the following transmission matrix:

$$B_3 = \begin{bmatrix} \sim & \sim & \sim & \sim & \sim \\ s_1 & -s_2 & s_5 & -s_6 & \sim \\ \sim & \sim & \sim & \sim & \sim \\ s_2 & s_1 & s_6 & s_5 & \sim \\ \sim & \sim & \sim & \sim & \sim \\ s_7 & -s_8 & s_3 & -s_4 & \sim \end{bmatrix} \quad (124j)$$

*Insert new subclause 8.4.8.3.4.3:*

#### **8.4.8.3.4.3 3 Tx Matrix C with Antenna Selection**

For the transmission matrix C, when k sub-streams are configured,  $x_i = [s_1, s_2, \dots, s_k]$ ,  $k=1, \dots, M$ ,  $M=1,2$  Transmission matrix is adaptively changed according to the CQICH. For 3-transmit antennas BS, the transmission matrix is listed in Table 316f, where the mapping of the matrix  $C_n$  to the CQICH is shown. The active antenna is power boosted.



**Table 316f—Enhanced 3 Tx Matrix C with Antenna Grouping**

Streams, k	CQICH (binary)			Power Boosting
	0b110000 (option 1)	0b110001 (option 2)	0b110010 (option 3)	
1	$C_1 = c \begin{bmatrix} s_1 \\ 0 \\ 0 \end{bmatrix}$	$C_2 = c \begin{bmatrix} 0 \\ s_1 \\ 0 \end{bmatrix}$	$C_3 = c \begin{bmatrix} 0 \\ 0 \\ s_1 \end{bmatrix}$	$c = 1$
2	$C_1 = c \begin{bmatrix} s_1 \\ s_2 \\ 0 \end{bmatrix}$	$C_2 = c \begin{bmatrix} s_1 \\ 0 \\ s_2 \end{bmatrix}$	$C_3 = c \begin{bmatrix} 0 \\ s_1 \\ s_2 \end{bmatrix}$	$c = 1/(\sqrt{2})$

Stream  $k=2$  indicates TLV=176, with Bit #1 and Bit#16 set.

**Insert new subclause 8.4.8.3.5:**

**8.4.8.3.5 Transmission schemes for 4-antenna BS**

For all permutation zones using 4-antenna BS, one of the following three transmission matrices shall be used:

$$A = \begin{bmatrix} s_1 & -s_2 & * & 0 & 0 \\ s_2 & s_1 & * & 0 & 0 \\ 0 & 0 & s_3 & -s_4 & * \\ 0 & 0 & s_4 & s_3 & * \end{bmatrix} \tag{124k}$$

$$B = \begin{bmatrix} s_1 & -s_2 & * & s_5 & -s_7 \\ s_2 & s_1 & * & s_6 & -s_8 \\ s_3 & -s_4 & * & s_7 & s_5 \\ s_4 & s_3 & * & s_8 & s_6 \end{bmatrix} \tag{124l}$$

$$C = \begin{bmatrix} s_1 \\ s_2 \\ s_3 \\ s_4 \end{bmatrix} \quad (124m)$$

where  $s_i$  may have different rates.

The permuted matrix- $A$  (over two OFDMA symbols and two subcarriers) for 4Tx-Rate 1 is given in three permuted matrices:

$$A_1 = \begin{bmatrix} S_1 & -S^*_2 & 0 & 0 \\ S_2 & S^*_1 & 0 & 0 \\ 0 & 0 & S_3 & -S^*_4 \\ 0 & 0 & S_4 & S^*_3 \end{bmatrix}, \quad A_2 = \begin{bmatrix} S_1 & -S^*_2 & 0 & 0 \\ 0 & 0 & S_3 & -S^*_4 \\ S_2 & S^*_1 & 0 & 0 \\ 0 & 0 & S_4 & S^*_3 \end{bmatrix}, \quad A_3 = \begin{bmatrix} S_1 & -S^*_2 & 0 & 0 \\ 0 & 0 & S_3 & -S^*_4 \\ 0 & 0 & S_4 & S^*_3 \\ S_2 & S^*_1 & 0 & 0 \end{bmatrix}. \quad (124n)$$

The mapping of subscript  $k$  to determine the matrix  $A_k$  is given by the following formula:

$$k = \text{mod}(\text{floor}(\text{logical\_data\_subcarrier\_number\_for\_first\_tone\_of\_code}-1)/2), 3) + 1$$

where

$$\text{logical\_data\_subcarrier\_number\_for\_first\_tone\_of\_code} = 1, 2, 3, \dots, \text{Total \# of data subcarriers.}$$

The permuted matrix- $B$  (over two OFDMA symbols and two subcarriers) for 4-Tx-Rate 2 is given in six permuted matrices:

$$B_1 = \begin{bmatrix} S_1 & -S^*_2 & S_5 & -S^*_7 \\ S_2 & S^*_1 & S_6 & -S^*_8 \\ S_3 & -S^*_4 & S_7 & S^*_5 \\ S_4 & S^*_3 & S_8 & S^*_6 \end{bmatrix}, \quad B_2 = \begin{bmatrix} S_1 & -S^*_2 & S_5 & -S^*_7 \\ S_2 & S^*_1 & S_6 & -S^*_8 \\ S_4 & S^*_3 & S_8 & S^*_6 \\ S_3 & -S^*_4 & S_7 & S^*_5 \end{bmatrix}, \quad B_3 = \begin{bmatrix} S_1 & -S^*_2 & S_5 & -S^*_7 \\ S_3 & -S^*_4 & S_7 & S^*_5 \\ S_2 & S^*_1 & S_6 & -S^*_8 \\ S_4 & S^*_3 & S_8 & S^*_6 \end{bmatrix}$$

$$B_4 = \begin{bmatrix} S_1 & -S^*_2 & S_5 & -S^*_7 \\ S_4 & S^*_3 & S_8 & S^*_6 \\ S_2 & S^*_1 & S_6 & -S^*_8 \\ S_3 & -S^*_4 & S_7 & S^*_5 \end{bmatrix}, \quad B_5 = \begin{bmatrix} S_1 & -S^*_2 & S_5 & -S^*_7 \\ S_3 & -S^*_4 & S_7 & S^*_5 \\ S_4 & S^*_3 & S_8 & S^*_6 \\ S_2 & S^*_1 & S_6 & -S^*_8 \end{bmatrix}, \quad B_6 = \begin{bmatrix} S_1 & -S^*_2 & S_5 & -S^*_7 \\ S_4 & S^*_3 & S_8 & S^*_6 \\ S_3 & -S^*_4 & S_7 & S^*_5 \\ S_2 & S^*_1 & S_6 & -S^*_8 \end{bmatrix}. \quad (124o)$$

The mapping of subscript  $k$  to determine the matrix  $B_k$  is given by the following formula:

$$k = \text{mod}(\text{floor}(\text{logical\_data\_subcarrier\_number\_for\_first\_tone\_of\_code}-1)/2), 6) + 1$$

where

$$\text{logical\_data\_subcarrier\_number\_for\_first\_tone\_of\_code} = 1, 2, 3, \dots, \text{Total \# of data subcarriers.}$$

***Insert new subclause 8.4.8.3.5.1:*****8.4.8.3.5.1 Enhanced 4 Tx Matrix A with Antenna Grouping**

For 4 Tx antenna BS, transmission matrix A in 8.4.8.3.5 may be employed with adaptive antenna grouping, which is fed back from MS.

When MS reports 0b101110 on its CQICH, then BS shall group antenna 0 and 1 for the first subcarrier and antenna 2 and 3 for the second subcarrier. In matrix form, it shall be read as

$$A_1 = \begin{bmatrix} s_1 & -s_2^* & 0 & 0 \\ s_2 & s_1^* & 0 & 0 \\ 0 & 0 & s_3 & -s_4^* \\ 0 & 0 & s_4 & s_3^* \end{bmatrix} \quad (124p)$$

When MS reports 0b101111 on its CQICH, then BS shall group antenna 0 and 2 for the first subcarrier and antenna 1 and 3 for the second subcarrier. In matrix form, it shall be read as

$$A_2 = \begin{bmatrix} s_1 & -s_2^* & 0 & 0 \\ 0 & 0 & s_3 & -s_4^* \\ s_2 & s_1^* & 0 & 0 \\ 0 & 0 & s_4 & s_3^* \end{bmatrix} \quad (124q)$$

When MS reports 0b110000 on its CQICH, then BS shall group antenna 0 and 3 for the first subcarrier and antenna 1 and 2 for the second subcarrier. In matrix form, it shall be read as

$$A_3 = \begin{bmatrix} s_1 & -s_2^* & 0 & 0 \\ 0 & 0 & s_3 & -s_4^* \\ 0 & 0 & s_4 & s_3^* \\ s_2 & s_1^* & 0 & 0 \end{bmatrix} \quad (124r)$$

***Insert new subclause 8.4.8.3.5.2:*****8.4.8.3.5.2 Enhanced 4 Tx Matrix B with Antenna Grouping**

For 4 Tx antenna BS, transmission matrix B for rate 2 may be employed with antenna grouping information that is fed back on a CQICH from MS.

When MS reports 0b110001 on its allocated CQICH, then BS shall group antenna 0 and 1 for the first diversity pair and antenna 2 and 3 for the second diversity pair. In matrix form, it shall be read as

$$B_1 = \begin{bmatrix} s_1 & -s_2^* & s_5 & -s_7^* \\ s_2 & s_1^* & s_7 & s_5^* \\ s_3 & -s_4^* & s_6 & -s_8^* \\ s_4 & s_3^* & s_8 & s_6^* \end{bmatrix} \quad (124s)$$

When MS reports 0b110010 on its allocated CQICH, then BS shall transmit in the following transmission matrix:

$$B_2 = \begin{bmatrix} s_1 & -s_2 & * & s_5 & -s_7 & * \\ s_2 & s_1 & * & s_7 & s_5 & * \\ s_4 & s_3 & * & s_8 & s_6 & * \\ s_3 & -s_4 & * & s_6 & -s_8 & * \end{bmatrix} \quad (124t)$$

When MS reports 0b110011 on its allocated CQICH, then BS shall group antenna 0 and 2 for the first diversity pair and antenna 1 and 3 for the second diversity pair. In matrix form, it shall be read as

$$B_3 = \begin{bmatrix} s_1 & -s_2 & * & s_5 & -s_7 & * \\ s_3 & -s_4 & * & s_6 & -s_8 & * \\ s_2 & s_1 & * & s_7 & s_5 & * \\ s_4 & s_3 & * & s_8 & s_6 & * \end{bmatrix} \quad (124u)$$

When MS reports 0b110100 on its allocated CQICH, then BS shall transmit in the following transmission matrix:

$$B_4 = \begin{bmatrix} s_1 & -s_2 & * & s_5 & -s_7 & * \\ s_4 & s_3 & * & s_8 & s_6 & * \\ s_2 & s_1 & * & s_7 & s_5 & * \\ s_3 & -s_4 & * & s_6 & -s_8 & * \end{bmatrix} \quad (124v)$$

When MS reports 0b110101 on its allocated CQICH, then BS shall group antenna 0 and 3 for the first diversity pair and antenna 1 and 2 for the second diversity pair. In matrix form, it shall be read as

$$B_5 = \begin{bmatrix} s_1 & -s_2 & * & s_5 & -s_7 & * \\ s_3 & -s_4 & * & s_6 & -s_8 & * \\ s_4 & s_3 & * & s_8 & s_6 & * \\ s_2 & s_1 & * & s_7 & s_5 & * \end{bmatrix} \quad (124w)$$

When MS reports 0b110110 on its allocated CQICH, then BS shall transmit in the following transmission matrix:

$$B_6 = \begin{bmatrix} s_1 & -s_2 & * & s_5 & -s_7 & * \\ s_4 & s_3 & * & s_8 & s_6 & * \\ s_3 & -s_4 & * & s_6 & -s_8 & * \\ s_2 & s_1 & * & s_7 & s_5 & * \end{bmatrix} \quad (124x)$$

*Insert new subclause 8.4.8.3.5.3:*

**8.4.8.3.5.3 4 Tx Matrix C with Antenna Selection**

For 4-transmit antennas BS, the transmission matrix is listed in Table 316g, where the mapping of the matrix  $C_n$  to the CQICH is shown. The active antenna is power boosted.

**Table 316g—Mapping of Pre-coding matrix and CQICH for 4 Tx Matrix C with Antenna Selection**

Streams, k	CQICH (binary)						Power boosting
	0b110000 (option 1)	0b110001 (option 2)	0b110010 (option 3)	0b110011 (option 4)	0b110100 (option 5)	0b110101 (option 6)	
1	$C_1 = c \begin{bmatrix} s_1 \\ 0 \\ 0 \\ 0 \end{bmatrix}$	$C_2 = c \begin{bmatrix} 0 \\ s_1 \\ 0 \\ 0 \end{bmatrix}$	$C_3 = c \begin{bmatrix} 0 \\ 0 \\ s_1 \\ 0 \end{bmatrix}$	$C_4 = c \begin{bmatrix} 0 \\ 0 \\ 0 \\ s_1 \end{bmatrix}$			$c = 1$
2	$C_1 = c \begin{bmatrix} s_1 \\ s_2 \\ 0 \\ 0 \end{bmatrix}$	$C_2 = c \begin{bmatrix} s_1 \\ 0 \\ s_2 \\ 0 \end{bmatrix}$	$C_3 = c \begin{bmatrix} s_1 \\ 0 \\ 0 \\ s_2 \end{bmatrix}$	$C_4 = c \begin{bmatrix} 0 \\ s_1 \\ s_2 \\ 0 \end{bmatrix}$	$C_5 = c \begin{bmatrix} 0 \\ s_1 \\ 0 \\ s_2 \end{bmatrix}$	$C_6 = c \begin{bmatrix} 0 \\ 0 \\ s_1 \\ s_2 \end{bmatrix}$	$c = \frac{1}{\sqrt{2}}$
3	$C_1 = c \begin{bmatrix} s_1 \\ s_2 \\ s_3 \\ 0 \end{bmatrix}$	$C_2 = c \begin{bmatrix} s_1 \\ s_2 \\ 0 \\ s_3 \end{bmatrix}$	$C_3 = c \begin{bmatrix} s_1 \\ 0 \\ s_2 \\ s_3 \end{bmatrix}$	$C_4 = c \begin{bmatrix} 0 \\ s_1 \\ s_2 \\ s_3 \end{bmatrix}$			$c = \frac{1}{\sqrt{3}}$

Stream  $k=2$  indicates TLV=176, with Bit #1 and Bit#16 set

Stream  $k=3$  indicates TLV=176, with Bit #11 and Bit#16 set

**Insert new subclause 8.4.8.3.6:**

**8.4.8.3.6 MIMO precoding**

The space time coding output can be weighted by a matrix before mapping onto transmit antennas:

$$z = Wx$$

where  $x$  is a  $M_t \times 1$  vector with the output from the space-time coding (per-subcarrier),  $M_t$  is the number of streams at the output of the space-time coding scheme. The matrix  $W$  is an  $N_t \times M_t$  weighting matrix where the quantity  $N_t$  is the number of actual transmit antennas. The vector  $z$  contains the signals after weighting for the different actual antennas. The labeling of the elements in the weighting matrix  $W$  is performed in accordance with the example of  $W$  given in Equation (124y) for the case of 4 actual antennas and 2 space-time coding output streams:

$$W = \begin{bmatrix} W_{11} & W_{12} \\ W_{21} & W_{22} \\ W_{31} & W_{32} \\ W_{41} & W_{42} \end{bmatrix} \tag{124y}$$

**Short-term closed loop precoding:**

When  $M_t = 1$ , then single stream precoding or beamforming shall be applied with the vector  $W$  of dimension  $N_t \times 1$ . The transmission scheme before the precoder is the regular single antenna transmission. When  $M_t = 2, 3$  or 4, then the two, three, or four STC output streams shall be transmitted with a precoding matrix of dimension  $N_t \times 2, N_t \times 3, N_t \times 4$ .

When using CQICH feedback type 0b100 (Index to precoding matrix in codebook) in Table 298a, the number of bits in the precoding matrix index in the codebook is determined by the number of bits in the CQICH Type (also in Table 298a).

**Long-term closed loop precoding:**

The rank of the precoding matrix is indicated in the long-term precoding feedback from the SS. The number of columns in the precoding matrix equals its rank. The STC scheme used, Matrix A, B or C, is selected from the set of STC schemes associated with the number of transmit antennas equaling the rank of the long-term precoding matrix used. For example, if the rank of the long-term precoding matrix is 2 and the spatial rate used is 1 then the Matrix A scheme for 2 Tx antennas is used.

When the long-term closed loop precoding is turned on, the life span of short-term precoding information, the rank of the long-term precoding codebook used and the index to the precoding matrix in the specified long-term precoding codebook is fed back with MAC-header feedback messages 0b0000 and 0b0001. If a short-term precoding matrix is available, the BS shall use this short-term matrix. If not, the BS shall use the fed back long-term precoding matrix, if available.

The long-term closed loop precoding uses the 6-bit codebook as specified in 8.4.5.4.10.12.

**Feeding back multiple precoder for band AMC operation**

For band AMC the BS has the choice to request a common precoding matrix for all bands or can request a programmable number, N (see Table 298a), of precoding matrices to be fed back for the N best bands selected in an ordered fashion. In the latter case, the precoding matrices are associated with the bands with the highest S/N values. As a secondary selection criteria, in case the ordering according to highest S/N is not unique, the bands with the lowest band index are chosen first. The index for each precoder is mapped to a CQICH channel of the corresponding size. The precoders for the different bands, in the order described previously, is signaled in the corresponding CQICH channels.

**Table 316h—Feedback for long-term precoding in MAC feedback header message**

MAC-header feedback type bit indication (binary)	Feedback element	Number of bits	Description
01000	Feedback of index to long-term precoding matrix in codebook	6	Index to long-term precoding matrix element in codebook
01000	Rank of precoding codebook	2	$k$ , Rank of precoding codebook = $k+1$
01000	FEC and QAM feedback	6	FEC and QAM specification

**Table 316i—Feedback for life span of short-term precoding in MAC feedback header message 0b01001**

Bit field (N) (binary)	Life span in number of frames
0000-1111	$0.125 * 2^{(N+1)}$

**Precoding state feed forward and precoding application delay**

If the precoding state is not fed forward in the DL burst allocation IE, then the BS shall apply precoding according to the precoding feedback from the SS (antenna grouping, antenna selection or codebook based) with a predetermined number of frames delay.

*Insert new subclause 8.4.8.4:*

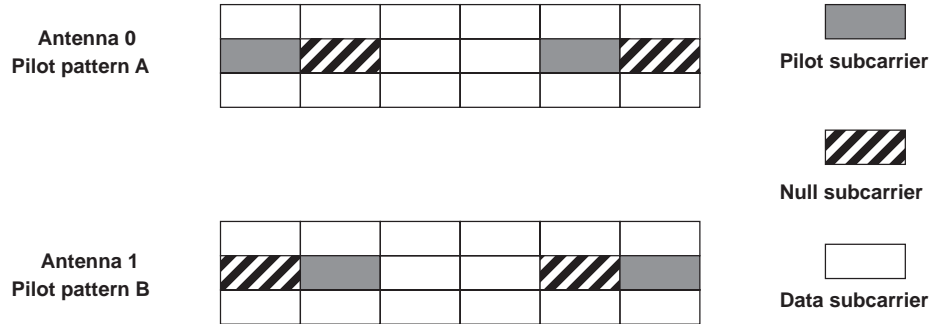
**8.4.8.4 STC for the optional zones in the uplink**

Two optional zones in the uplink, the optional PUSC and the optional AMC zones, are described in 8.4.6.2.5 and 8.4.6.3, respectively. STC may be used to improve system performance for these zones. Furthermore, two single transmit antenna MSs can perform collaborative spatial multiplexing onto the same subcarrier.

*Insert new subclause 8.4.8.4.1:*

**8.4.8.4.1 Allocation of pilot subcarriers**

For 2-antenna MS and the optional PUSC, pilots for each antenna shall be allocated as shown in Figure 251l.



**Figure 251l—Uplink pilot allocation for 2-antenna MS for the optional PUSC zones**

For 2-antenna MS and the optional AMC, pilot allocation pattern shall be identical to that for the downlink optional AMC with 2 antennas described in 8.4.8.3.1.1—all pilots in the even symbols shall be allocated for antenna 0 or pattern-A, while pilots in the odd symbols shall be allocated for antenna 1 or pattern-B. This is shown in Figure 251f.

Two single transmit antenna MSs can perform collaborative spatial multiplexing onto the same subcarrier. In this case, one MS should use uplink pilot allocation with pattern-A, and the other MS should use the uplink pilot allocation with pattern-B.

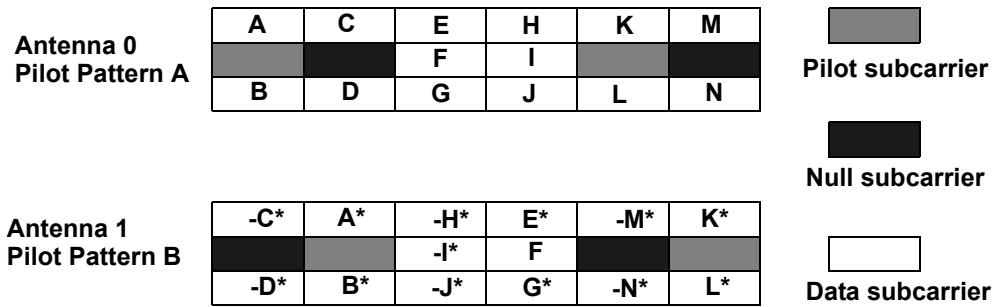
*Insert new subclause 8.4.8.4.2:*

**8.4.8.4.2 Allocation of data subchannels**

For the optional PUSC permutation with matrix A in 8.4.8.4.3, the data subchannels shall be allocated for two consecutive slots in time. As can be seen in Figure 251m, STC encoded data symbols shall be time mapped over two OFDMA symbols. The mapping starts at the lowest numbered subcarriers of lowest slot and continues in an ascending manner in subchannels first and then proceeds to the next two symbols in time.

For 2-antenna matrix B in the optional PUSC permutation, modulated data symbols shall be sequentially mapped for two transmit antennas along the subcarriers in the symbol. The mapping continues in an ascending manner in subchannels first and then proceeds to the next symbol in time.





**Figure 251m—Uplink data mapping for 2-antenna SS with matrix A for the optional PUSC permutation**

For the uplink optional AMC permutation with matrix A and B, the data subchannels shall take 1x6 (1 bin for 6 symbols) format. The subcarrier permutation represented by Equation (112) in 8.4.6.3 shall not be applied for the uplink optional AMC permutation with matrix A and B. The data mapping rule is identical to that for the downlink AMC permutation with 2 antennas.

*Insert new subclause 8.4.8.4.3:*

**8.4.8.4.3 Transmission schemes for 2-antenna MS in UL**

The following matrices define the transmission format with the row index indicating antenna number and column index indicating OFDMA symbol time. For both UL permutation zones with 2-antenna MS, one of the following two transmission matrices shall be used:

$$A = \begin{bmatrix} S_i & -S_{i+1}^* \\ S_{i+1} & S_i^* \end{bmatrix}$$

$$B = \begin{bmatrix} S_i \\ S_{i+1} \end{bmatrix}$$

where  $S_i$  and  $S_{i+1}$  may be encoded in different rates.

The matrix B may also be used for two single antenna MSs to share the same subchannel (collaborative spatial multiplexing).

*Insert new subclause 8.4.8.5:*

**8.4.8.5 MIMO midamble**

The MIMO midamble consists of one OFDM symbol that is mapped onto multiple antennas. Non-overlapping subcarriers are allotted to the transmit antennas.

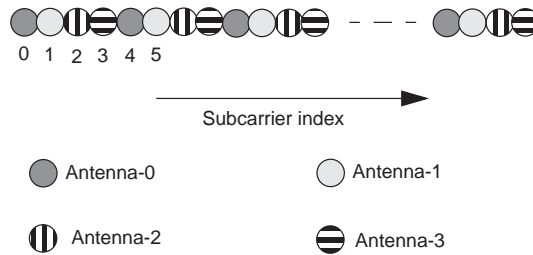
For FUSC and optional FUSC, the antenna to subcarrier mapping is shown in Figure 251n. Subcarriers index starts from the first one after the left guard band. DC subcarrier is also included in the numbering but nulled prior to transmission. The midamble carrier-set is defined using the following formula:

$$Midamble\_Carrier\_Set = -(N_{used}/2) + n + 2k \left\lceil \frac{N_t}{2} \right\rceil$$

where

- $N_t$  is the number of transmit antennas (2, 3, or 4),
- $n$  is the antenna index (0, 1, ...,  $N_t - 1$ ;  $N_t \leq 4$ ),
- $k$  is the subcarrier running index.

The subcarrier to antenna mapping is depicted in Figure 251n for the case when  $N_t = 4$ . The midamble sequence has the identical IDcell and segment mapping as the preamble.



**Figure 251n—Midamble FUSC structure (frequency domain)**

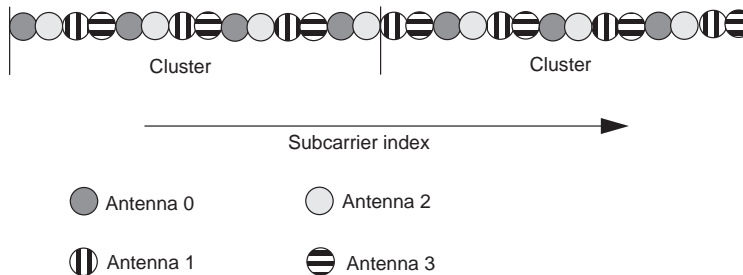
For PUSC, the subchannel permutations and grouping remains same as for the data. Instead all the subcarriers are used as pilots. Only one symbol is used as the midamble. The midamble is allocated to the subcarriers and antennas as follows.

$$Midamble\_Carrier\_Set = -(N_{used}/2) + n + N_t k$$

where

- $N_t$  is the number of transmit antennas,
- $n$  is the antenna index 1, ...,  $N_t - 1$ ,
- $k$  is the subcarrier running index.

Figure 251o shows the antenna to subcarrier mapping for the case when  $N_t = 4$ .



**Figure 251o—Midamble PUSC structure (frequency domain)**

**Insert new subclause 8.4.8.5.1:**

**8.4.8.5.1 Midamble Sequence for PUSC**

The midamble sequence for PUSC shall be obtained from the corresponding sequence used in the FUSC or optional FUSC for the relevant FFT size and number of antennas. For PUSC, however, all the used subcarriers shall further be clustered and divided into different segments as in the data traffic region.

**Insert new subclause 8.4.8.5.2:**

**8.4.8.5.2 Midamble Sequence for FUSC and optional FUSC**

The subcarrier locations and corresponding PN code BPSK modulation of subcarriers in a midamble are defined as in Equation (124z) and Equation (124aa). The DC carrier is nulled.

$$P_{ID_{cell},s}[k_{foi}] = \begin{cases} 1-(2)q_{ID_{cell}}[m], & k_{foi} = 2m\left\lceil\frac{N_T}{2}\right\rceil - \frac{N_{used}}{2} + n, m = 0, 1, \dots, \frac{N_{used}}{2\left\lceil\frac{N_T}{2}\right\rceil} - 1 \\ 0, & \text{otherwise} \end{cases} \quad (124z)$$

$$q_{ID_{cell}}[m] = \begin{cases} R\left(8\left\lfloor\frac{m}{9}\right\rfloor + m \bmod 9\right), & m \bmod 9 = 0, 1, 2, \dots, 7 \\ T\left(\left\lfloor\frac{m}{9}\right\rfloor\right), & m \bmod 9 = 8 \end{cases} \quad \left(m = 0, 1, \dots, \frac{N_{used}}{2\left\lceil\frac{N_T}{2}\right\rceil} - 1\right) \quad (124aa)$$

The sequence  $R(r)$  in (2) is either one of the following two formulas, depending on  $N_{FFT}$  and  $N_T$ . The choice of the sequence  $R(r)$ , and the length of sequence  $N_T$  supporting the choice are shown in Table 316j.

$$R_1(r) = H_{128}\left(ID_{cell} + 1, \Pi_{\left\lfloor\frac{r}{128}\right\rfloor}(r \bmod 128)\right); r = 8\left\lfloor\frac{m}{9}\right\rfloor + m \bmod 9 = 0, 1, \dots, N_r - 1 \quad (124ab)$$

$$R_2(r) = B_{ID_{cell} + 1}g_{\Pi(r)}; r = 8\left\lfloor\frac{m}{9}\right\rfloor + m \bmod 9 = 0, 1, \dots, N_r - 1 \quad (124ac)$$

**Table 316j— $N_r$  [The length of sequence  $R(r)$ ]**

$N_T$	2				3 or 4			
	$N_{FFT}$	2048	1024	512	128	2048	1024	512
$R_1(r)$	768	384	192	—	384	192	—	—
$R_2(r)$	—	—	—	48	—	—	96	24

In  $R_l(r)$ ,  $H_{128}(i, j)$  denotes the number at  $(i, j)$  of order 128 Walsh Hadamard matrix, where  $i, j = 0, 1, \dots, 127$ . The first low vector of  $H_{128}$  is the all-one sequence and shall not be used.  $\Pi_{\lfloor \frac{m}{128} \rfloor}(l); l = 0, 1, \dots, 127$  is

the  $l$ -th value of the  $\lfloor \frac{m}{128} \rfloor^{th}$  permutation out of six predefined permutations shown in Table 316k.

**Table 316k—Permutation ( $l = 0, 1, 2, \dots, 127$ )**

$\Pi_0(l)$	1, 65, 97, 113, 121, 125, 127, 126, 63, 94, 47, 86, 43, 84, 42, 21, 75, 100, 50, 25, 77, 103, 114, 57, 93, 111, 118, 59, 92, 46, 23, 74, 37, 83, 104, 52, 26, 13, 71, 98, 49, 89, 109, 119, 122, 61, 95, 110, 55, 90, 45, 87, 106, 53, 91, 108, 54, 27, 76, 38, 19, 72, 36, 18, 9, 69, 99, 112, 56, 28, 14, 7, 66, 33, 81, 105, 117, 123, 124, 62, 31, 78, 39, 82, 41, 85, 107, 116, 58, 29, 79, 102, 51, 88, 44, 22, 11, 68, 34, 17, 73, 101, 115, 120, 60, 30, 15, 70, 35, 80, 40, 20, 10, 5, 67, 96, 48, 24, 12, 6, 3, 64, 32, 16, 8, 4, 2, 0
$\Pi_1(l)$	25, 77, 103, 114, 57, 93, 111, 118, 59, 92, 46, 23, 74, 37, 83, 104, 52, 26, 13, 71, 98, 49, 89, 109, 119, 122, 61, 95, 110, 55, 90, 45, 87, 106, 53, 91, 108, 54, 27, 76, 38, 19, 72, 36, 18, 9, 69, 99, 112, 56, 28, 14, 7, 66, 33, 81, 105, 117, 123, 124, 62, 31, 78, 39, 82, 41, 85, 107, 116, 58, 29, 79, 102, 51, 88, 44, 22, 11, 68, 34, 17, 73, 101, 115, 120, 60, 30, 15, 70, 35, 80, 40, 20, 10, 5, 67, 96, 48, 24, 12, 6, 3, 64, 32, 16, 8, 4, 2, 1, 65, 97, 113, 121, 125, 127, 126, 63, 94, 47, 86, 43, 84, 42, 21, 75, 100, 50, 0
$\Pi_2(l)$	71, 98, 49, 89, 109, 119, 122, 61, 95, 110, 55, 90, 45, 87, 106, 53, 91, 108, 54, 27, 76, 38, 19, 72, 36, 18, 9, 69, 99, 112, 56, 28, 14, 7, 66, 33, 81, 105, 117, 123, 124, 62, 31, 78, 39, 82, 41, 85, 107, 116, 58, 29, 79, 102, 51, 88, 44, 22, 11, 68, 34, 17, 73, 101, 115, 120, 60, 30, 15, 70, 35, 80, 40, 20, 10, 5, 67, 96, 48, 24, 12, 6, 3, 64, 32, 16, 8, 4, 2, 1, 65, 97, 113, 121, 125, 127, 126, 63, 94, 47, 86, 43, 84, 42, 21, 75, 100, 50, 25, 77, 103, 114, 57, 93, 111, 118, 59, 92, 46, 23, 74, 37, 83, 104, 52, 26, 13, 0
$\Pi_3(l)$	69, 99, 112, 56, 28, 14, 7, 66, 33, 81, 105, 117, 123, 124, 62, 31, 78, 39, 82, 41, 85, 107, 116, 58, 29, 79, 102, 51, 88, 44, 22, 11, 68, 34, 17, 73, 101, 115, 120, 60, 30, 15, 70, 35, 80, 40, 20, 10, 5, 67, 96, 48, 24, 12, 6, 3, 64, 32, 16, 8, 4, 2, 1, 65, 97, 113, 121, 125, 127, 126, 63, 94, 47, 86, 43, 84, 42, 21, 75, 100, 50, 25, 77, 103, 114, 57, 93, 111, 118, 59, 92, 46, 23, 74, 37, 83, 104, 52, 26, 13, 71, 98, 49, 89, 109, 119, 122, 61, 95, 110, 55, 90, 45, 87, 106, 53, 91, 108, 54, 27, 76, 38, 19, 72, 36, 18, 9, 0
$\Pi_4(l)$	102, 51, 88, 44, 22, 11, 68, 34, 17, 73, 101, 115, 120, 60, 30, 15, 70, 35, 80, 40, 20, 10, 5, 67, 96, 48, 24, 12, 6, 3, 64, 32, 16, 8, 4, 2, 1, 65, 97, 113, 121, 125, 127, 126, 63, 94, 47, 86, 43, 84, 42, 21, 75, 100, 50, 25, 77, 103, 114, 57, 93, 111, 118, 59, 92, 46, 23, 74, 37, 83, 104, 52, 26, 13, 71, 98, 49, 89, 109, 119, 122, 61, 95, 110, 55, 90, 45, 87, 106, 53, 91, 108, 54, 27, 76, 38, 19, 72, 36, 18, 9, 69, 99, 112, 56, 28, 14, 7, 66, 33, 81, 105, 117, 123, 124, 62, 31, 78, 39, 82, 41, 85, 107, 116, 58, 29, 79, 0
$\Pi_5(l)$	70, 35, 80, 40, 20, 10, 5, 67, 96, 48, 24, 12, 6, 3, 64, 32, 16, 8, 4, 2, 1, 65, 97, 113, 121, 125, 127, 126, 63, 94, 47, 86, 43, 84, 42, 21, 75, 100, 50, 25, 77, 103, 114, 57, 93, 111, 118, 59, 92, 46, 23, 74, 37, 83, 104, 52, 26, 13, 71, 98, 49, 89, 109, 119, 122, 61, 95, 110, 55, 90, 45, 87, 106, 53, 91, 108, 54, 27, 76, 38, 19, 72, 36, 18, 9, 69, 99, 112, 56, 28, 14, 7, 66, 33, 81, 105, 117, 123, 124, 62, 31, 78, 39, 82, 41, 85, 107, 116, 58, 29, 79, 102, 51, 88, 44, 22, 11, 68, 34, 17, 73, 101, 115, 120, 60, 30, 15, 0

In  $R2(r)$ , if the  $k$ ,  $1 \leq k \leq 127$  can be converted into binary as  $b_6b_5b_4b_3b_2b_1b_0$ , define  $b_6$  as the MSB,  $b_0$  as the LSB,  $b_k$  is a row vector to represent  $B_k = [b_0b_1b_2b_3b_4b_5b_6]$ . The  $g_u; 0 \leq u \leq N_r - 1$  is  $u^{th}$  column vector of the generator matrix  $G$ .  $B_k g_u$  is an inner product of  $(1 \times 7)$  row vector and  $(7 \times 1)$  column vector. The generator matrix  $G$  and the permutation  $\Pi(l); l = 0, 1, 2, \dots, N_r - 1$  for each  $N_{FFT}$  and  $N_T$  are shown below.

The sequence  $T(k)$  is determined by IDcell and should be chosen to achieve low PAPR.

**Insert new subclause 8.4.8.5.2.1:**

**8.4.8.5.2.1 PAPR reduction sequence for BS with 2 antennas**

The PAPR reduction sequences for BS with 2 antennas are listed in Table 316l, Table 316m, Table 316n for the cases of FFT size 2048 point, 1024 point, 512 point respectively. The case of FFT size 128 point is dealt with by Table 316c and Table 316p, together with Equation (124ad).

**Table 316I—PAPR reduction sequence for BS  
with 2 antennas (2048 point FFT)**

ID cell	Sequence	PAPR	ID cell	Sequence	PAPR
0	E5F121DCFF4A0E63825399D3	5.92384	57	53F2BFC63878B6C2C10C8A2C	5.70754
1	D10BA3F1A15DDF9C4D819B45	6.28771	58	C20824E0B5348061E2A4C1CE	6.05831
2	13310AB0491064CE7516898C	5.88237	59	8F1B88288316B59939D490A9	6.002
3	E53C10EB0B1E830D7C2302A2	5.72241	60	3203E66C6406767186F8955A	6.79504
4	37DBDBACCEDC976D1DE87D53	6.54265	61	B335E583FD89A0A410876B81	6.17206
5	E43B8C8299E5B2B49798FA28	6.23106	62	C11D537E5E2992361F2CC44B	6.06154
6	52A78E348A46E8E84CF29D7B	6.96087	63	F1E074FEB2CF55427C573C6F	5.80776
7	CA6B366D37E54A7EDF32A688	6.23321	64	BC8C283A7CA014EC79837DD7	5.82436
8	3852A3F8B0E1E7FC41301F17	6.35304	65	DF29647F465044A0BC7D2720	6.28397
9	271E459188CBCD44B32B809	5.88167	66	F29CCF3995F08458FA0F8908	5.89065
10	1CB9181F0A47346785BC9464	6.5208	67	28F5D1FD67E98528DB28BB5D	6.08206
11	786E7023033922819D70233B	6.16551	68	DC5908BB6B8E1B84ADF881A8	6.01325
12	D7E0A495CFE8CEC3D2AF4B5D	5.99014	69	0AF44605329EE32ACF75481B	5.84218
13	360ECD45D330B876A8F13462	6.43524	70	C7CEF13FD6FE89346FB543B2	6.33524
14	C63BDDD2D536FF2416B7A424	6.01736	71	5D2B9D0E4306F96A65BAF4EB	6.34218
15	10A8B5DAB83CE78B3FCFC31D	6.19619	72	0E2D2473C890413D9A9D8DB1	6.05022
16	6152A33C894DC0B62EEA0DDA	6.13798	73	7C082A7E84B366733C6E19D1	5.9351
17	757A237D70ABD7AB1FFB04F0	5.95019	74	85C50A024C78CC1B3AEF4C94	5.84302
18	BC0D0BEA01E586B664401CFC	6.2348	75	298A3E89079EF4C27CC921A9	6.13354
19	8A5CD82D82B19593F8266E7E	5.67582	76	825D06F901CE94D8168D8A46	6.00828
20	F44201B0903E55006BDFD5B0	6.78315	77	73DCC20AFF8C5837F539EE22	6.27564
21	5F252E0EC94C7965A2B347F3	6.37986	78	553DD23CB093EFD7C544F013	5.88433
22	6E376986A947B180015A0A9A	6.24373	79	5EE648A514E40CF0E7ECE2A1	5.95859
23	3669CAF711FC2129743CFFBA	6.1472	80	F7B98C7D1DD5CE51B6B678A3	6.54896
24	C1D8E53D16322CB3B1386B0E	5.87095	81	9B840FF5F78473E2F75B8E2D	5.87521
25	9E1F780C45570E3A475F5A77	6.11801	82	8C99E9A614E8AC8C74566752	6.03187
26	32F36D066051FAE51512A8F3	6.27711	83	B7EC60A09ACD2CABB53DEDE9	5.95608
27	464AD0462512248F26313BC4	6.50894	84	2900FBF0CC91DA813CDBEAD0	5.87135
28	03F93CDFCA5B9D3262FD2D25	6.12574	85	949EF4015122026200DF05F1	6.11214

**Table 316I—PAPR reduction sequence for BS  
 with 2 antennas (2048 point FFT) (continued)**

ID cell	Sequence	PAPR	ID cell	Sequence	PAPR
29	694CAFC989888FC1F358CA8F	5.86597	86	F3AE5B267C36BF3877E4AC49	5.87287
30	8C9F1D8E186EAFEDF0D6F4DD	6.17035	87	A4E43FBE54A0280D65419C99	6.0007
31	C4E95F3E65B40D938946B132	5.84552	88	F116946F21EF61D108AC2F42	6.94574
32	5891E3188FA53AE34576A803	5.85053	89	5B82DE3F0ADB20D788A045A6	6.13544
33	409FF8A9E7FCDA58D4A5241B	6.10709	90	AC639F8BDB63A8C4E4746E65	6.25857
34	3C70E4E442FA01B79EE09FA5	6.20979	91	70C588D838AB0FC61F8EABDA	5.85846
35	36817EE5B08B5B4B9CE88CBE	5.77008	92	D6A8AD537E8258E745C1C476	5.82355
36	BA78FAA5BDCC40837F5205DA	6.31919	93	8A4F652DF088D93FC0073FD8	6.00051
37	A490E570CE08172BD82A3633	5.73775	94	450F92DF140D63380103F31B	6.48422
38	8433E275E271D4EC11019463	5.78564	95	EAAF05F63641E7AFED3A5A79	5.90759
39	F83B07F42EFAE5F1EA281A78	5.68333	96	5F501203D217CF94BC44A6C1	6.5396
40	B9B93373373FFCB301EFCDF77	5.79877	97	71F6C952D988BC8847E0BA88	6.09041
41	22B5A5AAC8B3756C6C4ADFE6	6.27794	98	BF472D6610532AE50CDF829A	6.28286
42	C6DFADA3233FF4EE17DE5E17	5.87103	99	D15D9E8AECFE8C296D5802D6	6.22803
43	70D09DC4F9121828C70B6064	5.76809	100	D5AD5575149C76589FF8784A	6.07452
44	F01F5956C24E2156253809D8	6.64621	101	7868B4788F33D2EA66C86BE2	5.83685
45	8E157642C21545D6AFC4C9EE	5.77721	102	B722E30271A97725EA79020A	5.97044
46	391D93EF8012E5D2F8E2C299	6.87607	103	30209E7F80F14A76FCB45DBF	6.06914
47	EC1D207A7BA6C4852C105E34	6.09394	104	6FA8FDC42599BDFDCEEF828	5.99957
48	55858594CBAC6A7760D72623	6.0547	105	9CAF25C12BA260391958223B	5.91873
49	FBB76DDCC08E8B0A89E8D35B	6.30027	106	CD82CBA6EA27C514AA8F40A0	5.72081
50	6394D6CFC5269D0B8DFCE4D6	5.71258	107	96852F4F3B879A23F97D3DFA	6.24847
51	F92EDE555781CC62F5C3FA42	6.26962	108	236F33011BD7E277C5BC9561	5.84184
52	E66B7E6E901C802D1725C31B	6.98039	109	9B74FD2CA98D58E7B8EDD5DB	6.1246
53	0BA101B2F3F78E672EFC0CC7	6.25099	110	2DC51FEED52392D7174435E8	5.80747
54	26E1EC3E787F6092D1634683	6.54994	111	8708EE1A78F79E3E14D30DD7	6.23013
55	4767A25488E79F75E2F45FA1	6.25162	112	FCDD639AD5BA5B1451CBD600	5.96117
56	1A2FC69DC4DCAD0399DAF857	6.06972	113	652492280DC624A59D2A3F82	6.32939

**Table 316m—PAPR reduction sequence for BS with 2 antennas (1024 point FFT)**

ID cell	Sequence	PAPR	ID cell	Sequence	PAPR	ID cell	Sequence	PAPR
0	C9A1F9FB33E2	5.73908	43	13CBBBDD1888	5.25927	86	6414C0DB128C	6.26365
1	C615462A8D6E	5.69178	44	34B0D91482A7	5.43386	87	08FEAB4846B9	5.5487
2	D8400C1E2B47	5.67259	45	0DB3ECE942B0	5.40054	88	7E160C4BA0F0	5.7677
3	DBCF1478431C	5.91286	46	A4D876BF7C4E	5.45618	89	5CCA9AF7C373	5.61368
4	CC93B30C0EB9	5.55863	47	7D492A0F5B39	6.40321	90	21B3DF421DE7	5.43398
5	C6F3D332B053	5.3082	48	C82DA6102B09	5.31582	91	9323DD2F2771	5.2348
6	9BA4E419EBB5	5.5186	49	F68C09C7D629	5.1445	92	A26015CF1514	5.78478
7	48FD85CD7E76	6.11686	50	4D6C3B62D026	6.44183	93	8220CF898D60	5.43634
8	E992B4493831	5.69693	51	EBD13D02E539	5.35096	94	8CCEC410F8A6	5.33904
9	4E1401A862B5	5.92235	52	760432EDBC5B	5.42816	95	4FFDECD6D0E0	5.50659
10	9D3239BF5543	5.50286	53	022040211B53	5.58372	96	42D052099826	5.68271
11	2B8584BFB3D8	5.19875	54	2663067DE01D	5.50621	97	8785DFDA586A	5.2863
12	AB42706F96A0	5.44334	55	C0776A8DD057	5.29609	98	68DDF31B930F	5.65759
13	9DB123495FB7	5.63328	56	96117C9722E1	5.61786	99	F0539BCDAACB	5.6598
14	A6EFBCB2865D	6.0094	57	204C31E521C4	5.27659	100	372C0613FE2C	5.21517
15	709300E57360	5.73209	58	C8C12F23551B	5.70925	101	37402B2A80A9	6.29655
16	6E2122FC796F	5.82368	59	1217E2F687C1	5.51497	102	523AE3212125	5.41681
17	7F01F8B4454F	5.47779	60	DBF86CB15B3B	5.57367	103	02EDF46F9694	5.47569
18	CDF8525E2FF7	5.33406	61	BCC4EC437886	5.94074	104	E64CC083190E	5.71759
19	0AC1FA2585A5	6.24242	62	AA2734F33EF9	5.71983	105	65DE3871D0D1	5.80455
20	46843DFB1135	5.65053	63	CBA739A84A4D	5.96463	106	7808E3E5FE8E	5.88159
21	8B411A6D7235	5.524	64	E12166CA6DF5	5.64715	107	070004E13E81	5.79589
22	096A3287FE74	5.65888	65	DE42128CD418	5.16399	108	1CE29934CF8D	5.33859
23	E26CD654FF1A	5.89291	66	F90F21A0B95F	5.52101	109	52B8A394BDBC	5.9872
24	D955EFF989FE	5.90035	67	DCC08885C1D0	5.34739	110	1A13C7DB3016	5.31546
25	882566402741	5.62867	68	152AFEF9AA90D	5.34108	111	CE75430244B7	5.40294
26	9FCD0AB3FCF8	5.79711	69	CB30CE0D8CD2	5.89277	112	DD89BD52F023	5.81172
27	8E477A39DA36	5.45249	70	849C1C0DA6A3	5.64765	113	6B98276F9841	5.59191

**Table 316m—PAPR reduction sequence for BS with 2 antennas (1024 point FFT)  
 (continued)**

ID cell	Sequence	PAPR	ID cell	Sequence	PAPR	ID cell	Sequence	PAPR
28	83740061371F	5.42528	71	B8177804D737	5.78193			
29	179FBF270668	5.59438	72	693BE40CEE81	5.6998			
30	0B4738E24AE1	6.26907	73	632921AF950C	6.29239			
31	9BD23A217294	5.83321	74	C4D296ABB9B0	5.55821			
32	E783A99153C7	5.57411	75	08DCE8EE0E46	5.61434			
33	60690386D94B	5.56542	76	616A6B8637F3	5.29314			
34	EEB11CF6A279	5.61602	77	DB69C2C67E5F	5.67251			
35	17737FC0364B	5.46925	78	B7922C4D47E0	5.54227			
36	DBA832CB29FF	5.46318	79	5A4273474A62	5.41366			
37	841030AA2B58	5.66141	80	50082E465126	5.57391			
38	573AE8A1189A	6.49919	81	2E3844099ABD	5.27701			
39	26EF1E523190	5.45727	82	F8EFB7F0CE2F	5.76264			
40	45F27228B846	6.37869	83	64B7E857C964	5.89799			
41	D26C39A8D803	5.63232	84	5B4DDAF2A8D1	6.02566			
42	4514BB4432A6	5.74245	85	B639EE82C328	5.71509			



**Table 316n—PAPR reduction sequence for BS with 2 antennas (512 point FFT)**

ID cell	Sequence	PAPR	ID cell	Sequence	PAPR	ID cell	Sequence	PAPR
0	C88B5B	4.67601	43	F3D2C6	4.93286	85	B286FB	5.2203
1	4B943B	5.01945	44	0BFE87	5.03341	86	36016D	5.00459
2	26A2CA	4.9099	45	92AA64	4.93443	87	98D31F	4.85287
3	ABF43A	4.9298	46	A5D580	5.18021	88	6A87B3	4.80097
4	F653DD	5.58288	47	6D6DFD	4.94058	89	958B99	5.40979
5	686FDB	5.08845	48	6A578D	5.58274	90	8AB689	4.89558
6	0D2D4F	5.49959	49	967EE4	5.18235	91	570A5C	4.75712
7	E4BEB2	5.03402	50	CE4755	6.35302	92	47A9A6	5.42678
8	C68129	5.41883	51	2D6ECE	5.92368	93	4B2F30	5.47629
9	4E1401A862B5	5.41345	52	6BA1CF	6.12984	94	0D6033	5.36666
10	9D3239BF5543	5.25745	53	019E02	6.09087	95	3F7DAA	4.73588
11	2B8584BFB3D8	4.60192	54	A06B8B	4.90168	96	E64518	5.68267
12	AB42706F96A0	5.20474	55	9CBA18	5.48837	97	F94B7D	4.92173
13	9DB123495FB7	5.1286	56	05FD60	5.16162	98	78D213	5.38737
14	A6EFBCB2865D	4.94086	57	FC2322	4.95813	99	9EDE1D	5.05499
15	709300E57360	4.73214	58	F0898A	5.74311	100	8E3B36	5.76876
16	36BF3C	5.22147	59	F22469	5.32756	101	74AF80	5.10266
17	56684C	5.74529	60	57673A	6.33084	102	CC8769	4.89204
18	654D89	5.24514	61	1A38DB	5.56632	103	265829	5.3906
19	2781F3	4.89117	62	A69433	4.90576	104	7CF001	5.44668
20	46876A	4.62728	63	9B80BB	4.82736	105	B5D0CE	5.14106
21	CE53D0	4.94685	64	6B75F8	4.66086	106	43277F	5.24521
22	523974	4.87706	65	DF32CD	5.28631	107	015C21	4.93279
23	4A0453	5.02621	66	D1F692	4.86675	108	A4AB8B	5.01596
24	47F9ED	5.91721	67	E6FCC8	5.65351	109	B3A938	5.15091
25	BB2C96	4.83723	68	08DF3D	4.79648	110	3333D3	4.78207
26	48B142	5.21914	69	39CFC0	4.95539	111	AFA03D	5.52105
27	FFDA6B	5.52578	70	EC8BAD	5.95318	112	88F995	5.11364
28	8F8DC4	4.95493	71	16B9AC	5.12127	113	E1668B	5.77986

**Table 316n—PAPR reduction sequence for BS with 2 antennas (512 point FFT) (continued)**

ID cell	Sequence	PAPR	ID cell	Sequence	PAPR	ID cell	Sequence	PAPR
29	1A1037	5.06145	72	6E6D24	5.88171			
30	50F345	5.39428	73	B2027C	5.22276			
31	9C2ABE	5.15445	74	E05272	5.72503			
32	97191F	4.88407	75	859C89	5.65769			
33	61FCD0	5.82153	76	6624DD	4.98579			
34	6F8969	6.25241	77	F2D404	5.27575			
35	156F56	5.42931	78	8B81D9	5.26581			
36	BC8D17	5.08773	79	5C69D7	4.97194			
37	F3092A	5.05832	80	645838	5.86814			
38	A41DBD	4.75378	81	8DEFA5	4.94176			
39	6EA1E4	4.83662	82	22059A	5.76969			
40	6A29F7	5.19888	83	70A052	5.26498			
41	462826	4.79626	84	50E6D6	5.65313			
42	5FB555	4.97374						

$$G = [g_0 g_1 g_2 \dots g_{47}] \tag{124ad}$$

$$= \begin{bmatrix} 0101010101010100000101011000110000000011111111 \\ 001100110011001100010001000100010000001101010110 \\ 0000111100001111010101010101010000010101100011 \\ 00000000111111100110011001100110001000100010001 \\ 0000001101010110000011110000111101010101010101 \\ 00000101011000110000000011111110011001100110011 \\ 000100010001000100000011010101100000111100001111 \end{bmatrix}$$

**Table 316o—Permutation ( $l = 0, 1, 2, \dots, 47$ )**

$\Pi(l)$	5,6,4,10,7,2,14,0,8,11,13,12,3,15,1,9,26,29,19,27,31,17,20,16,23,28,24,21,18,30,25,22,43,46,34,47,44,41,37,36,39,38,35,33,32,45,40,42
----------	---

**Table 316p—PAPR Reduction Sequence for BS with 2 Antennas (128 point FFT)**

ID cell	Sequence	PAPR	ID cell	Sequence	PAPR	ID cell	Sequence	PAPR
0	1 1 1 0 1 1	6.67057	43	1 0 0 1 1 0	6.50695	86	1 0 1 0 1 1	5.47231
1	0 0 1 1 0 0	5.883	44	0 0 0 0 0 1	5.58222	87	0 1 0 1 1 1	4.27052
2	1 1 1 1 1 1	4.95588	45	1 1 1 0 1 1	5.19814	88	0 0 0 1 0 1	4.98455
3	0 1 1 0 0 1	4.92942	46	1 0 0 1 1 0	5.50865	89	0 0 0 1 0 1	4.85573
4	1 0 0 1 0 0	4.84232	47	1 0 0 0 0 0	5.40503	90	1 0 1 1 0 0	4.66224
5	0 1 0 1 0 0	5.97707	48	1 0 0 1 0 0	4.48416	91	0 1 1 0 0 1	5.59862
6	0 0 0 0 1 1	5.2818	49	0 1 0 0 1 1	5.59862	92	0 1 0 1 0 1	5.13782
7	0 1 1 1 0 1	4.62935	50	0 1 0 1 0 0	4.76609	93	1 1 0 0 0 0	5.73533
8	1 1 1 1 0 1	4.80191	51	0 1 1 1 0 1	4.87033	94	0 1 1 1 1 1	6.31115
9	0 1 1 1 1 0	4.62839	52	1 1 1 0 0 1	5.60052	95	0 1 1 1 0 1	4.76096
10	1 0 0 0 0 0	4.93818	53	1 0 1 0 0 1	4.18939	96	0 1 0 1 1 1	4.43229
11	0 0 0 0 1 0	4.62239	54	1 1 1 1 0 1	5.00411	97	1 0 0 1 1 1	4.52351
12	1 1 0 0 1 1	6.23206	55	1 1 1 1 0 0	4.91284	98	1 0 0 1 0 0	4.16266
13	0 0 0 0 0 1	4.76556	56	0 0 0 0 1 0	6.92296	99	1 1 1 0 1 0	5.72573
14	1 1 0 1 1 1	5.21957	57	0 0 0 0 1 0	5.39012	100	0 1 0 1 0 0	4.34746
15	0 1 1 0 0 0	6.73261	58	0 1 1 0 0 1	6.0232	101	1 0 0 1 0 0	6.81937
16	0 0 1 1 1 0	4.9981	59	1 1 0 1 0 0	6.27241	102	0 1 0 1 1 1	5.86829
17	0 1 1 0 0 0	5.23977	60	0 0 1 0 1 0	5.26582	103	0 1 0 1 1 0	5.22038
18	1 1 1 1 1 0	5.59862	61	1 0 0 0 0 1	5.47146	104	1 0 0 0 0 0	4.8724
19	0 1 1 1 0 1	6.75846	62	0 0 0 0 1 0	6.43249	105	0 1 1 0 1 1	6.7858
20	0 0 1 1 1 1	4.86729	63	1 0 0 1 1 1	4.69906	106	1 0 0 0 1 0	5.75267
21	1 1 0 0 0 0	5.57405	64	1 1 1 0 0 0	5.28969	107	1 1 0 0 1 1	5.1796
22	1 0 1 0 0 1	4.82303	65	1 0 1 0 1 1	6.66865	108	1 1 1 0 0 0	6.00083
23	0 1 0 1 0 1	4.54948	66	1 0 1 0 1 1	5.90593	109	1 0 1 0 0 1	4.6724
24	0 1 1 1 0 1	5.45765	67	0 1 1 1 0 0	6.13642	110	1 0 0 1 0 0	4.8345
25	1 1 0 0 0 1	4.91648	68	0 0 1 0 0 0	4.9337	111	0 0 1 1 1 0	4.05646
26	1 0 0 1 0 1	3.95813	69	0 1 1 0 1 0	5.13715	112	0 0 1 1 1 1	5.6271
27	1 0 0 0 0 1	6.03433	70	1 1 1 1 0 0	5.05877	113	0 1 1 1 1 1	5.59862

**Table 316p—PAPR Reduction Sequence for BS with 2 Antennas (128 point FFT)  
(continued)**

ID cell	Sequence	PAPR	ID cell	Sequence	PAPR	ID cell	Sequence	PAPR
28	1 1 0 0 0 1	4.50629	71	1 0 0 1 0 0	5.42538			
29	0 1 0 0 0 1	4.80454	72	1 1 1 0 1 0	5.21428			
30	1 0 1 1 1 1	4.94614	73	1 0 1 1 0 1	4.27288			
31	1 0 1 1 0 0	4.54236	74	0 1 0 0 0 1	4.63478			
32	0 1 1 0 0 0	3.86311	75	1 0 1 0 0 1	5.47216			
33	0 1 1 0 0 0	5.18297	76	1 0 1 0 0 0	6.49514			
34	1 1 0 1 0 1	5.59137	77	1 1 0 0 0 0	5.35897			
35	1 0 0 1 0 0	5.51632	78	0 0 0 0 0 1	5.59862			
36	1 1 0 0 1 0	4.64969	79	0 1 0 0 0 0	5.36634			
37	1 1 1 0 0 0	5.59862	80	0 0 0 0 1 0	4.79522			
38	0 0 0 0 1 1	6.56393	81	0 0 1 1 1 0	5.03585			
39	1 0 1 0 0 0	6.63257	82	1 1 0 0 1 1	6.41538			
40	0 0 1 0 1 1	6.30837	83	0 1 1 0 0 1	5.92329			
41	0 0 0 1 0 1	5.76388	84	1 0 1 1 1 0	5.24541			
42	0 0 0 1 1 1	5.17733	85	0 0 0 0 0 1	6.41868			

**Insert new subclause 8.4.8.5.2.2:**

**8.4.8.5.2.2 PAPR Reduction Sequence for BS with 3 or 4 antennas**

For FFT size = 2048, the sequence  $T(k)$  is the same as  $N_t = 2, N_{FFT} = 1024$  case.

For FFT size = 1024, the sequence  $T(k)$  is the same as  $N_t = 2, N_{FFT} = 512$  case.

For FFT size = 512,

$$G = [g_0 g_1 g_2 \dots g_{95}] =$$

```
[00110011001100110101010101010100010001000100000010101100011000000110101011000000001111111  
00001111000011110011001100110011010101010101010100010001000100000101011000110000001101010110  
0000000011111110000111100001110011001100110011010101010101010100010001000100000010101100011  
0000001101010110000000001111111000011100001110011001100110011010101010101010001000100010001  
000001010110001100000011010101100000000111111100001110000111001100110011001101010101010101  
000100010001000100000101011000110000001101010110000000011111100001110000111001100110011001100110011]
```

**Table 316q—Permutation ( $l = 0, 1, 2, \dots, 95$ )**

$\Pi(l)$	2,6,0,10,14,11,7,3,8,15,1,12,9,4,13,5,18,26,24,17,29,19,21,16,23,22,25,28,27,31,20,30,41,34, 38,44,36,43,35,32,45,47,46,39,40,33,37,42,60,56,59,61,51,62,52,49,58,48,53,50,54,57,55,63, 71,77,76,74,67,66,68,75,78,64,69,79,72,70,65,73,81,92,83,87,82,94,86,88,95,91,93,90,84,85, 80,89
----------	--

**Table 316r—PAPR reduction sequence for BS with 3 or 4 antennas (512 point FFT)**

ID cell	Sequence	PAPR	ID cell	Sequence	PAPR	ID cell	Sequence	PAPR	ID cell	Sequence	PAPR
0	CB3	6.26336	32	1F3	5.26429	64	73E	5.29366	96	478	4.77121
1	D47	5.27748	33	573	4.94488	65	0FE	6.62956	97	17E	5.66118
2	59D	4.9581	34	07F	6.36319	66	5CB	4.88939	98	696	4.93494
3	F21	5.05997	35	9A3	5.91188	67	C59	4.30678	99	31A	5.36534
4	87E	6.51422	36	C86	5.36258	68	5B5	5.54517	100	9D7	4.78933
5	BFA	5.33856	37	349	4.98064	69	E2D	5.27261	101	2A4	5.45932
6	4D4	7.0618	38	C83	6.14253	70	5F6	5.03828	102	35C	6.40963
7	3E0	6.41769	39	EE0	5.95156	71	9A9	5.25379	103	CBD	5.39788
8	3E4	4.87727	40	4CA	5.40169	72	BDB	5.14859	104	44C	4.38835
9	6F7	4.15136	41	634	4.82317	73	AE7	5.39255	105	416	4.38145
10	8D0	5.86359	42	360	5.05168	74	2C2	4.97124	106	6B6	5.5007
11	33E	5.68455	43	7B6	5.20885	75	6A3	6.20876	107	E79	5.6706
12	CA3	5.79482	44	4A7	5.52378	76	D3A	4.83271	108	34F	5.62588
13	119	5.29216	45	0D4	6.47369	77	741	5.5686	109	DC4	5.29578
14	AA3	5.3423	46	523	5.20757	78	737	5.64126	110	586	5.00808
15	EC5	5.40257	47	F29	5.0776	79	7AC	5.17063	111	DF3	4.48385
16	A08	5.63148	48	A67	5.52381	80	79F	5.0828	112	F2B	5.53794
17	96C	5.44285	49	251	5.10732	81	3FA	5.22885	113	ED1	5.58523
18	9D3	5.19112	50	B8E	4.77121	82	99C	6.01707			
19	5BC	5.41859	51	5B0	5.38618	83	755	6.51422			
20	4BC	5.96539	52	B6B	5.20069	84	A44	4.93486			
21	D15	6.07706	53	DCC	6.18175	85	F67	4.86142			
22	A31	4.76142	54	356	5.46713	86	4D4	6.21941			
23	4B3	4.67373	55	7FB	6.23427	87	810	4.25677			

**Table 316r—PAPR reduction sequence for BS with 3 or 4 antennas (512 point FFT)  
 (continued)**

ID cell	Sequence	PAPR	ID cell	Sequence	PAPR	ID cell	Sequence	PAPR	ID cell	Sequence	PAPR
24	B0A	5.24324	56	C6B	4.64117	88	201	4.47647			
25	BB7	4.81109	57	956	5.81606	89	054	6.8165			
26	245	4.99566	58	100	5.04293	90	654	5.87238			
27	834	4.81878	59	DF0	6.56931	91	F34	5.31419			
28	A59	5.78273	60	663	5.4996	92	4FF	6.88515			
29	807	5.59368	61	602	5.72958	93	4AA	6.75475			
30	694	5.53837	62	894	4.96955	94	E8D	6.10937			
31	6C6	6.42782	63	247	5.37554	95	944	4.79898			

For FFT size = 128

$$G = [g_0 g_1 g_2 \dots g_{23}] \tag{124ae}$$

$$= \begin{bmatrix} 01010101010101010101010101 \\ 001100110011001100110011 \\ 000011110000111100001111 \\ 111111110000000011111111 \\ 000000001111111111111111 \\ 11111001010000010010000 \\ 111110100000011000001100 \end{bmatrix}$$

**Table 316s—Permutation ( $l = 0, 1, 2, \dots, 23$ )**

$\Pi(l)$	11,6,4,9,7,8,0,10,5,1,2,3,17,20,21,14,18,16,23,15,19,22,12,13
----------	---

**Table 316t—PAPR reduction sequence for BS  
with 3 or 4 antennas (128 point FFT)**

ID cell	Sequence	PAPR	ID cell	Sequence	PAPR	ID cell	Sequence	PAPR	ID cell	Sequence	PAPR
0	0 1 0	5.35724	32	1 0 1	4.61762	64	0 1 1	3.52173	96	1 0 0	4.18255
1	0 0 0	5.17414	33	1 0 1	3.5604	65	0 0 0	5.01602	97	1 1 0	3.49527
2	1 1 1	6.51422	34	0 1 0	5.96329	66	0 0 1	6.01058	98	0 1 0	4.47417
3	0 0 0	3.82903	35	0 0 0	6.00008	67	0 1 0	4.70152	99	0 1 1	6.09081
4	1 1 0	5.5707	36	0 1 1	5.2032	68	0 0 0	3.37021	100	1 0 1	4.2738
5	1 1 1	4.51562	37	0 1 1	5.5032	69	0 0 1	5.18544	101	0 0 1	3.77032
6	1 0 1	4.99659	38	1 1 1	4.63273	70	1 0 1	5.59372	102	0 0 0	4.79531
7	1 0 0	4.507	39	0 0 0	4.79863	71	1 1 0	4.64525	103	1 1 0	3.80557
8	0 0 0	2.77148	40	1 1 1	6.68743	72	0 0 0	4.54804	104	0 0 1	3.67728
9	0 1 1	4.52863	41	1 0 1	4.93428	73	1 0 1	6.18314	105	1 0 0	5.55408
10	0 0 1	4.77121	42	1 1 0	5.43501	74	0 1 0	4.32808	106	1 1 1	4.96913
11	1 0 0	4.59416	43	1 1 1	5.22032	75	0 0 1	4.56337	107	0 1 1	4.52983
12	0 1 0	3.78955	44	0 0 0	6.51422	76	0 0 0	5.36844	108	0 1 1	5.0537
13	1 0 0	4.60896	45	1 1 1	4.98055	77	0 1 1	4.98055	109	0 1 1	4.67829
14	1 0 0	4.5935	46	0 0 1	3.50075	78	0 0 0	4.43788	110	1 0 1	6.11194
15	1 0 0	4.22853	47	0 0 0	5.08034	79	1 0 0	6.51422	111	1 1 0	3.53966
16	1 0 1	4.53933	48	0 1 0	5.41647	80	1 1 1	4.21693	112	1 0 0	4.49668
17	1 0 0	4.22832	49	1 1 0	4.02914	81	0 0 1	4.73888	113	0 0 0	4.44827
18	0 1 1	4.53739	50	0 1 0	3.77237	82	1 1 1	5.31912			
19	0 0 1	4.84545	51	1 1 1	3.99062	83	0 0 1	6.51422			
20	1 0 0	5.1608	52	0 1 1	4.62794	84	0 0 1	6.01936			
21	1 1 0	6.19203	53	1 0 0	4.81314	85	1 0 1	5.38087			
22	0 0 1	4.58568	54	0 0 0	4.20522	86	1 1 0	4.70313			
23	0 1 1	5.684	55	1 0 0	5.39106	87	0 0 0	3.79899			
24	0 1 0	4.76503	56	0 1 1	5.58402	88	1 0 0	5.31434			
25	0 0 0	4.77579	57	1 1 1	4.58125	89	1 1 0	6.41534			
26	0 1 0	4.73628	58	0 0 0	4.72378	90	0 0 1	4.11983			

**Table 316t—PAPR reduction sequence for BS with 3 or 4 antennas (128 point FFT) (continued)**

ID cell	Sequence	PAPR	ID cell	Sequence	PAPR	ID cell	Sequence	PAPR	ID cell	Sequence	PAPR
27	1 0 0	4.98055	59	0 0 0	4.16781	91	1 1 0	4.18856			
28	0 1 1	4.77121	60	0 0 1	6.57249	92	0 1 0	4.81524			
29	1 0 0	4.44124	61	1 0 0	3.98784	93	0 1 0	5.0717			
30	0 0 0	5.17708	62	0 0 1	5.95339	94	0 1 0	5.05024			
31	0 0 0	4.2966	63	1 1 0	5.27337	95	0 0 0	4.77121			

*Insert new subclause 8.4.8.9:*

**8.4.8.9 STC subpacket combining**

In the STC transmission, for both downlink and uplink, the STC sub-packet re-transmission can be generated by using the Space time code incremental redundancy version. The transmission rule for space-time coded incremental redundancy codes set is listed in Table 316u, Table 316v, and Table 316w.

**Table 316u—STC subpacket combining (2-transmit antenna case)**

	Initial transmission	Odd re-transmission	Even re-transmission
Space time code incremental redundancy for matrix A	$S_2^{(0)} = \begin{bmatrix} S_1 \\ S_2 \end{bmatrix}$	$S_2^{(odd)} = \begin{bmatrix} -S_2^* \\ S_1^* \end{bmatrix}$	$S_2^{(even)} = \begin{bmatrix} S_1 \\ S_2 \end{bmatrix}$

**Table 316v—STC subpacket combining (3-transmit antenna case)**

	Initial transmission	Odd re-transmission	Even re-transmission
Space time code incremental redundancy for matrix C	$S_2^{(0)} = \begin{bmatrix} S_1 \\ S_2 \\ S_3 \end{bmatrix}$	$S_2^{(odd)} = \begin{bmatrix} -S_2^* \\ S_1^* \\ S_3^* \end{bmatrix}$	$S_2^{(even)} = \begin{bmatrix} S_1 \\ S_2 \\ S_3 \end{bmatrix}$



**Table 316w—STC subpacket combining (4-transmit antenna case)**

	initial transmission	odd re-transmission	even re-transmission
Space time code incremental redundancy for matrix C	$S_2^{(0)} = \begin{bmatrix} S_1 \\ S_2 \\ S_3 \\ S_4 \end{bmatrix}$	$S_2^{(odd)} = \begin{bmatrix} -S_2^* \\ S_1^* \\ -S_4^* \\ S_3^* \end{bmatrix}$	$S_2^{(even)} = \begin{bmatrix} S_1 \\ S_2 \\ S_3 \\ S_4 \end{bmatrix}$

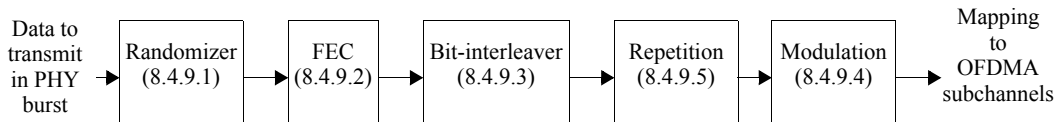
The MS shall process the initial transmission, first re-transmission, and second re-transmission etc. in the form of space time decoding. The re-transmission of FEC codeword shall use the Chase combining re-transmission.

**8.4.9 Channel coding**

*Change the first paragraph as indicated:*

Channel coding procedures include randomization (see 8.4.9.1), FEC encoding (see 8.4.9.2), bit interleaving (see 8.4.9.3), repetition (see 8.4.9.5) and modulation (see 8.4.9.4). ~~When repetition code is used, allocation for the transmission shall always include an even number of adjacent subchannels. The basic block shall pass the regular coding chain where the first subchannel shall set the randomization seed used in 8.4.9.1, and the data shall follow the coding chain up to the mapping. The data outputted from the modulation (8.4.9.4) shall be mapped onto the block of subchannels allocated for the basic block and then it will be also mapped on the following consecutive allocated subchannels (for repetition coding of 2, another block of subchannels of the same size is used; for repetition coding of 4, another 3 blocks of subchannels of the same size are used; and for repetition of 6, another 5 blocks of subchannels of the same size are used), the process of regular encoding and repetition encoding is shown in Figure 252.~~

*Replace Figure 252 with the following figure:*



**Figure 252—Channel coding process for regular and repetition coding transmission**

*Insert the following sentence as the end of the subclause:*

Repetition shall only be applied to QPSK modulation.

### 8.4.9.1 Randomization

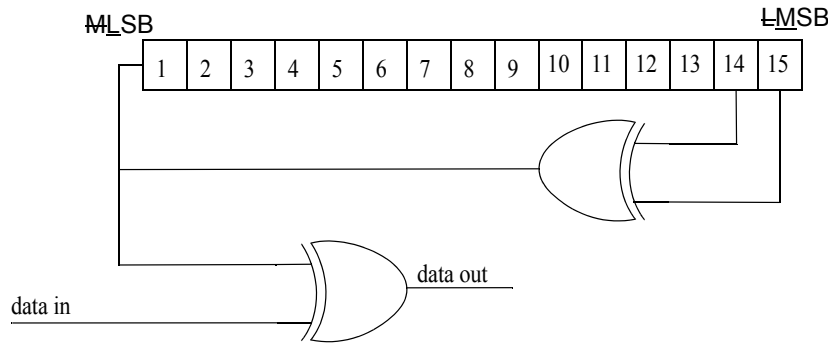
*Change the first paragraph as indicated:*

Data randomization is performed on all data transmitted on the downlink and uplink, except the FCH. The randomization is initialized on each FEC block (~~using the first Subchannel offset and OFDMA symbol offset on which the FEC block is mapped. Symbol offset, for both UL and DL, shall be counted from the start of the frame, where the DL preamble shall be count 0~~). If the amount of data to transmit does not fit exactly the amount of data allocated, padding of 0xFF (“1” only) shall be added to the end of the transmission block, up to the amount of data allocated. Here, the amount of data allocated means the amount of data that corresponds to the amount of  $\lfloor N_s/R \rfloor$  slots, where  $N_s$  is the number of the slots allocated for the data burst and  $R$  is the repetition factor used.

*Change the paragraph above Figure 254 as follows:*

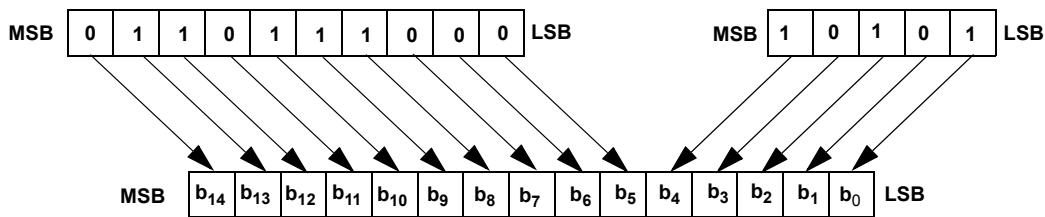
The randomizer is initialized with the vector created as shown in Figure 254. [LSB]0 1 1 0 1 1 1 0 0 0 1 0 1 0 1 [MSB].

*Change Figure 253 as indicated:*



**Figure 253—PRBS generator for data randomization**

*Delete Figure 254; insert Figure 254a:*



**OFDMA randomizer initialization vector**

**Figure 254a—Creation of the OFDMA randomizer initialization vector for HARQ**

*Insert the following text below Figure 254a:*

HARQ requires that the randomizer pattern be identical for each HARQ attempt. For HARQ operation, the randomizer shall be initialized with the vector created as shown in Figure 254a.

**8.4.9.2 Encoding**

*Replace any instance of the word ‘subchannel’ with word ‘slot’.*

*Change the text in 8.4.9.2 as indicated:*

Concatenation of a number of ~~subchannels~~slots shall be performed in order to make larger blocks of coding where it is possible, with the limitation of not ~~passing~~exceeding the largest supported block ~~under the same size for the applied modulation and coding rate (the block defined by 64-QAM modulation)~~. Table 318 specifies the concatenation of subchannels for different allocations and modulations. The parameters in Table 317 and Table 318 shall apply to the CC encoding scheme (see 8.4.9.2.1) and the BTC encoding scheme (see 8.4.9.2.2); for the CTC encoding scheme (see 8.4.9.2.3), the concatenation rule is defined in 8.4.9.2.3.1, and for the LDPC encoding scheme (see 8.4.9.2.5) the concatenation rule is defined in 8.4.2.9.5.4.

*Change the second bullet of the fourth paragraph as indicated:*

- *n*: number of allocated ~~subchannels~~slots/repetition factor

*Change Table 317 as indicated:*

**Table 317—~~Subchannel~~Slots concatenation rule**

<del>Number of subchannels</del> slots	<del>Subchannel</del> Slots concatenated
$n \leq j$	1 block of $n$ <del>subchannels</del> slots
$n > j$	If $(n \bmod j = 0)$ $k$ blocks of $j$ slots  else $(k-1)$ blocks of $j$ <del>subchannels</del> slots 1 block of $\text{ceil}((m+j)/2)$ <del>subchannels</del> slots 1 block of $\text{floor}((m+j)/2)$ <del>subchannels</del> slots

**8.4.9.2.1 Convolutional coding (CC)**

*Change the title of Table 319 to read: “The ~~inner~~ convolutional code with puncturing configuration”*

*Remove the column with value ‘5/6’ for the rate field in Table 319.*

*Change the title of Table 320 to read: “Useful data payload for a ~~subchannel~~slot”*

*Insert new subclause 8.4.9.2.1.1:*

**8.4.9.2.1.1 Incremental Redundancy HARQ support (optional)**

HARQ implementation is optional. An Incremental Redundancy (IR) based HARQ is taking the puncture pattern into account, and for each retransmission the coded block is not the same. Different puncture patterns

are used to create HARQ packets identified by SPID. The puncture patterns are predefined or can be easily deducted from the original pattern, and can be selected based on SPID. At the receiver, the received signals are de-punctured according to its specific puncture pattern, which is decided by the current SPID, then the combination is performed at bit metrics level.

The puncture pattern for the HARQ packet with SPID=0 is the same as the mandatory one in Table 320a. The puncture pattern for the HARQ packet with SPID=1 is the left cyclic shift of the one from SPID=0, as shown in Table 320a. Following the same rule, the puncture patterns for packets with SPID=2 and SPID=3 are shown in Table 320a.

**Table 320a—Puncture pattern definition for HARQ**

		Code Rate			
		1/2	2/3	3/4	5/6
SPID = 0	X	1	10	101	10101
	Y	1	11	110	11010
SPID = 1	X	1	01	011	01011
	Y	1	11	101	10101
SPID = 2	X	1	10	110	10110
	Y	1	11	011	01011
SPID = 3	X	1	01	101	01101
	Y	1	11	110	10110

*Change the title of 8.4.9.2.2 as indicated:*

**8.4.9.2.2 Block Turbo Coding (optional)**

*Change relevant rows in Table 322 and Table 323 as indicated:*

**Table 322—Useful data payload for a subchannel**

Encoding Rate	QPSK		16-QAM		64-QAM		Coded Bytes
	R=1/2	R=3/4	R=1/2	R=3/4	R=1/2	R=3/4	
Allowed data (bytes)	<del>+612</del>	20	16	20			24
	<del>+618</del>	25			16	25	36

**Table 323—Optional channel coding per modulation**

Data Bytes	Coded Bytes	Constituent	Code parameters
<del>+612</del>	24	<del>(8,7)(32,26)(32,31)(16,11)</del>	$I_x=214, I_y=05, B=06, Q=20$
<del>+618</del>	36	<del>(32,2631)(16,11)</del>	$I_x=445, I_y=25, B=69, Q=73$

**8.4.9.2.3 Convolutional turbo codes (optional)**

**8.4.9.2.3.1 CTC encoder**

*Replace any instance of the word ‘subchannel’ with word ‘slot’.*

*Change the first three sentences of the first paragraph as indicated:*

~~The Convolutional Turbo Code (CTC) defined in this subclause is designed to enable support of hybrid ARQ (HARQ). HARQ implementation is optional. The CTC encoder, including its constituent encoder, is depicted in Figure 257. The CTC defined in this subclause can be used for the support of the optional hybrid ARQ (HARQ).~~

*Change the second paragraph below Figure 257 as indicated:*

The order in which the encoded bit shall be fed into the subpacket generation block (8.4.9.2.3.4) is:

$$A, B, Y_1, Y_2, W_1, W_2 =$$

~~$$A_0, B_0, \dots, A_{N-1}, B_{N-1}, Y_{1,0}, Y_{1,1}, \dots, Y_{1,N-1}, Y_{2,0}, Y_{2,1}, \dots, Y_{2,N-1}, W_{1,0}, W_{1,1}, \dots, W_{1,N-1}, W_{2,0}, W_{2,1}, \dots, W_{2,N-1}$$~~

$$A_0, A_1, \dots, A_{N-1}, B_0, B_1, \dots, B_{N-1}, Y_{1,0}, Y_{1,1}, \dots, Y_{1,N-1}, Y_{2,0}, Y_{2,1}, \dots, Y_{2,N-1}$$

$$W_{1,0}, W_{1,1}, \dots, W_{1,N-1}, W_{2,0}, W_{2,1}, \dots, W_{2,N-1}$$

*Change the first sentence of the fourth paragraph below Figure 257 as indicated:*

Concatenation of a number of ~~subchannels~~ slots shall be performed in order to make larger blocks of coding where it is possible, with the limitation of not ~~passing~~ exceeding the largest supported block ~~under the same size for the applied modulation and coding rate (the block defined by 64 QAM modulation).~~

*Change the second bullet of the paragraph above Table 324 as indicated:*

- *n*: ~~number of allocated subchannels~~ number of allocated slots/repetition factor

Change Table 324 as indicated:

**Table 324—~~Subchannel~~Slots concatenation rule for CTC**

Number of <del>subchannels</del> slots	<del>Subchannels</del> Slots concatenated
$n \leq j$ $n \neq 7$	1 block of $n$ <del>subchannels</del> slots
$n = 7$	1 block of 4 <del>subchannels</del> slots 1 block of 3 <del>subchannels</del> slots
$n > j$	If $(n \bmod j = 0)$ $k$ blocks of $j$ slots  else $(k-1)$ blocks of $j$ <del>subchannels</del> slots 1 block of $L_{b1}$ <del>subchannels</del> slots 1 block of $L_{b2}$ <del>subchannels</del> slots  where $L_{b1} = \text{ceil}((m+j)/2)$ $L_{b2} = \text{floor}((m+j)/2)$  If $(L_{b1} = 7)$ or $(L_{b2} = 7)$ $L_{b1} = L_{b1} + 1; L_{b2} = L_{b2} - 1;$

Change the title of Table 326 and the entries as indicated:

**Table 326—~~Optimal~~ CTC channel coding per modulation**

Modulation	Data block size (bytes)	Encoded data block size (bytes)	Code rate	N	P <sub>0</sub>	P <sub>1</sub>	P <sub>2</sub>	P <sub>3</sub>
16-QAM	54	<del>108</del> 72	3/4	216	13	108	0	108
64-QAM	18	<del>24</del> 36	1/2	72	11	6	0	6

Change the title of Table 327 and the entries as indicated:

**Table 327—~~Optimal~~ CTC channel coding per modulation when supporting ~~H-ARQ~~ HARQ**

Data block size (bytes)	N	P <sub>0</sub>	P <sub>1</sub>	P <sub>2</sub>	P <sub>3</sub>
120	480	<del>13</del> 53	<del>240</del> 62	<del>120</del> 12	<del>360</del> 2
240	960	<del>13</del> 43	<del>480</del> 64	<del>240</del> 300	<del>720</del> 824
360	1440	<del>17</del> 43	720	360	540
480	1920	<del>17</del> 31	<del>960</del> 8	<del>480</del> 24	<del>1440</del> 16
600	2400	<del>17</del> 53	<del>1200</del> 66	<del>600</del> 24	<del>1800</del> 2

**8.4.9.2.3.2 CTC interleaver**

*Change the subclause as indicated:*

The interleaver requires the parameters  $P_0, P_1, P_2$  and  $P_3$ , shown in Table 326.

The two-step interleaver shall be performed by:

**Step 1: Switch alternate couples**

Let the sequence  $u_0 = [(A_0, B_0), (A_1, B_1), (A_2, B_2), (A_3, B_3), \dots, (A_{N-1}, B_{N-1})]$  be the input to first encoding  $C_1$ .

for  $j = 0 \dots N-1$

if  $(j \bmod 2 == 0)$  let  $(B, A) = (A, B)$  (i.e., switch the couple)

if  $(j \bmod 2 == 1)$  let  $(A_i, B_i) \rightarrow (B_i, A_i)$  (i.e., switch the couple)

This step gives a sequence  $u_1 = [(A_0, B_0), (B_1, A_1), (A_2, B_2), (B_2, A_2), \dots, (B_{N-1}, A_{N-1})] = [u_1(0), u_1(1), u_1(2), u_1(3), \dots, u_1(N-1)]$ .

**Step 2:  $P_i(j)$** 

The function  $P_i(j)$  provides the interleaved address  $i$  of the consider couple  $j$  the address of the couple of the sequence  $u_1$  that shall be mapped onto the address  $j$  of the interleaved sequence (i.e.,  $u_2(j) = u_1(P(j))$ ).

for  $j = 0 \dots N-1$

switch  $j \bmod 4$ :

case 0:  $= (P_0 \cdot j + 1) \bmod N$

case 1:  $= (P_0 \cdot j + 1 + N/2 + P_1) \bmod N$

case 2:  $= (P_0 \cdot j + 1 + P_2) \bmod N$

case 3:  $= (P_0 \cdot j + 1 + N/2 + P_3) \bmod N$

switch  $j \bmod 4$ :

case 0:  $P(j) = (P_0 \cdot j + 1) \bmod N$

case 1:  $(j) = (P_0 \cdot j + 1 + N/2 + P_1) \bmod N$

case 2:  $P(j) = (P_0 \cdot j + 1 + P_2) \bmod N$

case 3:  $(j) = (P_0 \cdot j + 1 + N/2 + P_3) \bmod N$

This step gives a sequence  $u_2 = [u_1(P(0)), u_1(P(1)), u_1(P(2)), u_1(P(3)), \dots, u_1(P(N-1))] = [(B_{P(0)}, A_{P(0)}), (A_{P(1)}, B_{P(1)}), (B_{P(2)}, A_{P(2)}), (A_{P(3)}, B_{P(3)}), \dots, (A_{P(N-1)}, B_{P(N-1)})]$ . Sequence  $u_2$  is the input to the second encoding  $C_2$ .

**8.4.9.2.3.3 Determination of CTC circulation states**

*Change the first sentence of the first paragraph as indicated:*

The state of the encoder is denoted  $S$  ( $0 \leq S \leq 7$ ) with  $S$  the value read binary (left to right) out of the constituent encoder memory  $S = 4s_1 + 2s_2 + s_3$  (see Figure 257).

**8.4.9.2.3.4 Subpacket generation**

*Replace ' $S \cdot N_{ep}$ ' with ' $3 \cdot N_{ep}$ ' in Figure 258.*

**8.4.9.2.3.4.1 Symbol separation**

*Change the subclause as indicated:*

All of the encoded symbols shall be demultiplexed into six subblocks denoted  $A, B, Y_1, Y_2, W_1$ , and  $W_2$ . The encoder output symbols shall be sequentially distributed into six subblocks with the first  $N$  encoder output symbols going to the  $A$  subblock, the second  $N$  encoder output going to the  $B$  subblock, the third  $N$  to the  $Y_1$  subblock, the fourth  $N$  to the  $Y_2$  subblock, the fifth  $N$  to the  $W_1$  subblock, the sixth  $N$  to the  $W_2$  subblock, etc.

**8.4.9.2.3.4.2 Subblock interleaving**

*Renumber the numbered list in the second paragraph to start with ‘1.’ instead of ‘3.’*

*Change the third bullet of the second paragraph as indicated:*

- Form a tentative output address  $T_k$  according to the formula:

$$T_k = 2^m(k \text{ mod } J) + BRO_m(\lfloor k/J \rfloor)$$

where  $BRO_m(y)$  indicates the bit-reversed  $m$ -bit value of  $y$  (i.e.,  $BRO_3(6) = 3$ ).

*Change relevant entries in Table 329 as indicated:*

**Table 329—Parameters for the subblock interleavers**

Block size (bits) $N_{EP}$	$N$	Subblock interleaver parameters	
		$m$	$J$
216	108	<u>6</u>	<u>3</u>
<u>360</u>	<u>180</u>	<u>6</u>	<u>3</u>

**8.4.9.2.3.4.4 Symbol selection**

*Change the first sentence of the second paragraph as indicated:*

Mother code is transmitted with one of the subpackets.

*Change the first and third bullets of the third paragraph as indicated:*

$k$  be the subpacket index when HARQ is enabled.  $k = 0$  for the first transmission and increases by one for the next subpacket.  $k = 0$  when ~~H-ARQ~~ HARQ is not used. When there are more than one FEC block in a burst, the subpacket index for each FEC block shall be the same.

$N_{SCHk}$  ~~be the number of subchannel(s) allocated for the  $k$ -th subpacket.~~  
be the number of the concatenated slots for the subpacket defined in Table 324 for non HARQ CTC scheme defined in 8.4.9.2.3.1 and be the same as  $N_{sch}$  that is indicated in the allocation IE for HARQ CTC scheme defined in 8.4.9.2.3.5

*Change the title of 8.4.9.2.3.5 as indicated:*

**8.4.9.2.3.5 ~~Optional H-ARQ~~ Optional IR HARQ (Incremental redundancy HARQ) support**

*Change the subclause as indicated:*

The procedure of HARQ CTC subpacket generation is as follows: Padding, CRC addition, Fragmentation, Randomization and CTC encoding. ~~H-ARQ~~ HARQ implementation is optional. The randomization block in 8.4.9.1, the concatenation scheme in 8.4.9.2.3.1, and the interleaving in 8.4.9.3 shall not be applied for the encoding described in this subclause.



**8.4.9.2.3.5.1 Padding**

*Change the last sentence of the first paragraph as indicated:*

The padded packet is input into the ~~randomization~~CRC encoding block.

*Renumber subclause 8.4.9.2.3.5.3 as 8.4.9.2.3.5.2*

**8.4.9.2.3.5.2 CRC encoding**

*Change the second paragraph as indicated:*

The size of the CRC is 16 bits. CRC16-CCITT, as defined in ITU-T Recommendation X.25, shall be included at the end of the padded ~~and randomized~~ packet. The CRC covers both the padded bits and the information part of the padded ~~and randomized~~ packet. After the CRC operation, ~~the~~ packet size shall belong to set {48, 96, 144, 192, 288, 384, 480, 960, 1920, 2880, 3840, 4800, 9600, 14400, 19200, 24000}.

*Renumber subclause 8.4.9.2.3.5.4 as 8.4.9.2.3.5.3*

*Renumber subclause 8.4.9.2.3.5.2 as 8.4.9.2.3.5.4*

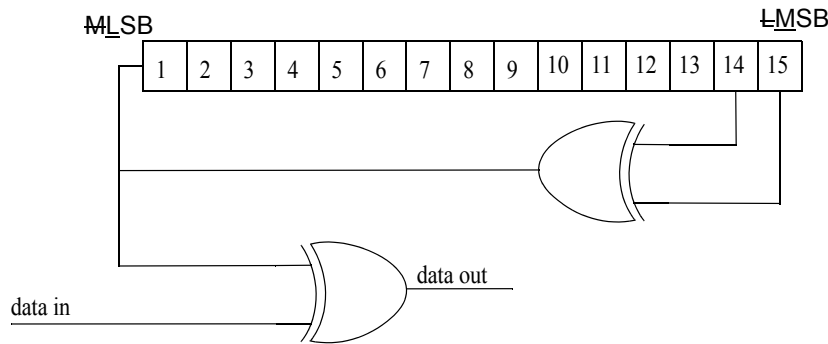
**8.4.9.2.3.5.4 Randomization**

*Change the first two paragraphs as indicated:*

The randomization is performed on each ~~allocation (burst) encoder packet~~, which means that for each ~~allocat~~ion of a data block encoder packet the randomizer shall be ~~used~~initialized independently.

The PRBS generator shall be  $1 + X^{14} + X^{15}$  as shown in Figure 260. Each data byte to be transmitted shall enter sequentially into the randomizer, MSB first. Preambles are not randomized. The seed value shall be used to calculate the randomization bits, which are combined in an XOR operation with the serialized bit stream of each FEC block. ~~The randomizer sequence is applied to the output from the padding block. The bit issued from the randomizer shall be applied to the CRC encoder.~~

*Change Figure 260 as indicated:*



**Figure 260—PRBS generator of the randomization**

*Change the two paragraphs below Figure 260 as indicated:*

~~The bit issued from the randomizer shall be applied to the encoder.~~

The scrambler is initialized with the vector ~~created as shown in Figure 261. The lowest 5 bits are  $ID_{cell}$  or  $UL\_ID_{cell}$  and the other bits are set “0.”~~ [LSB] 0 1 1 0 1 1 1 0 0 0 1 0 1 0 1 [MSB].

The bit issued from the randomizer shall be applied to the encoder.

**Delete Figure 261.**

**8.4.9.2.3.5.6 Modulation order of DL traffic burst**

**Change the first paragraph as indicated:**

For DL, the modulation order (2 for QPSK, 4 for 16-QAM, and 6 for 64-QAM) shall be set for all the allowed transmission formats as shown in Table 331. The transmission format is given by the  $N_{EP}$  (Encoding Packet Size) and the  $N_{SCH}$  (number of allotted ~~subchannels~~ slots).  $N_{EP}$  per an encoding packet is {144, 192, 288, 384, 480, 960, 1920, 2880, 3840, 4800}. The  $N_{SCH}$  per an encoding packet is {1, ..., 480}. In Table 331, the numbers in the first row are  $N_{EP}$ 's and the numbers in the remaining rows are  $N_{SCH}$ 's and related parameters. In Table 331, the modulation order is denoted by  $MOD$ , and it has the values of two for QPSK, four for 16-QAM, and six for 64-QAM.  $SCH$  denotes for the number of allocated slots.

**Change the third paragraph below Equation (128) as indicated:**

The information of  $N_{EP}$  and  $N_{SCH}$  shall be signaled in ~~UL HARQ~~ MAP. Instead of the actual values of  $N_{EP}$  and  $N_{SCH}$ , the encoded value of  $N_{EP}$  ( $N_{EP}$  code) and  $N_{SCH}$  ( $N_{SCH}$  code) shall be used for the signaling. They are encoded by 4 bits, respectively. The encoding of  $N_{EP}$  ( $N_{EP}$  code) is shown in Table 332. The encoding of  $N_{SCH}$  ( $N_{SCH}$  code) is performed per  $N_{EP}$  value. For each  $N_{EP}$ , there are less than 16 kinds of  $N_{SCH}$  values and they are encoded from “0” (the smallest number of ~~subchannels~~ slots) to “15” in increasing order. When the number of  $N_{SCH}$  values for a  $N_{EP}$  is smaller than 16, the smallest number of the smallest codes are used. When the fragmentation is applied and the number of the subpackets for an allocation is  $n$ ,  $n * N_{EP}$  and  $N_{SCH}$  (the number of ~~subchannels~~ slots allocated for a subpacket) should be signaled.

**Change relevant entries in Table 331 as indicated:**

**Table 331—Transmission format and modulation level for DL**

$N_{EP}$	144	192	288	384	480	960	1920	2880	3840	4800
$SCH$					<u>20.00</u>	20.00	20.00	20.00	20.00	20.00
$MPR$					<u>0.50</u>	<del>0.50</del> <u>1.0</u>	<u>1.0</u>	<u>2.0</u>	<u>3.0</u>	5.00
$MOD$					<u>2.00</u>	2.00	<u>2.00</u>	<u>4.00</u>	6.00	6.00
Rate					<u>1/4</u>	<del>1/4</del> <u>1/2</u>	1/2	1/2	<u>1/2</u> <u>2/3</u>	5/6
Rate					<u>0.25</u>	<del>0.25</del> <u>0.5</u>	0.50	0.50	<del>0.50</del> <u>0.67</u>	0.83
$SCH$			<u>36</u>							
$MPR$			<u>0.17</u>							
$MOD$			<u>2.00</u>							
Rate			<u>1/12</u>							
Rate			<u>0.08</u>							

**Insert the following note below Table 331:**

NOTE—In Table 331, the first Rate entry is the theoretical rate and the second Rate entry is an approximated rate.

**8.4.9.2.3.5.7 Modulation order of UL traffic burst**

*Change the first paragraph as indicated:*

For UL, the modulation order (2 for QPSK and 4 for 16-QAM) shall be set for all the allowed transmission formats as shown in Table 333. The transmission format is given by the  $N_{EP}$  (Encoding Packet Size) and the  $N_{SCH}$  (number of ~~allotted~~allocated subchannels~~slots~~).  $N_{EP}$  per an encoding packet is {48, 96, 144, 192, 288, 384, 480, 960, 1920, 2880, 3840, 4800}. The  $N_{SCH}$  per an encoding packet is {1...~~288~~240}. In Table 333, the numbers in the first row are  $N_{EP}$ 's and the numbers in the remaining rows are  $N_{SCH}$ 's and related parameters. In Table 333, the modulation order is denoted by MOD, and it has the values of two for QPSK, four for 16-QAM, and six for 64-QAM. SCH denotes for the number of allocated slots.

*Change the third paragraph below Equation (129) as indicated:*

The information of  $N_{EP}$  and  $N_{SCH}$  shall be signaled in UL HARQ MAP. Instead of the actual values of  $N_{EP}$  and  $N_{SCH}$ , the encoded value of  $N_{EP}$  ( $N_{EP}$  code) and  $N_{SCH}$  ( $N_{SCH}$  code) shall be used for the signaling. They are encoded by 4 bits, respectively. The encoding of  $N_{EP}$  ( $N_{EP}$  code) is shown in Table 332. The encoding of  $N_{SCH}$  ( $N_{SCH}$  code) is performed per  $N_{EP}$  value. For each  $N_{EP}$ , there are less than 16 kinds of  $N_{SCH}$  values and they are encoded from "0" (the smallest number of subchannels~~slots~~) to "15" in increasing order. When the number of  $N_{SCH}$  values for a  $N_{EP}$  is smaller than 16, then the corresponding number of codes is used. When the fragmentation is applied and the number of the subpackets for an allocation is  $n$ ,  $n * N_{EP}$  and  $N_{SCH}$  (the number of subchannels~~slots~~ allocated for a subpacket) should be signaled.

*Change relevant entries in Table 333 as indicated:*

**Table 333—Transmission format and modulation level for UL**

$N_{EP}$	48	96	144	192	288	384	480	960	1920	2880	3840	4800
SCH	3.00	3.00	3.00	3.00	3.00	3.00	3.00					
MPR	0.33	0.67	1.00	1.33	2.00	2.67	3.33					
MOD	2.00	2.00	2.00	2.00	4.00	4.00	4.00					
Rate	1/6	1/3	<del>1/2</del> <u>1/2</u>	2/3	1/2	2/3	5/6					
Rate	0.17	0.33	0.50	0.67	0.5	0.67	0.83					
SCH									13.00			
MPR									3.08			
MOD									<del>3.00</del>			
Rate									10/13			
Rate									0.77			
SCH			18.00		18.0					<u>18.00</u>	<del>18.00</del>	
MPR			0.17		0.33					<u>3.33</u>	<del>3.33</del>	
MOD			2.00		2.00					<u>4.00</u>	<del>4.00</del>	
Rate			1/12		1/6					<u>5/6</u>	<del>5/6</del>	
Rate			0.08		0.17					<u>0.83</u>	<del>0.83</del>	
SCH							<u>20.00</u>	20.00	20.00	20.00	<del>20.0</del>	
MPR							<u>0.50</u>	<del>0.500</del>	<del>1.00</del>	<del>2.00</del>	<del>3.00</del>	
MOD							<u>2.00</u>	2.00	<del>2.00</del>	4.00	<del>4.00</del>	
Rate							<u>1/4</u>	<u>1/4</u>	1/2	<del>1/2</del>	<del>3/4</del>	
Rate							<u>0.25</u>	<u>0.250</u>	0.50	<del>0.750</del>	<del>0.75</del>	
SCH							30.00	30.00	30.00	30.00	30.00	30.0
MPR							0.33	0.67	1.33	2.00	2.67	3.33
MOD							2.00	2.00	2.00	4.00	4.00	<del>3.00</del>
Rate							1/6	1/3	2/3	1/2	2/3	5/6
Rate							0.17	0.33	0.67	0.50	0.67	0.83

**Insert the following note below Table 333:**

NOTE—In Table 333, the first rate entry is the theoretical rate and the second rate entry is an approximated rate.

**Insert new subclause 8.4.9.2.5:**

**8.4.9.2.5 Low Density Parity Check code (optional)**

**Insert new subclause 8.4.9.2.5.1:**

**8.4.9.2.5.1 Code description**

The LDPC code is based on a set of one or more fundamental LDPC codes. Each of the fundamental codes is a systematic linear block code. Using the described methods in 8.4.9.2.5.2 Code Rate and Block Size Adjustment, the fundamental codes can accommodate various code rates and packet sizes.

Each LDPC code in the set of LDPC codes is defined by a matrix **H** of size *m*-by-*n*, where *n* is the length of the code and *m* is the number of parity check bits in the code. The number of systematic bits is *k* = *n* − *m*.

The matrix **H** is defined as:

$$\mathbf{H} = \begin{bmatrix} \mathbf{P}_{0,0} & \mathbf{P}_{0,1} & \mathbf{P}_{0,2} & \cdots & \mathbf{P}_{0,n_b-2} & \mathbf{P}_{0,n_b-1} \\ \mathbf{P}_{1,0} & \mathbf{P}_{1,1} & \mathbf{P}_{1,2} & \cdots & \mathbf{P}_{1,n_b-2} & \mathbf{P}_{1,n_b-1} \\ \mathbf{P}_{2,0} & \mathbf{P}_{2,1} & \mathbf{P}_{2,2} & \cdots & \mathbf{P}_{2,n_b-2} & \mathbf{P}_{2,n_b-1} \\ \cdots & \cdots & \cdots & \cdots & \cdots & \cdots \\ \mathbf{P}_{m_b-1,0} & \mathbf{P}_{m_b-1,1} & \mathbf{P}_{m_b-1,2} & \cdots & \mathbf{P}_{m_b-1,n_b-2} & \mathbf{P}_{m_b-1,n_b-1} \end{bmatrix} = \mathbf{P}^{H_b}$$

where  $\mathbf{P}_{i,j}$  is one of a set of *z*-by-*z* permutation matrices or a *z*-by-*z* zero matrix. The matrix **H** is expanded from a binary base matrix  $\mathbf{H}_b$  of size *m<sub>b</sub>*-by-*n<sub>b</sub>*, where *n* = *z* · *n<sub>b</sub>* and *m* = *z* · *m<sub>b</sub>*, with *z* an integer ≥ 1. The base matrix is expanded by replacing each 1 in the base matrix with a *z*-by-*z* permutation matrix, and each 0 with a *z*-by-*z* zero matrix. The base matrix size *n<sub>b</sub>* is an integer equal to 24.

The permutations used are circular right shifts, and the set of permutation matrices contains the *z*×*z* identity matrix and circular right shifted versions of the identity matrix. Because each permutation matrix is specified by a single circular right shift, the binary base matrix information and permutation replacement information can be combined into a single compact model matrix  $\mathbf{H}_{bm}$ . The model matrix  $\mathbf{H}_{bm}$  is the same size as the binary base matrix  $\mathbf{H}_b$ , with each binary entry (*i,j*) of the base matrix  $\mathbf{H}_b$  replaced to create the model matrix  $\mathbf{H}_{bm}$ . Each 0 in  $\mathbf{H}_b$  is replaced by a blank or negative value (e.g., by −1) to denote a *z*×*z* all-zero matrix, and each 1 in  $\mathbf{H}_b$  is replaced by a circular shift size  $p(i,j) \geq 0$ . The model matrix  $\mathbf{H}_{bm}$  can then be directly expanded to **H**.

$\mathbf{H}_b$  is partitioned into two sections, where  $\mathbf{H}_{b1}$  corresponds to the systematic bits and  $\mathbf{H}_{b2}$  corresponds to the parity-check bits, such that  $H_b = \left[ \begin{matrix} (\mathbf{H}_{b1})_{m_b \times k_b} & (\mathbf{H}_{b2})_{m_b \times m_b} \end{matrix} \right]$ .

Section  $\mathbf{H}_{b2}$  is further partitioned into two sections, where vector  $\mathbf{h}_b$  has odd weight, and  $\mathbf{H}'_{b2}$  has a dual-diagonal structure with matrix elements at row *i*, column *j* equal to 1 for *i=j*, 1 for *i=j+1*, and 0 elsewhere:

The base matrix has  $h_b(0)=1$ ,  $h_b(m_b-1)=1$ , and a third value  $h_b(j)$ ,  $0 < j < (m_b-1)$  equal to 1. The base matrix structure avoids having multiple weight −1 columns in the expanded matrix.

$$H_{b2} = \left[ \begin{array}{c|c} h_b & H'_{b2} \\ \hline & \end{array} \right]$$

$$= \left[ \begin{array}{c|ccc} h_b(0) & 1 & & \\ h_b(1) & 1 & 1 & 0 \\ \vdots & & \ddots & \\ \vdots & & & 1 & 1 \\ h_b(m_b-1) & & 0 & 1 & 1 \\ \hline & & & & 1 \end{array} \right]$$

In particular, the non-zero sub-matrices are circularly right shifted by a particular circular shift value. Each 1 in  $\mathbf{H}'_{b2}$  is assigned a shift size of 0, and is replaced by a  $zxz$  identity matrix when expanding to  $\mathbf{H}$ . The two located at the top and the bottom of  $\mathbf{h}_b$  are assigned equal shift sizes, and the third 1 in the middle of  $\mathbf{h}_b$  is given an unpaired shift size.

A base model matrix is defined for the largest code length ( $n = 2304$ ) of each code rate. The set of shifts  $\{p(i,j)\}$  in the base model matrix are used to determine the shift sizes for all other code lengths of the same code rate. Each base model matrix has  $n_b = 24$  columns, and the expansion factor  $z_f$  is equal to  $n/24$  for code length  $n$ . Here  $f$  is the index of the code lengths for a given code rate,  $f = 0, 1, 2, \dots, 18$ . For code length  $n = 2304$  the expansion factor is designated  $z_0 = 96$ .

For code rates 1/2, 3/4 A and B code, 2/3 B code, and 5/6 code, the shift sizes  $\{p(f, i, j)\}$  for a code size corresponding to expansion factor  $z_f$  are derived from  $\{p(i,j)\}$  by scaling  $p(i,j)$  proportionally,

$$p(f, i, j) = \begin{cases} p(i, j), & p(i, j) \leq 0 \\ \left\lfloor \frac{p(i, j)z_f}{z_0} \right\rfloor, & p(i, j) > 0 \end{cases} \tag{129a}$$

where  $\lfloor x \rfloor$  denotes the flooring function that gives the nearest integer towards  $-\infty$ .

For code rate 2/3 A code, the shift sizes  $\{p(f, i, j)\}$  for a code size corresponding to expansion factor  $z_f$  are derived from  $\{p(i,j)\}$  by using a modulo function.

$$p(f, i, j) = \begin{cases} p(i, j), & p(i, j) \leq 0 \\ \text{mod}(p(i, j), z_f), & p(i, j) > 0 \end{cases}$$

Rate 1/2:

```

-1 94 73 -1 -1 -1 -1 -1 55 83 -1 -1 7 0 -1 -1 -1 -1 -1 -1 -1 -1 -1
-1 27 -1 -1 -1 22 79 9 -1 -1 -1 12 -1 0 0 -1 -1 -1 -1 -1 -1 -1 -1
-1 -1 -1 24 22 81 -1 33 -1 -1 -1 0 -1 -1 0 0 -1 -1 -1 -1 -1 -1 -1
61 -1 47 -1 -1 -1 -1 -1 65 25 -1 -1 -1 -1 -1 0 0 -1 -1 -1 -1 -1 -1
-1 -1 39 -1 -1 -1 84 -1 -1 41 72 -1 -1 -1 -1 -1 0 0 -1 -1 -1 -1 -1
-1 -1 -1 -1 46 40 -1 82 -1 -1 -1 79 0 -1 -1 -1 -1 0 0 -1 -1 -1 -1
-1 -1 95 53 -1 -1 -1 -1 -1 14 18 -1 -1 -1 -1 -1 -1 0 0 -1 -1 -1
-1 11 73 -1 -1 -1 2 -1 -1 47 -1 -1 -1 -1 -1 -1 -1 0 0 -1 -1 -1
12 -1 -1 -1 83 24 -1 43 -1 -1 -1 51 -1 -1 -1 -1 -1 -1 -1 0 0 -1
-1 -1 -1 -1 94 -1 59 -1 -1 70 72 -1 -1 -1 -1 -1 -1 -1 -1 0 0 -1
-1 -1 7 65 -1 -1 -1 39 49 -1 -1 -1 -1 -1 -1 -1 -1 -1 -1 -1 0 0
43 -1 -1 -1 -1 66 -1 41 -1 -1 -1 26 7 -1 -1 -1 -1 -1 -1 -1 -1 -1 0
    
```

Note that the R=1/2 code is designed such that after a model matrix row permutation of [0, 2, 4, 11, 6, 8, 10, 1, 3, 5, 7, 9] consecutive rows do not intersect, which may be used to increase decoding throughput in some layered decoding architectures.

Rate 2/3 A code:

```

3 0 -1 -1 2 0 -1 3 7 -1 1 1 -1 -1 -1 -1 0 -1 -1 -1 -1 -1 -1
-1 -1 1 -1 36 -1 -1 34 10 -1 -1 18 2 -1 3 0 -1 0 0 -1 -1 -1 -1
-1 -1 12 2 -1 15 -1 40 -1 3 -1 15 -1 2 13 -1 -1 -1 0 0 -1 -1 -1
-1 -1 19 24 -1 3 0 -1 6 -1 17 -1 -1 -1 8 39 -1 -1 -1 0 0 -1 -1
20 -1 6 -1 -1 10 29 -1 -1 28 -1 14 -1 38 -1 -1 0 -1 -1 -1 0 0 -1
-1 -1 10 -1 28 20 -1 -1 8 -1 36 -1 9 -1 21 45 -1 -1 -1 -1 -1 0 0
35 25 -1 37 -1 21 -1 -1 5 -1 -1 0 -1 4 20 -1 -1 -1 -1 -1 -1 0 0
-1 6 6 -1 -1 -1 4 -1 14 30 -1 3 36 -1 14 -1 1 -1 -1 -1 -1 -1 0
    
```

Rate 2/3 B code:

```

2 -1 19 -1 47 -1 48 -1 36 -1 82 -1 47 -1 15 -1 95 0 -1 -1 -1 -1 -1
-1 69 -1 88 -1 33 -1 3 -1 16 -1 37 -1 40 -1 48 -1 0 0 -1 -1 -1 -1
10 -1 86 -1 62 -1 28 -1 85 -1 16 -1 34 -1 73 -1 -1 -1 0 0 -1 -1 -1
-1 28 -1 32 -1 81 -1 27 -1 88 -1 5 -1 56 -1 37 -1 -1 -1 0 0 -1 -1
23 -1 29 -1 15 -1 30 -1 66 -1 24 -1 50 -1 62 -1 -1 -1 -1 0 0 -1 -1
-1 30 -1 65 -1 54 -1 14 -1 0 -1 30 -1 74 -1 0 -1 -1 -1 -1 0 0 -1
32 -1 0 -1 15 -1 56 -1 85 -1 5 -1 6 -1 52 -1 0 -1 -1 -1 -1 0 0
-1 0 -1 47 -1 13 -1 61 -1 84 -1 55 -1 78 -1 41 95 -1 -1 -1 -1 -1 0
    
```

Note that the R=2/3 B code is designed such that after a model matrix row permutation of [0, 3, 6, 1, 4, 7, 2, 5] consecutive rows do not intersect, which may be used to increase decoding throughput in some layered decoding architectures.

Rate 3/4 A code:

```

6 38 3 93 -1 -1 -1 30 70 -1 86 -1 37 38 4 11 -1 46 48 0 -1 -1 -1 -1
62 94 19 84 -1 92 78 -1 15 -1 -1 92 -1 45 24 32 30 -1 -1 0 0 -1 -1
71 -1 55 -1 12 66 45 79 -1 78 -1 -1 10 -1 22 55 70 82 -1 -1 0 0 -1
38 61 -1 66 9 73 47 64 -1 39 61 43 -1 -1 -1 -1 95 32 0 -1 -1 0 0 -1
-1 -1 -1 -1 32 52 55 80 95 22 6 51 24 90 44 20 -1 -1 -1 -1 -1 0 0
-1 63 31 88 20 -1 -1 -1 6 40 56 16 71 53 -1 -1 27 26 48 -1 -1 -1 -1
    
```

Rate 3/4 B code:

```
-1 81 -1 28 -1 -1 14 25 17 -1 -1 85 29 52 78 95 22 92 0 0 -1 -1 -1 -1
42 -1 14 68 32 -1 -1 -1 -1 70 43 11 36 40 33 57 38 24 -1 0 0 -1 -1 -1
-1 -1 20 -1 -1 63 39 -1 70 67 -1 38 4 72 47 29 60 5 80 -1 0 0 -1 -1
64 2 -1 -1 63 -1 -1 3 51 -1 81 15 94 9 85 36 14 19 -1 -1 -1 0 0 -1
-1 53 60 80 -1 26 75 -1 -1 -1 -1 86 77 1 3 72 60 25 -1 -1 -1 -1 0 0
77 -1 -1 -1 15 28 -1 35 -1 72 30 68 85 84 26 64 11 89 0 -1 -1 -1 -1 0
```

Rate 5/6 code:

```
1 25 55 -1 47 4 -1 91 84 8 86 52 82 33 5 0 36 20 4 77 80 0 -1 -1
-1 6 -1 36 40 47 12 79 47 -1 41 21 12 71 14 72 0 44 49 0 0 0 0 -1
51 81 83 4 67 -1 21 -1 31 24 91 61 81 9 86 78 60 88 67 15 -1 -1 0 0
50 -1 50 15 -1 36 13 10 11 20 53 90 29 92 57 30 84 92 11 66 80 -1 -1 0
```

*Insert new subclause 8.4.9.2.5.2:*

**8.4.9.2.5.2 Code rate and block size adjustment**

The LDPC code flexibly supports different block sizes for each code rate through the use of an expansion factor. Each base model matrix has  $n_b=24$  columns, and the expansion factor ( $z$  factor) is equal to  $n/24$  for code length  $n$ . In each case, the number of information bits is equal to the code rate times the coded length  $n$ .

**Table 333a—LDPC block sizes and code rates**

$n$ (bits)	$n$ (byte s)	$z$ factor	$k$ (bytes)				Number of subchannels		
			R = 1/2	R = 2/3	R = 3/4	R = 5/6	QPSK	16QAM	64QAM
576	72	24	36	48	54	60	6	3	2
672	84	28	42	56	63	70	7	—	—
768	96	32	48	64	72	80	8	4	—
864	108	36	54	72	81	90	9	—	3
960	120	40	60	80	90	100	10	5	—
1056	132	44	66	88	99	110	11	—	—
1152	144	48	72	96	108	120	12	6	4
1248	156	52	78	104	117	130	13	—	—
1344	168	56	84	112	126	140	14	7	—
1440	180	60	90	120	135	150	15	—	5
1536	192	64	96	128	144	160	16	8	—
1632	204	68	102	136	153	170	17	—	—
1728	216	72	108	144	162	180	18	9	6
1824	228	76	114	152	171	190	19	—	—
1920	240	80	120	160	180	200	20	10	—
2016	252	84	126	168	189	210	21	—	7

**Table 333a—LDPC block sizes and code rates (continued)**

$n$ (bits)	$n$ (bytes)	$z$ factor	$k$ (bytes)				Number of subchannels		
			$R = 1/2$	$R = 2/3$	$R = 3/4$	$R = 5/6$	QPSK	16QAM	64QAM
2112	264	88	132	176	198	220	22	11	—
2208	276	92	138	184	207	230	23	—	—
2304	288	96	144	192	216	240	24	12	8

*Insert new subclause 8.4.9.2.5.3:*

**8.4.9.2.5.3 Packet encoding**

The encoding block size  $k$  shall depend on the number of subchannels allocated and the modulation specified for the current transmission. Concatenation of a number of subchannels shall be performed in order to make larger blocks of coding where it is possible, with the limitation of not passing the largest block under the same coding rate (the block defined by the 64-QAM modulation). Table 333b specifies the concatenation of subchannels for different allocations and modulations. The concatenation rule follows the subchannel concatenation rule for CC (see Table 317) except that for LDPC the concatenation does not depend on the code rate.

For any modulation and FEC rate, given an allocation of  $N_{SCH}$  subchannels, we define the following parameters:

- $j_i$ : parameter dependent on the modulation and number of antennas in case of spatial multiplexing
- $N_{SCH}$ : number of allocated subchannels
- $F$ :  $\text{floor}(N_{SCH}/j_i)$
- $M$ :  $N_{SCH} \text{ mod } j_i$

The subchannel concatenation rule for CC in Table 317 is applied, noting that in Table 317 the parameter  $n$  is equal to  $N_{SCH}$ , the parameter  $k$  is equal to  $F$ , and the parameter  $m$  is equal to  $M$ . The parameter  $j_i$  for LDPC is determined as shown in Table 333b:

**Table 333b—Parameter ' $j$ ' for LDPC**

$j_1$	$j_2$	$j_3$	$j_4$	Modulation
24	12	8	6	QPSK
12	6	4	3	16-QAM
8	4	2	2	64-QAM

Control information and packets that result in a codeword size  $n$  of less than 576 bits are encoded using convolutional coding (CC) with appropriate code rates and modulation orders, as described in 8.4.9.2.1.



**8.4.9.3 Interleaving**

*Change the first sentence of the first paragraph as indicated:*

All encoded data bits shall be interleaved by a block interleaver with a block size corresponding to the number of coded bits per the encoded block size  $N_{cbps}$  as set in 8.4.9.2.

*Insert new subclause 8.4.9.3.1:*

**8.4.9.3.1 Optional interleaver for CC**

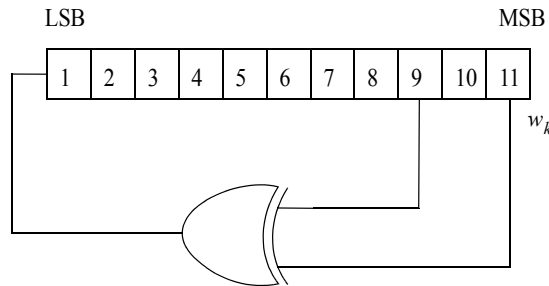
For the CC optional interleaver, the interleaver structure is as defined in 8.4.9.3. The value of  $d$  in Equation (126) through Equation (129) shall be set to  $16 \times n$  for the DL and  $16 \times n$  for the UL, where  $n$  is the number of allocated slots per FEC block.

**8.4.9.4 Modulation**

*Change the title of subclause 8.4.9.4.1 as indicated:*

**8.4.9.4.1 ~~Permutation definition~~ Subcarrier randomization**

*Replace Figure 262 with the following figure:*



**Figure 262—PRBS generator for pilot modulation**

*Change the second paragraph below Figure 262 as indicated:*

The initialization vector of the PRBS generator for both uplink and downlink shall be designated b10..b0, such that:

- b40..b64 = Five least significant bits of IDcell as indicated by the frame preamble in the first downlink zone and in the downlink AAS zone with Diversity\_Map support, DL\_PermBase following STC\_DL\_Zone\_IE() and 5 LSB of DL\_PermBase following AAS\_DL\_IE without Diversity\_Map support, except for zones marked by “Use all SC indicator = 1,” where these bits shall be set to 1, in the downlink. Five least significant bits of UL\_IDcell (as determined by the preamble) in the uplink. For downlink and uplink, b0 is MSB and b4 is LSB, respectively.
- b5..b46 = Set to the segment number + 1 as indicated by the frame preamble in the first downlink zone and in the downlink AAS zone with Diversity\_Map support, PRBS\_ID as indicated by the STC\_DL\_Zone\_IE or AAS\_DL\_IE without Diversity\_Map support in other downlink zones.

except for zones marked by “Use all SC indicator = 1,” where these bits shall be set to 10b11 in the uplink. For downlink and uplink, b5 is MSB and b6 is LSB, respectively.  
b37..b10 = 0b1111 (all ones) in the downlink and four least significant bits of the Frame Number in the uplink. Four least significant bits of symbol offset from the first data symbol in the frame (i.e., the symbol in the frame in which the DL-MAP starts) For downlink and uplink, b7 is MSB and b10 is LSB, respectively.

***Change the last paragraph as indicated:***

For example, should the initialization vector of the PRBS generator be b10..b0 = 10101010101, the initializations result in the sequence  $w_k = 10101010101000000000\dots$  in the uplink. ~~The PRBS shall be initialized so that its first output bit coincides with the first usable subcarrier (as defined in Table 313). The PRBS generator shall be clocked  $n$  times,  $n = \text{Symbol\_Offset} \bmod 32$ , before the generated output is applied to the subcarriers, where symbol offset is counted from the first symbol in each zone as zero in the downlink except downlink AAS zone with Diversity\_Map support where the symbol offset is counted from the first symbol of the first downlink zone as zero and from Allocation start time in the uplink (i.e., the first symbol in the uplink subframe is indexed 0). As a result, the PRBS shall be used such that its  $n$ -th output bit will coincide with the first usable subcarrier as defined for the zone in which the symbol resides. The output bit shall be counted from zero. Subcarriers belonging to UL allocations with UIUC=12 or UIUC=13 shall not be randomized. A new value shall be generated by the PRBS generator for every subcarrier up to the highest numbered usable subcarrier, in order of physical subcarriers, including the DC subcarrier and usable subcarriers that are not allocated.~~

***Insert the following paragraph at the end of the subclause:***

Consider DL PUSC. Let  $w_0, w_1, w_2, \dots$  be the bits generated after loading the correct initialization vector. The subcarriers of the first symbol in the zone (with symbol offset of zero) shall use the bits  $w_0, w_1, w_2, \dots, w_{1680}$ . For subcarriers of the second symbol (with symbol offset of 1) shall use the bits  $w_1, w_2, w_3, \dots, w_{1681}$ .

#### **8.4.9.4.2 Data modulation**

***Change the first sentence of the first paragraph as indicated:***

~~After bit interleaving the repetition block, the data bits are entered serially to the constellation mapper. Gray-mapped QPSK and 16-QAM (as shown in Figure 263) shall be supported, whereas the support of 64-QAM is optional.~~

***Change the last paragraph as indicated:***

Each  $M$  interleaved bits ( $M=2,4,6$ ) shall be mapped to the constellation bits  $b(M-1)$ - $b_0$  in MSB first order (i.e., the first bit shall be mapped to the higher index bit in the constellation), in addition, the  $M$  bits shall be ordered MSB first.

The constellation-mapped data shall be subsequently modulated onto the allocated data subcarriers. Before mapping the data to the physical subcarriers (i.e., after applying the subcarrier permutation), and each subcarrier shall be multiplied by the factor  $2^{*(1/2 - w_k)}$  according to the subcarrier physical index,  $k$ .

The operation shall be also applied for the subcarriers for the FAST\_FEEDBACK and ACK channels except the ranging.

In the downlink, data subcarriers that belong to slots that are not allocated in the DL-MAP shall not be transmitted (zero energy). Data subcarriers which are part of a gap allocation (DIUC=13) shall be modulated at

the BS discretion. In the downlink, such subcarriers that belong to the allocated slots for a burst but are not modulated shall not be transmitted (zero energy).

*Change the following text in 8.4.9.4.3 as indicated:*

#### **8.4.9.4.3 Pilot modulation**

*Change text in 8.4.9.4.3 as indicated:*

For the mandatory tile structure in the uplink, and for the TUSC1/TUSC2 structures in the downlink, pilot subcarriers shall be inserted into each data burst in order to constitute the symbol and they shall be modulated according to their subcarrier location within the OFDMA symbol.

In the downlink and for the optional uplink tile structure all permutations except uplink PUSC and downlink TUSC1, each pilot shall be transmitted with a boosting of 2.5 dB over the average non-boosted power of each data tone. The Pilot subcarriers shall be modulated according to Equation (135).

*Replace Equation (135) with the following:*

$$\begin{aligned} \operatorname{Re}\{c_k\} &= \frac{8}{3} \left( \frac{1}{2} - w_k \right) \cdot p_k \\ \operatorname{Im}\{c_k\} &= 0 \end{aligned} \quad (135)$$

where

$p_k$  is the pilot's polarity (as described in 8.4.6.3.3) for SDMA allocations in AMC AAS zone, and  $p = 1$  otherwise.

*Change the text in the last paragraph as indicated:*

In the downlink, for PUSC, FUSC, AMC and optional FUSC permutations, all pilots (of the segment, in case of PUSC) shall be modulated, whether or not all the subchannels are allocated in the DL-MAP. For AMC and PUSC-ASCA permutations in AAS zone or in a zone using 'Dedicated pilots', the BS ~~is not required to~~ shall not modulate the pilots that belong to ~~in~~ bins that are not allocated in the DL-MAP, or are allocated as gaps (DIUC=13).

*Insert the following text at the end of the subclause:*

In STC mode with DL PUSC or UL PUSC permutations, the power of pilot subcarriers shall be further scaled so that the total power transmitted by each antenna, is equal to the total power transmitted in non-STC mode, ignoring data boosting.

In the downlink, for PUSC, FUSC, AMC and optional FUSC permutations, all pilots (of the segment, in case of PUSC) shall be modulated, whether or not all the subchannels are allocated in the DL-MAP. For AMC permutation in AAS zone, the BS is not required to modulate the pilots that belong to bins that are not allocated in the DL-MAP, or are allocated as gaps (UIUC=13).

*Change the title of 8.4.9.4.3.1 as indicated:*

**8.4.9.4.3.1 Preambles/midambles pilot modulation**

*Insert new subclause 8.4.9.5:*

**8.4.9.5 Repetition**

Repetition coding can be used to further increase signal margin over the modulation and FEC mechanisms. In the case of repetition coding,  $R = 2, 4, \text{ or } 6$ , the number of allocated slots ( $N_s$ ) shall be a whole multiple of the repetition factor  $R$  for uplink. For the downlink, the number of the allocated slots ( $N_s$ ) shall be in the range of  $[R \times K, R \times K + (R - 1)]$ , where  $K$  is the number of the required slots before applying the repetition scheme. For example, when the required number of slots before the repetition is  $10 (= K)$  and the repetition of  $R = 6$  shall be applied for the burst transmission, then the number of the allocated slots ( $N_s$ ) for the burst can be from 60 slots to 65 slots.

The binary data that fits into a region that is repetition coded is reduced by a factor  $R$  compared to a non-repeated region of the  $(\lfloor N_s/R \rfloor \times R)$  slots with the same size and FEC code type. After FEC and bit-interleaving, the data is segmented into slots, and each group of bits designated to fit in a slot will be repeated  $R$  times to form  $R$  contiguous slots following the normal slot ordering that is used for data mapping. The actual constellation data can be different because of the subcarrier randomization as defined by 8.4.9.4.1. This repetition scheme applies only to QPSK modulation; it can be applied in all coding schemes except HARQ with CTC defined in 8.4.9.2.3.5.

*Insert new subclause 8.4.9.6:*

**8.4.9.6 Zone boosting**

When the usage of the subchannels in the first DL PUSC zone is limited by the “Used subchannel bitmap” in FCH, all subcarriers including pilot subcarriers in the corresponding zones shall be boosted. The amount of subcarrier boosting is the ratio of the number of the useful subcarriers excluding DC subcarrier and the number of the allowed subcarriers. The “allowed subcarriers” refers to the data and pilot subcarriers that are allowed to be used in the zone by the “Used subchannel bitmap” in FCH. When zone boosting is applied, the amount of additional subchannel boosting, as specified by the boosting field in the DL MAP\_IE that can be applied, shall not exceed 9 dB minus the amount of zone boosting.

*Insert a new subclause 8.4.9.7:*

**8.4.9.7 Multiple HARQ (optional)**

Supported Multiple HARQ modes may be enabled for any of the existing FEC modes. A change in the HARQ mode is signaled using the “HARQ Compact\_DL-MAP IE format for Switch HARQ Mode” (see 6.3.2.3.43.6.7). The definitions of the HARQ modes are defined in Table 333c.

**Table 333c—HARQ Modes definition**

HARQ Mode	Definition
0	CTC Incremental Redundancy
1	Generic Chase
2	Convolutional Coding (CC) Incremental Redundancy
3..15	<i>Reserved</i>

*Insert a new subclause 8.4.9.7.1:*

**8.4.9.7.1 Generic Chase HARQ**

When Chase Combining HARQ is enabled for a particular MS, the HARQ\_MAP will be used to signal the allocation and the HARQ Control IE will use the “Generic Chase” allocation format. The encoding of the companded subchannel field is defined in Table 333d. Concatenation rules for each respective coding mode are applied as defined for non-HARQ transmissions.

**Table 333d—Companded subchannels**

Companded subchannels	Assigned subchannels	Companded subchannels	Assigned subchannels
0	1	16	40
1	2	17	48
2	3	18	56
3	4	19	64
4	5	20	80
5	6	21	96
6	7	22	112
7	8	23	128
8	10	24	160
9	12	25	192
10	14	26	224
11	16	27	256
12	20	28	320
13	24	29	384
14	28	30	448
15	32	31	512

When HARQ is applied to a packet, error detection is provided on the HARQ packet through a Cyclic Redundancy Check (CRC).

The size of the CRC is 16 bits. CRC 16-CCITT, as defined in ITU-T Recommendation X.25, shall be included at the end of the HARQ packet and after the padding bits.

*Insert a new subclause 8.4.9.7.2:*

**8.4.9.7.2 CC Incremental Redundancy HARQ**

When Convolutional Coding (CC) Incremental Redundancy (IR) is enabled for a particular SS, the HARQ\_MAP will be used to signal the allocation and the HARQ Control IE will use the “CC IR” allocation format. The encoding of the companded subchannel field is identical to Generic Chase HARQ and is defined

in Table 332. Concatenation rules for each respective coding mode are applied as defined for non-HARQ transmissions.

### 8.4.10 Control mechanisms

#### 8.4.10.3 Power Control

*Change the third paragraph as indicated:*

To maintain at the BS a power density consistent with the modulation and FEC rate used by each SS, the BS may change the SS TX power through power correction messages, as well as the SS assigned modulation and FEC rate. There are, however, situations where the SS should automatically update its TX power, without being explicitly instructed by the BS. This happens when the SS transmits in region marked by UIUC = 0, UIUC = 12, or UIUC = 14. In all these situations, the SS shall use a temporary TX power value set according to Equation (138) (in dB),

$$P_{new} = P_{last} + (C/N_{new} - C/N_{last}) - (\log_{10}(R_{new}) - \log_{10}(R_{last})) + \text{Offset} \quad (138)$$

where

- $P_{new}$  is the temporary TX Power,
- $P_{last}$  is the last used TX Power,
- $C/N_{new}$  is the normalized C/N of new modulation/FEC rate instructed by the UIUC,
- $C/N_{last}$  is the normalized C/N of the last used modulation/FEC rate,
- $R_{new}$  is the number of repetitions for the new modulation/FEC rate instructed by the UIUC,
- $R_{last}$  is the number of repetitions on the last used modulation/FEC rate,
- Offset is an accumulation of power correction terms sent by the BS since the last transmission.

In all other situations, the SS shall use TX power value set according to Equation (138a) (in dB).

$$P_{new} = P_{last} + \text{Offset} \quad (138a)$$

The default normalized C/N values per modulation are given by Table 334. These values may be overridden by the BS by using a dedicated UCD message TLV.

*Change Table 334 as indicated:*

**Table 334—Normalized C/N per modulation**

Modulation/ FEC rate	Normalized C/N
<u>ACK region</u>	<u>-3.0</u>
<del>Fast_feedback</del> <u>FAST_FEEDBACK</u>	0
CDMA code	3
<u>QPSK 1/3</u>	<u>0.5</u>
QPSK 1/2	6
<u>QPSK 2/3</u>	<u>7.5</u>
QPSK 3/4	9

**Table 334—Normalized C/N per modulation (continued)**

Modulation/ FEC rate	Normalized C/N
<u>Sounding transmission</u>	<u>9</u>
16-QAM 1/2	12
<u>16-QAM 2/3</u>	<u>14.5</u>
16-QAM 3/4	15
<u>16-QAM 5/6</u>	<u>17.5</u>
64-QAM 1/2	18
64-QAM 2/3	20
64-QAM 3/4	21
64-QAM 5/6	23

*Delete the first paragraph below Table 334.*

To maintain at the BS a power density consistent with the modulation used by each SS, the BS may change the SS TX power as well as the SS assigned modulation and FEC rate. There are, however, situations where the SS should automatically update its TX power, without being explicitly instructed by the BS. This happens when the SS transmits in region marked by UIUC = 0, UIUC = 12, or UIUC = 14. In all these situations, the SS shall use a temporary TX power value set according to the formula  $\text{Temporary\_TX\_Power} = \text{Last\_TX\_Power\_Normalized\_C/N\_of\_last\_modulation} + \text{Normalized\_C/N\_of\_QPSK\_1/2\_modulation}$ .

*Change the second paragraph below Table 334 as indicated:*

The SS shall report the maximum available power and the normalized transmitted power. These parameters may be used by the base station for optimal assignment of coding schemes and modulations and also for optimal allocation of subchannels. The algorithm is vendor-specific. ~~These parameters are reported in the REG-RSP message.~~ The maximum available power may be reported in SBC-REQ. The current transmitted power shall also reported in the RNGEP-RSP message if the relevant flag in the REP-REQ message has been set.

*Insert a new subclause 8.4.10.3.1*

#### **8.4.10.3.1 Closed loop power control**

*Insert the following text before Table 334:*

For the periodic ranging, once MS sends periodic ranging code and fails to receive RNG-RSP, MS may adjust its Tx power for the subsequent periodic ranging codes transmission up to  $P_{TX\_IR\_MAX}$  (6.3.9.5.1). For the bandwidth request ranging, once MS sends bandwidth request ranging code and fails to receive CDMA allocation IE or RNG-RSP, MS may adjust its Tx power for the subsequent bandwidth request ranging codes transmission up to  $P_{TX\_IR\_MAX}$  (6.3.9.5.1).

***Insert a new subclause 8.4.10.3.2:***

**8.4.10.3.2 Optional open loop power control**

When the open loop power control is supported and the uplink power control mode is changed to open loop power control by PMC\_RSP, the power per a subcarrier shall be maintained for the UL transmission as follows. This open loop power control shall be applied for the all uplink bursts.

$$P(\text{dBm}) = L + C/N + NI - 10\log_{10}(R) + \text{Offset}_{SS_{perSS}} + \text{Offset}_{BS_{perSS}} \quad (138a)$$

where

- P* is the TX Power level (dBm) per a subcarrier for the current transmission, including MS Tx antenna gain.
- L* is the estimated average current UL propagation loss. It shall include SS Tx antenna gain and path loss, but exclude the BS Rx antenna gain.
- C/N* is the normalized *C/N* of the modulation/FEC rate for the current transmission, as appearing in Table 334. Table 334 can be modified by UCD (Normalized *C/N* override).
- R* is the number of repetitions for the modulation/FEC rate.
- NI* is the estimated average power level (dBm) of the noise and interference per a subcarrier at BS, not including BS Rx antenna gain.
- Offset<sub>SS<sub>perSS</sub></sub>* is the correction term for SS-specific power offset. It is controlled by SS. Its initial value is zero.
- Offset<sub>BS<sub>perSS</sub></sub>* is the correction term for SS-specific power offset. It is controlled by BS with power control messages. When *Offset<sub>BS<sub>perSS</sub></sub>* is set through the PMC\_RSP message, it shall include BS Rx antenna gain.

The estimated average current UL propagation loss, *L*, shall be calculated based on the total power received on the active subcarriers of the frame preamble, and with reference to the BS\_EIRP parameter sent by the BS.

The default normalized *C/N* values per modulation are given by Table 334. The operating parameters BS\_EIRP and *NI* are signaled by a DCD message (see Table 358).

Additionally, the BS controls the *Offset<sub>BS<sub>perSS</sub></sub>* using PMC\_RSP message (6.3.2.3.58) to override the *Offset<sub>BS<sub>perSS</sub></sub>* value, or using RNG-RSP (6.3.2.3.6), Fast Power Control (FPC) message (6.3.2.3.34), Power Control IE (8.4.5.4.5) and UL-MAP\_Fast\_Tracking\_IE (8.4.5.4.22) to adjust the *Offset<sub>BS<sub>perSS</sub></sub>* value. The accumulated power control value shall be used for *Offset<sub>BS<sub>perSS</sub></sub>*.

The *Offset<sub>BS<sub>perSS</sub></sub>* can be updated using relative or fixed form (as a function of the relevant adjustment commands used). Fixed form is used when the parameter is obtained from a PMC\_RSP message. In this case, the SS should replace the old *Offset<sub>BS<sub>perSS</sub></sub>* value by the new *Offset<sub>BS<sub>perSS</sub></sub>* sent by the BS. With all other messages mentioned in the previous paragraph, relative form is used. In this case, MS should increase and decrease the *Offset<sub>BS<sub>perSS</sub></sub>* according to the offset value sent by BS.

The actual power setting shall be quantized to the nearest implementable value, subject to the specification (8.4.12.1). For each transmission, the SS shall limit the power, as required to satisfy the spectral masks and EVM requirements.

**Passive Uplink open loop power control:**

In passive Uplink open loop power control the SS will set *Offset<sub>SS<sub>perSS</sub></sub>* to zero and modify the TX power value using Equation (138a).



**Active Uplink open loop power control**

An alternative way is that the SS may adjust  $Offset\_SS_{perSS}$  value within a range.

$$Offset\_Bound_{lower} \leq Offset\_SS_{perSS} \leq Offset\_Bound_{upper} \quad (138b)$$

where

$Offset\_Bound_{upper}$  is the upper bound of  $Offset\_SS_{perSS}$   
 $Offset\_Bound_{lower}$  is the lower bound of  $Offset\_SS_{perSS}$

Or in case ARQ is enabled at some UL connections, the  $Offset\_SS_{perSS}$  may be updated automatically based on the Ack/Nack within the range as specified by Equation (138c). The specific algorithm is described as follows (in dB):

$$\begin{aligned} \text{if NAK is received } & Offset\_SS_{perSS} = Offset\_SS_{perSS} + UP\_STEP \\ \text{else if ACK is received } & Offset\_SS_{perSS} = Offset\_SS_{perSS} - DOWN\_STEP \\ \text{else where } & Offset\_SS_{perSS} = Offset\_SS_{perSS} \end{aligned} \quad (138c)$$

where

$UP\_STEP$  is the up adjustment step as specified by “SS-specific up power offset adjustment step” TLV  
 $DOWN\_STEP$  is the down adjustment step as specified by “SS-specific down power offset adjustment step” TLV.

The operating parameters  $UP\_STEP$ ,  $DOWN\_STEP$ ,  $Offset\_Bound_{upper}$ ,  $Offset\_Bound_{lower}$  are signaled by a dedicated UCD message TLV.

**Insert a new subclause 8.4.10.3.2.1:****8.4.10.3.2.1 UL Tx power and Headroom transmission condition**

SS may report its transmission power status using Bandwidth request and UL Tx Power Report header (6.3.2.1.2.1.2), PHY channel report header (6.3.2.1.2.1.5) or UL Tx Power Report extended subheader (6.3.2.2.7.5). Further, when the following conditions are met, SS may send its transmission power status using Bandwidth request and UL Tx Power Report header (6.3.2.1.2.1.2), PHY channel report header (6.3.2.1.2.1.5) or UL Tx Power Report extended subheader (6.3.2.2.7.5).

$$|M_{avg}(n_{last}) - M_{avg}(n)| \geq Tx\_Power\_Report\_Threshold \quad (dB) \quad (138d)$$

or

$$n - n_{last} \geq Tx\_Power\_Report\_Interval$$

where

$$\begin{aligned} M(n) &= L + NI + Offset\_SS_{perSS} + Offset\_BS_{perSS} \quad (dB), \\ M_{avg}(n) &= 10 \log(\alpha_{p\_avg} \cdot 10^{M(n)/10} + (1 - \alpha_{p\_avg}) \cdot 10^{(M_{avg}(n-1))/10}), \end{aligned}$$

$n_{last}$  is the time index when the last SS Tx Power Report is sent. The unit is frame. Tx\_Power\_Report\_Threshold, Tx\_Power\_Report\_Interval, and  $\alpha_{p\_avg}$  are indicated in UCD. In UCD, there are sets of those parameters sets: Depending on the allocation CQICH to SS, the corresponding parameter set shall be used.

### 8.4.11 Channel quality measurements

#### 8.4.11.2 RSSI mean and standard deviation

*Change the second paragraph as indicated:*

Mean and standard deviation statistics shall be reported in units of dBm and dB, respectively. To prepare such reports, statistics shall be quantized in 1 dB increments, ranging from -40 dBm (encoded 0x53) to -123 dBm (encoded 0x00). Values outside this range shall be assigned the closest extreme value within the scale.

*Replace Equation (142) and Equation (143) with the following equations:*

$$\hat{x}_{RSSI}^2[k] = \begin{cases} |R[0]|^2 & k = 0 \\ (1 - \alpha_{avg})\hat{x}_{RSSI}^2[k-1] + \alpha_{avg}|R[k]|^2 & k > 0 \end{cases} \quad (mW)^2 \quad (142)$$

$$\hat{\sigma}_{RSSI \text{ dB}} = 5 \log \left( \hat{x}_{RSSI}^2[k] - (\hat{\mu}_{RSSI}[k])^2 \right) \quad dBm \quad (143)$$

*Insert the following paragraph at the end of the subclause:*

The message time index is incremented every frame. The reported RSSI value shall be an estimate of the total received power of the frame preamble of the segment of the connected BS.

#### 8.4.11.3 CINR mean and standard deviation

*Change the subclause as indicated:*

When physical CINR measurements are mandated by the BS, an SS shall obtain a CINR measurement (implementation-specific). From a succession of these measurements, the SS shall derive and update estimates of the mean and/or the standard deviation of the CINR, and report them via REP-RSP messages and/or report the estimate of the mean of the physical CINR via the fast-feedback channel (CQICH).

For the REP-RSP, the following encoding shall be used unless different encoding scheme is defined. Mean and standard deviation statistics for CINR shall be reported in units of dB. To prepare such reports, statistics shall be quantized in 1 dB increments, ranging from a minimum of -10 dB (encoded 0x00) to a maximum of 53 dB (encoded 0x3F). Values outside this range shall be assigned the closest extreme value within the scale.

The method used to estimate the CINR of a single message is left to individual implementation, but the relative and absolute accuracy of a CINR measurement derived from a single message shall be  $\pm 1$  dB and  $\pm 2$  dB, respectively. The specified accuracy shall apply to the range of CINR values starting from 3 dB below SNR of the most robust rate, to 10 dB above the SNR of the least robust rate. See Table 338.

If physical CINR report from the preamble was instructed, then the reported CINR shall be an estimate of the CINR over the subcarriers of the preamble. For the frequency reuse configuration=3 type, the reported CINR shall be the estimate of the CINR over the modulated subcarriers of the preamble. For the frequency reuse configuration=1, the reported CINR shall be the estimate of the average CINR over all subcarriers of

the preamble except the guard subcarriers and the DC subcarriers. In other words, the signal on the unmodulated subcarriers (except the guard subcarriers and the DC subcarriers) shall also be considered as noise and interference for the CINR estimate of the frequency reuse configuration=1. The reported value shall represent the average CINR on non-boasted data subcarriers of the first zone in the frame; hence preamble boosting shall be compensated for in both desired signal and interference/noise calculation.

In case physical CINR report on specific permutation zone was instructed, then the reported value shall represent the average CINR on non-boasted data subcarriers of the zone on which measurement was requested; hence pilot boosting shall be compensated for in both desired signal and interference/noise calculation.

In case physical CINR reporting on STC zone is instructed, the SS shall report the average post-combined CINR.

In addition, the range over which these single-packet measurements are measured should extend 3 dB on each side beyond the -10 dB to 53 dB limits for the final reported, averaged statistics.

One possible method to estimate the CINR of a single message is to compute the ratio of the sum of signal power and the sum of residual error for each data sample, using Equation (144).

$$CINR[k] = \frac{\sum_{n=0}^{N-1} |s[k, n]|^2}{\sum_{n=0}^{N-1} |r[k, n] - s[k, n]|^2} \quad (144)$$

where  $r[k, n]$  received sample  $n$  within message measured at time index  $k$  in frame units;  $s[k, n]$  the corresponding detected or pilot sample (with channel state weighting) corresponding to received symbol  $n$ . The message time index is incremented every frame. The SS shall maintain separate message time index counters and mean CINR estimates for REP-RSP-based reports and for Fast-Feedback-based reports. When the CINR configuration is changed (i.e., CINR report configuration in a CQICH IE or REP-REQ message differ from the previous CQICH IE or REP-REQ respectively), the SS shall reset the corresponding message time index to zero.

The mean CINR statistic (in dB) shall be derived from a multiplicity of single messages using Equation (145).

$$\hat{\mu}_{CINR\ dB}[k] = 10\log(\hat{\mu}_{CINR}[k]) \quad (145)$$

where

$$\hat{\mu}_{CINR}[k] = \begin{cases} CINR[0] & k = 0 \\ (1 - \alpha_{avg})\hat{\mu}_{CINR}[k-1] + \alpha_{avg} CINR[k] & k > 0 \end{cases} \quad (146)$$

$k$  is the time index for the message (with the initial message being indexed by  $k = 0$ , the next message by  $k = 1$ , etc.);  $CINR[k]$  is a linear measurement of CINR (derived by any mechanism which that delivers the prescribed accuracy) for message  $k$ ; and  $\alpha_{avg}$  is an averaging parameter specified by the BS.

To solve for the standard deviation, the expectation-squared statistic shall be updated using Equation (147).

$$\hat{x}_{CINR}^2[k] = \begin{cases} |CINR[0]|^2 & k = 0 \\ (1 - \alpha_{avg})\hat{x}_{CINR}^2[k-1] + \alpha_{avg}|CINR[k]|^2 & k > 0 \end{cases} \quad (147)$$

and the result applied to

$$\hat{\sigma}_{CINR\ dB} = 5 \log(|\hat{x}_{CINR}^2[k] - (\hat{\mu}_{CINR}[k])^2|) \quad dB \quad (148)$$

The averaging parameter ( $\alpha_{avg}$ ) may be sent as a DCD message TLV. Unless specified otherwise, the default averaging parameter ( $\alpha_{avg}$ ) is 1/4. When the averaging parameter ( $\alpha_{avg}$ ) is given to an SS through REP-REQ, this value shall only be used for deriving physical CINR estimates reported through REP-RSP, and can further only be changed through another REP-REQ message. When the averaging parameter is given to an SS through COICH\_Allocation IE, this value shall only be used for deriving physical CINR estimates reported through fast-feedback channel (COICH), and can further only be changed through another COICH Allocation IE. An averaging parameter value sent through DCD shall not override the averaging parameter value sent in a dedicated REP-REQ message or a COICH Allocation IE.

*Insert new subclause 8.4.11.4:*

#### 8.4.11.4 Optional Frequency Selectivity Characterization

In order to characterize the relationship between channel frequency selectivity and link performance in a compact form, the parameters of an effective CINR versus weighting parameter  $\beta$  curve can be sent from the SS to the BS using an unsolicited REP-RSP TLV. When requested by the BS, the SS shall compute a quadratic approximation of an effective CINR (dB) vs.  $\beta$  dB =  $10 \log(\beta)$  curve. The quadratic approximation is represented as: effective-CINR dB( $\beta$  dB) =  $a + b \times \beta$  dB +  $c \times \beta$  dB. Where  $a$ ,  $b$  and  $c$  are the Y-intercept, linear, and quadratic parameters, respectively, that are to be estimated by the SS. The quadratic approximation is derived by performing a curve fit to an experimentally derived effective CINR versus  $\beta$  curve.

#### 8.4.12 Transmitter requirements

##### 8.4.12.2 Transmitter spectral flatness

*Insert the following paragraph as the first paragraph:*

All requirements on the transmitter apply to the RF output connector of the equipment. For equipment with integral antenna only, a reference antenna with 0 dBi gain shall be assumed.

*Change the next paragraph as indicated:*

The average energy of the constellations in each of the  $n$  spectral lines shall deviate no more than indicated in Table 335. The absolute difference between adjacent subcarriers shall not exceed 0.1 dB excluding intentional boosting or suppression of subcarriers, CSIT sounding symbols and PAPR reduction subchannels are not allocated.

*Insert the following sentence after Table 335:*

The power transmitted at spectral line 0 shall not exceed -15 dB relative to total transmitted power.

**8.4.12.3 Transmitter constellation error and test method**

*Insert the following sentence to the end of the first paragraph:*

When measuring the transmitter constellation error, it should be noted that if multiple permutation zones are present in a DL sub-frame, the pilot level may shift when transitioning from zone to zone, as the BS attempts to maintain constant power density throughout the frame.

*Change Table 336 as indicated:*

**Table 336—Allowed relative constellation error versus data rate**

Burst type	Relative constellation error for SS (dB)	Relative constellation error for BS (dB)
QPSK-1/2	<del>16.4</del> -15	-15
QPSK-3/4	<del>18.2</del> -18	-18
16-QAM-1/2	<del>23.4</del> -20.5	-20.5
16-QAM-3/4	<del>25.2</del> -24	-24
<u>64-QAM-1/2</u>	-26	-26
64-QAM-2/3	<del>29.7</del> -28	-28
64-QAM-3/4	<del>31.4</del> -30	-30

*Replace the text starting from the second paragraph below Table 336 until the end of the subclause with the following new subclause:*

**8.4.12.3.1 RMS constellation error measurement for BS (downlink)**

The test may be performed in any permutation zone like PUSC. The sampled signal shall be processed in a manner similar to an actual receiver, according to the following steps:

- a) The BS under test shall transmit all subchannels defined in the symbol structure (see 8.4.6).
- b) Locate the Preamble.
- c) Perform timing and frequency estimation.
- d) Compensate the timing offset as estimated.
- e) The received signal shall be de-rotated according to estimated frequency offset.
- f) The complex channel response coefficients shall be estimated for each of the subcarriers.
- g) Divide each subcarrier value by the complex estimated channel response coefficient.
- h) For each data-carrying subcarrier, find the closest constellation point and compute the Euclidean distance from it.
- i) Compute the RMS average of all errors in a packet, given by Equation (149).

*Insert new subclause 8.4.12.3.2:*

#### 8.4.12.3.2 RMS constellation error measurement for SS

The sampled signal shall be processed in a manner similar to an actual receiver, according to the following steps:

- a) The SS under test shall transmit on part of the UL subchannels. Recommended value is 1/4 of the UL subchannels.
- b) The tester will locate a complete UL subframe.
- c) Perform timing and frequency estimation.
- d) Compensate the timing offset as estimated.
- e) The received signal shall be de-rotated according to estimated frequency offset.
- f) Estimate the average channel according to the pilots.
- g) Divide each subcarrier value with a complex estimated channel response coefficient.
- h) For each data-carrying subcarrier, find the closest constellation point and compute the Euclidean distance from it.
- i) Compute the RMS average of all errors in a packet. It is given by Equation (149).
- j) Normal RMS constellation error measurement shall be performed in scenarios where the number of modulated subcarriers is constant across symbols.
- k) In case the number of subcarriers varies between symbols, it is recommended to measure RMS constellation error separately for symbols with different power levels.

*Insert new subclause 8.4.12.3.3:*

#### 8.4.12.3.3 Calculation of RMS constellation error

$$Error_{RMS}^2 = \frac{\frac{1}{N_f} \sum_{i=1}^{N_f} \sum_{j=1}^{L_p} \sum_{k \in S} [(I(i,j,k) - I_0(i,j,k))^2 + (Q(i,j,k) - Q_0(i,j,k))^2]}{\sum_{j=1}^{L_p} \sum_{k \in S} [I_0(i,j,k)^2 + Q_0(i,j,k)^2]} \quad (149)$$

where

- |                            |  |
|----------------------------|--|
| $L_p$                      | is the length of the packet,   |
| $N_f$                      | is the number of frames for the measurement,   |
| $(I_0(i,j,k), Q_0(i,j,k))$ | denotes the ideal symbol point of the $i$ -th frame, $j$ -th OFDMA symbol of the frame, $k$ -th subcarrier of the OFDMA symbol in the complex plane, |
| $(I(i,j,k), Q(i,j,k))$     | denotes the observed point of the $i$ -th frame, $j$ -th OFDMA symbol of the frame,  |
| $k$ -th                    | is the subcarrier of the OFDMA symbol in the complex plane,  |
| $S$                        | is the group of modulated data subcarriers where the measurement is performed.   |

**Insert new subclause 8.4.12.3.4:****8.4.12.3.4 Unmodulated subcarrier errors for SS**

Unmodulated subcarrier errors is a measure of the amount of noise emitted by the SS on the unmodulated subcarriers (within the used subcarriers range). The measure is relative to the power emitted by the SS on the modulated subcarriers.

- a) The SS under test shall transmit on part of the UL subchannels.
- b) The tester will locate a complete UL subframe.
- c) Perform timing and frequency estimation.
- d) Compensate the timing offset as estimated.
- e) The received signal shall be de-rotated according to estimated frequency offset.
- f) The unmodulated subcarrier errors (relative to the transmitted power) shall be measured according to Equation (149a).
- g) The value of the unmodulated subcarrier error shall not exceed the maximum values defined in Table 336.

$$Error_{RMS}^2 = \frac{1}{N_f} \sum_{i=1}^{N_f} \frac{\sum_{j=1}^{L_p} \sum_{k \in S_u} [I(i,j,k)^2 + Q(i,j,k)^2]}{\sum_{j=1}^{L_p} \sum_{k \in S} [I_0(i,j,k)^2 + Q_0(i,j,k)^2]} \quad (149a)$$

where

- $L_p$  is the length of the packet,
- $N_f$  is the number of frames for the measurement,
- $(I_0(i,j,k), Q_0(i,j,k))$  denotes the ideal symbol point of the  $i$ -th frame,  $j$ -th OFDMA symbol of the frame,  $k$ -th subcarrier of the OFDMA symbol in the complex plane,
- $(I(i,j,k), Q(i,j,k))$  denotes the observed point of the  $i$ -th frame,  $j$ -th OFDMA symbol of the frame,
- $k$ -th is the subcarrier of the OFDMA symbol in the complex plane,
- $S$  is the group of modulated data subcarriers where the measurement is performed.
- $S_u$  is the group of the un-modulated data subcarriers. It includes all subcarriers in the range  $0 \dots N_{used}-1$ , except the DC subcarrier and the modulated subcarriers (in  $S$ ).

**Insert new subclause 8.4.12.4:****8.4.12.4 Transmitter reference timing accuracy**

At the BS, the transmitted downlink radio frame shall be time-aligned with the 1pps timing pulse (8.4.10.1.1). The start of the preamble symbol, excluding the CP duration, shall be time aligned with 1pps timing pulse when measured at the antenna port.

At the MS, upon close-loop adjustments of transmit and receive timings from BS through CDMA ranging methods during network entry and periodic ranging, the MS obtains the system time reference. Thereafter, the MS shall maintain the relative time reference when measured at the antenna port.

### 8.4.13 Receiver requirements

*Insert new subclause 8.4.13.1 entitled “OFDMA PHY requirements for enhanced handover performance”. The existing 8.4.13.1 Receiver sensitivity (along with the existing text under that subclause) shall become 8.4.13.1.1.*

#### **8.4.13.1 OFDMA PHY requirements for enhanced handover performance**

##### **8.4.13.1.1 Receiver sensitivity**

*Change the first paragraph as indicated:*

The BER measured after FEC shall be less than  $10^{-6}$  at the power levels ~~shown in Table 337~~ given by Equation (149b) for standard message and test conditions. ~~If the implemented bandwidth is not listed, then the values for the nearest smaller listed bandwidth shall apply.~~ The minimum input levels are measured as follows:

- ~~At the antenna connector or through a calibrated radiated test environment.~~
- Using the defined standardized message packet formats.
- Using an AWGN channel.

*Delete Table 337.*

*Change the paragraph below Table 337 as indicated:*

~~Table 337 (as well as Table 336) are derived assuming 5 dB implementation loss, a Noise Figure of 7 dB, and receiver SNR and  $E_b/N_0$  values as listed in Table 338.~~

The receiver minimum sensitivity level, RSS, is derived according to Equation (149b):

$$R_{SS} = -114 + SNR_{Rx} - 10 \times \log_{10}(R) + 10 \times \log_{10}\left(\frac{F_S \times N_{Used}}{N_{FFT}}\right) + ImpLoss + NF \quad (149b)$$

where

- $SNR_{Rx}$  is the receiver SNR as per Table 338.
- $R$  is the repetition factor, as described in 8.4.9.
- $F_S$  is the sampling frequency in MHz as defined in 8.4.2.4.
- $ImpLoss$  is the implementation loss, which includes non-ideal receiver effects such as channel estimation errors, tracking errors, quantization errors, and phase noise. The assumed value is 5 dB.
- $NF$  is the receiver noise figure, referenced to the antenna port. The assumed value is 8 dB.



*Change Table 338 as indicated:*

**Table 338—Receiver SNR and  $E_b/N_0$  assumptions**

Modulation	$E_b/N_0$ (dB)	Coding rate	Receiver SNR (dB)
QPSK	10.5	1/2	9.4 <u>5</u>
		3/4	11.2 <u>8</u>
16-QAM	14.5	1/2	16.4 <u>10.5</u>
		3/4	18.2 <u>14</u>
64-QAM	19.0	<u>1/2</u>	<u>16</u>
		2/3	22.7 <u>18</u>
		3/4	24.4 <u>20</u>

*Insert the following sentence below Table 338:*

*Note that these SNR values are derived in an AWGN environment, and assume that a tail-biting convolutional code (CC) is used.*

*Insert two new subclauses 8.4.13.1.2 and 8.4.13.1.3:*

#### **8.4.13.1.2 MS uplink transmit time tracking accuracy**

With the time reference MS maintained in 8.4.12.3, MS shall autonomously adjust uplink transmit timing according to the timing advances and retards of the detected downlink earliest arrival path in the preamble symbol. The autonomous timing reference shall be tracked at antenna port without BS close-loop timing control.

At the MS, the transmitted radio frame shall be time-aligned with the network specified uplink frame boundary. At zero timing advance and retard setting, the start of the first uplink data symbol, excluding the CP duration, shall be time aligned with the specified uplink frame boundary relative to the downlink arrival time when measured at the antenna port without BS close-loop control.

#### **8.4.13.1.3 MS autonomous neighbor cell scanning**

If an MS supports FBSS/MDHO capability as defined in 11.7.11, the MS shall support autonomous neighbor cell scanning procedure according to the following. The MS may also perform normal scanning procedures as defined in 6.3.20.1.2.

For autonomous scanning procedure, the MS shall perform neighbor cell scanning via preamble detection for neighbor cells in the same carrier frequency. The MS shall maintain the signal quality database for neighbor cells without being instructed by the BS.

*Change the title of 8.4.13.2 as indicated:*

#### **8.4.13.2 Receiver adjacent and ~~alternatenon-adjacent~~ channel rejection**

### 8.4.13.3 Receiver maximum input signal

*Insert new subclause 8.4.13.3.1 immediately after the title of subclause 8.4.13.3:*

#### 8.4.13.3.1 SS receiver maximum input signal

*Move the text of subclause 8.4.13.3 to subclause 8.4.13.3.1 with the following changes:*

The SS receiver shall be capable of decoding a maximum on-channel signal of  $-30$  dBm.

*Insert new subclause 8.4.13.3.2:*

#### 8.4.13.3.2 BS receiver maximum input signal

The BS receiver shall be capable of decoding a maximum on-channel signal of  $-45$  dBm.

### 8.4.14 Frequency control requirements

#### 8.4.14.1 Center frequency and symbol clock frequency tolerance

*Change the second paragraph as indicated:*

~~At the SS, both the transmitted center frequency and the symbol clock frequency shall be synchronized to the BS with a tolerance of maximum 2% of the subcarrier spacing. At the SS, both the transmitted center frequency and the sampling frequency shall be derived from the same reference oscillator. Thereby, the SS uplink transmission shall be locked to the BS, so that its center frequency shall deviate no more than 2% of the subcarrier spacing, compared to the BS center frequency.~~

*Change the last paragraph as indicated:*

During the synchronization period, the SS shall acquire frequency synchronization within the specified tolerance before attempting any uplink transmission. During normal operation, the SS shall track the frequency changes by estimating the downlink frequency offset and shall defer any transmission if synchronization is lost. To determine the transmit frequency, the SS shall accumulate the frequency offset corrections transmitted by the BS (for example in RNG-RSP message), and may add to the accumulated offset, an estimated UL frequency offset based on the downlink signal.

*Insert a new subclause 8.4.15:*

#### 8.4.15 Optional HARQ support

The following optional modes exist for HARQ

- Incremental redundancy for CTC—specified in 6.3.17 and in 8.4.9.2.3.5.
- Incremental redundancy for CC (convolutional code)—specified in 8.4.15.2 and 8.4.9.2.1.2
- Chase combining for all coding schemes specified in 8.4.15.1

These modes can be suppressed by the normal map and the HARQ map.

*Insert a new subclause 8.4.15.1:*

#### **8.4.15.1 Optional Chase HARQ support**

The optional Chase HARQ scheme enables BS and SS to enhance performance of HARQ enabled connection by means of chase combining scheme. This scheme is supported for all coding schemes. Each burst is appended with a CRC that is checked by the receiver. An uplink and a downlink ACK channels are defined (see 8.4.5.4.13 and 8.4.5.4.24). The receiver replies with an ACK in the corresponding ACK channel if the decoding succeeded and with a NACK if the decoding failed.

If the burst was not ACK-ed, the transmitter may transmit a burst with exactly the same data contents again. The receiver may combine the newly received burst with the formerly received burst(s) to enhance decoding performance.

*Insert a new subclause 8.4.15.1.1:*

##### **8.4.15.1.1 HARQ Retransmission process**

The process of retransmissions is controlled by the BS using the ACID (ARQ Channel ID) and AI\_SN fields in the DL and UL maps. Each HARQ channel (indicated by specific ACID of 0–15) is managed separately.

When the AI\_SN field in the HARQ channel remains the same between two HARQ burst allocations, it indicates retransmission. In this case, the transmitter is required to retransmit the same data that was transmitted using the same ACID and AI\_SN. The burst profile of the retransmission must be the same as in the first transmission; however, the level of boosting and repetition may be changed.

When the AI\_SN field in the HARQ channel is changed, it indicates transmission of new data. In this case, the data stored in the transmitter and receiver for this ACID and the previously used AI\_SN may be discarded.

*Insert a new subclause 8.4.15.1.2:*

##### **8.4.15.1.2 CRC**

Bursts transmitted using Chase HARQ shall include CRC of 16 bits. The CRC is appended to MAC data after padding (before partitioning to FEC blocks and encoding as defined in 8.4.9). Padding is done so that the total length after CRC concatenation matches the size of the burst indicated by the map.

The CRC shall be CRC16-CCITT, as defined in ITU-T Recommendation X.25, and it is calculated over all the bits in the burst, including data and padding.

This CRC shall be used for error detection and for ACK/NACK transmission.

*Insert a new subclause 8.4.15.1.3:*

##### **8.4.15.1.3 Concurrent transmission of UL HARQ bursts**

The BS may allocate more than one UL HARQ burst for an SS (see 8.4.4.5). The maximal number of UL bursts supported by an HARQ enabled SS is indicated by the capability field in 11.8.3.7.11 and includes both HARQ and non-HARQ bursts.

*Insert a new subclause 8.4.15.1.4:*

#### **8.4.15.1.4 Encoding**

When using Chase-HARQ with HARQ DL/UL IE in the normal maps, the encoding scheme is indicated by DIUC/UIUC code and the encoding process shall be the same as in non-HARQ transmission with the same DIUC/UIUC.

*Insert a new subclause 8.4.15.2:*

#### **8.4.15.2 Optional IR HARQ for CC (convolutional code)**

This mode of operation is similar to Chase HARQ (see 8.4.15.1). The specifications in 8.4.15.1 apply to this mode, except for the following differences:

- 1) An SPID field is supplied by the HARQ DL/UL MAP IE.
- 2) The value of SPID may be arbitrarily changed by the BS between retransmissions.
- 3) The encoding process is based on the non-HARQ coding scheme, except for the changes indicated in 8.4.9.2.1.2.

## 9. Configuration

*Change the title of subclause 9.1 as indicated:*

### **9.1 SS IP addressing used on secondary management connection**

*Insert the following after 9.1.1:*

#### **9.1.2 Mobile IP v4 fields used by the MS**

If Mobile IP v4 is used, the following fields shall be present in the Mobile IP registration request from the MS and shall be set as described below and encoded according to IETF RFC 3344.

- a) When the MS (or Mobile Node) attempts to obtain an IP address dynamically, the home address field shall be set to “0.0.0.0”.
- b) When the MS attempts to obtain an IP address in the visited network, the home agent address field shall be set to “0.0.0.0”. On the other hand, when the MS attempts to obtain an IP address in the home network, the home agent address field shall be set to “255.255.255.255”.
- c) The Network Access Identifier (NAI) extension [IETF RFC 2789] shall be included for identifying the Mobile IP user.
- d) The Challenge extension shall be included [IETF RFC 3012], if the Challenge extension is included in the Agent Advertisement message.
- e) A 128-bit key may be shared between an MS and an ASA server during the initial Mobile IP registration, and the MS-ASA Authentication extension may be generated based on the shared key [IETF RFC 3012].

The following fields are expected in the Mobile IP registration response returned to the MS. The MS shall configure itself based on the Mobile IP registration response

- The home address to be used by the MS.
- The MS’s NAI extension to identify a Mobile IP user [IETF RFC 2789]
- The challenge extension if the foreign agent supports more strong security.
- The MS and home agent authentication extension for authenticating the home agent.
- The key reply extensions for security between the MS and the home agent, and between the MS and foreign agent, if the MS requests keys between the MS and the home agent, and between the MS and the foreign agent.

Authorized licensed use limited to: Fish & Richardson. Downloaded on April 11,2016 at 21:40:33 UTC from IEEE Xplore. Restrictions apply.

## 10. Parameters and constants

### 10.1 Global values

Change Table 342 as indicated:

**Table 342—Parameters and constants**

System	Name	Time reference	Minimum value	Default value	Maximum value
BS	UCD Transition	<del>The time</del> <u>The number of frames from the end of the frame carrying the UCD message</u> the BS shall wait after repeating a UCD message with an incremented Configuration Change Count before issuing a UL-MAP message referring to Uplink_Burst_Profiles defined in that UCD message.	<del>2 MAC-frames-20ms</del> <u>following the last fragment of the message</u>		
BS	DCD Transition	<del>The time</del> <u>The number of frames from the end of the frame carrying the DCD message</u> the BS shall wait after repeating a DCD message with an incremented Configuration Change Count before issuing a DL-MAP message referring to Downlink_Burst_Profiles defined in that DCD message.	<del>2 MAC-frames-20ms</del> <u>following the last fragment of the message</u>		
SS,BS	Invited Ranging Retries	Number of retries on inviting Ranging Requests.	16		
BS,SS	$T_{proc}$	Time provided between arrival of the last bit of a UL-MAP at an SS and effectiveness of that map. <u>For OFDMA mode, the time shall be counted starting from the end of the burst carrying the UL-MAP.</u>	SC: 200 $\mu$ s OFDM: 1 ms OFDMA: <del>10 OFDMA-symbols</del> $T_{proc}=T_f$		
SS,MS	T3	Ranging Response reception timeout following the transmission of a Ranging Request.	—	<del>200 ms</del> <u>50 ms</u>	200 ms
SS	T4	Wait for <del>unicast</del> ranging opportunity <u>or data grant</u> . If the pending-until-complete field was used earlier by this SS, then the value of that field shall be added to this interval.	<del>30 s</del>		35 s
BS	T5	Wait for Uplink Channel Change response			<del>2 s</del>
SS	T16	Wait for bandwidth request <u>grant</u>	<del>10 ms</del>		service QoS-dependent

**Table 342—Parameters and constants (continued)**

System	Name	Time reference	Minimum value	Default value	Maximum value
SS	<del>T19</del>	<del>Time DL channel remains unusable</del>			
SS	SS downlink management message FPC processing time	Max. time between reception of Fast Power Control management message and compliance to its instructions by SS.			200 $\mu$ s (OFDM-only) 2.5 ms from the start of the frame ( $n+1$ ) were frame $n$ is the frame containing the FPC. If there is an UL allocation to the SS before the 2.5 ms in frame $n+1$ then the power change shall be applied before the end of the frame $n+1$ .
SS	T21	Time the SS searches for decodable DL-MAP on a given channel.			11 40 s
BS	<u>Ranging Correction Retries</u>			16	
SS	<u>RNG-RSP processing time</u>	<u>Time allowed for an SS following receipt of a RNG-RSP before it is expected to apply the corrections instructed by the BS. Minimum value.</u>			2.5 ms from the start of the frame ( $n+1$ ) were frame $n$ is the frame containing the RNG RSP. If there is an UL allocation to the SS before the 2.5 ms in frame $n+1$ then the power change shall be applied before the end of the frame $n+1$ .
SS	<u>Power control IE processing time</u>	<u>Time allowed for an SS following receipt of a UL-MAP including a power control IE before it is expected to apply the corrections instructed by the BS.</u>			2.5 ms from the start of the frame ( $n+1$ ) were frame $n$ is the frame containing the UL map containing the power control IE. If there is an UL allocation to the SS before the 2.5 ms in frame $n+1$ then the power change shall be applied before the end of the frame $n+1$ .



**Table 342—Parameters and constants (continued)**

System	Name	Time reference	Minimum value	Default value	Maximum value
SS	T28	<u>DBPC-REQ re-try timer for requesting less robust burst profile after rejection by the BS.</u>	<u>200 ms</u>	<u>1s</u>	<u>1 min</u>
SS	T29	<u>RNG-REQ/DBPC-REQ re-try timer for requesting more robust burst profile after rejecting by the BS.</u>	<u>200 ms</u>	<u>1s</u>	<u>30 s</u>
SS	T30	<u>DBPC-RSP reception timeout following the transmission of a DBPC-REQ.</u>	<u>200 ms</u>	<u>200 ms</u>	<u>200 ms</u>
MS	<u>Min_Sleep_Interval</u>	<u>Minimum sleeping time allowed to MS.</u>	<u>2 frames</u>	<u>=</u>	<u>=</u>
MS	<u>Max_Sleep_Interval</u>	<u>Maximum sleeping time allowed to MS.</u>	<u>=</u>	<u>=</u>	<u>1024 frames</u>
MS	<u>Listening_Interval</u>	<u>The time duration during which the MS, after waking up and synchronizing with the DL transmissions, can demodulate downlink transmissions and decide whether to stay awake or go back to sleep.</u>	<u>=</u>	<u>=</u>	<u>64 frames</u>
BS	<u>MOB-NBR-ADV interval</u>	<u>Nominal time between transmission of MOB-NBR-ADV messages.</u>	<u>=</u>	<u>=</u>	<u>30 s</u>
MS	<u>NBR_BS_Index Validity_Time</u>	<u>Time duration during which the MS can use the neighbor BS list in MOB_NBR-ADV message for the compression of neighbor BSIDs.</u>	<u>1 s</u>	<u>=</u>	<u>5 s</u>
BS, MS	<u>ASC-AGING-TIMER</u>	<u>Nominal time for aging of MS associations</u>	<u>0.1 s</u>	<u>=</u>	<u>10 s</u>
MS	<u>Serving BS ID AGING-TIMER</u>	<u>Nominal time for aging of serving BS association. Timer recycles on successful serving BS DL-MAP read</u>	<u>=</u>	<u>=</u>	<u>5 s</u>
MS	T42	<u>MOB_HO-IND timeout when sent with HO_IND_type = 0b10.</u>	<u>=</u>	<u>=</u>	<u>=</u>
BS	<u>Paging Retry Count</u>	<u>Number of retries on paging transmission. If the BS does not receive RNG-REQ from the MS until this value decreases to zero, it determines that the MS is unavailable.</u>	<u>=</u>	<u>3</u>	<u>16</u>

**Table 342—Parameters and constants (continued)**

System	Name	Time reference	Minimum value	Default value	Maximum value
<u>MS</u>	<u>Fast-Tracking Response Processing Time</u>	<u>Time allowed for an MS following receipt of a UL-MAP Fast tracking indication response before it is expected to apply the corrections instructed by the BS.</u>	=	<u>One DL sub-frame duration</u>	<u>25 ms</u>
<u>BS, MS</u>	<u>Mode Selection Feedback processing time</u>	<u>The time allowed between the end of the burst carrying the Mode Selection Feedback sub-header and the start of the UL-subframe carrying the Mode Selection Feedback response.</u>	<u>TDD: Frame duration FDD: 1/2 Frame duration</u>	=	=
<u>MS</u>	<u>Idle Mode Timer</u>	<u>MS timed interval to conduct Location Update. Set timer to MS Idle Mode Timeout capabilities setting. Timer recycles on successful Idle Mode Location Update.</u>	<u>128 s</u>	<u>4096 s</u>	<u>65536 s</u>
<u>BS</u>	<u>Idle Mode System Timer</u>	<u>For BS acting as Paging Controller, timed interval to receive notification of MS Idle Mode Location Update. Set timer to MS Idle Mode Timeout. Timer recycles on successful Idle Mode Location Update.</u>	<u>128 s</u>	<u>4096 s</u>	<u>65536 s</u>
<u>MS</u>	<u>T43</u>	<u>Time the MS waits for MOB_SLP-RSP.</u>	=	=	=
<u>MS</u>	<u>T44</u>	<u>Time the MS waits for MOB_SCN-RSP.</u>	=	=	=
<u>MS</u>	<u>T45</u>	<u>Time the MS waits for DREG-CMD.</u>	=	<u>250 ms</u>	<u>500 ms</u>
<u>BS</u>	<u>Management Resource Holding Timer</u>	<u>Time the BS maintain connection information with the MS after the BS send DREG-CMD to the MS.</u>	=	<u>500 ms</u>	<u>1 s</u>
<u>MS</u>	<u>DREG Request Retry Count</u>	<u>Number of retries on DREG Request Message.</u>	<u>3</u>	<u>3</u>	<u>16</u>
<u>BS</u>	<u>DREG Command Retry Count</u>	<u>Number of retries on DREG Command Message.</u>	<u>3</u>	<u>3</u>	<u>16</u>
<u>BS</u>	<u>T46</u>	<u>Time the BS waits for DREG-REQ in case of unsolicited Idle Mode initiation from BS.</u>	=	=	=

**Table 342—Parameters and constants (continued)**

System	Name	Time reference	Minimum value	Default value	Maximum value
<u>MS</u>	<u>HO Process Optimization MS Timer Retries</u>	<u>Number of SBC-REQ and/or REG-REQ retries while waiting for unsolicited SBC-RSP and/or REG-RSP as part of MS network re-entry and as indicated by HO Process Optimization message element of RNG-RSP.</u>	<u>3</u>	<u>==</u>	<u>==</u>
<u>BS</u>	<u>T47</u>	<u>PMC_RSP Timer: BS shall send the PMC_RSP before T47 + 1 frames after BS receives PMC_REQ (confirmation = 0) correctly.</u>	<u>8 frames</u>	<u>64 frames</u>	<u>1024 frames</u>
<u>MS, BS</u>	<u>Paging Interval Length</u>	<u>Time duration of Paging Interval of the BS.</u>	<u>2 frames</u>	<u>==</u>	<u>5 frames</u>
<u>MS</u>	<u>Max Dir Scan Time</u>	<u>Maximum scanning time of neighbor BSs by MS before reporting any results.</u>	<u>==</u>	<u>==</u>	<u>==</u>
<u>BS, MS</u>	<u>SACHallengeTimer</u>	<u>Time prior to re-send of SA-TEK-Challenge (in seconds).</u>	<u>0.5</u>	<u>1.0</u>	<u>2.0</u>
<u>BS, MS</u>	<u>SACHallenge-MaxResends</u>	<u>Maximum number of transmissions of SA-TEK-Challenge.</u>	<u>1</u>	<u>3</u>	<u>3</u>
<u>MS, BS</u>	<u>SATEKTimer</u>	<u>Time prior to re-send of SA-TEK-Request (in seconds).</u>	<u>0.1</u>	<u>0.3</u>	<u>1.0</u>
<u>MS, BS</u>	<u>SATEKRequest-MaxResends</u>	<u>Maximum number of transmissions of SA-TEK-Request.</u>	<u>1</u>	<u>3</u>	<u>3</u>
<u>BS</u>	<u>Second EAP Timeout</u>	<u>Time, in seconds, to wait for PKMv2_EAP_Start or PKMv2_Authenticated_EAP_Start after the success of the first EAP in double EAP mode.</u>	<u>0.3</u>	<u>1.0</u>	<u>1.0</u>
<u>BS</u>	<u>EAP Complete Resend</u>	<u>Total number of sending PKMv2_EAP_Complete message in double EAP mode.</u>	<u>1</u>	<u>3</u>	<u>3</u>

## 10.2 PKM parameter values

*Insert rows in 10.2 Table 343 as indicated:*

**Table 343—Operational ranges for privacy configuration settings**

System	Name	Description	Minimum value	Default value	Maximum value
<u>MS, BS</u>	<u>PMK or PAK pre-handshake lifetime</u>	<u>The lifetime assigned to PMK when created.</u>	<u>5 s</u>	<u>10 s</u>	<u>15 min</u>
<u>BS</u>	<u>PMK lifetime</u>	<u>If MSK lifetime is unspecified (i.e., by AAA server), PMK lifetime shall be set to this value. (in seconds).</u>	<u>60</u>	<u>3600</u>	<u>86400</u>
<u>BS, MS</u>	<u>SAChallengeTimer</u>	<u>Time prior to re-send of SA-TEK-Challenge (in seconds).</u>	<u>0.5</u>	<u>1.0</u>	<u>2.0</u>
<u>BS, MS</u>	<u>SaChallenge-MaxResends</u>	<u>Maximum number of transmissions of SA-TEK-Challenge.</u>	<u>1</u>	<u>3</u>	<u>3</u>
<u>MS, BS</u>	<u>SATEKTimer</u>	<u>Time prior to re-send of SA-TEK-Request (in seconds).</u>	<u>0.1</u>	<u>0.3</u>	<u>1.0</u>
<u>MS, BS</u>	<u>SATEKRequest-MaxResends</u>	<u>Maximum number of transmissions of SA-TEK-Request.</u>	<u>1</u>	<u>3</u>	<u>3</u>

## 10.3 PHY-specific values

### 10.3.3 WirelessMAN-OFDM parameters and constant definitions

#### 10.3.3.1 Uplink Allocation Start Time

*Change the subclause as indicated:*

Unit of Allocation Start Time shall be PSs from the start of the downlink frame in which the UL-MAP message occurred, or from the start of the AAS zone in case the UL MAP was transmitted in AAS zone. The minimum value specified for this parameter shall correspond to a point in the frame 1 ms after the last symbol of the UL-MAP.

In the case the UL-MAP is included in the STC zone, the allocation start time refers to the beginning of the STC zone including the STC preamble.

### 10.3.4 WirelessMAN-OFDMA parameters and constant definitions

#### 10.3.4.1 Uplink Allocation Start Time

*Change the subclause as indicated:*

Unit of Allocation Start Time shall be PSs from the start of the downlink frame in which the UL-MAP message occurred. The minimum value specified for this parameter shall ~~correspond to 10 OFDMA symbols~~ refer to the time indicated by  $T_{proc}$ , defined in Table 342.

## 10.4 Well-known addresses and identifiers

*Change 10.4 as indicated.*

**Table 345—CIDs**

CID	Value	Description
Initial Ranging	0x0000	Used by SS and BS during initial ranging process.
Basic CID	0x0001 - $m$	The same value is assigned to both the DL and UL connection.
Primary management	$m+1$ - $2m$	The same value is assigned to both the DL and UL connection.
Transport CIDs, Secondary Mgt CIDs	$2m+1$ - <del>FEFE</del> 9E	For the secondary management connection, the same value is assigned to both the DL and UL connection.
<u>Multicast CIDs</u>	<u>0xFEA0 - 0xFEFE</u>	<u>For the downlink multicast service, the same value is assigned to all MSs on the same channel that participate in this connection.</u>
AAS initial ranging CID	0xFEFF	A BS supporting AAS shall use this CID when allocating <del>a</del> <u>an AAS</u> <del>initial</del> Ranging period ( <u>using AAS Ranging Allocation IE</u> ) for AAS devices.
Multicast polling CIDs	0xFF00 - <del>0xFFFF</del> 02	A BS may be included in one or more multicast polling groups for the purposes of obtaining bandwidth via polling. These connections have no associated service flow.
<u>Normal mode multicast CID</u>	<u>0xFFFA</u>	<u>Used in DL-MAP to denote bursts for transmission of DL broadcast information to normal mode MS.</u>
<u>Sleep mode multicast CID</u>	<u>0xFFFB</u>	<u>Used in DL-MAP to denote bursts for transmission of DL broadcast information to Sleep mode MS. May also be used in MOB_TRF-IND messages.</u>
<u>Idle mode multicast CID</u>	<u>0xFFFC</u>	<u>Used in DL-MAP to denote bursts for transmission of DL broadcast information to Idle mode MS. May also be used in MOB_PAG-ADV messages.</u>
<u>Fragmentable Broadcast CID</u>	<u>0xFFFD</u>	<u>Used by the BS for transmission of management broadcast information with fragmentation. The fragment sub header shall use 11-bit long FSN on this connection.</u>
Padding CID	0xFFFE	Used for transmission of padding information by SS and BS.
Broadcast CID	0xFFFF	Used for broadcast information that is transmitted on a downlink to all SS.

It is noted that the multicast CID may have a format with Reduced CID on HARQ region.

Authorized licensed use limited to: Fish & Richardson. Downloaded on April 11,2016 at 21:40:33 UTC from IEEE Xplore. Restrictions apply.

## 11. TLV Encodings

### 11.1 Common encodings

#### 11.1.1 Current transmit power

*Change the first paragraph as indicated:*

The average parameter indicates the transmitted power used for the burst which carried the message. The parameter is reported in dBm and is quantized in 0.5 dBm steps ranging from ~~−6484~~ dBm (encoded 0x00) to ~~63.543.5~~ dBm (encoded 0xFF). Values outside this range shall be assigned the closest extreme. The parameter is only applicable to systems supporting the SCa, OFDM, or OFDMA PHY specifications. However, for the OFDM or OFDMA PHY, this value indicates the average transmitted power of each subcarrier for the burst which carried the message.

*Insert a new subclause “Authentication Tuples” before 11.1.2 HMAC Tuple and change 11.1.2 to be 11.1.2.1*

#### 11.1.2 Authentication Tuples

An authentication tuple shall be the last item in identified management messages.

##### 11.1.2.1 HMAC Tuple

*Change the first paragraph as indicated:*

This parameter contains the HMAC Key Sequence Number concatenated with an HMAC-Digest used for message authentication. The HMAC Key Sequence Number is stored in the four least significant bits of the first byte of the HMAC Tuple, and the most significant four bits are reserved. The HMAC-Tuple attribute format is shown in Table 347 and Table 348. When PKM is disabled (see 11.7.8.7), the content of this field shall be ignored and the message considered authenticated.

*Change the contents of Table 347 as indicated:*

Type	Length	Value	Scope
149	21	See Table 348	DSx-REQ, DSx-RSP, DSx-ACK, REG-REQ, REG-RSP, RES-CMD, DREG-REQ, DREG-CMD, TFTP-CPLT, <u>MOB_SLP-REQ, MOB_SLP-RSP,</u> <u>MOB_SCN-REQ, MOB_SCN-RSP,</u> <u>MOB_BSHO-REQ, MOB_MSHO-REQ,</u> <u>MOB_BSHO-RSP, MOB_HO-IND, DREG-REQ</u>

*Insert new subclause 11.1.2.2:*

##### 11.1.2.2 CMAC Tuple

This parameter contains the CMAC key sequence number, the CMAC Packet Number Counter (CMAC\_PN\_\*), and the CMAC value used for message authentication. The CMAC Tuple attribute format is shown in Table 348a and Table 348b.

A message received, that contains an CMAC Tuple, shall not be considered authentic if the length field of the tuple is incorrect, or if the locally computed value of the digest does not match the digest in the message.

NOTE—It would be appropriate for a MIB to increment an error count on receipt of a non authentic message, so that management can detect an active attack.

**Table 348a—CMAC Tuple definition**

Type	Length	Value	Scope
150	13 or 19	See Table 348b	DSx-REQ, DSx-RSP, DSx-ACK, REG-REQ, REG-RSP, RES-CMD, DREG-CMD, TFTP-CPLT, PKM-REQ, PKM-RSP, MOB_SLP-REQ, MOB_SLP-RSP, MOB_SCN-REQ, MOB_SCN-RSP, MOB_BSHO-REQ, MOB_MSHO-REQ, MOB_BSHO-RSP, MOB_HO-IND, DREG-REQ

**Table 348b—CMAC Tuple definition**

Field	Length (bits)	Note
Reserved	4	Set to 0
CMAC Key Sequence Number	4	CMAC key sequence number
BSID	48	Only used in case of MDHO zone—optional
CMAC Packet Number Counter, CMAC_PN_*	32	This context is different UL, DL
CMAC Value	64	CMAC with AES 128

*Insert new subclause 11.1.2.3:*

**11.1.2.3 Short-HMAC Tuple**

This parameter contains the HMAC Key Sequence Number concatenated with an HMAC Digest used for message authentication. The HMAC Key Sequence Number is stored in the four least significant bits of the first byte of the HMAC Tuple, and the most significant four bits are reserved. The HMAC Tuple attribute format is shown in Table 348c and Table 348d.

**Table 348c—Short-HMAC Tuple definition**

Type	Length	Value	Scope
151	<i>variable</i>	See Table 348d	MOB_SLP-REQ, MOB_SLP-RSP, MOB_SCN-REQ, MOB_SCN-RSP, MOB_MSHO-REQ, MOB_BSHO-RSP, MOB_HO-IND, RNG-REQ, RNG-RSP, PKM-REQ, PKM-RSP



**Table 348d—Short-HMAC Tuple definition**

Field	Length (bits)	Note
Reserved	4	—
HMAC Key Sequence Number	4	—
HMAC Packet Number Counter HMAC_PN_*	32	Replay counter
Short-HMAC Digest	<i>variable</i>	0—Truncate HMAC to 8 bytes in Short HMAC Tuple 1—Truncate to 10 bytes 2—Truncate to 12 bytes

**11.1.3 MAC version encoding**

*Change the TLV definition for MAC version encoding as follows:*

Type	Length	Value	Scope
148	1	Version number of IEEE 802.16 supported on this channel. 1: Indicates conformance with IEEE Std 802.16-2001 2: Indicates conformance with IEEE Std 802.16c-2002 and its predecessors 3: Indicates conformance with IEEE Std 802.16a-2003 and its predecessors 4: Indicates conformance with IEEE Std 802.16-2004 <u>5: Indicates conformance with IEEE Std 802.16-2004 and IEEE Std 802.16e-2005</u> <del>56</del> -255: <i>Reserved</i>	PMP: DCD, RNG-REQ  MESH: REG-REQ, REG-RSP

**11.1.5 Vendor ID encoding**

*Insert the following scoped messages into the table in 11.1.5:*

SBC-REQ (see 6.3.2.3.23)

SBC-RSP (see 6.3.2.3.24)

### 11.1.6 Vendor-specific information

*Change the example at the end of the subclause as indicated:*

*Example:*

Configuration with vendor A specific fields and vendor B specific fields:

VSIF (143) + *n* (number of bytes inside this VSIF)  
 §144 (Vendor ID Type) + 3 (length field) + Vendor ID of Vendor A  
 Vendor A Specific Type #1 + length of the field + Value #1  
 Vendor A Specific Type #2 + length of the field + Value #2

VSIF (143) + *n* (number of bytes inside this VSIF)  
 §144 (Vendor ID Type) + 3 (length field) + Vendor ID of Vendor B  
 Vendor B Specific Type + length of the field + Value

*Insert a new subclause 11.1.7:*

### 11.1.7 MOB-NBR-ADV message encodings

**Table 348e—MOB-NBR-ADV encodings**

Name	Type (1 byte)	Length (1 byte)	Value (variable-length)
DCD_settings	1	<i>variable</i>	The DCD_settings is a compound TLV value that encapsulates a DCD message that may be transmitted in the advertised BS downlink channel. This information is intended to enable fast synchronization of the MS with the advertised BS downlink. The DCD settings fields shall contain only neighbor's DCD TLV values that are different from the serving BS corresponding values. For values that are not included, the MS shall assume they are identical to the serving BSs corresponding values.
UCD_settings	2	<i>variable</i>	The UCD_settings is a compound TLV value that encapsulates a UCD message that may be transmitted in the advertised BS downlink channel. This information is intended to enable fast synchronization of the MS with the advertised BS uplink. The UCD settings fields shall contain only neighbor's UCD TLV values that are different from the serving BS's corresponding values. For values that are not included, the MS shall assume they are identical to the serving BS's corresponding values.
Neighbor BS trigger	4	<i>variable</i>	The Neighbor BS trigger is a compound TLV value that indicates the trigger being applied to this neighbor BS (Table 358a). The Neighbor BS trigger is included in MOB_NBR-ADV message, only if it is different from Trigger that is defined for the neighbor BS in DCD message or from the Neighbor BS trigger for the preceding neighbor BS.

The neighbor BS trigger TLV (type 4) in Table 348e is encoded using the description in Table 348f.

**Table 348f—Neighbor BS Trigger TLV description**

Name	Type	Length (1 byte)	Value
Type/function/action	4.1	1	See Table 348g for description.
Trigger value	4.2	1	Trigger value is the value used in comparing measured metric for determining a trigger condition.
Trigger averaging duration	4.3	1	Trigger averaging duration is the time in ms over which the metric measurements are averaged. When the mean value of the measurement meets the trigger condition, the MS reacts using the specified action.

The Type/function/action byte field of the Neighbor BS Trigger TLV in Table 348f is described in Table 348g.

**Table 348g—Neighbor BS Trigger; Type/Function/Action**

Name	Length (1 byte)	Value
Type	2 bits (MSB)	Trigger metric type: 0x0: CINR metric 0x1: RSSI metric 0x2: RTD metric 0x3: <i>Reserved</i>
Function	3 bits	Computation defining trigger condition: 0x0: <i>Reserved</i> 0x1: Metric of neighbor BS is greater than absolute value 0x2: Metric of neighbor BS is less than absolute value 0x3: Metric of neighbor BS is greater than serving BS metric by relative value 0x4: Metric of neighbor BS is less than serving BS metric by relative value 0x5-0x7: <i>Reserved</i>
Action	3 bits (LSB)	Action performed upon reaching trigger condition: 0x0: <i>Reserved</i> 0x1: Respond on trigger with MOB_SCN-REP 0x2: Respond on trigger with MOB_MSHO-REQ 0x3-0x7: <i>Reserved</i>

## 11.3 UCD management message encodings

### 11.3.1 UCD channel encodings

*Delete the entry with 'Bandwidth request opportunity size' under the Name column from Table 349.*

*Delete the entry with 'Ranging request opportunity size' under the Name column from Table 349.*

*Insert the following rows to Table 349:*

**Table 349—UCD channel encodings**

Name	Type (1 byte)	Length (1 byte)	Value (variable-length)	PHY scope
<u>HO_ranging_start</u> <sup>a</sup>	7	1	<u>Initial backoff window size for MS performing initial ranging during handover process, expressed as a power of 2. Range: 0-15 (the highest order bits shall be unused and set to 0).</u>	<u>SCa, OFDM, OFDMA (mobile only)</u>
<u>HO_ranging_end</u> <sup>a</sup>	8	1	<u>Final backoff window size for MS performing initial ranging during handover process, expressed as a power of 2. Range: 0-15 (the highest order bits shall be unused and set to 0).</u>	<u>SCa, OFDM, OFDMA (mobile only)</u>

*Insert the following table footnote immediately below Table 349:*

<sup>a</sup>SCa, OFDM, OFDMA (mobile only).

*Insert the following entries into Table 350 and Table 351:*

Name	Type (1 byte)	Length	Value
<u>Bandwidth request opportunity size</u>	157	2	<u>Size (in units of PS) of PHY payload that SS may use to format and transmit a bandwidth request message in a contention request opportunity. The value includes all PHY overhead as well as allowance for the MAC data the message may hold.</u>
<u>Contention ranging request opportunity size</u>	158	2	<u>Size (in units of PS) of the transmission opportunity that an SS may use to transmit a RNG-REQ message in a contention ranging request opportunity. The value includes all PHY overhead as well as the maximum SS/BS round trip propagation delay.</u>
<u>Contention ranging request burst size</u>	159	2	<u>Size (in units of PS) of PHY bursts that an SS shall use to transmit a RNG-REQ message in a contention ranging request opportunity.</u>

Insert the following entries to Table 352:

Name	Type (1 byte)	Length	Value
<u>Subchannelized Initial Ranging capable BS</u>	<u>152</u>	<u>1</u>	<u>Indicator that the BS is capable of receipt of subchannelized Initial Ranging requests (see 8.3.7.2). Value 0 (default) indicates the BS is not capable of receiving subchannelized Initial Ranging Request. Value 1 indicates the BS is capable of receiving subchannelized Initial Ranging Request. All subchannelization capable BSs shall be capable of receiving the subchannelized Initial Ranging Request. Values 2–255 Reserved.</u>
<u>Contention ranging request opportunity size</u>	<u>153</u>	<u>2</u>	<u>Size (in units of PS) of the transmission opportunity that an SS may use to transmit a RNG-REQ message in a contention ranging request opportunity. The value includes all PHY overhead as well as the maximum SS/BS round trip propagation delay.</u>
<u>Contention ranging request burst size</u>	<u>154</u>	<u>2</u>	<u>Size (in OFDM symbols) of PHY bursts that an SS shall use to transmit a RNG-REQ message in a contention ranging request opportunity. Default value: 4.</u>

Change Table 353 as indicated:

**Table 353—UCD PHY-specific channel encodings—WirelessMAN-OFDMA**

Name	Type (1 byte)	Length	Value
Start of ranging codes group	155	1	Indicates the starting number, $S$ , of the group of codes used for this uplink. <u>If not specified, the default value shall be set to zero.</u> All the ranging codes used on this uplink will be between $S$ and $(S+O+N+M+L) \bmod 256$ . Where, $N$ is the number of initial-ranging codes $M$ is the number of periodic-ranging codes $L$ is the number of bandwidth-request codes $O$ is the number of handover-ranging codes The range of values is $0 \leq S \leq 255$ .
Permutation base	156	1	Determines the <u>UL_IDeH UL_PermBase</u> parameter for the sub-carrier permutation to be used on this uplink channel. <u>UL_PermBase = 7 LSBs of Permutation base.</u>
UL allocated subchannels bitmap	157	9	This is a bitmap describing the <u>physical</u> subchannels allocated to the segment in the UL, when using the uplink PUSC permutation. The LSB of the first byte shall correspond to subchannel 0. For any bit that is not set, the corresponding subchannel shall not be used by the SS on that segment. <u>When this TLV is not present, BS may allocate any subchannels to an SS.</u>

**Table 353—UCD PHY-specific channel encodings—WirelessMAN-OFDMA (continued)**

Name	Type (1 byte)	Length	Value
Optional permutation UL allocated subchannels bitmap	158	13	This is a bitmap describing the physical subchannels allocated to the segment in the UL, when using the uplink optional PUSC permutation (see 8.4.6.2.5). The LSB of the first byte shall correspond to subchannel 0. For any bit that is not set, the corresponding subchannel shall not be used by the SS on that segment. <u>When this TLV is not present, BS may allocate any subchannels to an SS.</u>
Band AMC Allocation Threshold	159	1	dB unit threshold of the maximum of the standard deviations of the individual bands CINR measurements over time to trigger mode transition from normal subchannel to Band AMC
Band AMC Release Threshold	160	1	dB unit threshold of the maximum of the standard deviations of the individual bands CINR measurements over time to trigger mode transition from Band AMC to normal subchannel
Band AMC Allocation Timer	161	1	Frame unit <u>Minimum required number of frames to measure the average and standard deviation for the event of Band AMC triggering</u>
Band AMC Release Timer	162	1	Frame unit <u>Minimum required number of frames to measure the average and standard deviation for the event triggering from Band AMC to normal subchannel</u>
Band Status Reporting MAX Period	163	1	Frame unit <u>Maximum period between refreshing the Band CINR measurement by the unsolicited REP-RSP</u>
Band AMC Retry Timer	164	1	Frame unit <u>Backoff timer between consecutive mode transitions from normal subchannel to Band AMC when the previous request is failed</u>
H-ARQ ACK delay for $\text{HDL}$ burst	171	1	1 = one frame offset 2 = two frames offset 3 = three frames offset
<u>UL AMC Allocated physical bands bitmap</u>	<u>18</u>	<u>6</u>	<u>A bitmap describing the physical bands allocated to the segment in the UL. When using the optional AMC permutation with regular MAPs (see 8.4.6.3). The LSB of the first byte shall correspond to the physical band 0. For any bit that is not set, the corresponding physical bands shall not be used by the SS on that segment. When this TLV is not present, BS may allocate any physical bands to an SS.</u>
<u>Maximum retransmission</u>	<u>174</u>	<u>1</u>	<u>Maximum number of retransmission in UL HARQ. Default value shall be 4 retransmissions.</u>
<u>Normalized C/N override</u>	<u>175</u>	<u>8</u>	<u>This is a list of numbers, where each number is encoded by one nibble, and interpreted as a signed integer. The nibbles correspond in order to the list define by Table 334, starting from the second line, such that the LS nibble of the first byte corresponds to the second line in the table. The number encoded by each nibble represents the difference in normalized C/N relative to the previous line in the table.</u>

**Table 353—UCD PHY-specific channel encodings—WirelessMAN-OFDMA (continued)**

Name	Type (1 byte)	Length	Value
<u>Size of COICH_ID field</u>	<u>176</u>	<u>1</u>	<u>0 = 0 bits(default)</u> <u>1 = 3 bits</u> <u>2 = 4 bits</u> <u>3 = 5 bits</u> <u>4 = 6 bits</u> <u>5 = 7 bits</u> <u>6 = 8 bits</u> <u>7 = 9 bits</u> <u>8...255 = Reserved</u>
<u>Normalized C/N override 2</u>	<u>177</u>	<u>8</u>	<u>Bit#0–7: It shall be interpreted as signed integer in dB. It corresponds to the normalized C/N value in the first line (counting except for header cell of table)</u> <u>Bit#8–63: This is a list of numbers, where each number is encoded by one nibble, and interpreted as a signed integer. The nibbles correspond in order to the list define by Table 334, starting from the second line (counting except for the header cell of table), such that the LS nibble of the first byte corresponds to the second line in the table. The number encoded by each nibble represents the difference in normalized C/N relative to the previous line in the table.</u>
<u>Band AMC Entry Average CINR</u>	<u>185</u>	<u>1</u>	<u>dB unit</u> <u>Threshold of the average CINR of the whole bandwidth to trigger mode transition from normal subchannel to AMC.</u>
<u>UpperBound<sub>AAS_PREAMBLE</sub></u>	<u>186</u>	<u>1</u>	<u>Signed in units of 0.25 dB</u>
<u>LowerBound<sub>AAS_PREAMBLE</sub></u>	<u>187</u>	<u>1</u>	<u>Signed in units of 0.25 dB</u>
<u>Allow AAS Beam Select Messages</u>	<u>188</u>	<u>1</u>	<u>Boolean to indicate whether unsolicited AAS Beam Select messages (see 6.3.2.3.41) should be sent by the MS. The default value is 1, with possible values of 0-1:</u> <u>0 – MS should not send AAS Beam Select Messages</u> <u>1 – MS may send AAS Beam Select Messages</u>
<u>Use COICH indication flag</u>	<u>189</u>	<u>1</u>	<u>The N MSB values of this field represents the N-bit payload value on the Fast-Feedback channel reserved as indication flag for MS to initiate feedback on the Feedback header, where N is the number of payload bits used for S/N measurement feedback on the Fast-Feedback channel.</u> <u>The value shall not be set to all zeros.</u>
<u>MS-specific up power offset adjustment step</u>	<u>190</u>	<u>1</u>	<u>Unsigned in units of 0.01 dB</u>
<u>MS-specific down power offset adjustment step</u>	<u>191</u>	<u>1</u>	<u>Unsigned in units of 0.01 dB</u>
<u>Minimum level of power offset adjustment</u>	<u>192</u>	<u>1</u>	<u>Signed in units of 0.1 dB</u>
<u>Maximum level of power offset adjustment</u>	<u>193</u>	<u>1</u>	<u>Signed in units of 0.1 dB</u>
<u>Handover Ranging Codes</u>	<u>194</u>	<u>1</u>	<u>Number of handover ranging CDMA codes. Possible values are 0-255.</u>
<u>Initial ranging interval</u>	<u>195</u>	<u>1</u>	<u>Number of frames between initial ranging interval allocation.</u>

**Table 353—UCD PHY-specific channel encodings—WirelessMAN-OFDMA (continued)**

Name	Type (1 byte)	Length	Value
<u>Tx Power Report</u>	<u>196</u>	<u>3</u>	<p>Bit#0–3: <u>Tx Power Report Threshold</u>. It is unsigned integer and shall be read in dB scale. When “0b1111” it means infinite.</p> <p>Bit#4–7: It is unsigned integer whose value is d. Its value ‘d’ shall be interpreted as <u>Tx Power Report Interval</u> = <math>2^d</math>. When “0b1111” it means infinite.</p> <p>Bit#8–11: <math>\alpha_{p, avg}</math> in multiples of 1/16 (range [1/16,16/16])</p> <p>Bit#12–15: <u>Tx Power Report Threshold</u>. It is unsigned integer and shall be read in dB scale. When “0b1111” it means infinite. It shall be used when COICH is allocated to the SS.</p> <p>Bit#16–19: It is unsigned integer whose value is d. Its value ‘d’ shall be interpreted as <u>Tx Power Report Interval</u> = <math>2^d</math>. When “0b1111” it means infinite. It shall be used when COICH is allocated to the SS.</p> <p>Bit#20–24: <math>\alpha_{p, avg}</math> in multiples of 1/16 (range [1/16,16/16]). It shall be used when COICH is allocated to the SS.</p>
<u>Normalized C/N for Channel Sounding</u>	<u>197</u>	<u>1</u>	<u>Signed integer for the required C/N (dB) for Channel Sounding. This value shall override C/N for the channel sounding in Table 334a.</u>
<u>Initial ranging backoff start</u>	<u>198</u>	<u>1</u>	<u>Initial backoff window size for initial ranging contention, expressed as a power of 2. Values of n range 0-15 (the highest order bits shall be unused and set to 0) This TLV shall be used in NBR-ADV message only to represent corresponding values that appear in UCD message fields.</u>
<u>Initial ranging backoff end</u>	<u>199</u>	<u>1</u>	<u>Final backoff window size for initial ranging contention, expressed as a power of 2. Values of n range 0-15 (the highest order bits shall be unused and set to 0) This TLV shall be used in NBR-ADV message only to represent corresponding values that appear in UCD message fields.</u>
<u>Bandwidth request backoff start</u>	<u>200</u>	<u>1</u>	<u>Initial backoff window size for contention BW requests, expressed as a power of 2. Values of n range 0-15 (the highest order bits shall be unused and set to 0). This TLV shall be used in NBR-ADV message only to represent corresponding values that appear in UCD message fields.</u>
<u>Bandwidth request backoff end</u>	<u>201</u>	<u>1</u>	<u>Final backoff window size for contention BW requests, expressed as a power of 2. Values of n range 0-15 (the highest order bits shall be unused and set to 0). This TLV shall be used in NBR-ADV message only to represent corresponding values that appear in UCD message fields.</u>
<u>Uplink burst profile for multiple FEC types</u>	<u>202</u>	<u>1</u>	<u>May appear more than once (see 6.3.2.3.3 and 8.4.5.5). The length is the number of bytes in the overall object, including embedded TLV items.</u>



11.3.1.1 Uplink burst profile encodings

Change Table 357 in 11.3.1.1 “Uplink burst profile encodings” as shown:

Table 357—UCD burst profile encodings WirelessMAN-OFDMA

Name	Type	Length	Value
FEC Code type and modulation type	150	1	0 = QPSK (CC) 1/2 1 = QPSK (CC) 3/4 2 = 16-QAM (CC) 1/2 3 = 16-QAM (CC) 3/4 4 = 64-QAM (CC) 2/3 5 = 64-QAM (CC) 3/4 6 = QPSK (BTC) 1/2 7 = QPSK (BTC) 2/3 8 = 16-QAM (BTC) 3/5 9 = 16-QAM (BTC) 4/5 10 = 64-QAM (BTC) 5/8 11 = 64-QAM (BTC) 4/5 12 = QPSK (CTC) 1/2 13 = QPSK (CTC) 2/3 14 = QPSK (CTC) 3/4 15 = 16-QAM (CTC) 1/2 16 = 16-QAM (CTC) 3/4 17 = 64-QAM (CTC) 2/3 18 = 64-QAM (CTC) 3/4 19 = 64-QAM (CTC) 5/6 20 = QPSK (ZT CC) 1/2 21 = QPSK (ZT CC) 3/4 22 = 16-QAM (ZT CC) 1/2 23 = 16-QAM (ZT CC) 3/4 24 = 64-QAM (ZT CC) 2/3 25 = 64-QAM (ZT CC) 3/4 26..255 = <i>Reserved</i>  0 = QPSK (CC) 1/2 1 = QPSK (CC) 3/4 2 = 16-QAM (CC) 1/2 3 = 16-QAM (CC) 3/4 4 = 64-QAM (CC) 1/2 5 = 64-QAM (CC) 2/3 6 = 64-QAM (CC) 3/4 7 = QPSK (BTC) 1/2 8 = QPSK (BTC) 3/4 9 = 16-QAM (BTC) 3/5 10 = 16-QAM (BTC) 4/5 11 = 64-QAM (BTC) 5/8 12 = 64-QAM (BTC) 4/5 13 = QPSK (CTC) 1/2 14 = <i>Reserved</i> 15 = QPSK (CTC) 3/4 16 = 16-QAM (CTC) 1/2 17 = 16-QAM (CTC) 3/4 18 = 64-QAM (CTC) 1/2 19 = 64-QAM (CTC) 2/3 20 = 64-QAM (CTC) 3/4 21 = 64-QAM (CTC) 5/6 22 = QPSK (ZT CC) 1/2 23 = QPSK (ZT CC) 3/4 24 = 16-QAM (ZT CC) 1/2 25 = 16-QAM (ZT CC) 3/4 26 = 64-QAM (ZT CC) 1/2 27 = 64-QAM (ZT CC) 2/3 28 = 64-QAM (ZT CC) 3/4 29 = QPSK (LDPC) 1/2 30 = QPSK (LDPC) 2/3 A code 31 = QPSK (LDPC) 3/4 A code 32 = 16-QAM (LDPC) 1/2 33 = 16-QAM (LDPC) 2/3 A code 34 = 16-QAM (LDPC) 3/4 A code 35 = 64-QAM (LDPC) 1/2 36 = 64-QAM (LDPC) 2/3 A code

**Table 357—UCD burst profile encodings WirelessMAN-OFDMA (continued)**

Name	Type	Length	Value
			37 = 64-QAM (LDPC) 3/4 A code 38 = QPSK (LDPC) 2/3 B code 39 = QPSK (LDPC) 3/4 B code 40 = 16-QAM (LDPC) 2/3 B code 41 = 16-QAM (LDPC) 3/4 B code 42 = 64-QAM (LDPC) 2/3 B code 43 = 64-QAM (LDPC) 3/4 B code 44 = QPSK (CC with optional interleaver) 1/2 45 = QPSK (CC with optional interleaver) 3/4 46 = 16-QAM (CC with optional interleaver) 1/2 47 = 16-QAM (CC with optional interleaver) 3/4 48 = 64-QAM (CC with optional interleaver) 2/3 49 = 64-QAM (CC with optional interleaver) 3/4 50 = QPSK (LDPC) 5/6 51 = 16-QAM (LDPC) 5/6 52 = 64-QAM (LDPC) 5/6 53..255 = <i>Reserved</i>
Ranging data ratio	151	1	Reducing factor in units of 1 dB, between the power used for this burst and power should be used for CDMA Ranging. <u>It shall be encoded as signed integer.</u>
Normalized C/N override	<del>±52</del>	<del>5</del>	<del>This is a list of numbers, where each number is encoded by one nibble, and interpreted as a signed integer. The nibbles correspond in order to the list define by Table 334, starting from the second line, such that the LS nibble of the first byte corresponds to the second line in the table. The number encoded by each nibble represents the difference in normalized C/N relative to the previous line in the table.</del>

## 11.4 DCD management message encodings

### 11.4.1 DCD channel encodings

*Change Table 358 as indicated:*

**Table 358—DCD channel encoding**

Name	Type (1 byte)	Length	Value (variable length)	PHY scope
TTG	7	<del>±2</del>	TTG (in PSs). <u>Used on TDD systems only.</u>	SCa, <del>OFDM,</del> OFDMA
RTG	8	1	RTG (in PSs). <u>Used on TDD systems only.</u>	SCa, <del>OFDM,</del> OFDMA
<del><math>R_{SSEIRxP_{IR,max}}</math></del>	9	2	<del>Initial Ranging Max. Received Signal Strength</del> <del>maximum equivalent isotropic received power at BS</del> Signed in units of 1 dBm.	All

**Table 358—DCD channel encoding (continued)**

Name	Type (1 byte)	Length	Value (variable length)	PHY scope
Frame Number	15	3	The number of the frame containing the DCD message or the number of the frame of the last fragment of the DCD message if the DCD is fragmented.	OFDM
Size of CQICH_ID field	16	1	0 = Reserved 1 = 3 bits 2 = 4 bits 3 = 5 bits 4 = 6 bits 5 = 7 bits 6 = 8 bits 7 = 9 bits 8...255 = Reserved	OFDMA
H-ARQ ACK delay for DL burst	17	1	1 = 1 frame offset 2 = 2 frame offset 3 = 3 frame offset	OFDMA

Insert the following entries into Table 358:

**Table 358—DCD channel encoding**

Name	Type (1 byte)	Length	Value (variable length)	PHY scope
<u>Permutation type for broadcast region in HARQ zone</u>	<u>19</u>	<u>1</u>	<u>0 = PUSC</u> <u>1 = FUSC</u> <u>2 = optional FUSC</u> <u>3 = AMC</u>	<u>OFDMA</u>
<u>Maximum retransmission</u>	<u>20</u>	<u>1</u>	<u>Maximum number of retransmission in DL HARQ. Default value shall be 4 retransmissions.</u>	<u>OFDMA</u>
<u>Default RSSI and CINR averaging parameter</u>	<u>21</u>	<u>1</u>	<u>Bit #0-3: Default averaging parameter <math>\alpha_{avg}</math> for physical CINR measurements, in multiples of 1/16 (range [1/16, 16/16], 0x0 for 1/16, 0xF for 16/16).</u> <u>Bit #4-7: Default averaging parameter <math>\alpha_{avg}</math> for RSSI measurements, in multiples of 1/16 (range [1/16, 16/16], 0x0 for 1/16, 0xF for 16/16).</u> <u>Default value shall be 0x3.</u>	<u>OFDMA</u>
<u>DL AMC allocated physical bands bitmap</u>	<u>22</u>	<u>6</u>	<u>A bitmap describing the physical bands allocated to the segment in the DL, when allocating AMC sub-channels through the HARQ MAP, or through the Normal MAP, or for Band-AMC CINR reports, or using the optional AMC permutation (see 8.4.6.3).</u> <u>The LSB of the first byte shall correspond to band 0. For any bit that is not set, the corresponding band shall not be used by the SS on that segment.</u> <u>When this TLV is not present, BS may allocate any physical bands to an SS.</u>	<u>OFDMA</u>

**Table 358—DCD channel encoding (continued)**

Name	Type (1 byte)	Length	Value (variable length)	PHY scope
<u>DL region definition</u>	<u>34</u>	<i>variable</i>	<p><u>Num_region</u> (6 bits for the number of regions, 2 bit reserved)</p> <p>For (<math>i = 0; i &lt; \text{Num\_region}; i++</math>) {</p> <p>    <u>OFDMA symbol offset</u> (8 bits)</p> <p>    <u>Subchannel offset</u> (6 bits)</p> <p>    <u>No. OFDMA symbols</u> (8 bits)</p> <p>    <u>No. subchannels</u> (6 bits)</p> <p>}</p> <p><u>padding bits to align boundary of byte</u></p>	—
<u>HO type support</u>	<u>50</u>	<u>1</u>	<p>Bit 0: <u>HO</u></p> <p>Bit 1: <u>MDHO</u></p> <p>Bit 2: <u>FBSS HO</u></p> <p>Bit 3-7: <i>Reserved</i></p>	<u>OFDMA</u>
<u>H_Add Threshold</u>	<u>31</u>	<u>1</u>	<p>Threshold used by the MS to add a neighbor BS to the diversity set. When the CINR of a neighbor BS is higher than <u>H_Add</u>, the MS should send <u>MOB_MSHO-REQ</u> to request adding this neighbor BS to the diversity set. This threshold is used for the MS that is perform <u>MDHO/FBSS HO</u>. It is in the unit of dB. If the BS does not support <u>FBSS HO/MDHO</u>, this value is not set.</p>	<u>OFDMA</u>
<u>H_Delete Threshold</u>	<u>32</u>	<u>1</u>	<p>Threshold used by the MS to drop a BS from the diversity set. When the CINR of a BS is lower than <u>H_Delete</u>, the MS should send <u>MOB_MSHO-REQ</u> to request dropping this BS from the diversity set. This threshold is used for the MS that is performing <u>MDHO/FBSS HO</u>. It is in the unit of dB. If the BS does not support <u>FBSS HO/MDHO</u>, this value is not set.</p>	<u>OFDMA</u>
<u>ASR(Anchor Switch Report) Slot Length (M) and Switching Period (L)</u>	<u>33</u>	<u>1</u>	<p>Bit #0 - #3: <u>M</u>, in units of frames</p> <p>Bit #4 - #7: <u>L</u>, in units of ASR slots</p>	<u>OFDMA</u>
<u>Paging Group ID</u>	<u>35</u>	<u>2</u>	<p>One or more logical affiliation grouping of BS (see 6.3.2.3.55)</p>	—
<u>TUSC1 permutation active subchannels bitmap</u>	<u>36</u>	<u>9</u>	<p>This is a bitmap describing the subchannels allocated to the segment in the DL, when using the <u>TUSC1 permutation</u> (see 8.4.6.1.2.4). The LSB of the first byte shall correspond to subchannel 0. For any bit that is not set, the MS on that segment shall not use the corresponding subchannel. The active subchannels are renumbered consecutively starting from 0.</p>	—
<u>TUSC2 permutation active subchannels bitmap</u>	<u>37</u>	<u>13</u>	<p>This is a bitmap describing the subchannels allocated to the segment in the DL, when using the <u>TUSC2 permutation</u> (see 8.4.6.1.2.5). The LSB of the first byte shall correspond to subchannel 0. For any bit that is not set, the MS on that segment shall not use the corresponding subchannel. The active subchannels are renumbered consecutively starting from 0.</p>	—

**Table 358—DCD channel encoding (continued)**

Name	Type (1 byte)	Length	Value (variable length)	PHY scope
<u>Hysteresis margin</u>	<u>51</u>	<u>1</u>	<u>Hysteresis margin is used by the MS to include a neighbor BS to a list of possible target BSs. When the CINR of a neighbor BS is larger than the sum of the CINR of the current serving BS and the hysteresis margin for the time-to-trigger duration, then the neighbor BS is included in the list of possible target BSs in MOB_MSHO-REQ. It is the unit of dB and applicable for only HHO.</u>	<u>All</u>
<u>Time-to-Trigger duration</u>	<u>52</u>	<u>1</u>	<u>Time-to-Trigger duration is the time duration for MS decides to select a neighbor BS as a possible target BS. It is the unit of ms and applicable only for HHO.</u>	<u>All</u>
<u>Trigger</u>	<u>54</u>	<u>variable</u>	<u>The Trigger is a compound TLV value that indicates trigger metrics. The trigger in this encoding is defined for serving BS or commonly applied to neighbor BSs.</u>	—
<u>N+I</u>	<u>60</u>	<u>1</u>	<u>The operator will define the N+I (Noise + Interference) based on the related RF system design calculations.</u>	<u>OFDM</u>
<u>Downlink burst profile for multiple FEC types</u>	<u>153</u>	<u>1</u>	<u>May appear more than once (see 6.3.2.3.1 and 8.4.5.5). The length is the number of bytes in the overall object, including embedded TLV items.</u>	<u>OFDMA</u>
<u>BS Restart Count</u>	<u>154</u>	<u>1</u>	<u>The value is incremented by one whenever BS restarts (see 6.3.9.11). The value rolls over from 0 to 255.</u>	<u>All</u>

*Insert the following to the end of 11.4.1:*

The trigger TLV (type 54) in Table 358 is encoded using the description in Table 358a.

**Table 358a—Trigger TLV description**

Name	Type	Length (1 byte)	Value
Type/Function/Action	54.1	1	See Table 358b for description
Trigger value	54.2	1	Trigger value is the value used in comparing measured metric for determining a trigger condition
Trigger averaging duration	54.3	1	Trigger averaging duration is the time in ms over which the metric measurements are averaged. When the mean value of the measurement meets the trigger condition, the MS reacts using the specified action.

The Type/function/action byte field of the trigger description in Table 358a is described in Table 358b.

**Table 358b—Trigger; Type/function/action description**

Name	Length	Value
Type	2 bits(MSB)	Trigger metric type: 0x0: CINR metric 0x1: RSSI metric 0x2: RTD metric 0x3: <i>Reserved</i>
Function	3 bits	Computation defining trigger condition: 0x0: <i>Reserved</i> 0x1: Metric of neighbor BS is greater than absolute value 0x2: Metric of neighbor BS is less than absolute value 0x3: Metric of neighbor BS is greater than serving BS metric by relative value 0x4: Metric of neighbor BS is less than serving BS metric by relative value 0x5: Metric of serving BS greater than absolute value 0x6: Metric of serving BS less than absolute value 0x7: <i>Reserved</i> NOTE—0x1-0x4 not applicable for RTD trigger metric
Action	3 bits (LSB)	Action performed upon reaching trigger condition: 0x0: <i>Reserved</i> 0x1: Respond on trigger with MOB_SCN-REP after the end of each scanning interval 0x2: Respond on trigger with MOB_MSHO-REQ 0x3: On trigger, MS starts neighbor BS scanning process by sending MOB_SCN-REQ 0x4-0x7: <i>Reserved</i> NOTE—0x3 is not applicable when neighbor BS metrics are defined (i.e., only Function values 0x5-6 are applicable).

The CINR, RSSI, and RTD metric fields are encoded according to the descriptions found within 6.3.2.3.50 for the MOB\_SCN-REP message and 6.3.2.3.53 for the MOB\_MSHO-REQ message.

The RTD trigger shall only be measured on the serving BS rather than relative to or from neighbor BSs. The trigger functions 0x5 and 0x6 shall be the only applicable ones for the RTD trigger. When the Type is set to RTD metric (i.e., 0x2), only either of the trigger functions 0x5 or 0x6 shall be applicable.

**11.4.2 Downlink burst profile encodings**

*Delete the first paragraph and Table 359.*

*Delete the fields ‘DIUC mandatory exit threshold’ and ‘DIUC minimum entry threshold’ from Table 360, Table 361, Table 362, and Table 363.*

Change Table 363 as indicated:

**Table 363—DCD burst profile encodings—WirelessMAN-OFDMA**

Name	Type (1 byte)	Length	Value (variable length)
FEC Code type	150	1	0 = QPSK (CC) 1/2 1 = QPSK (CC) 3/4 2 = 16-QAM (CC) 1/2 3 = 16-QAM (CC) 3/4 4 = 64-QAM (CC) 2/3 5 = 64-QAM (CC) 3/4 6 = QPSK (BTC) 1/2 7 = QPSK (BTC) 3/4 or 2/3 8 = 16-QAM (BTC) 3/5 9 = 16-QAM (BTC) 4/5 10 = 64-QAM (BTC) 2/3 or 5/8 11 = 64-QAM (BTC) 5/6 or 4/5 12 = QPSK (CTC) 1/2 13 = QPSK (CTC) 2/3 14 = QPSK (CTC) 3/4 15 = 16-QAM (CTC) 1/2 16 = 16-QAM (CTC) 3/4 17 = 64-QAM (CTC) 2/3 18 = 64-QAM (CTC) 3/4 19 = 64-QAM (CTC) 5/6 20 = QPSK (ZT CC) 1/2 21 = QPSK (ZT CC) 3/4 22 = 16-QAM (ZT CC) 1/2 23 = 16-QAM (ZT CC) 3/4 24 = 64-QAM (ZT CC) 2/3 25 = 64-QAM (ZT CC) 3/4 26..255 = Reserved
FEC Code type	150	1	0 = QPSK (CC) 1/2 1 = QPSK (CC) 3/4 2 = 16-QAM (CC) 1/2 3 = 16-QAM (CC) 3/4 4 = 64-QAM (CC) 1/2 5 = 64-QAM (CC) 2/3 6 = 64-QAM (CC) 3/4 7 = QPSK (BTC) 1/2 8 = QPSK (BTC) 3/4 or 2/3 9 = 16-QAM (BTC) 3/5 10 = 16-QAM (BTC) 4/5 11 = 64-QAM (BTC) 2/3 or 5/8 12 = 64-QAM (BTC) 5/6 or 4/5 13 = QPSK (CTC) 1/2 14 = Reserved 15 = QPSK (CTC) 3/4 16 = 16-QAM (CTC) 1/2 17 = 16-QAM (CTC) 3/4 18 = 64-QAM (CTC) 1/2 19 = 64-QAM (CTC) 2/3 20 = 64-QAM (CTC) 3/4 21 = 64-QAM (CTC) 5/6 22 = QPSK (ZT CC) 1/2 23 = QPSK (ZT CC) 3/4 24 = 16-QAM (ZT CC) 1/2 25 = 16-QAM (ZT CC) 3/4 26 = 64-QAM (ZT CC) 1/2 27 = 64-QAM (ZT CC) 2/3 28 = 64-QAM (ZT CC) 3/4 29..43 = Reserved 44 = QPSK (CC with optional interleaver) 1/2 45 = QPSK (CC with optional interleaver) 3/4 46 = 16-QAM (CC with optional interleaver) 1/2 47 = 16-QAM (CC with optional interleaver) 3/4 48 = 64-QAM (CC with optional interleaver) 2/3 49 = 64-QAM (CC with optional interleaver) 3/4 50..255 = Reserved

## 11.5 RNG-REQ message encodings

Insert the following rows into Table 364:

**Table 364—RNG-REQ message encodings**

Name	Type (1 byte)	Length	Value (variable-length)
<u>Serving BS ID</u>	<u>5</u>	<u>6</u>	<u>The unique identifier of the former serving BS</u>
<u>Ranging Purpose Indication</u>	<u>6</u>	<u>1</u>	<u>Bit #0: HO indication (when this bit is set to 1 in combination with other included information elements indicates the MS is currently attempting to HO or Network Re-entry from Idle Mode to the BS)</u> <u>Bit #1: Location Update Request (when this bit is set to 1, it indicates MS action of Idle Mode Location Update Process)</u> <u>Bits 2-7: Reserved</u>
<u>HO ID</u>	<u>7</u>	<u>1</u>	<u>ID assigned by the target BS for use in initial ranging during MS handover to it (see 6.3.20.5)</u>
<u>Paging Controller ID</u>	<u>9</u>	<u>6</u>	<u>This is a logical network identifier for the serving BS or other network entity retaining MS service and operational information and/or administering paging activity for the MS while in Idle Mode</u>
<u>MAC Hash Skip Threshold</u>	<u>10</u>	<u>2</u>	<u>Maximum number of successive MOB_PAG-ADV messages that may be sent from a BS without individual notification for an MS, including MAC address hash of an MS for which Action Code is 00, 'No Action Required'.</u>
<u>Power Saving Class Parameters</u>	<u>21</u>	<i>variable</i>	<u>Compound TLV to specify Power Saving Class definition and/or operation</u>
<u>Power down Indicator</u>	<u>8</u>	<u>1</u>	<u>Presence of item in message indicates the MS is currently attempting to switch power off, regardless of value</u>
<u>Enabled-Action-Triggered</u>	<u>11</u>	<u>1</u>	<u>Indicates action performed upon reaching trigger condition in sleep mode</u> <u>If bit#0 is set to 1, respond on trigger with MOB_SCN-REPORT</u> <u>If bit#1 is set to 1, respond on trigger with MOB_MSHO-REQ</u> <u>If bit#2 is set to 1, on trigger, MS starts neighboring BS scanning process by sending MOB_SCN-REQ</u> <u>bit#3-bit#7: Reserved. Shall be set to 0.</u>
<u>Requested downlink repetition coding level</u>	<u>12</u>	<u>1</u>	<u>This parameter indicates repetition coding level Indication requested by the MS for downlink traffic. If this TLV is not present in the RNG-REQ, it shall be assumed that repetition coding is not requested.</u> <u>Bit 0-1: Repetition coding level:</u> <u>0b00 – no repetition</u> <u>0b01 – Repetition coding of 2</u> <u>0b10 – Repetition coding of 4</u> <u>0b11 – Repetition coding of 6</u> <u>The BS shall ignore this field if the DIUC requested in the 'requested downlink burst profile' TLV refers to modulations higher than QPSK.</u>  <u>Bits 2-7: Reserved</u>



**Insert new text and Table 364a:**

Power\_Saving\_Class\_Parameters Value field is composed from a number of encapsulated TLV fields as specified in Table 364a.

**Table 364a—Power saving class parameters**

Name	Type (1 byte)	Length	Value (variable-length)
Flags	1	1	Bit 0: Definition 1 = Definition of Power Saving Class present Bit 1: Operation (RNG-RSP only) 0 = Deactivation of Power Saving Class (for 1 = Activation of Power Saving Class types 1 and 2 only) Bit 2: TRF-IND_Required For Power Saving Class Type I only. 1 = BS shall transmit at least one TRF-IND message during each listening window of the Power Saving Class. This bit shall be set to 0 for another types Bits 3–7: <i>Reserved</i>
Power_Saving_Class_ID	2	1	Assigned Power Saving Class identifier Not used for RNG-REQ message
Power_Saving_Class_Type	3	1	Power Saving Class Type as specified in 6.3.2.3
Start_frame_number	4	1	Start frame number for first sleep window Not used for RNG-REQ message
initial-sleep window	5	1	Initial-sleep window
listening window	6	1	Assigned Duration of MS listening interval (measured in frames)
final-sleep window base	7	1	Assigned final value for sleep interval (measured in frames)—base
final-sleep window exponent	8	1	Assigned final value for sleep interval (measured in frames)—exponent
SLPID	9	1	A number assigned by the BS whenever an MS is instructed to enter sleep mode
CID	10	2	CID of connection to be included into the Power Saving Class. There may be several TLVs of this type in a single compound Power_Saving_Class_Parameters TLV
Direction	11	1	Direction for management connection, which is added to Power Saving Class

**11.6 RNG-RSP management message encodings**

*Change subclause 11.6 as indicated:*

CID update encodings (11.7.9) and SAID update encodings (11.7.18) may be used in RNG-RSP for re-establishment of connections.

Change the following rows in Table 367 as indicated:

**Table 367—RNG-RSP message encodings**

Name	Type (1 byte)	Length	Value (variable-length)	PHY Scope
Timing Adjust	1	4	Tx timing offset adjustment (signed 32-bit). The <del>amount of</del> time required to <del>advance</del> adjust SS transmission so <del>frames</del> <u>the bursts will</u> arrive at the expected time instance at the BS. Units are PHY specific (see 10.3). <u>The SS shall advance its burst transmission time if the value is negative and delay its burst transmission if the value is positive.</u>	All
Offset Frequency Adjust	3	4	Tx frequency offset adjustment (signed 32-bit, Hz units)  Specifies the relative change in transmission frequency that the SS is to make in order to better match the BS. (This is fine-frequency adjustment within a channel, not reassignment to a different channel.) <u>The SS shall increase its transmit frequency if the value is positive and decrease its transmit frequency if the value is negative.</u>	All
Ranging Status	4	1	Used to indicate whether uplink messages are received within acceptable limits by BS.  1 = continue, 2 = abort, 3 = success, <del>4 = rerange</del>	All
Uplink channel ID override	6	1	<del>Licensed bands: The identifier of the uplink channel with which the SS is to redo initial ranging (not used with PHYs without channelized uplinks).</del> License-exempt bands: The Channel Nr (see 8.5.1) where the SS should redo initial ranging.	All

Insert the following rows to Table 367:

**Table 367—RNG-RSP message encodings**

Name	Type (1 byte)	Length	Value (variable-length)	PHY Scope
<u>Service Level Prediction</u>	<u>17</u>	<u>1</u>	<u>This value indicates the level of service the MS can expect from this BS. The following encodings apply:</u> <u>0 = No service possible for this MS</u> <u>1 = Some service is available for one or several service flows authorized for the MS.</u> <u>2 = For each authorized service flow, a MAC connection can be established with OoS specified by the AuthorizedQoSParamSet.</u> <u>3 = No service level prediction available.</u>	<u>All</u>
<u>Global Service Class Name</u>	<u>18</u>	<u>4</u>	<u>—</u>	<u>All</u>
<u>QoS Parameters</u>	<u>[145/146]</u>	<u>variable</u>	<u>Compound TLV incorporating one or more 11.13 QoS Parameter Set definition encodings</u>	<u>All</u>

**Table 367—RNG-RSP message encodings (continued)**

Name	Type (1 byte)	Length	Value (variable-length)	PHY Scope
<u>SFID</u>	<u>[145/146].1</u>	4	==	<u>All</u>
<u>Resource Retain Flag</u>	<u>20</u>	1	<u>This value indicates whether the former serving BS retains the connection information of the MS. 0 = the connection information for the MS is deleted 1 = the connection information for the MS is retained</u>	<u>All</u>
<u>HO Process Optimization</u>	<u>21</u>	2	<p><u>For each Bit location, a value of ‘0’ indicates the associated re-entry management messages shall be required, a value of ‘1’ indicates the re-entry management message may be omitted.</u></p> <p><u>Bit #0: Omit SBC-REQ management messages during current re-entry processing</u></p> <p><u>Bit #1: Omit PKM Authentication phase except TEK phase during current re-entry processing</u></p> <p><u>Bit #2: Omit PKM TEK creation phase during re-entry processing</u></p> <p><u>Bit #3: Omit Network Address Acquisition management messages during current reentry processing</u></p> <p><u>Bit #4: Omit Time of Day Acquisition management messages during current reentry processing</u></p> <p><u>Bit #5: Omit TFTP management messages during current re-entry processing.</u></p> <p><u>Bit #6: Full service and operational state transfer or sharing between Serving BS and Target BS. (ARO, timers, counters, MAC state machines, etc.)</u></p> <p><u>Bit #7: post-HO re-entry MS DL data pending at target BS</u></p> <p><u>Bit #8: BS shall send an unsolicited SBC-RSP management message with updated capabilities information in case capabilities of Target BS are different from the ones of Serving BS</u></p> <p><u>Bit #9: Omit REG-REQ management message during current re-entry processing</u></p> <p><u>Bit #10: BS shall send an unsolicited REG-RSP management message with updated capabilities information</u></p> <p><u>Bit #11: (Target) BS supports virtual SDU SN. If Bit#11=1 and MS supports SDU SN, it shall issue SN_REPORT upon completion of HO to this BS.</u></p> <p><u>Bit #12: MS shall send Bandwidth Request header with zero BR as a notification of MS’s successful re-entry registration.</u></p> <p><u>Bit #13: If this bit is set to 1, MS shall trigger a higher layer protocol required to refresh its traffic IP address (e.g. DHCP Discover [IETF RFC 2131] or Mobile IPv4 re-registration [IETF RFC 3344]).</u></p> <p><u>#14–15: Reserved</u></p>	<u>All</u>
<u>HO ID</u>	<u>22</u>	1	<u>ID assigned by the target BS for use in initial ranging during MS handover to it (see 6.3.20.5)</u>	<u>All</u>

**Table 367—RNG-RSP message encodings (continued)**

Name	Type (1 byte)	Length	Value (variable-length)	PHY Scope
<u>SBC-RSP encodings</u>	<u>29</u>	<u>variable</u>	<u>SBC-RSP TLV items for HO optimization</u> <u>Only transmitted if HO Process Optimiza-</u> <u>tion[bit#8]==1</u>	<u>All</u>
<u>REG-RSP encodings</u>	<u>30</u>	<u>variable</u>	<u>REG-RSP TLV items for HO optimization</u> <u>Only transmitted if HO Process Optimiza-</u> <u>tion[bit#9]==1.</u>	<u>All</u>
<u>Location Update Response</u>	<u>23</u>	<u>1</u>	<u>0x00= Failure of Location Update. The MS shall</u> <u>perform Network Re-entry from Idle Mode</u> <u>0x01= Success of Location Update</u> <u>0x10, 0x11: Reserved</u>	<u>All</u>
<u>Paging Information</u>	<u>24</u>	<u>5</u>	<u>Paging Information shall only be included if Loca-</u> <u>tion Update Response=0x01 and if Paging Informa-</u> <u>tion has changed</u> <u>Bits 15:0 – PAGING_CYCLE—Cycle in which the</u> <u>paging message is transmitted within the paging</u> <u>group</u> <u>Bits 23:16 – PAGING OFFSET—Determines the</u> <u>frame within the cycle in which the paging message</u> <u>is transmitted. Must be smaller than PAGING</u> <u>CYCLE value</u> <u>Bits 39:24 – Paging Group ID—ID of the paging</u> <u>group the MS is assigned to</u>	<u>All</u>
<u>Paging Controller ID</u>	<u>25</u>	<u>6</u>	<u>This is a logical network identifier for the serving</u> <u>BS or other network entity retaining MS service and</u> <u>operational information and/or administering pag-</u> <u>ing activity for the MS while in Idle Mode. Paging</u> <u>Controller ID shall only be included if Location</u> <u>Update Response=0x01 and if Paging Controller ID</u> <u>has changed</u>	<u>All</u>
<u>MAC Hash Skip Threshold</u>	<u>28</u>	<u>2</u>	<u>Maximum number of successive MOB_PAG-ADV</u> <u>messages that may be sent from a BS without indi-</u> <u>vidual notification for an MS, including MAC</u> <u>address hash of an MS for which Action Code for</u> <u>the MS is 0b00, ‘No Action Required’.</u>	<u>All</u>
<u>Next Periodic Ranging</u>	<u>26</u>	<u>2</u>	<u>This value indicates offset of the frame in which the</u> <u>periodic ranging will be performed with respect to</u> <u>the frame where RNG-RSP is transmitted.</u> <u>This TLV encoding is included in RNG-RSP mes-</u> <u>sage only when its ranging status is ‘success’</u> <u>If MS receives RNG-RSP message with ‘Next Peri-</u> <u>odic Ranging’ = 0, it shall terminate sleep mode and</u> <u>return to Normal Opeation.</u>	<u>All</u>
<u>Power Saving Class Parameters</u>	<u>27</u>	<u>variable</u>	<u>Compound TLV to specify Power Saving Class defi-</u> <u>nition and/or operation</u>	<u>All</u>

**Table 367—RNG-RSP message encodings (continued)**

Name	Type (1 byte)	Length	Value (variable-length)	PHY Scope
<u>Enabled-Action-Triggered</u>	<u>32</u>	<u>1</u>	<u>Indicates action performed upon reaching trigger condition in sleep mode</u> <u>If bit#0 is set to 1, respond on trigger with MOB_SCN-REPORT</u> <u>If bit#1 is set to 1, respond on trigger with MOB_MSHO-REQ</u> <u>If bit#2 is set to 1, on trigger, MS starts neighboring BS scanning process by sending MOB_SCN-REQ</u> <u>bit#3–bit#7: Reserved. Shall be set to 0.</u>	<u>All</u>
<u>Downlink Operational Burst Profile for OFDMA</u>	<u>33</u>	<u>2</u>	<u>This parameter is sent in response to the RNG-REQ Requested Downlink Burst Profile parameter.</u> <u>Byte 0:</u> <u>Bits 0–3: Specifies the least robust DIUC that may be used by the BS for transmissions to the MS.</u> <u>Bits 4–7: Specifies Repetition Coding Indication</u> <u>0b0000 – No repetition coding</u> <u>0b0001 – Repetition coding of 2</u> <u>0b0010 – Repetition coding of 4</u> <u>0b0011 – Repetition coding of 6</u> <u>The repetition coding indication shall be 0b0000if the DIUC refers to modulations higher than QPSK.</u> <u>Byte 1: Configuration Change Count value of DCD defining the burst profile associated with DIUC.</u>	<u>OFDMA</u>

*Insert the following text below Table 367:*

Power Saving Class Parameters Value field is composed from a number of encapsulated TLV fields as specified in Table 364a.

*Insert new subclause 11.6.1:*

**11.6.1 SA Challenge Tuple**

This compound TLV enables the BS to abbreviate the 3-way handshake during handover by appending the initial challenge to the RNG-RSP message.

Name	Type	Length	Value	Scope
SA Challenge	31	variable	Compound	RNG-RSP

The following TLV values shall appear in each SA Challenge TLV:

Name	Type	Length	Value
BS_Random	31.1	8 bytes	—
AKId	31.2	8 bytes	—

## 11.7 REG-REQ/RSP management message encodings

*Insert new Table 369a:*

**Table 369a—REG-REQ/RSP management message encodings**

Type	Parameter	Type	Parameter
1	ARQ Parameters	23	Maximum Number of Bursts Transmitted Concurrently to the MS
2	SS Management Support	24	CID Update Encodings
3	IP Management Support	25	Compressed CID Update Encodings
4	IP Version	26	Method for Allocating IP Address for the Secondary Management Connection
5	Secondary Management CID	27	Handover Supported
6	The Number of Uplink Transport-CID Supported	28	System Resource Retain Timer
7	Classification, PHS Options, SDU Encapsulation Support	29	HO Process Optimization MS Timer
8	Maximum Number of Classifiers	30	MS Handover Retransmission Timer
9	PHS Support	31	Mobility Features Supported
10	ARQ Support	32	Sleep Mode Recovery Time
11	DSx Flow Control	33	MS-PREV-IP-ADDR
12	MAC CRC Support	34	SKIP-ADDR-ACQUISITION
13	MCA Flow Control	35	SAID Update Encodings
14	Multicast Polling Group CID Support	36	Total Number of Provisional Service Flow
15	The Number of Downlink Transport CID Supported	37	Idle Mode Timeout
16	<i>Reserved</i>	38	SA TEK Update
17	<i>Reserved</i>	39	GKEK Parameters
18	SS MAC Address (in Mesh mode only)	40	ARQ-ACK Type
19	<i>Reserved</i>	41	MS HO Connections Parameters Processing Time

**Table 369a—REG-REQ/RSP management message encodings (continued)**

Type	Parameter	Type	Parameter
20	Maximum MAC Data per Frame Support	42	MS HO TEK Processing Time
21	Packing Support	43	MAC Header and Subheader Support
22	MAC Extended rtPS Support	44	SN Reporting Base

**11.7.2 SS management support**

*Change the subclause as indicated*

This field indicates whether or not the SS is managed by standard-based IP messages over the secondary management connection. When the SS indicates in the REG-REQ that it is managed, the BS shall respond with this field in the REG-RSP message to indicate if the BS supports SS management. If BS also supports SS management, the BS and SS shall perform stages g), h), and i) of the initial network entry process (see 6.3.9). Otherwise, if the BS or the SS does not support SS management, these stages shall be skipped by the BS and SS.

Type	Length	Value	Scope
2	1	0: no secondary management connection 1: secondary management connection	REG-REQ REG-RSP

**11.7.6 Number of ~~uplink~~ CIDs supported**

*Change the title of 11.7.6 and include subclauses 11.7.6.1 and 11.7.6.2 as indicated:*

**11.7.6.1 Number of uplink transport CIDs supported**

This field shows the number of Uplink transport CIDs the SS can support. ~~The minimum value is three for managed SSs and two for unmanaged SSs. An SS shall support a Basic CID, a Primary Management CID, and 0 or more Transport CIDs. A managed SS shall also support a Secondary Management CID.~~

Type	Length	Value	Scope
6	2	Number of Uplink <u>transport</u> CIDs the SS can support.	REG-REQ, REG-RSP

### 11.7.6.2 Number of downlink transport CIDs supported

This field shows the number of Downlink transport CIDs the SS can support.

Type	Length	Value	Scope
15	2	Number of Downlink transport CIDs the SS can support.	REG-REQ, REG-RSP

### 11.7.7 Convergence sublayer capabilities

Change subclause 11.7.7.1 as indicated:

#### 11.7.7.1 Classification/PHS options and SDU encapsulation support

This parameter indicates which classification/PHS options and SDU encapsulation the SS supports. By default, Packet, IPv4 and IEEE 802.3/Ethernet shall be supported, thus absence of this parameter in REG-REQ means that named options are supported by the SS. When the length field of the TLV is 2 or 4, it indicates that bits 16-31 are zero.

Type	Length	Value	Scope
7	2 or 4	Bit #0: ATM Bit #1: Packet, IPv4 Bit #2: Packet, IPv6 Bit #3: Packet, IEEE 802.3/Ethernet Bit #4: Packet, IEEE 802.1/Q VLAN Bit #5: Packet, IPv4 over IEEE 802.3/Ethernet Bit #6: Packet, IPv6 over IEEE 802.3/Ethernet Bit #7: Packet, IPv4 over IEEE 802.1Q VLAN Bit #8: Packet, IPv6 over IEEE 802.1Q VLAN <del>Bits #9-15: Reserved; Shall be set to zero</del> Bit #9: Packet, IEEE 802.3/Ethernet (with optional IEEE 802.1Q VLAN tags) and ROHC header compression Bit #10: Packet, IEEE 802.3/Ethernet (with optional IEEE 802.1Q VLAN tags) and ECRTTP header compression Bit #11: Packet, IP (v4 or v6) with ROHC header compression Bit #12: Packet, IP (v4 or v6) with ECRTTP header compression Bits #13-31: Reserved; Shall be set to zero	REG-REQ REG-RSP

#### 11.7.7.3 PHS support

Change the table in the subclause as indicated:

Type	Length	Value	Scope
9	2	0: no PHS support 1: ATM PHS 2: Packet PHS 3: ATM and Packet PHS	REG-REQ REG-RSP



**11.7.8 SS capabilities encodings**

*Delete 11.7.8.3 MAC CRC support.*

*Change 11.7.8.6 to 11.8.4 and change its scope to SBC-REQ SBC-RSP.*

*Change 11.7.8.7 to 11.8.5, change its scope to SBC-REQ SBC-RSP and change the first paragraph as indicated:*

This field indicates authorization policy that both SS and BS need to negotiate and synchronize. A bit value of 0 indicates “not supported” while 1 indicates “supported.” If this field is omitted, then both SS and BS shall use the IEEE 802.16 security, constituting X.509 digital certificates and the RSA public key encryption algorithm, as authorization policy. If this field is present and equal to 0, PKM shall be considered disabled.

*Change 11.7.8.8 to 11.8.6 and change its scope to SBC-REQ SBC-RSP*

*Insert new subclause 11.7.8.10:*

**11.7.8.10 Maximum MAC data per frame support**

This compound TLV defines the maximum amount of MAC level data including MAC headers and HARQ retransmission bursts the MS is capable of processing in the DL/UL part of a single MAC frame. A value of 0 indicates such limitation does not exist, except the limitation of the physical medium. If those TLVs are absent then the default value (0) should be used.

Name	Type	Length	Value	Scope
Maximum MAC Data per Frame Support	20	variable	Compound	REG-REQ REG-RSP (OFDMA-PHY only)

**11.7.8.10.1 Maximum amount of MAC level data per DL frame**

Name	Type	Length	Value	Scope
Maximum amount of MAC level data per DL frame	20.1	2	Maximum amount of MAC level data per DL frame (in unites of 256 Bytes). A value of 0 means unlimited.	REG-REQ REG-RSP (OFDMA-PHY only)

**11.7.8.10.2 Maximum amount of MAC level data per UL frame**

Name	Type	Length	Value	Scope
Maximum amount of MAC level data per UL frame	20.2	2	Maximum amount of MAC level data per UL frame (in unites of 256 Bytes). A value of 0 means unlimited.	REG-REQ REG-RSP (OFDMA-PHY only)

*Insert new subclause 11.7.8.11:*

**11.7.8.11 Packing support**

The ‘Packing support’ field indicates the availability of MS support for Packing. Packing support for the BS is mandatory.

Type	Length	Value	Scope
21	1	0: No packing support capability 1: Packing supported 2-255: Reserved	REG-REQ REG-RSP

*Insert new subclause 11.7.8.12:*

**11.7.8.12 MAC Extended rtPS support**

The ‘MAC Extended rtPS support’ field indicates the availability of SS support for Extended rtPS.

Type	Length	Value	Scope
22	1	0 = No Extended rtPS support (default) 1 = Extended rtPS support	REG-REQ REG-RSP

*Insert new subclause 11.7.8.13:*

**11.7.8.13 Maximum number of bursts transmitted concurrently to the MS**

Name	Type (1 byte)	Length (1 byte)	Value (variable length)
Max_Num_Bursts	23	1	Valid values: 1–16 Maximum number of bursts transmitted concurrently to the MS. Includes all bursts without CID or with CIDs matching then MS’s CIDs

*Insert subclause 11.7.9:*

**11.7.9 SS MAC Address**

This field specifies the MAC address of the SS, used in MESH modes.

Type	Length	Value	Scope
18	6	The MAC address of the SS.	MESH: REG-REQ, REG-RSP

*Insert new subclause 11.7.10:*

**11.7.10 CID update encodings**

The ‘CID update encodings’ field provides a translation table that allows an MS to update its service flow and connection information so that it may continue service after a handover to a new serving BS.

Name	Type (1 byte)	Length (1 byte)	Value (variable length)	Scope
CID_update	24	variable	Compound	REG-RSP

These TLV values shall appear in each CID\_update TLV.

Name	Type (1 byte)	Length (1 byte)	Value (variable length)
New_CID	24.1	2	New CID after handover to new BS.
SFID	24.2	4	Service flow ID

The following TLV element may appear in a CID\_update TLV.

Name	Type (1 byte)	Length (1 byte)	Value (variable length)
Connection Info	24.3	variable	If any of the service flow parameters change, then those service flow parameter encoding TLVs that have changed will be added. Connection_Info is a compound TLV value that encapsulates the service flow parameters that have changed for the service. All the rules and settings that apply to the parameters when used in the DSC-RSP message apply to the contents encapsulated in this TLV.

*Insert new subclause 11.7.10.1:*

**11.7.10.1 Compressed CID update encodings**

The ‘Compressed CID update encodings’ field provides a translation table that allows an MS to update its connection ID. Only CIDs that have no parameter change can be translated by this TLV.

Name	Type	Length	Value	Scope
Compressed CID update	25	<i>variable</i>	The first byte indicates the length of the following BITMAP in bytes. The <i>n</i> -th bit, starting from the MSB of the BITMAP is set to 1 when the <i>n</i> -th SFID is to be updated to a new CID. Where, the SFIDs are sorted with increasing order. After the BITMAP, a list of new CID follows. The number of new CID is equal to the number of ones in the BITMAP.	REG-RSP

*Insert new subclause 11.7.11:*

**11.7.11 Method for allocating IP address for the secondary management connection**

Type	Length	Value	Scope
26	1	Bit #0: DHCP Bit #1: Mobile IPv4 Bit #2: DHCPv6 Bit #3: IPv6 Stateless Address Autoconfiguration Bits #4–7: <i>Reserved</i> ; shall be set to zero	REG-REQ/REG-RSP

*Insert new subclause 11.7.12:*

**11.7.12 Handover supported**

The ‘Handover supported’ field indicates what type(s) of HO the BS and the MS supports. A bit value of 0 indicates “not supported” while 1 indicates it is supported.

Type	Length	Value	Scope
27	1	Bit #0: MDHO/FBSS HO not supported when it is set to 1. When this bit is set to 1, the BS shall ignore all other bits. Bit #1: FBSS/MDHO DL RF Combining supported with monitoring MAPs from active BSs when this bit is set to 1 Bit #2: MDHO DL soft Combining supported with monitoring single MAP from anchor BS when this bit is set to 1. Bit #3: MDHO DL soft combining supported with monitoring MAPs from active BSs when this bit is set to 1 Bit #4: MDHO UL Multiple transmission Bits #5-7: <i>Reserved</i> , shall be set to zero	REG-REQ REG-RSP

*Insert new subclause 11.7.13:*

**11.7.13 HO Support**

*Insert new subclause 11.7.13.1:*

**11.7.13.1 System Resource\_Retain\_Time**

The Resource\_Retain\_Time is the duration for MS’s connection information that will be retained in serving BS. BS shall start Resource\_Retain\_Time timer at MS notification of pending HO attempt through MOB\_HO-IND or by detecting an MS drop. The unit of this value is 100 milliseconds.

Type	Length	Value	Scope
28	2	Multiple of 100 milliseconds 200 milliseconds is recommended as default	REG-RSP

*Insert new subclause 11.7.13.2:*

**11.7.13.2 HO Process Optimization MS Timer**

During network re-entry, the HO Process Optimization MS Timer is the duration in frames the MS shall wait until receipt of the next unsolicited network re-entry MAC management message as indicated in the HO Process Optimization element of the RNG-RSP message. MS shall start HO Process Optimization MS Timer on receipt of RNG-RSP with HO Process Optimization message element indicating one or more unsolicited network re-entry MAC management messages are pending and required to complete network re-entry and establish MS Normal Operation with target BS. HO Process Optimization MS Timer shall recycle on MS receipt of any unsolicited network re-entry MAC management message and shall terminate on MS establishment of Normal Operation with the target BS. On HO Process Optimization MS Timer timeout and while HO Process Optimization MS Timer Retries is valid, MS shall send the network re-entry MAC management request message corresponding to the expected and pending network re-entry MAC management response message as indicated in HO Process Optimization and recycle HO Process Optimization MS Timer.

Type	Length	Value	Scope
29	1	In frames	REG-REQ; REG-RSP

*Insert new subclause 11.7.13.3:*

**11.7.13.3 MS Handover Retransmission Timer**

After an MS transmits MOB\_MSHO-REQ to initiate a handover process, it shall start MS Handover Retransmission Timer and shall not transmit another MOB\_MSHO-REQ until the expiration of the MS Handover Retransmission Timer.

Type	Length	Value	Scope
30	1	In frames	REG-RSP

*Insert new subclause 11.7.14:*

**11.7.14 Mobility parameters support**

The following parameters are associated with mobile operations.

*Insert new subclause 11.7.14.1:*

**11.7.14.1 Mobility features supported**

The ‘Mobility features supported’ field indicates whether or not the MS supports mobility handover, sleep mode, and idle mode. A bit value of 0 indicates “not supported” while 1 indicates “supported”.

Type	Length	Value	Scope
31	1	Bit #0: Mobility (handover) support Bit #1: Sleep mode support Bit #2: Idle mode support	REG-REQ REG-RSP

*Insert new subclause 11.7.15:*

**11.7.15 Sleep mode recovery time**

The ‘Sleep mode recovery time’ field indicates the time required for an MS that is in a sleep mode to return to awake-mode. This parameter is optional and may be used by the BS to determine sleep interval window sizes when initiating sleep mode with an MS.

Type	Length	Value	Scope
32	1	Number of frames required for the MS to switch from sleep mode to awake-mode	REG-REQ

*Insert new subclause 11.7.16:*

**11.7.16 MS-PREV-IP-ADDR**

The ‘MS-PREV-IP-ADDR’ parameter specifies the IP address that the MS was assigned on the secondary management connection based on an association with its last serving BS. An IPv4 address shall be specified in conventional dotted format; e.g., ‘134.234.2.3’. An IPv6 address may be expressed in abridged or unabridged form; however, the form chosen shall be consistent with RFC 2373.

Type	Length	Value	String
33	<i>variable</i>	string	REG-REQ

*Insert new subclause 11.7.17:*

**11.7.17 SKIP-ADDR-ACQUISITION**

The ‘SKIP-ADDR-ACQUISITION’ parameter indicates to an MS whether it should reacquire its IP address on the secondary management connection and related context or reuse its prior context.

Type	Length	Value	Scope
34	1	0: No IP address change 1: Re-acquire IP address	REG-RSP

*Insert new subclause 11.7.18:*

**11.7.18 SAID update encodings**

The ‘SAID update encodings’ field provides a translation table that allows an MS to update its security associations so that it may continue security service after a handover to a new serving BS.

Name	Type	Length (1 byte)	Value	Scope
SAID update	35	<i>variable</i>	Compound	REG-RSP, RNG-RSP

The following TLV values shall appear in each SAID\_update TLV.

Name	Type (1 byte)	Length (1 byte)	Value (variable length)
New SAID	35.1	2	New SAID after handover to new BS
Old SAID	35.2	2	Old SAID before handover from Old BS

*Insert new subclause 11.7.19:*

**11.7.19 Total number of provisioned service flow**

When a BS shall transmit multiple DSA transactions for provisioned service flows, BS may include this TLV in REG-RSP message for provisioned service flows in order to indicate how many DSA transactions with provisioned service flows will be transmitted.

Type	Length	Value	Scope
36	1	Total number of DSA transactions for provisioned service flows for an MS	REG-RSP

*Insert new subclause 11.7.20:*

**11.7.20 Idle Mode**

*Insert new subclause 11.7.20.1:*

**11.7.20.1 Idle Mode Timeout**

MS reported default timer value for MS Idle Mode Timer

Type	Length	Value	Scope
37	2	Max time interval between MS Idle Mode Location Updates in seconds (default = 4096 seconds)	REG-REQ REG-RSP

*Insert new subclause 11.7.20.2:*

**11.7.20.2 Paging Interval Length**

MS reported default timer value for MS Idle Mode Timer

Type	Length	Value	Scope
45	1	Max duration in frames of Paging Listening Interval; used in calculation of Paging Listening Interval; value must be between 1 and 5 frames (default=2)	DCD

*Insert new subclause 11.7.21:*

**11.7.21 SA TEK Update**

The ‘SA TEK Update’ field provides a translation table that allows an MS to update its security associations and TEK pairs so that it may continue security service after a handover to a new serving BS.

The ‘SA TEK Update’ field is a compound TLV list where each entry identifies the primary and static SAs, their SA identifiers (SAID) and additional properties of the SA (e.g., type, cryptographic suite) that the MS is authorized to access. In case of HO, the details of any Dynamic SAs that the requesting MS was authorized in the previous serving BS are also included.

Additionally, in case of HO, for each active SA in previous serving BS, corresponding TEK, GTEK, and GKEK parameters are also included. Thus, SA\_TEK\_Update provides a shorthand method for renewing active SAs used by the MS in its previous serving BS. The TLVs specify SAID in the target BS that shall replace active SAID used in the previous serving BS and also “older” TEK-Parameters and “newer” TEKParameters relevant to the active SAIDs. The update may also include multicast/broadcast Group SAIDs (GSAIDs) and associated GTEK-Parameters pairs.

In case of unicast SAs, the TEK-Parameters attribute contains all of the keying material corresponding to a particular generation of an SAID’s TEK. This would include the TEK, the TEK’s remaining key lifetime, its key sequence number, and the cipher block chaining (CBC) initialization vector. The TEKs are encrypted with KEK.



In case of group or multicast SAs, the TEK-Parameters attribute contains all of the keying material corresponding to a particular generation of a GSAID's GTEK. This would include the newer GTEK parameter pairs, GTEK's remaining key lifetime, the GTEK's key sequence number, and the cipher block chaining (CBC) initialization vector. The type and length of the GTEK are equal to the ones of the TEK. The GKEK should be identically shared within the same multicast group or the broadcast group. The GTEKs are encrypted with GKEK and GKEKs are encrypted with KEK.

Multiple iterations of these TLVs may occur suitable to re-creating and re-assigning all active SAs and their (G)TEK pairs for the MS from its previous serving BS. If any of the Security Associations parameters change, then those Security Associations parameters encoding TLVs that have changed will be added.

This TLV may be sent in a single frame along with unsolicited REG-RSP.

The following TLV values shall appear in each SA TEK Update TLV

Name	Type	Length (1 byte)	Value	Scope
SA TEK Update	38	<i>variable</i>	Compound	REG-RSP

Name	Type	Length (1 byte)	Value
SA TEK Update Type	38.1	1	1: TEK parameters for a SA 2: GTEK parameters for a GSA 3–255: <i>Reserved</i>
New SAID	38.2	2	New SAID after handover to new BS
Old SAID	38.3	2	Old SAID before handover from old BS. In case of initial network entry, old SAID is same as new SAID.
Old TEK Parameters	13/GTEK Type 38.4	<i>variable</i>	“Older” generation of key parameters relevant to SAID. The Compound field contains the sub-attributes as defined in Table 372.
New TEK/GTEK Parameters	13/GTEK Type 38.5	<i>variable</i>	“Newer” generation of key parameters relevant to (G)SAID. The Compound field contains the sub-attributes as defined in Table 372.
GKEK Parameters	GKEK Type 38.6	<i>variable</i>	GKEK and its lifetime for the corresponding GTEK pair if this TLV is for a GSA.

***Insert new subclause 11.7.22:***

### **11.7.22 GKEK Parameters**

*Description:* This attribute is a compound attribute, consisting of a collection of sub-attributes. These sub-attributes represent all security parameters relevant to a particular generation of an GSAID's GKEK. A summary of the KEK-Parameters attribute format is shown as follows

Name	Type	Length (1 byte)	Value	Scope
GKEK Parameters	39	<i>variable</i>	Compound	REG-RSP

Attribute	Contents
GKEK	GKEK, encrypted with KEK
Key-Lifetime	GKEK remaining lifetime

*Insert new subclause 11.7.23:*

**11.7.23 ARQ-ACK Type**

The value of this parameter specifies the ARQ ACK type supported by the MS. The MS shall transmit this parameter if ARQ is supported. The requester includes its desired setting in the REQ message. The receiver of the REQ message shall take the common part of the values it prefers and values in the REQ message. Those common values are included in the RSP message and become the agreed upon the values set. Absence of the parameter during a REG dialog shall indicate the originator of the message desires all the possible ACK type to be supported.

Type	Length	Value	Scope
40	1	Bit 0 Selective ACK entry Bit 1 Cumulative ACK entry Bit 2 Cumulative with Selective ACK entry Bit 3 Cumulative ACK with Block Sequence ACK Bits 4-7 Reserved	REG-REQ, REG-RSP

*Insert new subclause 11.7.24:*

**11.7.24 HO parameters processing time**

Name	Type	Length	Value	Scope
MS HO connections parameters processing time	41	1	Time in ms the MS needs to process information on connections provided in RNGRSP or REG-RSP message during HO	REGREQ/RSP
MS HO TEK processing time	42	1	Time in ms the MS needs to completely process TEK information during HO	REGREQ/RSP

*Insert new subclause 11.7.25:*

**11.7.25 MAC header and extended subheader support**

The ‘MAC header and subheader support’ field indicates whether or not the MS and BS support various types of MAC header and extended subheaders. This field may be sent by either BS or MS. Omission of this field from the REG-REQ/RSP message indicates that none of the headers or subheaders are supported.

Type	Length	Value	Scope
43	3	Bit #0: Bandwidth request and UL Tx Power Report header support Bit #1: Bandwidth request and CINR report header support Bit #2: CQICH Allocation Request header support Bit #3: PHY channel report header support Bit #4: Bandwidth request and uplink sleep control header support Bit #5: SN report header support Bit #6: Feedback header support Bit #7-10: SDU_SN extended subheader support and parameter Bit #7: SDU_SN extended subheader support Bit #8-10 (=p): period of SDU_SN transmission for connection with ARQ disabled = once every $2^p$ MAC PDUs Bit #11: DL sleep control extended subheader Bit #12: Feedback request extended subheader Bit #13: MIMO mode feedback extended subheader Bit #14: UL Tx Power Report extended subheader Bit #15: Mini-feedback extended subheader Bit #16: SN request extended subheader Bit #17: PDU SN(short) extended subheader Bit #18: PDU SN(long) extended subheader Bit #19–23: <i>Reserved</i>	REG-REQ, REG-RSP

A bit value of 0 indicates “not supported” while 1 indicates “supported”.

*Insert new subclause 11.7.26:*

**11.7.26 SN Reporting Base**

SN Reporting Base indicates the (negative of the) base value that the MS shall use in sending fast DL measurement feedback on an enhanced fast-feedback channel.

Type	Length	Value	Scope
44	1	A positive integer in the range 0–255; the base value used in reporting shall be the negative of this value.	REG-RSP

## 11.8 SBC-REQ/RSP management message encodings

### 11.8.2 Capabilities for construction and transmission of MAC PDUs

Change the table as indicated:

Type	Length	Value	Scope
4	1	Bit #0: Ability to receive requests piggybacked with data Bit #1: <del>Ability to use 3-bit FSN values</del> <u>Specifies the size of FSN values used when forming MAC PDUs on non-ARQ connections</u> 0: Only 3-bit FSN values are supported 1: Only 11-bit FSN values are supported Bits #2-7: Reserved; shall be set to zero.	<del>REG-REQ</del> <del>REG-RSP</del> <u>SBC-REQ (see 6.3.2.3.23)</u> <u>SBC-RSP (see 6.3.2.3.24)</u>

### 11.8.3 Physical parameters supported

#### 11.8.3.6 WirelessMAN-OFDM specific parameters

##### 11.8.3.6.2 OFDM SS demodulator

In 11.8.3.6.2, change the TLV table as indicated:

Type	Length	Value	Scope
151	1	Bit #0: 64-QAM Bit #1: BTC Bit #2: CTC Bit #3: STC Bit #4: AAS <u>Bit #5: Subchannelization</u> <del>Bit #6: H-ARQ with SPID=0 only</del> Bits # <del>5</del> <u>7</u> : Reserved; shall be set to zero.	SBC-REQ (see 6.3.2.3.23) SBC-RSP (see 6.3.2.3.24)

##### 11.8.3.6.3 OFDM SS modulator

In 11.8.3.6.3, change the TLV table as indicated:

Type	Length	Value	Scope
152	1	Bit# 0: 64-QAM Bit# 1: BTC Bit# 2: CTC Bit# 3: Subchannelization Bit# 4: Focused contention BW request <u>Bit# 5: UL preamble / Midamble cyclic delay</u> Bits# <del>5</del> <u>6</u> -7: Reserved. Set to 0	SBC-REQ (see 6.3.2.3.23) SBC-RSP (see 6.3.2.3.24)

Delete subclause 11.8.3.6.4.

*Insert new subclause 11.8.3.6.6:*

**11.8.3.6.6 OFDM private map support**

The ‘OFDM private map support’ field indicates the private map parameters supported by a WirelessMAN-OFDM SS.

Type	Length	Value	Scope
155	1	Bit #0: regular private map support Bit #1: compressed and reduced private map support Bit #2–7: <i>Reserved</i>	SBC-REQ (see 6.3.2.3.23) SBC-RSP (see 6.3.2.3.24)

**11.8.3.7 WirelessMAN-OFDMA specific parameters**

*Change subclause 11.8.3.7.1 as indicated:*

**11.8.3.7.1 OFDMA MS FFT sizes**

The ‘OFDMA MS FFT sizes’ field indicates the FFT sizes supported by the MS. For each FFT size, a bit value of 0 indicates “not supported” while 1 indicates “supported”.

Type	Length	Value	Scope
150	1	Bit #0: FFT-256 Bit #1: FFT-2048 <u>Bit #2: FFT-128</u> <u>Bit #3: FFT-512</u> <u>Bit #4: FFT-1024</u> Bits #25–7: <i>Reserved</i>	SBC-REQ (see 6.3.2.3.23) SBC-RSP (see 6.3.2.3.24)

**11.8.3.7.2 OFDMA SS demodulator**

*Change the table and following text as indicated:*

Type	Length	Value	Scope
151	<i>variable</i>	Bit #0: 64-QAM Bit #1: BTC Bit #2: CTC Bit #3: STC Bit #4: <u>AAS Diversity Map Search</u> <u>CC with optional interleacer</u> Bit #5: <u>AAS Direct Signaling</u> <u>HARQ Chase</u> Bit #6: <u>HARQ CTC IR</u> Bit #7: <i>Reserved: shall be set to zero</i> Bit #8: HARQ CC IR <u>Bit #9: LDPC</u> <u>Bit #10 Dedicated pilots</u> Bits #11–15: <i>Reserved: shall be set to zero.</i>	SBC-REQ (see 6.3.2.3.23) SBC-RSP (see 6.3.2.3.24)

This field specifies the number of downlink H-ARQ channels ( $n$ ) the SS supports, where  $n = 1..16$ . The value of the TLV shall be set to  $(n-1)$ . When the length of the TLV 1 byte, it indicates that bits 8–15 are zero.

<u>161</u>	<u>1</u>	<u>The number of DL H-ARQ channels</u>	<u>SBC-REQ (see 6.3.2.3.23)</u> <u>SBC-RSP (see 6.3.2.3.24)</u>
------------	----------	--	--

*Change 11.8.3.7.3 as indicated:*

### 11.8.3.7.3 OFDMA SS modulator

This field indicates the different modulator options supported by a WirelessMAN-OFDMA PHY SS for uplink transmission. This field is not used for other PHY specifications. A bit value of 0 indicates “not supported” while 1 indicates “supported”.

Type	Length	Value	Scope
152	1	Bit# 0: 64-QAM Bit# 1: BTC Bit# 2: CTC Bit #3: <del>AAS Diversity Map Scan</del> STC Bit# 4: <del>AAS Direct Signaling</del> HARQ Chase Bit# 5: <del>H-ARQ CTC_IR</del> Bit# 6: <del>CC_IR</del> Bit# 7: <del>LDPC</del> Bits# 6-7: <del>Reserved</del> ; shall be set to zero	SBC-REQ (see 6.3.2.3.23) SBC-RSP (see 6.3.2.3.24)
<del>153</del>	<del>1</del>	<del>The number of HARQ ACK Channel</del>	<del>SBC-REQ (see 6.3.2.3.23)</del> <del>SBC-RSP (see 6.3.2.3.24)</del>

This field specifies the number of uplink H-ARQ channels ( $n$ ) the SS supports, where  $n = 1..16$ . The value of the TLV shall be set to  $(n-1)$ .

Type	Length	Value	Scope
<u>153</u>	<u>1</u>	<u>The number of UL H-ARQ channels</u>	<u>SBC-REQ (see 6.3.2.3.23)</u> <u>SBC-RSP (see 6.3.2.3.24)</u>

*Change the numbering of subclause 11.8.3.7.5 to 11.8.3.7.4 and change the title as indicated:*

### 11.8.3.7.4 OFDMA SS Ppermutation support

This field indicates the different optional OFDMA permutation modes (optional PUSC, optional FUSC and AMC) supported by a WirelessMAN-OFDMA SS. A bit value of 0 indicates “not supported” while 1 indicates “supported.”

Type	Length	Value	Scope
154	1	Bit# 0: Optional PUSC support Bit# 1: Optional FUSC support Bit# 2: AMC 1x6 support <u>Bit# 3: AMC 2x3 support</u> <u>Bit# 4: AMC 3x2 support</u> <u>Bit# 5: AMC support with HARQ map</u> <u>Bit# 6: TUSC1 support</u> <u>Bit# 7: TUSC2 support</u>	SBC-REQ (see 6.3.2.3.23) SBC-RSP (see 6.3.2.3.24)

NOTE—AMC support (bits #2-4) refers to support of AMC subchannelization using DL-MAP IE or ULMAP IE. When AMC support using HARQ map (Bit #5) is indicated, all AMC types indicated in format configuration IE (6.3.2.3.43.2) are supported when using AMC with HARQ map.

*Insert new subclause 11.8.3.7.5:*

**11.8.3.7.5 OFDMA SS demodulator for MIMO support**

This field indicates the different MIMO options supported by a WirelessMAN-OFDMA PHY SS in the downlink. This field is not used for other PHY specifications. A bit value of 0 indicates “not supported” while 1 indicates “supported”.

Type	Length	Value	Scope
156	2	Bit #0: 2-antenna STC matrix A Bit #1: 2-antenna STC matrix B, vertical coding Bit #2: 2-antenna STC matrix B, horizontal coding Bit #3: 4-antenna STC matrix A Bit #4: 4-antenna STC matrix B vertical coding Bit #5: 4-antenna STC matrix B, horizontal coding Bit #6: 4-antenna STC matrix C, vertical coding Bit #7: 4-antenna STC matrix C, horizontal coding Bit #8–16: <i>Reserved</i>	SBC-REQ (see 6.3.2.3.23) SBC-RSP (see 6.3.2.3.24)

The ‘OFDMA SS Demodulator for MIMO Support’ field that follows indicates the MIMO capability of OFDMA MS demodulator. A bit value of 0 indicates “not supported” while 1 indicates “supported”.

Type	Length	Value	Scope
176	3	Bit #0 2-antenna STC matrix A Bit #1 2-antenna STC matrix B, vertical coding Bit #2 Four receive antennas Bit #3 4-antenna STC matrix A Bit #4 4-antenna STC matrix B, vertical coding Bit #5 4-antenna STC matrix B, horizontal coding Bit #6 4-antenna STC matrix C, vertical coding Bit #7 4-antenna STC matrix C, horizontal coding Bit #8 3-antenna STC matrix A Bit #9 3-antenna STC matrix B Bit #10 3-antenna STC matrix C, vertical coding Bit #11 3-antenna STC matrix C, horizontal coding Bit #12 Capable of calculating precoding weight Bit #13 Capable of adaptive rate control Bit #14 Capable of calculating channel matrix Bit #15 Capable of antenna grouping Bit #16 Capable of antenna selection Bit #17 Capable of codebook based precoding Bit #18 Capable of long-term precoding Bit #19 Capable of MIMO Midamble Bit #20–23: <i>Reserved</i>	SBC-REQ (See 6.3.2.3.23) SBC-RSP (See 6.3.2.3.24)

*Insert new subclause 11.8.3.7.6:*

**11.8.3.7.6 OFDMA SS MIMO uplink support**

This field indicates the different MIMO options supported by a WirelessMAN-OFDMA PHY SS in the uplink. This field is not used for other PHY specifications. A bit value of 0 indicates “not supported” while 1 indicates “supported”.

Type	Length	Value	Scope
157	1	Bit #0: 2-antenna STTD Bit #1: 2-antenna SM with vertical coding Bit #2: single-antenna cooperative SM Bit #3–7: <i>Reserved</i>	SBC-REQ (see 6.3.2.3.23) SBC-RSP (see 6.3.2.3.24)

*Insert new subclause 11.8.3.7.7:*

**11.8.3.7.7 OFDMA AAS private map support**

This field indicates the AAS private map parameters supported by a WirelessMAN-OFDMA SS.

- Private map chain enable indicates if a private map is allowed to point to another private map. If not enabled, private map chains are not allowed.
- The frame offset value indicates the frame offset the SS can support with private maps. A value of 0 indicates the private map allocations are for the subsequent frame (one frame in the future), a value of 1 indicates it is for two frames in the future. When used with compressed private maps, these fields are required to be used. When used with reduced private maps, these are minimum values and the actual frame offset is defined by the frame offset field in the private map.
- The concurrency field indicates how many parallel private map chains can be supported by an SS.



Type	Length	Value	Scope
158	1	Bit #0: HARQ MAP capability Bit #1: private map support Bit #2: Reduced private map support Bit #3: Private Map Chain Enable Bit #4: Private Map DL frame offset 0: support compressed private maps with Frame Offset = 0 1: support compressed private maps with Frame Offset = 1 Bit #5: Private Map UL frame offset 0: support compressed private maps with Frame Offset = 0 1: support compressed private maps with Frame Offset = 1 Bits #6-7: private map chain concurrency 0: indicates no limit 1-3: indicate maximum concurrent private map chains	SBC-REQ (see 6.3.2.3.23) SBC-RSP (see 6.3.2.3.24)

*Insert new subclause 11.8.3.7.8:*

#### 11.8.3.7.8 OFDMA AAS capabilities

This field indicates the different AAS options supported by a WirelessMAN-OFDMA PHY SS in the downlink. This field is not used for other PHY specifications. A bit value of 0 indicates “not supported” while 1 indicates “supported”.

Type	Length	Value	Scope
159	2	Bit# 0: AAS Zone Bit# 1: AAS Diversity Map Scan (AAS-DLFP) Bit# 2: AAS-FBCK-RSP support Bit# 3: Downlink AAS preamble Bit# 4: Uplink AAS preamble Bit #5-16: <i>Reserved</i>	SBC-REQ (see 6.3.2.3.23) SBC-RSP (see 6.3.2.3.24)

A subscriber supporting any mode of AAS should set Bit #0 to indicate support of AAS zone (as specified in 8.4.5.3.3). It may, in addition, use Bit #1 to indicate use of the AAS-DLFP channel specified in 8.4.4.6. The SS may indicate support of AAS preamble. An SS not supporting the preamble in downlink/uplink expects a preamble length of 0. Support of the AAS zone as well as support of the signaling methods “AAS Diversity Map Scan” and “AAS Direct Signaling” is relevant to both UL and DL.

*Insert new subclause 11.8.3.7.9:*

**11.8.3.7.9 OFDMA SS CINR measurement capability**

Type	Length	Value	Scope
160	1	Bit #0:Physical CINR measurement from the preamble Bit #1:Physical CINR measurement for a permutation zone from pilot subcarriers Bit #2:Physical CINR measurement for a permutation zone from data subcarriers Bit #3:Effective CINR measurement from the preamble Bit #4:Effective CINR measurement for a permutation zone from pilot subcarriers Bit #5:Effective CINR measurement for a permutation zone from data subcarriers Bit #6:Support for 2 concurrent CQI channels Bit #7:Frequency selectivity characterization report	SBC-REQ (see 6.3.2.3.23) SBC-RSP (see 6.3.2.3.24)

*Insert new subclause 11.8.3.7.10:*

**11.8.3.7.10 OFDM SS uplink power control support**

The ‘OFDM SS uplink power control support’ field indicates the uplink power control options supported by a WirelessMAN-OFDM PHY SS for uplink transmission This field is not used for other PHY specifications. A bit value of 0 indicates “not supported” while 1 indicates “supported”.

Type	Length	Value	Scope
156	1	Bit #0: Uplink open loop power control support Bit #1: Uplink AAS preamble power control support. Bits #2–7: <i>Reserved</i> , shall be set to zero.	SBC-REQ (see 6.3.2.3.23) SBC-RSP (see 6.3.2.3.24)
157	1	The minimum number of frames that SS takes to switch from the open loop power control scheme to the closed loop power control scheme or vice versa.	SBC-REQ (see 6.3.2.3.23) SBC-RSP (see 6.3.2.3.24)

*Insert new subclause 11.8.3.7.11:*

**11.8.3.7.11 OFDMA SS uplink power control support**

The ‘OFDMA SS uplink power control support’ field indicates the uplink power control options supported by a WirelessMAN-OFDMA PHY SS for uplink transmission This field is not used for other PHY specifications. A bit value of 0 indicates “not supported” while 1 indicates “supported”.

*Insert new subclause 11.8.3.7.12:*

**11.8.3.7.12 OFDMA MAP Capability**

The ‘OFDMA MAP Capability’ field indicates the different MAP options supported by a WirelessMAN-OFDMA PHY. This field is not used for other PHY specifications. A bit value of 0 indicates “not supported” while 1 indicates “supported”.

Type	Length	Value	Scope
170	1	Bit #0: Uplink open loop power control support Bit #1: Uplink AAS preamble power control support. Bits #2–7: <i>Reserved</i> , shall be set to zero	SBC-REQ (see 6.3.2.3.23) SBC-RSP (see 6.3.2.3.24)
171	1	The minimum number of frames that SS takes to switch from the open loop power control scheme to the closed loop power control scheme or vice versa	SBC-REQ (see 6.3.2.3.23) SBC-RSP (see 6.3.2.3.24)

Support for Extended HARQ IE in mandates a support for SUB-DL-UL-MAP for first zone.

Type	Length	Value	Scope
172	1	Bit #0: HARQ MAP Capability Bit #1: Extended HARQ IE capability Bit #2: Sub MAP capability for first zone Bit #3: Sub MAP capability for other zones Bit #4: DL region definition support Bits #5-7: <i>Reserved</i>	SBC-REQ (see 6.3.2.3.23) SBC-RSP (see 6.3.2.3.24)

*Insert new subclause 11.8.3.7.13:*

**11.8.3.7.13 Uplink control channel support**

The ‘Uplink control channel support’ indicates the different uplink control channels supported by a WirelessMAN-OFDMA PHY MS for uplink transmission. A bit value of 0 indicates “not supported” while 1 indicates “supported”.

Type	Length	Value	Scope
173	1	Bit #0: 3 bit-MIMO Fast-feedback Bit #1: Enhanced FAST_FEEDBACK Under negotiation for SBC fast feedback, if enhanced feature is enabled, the SS should use only the enhanced fast-feedback channel in the CQICH allocation IE (see 8.4.5.4.15 and 8.4.5.4.16). Bit #2: UL ACK Bit #3: <i>Reserved</i> . Shall be set to zero. Bit #4: UEP fast-feedback Bit #5: A measurement report shall be performed on the last DL burst, as described in 8.4.5.4.10.1 Bit #6: Primary/Secondary FAST_FEEDBACK Bit #7: DIUC-CQI Fast-feedback	SBC-REQ (see 6.3.2.3.23) SBC-RSP (see 6.3.2.3.24)

*Insert new subclause 11.8.3.7.14:*

**11.8.3.7.14 OFDMA MS CSIT capability**

The ‘OFDMA MS CSIT capability’ indicates MS capability of supporting CSIT (uplink sounding). A bit value of 0 indicates “not supported” while 1 indicates “supported”. If this field is omitted, then by default MS is considered not supporting CSIT. Capability type A indicates sounding that does not use subcarrier permutations of the downlink.

Capability type B indicates sounding over subcarriers distributed according to permutations of the downlink.

Type	Length	Value	Scope
174	2	Bit #0: CSIT compatibility type A. Bit #1: CSIT compatibility type B. Bit #2: Power assignment capability (indicate support for non equal power assignment) Bits #3–5: Sounding response time capability Bits #6–9: max number of simultaneous sounding instructions (0 = unlimited) Bit #10: SS does not support P values of 9 and 18 when supporting CSIT type A Bit #11–15: Reserved	SBC-REQ (see 6.3.2.3.23) SBC-RSP (see 6.3.2.3.24)

The sounding response time capability encodings are as follows:

Bits 3–5	Time needed for SS to respond to a sounding command transmitted by the BS
000	0.5 ms
001	0.75 ms
010	1 ms
011	1.25 ms
100	1.5 ms
101	min(2 ms, Next Frame)
110	min(5ms, Next Frame)
111	Next Frame

*Insert new subclause 11.8.3.7.15:*

**11.8.3.7.15 Maximum number of burst per frame capability in HARQ**

The ‘Maximum number of burst per frame capability’ field indicates the maximum number of uplink/downlink data burst allocations for the SS in a single UL/DL subframe (note that the number of UL non-HARQ burst is always limited to 1).

Type	Length	Value	Scope
175	1	Bits #0–2: Maximum number of UL HARQ bursts per HARQ enabled MS per frame. (0b000 = one, default) Bit #3: Indicates whether the maximum number of UL HARQ bursts per frame (i.e., Bits #2–0) includes the one Non-HARQ burst. (0 = not included, default) Bits #4–7: Maximum number of DL HARQ bursts per HARQ enabled MS per frame. (0b0000 = one, default)	SBC-REQ (see 6.3.2.3.23) SBC-RSP (see 6.3.2.3.24)

*Insert new subclause 11.8.3.7.16:*

**11.8.3.7.16 OFDMA SS Modulator for MIMO Support**

The ‘OFDMA SS Modulator for MIMO Support’ field indicates the MIMO capability of OFDMA SS modulator. A bit value of 0 indicates “not supported” while 1 indicates “supported”.

Type	Length	Value	Scope
177	1	Bit #0: Two transmit antennas Bit #1: Capable of transmit diversity Bit #2: Capable of spatial multiplexing Bit #3: Capable of beamforming Bit #4: Capable of adaptive rate control Bit #5: Capable of single antenna Bit #6: Capable of two-antenna Bit #7: <i>Reserved</i> ; shall be set to zero	SBC-REQ (See 6.3.2.3.23) SBC-RSP (See 6.3.2.3.24)

*Insert new subclause 11.8.3.7.17:*

**11.8.3.7.17 SDMA Pilot capability**

Type	Length	Value	Scope
178	1	Bit #0-#1: SDMA pilot pattern support for AMC zone: 0b00 – no support 0b01 – support SDMA pilot patterns #A and #B 0b11 – support all SDMA pilot patterns 0b10 – <i>Reserved</i> Bit #2-7 <i>Reserved</i>	SBC-REQ SBC-RSP

*Insert new subclause 11.8.3.7.18:*

**11.8.3.7.18 OFDMA Multiple Downlink Burst Profile Capability**

This value indicates Downlink/Uplink Burst Profile which shall be used for MS and BS. If this TLV is not included in SBCREQ message, BS shall not include this TLV in SBC-RSP message.

Type	Length	Value	Scope
179	1	Bit #0: Downlink burst profile for multiple FEC types (Table 304a) Bit #1: Uplink burst profile for multiple FEC types (Table 304b) Bit #2-7: <i>Reserved</i> (shall be set to 0)	SBC-REQ (see 6.3.2.3.23) SBC-RSP (see 6.3.2.3.24)

***Insert new subclause 11.8.3.7.19:***

**11.8.3.7.19 HARQ buffer capability**

Downlink/Uplink HARQ buffering capability indicates the maximal number of data bits the SS is able to store for downlink/uplink HARQ. The buffering capability is separately indicated for  $N_{EP}/N_{SCH}$  based incremental redundancy used for CTC, and for DIUC/duration based HARQ methods (Chase combining and CC-IR), and separately for uplink and downlink transmissions. The buffering capability is indicated by two parameters:

- 1) Number of bits per channel—this is the total number of data bits that the SS may buffer per HARQ channel.
- 2) Aggregation flag—when this flag is clear, the number of bits is counted separately for each channel. When the flag is set, buffering capability may be shared between channels, as explained below.

The number of bits per channel is indicated as follows:

- For incremental redundancy CTC ( $N_{EP}$  based): Number of bits is indicated by  $N_{EP}$  code, according to Table 330.
- For Chase combining and CC-IR (DIUC based): Number of bits is indicated by a value  $K=0..63$  according to the following equation: Number of bits = floor( $512 \times 2K/4$ ) Bits.

When aggregation flag is clear, the number of bits that were allocated in each HARQ channel in the last transmission must not exceed “Number of bits per channel”.

When aggregation flag is set, the sum over all HARQ channels, of the number of bits that were allocated in the HARQ channel in the last transmission, must not exceed the “Number of bits per channel” multiplied by the maximum number channels supported by the SS. Note that sum total of the data bits supported is the same in both cases is the same. The number of channels supported by the SS is indicated in 11.8.3.7.3.

The IR-CTC HARQ buffer capability shall also be applied to bursts for which ACK channel is not allocated (ACK disable is set).

***Insert new subclause 11.8.3.7.19.1:***

**11.8.3.7.19.1 HARQ incremental redundancy buffer capability**

Type	Length	Value	Scope
162	2	Bits #0–3: $N_{EP}$ value indicating downlink HARQ buffering capability for incremental redundancy CTC. Bit #4: Aggregation Flag for DL Bits #5–7: <i>Reserved</i> Bits #8–11: $N_{EP}$ value indicating uplink HARQ buffering capability for incremental redundancy CTC. Bit #12: Aggregation Flag for UL Bits #13–15: <i>Reserved</i>	SBC-REQ SBC-RSP

*Insert new subclause 11.8.3.7.19.2:*

**11.8.3.7.19.2 HARQ Chase combining and CC-IR buffer capability**

Type	Length	Value	Scope
163	2	Bits #0–5: Downlink HARQ buffering capability for chase combining (K) Bit #6: Aggregation Flag for DL Bit #7: <i>Reserved</i> . Bits #8–13: Uplink HARQ buffering capability for chase combining (K) Bit #14: Aggregation Flag for UL Bit #15: <i>Reserved</i>	SBC-REQ SBC-RSP

*Insert new subclause 11.8.4:*

**11.8.4 Security Negotiation Parameters**

This field is a compound attribute indicating security capabilities to negotiate before performing the initial authorization procedure and the reauthorization procedure.

Type	Length	Value	Scope
25	<i>variable</i>	The compound field contains the sub-attributes as defined in the table below.	SBC-REQ SBC-RSP

Sub-attribute	Contents
PKM Version Support	Version of privacy sublayer supported
Authorization Policy Support	Authorization policy to support
Message Authentication Code Mode	Message authentication code to support
PN Window Size	Size capability of the receiver PN window per SAID

**11.8.4.1 PKM Version Support**

The ‘PKM Version Support’ field indicates a PKM version. A bit value of 0 indicates “not supported” while 1 indicates “supported”. Both an SS and a BS should negotiate only one PKM version.

Type	Length	Value
25.1	1	Bit #0: PKM version 1 Bit #1: PKM version 2 Bit #2-7: <i>Reserved</i> . Set to 0

### 11.8.4.2 Authorization policy support

The ‘Authorization policy support’ field indicates authorization policy used by the MS and BS to negotiate and synchronize. A bit value of 0 indicates “not supported” while 1 indicates “supported”.

Type	Length	Value
25.2	1	Bit #0: RSA-based authorization at the initial network entry Bit #1: EAP-based authorization at the initial network entry Bit #2: Authenticated EAP-based authorization at the initial network entry Bit #3: Reserved. Set to 0 Bit #4: RSA-based authorization at re-entry Bit #5: EAP-based authorization at re-entry Bit #6: Authenticated EAP-based authorization at re-entry Bit #7: <i>Reserved</i> . Set to 0

Authenticated EAP-based authorization basically means that a message containing EAP payload is protected by CMAC Digest. The CMAC\_KEY\_U and CMAC\_KEY\_D are generated with the EIK obtained from RSA-based authorization or EAP-based authorization.

The PKMv2 Auth-Request/Reply/Reject/Acknowledgement messages shall be used in the RSA-based authorization procedure.

The PKMv2 EAP-Transfer message shall be used in the EAP-based authorization procedure. The PKMv2 Authentication EAP-Transfer message shall be used in the Authenticated EAP-based authorization procedure.

Bits #4–6 are only applied to the SBC-REQ message. Those bits shall be set to 0 in the SBC-RSP message. MS and BS will execute the reauthorization procedure according to the authorization policy negotiated in current BS when AK lifetime is expired and so on. After MS moves into another BS, MS and target BS will execute the reauthorization procedure according to the authorization policy of HO re-entry negotiated in the target BS when the lifetime of AK, which is negotiated between MS and target BS, is expired and so on.

The MS should support at least one authorization policy and inform BS of all supportable authorization policies by the SBC-REQ message. The BS negotiates the authorization policy. If all bits of this attribute included in the SBC-RSP message are 0, then no authorization is applied. Both the BS and the MS shall not use the authorization function.

The following table shows possible authorization policies that the MS can support.

The table shows the bit representation of Bits #0–2 and Bits #4–6 in ‘Authorization Policy Support’ field in an SBC-REQ and a PKMv2 SA-TEK-Request messages.



Value			Description	Scope
Bit #0/ Bit #4	Bit #1/ Bit #5	Bit #2/ Bit #6		
0	0	0	No Authorization (MS cannot support any authorization)	SBC-REQ, PKM-REQ
0	0	1	N/A	
0	1	0	Only EAP-based authorization	
0	1	1	Only EAP-based authorization or authenticated EAP-based authorization after EAP-based authorization	
1	0	0	Only RSA-based authorization	
1	0	1	Only RSA-based authorization or authenticated EAP-based authorization after RSA-based authorization	
1	1	0	Only RSA-based authorization or Only EAP-based authorization or EAP-based authorization after RSA-based authorization	
1	1	1	Only RSA-based authorization or Only EAP-based authorization or EAP-based authorization after RSA-based authorization or authenticated EAP-based authorization after RSA-based authorization or authenticated EAP-based authorization after EAP-based authorization	

The following table shows the bit representation of Bit #0–2 in ‘Authorization Policy Support’ field in an SBC-RSP and a PKMv2 SA-TEK-Response messages.

Value			Description	Scope
Bit #0	Bit #1	Bit #2		
0	0	0	No Authorization	SBC-RSP, PKM-RSP
0	0	1	N/A	
0	1	0	Only EAP-based authorization	
0	1	1	Authenticated EAP-based authorization after EAP-based authorization	
1	0	0	Only RSA-based authorization	
1	0	1	Authenticated EAP-based authorization after RSA-based authorization	
1	1	0	EAP-based authorization after RSA-based authorization	
1	1	1	N/A	

If MS and BS decide “No authorization” as their authorization policy, the MS and BS shall perform neither SA-TEK handshake nor TEK exchange procedure.

**11.8.4.3 MAC (Message Authentication Code) Mode**

This field indicates a MAC (Message Authentication Code) mode that MS supports. Both MS and BS shall determine and use a MAC mode. A bit value of 0 indicates “not supported” while 1 indicates “supported”. If this attribute is not present, only HMAC is supported.

Type	Length	Value
25.3	1	Bit# 0: HMAC Bit# 1: CMAC Bit# 2: 64-bit short-HMAC <sup>a</sup> Bit# 3: 80-bit short-HMAC <sup>a</sup> Bit# 4: 96-bit short-HMAC <sup>a</sup> Bit# 5-7: Reserved. Set to 0

<sup>a</sup>If the short-HMAC mode is selected, then the short-HMAC Tuple shall be applied to the following messages: MOB\_SLP-REQ/RSP, MOB\_SCN-REQ/RSP, MOB\_MSHO-REQ, MOB\_BSHO-REQ/RSP, MOB\_HO-IND, RNG-REQ/RSP. Otherwise, the HMAC Tuple shall be applied.

The MS should support at least one MAC mode and inform BS of all supportable MAC modes by the SBC-REQ message. The BS negotiates the MAC mode. If all bits of this attribute included in the SBC-RSP message are 0, then no message authentication code is applied. Both the MS and the BS does not need to authenticate the MAC (Medium Access Control) messages.

Short HMAC can be used only for HMAC is enabled.

**11.8.4.4 PN window size**

Specifies the size capability of the receiver PN window for SAs and management connections. The receiver shall track PNs within this window to prevent replay attacks (see 7.5.1.2.4).

Type	Length	Value
25.4	2	PN Window Size in PNs

*Insert new subclause 11.8.5:*

**11.8.5 Power save class types capability**

For MS supporting sleep mode, this parameter defines the capability of the MS supporting different power save class types in sleep mode.

Type	Length	Value	Scope
26	1	Bit #0: power save class type I supported. Bit #1: power save class type II supported. Bit #2: power save class type III supported. Bits #3-4: number of power save class instances supported from class types 1 and 2 Bits #5-7: number of power save class instances supported from class type III	SBC-REQ, SBC-RSP

*Insert new subclause 11.8.6:*

**11.8.6 Extension capability**

Specifies extension capability supports:

Type	Length	Value	Scope
27	1	Bit #0: Support Extended subheader format Bit #1–7: Reserved	SBC-REQ/RSP

*Insert new subclause 11.8.7:*

**11.8.7 HO Trigger metric support**

This field indicates trigger metrics that MS or BS supports. For each bit, a value of 0 indicates “not supported” while 1 indicates “supported”.

Type	Length	Value	Scope
28	1	Bit #0: BS CINR mean Bit #1: BS RSSI mean Bit #2: Relative delay Bit #3: BS RTD Bit #4–7: <i>Reserved</i> ; shall be set to zero	SBC-REQ SBC-RSP

*Insert new subclause 11.8.8:*

**11.8.8 Association type support**

The *Association type support* field indicates the association level supported by the MS or the BS.

Type	Length	Value	Scope
167	1	Bit #0: Scanning without Association: Association not supported Bit #1: Association level 0: Scanning or association without coordination. Bit #2: Association level 1: association with coordination. Bit #3: Association level 2: network assisted association. Bit #4: Directed association support. Bits #5–7 <i>Reserved</i>	SBC-REQ (see 6.3.2.3.23) SBC-RSP (see 6.3.2.3.24)

If a bit is set to ‘1’, then MS or BS indicates support at the respective association type and level. The MS may associate according to arrangements by the BS at levels up to and including the one for which the MS has indicated support.

## 11.9 PKM-REQ/RSP management message encodings

Change Table 370 as indicated (only changed/new text is shown):

**Table 370—PKM attribute types**

Type	PKM attribute
<u>22</u>	<del>Version</del> <i>Reserved</i>
<u>25</u>	<u>Security Negotiation Parameters</u>
<u>28</u>	<u>EAP Payload</u>
<u>29</u>	<u>Nonce</u>
<u>30</u>	<u>Auth Result Code</u>
<u>31</u>	<u>SA service type</u>
<u>32</u>	<u>Frame Number</u>
<u>33</u>	<u>SS_RANDOM</u>
<u>34</u>	<u>BS_RANDOM</u>
<u>35</u>	<u>pre-PAK</u>
<u>36</u>	<u>PAK/AK Sequence Number</u>
<u>37</u>	<u>BS-Certificate</u>
<u>38</u>	<u>SigBS</u>
<u>39</u>	<u>MS-MAC Address</u>
<u>40</u>	<u>CMAC-Digest</u>
<u>41</u>	<u>Key Push Modes</u>
<u>42</u>	<u>Key Push Counter</u>
<u>43</u>	<u>GKEK</u>
<u>44</u>	<u>SigSS</u>
<u>45</u>	<u>AKID</u>
<u>46</u>	<u>Associated GKEK Sequence Number</u>
<u>47</u>	<u>GKEK-Parameters</u>
<del>2848</del> –255	<i>Reserved</i>

**11.9.3 TEK**

*Change 11.9.3 as indicated:*

Type	Length	Value (string)
8	8	Encrypted TEK for DES
	<u>16</u>	<u>Encrypted TEK for AES</u>
	<u>24</u>	<u>Encrypted TEK for AES Key Wrap</u>

When the TEK encryption algorithm identifier in the SA is 0x01, the length shall be 8 and the TEK shall be encrypted with 3DES in EDE mode according to the procedure defined in 7.5.2.1.

When the TEK encryption algorithm identifier in the SA is 0x03, the length shall be 16 and the TEK shall be encrypted with AES in ECB mode according to the procedure in 7.5.2.3.

When the TEK encryption algorithm identifier in the SA is 0x04, the length shall be 24 and the TEK shall be encrypted with the AES Key Wrap algorithm according to the procedure in 7.5.2.4.

**Table 371a—TEK encryption algorithm identifiers**

<u>Value</u>	<u>Description</u>
<u>0</u>	<i>Reserved</i>
<u>1</u>	<u>3-DES EDE with 128-bit key</u>
<u>2</u>	<u>RSA with 1024-bit key</u>
<u>3</u>	<u>ECB mode AES with 128-bit key</u>
<u>4</u>	<u>AES Key Wrap with 128-bit key</u>
<u>5–255</u>	<i>Reserved</i>

*Change 11.9.4 as indicated:*

**11.9.4 Key lifetime**

*Description:* This attribute contains the lifetime, in seconds, of an AK or a TEK or a PAK, or a PMK. It is a 32-bit unsigned quantity representing the number of remaining seconds for which the associated key shall be valid. Note that this attribute can be used as a single TLV or as part of a compound TLV top-level attribute (AK) as well as a subattribute (TEK).

Type	Length	Value (uint32)
9	4	32-bit quantity representing key lifetime A key lifetime of zero indicates that the corresponding <u>key AK or TEK</u> is not valid.

*Change 11.9.5 as indicated:*

### 11.9.5 Key-Sequence-Number

*Description:* This attribute contains sequence number for a TEK or AK or a PAK, or a PMK. The 2-bit or 4-bit quantity, however, is stored in a single byte, with the high-order 6 or 4 bits set to 0. A summary of the Key-Sequence-Number attribute format is shown below. Note that this attribute can be used as a single TLV or as part of a compound TLV top-level attribute (AK) as well as a subattribute (TEK

Type	Length	Value (uint8)
10	1	2-bit sequence number (TEK) 4-bit sequence number (AK, PAK, PMK)

### 11.9.6 HMAC Digest

*Insert new subclause 11.9.6.1:*

#### 11.9.6.1 Short-HMAC Digest

*Description:* This attribute contains the highest-order bytes of the keyed hash used for message authentication. The HMAC algorithm is defined in IETF RFC 2104. The 20 byte HMAC result is truncated to the length indicated by the BS in the Short-HMAC digest length parameter (see 11.1.2.3), or to 10 bytes if the Short-HMAC digest length parameter was not specified.

Type	Length	Value (uint16)
11	variable(8, 10, or 12 bytes as described in 11.1.2.3)	The highest order bytes of the truncated HMAC-SHA1 keyed hash

### 11.9.7 SAID

*Change text in 11.9.7 as indicated:*

*Description:* This attribute contains a 16-bit SAID used by the Privacy Protocol to identify the SA. The SAID for the multicast service or the broadcast service is the GSAID. Null SAID shall used when “No authorization” is applied. The value of Null SAID is 0xffff.

### 11.9.8 TEK parameters

*Change 11.9.8 as indicated:*

*Description:* This attribute is a compound attribute, consisting of a collection of subattributes. These subattributes represent all security parameters relevant to a particular generation of an SAID’s TEK. A summary of the TEK-Parameters attribute format is shown below. The GTEK and GKEK are defined only

for the multicast service or the broadcast service. The GTEK is the TEK for the multicast service or the broadcast service.

**Table 372—TEK-parameters subattributes**

Attribute	Contents
TEK	TEK, encrypted with the KEK <u>GTEK, encrypted with the GKEK</u>
Key-Lifetime	TEK Remaining Lifetime
Key-Sequence-Number	TEK Sequence Number
CBC-IV	CBC Initialization Vector
<u>Associated GKEK Sequence Number</u>	<u>Associated GKEK sequence number with this TEK-Parameters</u>

*Insert the following text at the end of the 11.9.8:*

The CBC-IV attribute is required when the data encryption algorithm identifier in the SA ciphersuite is 0x01 (DES in CBC mode).

The CBC-IV attribute is not required when the data encryption algorithm identifier in the SA ciphersuite is 0x02 (AES).

The CBC-IV attribute is required when the data encryption algorithm identifier in the SA ciphersuite is 0x03 (AES in CBC mode).

**11.9.13 Security capabilities**

*Change the text as indicated:*

~~Description: The Security-Capabilities attribute contains is a compound attribute whose subattributes identify the version of PKM an SS supports and the cryptographic suite(s) an SS supports.~~

Type	Length	Value (compound)
19	<i>variable</i>	The Compound field contains the subattributes as defined in Table 374

**Table 374—Security-capabilities subattributes**

Attribute	Contents
Cryptographic-Suite-List	List of supported cryptographic suites
<del>Version</del>	<del>Version of Privacy supported</del>

### 11.9.14 Cryptographic suite

*Change the text as indicated:*

**Table 375—Data encryption algorithm identifiers**

Value	Description
0	No data encryption
1	CBC-Mode, 56-bit DES
<u>2</u>	<del>AES, CCM mode</del> <u>CCM-Mode, 128-bit AES</u>
<u>3</u>	<u>CBC-Mode, 128-bit AES</u>
128	<u>CTR-Mode 128 bits AES for MBS with 8 bits ROC</u>
<del>24–127 and</del> <u>129–255</u>	<i>Reserved</i>

**Table 376—Data authentication algorithm identifiers**

Value	Description
0	No data authentication
<u>1</u>	<u>CCM-Mode, 128-bit AES</u>
<del>2–255</del>	<i>Reserved</i>

**Table 377—TEK encryption algorithm identifiers**

Value	Description
0	Reserved
1	3-DES EDE with 128-bit key
2	RSA with 1024-bit key
<u>3</u>	<u>ECB mode AES with 128-bit key</u>
<u>4</u>	<u>AES Key Wrap with 128-bit key</u>
<del>35–255</del>	<i>Reserved</i>



**Table 378—Allowed cryptographic suites**

Value	Description
0x000001	No data encryption, no data authentication and 3-DES, 128
0x010001	CBC-Mode 56-bit DES, no data authentication and 3-DES, 128
0x000002	No data encryption, no data authentication and RSA, 1024
0x010002	CBC-Mode 56-bit DES, no data authentication and RSA, 1024
<u>0x020103</u>	<u>CCM-Mode 128-bit AES, CCM-Mode, 128-bit, ECB mode AES with 128-bit key</u>
<u>0x020104</u>	<u>CCM-Mode 128bits AES, CCM-Mode, AES Key Wrap with 128-bit key</u>
<u>0x030003</u>	<u>CBC-Mode 128-bit AES, no data authentication, ECB mode AES with 128-bit key</u>
<u>0x800003</u>	<u>MBS CTR Mode 128 bits AES, no data authentication, AES ECB mode with 128-bit key</u>
<u>0x800004</u>	<u>MBS CTR mode 128 bits AES, no data authentication, AES Key Wrap with 128-bit key</u>
All remaining values	<i>Reserved</i>

*Delete all of 11.9.16.*

**~~41.9.16 Version~~**

*Change 11.9.17 as indicated:*

**11.9.17 SA-Descriptor**

Description: The SA-Descriptor attribute is a compound attribute whose subattributes describe the properties of a Security Association (SA). These properties include the SAID, the SA type, the SA service type, and the cryptographic suite employed within the SA.

**Table 383—SA-Descriptor subattributes**

Attribute	Contents
SAID	Security Association ID
SA-Type	Type of SA
<u>SA service type</u>	<u>Service type of the corresponding SA type. This shall be defined only when SA type is Static SA or Dynamic SA.</u>
Cryptographic-Suite	Cryptographic suite employed within the SA

### 11.9.19 PKM configuration settings

*Change the table in 11.9.19 as indicated:*

Type	Length	Value ( <del>compound</del> )	Scope
27	variable	<u>Compound</u>	Auth Reply_PMKv2-rsa reply, sa-tek-response

*Insert new subclause 11.9.20:*

### 11.9.20 Nonce

*Description:* A quantity used to protect message exchanges from Replay Attack. As always, values for nonces should be generated using reliable random or pseudo-random generators.

Type	Length	Value (string)
29	4	Randomly generated value

*Insert new subclause 11.9.21:*

### 11.9.21 SS\_RANDOM

*Description:* This attribute contains a quantity that is pseudo random number generated from the MS and used as fresh number for mutual authorization message handshake.

Type	Length	Value
33	8	MS generated random number

*Insert new subclause 11.9.22:*

### 11.9.22 BS\_RANDOM

*Description:* This attribute contains a quantity that is pseudo random number generated from the BS and used as fresh number for mutual authorization message handshake.

Type	Length	Value
34	8	BS generated random number

*Insert new subclause 11.9.23:*

**11.9.23 Pre-PAK**

*Description:* This PAK (Primary Authorization Key) is 16 byte quantity, from which annn AK, KEK, two MAC message authentication keys, and two EAP message protection keys are derived. This attribute contains a 128 byte quantity containing the PAK RSA-encrypted with the MS’s 1024-bit RSA public key. Details of the RSA encryption procedure are given 7.x The ciphertext produced by the RSA algorithm shall be the length of the RSA modulus, i.e., 128 bytes.

Type	Length	Value
35	128	128 byte quantity representing an RSA-encrypted pre-PAK, which generates PAK

*Insert new subclause 11.9.24:*

**11.9.24 BS-Certificate**

*Description:* This attribute is a string attribute containing an X.509 BS Certificate, as defined 7.x. A summary of the BS-Certificate attribute format is shown below. The fields are transmitted from left to right.

Type	Length	Value
37	<i>variable</i> Length shall not cause resulting MAC management message to exceed the maximum allowed size.	X.509 BS Certificate (DER-encoded ASN.1)

*Insert new subclause 11.9.25:*

**11.9.25 SigBS**

*Description:* This attribute contains a RSA signature computed over the PKMv2 RSA Reply message or the PKMv2 RSA Reject message with the BS’s private key.

Type	Length	Value
38	128	An RSA signature computed over all attributes included in the PKMv2 RSA Reply message or the PKMv2 RSA Reject message with the BS’s private key. This value is calculated using PKCS #1 OAEP 1.5 signing algorithm with SHA-1 hash.

*Insert new subclause 11.9.26:*

**11.9.26 MS-MAC address**

*Description:* This attribute is the MAC address of MS.

Type	Length	Value
39	6	The MAC address of the MS

*Insert new subclause 11.9.27:*

**11.9.27 CMAC Digest**

*Description:* This attribute contains a packet number counter CMAC\_PN\_\* incremented per packet on each direction and the Message Authentication Code value used for message authentication. The CMAC algorithm is defined in draft SP 800-38B.

The CMAC digest includes

Type	Length	Value
40	12	See that follows

Field	Length (bits)	Note
CMAC Packet Number counter, CMAC_PN_*	32	This context is different in UL, DL
CMAC value	64	CMAC with AES 128

*Insert new subclause 11.9.28:*

**11.9.28 Key Push Modes**

*Description:* The field, key push modes, is used to distinguish usage code of a PKMv2 Group Key Update Command message.

Type	Length	Value
41	1	0, GKEK update mode 1, GTEK update mode 2–255, <i>Reserved</i>

A PKMv2 Group Key Update Command message for the GKEK update mode is to distribute new GKEK to each SS carried on the Primary Management connection. The BS transmits this message before the M&B TEK Grace Time starts.

A PKMv2 Group Key Update Command message for the GTEK update mode is to distribute new GTEK to all SS carried on the Broadcast connection. The BS transmits this message after the M&B TEK Grace Time starts.

Attributes of a PKMv2 Group Key Update Command message are different according to the value of the Key Push Modes as shown in the following table.

Attribute	GKEK update mode	GTEK update mode
Key-Sequence-Number	AK Sequence Number	GKEK Sequence Number
GSAID	Yes	Yes
Key Push Modes	Yes	Yes
Key Push Counter	Yes	Yes
GTEK-Parameters	No	Yes
GKEK-Parameters	Yes	No
HMAC/CMAC-Digest	Yes	Yes

Key-Sequence-Number, GSAID, Key Push Modes, and HMAC/CMAC-Digest fields are included in two PKMv2 Group Key Update Command message regardless of the value of the Key Push Modes.

GKEK-Parameters attribute should be included in a PKMv2 Group Key Update Command message for the GKEK update mode. And GTEK-Parameters attribute should be included in that message for the GTEK update mode.

CBC-IV can be included only when the TEK encryption algorithm identifier in the cryptographic suite equal to 0x01.

One of HMAC Digest or CMAC-Digest shall be used to authenticate the Key Update Command messages.

*Insert new subclause 11.9.29:*

**11.9.29 Key Push Counter**

*Description:* Key Push Counter is used to protect for replay attack. This value is one greater than (modulo 65536) that of older generation.

Type	Length	Value
42	2	16-bit counter

*Insert new subclause 11.9.30:*

**11.9.30 GKEK (Group Key Encryption Key)**

*Description:* 128-bit GKEK may be randomly generated in a BS or an ASA server. The ‘GKEK (Group Key Encryption Key)’ field is used to encrypt the GTEK for the multicast service or the broadcast service.

Type	Length	Value
43	16	GKEK, encrypted with the KEK derived from AK

*Insert subclause 11.9.31:*

**11.9.31 SigSS**

*Description:* This attribute contains an RSA signature computed over the PKMv2 RSA Request message or the PKMv2 RSA Acknowledgement message with the SS’s private key.

Type	Length	Value
44	128	An RSA signature computed over all attributes included in the PKMv2 RSA Request message or the PKMv2 RSA Acknowledgement message with the SS’s private key. This value is calculated using RSASSA-PKCS-v1_5-Sign algorithm with SHA-1 hash.

*Insert subclause 11.9.32:*

**11.9.32 AKID**

*Description:* This attribute identifies the AK as defined in Table 133.

Type	Length	Value
45	8	AKID as defined in Table 133

*Insert subclause 11.9.33:*

### 11.9.33 EAP payload

*Description:* This attribute contains the payload used in the upper EAP authorization layer. The security sub-layer does not interpret this attribute.

Type	Length	Value
28	variable	EAP payload

*Insert subclause 11.9.34:*

### 11.9.34 Auth result code

*Description:* This attribute contains the result code of the RSA-based authorization (only for PKMv2).

Type	Length	Value
30	1	0, Success 1, Reject 2-255, Reserved.

*Insert subclause 11.9.35:*

### 11.9.35 SA service type

*Description:* This attribute indicates service types of the corresponding SA type. This attribute shall be defined only when the SA type is Static SA or Dynamic SA. The GTEK shall be used to encrypt connection for group multicast service. The MTK shall be used to encrypt connection for MBS service.

Type	Length	Value
31	1	0: Unicast service 1: Group multicast service 2: MBS service 3-255: Reserved.

*Insert subclause 11.9.36:*

### 11.9.36 PKMv2 configuration settings

*Description:* This field defines the parameters associated with PKMv2 operation. It is composed of a number of encapsulated TLV fields.

Type	Length	Value (compound)	Scope
27	Variable		Auth Reply,PKMv2 SA-TEK-response

*Insert new subclause 11.9.37:*

**11.9.37 Frame number**

*Description:* This attribute contains a 24-bit absolute frame number in which the old PMK and all its associated AKs should be discarded. The value is in most significant bit first order.

Type	Length	Value
32	3	24-bit Frame Number in MSB first order

**11.11 REP-REQ management message encodings**

*Change third row of the second table in 11.11 as indicated:*

Name	Type	Length	Value
Channel Type request	1..3	1	0b00 = Normal subchannel, 0b01 = Band AMC Channel, 0b10 = Safety Channel, 0b11 = <del>Reserved</del> <u>Sounding</u>



*Insert the following entries into the second table of 11.11:*

Name	Type	Length	Value
Zone-specific physical CINR request	1.4	3	<p>Bits #0-2: Type of zone on which CINR is to be reported            0b000: PUSC zone with 'use all SC=0'            0b001: PUSC zone with 'use all SC=1' / PUSC AAS zone            0b010: FUSC zone            0b011: Optional FUSC zone            0b100: Safety Channel region            0b101: AMC zone (only applicable to AAS mode)            0b110 – 0b111: <i>Reserved</i></p> <p>Bit #3: 1 if zone for which CINR should be estimated is STC zone, 0 otherwise.</p> <p>Bit #4: 1 if zone for which CINR should be estimated is AAS zone, 0 otherwise.</p> <p>Bits #5-6: PRBS_ID of the zone for which CINR should be estimated. Ignored for Safety Channel.</p> <p>Bit #7: Data/pilot-based CINR measurement:            0 - Report the CINR estimate from pilot subcarriers,            1 - Report the CINR estimate from data subcarriers</p> <p>Bits #8-13: Reported CINR shall only be estimated for the sub-channels of PUSC major groups for which the corresponding bit is set. Bit #(k+7) refers to major group k. Only applicable for CINR measurement on a PUSC zone</p> <p>Bits #14-17: <math>\alpha_{avg}</math> in multiples of 1/16 (range is [1/16,16/16])</p> <p>Bit #18: 0 - report only mean of CINR            1 - report both mean and standard deviation of CINR</p> <p>Bits #19-23: <i>Reserved</i>, shall be set to zero</p>
Preamble physical CINR request	1.5	1	<p>Bits #0-1: Type of preamble physical CINR measurement            0b00 - Report the estimation of CINR measured from preamble for frequency reuse configuration=1            0b01 - Report the estimation of CINR measured from preamble for frequency reuse configuration=3            0b10 - Report the estimation of CINR measured from preamble for band AMC            0b11 - <i>Reserved</i></p> <p>Bits #2-5: <math>\alpha_{avg}</math> in multiples of 1/16 (range is [1/16,16/16])</p> <p>Bit #6: 0 - report only mean of CINR            1 - report both mean and standard deviation of CINR</p> <p>Bit #7: <i>Reserved</i>, shall be set to zero</p>

Name	Type	Length	Value
Zone-specific effective CINR request	1.6	2	Bits #0-2: Type of zone on which effective CINR is to be reported 0b000: PUSC zone with 'use all SC=0' 0b001: PUSC zone with 'use all SC=1' / PUSC AAS zone 0b010: FUSC zone 0b011: Optional FUSC zone 0b100: Reserved 0b101: AMC zone (only applicable to AAS mode) 0b110 - 0b111: <i>Reserved</i> Bit #3: 1 if zone for which effective CINR should be reported is STC zone, 0 otherwise. Bit #4: 1 if zone for which effective CINR should be estimated is AAS zone, 0 otherwise. Bits #5-6: PRBS_ID of the zone for which effective CINR should be reported. Ignored for Safety Channel. Bit #7: Data/pilot-based effective CINR measurement: 0 - Report the CINR estimate from pilot subcarriers, 1 - Report the CINR estimate from data subcarriers Bits #8-13: Reported effective CINR shall only be estimated for the subchannels of PUSC major groups for which the corresponding bit is set. Bit #(k+7) refers to major group k. Only applicable for CINR measurement on a PUSC zone Bit #14-15: <i>Reserved</i> , shall be set to zero
Preamble effective CINR request	1.7	1	Bits #0-1: Type of preamble-based effective CINR measurement 0b00 - Report the estimation of effective CINR measured from preamble for frequency reuse configuration=1 0b01 - Report the estimation of effective CINR measured from preamble for frequency reuse configuration=3 0b10-11 - <i>Reserved</i> Bit #2-7: <i>Reserved</i> , shall be set to zero
Channel selectivity report	1.8	1	Bit #0: 1 - include frequency selectivity report Bit #1-7: <i>Reserved</i> , shall be set to zero

### 11.12 REP-RSP management message encodings

Change the second table of the subclause as indicated:

REP-REQ Report type	Name	Type	Length	Value
Bit #0 = 1	Start frame	1.2	2	16 LSBs of Frame number in which measurement for this channel started
Bit #0 = 1	Basic report	1.4	1	Bit #0: WirelessHUMAN detected on the channel Bit #1: Unknown transmissions detected on the channel Bit #2: <del>Primary</del> <u>Specific Spectrum</u> User detected on the channel Bit #3: Unmeasured. Channel not measured

Change the ‘Channel Type = 01’ of the last table of the subclause as indicated:

REP-REQ Channel Type request	Name	Type	Length	Value
Channel Type = 01	Band AMC Report	2.2	4	First 12 bits for the band indicating bitmap and Next 250 bits for CINR reports (5 bits per each band)

Insert the following rows into the third table as indicated:

REP-REQ Channel Type request (binary)	Name	Type	Length	Value
01	<u>Enhanced Band AMC Report</u>	<u>2.4</u>	<u>5</u>	<u>First 12 bits for the band indicating bit-map and next 25 bits for CINR measurement (5 bits per each band)</u>
11	<u>Sounding Report</u>	<u>2.5</u>	<u>1</u>	<u>Average SINR. 8 bits in the same format used in 8.4.11.3</u>

For REP-REQ Channel Type request type 1.3, with value 0b01 = Band AMC Channel, enhanced COICH enabled MS shall report with type 2.4; otherwise, SS and MS shall report with type 2.2.

Insert the following table at the end of the subclause:

REP-REQ Zone-specific physical CINR request	Name	Type	Length	Value
Bits #0-2 = 0b000	PUSC zone with ‘use all SC=0’	3.1	1 or 2	Bit #0-4: Mean of physical CINR estimate for PUSC zone with ‘use all SC=0’ and PRBS_ID indicated in ‘zone-specific physical CINR request’. Bit #5: Report type: 0–CINR estimated from pilot subcarriers, 1–CINR estimated from data subcarriers Bit #6-7: <i>Reserved</i> , shall be set to zero Bit #8-12: Standard deviation of CINR estimate for PUSC zone with ‘use all SC=0’ and PRBS_ID indicated in ‘zone-specific CINR request’. Bit #13-15: <i>Reserved</i> , shall be set to zero  NOTE—The second byte shall only be sent if length=2

REP-REQ Zone-specific physical CINR request	Name	Type	Length	Value
Bits #0-2 = 0b001	PUSC zone with 'use all SC=1'	3.2	1 or 2	<p>Bit #0-4: Mean of physical CINR estimate for PUSC zone with 'use all SC=1' and PRBS_ID indicated in 'zone-specific physical CINR request'. CINR reported corresponds to a subset of major groups as specified in 'CINR type request'.</p> <p>Bit #5: Report type: 0 - CINR estimated from pilot subcarriers, 1- CINR estimated from data subcarriers</p> <p>Bit #6-7: <i>Reserved</i>, shall be set to zero</p> <p>Bit #8-12: Standard deviation of CINR estimate for PUSC zone with 'use all SC=1' and PRBS_ID indicated in 'zone-specific CINR request'. CINR reported corresponds to a subset of major groups as specified in 'CINR type request'.</p> <p>Bit #13-15: <i>Reserved</i>, shall be set to zero</p> <p>NOTE—The second byte shall only be sent if length=2.</p>
Bits #0-2 = 0b010	FUSC zone	3.3	1 or 2	<p>Bit #0-4: Mean of physical CINR estimate for FUSC zone with PRBS_ID indicated in 'zone-specific physical CINR request'.</p> <p>Bit #5: Report type: 0 - CINR estimated from pilot subcarriers, 1- CINR estimated from data subcarriers</p> <p>Bit #6-7: <i>Reserved</i>, shall be set to zero</p> <p>Bit #8-12: Standard deviation of CINR estimate for FUSC zone with PRBS_ID indicated in 'zone-specific CINR request'.</p> <p>Bit #13-15: <i>Reserved</i>, shall be set to zero</p> <p>NOTE—The second byte shall only be sent if length=2.</p>
Bits #0-2 = 0b011	Optional FUSC zone	3.4	1 or 2	<p>Bit #0-4: Mean of physical CINR estimate for Optional FUSC with PRBS_ID indicated in 'zone-specific physical CINR request'.</p> <p>Bit #5: Report type: 0 - CINR estimated from pilot subcarriers, 1- CINR estimated from data subcarriers</p> <p>Bit #6-7: <i>Reserved</i>, shall be set to zero</p> <p>Bit #8-12: Standard deviation of CINR estimate for Optional FUSC with PRBS_ID indicated in 'zone-specific CINR request'.</p> <p>Bit #13-15: <i>Reserved</i>, shall be set to zero</p> <p>NOTE—The second byte shall only be sent if length=2.</p>
Bits #0-2 = 0b100	Safety channel	3.5	5	The first 20 bits for the reported bin indices and the next 20 bits for CINR reports (5 bits for each bin).

REP-REQ Zone-specific physical CINR request	Name	Type	Length	Value
Bits #0-2 = 0b101	AMC zone	3.6	1 or 2	<p>Bit #0-4: Mean of physical CINR estimate for AMC AAS zone with PRBS_ID indicated in 'zone specific physical CINR request'.</p> <p>Bit #5: Report type: 0 - CINR estimated from pilot subcarriers, 1- CINR estimated from data subcarriers</p> <p>Bit #6-7: <i>Reserved</i>, shall be set to zero</p> <p>Bit #8-12: Standard deviation of CINR estimate for AMC AAS zone.</p> <p>Bit #13-15:<i>Reserved</i>, shall be set to zero</p> <p>NOTE—The second byte shall only be sent if length=2.</p>

REP-REQ Preamble physical CINR request	Name	Type	Length	Value
Bits #0-1 = 0b00	The estimation of physical CINR measured from preamble for frequency reuse configuration=1	4.1	1 or 2	<p>Bit #0-4: The mean of physical CINR estimation measured from preamble for frequency reuse configuration=1.</p> <p>Bit #5-7: <i>Reserved</i>, shall be set to zero.</p> <p>Bit #8-12: The standard deviation of CINR estimation measured from preamble for frequency reuse configuration=1.</p> <p>Bit #13-15:<i>Reserved</i>, shall be set to zero</p> <p>NOTE—The second byte shall only be sent if length=2.</p>
Bits #0-1 = 0b01	The estimation of physical CINR measured from preamble for frequency reuse configuration=3	4.2	1 or 2	<p>Bit #0-4: The mean of physical CINR estimation measured from preamble for frequency reuse configuration=3.</p> <p>Bit #5-7: <i>Reserved</i>, shall be set to zero.</p> <p>Bit #8-12: The standard deviation of CINR estimation measured from preamble for frequency reuse configuration=3.</p> <p>Bit #13-15:<i>Reserved</i>, shall be set to zero</p> <p>NOTE—The second byte shall only be sent if length=2.</p>
Bits #0-1 = 0b10	The estimation of physical CINR measured from preamble for Band AMC zone.	4.3	4	The estimation of physical CINR measured from preamble for band AMC subchannel. First 12 bits for the band indicating bitmap and Next 20 bits for CINR reports (5 bits per each band).

REP-REQ zone specific effective CINR request	Name	Type	Length	Value
Bits #0-2 = 0b000	PUSC zone with 'use all SC=0'	5.1	1	Bit #0-3: Effective CINR for PUSC zone with 'use all SC=0' and PRBS_ID indicated by 'Effective CINR request'. Encoding is defined in 8.4.5.4.10.5. Bit #4: Report type: 0 - effective CINR estimated from pilot subcarriers, 1 - effective CINR estimated from data subcarriers Bit #5-7: 3 least significant bits of CQICH_ID
Bits #0-2 = 0b001	PUSC zone with 'use all SC=1' / PUSC AAS zone	5.2	1	Bit #0-3: Effective CINR for PUSC zone with 'use all SC=1' (or PUSC AAS zone) and PRBS_ID indicated by 'Effective CINR request'. Encoding is defined in 8.4.5.4.10.5. Bit #4: Report type: 0 - effective CINR estimated from pilot subcarriers, 1 - effective CINR estimated from data subcarriers Bit #5-7: 3 least significant bits of CQICH_ID
Bits #0-2 = 0b010	FUSC zone	5.3	1	Bit #0-3: Effective CINR for FUSC zone with PRBS_ID indicated by 'Effective CINR request'. Encoding is defined in 8.4.5.4.10.5. Bit #4: Report type: 0 - effective CINR estimated from pilot subcarriers, 1 - effective CINR estimated from data subcarriers Bit #5-7: 3 least significant bits of CQICH_ID
Bits #0-2 = 0b011	Optional FUSC zone	5.4	1	Bit #0-3: Effective CINR for Optional FUSC zone with PRBS_ID indicated by 'Effective CINR request'. Encoding is defined in 8.4.5.4.10.5. Bit #4: Report type: 0 - effective CINR estimated from pilot subcarriers, 1 - effective CINR estimated from data subcarriers Bit #5-7: 3 least significant bits of CQICH_ID
Bits #0-2 = 0b101	AMC AAS zone	5.5	1	Bit #0-3: Effective CINR for AMC AAS zone with PRBS_ID indicated by 'Effective CINR request'. Encoding is defined in 8.4.5.4.10.5. Bit #4: Report type: 0 - effective CINR estimated from pilot subcarriers, 1 - effective CINR estimated from data subcarriers Bit #5-7: 3 least significant bits of CQICH_ID

NOTE—COICH\_ID applies to triggered update (see 6.3.18.2) for COI channel allocated with a COICH\_ID, and shall be zero in all other cases.

REP-REQ preamble effective-CINR request	Name	Type	Length	Value
Bits #0-1 = 0b00	The estimation of effective CINR measured from preamble for frequency reuse configuration=1	6.1	1	Bit #0-3: Effective CINR based on measurement from preamble with frequency reuse configuration=1. Encoding is defined in 8.4.5.4.10.5. Bit #4-7: 4 least significant bits of COICH_ID
Bits #0-1 = 0b01	The estimation of effective CINR measured from preamble for frequency reuse configuration=3	6.2	1	Bit #0-3: Effective CINR based on measurement from preamble with frequency reuse configuration=3. Encoding is defined in 8.4.5.4.10.5. Bit #4-7: 4 least significant bits of COICH_ID

NOTE—COICH\_ID applies to triggered update (see 6.3.18.2) for COI channel allocated with a COICH\_ID, and shall be zero in all other cases.

REP-REQ Channel selectivity report	Name	Type	Length	Value
Bits #0 = 1	Frequency selectivity report	6.3	3	Bit #0–7: <i>a</i> Bit #8–15: <i>b</i> Bit #16–23: <i>c</i>

*Insert the following text at the end of 11.12:*

For the type ~~2.4, 2.5, 2.6, 2.x~~, the following 5 bit, CINR measurement encoding shall be used:

$$n = \begin{cases} 0 & CINR \leq -3dB \\ n & (n - 4)dB < CINR \leq (n - 3)dB, 0 < n < 31 \\ 31 & CINR > 27dB \end{cases} \quad (154a)$$

For the TLVs with type 3.x and 4.x, the following 5 bit physical CINR measurement encoding shall be used:

$$\text{Payload bits} = \begin{cases} 0 & CINR \leq -3dB \\ n & (n - 4) < CINR \leq (n - 3), 0 < n < 31 \\ 31 & CINR > 27dB \end{cases} \quad (154b)$$

### 11.13 Service flow management encodings

*Change the text in the following table as indicated:*

**Table 383—Service flow encodings**

Type	Parameter
1	Service Flow Identifier
2	CID
3	Service Class Name
4	<del>Reserved</del> <u>MBS service</u>
5	QoS Parameter Set Type
6	Traffic Priority
7	Maximum Sustained Traffic Rate
8	Maximum Traffic Burst
9	Minimum Reserved Traffic Rate
10	<del>Minimum Tolerable Traffic Rate</del> <u>Reserved</u>
11	Service Flow Scheduling Type
12	Request/Transmission Policy
13	Tolerated Jitter
14	Maximum Latency
15	Fixed-length versus Variable-length SDU Indicator
16	SDU Size
17	Target SAID
18	ARQ Enable
19	ARQ_WINDOW_SIZE
20	ARQ_RETRY_TIMEOUT - Transmitter Delay
21	ARQ_RETRY_TIMEOUT - Receiver Delay
22	ARQ_BLOCK_LIFETIME
23	ARQ_SYNC_LOSS
24	ARQ_DELIVER_IN_ORDER
25	ARQ_PURGE_TIMEOUT
26	ARQ_BLOCK_SIZE
27	Reserved
28	CS Specification
<del>30</del> <u>29</u>	Type of Data Delivery Services
<del>31</del> <u>30</u>	SDU Inter-arrival Interval
<del>32</del> <u>31</u>	Time Base



**Table 383—Service flow encodings (continued)**

Type	Parameter
<del>33</del> <u>32</u>	Paging Preference
<u>33</u>	<u>MBS zone identifier assignment</u>
34	Traffic Indication Preference
<u>35</u>	<u>Global Service Class Name</u>
<u>36</u>	<u>Reserved</u>
<u>37</u>	<u>SN Feedback Enabled</u>
<u>38</u>	<u>FSN size</u>
<u>39</u>	<u>CID allocation for Active BSs</u>
<u>40</u>	<u>Unsolicited Grant Interval</u>
<u>41</u>	<u>Unsolicited Polling Interval</u>
<u>42</u>	<u>PDU SN extended subheader for HARQ reordering</u>
<u>43</u>	<u>MBS contents ID</u>
<u>44</u>	<u>HARQ Service Flows</u>
<u>45</u>	<u>Authorization Token</u>
<u>46</u>	<u>HARQ Channel mapping</u>

***Change the fourth paragraph as indicated:***

The CC indicates the status for the dynamic service (DSx-xxx) messages. The value ~~may~~ appears in the Confirmation Code field of a DSx message ~~or as the value of a TLV-encoded error parameter.~~

***Delete the last paragraph:***

~~In the case CC = “reject-not-supported-parameter” or CC = “reject-not-supported-parameter-value”, the corresponding TLV(s) may be returned to caller in DSx-RSP message. In the case of CC = “reject-not-supported-parameter-value,” the value field of the returned TLV should contain the closest value that is supported.~~

**11.13.4 QoS parameter set type*****Change the first paragraph as indicated:***

This parameter shall appear within every service flow encoding. It specifies the proper application of the QoS Parameter Set: to the Provisioned set, the Admitted set, and/or the Active set. The QoS Parameter Set is a subset of the following parameter set:

- Traffic priority (11.13.5)
- Maximum sustained traffic rate (11.13.6)
- Maximum traffic burst (11.13.7)
- Minimum Reserved traffic rate (11.13.8)
- Vendor specific QoS parameters (11.13.10)
- Tolerated jitter (11.13.13)

- Maximum latency (11.13.14)
- Unsolicited grant interval (11.13.20)
- Unsolicited polling interval (11.13.21)

When two QoS Parameter Sets are the same, a multibit value of this parameter may be used to apply the QoS parameters to more than one set. A single message may contain multiple QoS parameter sets in separate type 145/146 service flow encodings for the same service flow. This allows specification of the QoS Parameter Sets when their parameters are different. Non-QoS parameters shall appear only in the first Service Flow Management Encodings. Bit 0 is the LSB of the Value field.

**11.13.5 Traffic priority**

*Change the second paragraph as indicated:*

For uplink service flows, the BS shall use this parameter when determining precedence in request service and grant generation, ~~and the SS shall preferentially select contention Request opportunities for Priority Request CIDs based on this priority and its Request/Transmission Policy (see 11.13.12).~~

*Change the Table in the subclause as indicated:*

Type	Length	Value	Scope
[145/146].6	1	0 to 7—Higher numbers indicate higher priority Default 0	DSx-REQ DSx-RSP DSx-ACK <u>REG-RSP</u>

**11.13.6 Maximum sustained traffic rate**

*Change the first paragraph as indicated*

This parameter defines the peak information rate of the service. The rate is expressed in bits per second and pertains to the SDUs at the input to the Convergence Sublayer system. ~~Hence Explicitly,~~ this parameter does not include 802.16 MAC overhead such as MAC headers or CRCs. ~~This parameter does not limit the instantaneous rate of the service since this is governed by the physical attributes of the ingress port. However,~~ At the BS and SS in the uplink direction, the service shall be policed to conform to this parameter, on the average, over time. ~~At the BS in the downlink direction, it may be assumed that the service was already policed at the ingress to the network and the BS is not required to do additional policing.~~ If this parameter is omitted or set to zero, then there is no explicitly mandated maximum rate. This field specifies only a bound, not a guarantee that the rate is available.

The algorithm for measuring whether a flow exceeds its Maximum Sustained Traffic Rate ~~police to this parameter~~ is left to vendor differentiation and is outside the scope of the standard.

SDUs deemed to exceed the Maximum Sustained Traffic Rate may be, for instance, delayed or dropped according to the discretion of the vendor.

*Change the table as indicated:*

Type	Length	Value	Scope
[145/146].7	4	Rate (in bits per second)	DSx-REQ DSx-RSP DSx-ACK REG-RSP

**11.13.8 Minimum reserved traffic rate**

*Change the content of the subclause as indicated*

This parameter specifies the minimum rate reserved for this service flow. The rate is expressed in bits per second and specifies the minimum amount of data to be transported on behalf of the service flow when averaged over time. The specified rate shall only be honored when sufficient data is available for scheduling. ~~When insufficient data exists, the requirement imposed by this parameter shall be satisfied by assuring that the available data is transmitted as soon as possible.~~

The BS and SS shall be able to transport traffic ~~satisfy bandwidth requests for a service flow~~ up to its Minimum Reserved Traffic Rate. If less ~~bandwidth than the its~~ bandwidth ~~is available~~ requested for a service flow, the BS and SS may reallocate the excess reserved bandwidth for other purposes. The data for this parameter is measured at the input of the Convergence Sublayer. The aggregate Minimum Reserved Traffic Rate of all service flows may exceed the amount of available bandwidth. ~~The value of this parameter is calculated from the byte following the MAC header HCS to the end of the MAC PDU payload.~~ If this parameter is omitted, then it defaults to a value of 0 bits per second (i.e., no bandwidth is reserved for the flow).

*Change the table as indicated:*

Type	Length	Value	Scope
[145/146].9	4	Rate (in bits per second)	DSx-REQ DSx-RSP DSx-ACK REG-RSP

**11.13.11 ~~Service flow~~ Uplink grant scheduling type**

*Change the title and the content of the subclause as indicated:*

The value of this parameter specifies the Uplink grant scheduling ~~service type~~ that shall be enabled for the associated uplink service flow (see 6.3.5.2). If the parameter is omitted, BE ~~service~~ is assumed.

Type	Length	Value	Scope
[145/146].11	1	0: <i>Reserved</i> 1: for Undefined (BS implementation-dependent <sup>a</sup> ) 2: for BE (default) 3: for nrtPS 4: for rtPS 5: <del>Reserved</del> for Extended rtPS 6: for UGS 7–255: <i>Reserved</i>	DSA-REQ DSA-RSP DSA-ACK

<sup>a</sup>The specific implementation-dependent scheduling service type could be defined in a message of Type 145/146.143 (vendor-specific QoS parameters).

### 11.13.12 Request/transmission policy

*Change the content of the subclause as indicated*

The value of this parameter provides the capability to specify certain attributes for the associated service flow. These attributes include options for PDU formation and, for uplink service flows, restrictions on the types of bandwidth request options that may be used. An attribute is enabled by setting the corresponding bit position to 1. For attributes affecting uplink bandwidth request types, a value of zero indicates the default actions described in the scheduling service description in 6.3.5 shall be used. A value of one indicates that the action associated with the attribute bit overrides the default action.

Type	Length	Value	Scope
[145/146].12	4 <u>1</u>	Bit #0 – Service flow shall not use broadcast bandwidth request opportunities. (Uplink only) Bit #1 – <del>Reserved; shall be set to zero</del> <u>Service flow shall not use multicast bandwidth request opportunities. (Uplink only)</u> Bit #2 – The service flow shall not piggyback requests with data. (Uplink only) Bit #3 – The service flow shall not fragment data. Bit #4 – The service flow shall not suppress payload headers (CS parameter) Bit #5 – The service flow shall not pack multiple SDUs (or fragments) into single MAC PDUs Bit #6 – The service flow shall not include CRC in the MAC PDU. Bit #7 – <i>Reserved</i> ; shall be set to zero	DSA-REQ DSA-RSP DSA-ACK

### 11.13.14 Maximum latency

*Change the first paragraph as indicated:*

The value of this parameter specifies the maximum latency between the ingress of a packet to the Convergence Sublayer ~~reception of a packet by the BS or SS on its network interface~~ and the forwarding of the SDU packet ~~packet~~ to its RF ~~Air~~ Interface.

*Change the Table in the subclause as indicated:*

Type	Length	Value	Scope
[145/146].14	4	ms	DSx-REQ DSx-RSP DSx-ACK REG-RSP

**11.13.17 Target SAID**

*Change the first paragraph as indicated:*

The target SAID parameter indicates the SAID onto which the service flow that is being set up shall be mapped.

Type	Length	Value	Scope
[145/146].17	2	SAID onto which SF is mapped	DSA-REQ DSA-RSP DSC-REQ DSC-RSP

**11.13.18 ARQ TLVs for ARQ-enabled connections**

**11.13.18.8 ARQ\_BLOCK\_SIZE**

*Change the table as indicated:*

Type	Length	Value	Scope
[145/146].26 1.26	2	0-15: <i>Reserved</i> 1-2040: 16, 32, 64, 128, 256, 512, or 1024 2041-65535: <i>Reserved</i>	DSA-REQ, DSA-RSP REG-REQ, REG-RSP

*Insert new subclause 11.8.18.9:*

**11.13.18.9 RECEIVER\_ARQ\_ACK\_PROCESSING\_TIME**

The BS or SS may provide this parameter. The DSA-REQ and DSA-RSP messages may contain the value of this parameter. This optional parameter indicates the number of ms required by the ARQ receiver to process the received ARQ blocks and provide a valid ACK or NAK. This does not mean that the receiver would actually transmit an ACK or NAK after this time, but rather it can be optionally used by the transmitter that receives an ACK bit-map to determine which bits are re-transmissions of historical NAKs or ACKs, that are not based on newly received ARQ blocks.

Type	Length	Value	Scope
[145/146].27 1.27	1	0–255	DSA-REQ, DSA-RSP REG-REQ, REG-RSP

**11.13.19 CS specific service flow encodings**

**11.13.19.1 CS specification**

*Change the table in 11.13.19.1 as indicated:*

Type	Length	Value	Scope
[145/146].28	1	0: <del>No CS</del> Reserved 1: Packet, IPv4 2: Packet, IPv6 3: Packet, IEEE 802.3/Ethernet 4: Packet, IEEE 802.1Q VLAN 5: Packet, IPv4 over IEEE 802.3/Ethernet 6: Packet, IPv6 over IEEE 802.3/Ethernet 7: Packet, IPv4 over IEEE 802.1Q VLAN 8: Packet, IPv6 over IEEE 802.1Q VLAN 9: ATM 10: <u>Packet, IEEE 802.3/Ethernet<sup>a</sup> with ROHC header compression</u> 11: <u>Packet, IEEE 802.3/Ethernet<sup>b</sup> with ECRTTP header compression</u> 12: <u>Packet, IP2 with ROHC header compression</u> 13: <u>Packet, IP2 with ECRTTP header compression</u> 14–255: <u>Reserved</u>	DSx-REQ

<sup>a</sup>Classifiers for IEEE 802.1Q VLAN tags may be applied to service flows of this CS type.

<sup>b</sup>SDUs for service flows of this CS type may carry either IPv4 or IPv6 in the header-compressed payload.

**11.13.19.2 CS parameter encoding rules**

*Change the table in 11.13.19.2 as indicated:*

cst	CS
99	ATM
100	Packet, IPv4
101	Packet, IPv6
102	Packet, IEEE 802.3/Ethernet
103	Packet, IEEE 802.1Q VLAN
104	Packet, IPv4 over IEEE 802.3/Ethernet
105	Packet, IPv6 over IEEE 802.3/Ethernet
106	Packet, IPv4 over <del>802.3/Ethernet</del> <u>IEEE 802.1Q VLAN</u>
107	Packet, IPv6 over <del>802.3/Ethernet</del> <u>IEEE 802.1Q VLAN</u>
<u>108</u>	<u>Packet, IP with header ROHC compression</u>
<u>109</u>	<u>Packet, IP with ECRTTP header compression</u>
<u>110</u>	<u>Packet, IP over IEEE 802.3/Ethernet with ROHC header compression</u>
<u>111</u>	<u>Packet, IP over IEEE 802.3/Ethernet with ECRTTP header compression</u>

*Insert the following table at the end of the subclause:*

Type	Length	Value
[145/146].cst	variable	Compound

**11.13.19.3 Packet CS encodings for configuration and MAC messaging**

*Delete 11.13.19.3.3 and all its subclauses.*

~~**11.13.19.3.3 Classifier error parameter set**~~

**11.13.19.3.4 Packet classification rule**

**11.13.19.3.4.3 Protocol**

*Change content of 11.13.19.3.4.3 as indicated:*

The value of the field specifies a ~~list of~~ matching values for the IP Protocol field. For IPv6 (IETF RFC 2460), this refers to next header entry in the last header of the IP header chain. The encoding of the value field is that defined by the IANA document “Protocol Numbers.” If this parameter is omitted, then comparison of the IP header Protocol field for this entry is irrelevant.

Type	Length	Value
[145/146].cst.3.3	<del>#</del>	<del>prot1, prot2, ..., prot n protocol</del>

**11.13.19.3.4.4 IP masked source address**

*Change content of 11.13.19.3.4.4 as indicated:*

This parameter specifies an ~~list of~~ IP source addresses (designated “src<sub>i</sub>”) and ~~their~~ its corresponding address masks (designated “smask<sub>i</sub>”). An IP packet with IP source address “ip-src” matches this parameter if src<sub>i</sub> = (ip-src AND smask<sub>i</sub>) ~~for any i from 1 to n.~~ If this parameter is omitted, then comparison of the IP packet source address for this entry is irrelevant.

Type	Length	Value
[145/146].cst.3.4	<del>#</del> 8 (IPv4) or <del>#</del> 32 (IPv6)	<del>src<sub>1</sub>, smask<sub>1</sub>, ..., src<sub>n</sub>, smask<sub>n</sub>, ..., src<sub>n</sub>, smask<sub>n</sub>, src, smask</del>

*Change the title of 11.13.19.3.4.5 as indicated:*

**11.13.19.3.4.5 IP masked destination address**

*Change content of 11.13.19.3.4.5 as indicated:*

This parameter specifies a ~~list of~~ list of IP destination addresses (designated “dst<sub>i</sub>”) and ~~their~~ its corresponding address masks (designated “dmask<sub>i</sub>”). An IP packet with IP destination address “ip-dst” matches this parameter if dst<sub>i</sub> = (ip-dst AND dmask<sub>i</sub>) for any i from 1 to n. If this parameter is omitted, then comparison of the IP packet destination address for this entry is irrelevant.

Type	Length	Value
[145/146].cst.3.5	n*8 (IPv4) or n*32 (IPv6)	<del>dst<sub>1</sub>, dmask<sub>1</sub>, ..., dst<sub>p</sub>, dmask<sub>p</sub>, ..., dst<sub>n</sub>, dmask<sub>n</sub></del> dst, dmask

#### 11.13.19.3.4.6 Protocol source port range

*Change content of 11.13.19.3.4.6 as indicated:*

The value of the field specifies a ~~list of nonoverlapping~~ ranges of protocol source port values. Classifier rules with port numbers are protocol specific; i.e., a rule on port numbers without a protocol specification shall not be defined. An IP packet with protocol port value “src-port” matches this parameter if src-port is greater than or equal to sportlow and src-port is less than or equal to sporthigh. If this parameter is omitted, the protocol source port is irrelevant. This parameter is irrelevant for protocols without port numbers.

Type	Length	Value
[145/146].cst.3.6	n*4	<del>sportlow1, sporthigh2, ..., sportlow<sub>n</sub>, sporthigh<sub>n</sub></del> sportlow, sporthigh

#### 11.13.19.3.4.7 Protocol destination port range

*Change content of 11.13.19.3.4.7 as indicated:*

The value of the field specifies a ~~list of nonoverlapping~~ ranges of protocol destination port values. Classifier rules with port numbers are protocol specific; i.e., a rule on port numbers without a protocol specification shall not be defined. An IP packet with protocol port value “dst-port” matches this parameter if dst-port is greater than or equal to dportlow and dst-port is less than or equal to dporthigh. If this parameter is omitted, the protocol destination port is irrelevant. This parameter is irrelevant for protocols without port numbers.

Type	Length	Value
[145/146].cst.3.7	n*4	<del>dportlow1, dporthigh2, ..., dportlow<sub>n</sub>, dporthigh<sub>n</sub></del> dportlow, dporthigh

#### 11.13.19.3.4.8 IEEE 802.3/Ethernet destination MAC address

*Change content of 11.13.19.3.4.8 as indicated:*

This parameter specifies a ~~list of~~ list of MAC destination addresses (designated “dst<sub>i</sub>”) and ~~their~~ its corresponding address masks (designated “msk<sub>i</sub>”). An IEEE 802.3/Ethernet packet with MAC destination address



“etherdst” corresponds to this parameter if  $dst_i = (etherdst \text{ AND } msk_i)$  for any  $i$  from 1 to  $n$ . If this parameter is omitted, then comparison of the IEEE 802.3/Ethernet destination MAC address for this entry is irrelevant.

Type	Length	Value
[145/146].cst.3.8	#*12	$dst_1, msk_1, \dots, dst_p, msk_p, \dots, dst_n, msk_n, \underline{dst}, \underline{msk}$

**11.13.19.3.4.9 IEEE 802.3/Ethernet source MAC address**

*Change content of 11.13.19.3.4.9 as indicated:*

This parameter specifies a list of MAC source addresses (designated “src $i$ ”) and their corresponding address masks (designated “msk $i$ ”). An IEEE 802.3/Ethernet packet with MAC source address “ethersrc” corresponds to this parameter if  $src_i = (ethersrc \text{ AND } msk_i)$  for any  $i$  from 1 to  $n$ . If this parameter is omitted, then comparison of the IEEE 802.3/Ethernet source MAC address for this entry is irrelevant.

Type	Length	Value
[145/146].cst.3.9	#*12	$src_1, msk_1, \dots, src_p, msk_p, \dots, src_n, msk_n, \underline{src}, \underline{msk}$

*Insert new subclause 11.13.19.3.4.16:*

**11.13.19.3.4.16 Large Context ID for ROHC- or ECRTP-compressed packet or ROHC feedback packet**

The values of the field specify the context ID for ROHC- or ECRTP-compressed packets. The CS will attempt to match the context ID with the payload packet’s one-byte or two-byte embedded Context ID field according to the scheme described in RFC 3095 section 5.1.3.

Type	Length	Value
[145/146].cst.3.16	2	0–65535: Context ID

*Insert new subclause 11.13.19.3.4.17:*

**11.13.19.3.4.17 Classifier Action Rule**

The value of this field specifies an action associate with the classifier rule.

If this classification action rule exists, its action shall be applied on the packets that match this classifier rule.

Type	Length	Value
[145/146].cst.3.19	1	See below

**Bit #0:**  
 0 = none.  
 1 = Discard packet  
**Bit #1-7:** *Reserved.*

*Insert new subclause 11.13.19.3.4.18:*

**11.13.19.3.4.18 Short-format Context ID for ROHC- or ECRTP-compressed packet or ROHC feedback packet**

The values of the field specify a short-format context ID for ROHC- or ECRTP-compressed packets. The CS will attempt to match the context ID with the payload packet's zero- or one-byte prefix Context ID field according to the scheme described in RFC 3095 section 5.1.3.

Type	Length	Value
[145/146].cst.3.18	1	0-15: Context ID

*Delete 11.13.19.3.6 and all its subclauses.*

~~**11.13.19.3.6 PHS error parameter set**~~

**11.13.19.3.7.1 PHSI**

*Change the first paragraph as indicated:*

The PHSI has a value between 1 and 255, which uniquely references the suppressed byte string. The index is unique per service flow. ~~The uplink and downlink PHSI values are independent of each other.~~

**11.13.19.3.7.4 PHSS**

*Change the second paragraph as indicated:*

~~This TLV is used when a service flow is being created. For all packets that get classified and assigned to a service flow with PHS enabled, suppression shall be performed over the specified number of bytes as indicated by the PHSS and according to the PHSM. A PHS rule shall contain the PHSS TLV. The range of valid values for PHSS is 1–255. If this TLV is not included in a service flow definition, or is included with a value of 0 bytes, then PHS is disabled. A nonzero value indicates PHS is enabled.~~

*Change subclause 11.13.19.3.8 to 11.13.19.3.4.16 and change its contents as indicated, and renumber the following subclauses accordingly.*

**11.13.19.3.8 IPv6 Flow label**

*Change the subclause as indicated:*

The value of this field specifies a list of matching values for the IPv6 Flow label field. As the flow label field has a length of 20 bits, the first 4 bits of the most significant byte shall be set to 0x0 and disregarded.

Type	Length	Scope
[145/146].[101/105/107].3.15	n*3	Flow Label #1...Flow label#n

*Change the title of subclause 11.13.19.4 as indicated:*

**11.13.19.4 ATM CS Encodings for ~~C~~onfiguration and ~~M~~essaging**

**11.13.19.4.2 ATM Classifier TLV**

**11.13.19.4.2.3 ATM Classifier ID**

*Change the 'Length' value in the Table from 16 to 2.*

*Delete subclause 11.13.19.4.4.*

~~**11.13.19.4.4 ATM Classifier Error Parameter Set**~~

*Insert new subclause 11.13.20:*

**11.13.20 Unsolicited grant interval**

The value of this parameter specifies the nominal interval between successive data grant opportunities for this service flow. The ideal schedule for enforcing this parameter is defined by a reference time  $t_0$ , with the desired transmission time  $t_i = t_0 + i \times \text{interval}$ . The actual grant time,  $t'_i$  shall be in the range  $t_i \leq t'_i \leq t_i + \text{jitter}$ , where interval is the value specified with this TLV, and jitter is the Tolerated Jitter.

Type	Length	Value	Scope
[145/146].40	2	ms	DSA-REQ, DSA-RSP, DSC-REQ, DSC-RSP

*Insert new subclause 11.13.21:*

**11.13.21 Unsolicited polling interval**

The value of this parameter specifies the maximal nominal interval between successive polling grants opportunities for this Service Flow. The ideal schedule for enforcing this parameter is defined by a reference time  $t_0$ , with the desired polling time  $t_i = t_{(i-1)} + \text{interval}$ .

Type	Length	Value	Scope
[145/146].41	<u>2</u>	<u>ms</u>	<u>DSA-REQ,</u> <u>DSA-RSP,</u> <u>DSC-REQ,</u> <u>DSC-REP</u>

*Insert new subclause 11.13.22:*

**11.13.22 FSN size**

This TLV indicates the size of the FSN for the connection that is being setup. A value of 0 indicates that FSN is 3-bit long and a value of 1 indicates that FSN is 11-bit long.

Type	Length	Value	Scope
[145/146].42	1	0 = 3-bit FSN 1 = 11-bit FSN Default = 1	DSA-REQ DSA-RSP DSA-ACK

*Insert new subclause 11.13.23:*

**11.13.23 MBS service**

This TLV indicates whether or not the MBS service is being requested for the connection that is being setup. A value of 1 indicates Single-BS-MBS is requested and a value of 2 indicates Multi-BS-MBS is requested. If MS or BS want to initiate MBS service, DSA-REQ with MBS service shall be used. The DSA-RSP message shall contain the acceptance or rejection of request and if there is no available MBS, MBS service value may be set to 0. ARQ shall not be enabled for this connection.

Type	Length	Value	Scope
[145/146].4	1	0: No available MBS 1: Single-BS-MBS 2: Multi-BS-MBS	DSx-REQ DSx-RSP DSx-ACK

*Insert new subclause 11.13.24:*

**11.13.24 Global Service Class Name**

The value of this field refers to a predefined BS service configuration to be used for this service flow. The Global Service Class Name itself contains coded references to extensible tables defining QoS Parameters.

Type	Length	Value	Scope
[145/146].35	6	Variable: combination of ASCII characters and hex values	DSx-REQ DSx-RSP DSx-ACK

When the Global Service Class Name is used in a service flow encoding, it indicates that all the unspecified QoS Parameters of the service flow need to be provided by the BS. Global Service Class Names are by definition synchronized among all BS.

*Insert new subclause 11.13.25:*

**11.13.25 Type of Data Delivery Services**

The value of this parameter specifies type of Data Delivery Service as defined in 6.3.18.

Type	Length	Value	Scope
[145/146].29	1	0: Continuing Grant Service 1: Real Time–Variable Rate Service 2: Non-Real Time–Variable Rate Service 3: Best Efforts Service 4: Extended Real-Time Variable Rate Service	DSA-REQ, DSA-RSP DSC-REQ, DSC-RSP REG-REQ, REG-RSP

*Insert new subclause 11.13.26:*

**11.13.26 SDU Inter-arrival Interval**

This parameter specifies nominal interval between consequent SDU arrivals as measured at MAC SAP.

Type	Length	Value	Scope
[145/146].30	2	SDU Inter-arrival Interval in the resolution of 0.5 milliseconds	DSA-REQ, DSA-RSP DSC-REQ, DSC-RSP REG-REQ, REG-RSP

*Insert new subclause 11.13.27:*

**11.13.27 Time Base**

This parameter specifies time base for rate measurement as defined in 6.3.20.

Type	Length	Value	Scope
[145/146].31	2	Time base in milliseconds	DSA-REQ, DSA-RSP DSC-REQ, DSC-RSP REG-REQ, REG-RSP

*Insert new subclause 11.13.28:*

**11.13.28 Traffic Indication Preference**

This parameter specifies whether traffic on a service flow should generate MOB\_TRF-IND messages to an MS in sleep mode.

Type	Length	Value	DSX
[145/146].34	1	0: No traffic indication 1: Traffic indication	DSx-REQ DSx-RSP DSx-ACK

*Insert new subclause 11.13.29:*

**11.13.29 MBS zone identifier assignment**

The DSA-RSP message may contain the value of this parameter to specify a MBS Zone identifier. This parameter indicates a MBS zone through which the connection or virtual connection for the associated service flow is valid.

Type	Length	Value	Scope
[145/146].33	8	MBS zone identifier	DSA-REQ/RSP DCD

*Insert new subclause 11.13.30:*

**11.13.30 Paging preference**

This parameter specifies whether a service flow may generate paging.

Type	Length	Value	DSX
[145/146].32	1	0: No paging generation 1: Paging generation	DSx-REQ DSx-RSP DSx-ACK

*Insert new subclause 11.13.31:*

**11.13.31 SN Feedback Enabled**

The ‘SN Feedback Enabled’ field indicates whether or not SN feedback is enabled for the given connection. A value of 0 indicates that SN feedback is not enabled. A value of 1 indicates that SN feedback is enabled.

Type	Length	Value	Scope
[145/146].37	1	0 - SN feedback is disabled (default) 1 - SN feedback is enabled	DSA-REQ, DSA-RSP, DSC-REQ, DSC-REP

**Insert new subclause 11.13.32:**

**11.13.32 HARQ Service Flows**

The ‘HARQ Service Flows’ field specifies whether the connection uses HARQ or not.

The relevance connections of this parameter when appears in REG-REQ/RSP messages are Basic, Primary, and Secondary CIDs.

Transport CIDs that have HARQ Connection enabled indication must only be transmitted inside HARQ PHY burst type. Basic, Primary, and secondary CIDs that have HARQ Connection enabled indication can be either transmitted inside HARQ or non-HARQ PHY burst type.

Type	Length	Value	Scope
[145/146].44	1	0 = Non HARQ (default) 1 = HARQ Connection	DSA-REQ, DSA-RSP, REG-REQ, REG-RSP

**Insert new subclause 11.13.33:**

**11.13.33 CID allocation for Active BSs**

The value of this field specifies a list of CIDs assigned by active BSs in the diversity set except for the anchor BS for the service flow with non-null admittedQoSParamSet or ActiveQoSParamSet. There is one CID per active BS and the CID is used when the active BS becomes the anchor BS. If CID assignment is sent for each active BS in MOB\_BSHO-RSP and MOB\_BSHO-REQ messages, the DSx messages shall contain CID allocation for Active BSs. The CID for anchor BS is defined by 11.13.2. The value of (Num of active BS) is used to calculate length is the number of BSs in the diversity set.

Type	Length	Value	Scope
[145/146].39	<i>variable</i> Length is defined as: (Num of active BS -1) * 2	List of CIDs for the active BSs. Starting from the first byte, every 2 bytes contains one CID value per active BS. CIDs are listed based on the TEMP_BS_ID of the active BS. The BS. The TEMP_BS_IDs are sorted in an ascending order	DSA-REQ/RSP DSC-REQ/RSP

**Insert new subclause 11.13.34:**

**11.13.34 Authorization Token**

The value of this field specifies an authorization token that may be used when MS creates or modifies a service flow by sending DSA-REQ or DSC-REQ message. An authorization token identifies a session and its QoS parameters, and is used for authorizing the QoS for one or more IP flows generated by higher-level service creation/modification procedures. The token is provided to the MS by the higher-level service through some mechanism that is outside the scope of this specification. The MS must include the token in this TLV exactly as received from the higher-level service and must treat the token as an opaque octet string whose

meaning is of significance only to those higher-level services. The field should not be included in the DSA-REQ or DSC-REQ messages that are sent by BS.

Type	Length	Value	Scope
[145/146].45	<i>variable</i>	Authorization token that is used for authorizing the QoS for one or service flows generated by MS-initiated higher-level service flow creation or modification procedures	DSA-REQ DSC-REQ

***Insert new subclause 11.13.35:***

**11.13.35 HARQ Channel mapping**

This TLV is valid only in HARQ enabled connection. It specifies a HARQ channel number that may be used to carry data from this connection. This TLV may specify more than one channel per connection. HARQ channels may share more than one connection. An absent of this TLV means all HARQ channels can be used by this connection.

The absence of this TLV in any of the REQ or RSP messages of the connection creation means all HARQ channels can be used by this connection.

The relevance connections of this parameter when appears in REG-REQ/RSP messages are Basic, Primary, and Secondary CIDs.

Type	Length	Value	Scope
[145/146].46	<i>variable</i>	HARQ channel Index (1 byte each)	DSA-REQ, DSA-RSP, REG-REQ, REG-RSP

***Insert new subclause 11.13.36:***

**11.13.36 PDU SN extended subheader for HARQ reordering**

This TLV is valid only in HARQ enabled connection. It specifies whether PDU SN extended subheader should be applied by the transmitter on every PDU on this connection. This SN may be used by the receiver to ensure PDU ordering.

This counter should start at 0 and should be reset after HHO/FBSS operations

The relevance connections of this parameter when appears in REG-REQ/RSP messages are Basic, Primary, and Secondary CIDs (each should have its own PDU numbering)

Value of 0 in either of the messages means the endpoint does not support the PDU SN number for the specific connection. If both end points support PDU SN for the connection, the larger SN number should be chosen.



Type	Length	Value	Scope
[145/146].42	1	0–No support for PDU SN in this connection (default) 1–PDU SN (short) extended SH 2–PDU SN (long) extended SH 3–256–Reserved.	DSA-REQ, DSA-RSP, REG-REQ, REG-RSP

*Insert new subclause 11.13.37:*

**11.13.37 MBS contents IDs**

If MS sends DSA-REQ message which requests a MBS service as described in 11.13.20, BS may respond to it with DSA-RSP message including MBS Contents Identifier TLV in order to establish an MBS connection with multiple MBS contents.

TLV values shall be composed of 2 byte-long MBS Contents IDs to distinguish the logical MBS connection for each MBS contents. Since MBS Contents ID is vendor-specific and dependent on application-level implementation, it is unnecessary to specify in this standard.

A 1 byte-long Logical Channel ID, which pairs with Multicast CID in MBS\_DATA\_IE, is allocated to each 2 byte-long MBS Contents IDs in order that it is included in TLV value. For example, Logical Channel ID ‘0’ is allocated to MBS Contents ID(0), Logical Channel ID ‘1’ is allocated to MBS Contents ID(1) and so on. Logical Channel ID is used for MS to discriminate the MBS message in MBS data burst.

According to the Dynamic Service Addition (DSA) procedure described in 6.3.13.1, a BS may send MS a DSA-REQ message to establish connection. Therefore, BS may also send MS a DSA-REQ message including MBS Contents Identifier TLV in order to make an establishment of MBS connection with multiple MBS contents.

Type	Length	Value	Scope
[145/146].43	<i>variable (2*n)</i>	MBS Contents ID(0), MBS Contents ID(1), ... MBS Contents ID(n-1)	DSA-REQ DSA-RSP DSA-ACK

*Insert a new subclause 11.14:*

**11.14 DREG-CMD/REQ message encodings**

Name	Type	Length	Value
Paging Information	1	5	Bits 15:0 – PAGING_CYCLE—Cycle in which the paging message is transmitted within the paging group Bits 23:16 – PAGING OFFSET—Determines the frame within the cycle in which the paging message is transmitted. Must be smaller than PAGING CYCLE value Bits 39:24– Paging-group-ID—ID of the paging group the MS is assigned to
REQ-duration	2	1	Waiting value for the DREG-REQ message re-transmission (measured in frames)
Paging Controller ID	3	6	This is a logical network identifier for the serving BS or other network entity retaining MS service and operational information and/or administering paging activity for the MS while in IDLE Mode
MAC Hash Skip Threshold	5	2	Maximum number of successive MOB_PAG-ADV messages that may be sent from a BS without individual notification for an MS for which BS is allowed to skip MS MAC Address Hash when the Action Code for the MS is 0b00, 'No Action Required'. If the value is set to 0xFF, a BS shall omit MAC Address hash of the MS with 'No Action Required' for every MOB_PAG-ADV message. On the contrary, if the value is set to zero, a BS shall include the MS MAC Address hash in every MOB_PAG-ADV message.

Name	Type	Length	Value
Idle Mode Retain Information	4	1	<p>Idle Mode Retain Information is provided as part of this message is indicative only. Network Re-entry from Idle Mode process requirements may change at time of actual reentry. For each Bit location, a value of 0 indicates the information for the associated reentry management messages shall not be retained and managed, a value of 1 indicates the information for the associated re-entry management message shall be retained and managed</p> <p>Bit #0: Retain MS service and operational information associated with SBC-REQ/RSP messages</p> <p>Bit #1: Retain MS service and operational information associated with PKM-REQ/RSP messages</p> <p>Bit #2: Retain MS service and operational information associated with REG-REQ/RSP messages</p> <p>Bit #3: Retain MS service and operational information associated with Network Address</p> <p>Bit #4: Retain MS service and operational information associated with Time of Day</p> <p>Bit #5: Retain MS service and operational information associated with TFTP messages</p> <p>Bit #6: Retain MS service and operational information associated with Full service (MAC state machines, CS classifier information, etc.). The information retained by setting Bit #6 does not include those information associated with SBC-REQ/RSP messages, PKM-REQ/RSP messages, REG-REQ/RSP messages, Network Address, Time of Day, and TFTP messages unless otherwise specified by setting one or more Bits #0-#5.</p> <p>Bit #7: Consider Paging Preference of each Service Flow in resource retention. Bit #7 is meaningful when Bit #2 and Bit #6 have a value of 1. If Bit #2, Bit #6 and Bit #7 is 1, MS service and operational information associated with Full service (MAC state machines, CS classifier information, etc.) are retained for Service Flows with positive Paging Preference. If Bit #2 and Bit #6 are 1 and Bit #7 is 0, MS service and operational information associated with Full service (MAC state machines, CS classifier information, etc.) are retained for all Service Flows.</p>
Paging cycle request	52	2	Requested Cycle in which the paging message is transmitted within the paging group.

*Insert new subclause 11.15:*

## 11.15 Handover management encodings

*Insert new subclause 11.15.1:*

### 11.15.1 Resource\_Retain\_Time

The Resource\_Retain\_Time is Time duration for MS's connection information that will be retained in serving BS. This value is measured in 100 milliseconds. If this value is set to 0, the serving BS will retain the MS's connection information during Resource Retain Time negotiated at early registration stage. If this value is set to non-zero, it is the proposed Resource Retain Time by serving BS and the serving BS will retain the MS's connection information during that time after reception of MOB\_HO-IND message.(HO\_IND\_type=0b00)

Type	Length	Value	Scope
1	2	0: The serving BS will retain the MS's connection information during Resource Retain Time negotiated at registration stage. 1-255: Resource Retain Time (100 milliseconds unit)	MOB_BSHO-REQ MOB_BSHO-RSP

*Insert new subclause 11.16:*

## 11.16 Sleep mode management encodings

*Insert new subclause 11.16.1:*

### 11.16.1 SLPID\_Update

The SLPID\_Update TLV specifies a new SLPID that replaces an old SLPID. This TLV may include multiple Old\_New\_SLPID values for the MSs negatively indicated in MOB\_TRF-IND message.

Type	Length	Value	Scope
1	<i>variable</i>	See following table	RNG-RSP MOB_TRF-IND

Field	Length (bits)	Note
Old New SLPID	20	First 10 bits indicates old SLPID and the second 10 bits indicates new SLPID

*Insert new subclause 11.16.2:*

### 11.16.2 Next Periodic Ranging

This value indicates offset of the frame in which the periodic ranging will be performed with respect to the frame where MOB\_SLP-RSP is transmitted. If MS receives MOB\_SLP-RSP message with 'Next Periodic Ranging' = 0, it shall deactivate all active Power Saving Classes and return to Normal Operation.

Type	Length	Value	Scope
2	2	Offset in frames	MOB_SLP-RSP

*Insert new subclause 11.17:*

**11.17 MOB\_PAG-ADV management message encodings**

The encoding described in this subclause is specific to the MOB\_PAG-ADV message (6.3.2.3.59).

*Insert new subclause 11.17.1:*

**11.17.1 CDMA code and transmission opportunity assignment**

The ‘CDMA code and transmission opportunity assignment’ field indicates the assigned code and transmission opportunity for an MS that is paged to use over dedicated CDMA ranging region.

Type	Length (bits)	Value	Scope
150	variable; 8+ N <sub>assign</sub> x 16)	Bit #0 - #7: N <sub>assign</sub> Subsequent (N <sub>assign</sub> x 16) bits: for (i = 0, i < N <sub>assign</sub> , i++) { 8-bits code index assigned to an MS who is paged 8-bits transmission opportunity offset assigned to an MS who is paged }	OFDMA

*Insert new subclause 11.17.2:*

**11.17.2 Page-Response Window**

The ‘Page-Response Window’ TLV indicates the Page-Response window for an MS who is paged to transmit the assigned code for CDMA ranging channel.

Type	Length	Value	PHY Scope
152	1	Page-Response window, in frames	OFDMA

*Insert new subclause:]*

**11.17.3 Enabled-Action-Triggered**

This value indicates the enabled action that MS performs upon reaching trigger condition in sleep mode. MS may include this TLV item in MOB\_SLP-REQ message to request an activation of type of Power Saving Class. BS shall include this TLV in MOB\_SLP-RSP message transmitted in response to the MOB\_SLP-REQ message.

Type	Length	Value	Scope
3	1	Indicates action performed upon reaching trigger condition in sleep mode If bit#0 is set to 1, respond on trigger with MOB_SCN-REPORT If bit#1 is set to 1, respond on trigger with MOB_MSHO-REQ If bit#2 is set to 1, on trigger, MS starts neighboring BS scanning process by sending MOB_SCN-REQ Bit#3–bit#7: <i>Reserved</i> . Shall be set to 0.	MOB_SLP-REQ/RSP

*Insert new subclause 11.18:*

### 11.18 MOB\_NBR-ADV management message encodings

The encodings described in this subclause are specific to the MOB\_NBR-ADV message (6.3.2.3.47).

*Insert new subclause 11.18.1:*

#### 11.18.1 PHY Mode ID

*Insert the following tables into 11.18.1:*

Name	Type	Length	Value	PHY scope
PHY Mode ID	22	2	Set to 0 for SCA	SCA, OFDM, OFDMA

**Table 384a—Phy Mode ID fields description for OFDM PHY**

Item	Size	Notes
<b>Bandwidth</b>	7 bits	Channel BW in units of 125 kHz.
<b>FFT Size</b>	3 bits	0b011: 256 0b000-0b010, 0b100-0b111: <i>Reserved</i>
<b>Cyclic Prefix (CP)</b>	2 bits	0b00 = 1/4 0b01 = 1/8 0b10 = 1/16 0b11 = 1/32
<b>Frame duration code</b>	4 bits	0b0000 = 2.0 ms 0b0001 = 2.5 ms 0b0010 = 4 ms 0b0011 = 5 ms 0b0100 = 8 ms 0b0101 = 10 ms 0b0110 = 12.5 ms 0b0111 = 20 ms 0b1000-0b1111 = <i>Reserved</i>

**Table 384b—Phy Mode ID fields description for OFDMA PHY**

Item	Size	Notes
Bandwidth	7 bits	Channel BW in units of 125Khz.
FFT Size	3 bits	0b000: 2048 0b001: 1024 0b010: 512 0b011: Reserved 0b100: 128 0b101–0b111: Reserved for future FFT size use
Cycle prefix (CP)	2 bits	0b00 = 1/4 0b01 = 1/8 0b10 = 1/16 0b11 = 1/32
Frame duration code	4 bits	0b0000 = 2.0 ms 0b0001 = 2.5 ms 0b0010 = 4 ms 0b0011 = 5 ms 0b0100 = 8 ms 0b0101 = 10 ms 0b0110 = 12.5 ms 0b0111 = 20 ms 0b1000 - 0b1111 = <i>Reserved</i>

Name	Type	Length	Value	PHY scope
FA Index	21	1	To be determined by a service provider or a governmental body like FCC after the licensed band is determined. If this TLV is present in the DCD message, the DL center frequency can be omitted in the message.	SCa, OFDM, OFDMA

Name	Type	Length	Value	PHY scope
PHY Mode ID	22	2	Set to 0 for SCa Refer to Table 106f and Table 106g for the Phy Mode ID fields description of the other PHYs.	SCa, OFDM, OFDMA

*Insert new subclause 11.19:*

### 11.19 MOB\_SCN-REP message encodings

Name	Type	Length	Value
Ranging_Parameters_Validity_Time	—	1	Estimated number of frames starting from the frame following the reception of the MOB_SCN-REP message, in which channel parameters learned by the MS during Association of specific BS stay valid and can be reused during future Network Reentry to the BS without additional CDMA-based Initial Ranging. A value of zero in this parameter signifies that this parameter should be ignored



## 12. System profiles

### 12.1 WirelessMAN-SC (10–66 GHz) system profiles

#### 12.1.1 WirelessMAN-SC MAC system profiles

*Change the title of 12.1.1.3 as indicated:*

##### 12.1.1.3 Conventions for MAC Management messages for profiles profM1 and profM2

*Change the second bullet of the first paragraph as indicated:*

- No TLVs besides ~~Error Encodings~~ and HMAC Tuples shall be reported back in DSA-RSP and DSC-RSP messages.

*Change the title of 12.1.1.4 as indicated:*

##### 12.1.1.4 MAC Management message Pparameter Ttransmission Oorder

###### 12.1.1.4.3 UCD

*Change the subclause as indicated:*

The parameters of the ~~D~~UCD message are PHY profile specific.

*Change 12.1.1.4.7 as follows:*

###### 12.1.1.4.7 REG-REQ

- Vendor ID Encoding (optional)
- ~~Uplink~~ CID Support
- PKM Flow Control (default = no limit)
- DSx Flow Control (default = no limit)
- MCA Flow Control (default = no limit)
- IP version (default = IPv4)
- MAC CRC support (default = support)
- Multicast Polling Group CID support (default = 4)
- Convergence Sublayer Support (1 instance for each CS supported)
- Maximum number of classifiers (default = 0, no limit)
- PHS support (default = 0, no PHS support)
- HMAC Tuple

*Change the title of 12.1.1.4.20 as indicated:*

###### 12.1.1.4.20 DSA-RSP—BS Initiated ~~S~~service ~~A~~addition

*Change the subclause as indicated:*

- Uplink Service Parameters
- ~~Service Flow Error Parameter Set(s) (one per errored parameter)~~
  - ~~Errored Parameter~~
  - ~~Error Code~~
  - ~~Error Message (optional)~~

- Downlink Service Parameter(s)
- ~~Service Flow Error Parameter Set(s) (one per errored parameter)~~
  - ~~Errored Parameter~~
  - ~~Error Code~~
  - ~~Error Message (optional)~~
- HMAC Tuple

*Change the title of 12.1.1.4.23 as indicated:*

#### **12.1.1.4.23 DSC-RSP—BS Initiated ~~S~~service ~~C~~change**

*Change the subclause as indicated:*

- Uplink Service Parameters
- ~~Service Flow Error Parameter Set(s) (one per errored parameter)~~
  - ~~Errored Parameter~~
  - ~~Error Code~~
  - ~~Error Message (optional)~~
- Downlink Service Parameter(s)
- ~~Service Flow Error Parameter Set(s) (one per errored parameter)~~
  - ~~Errored Parameter~~
  - ~~Error Code~~
  - ~~Error Message (optional)~~
- HMAC Tuple

#### **12.1.1.6 Message parameters specific to profM2**

*Change the title of 12.1.1.6.1 as indicated:*

##### **12.1.1.6.1 Packet CS ~~P~~parameters for DSA-REQ—BS ~~I~~initiated**

*Change the subclause as indicated:*

- Packet Classification Rule(s) (uplink service flows only, default is no classification)
- Classifier Rule ~~ID~~ Index
- Classifier Rule Priority (default to 0)
- IP Type of Service/DSCP (only for IP CSs, default = do not classify on this)
- Protocol (only for IP CSs, default = do not classify on this)
- IP Masked Source Address (only for IP CSs, default = do not classify on this)
- IP Destination Address (only for IP CSs, default = do not classify on this)
- Protocol Source Port Range (only for IP CSs, default = do not classify on this)
- Protocol Destination Port Range (only for IP CSs, default = do not classify on this)
- Ethernet Destination MAC Address (only for Ethernet CSs, default = do not classify on this)
- Ethernet Source MAC Address (only for Ethernet CSs, default = do not classify on this)
- Ethertype/IEEE 802.2 SAP (only for Ethernet CSs, default = do not classify on this)
- IEEE 802.1D User Priority (only for VLAN CSs, default = do not classify on this)
- IEEE 802.1Q VLAN\_ID (only for VLAN CSs, default = do not classify on this)
- Associated PHSI (default is no PHS for this classifier match)
- Vendor-specific Classifier Parameters
- PHS Rule(s)
- PHSI
- PHSS
- PHSF
- PHSM (default is suppress all bytes of the suppression field)

- PHSV (default is verify)
- Vendor-specific PHS Parameters

*Change the title of 12.1.1.6.2 as indicated:*

#### **12.1.1.6.2 Packet CS Parameters for DSA-RSP—BS Initiated**

*Change the subclause as indicated:*

- Packet Classification Rule(s) (uplink service flows only, default is no classification)
- ~~Classifier Error Parameter Set(s) (one per errored parameter)~~
  - ~~Classifier Rule ID~~
  - ~~Errored Parameter~~
  - ~~Error Code~~
  - ~~Error Message (optional)~~
- PHS Rule(s)
- ~~PHS Error Parameter Set(s) (one per errored parameter)~~
- ~~PHSI~~
  - ~~Errored Parameter~~
  - ~~Error Code~~
  - ~~Error Message (optional)~~

#### **12.1.1.6.3 Packet CS Parameters for DSC-REQ—BS Initiated**

*Change the subclause as indicated:*

- Classifier Dynamic Service Change Action(s)
- Packet Classification Rule(s) (uplink service flows only, 1 per Action)
- Classifier Rule ~~ID~~ Index
- Classifier Rule Priority (default to 0)
- IP Type of Service/DSCP (only for IP CSs, default = do not classify on this)
- Protocol (only for IP CSs, default = do not classify on this)
- IP Masked Source Address (only for IP CSs, default = do not classify on this)
- IP Destination Address (only for IP CSs, default = do not classify on this)
- Protocol Source Port Range (only for IP CSs, default = do not classify on this)
- Protocol Destination Port Range (only for IP CSs, default = do not classify on this)
- Ethernet Destination MAC Address (only for Ethernet CSs, default = do not classify on this)
- Ethernet Source MAC Address (only for Ethernet CSs, default = do not classify on this)
- Ethertype/IEEE 802.2 SAP (only for Ethernet CSs, default = do not classify on this)
- IEEE 802.1D User Priority (only for VLAN CSs, default = do not classify on this)
- IEEE 802.1Q VLAN\_ID (only for VLAN CSs, default = do not classify on this)
- Associated PHSI (default is no PHS for this classifier match)
- Vendor-specific Classifier Parameters
- PHS Dynamic Service Change Action
- PHS Rule(s) (1 per Action)
- PHSI
- PHSS
- PHSF
- PHSM (default is suppress all bytes of the suppression field)
- PHSV (default is verify)
- Vendor-specific PHS Parameters

#### 12.1.1.6.4 Packet CS Parameters for DSC-RSP—BS Initiated

*Change the subclause as indicated:*

- Uplink Service Parameters
- ~~Service Flow Error Parameter Set(s) (one per errored parameter)~~
  - ~~Errored Parameter~~
  - ~~Error Code~~
  - ~~Error Message (optional)~~
- Downlink Service Parameter(s)
- ~~Service Flow Error Parameter Set(s) (one per errored parameter)~~
  - ~~Errored Parameter~~
  - ~~Error Code~~
  - ~~Error Message (optional)~~

### 12.2 WirelessMAN-SCa and WirelessHUMAN(-SCa) system profiles

#### 12.2.3 WirelessMAN-SCa Physical Layer (PHY) Profiles

##### 12.2.3.2 Specific PHY profiles

##### 12.2.3.2.3 WirelessHUMAN-specific PHY profile features

*Change the fifth bullet of the subclause as indicated:*

- DFS capability (if mandated by regulation)
  - Detection of primary-specific spectrum users with received signal strength in excess of -64 dBm as defined by regulatory requirements
  - Channel switching within 300  $\mu$ s as defined by regulatory requirements

#### 12.2.4 WirelessMAN-SCa RF profiles

##### 12.2.4.3 RF profiles for 10 MHz channelization

*Change all the references for 8.6.2 to 8.5.2.*

### 12.3 WirelessMAN-OFDM and WirelessHUMAN(-OFDM) system profiles

#### 12.3.1 WirelessMAN-OFDM and WirelessHUMAN(-OFDM) MAC profiles

##### 12.3.1.1 ProfM3\_PMP: Basic Packet PMP MAC System Profile

*In the Table 401, change text in column “Conditions/Notes” for row “DFS” as indicated:*

Required when ~~intended~~ if mandated by regulation for license exempt ~~bands~~ usage. Not required when intended for licensed ~~bands~~ usage.

##### 12.3.1.1.2 MAC Management Message Parameter Transmission Order

*Change the third sentence of the first paragraph as indicated:*

Both mandatory and optional TLVs shall subsequently be sequenced in order of increasing Type value except for the HMAC TLV, which shall be the final attribute in the messages' TLV attribute list.

**12.3.1.2 ProfM3\_Mesh: Basic Packet Mesh MAC system profile**

*In the Table 402, change text in column “Conditions/Notes” for row “DFS” as indicated:*

Required when ~~intended~~ if mandated by regulation for license exempt ~~bands~~ usage. Not required when intended for licensed ~~bands~~ usage.

*Insert a new row into Table 402:*

**Table 402a—Optional feature requirements profm3\_mesh**

TEK encryption algorithms: 3-DES EDE with 128-bit key (type I) RSA with 1024-bit key (type II) ECB mode AES with 128-bit key (type III)	Yes <sup>1</sup> Yes <sup>2</sup> No	1: Mandatory for PMP mode 2: Mandatory for mesh mode
--	--	---

**12.3.2 WirelessMAN-OFDM and WirelessHUMAN(-OFDM) Physical Layer Profiles**

*Change the relevant entry in Table 404 as indicated:.*

**Table 404—Minimum Performance basic requirements**

Capability	Minimum performance	
Tx relative constellation error:	<u>SS</u>	<u>BS</u>
BPSK-1/2	≤ -13.0 dB	≤ -13.0 dB
QPSK-1/2	≤ -16.0 dB	≤ -16.0 dB
QPSK-3/4	≤ -18.5 dB	≤ -18.5 dB
16-QAM-1/2	≤ -21.5 dB	≤ -21.5 dB
16-QAM-3/4	≤ -25.0 dB	≤ -25.0 dB
64-QAM-2/3	≤ -28.5 dB	≤ -29.0 dB
64-QAM-3/4	≤ -31.0 dB	≤ -31.0 dB

**12.3.2.4 ProfP3\_3: WirelessMAN-OFDM PHY profile for 3 MHz channelization**

*Change the relevant entries in Table 408 as indicated:*

**Table 408—Minimum Performance requirements for profP3\_3**

Capability	Minimum performance
$T_b$	$= 73 \frac{99}{437} \mu s + 74 \frac{18}{43} \mu s$
Reference frequency tolerance	
SS to BS synchronization tolerance	≤ 273.13268.75 Hz
Mesh to Mesh synchronization tolerance	≤ 409.67403.13 Hz

### 12.3.2.5 ProfP3\_5.5: WirelessMAN-OFDM PHY profile for 5.5 MHz channelization

Change the relevant entries in Table 409 as indicated:

**Table 409—Minimum Performance requirements for profP3\_5.5**

Capability	Minimum performance
$T_b$	$= 40 \frac{120}{157} \mu\text{s} \pm 40 \frac{40}{79} \mu\text{s}$
Reference frequency tolerance SS to BS synchronization tolerance Mesh to Mesh synchronization tolerance	$\leq 490.63493.75$ Hz $\leq 735.94740.63$ Hz

### 12.3.2.6 profP3\_10: WirelessHUMAN(-OFDM) PHY profile for 10 MHz channelization

Change the last bullet in the first paragraph as indicated:

- DFS capability (if mandated by regulation)
- Ability to detect primary-specific spectrum users with ~~received signal strength in excess of 67 dBm as defined by regulatory requirements~~
- Ability to switch channel within ~~300  $\mu\text{s}$~~  as defined by regulatory requirements.

Change the relevant entries in Table 410 as indicated:

**Table 410—Minimum Performance requirements for profP3\_10**

Capability	Minimum performance
$T_b$	$= 22 \frac{146}{357} \mu\text{s} \pm 22 \frac{2}{9} \mu\text{s}$
Reference frequency tolerance SS to BS synchronization tolerance Mesh to Mesh synchronization tolerance	$\leq 892.5900$ Hz $\leq 43391350$ Hz
Reference time tolerance	$\pm (T_b/32)/2$

### 12.3.3 WirelessMAN-OFDM RF profiles

Change the subclause as indicated:

For licensed bands, no explicit RF profiles are defined. A compliant system shall adhere to the requirements of 8.3.10.24 for the specified supported bands.

**12.4 WirelessMAN-OFDMA and WirelessHUMAN(-OFDMA) system profiles**

*Change Table 411 as indicated:*

**Table 411—Profile definitions**

Identifier	Description
OFDMA_profM1	WirelessMAN-OFDMA basic packet PMP MAC Profile
OFDMA_profP1	WirelessMAN-OFDMA 1.25 MHz channel basic PHY Profile
OFDMA_profP2	WirelessMAN-OFDMA 3.5 MHz channel basic PHY Profile
OFDMA_profP3	WirelessMAN-OFDMA 7 MHz channel basic PHY Profile
OFDMA_profP4	WirelessMAN-OFDMA 8.75 MHz channel basic PHY Profile
OFDMA_profP4 <sub>5</sub>	WirelessMAN-OFDMA 14 MHz channel basic PHY Profile
OFDMA_profP6	WirelessMAN-OFDMA 17.5 MHz channel basic PHY Profile
OFDMA_profP5 <sub>7</sub>	WirelessMAN-OFDMA 28 MHz channel basic PHY Profile
OFDMA_profP6 <sub>8</sub>	WirelessHUMAN(-OFDMA) 10 MHz channel basic PHY Profile
OFDMA_profP7 <sub>9</sub>	WirelessHUMAN(-OFDMA) 20 MHz channel basic PHY Profile

*Change the title of 12.4.2 as indicated:*

**12.4.2 WirelessMAN-OFDMA and WirelessHUMAN(-OFDMA) MAC Pprofiles**

*Change the title of 12.4.2.1 as indicated:*

**12.4.2.1 Basic Ppacket PMP MAC Pprofile**

*Change the last bullet of the second paragraph as indicated:*

- DFS shall be required for the license exempt bands ~~only~~ if mandated by regulation.

*Change the title of 12.4.2.1.1 as indicated:*

**12.4.2.1.1 Conventions for MAC Mmanagement Mmessages**

*Change the second bullet of the first paragraph as indicated:*

- No TLVs besides ~~Error Encodings and~~ HMAC Tuples shall be reported back in DSA-RSP and DSC-RSP messages.

*Change the title of 12.4.2.1.2 as indicated:*

**12.4.2.1.2 MAC Mmanagement Mmessage Pparameter Ttransmission Oorder**

*Change the fourth sentence of the first paragraph as indicated:*

For the required features, the relevant parameters shall be transmitted in order of increasing Type value of the parameter's TLV key except for the HMAC TLV which shall be the final attribute in the messages' TLV attribute list.

*Change the title of 12.4.3 as indicated:*

**12.4.3 WirelessMAN-OFDMA and WirelessHUMAN(-OFDMA) System PHY Profiles**

*Change the title of 12.4.3.1 as indicated:*

**12.4.3.1 Common Features of PHY Profiles**

*Change the title of 12.4.3.1.4 as indicated:*

**12.4.3.1.4 WirelessHUMAN PHY Profiles Features**

*Change the second and last bullet in the first paragraph as indicated:*

- Where mandated by regulation, Ability to detect primary specific spectrum users with received signal strength in excess of -61 dBm as defined by regulatory requirements
- Ability to switch channel within 300  $\mu$ s as defined by regulatory requirements

**12.4.3.1.5 Minimum performance requirements**

*Change Table 413 as indicated:*

**Table 413—Minimum performance requirements for all profiles**

Capability	Minimum performance
Tx Dynamic range SS BS	$\geq 30$ dB $\geq 10$ dB
Tx Power Level minimum adjustment step	$\leq 1$ dB
Tx Power Level minimum relative step accuracy	$\leq \pm 0.5$ dB
BS Spectral flatness, when using all subchannels. Absolute difference between adjacent subcarriers: (2.5dB should be added for Pilot carriers within the symbol due to their boosting).  Deviation of average energy in each carrier from the measured energy averaged over all <del>702</del> active tones: <del>Carriers -425 to -1 and +1 to +425</del> Carriers - <u><math>\text{floor}((N_{\text{used}}-1)/4)</math> to -1 and +1 to <math>\text{floor}((N_{\text{used}}-1)/4)</math>:</u>  <del>Carriers -851 to -425 and +425 to +851</del> Carriers - <u><math>\text{floor}((N_{\text{used}}-1)/2)</math> to <math>-\text{floor}((N_{\text{used}}-1)/4)</math> and <math>\text{floor}((N_{\text{used}}-1)/4)</math> to <math>\text{floor}((N_{\text{used}}-1)/2)</math>:</u>	$\leq 0.1$ dB  $\leq \pm 2$ dB  $\leq +2/-4$ dB



**Table 413—Minimum performance requirements for all profiles (continued)**

Capability	Minimum performance	
SS Spectral flatness, when using all subchannels. Absolute difference between adjacent subcarriers: (2.5 dB should be added for Pilot carriers within the symbol due to their boosting).	$\leq 0.1$ dB	
Deviation of average energy in each carrier from the measured energy averaged over all <del>1696</del> active tones: Carriers <del>424 to -1 and +1 to +424</del> Carriers - $\text{floor}((N_{\text{used}}-1)/4)$ to $-1$ and $+1$ to $+\text{floor}((N_{\text{used}}-1)/4)$ :	$\leq \pm 2$ dB	
Carriers <del>848 to -424 and +424 to +848</del> Carri- ers $-\text{floor}((N_{\text{used}}-1)/2)$ to $-\text{floor}((N_{\text{used}}-1)/4)$ and $\text{floor}((N_{\text{used}}-1)/4)$ to $\text{floor}((N_{\text{used}}-1)/2)$ :	$\leq +2/-4$ dB	
Spectral mask (OOB)	Local regulation	
Tx relative constellation error: QPSK-1/2 QPSK-3/4 16-QAM-1/2 16-QAM-3/4 <del>64-QAM-1/2</del> 64-QAM-2/3 (if 64-QAM supported) 64-QAM-3/4 (if 64-QAM supported)	<u>SS</u> $\leq -19.4$ <del>-15</del> dB $\leq -21.2$ <del>-18</del> dB $\leq -26.4$ <del>-20.5</del> dB $\leq -28.2$ <del>-24</del> dB $\leq -26$ dB $\leq -32.7$ <del>-28</del> dB $\leq -34.4$ <del>-30</del> dB	<u>BS</u> $\leq -15$ dB $\leq -16$ <del>-18</del> dB $\leq -20.5$ dB $\leq -24$ dB $\leq -26$ dB $\leq -28$ dB $\leq -30$ dB
Rx max. input level on-channel reception tolerance	$\geq -30$ dBm	
Rx max. input level on-channel damage tolerance	$\geq 0$ dBm	
Number Of Subchannels Supported when receiving/ transmitting SS BS	1-32 1-32	
First adjacent channel rejection at BER= $10^{-6}$ for 3 dB degradation C/I 16-QAM-3/4 64-QAM-3/4 (if 64-QAM supported)	$\geq 11$ dB $\geq 4$ dB	
Second adjacent channel rejection at BER= $10^{-6}$ for 3 dB degradation C/I 16-QAM-3/4 64-QAM-3/4 (if 64-QAM supported)	$\geq 30$ dB $\geq 23$ dB	
SSTTG and SSRTG: TDD H-FDD	$\leq 50$ $\mu$ s $\leq 100$ $\mu$ s	
Reference time tolerance	$\pm (T_b/32)/404$	

Change the title of 12.4.3.2 as indicated:

**12.4.3.2 WirelessMAN-OFDMA 1.25 MHz channel basic PHY Pprofile**

Change Table 414 as indicated:

**Table 414—Minimum performance requirements for OFDMA\_ProfP1**

Capability	Minimum performance
Channel bandwidth	1.25 MHz
Operation mode	Licensed bands only
Tx Dynamic range SS BS	$\geq 40$ dB $\geq 10$ dB
Tx relative constellation error: QPSK-1/2 16-QAM-3/4	$\leq 22.4$ dB $\leq 28.2$ dB
1 <sup>st</sup> adjacent channel rejection at BER=10 <sup>-6</sup> for 3-dB degradation C/I 16-QAM-3/4	$\geq 30$ dB
2 <sup>nd</sup> adjacent channel rejection at BER=10 <sup>-6</sup> for 3-dB degradation C/I 16-QAM-3/4	$\geq 80$ dB
BER performance threshold, BER=10 <sup>-6</sup> (using all subchannels BS/SS) QPSK-1/2 16-QAM-3/4  [Add to sensitivity 10*log10(NumberOfSub-ChannelsUsed/32) when using less subchannels in the BS Rx]	$\leq -90$ dBm $\leq -80$ dBm
Reference frequency tolerance BS SS to BS synchronization tolerance	$\leq \pm 1 * 10^{-6}$ $\leq 2$ Hz
TTG (TDD only)	$\geq 200$ $\mu$ s
RTG (TDD only)	$\geq 5$ $\mu$ s
Frame duration code set	{4,7}

*Change the title of 12.4.3.3 as indicated:*

**12.4.3.3 WirelessMAN-OFDMA 3.5 MHz channel basic PHY Pprofile**

*Change the Table 415 as indicated:*

**Table 415—Minimum performance requirements for OFDMA\_ProfP2**

Capability	Minimum performance
Channel bandwidth	3.5 MHz
Operation mode	Licensed bands only
BER performance threshold, BER=10 <sup>-6</sup> (using all subchannels BS/SS) QPSK-1/2 QPSK-3/4 16QAM-1/2 16QAM-3/4 64QAM-2/3 (if 64-QAM supported) 64QAM-3/4 (if 64-QAM supported)  [Add to sensitivity 10*log10(NumberOfSub-ChannelsUsed/32) when using less subchannels in the BS Rx]	$\leq -87$ dBm $\leq -85$ dBm $\leq -80$ dBm $\leq -78$ dBm $\leq -74$ dBm $\leq -72$ dBm
Reference frequency tolerance BS SS to BS synchronization tolerance	$\leq \pm 4 \times 10^{-6}$ $\leq 20$ Hz
Frame duration code set	{4,7}

*Change the title of 12.4.3.4 as indicated:*

**12.4.3.4 WirelessMAN-OFDMA 7 MHz channel basic PHY Pprofile**

*Change the Table 416 as indicated:*

**Table 416—Minimum performance requirements for OFDMA\_ProfP3**

Capability	Minimum performance
Channel bandwidth	7 MHz
Operation mode	Licensed bands only
BER performance threshold, BER=10 <sup>-6</sup> (using all subchannels BS/SS) QPSK-1/2 QPSK-3/4 16QAM-1/2 16QAM-3/4 64QAM-2/3 (if 64-QAM supported) 64QAM-3/4 (if 64-QAM supported)  [Add to sensitivity 10*log10(NumberOfSub-ChannelsUsed/32) when using less subchannels in the BS Rx]	$\leq -84$ dBm $\leq -82$ dBm $\leq -77$ dBm $\leq -75$ dBm $\leq -71$ dBm $\leq -69$ dBm

**Table 416—Minimum performance requirements for OFDMA\_ProfP3 (continued)**

Capability	Minimum performance
Reference frequency tolerance BS SS to BS synchronization tolerance	$\leq \pm 4 \times 10^{-6}$ $\leq 40$ Hz
Frame duration code set	{2,3,5}

Change the title of 12.4.3.5 as indicated:

**12.4.3.5 WirelessMAN-OFDMA 8.75 MHz channel basic PHY Pprofile**

Change the text under ‘Minimum performance’ of ‘BS Reference frequency tolerance’ field in Table 417 to ‘ $\leq \pm 2 \times 10^{-6}$ ’.

Change the note below Table 417 as indicated:

NOTE—When using this profile, the sampling frequency (see 8.4.2.4) shall be:  $F_s = \text{floor}(n \times BW / 28000) \times 28000$

Change the title of 12.4.3.6 as indicated:

**12.4.3.6 WirelessMAN-OFDMA 14 MHz channel basic PHY Pprofile**

Change the Table 418 as indicated:

**Table 418—Minimum performance requirements for OFDMA\_ProfP5**

Capability	Minimum performance
Channel bandwidth	14 MHz
Operation mode	Licensed bands only
BER performance threshold, BER= $10^{-6}$ (using all subchannels BS/SS) QPSK-1/2 QPSK-3/4 16-QAM-1/2 16-QAM-3/4 64-QAM-2/3 (if 64-QAM supported) 64-QAM-3/4 (if 64-QAM supported)  [Add to sensitivity $10 \times \log_{10}(\text{NumberOfSubChannelsUsed}/32)$ when using less subchannels in the BS Rx]	$\leq -81$ dBm $\leq -79$ dBm $\leq -74$ dBm $\leq -72$ dBm $\leq -68$ dBm $\leq -66$ dBm
Reference frequency tolerance BS SS to BS synchronization tolerance	$\leq \pm 4 \times 10^{-6}$ $\leq 80$ Hz
Frame duration code set	{2,3,5}

*Change the title of 12.4.3.7 as indicated:*

#### **12.4.3.7 WirelessMAN-OFDMA 17.5 MHz channel basic PHY Pprofile**

*Change the text under ‘Minimum performance’ of ‘BS Reference frequency tolerance’ field in Table 419 to ‘ $\leq \pm 2 \cdot 10^{-6}$ ’.*

*Change the note below Table 419 as indicated:*

NOTE—When using this profile, the sampling frequency (see 8.4.2.4) shall be:  $F_s = \text{floor}(n \times BW / 28000) \times 28000$

*Change the title of 12.4.3.8 as indicated:*

#### **12.4.3.8 WirelessMAN-OFDMA 28 MHz channel basic PHY Pprofile**

*Change the text under ‘Minimum performance’ of ‘BS Reference frequency tolerance’ field in Table 420 to ‘ $\leq \pm 2 \cdot 10^{-6}$ ’.*

*Change the title of 12.4.3.9 as indicated:*

#### **12.4.3.9 WirelessHUMAN(-OFDMA) 10 MHz channel basic PHY Pprofile**

*Change the text under ‘Minimum performance’ of ‘BS Reference frequency tolerance’ field in Table 421 to ‘ $\leq \pm 2 \cdot 10^{-6}$ ’.*

*Change the title of 12.4.3.10 as indicated:*

#### **12.4.3.10 WirelessHUMAN(-OFDMA) 20 MHz channel basic PHY Pprofile**

*Change the text under ‘Minimum performance’ of ‘BS Reference frequency tolerance’ field in Table 422 to ‘ $\leq \pm 2 \cdot 10^{-6}$ ’.*

### **12.4.4 WirelessMAN-OFDMA RF profiles**

*Change the second paragraph as indicated:*

Table 423 defines the RF channels for the license bands, for informative purpose. †The channels shall be calculated using the following formula

$$F_{start} + n \cdot \Delta F_c, \forall n \in N_{range}$$

*Insert to the ‘Channel Bandwidth’, ‘Center Frequency Step  $\Delta F_c$ ’, ‘Uplink  $F_{start}$ ’ and ‘Downlink  $F_{start}$ ’ columns titles in Table 423 the text:*

(MHz)

Authorized licensed use limited to: Fish & Richardson. Downloaded on April 11,2016 at 21:40:33 UTC from IEEE Xplore. Restrictions apply.

## Annex A

(informative)

## Bibliography

*Change reference [B10] as indicated:*

~~[B10] ERC/DEC/(99)23, *ERC Decision on the harmonised frequency bands to be designated for the introduction of HIPERLANs, 29-11-1999*, <http://www.ero.dk/doc98/official/pdf/DEC9923E.PDF>.~~

[B10] (ECC/DEC/(04)08) ECC Decision of 09 July 2004 on the harmonized use of the 5 GHz frequency bands for the implementation of Wireless Access Systems including Radio Local Area Networks (WAS/RLANs), 9th July 2004 revised November 2004,  
<http://www.ero.dk/documentation/docs/doccategory.asp?catid=1&catname=ECC/ERC/ECTRA%20Decisions>.

*Insert new reference [B11] and renumber the following references as needed:*

[B11] Recommendation ITU-R M.1652, Dynamic frequency selection (DFS) in wireless access systems including radio local area networks for the purpose of protecting the radio determination service in the 5 GHz band, 2003, <http://www.itu.int/rec/recommendation.asp?type=folders&lang=e&parent=R-REC-M.1652>.

Authorized licensed use limited to: Fish & Richardson. Downloaded on April 11,2016 at 21:40:33 UTC from IEEE Xplore. Restrictions apply.



## **Annex B**

(informative)

### **Supporting material for frequencies below 11 GHz**

#### **B.1 Targeted frequency bands**

*Delete the section and renumber subsequent sections as needed.*

#### **B.2 License-exempt co-existence and interference analyses**

*Delete the section and renumber subsequent sections as needed.*

#### **B.3 Performance characteristics**

##### **B.3.2 WirelessMAN-OFDM/OFDMA PHY symbol and performance parameters**

*In Table B.26, change the 'n' value for 'WCS' from '144/145' to '144/125'.*

Authorized licensed use limited to: Fish & Richardson. Downloaded on April 11, 2016 at 21:40:33 UTC from IEEE Xplore. Restrictions apply.

## Annex C

(informative)

### Example MAC common part sublayer service definition

#### C.1 MAC service definition

##### C.1.1 MAC service definition for PMP

###### C.1.1.1 Primitives

###### C.1.1.1.1 MAC\_CREATE\_SERVICE\_FLOW.request

###### C.1.1.1.1.2 Semantics of the service primitive

*Change the fourth paragraph as indicated:*

The convergence sublayer parameter indicates which CS handles data received on this connection. ~~If the value is zero, then no CS is used; other v~~Values for specific CSs are given in 11.13.19.

Authorized licensed use limited to: Fish & Richardson. Downloaded on April 11,2016 at 21:40:33 UTC from IEEE Xplore. Restrictions apply.

*Insert the following annex:*

## **Annex D**

(informative)

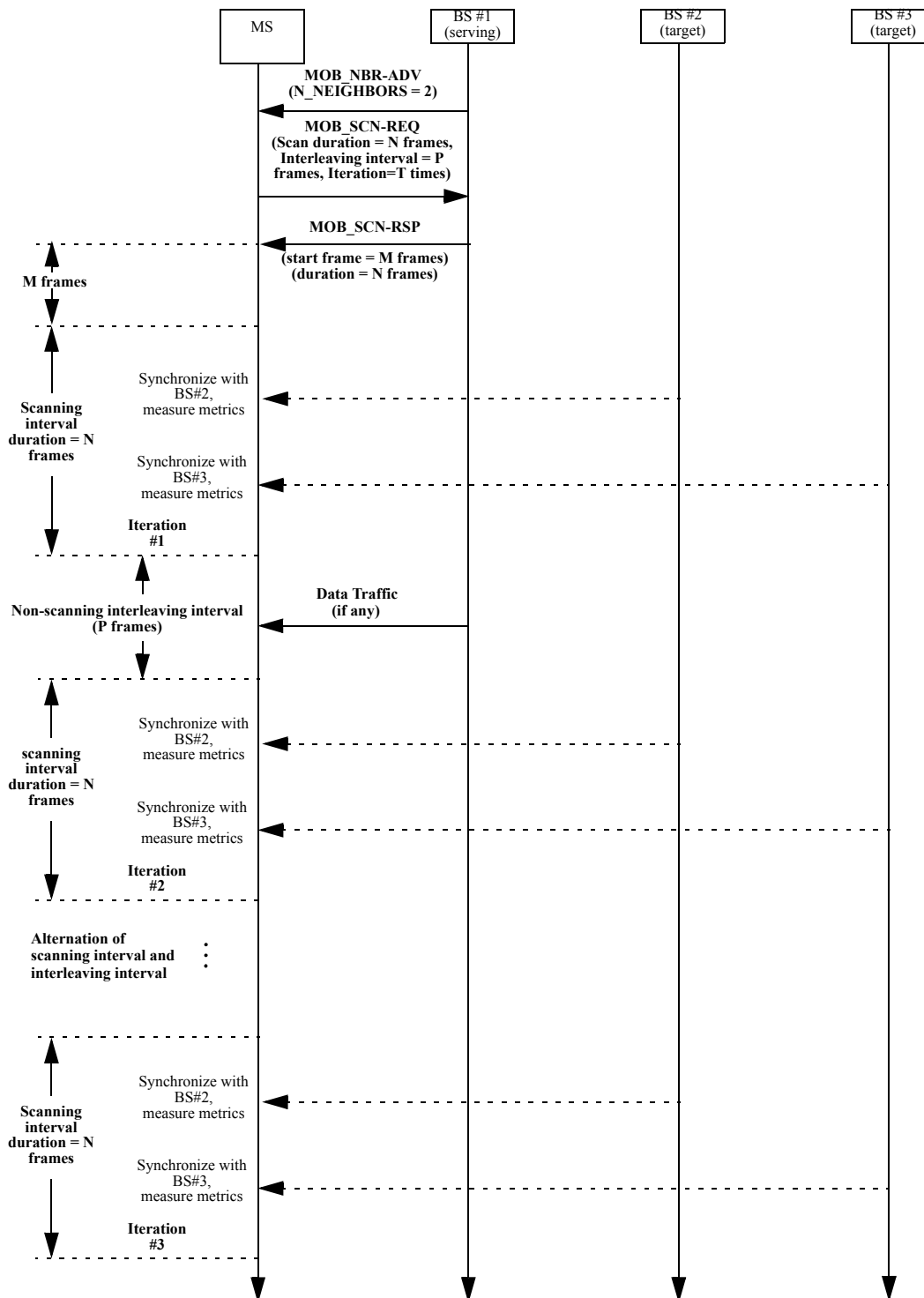
### **Messages sequence charts (MSCs)**

This annex provides example MSCs for the procedures of handover and sleep mode operations.

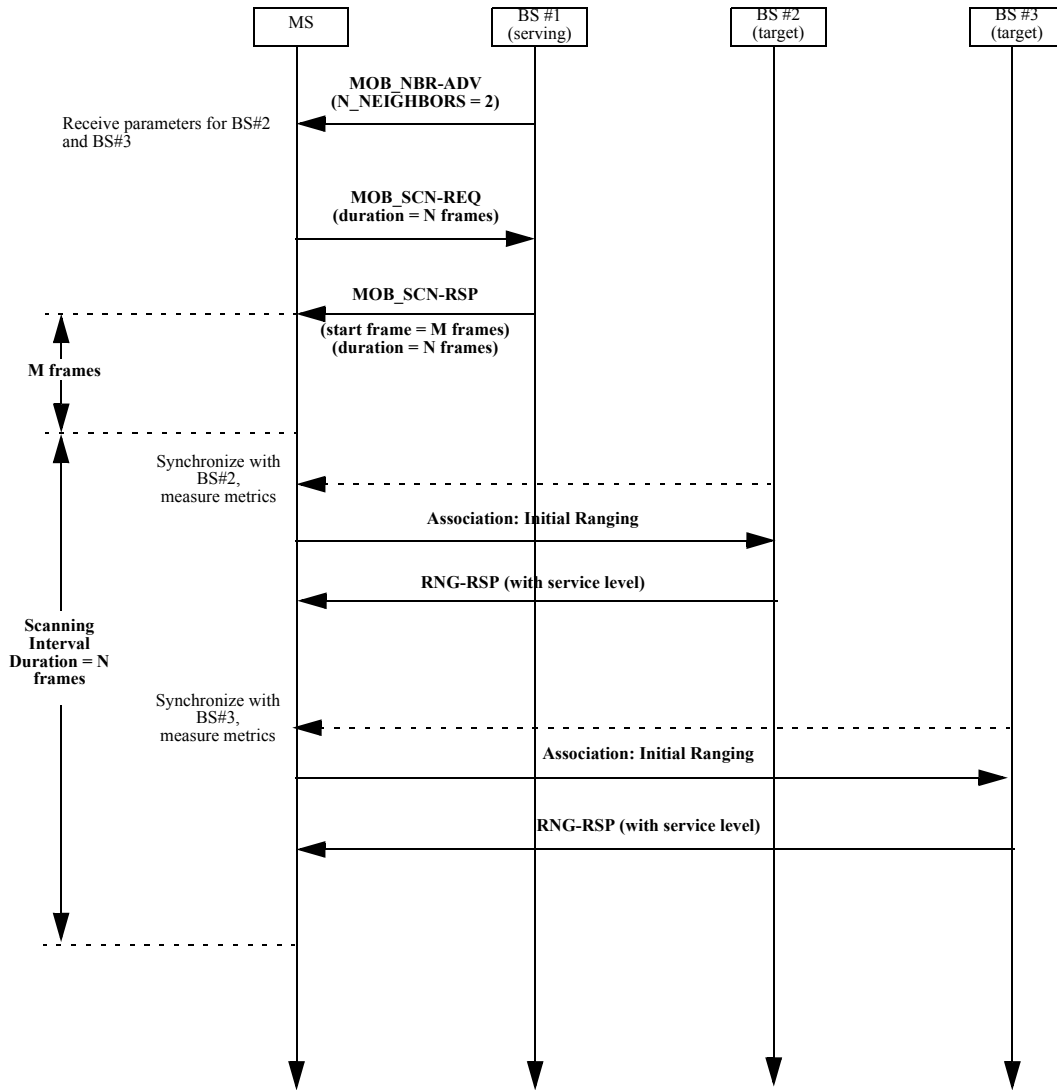
#### **D.1 Handover MSCs**

##### **D.1.1 Neighbor BS advertisement and scanning**

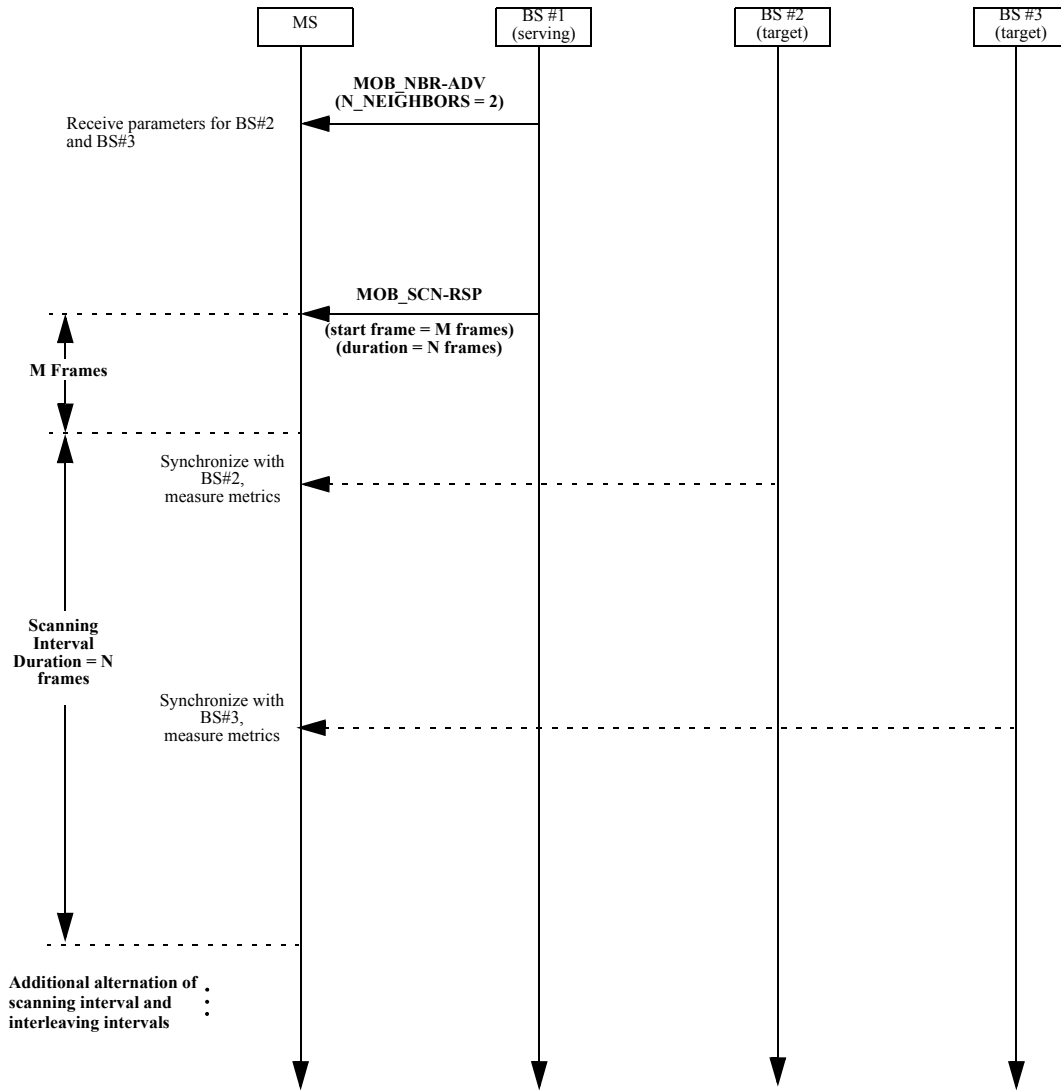
The following figures describe the example message flows for neighbor BS advertisements and scanning of neighbors by the MS request, BS request and periodic scanning of neighbors during handover.



**Figure D.1—Example Neighbor BS advertisement and scanning (without association) by MS request**

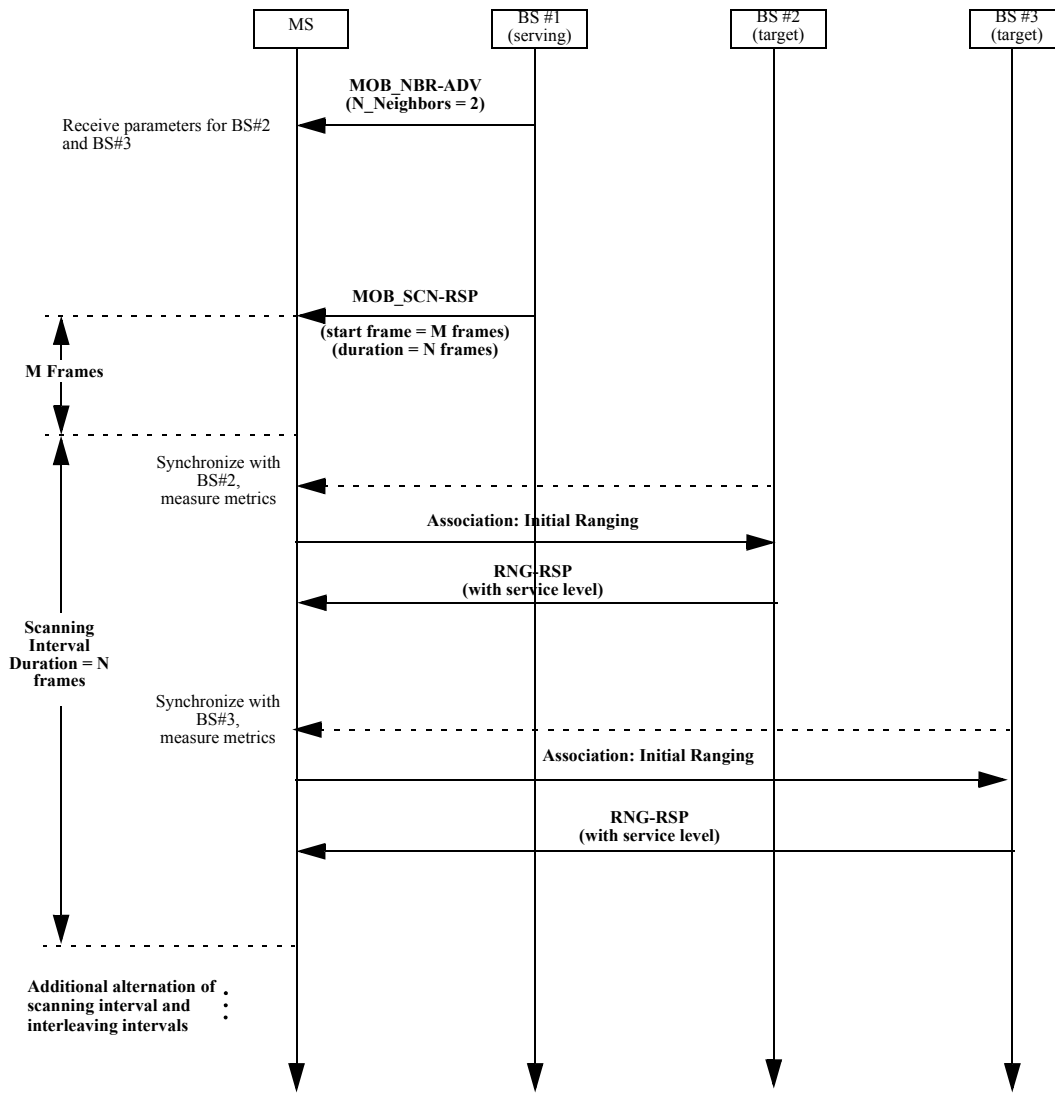


**Figure D.2—Example Neighbor BS advertisement and scanning (with non-coordinated association) by MS request**



**Figure D.3—Example Neighbor BS advertisement and scanning (without association) by BS request**





**Figure D.4—Example Neighbor BS advertisement and scanning (with association) by BS request**

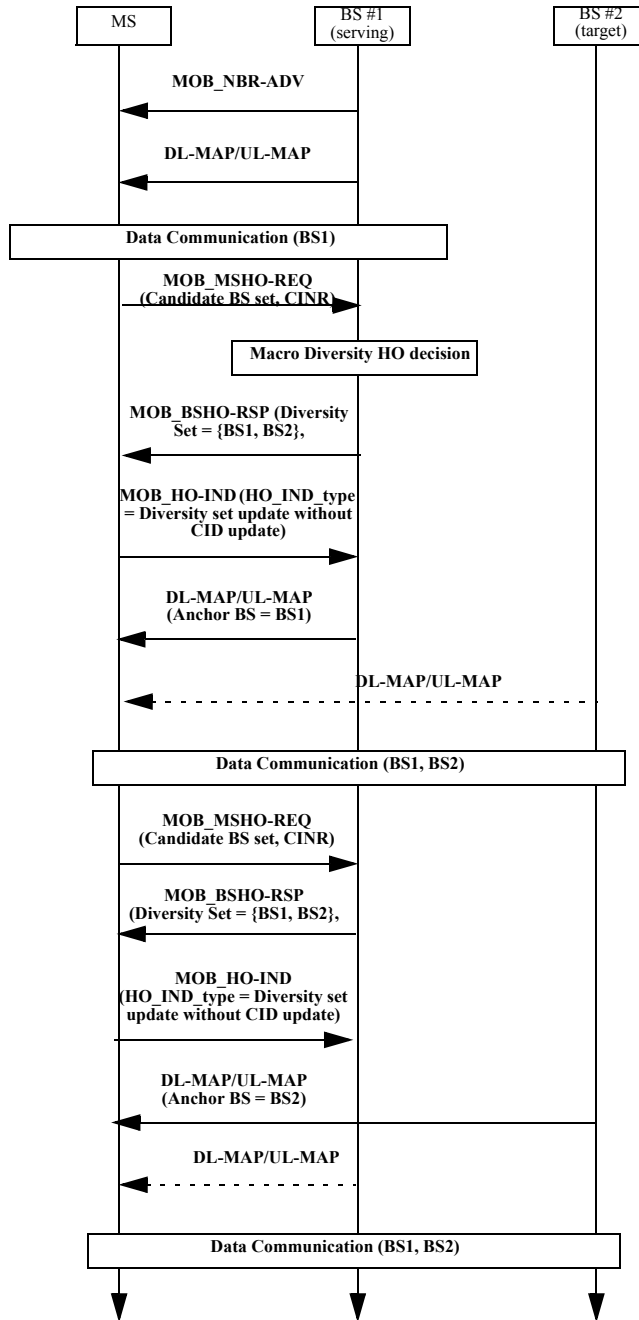


Figure D.5—Example Macro Diversity HO (Diversity Set Update: Add)

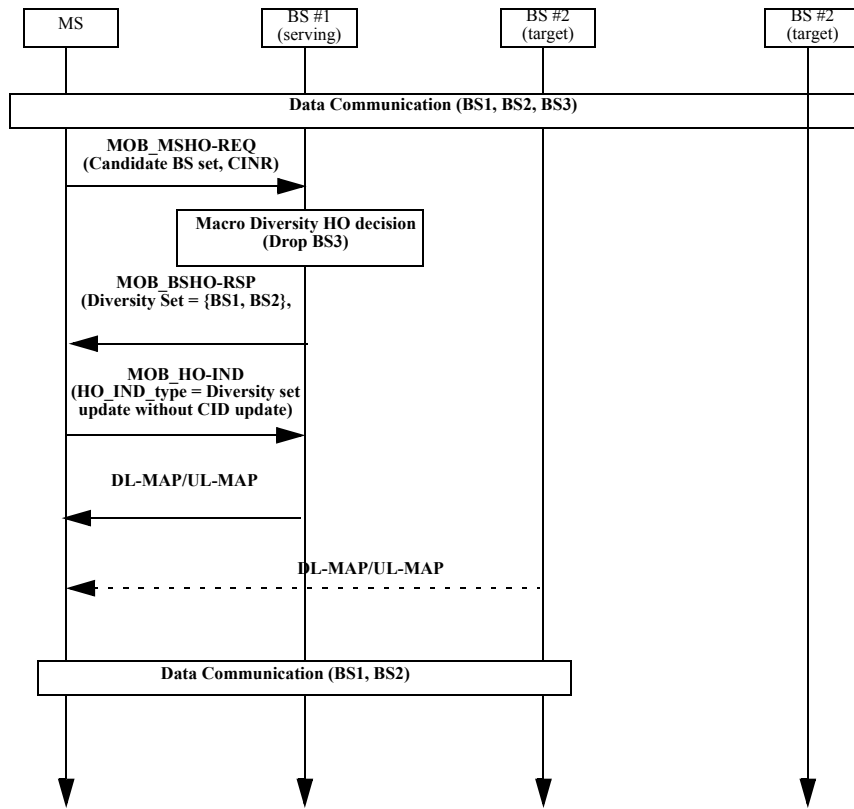


Figure D.6—Example Macro Diversity HO (Diversity Set Update: Drop)

## D.2 Sleep mode MSCs

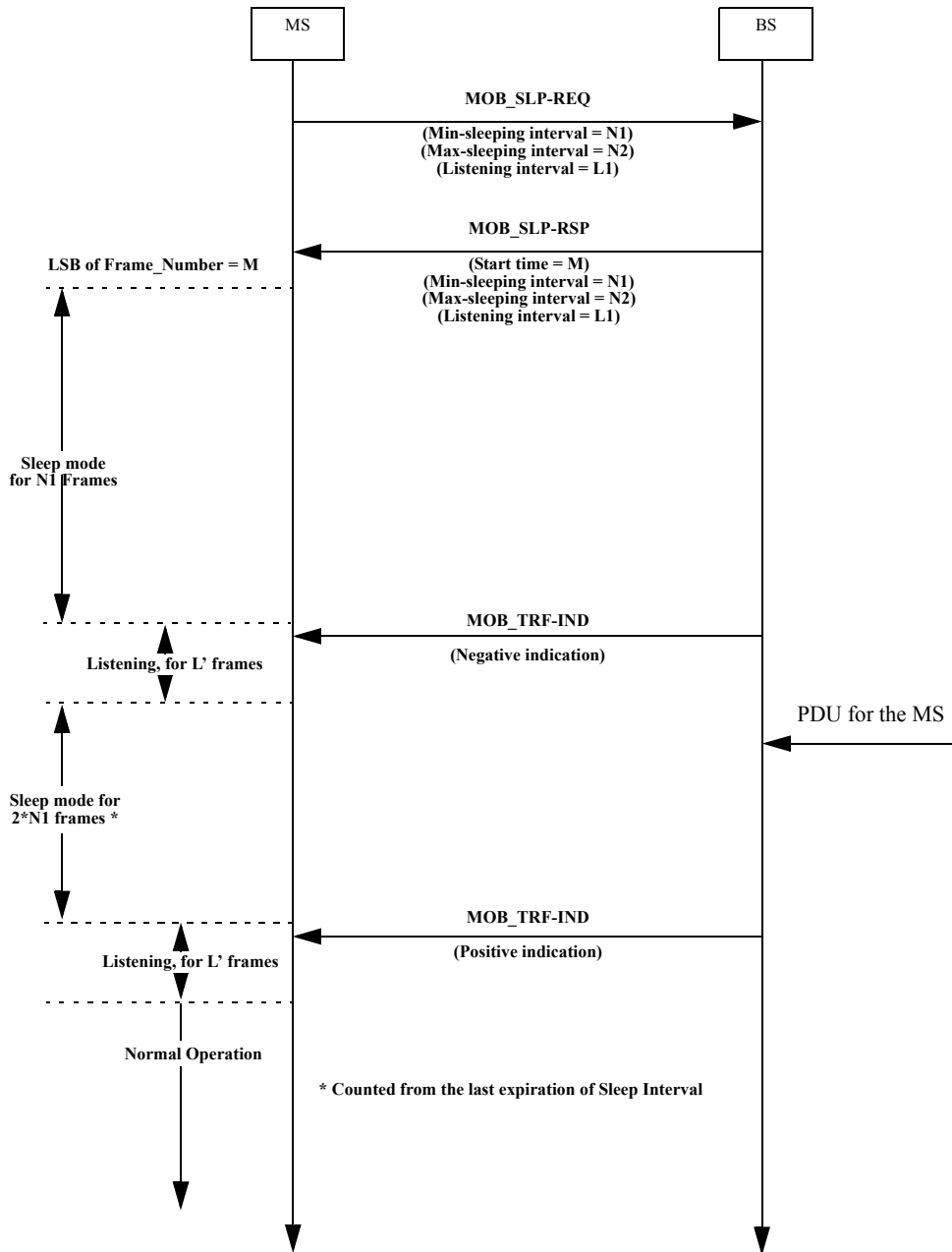


Figure D.7—Example sleep mode — MS initiated

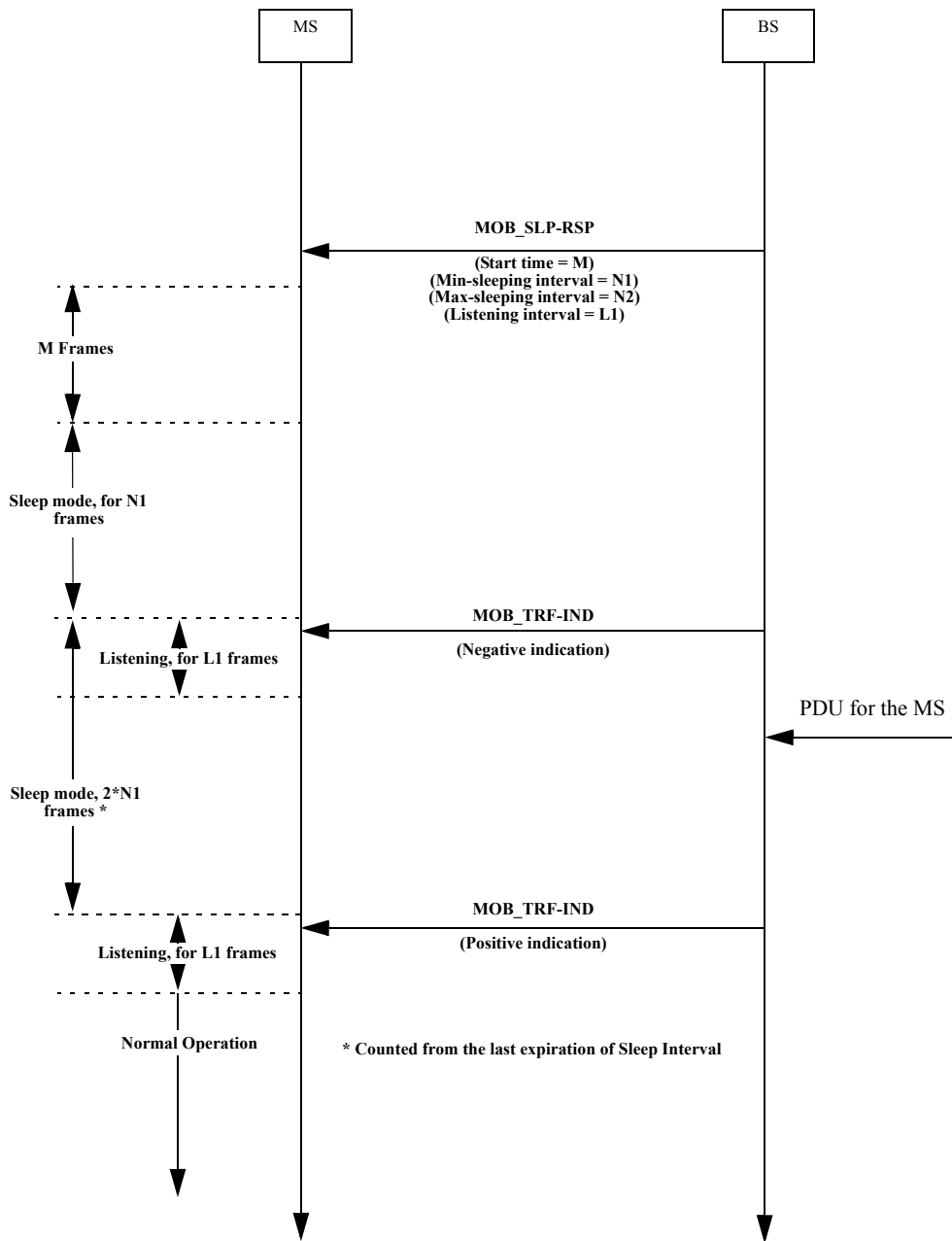


Figure D.8—Example sleep mode — BS initiated

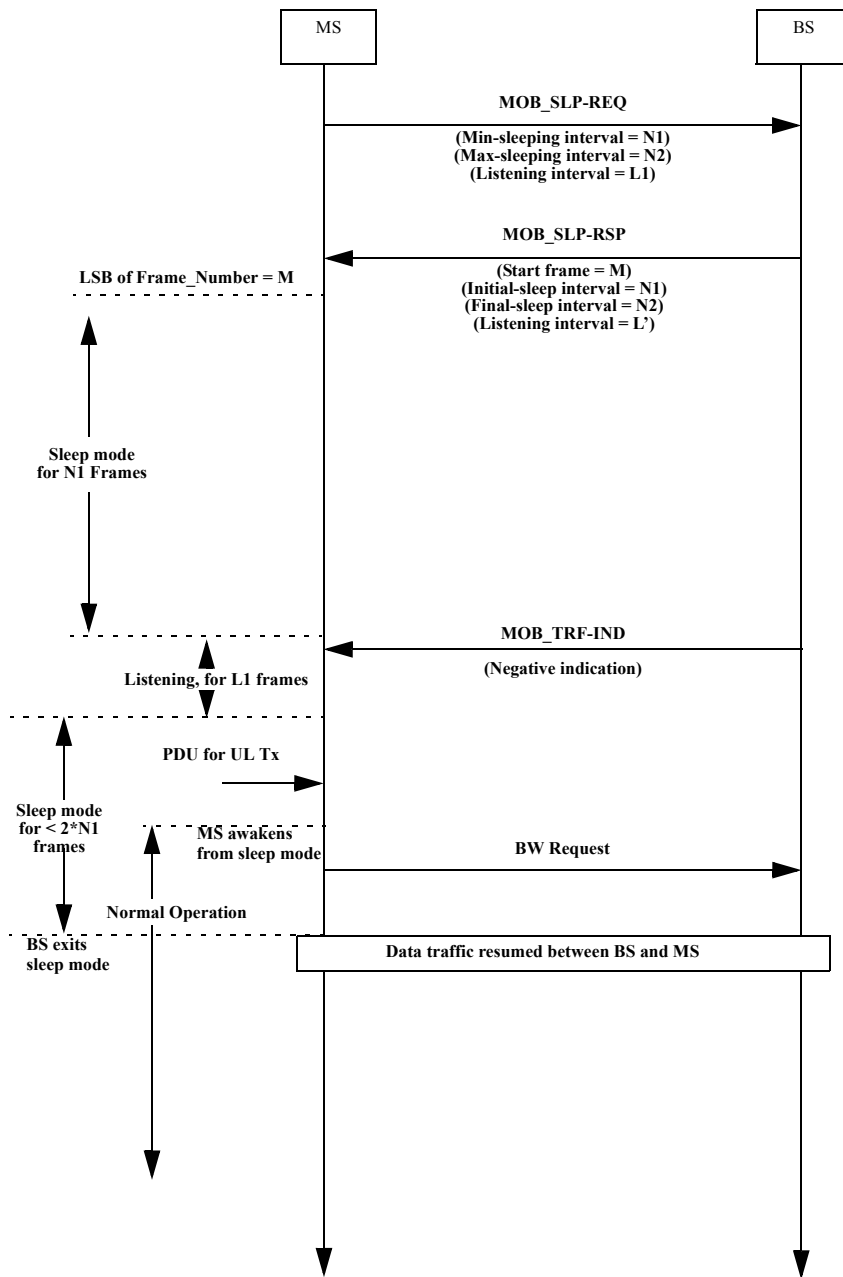


Figure D.9—Sleep mode—MS initiating awakening

*Insert the following annex:*

## **Annex E**

(informative)

### **Block diagrams**

This annex provides example block diagrams for the procedures of handover.

#### **E.1 Handover block diagrams**

##### **E.1.1 Handover initiated by Mobile Station**

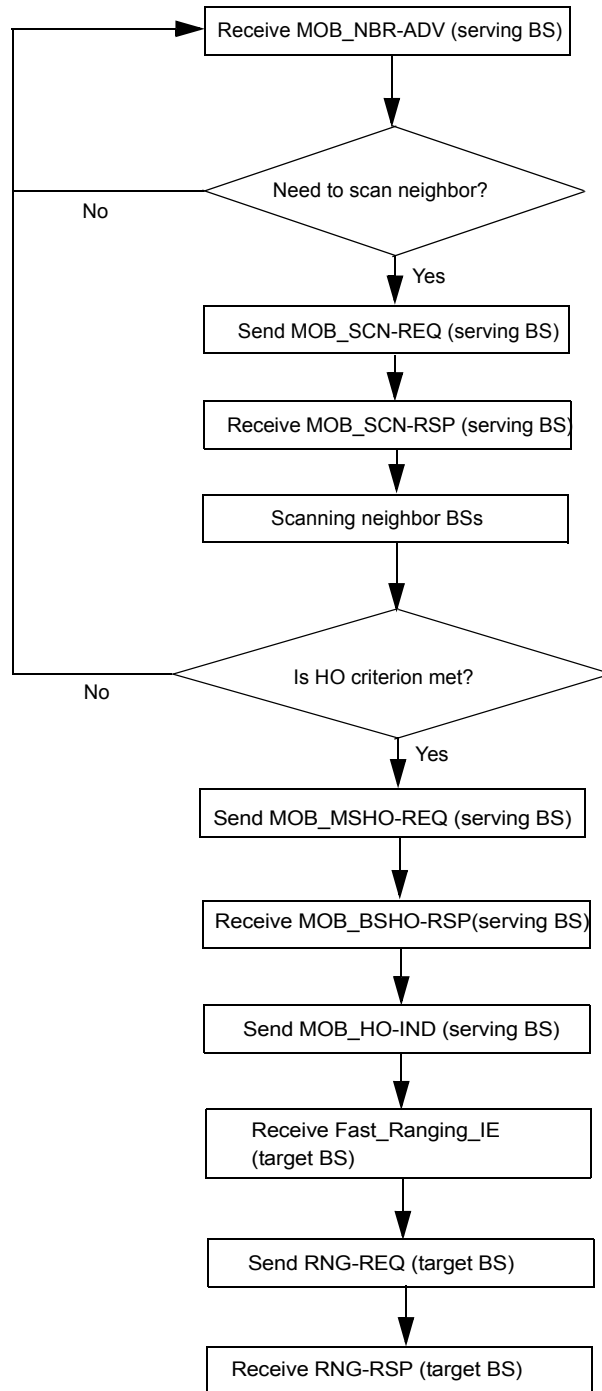
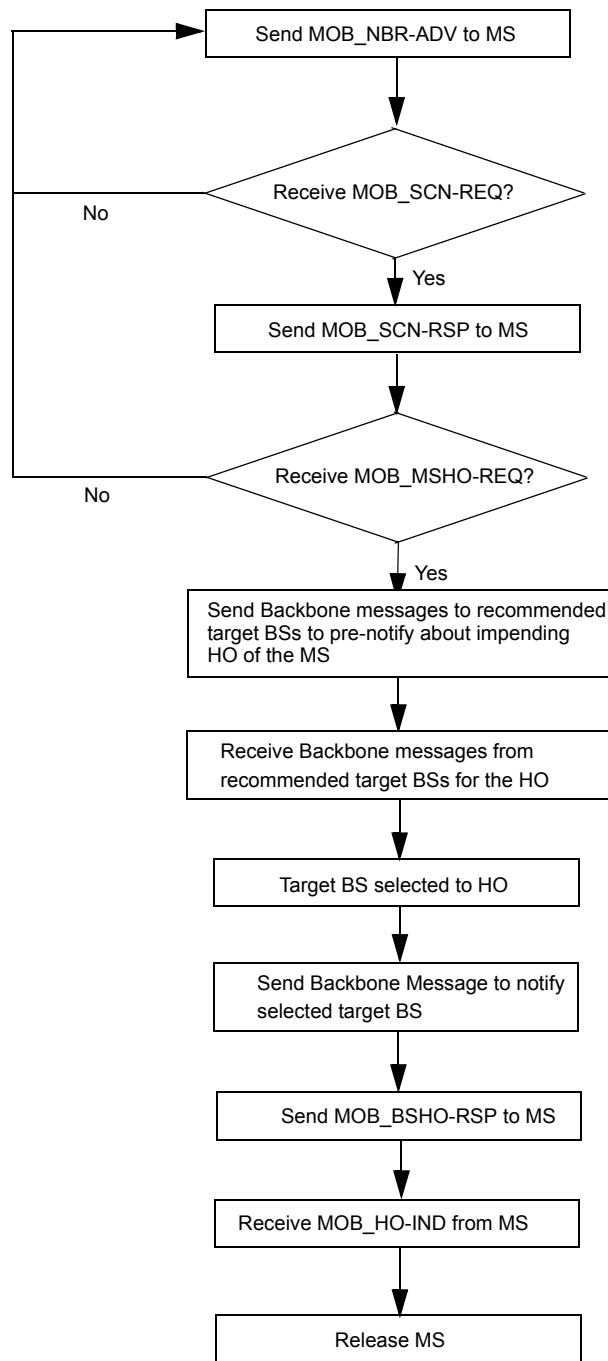


Figure E.1—MS initiated HO process block diagram as seen by MS





**Figure E.2—MS initiated HO process block diagram as seen by serving BS where final target BS is selected by serving BS**

### E.1.2 Handover initiated by Base Station

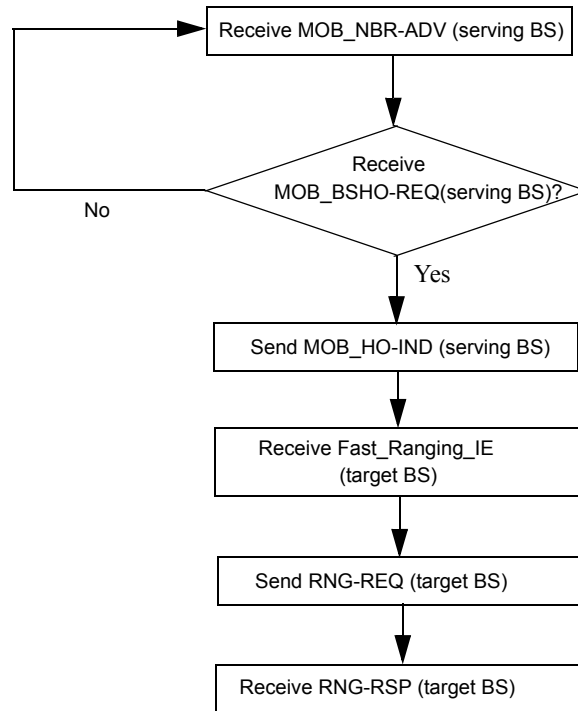
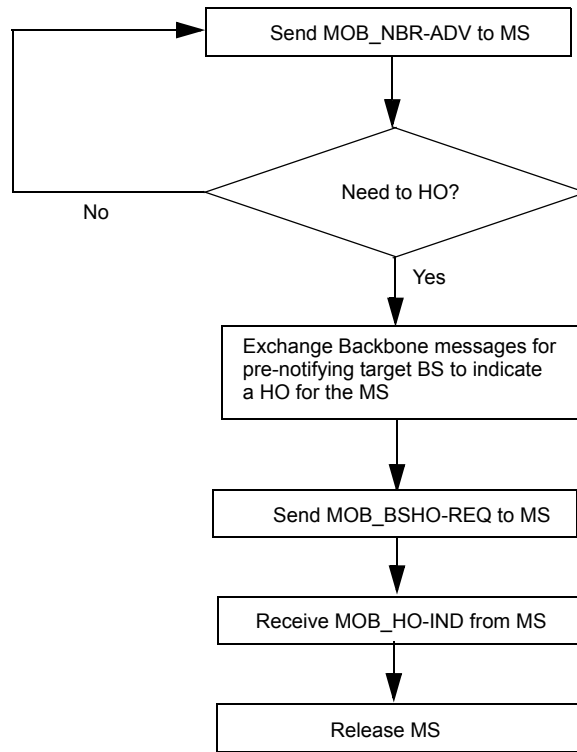


Figure E.3—BS Initiated HO process block diagram as seen by MS



**Figure E.4—BS Initiated HO process block diagram as seen by serving BS**

Authorized licensed use limited to: Fish & Richardson. Downloaded on April 11,2016 at 21:40:33 UTC from IEEE Xplore. Restrictions apply.

*Insert the following annex:*

## **Annex F**

(informative)

### **Test vectors**

#### **F.1 Cryptographic method test vectors**

##### **F.1.1 AES CTR Mode Known Answer Test for Variable Text**

###### **F.1.1.1 TEST vector**

###### **F.1.1.1.1 Test 1**

**PLAIN TEXT: 64 Bytes**

```
d8 65 c9 cd ea 33 56 c5 48 8e 7b a1 5e 84 f4 eb
a3 b8 25 9c 05 3f 24 ce 29 67 22 1c 00 38 84 d7
9d 4c a4 87 7f fa 4b c6 87 c6 67 e5 49 5b cf ec
12 f4 87 17 32 aa e4 5a 11 06 76 11 3d f9 e7 da
```

**Roll-over-counter: 1 Byte**

```
00
```

**PHY Synchronization: 3 Byte**

```
ffffff
```

**Counter: 16 Bytes**

```
00 ff ff ff 00 ff ff ff 00 ff ff ff 00 ff ff ff
```

**Key: 16Bytes**

```
00 00 00 00 00 00 00 00 ff ff ff ff ff ff ff ff
```

**CIPHER TEXT: 64 Byte + 1 Byte(Roll-over-counter)**

```
00 65 e1 16 74 b6 2e 38 bc ad 88 b4 d8 30 7e 44  
2b cb 5d 66 ee 5c 1c 82 ca 3d cf 21 db 90 c9 13  
b4 25 10 f4 d1 41 1e 04 8a 60 99 cf 02 32 d4 fe  
24 db 28 78 f0 fb 1c b6 c8 b5 41 63 6d e9 a6 1b  
15
```

**DECRYPT TEXT: 64 Byte**

```
d8 65 c9 cd ea 33 56 c5 48 8e 7b a1 5e 84 f4 eb  
a3 b8 25 9c 05 3f 24 ce 29 67 22 1c 00 38 84 d7  
9d 4c a4 87 7f fa 4b c6 87 c6 67 e5 49 5b cf ec  
12 f4 87 17 32 aa e4 5a 11 06 76 11 3d f9 e7 da
```

**F.1.1.1.2 Test 2**

**PLAIN TEXT: 256 Bytes**

```
45 8b 61 c3 84 ab 89 0b 71 ef ef b9 49 be a4 5b  
b1 2b 71 e2 d5 55 3b e5 5a b0 f5 97 a9 dc 71 ed  
66 d1 b0 ea 7c 38 f4 ec 26 e2 a5 6f 9f 48 ca 4f  
73 3a 31 47 8f 6b 2c e9 1b 21 7f c3 fd f0 b0 63  
c0 5f 4c 3c 96 3f 28 bc 21 cc 2b bf 14 f4 0e 86  
2e 3e cd bc a9 f8 a4 c3 18 23 86 15 12 35 77 d2  
93 c2 0e 29 00 35 e4 21 00 0e df 13 02 ed 99 2f  
2a 65 ea d2 5c 8e 95 74 b0 1a 88 c2 4e ff 94 e1  
c0 a2 0a c0 d6 ed e0 d5 fb bf e8 fc ab 80 2a d5  
e4 14 a7 40 a2 3b b4 52 55 3c 13 a3 3a a7 83 f9  
48 8c b9 1d 79 98 f2 74 57 da 70 01 59 9a d6 3c  
ad 7c 7c 4f b7 2f a0 0b 6a b3 ad a4 59 30 9c a1  
bc 55 be 34 ec b0 a8 42 89 17 43 e1 b0 18 1d 5d  
94 98 ab 4a c7 4a 55 31 fc 01 d4 55 31 70 f6 ec  
c4 b3 20 b0 63 c7 f2 eb dd 35 cc 8d 4d e8 e9 e0  
80 94 2a 47 de 7f 77 da 7f 4b 2f b0 bb 24 9b 7f
```

**Roll-over-counter: 1 Byte**

00

**PHY Synchronization: 3 Byte**

ffffff

**Counter: 16 Bytes**

00 ff ff ff 00 ff ff ff 00 ff ff ff 00 ff ff ff

**Key: 16Bytes**

00 00 00 00 00 00 00 00 ff ff ff ff ff ff ff ff

**CIPHER TEXT: 256 Byte + 1 Byte(Roll-over-counter)**

00 f8 0f be 7a d8 b6 e7 72 94 e9 20 c0 27 44 14  
9b d9 ce 32 90 8c 76 9d e1 4e 18 f6 50 39 2d e6  
8e de 8d e0 bc 42 dc bb a0 c1 bd 0d 88 e4 c7 fb  
87 ba e6 ce a0 46 dd 7e 7b bf 66 6a bf 29 af 4c  
ac ec 7b ca 8c 91 41 41 f5 18 98 be 04 ec 83 7b  
b3 1e 08 65 93 d9 74 fb c2 58 c4 d1 e9 17 fa a8  
08 09 a9 21 24 a5 f8 c1 90 89 8e b8 e1 18 28 aa  
e8 da 8c c4 bd 0a 5c f8 36 bd 5c da 33 3b 72 d9  
52 f7 ba 62 94 9b 2c 9a 27 34 b5 c9 6b 0a 69 9a  
44 3f bf a7 a4 a2 cb 4b ab 95 2f e8 b8 94 19 e9  
6f e1 d9 00 cd 60 e7 2b 38 db a6 86 4e f0 83 fe  
13 1a c2 d2 33 2f 8d 30 fa bb bd 0e c6 26 e4 55  
e4 37 a4 78 62 33 4d f4 07 53 f2 a6 26 8b 15 94  
55 ca a5 da 0d 4a eb f6 6d e5 bf 10 b9 28 17 83  
49 1f 80 3c 50 56 68 0a 40 08 86 b1 8e ec 48 01  
38 33 9c c7 4c 68 aa c9 a3 8d 28 57 8e eb 62 39  
c0

**DECRYPT TEXT: 256 Byte**

```
45 8b 61 c3 84 ab 89 0b 71 ef ef b9 49 be a4 5b
b1 2b 71 e2 d5 55 3b e5 5a b0 f5 97 a9 dc 71 ed
66 d1 b0 ea 7c 38 f4 ec 26 e2 a5 6f 9f 48 ca 4f
73 3a 31 47 8f 6b 2c e9 1b 21 7f c3 fd f0 b0 63
c0 5f 4c 3c 96 3f 28 bc 21 cc 2b bf 14 f4 0e 86
2e 3e cd bc a9 f8 a4 c3 18 23 86 15 12 35 77 d2
93 c2 0e 29 00 35 e4 21 00 0e df 13 02 ed 99 2f
2a 65 ea d2 5c 8e 95 74 b0 1a 88 c2 4e ff 94 e1
c0 a2 0a c0 d6 ed e0 d5 fb bf e8 fc ab 80 2a d5
e4 14 a7 40 a2 3b b4 52 55 3c 13 a3 3a a7 83 f9
48 8c b9 1d 79 98 f2 74 57 da 70 01 59 9a d6 3c
ad 7c 7c 4f b7 2f a0 0b 6a b3 ad a4 59 30 9c a1
bc 55 be 34 ec b0 a8 42 89 17 43 e1 b0 18 1d 5d
94 98 ab 4a c7 4a 55 31 fc 01 d4 55 31 70 f6 ec
c4 b3 20 b0 63 c7 f2 eb dd 35 cc 8d 4d e8 e9 e0
80 94 2a 47 de 7f 77 da 7f 4b 2f b0 bb 24 9b 7f
```

**F.1.1.1.3 Test 3**

**PLAIN TEXT: 1500 Bytes**



d7 ba 2e 39 80 20 24 5d 54 ef e9 a0 d7 d2 7f 56  
 65 a9 9c 43 27 13 1c a6 5e 4a 55 18 6e f0 96 44  
 a9 c4 7d 29 e3 a1 85 36 8f 6e d5 65 3f 54 bb a4  
 fd 57 e6 23 6a 02 c9 c7 4c 1e de b9 0d 73 fd b6  
 36 7a de 19 1a 63 4e a9 d0 22 0e 0e 76 c8 b2 72  
 1f 97 95 88 99 5d 4e e4 7b 2c 9d 87 9f 99 3c d5  
 12 1a ed 2c 7c 3a d4 4b 5c e1 59 d1 a9 0a 42 c8  
 a1 d7 4f 39 33 9d 1d ad c9 b9 34 67 51 70 3c 63  
 89 28 8f 04 62 62 4f bd 43 a7 8e ec b0 d0 b3 50  
 a6 02 89 d9 9f a5 85 67 5d b9 ce ae 28 09 11 b0  
 31 9f b4 92 01 02 4f 43 a8 dc 2f 58 ab e2 a8 51  
 e3 30 29 81 d5 ad e8 31 65 b5 df 8d be ef 3c ee  
 8e ef 7f 8e f1 cd d1 99 a9 ff f0 54 e0 97 a4 c3  
 c7 cc 44 9b 79 2b cc de e0 ab 6a 9d 99 a6 8a 26  
 95 09 b4 85 d6 84 1d 7e 83 0d d1 63 a4 74 25 6a  
 40 69 05 b8 93 d1 96 73 7b ff 10 14 a5 99 39 39  
 a2 ed bd 77 71 da f4 f3 e7 c5 56 8a 39 7b f4 78  
 e3 f8 30 76 c8 c5 e8 42 c3 f7 55 68 90 8e a0 31  
 7b 5d a8 eb 36 9c de 1d 60 33 a6 98 ae 99 10 90  
 91 3f 05 59 03 ed 9a c6 e4 ef 2d 73 7d cc a4 f8  
 28 4b e2 5e e7 c0 7a 46 f3 20 de a0 b8 ed 30 49  
 2b 34 a1 2e 21 3b f3 04 2a 1f 77 a7 eb 1a 9e 13  
 65 80 70 4c 3f ea 91 31 09 6f d1 c1 5c 00 0a 87  
 34 aa b4 54 e4 a6 58 0d c5 ce b3 af e8 51 c1 4d  
 d0 31 98 0e 1a 29 3f 23 97 0f e4 f3 0f ed 79 42  
 97 2c 96 7a d1 ee 87 96 bb 3a 44 a3 8a 05 ef 59  
 35 86 67 4f af a6 72 45 b5 56 37 c3 43 af 05 d9  
 db 9a 53 ab 87 da 41 42 13 84 e4 9d 88 d3 f6 bd  
 59 5d 0c 07 02 7d 4b b6 d2 82 78 15 31 7c ed 0c  
 16 3f b7 9d 18 f7 df 2b 7a c2 c8 02 95 bd bf ed  
 19 ca f3 1a 47 3e d0 19 c0 47 2d f1 c3 19 fc d9  
 58 b2 75 70 a8 53 9a 22 15 61 24 a9 1e e2 96 36  
 ac 88 50 f2 c5 20 0a 84 67 37 74 2a 4f 70 02 a7  
 21 77 16 c8 ca b0 ea df 11 0d 87 2e ee 1d 64 99  
 a4 b4 8b 69 d3 94 ec 39 cb 60 62 19 cf 64 c0 f0  
 da d5 b7 a3 85 a0 81 95 ac 08 c2 9a 24 25 33 c8  
 d9 bd 30 ab 51 1c e4 1b 7b 46 34 4a a9 f3 39 82  
 c8 f0 25 4c 90 a5 e0 3c ad a2 d6 d1 c6 08 98 9f  
 c4 c7 49 14 e2 2d 2e 5d 72 61 a6 1a 54 df 9c 1b  
 cf c0 67 5e 65 46 9a 12 e7 6f e2 ad 76 79 4b 3a  
 3f 94 4e 21 c0 7b 7d 32 dc 23 4c 30 01 e7 4a d0  
 a7 b1 2d 0c f6 c7 1d dd 36 ff 8a ab 78 d5 e5 b7  
 68 32 d7 28 ad 53 59 89 76 a4 b8 76 8b 02 45 32  
 b2 72 3d a8 39 5a 84 6e 58 0d 19 d0 e2 fd 86 49  
 2f 5c 71 db af ca 63 24 6e 1b 9a f8 1c df 29 ce  
 51 66 75 89 bf f9 f6 17 06 0e e6 e7 0b 6c 30 39  
 c8 a0 13 77 69 76 9b d6 91 34 ce ad 13 f7 7a 63  
 5c ef eb 1b e7 e1 32 ec ee 17 d3 f8 83 02 31 4a  
 a1 44 c0 0a b9 5a e0 49 8e ad f6 a0 a4 6f 03 ff  
 5e ed 1a 44 ce 4b 30 bb 62 02 b3 e4 03 e3 2e a4  
 26 ed ad df 47 8d 28 d5 3a 1d 74 dd 8c 77 dc e9  
 63 f5 2d 31 40 5d eb a1 5e 9e 85 61 81 b2 05 a7  
 9f b2 86 e6 3e ad ba 77 ca 2e 54 56 a4 2f 3f 07

24 6b 37 63 c8 22 04 26 bf 88 87 40 3a 8b e6 d9  
3d 6b be 7b 18 77 f1 e2 a4 45 37 48 73 76 4e 97  
e1 84 f9 a8 a5 fd cd 64 84 53 a3 be de 89 96 1a  
f4 53 94 0c ca 85 ed 6e c9 24 b5 3c 99 03 d2 7a  
86 cb 21 2b c7 ed 8f 4b 40 32 09 1d bb 9e 37 ae  
f1 ca b9 bb 4f a6 28 18 c9 dd 53 62 df 25 db 64  
ef fc 8f b6 e9 1e 01 28 4f 09 45 09 a6 7b b7 97  
45 70 51 93 15 78 aa de 54 fd 40 32 21 1a 96 10  
16 25 c5 fe 42 c5 25 91 cd 6a 9a 73 e4 50 0a 29  
c0 5a bc d4 d2 65 b2 26 62 f1 58 82 0b ed 92 20  
12 57 1d 53 1c 42 e4 e9 ac 7d 5b 90 cd 65 b8 8d  
be 73 60 8f d8 12 b5 39 02 0c bb 0c f9 4c 2c 0a  
a3 49 5d be 8a 40 a6 35 bd 01 c4 8a 65 7c 16 23  
ee 76 b2 c5 87 66 fe 89 71 b8 95 69 04 c0 72 a6  
08 cf 64 92 0f 09 c7 cb 0a 8b 55 6e 06 6a 91 f3  
e0 42 b8 67 a7 b5 ef 17 6d 84 80 71 44 f2 17 4b  
c0 7a dd ce 83 a3 99 8c 2d ee fa 33 58 8a 25 37  
cb dd 9d 72 92 8c 89 ff 10 08 6f 53 fa 85 9d b9  
ff 7a 87 81 1c 20 0c 49 0d 06 7b 64 8f a0 9b 5a  
7d 38 cc 0e c4 54 0d d3 5c 7b 25 55 00 c2 0e ff  
3b 95 7f 57 b4 8b a0 c1 90 1b 25 1f ba c0 79 37  
f7 44 45 ba 98 51 8d f3 cc b1 47 cc 73 54 ca ae  
e9 48 05 9c d2 a4 5d 62 be 82 81 78 41 f9 ae 38  
3d f2 f1 d4 43 7e c6 0e 2e 0d d9 a1 61 a2 4e 49  
e9 52 e5 bb f5 42 1c b3 c3 9c 2b 04 95 d9 3b d1  
ca 2b a5 0c a8 6a 1a d6 77 f2 76 d7 93 c4 20 7c  
15 04 37 0a 45 53 bd 08 ef e7 0b 83 bf 45 54 89  
70 f8 95 18 62 ae ee d9 a0 64 b0 33 27 cf af 3c  
d3 e5 45 18 37 01 1f 26 e8 29 a9 a6 6e fc 2f dd  
f4 c3 f5 56 71 e2 2e 10 45 dd 42 6b ac f0 a6 7e  
d5 eb 95 0c ec b4 31 d3 dd da 79 4a d6 a7 27 c9  
69 1b 1f da fd 4c e9 41 29 2b ac d4 1a 52 52 ef  
3d e6 fa 28 99 2b fb 75 04 73 bf d9 19 e5 a2 82  
00 c0 5c fc 0c 44 3d 35 6e e8 08 88 3a 59 76 76  
3f 70 9d d8 9b 97 4c 9e 09 0a 77 22 ef 18 a4 ee  
d8 ff e9 e3 43 25 17 b1 0d 1f 38 46 78 ae bb b7  
1e 57 8e b8 ee d9 56 f7 e3 cc 19 d1 e4 bd bf bb  
bc a8 9e fe cc b5 ae d9 d3 e6 1e 4b 93 d9 01 b0  
30 8e 68 1d 67 bd 14 49 88 2c 1a 6b e8 d8 25 a4  
7f c3 a1 4b 77 4f 24 4a 34 42 94 c6 1a 95 76 4a  
23 de 67 89 9a 7a d2 22 a6 ec 8c 8e

**Roll-over-counter: 1 Byte**

00

**PHY Synchronization: 3 Byte**

ffffff

**Counter: 16 Bytes**

00 ff ff ff 00 ff ff ff 00 ff ff ff 00 ff ff ff

**Key: 16Bytes**

00 00 00 00 00 00 00 00 ff ff ff ff ff ff ff ff

**CIPHER TEXT: 1500 Byte + 1 Byte(Roll-over-counter)**

00 6a 3e f1 80 dc 3d 4a 24 b1 e9 26 d9 b9 28 cf  
96 0d 4c df 31 7e 30 ba a2 4a e2 56 df fe 01 01  
27 11 98 2d 7f dd 45 ca 7a 68 31 7d 82 44 db 8a  
6c 34 8b 19 c4 a3 b4 9b 55 e8 59 cb c5 d9 2c 01  
79 1a 5e 58 a9 1d 1d 27 e0 e9 76 9b b5 8e bf c7  
47 2f a1 3d a7 e9 d1 11 e5 3b cb ca 7b 9a 56 e3  
0f 88 71 c2 21 d9 f7 f1 fa d5 61 3e 23 b3 cf 71  
0f 51 3e 61 56 65 4f 70 ef c4 ff 66 96 24 fd 71  
d0 be 30 e7 50 2f a3 35 4f 8c ad af 7b 11 39 03  
c1 7d a9 89 3d 9f 55 7a 9e 9d aa 35 b5 86 b7 7b  
26 98 ca 0d 42 18 7d 96 0f 24 a0 d9 17 02 fb 80  
7e 54 8e 87 fd 4d 0f 78 c0 b4 bb 7c ef c1 3b f5  
ab 05 1e b9 d8 2e 30 8d dc 73 1a 15 93 db 9a 2d  
cb 99 f1 35 dc f4 8a 6f 82 f9 15 ae 71 80 c1 ff  
83 4e 3a a8 65 e3 2b e5 d5 56 be ac 60 05 d4 cd  
b2 f3 61 e8 b3 25 04 28 0a 89 9c 68 2a f5 df 9b  
86 fb 5d aa 90 d1 af 43 06 c0 9f d4 9d 1c 0d cb  
c9 d2 ef 3e bc 9c 92 a4 61 36 b8 f6 4b d7 6d 8f  
2e d3 ec 87 40 9d 19 a0 e4 10 f7 74 76 7d f1 60  
4b 98 70 ce 5d aa 28 0e 42 dc 4e a3 86 0d 30 5f  
f6 2f 6a b8 a0 c3 f7 85 56 58 53 d4 e0 16 a8 be  
09 0a d9 d9 1f ab 02 b9 94 74 75 1c f4 ca 6d 75  
93 4f 08 1c b6 46 46 ff 97 c2 c0 af 64 39 a3 4c  
e1 90 74 6d d0 a8 2b 75 0f 21 a5 3b ad 95 6f 42  
c2 9d 23 19 e4 f3 3f 45 c2 eb c5 bd 2c 75 5f 77  
d9 01 0f ef e9 01 53 2e 34 17 21 ba 5a d8 bc 60  
1a f2 32 e1 f2 88 fc a2 ac 55 7d 47 b2 1b cf cd  
79 c1 9a ac 24 19 e0 5e 56 f8 db c3 3b c9 aa f4  
fd 19 80 83 2a 59 4a c6 5e f8 40 13 00 d9 77 5c  
4a ca b0 5b 53 de 4c a0 3d 96 04 60 d8 bf d5 a3  
f9 da 41 ed 8e 0b e9 a8 52 40 46 c1 21 78 4e 04  
5b 0b 20 ad 4b 23 32 51 8e e7 b2 ac a1 51 c8 4d  
0f e0 cd e5 64 16 71 df 64 76 1d 51 71 02 a2 76  
66 38 01 46 87 ec 44 6f 1d 44 f5 8b 7b 7e 63 14  
4b 29 2b 8d fc a6 3e 14 75 b8 a8 27 23 b3 f2 1c  
79 a8 2f 2b 3b 69 3e d9 0d 74 1a 32 c6 b0 98 86  
18 3f 9f a2 c0 a5 bb b8 85 61 7b 0d 23 47 e4 39  
0f 53 cf 9c 19 34 55 3c de 0e 24 ed 07 6c e9 d3  
7d 91 aa 32 33 5a df 42 90 55 63 eb cf f7 b8 62  
9b 40 2a 3c e8 06 ef 84 50 da 51 fc 82 26 63 fb  
c2 58 44 d6 1b 56 db 52 d9 7f c0 36 63 8f 70 2a  
6e be ee 72 23 40 3e db 47 96 d3 eb 4c 9e dc cf  
db f5 70 dd 01 ec a6 93 95 f0 91 06 c4 6f 74 5e  
c7 cd 74 e7 45 53 af 92 c3 96 f3 4d 10 85 b2 11  
4f cc 19 b0 a6 11 f5 ac 5a 2b 2b 96 44 3d 35 b4  
3a ad 66 32 d6 b5 66 4a 55 2f aa df a2 2d d9 0e  
e3 90 90 dd 0b 09 5a 3a 27 24 98 ff 27 2b 45 0e  
f4 22 42 1c f2 4a 2d 00 98 b5 ea 88 87 a9 fe 8d  
58 8a 4e 64 85 82 13 d1 13 43 66 b4 91 85 20 8d  
b7 e2 a5 20 17 02 78 f7 19 a0 b4 74 a2 80 ec 5f  
8d 47 7c 23 7f df 35 df d4 ad c8 ac 9a e5 df 6e  
e0 5c 81 ce 6a 6c 75 b1 07 09 b7 f0 97 73 82 56  
93 e6 fe 5d b1 8e 85 08 f3 df 53 50 4d 3c 12 71

```

45 50 45 47 c1 64 f0 09 38 26 3d 56 e6 ed de 71
17 28 3b 51 08 c0 e9 d1 13 ae 7c ff 82 73 0b ee
ae 8d 3d a1 e2 47 a4 0c 66 67 83 61 6e 1a 49 7f
d6 9d d0 21 70 fc 99 f5 f0 0c 0f 1a 5e b6 94 ac
4a 7d f6 f1 89 dd 49 2d f9 0f 1c 21 ae 8c 5c c3
0c 38 3e 24 9d 32 9f 4a 0c a6 83 93 f1 e5 1c 4e
c3 a2 5d 77 95 51 60 7b e5 09 eb 4c b7 5b 1b 7f
09 89 e0 63 5c 36 1f 42 9b 18 66 39 28 18 ad ec
c7 56 d8 95 4f e8 b8 02 8f 0a 57 6b 7e d1 1c 61
e2 b8 40 54 12 d0 01 be f6 e4 e4 01 09 86 56 48
12 a5 85 62 d9 34 00 8e c5 b3 77 e2 e7 08 5e 9d
61 d8 dc b1 4c 3c 21 75 31 5d 75 ce 5d 15 27 fe
7f 85 21 10 d3 41 07 74 0b 35 af 1a 45 9c db 4e
a1 f4 f4 c0 28 d9 d4 54 ad ef e2 d6 1e 94 10 f8
3e ed ae ef 6d e9 d1 19 b5 2b ed d2 54 b8 b0 47
5b 8b c7 e6 2c 82 ed 7d d6 f4 f8 59 60 7c 15 12
fd 68 41 fe 46 77 f8 96 99 45 dd ed 47 68 4d 6d
e8 51 cc da 66 a0 56 4d e9 74 af f8 06 ff 92 7e
6d 12 ba 21 3c 86 04 cf a0 c0 bd 18 86 c2 11 bc
13 81 a2 54 60 a8 21 fd 50 b2 19 5c 8c 5a ee 00
fe 11 b8 71 ea 15 c3 15 28 1c 41 d5 a7 27 22 c2
42 e7 5f 1b aa ec f9 09 04 00 0d 0d 63 8b 84 aa
a0 d2 e7 f5 1b b6 d8 5f f7 5c 53 f0 9a 41 f2 27
96 33 c4 93 d9 11 5c 5b 1a a4 d4 f8 2c c0 fc 79
99 ad 8b cd 34 fb 7e e6 60 40 11 80 30 b2 0d 23
36 df d8 b5 0c d2 76 1a 1f 4d 7b d9 32 3e 97 09
f7 5f b1 6c 3c 6b 78 17 c0 4e 63 66 a7 8b 46 85
38 bd fa d1 e2 e9 3d c8 33 33 94 08 b2 c2 8b c8
ab 89 1f 78 d8 7c f7 0b 61 f2 f2 6c 81 38 72 f5
9d d3 32 43 7b 15 68 e3 d8 eb be 73 d1 1d 35 16
a1 17 dc 02 65 da 91 62 2a 9f 82 6d 75 f7 ab 0c
83 63 e2 7f d9 25 9b 44 9e 35 fd 0e 1a 1e b1 c7
e4 46 a6 03 2a 11 ba d1 2a aa 34 6b ee d1 ae 3b
c4 bc cb f9 35 03 e0 e6 03 55 1f bf b0 c0 b4 7d
99 ad 7d 5b 65 63 a7 9c a4 61 8b 5d 11 bf 40 43
bb 83 4d d8 fa ec 25 60 e2 a2 3c b0 6e 23 92 4b
ff 47 83 7f 06 4d 27 67 d8 50 80 07 69 ae e3 d0
7b 9e 18 7a 1f 46 52 b5 4e 6a bc 34 f7 91 60 ee
5b f9 2c a7 ce 8f 90 d0 e5 6f d1 44 f0 2f 98 d3
26 79 80 7a 7c 76 bf 86 25 e6 d1 c6 0a 24 7b 61
63 ff 6a f3 f5 d5 8b ce 4f c5 2c d6 0c

```

**DECRYPT TEXT: 1500 Byte**

d7 ba 2e 39 80 20 24 5d 54 ef e9 a0 d7 d2 7f 56  
65 a9 9c 43 27 13 1c a6 5e 4a 55 18 6e f0 96 44  
a9 c4 7d 29 e3 a1 85 36 8f 6e d5 65 3f 54 bb a4  
fd 57 e6 23 6a 02 c9 c7 4c 1e de b9 0d 73 fd b6  
36 7a de 19 1a 63 4e a9 d0 22 0e 0e 76 c8 b2 72  
1f 97 95 88 99 5d 4e e4 7b 2c 9d 87 9f 99 3c d5  
12 1a ed 2c 7c 3a d4 4b 5c e1 59 d1 a9 0a 42 c8  
a1 d7 4f 39 33 9d 1d ad c9 b9 34 67 51 70 3c 63  
89 28 8f 04 62 62 4f bd 43 a7 8e ec b0 d0 b3 50  
a6 02 89 d9 9f a5 85 67 5d b9 ce ae 28 09 11 b0  
31 9f b4 92 01 02 4f 43 a8 dc 2f 58 ab e2 a8 51  
e3 30 29 81 d5 ad e8 31 65 b5 df 8d be ef 3c ee  
8e ef 7f 8e f1 cd d1 99 a9 ff f0 54 e0 97 a4 c3  
c7 cc 44 9b 79 2b cc de e0 ab 6a 9d 99 a6 8a 26  
95 09 b4 85 d6 84 1d 7e 83 0d d1 63 a4 74 25 6a  
40 69 05 b8 93 d1 96 73 7b ff 10 14 a5 99 39 39  
a2 ed bd 77 71 da f4 f3 e7 c5 56 8a 39 7b f4 78  
e3 f8 30 76 c8 c5 e8 42 c3 f7 55 68 90 8e a0 31  
7b 5d a8 eb 36 9c de 1d 60 33 a6 98 ae 99 10 90  
91 3f 05 59 03 ed 9a c6 e4 ef 2d 73 7d cc a4 f8  
28 4b e2 5e e7 c0 7a 46 f3 20 de a0 b8 ed 30 49  
2b 34 a1 2e 21 3b f3 04 2a 1f 77 a7 eb 1a 9e 13  
65 80 70 4c 3f ea 91 31 09 6f d1 c1 5c 00 0a 87  
34 aa b4 54 e4 a6 58 0d c5 ce b3 af e8 51 c1 4d  
d0 31 98 0e 1a 29 3f 23 97 0f e4 f3 0f ed 79 42  
97 2c 96 7a d1 ee 87 96 bb 3a 44 a3 8a 05 ef 59  
35 86 67 4f af a6 72 45 b5 56 37 c3 43 af 05 d9  
db 9a 53 ab 87 da 41 42 13 84 e4 9d 88 d3 f6 bd  
59 5d 0c 07 02 7d 4b b6 d2 82 78 15 31 7c ed 0c  
16 3f b7 9d 18 f7 df 2b 7a c2 c8 02 95 bd bf ed  
19 ca f3 1a 47 3e d0 19 c0 47 2d f1 c3 19 fc d9  
58 b2 75 70 a8 53 9a 22 15 61 24 a9 1e e2 96 36  
ac 88 50 f2 c5 20 0a 84 67 37 74 2a 4f 70 02 a7  
21 77 16 c8 ca b0 ea df 11 0d 87 2e ee 1d 64 99  
a4 b4 8b 69 d3 94 ec 39 cb 60 62 19 cf 64 c0 f0  
da d5 b7 a3 85 a0 81 95 ac 08 c2 9a 24 25 33 c8  
d9 bd 30 ab 51 1c e4 1b 7b 46 34 4a a9 f3 39 82  
c8 f0 25 4c 90 a5 e0 3c ad a2 d6 d1 c6 08 98 9f  
c4 c7 49 14 e2 2d 2e 5d 72 61 a6 1a 54 df 9c 1b  
cf c0 67 5e 65 46 9a 12 e7 6f e2 ad 76 79 4b 3a  
3f 94 4e 21 c0 7b 7d 32 dc 23 4c 30 01 e7 4a d0  
a7 b1 2d 0c f6 c7 1d dd 36 ff 8a ab 78 d5 e5 b7  
68 32 d7 28 ad 53 59 89 76 a4 b8 76 8b 02 45 32  
b2 72 3d a8 39 5a 84 6e 58 0d 19 d0 e2 fd 86 49  
2f 5c 71 db af ca 63 24 6e 1b 9a f8 1c df 29 ce  
51 66 75 89 bf f9 f6 17 06 0e e6 e7 0b 6c 30 39  
c8 a0 13 77 69 76 9b d6 91 34 ce ad 13 f7 7a 63  
5c ef eb 1b e7 e1 32 ec ee 17 d3 f8 83 02 31 4a  
a1 44 c0 0a b9 5a e0 49 8e ad f6 a0 a4 6f 03 ff  
5e ed 1a 44 ce 4b 30 bb 62 02 b3 e4 03 e3 2e a4  
26 ed ad df 47 8d 28 d5 3a 1d 74 dd 8c 77 dc e9  
63 f5 2d 31 40 5d eb a1 5e 9e 85 61 81 b2 05 a7  
9f b2 86 e6 3e ad ba 77 ca 2e 54 56 a4 2f 3f 07

24 6b 37 63 c8 22 04 26 bf 88 87 40 3a 8b e6 d9  
 3d 6b be 7b 18 77 f1 e2 a4 45 37 48 73 76 4e 97  
 e1 84 f9 a8 a5 fd cd 64 84 53 a3 be de 89 96 1a  
 f4 53 94 0c ca 85 ed 6e c9 24 b5 3c 99 03 d2 7a  
 86 cb 21 2b c7 ed 8f 4b 40 32 09 1d bb 9e 37 ae  
 f1 ca b9 bb 4f a6 28 18 c9 dd 53 62 df 25 db 64  
 ef fc 8f b6 e9 1e 01 28 4f 09 45 09 a6 7b b7 97  
 45 70 51 93 15 78 aa de 54 fd 40 32 21 1a 96 10  
 16 25 c5 fe 42 c5 25 91 cd 6a 9a 73 e4 50 0a 29  
 c0 5a bc d4 d2 65 b2 26 62 f1 58 82 0b ed 92 20  
 12 57 1d 53 1c 42 e4 e9 ac 7d 5b 90 cd 65 b8 8d  
 be 73 60 8f d8 12 b5 39 02 0c bb 0c f9 4c 2c 0a  
 a3 49 5d be 8a 40 a6 35 bd 01 c4 8a 65 7c 16 23  
 ee 76 b2 c5 87 66 fe 89 71 b8 95 69 04 c0 72 a6  
 08 cf 64 92 0f 09 c7 cb 0a 8b 55 6e 06 6a 91 f3  
 e0 42 b8 67 a7 b5 ef 17 6d 84 80 71 44 f2 17 4b  
 c0 7a dd ce 83 a3 99 8c 2d ee fa 33 58 8a 25 37  
 cb dd 9d 72 92 8c 89 ff 10 08 6f 53 fa 85 9d b9  
 ff 7a 87 81 1c 20 0c 49 0d 06 7b 64 8f a0 9b 5a  
 7d 38 cc 0e c4 54 0d d3 5c 7b 25 55 00 c2 0e ff  
 3b 95 7f 57 b4 8b a0 c1 90 1b 25 1f ba c0 79 37  
 f7 44 45 ba 98 51 8d f3 cc b1 47 cc 73 54 ca ae  
 e9 48 05 9c d2 a4 5d 62 be 82 81 78 41 f9 ae 38  
 3d f2 f1 d4 43 7e c6 0e 2e 0d d9 a1 61 a2 4e 49  
 e9 52 e5 bb f5 42 1c b3 c3 9c 2b 04 95 d9 3b d1  
 ca 2b a5 0c a8 6a 1a d6 77 f2 76 d7 93 c4 20 7c  
 15 04 37 0a 45 53 bd 08 ef e7 0b 83 bf 45 54 89  
 70 f8 95 18 62 ae ee d9 a0 64 b0 33 27 cf af 3c  
 d3 e5 45 18 37 01 1f 26 e8 29 a9 a6 6e fc 2f dd  
 f4 c3 f5 56 71 e2 2e 10 45 dd 42 6b ac f0 a6 7e  
 d5 eb 95 0c ec b4 31 d3 dd da 79 4a d6 a7 27 c9  
 69 1b 1f da fd 4c e9 41 29 2b ac d4 1a 52 52 ef  
 3d e6 fa 28 99 2b fb 75 04 73 bf d9 19 e5 a2 82  
 00 c0 5c fc 0c 44 3d 35 6e e8 08 88 3a 59 76 76  
 3f 70 9d d8 9b 97 4c 9e 09 0a 77 22 ef 18 a4 ee  
 d8 ff e9 e3 43 25 17 b1 0d 1f 38 46 78 ae bb b7  
 1e 57 8e b8 ee d9 56 f7 e3 cc 19 d1 e4 bd bf bb  
 bc a8 9e fe cc b5 ae d9 d3 e6 1e 4b 93 d9 01 b0  
 30 8e 68 1d 67 bd 14 49 88 2c 1a 6b e8 d8 25 a4  
 7f c3 a1 4b 77 4f 24 4a 34 42 94 c6 1a 95 76 4a  
 23 de 67 89 9a 7a d2 22 a6 ec 8c 8e

#### F.1.1.1.4 Test Program

```

/*****
/* 802.16e MBS (Multimedia Broadcast Service) AES-CTR mode example */
/* program for KAT (Known Answer Test). KAT help implementors to */
/* verify AES algorithm and CTR mode correctly for MBS defined */
/* in PKMv2 */
/* Version Number: 0.2 */
/* Name: JunHyuk Song, Jicheol Lee */
*****/

#include <stdlib.h>
#include <stdio.h>

#define MAX_BUF1000

/*****
*** AES 16X16 SBOX Table ***
*****/

unsigned char sbox_table[256] =
{
    0x63, 0x7c, 0x77, 0x7b, 0xf2, 0x6b, 0x6f, 0xc5,
    0x30, 0x01, 0x67, 0x2b, 0xfe, 0xd7, 0xab, 0x76,
    0xca, 0x82, 0xc9, 0x7d, 0xfa, 0x59, 0x47, 0xf0,
    0xad, 0xd4, 0xa2, 0xaf, 0x9c, 0xa4, 0x72, 0xc0,
    0xb7, 0xfd, 0x93, 0x26, 0x36, 0x3f, 0xf7, 0xcc,
    0x34, 0xa5, 0xe5, 0xf1, 0x71, 0xd8, 0x31, 0x15,
    0x04, 0xc7, 0x23, 0xc3, 0x18, 0x96, 0x05, 0x9a,
    0x07, 0x12, 0x80, 0xe2, 0xeb, 0x27, 0xb2, 0x75,
    0x09, 0x83, 0x2c, 0x1a, 0x1b, 0x6e, 0x5a, 0xa0,
    0x52, 0x3b, 0xd6, 0xb3, 0x29, 0xe3, 0x2f, 0x84,
    0x53, 0xd1, 0x00, 0xed, 0x20, 0xfc, 0xb1, 0x5b,
    0x6a, 0xcb, 0xbe, 0x39, 0x4a, 0x4c, 0x58, 0xcf,
    0xd0, 0xef, 0xaa, 0xfb, 0x43, 0x4d, 0x33, 0x85,
    0x45, 0xf9, 0x02, 0x7f, 0x50, 0x3c, 0x9f, 0xa8,
    0x51, 0xa3, 0x40, 0x8f, 0x92, 0x9d, 0x38, 0xf5,
    0xbc, 0xb6, 0xda, 0x21, 0x10, 0xff, 0xf3, 0xd2,
    0xcd, 0x0c, 0x13, 0xec, 0x5f, 0x97, 0x44, 0x17,
    0xc4, 0xa7, 0x7e, 0x3d, 0x64, 0x5d, 0x19, 0x73,
    0x60, 0x81, 0x4f, 0xdc, 0x22, 0x2a, 0x90, 0x88,
    0x46, 0xee, 0xb8, 0x14, 0xde, 0x5e, 0x0b, 0xdb,
    0xe0, 0x32, 0x3a, 0x0a, 0x49, 0x06, 0x24, 0x5c,
    0xc2, 0xd3, 0xac, 0x62, 0x91, 0x95, 0xe4, 0x79,
    0xe7, 0xc8, 0x37, 0x6d, 0x8d, 0xd5, 0x4e, 0xa9,
    0x6c, 0x56, 0xf4, 0xea, 0x65, 0x7a, 0xae, 0x08,
    0xba, 0x78, 0x25, 0x2e, 0x1c, 0xa6, 0xb4, 0xc6,
    0xe8, 0xdd, 0x74, 0x1f, 0x4b, 0xbd, 0x8b, 0x8a,
    0x70, 0x3e, 0xb5, 0x66, 0x48, 0x03, 0xf6, 0x0e,
    0x61, 0x35, 0x57, 0xb9, 0x86, 0xc1, 0x1d, 0x9e,
    0xe1, 0xf8, 0x98, 0x11, 0x69, 0xd9, 0x8e, 0x94,
    0x9b, 0x1e, 0x87, 0xe9, 0xce, 0x55, 0x28, 0xdf,
    0x8c, 0xa1, 0x89, 0x0d, 0xbf, 0xe6, 0x42, 0x68,
    0x41, 0x99, 0x2d, 0x0f, 0xb0, 0x54, 0xbb, 0x16
};

/*****
*** Function Prototypes ***
*****/

void bitwise_xor(unsigned char *ina, unsigned char *inb, unsigned char *out);
void print_hex(unsigned char *buf, int len);

/*****
*** AES algorithm operation functions ***
*****/

void xor_128(unsigned char *a, unsigned char *b, unsigned char *out);
void xor_32(unsigned char *a, unsigned char *b, unsigned char *out);

unsigned char sbox(unsigned char a);
void next_key(unsigned char *key, int round);
void byte_sub(unsigned char *in, unsigned char *out);
void shift_row(unsigned char *in, unsigned char *out);
void mix_column(unsigned char *in, unsigned char *out);
void add_round_key(unsigned char *shiftrow_in,
                  unsigned char *mcol_in,
                  unsigned char *block_in,
                  int round,
                  unsigned char *out);
void aes128k128d(unsigned char *key, unsigned char *data, unsigned char *ciphertext);

```



```

/*****
/* This function is to generate 32bit nonce */
/* based on GCC rand() */
*****/

unsigned long random_32bit(void)
{
    return (unsigned long) rand();
}
/*****
/* This function is to generate random plain text */
*****/

unsigned char random_8bit(void)
{
    unsigned char ret;

    ret = (unsigned char) 1 + (int) (256.0*rand()/(RAND_MAX+1.0));
    return ret;
}

void generate_plain(unsigned char *plain, int len)
{
    int i;

    for ( i=0; i<len; i++ ) {
        plain[i] = random_8bit();
    }
}

/*****
/* AES Encryption functions are defined here. */
/* Performs a 128 bit AES encryption with 128 bit key and data blocks based */
/* based on NIST Special Publication 800-38A, FIPS 197 */
*****/

/*****
/* 128 bits XOR function */
*****/

void xor_128(unsigned char *a, unsigned char *b, unsigned char *out)
{
    int i;
    for (i=0;i<16; i++)
    {
        out[i] = a[i] ^ b[i];
    }
}

/*****
/* 32 bits XOR function */
*****/

void xor_32(unsigned char *a, unsigned char *b, unsigned char *out)
{
    int i;
    for (i=0;i<4; i++)
    {
        out[i] = a[i] ^ b[i];
    }
}

/*****
/* AES SBOX Table Setup */
*****/

unsigned char sbox(unsigned char a)
{
    return sbox_table[(int)a];
}

/*****
/* AES next_key operation */
*****/

```

```

/*****/

void next_key(unsigned char *key, int round)
{
    unsigned char rcon;
    unsigned char sbox_key[4];
    unsigned char rcon_table[12] =
    {
        0x01, 0x02, 0x04, 0x08, 0x10, 0x20, 0x40, 0x80,
        0x1b, 0x36, 0x36, 0x36
    };

    sbox_key[0] = sbox(key[13]);
    sbox_key[1] = sbox(key[14]);
    sbox_key[2] = sbox(key[15]);
    sbox_key[3] = sbox(key[12]);

    rcon = rcon_table[round];

    xor_32(&key[0], sbox_key, &key[0]);
    key[0] = key[0] ^ rcon;

    xor_32(&key[4], &key[0], &key[4]);
    xor_32(&key[8], &key[4], &key[8]);
    xor_32(&key[12], &key[8], &key[12]);
}

/*****/
/* AES Byte Substitution *****/
/*****/

void byte_sub(unsigned char *in, unsigned char *out)
{
    int i;
    for (i=0; i< 16; i++)
    {
        out[i] = sbox(in[i]);
    }
}

/*****/
/* AES Shift Row Operation *****/
/*****/

void shift_row(unsigned char *in, unsigned char *out)
{
    out[0] = in[0];
    out[1] = in[5];
    out[2] = in[10];
    out[3] = in[15];
    out[4] = in[4];
    out[5] = in[9];
    out[6] = in[14];
    out[7] = in[3];
    out[8] = in[8];
    out[9] = in[13];
    out[10] = in[2];
    out[11] = in[7];
    out[12] = in[12];
    out[13] = in[1];
    out[14] = in[6];
    out[15] = in[11];
}

/*****/
/* AES mix_column operation *****/
/*****/

void mix_column(unsigned char *in, unsigned char *out)
{
    int i;
    unsigned char addlb[4];
    unsigned char addbf7[4];
    unsigned char rotl[4];
    unsigned char swap_halves[4];
    unsigned char andf7[4];
    unsigned char rotr[4];

```

```

unsigned char temp[4];
unsigned char tempb[4];

for (i=0 ; i<4; i++)
{
    if ((in[i] & 0x80)== 0x80)
        add1b[i] = 0x1b;
    else
        add1b[i] = 0x00;
}

swap_halfs[0] = in[2];    /* Swap halves */
swap_halfs[1] = in[3];
swap_halfs[2] = in[0];
swap_halfs[3] = in[1];

rotl[0] = in[3];        /* Rotate left 8 bits */
rotl[1] = in[0];
rotl[2] = in[1];
rotl[3] = in[2];

andf7[0] = in[0] & 0x7f;
andf7[1] = in[1] & 0x7f;
andf7[2] = in[2] & 0x7f;
andf7[3] = in[3] & 0x7f;

for (i = 3; i>0; i--)    /* logical shift left 1 bit */
{
    andf7[i] = andf7[i] << 1;
    if ((andf7[i-1] & 0x80) == 0x80)
    {
        andf7[i] = (andf7[i] | 0x01);
    }
}
andf7[0] = andf7[0] << 1;
andf7[0] = andf7[0] & 0xfe;

xor_32(add1b, andf7, add1bf7);

xor_32(in, add1bf7, rotr);

temp[0] = rotr[0];      /* Rotate right 8 bits */
rotr[0] = rotr[1];
rotr[1] = rotr[2];
rotr[2] = rotr[3];
rotr[3] = temp[0];

xor_32(add1bf7, rotr, temp);
xor_32(swap_halfs, rotr, tempb);
xor_32(temp, tempb, out);
}

/* AES Encryption function that will do multiple round of AddRoundKey, SubBytes,
ShiftRows, and MixColumns operations */

void aes128k128d(unsigned char *key, unsigned char *data, unsigned char *ciphertext)
{
    int round;
    int i;
    unsigned char intermediatea[16];
    unsigned char intermediateb[16];
    unsigned char round_key[16];

    for(i=0; i<16; i++) round_key[i] = key[i];

    for (round = 0; round < 11; round++)
    {
        if (round == 0) /* First AddRound Key Operation */
        {
            xor_128(round_key, data, ciphertext);
            next_key(round_key, round);
        }
        else if (round == 10) /* Final Round operations */
        {
            byte_sub(ciphertext, intermediatea);
            shift_row(intermediatea, intermediateb);
            xor_128(intermediateb, round_key, ciphertext);
        }
        else /* 1 - 9 */
        {
            byte_sub(ciphertext, intermediatea);

```

```

        shift_row(intermediatea, intermediateb);
        mix_column(&intermediateb[0], &intermediatea[0]);
        mix_column(&intermediateb[4], &intermediatea[4]);
        mix_column(&intermediateb[8], &intermediatea[8]);
        mix_column(&intermediateb[12], &intermediatea[12]);
        xor_128(intermediatea, round_key, ciphertext);
        next_key(round_key, round);
    }
}

/*****
/* bitwise_xor()
/* A 128 bit, bitwise exclusive or
*****/

void bitwise_xor(unsigned char *ina, unsigned char *inb, unsigned char *out)
{
    int i;
    for (i=0; i<16; i++)
    {
        out[i] = ina[i] ^ inb[i];
    }
}

/*****
/* It generate 128bit key as
/* 00 00 00 00 00 00 00 00 ff ff ff ff ff ff ff ff
/* for Variable Key Known Answer Test
*****/

void generate_key(unsigned char *key)
{
    int i;

    for (i=0; i<8; i++) {
        key[i] = 0x00;
    }
    for (i=8; i<16; i++) {
        key[i] = 0xff;
    }
}

/*****
/* Initialization of Counter
/* first, construct 32 bit value by concatenate 8bit-rollovercounter
* and 24bit-phy_sync
* seconds, concatenate the above results 4 times
*****/

void init_counter(unsigned char rollcnt, unsigned long phy_sync, unsigned char *ctr)
{
    int i, j;

    for ( i=0; i<4; i++) {
        ctr[i*4+0] = rollcnt;
        ctr[i*4+1] = (phy_sync >> 16 ) & 0xff;
        ctr[i*4+2] = (phy_sync >> 8 ) & 0xff;
        ctr[i*4+3] = phy_sync & 0xff;
    }
}

/*****
/* It increment counter by one upon encryption of each block */
*****/

void add_counter(char *ctr)
{
    int value, i;
    int overflow;

    overflow = 1;
    for ( i=15; i>=0 ; i-- ) {
        if ( overflow == 0 ) break;
        value = ctr[i] & 0xff;
        value ++;
        if ( value >= 256 )
            overflow = 1;
        else overflow = 0;
    }
}

```

```

        ctr[i] = value & 0xff;
    }
}
/* Return Roll over Counter */
unsigned char get_rollcnt(void)
{
    return 0x00;
}
unsigned long get_phy_sync(void)
{
    /* Suppose that phy sync 24bits are all one in this example. */
    return 0x00ffffff;
}

/*****
/* int encrypt_pdu()
/* Encrypts a plaintext pdu in accordance with
/* the proposed 802.16e AES CTR specification.
/* Roll-over-counter takes place.
/* Returns the resulting cipher text
*****/
int encrypt_pdu(unsigned char *key, unsigned char *plain, int len, unsigned char *cipher)
{
    int i, n_blocks, n_remain, out_len = 0;
    unsigned charctr[16], rollcnt;
    unsigned char aes_out[16], remain[16], temp[16];
    unsigned longphy_sync_value;

    rollcnt = get_rollcnt();
    phy_sync_value = get_phy_sync();
#ifdef DEBUG
    printf("Roll-over-counter: 1 Byte\n\n");
    printf("%02x\n\n", rollcnt);
    printf("PHY Synchronization: 3 Byte\n\n");
    printf("%06x\n\n", phy_sync_value);
#endif

    cipher[0] = rollcnt;

    out_len += 1;

    n_blocks = len / 16;
    n_remain = len % 16;

    init_counter(rollcnt, phy_sync_value, ctr);
#ifdef DEBUG
    printf("Counter: 16 Bytes\n\n");
    print_hex(ctr, 16);
    printf("\n");
    printf("Key: 16Bytes\n\n");
    print_hex(key, 16);
    printf("\n");
#endif
    for ( i=0; i<n_blocks; i++ ) {
        aes128k128d(key, ctr, aes_out);
        bitwise_xor(aes_out, &plain[i*16], &cipher[i*16+1]);
        add_counter(ctr);

        out_len += 16;
    }

    for ( i=0; i<16; i++ ) {
        remain[i] = 0;
    }
    for ( i=0; i<n_remain; i++ ) {
        remain[i] = plain[n_blocks*16+i];
    }
    aes128k128d(key, ctr, aes_out);
    bitwise_xor(aes_out, &remain[0], &temp[0]);

    for ( i=0; i<n_remain; i++ ) {
        cipher[n_blocks*16+1+i] = temp[i];
    }
    out_len += n_remain;
    return out_len;
}
/*****
/* int decrypt_pdu()
/* decrypts a cipher pdu in accordance with
/* the proposed 802.16e AES CTR specification.
/* Decode roll-over-counter field
*****/

```

```

/* Returns the resulting decrypted text */
/******/

int decrypt_pdu(unsigned char *key, unsigned char *cipher, int len, unsigned char *plain)
{
    int i, n_blocks, n_remain, out_len = 0;
    unsigned charctr[16], rollcnt;
    unsigned char aes_out[16], remain[16], temp[16];
    unsigned longphy_sync_value;

    phy_sync_value = get_phy_sync();
    rollcnt = cipher[0];

    len -= 1;

    n_blocks = len / 16;
    n_remain = len % 16;

    init_counter(rollcnt, phy_sync_value, ctr);
    for ( i=0; i<n_blocks; i++ ) {
        aes128k128d(key, ctr, aes_out);
        bitwise_xor(aes_out, &cipher[i*16+1], &plain[i*16]);
        add_counter(ctr);
        out_len += 16;
    }

    for ( i=0; i<16; i++ ) {
        remain[i] = 0;
    }
    for ( i=0; i<n_remain; i++ ) {
        remain[i] = cipher[n_blocks*16+1+i];
    }
    aes128k128d(key, ctr, aes_out);
    bitwise_xor(aes_out, &remain[0], &temp[0]);

    for ( i=0; i<n_remain; i++ ) {
        plain[n_blocks*16+i] = temp[i];
    }
    out_len += n_remain;
    return out_len;
}

/* HEX value print out function */
void print_hex(unsigned char *buf, int len)
{
    int i;

    for ( i=0; i<len; i++ ) {
        printf("%02x ", buf[i]);
        if ( ( i % 16 ) == 15 ) printf("\n");
    }
    if ( ( i % 16 ) != 0 ) printf("\n");
}

int compare(unsigned char *x, unsigned char *y, int len)
{
    int i;

    for ( i=0; i<len; i++ ) {
        if ( x[i] == y[i] ) continue;
        return (x[i] - y[i]);
    }
    return 0;
}

int test_case(int length)
{
    unsigned charkey[16];
    unsigned charplain[MAX_BUF];
    unsigned charcipher[MAX_BUF+4];
    unsigned chardecrypt[MAX_BUF];

    /* 0. Get a 128bits key */
    generate_key(key);

    /* 1. Generate Plain Text with length */
    generate_plain(plain, length);

#ifdef DEBUG

```

```

        printf("PLAIN TEXT: %d Bytes\n\n",length);
        print_hex(plain,length);
        printf("\n\n");
    #endif

    /* 2. Encrypt Plain Text to Cipher Text */

    encrypt_pdu(key,plain,length,cipher);

    #ifdef DEBUG
        printf("CIPHER TEXT: %d Byte + 1 Byte(Roll-over-counter)\n\n",length);
        print_hex(cipher,length+1);
        printf("\n\n");
    #endif

    /* 3. Decrypt Cipher Text to decrypt text */

    decrypt_pdu(key,cipher,length+1,decrypt);

    #ifdef DEBUG
        printf("DECRYPT TEXT: %d Byte\n\n",length);
        print_hex(decrypt,length);
        printf("\n\n");
    #endif

    /* 4. Compare decrypt text and original plain text */

    if ( compare(decrypt,plain,length) == 0 ) {
        return 1; /* Test Success */
    } else {
        return 0; /* Test Failure */
    }
}

/*****/
/* AES CTR main() */
/* Test vectors */
/*****/

int main()
{
    int i, len[] = { 64, 256, 1500 };

    for ( i=0; i<sizeof(len)/sizeof(len[0]); i++ ) {
        printf("Test %d\n\n",i+1);
        if ( !test_case(len[i]) ) {
            printf(" ==> Failure\n");
        }
    }
    return 0;
}

```

## F.2 Test vectors for CRC16 CCITT X.25

```
unsigned char crc16vector1[] = {
0x01, 0x02, 0x03, 0x04, 0x05, 0x06, 0x07, 0x08, 0x09, 0x0a,
/*CRC*/
0xd3,0x8d};/* last two bytes are CRC in big endian format */

unsigned char crc16vector2[] = {
0x01, 0x02, 0x03, 0x04, 0x05, 0x06, 0x07, 0x08, 0x09, 0x0a,
0x0b, 0x0c, 0x0d, 0x0e, 0x0f, 0x10, 0x11, 0x12, 0x13, 0x14,
/*CRC*/
0xe3, 0x94};/* last two bytes are CRC in big endian format */

unsigned char crc16[] = {
0xC0, 0xFC, 0xDA, 0x37}; /* last two bytes are CRC in big endian format */

unsigned char crc16A[] = {
0x80, 0xCE, 0xC1, 0xEA}; /* last two bytes are CRC in big endian format */

unsigned char crc16B[] = {
0x80, 0xFC, 0xD7, 0xFB}; /* last two bytes are CRC in big endian format */

unsigned char crc16C[] = {
0xC0, 0xCE, 0xCC, 0x26}; /* last two bytes are CRC in big endian format */
```



*Insert the following annex:*

## Annex G

(informative)

### Network model for mobile communications

#### G.1 Network reference model

##### G.1.1 Entities

The network reference model includes groups of BS units providing network service (not necessarily contiguous) to authorized MS in a geographic region. A group of BS units that share administrative affiliation, and are connected by a backbone (wired or unwired) are referred to as a provider network. Multiple provider networks of varying design, performance, and ownership/administration may coexist in the same region.

Provider networks may employ specialized servers for AAA (Authorization, Authentication and Accounting), management, provisioning, and other functions. These servers responsible are collectively termed Authentication and Service Authorization Servers (ASA-servers) in this specification. A provider may deploy single or multiple ASA-servers, and may do so in a centralized or distributed manner.

The mobility related entities are described in Table G.1.

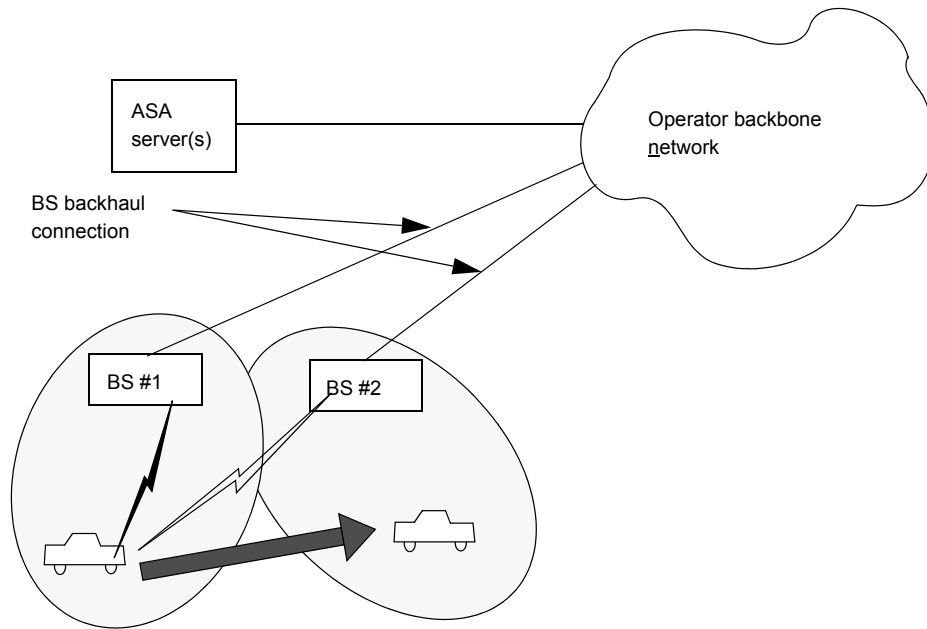
Operations between BSs and ASA servers are not specified.

**Table G.1—Mobility related entities**

Entity	Description
MS	Mobile Station, contains MAC (CS), and PHY layers
BS	Base Station: as defined in 3.5
ASA Server(s)	Authentication and Service Authorization Server servicing the whole operator's network. These servers are optional, and may be implemented as a distributed entity.

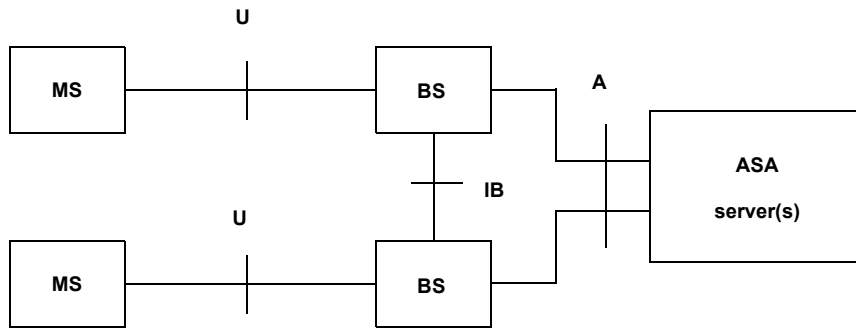
Depending on a provider network's configuration and administrative policies, an MS may perform a handover from one BS to another. A provider network's scheme for managing handovers might be localized in the relevant BSs, or it might be distributed and/or involve ASA servers.

Figure G.1 shows an example where two BS are connected to an operator backbone. BS #1 is the serving BS for an MS. BS #2 is the neighbor BS. If the MS moves closer to BS #2, as depicted by the shaded arrow, BS #2 might become a target BS for a handover.



**Figure G.1—Network model example**

Figure G.2 shows the network reference model in the control plane.



**Figure G.2—Logical network reference model, control plane**

The following reference points (Table G.2) are present at the control plane network model

**Table G.2—Reference points at the control plane**

Reference point	Elements to be specified by IEEE 802.16e	Comments
U	PHY, MAC (including CS) operations, including message exchanges for mobility support	—
IB	BS-to-BS messages	Transport protocol is not specified
A	Messages serving MS authentication and service authorization functions	Transport protocol is not specified

Authorized licensed use limited to: Fish & Richardson. Downloaded on April 11,2016 at 21:40:33 UTC from IEEE Xplore. Restrictions apply.

*Insert the following annex:*

## Annex H

(informative)

### LDPC direct encoding

The LDPC code is flexible in that it can accommodate various code rates as well as packet sizes.

The encoding of a packet at the transmitter generates parity-check bits  $\mathbf{p}=(p_0, \dots, p_{m-1})$  based on an information block  $\mathbf{s}=(s_0, \dots, s_{k-1})$ , and transmits the parity-check bits along with the information block. Because the current symbol set to be encoded and transmitted is contained in the transmitted codeword, the information block is also known as systematic bits. The encoder receives the information block  $\mathbf{s}=(s_0, \dots, s_{k-1})$  and uses the matrix  $\mathbf{H}_{\text{bm}}$  to determine the parity-check bits. The expanded matrix  $\mathbf{H}$  is determined from the model matrix  $\mathbf{H}_{\text{bm}}$ . Since the expanded matrix  $\mathbf{H}$  is a binary matrix, encoding of a packet can be performed with vector or matrix operations conducted over GF(2).

One method of encoding is to determine a generator matrix  $\mathbf{G}$  from  $\mathbf{H}$  such that  $\mathbf{G} \mathbf{H}^T = \mathbf{0}$ . A  $k$ -bit information block  $\mathbf{s}_{1 \times k}$  can be encoded by the code generator matrix  $\mathbf{G}_{k \times n}$  via the operation  $\mathbf{x} = \mathbf{s} \mathbf{G}$  to become an  $n$ -bit codeword  $\mathbf{x}_{1 \times n}$ , with codeword  $\mathbf{x}=[\mathbf{s} \ \mathbf{p}]=[s_0, s_1, \dots, s_{k-1}, p_0, p_1, \dots, p_{m-1}]$ , where  $p_0, \dots, p_{m-1}$  are the parity-check bits; and  $s_0, \dots, s_{k-1}$  are the systematic bits.

Encoding an LDPC code from  $\mathbf{G}$  can be quite complex. The LDPC codes are defined such that very low complexity encoding directly from  $\mathbf{H}$  is possible.

The following informative subsection shows two such methods.

#### H.1 Method 1a

Encoding is the process of determining the parity sequence  $\mathbf{p}$  given an information sequence  $\mathbf{s}$ . To encode, the information block  $\mathbf{s}$  is divided into  $k_b = n_b - m_b$  groups of  $z$  bits. Let this grouped  $\mathbf{s}$  be denoted  $\mathbf{u}$ ,

$$\mathbf{u} = [u(0) \ u(1) \ \dots \ u(k_b - 1)],$$

where each element of  $\mathbf{u}$  is a column vector as follows

$$u(i) = [S_{iz} \ S_{iz+1} \ \dots \ S_{(i+1)z-1}]^T$$

Using the model matrix  $\mathbf{H}_{\text{bm}}$ , the parity sequence  $\mathbf{p}$  is determined in groups of  $z$ . Let the grouped parity sequence  $\mathbf{p}$  be denoted  $\mathbf{v}$ ,

$$\mathbf{v} = [v(0) \ v(1) \ \dots \ v(m_b - 1)],$$

where each element of  $\mathbf{v}$  is a column vector as follows

$$\mathbf{v}(i) = \left[ p_{iz} \ p_{iz+1} \ \cdots \ p_{(i+1)z-1} \right]^T$$

Encoding proceeds in two steps, (1) initialization, which determines  $\mathbf{v}(0)$ , and (b) recursion, which determines  $\mathbf{v}(i+1)$  from  $\mathbf{v}(i)$ ,  $0 \leq i \leq m_b - 2$ .

An expression for  $\mathbf{v}(0)$  can be derived by summing over the rows of  $\mathbf{H}_{bm}$  to obtain

$$P_{p(x, k_b)} \mathbf{v}(0) = \sum_{j=0}^{k_b-1} \sum_{i=0}^{m_b-1} P_{p(i, j)} u(j) \quad (\text{H.1})$$

where  $x$ ,  $1 \leq x \leq m_b - 2$ , is the row index of  $\mathbf{h}_{bm}$  where the entry is nonnegative and unpaired, and  $\mathbf{P}_i$  represents the  $zxz$  identity matrix circularly right shifted by size  $i$ .

Equation (H.2) is solved for  $\mathbf{v}(0)$  by multiplying by  $P_{p(x, k_b)}^{-1}$ , and  $P_{p(x, k_b)}^{-1} = P_{z-p(x, k_b)}$  since  $p(x, k_b)$  represents a circular shift.

Considering the structure of  $\mathbf{H}'_{b2}$ , the recursion can be derived as follows,

$$\mathbf{v}(1) = \sum_{j=0}^{k_b-1} P_{p(i, j)} u(j) + P_{p(i, k_b)} \mathbf{v}(0), \quad i = 0, \quad (\text{H.2})$$

$$\mathbf{v}(i+1) = \mathbf{v}(i) + \sum_{j=0}^{k_b-1} P_{p(i, j)} u(j) + P_{p(i, k_b)} \mathbf{v}(0), \quad i = 1, \dots, m_b - 2 \quad (\text{H.3})$$

where

$$P_{-1} \equiv \mathbf{0}_{z \times z}$$

Thus all parity bits not in  $\mathbf{v}(0)$  are determined by evaluation Equation (H.3) for  $0 \leq i \leq m_b - 2$ . Equation (H.1), Equation (H.2), and Equation (H.3) completely describe the encoding algorithm. These equations also have a straightforward interpretation in terms of standard digital logic architectures. Since the non-zero elements  $p(i, j)$  of  $\mathbf{H}_{bm}$  represent circular shift sizes of a vector, all products of the form  $\mathbf{P}_{p(i, j)} \mathbf{u}(j)$  can be implemented by a size- $z$  barrel shifter.

## H.2 Method 1b

Equivalently, Method 1 can be implemented in a parallel fashion where almost all parity check parity bits are generated simultaneously. The initialization and the recursion steps of Method 1 become

- 1) Initialization. The parity check bit vector  $\mathbf{v}(0)$  are computed by

$$P_{p(x, k_b)} \mathbf{v}(0) = \sum_{j=0}^{k_b-1} \left( \sum_{q=0}^{m_b-1} P_{p(q, j)} \right) u(j) \quad (\text{H.4})$$

- 2) Parallel computation. The parity check bit vectors  $\mathbf{v}(1) \sim \mathbf{v}(m_b - 1)$  are concurrently computed by

$$v(i) = \sum_{j=0}^{k_b-1} \left( \sum_{q=i}^{m_b-1} P_{p(q,j)} \right) u(j) + \sum_{q=i}^{m_b-1} P_{p(q,k_b)} v(0) \quad i = 1, \dots, m_b - 1 \quad (\text{H.5})$$

The parallel encoding method may significantly reduced the latency at the expense of extra storage for the sum:

$$\left( \sum_{q=i}^{m_b-1} P_{p(q,j)} \right)$$

### H.3 Method 2

For efficient encoding of LDPC, **H** are divided into the form

$$H = \begin{bmatrix} A & B & T \\ C & D & E \end{bmatrix} \quad (\text{H.6})$$

where *A* is  $(m-z) \times k\alpha$ , *B* is  $(m-z) \times z$ , *T* is  $(m-z) \times (m-z)$ , *C* is  $z \times k$ , *D* is  $z \times z$ , and finally *E* is  $z \times (m-z)$ .  $\begin{pmatrix} B \\ D \end{pmatrix}$  and **D** correspond to the expanded  $\mathbf{h}_b$  and  $\mathbf{h}_b(m_b-1)$ , respectively.

Let  $v = (u, p_1, p_2)$  where *u* denotes the systematic part,  $\mathbf{p}_1$  and  $\mathbf{p}_2$  combined denote the parity part,  $\mathbf{p}_1$  has length **z**, and  $\mathbf{p}_2$  has length  $(m-z)$ . The definition equation  $(H \cdot v^T) = 0$  splits into two equations, as in Equation (H.8) and Equation (H.9).

$$Au^T + Bp_1^T + Tp_2^T = 0 \quad (\text{H.7})$$

and

$$(ET^{-1}A + C)u^T + (ET^{-1}B + D)p_1^T = 0 \quad (\text{H.8})$$

Define  $\phi := (ET^{-1}B + D)$  and with the parity check matrix as indicated  $\phi = I$ . Then from Equation (H.8), it can be concluded that

$$P_1^T = (ET^{-1}A + C)u^T \quad (\text{H.9})$$

and

$$P_2^T = T^{-1}(Au^T + Bp_1^T) \quad (\text{H.10})$$

As a result, the encoding procedures and the corresponding operations can be summarized below and illustrated in Figure H.1.

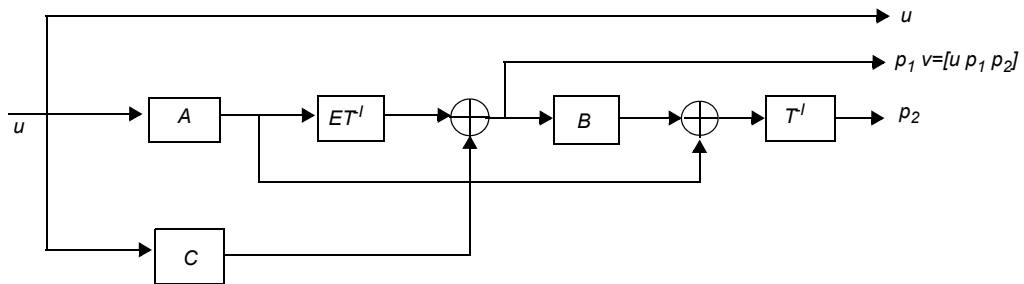
## H.4 Encoding procedure

**Step 1)** Compute  $Au^T$  and  $Cu^T$ .

**Step 2)** Compute  $ET^{-1}(Au^T)$ .

**Step 3)** Compute  $p_1^T$  by  $p_1^T = ET^{-1}(Au^T) + Cu^T$

**Step 4)** Compute  $p_2^T$  by  $Tp_2^T = Au^T + Bp_1^T$



**Figure H.1—Block diagram of the encoder architecture for the block LDPC code**