

Surface Capacitive...3

❖ Disadvantages

- ◆ No multi-touch
- ◆ Finger-only (or tethered pen)
- ◆ Calibration drift & susceptible to EMI
- ◆ Moderate optical quality (85% - 90%)

❖ Applications

- ◆ Regulated (casino) gaming
- ◆ Point-of-Sale (POS) terminals
- ◆ Point-of-Information (POI) kiosks
- ◆ Medical equipment



❖ Suppliers

- ◆ 3M is the only significant supplier left

❖ Status

- ◆ It will be an irrelevant, obsolete technology in 5-7 years



Source: 3M

Wacom's Improved RRFC Surface Capacitive Technology...1

❖ How it works

- ◆ A linear voltage AND a ramp-shaped electrostatic field is created on the surface by applying AC on 2 corners & DC on the other two corners
- ◆ Controller switches signals around all 4 corners, creating 4 ramp fields vs. single flat field in standard capacitive, and measures current in each case
- ◆ Resulting touch-event signal is independent of all capacitance effects except those due to finger-touch
- ◆ Controller does additional digital signal processing to compensate for factors that affect accuracy and drift

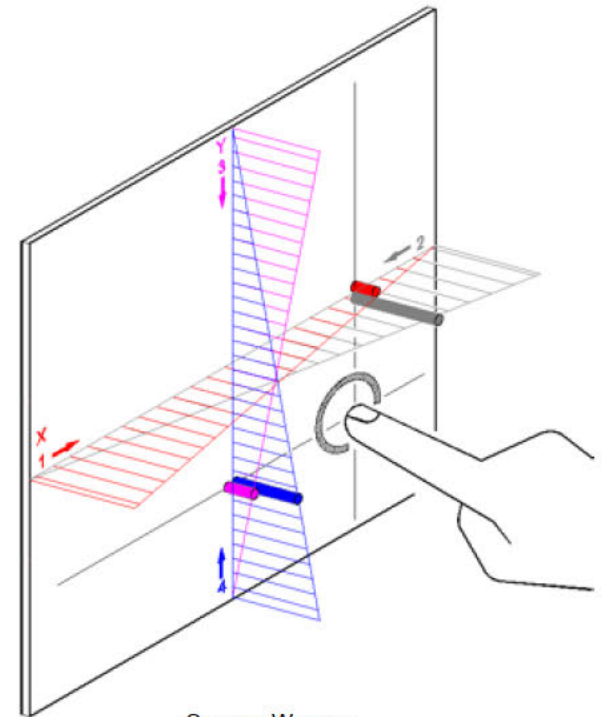

Source: Wacom
(Trademark = CapPLUS)

RRFC = Reversing Ramped
Field Capacitive

Wacom's Improved RRFC Surface Capacitive Technology...2

❖ Advantages

- ◆ Solves all the problems of traditional surface capacitive
 - Works in mobile & stationary devices (10" to 32" now; 46" capable)
 - Unaffected by grounding changes, EMI, variations in skin dryness & finger size, temperature, humidity, metal bezels, etc.
 - Works outdoors in rain and snow
 - Works through latex or polypropylene gloves
 - Allows 4X thicker hardcoat for improved durability
- ◆ Uses same ASIC as Wacom's EMR pen digitizer, so dual-mode input is lower cost & more efficient (e.g., in Tablet PC)

❖ Disadvantages (2 very big ones!)

- ◆ No multi-touch
- ◆ Sole-source supplier

Resistive Touch Technologies

- ❖ Analog Resistive
- ❖ Analog Multi-Touch Resistive (AMR)
- ❖ Digital Multi-Touch Resistive (DMR)



Analog Resistive

Source: Engadget

Analog Resistive...1

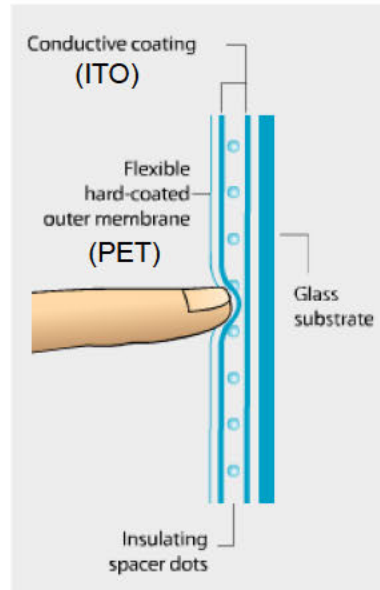
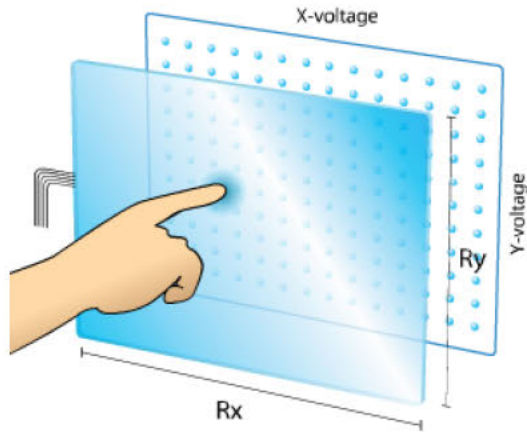

Source: Bergquist

Source: Elo Touch Solutions

Analog Resistive...2

(4-Wire Construction)

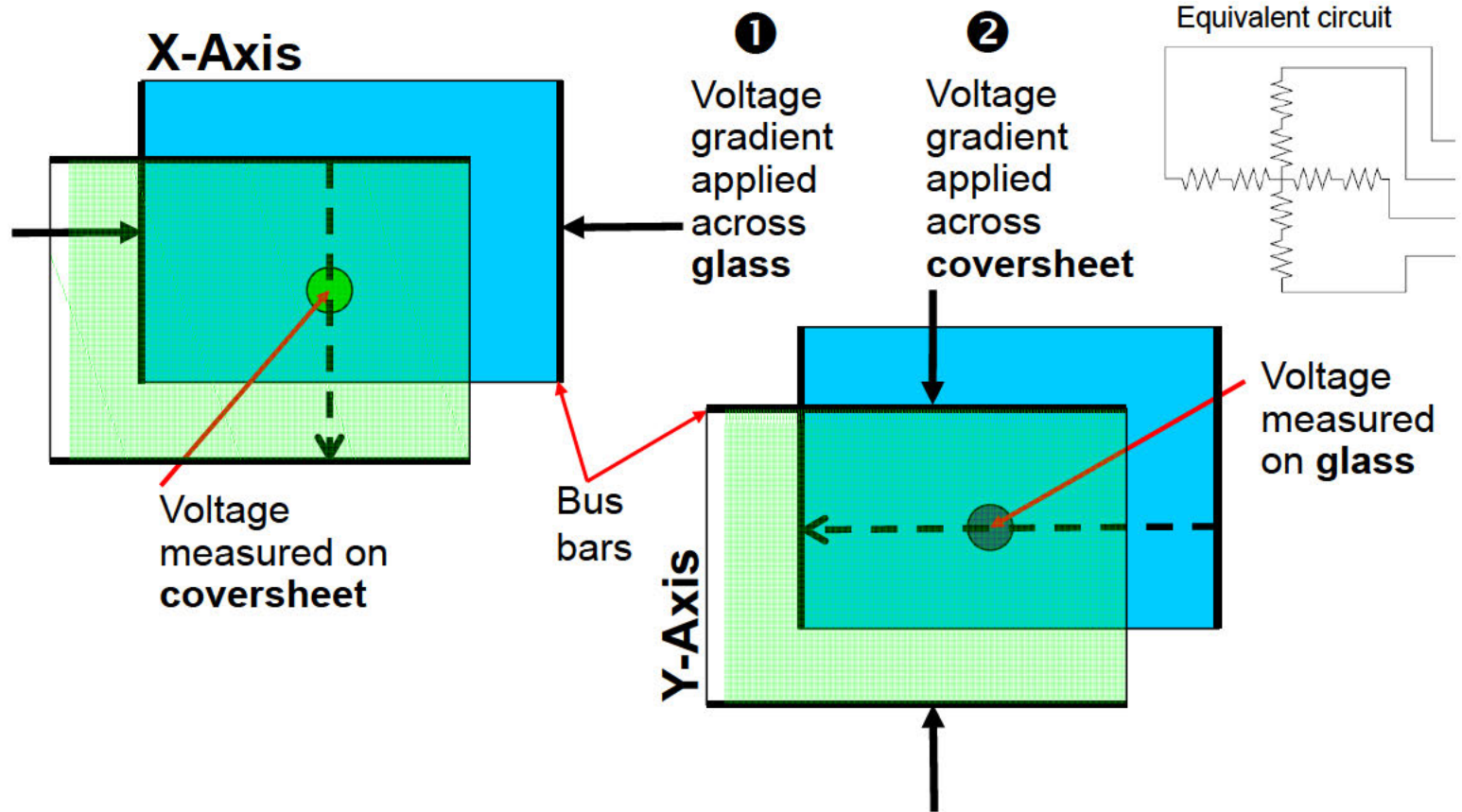

Analog Resistive...3

(5-Wire Construction)

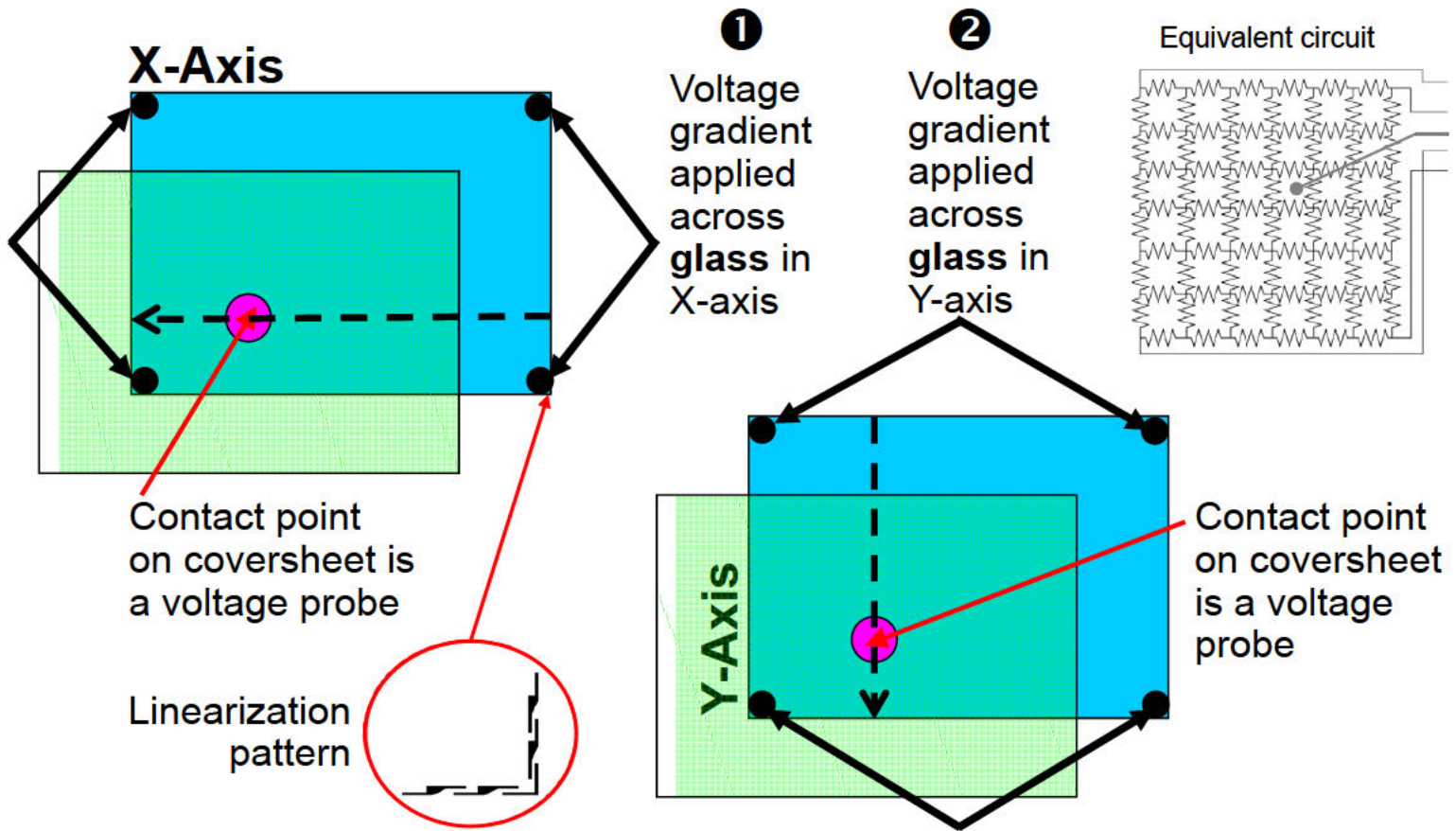

Analog Resistive...4

❖ Types

- ◆ **4-wire** (low cost, short life) is common in mobile devices
- ◆ **5-wire** (higher cost, long life) is common in stationary devices
- ◆ 6-wire & 7-wire = obsolete 5-wire; 8-wire = replacement only

❖ Constructions

- ◆ Film (PET) + glass (previous illustration) is the most common
- ◆ Film + film (used in some cellphones) can be made flexible
- ◆ Glass + glass is the most durable; automotive is the primary use
- ◆ Film + film + glass, others...

❖ Options

- ◆ Surface treatments (AR, AG, AF, AC, AB), rugged substrate, dual-force touch, high-transmissivity, surface armoring, many others...



(50- μ M glass) Source: Schott

Analog Resistive...5

❖ Size range

- ◆ 1" to ~24" (>20" is rare)

❖ Controllers

- ◆ Many sources
- ◆ Single chip, embedded in chipset/CPU, or "universal" controller board

❖ Advantages

- ◆ Works with finger, stylus or any non-sharp object
- ◆ Lowest-cost touch technology
- ◆ Widely available (it's a commodity)
- ◆ Easily sealable to IP65 or NEMA-4
- ◆ Resistant to screen contaminants
- ◆ Low power consumption



Source: Liyitec

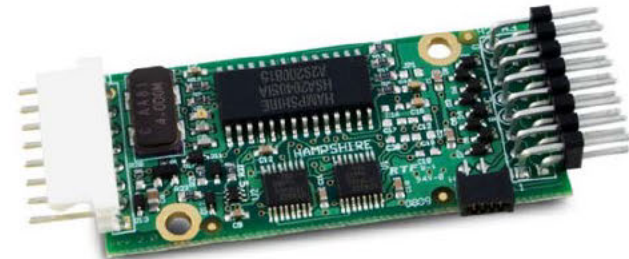

Source: Microchip

Analog Resistive...6

❖ Disadvantages

- ◆ Not durable (PET top surface is easily damaged)
- ◆ Poor optical quality (10%-20% light loss)
- ◆ No multi-touch

❖ Applications

- ◆ Mobile devices (shrinking)
- ◆ Point of sale (POS) terminals
- ◆ Automotive
- ◆ Industrial
- ◆ Wherever cost is #1



Source: Sinocan

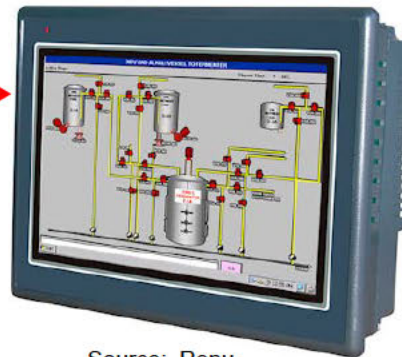

Source: Renu

Analog Resistive...7

❖ Suppliers

- ◆ Young Fast, Nissha, Nanjing Wally, Truly, EELY, Mutto, J-Touch...
- ◆ 60+ suppliers

❖ Market trends

- ◆ Analog resistive is shrinking in units and revenue
 - P-cap dominates in most consumer applications
- ◆ Analog resistive is still significant in commercial applications
 - Especially POS and industrial-control terminals

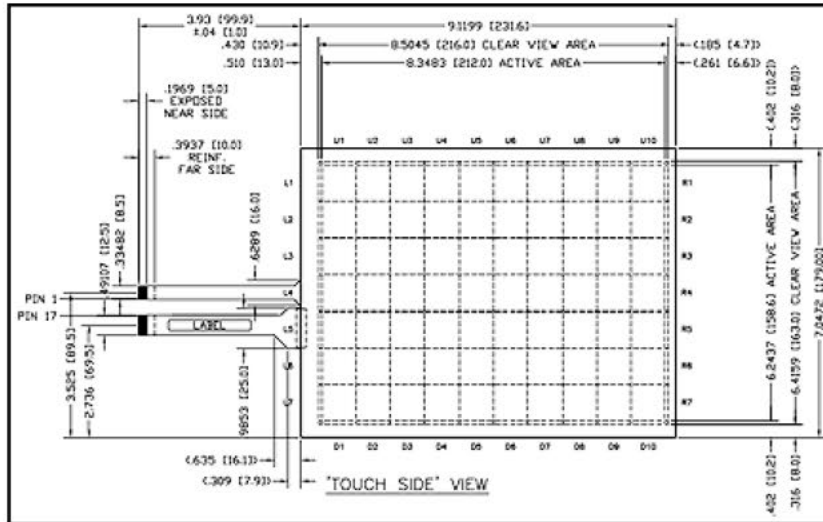

Source: Touch International

Analog Multi-Touch Resistive

Analog Multi-Touch Resistive...1

❖ Multiple names

- ◆ AMR (Analog Multi-Touch/Matrix Resistive)
- ◆ MARS (Multi-Touch Analog Resistive Sensor)
- ◆ “Hybrid analog-digital”

❖ Primary limitation

- ◆ Can't touch with two fingers on the same square

Typical AMR design for consumer product

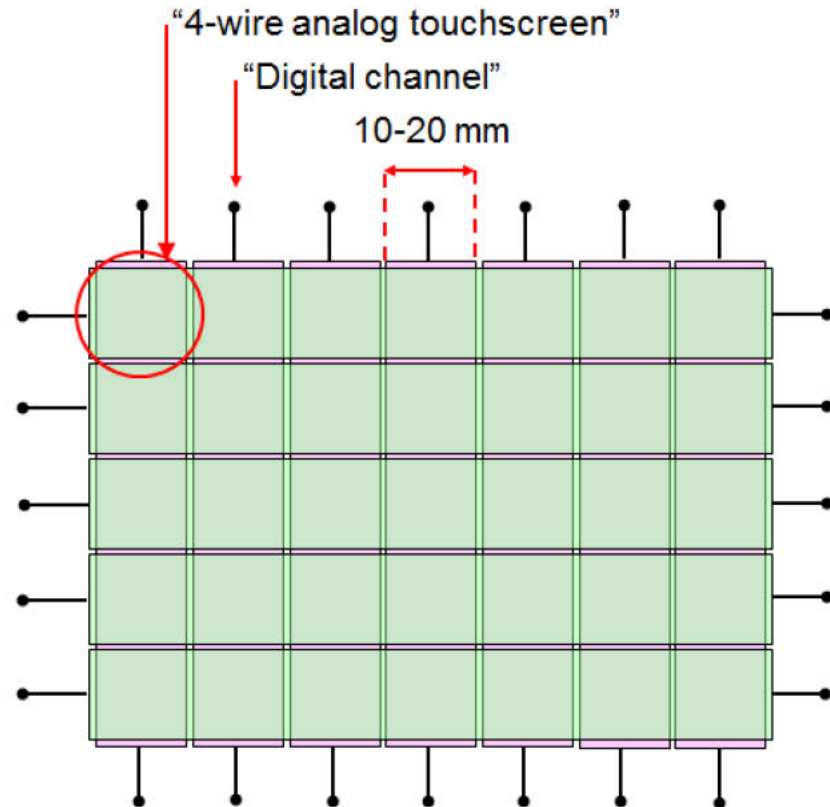

Source: The Author

Analog Multi-Touch Resistive...2

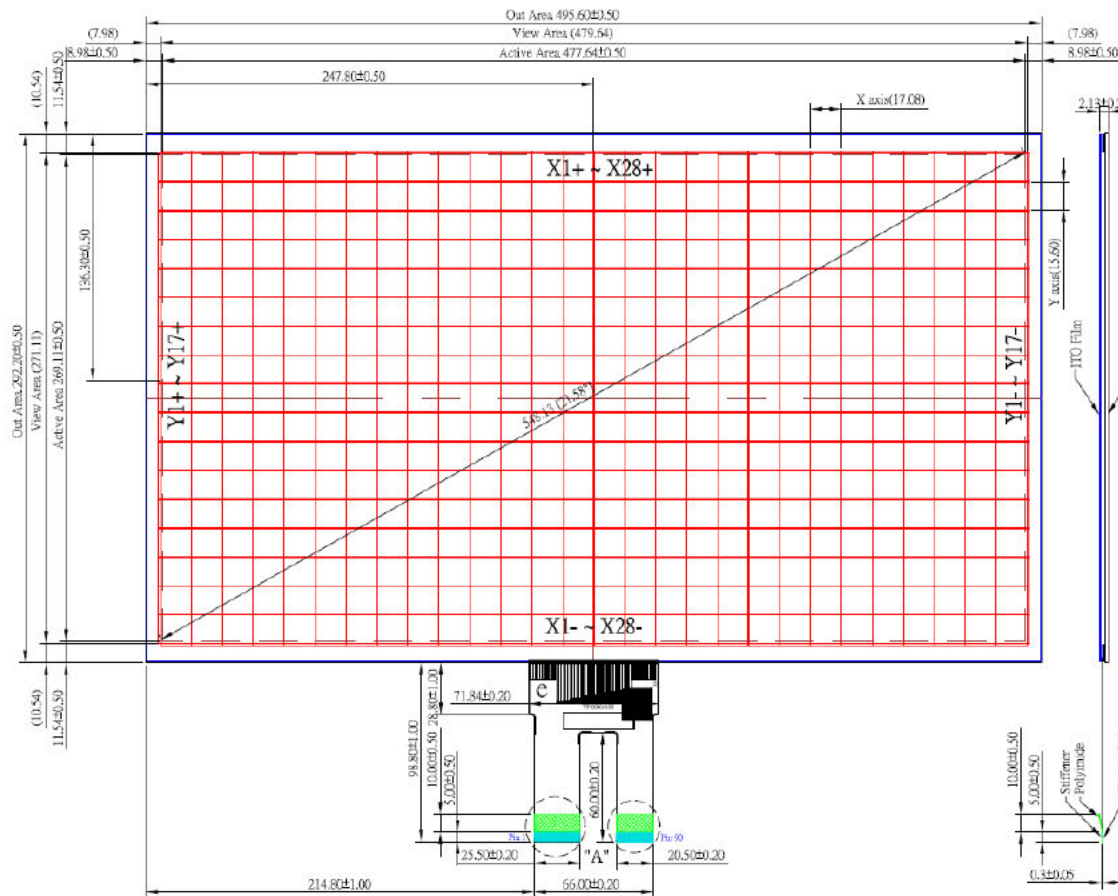

Actual Product

21.5" analog multi-touch resistive by eTurboTouch

28 x 17 lines
= 17 mm x
16 mm squares
(90 pins)

23" = 35 x 22 lines
15 mm x 13 mm
(114 pins)

Analog Multi-Touch Resistive...3

❖ Gateway ZX6910 AiO with 23" AMR touchscreen from eTurboTouch

- ◆ Example of a failed consumer product with 15x13 mm AMR
 - Drawing parallel lines with two closely held fingers

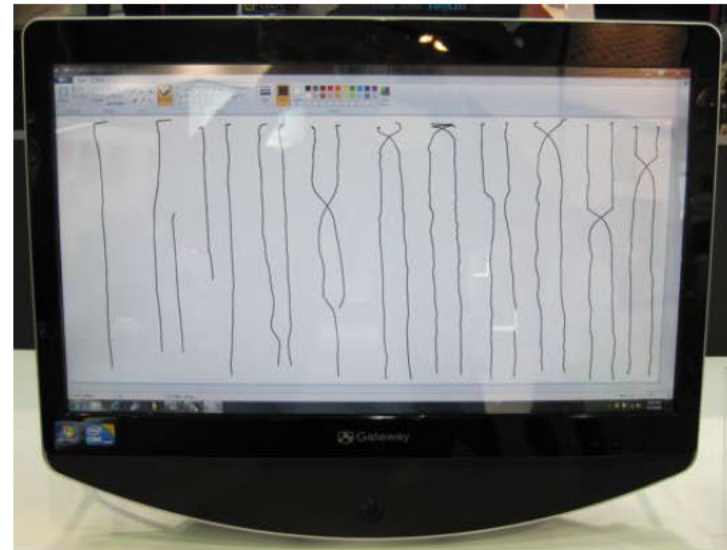

Source: Photos by Author

Analog Multi-Touch Resistive...4

❖ Controllers

- ◆ AD Semi & others; some home-grown (e.g., Touch International)

❖ Suppliers

- ◆ eTurboTouch, Touch International, Mildex, Mutto, EETI...

❖ Advantages

- ◆ Multi-touch (but without two touches on the same square)
- ◆ Simple & familiar resistive technology
- ◆ Lower cost than p-cap

❖ Disadvantages

- ◆ Poor durability (PET top surface)
- ◆ Poor optical performance
- ◆ Non-zero touch force

❖ Applications

- ◆ Industrial & other commercial

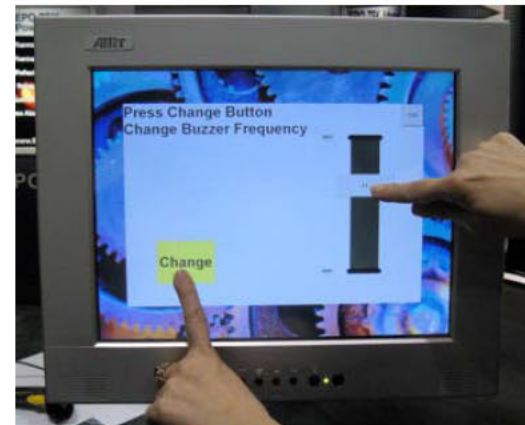

Source: Apex



Digital Multi-Touch Resistive

Digital Multi-Touch Resistive...1

❖ Stantum's product (iVSM)

- ◆ "Interpolated Voltage-Sensing Matrix"
- ◆ Stantum's strategy is to license controller IP to IC manufacturers, not to sell touchscreens
- ◆ Aimed at tablets
- ◆ Fine pitch results in a much higher number of connections than AMR (400+ on a 10" tablet screen)
 - 250-290 I/O's per controller

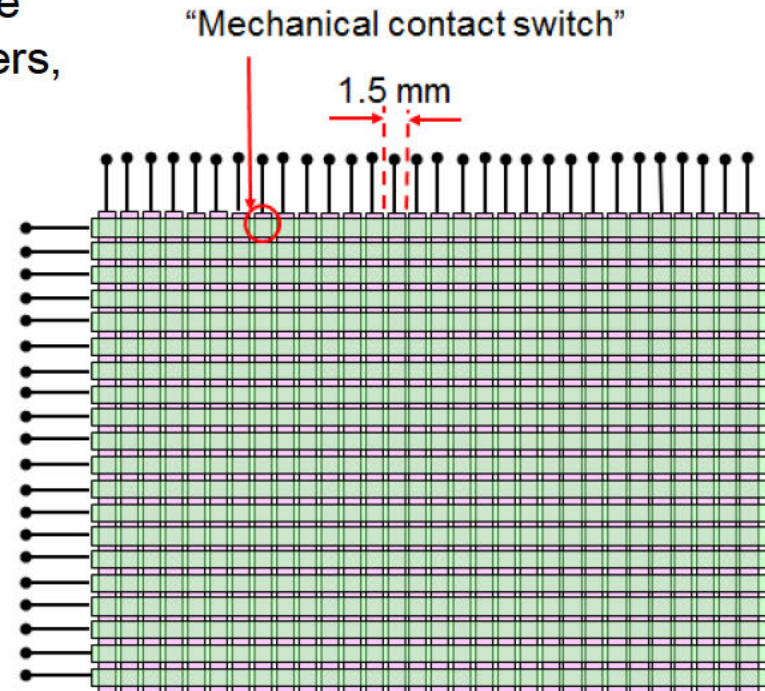

Source: Author

Digital Multi-Touch Resistive...2

❖ **Controllers**

- ◆ ST Micro is currently the only one
 - Number of touch points is controller-dependent (2-10)

❖ **Advantages**

- ◆ Multi-touch
- ◆ Simple & familiar resistive technology
- ◆ Lower cost than p-cap

❖ **Disadvantages**

- ◆ Poor durability (PET top surface)
- ◆ Poor optical performance
- ◆ Non-zero touch force

❖ **Applications**

- ◆ Commercial mobile applications such as education

Digital Multi-Touch Resistive...3

❖ **Stantum's successes (against a BIG P-cap headwind)**

- ◆ Co-developed a pen & finger solution with Nissha for 5.7 to 12-inch tablets
- ◆ Licensed IP to a US-based semiconductor vendor developing a controller optimized for 5.7" to 12" tablets
- ◆ Design win with a tier-1 OEM for a pen & finger A4 e-reader targeted at education and note-taking
- ◆ Two 7" tablets for military applications (one by Harris)
- ◆ 10.4" professional lighting-control application (Europe)
- ◆ Signed a licensing agreement with a tier-1 OEM for a mobile enterprise tablet

Digital Multi-Touch Resistive...4

- ❖ One of Stantum's shipping (military) OEM products



Source:
Harris

“A new 7-inch Android tablet that's so hard-as-nails it would make a Galaxy Tab go home and call its mother” (Engadget)

Digital Multi-Touch Resistive...5

- ❖ The funny thing is, Stantum's original products were ***the first commercial products to use multi-touch!***
 - ◆ In **2005**, when the company was selling music controllers under the name "Jazz Mutant"



Source: Jazz Mutant

Acoustic Touch Technologies

- ❖ Surface Acoustic Wave (SAW)
- ❖ Acoustic Pulse Recognition (APR by Elo)
- ❖ Dispersive Signal Technology (DST by 3M)



Source: Kodak

Surface Acoustic Wave

Surface Acoustic Wave...1

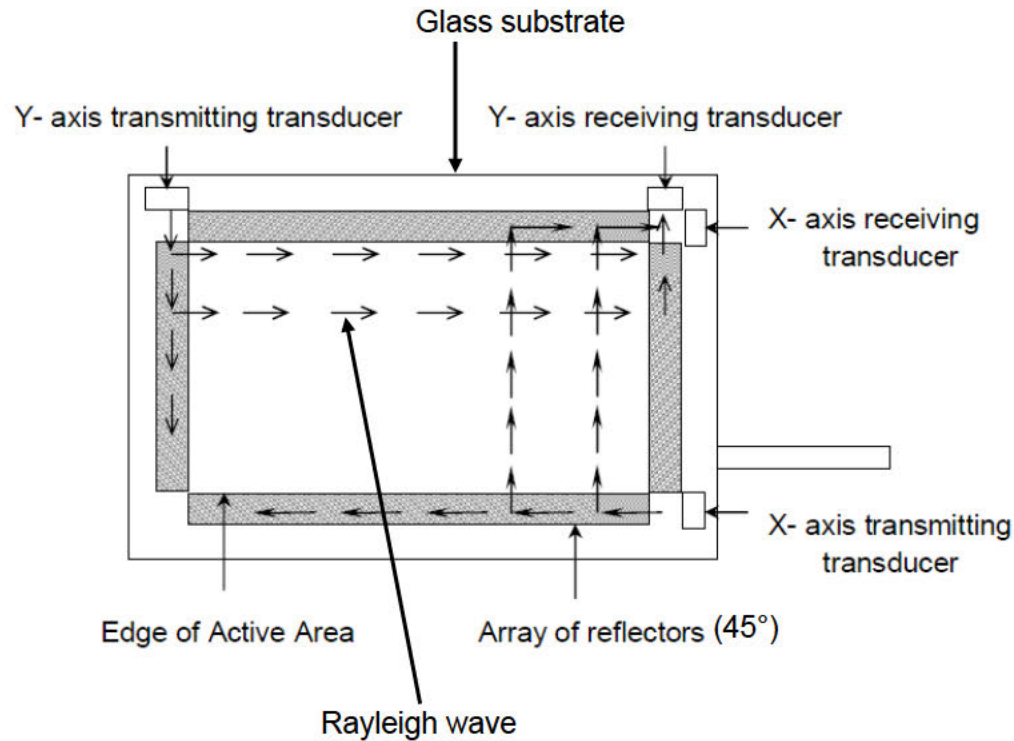

Source: Onetouch

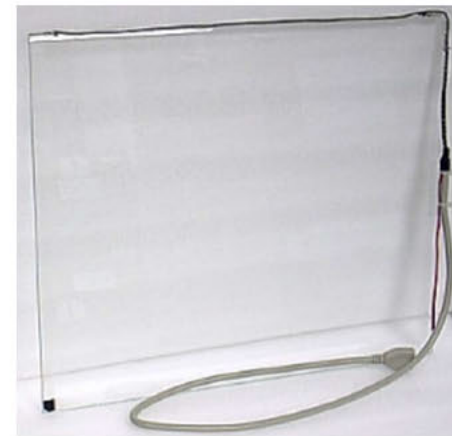

Source: A-Touch

Surface Acoustic Wave...2

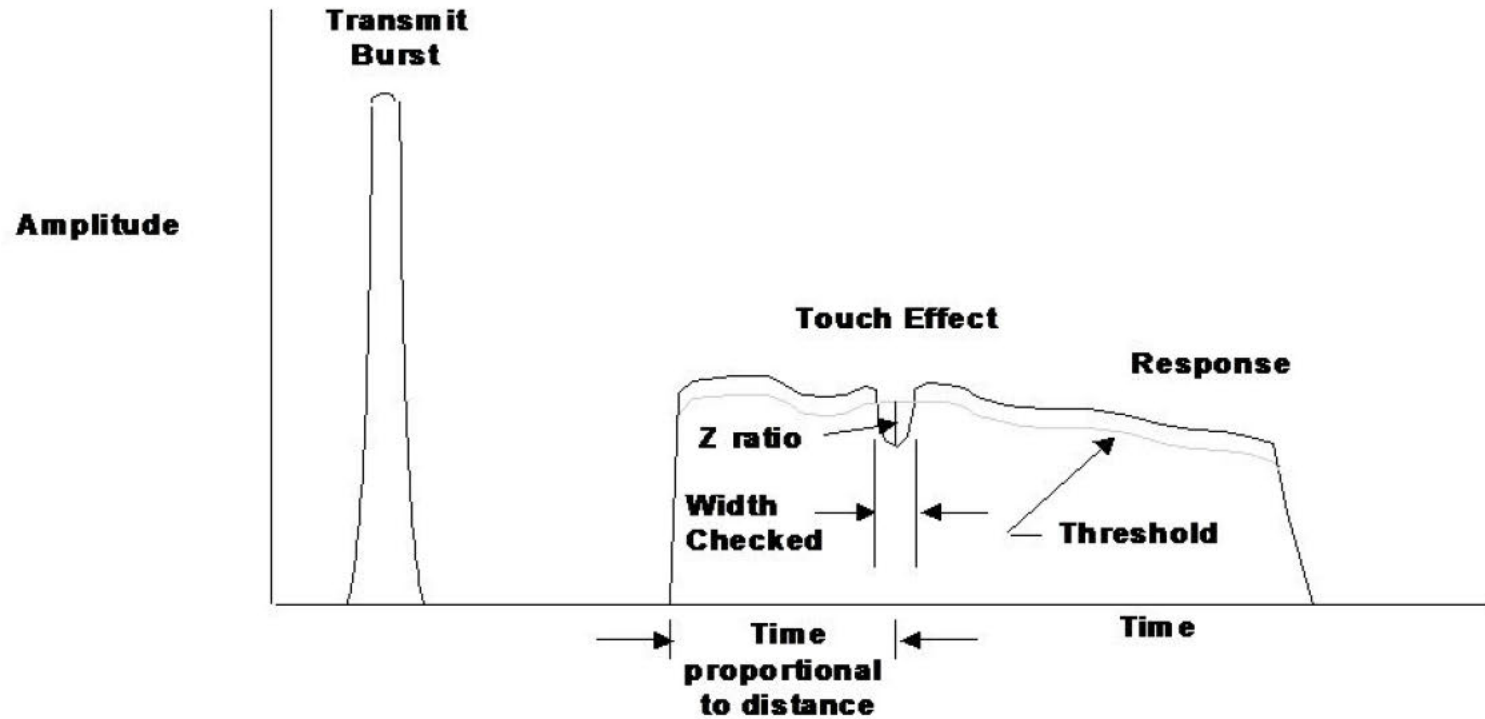

Source: Elo Touch Solutions

Surface Acoustic Wave...3

❖ How two touches are supported by SAW

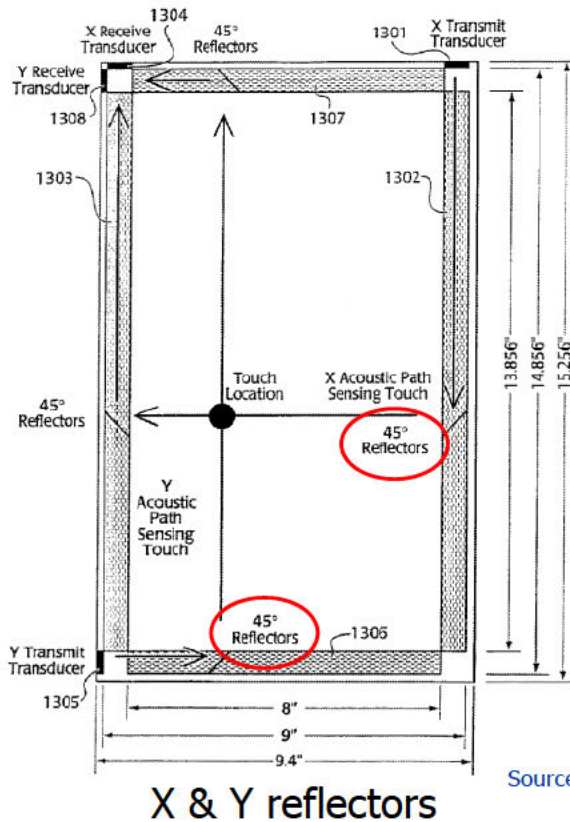

Source: US Patent Application
2010/0117993

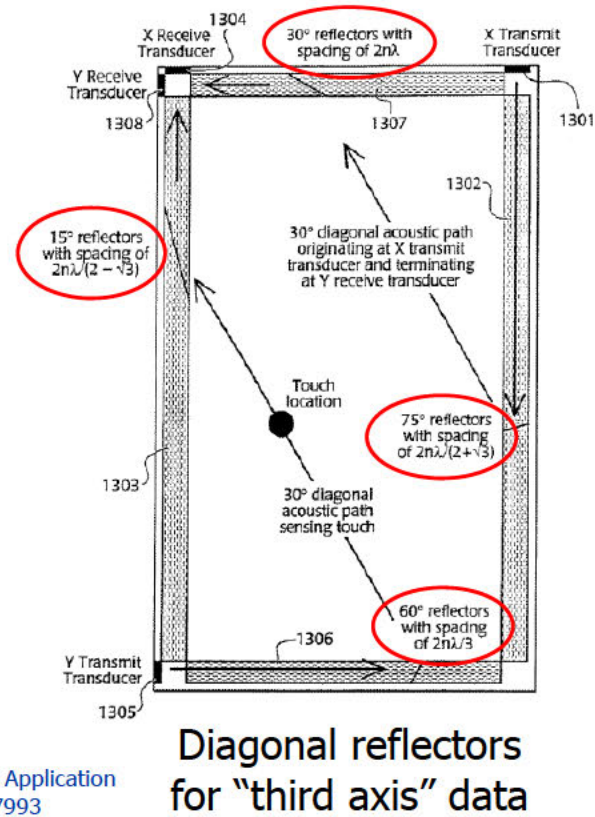

Surface Acoustic Wave...4

❖ Both **Elo Touch Solutions** and **General Touch** (China) are emphasizing zero-bezel and two-touch SAW

- ◆ This makes sense because SAW and Win7/8 will be important in commercial applications for at least the next five years
- ◆ Both companies put the piezos and reflectors on the back of the glass to achieve zero-bezel
- ◆ For two-touch zero-bezel, Elo uses a single set of multiplexed reflectors on the back of the glass (see US7629969) instead of the two sets of reflectors used on top of the glass for two-touch normal bezel

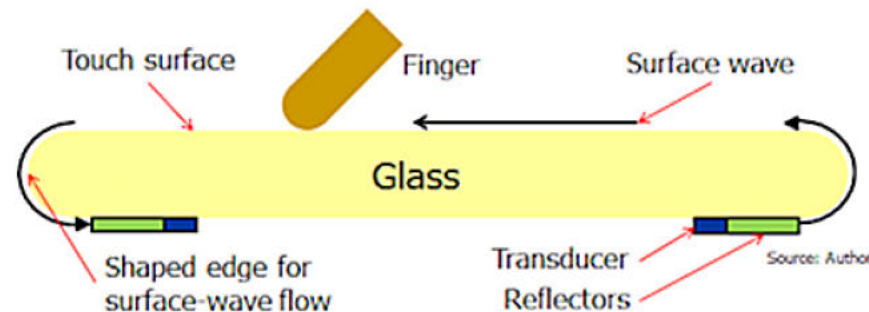

Surface Acoustic Wave...5

❖ Elo Touch Solutions' zero-bezel SAW



Source: Photos by Author

Surface Acoustic Wave...6

❖ Size range

- ◆ 6" to 52" (but some integrators won't use it above 32")

❖ Advantages

- ◆ Clear substrate (high optical performance)
- ◆ Finger, gloved hand & soft-stylus activation
- ◆ Very durable; can be vandal-proofed with tempered or CS glass

❖ Disadvantages

- ◆ Very sensitive to any surface contamination, including water
- ◆ Relatively high activation force (50-80g typical)
- ◆ Requires "soft" (sound-absorbing) touch object
- ◆ Can be challenging to seal

❖ Applications

- ◆ Kiosks
- ◆ Gaming



Source:
Euro
Kiosks
Network

Surface Acoustic Wave...7

❖ Suppliers

- ◆ Elo Touch Solutions and General Touch have >90% share
- ◆ <10 suppliers

❖ Market trends

- ◆ Two-touch and zero-bezel SAW should help reduce loss of share to p-cap in commercial applications
 - SAW will continue to grow moderately through 2017
- ◆ Chinese suppliers other than General Touch have significant difficulty competing due to distribution and brand limitations



Source: Elo TouchSystems

Acoustic Pulse Recognition (APR)

Acoustic Pulse Recognition...1

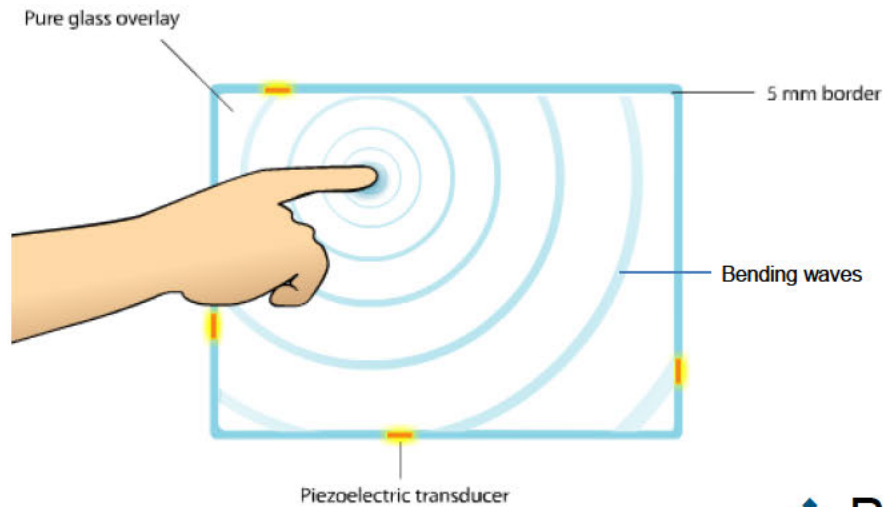

Source: Elo Touch Solutions

- ❖ Plain glass sensor with 4 piezos on the edges
- ❖ Table look-up of bending wave samples (“acoustic touch signatures”)

Acoustic Pulse Recognition...2

❖ Variations

- ◆ “Stationary APR” from 10” to 52” with controller board
- ◆ “Mobile APR” from 2.8” to 10” with controller ASIC

❖ Advantages

- ◆ Works with finger, stylus or any other touch object
- ◆ Very durable & transparent touch sensor
- ◆ Very simple sensor (plain glass + 4 piezoelectric transducers)
- ◆ Resistant to surface contamination; works with scratches
- ◆ Totally flush top surface (“Zero-Bezel”)

❖ Disadvantages

- ◆ **No “touch & hold”; no multi-touch**
- ◆ Requires enough touch-object velocity (a tap) to generate waves
- ◆ Control of mounting method in bezel is critical

Acoustic Pulse Recognition...3

❖ Outlook: Not good!

- ◆ It's not available as a component (touchscreen) because it requires unique calibration and specialized integration
- ◆ Unsuitable for applications that use the Windows UI because of the lack of touch-and-hold
- ◆ Unsuitable for public-access applications because of the need to tap (everyone today expects p-cap's light touch)
- ◆ Unsuitable for consumer electronics applications because of the lack of multi-touch
- ◆ Elo Touch Solutions (sole-source!) withdrew APR from digital signage applications because of poor performance (they're using Lumio's camera-based optical instead)
- ◆ What's left? POS terminals!

Acoustic Pulse Recognition...4

❖ APR and Sensitive Object

- ◆ Elo Touch Solutions (then part of Tyco Electronics) purchased Sensitive Object (“S.O.”) in January, 2010 for **\$62M**
- ◆ Sensitive Object’s technology (“ReverSys”) is so similar to APR that the two companies cross-licensed in July, 2007

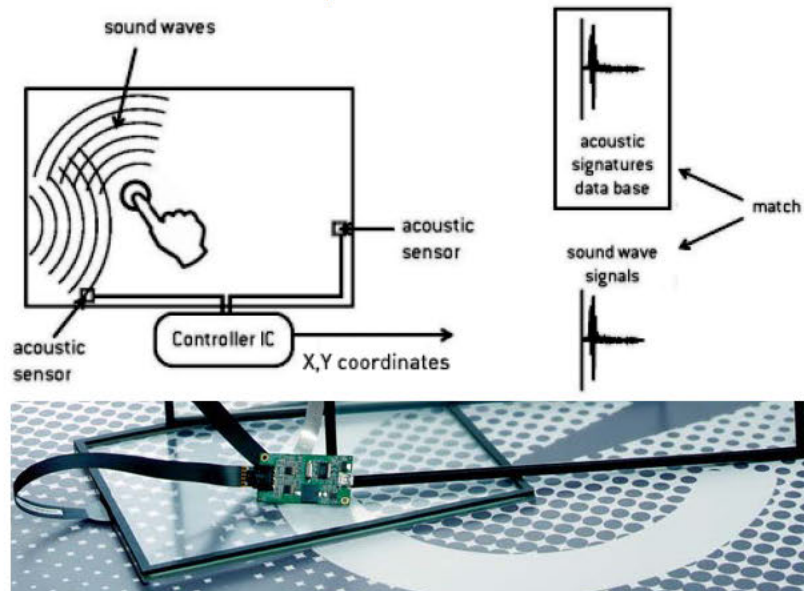

In the 3.5 years since Elo purchased S.O., there have been zero new products that can be attributed to the acquisition

Source: Sensitive Object

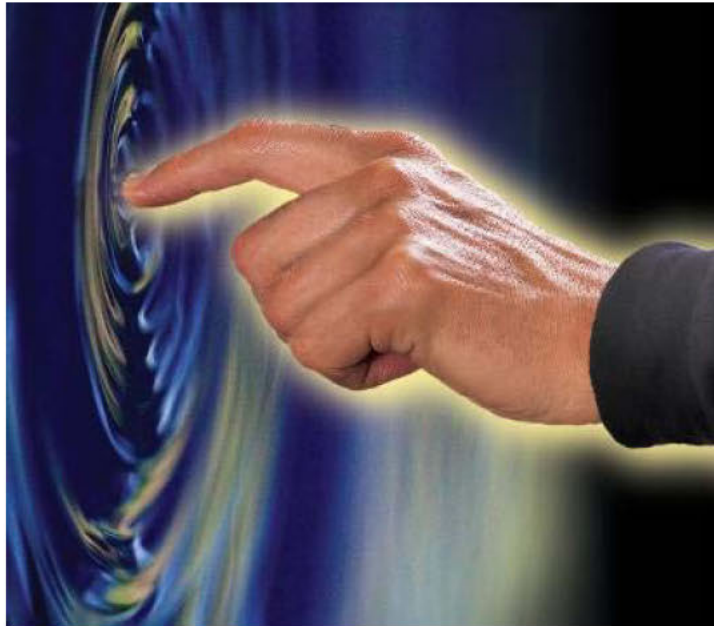

Source: 3M

Dispersive Signal Technology (DST)

Dispersive Signal Technology...1

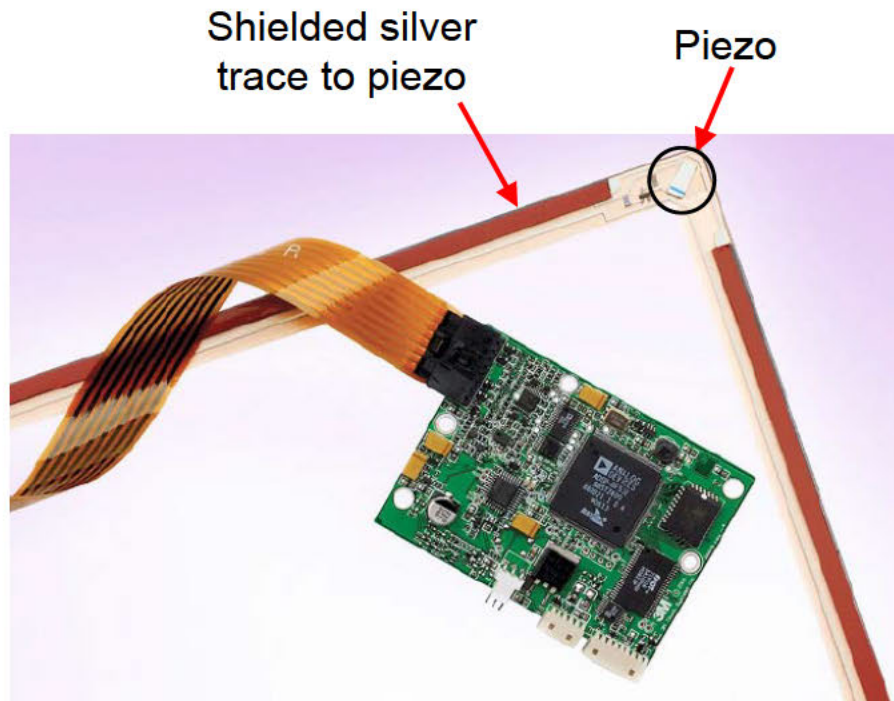

Source: 3M

- ❖ Plain glass sensor with 4 piezos in the corners
- ❖ Real-time analysis of bending waves in the glass (“time of flight” calculation)

Dispersive Signal Technology...2

❖ Visualization of the effect of bending waves on a rigid substrate

Source: 3M

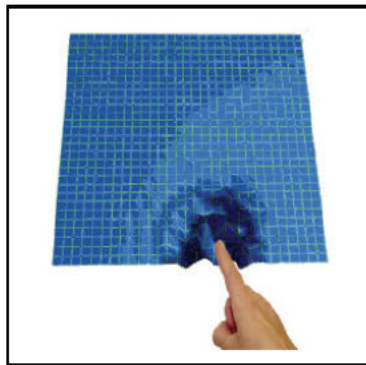

Initial Touch Contact

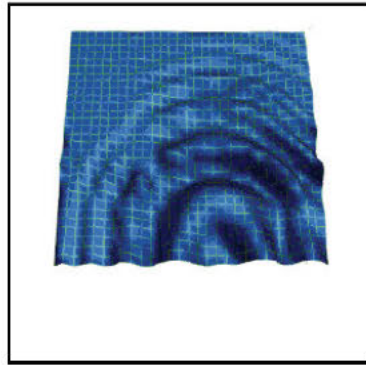

Progressing Dispersion with the Beginning of Reflection Effects Down

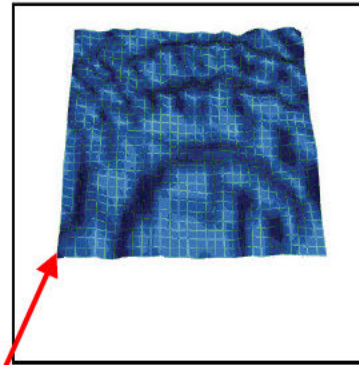

Highly Complex Dispersion Pattern with Reflections

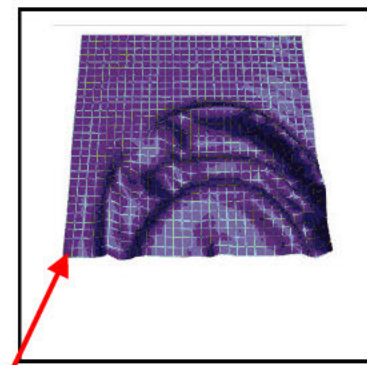

Post-Algorithm Pattern

Waveform that would be sampled by APR

Waveform resulting from processing by DST algorithms

Dispersive Signal Technology...3

❖ Size range

32" to 55" (available only on displays sold by 3M-trained integrators)

❖ Advantages

- ◆ Works with finger, stylus or any other touch object
- ◆ Very durable & transparent touch sensor
- ◆ Very simple sensor (plain glass + 4 piezoelectric transducers)
- ◆ Operates with static objects or scratches on the touch surface
- ◆ Fast response; highly repeatable touch accuracy; **light touch**

❖ Disadvantages

- ◆ **No “touch & hold”; no multi-touch**
- ◆ Control of mounting method in bezel is critical

❖ Applications

- ◆ Interactive digital signage; point-of-information (POI)

❖ Status: **3M has discontinued all new development**

Acoustic Touch Startup: Sentons

❖ Sentons

- ◆ *“The next generation in high-performance multi-touch interfaces”*
- ◆ A fabless analog semiconductor startup
 - Taking a new approach to real-time bending-wave analysis, applying the ever-increasing CPU horsepower provided by Moore’s Law
 - 27” Sentons multi-touch touch-screen can be 30% of p-cap cost, even lower than camera-based optical
- ◆ Started by five people from Telegent, the analog mobile-TV chip startup that flamed out in July 2011

S E N T O N S



Source: Sentons Website

Optical Touch Technologies

- ❖ Traditional Infrared (IR)
- ❖ Waveguide Infrared (DVT by RPO) →
- ❖ Multi-Touch Infrared
- ❖ Camera-Based Optical
- ❖ Planar Scatter Detection (PSD)
- ❖ Vision-Based





Traditional Infrared

Traditional Infrared...1

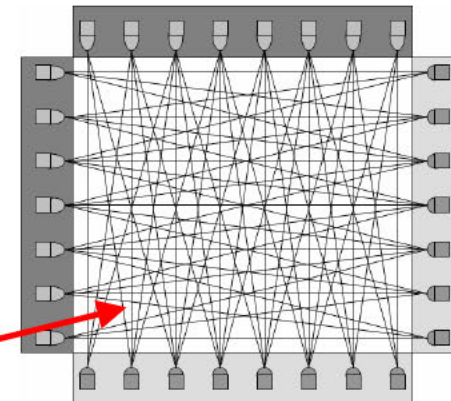
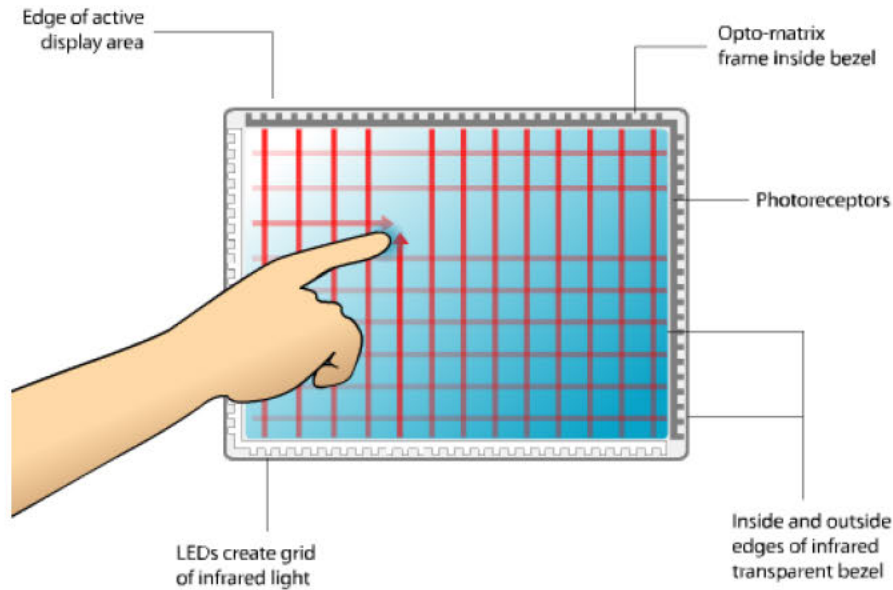

“Cross-beam” light paths increases resolution and fault-tolerance in infrared touchscreens (Elo)

Source: Elo Touch Solutions

Traditional Infrared...2

❖ Variations

- ◆ Bare PCB vs. enclosed frame; frame width & profile height; no glass substrate; enhanced sunlight immunity; force-sensing

❖ Size range

- ◆ 8" to 150"

❖ Controllers

- ◆ Mostly proprietary, except IRTouch (China)

❖ Advantages

- ◆ Scalable to very large sizes
- ◆ Multi-touch capable (only 2 touches, and with some “ghost” points)
- ◆ Can be activated with any IR-opaque object
- ◆ High durability, optical performance and sealability
- ◆ Doesn't require a substrate

Traditional Infrared...3

❖ Multi-touch in traditional infrared

- ◆ Limited to 2 not-so-good touches
- ◆ “Ghost” points are the problem, and **there’s no good solution**

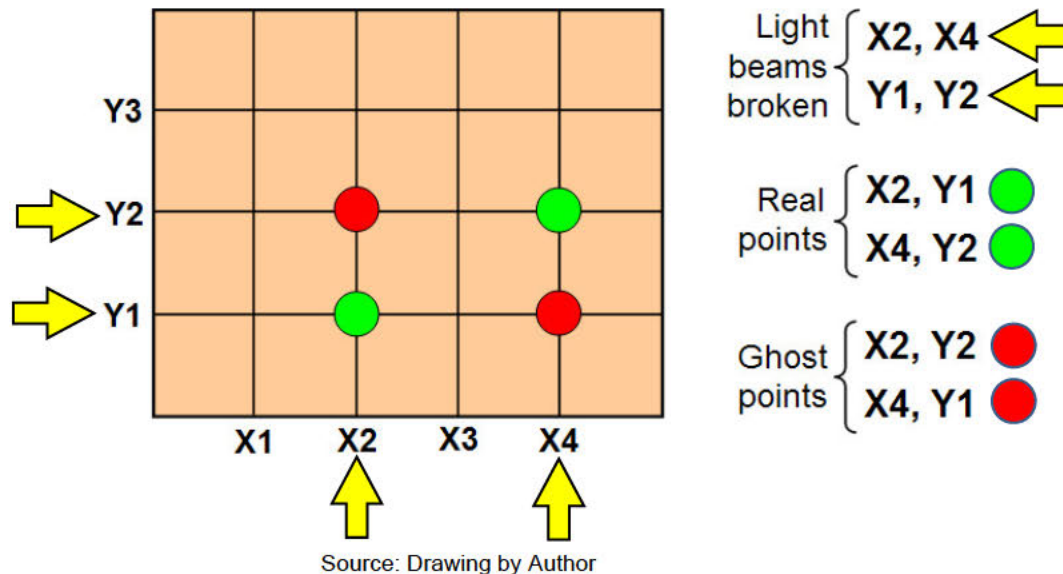

Traditional Infrared...4

❖ Disadvantages

- ◆ Profile height (IR transceivers project above touch surface)
- ◆ Bezel must be designed to include IR-transparent window
- ◆ Sunlight immunity can be a problem in extreme environments
- ◆ Surface obstruction or hover can cause a false touch
- ◆ Low resolution
- ◆ High cost

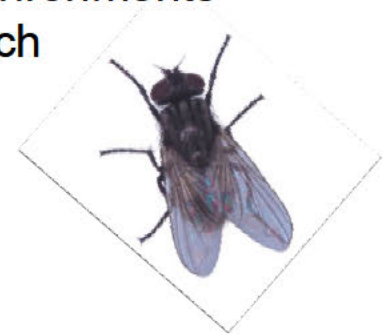

❖ Applications

- ◆ Large displays (digital signage)
- ◆ POS (limited)
- ◆ Kiosks

❖ Suppliers

- ◆ IRTouch Systems, Minato, Nexio, OneTouch, SMK, **Neonode...**
- ◆ 10+ suppliers

Traditional Infrared...5

❖ **Mobile Infrared:** Neonode mobile phone implemented with traditional IR touch (2009)

- ◆ Same battery life as iPhone
- ◆ Low bezel profile height (~1.7mm)
- ◆ Finger-only
- ◆ No multi-touch

❖ *Neonode couldn't complete in the cellphone market and went bankrupt in 2009*



Source:
Neonode &
Pen Computing



Sony e-book readers (2010)

Source: PC World



Traditional Infrared...6

- ❖ **Neonode in 2013 has become the largest supplier of touchscreens for eReaders!**
 - ◆ Amazon Kindle and B&N Nook both use Neonode
 - ◆ Neonode has strong IP on methods of minimizing border width and profile height
 - They're also in transition from traditional infrared architecture to multi-touch infrared architecture
 - ◆ Neonode has announced design wins in e-readers, smartphones, tablets, toys, printers, gaming consoles, in-flight infotainment systems, and automotive consoles
 - How much of it is real beyond e-readers is unclear
 - ◆ Neonode doesn't supply any actual hardware, just licenses and engineering implementation consulting services



Source: RPO



Waveguide Infrared

Waveguide Infrared...1

❖ Objective

- ◆ Reduce IR touchscreen cost by replacing multiple IR-emitters with a single LED and using optical waveguides to distribute the light and to channel it to a line-scan CMOS pixel array

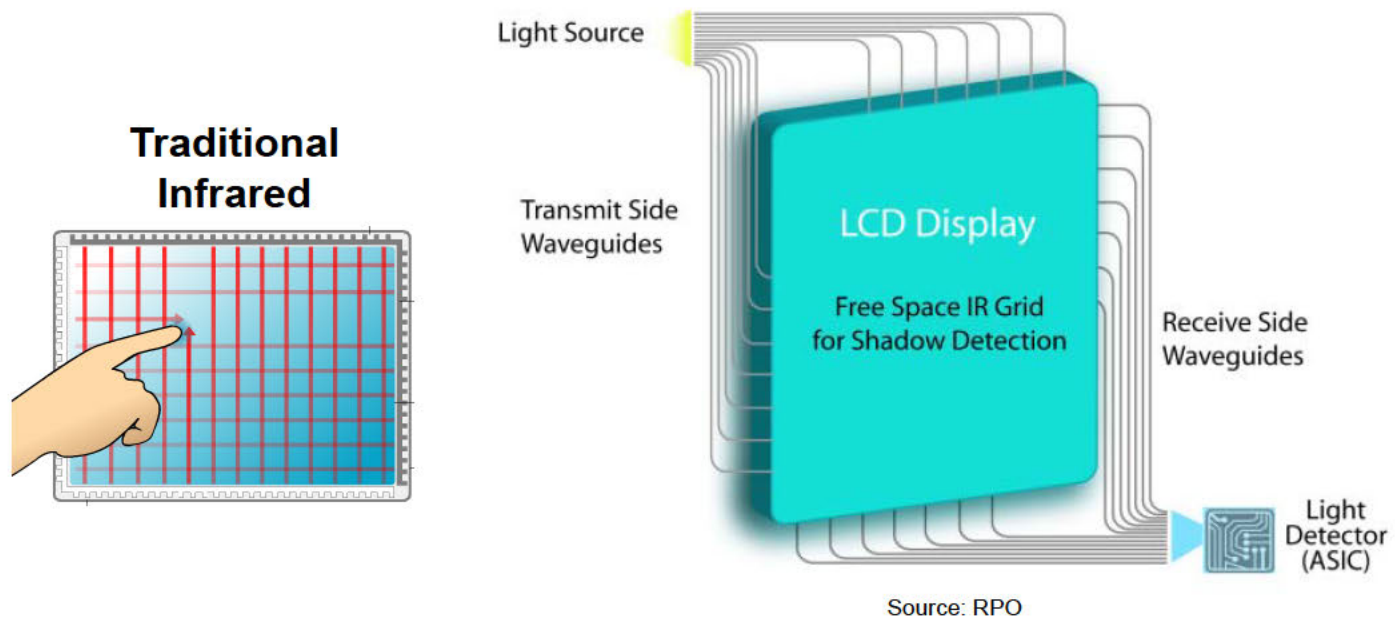

Waveguide Infrared...2

RPO's actual construction (3.5" screen)

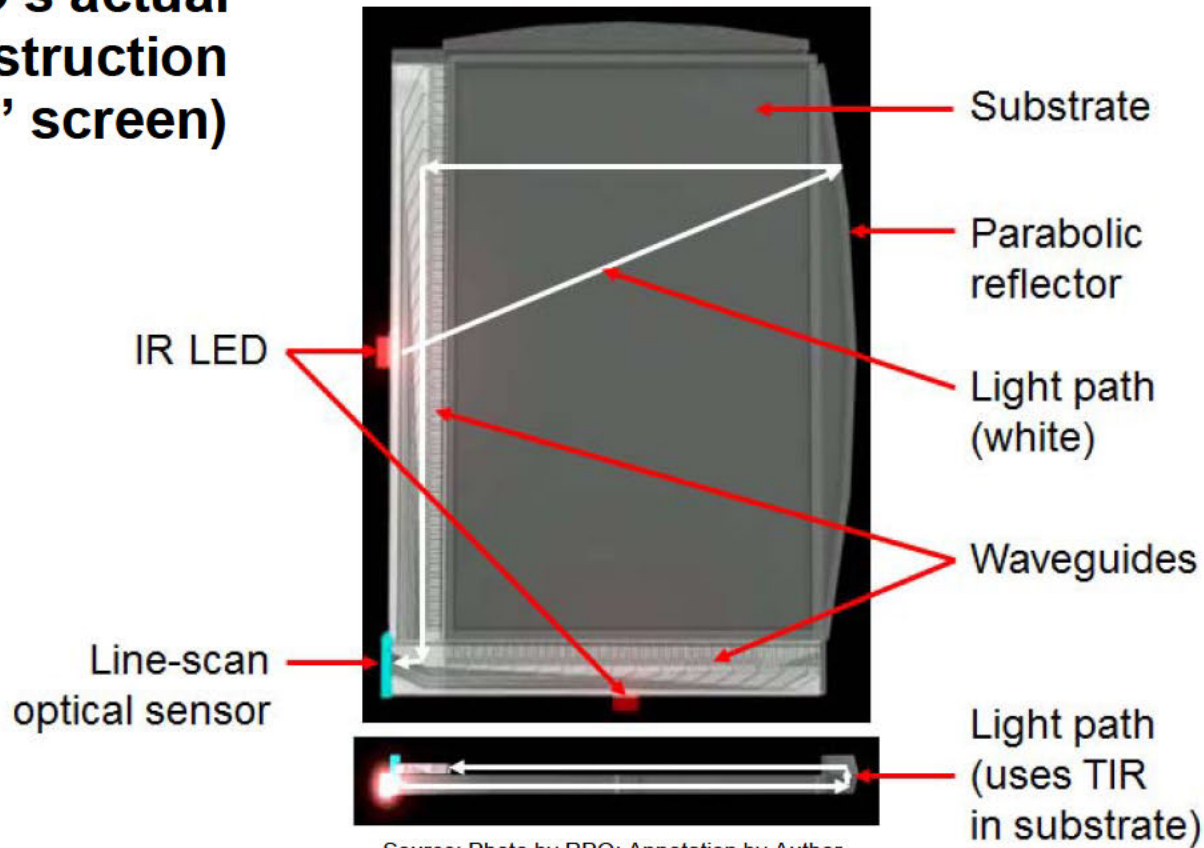

Waveguide Infrared...3

❖ RPO timeline

- ◆ Announced IR optical-waveguide infrared touch at SID 2007
- ◆ Showed improved performance at SID 2008
- ◆ Showed larger sizes at SID 2009
- ◆ Appeared in a 13.3" LG Display notebook at SID 2010
- ◆ Went into “voluntary administration” (liquidation) in April ... 2011
- ◆ Sold all assets to an NPE (patent troll) in February 2012
(along with Poa Sana’s assets... it’s a long story!)

❖ Why did it fail?

- ◆ There wasn’t any particular application for which it was “best”
- ◆ Waveguide technology limited touchscreen size to under ~14”
- ◆ RPO bet on one big partner in 2010 who cancelled their project abruptly, leaving the company with insufficient \$\$\$ to keep going



Source: Citron

Multi-Touch Infrared

Multi-Touch Infrared...1

❖ A little bit of history on the 2nd-oldest touch technology

- ◆ IR touch first appeared in **1972** (PLATO IV instructional terminal)
- ◆ IR touch was used in HP's first microcomputer, the HP150, in **1983**
- ◆ After 30+ years of stability, it's changed from single-touch to (briefly) 2-touch, and now multi-touch!



Source: University of Illinois

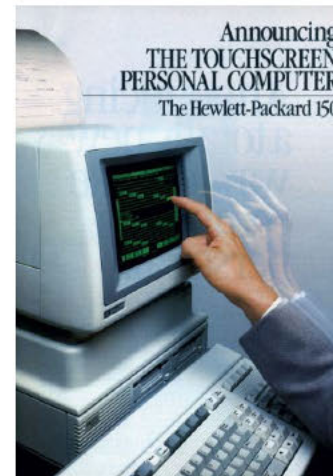

Source: VintageComputing.com

Multi-Touch Infrared...2

❖ “PQ Labs” method

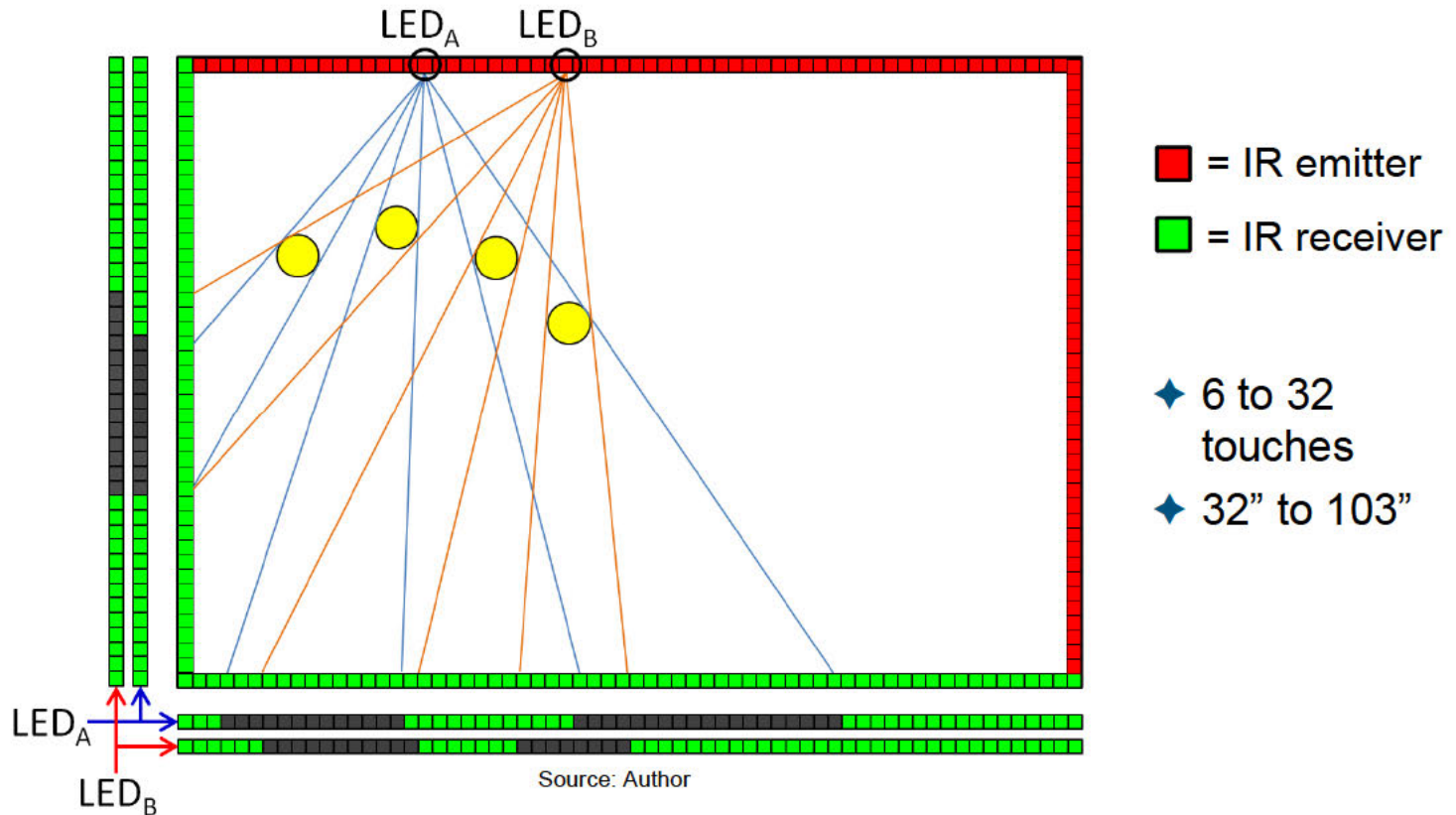

Multi-Touch Infrared...3

❖ “PulseIR” (Image Display Systems) method

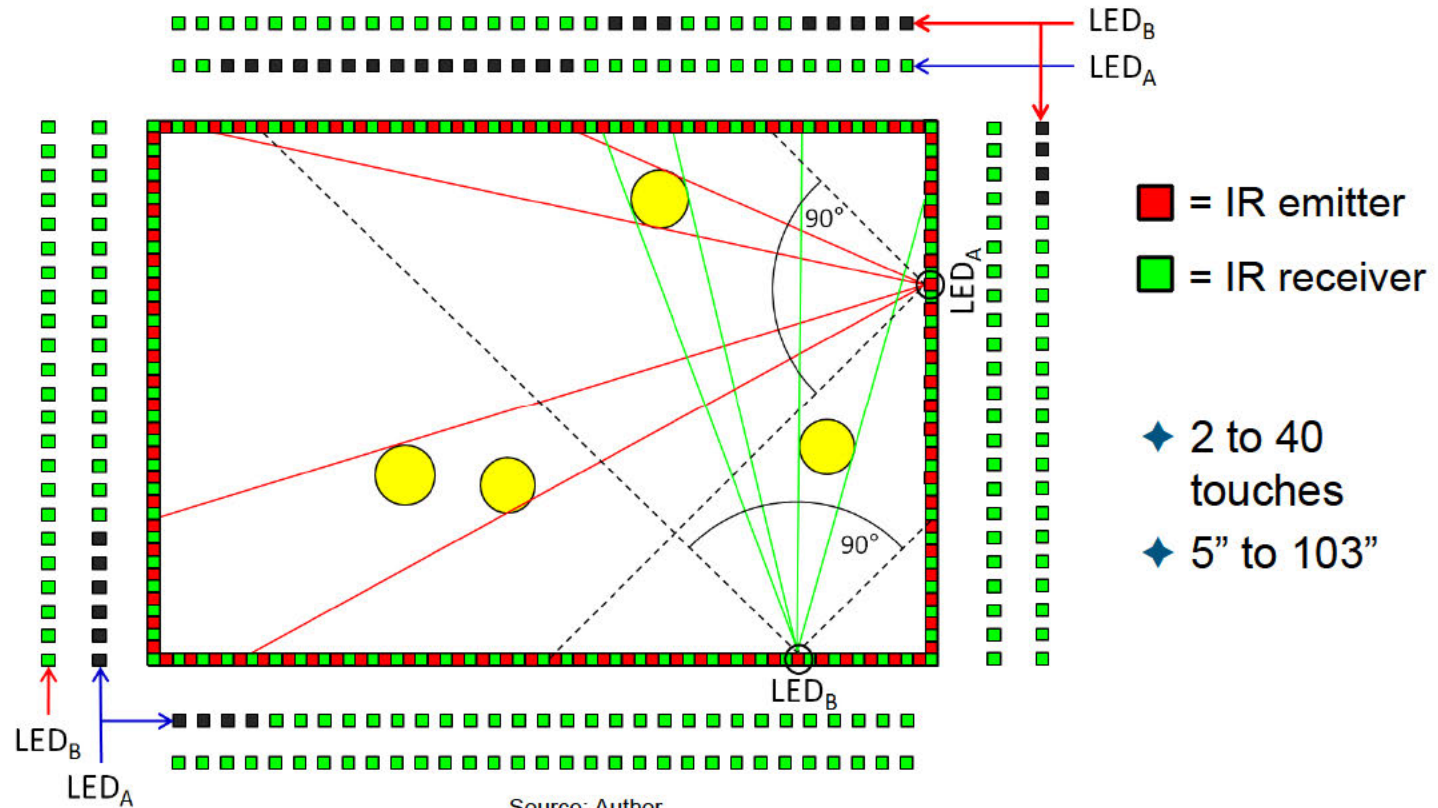

Multi-Touch Infrared...4

❖ Another possible method... being used?

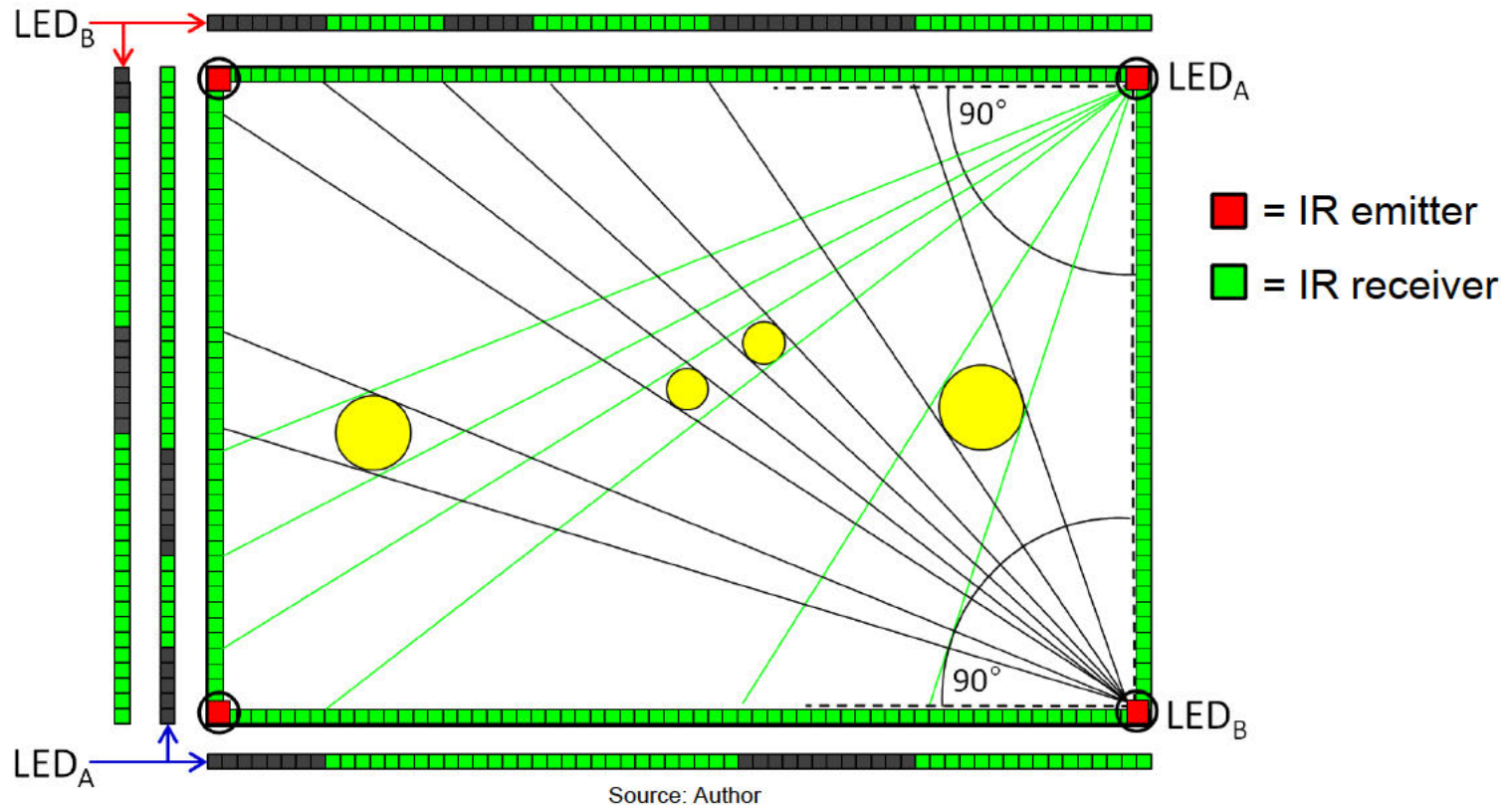

Multi-Touch Infrared...5

❖ Variations

- ◆ Number of touch points: 2 to 48 (determined by the controller)
- ◆ Architecture: 3 different ways of organizing the IR emitters and receivers (so far)
 - PQ Labs is licensing; others may be also

❖ Controller

- ◆ Proprietary; generally requires a large amount of processing

❖ Advantages

- ◆ High number of multi-touch points
- ◆ Object-size recognition
 - Controller maintains position & size data for all touching objects
- ◆ Similar advantages to those of traditional infrared
 - Works with a finger, stylus or any other IR-opaque touch object
 - Scalable to very large sizes (at some cost)
 - High durability and sealability

Multi-Touch Infrared...6

❖ Disadvantages

- ◆ Relatively low resolution (can get stair-stepping in lines)
- ◆ Increased processing load as size and number of touches goes up
- ◆ Different minimum-object-size spec for stationary & moving objects
- ◆ Large objects close to emitters can decrease performance
- ◆ As with any traditional IR system, pre-touch (or “pen-up”) is mostly a big problem that gets worse as the screen size increases
- ◆ Most can't meet Win8 Logo due to pre-touch and accuracy

❖ Applications

- ◆ Multi-player games on large horizontal displays
- ◆ Multi-user interactive digital signage
- ◆ 3D design and interaction; data visualization for business
- ◆ NOT interactive “whiteboard” displays due to pre-touch/pen-up



Multi-Touch Infrared...7

- ❖ Latest new multi-touch infrared product:
“Projected Infrared Touch” (PIT) from General Touch
 - ◆ Proprietary design using traditional opto layout (like PQ Labs)
 - ◆ Meets Win8 Logo
 - ◆ Bezel is a light-guide/prism (**2.5 mm high, 4 mm wide**) that allows IR emitters & receivers to be located under the cover-glass, outside the LCD frame (reduced parallax due to no PCB on top)

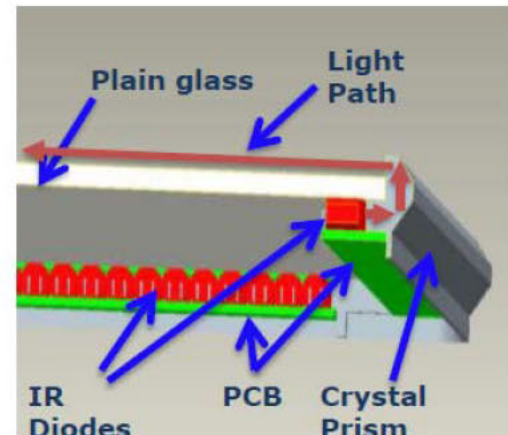
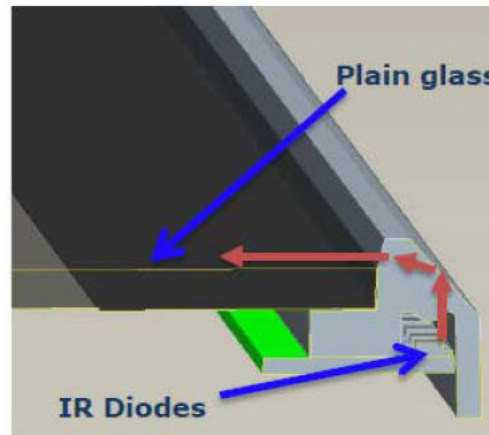

Source: General Touch

Multi-Touch Infrared...8

❖ Additional PIT features

- ◆ 15" to 42" size range standard; over 42" is custom
 - First sizes to launch in 2Q-2013 are 21.5" & 23" (for AiO)
- ◆ 2-touch for lowest cost; 5-touch for Win8; 10-touch for high-end
 - Only the controller changes
- ◆ Entire surface is touch-active, including the 20 mm (MS) border
 - Active icons can be silk-screened in the border's black matrix
- ◆ Pre-touch meets the Win8 spec of 0.5 mm
 - Exceptionally low for any infrared touchscreen
- ◆ Touch surface can be any material that meets surface flatness spec
 - Can be sealed to IP65

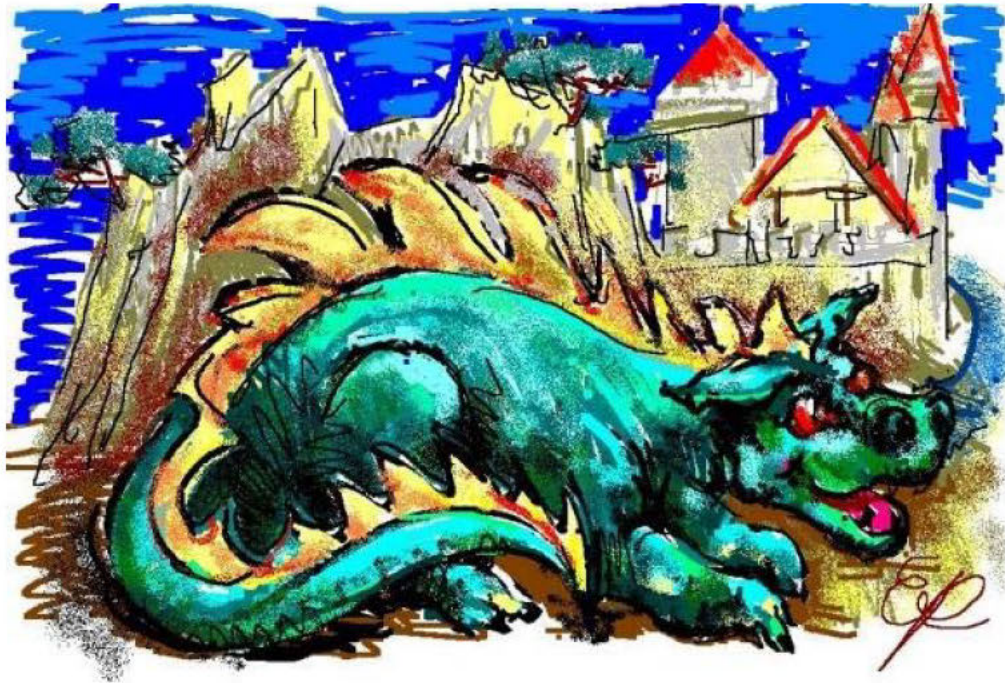

Camera- Based Optical

This picture was drawn on a 46" LCD equipped with a NextWindow optical touch-screen by a visitor to the AETI Exhibition in London on January 24, 2006.

Camera-Based Optical...1

- ❖ Win7 = 2 touches; 2 cameras did it (inadequately)
- ❖ Win8 = 5 touches; 6 cameras are required

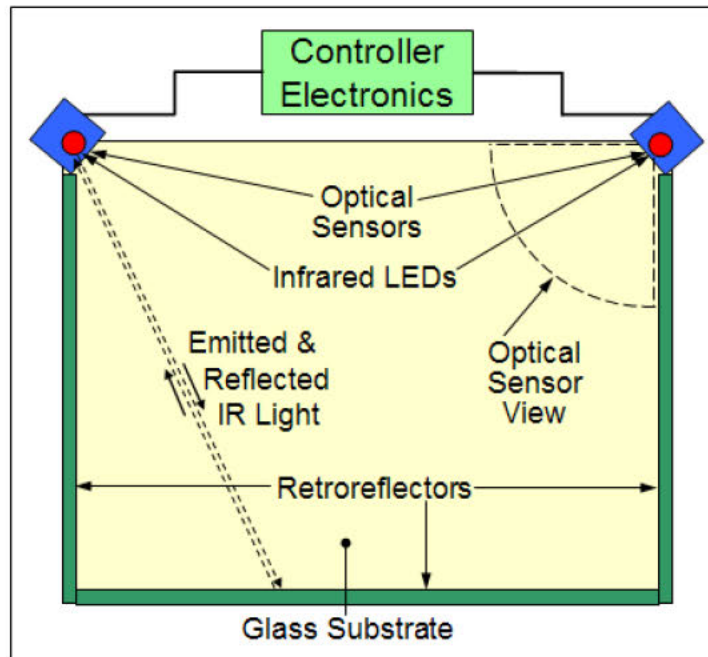

Source: NextWindow

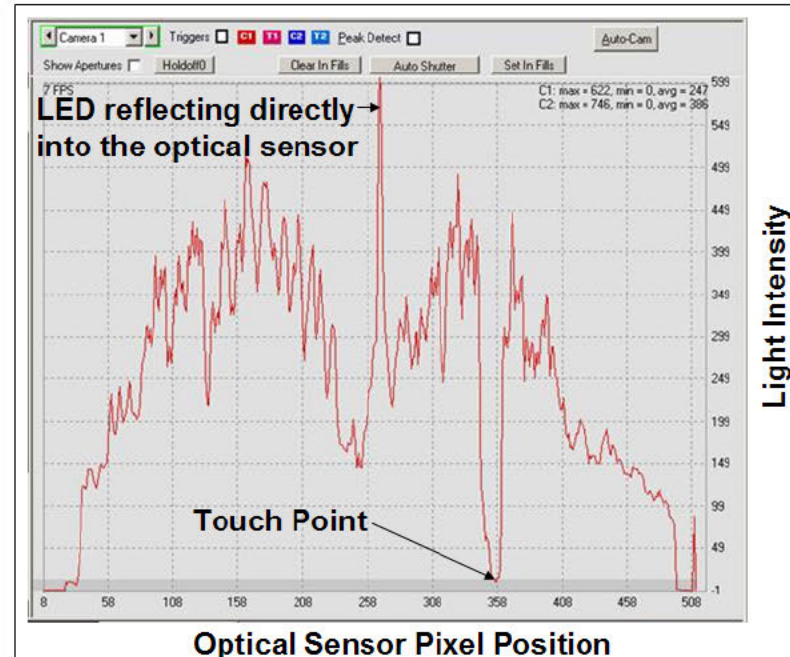

Camera-Based Optical...2

- ❖ Two touches with two cameras (Win7 market focus) had two main limitations

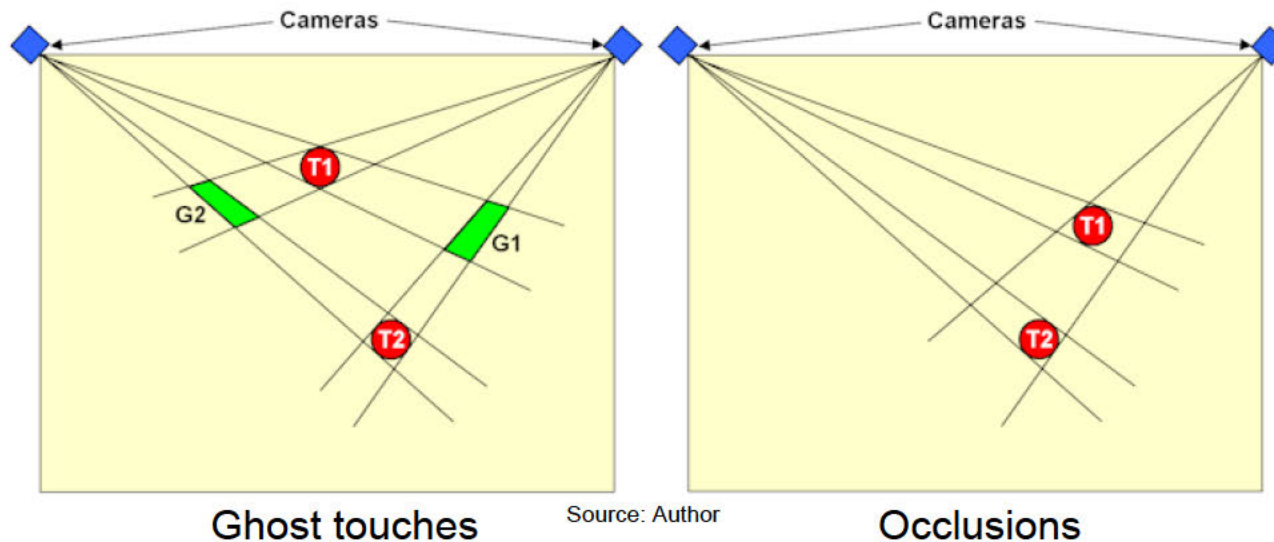

The quality of the touch experience depended on the sophistication of the algorithms that handled ghost touches and occlusions

Camera-Based Optical...3

❖ Another alternative: A mirror creates “virtual cameras”

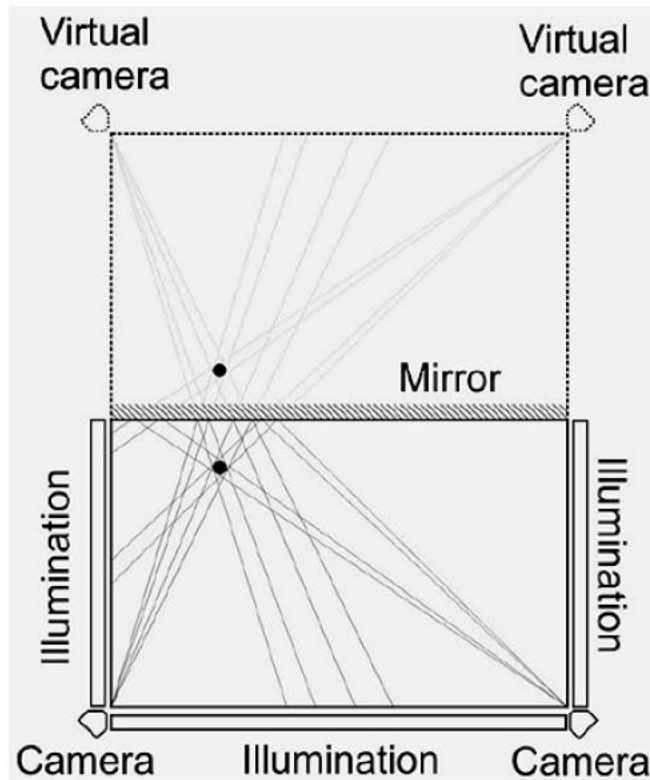

Source: Lumio

❖ Results

- ◆ SMART invented it in 2003 but shelved it
- ◆ Lumio tried it in 2010 but found that four real cameras were better
 - Lower cost
 - No mirror alignment issues
 - Less sensitivity to environment
 - Fewer pixels required for same resolution
 - Less CPU processing

Camera-Based Optical...4

❖ Another alternative: Baanto ShadowSense™

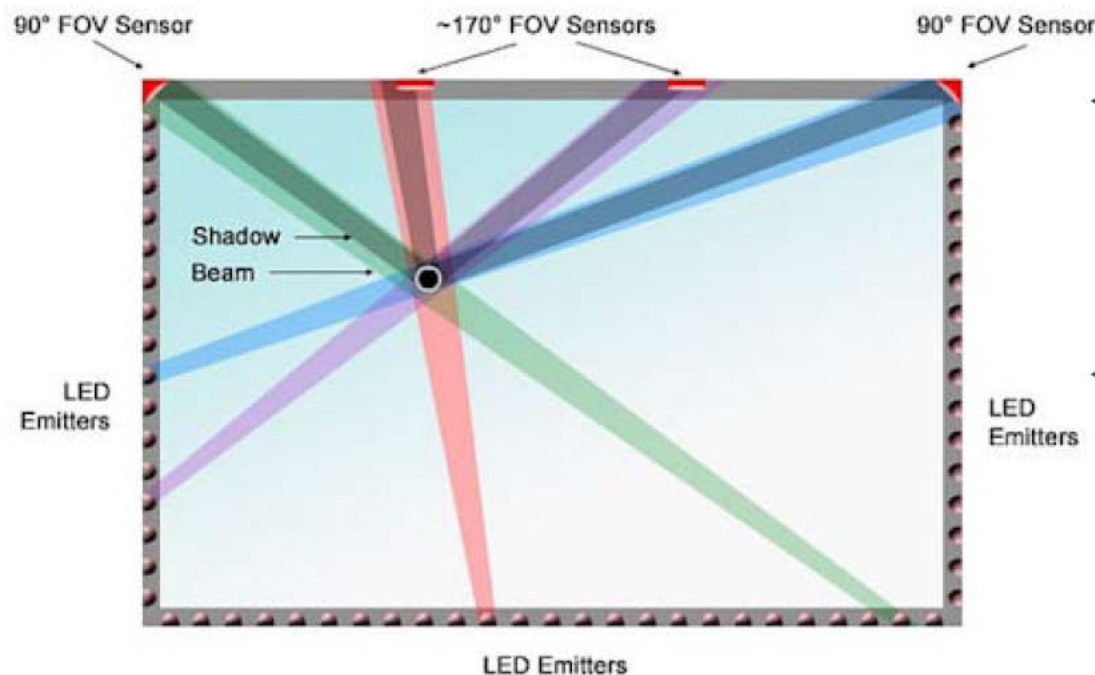

- ◆ Baanto's sensors aren't cameras; they're PIN diodes (photo-detectors)
- ◆ 940 nm LEDs provide back illumination instead of retro-reflectors

Source: Baanto

("FOV" = *Field of View*)

Camera-Based Optical...5

❖ Baanto's competitive comparison

- ◆ 4 sources of sensor-data work much better than two!

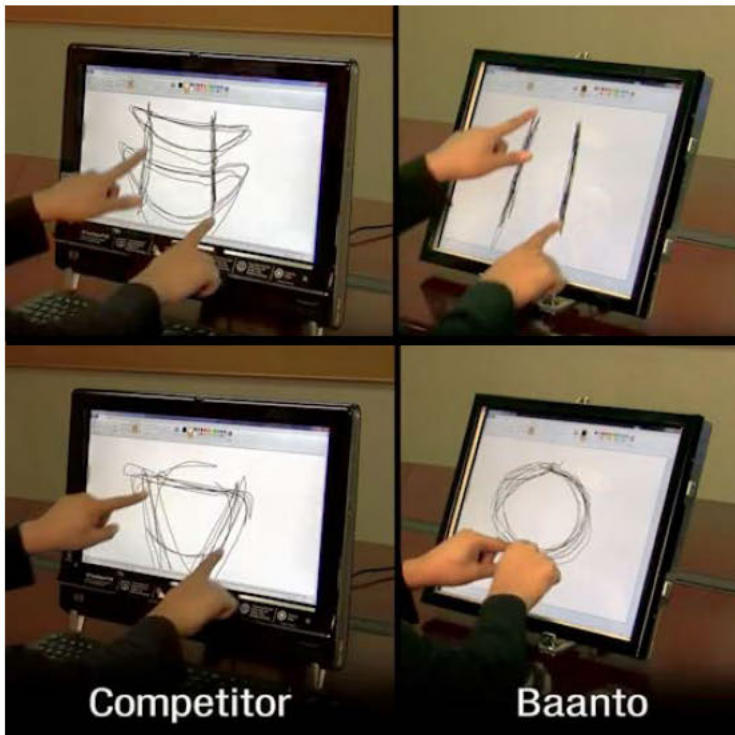

Source: Baanto

❖ Suppliers

- ◆ NextWindow (SMART)
- ◆ Lumio
- ◆ IRTouch
- ◆ Xiroku/eIT
- ◆ Baanto
- ◆ LG Displays
- ◆ Qisda
- ◆ Several more in China

Camera-Based Optical...6

❖ Advantages

- ◆ Stylus independence
- ◆ Scalability to large sizes (15" to 120")
- ◆ Multi-touch (2-5 touches)
- ◆ Object-size recognition
- ◆ Low cost



❖ Disadvantages

- ◆ Profile height (~3 mm on a 19" screen)
- ◆ The "unintended touch" problem
- ◆ Screen rigidity requirement

❖ Applications

- ◆ Consumer touch monitors & AiOs
- ◆ Interactive digital signage, point-of-information, & education

HP TouchSmart all-in-one computer
Source: HP



Camera-Based Optical...7

❖ Optical is able to meet the Win8 touch specifications

- ◆ NextWindow's newest desktop-component product (15" to 30") uses six CMOS cameras (4 in the corners + 2 on the top edge)

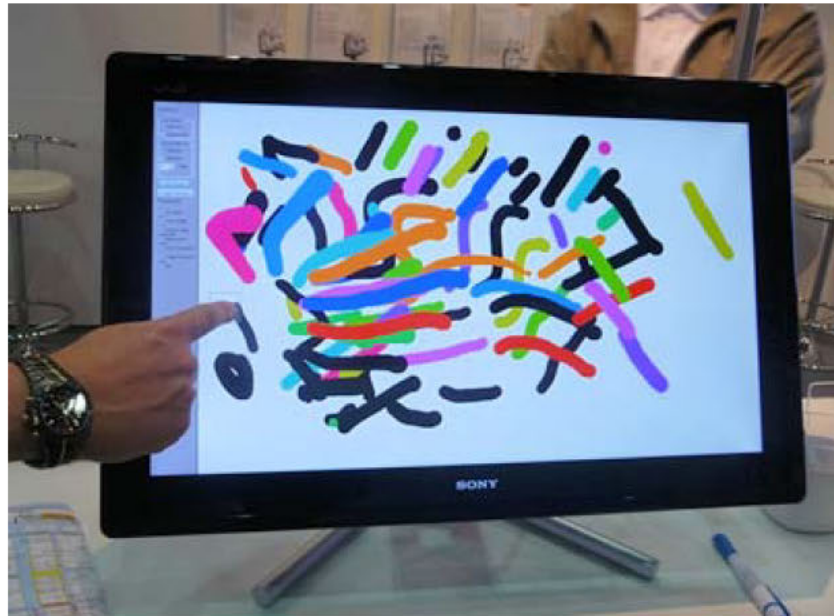

Source: Jennifer Colegrove (DisplaySearch) at FineTech 2012

Camera-Based Optical...8

- ❖ The range of form-factors and configurations in which optical touch is used is expanding

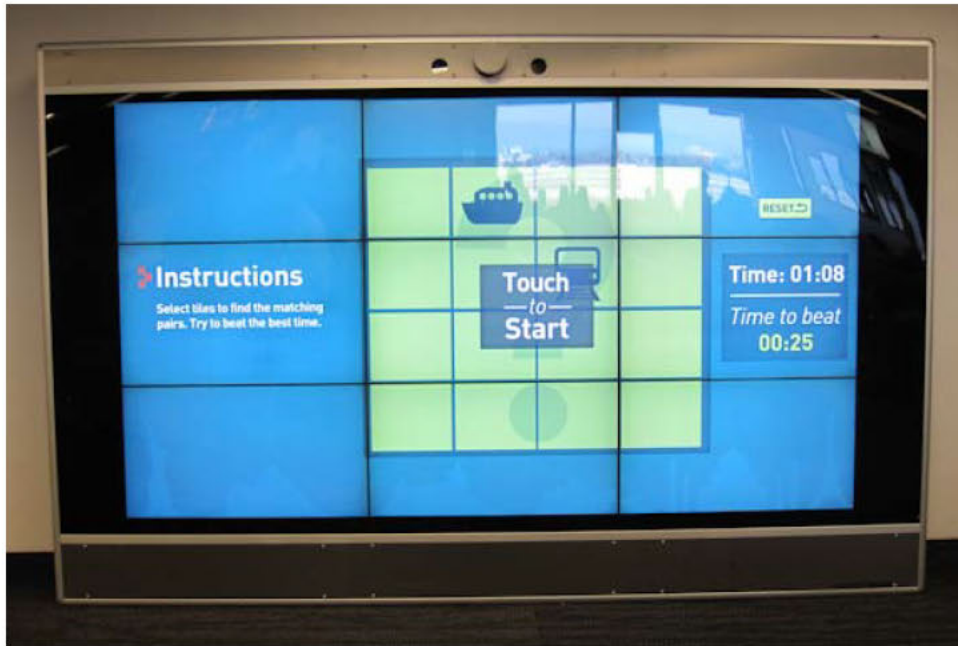

Source: Photos by Author

Cameras & lasers
at top of video wall

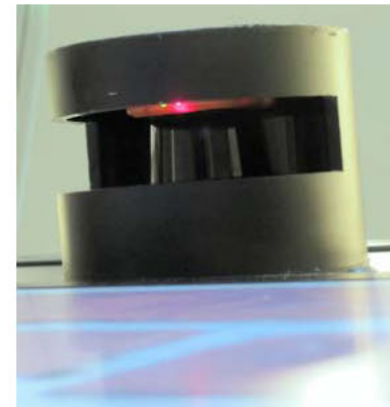

Camera-Based Optical...9

❖ Outlook

- ◆ Touch on the consumer desktop (in Win7 AiOs) failed to take off due to lack of any applications
 - Touch penetration hit 30% in 2010 but dropped to ~10% in 2012
- ◆ Win8 may drive more penetration, but there is still the “gorilla arm” usage-model question
 - “Adaptive” AiOs will help address that issue
- ◆ Camera-based optical touch is ideal for large-format, but...
 - The interactive digital-signage market hasn't emerged yet
 - Interactive information on large screens is still a niche market
 - The education market (whiteboards) has been slow to adopt optical because of entrenched resistive and electromagnetic technologies



Dell ST2220T (Win7) Touch Monitor



Source: FlatFrog

Planar Scatter Detection (PSD)

Planar Scatter Detection...1

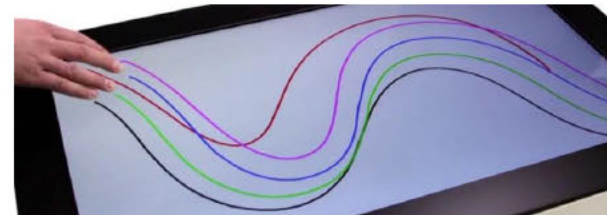
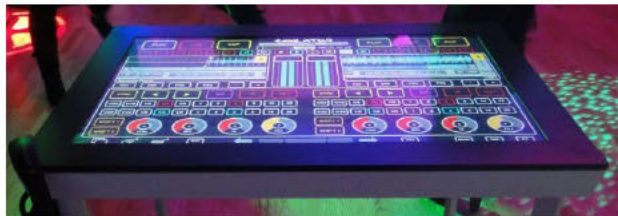
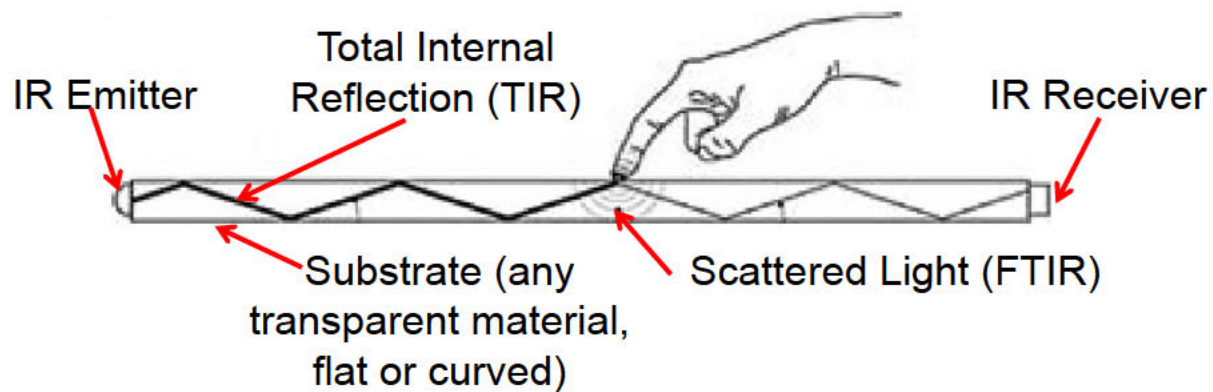

Source: FlatFrog

Planar Scatter Detection...2

❖ Characteristics it shares with p-cap

- ◆ Flush surface (“zero bezel”)
- ◆ Very light touch
- ◆ Multi-touch (40 touches)
- ◆ Windows 8 Logo

❖ Characteristics that are better than p-cap

- ◆ Plain glass or plastic substrate (0.3 mm) – no ITO
- ◆ Works with glove, stylus or other objects (400 dpi)
- ◆ Pressure-sensitive (10 bits)
- ◆ Insensitive to EMI/RFI
- ◆ High scan-rate for larger screens (up to 1 KHz)
- ◆ Lower cost



Source: FlatFrog

Planar Scatter Detection...3

❖ Size range

- ◆ 32" (with display) at launch in May, 2012
- ◆ Practical size range 15" to 84"

❖ Disadvantages

- ◆ Initial product is a 32" display for \$5,500 MSRP (+\$190 housing)
- ◆ Designed for indoor use (no sunlight) without dust or smoke
 - Limited to 30°C ambient due to display
 - Sensitive to contamination on surface
- ◆ Scaling to larger sizes is similar to traditional infrared
 - ~200 IR emitter-receiver pairs required for 32" display; 96 pairs for 22"
- ◆ FlatFrog is a small company with limited resources

Planar Scatter Detection...4

❖ Applications

- ◆ Realistic today: Gaming, digital signage, POI, medical, hospitality, command & control
- ◆ Future: consumer electronics, education

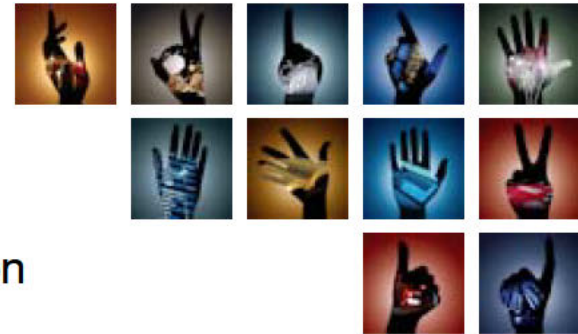

Source: FlatFrog

❖ Full disclosure:

- ◆ Intel has invested in and is doing a joint development project with FlatFrog to extend and improve the technology beyond what they have already done
 - Current focus is on all-in-one PCs (20" to 30")
- ◆ Supply-chain (availability) will also be improved

Optical-Touch Startup: RAPT

❖ RAPT

- ◆ “*Opto-electro-mechanical*” (rumored to be similar to FlatFrog)
- ◆ “*The most robust multi-touch system on the planet and quite different from current solutions in the market*”

	<u>Capacitive</u>	<u>Optical</u>	<u>RAPT</u>
Multi-touch Robustness	✓		✓
Small Screen	✓		✓
Ambient Light Performance	✓		✓
Flush Display	✓		✓
Cost Effectiveness		✓	✓
Large Screen		✓	✓
Glove and Stylus		✓	✓
Curved Surfaces			✓

Source: RAPT Website





Source: Perceptive Pixel

Vision- Based

Vision-Based...1

❖ Principle (simplest version)

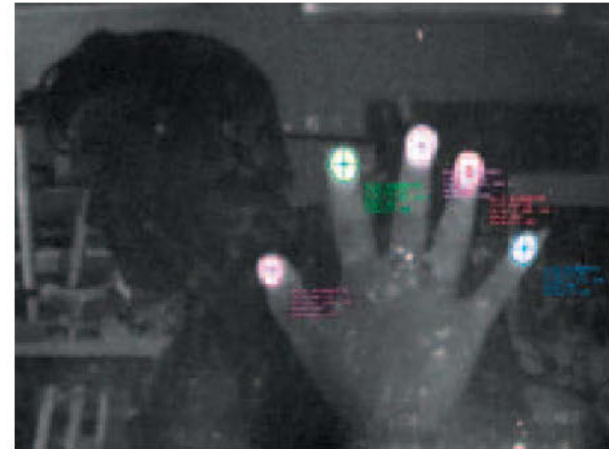
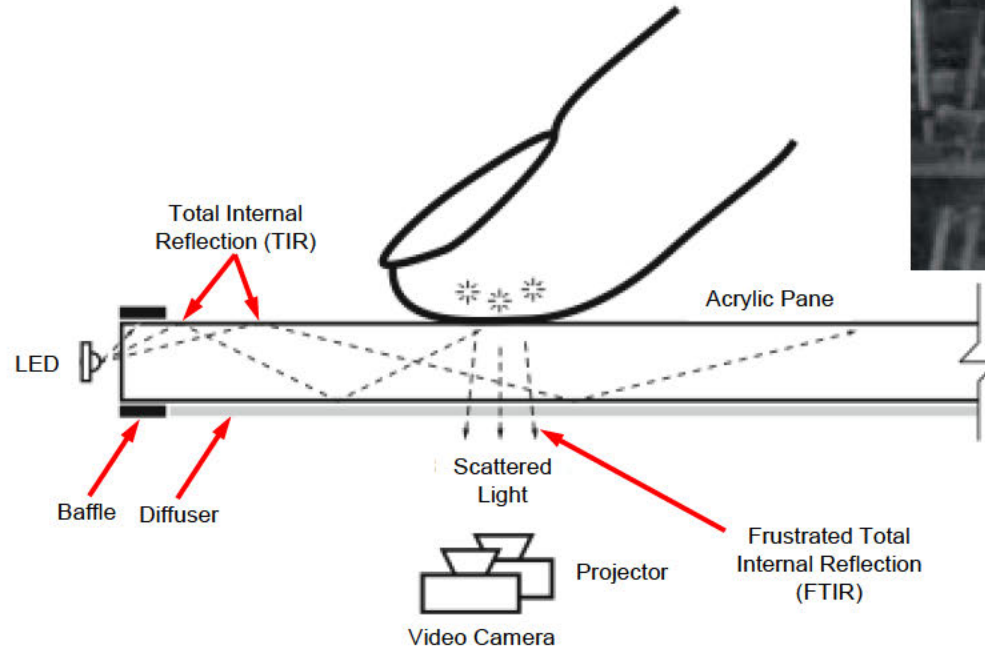

Multiple touch points;
Image taken without a diffuser
(Source: Perceptive Pixel)

Source: Perceptive Pixel

Vision-Based...2

Microsoft Surface (v1, 2007)

“Surface computing is about integrating the physical and virtual worlds through the use of vision-based touch”

Source: [Information Display](#)

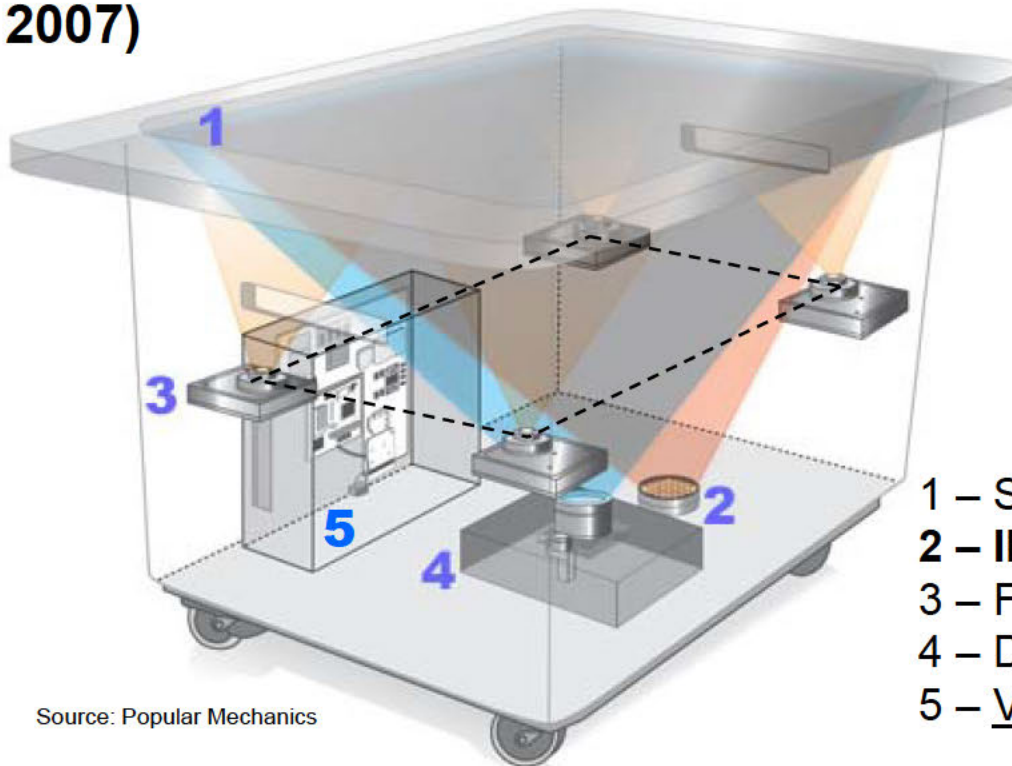

Projector
resolution
1024x768

Touch
resolution
1280x960

- 1 – Screen with diffuser
- 2 – IR LED light source
- 3 – Four IR cameras
- 4 – DLP projector
- 5 – Vista desktop

Source: Popular Mechanics

Vision-Based...3

❖ Samsung SUR40 with Microsoft Surface (v2.0, 2012)



Document
on surface



Source: Microsoft



Source: TechCrunch.com

Vision-Based...4

❖ Samsung SUR40

- ◆ 40" full-HD (1920x1080) Samsung LCD (55 ppi)
 - 4" thickness includes 2.9 GHz PC with embedded 64-bit Win-7
- ◆ Corning Gorilla Glass bonded to LCD
 - Display still has some bezel height (not a flush surface)
- ◆ **In-cell touch: 8 display pixels per aSiGe IR light sensor** (8 ppi)
 - By far the most sophisticated in-cell light-sensing so far
 - IR light source is added to the backlight
 - aSiGe sensor is 15X more sensitive than aSi, but that means the touch-screen is **15X more sensitive to ambient IR**
- ◆ 50+ simultaneous touch points
 - Surface image-processing software is Microsoft's primary value-add
- ◆ \$8,400 – targeted at enterprise
- ◆ Microsoft has a 3-4 year exclusive on the SUR40, which means that Samsung doesn't see much value for themselves

Vision-Based...5

❖ MultiTaction embedded-camera display

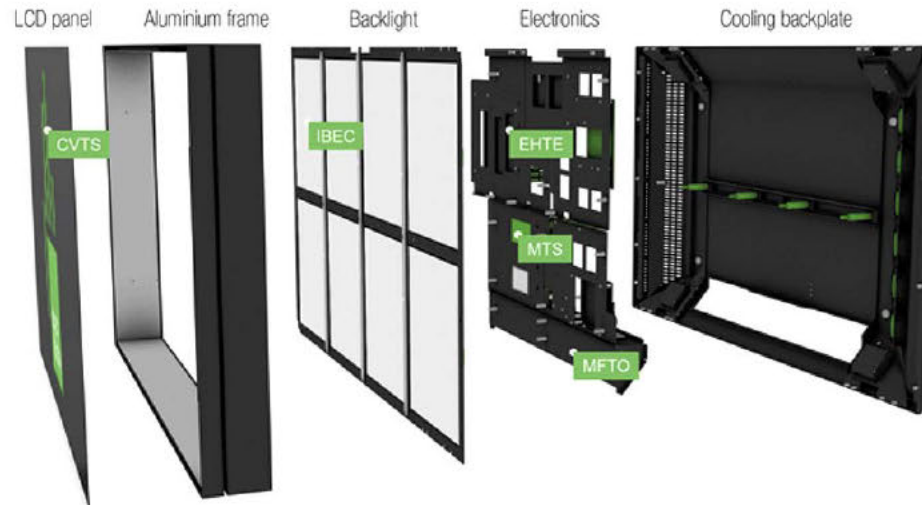

- CVTS = Computer Vision Through Screen
- IBEC = Integrated Backlight Emitter Camera
- MTS = Matrix Tracking System
- EHTe = Extensible Hybrid Tracking Engine
- MFTO = Multi-Format Tracking Output

Vision-Based...6

❖ MultiTaction advantages

- ◆ Immune to external lighting conditions
 - Reads both ambient light and reflected light from IR backlight emitters
- ◆ Unlimited number of touch points and users
 - Identifies hands, not just touch points
- ◆ Object recognition using 2D markers and generic shape-recognition
- ◆ Works with IR-emitting stylus
 - Clear differentiation between finger and stylus
- ◆ Supports Windows, Mac OS X, and Linux
 - Outputs touch data in TUIO, XML or Windows-Touch format
 - Works with all third-party software development platforms and most commercial multi-touch software suites
- ◆ Modular displays can be formed into multi-user interactive walls

Vision-Based...7

❖ Advantages

- ◆ Ideal data source for analysis by image-processing software
- ◆ Object recognition by “reading” tokens on objects
- ◆ Potentially unlimited number of touch points

❖ Disadvantages

- ◆ Projection
 - All the usual disadvantages of projection
- ◆ LCD in-cell light-sensing (SUR40)
 - High sensitivity to ambient IR
- ◆ Embedded cameras (MultiTaction)
 - Display thickness and cost

❖ Applications

- ◆ Interactive “video walls”; digital signage; high-end retail
- ◆ University research (low-cost, easy to build)



Source: NORTD

http://www.maximumpc.com/article/features/build_your_own_multitouch_surface_computer?page=0,0

Other Touch Technologies

❖ Force-Sensing

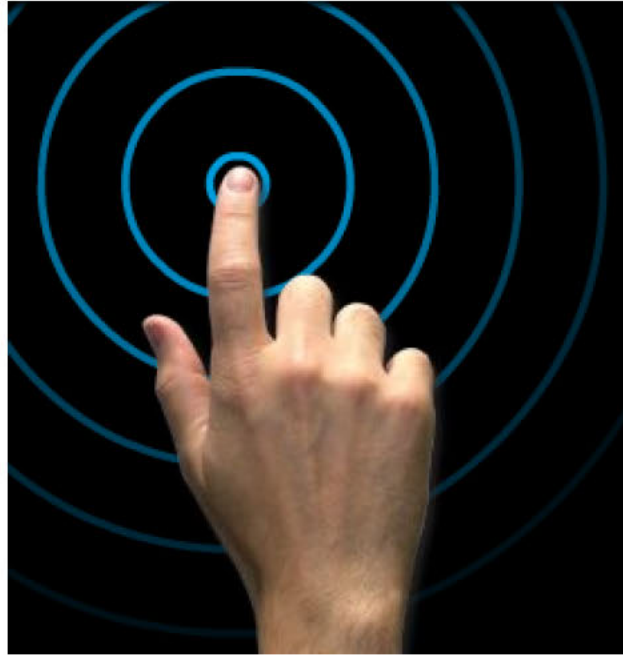

Source: Vissumo

Force Sensing

Force Sensing...1

❖ Original Principle

- ◆ Suspend the touch-screen from force-sensors (strain gauges or piezos) such that movement is constrained to only the z-axis

❖ Variations

- ◆ **IBM “TouchSelect”**: Strain gauges (early 1990s, unsuccessful)
- ◆ **Vissumo**: “Beam-mounted” sensors (ran out of money in 2009)
- ◆ **F-Origin**: “Spring-arm mounted” sensors (recovered well after shrinking to just one person)
- ◆ **FloatingTouch**: “Flexible adhesive pad” sensors **(start-up)**
- ◆ **NextInput**: “Array of pressure-sensitive organic transistors under display” **(start-up)**

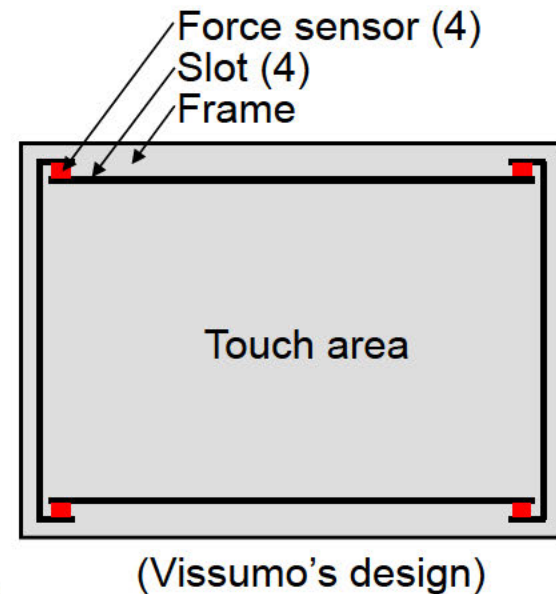

Force Sensing...2

Vissumo's Amazing Demo Box

4 strain gauges supporting one touch panel

Glass-covered LCD integrated into touch panel with "soft keys" printed on back of glass

Irregularly shaped, raised, textured, wooden touch surface
Motor attached to and penetrating touch panel with printed speed control keys and push-pull control lever

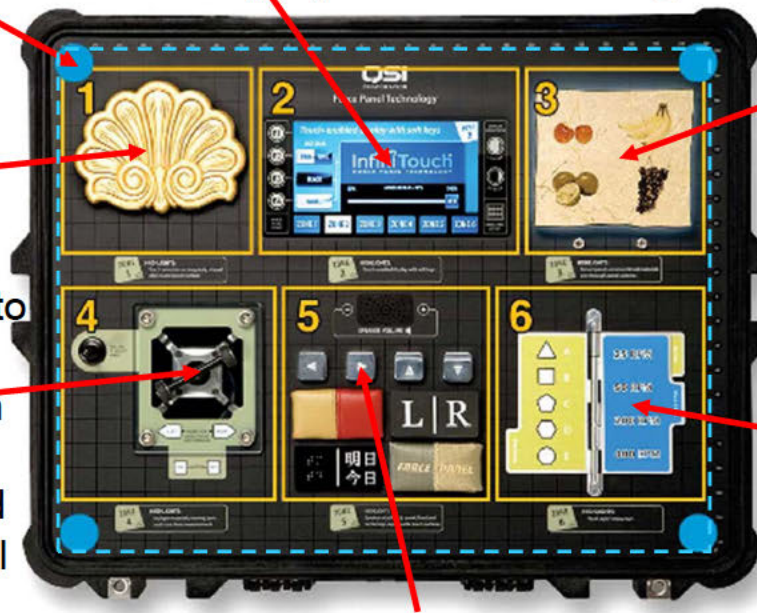

Raised, marble touch surface with toggle switches penetrating touch panel

Multi-page "book" with touchable & movable metal pages

"Snap-dome" keys attached to touch panel; removable padded and textured keys; speaker attached with holes through the touch panel.

Source: Photo by author

Force Sensing...3

❖ F-Origin's spring-arm suspension

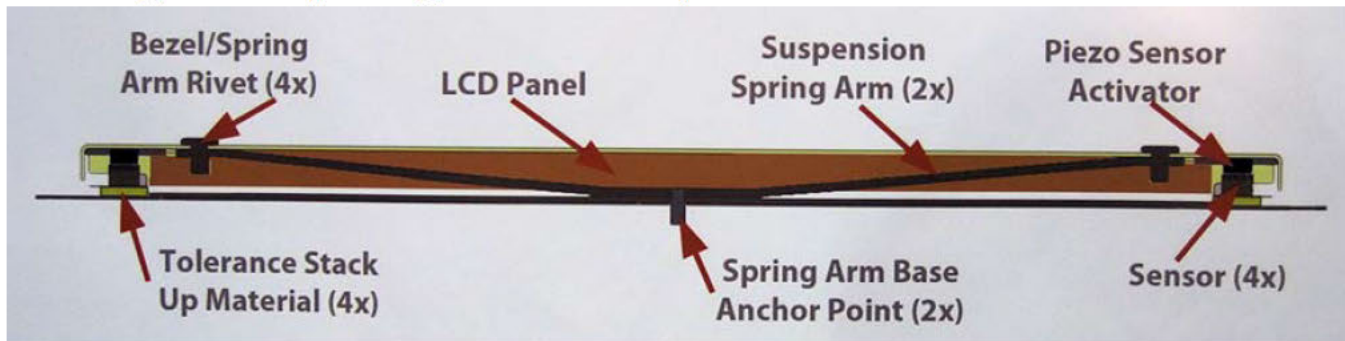

❖ F-Origin's system block diagram

Source: F-Origin

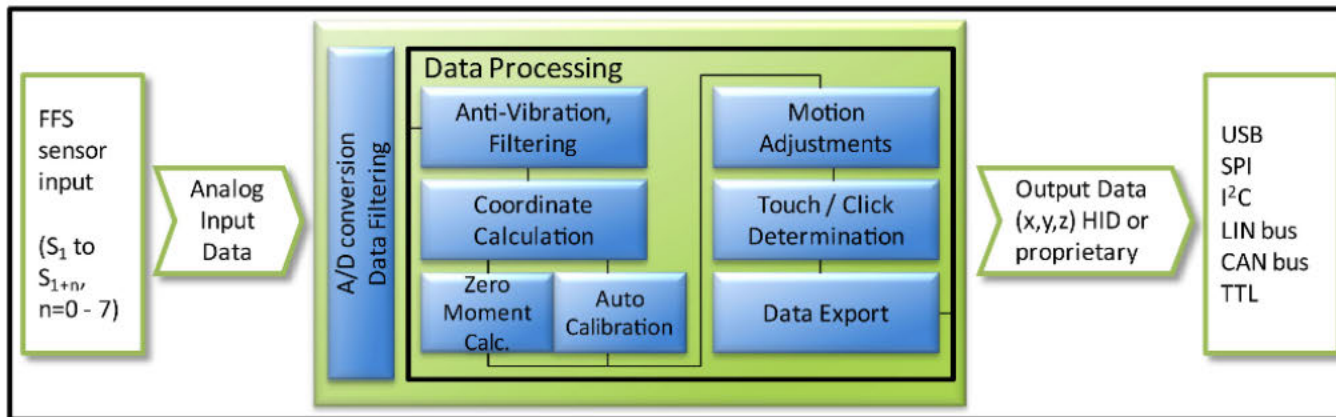

Force Sensing...4

❖ Advantages

- ◆ Touch-object independence (touch with anything)
- ◆ Touch-surface independence (any rigid material)
 - Can use bezel or zero-bezel
 - No other touch technology can handle 3D substrates with embedded moving objects
- ◆ Adjustable sensitivity (press lightly to highlight, harder to select)
 - Minimizes false touches
- ◆ Continuous calibration filters out environmental conditions

❖ Disadvantages

- ◆ Limited multi-touch (2-touch = 8 sensors)
- ◆ Mechanical nature reduces reliability
- ◆ Most sensors add volume

❖ Applications

- ◆ Mostly commercial, although NextInput is aiming at consumer



Source: Vissumo

Conclusions

- ❖ Touch Technology versus Application
- ❖ Usability, Performance, & Integration Characteristics
- ❖ Touch Technology Primary Advantages and Flaws
- ❖ Prediction of the Future

Touch Technology vs. Application

Application	Example	Touch Technologies														
		Analog Resistive	Multi-Touch Resistive	Surface Capacitive	Projected Capacitive	SAW	Traditional IR	Waveguide IR	Optical	APR	DST	Force Sensing	LCD In-Cell (Light)	LCD In-Cell (Voltage)	LCD In-Cell (Charge)	LCD On-Cell (Charge)
Kiosk Point of Info (POI)	Museum information	○	X	○	X	○	○	X	○	○	○	X	X	X	X	X
Kiosk Commerce	Digital photo printing	○	X	○	○	○	X	X	X	○	○	X	X	X	X	X
Kiosk Ruggedized	Gas pump	X	X	○	○	○	○	X	X	X	X	○	X	X	X	X
Point of Sale (POS)	Restaurant; lottery	○	X	○	○	○	○	X	X	○	X	○	X	X	X	X
Office Automation	Office monitor	○	X	○	X	○	X	X	X	X	X	X	X	X	X	X
Industrial Control	Machine control	○	○	○	X	○	○	X	X	X	X	○	X	X	X	X
Medical Equipment	Medical devices	○	X	X	○	○	X	X	X	○	X	X	X	X	X	X
Healthcare	Patient info monitor	○	X	X	X	○	X	X	X	○	X	X	X	X	X	X
Military Fixed & Mobile	Submarine console	○	X	○	X	X	○	X	X	X	X	X	X	X	X	X
Training & Conference	Boardroom display	○	X	X	X	○	○	X	○	X	○	X	X	X	X	X
Legal Gaming	Casino machine	X	X	○	X	X	X	X	X	X	X	X	X	X	X	X
Amusement Gaming	Bar-top game	X	X	○	X	○	X	X	X	○	X	X	X	X	X	X
In-Vehicle	GPS navigation	○	X	X	○	X	X	○	X	X	X	X	X	X	X	X
ATM Machine	ATM machine	X	X	○	○	○	○	X	X	X	X	X	X	X	X	X
Mobile Device	Smartphone	○	○	X	○	X	X	○	X	○	X	○	○	○	○	○
Appliance	Refrigerator door	○	X	X	○	X	X	X	X	○	X	X	X	X	X	X
Architectural	Elevator control	X	○	X	X	X	X	X	X	X	X	○	X	X	X	X
Consumer AiO & Monitor	HP TouchSmart	○	X	X	X	○	X	X	○	X	X	X	X	X	X	X
Music Controller	Jazz Mutant	○	○	X	○	X	X	X	X	X	X	X	X	X	X	X
Digital Signage	Thru-window store	X	X	X	○	○	○	X	○	○	○	X	X	X	X	X

13 Usability Characteristics

Desirable Characteristic	Touch Technologies														
	Analog Resistive	Multi-Touch Resistive	Surface Capacitive	Projected Capacitive	SAW	Traditional IR	Waveguide IR	Optical	APR	DST	Force Sensing	LCD In-Cell (Light)	LCD In-Cell (Voltage)	LCD In-Cell (Charge)	LCD On-Cell (Charge)
Usability															
Touch with any object	H	H	L	L	M	H	H	H	H	H	H	M	M	M	L
No unintended touch	H	H	H	H	H	L	L	L	H	H	H	H	H	H	H
Multi-touch	L	H	L	H	M	M	M	M	L	L	L	H	H	H	H
Touch & hold	H	H	H	H	H	H	H	H	L	L	H	H	H	H	H
High durability	L	L	M	H	H	H	H	H	H	H	H	M	L	L	H
High sensitivity (light touch)	M	M	H	H	M	H	H	H	M	H	L	H	H	H	H
Fast response & drag	M	M	H	H	M	M	H	H	M	H	L	L	H	M	M
Stable calibration	M	H	L	H	H	H	H	H	H	H	H	H	H	H	H
Very smooth surface	L	L	H	M	M	M	M	M	M	M	M	M	L	L	M
No liquid crystal pooling	H	H	H	H	H	H	H	H	H	H	H	H	L	L	H
Resistant to contaminants	H	H	M	H	L	M	L	M	H	H	H	L	L	L	H
Works in rain, snow & ice	H	H	L	H	L	L	L	L	L	L	H	L	L	L	H
Works with scratches	L	L	M	H	H	H	H	H	M	H	H	L	L	L	H

13 Performance Characteristics

Desirable Characteristic	Touch Technologies														
	Analog Resistive	Multi-Touch Resistive	Surface Capacitive	Projected Capacitive	SAW	Traditional IR	Waveguide IR	Optical	APR	DST	Force Sensing	LCD In-Cell (Light)	LCD In-Cell (Voltage)	LCD In-Cell (Charge)	LCD On-Cell (Charge)
Performance															
High optical performance	L	L	M	M	H	H	H	H	H	H	H	H	H	H	M
High resolution	H	M	H	H	M	L	H	H	M	M	L	M	H	L	H
High linearity	H	H	M	M	M	M	H	M	M	M	H	H	H	H	M
High accuracy & repeatability	H	M	M	H	H	M	H	M	M	M	H	H	H	H	H
Low power consumption	H	H	L	M	L	L	M	M	H	L	H	H	L	M	M
Insensitive to vibration	H	H	H	H	H	H	H	H	H	M	L	H	H	H	H
Insensitive to EMI & RFI	H	H	L	L	H	H	H	H	H	H	H	L	L	L	M
Insensitive to ambient light	H	H	H	H	H	M	H	M	H	H	H	L	H	H	H
Insensitive to UV light	L	L	H	H	H	H	H	H	H	H	H	H	M	M	H
Touch-object size recognition	L	M	L	H	L	L	H	H	L	L	L	M	H	M	H
Measures Z-axis	L	L	L	M	M	L	L	L	L	L	L	L	L	L	M
Handwriting recognition	H	M	L	M	L	L	M	H	L	L	L	M	H	L	M
Works with bi-stable reflective	H	H	L	H	L	L	M	L	H	L	L	M	L	L	H

13 Integration Characteristics

Desirable Characteristic	Touch Technologies														
	Analog Resistive	Multi-Touch Resistive	Surface Capacitive	Projected Capacitive	SAW	Traditional IR	Waveguide IR	Optical	APR	DST	Force Sensing	LCD In-Cell (Light)	LCD In-Cell (Voltage)	LCD In-Cell (Charge)	LCD On-Cell (Charge)
Integration															
Substrate independence	M	M	L	H	L	H	H	H	L	L	H	L	L	L	L
Scalable	M	L	M	H	M	M	L	H	H	H	H	L	L	L	L
Easy integration	H	M	L	L	M	M	M	H	L	L	M	H	H	H	H
Flush surface (low profile)	M	M	M	H	M	L	M	L	H	H	M	H	M	M	H
Narrow border width	H	M	M	H	L	L	M	L	H	H	M	H	H	H	H
Thin and light	H	H	L	H	L	L	M	L	L	L	L	H	H	H	H
Easy to seal	H	H	H	H	L	M	M	L	H	H	M	M	L	L	M
Can be vandal-proofed	L	L	M	H	H	M	M	L	H	H	H	L	L	L	L
Works on curved surface	M	M	L	H	L	L	L	L	L	L	H	H	L	L	H
Can be laminated to LCD	H	H	H	H	M	M	H	H	L	L	L	H	H	H	H
HID (Plug & Play) interface	L	L	L	L	L	L	L	H	L	H	L	L	L	L	L
Simple controller	H	M	L	L	L	L	M	M	M	L	H	L	H	M	M
Controller chip available	H	H	L	H	H	L	H	L	H	L	H	L	L	L	L

There Is No Perfect Touch Technology!

Touch Technology	Major Advantage	Major Flaw
Projected Capacitive	Multi-touch	High cost
Surface Capacitive	Touch sensitivity	High drift
Analog Resistive	Low cost	Low durability
Analog Multi-Touch Resistive	Multi-touch	Resolution
Digital Multi-Touch Resistive	High resolution	Low durability
Surface Acoustic Wave	Durability	Soft touch object
Acoustic Pulse Recognition	Any touch-object	No touch & hold
Dispersive Signal Technology	Any touch-object	No touch & hold
Traditional Infrared	Reliability	High cost
Waveguide Infrared	Low cost	Contamination
Multi-Touch Infrared	Multi-touch	Performance
Camera-Based Optical	Scalability	Profile height
Planar Scatter Detection	Flush surface	High cost
Vision-Based	Multi-touch	Rear projection
Embedded (Hybrid & On-Cell)	Integration	Volume required
Embedded (Light-Sensing)	Integration	Ambient IR
Force-Sensing	3D substrate	Multi-touch

A Prediction of Which Technologies Will Win in the Next Five Years...1

Application	Winning Technology	Runner-Up Technology
Automotive	Projected Capacitive	Analog Resistive
Casino Gaming	Projected Capacitive	Surface Capacitive
Consumer AiOs and Monitors	Projected Capacitive	Camera-Based Optical
Consumer Games	Analog Resistive	Projected Capacitive
Consumer Tablets & Notebooks	Projected Capacitive	Embedded
Interactive Digital Signage	Camera-Based Optical	Traditional & Multi-Touch Infrared
e-Readers	Traditional Infrared	EMR Stylus
Industrial Terminals	Analog Resistive	Projected Capacitive
Kiosks	Surface Acoustic Wave	Projected Capacitive
Mobile Phones	Projected Capacitive	Embedded
POS Terminals	Analog Resistive	Projected Capacitive

Source: Author (3/13)

A Prediction of Which Technologies Will Win in the Next Five Years...2

#	Touch Technology	5-Year Prediction
1A	Projected Capacitive	Dominant
1B	Surface Capacitive	Significant Reduction
2A	Analog Resistive	Major Reduction
2B	Analog Multi-Touch Resistive (AMR)	Disappear
2C	Digital Multi-Touch Resistive (DMR)	Small Niche
3A	Surface Acoustic Wave (SAW)	Moderate Growth
3B	Acoustic Pulse Recognition (APR)	Small Niche
3C	Dispersive Signal Technology (DST)	Disappear
4A	Traditional Infrared	Reduced Large-Format; Increased Small-Medium
4B	Multi-Touch Infrared	Moderate Growth
4C	Camera-Based Optical	Increased Large-Format; Decreased Desktop
4D	Planar Scatter Detection (PSD)	Viable Niche
4E	Vision-Based	Viable Niche
5	Embedded	Significant Growth
6	Force-Sensing	Disappear

Source: Author (3/13)

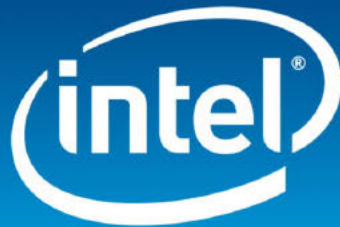

Sponsors of Tomorrow.™

Thank You!

Intel Corporation
2200 Mission College Blvd.
Santa Clara, CA 95054

408-506-7556 mobile
408-765-0056 office
408-765-5101 fax

geoff.walker@intel.com
www.intel.com