

Under the Paperwork Reduction Act of 1995, no persons are required to respond to a collection of information unless it displays a valid OMB control number.

<b>TRANSMITTAL LETTER TO THE UNITED STATES DESIGNATED/ELECTED OFFICE (DO/EO/US) CONCERNING A SUBMISSION UNDER 35 U.S.C. 371</b>		ATTORNEY'S DOCKET NUMBER 2101-3596
		U.S. APPLICATION NO. (if known, see 37 CFR 1.5)
INTERNATIONAL APPLICATION NO. PCT/KR2007/002784	INTERNATIONAL FILING DATE 8 June 2007	PRIORITY DATE CLAIMED 9 June 2006
TITLE OF INVENTION METHOD OF TRANSMITTING DATA IN A MOBILE COMMUNICATION SYSTEM		
APPLICANT(S) FOR DO/EO/US Yeong Hyeon KWON, Seung Hee HAN, Hyun Hwa PARK, Dong Cheol KIM, Hyun Woo LEE and Min Seok NOH		
Applicant herewith submits to the United States Designated/Elected Office (DO/EO/US) the following items and other information:		
<p>1. <input checked="" type="checkbox"/> This is a <b>FIRST</b> submission of items concerning a submission under 35 U.S.C. 371.</p> <p>2. <input type="checkbox"/> This is a <b>SECOND</b> or <b>SUBSEQUENT</b> submission of items concerning a submission under 35 U.S.C. 371.</p> <p>3. <input type="checkbox"/> This is an express request to begin national examination procedures (35 U.S.C. 371(f)). The submission must include items (5), (6), (9) and (21) indicated below.</p> <p>4. <input checked="" type="checkbox"/> The US has been elected (Article 31).</p> <p>5. <input checked="" type="checkbox"/> A copy of the International Application as filed (35 U.S.C. 371(c)(2))</p> <p style="padding-left: 20px;">a. <input checked="" type="checkbox"/> is attached hereto (required only if not communicated by the International Bureau).</p> <p style="padding-left: 20px;">b. <input type="checkbox"/> has been communicated by the International Bureau.</p> <p style="padding-left: 20px;">c. <input type="checkbox"/> is not required, as the application was filed in the United States Receiving Office (RO/US).</p> <p>6. <input type="checkbox"/> An English language translation of the International Application as filed (35 U.S.C. 371(c)(2)).</p> <p style="padding-left: 20px;">a. <input type="checkbox"/> is attached hereto.</p> <p style="padding-left: 20px;">b. <input type="checkbox"/> has been previously submitted under 35 U.S.C. 154(d)(4).</p> <p>7. <input type="checkbox"/> Amendments to the claims of the International Application under PCT Article 19 (35 U.S.C. 371(c)(3))</p> <p style="padding-left: 20px;">a. <input type="checkbox"/> are attached hereto (required only if not communicated by the International Bureau).</p> <p style="padding-left: 20px;">b. <input type="checkbox"/> have been communicated by the international Bureau.</p> <p style="padding-left: 20px;">c. <input type="checkbox"/> have not been made; however, the time limit for making such amendments has NOT expired.</p> <p style="padding-left: 20px;">d. <input type="checkbox"/> have not been made and will not be made.</p> <p>8. <input type="checkbox"/> An English language translation of the amendments to the claims under PCT Article 19 (35 U.S.C. 371(c)(3)).</p> <p>9. <input type="checkbox"/> An oath or declaration of the inventor(s) (35 U.S.C. 371(c)(4)).</p> <p>10. <input type="checkbox"/> An English language translation of the annexes of the International Preliminary Examination Report under PCT Article 36 (35 U.S.C. 371(c)(5)).</p> <p><b>Items 11 to 20 below concern document(s) or information included:</b></p> <p>11. <input type="checkbox"/> An Information Disclosure Statement under 37 CFR 1.97 and 1.98.</p> <p>12. <input type="checkbox"/> An assignment document for recording. A separate cover sheet in compliance with 37 CFR 3.28 and 3.31 is included.</p> <p>13. <input type="checkbox"/> A preliminary amendment.</p> <p>14. <input type="checkbox"/> An Application Data Sheet under 37 CFR 1.76.</p> <p>15. <input type="checkbox"/> A substitute specification.</p> <p>16. <input type="checkbox"/> A power of attorney and/or change of address letter.</p> <p>17. <input type="checkbox"/> A computer-readable form of the sequence listing in accordance with PCT Rule 13ter.3 and 37 CFR 1.821- 1.825.</p> <p>18. <input type="checkbox"/> A second copy of the published International Application under 35 U.S.C. 154(d)(4).</p> <p>19. <input type="checkbox"/> A second copy of the English language translation of the international application under 35 U.S.C. 154(d)(4).</p>		

This collection of information is required by 37 CFR 1.414 and 1.491-1.492. The information is required to obtain or retain a benefit by the public, which is to file (and by the USPTO to process) an application. Confidentiality is governed by 35 U.S.C. 122 and 37 CFR 1.11 and 1.14. This collection is estimated to take 15 minutes to complete, including gathering information, preparing, and submitting the completed form to the USPTO. Time will vary depending upon the individual case. Any comments on the amount of time you require to complete this form and/or suggestions for reducing this burden, should be sent to the Chief Information Officer, U.S. Patent and Trademark Office, U.S. Department of Commerce, P.O. Box 1450, Alexandria, VA 22313-1450. DO NOT SEND FEES OR COMPLETED FORMS TO THIS ADDRESS. SEND TO: Mail Stop PCT, Commissioner for Patents, P.O. Box 1450, Alexandria, VA 22313-1450. Page 1 of 3

EVOLVED-0001646

ZTE/HTC

Exhibit 1005-0001

Under the Paperwork Reduction Act of 1995, no persons are required to respond to a collection of information unless it displays a valid OMB control number.

U.S. APPLICATION NO. (if known, see 37 CFR 1.5)		INTERNATIONAL APPLICATION NO. PCT/KR2007/002784		ATTORNEY'S DOCKET NUMBER 2101-3596	
20. Other items or information:					
The following fees have been submitted				CALCULATIONS PTO USE ONLY	
21. <input checked="" type="checkbox"/> Basic national fee (37 CFR 1.492(a))..... \$330				\$ 330	
22. <input checked="" type="checkbox"/> Examination fee (37 CFR 1.492(c))				\$ 220	
If the written opinion prepared by ISA/US or the international preliminary examination report prepared by IPEA/US indicates all claims satisfy provisions of PCT Article 33(1)-(4)..... \$0					
All other situations..... \$220					
23. <input checked="" type="checkbox"/> Search fee (37 CFR 1.492(b))				\$ 540	
If the written opinion of the ISA/US or the International preliminary examination report prepared by IPEA/US indicates all claims satisfy provisions of PCT Article 33(1)-(4)..... \$0					
Search fee (37 CFR 1.445(a)(2)) has been paid on the international application to the USPTO as an International Searching Authority..... \$100					
International Search Report prepared by an ISA other than the US and provided to the Office or previously communicated to the US by the IB..... \$430					
All other situations..... \$540					
<b>TOTAL OF 21, 22 and 23 =</b>				<b>1,090</b>	
<input type="checkbox"/> Additional fee for specification and drawings filed in paper over 100 sheets (excluding sequence listing in compliance with 37 CFR 1.821(c) or (e) in an electronic medium or computer program listing in an electronic medium) (37 CFR 1.492(j)). The fee is \$270 for each additional 50 sheets of paper or fraction thereof.					
Total Sheets	Extra Sheets	Number of each additional 50 or fraction thereof (round up to a whole number)		RATE	
- 100 =	/50 =			x \$270	\$
Surcharge of \$130.00 for furnishing any of the search fee, examination fee, or the oath or declaration after the date of commencement of the national stage (37 CFR 1.492(h)).					
				\$	
CLAIMS	NUMBER FILED	NUMBER EXTRA	RATE	\$	
Total claims	31	- 20 = 11	x \$ 52	\$ 572	
Independent claims	7	- 3 = 4	x \$220	\$ 880	
MULTIPLE DEPENDENT CLAIM(S) (if applicable)				+ \$390	\$ 390
<b>TOTAL OF ABOVE CALCULATIONS =</b>				\$	
<input type="checkbox"/> Applicant claims small entity status. See 37 CFR 1.27. Fees above are reduced by 1/2.					
<b>SUBTOTAL =</b>				\$ 2,932	
Processing fee of \$130.00 for furnishing the English translation later than 30 months from the earliest claimed priority date (37 CFR 1.492(i)).					
				+	\$
<b>TOTAL NATIONAL FEE =</b>				\$ 2,932	
Fee for recording the enclosed assignment (37 CFR 1.21(h)). The assignment must be accompanied by an appropriate cover sheet (37 CFR 3.28, 3.31). \$40.00 per property					
				+	\$
<b>TOTAL FEES ENCLOSED =</b>				\$ 2,932	
				Amount to be refunded:	\$
				Amount to be charged	\$ 2,932

Under the Paperwork Reduction Act of 1995, no persons are required to respond to a collection of information unless it displays a valid OMB control number.

- a.  A check in the amount of \$ \_\_\_\_\_ to cover the above fees is enclosed.
- b.  Please charge my Deposit Account No. 502290 in the amount of \$ 2,932 to cover the above fees.
- c.  The Commissioner is hereby authorized to charge any additional fees which may be required, or credit any overpayment to Deposit Account No. 502290.
- d.  Fees are to be charged to a credit card. **WARNING:** Information on this form may become public. **Credit card information should not be included on this form.** Provide credit card information and authorization on PTO-2038. The PTO-2038 should only be mailed or faxed to the USPTO. However, when paying the basic national fee, the PTO-2038 may NOT be faxed to the USPTO.

**ADVISORY:** If filing by EFS-Web, do **NOT** attach the PTO-2038 form as a PDF along with your EFS-Web submission. Please be advised that this is **not** recommended and by doing so your **credit card information may be displayed via PAIR**. To protect your information, it is recommended paying fees online by using the electronic payment method.

**NOTE:** Where an appropriate time limit under 37 CFR 1.495 has not been met, a petition to revive (37 CFR 1.137(a) or (b)) must be filed and granted to restore the International Application to pending status.

SEND ALL CORRESPONDENCE TO:

Jonathan Y. Kang, Esq.  
Lee, Hong, Degerman, Kang & Waimey  
At the address associated with  
Customer No. 35884

/Lew Edward V. Macapagal/

SIGNATURE

Lew Edward V. Macapagal

NAME

55,416

REGISTRATION NUMBER

FIG. 1

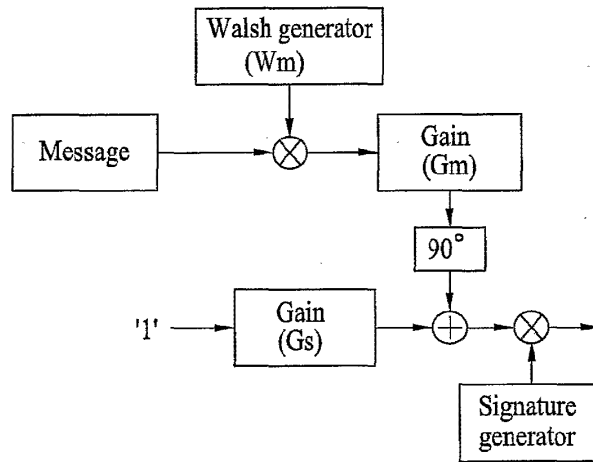
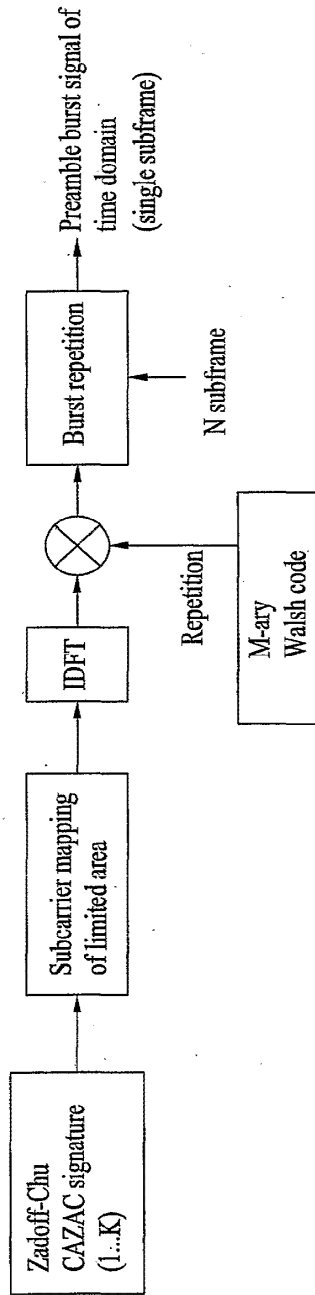



FIG. 2



3/22

FIG. 3A

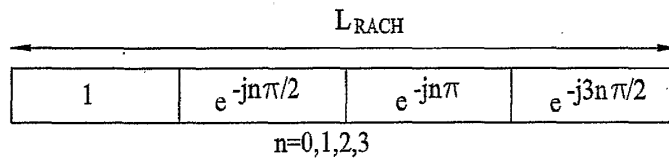

FIG. 3B

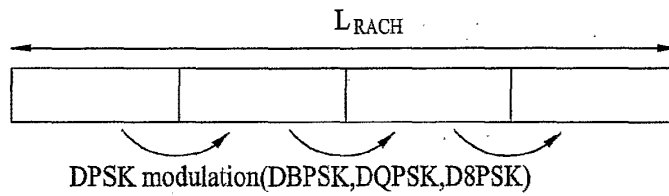

FIG. 4A

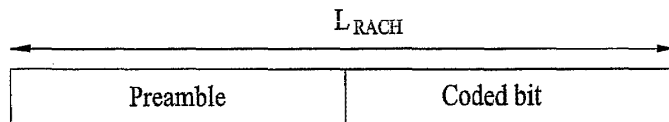

FIG. 4B

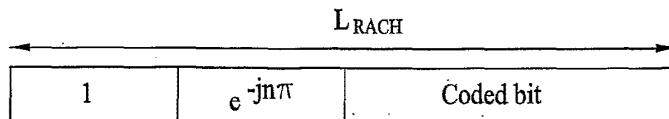
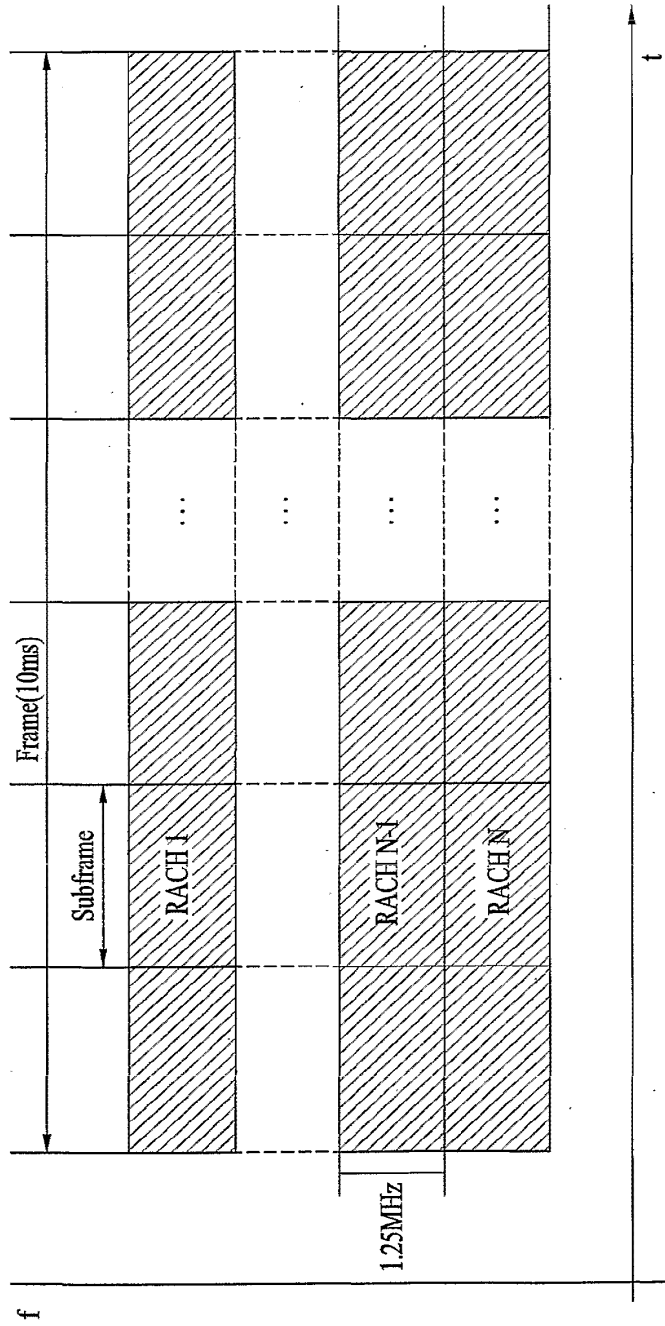

FIG. 5



5/22

FIG. 6A

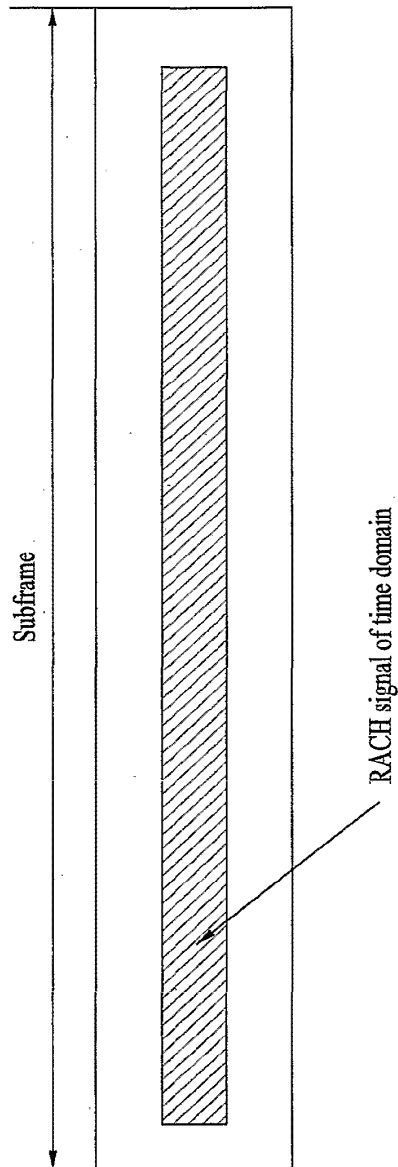

FIG. 6B

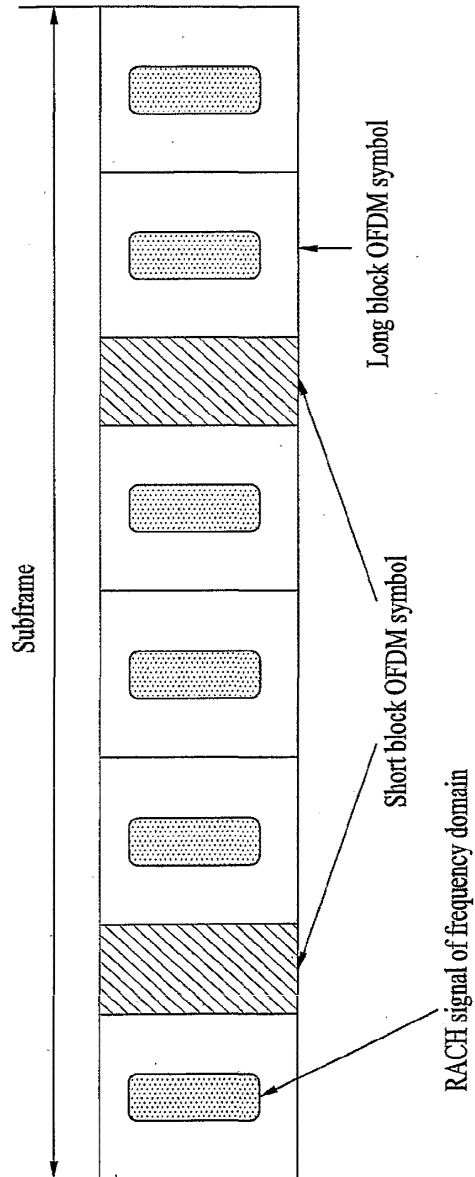

FIG. 7

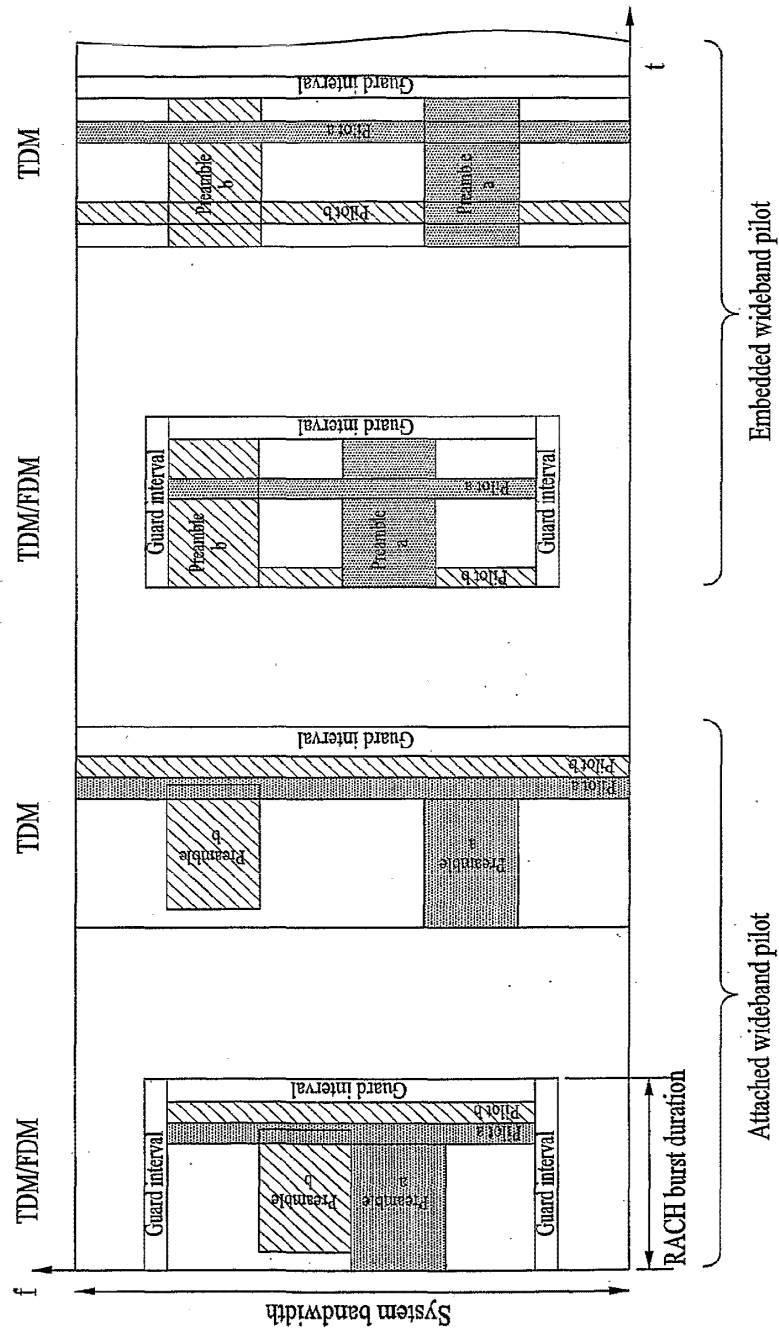
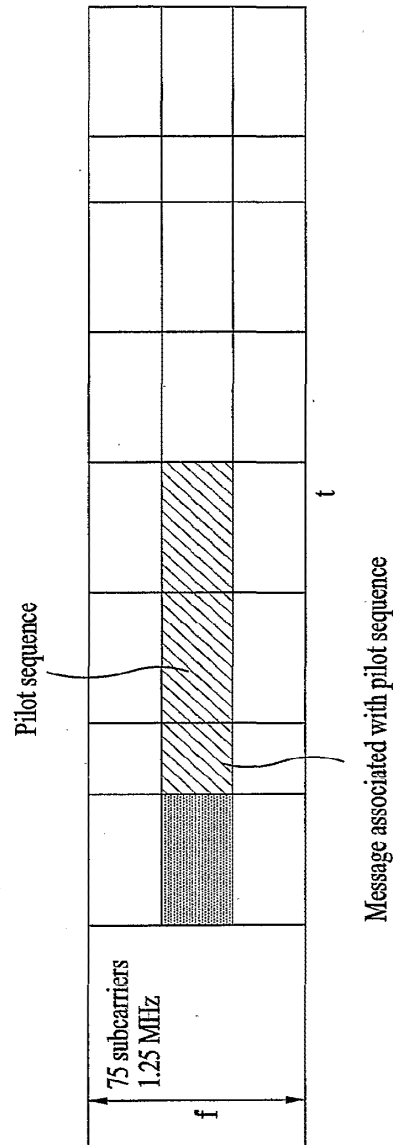
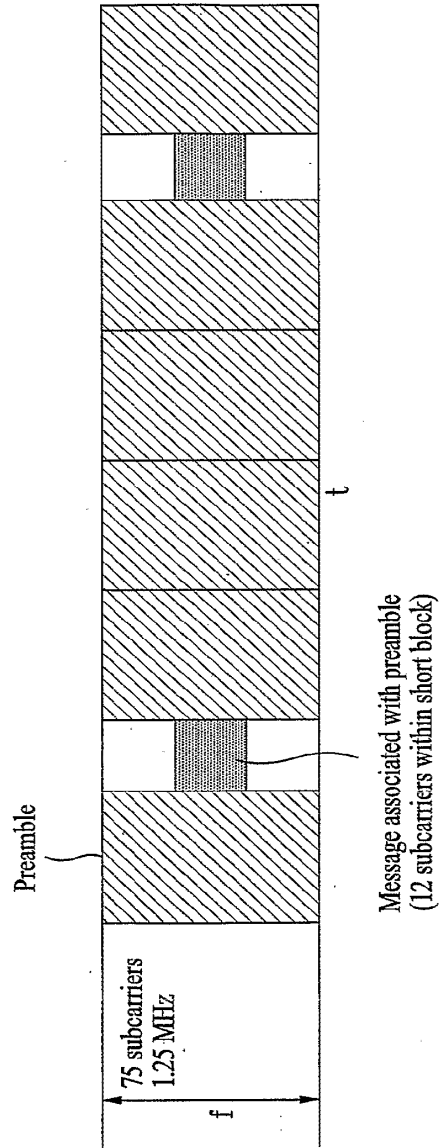

FIG. 8A



9/22

FIG. 8B





10/22

FIG. 9

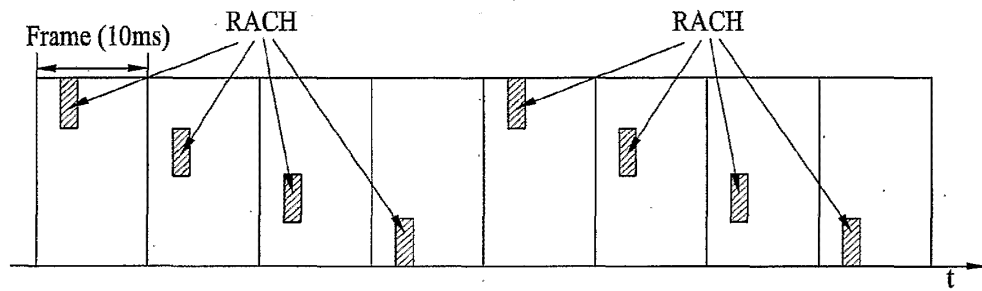

11/22

FIG. 10

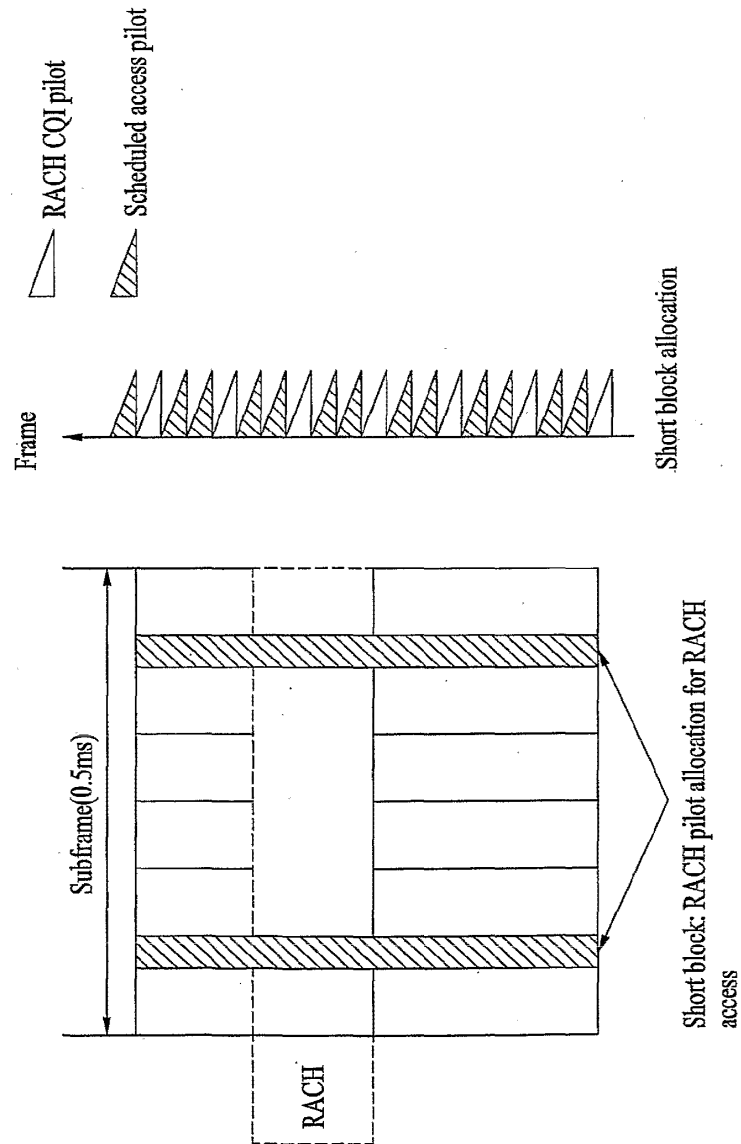

12/22

FIG. 11

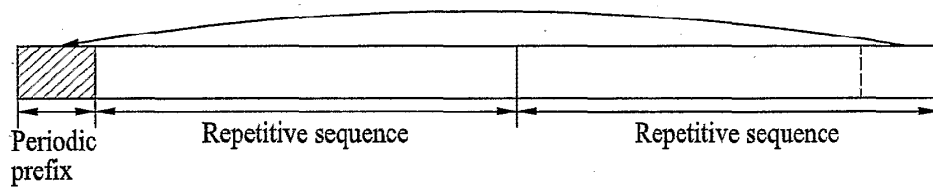

FIG. 12

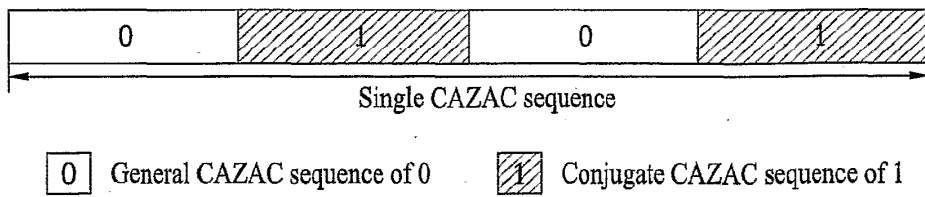
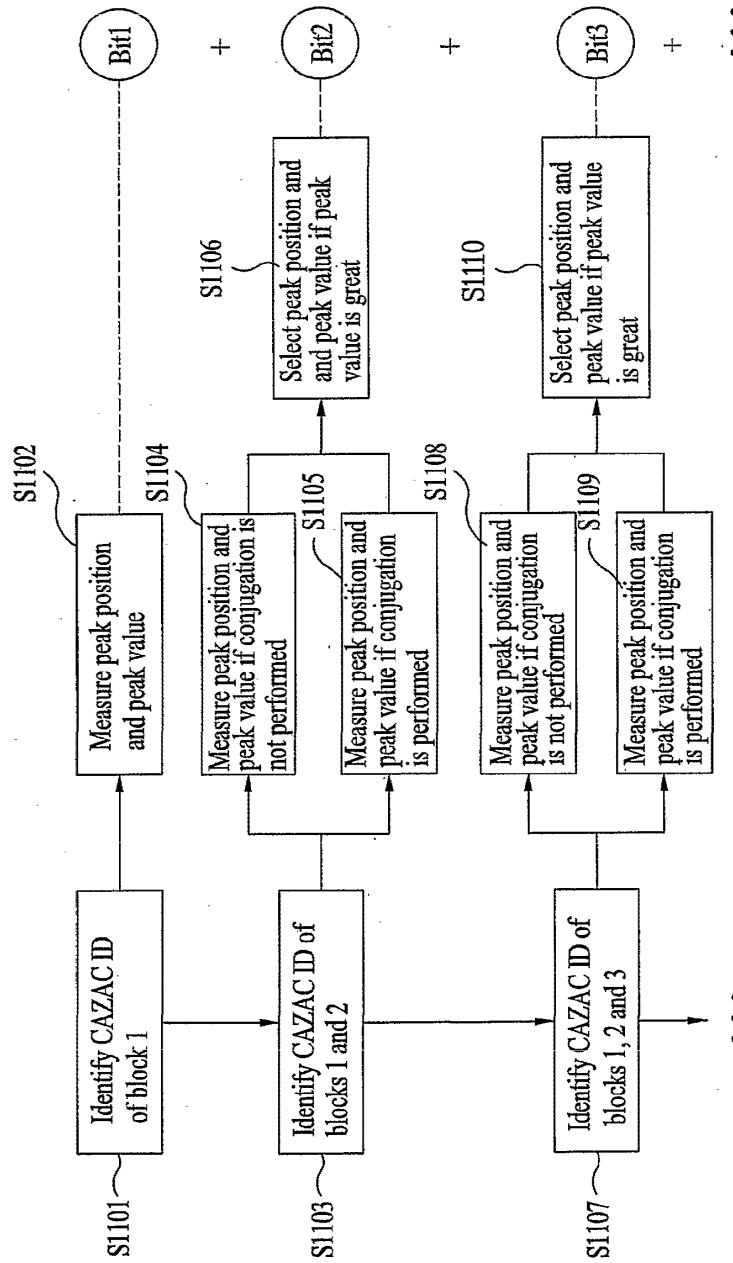

FIG. 13



14/22

FIG. 14

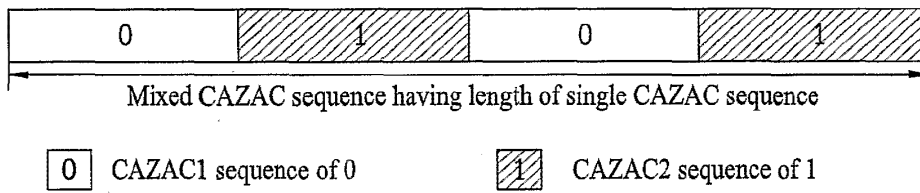

FIG. 15

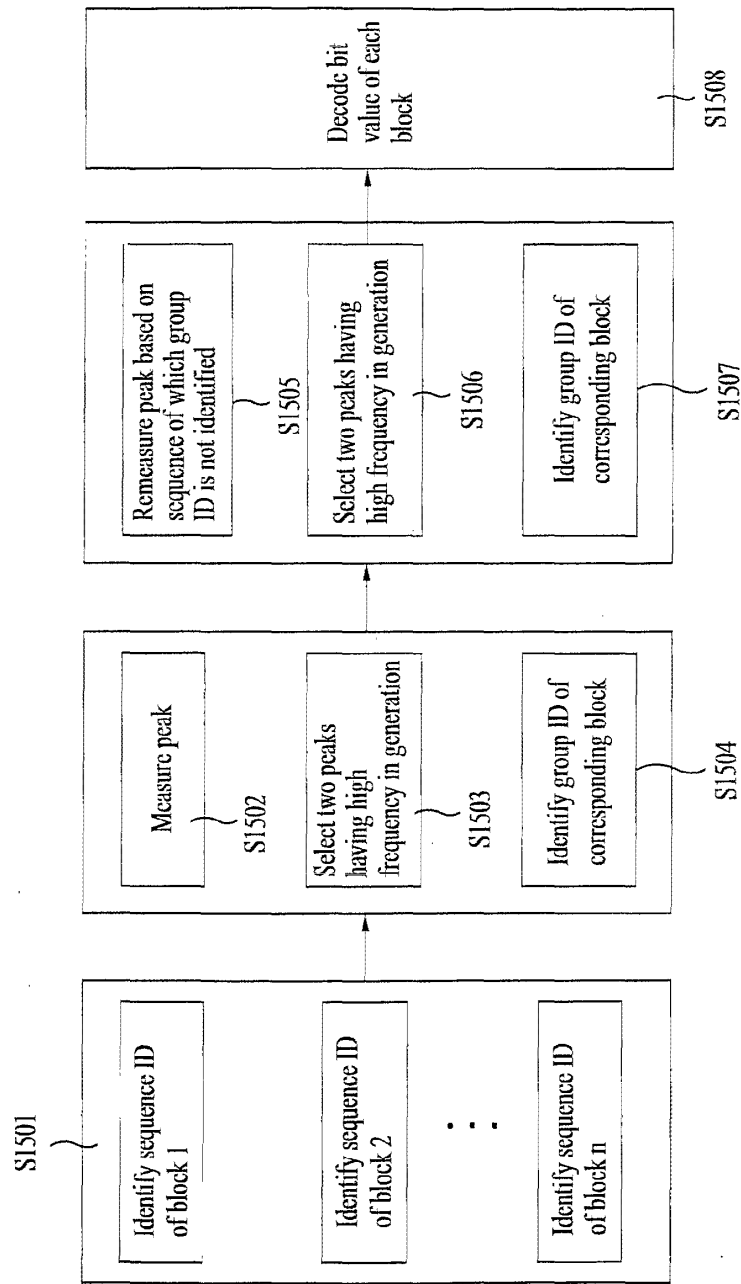

FIG. 16

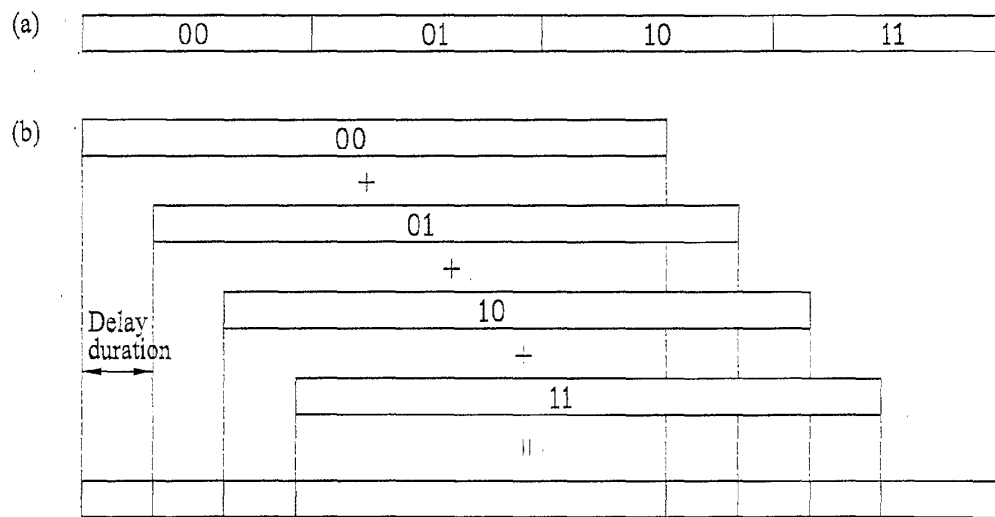

FIG. 17

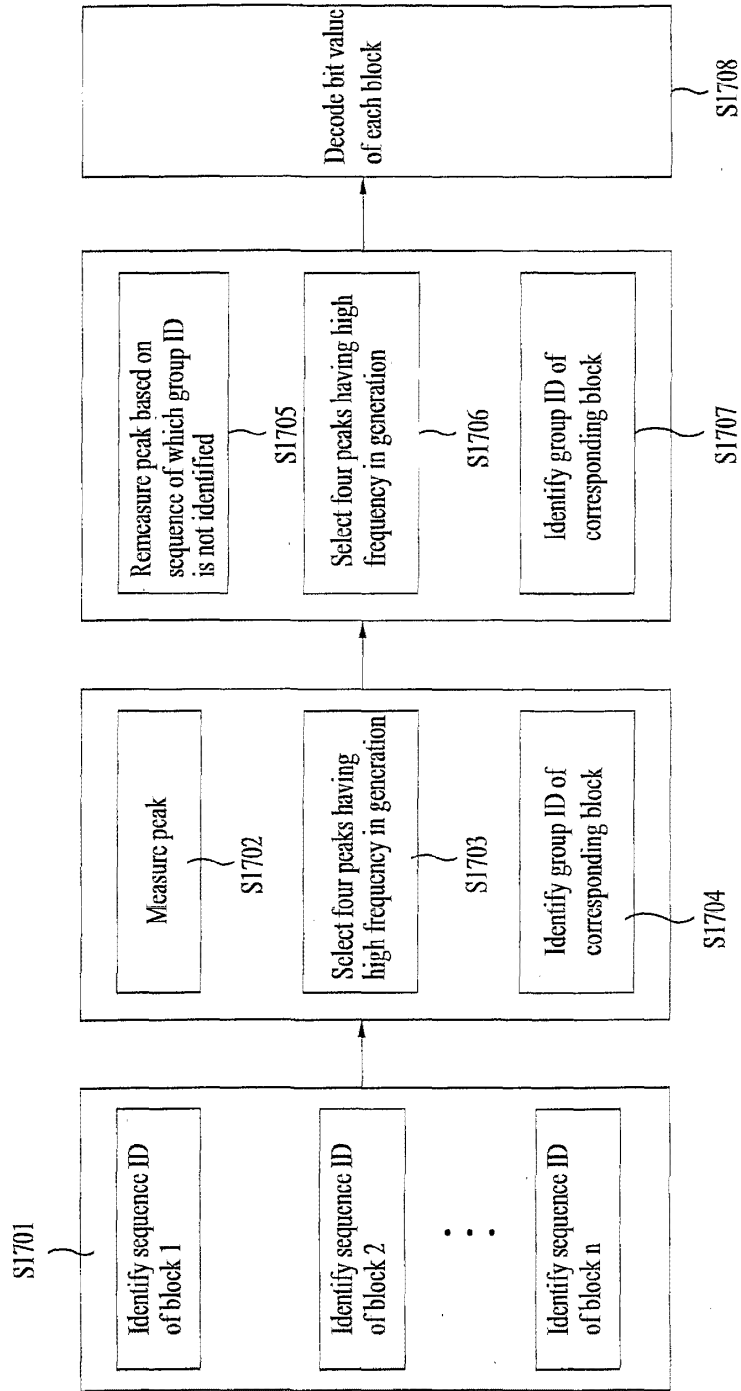



FIG. 18

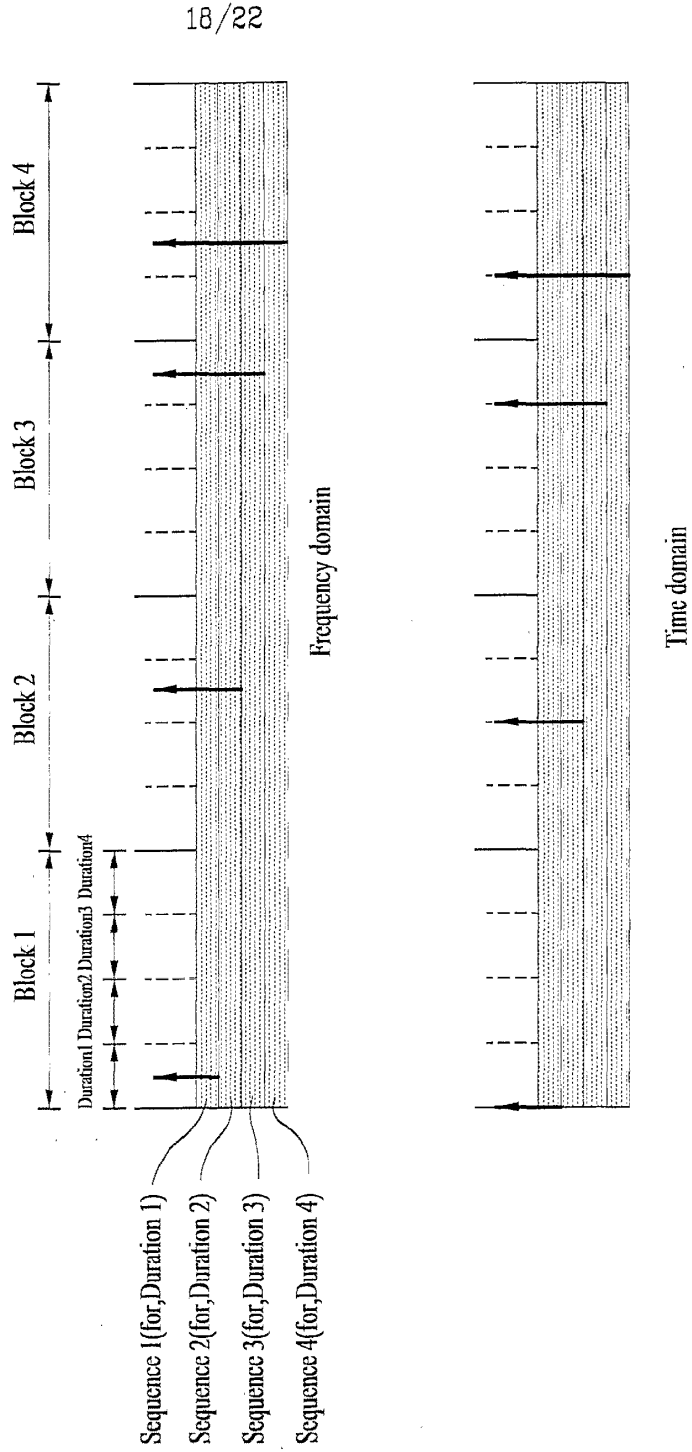
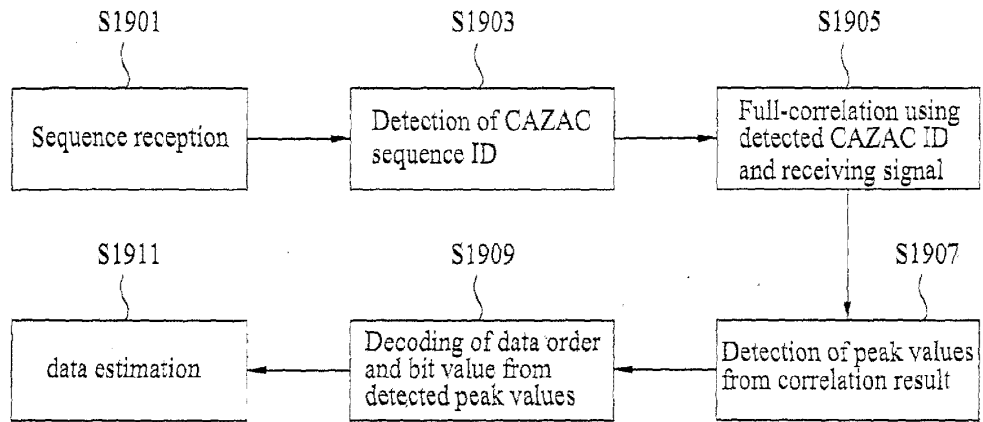

FIG. 19



20/22

FIG. 20A

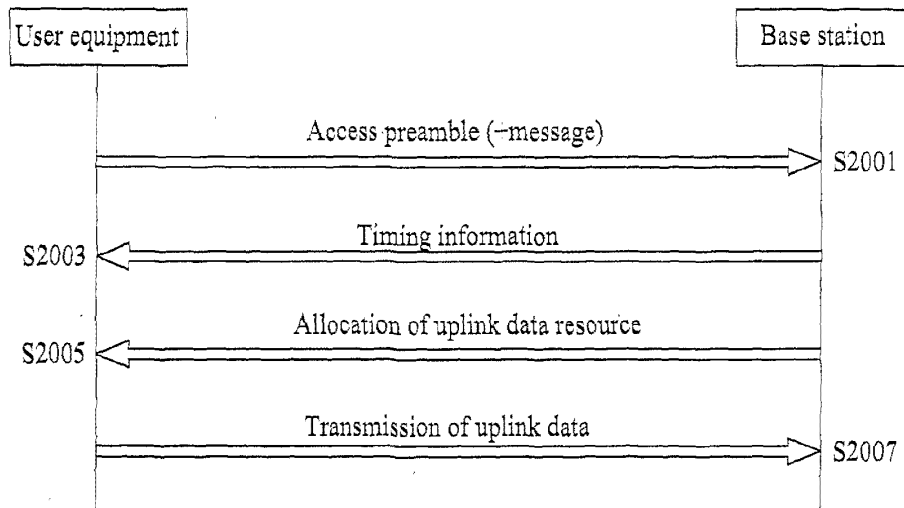

FIG. 20B

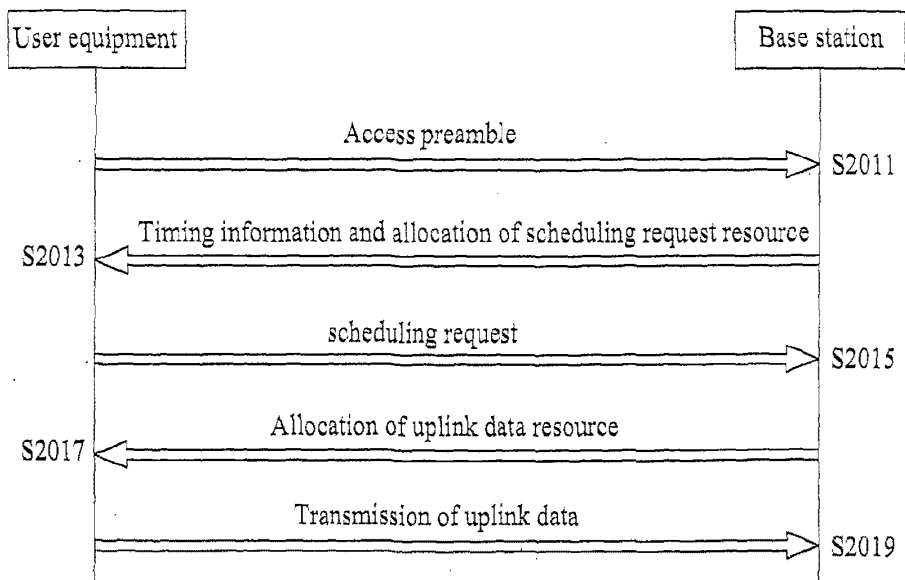

FIG. 21

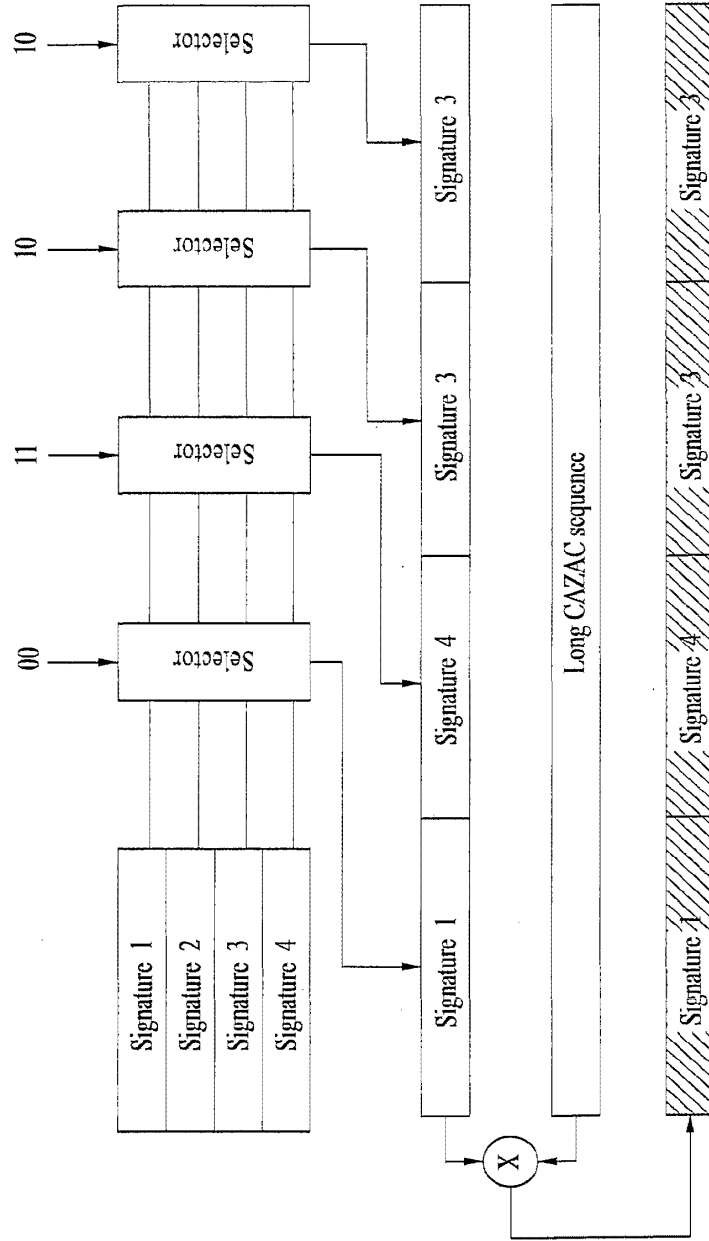
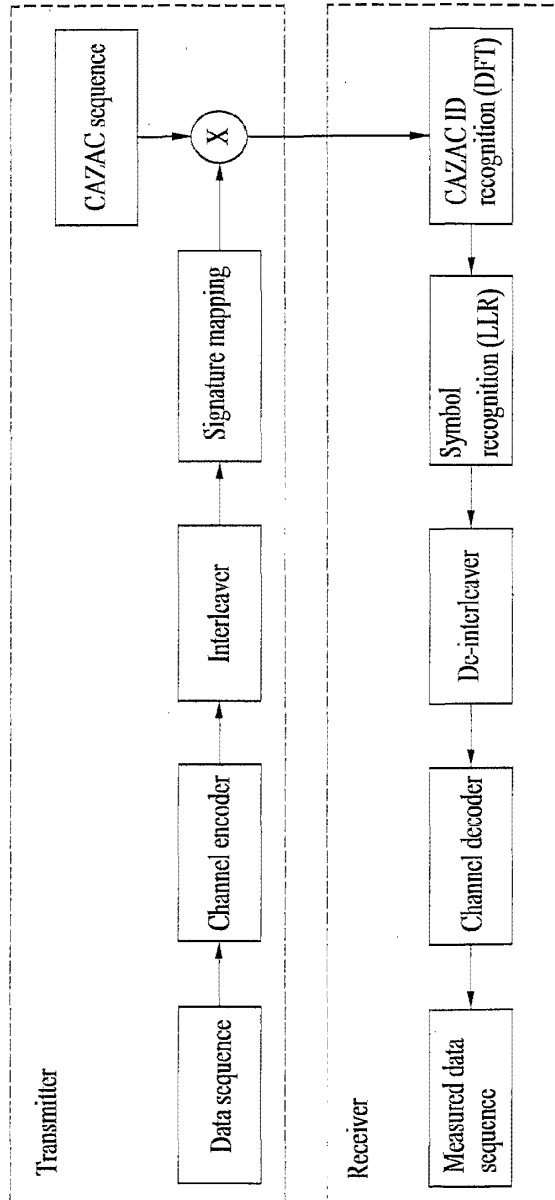

FIG. 22



## Electronic Patent Application Fee Transmittal

<b>Application Number:</b>					
<b>Filing Date:</b>					
<b>Title of Invention:</b>	METHOD OF TRANSMITTING DATA IN A MOBILE COMMUNICATION SYSTEM				
<b>First Named Inventor/Applicant Name:</b>	Yeong Hyeon Kwon				
<b>Filer:</b>	Lew Edward V. Macapagal/Maggie Wen				
<b>Attorney Docket Number:</b>	2101-3596				
Filed as Large Entity					
<b>U.S. National Stage under 35 USC 371 Filing Fees</b>					
<b>Description</b>	<b>Fee Code</b>	<b>Quantity</b>	<b>Amount</b>	<b>Sub-Total in USD(\$)</b>	
<b>Basic Filing:</b>					
National Stage Fee	1631	1	330	330	
National Stage Search - all other cases	1632	1	540	540	
National Stage Exam - all other cases	1633	1	220	220	
<b>Pages:</b>					
<b>Claims:</b>					
Claims in excess of 20	1615	11	52	572	
Independent claims in excess of 3	1614	4	220	880	
Multiple dependent claims	1616	1	390	390	

**EVOLVED-0001671**

ZTE/HTC

Exhibit 1005-0026

Description	Fee Code	Quantity	Amount	Sub-Total in USD(\$)
<b>Miscellaneous-Filing:</b>				
<b>Petition:</b>				
<b>Patent-Appeals-and-Interference:</b>				
<b>Post-Allowance-and-Post-Issuance:</b>				
<b>Extension-of-Time:</b>				
<b>Miscellaneous:</b>				
			<b>Total in USD (\$)</b>	<b>2932</b>

**[CLAIMS]**

1. A method of transmitting data on a random access channel in a mobile communication system, the method comprising:

5           generating a new code by multiplying a code sequence by an exponential sequence;

and

transmitting the new code sequence to a receiving side.

2. The method of claim 1, wherein the code sequence is a CAZAC (constant  
10 amplitude zero autocorrelation) sequence.

3. The method of claim 1 or 2, wherein the code sequence is transmitted as a preamble.

15           4. A method of transmitting data by using a code sequence in a mobile communication system, the method comprising:

conjugating at least one element included in at least one block of a code sequence divided by at least two blocks to indicate predetermined information; and

20           transmitting the code sequence, in which the at least one block is conjugated, to a receiving side.

5. The method of claim 4, wherein the code sequence is a CAZAC sequence.

25           6. A method of transmitting data by using a code sequence in a mobile communication system, the method comprising:



generating a second code sequence indicating predetermined information by combining at least two first code sequences mapped with at least one information bit, respectively; and

transmitting the second code sequence to a receiving side.

5

7. The method of claim 6, wherein the first code sequence is a CAZAC sequence.

8. The method of claim 6, wherein, if each of the first code sequences is mapped with 'n' number of information bits, the at least two first code sequences are selected from a sequence group consisting of  $2^n$  number of first code sequences.

10

9. The method of claim 6, wherein the combination of the at least two first code sequences is performed by summing the at least two first code sequences after giving predetermined delay to each of the at least two first code sequences.

15

10. A method of transmitting a code sequence in a mobile communication system, the method comprising:

generating a combination code sequence by combining a base code sequence to at least one code sequence obtained by circular shift of the base code sequence; and

20

transmitting the combination code sequence to a receiving side.

11. The method of claim 10, wherein each of the base code sequence and the at least one code sequence identifies one or more information bit.

12. The method of claim 10, wherein the step of generating the combination code sequence is performed in a frequency domain.

25

13. The method of claim 10, wherein the step of generating the combination code sequence is performed in a time domain.

5           14. The method of claim 10, wherein the combination code sequence is transmitted through a random access channel (RACH).

15. The method of claim 10, wherein the at least one code sequence is obtained by circular shift of the base code sequence as much as integer times of circular shift unit.

10

16. A method of transmitting a code sequence in a mobile communication system, the method comprising:

generating a repetitive code sequence by repeatedly concatenating a first code sequence at least one or more times;

15

generating a cyclic prefix (CP) by copying a certain part of a rear end of the repetitive code sequence and concatenating the copied part to a front end of the repetitive code sequence; and

transmitting the repetitive code sequence, in which the CP is generated, to a receiving side.

20

17. The method of claim 16, wherein the repetitive code sequence is transmitted as a preamble on a random access channel.

18. A method of allocating a random access channel in a multi-carrier system, the method comprising:

25

allocating a random access channel to each of at least two consecutive frames in a

way that frequency bands of the random access channels allocated to the at least two consecutive frames are not overlapped with each other; and

transmitting allocation information of the random access channels allocated to the at least two consecutive frames to at least one user equipment.

5

19. The method of claim 18, wherein the frequency bands of the random access channels allocated to the at least two consecutive frames have a pattern which is periodically repeated.

10

20. The method of claim 18, wherein the allocation information includes a hopping pattern of the frequency bands of the random access channels allocated to the at least two consecutive frames.

15

21. The method of claim 18, wherein the random access channels are uniformly allocated to the at least two consecutive frames.

20

22. The method of claim 18, further comprising allocating a channel region for transmission of a pilot signal at the user equipment to at least one sub-frame to which the random access channel is allocated.

23. The method of claim 22, wherein the user equipment trying to random access through the random access channel transmits a pilot signal through the channel region.

25

24. A method of transmitting data by using a code sequence in a mobile communication system, the method comprising:

mapping each of a plurality of blocks having at least one bit of a input data stream, respectively to a corresponding signature sequence;

multiplying a signature sequence stream, to which the plurality of blocks are mapped, by a specific code sequence; and

5 transmitting the signature sequence stream multiplied by the specific code sequence to a receiving side.

25. The method of claim 24, wherein the specific code sequence is a single CAZAC sequence.

10

26. The method of claim 24, wherein the specific code sequence is a sequence obtained by concatenating at least two different CAZAC sequences.

27. The method of claim 24, wherein the signature sequence is an exponential sequence.

15

28. The method of claim 24, wherein the signature sequence is a Hadamard sequence.

29. The method of claim 24, further comprising repeating each signature sequence so as to match a length of the signature sequence stream, to which the plurality of blocks are mapped, with a length of the specific code sequence.

20

30. The method of claim 24, wherein the signature sequence mapping is Gray mapping.

25

**METHOD OF TRANSMITTING DATA  
IN A MOBILE COMMUNICATION SYSTEM**

**[DESCRIPTION]**

5 TECHNICAL FIELD

The present invention relates to a mobile communication system, and more particularly, to a method of expanding a code sequence, a structure of a random access channel and a method of transmitting data in a mobile communication system.

10 BACKGROUND ART

A user equipment uses a random access channel (RACH) to access a network in a state that the user equipment is not uplink synchronized with a base station. A signal having repetitive characteristic in a time domain is used in the random access channel, so that a receiver easily searches a start position of a transmission signal. In general, the repetitive  
15 characteristic is realized by repetitive transmission of a preamble.

A representative example of a sequence for realizing the preamble includes a CAZAC (Constant Amplitude Zero Auto Correlation) sequence. The CAZAC sequence is expressed by a Dirac-Delta function in case of auto-correlation and has a constant value in case of cross-correlation. In this respect, it has been estimated that the CAZAC sequence has  
20 excellent transmission characteristics. However, the CAZAC sequence has limitation in that maximum  $N-1$  number of sequences can be used for a sequence having a length of  $N$ . For this reason, a method for increasing available bits of the sequence while maintaining the excellent transmission characteristics is required.

Meanwhile, there are provided various methods for transmitting data from a random  
25 access channel by using the CAZAC sequence. Of them, the first method is to directly

interpret CAZAC sequence ID to message information. Assuming that data to be transmitted is a preamble, if a sufficient number of sequences that can be used as the preamble are provided, message passing can be performed with only CAZAC sequence ID without additional manipulation. However, since a method of transmitting additional information should be considered in an actual synchronized RACH, problems occur in that there is difficulty in realizing a sufficient number of CAZAC sequence sets, and the cost required for search of a receiver increases.

The second method is to simultaneously transmit CAZAC sequence and Walsh sequence by using a code division multiplexing (CDM) mode. In this case, CAZAC sequence ID is used as user equipment identification information, and the Walsh sequence transmitted in the CDM mode is interpreted as message information. FIG. 1 is a block schematic view illustrating a transmitter for realizing the second method. However, the second method has limitation in that even though the Walsh sequence is added to the CAZAC sequence, bits of message that can additionally be obtained are only  $\log_2 N$  bits when the Walsh sequence has a length of  $N$ .

The third method is to transmit CAZAC sequence and Walsh sequence in such a way to mix the Walsh sequence with the CAZAC sequence. In this case, CAZAC sequence ID is used as user equipment identification information, and the Walsh sequence is interpreted as message information. FIG. 2 is a block diagram illustrating a data processing procedure at a transmitter for realizing the third method. However, according to the third method, since the Walsh sequence acts as noise in detection of the CAZAC sequence to cause difficulty in detecting sequence ID, there is limitation in that repetitive sequences should be transmitted to prevent the Walsh sequence from acting as noise in detection of the CAZAC sequence.

The fourth method is to either give orthogonality between blocks constituting a corresponding sequence by multiplying an exponential term by a CAZAC sequence or

directly apply data modulation such as DPSK, DQPSK, D8PSK, etc. In this case, CAZAC sequence ID is used as user equipment identification information, and the modulated sequence is demodulated and then used as message information. FIG. 3A illustrates data modulation according to the former method of the fourth method, and FIG. 3B illustrates data modulation according to the latter method of the fourth.

Furthermore, the fifth method is to transmit CAZAC sequence by attaching a message part to the CAZAC sequence. FIG. 4A illustrates the case where a message (coded bit) is attached to the CAZAC sequence used as a preamble, and FIG. 4B illustrates the case where a message (coded bit) is attached to a sequence consisting of a predetermined number of blocks to which orthogonality is given.

However, the fourth method and the fifth method have a problem in that they are susceptible to change of channel condition.

#### DISCLOSURE OF THE INVENTION

Accordingly, the present invention has been suggested to substantially obviate one or more problems due to limitations and disadvantages of the related art, and an object of the present invention is to provide a method of transmitting and receiving message between a user equipment and a base station by using a long sequence to maximize time/frequency diversity and alleviating performance attenuation due to channel.

Another object of the present invention is to provide a method of transmitting data through a code sequence in a mobile communication system, in which the quantity of data can be increased and the transmitted data becomes robust to noise or channel change.

Still another object of the present invention is to provide a method of suggesting a structure of an efficient random access channel in a multi-carrier system.

Further still another object of the present invention is to provide a method of

minimizing access time of a user equipment to a random access channel in a mobile communication system.

To achieve these objects and other advantages and in accordance with the purpose of the invention, as embodied and broadly described herein, a data transmission method through a random access channel in a mobile communication system comprises generating a new code by multiplying a code sequence by an exponential sequence, and transmitting the new code sequence to a receiving side.

In another aspect of the present invention, a data transmission method by using a code sequence in a mobile communication system comprises conjugating at least one element included in at least one block of a code sequence divided by at least two blocks to indicate predetermined information, and transmitting the code sequence, in which the at least one block is conjugated, to a receiving side.

In still another aspect of the present invention, a data transmission method by using a code sequence in a mobile communication system generating a second code sequence indicating predetermined information by combining at least two first code sequences mapped with at least one information bit, respectively, and transmitting the second code sequence to a receiving side.

In further still another aspect of the present invention, a code sequence transmission method in a mobile communication system comprises generating a combination code sequence by combining a base code sequence to at least one code sequence obtained by circular shift of the base code sequence, and transmitting the combination code sequence to a receiving side.

In further still another aspect of the present invention, a code sequence transmission method in a mobile communication system generating a repetitive code sequence by repeatedly concatenating a first code sequence at least one or more times, generating a cyclic



prefix (CP) by copying a certain part of a rear end of the repetitive code sequence and concatenating the copied part to a front end of the repetitive code sequence, and transmitting the repetitive code sequence, in which the CP is generated, to a receiving side.

In further still another aspect of the present invention, a method of allocating a random access channel (RACH) in a multi-carrier system comprises allocating a random access channel to each of at least two consecutive frames in a way that frequency bands of the random access channels allocated to the at least two consecutive frames are not overlapped with each other, and transmitting allocation information of the random access channels allocated to the at least two consecutive frames to at least one user equipment.

In further still another aspect of the present invention, a data transmission method through a code sequence in a mobile communication system mapping each of a plurality of blocks having at least one bit of a input data stream, respectively to a corresponding signature sequence, multiplying a signature sequence stream, to which the plurality of blocks are mapped, by a specific code sequence, and transmitting the signature sequence stream multiplied by the specific code sequence to a receiving side.

#### BRIEF DESCRIPTION OF THE DRAWINGS

FIG. 1 illustrates an example of a data transmission method through a random access channel in an OFDMA system according to the related art;

FIG. 2 illustrates another example of a data transmission method through a random access channel in an OFDMA system according to the related art;

FIG. 3A and FIG. 3B illustrate still another example of a data transmission method through a random access channel in an OFDMA system according to the related art;

FIG. 4A and FIG. 4B illustrate further still another example of a data transmission method through a random access channel in an OFDMA system according to the related art;

FIG. 5 illustrates an example of a structure of a random access channel used in an OFDMA system;

FIG. 6A and FIG. 6B illustrate examples of sending an RACH signal in a time domain or a frequency domain based on a structure of a random access channel of FIG. 5;

5 FIG. 7 illustrates another example of a structure of a random access channel used in an OFDMA system;

FIG. 8A and FIG. 8B illustrate still another example of a structure of a random access channel used in an OFDMA system;

10 FIG. 9 illustrates a structure of a random access channel according to one embodiment of the present invention;

FIG. 10 illustrates a structure of a random access channel of a sub-frame to which RACH pilot is allocated;

FIG. 11 illustrates a repetitive structure of a preamble according to one embodiment of the present invention;

15 FIG. 12 is a structural view of unit data to illustrate one embodiment of the present invention, which transmits data by using a code sequence expanded through conjugation;

FIG. 13 is a flow chart illustrating a procedure of receiving and decoding data transmitted in a code sequence expanded through conjugation in accordance with one embodiment of the present invention;

20 FIG. 14 is a structural view of unit data to illustrate one embodiment of the present invention, which transmits data by using a code sequence expanded through grouping;

FIG. 15 is a flow chart illustrating a procedure of receiving and decoding data transmitted in a code sequence expanded through grouping;

25 FIG. 16 is a structural view of unit data to illustrate one embodiment of the present invention, which transmits data by using a code sequence expanded through grouping and

delay processing;

FIG. 17 is a flow chart illustrating a procedure of receiving and decoding data transmitted in a code sequence expanded through grouping and delay processing;

FIG. 18 is a structural view of unit data to illustrate one embodiment of the present invention, which transmits data by using a code sequence expanded through PPM modulation;

FIG. 19 is a flow chart illustrating a procedure of receiving and decoding data transmitted in a code sequence expanded through PPM modulation;

FIG. 20A and FIG. 20B are flow charts illustrating a procedure of performing synchronization in a random access channel in accordance with a data transmission method of the present invention;

FIG. 21 illustrates a method of transmitting data to a receiver through a signaling channel in accordance with one embodiment of the present invention; and

FIG. 22 illustrates an example of a receiver and a transmitter for transmitting a preamble and data through RACH, SCH or other channel in accordance with one embodiment of the present invention.

#### BEST MODE FOR CARRYING OUT THE INVENTION

Hereinafter, structures, operations, and other features of the present invention will be understood readily by the preferred embodiments of the present invention, examples of which are illustrated in the accompanying drawings.

A random access channel (RACH) is used to allow a user equipment to access a network in a state that the user equipment is not uplink synchronized with a base station. A random access mode can be classified into an initial ranging access mode and a periodic ranging access mode depending on an access mode to network. According to the initial

ranging access mode, the user equipment acquires downlink synchronization and first accesses a base station. According to the periodic ranging access mode, the user equipment connected with a network accesses the network if necessary. The initial ranging access mode is used to allow the user equipment to synchronize with the network while accessing the network and receive its required ID from the network. The periodic ranging access mode is used to initiate a protocol to receive data from the base station or when a packet to be transmitted exists.

In particular, the periodic ranging access mode can be classified into two types in the 3GPP LTE (long term evolution) system, i.e., a synchronized access mode and a non-synchronized access mode. The synchronized access mode is used if an uplink signal is within a synchronization limit when the user equipment accesses the RACH. The non-synchronized access mode is used if the uplink signal is beyond the synchronization limit. The non-synchronized access mode is used when the user first accesses the base station or synchronization update is not performed after synchronization is performed. At this time, the synchronized access mode is the same as the periodic ranging access mode, and is used when the user equipment accesses the RACH for the purpose of notifying the base station of the change status of the user equipment and requesting resource allocation.

On the other hand, the synchronized access mode alleviates limitation of a guard time in the RACH by assuming that the user equipment does not depart from uplink synchronization with the base station. For this reason, much more time-frequency resources can be used. For example, a considerable amount of messages (more than 24 bits) may be added to a preamble sequence for random access in the synchronized access mode so that both the preamble sequence and the messages may be transmitted together.

A structure of the RACH, which performs a unique function of the RACH while satisfying the aforementioned synchronized and non-synchronized access modes will now be

described.

FIG. 5 is a diagram illustrating an example of a structure of a random access channel (RACH) used in an OFDMA system. As shown in FIG. 5, it is noted that the RACH is divided into N number of sub-frames on a time axis and M number of frequency bands on a frequency axis depending on a radius of a cell. Frequency in generation of the RACH is determined depending on QoS (Quality of Service) requirements in a medium access control (MAC) layer. In general, the RACH is generated per certain period (several tens of milliseconds (ms) to several hundreds of ms). In this case, frequency diversity effect and time diversity effect are provided in generating several RACHs and at the same time collision between user equipments which access through the RACH is reduced. The length of the sub-frame can be 0.5 ms, 1 ms, etc.

In the RACH structure as shown in FIG. 5, a random sub-frame will be referred to as a time-frequency resource (TFR) which is a basic unit of data transmission. FIG. 6A is a diagram illustrating a type of sending a random access signal to the TFR in a time domain, and FIG. 6B illustrates a type of sending a RACH signal in a frequency domain.

As shown in FIG. 6A, if a random access signal is generated in a time domain, the original sub-frame structure is disregarded and the signal is aligned through only the TFR. By contrast, as shown in FIG. 6B, in case of the synchronized random access mode, the sub-frame structure is maintained in the frequency domain and at the same time a random access signal to be transmitted to sub-carriers of each OFDM symbol is generated. Accordingly, orthogonality can be maintained between respective blocks constituting TFR, and channel estimation can easily be performed.

FIG. 7 is a diagram illustrating another example of a structure of RACH used in an OFDMA system. As shown in FIG. 7, it is noted that a preamble 'b' and a pilot 'a' are partially overlapped in a TDM/FDM mode and a TDM mode of RACH burst duration of an

attached wideband pilot. It is also noted that a pilot 'a' and a pilot 'b' are simultaneously overlapped with a preamble 'a' and the preamble 'b' in the TDM/FDM mode and the TDM mode of an embedded wideband pilot. In other words, it is designed that a preamble and a pilot are together transmitted through the RACH, so that message decoding is easily performed through channel estimation if message is added to the RACH. Alternatively, a wideband pilot is used so that channel quality information (CQI) of a total of RACH bands can be acquired in addition to a preamble band of the RACH.

FIG. 8A and FIG. 8B are diagrams illustrating another examples of a structure of the RACH used in the OFDMA system,

As shown in FIG. 8A, a preamble is transmitted for a predetermined time period through a frequency band, and a short block duration is provided at a certain period so that a pilot for decoding a preamble is transmitted to a corresponding short block. At this time, the pilot transmission is performed through a part of a total of frequency bands (transmission through 25 sub-carriers corresponding to a middle band of a total of 75 sub-carriers), so that the pilot can be transmitted to a specific user equipment under a multi-access environment.

Furthermore, as shown in FIG. 8B, a message to be transmitted and a pilot for decoding the message are multiplexed and continue to be transmitted through some frequency bands (for example, 25 middle sub-carrier bands of a total of 75 sub-carrier bands) selected from a total of frequency bands. Accordingly, respective user equipments which perform multi-access can be identified by allocating some frequency bands at different frequencies.

FIG. 9 is a diagram illustrating a structure of RACH according to one embodiment of the present invention.

Generally, frequency in generation of the RACH is determined depending on QoS requirements in a MAC layer. The RACH is generated at a variable period (several ms to several hundreds of ms) depending on requirements of a cell. The RACH can be generated in

a time domain or a frequency domain as described above with reference to FIG. 6A and FIG. 6B. In the embodiment of FIG. 9, the structure of the RACH corresponds to the case where a random access signal is generated in the frequency domain.

Referring to FIG. 9, in this embodiment, to overcome a drawback of a long interval  
5 required for retry when the user equipment fails to access the RACH, a corresponding RACH resource is dispersed in each frame within one period if frequency in generation of the RACH and the quantity of overhead are determined. The number of frames included in one period can freely be determined as occasion demands. At this time, it is preferable that the RACH is divisionally arranged so as to be uniformly distributed for each frequency band with respect  
10 to a plurality of frames constituting one period. However, position on the time axis may be changed without change of position on the frequency axis and vice versa depending on specific requirements (synchronized action or decrease of inter-cell interference) of a cell or if a system band is small. Also, arrangement of any one of frequency and time may be changed to obtain the minimum interval between the RACHs arranged in each frame.

15 In the embodiment of FIG. 9, the network should notify the user equipment of position information of the allocated RACH resource. In other words, the network can notify each user equipment of frequency and time information occupied by the RACH resource allocated for each frame included in one period, and each user equipment can try random access through the allocated RACH resource by using the position information from the  
20 network. The position information of the RACH resource of each frame can be expressed by sub-carrier offset, the number of sub-carriers, timing offset, and the number of symbols. However, if the RACH information on each frame is expressed by the above four parameters, it may be undesirable in that the quantity of the information can be increased. Accordingly, a method of decreasing the quantity of the information for expressing the position information  
25 of the RACH allocated on each frame is required. The position information of the RACH can

be transmitted through a broadcast channel (BCH) or other downlink control channel.

As one method, a method using a hopping pattern may be considered. The hopping pattern means a pattern consisting of information indicating frequency domains of the RACH resource allocated to each frame within one period. In other words, in the embodiment of FIG 9, since the RACH resource is divisionally arranged so as to be uniformly distributed for each frequency band with respect to a plurality of frames constituting one period, an indicator which indicates a frequency band that can be allocated to each frame as the RACH resource is previously determined, and the frequency band of the RACH resource allocated to each frame within one period can be notified through a pattern of the indicator which indicates a corresponding frequency band.

For example, if four frames are used as one period in a system which uses a total of bands of 10MHz, the position of the RACH includes sub-bands having an interval of 2.5MHz as one RACH frequency band (band smaller than 1.25MHz or 2.5MHz). At this time, a total of bands consist of four sub-bands, wherein the respective sub-bands are designated by indicators, which indicate each sub-band, as 1, 2, 3 and 4 in due order from a high frequency band to a low frequency band. In this way, the frequency band position information of the RACH resource allocated to all frames within one period can be expressed by patterns configured by the above indicators, for example 2, 3, 1, 4. The hopping pattern may be configured differently or equally depending on each frame. Time information of the RACH resource allocated to each frame within one period can generally be expressed by timing offset and the number of symbols. At this time, at least any one of the timing offset and the number of symbols may be fixed to decrease the quantity of the information. For example, if it is previously scheduled that the timing offset and the number of symbols for the RACH resource of each frame are fixed, the network only needs to transmit the hopping pattern to notify the user equipment of the position information of the RACH resource of all frames



within one period.

If each sub-band is narrow or considering influence of interference between user equipments, hopping patterns for all frames may be set equally. In this case, the network only needs to notify the user equipment of a frame period.

5 Hereinafter, the procedure of transmitting uplink data from the user equipment to the base station by using the structure of the RACH as shown in the embodiment of FIG. 9 will be described. In this case, data transmission is performed through the RACH among reverse common channels consisting of a plurality of frames.

10 First of all, the user equipment tries to access the dispersed RACH included in the current frame to transfer its information to the base station. If the user equipment successfully accesses the RACH, the user equipment transmits preamble data through the corresponding RACH. However, if the user equipment fails to access the RACH, the user equipment tries to access the RACH divisionally arranged in the frame of the next order. At this time, the RACH included in the frame of the next order is preferably arranged in a frequency band different  
15 from that of the RACH of the previous frame if the frequency band is not sufficiently wide or there are no specific requirements (inter-cell interference or limitation in action range of user equipment). Also, the above access procedure continues to be performed in the frame of the next order until the user equipment successfully accesses the RACH.

20 Meanwhile, in case of the synchronized RACH, the sub-frame of each frame preferably includes a short block to which a pilot for the user equipment which has accessed the corresponding RACH is allocated. At least one RACH pilot and access pilot may be allocated to the short block at a predetermined pattern. In other words, the user equipment which has accessed the RACH should know channel information to receive a channel from the base station. The channel information may be set in RACH pilot within an uplink short  
25 block. The base station allocates a proper channel to the user equipment through the

corresponding RACH pilot. Meanwhile, if the user equipment which accesses the RACH notifies the base station of information of channel quality as to whether the user equipment is preferably allocated with which channel through the RACH pilot, a favorable channel can be allocated to the user equipment during scheduling, whereby communication of good quality  
5 can be maintained.

Accordingly, the RACH pilot that can be used for the user equipment which accesses the RACH is separately allocated to the sub-frame which includes RACH. Thus, the user equipment which accesses the RACH sends a preamble to the base station through the corresponding RACH and also sends a pilot for transmission of channel quality information  
10 to the designated RACH pilot. The RACH pilot is a sequence designated depending on a preamble, and it is preferable that the user equipments, which use different preamble sequences, use different RACH pilot sequences if possible or select RACH pilot of different sub-carriers or partially overlapped sub-carriers.

FIG. 10 is a diagram illustrating a structure of a random access channel of a sub-frame to which the RACH pilot is allocated. It is noted that each sub-frame includes at least  
15 one short block to which at least one RACH pilot and access pilot are allocated at a predetermined pattern. In this case, the RACH pilot exists in the frequency band of the allocated RACH and other system bands. In this embodiment, it has been described that two short blocks exist per one frame and the RACH pilot is transmitted to the short blocks.  
20 However, the present invention is not limited to such embodiment, and various modifications can be made within the apparent range by those skilled in the art.

As described above, it has been described that preamble, synchronization timing information including pilot information, uplink resource allocation information and message such as uplink data can be transmitted through the RACH of various structures. It will be  
25 apparent that the data transmission method according to the embodiments of the present

invention can be used in the RACH and other channels.

Meanwhile, the preamble and the message may separately be transmitted through the RACH. Alternatively, the message may be transmitted by being implicitly included in the preamble. One embodiment of the present invention relates to a method of transmitting a preamble through the latter transmission manner. In one embodiment of the present invention, a code sequence more expanded than that of the related art can be used for effective transmission of the preamble. Hereinafter, a method of improving CAZAC sequence according to one embodiment of the present invention for effective transmission of the preamble will be described.

Since the receiver should search a start position of a transmission signal in the random access channel, it is generally designed that a transmission signal has a specific pattern in a time domain. To this end, the preamble is transmitted repeatedly or a certain interval is maintained between sub-carriers in a frequency domain to obtain repetitive characteristics in the time domain, thereby identifying time synchronization.

In the former case, the preamble represents a reference signal used for the purpose of initial synchronization setting, cell detection, frequency offset, and channel estimation. In a cellular mobile communication system, a sequence having good cross-correlation characteristic is preferably used for repetitive transmission of the preamble. To this end, binary hardamard code or poly-phase CAZAC sequence may be used. Particularly, the CAZAC sequence has been estimated that it has excellent transmission characteristics as it is expressed by a Dirac-Delta function in case of auto-correlation and has a constant value in case of cross-correlation.

The CAZAC sequence can be classified into GCL sequence (Equation 1) and Zadoff-Chu sequence (Equation 2) as follows.

[Equation 1]

16

$$c(k;N,M) = \exp\left(-\frac{j\pi M k(k+1)}{N}\right) \quad \text{for odd } N$$

$$c(k;N,M) = \exp\left(-\frac{j\pi M k^2}{N}\right) \quad \text{for even } N$$

[Equation 2]

$$c(k;N,M) = \exp\left(\frac{j\pi M k(k+1)}{N}\right) \quad \text{for odd } N$$

$$c(k;N,M) = \exp\left(\frac{j\pi M k^2}{N}\right) \quad \text{for even } N$$

5

In the above Equations, it is noted that if the CAZAC sequence has a length of N, actually available sequences are limited to N-1 number of sequences. Accordingly, it is necessary to increase the number of CAZAC sequences to efficiently use them in an actual system.

10 For example, a method of expanding the number of available sequences by 1 is suggested by providing an improved CAZAC sequence p(k) in such a way to multiply a CAZAC sequence c(k) by a predetermined modulation sequence m(k). In other words, assuming that Zadoff-Chu sequence is used as the CAZAC sequence, the CAZAC sequence c(k), the modulation sequence m(k) and the improved CAZAC sequence p(k) can be defined

15 by the following Equations 3, 4, and 5, respectively.

[Equation 3]

CAZAC sequence:

$$c(k;N,M) = \exp\left(\frac{j\pi M k(k+1)}{N}\right)$$

[Equation 4]

Modulation sequence:

$$m(k) = \exp\left(\frac{j2\pi\delta}{N} k\right)$$

5

[Equation 5]

Improved CAZAC sequence (or improved preamble):

$$p(k) = c(k) * m(k) = \exp\left(\frac{j\pi M}{N} k(k+1) + \frac{j2\pi\delta}{N} k\right)$$

The improved CAZAC sequence p(k) maintains auto-correlation and cross-correlation characteristics of the CAZAC sequence. The following Equation 6 illustrates auto-correlation characteristic of p(k), and it is noted from the Equation 6 that the final result is a Dirac-delta function. In particular, if the modulation sequence m(k) is a sequence having a certain phase, it is characterized in that the modulation sequence m(k) always maintains the auto-correlation characteristic.

[Equation 6]

$$ad(d) = \sum_k \exp\left(\frac{j\pi M}{N} (k+d)(k+d+1) + \frac{j2\pi\delta}{N} (k+d)\right)$$

$$\exp\left(-\frac{j\pi M}{N} k(k+1) - \frac{j2\pi\delta}{N} k\right)$$

$$= \sum_k \exp\left(\frac{j2\pi M}{N} (2dk + d(d+1)) + \frac{j2\pi\delta}{N} d\right)$$

$$= \exp\left(\frac{j2\pi\delta}{N} d\right) \sum_k \exp\left(\frac{j\pi M}{N} (2dk + d(d+1))\right) = \begin{cases} 1 & d = 0 \\ 0 & d \neq 0 \end{cases}$$

15

Furthermore, the following Equation 7 illustrates cross-correlation characteristic of  $p(k)$ .

[Equation 7]

$$\begin{aligned}
 cc(d) &= \sum_k \exp\left(\frac{j\pi(M+x)}{N}(k+d)(k+d+1) + \frac{j2\pi\delta}{N}(k+d)\right) \\
 &\quad \exp\left(-\frac{j\pi M}{N}k(k+1) - \frac{j2\pi\delta}{N}k\right) \\
 &= \sum_k \exp\left(\frac{j\pi x}{N}(k+d)(k+d+1)\right) \\
 &\quad \exp\left(\frac{j\pi M}{N}(k+d)(k+d+1) + \frac{j2\pi\delta}{N}(k+d)\right) \\
 &\quad \exp\left(-\frac{j\pi M}{N}k(k+1) - \frac{j2\pi\delta}{N}k\right) \\
 &= \sum_k \exp\left(\frac{j\pi x}{N}(k+d)(k+d+1)\right) \\
 &\quad \exp\left(\frac{j\pi M}{N}(2dk + d(d+1)) + \frac{j2\pi\delta}{N}d\right) \\
 &= \exp\left(\frac{j\pi M}{N}d(d+1)\right) \sum_k \exp\left(\frac{j\pi x}{N}(k+d)(k+d+1)\right) \\
 &\quad \exp\left(\frac{j2\pi d M}{N}k\right)
 \end{aligned}$$

5            In this case, although Equation 7 seems to be similar to Equation 6, it is noted that in view of summation term, auto-correlation is expressed by sum of exponential but cross-correlation is expressed by the product of two sequences. The first term is another CAZAC sequence of which seed value is  $x$ , and the second term is a simple exponential function. The sum of the product of two sequences is equal to obtaining a coefficient of the exponential  
 10            function, and its value is equal to a value obtained by converting the CAZAC sequence of

which seed value is  $x$  into a frequency domain and extracting a value from the frequency position of exponential.

Since the CAZAC sequence has auto-correlation of Dirac-delta characteristic, if it undergoes Fourier transform, it maintains auto-correlation characteristic of Dirac-delta of a constant amplitude even in the transformed area. For this reason, if values of specific positions are extracted from the frequency domain, their sizes are 1 and equal to each other but their phases are different from each other. Accordingly, if this result is added to the Equation 7 to obtain cross-correlation, the obtained cross-correlation can briefly be expressed by the following Equation 8.

10 [Equation 8]

$$\begin{aligned}
 cc(d) &= \exp\left(\frac{j\pi M}{N}d(d+1) + \frac{j2\pi\delta}{N}d\right) \sum_k \exp\left(\frac{j\pi x}{N}(k+d)(k+d+1)\right) \\
 &\quad \exp\left(\frac{j2\pi dM}{N}k\right) \\
 &= \exp\left(\frac{j\pi M}{N}d(d+1) + \frac{j2\pi\delta}{N}d\right) C(dM/N; x)
 \end{aligned}$$

It is noted from the Equation 8 that since  $C(dM/N; x)$  always has a size of 1 and an exponential term also has a size of 1, the cross-correlation is always fixed at 1.

After all, characteristics of the related art CAZAC sequence can be maintained by the Equation 5 and at the same time the number of codes can be increased. This means that the result in the area where the exponential terms are multiplied is equal to applying circular shift to the Fourier transformed area, and multiplying exponential sequences in the time domain is equal to performing circular shift in the frequency domain.

In other words, it is noted that if correlation between two sequences  $p(k; M, N, d_1)$  and  $p(k; M, N, d_2)$  of which seed values are equal to each other is obtained, impulse occurs in a

point where a delay value  $d$  in cross-correlation reaches  $d_1-d_2$ . Although design of the improved sequence as above has the same result as that of circular shift of the CAZAC sequence, this embodiment of the present invention is advantageous in that the result can be obtained by a simple procedure such as multiplying two exponential sequences without  
5 Fourier inverse transform after Fourier transform and circular shift.

Hereinafter, a method of improving data transmission reliability of a preamble by performing predetermined data processing for the related art code sequence and a method of expanding a length of a code sequence when data are simultaneously transmitted will be described. If the CAZAC sequence is used as the code sequence, the CAZAC sequence  
10 expanded by the above method is preferably used. However, the CAZAC sequence is not necessarily limited to the CAZAC sequence expanded by the above method, and the related art CAZAC sequence may be used.

First of all, a structure of transmission data, i.e., preamble, which is commonly applied to the embodiments of the present invention, will be described.

15 In a 3GPP LTE (Long Term Evolution) system, a transmitter can repeatedly transmit the same sequence two times or more so as to allow a receiver to easily detect transmission data or improve additional detection performance (i.e., increase of spreading gain). Accordingly, since the receiver only needs to detect repetitive patterns regardless of the type of the received sequence, it can simply identify time position of a user equipment which  
20 accesses the RACH and improve detection performance.

FIG. 11 is a diagram illustrating a structure of a preamble according to one embodiment of the present invention. In an orthogonal frequency divisional transmission system, a cyclic prefix (CP) is used, in which the last part of OFDM symbol is copied and then prefixed to the OFDM symbol to compensate a multi-path loss in signal transmission.  
25 Accordingly, if the OFDM symbol consists of two repetitive preambles, a part of the



preamble of the later order is copied in the first part by CP to enable compensation of the multi-path loss for the corresponding preamble. Also, the CP is advantageous in that it is easy to identify user equipments which access different RACHs in case of CAZAC having good periodic correlation.

5           Since inter-symbol interference does not occur even though a single sequence is transmitted by prefixing CP thereto instead of repetitive transmission of sequence, a predetermined receiving algorithm can be realized in the frequency domain without any problem. However, if the receiver realizes a receiving algorithm in the time domain with neither repetitive transmission nor CP, the receiver should detect all kinds of code sequences  
10 to identify user equipments which access the RACH. In this respect, the preamble is preferably realized by a structure of a repetitive pattern. At this time, whether to realize a repetition pattern can be determined depending on a data rate supported by the system or the number of repetitive times can be determined if a repetitive pattern is realized. For example, to support a minimum data rate supported by the system, RACH preamble can repeatedly be  
15 transmitted one or more times depending on the length of the sequence.

First to fourth embodiments which will be described later relate to a data processing method of a sequence constituting the structure of the preamble. In these embodiments, data transmitted to the receiver could be the structure of the preamble of FIG. 11 or a partially omitted structure (having neither repetitive transmission nor CP). Although it is assumed that  
20 the CAZAC sequence is used as the code sequence for data transmission, the code sequence is not necessarily limited to the CAZAC sequence. Every sequence having excellent transmission characteristic, such as Hadarmad code and gold code, can be used as the code sequence.

<First Embodiment>

25           To transmit data, a landmark that can be identified is generally required for a

transmission signal constituting data. In this embodiment, conjugation is used as the landmark. Since a phase variation width between a conjugated transmission signal and other transmission signal is very great, interference between transmission signals decreases, whereby reliability of data transmission can be improved in spite of influence of channel.

5           FIG. 12 illustrates a method of transmitting data through conjugation according to one embodiment of the present invention. In the embodiment of FIG. 12, one CAZAC sequence is divided into four blocks, and '0' or '1' indicates whether to perform conjugate for each block. For example, it may be promised that a block which is not conjugated is expressed by '0', and a block which is conjugated is expressed by '1.' In this way, one  
10 CAZAC sequence can express information of 4 bits. In other words, if one CAZAC sequence is divided into N number of blocks, information of N bits can be expressed.

At this time, in a single CAZAC sequence of a long length corresponding to a length of transmission data, a part of the single CAZAC sequence, which corresponds to a specific block having a value of 1, may be conjugated. Also, in a plurality of CAZAC sequences of a  
15 short length corresponding to each block length of transmission data, a CAZAC sequence corresponding to a specific block having a value of 1 may be conjugated.

FIG. 13 is a diagram illustrating an example of a method of receiving and decoding the sequence transmitted through conjugation from the transmitter in accordance with one embodiment of the present invention.

20           It is preferable that the transmitter always allocates a value of 0 to the first block of the transmission data so that the first block is used as a reference later. Accordingly, the receiver identifies sequence ID for the received first block (S1101), and then measures a peak by using only the corresponding block (S1102). Next, the receiver identifies sequence IDs for the first and second blocks (S1103), and then measures a peak by using the first and second  
25 blocks together. At this time, since it is unclear whether the sequence of the second block is in

the conjugated status, the receiver respectively measures a peak corresponding to the case where the corresponding block is conjugated (S1104) and a peak corresponding to the case where the corresponding block is not conjugated (S1105), and then selects greater one of the two peaks (S1106). Subsequently, the receiver identifies sequence IDs for the first to third blocks (S1107), and then measures a peak by using the first to third blocks together. In this case, since it is unclear whether the sequence of the third block is in the conjugated status, the receiver respectively measures a peak corresponding to the case where the corresponding block is conjugated (S1108) and a peak corresponding to the case where the corresponding block is not conjugated (S1109), and then selects greater one of the two peaks (S1110). In this way, decoding is performed for the first block to the last block so that the original data is finally decoded.

<Second Embodiment>

FIG. 14 is a diagram illustrating a method of transmitting data using a sequence according to another preferred embodiment of the present invention. Although data transmission is performed by change of the sequence in the first embodiment, in this embodiment, a type of a sequence for expressing one block is divided into a sequence (first sequence) for a block value of '0' and a sequence (second sequence) for a block value of '1,' and the first and second sequence are grouped. In this case, since the receiver detects only sequence ID (ID of the first sequence or ID of the second sequence) for each block, the receiver is less affected by noise or channel.

All sequences are expressed by one group " $\{c_0(k;M_i), c_1(k;M_j)\}$ " by grouping two sub-sequences (first sequence and second sequence) ( $i$  and  $j$  are integers different from each other). In this case,  $c_0(k;M_i)$  is the first sequence for the block value of 0 (or bit value), and  $c_1(k;M_j)$  is the second sequence for the block value of 1. At this time, a CAZAC sequence of a long length corresponding to a length of transmission data may be used as each sub-

sequence constituting each group. Alternatively, a CAZAC sequence of a short length corresponding to each block length of transmission data may be used as each sub-sequence constituting each group.

Meanwhile, the receiver identifies sequence ID of each block, and identifies a type  
5 of the sequence (first sequence or second sequence) for each block from a sequence ID set consisting of the identified sequence IDs. At this time, the type of the sequence for each block can be expressed by group ID. In other words, in this embodiment, since it is assumed that code values of each block can be expressed by 0 and 1, two types of the sequence for each block or two types of group ID are obtained. The code values of each block can be restored  
10 through group ID. This decoding procedure will be described in detail with reference to FIG. 15.

The receiver identifies sequence ID of each block constituting a corresponding sequence if the sequence is received (S1501), and measures a peak for a sequence ID set consisting of the identified sequence IDs (S1502). In this case, two peaks having high  
15 frequency in generation are selected (S1503) so that sequences which generate the corresponding peaks are identified as the first sequence and the second sequence constituting the group. At this time, if the first sequence and the second sequence are expressed by predetermined group IDs, respectively, first group ID indicating a code value of 0 and second group ID indicating a code value of 1 can be identified. After all, group ID of each block can  
20 be identified through the step S1503 (S1504), and thus the code value of each block can be identified (S1508).

If sequence IDs that can not identify group ID exist due to error occurring during the decoding procedure, peaks are searched for a set of corresponding sequence IDs (S1505), and among the peaks, two powerful peaks are detected (S1506) so that group IDs are again  
25 identified from the detected powerful peaks (S1507). Subsequently, code values of the

corresponding blocks can be identified from the identified group IDs (S1508).

<Third Embodiment>

FIG. 16 is a diagram illustrating a method of transmitting data using a sequence according to another preferred embodiment of the present invention.

5 If the second embodiment is more expanded, a total number of data bits that can be transmitted through one group can be increased. For example, if two sequences are defined as one group like the second embodiment, data of 1 bit per block can be transmitted. If four sequences are defined as one group, data of 2 bits per block can be transmitted. If eight sequences are defined as one group, data of 3 bits per block can be transmitted. However,  
10 since a plurality of sequences are grouped and defined as one set, a problem occurs in that if the length of each sequence is short, the number of groups that can be selected is decreased in proportion to the short length of each sequence.

Accordingly, it is necessary to expand the length of the sequence to increase the number of groups that can be selected. To this end, in this embodiment, the length of the  
15 sequence for each block is expanded while respective sequences are multi-overlapped as shown in FIG. 16B and independence is maintained owing to transmission delay between the overlapped sequences.

Referring to FIG. 16(a), a data value of 2 bits is given to each block. Accordingly, a sequence group for each block consists of four different CAZAC sequences. Since each  
20 CAZAC sequence constituting the sequence group should identify four values, a group size should be increased correspondingly. However, in this case, a problem occurs in that the number of groups that can be used by each base station is decreased. Accordingly, as shown in FIG. 16, the length of each CAZAC sequence is expanded as much as need be while a predetermined delay is given to each CAZAC sequence during data transmission, whereby  
25 independence is maintained between the respective CAZAC sequences.

Meanwhile, the receiver identifies ID of a corresponding block based on the order of each CAZAC sequence represented in the time/frequency domain, and its method of decoding a code value from corresponding block ID is almost identical with that of the second embodiment. Hereinafter, a data decoding procedure of the receiver will be described in detail with reference to FIG. 17.

The receiver identifies sequence ID of each block constituting a corresponding sequence if the sequence is received (S1701), and measures a peak for a sequence ID set consisting of the identified sequence IDs (S1702). In this embodiment, since one block expresses two bits, first, second, third and four sequences which express 00, 01, 10, 11 form one group. Accordingly, the receiver should select 4 peaks having high frequency in generation as a result of measurement (S1703). In this case, the selected peaks are respectively mapped to the first, second, third and fourth sequences in accordance with the order represented in the time/frequency domain. Also, if the first sequence to the fourth sequence are expressed by predetermined group IDs, respectively, first group ID indicating a code value of 00, second group ID indicating a code value of 01, third group ID indicating a code value of 10, and fourth group ID indicating a code value of 11 can be identified. After all, group ID of each block can be identified through the step S1703 (S1704), and thus the code value of each block can be identified (S1708).

If sequence IDs that can not identify group ID exist due to error occurring during the decoding procedure, peaks are again searched for a set of corresponding sequence IDs (S1705), and among the peaks, four powerful peaks are detected (S1706) so that group IDs are again identified from the detected powerful peaks (S1707). Subsequently, code values of the corresponding blocks can be identified from the identified group IDs (S1708).

<Fourth Embodiment>

FIG. 18 is a diagram illustrating a method of transmitting data using a sequence

according to another preferred embodiment of the present invention.

In the case that the second embodiment and the third embodiment are more expanded, the signal position is changed through pulse position modulation (PPM) so that the length of the sequence can be expanded logically. The PPM originally transmits data with relative pulse delay but PPM based on start position of the sequence is used in this  
5 embodiment.

If bits of data to be transmitted are determined, the base station selects a sequence to be used for transmission of corresponding data and determines a length of a block for applying PPM to a corresponding sequence and a length of a duration constituting each block.  
10 A sequence corresponding to each block is separately required when a preamble is generated. However, in this embodiment, since circular shift equivalent to a specific duration within a specific block constituting a corresponding sequence is applied for the same sequence, the respective sequences are originally the same as one another but are identified from one another by circular shift.

For example, assuming that one sequence length is divided into four blocks (block 1 to block 4) and each block is expressed by 2 bits, each block is again divided into four durations (duration 1 to duration 4) to express values of "00, 01, 10, 11." At this time, four durations included in one block are used as start identification positions of circular shift for a sequence corresponding to a corresponding block. If a preamble to be transmitted has a total  
20 length of 256, block 1 can have a circular shift value of 0~63, block 2 64~127, block 3 128~195, and block 4 196~255. If a specific sequence to be used for transmission of the preamble is determined and "00" is transmitted through block 1, sequence 1 undergoes circular shift so that a start position is arranged in duration 1 (0~15) of block 1. If "10" is transmitted to block 2, sequence 2 undergoes circular shift so that a start position is arranged  
25 in duration 3 (96~111) of block 2. In this way, circular shift is applied for the other blocks

and then the respective sequences (sequence 1 to sequence 4) are grouped into one to generate one preamble. In this case, the number of blocks can be generated from 1 to every random number. Also, a minimum unit of circular shift can be limited to more than a certain value considering channel or timing error.

5           Meanwhile, the receiver identifies respective sub sequences (sequence 1 to sequence 4) constituting corresponding sequences by data processing the transmitted sequences, and searches a start position of each of the identified sequences to perform data decoding. This will be described in detail with reference to FIG. 19.

10           If a sequence is received in the receiver (S1901), the receiver detects ID of the corresponding sequence (S1903) and performs full correlation through predetermined data processing for a total of received signals (received sequence) by using the detected result (S1905). At this time, a full search algorithm or a differential search algorithm can be used for detection of the sequence ID.

15           Since the received signal is transmitted from the transmitter by gathering a plurality of sequences, the signal which has undergone the correlation includes a plurality of peaks. In this embodiment, four peaks are detected, and the receiver determines whether each of the detected peaks corresponds to which one of block 1 to block 4 and also corresponds to which duration of a corresponding block (S1909) to decode bit order and bit value of the original data (S1911).

20           The method of effectively transmitting the preamble sequence and message through the RACH has been described as above. Finally, a procedure of transmitting a preamble from a user equipment (UE) to a base station (Node-B) and performing synchronization between both the user equipment and the base station will be described based on two embodiments. FIG. 20A and FIG. 20B illustrate the two embodiments.

25           In the embodiment of FIG. 20A, synchronization is performed in such a manner the



user equipment accesses the base station only once. In other words, if the user equipment transmits a preamble and a message including information required for synchronization to the base station (S2001), the base station transmits timing information to the user equipment (S2003) and at the same time allocates a resource for transmission of uplink data (S2005).

5 The user equipment transmits the uplink data to the base station through the allocated resource (S2007).

In the embodiment of FIG. 20B, for synchronization, the user equipment accesses the base station twice. In other words, if the user equipment transmits a preamble to the base station (S2011), the base station transmits timing information to the user equipment and at the same time allocates a resource for a request of scheduling (S2013). The user equipment  
10 transmits a message for a request of scheduling to the base station through the allocated resource (S2015). Then, the base station allocates a resource for transmission of uplink data to the user equipment (S2017). In this way, the user equipment transmits the uplink data to the base station through the secondly allocated resource (S2019).

15 FIG. 21 is a diagram illustrating a method of transmitting data to a receiver through a signaling channel in accordance with one embodiment of the present invention.

Since the receiver should search a start position of a transmission signal in actually realizing the random access channel, it is generally designed that the random access channel has a specific pattern in the time domain. To this end, a preamble sequence may be used so  
20 that the random access signal originally has a repetitive pattern. Alternatively, a certain interval may be maintained between sub-carriers in the frequency domain to obtain repetitive characteristics in the time domain. Accordingly, the access modes of FIG. 6A and FIG. 6B are characterized in that the start position of the transmission signal should easily be searched in the time domain. To this end, the CAZAC sequence is used. The CAZAC sequence can be  
25 classified into GCL sequence (Equation 1) and Zadoff-Chu sequence (Equation 2).

Meanwhile, a specific sequence of a long length is preferably used to transmit unique information of the user equipment or the base station through RACH (Random Access Channel) or SCH (Synchronization Channel). This is because that the receiver easily detects corresponding ID and more various kinds of sequences can be used to provide convenience  
5 for system design.

However, if message is transmitted with corresponding ID at a sequence of a long length, since the quantity of the message is increased by  $\log_2$  function, there is limitation in message passing with ID only when the sequence exceeds a certain length. Accordingly, in this embodiment, the sequence is divided by several short blocks, and a short signature  
10 sequence corresponding to data to be transmitted to each block of the sequence is used instead of specific manipulation such as conjugation or negation.

Referring to FIG. 21, the sequence is divided into a predetermined number of blocks, and a short signature sequence corresponding to data to be transmitted is applied for each of the divided blocks. A long CAZAC sequence is multiplied by combination of the blocks for  
15 which the short signature sequence is applied, whereby a final data sequence to be transmitted to the receiver is completed.

In this case, assuming that the short signature sequence consists of four signatures, the following signature sets can be used. Also, if there is difference between respective data constituting the signature sets, any other signature set may be used without specific limitation.

- 20 1) Modulation values:  $\{1+j, 1-j, -1-j, -1+j\}$
- 2) Exponential sequence:  $\{\exp(jw_0n), [\exp(jw_1n)], [\exp(jw_2n)], [\exp(jw_3n)]\}$ ,  
where  $n=0\dots N_s$ , and  $N_s$  is a length of each block
- 3) Walsh Hadamard sequence:  $\{[1111], [1-11-1], [11-1-1], [1-1-11]\}$ , where, if the length  $N_s$  of each block is longer than 4, each sequence is repeated to adjust the length.

25 Examples of the long CAZAC sequence that can be used in the embodiment of FIG.

21 include, but not limited to, one GCL CAZAC sequence, Zadoff-Chu CAZAC sequence, and a sequence generated by concatenation of two or more short GCL or Zadoff-Chu CAZAC sequences having the same length or different lengths.

5 The aforementioned manner of applying a short signature sequence for data transmission and reception to the long CAZAC sequence is advantageous in that it is less affected by channel than the related art modulation method of transmission data and performance is little decreased even though the number of bits constituting one signature is increased.

10 FIG. 22 illustrates an example of a receiver and a transmitter for transmitting a preamble and data through RACH, SCH or other channel by using the aforementioned manner.

15 Since the number of bits can be increased in accordance with increase of signatures, channel coding can be applied for the transmitter. If channel coding is performed, time/frequency diversity can be obtained through an interleaver. Also, bit to signature mapping can be performed to minimize a bit error rate. In this case, Gray mapping can be used. The sequence which has undergone this procedure is mixed with CAZAC and then transmitted.

20 The receiver detects CAZAC ID, and calculates a log-likelihood ratio (LLR) for each of bits. Then, the receiver decodes transmission data through a channel decoder. Considering complexity according to sequence search of the receiver configured as shown in FIG. 22, the transmitter preferably uses an exponential sequence as a signature sequence. In this case, the receiver can simply search CAZAC ID through phase difference Fourier Transform. Afterwards, the receiver can again simply calculate LLR from the signature through Fourier Transform.

25 According to the present invention, the structure on the frequency axis/time axis of

the RACH can be identified more definitely. Also, since the RACH resource is divisionally distributed for each frame, even though the user equipment fails to access a specific RACH, the user equipment can directly access RACH of the next frame, whereby access to the base station is improved. Moreover, the user equipment can easily access the RACH even in case  
5 of a traffic area of which QoS condition is strict.

Furthermore, according to the present invention, since information is transmitted and received between the user equipment and the base station by using the code sequence, time/frequency diversity can be maximized, and performance attenuation due to influence of channel can be alleviated through the signature manner.

10 According to the present invention, since the total length of the corresponding sequence can be used with maintaining the advantage of the code sequence according to the related art, data transmission can be performed more efficiently. Also, since the code sequence undergoes predetermined data processing, the quantity of information to be transmitted can be increased and the transmitted data becomes robust to noise or channel.

15 It will be apparent to those skilled in the art that the present invention can be embodied in other specific forms without departing from the spirit and essential characteristics of the invention. Thus, the above embodiments are to be considered in all respects as illustrative and not restrictive. The scope of the invention should be determined by reasonable interpretation of the appended claims and all change which comes within the  
20 equivalent scope of the invention are included in the scope of the invention.

#### INDUSTRIAL APPLICABILITY

The present invention is applicable to a wireless communication system such as a mobile communication system or a wireless Internet system.

25

(12) INTERNATIONAL APPLICATION PUBLISHED UNDER THE PATENT COOPERATION TREATY (PCT)

(19) World Intellectual Property Organization  
International Bureau



(43) International Publication Date  
13 December 2007 (13.12.2007)

PCT

(10) International Publication Number  
WO 2007/142492 A2

- (51) **International Patent Classification:**  
H04L 27/26 (2006.01) H04Q 7/38 (2006.01)
- (21) **International Application Number:**  
PCT/KR2007/002784
- (22) **International Filing Date:** 8 June 2007 (08.06.2007)
- (25) **Filing Language:** Korean
- (26) **Publication Language:** English
- (30) **Priority Data:**  
10-2006-0052167 9 June 2006 (09.06.2006) KR  
10-2006-0057488 26 June 2006 (26.06.2006) KR
- (71) **Applicant (for all designated States except US):** LG ELECTRONICS INC. [KR/KR]; 20, Yeouido-dong, Yeongdeungpo-gu, Seoul 150-721 (KR).
- (72) **Inventors; and**
- (75) **Inventors/Applicants (for US only):** KWON, Yeong Hyeon [KR/KR]; LG Institute, Hogye 1(il)-dong, Dongan-gu., Anyang-si, Gyeonggi-do, 431-749 (KR). HAN, Seung Hee [KR/KR]; LG Institute, Hogye 1(il)-dong, Dongan-gu., Anyang-si, Gyeonggi-do, 431-749 (KR). PARK, Hyun Hwa [KR/KR]; LG Institute, Hogye 1(il)-dong, Dongan-gu., Anyang-si, Gyeonggi-do, 431-749 (KR). KIM, Dong Cheol [KR/KR]; LG Institute, Hogye 1(il)-dong, Dongan-gu., Anyang-si, Gyeonggi-do, 431-749 (KR). LEE, Hyun Woo [KR/KR]; LG Institute, Hogye 1(il)-dong, Dongan-gu., Anyang-si, Gyeonggi-do, 431-749 (KR). NOH, Min Seok [KR/KR]; LG Institute, Hogye 1(il)-dong, Dongan-gu., Anyang-si, Gyeonggi-do, 431-749 (KR).
- (74) **Agents:** KIM, Yong In et al.; KBK & Associates, 15 th Floor, Yosam-Building, 648-23, Yeoksam-dong, Kangnam-gu, Seoul, 135-080 (KR).
- (81) **Designated States (unless otherwise indicated, for every kind of national protection available):** AE, AG, AL, AM, AT, AU, AZ, BA, BB, BG, BH, BR, BW, BY, BZ, CA, CH, CN, CO, CR, CU, CZ, DE, DK, DM, DZ, EC, EE, EG, ES, FI, GB, GD, GE, GH, GM, GT, HN, HR, HU, ID, IL, IN, IS, JP, KE, KG, KM, KN, KP, KZ, LA, LC, LK, LR, LS, LT, LU, LY, MA, MD, MG, MK, MN, MW, MX, MY, MZ, NA, NG, NI, NO, NZ, OM, PG, PH, PL, PT, RO, RS, RU, SC, SD, SE, SG, SK, SL, SM, SV, SY, TJ, TM, TN, TR, TT, TZ, UA, UG, US, UZ, VC, VN, ZA, ZM, ZW.
- (84) **Designated States (unless otherwise indicated, for every kind of regional protection available):** ARIPO (BW, GH, GM, KE, LS, MW, MZ, NA, SD, SL, SZ, TZ, UG, ZM, ZW), Eurasian (AM, AZ, BY, KG, KZ, MD, RU, TJ, TM), European (AT, BE, BG, CH, CY, CZ, DE, DK, EE, ES, FI, FR, GB, GR, HU, IE, IS, IT, LI, LU, LV, MC, MT, NL, PL, PT, RO, SE, SI, SK, TR), OAPI (BF, BJ, CF, CG, CI, CM, GA, GN, GQ, GW, ML, MR, NE, SN, TD, TG).
- Published:**  
— without international search report and to be republished upon receipt of that report
- For two-letter codes and other abbreviations, refer to the "Guidance Notes on Codes and Abbreviations" appearing at the beginning of each regular issue of the PCT Gazette.*

WO 2007/142492 A2

(54) **Title:** METHOD OF TRANSMITTING DATA IN A MOBILE COMMUNICAITON SYSTEM

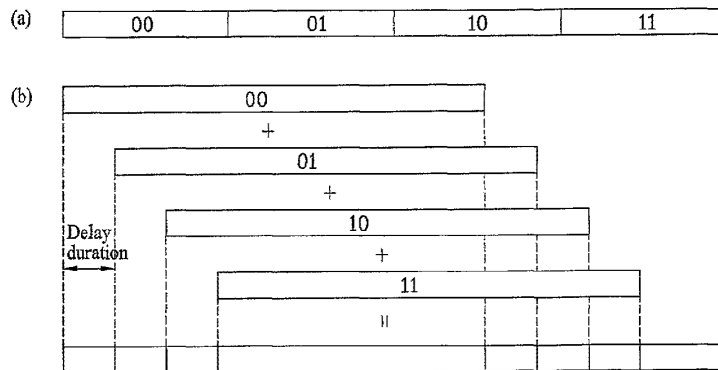

(57) **Abstract:** Disclosed is a data transmission method in a mobile omunication system. The data transmission method through a code sequence in a mobile communication system includes grouping input data streams into a plurality of blocks consisting of at least one bit so as to map each block to a corresponding signature sequence, multiplying a signature sequence stream, to which the plurality of blocks are mapped, by a specific code sequence, and transmitting the signature sequence stream multiplied by the specific code sequence to a receiver.

EVOLVED-0001710

ZTE/HTC

Exhibit 1005-0065

## Electronic Acknowledgement Receipt

<b>EFS ID:</b>	4416792
<b>Application Number:</b>	12303947
<b>International Application Number:</b>	PCT/KR07/02784
<b>Confirmation Number:</b>	1730
<b>Title of Invention:</b>	METHOD OF TRANSMITTING DATA IN A MOBILE COMMUNICATION SYSTEM
<b>First Named Inventor/Applicant Name:</b>	Yeong Hyeon Kwon
<b>Customer Number:</b>	35884
<b>Filer:</b>	Lew Edward V. Macapagal/Maggie Wen
<b>Filer Authorized By:</b>	Lew Edward V. Macapagal
<b>Attorney Docket Number:</b>	2101-3596
<b>Receipt Date:</b>	08-DEC-2008
<b>Filing Date:</b>	
<b>Time Stamp:</b>	19:27:05
<b>Application Type:</b>	U.S. National Stage under 35 USC 371

### Payment information:

Submitted with Payment	yes
Payment Type	Credit Card
Payment was successfully received in RAM	\$2932
RAM confirmation Number	4525
Deposit Account	
Authorized User	

### File Listing:

Document Number	Document Description	File Name	File Size(Bytes)/ Message Digest	Multi Part /.zip	Pages (if appl.)
-----------------	----------------------	-----------	----------------------------------	------------------	------------------

**EVOLVED-0001711**

ZTE/HTC  
Exhibit 1005-0066

1	Transmittal of New Application	2101-3596_XM.pdf	44459 c0220a3f87c4c94648483a9fb65b9f66c453eb9	no	3
<b>Warnings:</b>					
<b>Information:</b>					
2		TZ07-108_PUB_WO200714249 2.pdf	2269392 6f337df35d68a2f95211d742450d96c4d6a1178	yes	60
<b>Multipart Description/PDF files in .zip description</b>					
		<b>Document Description</b>	<b>Start</b>	<b>End</b>	
		Abstract	1	1	
		Specification	2	33	
		Claims	34	38	
		Drawings-only black and white line drawings	39	60	
<b>Warnings:</b>					
<b>Information:</b>					
3	Fee Worksheet (PTO-06)	fee-info.pdf	39925 bbfb9132278e51e331beaafd1cb498e5795d0bc4	no	2
<b>Warnings:</b>					
<b>Information:</b>					
<b>Total Files Size (in bytes):</b>			2353776		
<p><b>This Acknowledgement Receipt evidences receipt on the noted date by the USPTO of the indicated documents, characterized by the applicant, and including page counts, where applicable. It serves as evidence of receipt similar to a Post Card, as described in MPEP 503.</b></p> <p><b><u>New Applications Under 35 U.S.C. 111</u></b>  <b>If a new application is being filed and the application includes the necessary components for a filing date (see 37 CFR 1.53(b)-(d) and MPEP 506), a Filing Receipt (37 CFR 1.54) will be issued in due course and the date shown on this Acknowledgement Receipt will establish the filing date of the application.</b></p> <p><b><u>National Stage of an International Application under 35 U.S.C. 371</u></b>  <b>If a timely submission to enter the national stage of an international application is compliant with the conditions of 35 U.S.C. 371 and other applicable requirements a Form PCT/DO/EO/903 indicating acceptance of the application as a national stage submission under 35 U.S.C. 371 will be issued in addition to the Filing Receipt, in due course.</b></p> <p><b><u>New International Application Filed with the USPTO as a Receiving Office</u></b>  <b>If a new international application is being filed and the international application includes the necessary components for an international filing date (see PCT Article 11 and MPEP 1810), a Notification of the International Application Number and of the International Filing Date (Form PCT/RO/105) will be issued in due course, subject to prescriptions concerning national security, and the date shown on this Acknowledgement Receipt will establish the international filing date of the application.</b></p>					

12/303, 947

(12) INTERNATIONAL APPLICATION PUBLISHED UNDER THE PATENT COOPERATION TREATY (PCT)

(19) World Intellectual Property Organization  
International Bureau



(43) International Publication Date  
13 December 2007 (13.12.2007)

PCT

(10) International Publication Number  
WO 2007/142492 A3

- (51) International Patent Classification:  
H04L 27/26 (2006.01) H04W 74/08 (2009.01)
  - (21) International Application Number:  
PCT/KR2007/002784
  - (22) International Filing Date: 8 June 2007 (08.06.2007)
  - (25) Filing Language: Korean
  - (26) Publication Language: English
  - (30) Priority Data:  
10-2006-0052167 9 June 2006 (09.06.2006) KR  
10-2006-0057488 26 June 2006 (26.06.2006) KR
  - (71) Applicant (for all designated States except US): LG ELECTRONICS INC. [KR/KR]; 20, Yeouido-dong, Yeongdeungpo-gu, Seoul 150-721 (KR).
  - (72) Inventors; and
  - (75) Inventors/Applicants (for US only): KWON, Yeong Hyeon [KR/KR]; LG Institute, Hoge 1(il)-dong, Dongan-gu., Anyang-si, Gyeonggi-do, 431-749 (KR). HAN, Seung Hee [KR/KR]; LG Institute, Hoge 1(il)-dong, Dongan-gu., Anyang-si, Gyeonggi-do, 431-749 (KR). PARK, Hyun Hwa [KR/KR]; LG Institute, Hoge 1(il)-dong, Dongan-gu., Anyang-si, Gyeonggi-do, 431-749 (KR). KIM, Dong Cheol [KR/KR]; LG Institute, Hoge 1(il)-dong, Dongan-gu., Anyang-si, Gyeonggi-do, 431-749 (KR). LEE, Hyun Woo [KR/KR]; LG Institute, Hoge 1(il)-dong, Dongan-gu., Anyang-si, Gyeonggi-do, 431-749 (KR).
  - (74) Agents: KIM, Yong In et al.; KBK & Associates, 15 th Floor, Yosam-Building, 648-23, Yeoksam-dong, Kangnam-gu, Seoul, 135-080 (KR).
  - (81) Designated States (unless otherwise indicated, for every kind of national protection available): AE, AG, AL, AM, AT, AU, AZ, BA, BB, BG, BH, BR, BW, BY, BZ, CA, CH, CN, CO, CR, CU, CZ, DE, DK, DM, DZ, EC, EE, EG, ES, FI, GB, GD, GE, GH, GM, GT, HN, HR, HU, ID, IL, IN, IS, JP, KE, KG, KM, KN, KP, KZ, LA, LC, LK, LR, LS, LT, LU, LY, MA, MD, MG, MK, MN, MW, MX, MY, MZ, NA, NG, NI, NO, NZ, OM, PG, PH, PL, PT, RO, RS, RU, SC, SD, SE, SG, SK, SL, SM, SV, SY, TJ, TM, TN, TR, TT, TZ, UA, UG, US, UZ, VC, VN, ZA, ZM, ZW.
  - (84) Designated States (unless otherwise indicated, for every kind of regional protection available): ARIPO (BW, GH, GM, KE, LS, MW, MZ, NA, SD, SL, SZ, TZ, UG, ZM, ZW), Eurasian (AM, AZ, BY, KG, KZ, MD, RU, TJ, TM), European (AT, BE, BG, CH, CY, CZ, DE, DK, EE, ES, FI, FR, GB, GR, HU, IE, IS, IT, LT, LU, LV, MC, MT, NL, PL, PT, RO, SE, SI, SK, TR), OAPI (BF, BJ, CF, CG, CI, CM, GA, GN, GQ, GW, ML, MR, NE, SN, TD, TG).
- Published:  
— with international search report

[Continued on next page]

(54) Title: METHOD OF TRANSMITTING DATA IN A MOBILE COMMUNICAITON SYSTEM

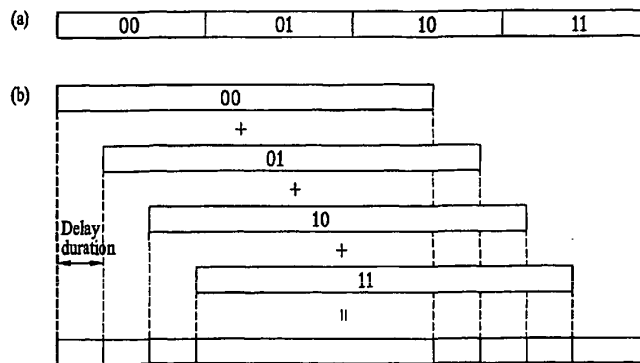

(57) Abstract: Disclosed is a data transmission method in a mobile omunication system. The data transmission method through a code sequence in a mobile communication system includes grouping input data streams into a plurality of blocks consisting of at least one bit so as to map each block to a corresponding signature sequence, multiplying a signature sequence stream, to which the plurality of blocks are mapped, by a specific code sequence, and transmitting the signature sequence stream multiplied by the specific code sequence to a receiver.

WO 2007/142492 A3

EVOLVED-0001713

ZTE/HTC

Exhibit 1005-0068





— *before the expiration of the time limit for amending the claims and to be republished in the event of receipt of amendments*

(88) **Date of publication of the International search report:**  
11 June 2009

## INTERNATIONAL SEARCH REPORT

International application No.  
PCT/KR 2007/002784

<b>A. CLASSIFICATION OF SUBJECT MATTER</b> IPC <sup>8</sup> : <b>H04L 27/26 (2006.01); H04W 74/08 (2009.01)</b> According to International Patent Classification (IPC) or to both national classification and IPC		
<b>B. FIELDS SEARCHED</b> Minimum documentation searched (classification system followed by classification symbols) IPC <sup>8</sup> : H04L, H04Q Documentation searched other than minimum documentation to the extent that such documents are included in the fields searched Electronic data base consulted during the international search (name of data base and, where practicable, search terms used) EPODOC, WPI, ESPACENET		
<b>C. DOCUMENTS CONSIDERED TO BE RELEVANT</b>		
Category*	Citation of document, with indication, where appropriate, of the relevant passages	Relevant to claim No.
A	US 2005/0286409 A1 (Yoon et al.) 29 December 2005 (29.12.2005) <i>Abstract, columns 0030 - 0046</i> --	1-30
A	WO 1996/037079 A1 (QUALCOMM INC.) 21 November 1996 (21.11.1996) <i>Abstract, fig. 2, page 5, line 16 - page 7, line 32</i> --	1-30
A	WO 2001/011909 A1 (KONINKLIJKE PHILIPS ELECTRONICS N.V.) 15 February 2001 (15.02.2001) <i>Abstract, page 2, line 4 - line 31</i> ---	1-30
<input type="checkbox"/> Further documents are listed in the continuation of Box C. <input checked="" type="checkbox"/> See patent family annex.		
* Special categories of cited documents: "A" document defining the general state of the art which is not considered to be of particular relevance "E" earlier application or patent but published on or after the international filing date "L" document which may throw doubts on priority claim(s) or which is cited to establish the publication date of another citation or other special reason (as specified) "O" document referring to an oral disclosure, use, exhibition or other means "P" document published prior to the international filing date but later than the priority date claimed "T" later document published after the international filing date or priority date and not in conflict with the application but cited to understand the principle or theory underlying the invention "X" document of particular relevance; the claimed invention cannot be considered novel or cannot be considered to involve an inventive step when the document is taken alone "Y" document of particular relevance; the claimed invention cannot be considered to involve an inventive step when the document is combined with one or more other such documents, such combination being obvious to a person skilled in the art "&" document member of the same patent family		
Date of the actual completion of the international search 16 February 2009 (16.02.2009)		Date of mailing of the international search report 22 April 2009 (22.04.2009)
Name and mailing address of the ISA/ AT <b>Austrian Patent Office</b> Dresdner Straße 87, A-1200 Vienna Facsimile No. +43 / 1 / 534 24 / 535		Authorized officer <b>ERDÖS György</b> Telephone No. +36 /1/ 474-5918

**INTERNATIONAL SEARCH REPORT**  
Information on patent family members

International application No.  
**PCT/KR 2007/002784**

Patent document cited in search report	Publication date	Patent family member(s)	Publication date
US A 2005286409		KR A 20050122756 US A1 2005286409	2005-12-29 2005-12-29
WO A 9637079		MX A 9708855 JP A 2000324139 BR A 9608353 FI A 974215 WO A1 9637079 RU C2 2209528	1998-03-31 2000-11-24 1998-07-28 1998-01-16 1996-11-21 2003-07-27
WO A 0111909		US B1 6795420 JP T 2003506980T WO A1 0111909 EP A1 1118237 CN A 1327699	2004-09-21 2003-02-18 2001-02-15 2001-07-25 2001-12-19

Form PCT/ISA/210 (patent family annex) (July 1998; reprint January 2004)

**EVOLVED-0001716**

ZTE/HTC  
Exhibit 1005-0071

**PATENT COOPERATION TREATY**

**PCT**

**INTERNATIONAL PRELIMINARY REPORT ON PATENTABILITY**  
(Chapter I of the Patent Cooperation Treaty)

(PCT Rule 44bis)

Applicant's or agent's file reference TZ07-108WOCT	<b>FOR FURTHER ACTION</b>		See item 4 below
International application No. PCT/KR2007/002784	International filing date ( <i>day/month/year</i> ) 08 June 2007 (08.06.2007)	Priority date ( <i>day/month/year</i> ) 09 June 2006 (09.06.2006)	
International Patent Classification (8th edition unless older edition indicated) See relevant information in Form PCT/ISA/237			
Applicant LG ELECTRONICS INC.			

<p>1. This international preliminary report on patentability (Chapter I) is issued by the International Bureau on behalf of the International Searching Authority under Rule 44 bis.1(a).</p> <p>2. This REPORT consists of a total of 3 sheets, including this cover sheet.</p> <p>In the attached sheets, any reference to the written opinion of the International Searching Authority should be read as a reference to the international preliminary report on patentability (Chapter I) instead.</p>																
<p>3. This report contains indications relating to the following items:</p> <table> <tr> <td><input checked="" type="checkbox"/> Box No. I</td> <td>Basis of the report</td> </tr> <tr> <td><input type="checkbox"/> Box No. II</td> <td>Priority</td> </tr> <tr> <td><input type="checkbox"/> Box No. III</td> <td>Non-establishment of opinion with regard to novelty, inventive step and industrial applicability</td> </tr> <tr> <td><input type="checkbox"/> Box No. IV</td> <td>Lack of unity of invention</td> </tr> <tr> <td><input checked="" type="checkbox"/> Box No. V</td> <td>Reasoned statement under Article 35(2) with regard to novelty, inventive step or industrial applicability; citations and explanations supporting such statement</td> </tr> <tr> <td><input type="checkbox"/> Box No. VI</td> <td>Certain documents cited</td> </tr> <tr> <td><input type="checkbox"/> Box No. VII</td> <td>Certain defects in the international application</td> </tr> <tr> <td><input type="checkbox"/> Box No. VIII</td> <td>Certain observations on the international application</td> </tr> </table> <p>4. The International Bureau will communicate this report to designated Offices in accordance with Rules 44bis.3(c) and 93bis.1 but not, except where the applicant makes an express request under Article 23(2), before the expiration of 30 months from the priority date (Rule 44bis .2).</p>	<input checked="" type="checkbox"/> Box No. I	Basis of the report	<input type="checkbox"/> Box No. II	Priority	<input type="checkbox"/> Box No. III	Non-establishment of opinion with regard to novelty, inventive step and industrial applicability	<input type="checkbox"/> Box No. IV	Lack of unity of invention	<input checked="" type="checkbox"/> Box No. V	Reasoned statement under Article 35(2) with regard to novelty, inventive step or industrial applicability; citations and explanations supporting such statement	<input type="checkbox"/> Box No. VI	Certain documents cited	<input type="checkbox"/> Box No. VII	Certain defects in the international application	<input type="checkbox"/> Box No. VIII	Certain observations on the international application
<input checked="" type="checkbox"/> Box No. I	Basis of the report															
<input type="checkbox"/> Box No. II	Priority															
<input type="checkbox"/> Box No. III	Non-establishment of opinion with regard to novelty, inventive step and industrial applicability															
<input type="checkbox"/> Box No. IV	Lack of unity of invention															
<input checked="" type="checkbox"/> Box No. V	Reasoned statement under Article 35(2) with regard to novelty, inventive step or industrial applicability; citations and explanations supporting such statement															
<input type="checkbox"/> Box No. VI	Certain documents cited															
<input type="checkbox"/> Box No. VII	Certain defects in the international application															
<input type="checkbox"/> Box No. VIII	Certain observations on the international application															

<p align="center">The International Bureau of WIPO 34, chemin des Colombettes 1211 Geneva 20, Switzerland</p> <p>Facsimile No. +41 22 338 82 70</p>	<p>Date of issuance of this report 12 May 2009 (12.05.2009)</p>
	<p>Authorized officer</p> <p align="center"><b>Philippe Becamel</b></p> <p>e-mail: pt12.pct@wipo.int</p>

Form PCT/IB/373 (January 2004)

**EVOLVED-0001717**

ZTE/HTC  
Exhibit 1005-0072

**PATENT COOPERATION TREATY**

To:  
**KIM Yong In**  
**KBK & Associates**  
 15th Floor Yo Sam Building, 648-23,  
 Yeoksam-dong, Kangnam-gu,  
 Seoul 135-080  
 Republic of Korea

**PCT**  
**WRITTEN OPINION OF THE**  
**INTERNATIONAL SEARCHING AUTHORITY**  
 (PCT Rule 43bis.1)

Date of mailing **22 April 2009 (22.04.2009)**  
 (day/month/year)

Applicant's or agent's file reference  
**TZ07-108WOCT**

**FOR FURTHER ACTION**  
 See paragraph 2 below

International application No. <b>PCT/KR 2007/002784</b>	International filing date (day/month/year) <b>08 June 2007 (08.06.2007)</b>	Priority Date (day/month/year) <b>09 June 2006 (09.06.2006)</b>
--	--	--

International Patent Classification (IPC) or both national classification and IPC  
**H04L 27/26 (2006.01); H04W 74/08 (2009.01)**

Applicant  
**LG ELECTRONICS INC.**

1. This opinion contains indications relating to the following items:

- Cont. No. I Basis of the opinion
- Cont. No. II Priority
- Cont. No. III Non-establishment of opinion with regard to novelty, inventive step and industrial applicability
- Cont. No. IV Lack of unity of invention
- Cont. No. V Reasoned statement under Rule 43bis.1(a)(i) with regard to novelty, inventive step or industrial applicability; citations and explanations supporting such statement
- Cont. No. VI Certain documents cited
- Cont. No. VII Certain defects in the international application
- Cont. No. VIII Certain observations on the international application

2. **FURTHER ACTION**

If a demand for international preliminary examination is made, this opinion will be considered to be a written opinion of the International Preliminary Examining Authority ("IPEA") except that this does not apply where the applicant chooses an Authority other than this one to be the IPEA and the chosen IPEA has notified the International Bureau under Rule 66.1bis(b) that written opinions of this International Searching Authority will not be so considered.

If this opinion is, as provided above, considered to be a written opinion of the IPEA, the applicant is invited to submit to the IPEA a written reply together, where appropriate, with amendments, before the expiration of 3 months from the date of mailing of Form PCT/ISA/220 or before the expiration of 22 months from the priority date, whichever expires later.

For further options, see Form PCT/ISA/220.

3. For further details, see notes to Form PCT/ISA/220.

Name and mailing address of the ISA/ AT <b>Austrian Patent Office</b> Dresdner Straße 87, A-1200 Vienna Facsimile No. +43 / 1 / 534 24 / 535	Authorized officer <b>ERDÖS György</b> Telephone No. +36 /1/ 474-5918
---	---

WRITTEN OPINION OF THE  
INTERNATIONAL SEARCHING AUTHORITY

International application No.  
PCT/KR 2007/002784

**Continuation No. I**

**Basis of the opinion**

1. With regard to the **language**, this opinion has been established on the basis of a translation from the original language into the following language: English, which is the language of a translation furnished for the purposes of international search (under Rules 12.3 and 23.1(b)).

**Continuation No. V**

**Reasoned statement under Rule 43bis.1(a)(i) with regard to novelty, inventive step or industrial applicability; citations and explanations supporting such statement**

1. Statement

Novelty (N)	Claims 1-30	YES
	Claims -	NO
Inventive step (IS)	Claims 1-30	YES
	Claims -	NO
Industrial applicability (IA)	Claims 1-30	YES
	Claims -	NO

2. Citations and explanations:

This report makes reference to the following documents:

D1: US 2005/0286409 A1  
D2: WO 1996/37070 A1  
D3: WO 2001/11909 A1

The present application relates to a data transmission method in a mobile communication system. The data transmission method through a code sequence in a mobile communication system includes grouping input data streams into a plurality of blocks consisting of at least one bit so as to map each block to a corresponding signature sequence, multiplying a signature sequence stream, to which the plurality of blocks are mapped, by a specific code sequence, and transmitting the signature sequence stream multiplied by the specific code sequence to a receiver.

Neither of the retrieved and cited documents taken them alone or in combination discloses or suggests methods transmitting data or code sequence in a mobile communication system as defined in claim 1 or 4 or 10 or 16 or 24. As this pertains to the independent claims 1, 4, 10, 16, 24 and as all other claims refer to said claims, the whole subject matter of the present application is considered novel and inventive. Industrial applicability is given.

From the INTERNATIONAL BUREAU

**PCT**

NOTIFICATION CONCERNING  
SUBMISSION OR TRANSMITTAL  
OF PRIORITY DOCUMENT

(PCT Administrative Instructions, Section 411)

To:  
  
KIM, Yong In  
KBK & Associates  
15 th Floor, Yosam-Building, 648-23  
Yeoksam-dong, Kangnam-gu  
Seoul, 135-080  
RÉPUBLIQUE DE CORÉE

Date of mailing (day/month/year) 06 September 2007 (06.09.2007)	
Applicant's or agent's file reference TZ07-108WOCT	IMPORTANT NOTIFICATION
International application No. PCT/KR2007/002784	International filing date (day/month/year) 08 June 2007 (08.06.2007)
International publication date (day/month/year) Not yet published	Priority date (day/month/year) 09 June 2006 (09.06.2006)
Applicant LG ELECTRONICS INC. et al	

1. By means of this Form, which replaces any previously issued notification concerning submission or transmittal of priority documents, the applicant is hereby notified of the date of receipt by the International Bureau of the priority document(s) relating to all earlier application(s) whose priority is claimed. Unless otherwise indicated by the letters "NR", in the right-hand column or by an asterisk appearing next to a date of receipt, the priority document concerned was submitted or transmitted to the International Bureau in compliance with Rule 17.1(a) or (b).

2. (If applicable) The letters "NR" appearing in the right-hand column denote a priority document which, on the date of mailing of this Form, had not yet been received by the International Bureau under Rule 17.1(a) or (b). Where, under Rule 17.1(a), the priority document must be submitted by the applicant to the receiving Office or the International Bureau, but the applicant fails to submit the priority document within the applicable time limit under that Rule, the attention of the applicant is directed to Rule 17.1(c) which provides that no designated Office may disregard the priority claim concerned before giving the applicant an opportunity, upon entry into the national phase, to furnish the priority document within a time limit which is reasonable under the circumstances.

3. (If applicable) An asterisk (\*) appearing next to a date of receipt, in the right-hand column, denotes a priority document submitted or transmitted to the International Bureau but not in compliance with Rule 17.1(a) or (b) (the priority document was received after the time limit prescribed in Rule 17.1(a) or the request to prepare and transmit the priority document was submitted to the receiving Office after the applicable time limit under Rule 17.1(b)). Even though the priority document was not furnished in compliance with Rule 17.1(a) or (b), the International Bureau will nevertheless transmit a copy of the document to the designated Offices, for their consideration. In case such a copy is not accepted by the designated Office as the priority document, Rule 17.1(c) provides that no designated Office may disregard the priority claim concerned before giving the applicant an opportunity, upon entry into the national phase, to furnish the priority document within a time limit which is reasonable under the circumstances.

Priority date	Priority application No.	Country or regional Office or PCT receiving Office	Date of receipt of priority document
09 June 2006 (09.06.2006)	10-2006-0052167	KR	05 July 2007 (05.07.2007)
26 June 2006 (26.06.2006)	10-2006-0057488	KR	05 July 2007 (05.07.2007)

The International Bureau of WIPO 34, chemin des Colombettes 1211 Geneva 20, Switzerland	Authorized officer  Philippe Becamel
Facsimile No. +41 22 338 82 70	Facsimile No. +41 22 338 82 70 Telephone No. +41 22 338 74 12

(19) World Intellectual Property Organization  
International Bureau



(43) International Publication Date  
13 December 2007 (13.12.2007)

PCT

(10) International Publication Number  
WO 2007/142492 A2

- (51) **International Patent Classification:**  
H04L 27/26 (2006.01) H04Q 7/38 (2006.01)
- (21) **International Application Number:**  
PCT/KR2007/002784
- (22) **International Filing Date:** 8 June 2007 (08.06.2007)
- (25) **Filing Language:** Korean
- (26) **Publication Language:** English
- (30) **Priority Data:**  
10-2006-0052167 9 June 2006 (09.06.2006) KR  
10-2006-0057488 26 June 2006 (26.06.2006) KR
- (71) **Applicant (for all designated States except US):** LG ELECTRONICS INC. [KR/KR]; 20, Yeouido-dong, Yeongdeungpo-gu, Seoul 150-721 (KR).
- (72) **Inventors; and**
- (75) **Inventors/Applicants (for US only):** KWON, Yeong Hyeon [KR/KR]; LG Institute, Hoge 1(il)-dong, Dongan-gu., Anyang-si, Gyeonggi-do, 431-749 (KR). HAN, Seung Hee [KR/KR]; LG Institute, Hoge 1(il)-dong, Dongan-gu., Anyang-si, Gyeonggi-do, 431-749 (KR). PARK, Hyun Hwa [KR/KR]; LG Institute, Hoge 1(il)-dong, Dongan-gu., Anyang-si, Gyeonggi-do, 431-749 (KR). KIM, Dong Cheol [KR/KR]; LG Institute, Hoge 1(il)-dong, Dongan-gu., Anyang-si, Gyeonggi-do, 431-749 (KR). LEE, Hyun Woo [KR/KR]; LG Institute, Hoge 1(il)-dong, Dongan-gu., Anyang-si, Gyeonggi-do, 431-749 (KR). NOH, Min Seok [KR/KR]; LG Institute, Hoge 1(il)-dong, Dongan-gu., Anyang-si, Gyeonggi-do, 431-749 (KR).
- (74) **Agents:** KIM, Yong In et al.; KBK & Associates, 15 th Floor, Yosam-Building, 648-23, Yeoksam-dong, Kangnam-gu, Seoul, 135-080 (KR).
- (81) **Designated States (unless otherwise indicated, for every kind of national protection available):** AE, AG, AL, AM, AT, AU, AZ, BA, BB, BG, BH, BR, BW, BY, BZ, CA, CH, CN, CO, CR, CU, CZ, DE, DK, DM, DZ, EC, EE, EG, ES, FI, GB, GD, GE, GH, GM, GT, HN, HR, HU, ID, IL, IN, IS, JP, KE, KG, KM, KN, KP, KZ, LA, LC, LK, LR, LS, LT, LU, LY, MA, MD, MG, MK, MN, MW, MX, MY, MZ, NA, NG, NI, NO, NZ, OM, PG, PH, PL, PT, RO, RS, RU, SC, SD, SE, SG, SK, SL, SM, SV, SY, TJ, TM, TN, TR, TT, TZ, UA, UG, US, UZ, VC, VN, ZA, ZM, ZW.
- (84) **Designated States (unless otherwise indicated, for every kind of regional protection available):** ARIPO (BW, GH, GM, KE, LS, MW, MZ, NA, SD, SL, SZ, TZ, UG, ZM, ZW), Eurasian (AM, AZ, BY, KG, KZ, MD, RU, TJ, TM), European (AT, BE, BG, CH, CY, CZ, DE, DK, EE, ES, FI, FR, GB, GR, HU, IE, IS, IT, LT, LU, LV, MC, MT, NL, PL, PT, RO, SE, SI, SK, TR), OAPI (BF, BJ, CF, CG, CI, CM, GA, GN, GQ, GW, MI, MR, NE, SN, TD, TG).
- Published:**  
— without international search report and to be republished upon receipt of that report
- For two-letter codes and other abbreviations, refer to the "Guidance Notes on Codes and Abbreviations" appearing at the beginning of each regular issue of the PCT Gazette.*

WO 2007/142492 A2

(54) **Title:** METHOD OF TRANSMITTING DATA IN A MOBILE COMMUNICAITON SYSTEM

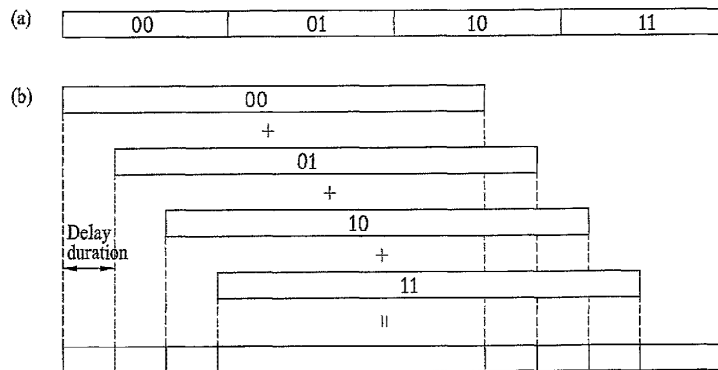

(57) **Abstract:** Disclosed is a data transmission method in a mobile omunication system. The data transmission method through a code sequence in a mobile communication system includes grouping input data streams into a plurality of blocks consisting of at least one bit so as to map each block to a corresponding signature sequence, multiplying a signature sequence stream, to which the plurality of blocks are mapped, by a specific code sequence, and transmitting the signature sequence stream multiplied by the specific code sequence to a receiver.



# Document made available under the Patent Cooperation Treaty (PCT)

International application number: PCT/KR2007/002784

International filing date: 08 June 2007 (08.06.2007)

Document type: Certified copy of priority document

Document details: Country/Office: KR  
Number: 10-2006-0052167  
Filing date: 09 June 2006 (09.06.2006)

Date of receipt at the International Bureau: 05 July 2007 (05.07.2007)

Remark: Priority document submitted or transmitted to the International Bureau in compliance with Rule 17.1(a) or (b)



World Intellectual Property Organization (WIPO) - Geneva, Switzerland  
Organisation Mondiale de la Propriété Intellectuelle (OMPI) - Genève, Suisse

**EVOLVED-0001722**

ZTE/HTC  
Exhibit 1005-0077

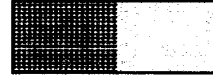

별첨 사본은 아래 출원의 원본과 동일함을 증명함.

This is to certify that the following application annexed hereto  
is a true copy from the records of the Korean Intellectual  
Property Office

출원 번호 : 10-2006-0052167  
Application Number

출원 년 월 일 : 2006년 06월 09일  
Filling Date JUN 09, 2006

출원인 : 엘지전자 주식회사  
Applicant(s) LG Electronics Inc.

2007 년 07 월 03 일

특 허 청

COMMISSIONER

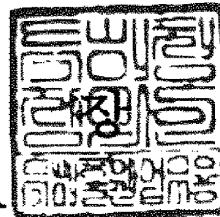

EVOLVED-0001723

ZTE/HTC

Exhibit 1005-0078

**【서지사항】**

**【서류명】** 특허출원서  
**【권리구분】** 특허  
**【수신처】** 특허청장  
**【참조번호】** 0013  
**【제출일자】** 2006.06.09  
**【국제특허분류】** H04B  
**【발명의 국문명칭】** 랜덤 액세스 채널을 통한 데이터 전송 방법  
**【발명의 영문명칭】** Method for data transferring through Random Access Channel  
**【출원인】**  
**【명칭】** 엘지전자 주식회사  
**【출원인코드】** 1-2002-012840-3  
**【대리인】**  
**【성명】** 김용인  
**【대리인코드】** 9-1998-000022-1  
**【포괄위임등록번호】** 2006-037573-8  
**【대리인】**  
**【성명】** 심창섭  
**【대리인코드】** 9-1998-000279-9  
**【포괄위임등록번호】** 2006-037574-5  
**【발명자】**  
**【성명】** 권영현  
**【성명의 영문표기】** KWON, Yeong Hyeon  
**【주민등록번호】** 740611-1533118  
**【우편번호】** 440-824  
**【주소】** 경기 수원시 장안구 율전동 103-6 스마일빌 402호  
**【국적】** KR

**【발명자】**

**【성명】** 한승희  
**【성명의 영문표기】** HAN, Seung Hee  
**【주민등록번호】** 761128-1261917  
**【우편번호】** 122-899  
**【주소】** 서울 은평구 역촌1동 42-35  
**【국적】** KR

**【발명자】**

**【성명】** 박현화  
**【성명의 영문표기】** PARK, Hyun Hwa  
**【주민등록번호】** 800803-2357323  
**【우편번호】** 431-050  
**【주소】** 경기 안양시 동안구 비산동 1115번지 신안 메트로칸 1133호  
**【국적】** KR

**【발명자】**

**【성명】** 김동철  
**【성명의 영문표기】** KIM, Dong Cheol  
**【주민등록번호】** 781009-1632216  
**【우편번호】** 437-080  
**【주소】** 경기 의왕시 내손동 763 대명 스위트빌 401호  
**【국적】** KR

**【발명자】**

**【성명】** 이현우  
**【성명의 영문표기】** LEE, Hyun Woo  
**【주민등록번호】** 770601-1063313  
**【우편번호】** 431-080  
**【주소】** 경기 안양시 동안구 호계동 1103-3 네오빌 204호  
**【국적】** KR

**【발명자】**

**【성명】** 노민석  
**【성명의 영문표기】** NOH,Min Seok  
**【주민등록번호】** 770911-1558611  
**【우편번호】** 152-053  
**【주소】** 서울 구로구 구로3동 오피스텔 미래지오 2층 211호  
**【국적】** KR

**【취지】** 특허법 제42조의 규정에 의하여 위와 같이 출원합니다.

대리인 김용인 (인)  
대리인 심창섭 (인)

**【수수료】**

<b>【기본출원료】</b>	0 면	38,000 원
<b>【가산출원료】</b>	32 면	0 원
<b>【우선권주장료】</b>	0 건	0 원
<b>【심사청구료】</b>	0 항	0 원
<b>【합계】</b>		38,000 원

## 【요약서】

### 【요약】

랜덤 액세스 채널을 통하여 효율적으로 데이터를 송수신하는 방법이 제공된다. 이를 위한 첫 번째 방법은 다수의 프레임으로 구성되는 역방향 공통 채널 중 랜덤 액세스 채널(Random Access Channel, RACH)을 통해 데이터를 전송하는 방법에 관한 것으로서, 단말이 소정 개수의 프레임을 주기로 각 프레임에 분할 배치된 RACH 중 현재 프레임의 RACH에 접근을 시도하는 단계와, 상기 접근에 성공한 경우 해당 RACH를 통해 프리엠블(preamble) 데이터를 전송하는 단계와, 상기 접근에 실패한 경우 다음 차순의 프레임에 분할 배치된 RACH에 접근을 시도하는 단계를 포함한다. 한편, 두 번째 방법은 시그널링 채널을 통해 수신측에 데이터를 전송하는 방법에 관한 것으로서, 제1 시퀀스(sequence)를 소정 개수의 블록으로 구획하는 단계와, 상기 구획된 각 블록에 전송할 데이터에 해당하는 제2 시퀀스를 적용하는 단계와, 상기 제2 시퀀스가 적용된 블록들의 조합에 제3 시퀀스를 곱하여 수신측에 전송하는 단계를 포함한다.

### 【대표도】

도 5

### 【색인어】

RACH, subframe, preamble, sequence, CAZAC, short signature

**【명세서】**

**【발명의 명칭】**

랜덤 액세스 채널을 통한 데이터 전송 방법 {Method for data transferring through Random Access Channel}

**【도면의 간단한 설명】**

- <1> 도 1은 종래의 랜덤 액세스 채널 구조에 대한 일 실시예.
- <2> 도 2는 종래의 랜덤 액세스 채널 구조에 대한 다른 일 실시예.
- <3> 도 3은 상기 도 1 및 도 2에 공통적으로 적용되는 랜덤 액세스 채널 구조를 모식적으로 도시한 것.
- <4> 도 4a 내지 도 4b는 각각 시간 영역 및 주파수 영역에서 랜덤 액세스 채널의 신호를 실는 형태를 모식적으로 도시한 것.
- <5> 도 5는 본 발명에 의한 랜덤 액세스 채널의 구조를 모식적으로 도시한 것.
- <6> 도 6은 RACH 파일럿이 할당된 서브 프레임의 랜덤 액세스 채널 구조를 모식적으로 도시한 것.
- <7> 도 7은 본 발명에 의한 시그널 채널 데이터 전송 방법의 개념도.
- <8> 도 8은 본 발명에 의한 시그널 채널 데이터의 전송 방법을 송신측 및 수신측에서 도시한 개념도.

**【발명의 상세한 설명】**

**【발명의 목적】**

【발명이 속하는 기술분야 및 그 분야의 종래기술】

<9> 본 발명은 랜덤 액세스 채널을 통하여 효율적으로 데이터를 송수신하는 방법에 관한 것으로서, 이를 위한 첫 번째 방법은 다수의 프레임으로 구성되는 역방향 공통 채널 중 랜덤 액세스 채널(Random Access Channel, RACH)을 통해 데이터를 전송하는 방법에 관한 것이고, 두 번째 방법은 긴 CAZAC 시퀀스 및 짧은 시그니처 시퀀스를 이용하여 모듈링 또는 디모듈링된 시그널링 채널 데이터를 송수신하는 방법에 관한 것이다.

<10> 3GPP LTE(3rd Generation Partnership Project Long Term Evolution) 시스템에서의 채널은 물리채널과 하나 또는 복수의 물리채널 상에 매핑되는 논리채널로 이루어지며, 논리채널은 사용 목적에 따라 다시 제어채널, 공통채널, 전용제어채널 및 트래픽채널 등으로 구분된다. 여기서 역방향 공통채널 중 하나인 랜덤 액세스 채널(Random Access Channel, 이하 'RACH')은 주로 단말기(User Equipment; UE)를 네트워크에 등록하기 위해 또는 셀 간 이동시 위치 등록을 위해 및 초기 호 설정 등의 신호 전송 용도로 사용된다.

<11> 이하에서는 종래에 공개된 각종 RACH 구조를 살펴보고 이들이 공통적으로 지니는 문제점을 짚어보기로 한다.

<12> 도 1은 종래 OFDMA 시스템에서 사용되는 RACH의 구조를 도시한 것이다. 도면에서 보듯, RACH는 셀의 반경에 따라 시간축으로 N개의 서브 프레임(sub-frame)으로 분할되고, 주파수축으로 N개의 주파수 대역으로 분할됨을 알 수 있다. RACH의 생성 빈도는 MAC에서의 QoS 요구 조건에 따라서 정해지는데, 일반적으로 수십 ms



단위로 한 번씩 또는 수백 ms 단위로 한 번씩 채널이 생성된다. 이는 여러 개의 subcarrier 별로 다른 RACH를 설정하여 단말간 충돌을 줄이는 구조이다.

<13> 도 2는 텍사스 인스트루먼트(TI)사에 정의한 RACH의 구조를 도시한 것이다. 도면에서 보듯 PACH에 동상의 프리엠블 외에 파일럿까지 함께 전송할 수 있도록 설계되어 있으며, RACH에 메시지가 추가되는 경우 채널추정을 통해 메시지 복호를 용이하게 하고, 광대역 파일럿을 사용함으로써 RACH의 프리엠블(preamble)이 사용하는 대역 이외의 RACH 총 채널 대역에 대한 채널품질정보(Channel Quality Information, 이하 'CQI')를 획득할 수 있도록 한다. 특히, RACH가 할당되는 시스템 대역에 한하여 파일럿이 할당되는 특징이 있다.

<14> 도 3은 위와 같은 도 1 및 도 2에 공통적으로 적용되는 RACH 구조를 모식적으로 도시한 것이다. 종래의 RACH는 주파수축 및 시간축으로의 구조를 명확하게 제시하지 않고 있으나, 대략적으로는 도 3과 같은 버스트(burst) 형태의 구조로 파악해 볼 수 있다. 이러한 버스트 형태는 단말이 특정 프레임의 RACH에 접근했다가 실패하는 경우 다음 주기의 프레임에 할당된 RACH가 나타날 때까지 상당한 시간을 기다려야 하는 문제점, 즉 단말이 RACH 접근에 실패할 경우 재시도까지의 간격이 길어지는 문제점이 발생한다. 또한, RACH 중에서 선택된 주파수 대역의 채널 특징이 좋지 않을 경우 RACH의 접근 실패가 발생할 확률이 높아지는데 버스트 형태의 RACH는 단말에게 여러 주파수 선택의 기회를 주지 않는 문제가 있다.

<15> 한편, 3GPP LTE 시스템에서 RACH를 통해 소정의 메시지를 전송하는 방법은 크게 두 가지로 구분된다. 즉, 해당 메시지가 프리엠블 시퀀스(Preamble sequenc

e)와 별개로 전송되는 방법과, 해당 메시지가 프리엠블 시퀀스에 함축적으로 포함 되어 전송되는 방법이 있는데, 상기 도 2의 부속된 광대역 파일럿(attached wideband pilot)을 통해 전송되는 방식은 전자에 해당하고 상기 도 2의 임베디드된 광대역 파일럿(embedded wideband pilot)을 통해 전송되는 방식은 후자에 해당한다.

<16> 후자에 있어서, 긴 시퀀스(long sequence)를 그대로 사용하는 경우에는 시퀀스의 길이로 증가함에 따라서 사용할 수 있는 시퀀스 개수는 선형적으로 증가하지만 전달 가능한 메시지의 양으로 보면  $\log_2$ 의 함수로 증가하기 때문에 사용 가능한 시퀀스의 수가 줄어들어 전송될 수 있는 메시지의 양에 한계가 있다. 반면, 짧은 프리엠블 시퀀스(short preamble sequence)를 사용하는 경우에는 반복되는 짧은 시퀀스에 다른 시퀀스를 덧씌워서 전송하기 때문에 시퀀스 ID의 검출 성능이 저하되는 문제가 있고, 짧은 시퀀스 자체를 모듈레이션하는 경우에는 특정 시퀀스 영역만으로 원본 데이터를 추정해야 하기 때문에 시간/주파수 다이버시티 효과가 경감되는 문제가 있다. 또한 직접 모듈레이션 방법은 채널의 영향에 의하여 그 성능이 절대적으로 악화된다.

**【발명이 이루고자 하는 기술적 과제】**

<17> 본 발명은 위와 같은 문제점을 해결하기 위해 제안된 것으로서, RACH의 주파수축/시간축 상의 구조를 보다 명확히 제시하는 한편 단말이 RACH에 접근하는 시간을 최소화할 수 있는 방안을 제공하는 데에 그 목적이 있다.

<18> 본 발명의 다른 목적은 단말과 기지국 간에 메시지를 송수신 함에 있어서 가능한 한 긴 시퀀스를 이용하여 메시지를 전달함으로써 시간/주파수 다이버시티를 최대화하는 한편 채널의 영향으로 인한 성능 감쇄 현상을 완화하기 위한 방안을 제공하는 데에 있다.

**【발명의 구성】**

<19> 위와 같은 목적을 달성하기 위한 본 발명의 일 실시예는 다수의 프레임으로 구성되는 역방향 공통 채널 중 랜덤 액세스 채널(Random Access Channel, RACH)을 통해 데이터를 전송하는 방법에 관한 것으로서, 단말이 소정 개수의 프레임을 주기로 각 프레임에 분할 배치된 RACH 중 현재 프레임의 RACH에 접근을 시도하는 단계와, 상기 접근에 성공한 경우, 해당 RACH를 통해 프리앰블(preamble) 데이터를 전송하는 단계 및 상기 접근에 실패한 경우, 다음 차순의 프레임에 분할 배치된 RACH에 접근을 시도하는 단계를 포함한다.

<20> 여기서, 상기 RACH는 시간-주파수 다이버시티(time-frequency diversity)효과를 얻기 위하여 한 주기를 이루는 각 프레임에 주파수 대역별로 균일하게 분포되도록 분할 배치되는 것이 바람직하고, 상기 RACH는 각 프레임에 배치된 RACH의 간격이 최소가 되도록 주파수 및 시간 대역 중 어느 하나 이상의 위치가 변경될 수 있다.

<21> 또한, 상기 각 프레임의 서브 프레임에는 해당 RACH로 접근한 단말을 위한 RACH 파일럿(RACH pilot)이 할당되어 있는 단블럭(short block)이 하나 이상 포함될 수 있으며, 상기 단블럭에는 하나 이상의 RACH 파일럿(RACH Pilot)과 액세스 파

일럿(Access Pilot)이 소정의 패턴으로 할당될 수 있다.

<22> 위와 같은 목적을 달성하기 위한 본 발명의 다른 일 실시예는 시그널링 채널을 통해 수신측에 데이터를 전송하는 방법에 관한 것으로서, 제1 시퀀스(sequence)를 소정 개수의 블록으로 구획하는 단계와, 상기 구획된 각 블록에, 전송할 데이터에 해당하는 제2 시퀀스를 적용하는 단계 및 상기 제2 시퀀스가 적용된 블록들의 조합에 제3 시퀀스를 곱하여 수신측에 전송하는 단계를 포함한다.

<23> 여기서, 상기 제2 시퀀스로는 소정 패턴의 짧은 시그너처 시퀀스(short signature sequence)가 이용될 수 있으며, 상기 짧은 시그너처 시퀀스는 상기 구획된 블록 개수의 모듈화값(Modulation values)으로 구성되거나, 상기 구획된 블록 개수의 지수화 시퀀스(Exponential sequence)로 구성되거나, 상기 구획된 블록 개수의 왈시 하다마드 시퀀스(Walsh Hadamard sequence)로 구성될 수 있다.

<24> 또한, 상기 제3 시퀀스로 긴 CAZAC 시퀀스(long CAZAC sequence)가 이용될 수 있다.

<25> 한편, 상기 수신측으로의 데이터 전송에 앞서 상기 제3 시퀀스가 곱해진 제1 시퀀스를 채널 코딩(channel coding)하는 단계와, 상기 채널 코딩된 데이터를 인터리빙(interleaving)하는 단계와, 상기 인터리빙된 데이터를 시그너처 맵핑(signature mapping)하는 단계 및 상기 시그너처 맵핑된 데이터에 CAZAC 시퀀스를 곱하는 단계가 더 포함될 수 있으며, 상기 시그너처 맵핑으로 그레이 맵핑(Gray mapping)이 이용될 수 있다.

<26> 위와 같은 목적을 달성하기 위한 본 발명의 다른 일 실시예는 시그널링 채널

을 통해 송신측으로부터 데이터를 수신하는 방법에 관한 것으로서, 상기 수신된 데이터에 제4 시퀀스를 곱하는 단계와, 상기 제4 시퀀스가 곱해진 데이터를 소정 개수의 블럭으로 구획하여 블럭별 제5 시퀀스를 추정하는 단계와, 제6 시퀀스를 상기 개수의 블럭으로 구획하는 단계 및 상기 제6 시퀀스의 각 블럭을 제5 시퀀스의 각 블럭에 역으로 적용하여 최종 데이터 시퀀스를 추정하는 단계를 포함한다.

<27>           상기 제4 시퀀스로 긴 CAZAC 시퀀스(long CAZAC sequence)가 이용될 수 있고, 상기 제5 시퀀스로는 소정 패턴의 짧은 시그니처 시퀀스(short signature sequence)가 이용될 수 있다. 이때, 상기 짧은 시그니처 시퀀스는 상기 구획된 블럭 개수의 모듈화값(Modulation values)으로 구성될 수도 있고, 상기 구획된 블럭 개수의 지수화 시퀀스(Exponential sequence)로 구성될 수도 있으며, 상기 구획된 블럭 개수의 왈시 하다마드 시퀀스(Walsh Hadamard sequence)로 구성될 수도 있다.

<28>           한편, 상기 제1 시퀀스의 곱하기 단계 이전에는 수신된 시그널링 데이터로부터 CAZAC 아이디를 추출하는 단계와, 수신된 시그널링 데이터로부터 로그 유사도비(log-likelihood ratio)를 산출하는 단계와, 수신된 시그널링 데이터를 디인터리빙(Deinterleaving)하는 단계 및 상기 디인터리빙된 데이터를 채널 디코딩(channel decoding)하는 단계를 더 포함할 수 있다.

<29>           이하, 본 발명의 명세서에 첨부된 도면을 참고하여 본 발명의 바람직한 실시예에 대해 설명한다.

<30>           랜덤 액세스 채널(Random Access Channel, 이하 'RACH')은 단말(User Equipment; UE)이 기지국(Node-B)과 업링크(uplink) 동기가 이루어지지 않은 상태

에서 네트워크에 접근하기 위한 통보로 사용된다. 즉, 단말이 다운링크(downlink) 동기화를 이루고 맨 처음 기지국에 접근하는 경우(initial ranging, 초기 접근)와, 네트워크에 접속된 상태로 단말의 필요에 따라서 네트워크에 그때마다 접근하는 경우(periodic ranging, 주기적 접근)에 RACH가 사용된다. 여기서, 전자의 경우는 단말이 네트워크에 접속하면서 동기를 이루고 자신에게 필요한 아이디(ID)를 제공받기 위한 용도로 사용되고, 후자는 전송할 패킷이 존재하거나 기지국으로부터 정보를 수신하기 위해 프로토콜을 초기화(initiation)시키기 위한 용도로 사용된다.

<31>           특히 후자의 경우는 3GPP LTE에 의할 때 다시 두 가지로 구분할 수 있는데, 단말이 RACH에 접근할 때 자신의 업링크(uplink) 신호가 동기 한계 내에 있을 때 사용하는 동기화 접근 모드(synchronized access mode)와, 동기 한계를 벗어났을 때 사용하는 비동기화 접근 모드(non-synchronized access mode)로 구분할 수 있다. 비동기화 접근 모드는 단말이 최초로 기지국에 접근하는 경우나, 동기 과정을 거친 후 동기 갱신(update)가 이루어지지 않았을 경우에 사용되는 방식이다. 이때, 동기화 접근 모드는 상기 주기적 접근(periodic ranging)과 같은 개념이며, 단말이 기지국에게 자신의 변경사항 통보와 자원할당 요청을 목적으로 RACH에 접근하는 경우에 이용된다.

<32>           이에 비해, 동기화 접근 모드는 단말이 기지국과 업링크(uplink) 동기를 벗어남이 적은 상태라 가정하고 그 가정에 따라 RACH에 있어서 보호 시간(Guard time)의 제한을 완화한다. 이로 인해 더 많은 시간-주파수 자원(time-frequency resource)을 사용할 수 있는데, 3GPP LTE에서는 동기화 접근 모드에서 랜덤 액세스

용 프리앰블 시퀀스(preamble sequence)에 상당한 양의 메시지(24bits 이상)를 더하여 양자를 함께 전송하도록 하고 있다. 따라서, 본 발명에 있어서 새롭게 정의된 RACH 구조에 의해 데이터를 전송하는 방법(제1 실시예)에 대하여는 비동기화 접근 모드 및 동기화 접근 모드가 적용되고, 단말과 기지국 간에 시그널 데이터를 송수신하는 방법(제2 실시예)에 대하여는 제안된 방법 이외의 다른 랜덤 액세스 기법에도 적용될 수 있다.

<33> <제1 실시예>

<34> 일반적으로 RACH의 생성 빈도는 물리 채널(MAC)에서의 QoS(Quality of Service) 요구 조건에 따라 정해지며, 수십 ms 단위 또는 수백 ms 단위로 RACH가 생성된다. 이러한 RACH는 시간 영역 또는 주파수 영역에서 생성될 수 있는데, 시간 영역에서 랜덤 액세스 신호를 생성하는 경우에는 본래의 서브 프레임 구조가 무시되고 단지 시간-주파수 자원(time-frequency resource, TFR) 만으로 신호를 정렬하여 전송한다. 참고로, 도 4a는 시간 영역에서 RACH의 신호를 실는 형태를 모식적으로 도시하고 있다.

<35> 반면, 주파수 영역에서 랜덤 액세스 신호를 생성하는 경우에는 서브 프레임 구조를 어느 정도 유지하면서 각각 OFDM(Orthogonal Frequency Division Multiflexing) 심벌의 반송파에 상기 생성된 랜덤 액세스 신호를 실어서 전송하므로, 각 블록 사이의 직교성이 유지되고 채널 추정 또한 용이하게 수행되는 장점이 있다. 따라서, 본 실시예에서는 주파수 영역에서 랜덤 액세스 신호가 생성되는 경우에 있어서의 RACH 구조에 초점을 맞추어 설명하기로 한다. 참고로, 도 4b는 주파

수 영역에서 RACH의 신호를 실는 형태를 모식적으로 도시한 것이다.

<36>           본 실시예에서는 상기 도 3에서 먼저 설명한 바와 같이 단말이 RACH 접근에 실패할 경우 재시도까지의 간격이 길어지는 단점을 극복하기 위해, RACH의 발생 빈도와 오버헤드(overhead)의 양이 결정되면 해당 RACH 자원을 한 주기 내의 각 프레임에 분산하여 배치한다. 이때, RACH는 한 주기를 이루는 복수의 프레임에 대하여 주파수 대역별로 균일하게 분포되도록 분할 배치되는 것이 바람직하다. 또한, 각 프레임에 배치된 RACH의 간격이 최소가 되도록 주파수 및 시간 대역 중 어느 하나 이상의 위치가 변경될 수도 있다. 참고로, 도 5는 이와 같은 실시예에 의한 RACH의 구조를 모식적으로 도시한 것이다.

<37>           이제, 이와 같은 RACH 구조에서 단말이 기지국에 업링크 데이터를 전송하는 과정을 살펴보면 다음과 같다. 여기서, 데이터의 전송은 다수의 프레임으로 구성되는 역방향 공통 채널 중에서 특히 RACH을 통해 수행되는 것을 전제로 한다.

<38>           먼저, 단말은 자신의 일정 정보를 기지국에 전달하기 위해 현재 프레임에 포함되어 있는 분산된 RACH에 접근을 시도한다. 여기서, 만약 접근에 성공하면 해당 RACH를 통해 프리앰블(preamble) 데이터를 전송하지만, 접근에 실패하면 다음 차순의 프레임에 분할 배치된 RACH에 접근을 시도한다. 이때, 다음 차순의 프레임에 포함된 RACH는 이전 프레임의 RACH와 상이한 주파수 대역에 배치되는 것이 바람직하다. 또한, 상기와 같은 접근 절차는 접근에 성공할 때까지 다음 차순의 프레임에서 계속적으로 수행된다.

<39>           한편, 각 프레임의 서브 프레임에는 해당 RACH로 접근한 단말을 위한 파일럿



이 할당되어 있는 단블럭(short block)이 포함되는 것이 바람직하다. 이러한 단블럭에는 하나 이상의 RACH 파일럿(RACH Pilot)과 액세스 파일럿(Access Pilot)이 소정의 패턴으로 할당될 수 있다. 즉, RACH로 접근한 단말이 기지국으로부터 채널을 할당받기 위해서는 채널에 대한 정보를 알 수 있어야 하는데, 이와 같은 채널 정보는 업링크 단블럭(uplink short block) 내의 RACH 파일럿에 설정될 수 있다. 기지국은 해당 RACH 파일럿을 통해 단말에게 적절한 채널을 할당해준다. 한편, RACH로 접근하는 단말 입장에서도 상기 RACH 파일럿을 통해서 어떤 채널을 할당받는 것이 좋은지에 대한 채널품질정보를 기지국에 알려줄 수 있다면 스케줄링될 때 단말에 유리한 채널이 할당될 수 있으므로 양질의 통신을 지속시킬 수도 있다는 장점이 있다.

<40> 따라서, RACH가 포함된 서브 프레임에서는 RACH에 접근하는 단말이 사용할 수 있는 RACH 파일럿을 따로 할당해두고, RACH에 접근하는 단말은 해당 RACH를 통해 기지국으로 프리앰블(Preamble)을 보내는 한편, 지정된 RACH 파일럿에 채널품질 정보 전송용 파일럿도 함께 보낸다. 상기 RACH 파일럿은 프리앰블(Preamble)에 따라서 정해지는 시퀀스(sequence)이며, 서로 다른 프리앰블 시퀀스(Preamble sequence)를 사용하는 단말은 가능하면 서로 다른 RACH 파일럿 시퀀스를 사용하거나, 다른(또는 일부가 겹치는 형태) 부반송파(subcarrier)의 RACH 파일럿을 선택하는 것이 바람직하다. 참고로, 도 6은 RACH 파일럿이 할당된 서브 프레임의 랜덤 액세스 채널 구조를 모식적으로 도시한 것이다. 여기서 각 서브 프레임에는 하나 이상의 RACH 파일럿(RACH Pilot)과 액세스 파일럿(Access Pilot)이 소정의 패턴으로

할당되어 있는 단블럭(short block)이 하나 이상 포함되어 있는 것을 확인할 수 있다. 이 경우 RACH 파일럿은 할당된 RACH의 주파수 대역에만 존재하는 것이 아니라 그 외의 시스템 대역에서도 존재하게 된다. 본 실시예에서는 할당 패턴에 있어서 하나의 프레임당 2개의 단블럭이 존재하고 그에 RACH 파일럿이 전송되는 경우를 예로 들었지만, 여기에 한정하지 않고 당업자가 자명한 범위 내에서 다양한 변형이 가능하다.

<41> <제2 실시예>

<42> 일반적으로 실제 RACH 채널을 구현하는 데에 있어서 신호의 시작 위치를 검색해야 하는 부담으로 인해 랜덤 액세스 신호가 시간 영역에서 특정 패턴을 가지도록 설계한다. 이를 위해 본래부터 반복적인 패턴을 가지도록 프리앰블 시퀀스(preamble sequence)를 사용할 수도 있고, 주파수 영역에서 반송파 간의 사이클을 일정 구간 띄우는 방식으로 시간 영역에서의 반복 특성을 만들어 낼 수도 있다. 따라서, 상기도 4a 및 도 4b의 접근 방식 모두 시간 영역에서 용이하게 검색되기 위한 특징이 있어야 하며, 이를 위해 CAZAC(Constant Amplitude Zero AutoCorrelation) 시퀀스가 사용된다. CAZAC 시퀀스는 크게 GCL 시퀀스(수식 1)와 Zadoff-Chu 시퀀스(수식 2)로 구분할 수 있다.

【수학식 1】

<43> 
$$c(k; N, M) = \exp\left(-\frac{j\pi M k(k+1)}{N}\right) \text{ for odd } N$$

<44> 
$$c(k;N,M)=\exp\left(-\frac{j\pi M k^2}{N}\right)$$
 for even N

【수학식 2】

<45> 
$$c(k;N,M)=\exp\left(\frac{j\pi M k(k+1)}{N}\right)$$
 for odd N

<46> 
$$c(k;N,M)=\exp\left(\frac{j\pi M k^2}{N}\right)$$
 for even N

<47> 한편, RACH(Random Access Channel)나 SCH(Synchronization Channel)에서 접근 단말 또는 기지국의 고유(unique) 정보를 전달하기 위해 원칙적으로 긴 특정 sequence를 사용하는 것이 바람직하다. 왜냐하면, 시퀀스의 길이가 길면 수신단에서 해당 ID를 검출하기 용이할 뿐 아니라, 더 많은 종류의 시퀀스를 사용할 수 있으므로 시스템 설계에 편리함을 제공하기 때문이다.

<48> 그러나, 시퀀스의 길이를 길게 하여 해당 ID로 메시지를 전달할 경우 메시지의 양은  $\log_2$  함수로 증가하므로 시퀀스가 일정 길이 이상이 되면 ID만으로 메시지를 전달하는 데에 한계가 있다. 따라서, 본 실시예에서는 시퀀스를 몇 개의 단블록(short block)으로 구획하고, 자체에 컨쥬테이트(conjugate) 또는 니게이션(negation) 등의 특정한 조작을 가하기보다는 시퀀스의 각 블록에 전송하고자 하는 데이터에 해당하는 짧은 시그너처 시퀀스(short signature sequence)를 적용하기로 한다. 참고로, 도 6은 본 발명에 의한 시그널 채널 데이터의 전송 방법을 도시한

개념도이다.

<49> 본 실시예에 따라 시그널링 채널을 통해 수신측에 데이터를 전송하는 방법에도 7을 참고로 좀더 상세하게 설명하면 다음과 같다.

<50> 먼저, 시퀀스(sequence)를 소정 개수의 블록으로 구획하고 그 구획된 각 블록에, 전송할 데이터에 해당하는 짧은 시그니처 시퀀스(short signature sequence)를 적용한다. 그리고, 상기 짧은 시그니처 시퀀스가 적용된 블록들의 조합에 긴 CAZAC 시퀀스(long CAZAC sequence)를 곱하여 수신측에 전송할 최종적인 데이터 시퀀스를 완성한다.

<51> 여기서, 상기 짧은 시그니처 시퀀스가 4개의 시그니처로 이루어진다고 가정할 때 아래와 같은 시그니처 세트들이 사용될 수 있다. 또한, 시그니처 세트를 구성하는 각 데이터 간에 차별성이 있다면 그 외에 어떤 시그니처 세트라도 사용이 가능하다.

<52> 1) 모듈레이션 값(Modulation values):  $\{1+j, 1-j, -1-j, -1+j\}$

<53> 2) 지수적 시퀀스(Exponential sequence):  $\{[\exp(jw_0 n)], [\exp(jw_1 n)], [\exp(jw_2 n)], [\exp(jw_3 n)]\}$  여기서  $n=0 \dots N_s$ 이고,  $N_s$ 는 각 블록의 길이

<54> 3) 왈시 하마다드 시퀀스(Walsh Hadamard sequence):  $\{[1111], [1-1-1-1], [11-1-1], [1-1-11]\}$  여기서, 블록의 길이  $N_s$ 가 4보다 길면 각 sequence를 반복시켜서 길이를 맞춤.

<55> 이상과 같이 긴 CAZAC 시퀀스에 데이터 송수신을 위한 짧은 시그니처 시퀀스

를 사용하는 방식은 종래 기술에 있어서 곧바로 전송 데이터를 변조하는 방식에 비해 채널의 영향이 적다는 장점이 있으며, 하나의 시그니처를 구성하는 비트 수를 늘리더라도 성능의 감소가 크지 않은 특징이 있다.

<56>           상기 방식을 이용하여 RACH 또는 SCH에 프리엠블(preamble)과 데이터를 전송하기 위한 송신측 구성 및 수신측 구성을 도 8을 참고로 살펴보면 다음과 같다.

<57>           송신단에 있어서, 상기와 같은 경우 시그니처 증가에 따른 비트 수 증가가 가능하기 때문에 채널 코딩이 적용 가능하며, 채널 코딩을 수행하는 경우 다시 인터리버를 통해서 시간/주파수 다이버시티를 얻을 수 있다. 또한, 비트 에러율을 최소화하기 위해서 비트 -> 시그니처 맵핑을 수행할 수 있으며, 이 경우 특히 그레이 맵핑(Gray mapping)을 이용할 수 있다. 이와 같은 과정을 거친 시퀀스는 최종적으로 CAZAC으로 믹싱되어 송신된다.

<58>           수신단에서는 CAZAC에 대한 ID를 검출하고, 그 다음 각 bit들에 대해서 로그 유사도비(log-likelihood ratio, LLR)를 계산한다. 그런 다음 채널 디코더를 통해서 전송 데이터를 복호화 한다. 도 8과 같은 구성의 수신단에서 시퀀스 검색에 따른 복잡도(complexity)를 고려하면, 전송단에서 시그니처 시퀀스로 지수적 시퀀스(exponential sequence)를 사용하는 것이 적절하다. 이러한 경우 수신단에서는 위상차 푸리에 변환(phase difference Fourier Transform)을 통해서 CAZAC ID 검색을 간단하게 수행할 수 있으며, 이후 시그니처로부터 다시 LLR을 계산하는 경우에도 푸리에 변환(Fourier Transform)을 통해 간단하게 구현할 수 있다.

<59>           이상에서 설명한 본 발명은, 본 발명이 속하는 기술분야에서 통상의 지식을

가진 자에 있어 본 발명의 기술적 사상을 벗어나지 않는 범위 내에서 여러 가지 치환, 변형 및 변경이 가능하므로 전술한 실시예 및 첨부된 도면에 의해 한정되는 것이 아니다.

**【발명의 효과】**

<60> 본 발명에 의하면 RACH의 주파수축/시간축 상의 구조를 보다 명확하게 파악할 수 있고, RACH 자원이 프레임별로 균일하게 분할 분포되어 특정 RACH에의 접근이 실패하더라도 곧바로 다음 프레임의 RACH로 접근할 수 있으므로 기지국으로의 접근성이 향상되며, QoS(Quality of Service) 조건이 까다로운 트래픽 영역에서도 RACH로의 접근을 용이하게 할 수 있다.

<61> 또한, 본 발명에 의하면 단말과 기지국 간에 긴 시퀀스를 이용하여 메시지를 송수신하므로 시간/주파수 나이버시티를 최대화할 수 있고, 시그너처 방식을 통해 채널의 영향에 의한 성능 감쇄 현상을 완화할 수 있다.

**【특허청구범위】**

**【청구항 1】**

다수의 프레임으로 구성되는 역방향 공통 채널 중 랜덤 액세스 채널(Random Access Channel, RACH)을 통해 데이터를 전송하는 방법에 있어서,

단말이 소정 개수의 프레임을 주기로 각 프레임에 분할 배치된 RACH 중 현재 프레임의 RACH에 접근을 시도하는 단계;

상기 접근에 성공한 경우, 해당 RACH를 통해 프리앰블(preamble) 데이터를 전송하는 단계; 및

상기 접근에 실패한 경우, 다음 차순의 프레임에 분할 배치된 RACH에 접근을 시도하는 단계

를 포함하는 랜덤 액세스 채널을 통한 데이터 전송 방법.

**【청구항 2】**

제1항에 있어서,

상기 RACH는 한 주기를 이루는 각 프레임에 주파수 대역별로 균일하게 분포 되도록 분할 배치되는 랜덤 액세스 채널을 통한 데이터 전송 방법.

**【청구항 3】**

제2항에 있어서,

상기 RACH는 각 프레임에 배치된 RACH의 간격이 최소가 되도록 주파수 및 시간 대역 중 어느 하나 이상의 위치가 변경되는 랜덤 액세스 채널을 통한 데이터 전송 방법.

송 방법.

**【청구항 4】**

제1항 내지 제3항 중 어느 한 항에 있어서,

상기 각 프레임의 서브 프레임에는 해당 RACH로 접근한 단말을 위한 파일럿 (pilot)이 할당되어 있는 단블럭(short block)이 하나 이상 포함되어 있는 랜덤 액세스 채널을 통한 데이터 전송 방법.

**【청구항 5】**

제4항에 있어서,

상기 단블럭에는 하나 이상의 RACH 파일럿(RACH Pilot)과 액세스 파일럿 (Access Pilot)이 소정의 패턴으로 할당되어 있는 랜덤 액세스 채널을 통한 데이터 전송 방법.

**【청구항 6】**

시그널링 채널을 통해 수신측에 데이터를 전송하는 방법에 있어서,

제1 시퀀스(sequence)를 소정 개수의 블럭으로 구획하는 단계;

상기 구획된 각 블럭에, 전송할 데이터에 해당하는 제2 시퀀스를 적용하는 단계; 및

상기 제2 시퀀스가 적용된 블럭들의 조합에 제3 시퀀스를 곱하여 수신측에 전송하는 단계

를 포함하는 시그널링 데이터 전송 방법.



**【청구항 7】**

제6항에 있어서,

상기 제2 시퀀스로 소정 패턴의 짧은 시그너처 시퀀스(short signature sequence)가 이용되는 시그널링 데이터 전송 방법.

**【청구항 8】**

제7항에 있어서,

상기 짧은 시그너처 시퀀스는 상기 구획된 블럭 개수의 모듈화값(Modulation values)으로 구성되는 시그널링 데이터 전송 방법.

**【청구항 9】**

제7항에 있어서,

상기 짧은 시그너처 시퀀스는 상기 구획된 블럭 개수의 지수화 시퀀스(Exponential sequence)로 구성되는 시그널링 데이터 전송 방법.

**【청구항 10】**

제7항에 있어서,

상기 짧은 시그너처 시퀀스는 상기 구획된 블럭 개수의 왈시 하다마드 시퀀스(Walsh Hadamard sequence)로 구성되는 시그널링 데이터 전송 방법.

**【청구항 11】**

제6항 내지 제10항 중 어느 한 항에 있어서,

상기 제3 시퀀스로 긴 CAZAC 시퀀스(long CAZAC sequence)가 이용되는 시그

널링 데이터 전송 방법.

**【청구항 12】**

제6항에 있어서, 상기 수신측으로의 데이터 전송에 앞서  
상기 제3 시퀀스가 곱해진 제1 시퀀스를 채널 코딩(channel coding)하는 단  
계;  
상기 채널 코딩된 데이터를 인터리빙(interleaving)하는 단계;  
상기 인터리빙된 데이터를 시그너처 맵핑(signature mapping)하는 단계; 및  
상기 시그너처 맵핑된 데이터에 CAZAC 시퀀스를 곱하는 단계  
가 더 포함되는 시그널링 데이터 전송 방법.

**【청구항 13】**

제12항에 있어서,  
상기 시그너처 맵핑으로 그레이 맵핑(Gray mapping)이 이용되는 시그널링 데  
이터 전송 방법.

**【청구항 14】**

시그널링 채널을 통해 송신측으로부터 데이터를 수신하는 방법에 있어서,  
상기 수신된 데이터에 제1 시퀀스를 곱하는 단계;  
상기 제1 시퀀스가 곱해진 데이터를 소정 개수의 블록으로 구획하여 블록별  
제2 시퀀스를 추정하는 단계;  
제3 시퀀스를 상기 개수의 블록으로 구획하는 단계; 및

상기 제3 시퀀스의 각 블록을 제2 시퀀스의 각 블록에 역으로 적용하여 최종 데이터 시퀀스를 추정하는 단계;

를 포함하는 시그널링 데이터 전송 방법.

**【청구항 15】**

제14항에 있어서,

상기 제1 시퀀스로 긴 CAZAC 시퀀스(long CAZAC sequence)가 이용되는 시그널링 데이터 전송 방법.

**【청구항 16】**

제14항 또는 제15항에 있어서,

상기 제2 시퀀스로 소정 패턴의 짧은 시그너처 시퀀스(short signature sequence)가 이용되는 시그널링 데이터 전송 방법.

**【청구항 17】**

제16항에 있어서,

상기 짧은 시그너처 시퀀스는 상기 구획된 블록 개수의 모듈화값(Modulation values)으로 구성되는 시그널링 데이터 전송 방법.

**【청구항 18】**

제16항에 있어서,

상기 짧은 시그너처 시퀀스는 상기 구획된 블록 개수의 지수화 시퀀스(Exponential sequence)로 구성되는 시그널링 데이터 전송 방법.

【청구항 19】

제16항에 있어서,

상기 짧은 시그너처 시퀀스는 상기 구획된 블록 개수의 왈시 하다마드 시퀀스(Walsh Hadamard sequence)로 구성되는 시그널링 데이터 전송 방법.

【청구항 20】

제14항에 있어서, 상기 제1 시퀀스의 곱하기 단계 이전에

수신된 시그널링 데이터로부터 CAZAC 아이디를 추출하는 단계;

수신된 시그널링 데이터로부터 로그 유사도비(log-likelihood ratio)를 산출하는 단계;

수신된 시그널링 데이터를 디인터리빙(Deinterleaving)하는 단계; 및

상기 디인터리빙된 데이터를 채널 디코딩(channel decoding)하는 단계;

를 더 포함하는 시그널링 데이터 전송 방법.

【도면】

【도 1】

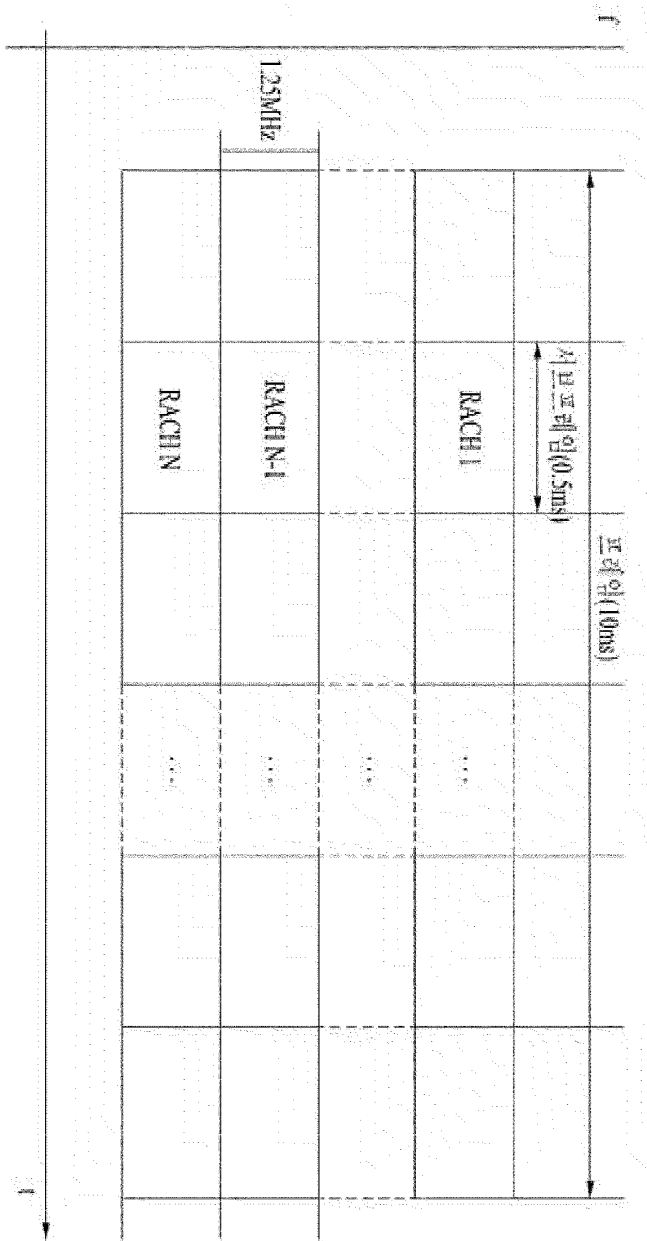

【도 2】

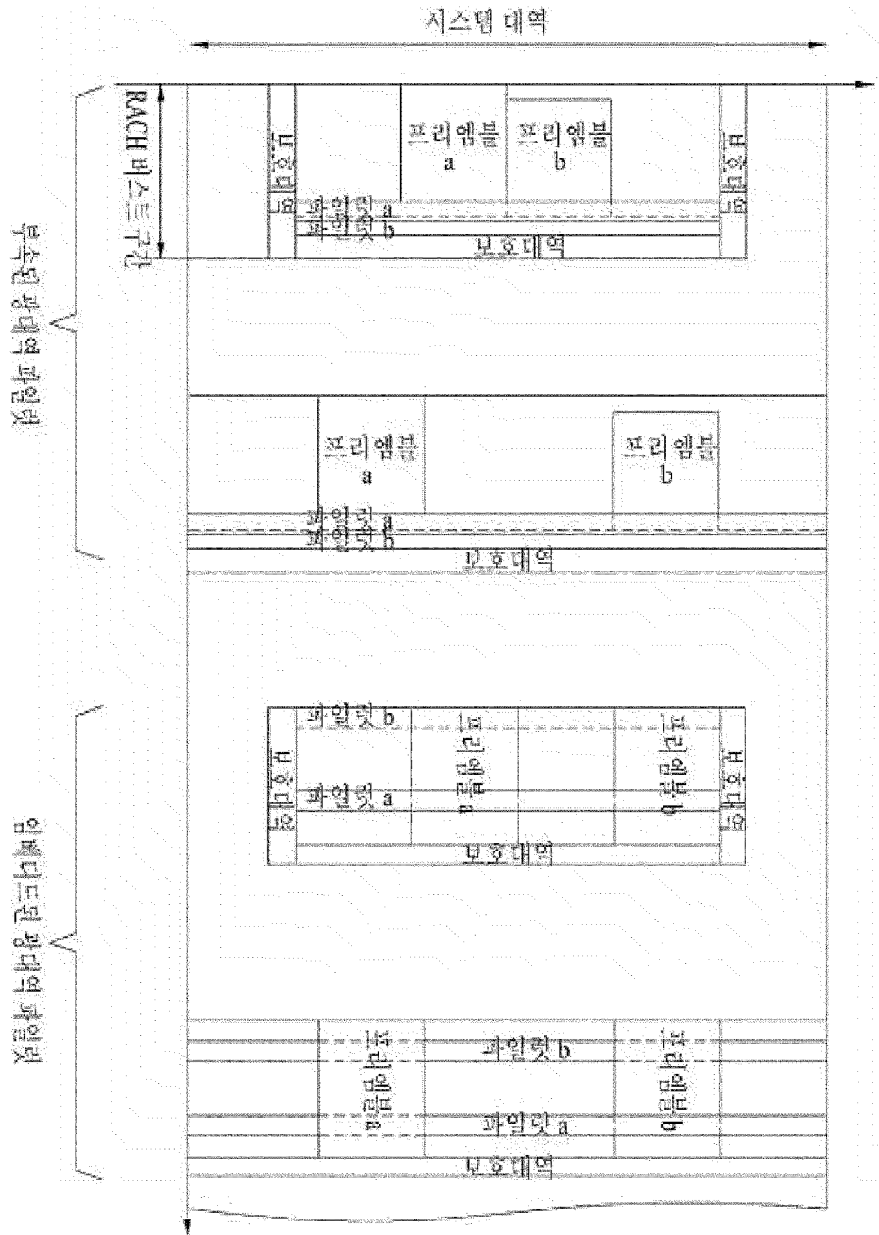

【도 3】

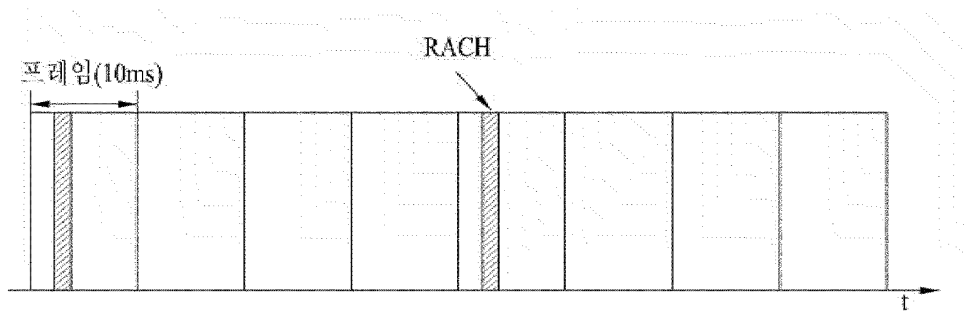

【도 4a】

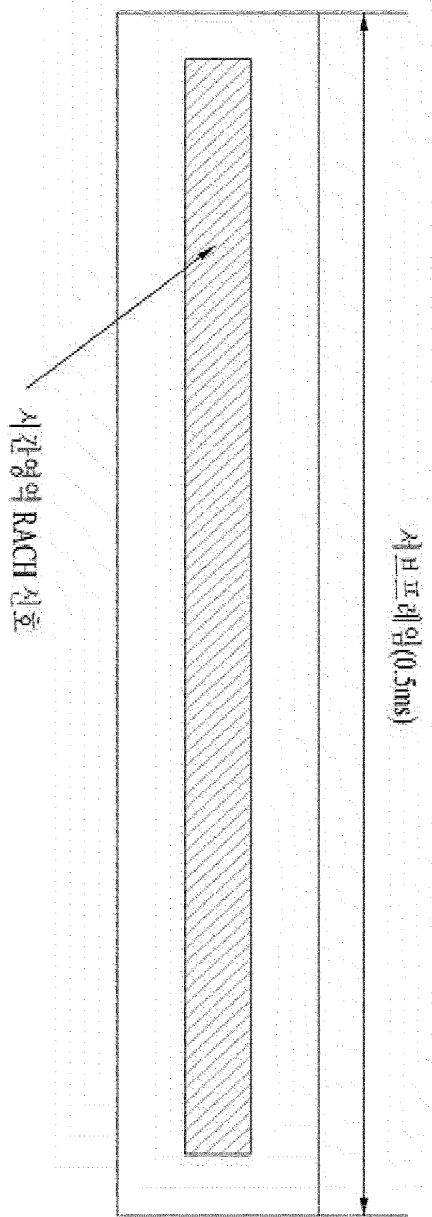



【도 4b】

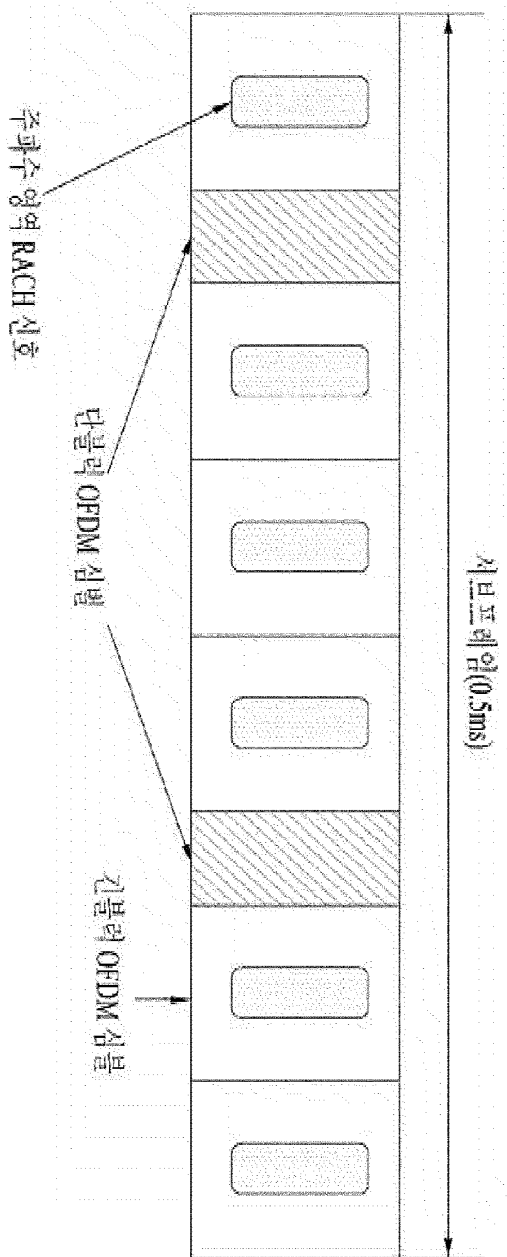

【도 5】

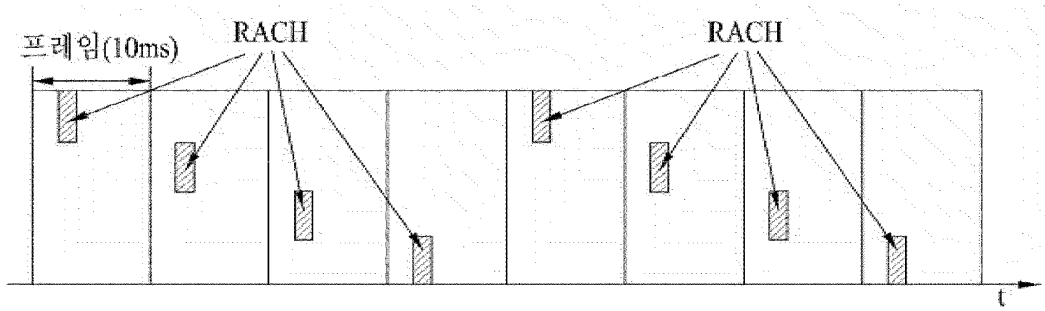

【 6】

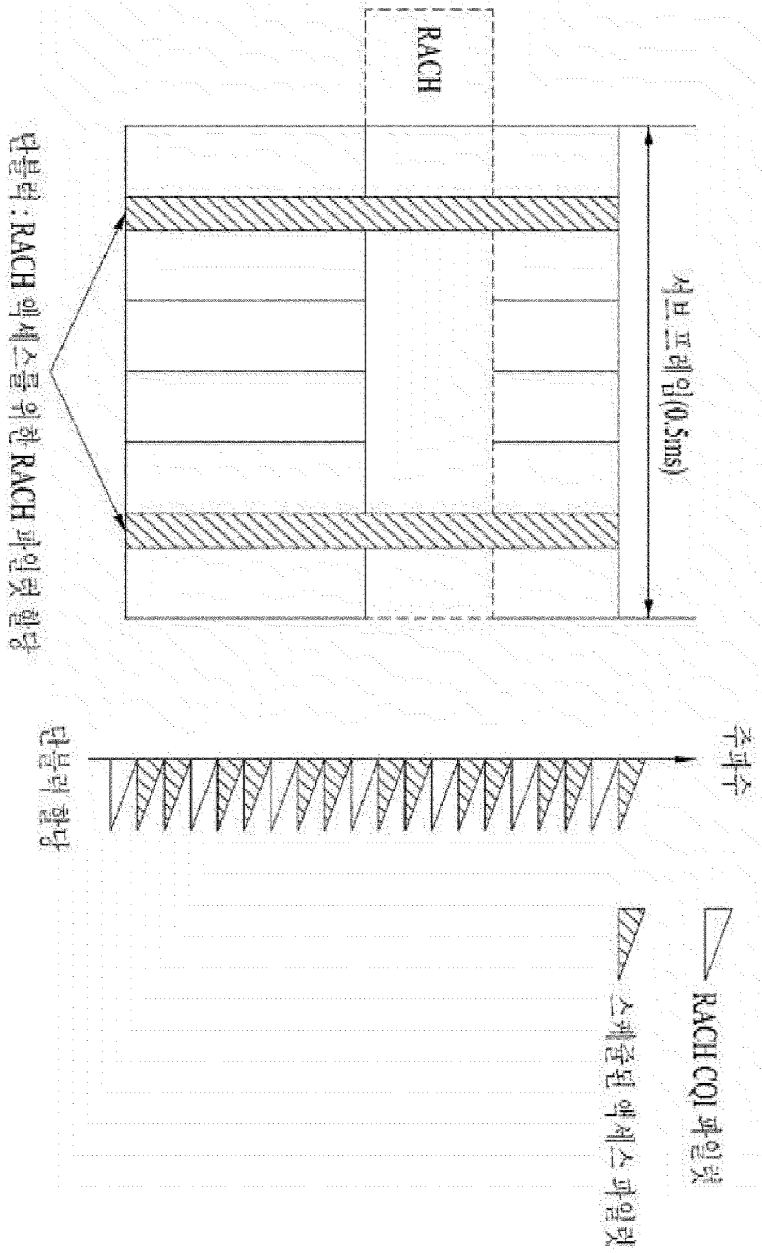

【도 7】

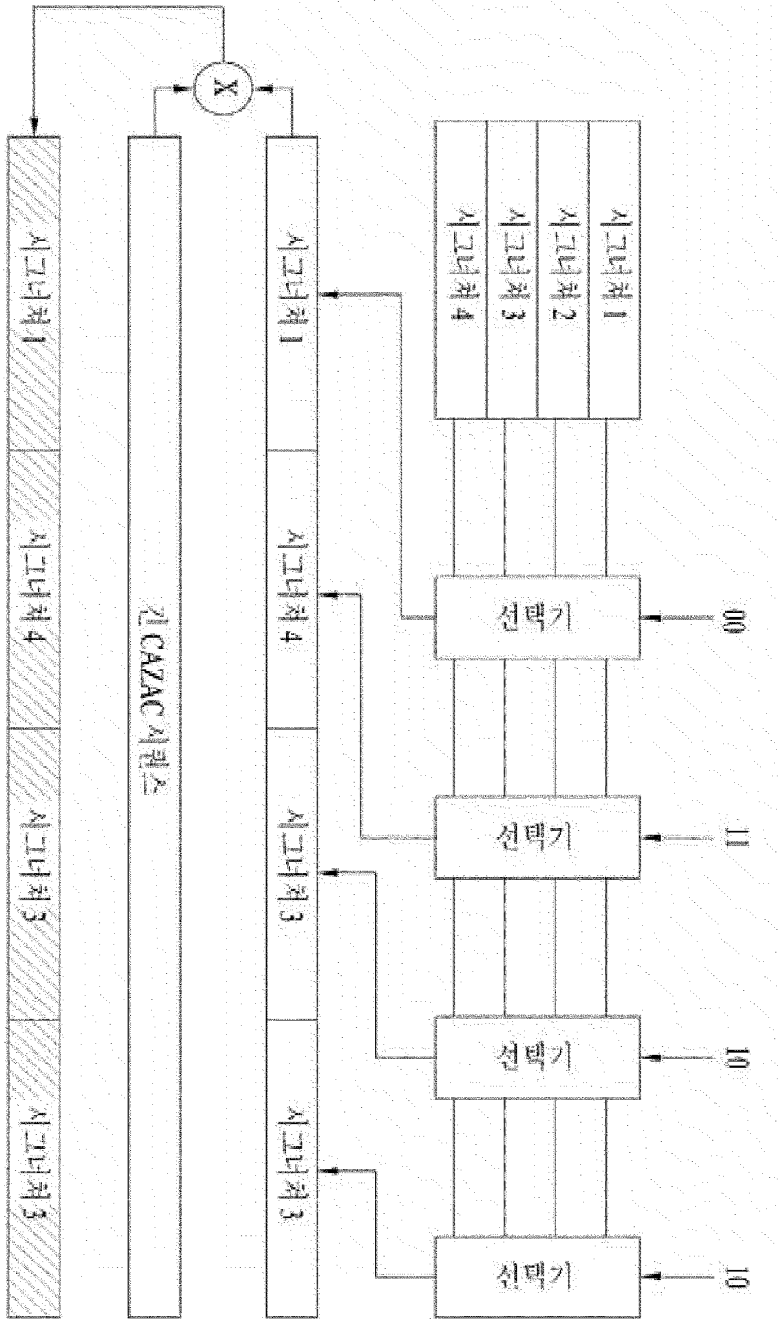

【도 8】

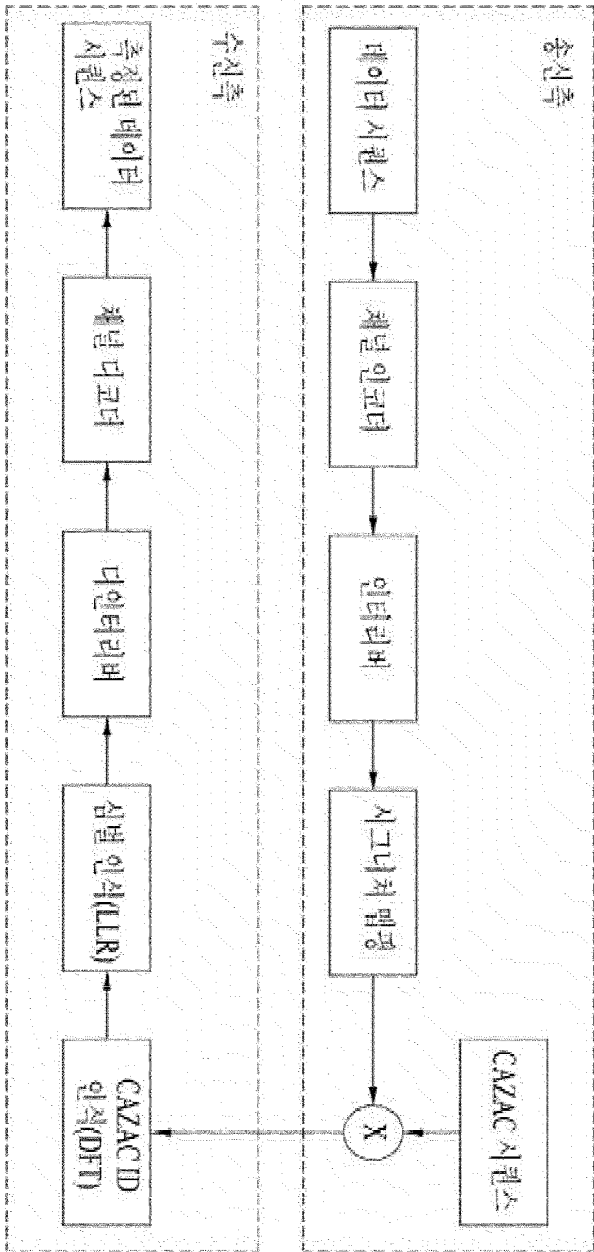

(12) INTERNATIONAL APPLICATION PUBLISHED UNDER THE PATENT COOPERATION TREATY (PCT)

(19) World Intellectual Property Organization  
International Bureau



(43) International Publication Date  
13 December 2007 (13.12.2007)

PCT

(10) International Publication Number  
**WO 2007/142492 A3**

- (51) International Patent Classification:  
*H04L 27/26* (2006.01)     *H04W 74/08* (2009.01)
- (21) International Application Number:  
PCT/KR2007/002784
- (22) International Filing Date:     8 June 2007 (08.06.2007)
- (25) Filing Language:     Korean
- (26) Publication Language:     English
- (30) Priority Data:  
10-2006-0052167     9 June 2006 (09.06.2006)     KR  
10-2006-0057488     26 June 2006 (26.06.2006)     KR
- (71) Applicant (for all designated States except US): **LG ELECTRONICS INC.** [KR/KR]; 20, Yeouido-dong, Yeongdeungpo-gu, Seoul 150-721 (KR).
- (72) Inventors; and
- (75) Inventors/Applicants (for US only): **KWON, Yeong Hyeon** [KR/KR]; LG Institute, Hogue 1(il)-dong, Dongan-gu., Anyang-si, Gyeonggi-do, 431-749 (KR). **HAN, Seung Hee** [KR/KR]; LG Institute, Hogue 1(il)-dong, Dongan-gu., Anyang-si, Gyeonggi-do, 431-749 (KR). **PARK, Hyun Hwa** [KR/KR]; LG Institute, Hogue 1(il)-dong, Dongan-gu., Anyang-si, Gyeonggi-do, 431-749 (KR). **KIM, Dong Cheol** [KR/KR]; LG Institute, Hogue 1(il)-dong, Dongan-gu., Anyang-si, Gyeonggi-do, 431-749 (KR). **LEE, Hyun Woo** [KR/KR]; LG Institute, Hogue

1(il)-dong, Dongan-gu., Anyang-si, Gyeonggi-do, 431-749 (KR). **NOH, Min Seok** [KR/KR]; LG Institute, Hogue 1(il)-dong, Dongan-gu., Anyang-si, Gyeonggi-do, 431-749 (KR).

(74) Agents: **KIM, Yong In** et al.; KBK & Associates, 15 th Floor, Yosam-Building, 648-23, Yeoksam-dong, Kangnam-gu, Seoul, 135-080 (KR).

(81) Designated States (unless otherwise indicated, for every kind of national protection available): AE, AG, AL, AM, AT, AU, AZ, BA, BB, BG, BH, BR, BW, BY, BZ, CA, CH, CN, CO, CR, CU, CZ, DE, DK, DM, DZ, EC, EE, EG, ES, FI, GB, GD, GE, GH, GM, GT, HN, HR, HU, ID, IL, IN, IS, JP, KE, KG, KM, KN, KP, KZ, LA, LC, LK, LR, LS, LT, LU, LY, MA, MD, MG, MK, MN, MW, MX, MY, MZ, NA, NG, NI, NO, NZ, OM, PG, PH, PL, PT, RO, RS, RU, SC, SD, SE, SG, SK, SL, SM, SV, SY, TJ, TM, TN, TR, TT, TZ, UA, UG, US, UZ, VC, VN, ZA, ZM, ZW.

(84) Designated States (unless otherwise indicated, for every kind of regional protection available): ARIPO (BW, GH, GM, KE, LS, MW, MZ, NA, SD, SL, SZ, TZ, UG, ZM, ZW), Eurasian (AM, AZ, BY, KG, KZ, MD, RU, TJ, TM), European (AT, BE, BG, CH, CY, CZ, DE, DK, EE, ES, FI, FR, GB, GR, HU, IE, IS, IT, LT, LU, LV, MC, MT, NL, PL, PT, RO, SE, SI, SK, TR), OAPI (BF, BJ, CF, CG, CI, CM, GA, GN, GQ, GW, ML, MR, NE, SN, TD, TG).

Published: — with international search report

[Continued on next page]

WO 2007/142492 A3

(54) Title: METHOD OF TRANSMITTING DATA IN A MOBILE COMMUNICAITON SYSTEM

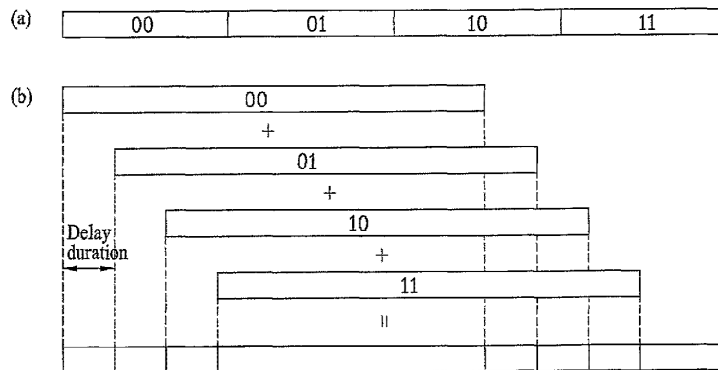

(57) Abstract: Disclosed is a data transmission method in a mobile omunication system. The data transmission method through a code sequence in a mobile communication system includes grouping input data streams into a plurality of blocks consisting of at least one bit so as to map each block to a corresponding signature sequence, multiplying a signature sequence stream, to which the plurality of blocks are mapped, by a specific code sequence, and transmitting the signature sequence stream multiplied by the specific code sequence to a receiver.



— *before the expiration of the time limit for amending the claims and to be republished in the event of receipt of amendments*

(88) **Date of publication of the international search report:**  
11 June 2009

FIG. 1

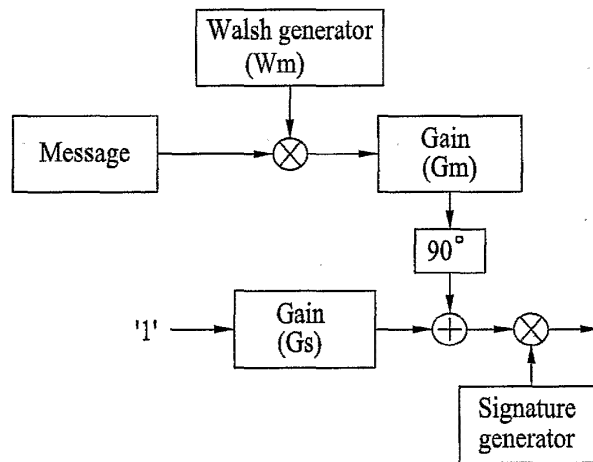
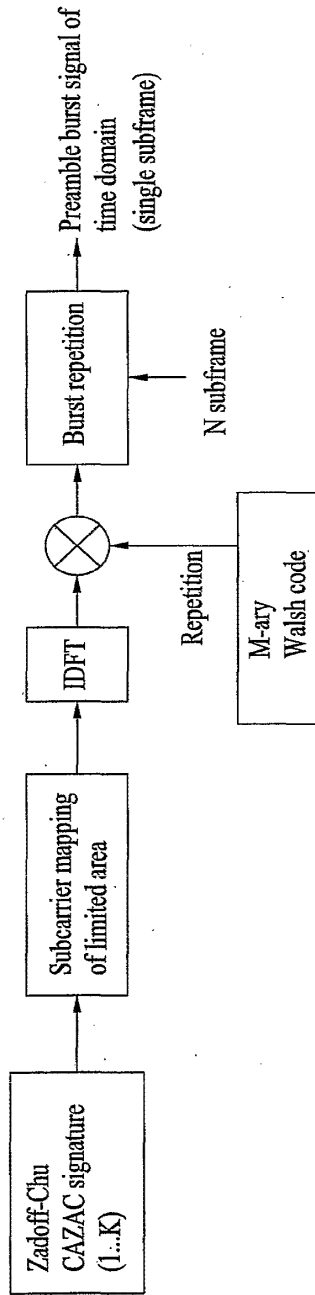



FIG. 2



3/22

FIG. 3A

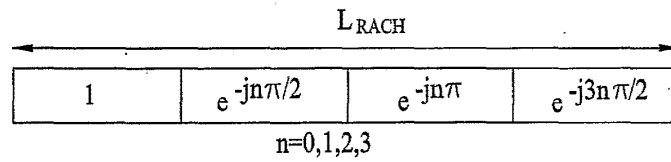

FIG. 3B

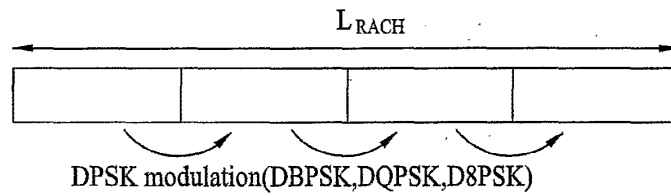

FIG. 4A

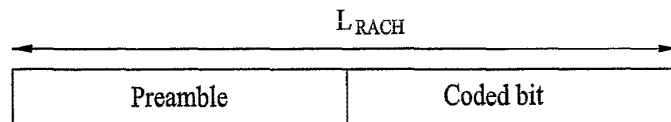

FIG. 4B

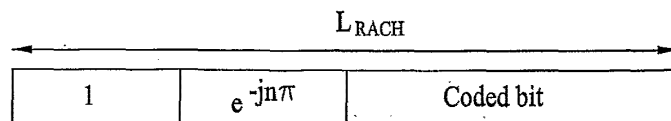
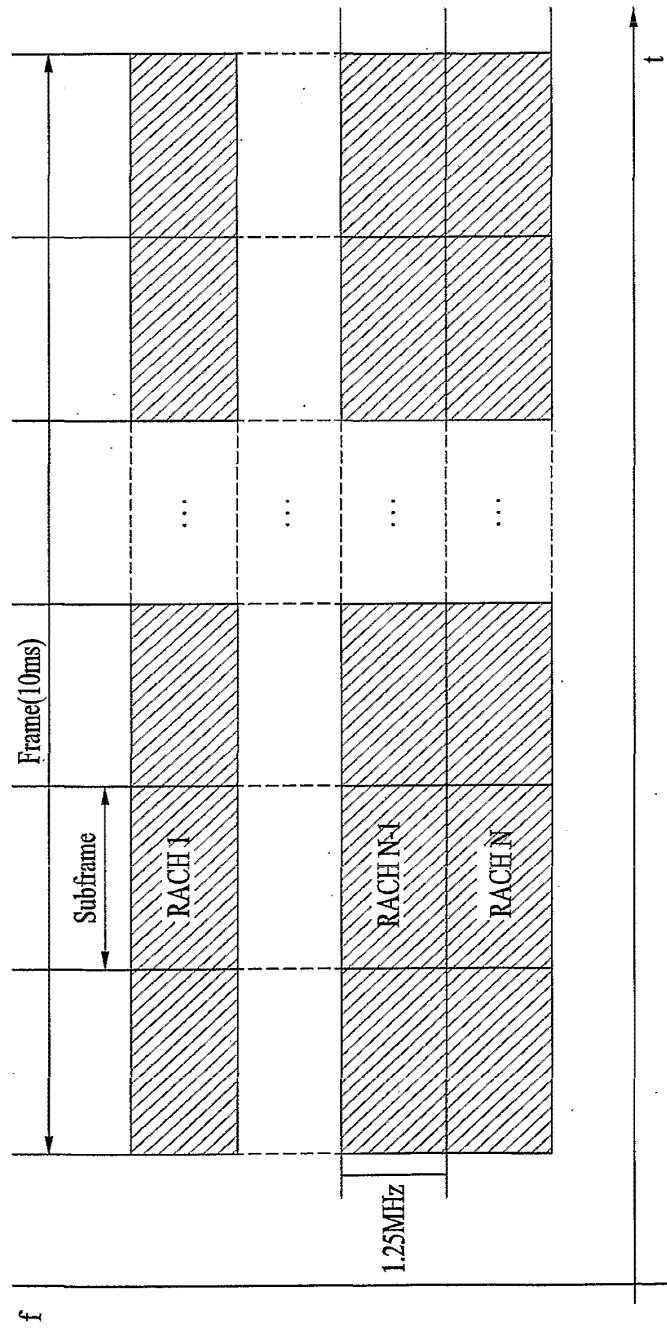

FIG. 5



5/22

FIG. 6A

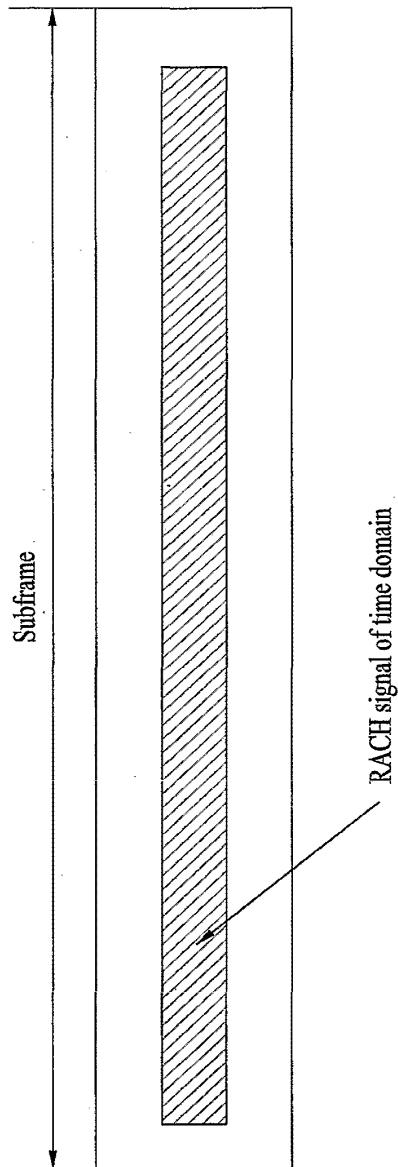

FIG. 6B

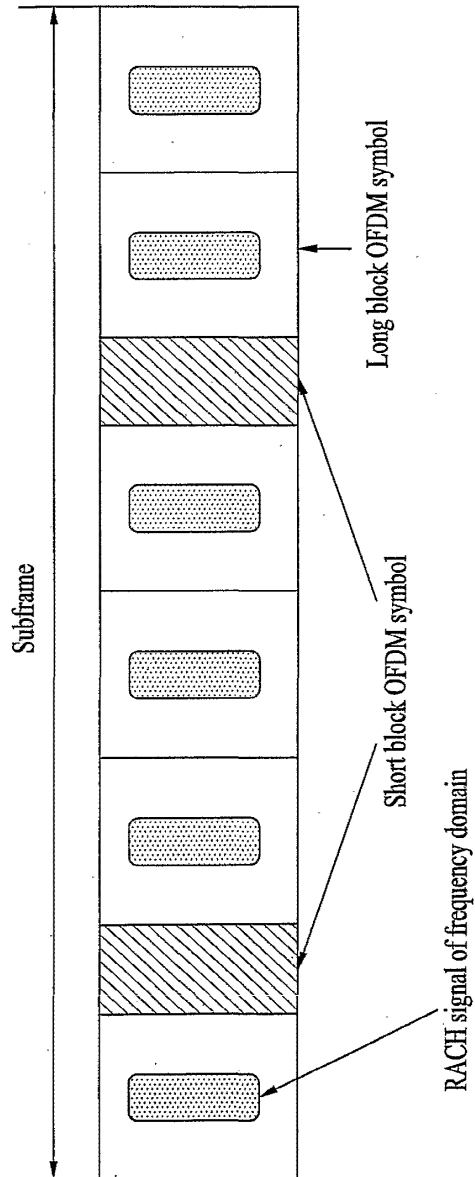

FIG. 7

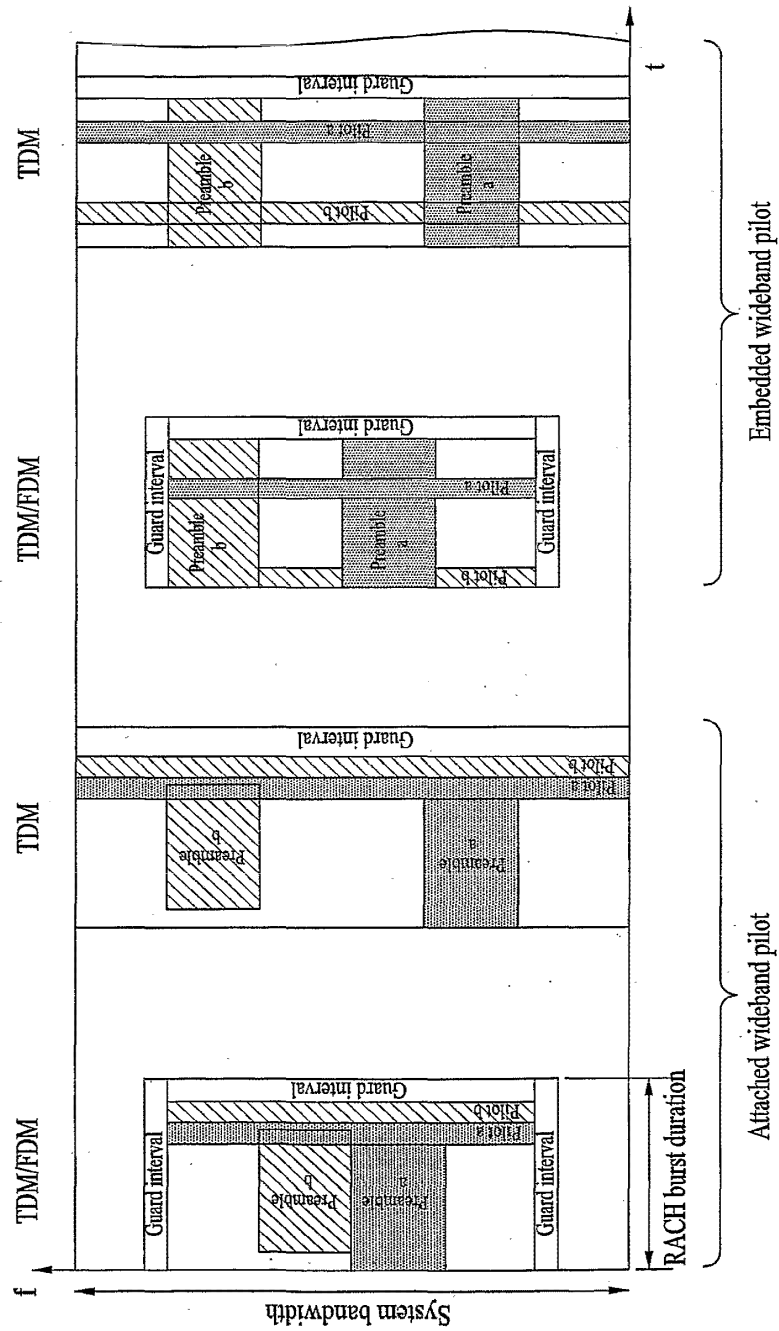
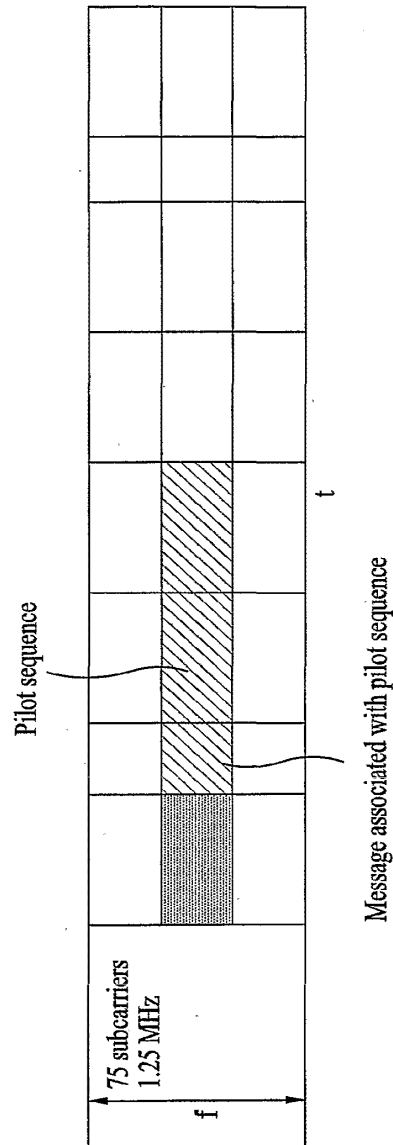
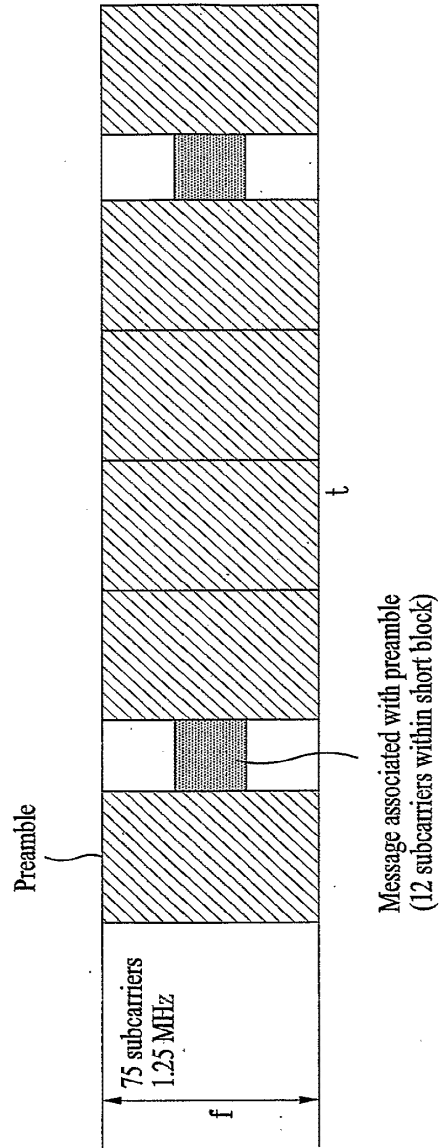

FIG. 8A



9/22

FIG. 8B





10/22

FIG. 9

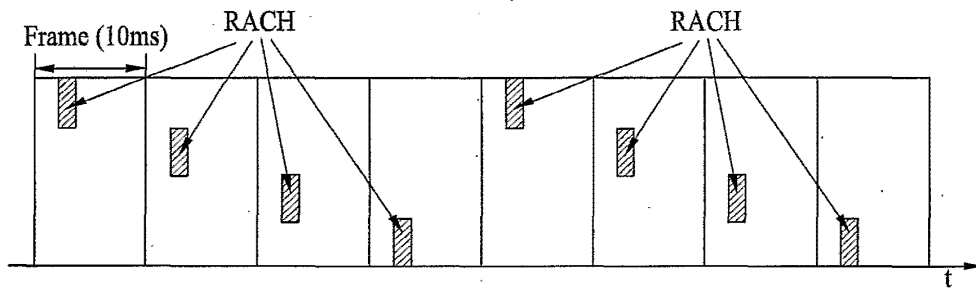

11/22

FIG. 10

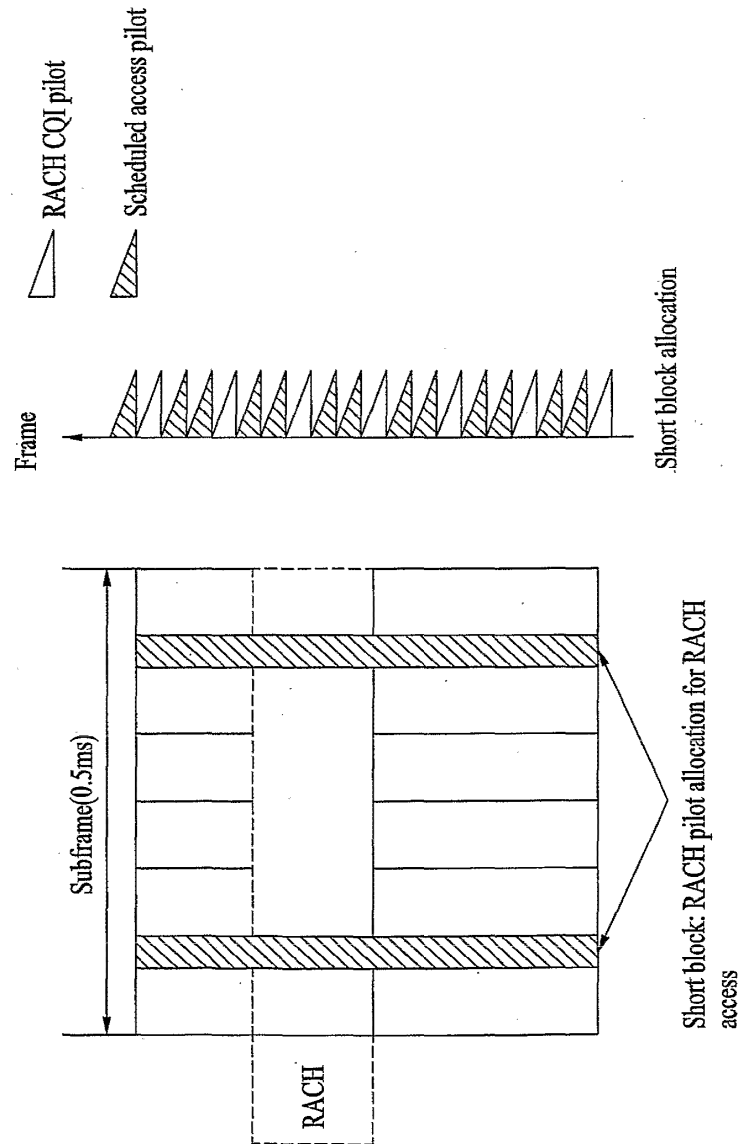

12/22

FIG. 11

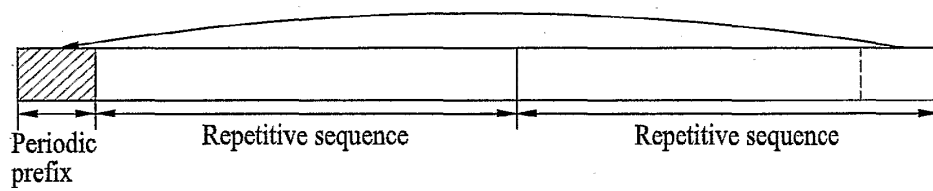

FIG. 12

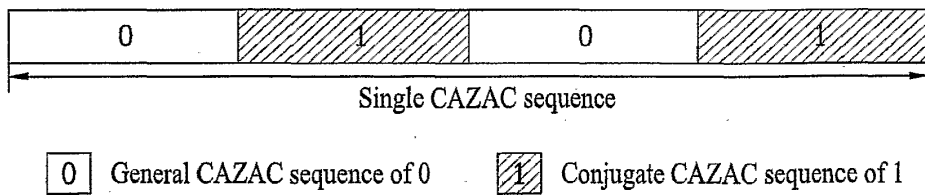
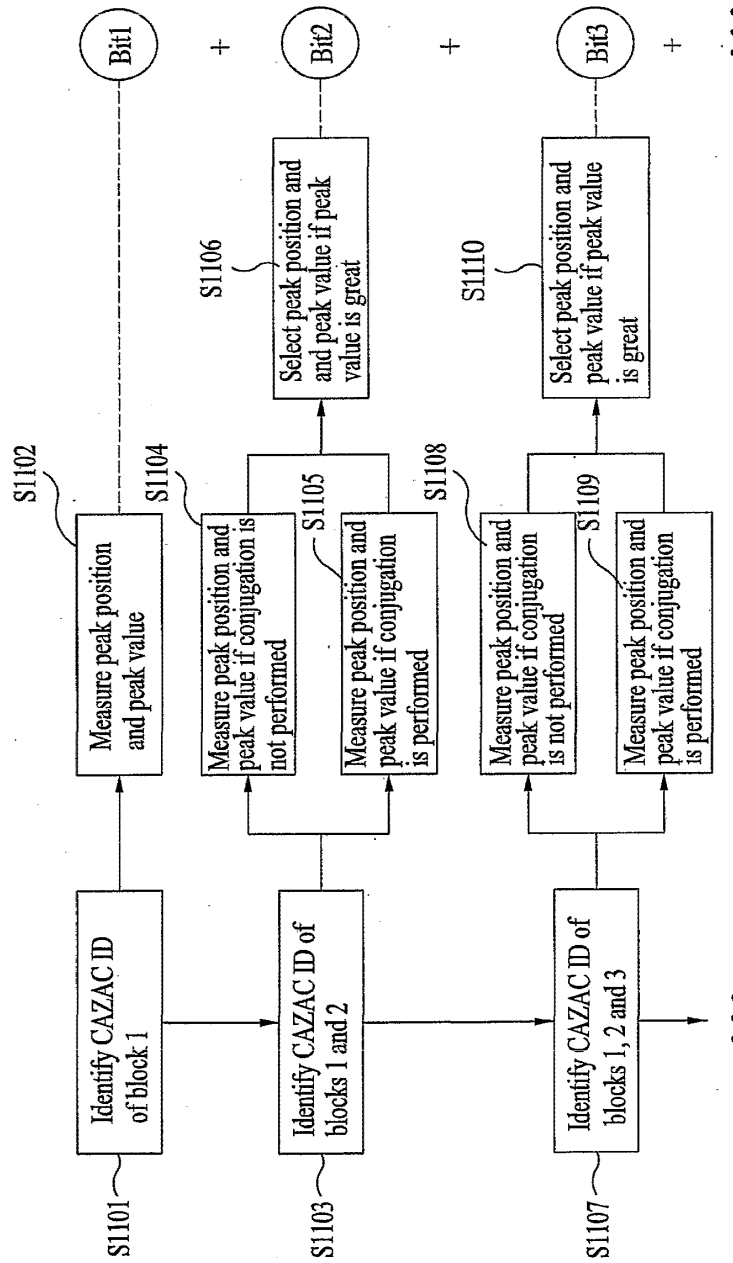

FIG. 13



14/22

FIG. 14

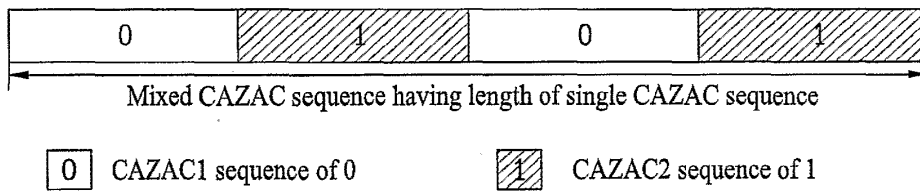
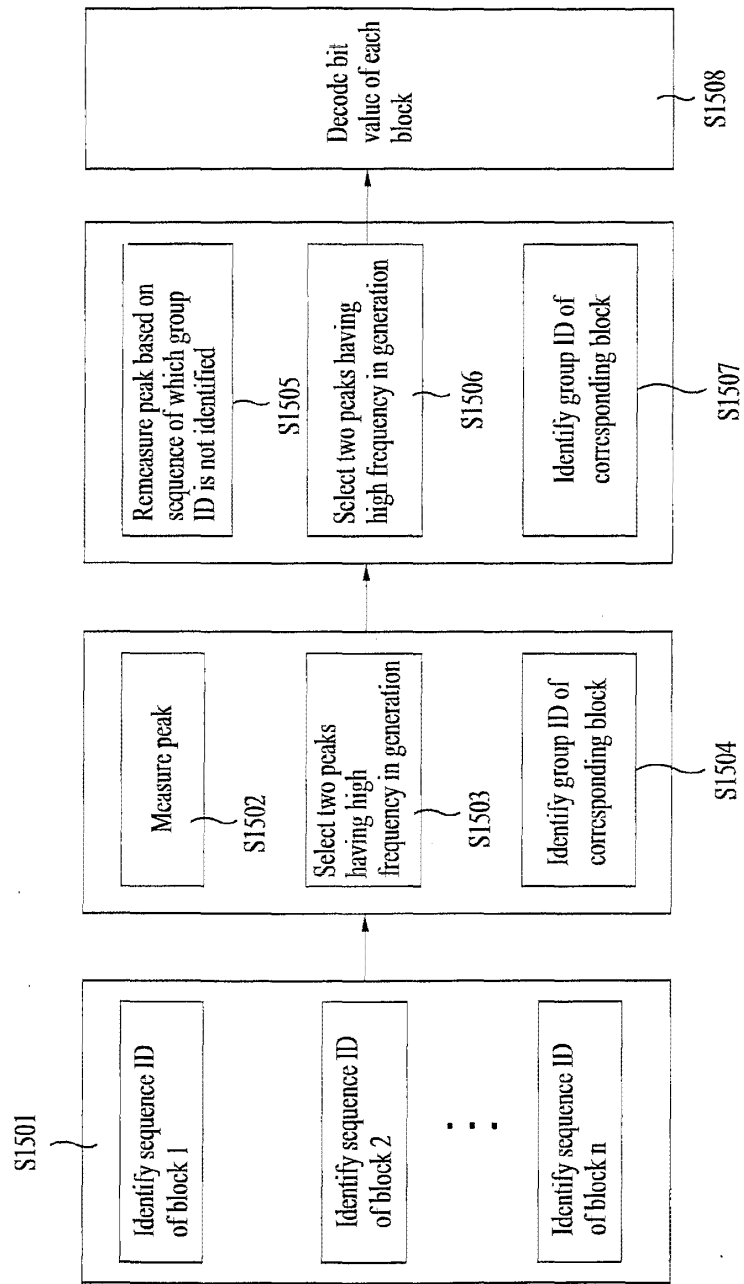

FIG. 15



16/22

FIG. 16

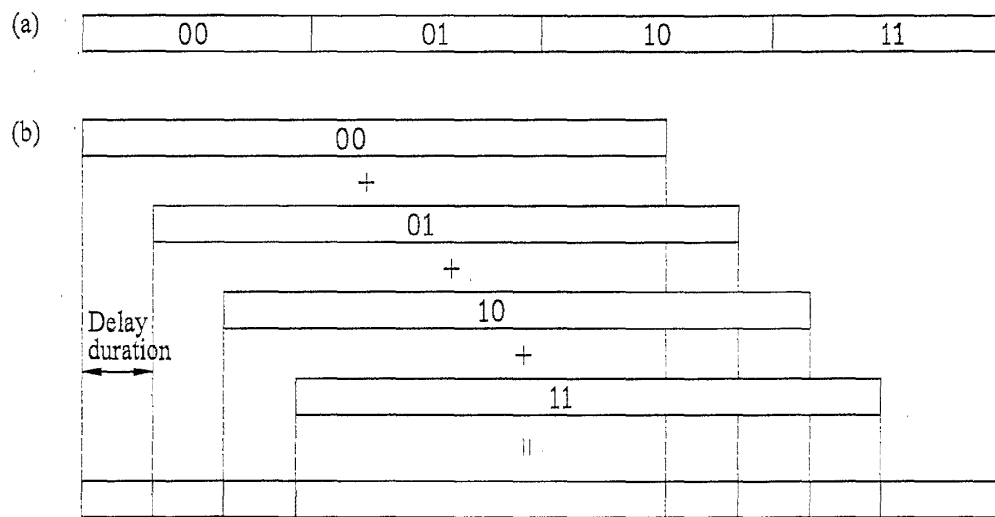

FIG. 17

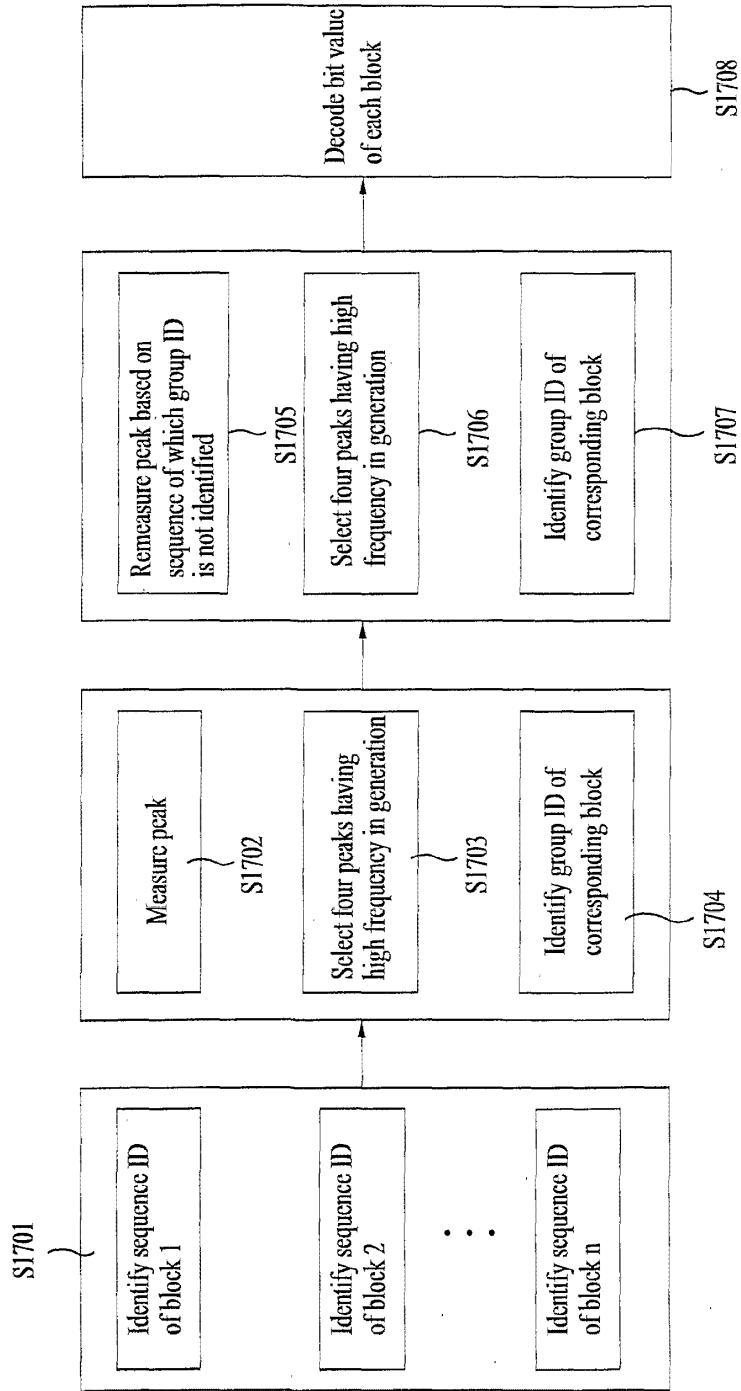



FIG. 18

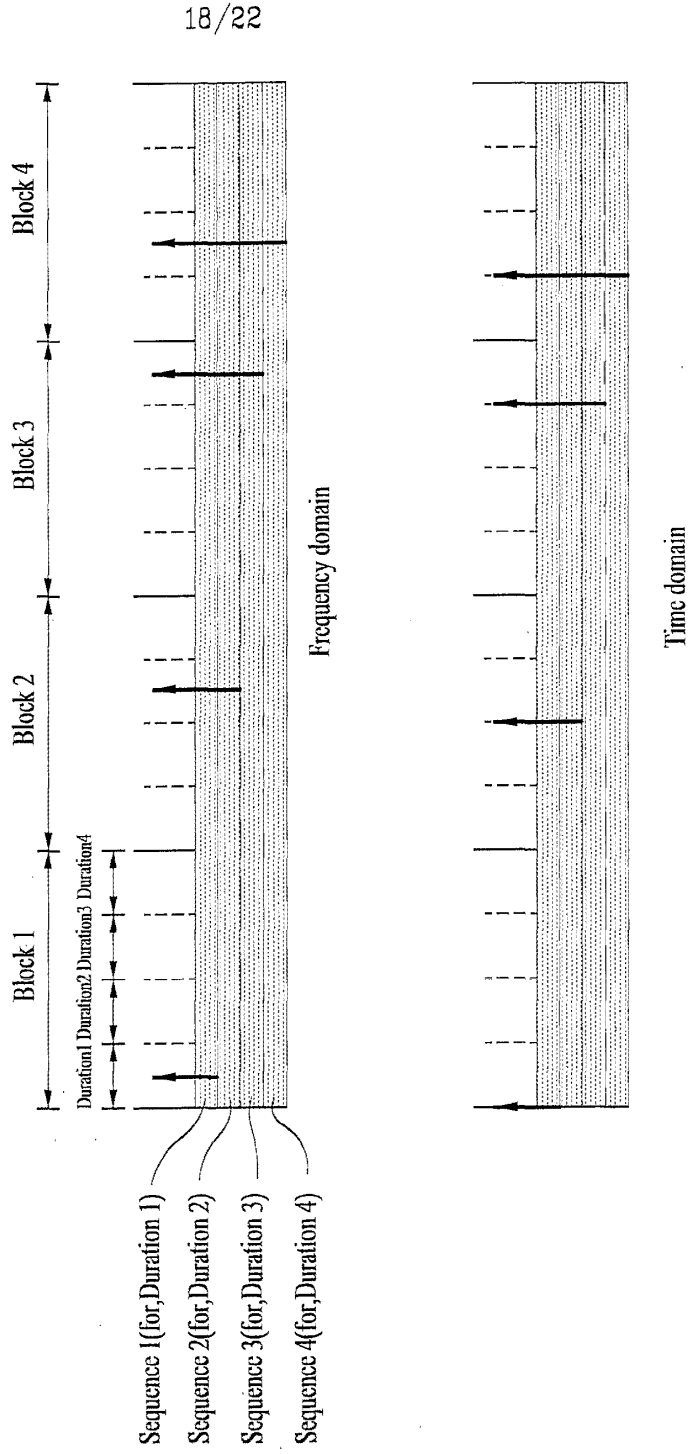

FIG. 19

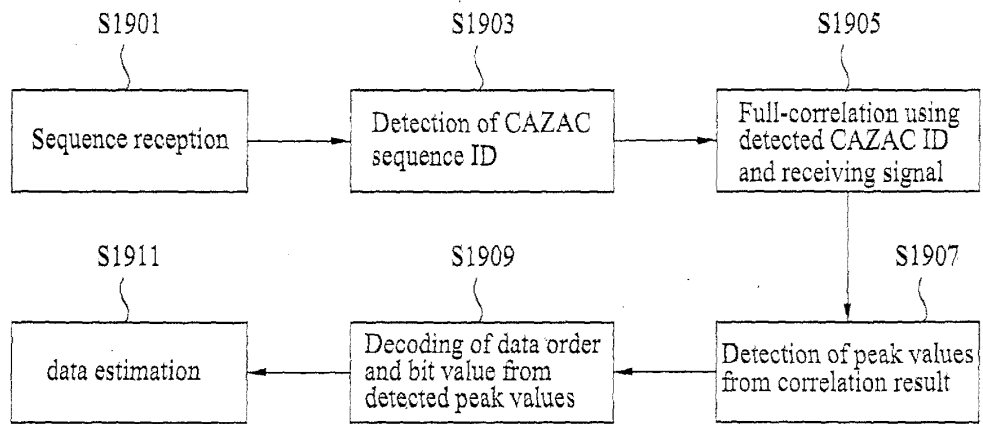

FIG. 20A

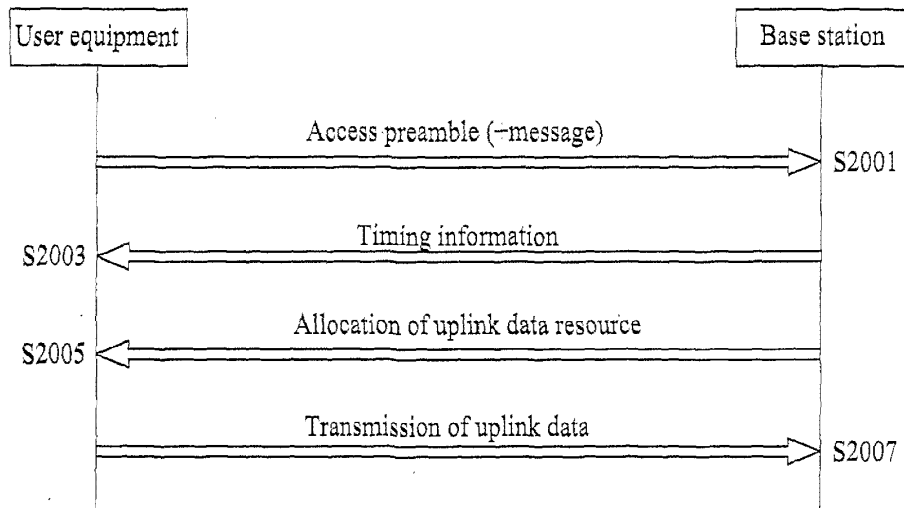

FIG. 20B

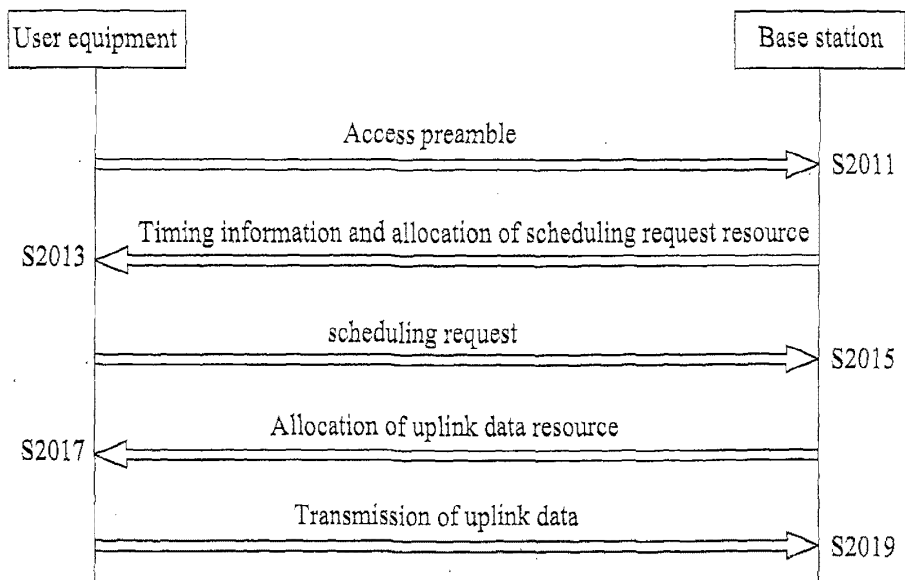

FIG. 21

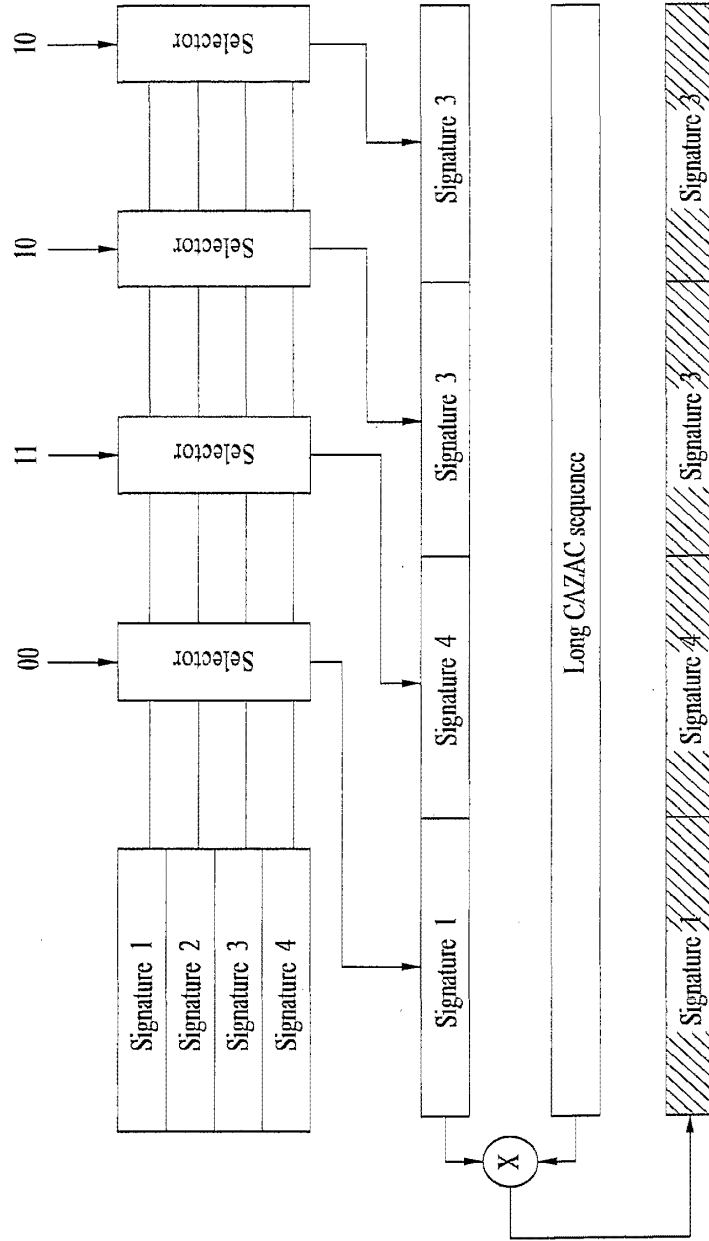

FIG. 22



**[CLAIMS]**

1. A method of transmitting data on a random access channel in a mobile communication system, the method comprising:
- 5           generating a new code by multiplying a code sequence by an exponential sequence;  
and  
transmitting the new code sequence to a receiving side.
2. The method of claim 1, wherein the code sequence is a CAZAC (constant  
10 amplitude zero autocorrelation) sequence.
3. The method of claim 1 or 2, wherein the code sequence is transmitted as a preamble.
- 15           4. A method of transmitting data by using a code sequence in a mobile communication system, the method comprising:
- conjugating at least one element included in at least one block of a code sequence divided by at least two blocks to indicate predetermined information; and  
transmitting the code sequence, in which the at least one block is conjugated, to a  
20 receiving side.
5. The method of claim 4, wherein the code sequence is a CAZAC sequence.
6. A method of transmitting data by using a code sequence in a mobile  
25 communication system, the method comprising:

generating a second code sequence indicating predetermined information by combining at least two first code sequences mapped with at least one information bit, respectively; and

transmitting the second code sequence to a receiving side.

5

7. The method of claim 6, wherein the first code sequence is a CAZAC sequence.

8. The method of claim 6, wherein, if each of the first code sequences is mapped with 'n' number of information bits, the at least two first code sequences are selected from a sequence group consisting of  $2^n$  number of first code sequences.

10

9. The method of claim 6, wherein the combination of the at least two first code sequences is performed by summing the at least two first code sequences after giving predetermined delay to each of the at least two first code sequences.

15

10. A method of transmitting a code sequence in a mobile communication system, the method comprising:

generating a combination code sequence by combining a base code sequence to at least one code sequence obtained by circular shift of the base code sequence; and

20

transmitting the combination code sequence to a receiving side.

11. The method of claim 10, wherein each of the base code sequence and the at least one code sequence identifies one or more information bit.

12. The method of claim 10, wherein the step of generating the combination code sequence is performed in a frequency domain.

25

13. The method of claim 10, wherein the step of generating the combination code sequence is performed in a time domain.

5           14. The method of claim 10, wherein the combination code sequence is transmitted through a random access channel (RACH).

15. The method of claim 10, wherein the at least one code sequence is obtained by circular shift of the base code sequence as much as integer times of circular shift unit.

10

16. A method of transmitting a code sequence in a mobile communication system, the method comprising:

generating a repetitive code sequence by repeatedly concatenating a first code sequence at least one or more times;

15

generating a cyclic prefix (CP) by copying a certain part of a rear end of the repetitive code sequence and concatenating the copied part to a front end of the repetitive code sequence; and

transmitting the repetitive code sequence, in which the CP is generated, to a receiving side.

20

17. The method of claim 16, wherein the repetitive code sequence is transmitted as a preamble on a random access channel.

18. A method of allocating a random access channel in a multi-carrier system, the method comprising:

25

allocating a random access channel to each of at least two consecutive frames in a



way that frequency bands of the random access channels allocated to the at least two consecutive frames are not overlapped with each other; and

transmitting allocation information of the random access channels allocated to the at least two consecutive frames to at least one user equipment.

5

19. The method of claim 18, wherein the frequency bands of the random access channels allocated to the at least two consecutive frames have a pattern which is periodically repeated.

10

20. The method of claim 18, wherein the allocation information includes a hopping pattern of the frequency bands of the random access channels allocated to the at least two consecutive frames.

15

21. The method of claim 18, wherein the random access channels are uniformly allocated to the at least two consecutive frames.

20

22. The method of claim 18, further comprising allocating a channel region for transmission of a pilot signal at the user equipment to at least one sub-frame to which the random access channel is allocated.

23. The method of claim 22, wherein the user equipment trying to random access through the random access channel transmits a pilot signal through the channel region.

25

24. A method of transmitting data by using a code sequence in a mobile communication system, the method comprising:

mapping each of a plurality of blocks having at least one bit of a input data stream, respectively to a corresponding signature sequence;

multiplying a signature sequence stream, to which the plurality of blocks are mapped, by a specific code sequence; and

5 transmitting the signature sequence stream multiplied by the specific code sequence to a receiving side.

25. The method of claim 24, wherein the specific code sequence is a single CAZAC sequence.

10

26. The method of claim 24, wherein the specific code sequence is a sequence obtained by concatenating at least two different CAZAC sequences.

27. The method of claim 24, wherein the signature sequence is an exponential sequence.

15

28. The method of claim 24, wherein the signature sequence is a Hadamard sequence.

29. The method of claim 24, further comprising repeating each signature sequence so as to match a length of the signature sequence stream, to which the plurality of blocks are mapped, with a length of the specific code sequence.

20

30. The method of claim 24, wherein the signature sequence mapping is Gray mapping.

25

**METHOD OF TRANSMITTING DATA  
IN A MOBILE COMMUNICATION SYSTEM**

**[DESCRIPTION]**

5 TECHNICAL FIELD

The present invention relates to a mobile communication system, and more particularly, to a method of expanding a code sequence, a structure of a random access channel and a method of transmitting data in a mobile communication system.

10 BACKGROUND ART

A user equipment uses a random access channel (RACH) to access a network in a state that the user equipment is not uplink synchronized with a base station. A signal having repetitive characteristic in a time domain is used in the random access channel, so that a receiver easily searches a start position of a transmission signal. In general, the repetitive  
15 characteristic is realized by repetitive transmission of a preamble.

A representative example of a sequence for realizing the preamble includes a CAZAC (Constant Amplitude Zero Auto Correlation) sequence. The CAZAC sequence is expressed by a Dirac-Delta function in case of auto-correlation and has a constant value in case of cross-correlation. In this respect, it has been estimated that the CAZAC sequence has  
20 excellent transmission characteristics. However, the CAZAC sequence has limitation in that maximum  $N-1$  number of sequences can be used for a sequence having a length of  $N$ . For this reason, a method for increasing available bits of the sequence while maintaining the excellent transmission characteristics is required.

Meanwhile, there are provided various methods for transmitting data from a random  
25 access channel by using the CAZAC sequence. Of them, the first method is to directly

interpret CAZAC sequence ID to message information. Assuming that data to be transmitted is a preamble, if a sufficient number of sequences that can be used as the preamble are provided, message passing can be performed with only CAZAC sequence ID without additional manipulation. However, since a method of transmitting additional information should be considered in an actual synchronized RACH, problems occur in that there is difficulty in realizing a sufficient number of CAZAC sequence sets, and the cost required for search of a receiver increases.

The second method is to simultaneously transmit CAZAC sequence and Walsh sequence by using a code division multiplexing (CDM) mode. In this case, CAZAC sequence ID is used as user equipment identification information, and the Walsh sequence transmitted in the CDM mode is interpreted as message information. FIG. 1 is a block schematic view illustrating a transmitter for realizing the second method. However, the second method has limitation in that even though the Walsh sequence is added to the CAZAC sequence, bits of message that can additionally be obtained are only  $\log_2 N$  bits when the Walsh sequence has a length of  $N$ .

The third method is to transmit CAZAC sequence and Walsh sequence in such a way to mix the Walsh sequence with the CAZAC sequence. In this case, CAZAC sequence ID is used as user equipment identification information, and the Walsh sequence is interpreted as message information. FIG. 2 is a block diagram illustrating a data processing procedure at a transmitter for realizing the third method. However, according to the third method, since the Walsh sequence acts as noise in detection of the CAZAC sequence to cause difficulty in detecting sequence ID, there is limitation in that repetitive sequences should be transmitted to prevent the Walsh sequence from acting as noise in detection of the CAZAC sequence.

The fourth method is to either give orthogonality between blocks constituting a corresponding sequence by multiplying an exponential term by a CAZAC sequence or

directly apply data modulation such as DPSK, DQPSK, D8PSK, etc. In this case, CAZAC sequence ID is used as user equipment identification information, and the modulated sequence is demodulated and then used as message information. FIG. 3A illustrates data modulation according to the former method of the fourth method, and FIG. 3B illustrates data modulation according to the latter method of the fourth.

Furthermore, the fifth method is to transmit CAZAC sequence by attaching a message part to the CAZAC sequence. FIG. 4A illustrates the case where a message (coded bit) is attached to the CAZAC sequence used as a preamble, and FIG. 4B illustrates the case where a message (coded bit) is attached to a sequence consisting of a predetermined number of blocks to which orthogonality is given.

However, the fourth method and the fifth method have a problem in that they are susceptible to change of channel condition.

#### DISCLOSURE OF THE INVENTION

Accordingly, the present invention has been suggested to substantially obviate one or more problems due to limitations and disadvantages of the related art, and an object of the present invention is to provide a method of transmitting and receiving message between a user equipment and a base station by using a long sequence to maximize time/frequency diversity and alleviating performance attenuation due to channel.

Another object of the present invention is to provide a method of transmitting data through a code sequence in a mobile communication system, in which the quantity of data can be increased and the transmitted data becomes robust to noise or channel change.

Still another object of the present invention is to provide a method of suggesting a structure of an efficient random access channel in a multi-carrier system.

Further still another object of the present invention is to provide a method of

minimizing access time of a user equipment to a random access channel in a mobile communication system.

To achieve these objects and other advantages and in accordance with the purpose of the invention, as embodied and broadly described herein, a data transmission method through a random access channel in a mobile communication system comprises generating a new code by multiplying a code sequence by an exponential sequence, and transmitting the new code sequence to a receiving side.

In another aspect of the present invention, a data transmission method by using a code sequence in a mobile communication system comprises conjugating at least one element included in at least one block of a code sequence divided by at least two blocks to indicate predetermined information, and transmitting the code sequence, in which the at least one block is conjugated, to a receiving side.

In still another aspect of the present invention, a data transmission method by using a code sequence in a mobile communication system generating a second code sequence indicating predetermined information by combining at least two first code sequences mapped with at least one information bit, respectively, and transmitting the second code sequence to a receiving side.

In further still another aspect of the present invention, a code sequence transmission method in a mobile communication system comprises generating a combination code sequence by combining a base code sequence to at least one code sequence obtained by circular shift of the base code sequence, and transmitting the combination code sequence to a receiving side.

In further still another aspect of the present invention, a code sequence transmission method in a mobile communication system generating a repetitive code sequence by repeatedly concatenating a first code sequence at least one or more times, generating a cyclic

prefix (CP) by copying a certain part of a rear end of the repetitive code sequence and concatenating the copied part to a front end of the repetitive code sequence, and transmitting the repetitive code sequence, in which the CP is generated, to a receiving side.

5 In further still another aspect of the present invention, a method of allocating a random access channel (RACH) in a multi-carrier system comprises allocating a random access channel to each of at least two consecutive frames in a way that frequency bands of the random access channels allocated to the at least two consecutive frames are not overlapped with each other, and transmitting allocation information of the random access channels allocated to the at least two consecutive frames to at least one user equipment.

10 In further still another aspect of the present invention, a data transmission method through a code sequence in a mobile communication system mapping each of a plurality of blocks having at least one bit of a input data stream, respectively to a corresponding signature sequence, multiplying a signature sequence stream, to which the plurality of blocks are mapped, by a specific code sequence, and transmitting the signature sequence stream  
15 multiplied by the specific code sequence to a receiving side.

#### BRIEF DESCRIPTION OF THE DRAWINGS

FIG. 1 illustrates an example of a data transmission method through a random access channel in an OFDMA system according to the related art;

20 FIG. 2 illustrates another example of a data transmission method through a random access channel in an OFDMA system according to the related art;

FIG. 3A and FIG. 3B illustrate still another example of a data transmission method through a random access channel in an OFDMA system according to the related art;

25 FIG. 4A and FIG. 4B illustrate further still another example of a data transmission method through a random access channel in an OFDMA system according to the related art;

FIG. 5 illustrates an example of a structure of a random access channel used in an OFDMA system;

FIG. 6A and FIG. 6B illustrate examples of sending an RACH signal in a time domain or a frequency domain based on a structure of a random access channel of FIG. 5;

5 FIG. 7 illustrates another example of a structure of a random access channel used in an OFDMA system;

FIG. 8A and FIG. 8B illustrate still another example of a structure of a random access channel used in an OFDMA system;

10 FIG. 9 illustrates a structure of a random access channel according to one embodiment of the present invention;

FIG. 10 illustrates a structure of a random access channel of a sub-frame to which RACH pilot is allocated;

FIG. 11 illustrates a repetitive structure of a preamble according to one embodiment of the present invention;

15 FIG. 12 is a structural view of unit data to illustrate one embodiment of the present invention, which transmits data by using a code sequence expanded through conjugation;

FIG. 13 is a flow chart illustrating a procedure of receiving and decoding data transmitted in a code sequence expanded through conjugation in accordance with one embodiment of the present invention;

20 FIG. 14 is a structural view of unit data to illustrate one embodiment of the present invention, which transmits data by using a code sequence expanded through grouping;

FIG. 15 is a flow chart illustrating a procedure of receiving and decoding data transmitted in a code sequence expanded through grouping;

25 FIG. 16 is a structural view of unit data to illustrate one embodiment of the present invention, which transmits data by using a code sequence expanded through grouping and



delay processing;

FIG. 17 is a flow chart illustrating a procedure of receiving and decoding data transmitted in a code sequence expanded through grouping and delay processing;

FIG. 18 is a structural view of unit data to illustrate one embodiment of the present invention, which transmits data by using a code sequence expanded through PPM modulation;

FIG. 19 is a flow chart illustrating a procedure of receiving and decoding data transmitted in a code sequence expanded through PPM modulation;

FIG. 20A and FIG. 20B are flow charts illustrating a procedure of performing synchronization in a random access channel in accordance with a data transmission method of the present invention;

FIG. 21 illustrates a method of transmitting data to a receiver through a signaling channel in accordance with one embodiment of the present invention; and

FIG. 22 illustrates an example of a receiver and a transmitter for transmitting a preamble and data through RACH, SCH or other channel in accordance with one embodiment of the present invention.

#### BEST MODE FOR CARRYING OUT THE INVENTION

Hereinafter, structures, operations, and other features of the present invention will be understood readily by the preferred embodiments of the present invention, examples of which are illustrated in the accompanying drawings.

A random access channel (RACH) is used to allow a user equipment to access a network in a state that the user equipment is not uplink synchronized with a base station. A random access mode can be classified into an initial ranging access mode and a periodic ranging access mode depending on an access mode to network. According to the initial

ranging access mode, the user equipment acquires downlink synchronization and first accesses a base station. According to the periodic ranging access mode, the user equipment connected with a network accesses the network if necessary. The initial ranging access mode is used to allow the user equipment to synchronize with the network while accessing the network and receive its required ID from the network. The periodic ranging access mode is used to initiate a protocol to receive data from the base station or when a packet to be transmitted exists.

In particular, the periodic ranging access mode can be classified into two types in the 3GPP LTE (long term evolution) system, i.e., a synchronized access mode and a non-synchronized access mode. The synchronized access mode is used if an uplink signal is within a synchronization limit when the user equipment accesses the RACH. The non-synchronized access mode is used if the uplink signal is beyond the synchronization limit. The non-synchronized access mode is used when the user first accesses the base station or synchronization update is not performed after synchronization is performed. At this time, the synchronized access mode is the same as the periodic ranging access mode, and is used when the user equipment accesses the RACH for the purpose of notifying the base station of the change status of the user equipment and requesting resource allocation.

On the other hand, the synchronized access mode alleviates limitation of a guard time in the RACH by assuming that the user equipment does not depart from uplink synchronization with the base station. For this reason, much more time-frequency resources can be used. For example, a considerable amount of messages (more than 24 bits) may be added to a preamble sequence for random access in the synchronized access mode so that both the preamble sequence and the messages may be transmitted together.

A structure of the RACH, which performs a unique function of the RACH while satisfying the aforementioned synchronized and non-synchronized access modes will now be

described.

FIG. 5 is a diagram illustrating an example of a structure of a random access channel (RACH) used in an OFDMA system. As shown in FIG. 5, it is noted that the RACH is divided into N number of sub-frames on a time axis and M number of frequency bands on a frequency axis depending on a radius of a cell. Frequency in generation of the RACH is determined depending on QoS (Quality of Service) requirements in a medium access control (MAC) layer. In general, the RACH is generated per certain period (several tens of milliseconds (ms) to several hundreds of ms). In this case, frequency diversity effect and time diversity effect are provided in generating several RACHs and at the same time collision between user equipments which access through the RACH is reduced. The length of the sub-frame can be 0.5 ms, 1 ms, etc.

In the RACH structure as shown in FIG. 5, a random sub-frame will be referred to as a time-frequency resource (TFR) which is a basic unit of data transmission. FIG. 6A is a diagram illustrating a type of sending a random access signal to the TFR in a time domain, and FIG. 6B illustrates a type of sending a RACH signal in a frequency domain.

As shown in FIG. 6A, if a random access signal is generated in a time domain, the original sub-frame structure is disregarded and the signal is aligned through only the TFR. By contrast, as shown in FIG. 6B, in case of the synchronized random access mode, the sub-frame structure is maintained in the frequency domain and at the same time a random access signal to be transmitted to sub-carriers of each OFDM symbol is generated. Accordingly, orthogonality can be maintained between respective blocks constituting TFR, and channel estimation can easily be performed.

FIG. 7 is a diagram illustrating another example of a structure of RACH used in an OFDMA system. As shown in FIG. 7, it is noted that a preamble 'b' and a pilot 'a' are partially overlapped in a TDM/FDM mode and a TDM mode of RACH burst duration of an

attached wideband pilot. It is also noted that a pilot 'a' and a pilot 'b' are simultaneously overlapped with a preamble 'a' and the preamble 'b' in the TDM/FDM mode and the TDM mode of an embedded wideband pilot. In other words, it is designed that a preamble and a pilot are together transmitted through the RACH, so that message decoding is easily performed through channel estimation if message is added to the RACH. Alternatively, a wideband pilot is used so that channel quality information (CQI) of a total of RACH bands can be acquired in addition to a preamble band of the RACH.

FIG. 8A and FIG. 8B are diagrams illustrating another examples of a structure of the RACH used in the OFDMA system,

As shown in FIG. 8A, a preamble is transmitted for a predetermined time period through a frequency band, and a short block duration is provided at a certain period so that a pilot for decoding a preamble is transmitted to a corresponding short block. At this time, the pilot transmission is performed through a part of a total of frequency bands (transmission through 25 sub-carriers corresponding to a middle band of a total of 75 sub-carriers), so that the pilot can be transmitted to a specific user equipment under a multi-access environment.

Furthermore, as shown in FIG. 8B, a message to be transmitted and a pilot for decoding the message are multiplexed and continue to be transmitted through some frequency bands (for example, 25 middle sub-carrier bands of a total of 75 sub-carrier bands) selected from a total of frequency bands. Accordingly, respective user equipments which perform multi-access can be identified by allocating some frequency bands at different frequencies.

FIG. 9 is a diagram illustrating a structure of RACH according to one embodiment of the present invention.

Generally, frequency in generation of the RACH is determined depending on QoS requirements in a MAC layer. The RACH is generated at a variable period (several ms to several hundreds of ms) depending on requirements of a cell. The RACH can be generated in

a time domain or a frequency domain as described above with reference to FIG. 6A and FIG. 6B. In the embodiment of FIG. 9, the structure of the RACH corresponds to the case where a random access signal is generated in the frequency domain.

Referring to FIG. 9, in this embodiment, to overcome a drawback of a long interval required for retry when the user equipment fails to access the RACH, a corresponding RACH resource is dispersed in each frame within one period if frequency in generation of the RACH and the quantity of overhead are determined. The number of frames included in one period can freely be determined as occasion demands. At this time, it is preferable that the RACH is divisionally arranged so as to be uniformly distributed for each frequency band with respect to a plurality of frames constituting one period. However, position on the time axis may be changed without change of position on the frequency axis and vice versa depending on specific requirements (synchronized action or decrease of inter-cell interference) of a cell or if a system band is small. Also, arrangement of any one of frequency and time may be changed to obtain the minimum interval between the RACHs arranged in each frame.

In the embodiment of FIG. 9, the network should notify the user equipment of position information of the allocated RACH resource. In other words, the network can notify each user equipment of frequency and time information occupied by the RACH resource allocated for each frame included in one period, and each user equipment can try random access through the allocated RACH resource by using the position information from the network. The position information of the RACH resource of each frame can be expressed by sub-carrier offset, the number of sub-carriers, timing offset, and the number of symbols. However, if the RACH information on each frame is expressed by the above four parameters, it may be undesirable in that the quantity of the information can be increased. Accordingly, a method of decreasing the quantity of the information for expressing the position information of the RACH allocated on each frame is required. The position information of the RACH can

be transmitted through a broadcast channel (BCH) or other downlink control channel.

As one method, a method using a hopping pattern may be considered. The hopping pattern means a pattern consisting of information indicating frequency domains of the RACH resource allocated to each frame within one period. In other words, in the embodiment of FIG. 9, since the RACH resource is divisionally arranged so as to be uniformly distributed for each frequency band with respect to a plurality of frames constituting one period, an indicator which indicates a frequency band that can be allocated to each frame as the RACH resource is previously determined, and the frequency band of the RACH resource allocated to each frame within one period can be notified through a pattern of the indicator which indicates a corresponding frequency band.

For example, if four frames are used as one period in a system which uses a total of bands of 10MHz, the position of the RACH includes sub-bands having an interval of 2.5MHz as one RACH frequency band (band smaller than 1.25MHz or 2.5MHz). At this time, a total of bands consist of four sub-bands, wherein the respective sub-bands are designated by indicators, which indicate each sub-band, as 1, 2, 3 and 4 in due order from a high frequency band to a low frequency band. In this way, the frequency band position information of the RACH resource allocated to all frames within one period can be expressed by patterns configured by the above indicators, for example 2, 3, 1, 4. The hopping pattern may be configured differently or equally depending on each frame. Time information of the RACH resource allocated to each frame within one period can generally be expressed by timing offset and the number of symbols. At this time, at least any one of the timing offset and the number of symbols may be fixed to decrease the quantity of the information. For example, if it is previously scheduled that the timing offset and the number of symbols for the RACH resource of each frame are fixed, the network only needs to transmit the hopping pattern to notify the user equipment of the position information of the RACH resource of all frames

within one period.

If each sub-band is narrow or considering influence of interference between user equipments, hopping patterns for all frames may be set equally. In this case, the network only needs to notify the user equipment of a frame period.

5 Hereinafter, the procedure of transmitting uplink data from the user equipment to the base station by using the structure of the RACH as shown in the embodiment of FIG. 9 will be described. In this case, data transmission is performed through the RACH among reverse common channels consisting of a plurality of frames.

10 First of all, the user equipment tries to access the dispersed RACH included in the current frame to transfer its information to the base station. If the user equipment successfully accesses the RACH, the user equipment transmits preamble data through the corresponding RACH. However, if the user equipment fails to access the RACH, the user equipment tries to access the RACH divisionally arranged in the frame of the next order. At this time, the RACH included in the frame of the next order is preferably arranged in a frequency band different  
15 from that of the RACH of the previous frame if the frequency band is not sufficiently wide or there are no specific requirements (inter-cell interference or limitation in action range of user equipment). Also, the above access procedure continues to be performed in the frame of the next order until the user equipment successfully accesses the RACH.

20 Meanwhile, in case of the synchronized RACH, the sub-frame of each frame preferably includes a short block to which a pilot for the user equipment which has accessed the corresponding RACH is allocated. At least one RACH pilot and access pilot may be allocated to the short block at a predetermined pattern. In other words, the user equipment which has accessed the RACH should know channel information to receive a channel from the base station. The channel information may be set in RACH pilot within an uplink short  
25 block. The base station allocates a proper channel to the user equipment through the

corresponding RACH pilot. Meanwhile, if the user equipment which accesses the RACH notifies the base station of information of channel quality as to whether the user equipment is preferably allocated with which channel through the RACH pilot, a favorable channel can be allocated to the user equipment during scheduling, whereby communication of good quality  
5 can be maintained.

Accordingly, the RACH pilot that can be used for the user equipment which accesses the RACH is separately allocated to the sub-frame which includes RACH. Thus, the user equipment which accesses the RACH sends a preamble to the base station through the corresponding RACH and also sends a pilot for transmission of channel quality information  
10 to the designated RACH pilot. The RACH pilot is a sequence designated depending on a preamble, and it is preferable that the user equipments, which use different preamble sequences, use different RACH pilot sequences if possible or select RACH pilot of different sub-carriers or partially overlapped sub-carriers.

FIG. 10 is a diagram illustrating a structure of a random access channel of a sub-  
15 frame to which the RACH pilot is allocated. It is noted that each sub-frame includes at least one short block to which at least one RACH pilot and access pilot are allocated at a predetermined pattern. In this case, the RACH pilot exists in the frequency band of the allocated RACH and other system bands. In this embodiment, it has been described that two short blocks exist per one frame and the RACH pilot is transmitted to the short blocks.  
20 However, the present invention is not limited to such embodiment, and various modifications can be made within the apparent range by those skilled in the art.

As described above, it has been described that preamble, synchronization timing information including pilot information, uplink resource allocation information and message such as uplink data can be transmitted through the RACH of various structures. It will be  
25 apparent that the data transmission method according to the embodiments of the present



invention can be used in the RACH and other channels.

Meanwhile, the preamble and the message may separately be transmitted through the RACH. Alternatively, the message may be transmitted by being implicitly included in the preamble. One embodiment of the present invention relates to a method of transmitting a preamble through the latter transmission manner. In one embodiment of the present invention, a code sequence more expanded than that of the related art can be used for effective transmission of the preamble. Hereinafter, a method of improving CAZAC sequence according to one embodiment of the present invention for effective transmission of the preamble will be described.

Since the receiver should search a start position of a transmission signal in the random access channel, it is generally designed that a transmission signal has a specific pattern in a time domain. To this end, the preamble is transmitted repeatedly or a certain interval is maintained between sub-carriers in a frequency domain to obtain repetitive characteristics in the time domain, thereby identifying time synchronization.

In the former case, the preamble represents a reference signal used for the purpose of initial synchronization setting, cell detection, frequency offset, and channel estimation. In a cellular mobile communication system, a sequence having good cross-correlation characteristic is preferably used for repetitive transmission of the preamble. To this end, binary hardamard code or poly-phase CAZAC sequence may be used. Particularly, the CAZAC sequence has been estimated that it has excellent transmission characteristics as it is expressed by a Dirac-Delta function in case of auto-correlation and has a constant value in case of cross-correlation.

The CAZAC sequence can be classified into GCL sequence (Equation 1) and Zadoff-Chu sequence (Equation 2) as follows.

[Equation 1]

16

$$c(k;N,M) = \exp\left(-\frac{j\pi M k(k+1)}{N}\right) \quad \text{for odd N}$$

$$c(k;N,M) = \exp\left(-\frac{j\pi M k^2}{N}\right) \quad \text{for even N}$$

[Equation 2]

$$c(k;N,M) = \exp\left(\frac{j\pi M k(k+1)}{N}\right) \quad \text{for odd N}$$

$$c(k;N,M) = \exp\left(\frac{j\pi M k^2}{N}\right) \quad \text{for even N}$$

5

In the above Equations, it is noted that if the CAZAC sequence has a length of N, actually available sequences are limited to N-1 number of sequences. Accordingly, it is necessary to increase the number of CAZAC sequences to efficiently use them in an actual system.

10 For example, a method of expanding the number of available sequences by 1 is suggested by providing an improved CAZAC sequence p(k) in such a way to multiply a CAZAC sequence c(k) by a predetermined modulation sequence m(k). In other words, assuming that Zadoff-Chu sequence is used as the CAZAC sequence, the CAZAC sequence c(k), the modulation sequence m(k) and the improved CAZAC sequence p(k) can be defined

15 by the following Equations 3, 4, and 5, respectively.

[Equation 3]

CAZAC sequence:

$$c(k;N,M) = \exp\left(\frac{j\pi M k(k+1)}{N}\right)$$

[Equation 4]

Modulation sequence:

$$m(k) = \exp\left(\frac{j2\pi\delta}{N} k\right)$$

5

[Equation 5]

Improved CAZAC sequence (or improved preamble):

$$p(k) = c(k) * m(k) = \exp\left(\frac{j\pi M}{N} k(k+1) + \frac{j2\pi\delta}{N} k\right)$$

The improved CAZAC sequence p(k) maintains auto-correlation and cross-correlation characteristics of the CAZAC sequence. The following Equation 6 illustrates auto-correlation characteristic of p(k), and it is noted from the Equation 6 that the final result is a Dirac-delta function. In particular, if the modulation sequence m(k) is a sequence having a certain phase, it is characterized in that the modulation sequence m(k) always maintains the auto-correlation characteristic.

[Equation 6]

$$ad(d) = \sum_k \exp\left(\frac{j\pi M}{N} (k+d)(k+d+1) + \frac{j2\pi\delta}{N} (k+d)\right)$$

$$\exp\left(-\frac{j\pi M}{N} k(k+1) - \frac{j2\pi\delta}{N} k\right)$$

$$= \sum_k \exp\left(\frac{j2\pi M}{N} (2dk + d(d+1)) + \frac{j2\pi\delta}{N} d\right)$$

$$= \exp\left(\frac{j2\pi\delta}{N} d\right) \sum_k \exp\left(\frac{j\pi M}{N} (2dk + d(d+1))\right) = \begin{cases} 1 & d = 0 \\ 0 & d \neq 0 \end{cases}$$

15

Furthermore, the following Equation 7 illustrates cross-correlation characteristic of  $p(k)$ .

[Equation 7]

$$\begin{aligned}
 cc(d) &= \sum_k \exp\left(\frac{j\pi(M+x)}{N}(k+d)(k+d+1) + \frac{j2\pi\delta}{N}(k+d)\right) \\
 &\quad \exp\left(-\frac{j\pi M}{N}k(k+1) - \frac{j2\pi\delta}{N}k\right) \\
 &= \sum_k \exp\left(\frac{j\pi x}{N}(k+d)(k+d+1)\right) \\
 &\quad \exp\left(\frac{j\pi M}{N}(k+d)(k+d+1) + \frac{j2\pi\delta}{N}(k+d)\right) \\
 &\quad \exp\left(-\frac{j\pi M}{N}k(k+1) - \frac{j2\pi\delta}{N}k\right) \\
 &= \sum_k \exp\left(\frac{j\pi x}{N}(k+d)(k+d+1)\right) \\
 &\quad \exp\left(\frac{j\pi M}{N}(2dk + d(d+1)) + \frac{j2\pi\delta}{N}d\right) \\
 &= \exp\left(\frac{j\pi M}{N}d(d+1)\right) \sum_k \exp\left(\frac{j\pi x}{N}(k+d)(k+d+1)\right) \\
 &\quad \exp\left(\frac{j2\pi d M}{N}k\right)
 \end{aligned}$$

- 5            In this case, although Equation 7 seems to be similar to Equation 6, it is noted that in view of summation term, auto-correlation is expressed by sum of exponential but cross-correlation is expressed by the product of two sequences. The first term is another CAZAC sequence of which seed value is  $x$ , and the second term is a simple exponential function. The sum of the product of two sequences is equal to obtaining a coefficient of the exponential
- 10            function, and its value is equal to a value obtained by converting the CAZAC sequence of

which seed value is  $x$  into a frequency domain and extracting a value from the frequency position of exponential.

Since the CAZAC sequence has auto-correlation of Dirac-delta characteristic, if it undergoes Fourier transform, it maintains auto-correlation characteristic of Dirac-delta of a constant amplitude even in the transformed area. For this reason, if values of specific positions are extracted from the frequency domain, their sizes are 1 and equal to each other but their phases are different from each other. Accordingly, if this result is added to the Equation 7 to obtain cross-correlation, the obtained cross-correlation can briefly be expressed by the following Equation 8.

10 [Equation 8]

$$\begin{aligned}
 cc(d) &= \exp\left(\frac{j\pi M}{N}d(d+1) + \frac{j2\pi\delta}{N}d\right) \sum_k \exp\left(\frac{j\pi x}{N}(k+d)(k+d+1)\right) \\
 &\quad \exp\left(\frac{j2\pi dM}{N}k\right) \\
 &= \exp\left(\frac{j\pi M}{N}d(d+1) + \frac{j2\pi\delta}{N}d\right) C(dM/N; x)
 \end{aligned}$$

It is noted from the Equation 8 that since  $C(dM/N; x)$  always has a size of 1 and an exponential term also has a size of 1, the cross-correlation is always fixed at 1.

After all, characteristics of the related art CAZAC sequence can be maintained by the Equation 5 and at the same time the number of codes can be increased. This means that the result in the area where the exponential terms are multiplied is equal to applying circular shift to the Fourier transformed area, and multiplying exponential sequences in the time domain is equal to performing circular shift in the frequency domain.

In other words, it is noted that if correlation between two sequences  $p(k; M, N, d_1)$  and  $p(k; M, N, d_2)$  of which seed values are equal to each other is obtained, impulse occurs in a

point where a delay value  $d$  in cross-correlation reaches  $d_1-d_2$ . Although design of the improved sequence as above has the same result as that of circular shift of the CAZAC sequence, this embodiment of the present invention is advantageous in that the result can be obtained by a simple procedure such as multiplying two exponential sequences without  
5 Fourier inverse transform after Fourier transform and circular shift.

Hereinafter, a method of improving data transmission reliability of a preamble by performing predetermined data processing for the related art code sequence and a method of expanding a length of a code sequence when data are simultaneously transmitted will be described. If the CAZAC sequence is used as the code sequence, the CAZAC sequence  
10 expanded by the above method is preferably used. However, the CAZAC sequence is not necessarily limited to the CAZAC sequence expanded by the above method, and the related art CAZAC sequence may be used.

First of all, a structure of transmission data, i.e., preamble, which is commonly applied to the embodiments of the present invention, will be described.

15 In a 3GPP LTE (Long Term Evolution) system, a transmitter can repeatedly transmit the same sequence two times or more so as to allow a receiver to easily detect transmission data or improve additional detection performance (i.e., increase of spreading gain). Accordingly, since the receiver only needs to detect repetitive patterns regardless of the type of the received sequence, it can simply identify time position of a user equipment which  
20 accesses the RACH and improve detection performance.

FIG. 11 is a diagram illustrating a structure of a preamble according to one embodiment of the present invention. In an orthogonal frequency divisional transmission system, a cyclic prefix (CP) is used, in which the last part of OFDM symbol is copied and then prefixed to the OFDM symbol to compensate a multi-path loss in signal transmission.  
25 Accordingly, if the OFDM symbol consists of two repetitive preambles, a part of the

preamble of the later order is copied in the first part by CP to enable compensation of the multi-path loss for the corresponding preamble. Also, the CP is advantageous in that it is easy to identify user equipments which access different RACHs in case of CAZAC having good periodic correlation.

5           Since inter-symbol interference does not occur even though a single sequence is transmitted by prefixing CP thereto instead of repetitive transmission of sequence, a predetermined receiving algorithm can be realized in the frequency domain without any problem. However, if the receiver realizes a receiving algorithm in the time domain with neither repetitive transmission nor CP, the receiver should detect all kinds of code sequences  
10 to identify user equipments which access the RACH. In this respect, the preamble is preferably realized by a structure of a repetitive pattern. At this time, whether to realize a repetition pattern can be determined depending on a data rate supported by the system or the number of repetitive times can be determined if a repetitive pattern is realized. For example, to support a minimum data rate supported by the system, RACH preamble can repeatedly be  
15 transmitted one or more times depending on the length of the sequence.

          First to fourth embodiments which will be described later relate to a data processing method of a sequence constituting the structure of the preamble. In these embodiments, data transmitted to the receiver could be the structure of the preamble of FIG. 11 or a partially omitted structure (having neither repetitive transmission nor CP). Although it is assumed that  
20 the CAZAC sequence is used as the code sequence for data transmission, the code sequence is not necessarily limited to the CAZAC sequence. Every sequence having excellent transmission characteristic, such as Hadarmad code and gold code, can be used as the code sequence.

<First Embodiment>

25           To transmit data, a landmark that can be identified is generally required for a

transmission signal constituting data. In this embodiment, conjugation is used as the landmark. Since a phase variation width between a conjugated transmission signal and other transmission signal is very great, interference between transmission signals decreases, whereby reliability of data transmission can be improved in spite of influence of channel.

5           FIG. 12 illustrates a method of transmitting data through conjugation according to one embodiment of the present invention. In the embodiment of FIG. 12, one CAZAC sequence is divided into four blocks, and '0' or '1' indicates whether to perform conjugate for each block. For example, it may be promised that a block which is not conjugated is expressed by '0', and a block which is conjugated is expressed by '1.' In this way, one  
10 CAZAC sequence can express information of 4 bits. In other words, if one CAZAC sequence is divided into N number of blocks, information of N bits can be expressed.

At this time, in a single CAZAC sequence of a long length corresponding to a length of transmission data, a part of the single CAZAC sequence, which corresponds to a specific block having a value of 1, may be conjugated. Also, in a plurality of CAZAC sequences of a  
15 short length corresponding to each block length of transmission data, a CAZAC sequence corresponding to a specific block having a value of 1 may be conjugated.

FIG. 13 is a diagram illustrating an example of a method of receiving and decoding the sequence transmitted through conjugation from the transmitter in accordance with one embodiment of the present invention.

20           It is preferable that the transmitter always allocates a value of 0 to the first block of the transmission data so that the first block is used as a reference later. Accordingly, the receiver identifies sequence ID for the received first block (S1101), and then measures a peak by using only the corresponding block (S1102). Next, the receiver identifies sequence IDs for the first and second blocks (S1103), and then measures a peak by using the first and second  
25 blocks together. At this time, since it is unclear whether the sequence of the second block is in



the conjugated status, the receiver respectively measures a peak corresponding to the case where the corresponding block is conjugated (S1104) and a peak corresponding to the case where the corresponding block is not conjugated (S1105), and then selects greater one of the two peaks (S1106). Subsequently, the receiver identifies sequence IDs for the first to third blocks (S1107), and then measures a peak by using the first to third blocks together. In this case, since it is unclear whether the sequence of the third block is in the conjugated status, the receiver respectively measures a peak corresponding to the case where the corresponding block is conjugated (S1108) and a peak corresponding to the case where the corresponding block is not conjugated (S1109), and then selects greater one of the two peaks (S1110). In this way, decoding is performed for the first block to the last block so that the original data is finally decoded.

<Second Embodiment>

FIG. 14 is a diagram illustrating a method of transmitting data using a sequence according to another preferred embodiment of the present invention. Although data transmission is performed by change of the sequence in the first embodiment, in this embodiment, a type of a sequence for expressing one block is divided into a sequence (first sequence) for a block value of '0' and a sequence (second sequence) for a block value of '1,' and the first and second sequence are grouped. In this case, since the receiver detects only sequence ID (ID of the first sequence or ID of the second sequence) for each block, the receiver is less affected by noise or channel.

All sequences are expressed by one group " $\{c_0(k;M_i), c_1(k;M_j)\}$ " by grouping two sub-sequences (first sequence and second sequence) ( $i$  and  $j$  are integers different from each other). In this case,  $c_0(k;M_i)$  is the first sequence for the block value of 0 (or bit value), and  $c_1(k;M_j)$  is the second sequence for the block value of 1. At this time, a CAZAC sequence of a long length corresponding to a length of transmission data may be used as each sub-

sequence constituting each group. Alternatively, a CAZAC sequence of a short length corresponding to each block length of transmission data may be used as each sub-sequence constituting each group.

Meanwhile, the receiver identifies sequence ID of each block, and identifies a type  
5 of the sequence (first sequence or second sequence) for each block from a sequence ID set consisting of the identified sequence IDs. At this time, the type of the sequence for each block can be expressed by group ID. In other words, in this embodiment, since it is assumed that code values of each block can be expressed by 0 and 1, two types of the sequence for each block or two types of group ID are obtained. The code values of each block can be restored  
10 through group ID. This decoding procedure will be described in detail with reference to FIG. 15.

The receiver identifies sequence ID of each block constituting a corresponding sequence if the sequence is received (S1501), and measures a peak for a sequence ID set consisting of the identified sequence IDs (S1502). In this case, two peaks having high  
15 frequency in generation are selected (S1503) so that sequences which generate the corresponding peaks are identified as the first sequence and the second sequence constituting the group. At this time, if the first sequence and the second sequence are expressed by predetermined group IDs, respectively, first group ID indicating a code value of 0 and second group ID indicating a code value of 1 can be identified. After all, group ID of each block can  
20 be identified through the step S1503 (S1504), and thus the code value of each block can be identified (S1508).

If sequence IDs that can not identify group ID exist due to error occurring during the decoding procedure, peaks are searched for a set of corresponding sequence IDs (S1505), and among the peaks, two powerful peaks are detected (S1506) so that group IDs are again  
25 identified from the detected powerful peaks (S1507). Subsequently, code values of the

corresponding blocks can be identified from the identified group IDs (S1508).

<Third Embodiment>

FIG. 16 is a diagram illustrating a method of transmitting data using a sequence according to another preferred embodiment of the present invention.

5 If the second embodiment is more expanded, a total number of data bits that can be transmitted through one group can be increased. For example, if two sequences are defined as one group like the second embodiment, data of 1 bit per block can be transmitted. If four sequences are defined as one group, data of 2 bits per block can be transmitted. If eight sequences are defined as one group, data of 3 bits per block can be transmitted. However,  
10 since a plurality of sequences are grouped and defined as one set, a problem occurs in that if the length of each sequence is short, the number of groups that can be selected is decreased in proportion to the short length of each sequence.

Accordingly, it is necessary to expand the length of the sequence to increase the number of groups that can be selected. To this end, in this embodiment, the length of the  
15 sequence for each block is expanded while respective sequences are multi-overlapped as shown in FIG. 16B and independence is maintained owing to transmission delay between the overlapped sequences.

Referring to FIG. 16(a), a data value of 2 bits is given to each block. Accordingly, a sequence group for each block consists of four different CAZAC sequences. Since each  
20 CAZAC sequence constituting the sequence group should identify four values, a group size should be increased correspondingly. However, in this case, a problem occurs in that the number of groups that can be used by each base station is decreased. Accordingly, as shown in FIG. 16, the length of each CAZAC sequence is expanded as much as need be while a predetermined delay is given to each CAZAC sequence during data transmission, whereby  
25 independence is maintained between the respective CAZAC sequences.

Meanwhile, the receiver identifies ID of a corresponding block based on the order of each CAZAC sequence represented in the time/frequency domain, and its method of decoding a code value from corresponding block ID is almost identical with that of the second embodiment. Hereinafter, a data decoding procedure of the receiver will be described in detail with reference to FIG. 17.

The receiver identifies sequence ID of each block constituting a corresponding sequence if the sequence is received (S1701), and measures a peak for a sequence ID set consisting of the identified sequence IDs (S1702). In this embodiment, since one block expresses two bits, first, second, third and four sequences which express 00, 01, 10, 11 form one group. Accordingly, the receiver should select 4 peaks having high frequency in generation as a result of measurement (S1703). In this case, the selected peaks are respectively mapped to the first, second, third and fourth sequences in accordance with the order represented in the time/frequency domain. Also, if the first sequence to the fourth sequence are expressed by predetermined group IDs, respectively, first group ID indicating a code value of 00, second group ID indicating a code value of 01, third group ID indicating a code value of 10, and fourth group ID indicating a code value of 11 can be identified. After all, group ID of each block can be identified through the step S1703 (S1704), and thus the code value of each block can be identified (S1708).

If sequence IDs that can not identify group ID exist due to error occurring during the decoding procedure, peaks are again searched for a set of corresponding sequence IDs (S1705), and among the peaks, four powerful peaks are detected (S1706) so that group IDs are again identified from the detected powerful peaks (S1707). Subsequently, code values of the corresponding blocks can be identified from the identified group IDs (S1708).

<Fourth Embodiment>

FIG. 18 is a diagram illustrating a method of transmitting data using a sequence

according to another preferred embodiment of the present invention.

In the case that the second embodiment and the third embodiment are more expanded, the signal position is changed through pulse position modulation (PPM) so that the length of the sequence can be expanded logically. The PPM originally transmits data with relative pulse delay but PPM based on start position of the sequence is used in this  
5 embodiment.

If bits of data to be transmitted are determined, the base station selects a sequence to be used for transmission of corresponding data and determines a length of a block for applying PPM to a corresponding sequence and a length of a duration constituting each block.  
10 A sequence corresponding to each block is separately required when a preamble is generated. However, in this embodiment, since circular shift equivalent to a specific duration within a specific block constituting a corresponding sequence is applied for the same sequence, the respective sequences are originally the same as one another but are identified from one another by circular shift.

For example, assuming that one sequence length is divided into four blocks (block 1 to block 4) and each block is expressed by 2 bits, each block is again divided into four durations (duration 1 to duration 4) to express values of "00, 01, 10, 11." At this time, four durations included in one block are used as start identification positions of circular shift for a sequence corresponding to a corresponding block. If a preamble to be transmitted has a total  
20 length of 256, block 1 can have a circular shift value of 0~63, block 2 64~127, block 3 128~195, and block 4 196~255. If a specific sequence to be used for transmission of the preamble is determined and "00" is transmitted through block 1, sequence 1 undergoes circular shift so that a start position is arranged in duration 1 (0~15) of block 1. If "10" is transmitted to block 2, sequence 2 undergoes circular shift so that a start position is arranged  
25 in duration 3 (96~111) of block 2. In this way, circular shift is applied for the other blocks

and then the respective sequences (sequence 1 to sequence 4) are grouped into one to generate one preamble. In this case, the number of blocks can be generated from 1 to every random number. Also, a minimum unit of circular shift can be limited to more than a certain value considering channel or timing error.

5           Meanwhile, the receiver identifies respective sub sequences (sequence 1 to sequence 4) constituting corresponding sequences by data processing the transmitted sequences, and searches a start position of each of the identified sequences to perform data decoding. This will be described in detail with reference to FIG. 19.

10           If a sequence is received in the receiver (S1901), the receiver detects ID of the corresponding sequence (S1903) and performs full correlation through predetermined data processing for a total of received signals (received sequence) by using the detected result (S1905). At this time, a full search algorithm or a differential search algorithm can be used for detection of the sequence ID.

15           Since the received signal is transmitted from the transmitter by gathering a plurality of sequences, the signal which has undergone the correlation includes a plurality of peaks. In this embodiment, four peaks are detected, and the receiver determines whether each of the detected peaks corresponds to which one of block 1 to block 4 and also corresponds to which duration of a corresponding block (S1909) to decode bit order and bit value of the original data (S1911).

20           The method of effectively transmitting the preamble sequence and message through the RACH has been described as above. Finally, a procedure of transmitting a preamble from a user equipment (UE) to a base station (Node-B) and performing synchronization between both the user equipment and the base station will be described based on two embodiments. FIG. 20A and FIG. 20B illustrate the two embodiments.

25           In the embodiment of FIG. 20A, synchronization is performed in such a manner the

user equipment accesses the base station only once. In other words, if the user equipment transmits a preamble and a message including information required for synchronization to the base station (S2001), the base station transmits timing information to the user equipment (S2003) and at the same time allocates a resource for transmission of uplink data (S2005).

5 The user equipment transmits the uplink data to the base station through the allocated resource (S2007).

In the embodiment of FIG. 20B, for synchronization, the user equipment accesses the base station twice. In other words, if the user equipment transmits a preamble to the base station (S2011), the base station transmits timing information to the user equipment and at the same time allocates a resource for a request of scheduling (S2013). The user equipment  
10 transmits a message for a request of scheduling to the base station through the allocated resource (S2015). Then, the base station allocates a resource for transmission of uplink data to the user equipment (S2017). In this way, the user equipment transmits the uplink data to the base station through the secondly allocated resource (S2019).

15 FIG. 21 is a diagram illustrating a method of transmitting data to a receiver through a signaling channel in accordance with one embodiment of the present invention.

Since the receiver should search a start position of a transmission signal in actually realizing the random access channel, it is generally designed that the random access channel has a specific pattern in the time domain. To this end, a preamble sequence may be used so  
20 that the random access signal originally has a repetitive pattern. Alternatively, a certain interval may be maintained between sub-carriers in the frequency domain to obtain repetitive characteristics in the time domain. Accordingly, the access modes of FIG. 6A and FIG. 6B are characterized in that the start position of the transmission signal should easily be searched in the time domain. To this end, the CAZAC sequence is used. The CAZAC sequence can be  
25 classified into GCL sequence (Equation 1) and Zadoff-Chu sequence (Equation 2).

Meanwhile, a specific sequence of a long length is preferably used to transmit unique information of the user equipment or the base station through RACH (Random Access Channel) or SCH (Synchronization Channel). This is because that the receiver easily detects corresponding ID and more various kinds of sequences can be used to provide convenience  
5 for system design.

However, if message is transmitted with corresponding ID at a sequence of a long length, since the quantity of the message is increased by  $\log_2$  function, there is limitation in message passing with ID only when the sequence exceeds a certain length. Accordingly, in this embodiment, the sequence is divided by several short blocks, and a short signature  
10 sequence corresponding to data to be transmitted to each block of the sequence is used instead of specific manipulation such as conjugation or negation.

Referring to FIG. 21, the sequence is divided into a predetermined number of blocks, and a short signature sequence corresponding to data to be transmitted is applied for each of the divided blocks. A long CAZAC sequence is multiplied by combination of the blocks for  
15 which the short signature sequence is applied, whereby a final data sequence to be transmitted to the receiver is completed.

In this case, assuming that the short signature sequence consists of four signatures, the following signature sets can be used. Also, if there is difference between respective data constituting the signature sets, any other signature set may be used without specific limitation.

- 20 1) Modulation values:  $\{1+j, 1-j, -1-j, -1+j\}$
- 2) Exponential sequence:  $\{\exp(jw_0n), \exp(jw_1n), \exp(jw_2n), \exp(jw_3n)\}$ ,  
where  $n=0\dots N_s$ , and  $N_s$  is a length of each block
- 3) Walsh Hadamard sequence:  $\{[1111], [1-11-1], [11-1-1], [1-1-11]\}$ , where, if the length  $N_s$  of each block is longer than 4, each sequence is repeated to adjust the length.

25 Examples of the long CAZAC sequence that can be used in the embodiment of FIG.



21 include, but not limited to, one GCL CAZAC sequence, Zadoff-Chu CAZAC sequence, and a sequence generated by concatenation of two or more short GCL or Zadoff-Chu CAZAC sequences having the same length or different lengths.

5 The aforementioned manner of applying a short signature sequence for data transmission and reception to the long CAZAC sequence is advantageous in that it is less affected by channel than the related art modulation method of transmission data and performance is little decreased even though the number of bits constituting one signature is increased.

10 FIG. 22 illustrates an example of a receiver and a transmitter for transmitting a preamble and data through RACH, SCH or other channel by using the aforementioned manner.

15 Since the number of bits can be increased in accordance with increase of signatures, channel coding can be applied for the transmitter. If channel coding is performed, time/frequency diversity can be obtained through an interleaver. Also, bit to signature mapping can be performed to minimize a bit error rate. In this case, Gray mapping can be used. The sequence which has undergone this procedure is mixed with CAZAC and then transmitted.

20 The receiver detects CAZAC ID, and calculates a log-likelihood ratio (LLR) for each of bits. Then, the receiver decodes transmission data through a channel decoder. Considering complexity according to sequence search of the receiver configured as shown in FIG. 22, the transmitter preferably uses an exponential sequence as a signature sequence. In this case, the receiver can simply search CAZAC ID through phase difference Fourier Transform. Afterwards, the receiver can again simply calculate LLR from the signature through Fourier Transform.

25 According to the present invention, the structure on the frequency axis/time axis of

the RACH can be identified more definitely. Also, since the RACH resource is divisionally distributed for each frame, even though the user equipment fails to access a specific RACH, the user equipment can directly access RACH of the next frame, whereby access to the base station is improved. Moreover, the user equipment can easily access the RACH even in case  
5 of a traffic area of which QoS condition is strict.

Furthermore, according to the present invention, since information is transmitted and received between the user equipment and the base station by using the code sequence, time/frequency diversity can be maximized, and performance attenuation due to influence of channel can be alleviated through the signature manner.

10 According to the present invention, since the total length of the corresponding sequence can be used with maintaining the advantage of the code sequence according to the related art, data transmission can be performed more efficiently. Also, since the code sequence undergoes predetermined data processing, the quantity of information to be transmitted can be increased and the transmitted data becomes robust to noise or channel.

15 It will be apparent to those skilled in the art that the present invention can be embodied in other specific forms without departing from the spirit and essential characteristics of the invention. Thus, the above embodiments are to be considered in all respects as illustrative and not restrictive. The scope of the invention should be determined by reasonable interpretation of the appended claims and all change which comes within the  
20 equivalent scope of the invention are included in the scope of the invention.

#### INDUSTRIAL APPLICABILITY

The present invention is applicable to a wireless communication system such as a mobile communication system or a wireless Internet system.

25

# Document made available under the Patent Cooperation Treaty (PCT)

International application number: PCT/KR2007/002784

International filing date: 08 June 2007 (08.06.2007)

Document type: Certified copy of priority document

Document details: Country/Office: KR  
Number: 10-2006-0057488  
Filing date: 26 June 2006 (26.06.2006)

Date of receipt at the International Bureau: 05 July 2007 (05.07.2007)

Remark: Priority document submitted or transmitted to the International Bureau in compliance with Rule 17.1(a) or (b)



World Intellectual Property Organization (WIPO) - Geneva, Switzerland  
Organisation Mondiale de la Propriété Intellectuelle (OMPI) - Genève, Suisse

**EVOLVED-0001820**

ZTE/HTC  
Exhibit 1005-0175

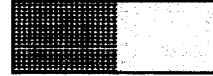

별첨 사본은 아래 출원의 원본과 동일함을 증명함.

This is to certify that the following application annexed hereto  
is a true copy from the records of the Korean Intellectual  
Property Office

출원 번호 : 10-2006-0057488  
Application Number

출원 년 월 일 : 2006년 06월 26일  
Filing Date JUN 26, 2006

출원인 : 엘지전자 주식회사  
Applicant(s) LG Electronics Inc.

2007 년 07 월 03 일

특 허 청

COMMISSIONER

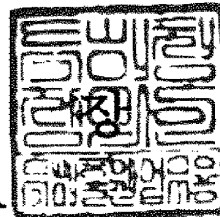

EVOLVED-0001821

ZTE/HTC

Exhibit 1005-0176

**【서지사항】**

**【서류명】** 특허출원서  
**【권리구분】** 특허  
**【수신처】** 특허청장  
**【참조번호】** 0019  
**【제출일자】** 2006.06.26  
**【국제특허분류】** H04B  
**【발명의 국문명칭】** 랜덤 액세스 채널을 통한 데이터 송수신 방법  
**【발명의 영문명칭】** Method for data transferring through Random Access Channel  
**【출원인】**  
**【명칭】** 엘지전자 주식회사  
**【출원인코드】** 1-2002-012840-3  
**【대리인】**  
**【성명】** 김용인  
**【대리인코드】** 9-1998-000022-1  
**【포괄위임등록번호】** 2006-037573-8  
**【대리인】**  
**【성명】** 심창섭  
**【대리인코드】** 9-1998-000279-9  
**【포괄위임등록번호】** 2006-037574-5  
**【발명자】**  
**【성명】** 권영현  
**【성명의 영문표기】** KWON, Yeong Hyeon  
**【주민등록번호】** 740611-1533118  
**【우편번호】** 440-824  
**【주소】** 경기 수원시 장안구 율전동 103-6 스마일빌 402호  
**【국적】** KR

**【발명자】**

**【성명】** 한승희  
**【성명의 영문표기】** HAN, Seung Hee  
**【주민등록번호】** 761128-1261917  
**【우편번호】** 122-899  
**【주소】** 서울 은평구 역촌1동 42-35  
**【국적】** KR

**【발명자】**

**【성명】** 박현화  
**【성명의 영문표기】** PARK, Hyun Hwa  
**【주민등록번호】** 800803-2357323  
**【우편번호】** 431-050  
**【주소】** 경기 안양시 동안구 비산동 1115번지 신안 메트로칸 1133호  
**【국적】** KR

**【발명자】**

**【성명】** 김동철  
**【성명의 영문표기】** KIM, Dong Cheol  
**【주민등록번호】** 781009-1632216  
**【우편번호】** 437-080  
**【주소】** 경기 의왕시 내손동 763 대명 스위트빌 401호  
**【국적】** KR

**【발명자】**

**【성명】** 이현우  
**【성명의 영문표기】** LEE, Hyun Woo  
**【주민등록번호】** 770601-1063313  
**【우편번호】** 431-080  
**【주소】** 경기 안양시 동안구 호계동 1103-3 네오빌 204호  
**【국적】** KR

**【발명자】**

**【성명】** 노민석  
**【성명의 영문표기】** NOH, Min Seok  
**【주민등록번호】** 770911-1558611  
**【우편번호】** 152-053  
**【주소】** 서울 구로구 구로3동 오피스텔 미래지오 2층 211호  
**【국적】** KR

**【취지】** 특허법 제42조의 규정에 의하여 위와 같이 출원합니다.

대리인 김용인 (인)  
 대리인 심창섭 (인)

**【수수료】**

**【기본출원료】** 0 면 38,000 원  
**【가산출원료】** 55 면 0 원  
**【우선권주장료】** 0 건 0 원  
**【심사청구료】** 0 항 0 원  
**【합계】** 38,000 원

## 【요약서】

### 【요약】

랜덤 액세스 채널에서 코드 시퀀스를 확장하여 데이터를 전송하는 방법들이 제공된다. 프리앰블 시퀀스로 CAZAC 시퀀스를 사용한다고 가정하는 경우, 첫 번째 방법은 CAZAC 시퀀스에 소정의 지수 시퀀스를 곱하여 전송에 이용할 수 있는 CAZAC 시퀀스의 비트수를 확장하는 것이고, 두 번째 방법은 전송 데이터의 블록값에 따라 해당 CAZAC 시퀀스에 켈레화(conjugation)를 수행하여 블록간 위상차를 크게 만드는 것이며, 세 번째 방법은 두 종류의 시퀀스를 하나의 그룹으로 하는 CAZAC 시퀀스를 적용하고 이 두 종류의 시퀀스를 이용하여 데이터를 표시하는 것이고, 네 번째 방법은 전송 데이터의 각 블록에 상응하는 CAZAC 시퀀스 간에 딜레이를 주어 중첩시키되 각 CAZAC 시퀀스의 길이를 길게 설계하는 것이며, 다섯 번째 방법은 전송 데이터의 각 블록에 상응하는 CAZAC 시퀀스에 순환지연을 적용하여 하나의 시퀀스에 다양한 데이터 값을 적용할 수 있다.

### 【대표도】

도 16

### 【색인어】

RACH, CAZAC, conjugate, code sequence, preamble



【명세서】

【발명의 명칭】

랜덤 액세스 채널을 통한 데이터 송수신 방법 {Method for data transferring through Random Access Channel}

【도면의 간단한 설명】

- <1> 도 1은 OFDMA 시스템에서 RACH를 통한 종래 데이터 전송 방법의 일실시예.
- <2> 도 2는 OFDMA 시스템에서 RACH를 통한 종래 데이터 전송 방법의 다른 일실시예.
- <3> 도 3a 및 도 3b는 OFDMA 시스템에서 RACH를 통한 종래 데이터 전송 방법의 또 다른 일실시예.
- <4> 도 4a 및 도 4b는 OFDMA 시스템에서 RACH를 통한 종래 데이터 전송 방법의 또 다른 일실시예.
- <5> 도 5는 OFDMA 시스템에서 사용되는 종래 RACH 구조의 일 실시예.
- <6> 도 6a 및 도 6b는 도 5의 RACH 구조를 전체로 시간 영역 또는 주파수 영역에서 RACH 신호를 실기 위한 실시예들.
- <7> 도 7은 OFDMA 시스템에서 사용되는 종래 RACH 구조의 다른 일 실시예.
- <8> 도 8a 및 도 8b는 OFDMA 시스템에서 사용되는 종래 RACH 구조의 또 다른 일 실시예.
- <9> 도 9는 본 발명에서 사용되는 프리앰블의 반복 구조를 도시한 것.

- <10> 도 10은 컬레화를 통해 확장된 코드 시퀀스로 데이터를 전송하는 본 발명의 일실시예를 설명하기 위한 단위 데이터의 구조도.
- <11> 도 11은 컬레화를 통해 확장된 코드 시퀀스로 전송되어 온 데이터를 수신하여 복호화하는 과정을 설명한 플로우차트.
- <12> 도 12는 그룹화를 통해 확장된 코드 시퀀스로 데이터를 전송하는 본 발명의 일실시예를 설명하기 위한 단위 데이터의 구조도.
- <13> 도 13은 그룹화를 통해 확장된 코드 시퀀스로 전송되어 온 데이터를 수신하여 복호화하는 과정을 설명한 플로우차트.
- <14> 도 14는 딜레이 처리와 그룹화를 통해 확장된 코드 시퀀스로 데이터를 전송하는 본 발명의 일실시예를 설명하기 위한 단위 데이터의 구조도.
- <15> 도 15는 딜레이 처리와 그룹화를 통해 확장된 코드 시퀀스로 전송되어 온 데이터를 수신하여 복호화하는 과정을 설명한 플로우차트.
- <16> 도 16은 PPM 변조를 통해 확장된 코드 시퀀스로 데이터를 전송하는 본 발명의 일실시예를 설명하기 위한 단위 데이터의 구조도.
- <17> 도 17은 PPM 변조를 통해 확장된 코드 시퀀스로 전송되어 온 데이터를 수신하여 복호화하는 과정을 설명한 플로우차트.
- <18> 도 18a 및 도 18b는 본 발명의 데이터 전송 방법에 의해 RACH에서 동기화가 수행되는 과정을 도시한 플로우차트.

**【발명의 상세한 설명】**

**【발명의 목적】**

**【발명이 속하는 기술분야 및 그 분야의 종래기술】**

<19> 본 발명은 랜덤 액세스 채널에서 코드 시퀀스를 확장하여 데이터를 전송하는 방법들에 관한 것이다.

<20> 랜덤 액세스 채널(Random Access Channel, RACH)은 단말이 기지국과 업링크(uplink) 동기가 이루어지지 않은 상태에서 네트워크에 접근하기 위해 사용된다. 이와 같은 랜덤 액세스 채널에서는 수신측에서 전송 신호의 시작 위치를 용이하게 검색할 수 있도록 시간 영역에서 반복 특성을 가지는 신호가 사용되는데, 일반적으로 프리앰블(preamble)을 반복적으로 전송함으로써 반복 특성을 구현한다.

<21> 상기 프리앰블을 구현하기 위한 대표적인 시퀀스로 CAZAC(Constant Amplitude Zero AutoCorrelation) 시퀀스를 들 수 있다. CAZAC 시퀀스는 자기상관(auto-correlation)의 경우 디랙-델타(Dirac-Delta) 함수로 표현되고, 교차상관(cross-correlation)의 경우 상수값을 가지므로 우수한 전송 특성을 가지는 것으로 평가받고 있다. 그러나, 길이 N의 시퀀스에 대하여 최대 N-1개의 시퀀스만을 사용할 수 있다는 한계가 있어 상기의 우수한 특성을 그대로 유지하면서 시퀀스의 사용 가능 비트수를 늘리기 위한 방안이 요구되고 있다.

<22> 한편, CAZAC 시퀀스를 이용하여 랜덤 액세스 채널에서 데이터를 전송하기 위해 다양한 방법들이 제시되고 있다. 이를 위한 제1방법은 CAZAC 시퀀스 ID를 곧바로 메시지 정보로 해석하는 것이다. 그러나, 제1방법에 있어서 전송하고자 하는 데이터가 프리앰블이라 할 때 프리앰블로 사용될 수 있는 시퀀스의 수가 충분히 많은

<25> 제4방법은 CAZAC 시퀀스에 지수(exponential) 텀을 곱하여 해당 시퀀스를 구  
 성하는 블록 간에 적교성을 부여하거나, DPSK, DQPSK, D8PSK 등의 변조를 적  
 절 적용하는 것으로서, CAZAC 시퀀스 ID는 단말 구분 정보로 활용하고 변조된 시퀀  
 북 시퀀스로 전송되어야 하는 한계가 있다.

<24> 제3방법은 CAZAC 시퀀스에 원시 시퀀스를 곱성하여 전송하는 것으로서,  
 CAZAC 시퀀스 ID는 단말 구분 정보로 활용하고 원시 시퀀스는 메시지 정보로 해석  
 한다. 도 2는 3방법을 구현하기 위한 송신측에서의 데이터 진해 절차를 블록으로  
 도시하고 있다. 그러나, 제3방법은 원시 시퀀스가 CAZAC 시퀀스의 검출에 잡음으로  
 작용하여 시퀀스 ID의 검출에 어려움이 발생하므로 이를 방지하기 위해 반드시 반  
 (bit)에 불과하다는 한계가 있다.

<23> 제2방법은 CAZAC 시퀀스와 왈시(Walsh) 시퀀스를 코드분할 다중화(code  
 division multiplexing, CDM) 방식으로 동시에 전송하는 것으로서, CAZAC 시퀀스  
 ID는 단말 구분 정보로 활용하고 CDM 방식으로 전송된 시퀀스는 메시지 정보로 해  
 석한다. 도 1은 제2방법을 구현하기 위한 송신측에서의 데이터 진해 절차를 블록으  
 로 도시하고 있다. 그러나, 제2방법은 CAZAC 시퀀스에 원시 시퀀스가 더해져도 추  
 가로 확보할 수 있는 메시지의 비트수는 왈시 시퀀스의 길이가 N일 때  $\log_2 N$  비트  
 는 문제가 있다.

경우라면 추가적인 조작 없이 CAZAC 시퀀스 ID만으로 메시지를 전달할 수 있으나,  
 원채 RACH에서는 최대 24bit까지 고려해야 하므로 충분한 수의 CAZAC 시퀀스 결합  
 른 구현하는 데에 어려움이 있고, 수신측에서 검출에 소요되는 비용 역시 상당하다

스를 복조하여 메시지 정보로 활용한다. 도 3a는 전자의 방법에 의한 데이터 변조를 도시하고 있고, 도 3b는 후자의 방법에 의한 데이터 변조를 도시하고 있다.

<26> 또한, 제5방법은 CAZAC 시퀀스에 메시지 부분을 덧붙여서 전송하는 것으로서, 도 4a는 프리앰블로 이용되는 CAZAC 시퀀스에 메시지(코딩된 비트)가 덧붙여진 경우를 도시하고 있고, 도 4b는 직교성이 부여된 소정 개수의 블록으로 구성되는 시퀀스에 메시지(코딩된 비트)가 덧붙여진 경우를 도시하고 있다.

<27> 그러나, 상기 제4방법 및 제5방법은 공히 채널 여건의 변화에 민감하다는 문제가 있다.

**【발명이 이루고자 하는 기술적 과제】**

<28> 본 발명은 위와 같은 문제점을 해결하기 위해 제안된 것으로서, 랜덤 액세스 채널에서 데이터를 전송하는데 있어서 코드 시퀀스의 전체 길이를 모두 활용할 수 있도록 하는 코드 시퀀스의 데이터 처리 방법을 제공하는 데에 그 목적이 있다.

<29> 본 발명의 다른 목적은 랜덤 액세스 채널에서 데이터를 전송함에 있어서 전송할 정보량이 증대되거나 전송 데이터가 노이즈나 채널에 강해지도록 하는 코드 시퀀스의 데이터 처리 방법을 제공하는 데에 있다.

**【발명의 구성】**

<30> 상기 첫 번째 목적을 달성하기 위한 본 발명은 코드 시퀀스를 확장하여 데이터를 전송하는 방법에 관한 것으로서, 데이터 전송에 사용 가능한 코드 수가 추가되도록 상기 코드 시퀀스를 데이터 처리하는 단계와, 상기 데이터 처리된 코드 시퀀스로 데이터를 수신측에 전송하는 단계를 포함하여 이루어지며, 상기 데이터 처

리는 상기 CAZAC 시퀀스에 소정의 지수(exponential) 시퀀스를 곱함으로써 수행된다.

<31>            상기 두 번째 목적을 달성하기 위한 본 발명의 일 실시예는 데이터 전송을 위한 코드 시퀀스를 확장하는 방법에 관한 것으로서, 상기 데이터를 구성하는 각 블록의 비트값에 따라 해당 블록에 상응하는 코드 시퀀스에 소정의 데이터 처리를 수행하는 단계와, 상기 데이터 처리된 코드 시퀀스를 수신측에 전송하는 단계를 포함하여 이루어지며, 상기 코드 시퀀스의 데이터 처리는 상기 데이터를 구성하는 특정 블록의 비트값이 1인 경우, 해당 블록에 상응하는 CAZAC 시퀀스를 켈레화(conjugation)하는 것이다.

<32>            이와 같이, 전송 데이터를 구성하는 각 블록의 비트값에 따라 해당 코드 시퀀스를 켈레화(conjugation)가 수행되어 전송된 코드 시퀀스를 수신측에서 복호화하는 방법은, 수신된 데이터에 있어서, 첫 번째 블록에 대한 초기 피크(peak)를 추정하는 제1단계와, 피크 추정이 수행된 블록과 다음 순번의 블록에 대해 피크(peak)를 추정하는 제2단계와, 마지막 순번의 블록에 이르기까지 상기 제2단계를 반복하는 제3단계를 포함하여 이루어진다. 여기서, 상기 첫 번째 블록은 항상 0으로 설정되어 수신되어야 하며, 상기 제2단계는 피크 추정이 수행된 블록과 다음 순번의 블록에 대해 켈레화(conjugation)되었음을 전제로 제1피크(peak)를 추정하는 제2-1단계와, 동일한 블록들에 대해 켈레화(conjugation)가 되지 않았음을 전제로 제2피크(peak)를 추정하는 제2-2단계 및 상기 제1피크와 제2피크 중 큰 쪽을 해당 블록들의 피크로 결정하는 제2-3단계를 포함한다.

<33>            상기 두 번째 목적을 달성하기 위한 본 발명의 다른 일 실시예는 데이터 전송을 위한 코드 시퀀스를 확장하는 방법에 관한 것으로서, 상기 데이터를 구성하는 각 블록의 값에 따라 특정 시퀀스가 선택되는 단계와, 상기 선택된 시퀀스들로 이루어진 코드 시퀀스를 수신측에 전송하는 단계를 포함하여 이루어진다.

<34>            여기서, 상기 코드 시퀀스는 상기 데이터를 구성하는 각 블록의 비트수  $n(n=1, 2, 3, \dots)$ 에 따라  $2^n$ 개의 서로 다른 시퀀스를 포함하는 그룹으로 이루어지며, 상기 특정 시퀀스의 선택은 각 블록의 비트값에 상응하는 특정 시퀀스를 상기 그룹에서 선택하는 것일 수 있다.

<35>            또한, 상기 선택된 각 시퀀스가 서로 독립성을 유지하면서 중첩되도록 데이터 처리하는 단계를 더 포함할 수 있는데, 이 경우 상기 선택된 각 시퀀스는 소정 간격의 딜레이를 두고 순차적으로 중첩되도록 데이터 처리되는 것이 바람직하다.

<36>            또한, 상기 그룹에 포함되는 시퀀스는 전체 블록 길이의 단일 CAZAC 시퀀스가 사용될 수도 있고, 상기 그룹에 포함되는 시퀀스는 단일 블록 길이의 짧은 CAZAC 시퀀스가 사용될 수도 있다.

<37>            이와 같이, 그룹화된 시퀀스 중 특정 시퀀스의 선택을 통해 확장되는 코드 시퀀스를 이용하여 전송된 데이터를 복호화하는 방법은, 수신된 데이터의 블록별 시퀀스 ID(sequence ID)를 파악하는 단계와, 상기 파악된 코드 시퀀스 ID의 세트로부터 각 블록의 그룹 ID(group ID)를 파악하는 단계와, 상기 파악된 그룹 ID로부터 데이터값을 복호화하는 단계를 포함한다.

<38> 여기서, 상기 그룹 ID 파악 단계는 각 코드 시퀀스 ID에 해당하는 블록에 대하여 피크(peak)를 추정하는 단계와, 상기 추정된 피크 중 발생 빈도가 높은 2개의 피크로부터 각 블록의 그룹 ID를 파악하는 단계를 포함하며, 그룹 ID가 파악되지 않은 블록에 대하여 상기 피크 추정 단계를 반복함으로써 그룹 ID를 재파악하는 단계를 더 포함될 수 있다.

<39> 또한, 상기 그룹 ID 파악 단계는 각 코드 시퀀스 ID에 해당하는 블록에 대하여 피크(peak)를 추정하는 단계와, 상기 추정된 피크 중 발생 빈도가 높은  $2^n$  ( $n=1,2,3,\dots$ )개의 피크로부터 각 블록의 그룹 ID를 파악하는 단계를 포함하여 이루어질 수도 있으며, 이 경우에도 그룹 ID가 파악되지 않은 블록에 대하여 상기 피크 추정 단계를 반복함으로써 그룹 ID를 재파악하는 단계를 더 포함할 수 있다.

<40> 상기 두 번째 목적을 달성하기 위한 본 발명의 또 다른 일 실시예는 데이터 전송을 위한 코드 시퀀스를 확장하는 방법에 관한 것으로서, 상기 데이터를 구성하는 각 블록에 상응하는 시퀀스들이 해당 블록의 값을 표시하도록 각각의 시퀀스를 데이터 처리하는 단계와, 상기 데이터 처리된 각 시퀀스를 중첩하여 수신측으로 전송하는 단계를 포함하여 이루어진다.

<41> 이때, 상기 전송 데이터를 구성하는 각 블록은 해당 블록의 비트수  $n$  ( $n=1, 2, 3,\dots$ )에 따라  $2^n$ 개의 구간으로 구분되고, 상기 데이터 처리는 특정 블록의 특정 구간이 시작점이 되도록 해당 블록에 상응하는 시퀀스를 변조(modulation)하는 것인데, 상기 변조 방법으로 PPM(Pulse Position Modulation)이 이용되는 것이 바람



직하다.

<42> 이와 같이 전송 데이터를 구성하는 블록에 대한 시퀀스 각각에 대해 PPM을 수행하여 중첩시킨 데이터를 수신하고 이를 복호화하는 방법은, 수신된 데이터에 대한 시퀀스 ID를 검출하는 단계와, 상기 검출된 시퀀스 ID에 해당하는 미리 준비된 시퀀스를 이용하여 수신 데이터를 코렐레이션(correlation) 하는 단계와, 상기 코렐레이션된 데이터로부터 해당 데이터를 구성하는 블록 개수만큼의 피크(peak)를 측정하는 단계 및 상기 측정된 피크를 이용하여 각 블록에 대한 데이터값을 복호화하는 단계를 포함하여 이루어지며, 상기 데이터값 복호화 단계는 측정된 각 피크가 어떤 블록의 어떤 구간에 속하는지를 판독함으로써 데이터 비트의 순서와 데이터 비트의 내용을 복호화한다.

<43> 한편, 상기 실시예들에 공통적으로 사용되는 코드 시퀀스는 CAZAC(Constant Amplitude Zero Autocorrelation) 시퀀스가 될 수 있다.

<44> 이하, 본 발명에 첨부된 도면을 참고하여 본 발명의 바람직한 실시예에 대해 상세하게 살펴보기로 한다.

<45> 랜덤 액세스 채널(Random Access Channel, RACH)은 단말이 기지국과 업링크(uplink) 동기가 이루어지지 않은 상태에서 네트워크에 접근하기 위해 사용되는 것으로서, 네트워크에의 접근 방식에 따라 단말이 다운링크 동기를 잡고 맨 처음 기지국에 접근하는 방식(initial ranging)과, 네트워크에 접속된 상태로 단말의 필요에 따라 네트워크에 그때마다 접근하는 방식(periodic ranging)으로 구분할 수 있다. 여기서, 전자의 경우는 단말이 네트워크에 접속하면서 동기를 이루고 자신에게

필요한 아이디(ID)를 제공받기 위한 용도로 사용되고, 후자는 전송할 패킷이 존재하거나 기지국으로부터 정보를 수신하기 위해 프로토콜을 초기화(initiation)시키기 위한 용도로 사용된다.

<46> 특히 후자의 경우는 3GPP LTE에 의한 때 나시 두 가지로 구분할 수 있는데, 단말이 RACH에 접근할 때 자신의 업링크(uplink) 신호가 동기 한계 내에 있을 때 사용하는 동기화 접근 모드(synchronized access mode)와, 동기 한계를 벗어났을 때 사용하는 비동기화 접근 모드(non-synchronized access mode)로 구분할 수 있다. 비동기화 접근 모드는 단말이 최초로 기지국에 접근하는 경우나, 동기 과정을 기친 후 동기 갱신(update)가 이루어지지 않았을 경우에 사용되는 방식이다. 이때, 동기화 접근 모드는 상기 주기적 접근(periodic ranging)과 같은 개념이며, 단말이 기지국에게 자신의 변경사항 통보와 자원할당 요청을 목적으로 RACH에 접근하는 경우에 이용된다.

<47> 그에 비해, 동기화 접근 모드는 단말이 기지국과 업링크(uplink) 동기를 벗어나지 않은 상태라 가정하고 그 가정에 따라 RACH에 있어서 보호 시간(Guard time)의 제한을 완화한다. 이로 인해 더 많은 시간-주파수 자원(time-frequency resource)을 사용할 수 있는데, 3GPP LTE에서는 동기화 접근 모드에서 랜덤 액세스용 프리앰블 시퀀스(preamble sequence)에 상당한 양의 메시지(24bits 이상)를 더하여 양자를 함께 전송하도록 하고 있다.

<48> 이상과 같은 동기 및 비동기 접근 모드를 만족하면서 RACH의 고유의 역할을 수행하기 위한 종래의 RACH 구조를 살펴보면 다음과 같다.

<49> 도 5는 종래 OFDMA 시스템에서 사용되는 RACH 구조의 일실시예를 도시한 것이다. 도면에서 보듯, RACH는 셀의 반경에 따라 시간축으로 N개의 서브 프레임(subframe)으로 분할되고, 주파수축으로 N개의 주파수 대역으로 분할됨을 알 수 있다. RACH의 생성 빈도는 MAC에서의 QoS 요구 조건에 따라서 정해지는데, 일반적으로 수십 ms 단위로 한 번씩 또는 수백 ms 단위로 한 번씩 채널이 생성된다. 이는 여러 개의 subcarrier 별로 다른 RACH를 설정하여 단말간 충돌을 줄이는 구조이다.

<50> 도 5와 같은 RACH 구조에서 임의의 서브 프레임은 시간-주파수 자원(Time-Frequency Resource, TFR)이라 하여 데이터 전송의 기본 단위가 된다. 도 6a는 이와 같은 TFR에 시간 영역에서 랜덤 액세스 신호를 실는 형태를 도시하고 있고, 도 6b는 주파수 영역에서 RACH 신호를 실는 형태를 도시하고 있다.

<51> 도 6a에서 보듯 시간 영역에서 랜덤 액세스 신호를 생성하는 경우에는 본래의 서브 프레임 구조가 무시되고 단지 TFR만을 통해 신호를 정렬하여 전송한다. 반면, 도 6b에서 보듯 주파수 영역에서는 서브 프레임 구조를 어느 정도 유지하면서 각 OFDM 심볼의 부반송파에 전송하고자 하는 랜덤 액세스 신호를 생성한다. 따라서 TFR을 이루는 각 블록 사이에 직교성이 유지되고, 채널 추정 또한 용이하게 수행될 수 있다.

<52> 도 7은 종래 OFDMA 시스템에서 사용되는 RACH 구조의 다른 일실시예를 도시한 것이다. 도면에서 보듯, 첨부된 광대역 파일럿(attached wideband pilot)의 RACH 버스트 구간(RACH burst duration) 중 TDM/FDM 방식 및 TDM 방식에서 공히 프리앰블 b와 파일럿 a가 일부 중복되도록 전송됨을 알 수 있고, 임베디드된 광대역

파일럿(embedded wideband pilot)에서는 TDM/FDM 방식 및 TDM 방식에서 공히 파일럿 a, 파일럿 b 각각이 프리앰블 a 및 프리앰블 b에 동시에 중복되도록 전송됨을 알 수 있다. 다시 말해, RACH를 통해 프리앰블과 파일럿을 함께 전송할 수 있도록 설계함으로써 RACH에 메시지가 추가되는 경우 채널추정을 통해 메시지 복호를 용이하게 하거나, 광대역 파일럿을 사용함으로써 RACH의 프리앰블(preamble)이 사용하는 대역 이외의 RACH 총 채널 대역에 대한 채널품질정보(Channel Quality Information, 이하 'CQI')를 획득할 수 있도록 한다.

<53>           도 8a 및 도 8b는 종래 OFDMA 시스템에서 사용되는 RACH 구조의 또 다른 일 실시예를 도시한 것이다.

<54>           도 8a에서 보듯 본 실시예에서 전체 시스템 대역이 75개의 부반송파로 이루어진다고 할 때, 전체 주파수 대역을 통해 소정 시간 동안 프리앰블을 전송하되 일정 주기로 단블록(short block) 구간을 두어 해당 단블록에 프리앰블을 복호화하기 위한 파일럿을 전송한다. 이때, 상기 파일럿 전송을 전체 주파수 대역 중 일부 대역을 통해 수행함으로써(이를테면 전체 75개의 부반송파 중 중간 대역의 25개 부반송파에를 통해 전송) 멀티 접속 환경에서 특정 단말에 대해서 파일럿을 전송할 수 있다.

<55>           또한, 도 8b에서 보듯 전송하고자 하는 메시지와 이를 복호화하기 위한 파일럿을 멀티플렉싱(multiplexing)하여 지속적으로 전송하되, 전체 주파수 대역 중 선택된 일부 주파수 대역(이를테면 전체 75개의 부반송파 대역 중 중간의 25개 부반송파 대역)을 통해 전송한다. 따라서, 일부 주파수 대역을 다른 주파수로 할당함으

로써 멀티 접속을 하는 각 사용자 단말을 구별할 수 있다.

<56>           이상에서, 다양한 구조의 RACH를 통해 프리앰블(preamble)과, 파일럿 정보 (pilot)를 위시한 동기 타이밍 정보(timing information), 업링크 자원 할당 정보 (uplink resource allocation information) 및 업링크 데이터(uplink data) 등의 메시지가 전송될 수 있음을 살펴보았다.

<57>           한편, RACH를 통해 상기 프리앰블과 메시지는 별개로 전송될 수도 있고, 프리앰블에 메시지가 함축적으로 포함되어 전달될 수도 있다. 본 발명은 특히 후자의 방식을 통해 프리앰블을 전송하는 방법에 관한 것이며, 효과적인 프리앰블의 전송을 위해 종래에 비해 확장된 개념의 코드 시퀀스를 사용하는 것을 특징으로 한다. 이하에서는 프리앰블을 위한 코드 시퀀스로서 CAZAC 시퀀스가 유력한 이유를 알아보고, 이어서 효과적인 프리앰블 전송을 위한 본 발명의 CAZAC 시퀀스 개선 방안 (제1 실시예)을 설명하기로 한다.

<58>           랜덤 액세스 채널에서는 수신측이 전송 신호의 시작 위치를 검색해 내야 하는 부담이 있으므로 전송 신호가 시간 영역에서 특정한 패턴을 가지도록 설계하는 것이 일반적이다. 이를 위해 프리앰블(preamble)을 반복적으로 전송하거나, 주파수 영역에서 부반송파(subcarrier)의 사이에 일정한 간격을 뒀으로써 시간 영역에서 반복 특성을 구현되도록 하고, 이로부터 시간 동기를 알아내도록 하고 있다.

<59>           여기서, 진자의 프리앰블(preamble)은 통신 시스템에서 초기 동기 설정, 셀 탐색, 주파수 오프셋 및 채널 추정 등의 목적으로 사용되는 기준 신호(reference signal)를 가리키며, 셀룰러(cellular) 이동통신 시스템에서는 프리앰블의 반복 전

송을 위해 상호상관 특성이 좋은 시퀀스가 사용되는 것이 바람직하다. 이를 위해 이진 하다마드 코드(binary hardamard code)나 다위상(poly-phase) CAZAC(Constant Amplitude Zero Auto-Correlation) 시퀀스가 사용될 수 있으며, 이 중 특히 CAZAC 시퀀스는 자기상관(auto-correlation)의 경우 디랙-델타(Dirac-Delta) 함수로 표현되고 교차상관(cross-correlation)의 경우 상수값을 가지므로 진송 특성이 우수한 것으로 평가받고 있다.

<60> CAZAC 시퀀스는 다음과 같이 크게 GCL 시퀀스(수식 1)와 Zadoff-Chu 시퀀스(수식 2)로 구분할 수 있다.

【수학식 1】

$$<61> \quad c(k;N,M) = \exp\left(-\frac{j\pi M k(k+1)}{N}\right) \quad \text{for odd } N$$

$$<62> \quad c(k;N,M) = \exp\left(-\frac{j\pi M k^2}{N}\right) \quad \text{for even } N$$

【수학식 2】

$$<63> \quad c(k;N,M) = \exp\left(\frac{j\pi M k(k+1)}{N}\right) \quad \text{for odd } N$$

$$<64> \quad c(k;N,M) = \exp\left(\frac{j\pi M k^2}{N}\right) \quad \text{for even } N$$

<65> 상기 수식들로 부터 CAZAC 시퀀스는 그 길이가 N인 경우 실제로 사용할 수

있는 시퀀스는 N-1개에 한정된다는 것을 알 수 있다.

<66> <제1 실시예>

<67> 따라서, 본 실시예에서는 CAZAC 시퀀스  $c(k)$ 에 소정의 모듈레이션 시퀀스  $m(k)$ 를 곱하는 방식으로 개선된 CAZAC 시퀀스  $p(k)$ 를 제공함으로써 실제로 사용 가능한 시퀀스의 개수를 1만큼 확장한다. 즉, CAZAC 시퀀스로 Zadoff-Chu 시퀀스가 사용된다고 가정하면 CAZAC 시퀀스  $c(k)$ , 모듈레이션 시퀀스  $m(k)$  및 개선된 CAZAC 시퀀스  $p(k)$ 는 다음의 수식 3, 수식 4 및 수식 5로 각각 정의될 수 있다.

【수학식 3】

<68> CAZAC 시퀀스 :

<69> 
$$c(k;N,M)=\exp\left(\frac{j\pi Mk(k+1)}{N}\right)$$

【수학식 4】

<70> 모듈레이션 시퀀스(modulation sequence) :

<71> 
$$m(k)=\exp\left(\frac{j2\pi\delta}{N}k\right)$$

【수학식 5】

<72> 개선된 CAZAC 시퀀스(또는 개선된 프리앰블) :

<73> 
$$p(k)=c(k)*m(k)=\exp\left(\frac{j\pi M}{N}k(k+1)+\frac{j2\pi\delta}{N}k\right)$$

<74> 개선된 CAZAC 시퀀스  $p(k)$ 는 CAZAC 시퀀스의 자기상관(auto-correlation)과 상호상관(cross-correlation) 특성을 그대로 유지한다. 다음의 수식 6은  $p(k)$ 의 자기상관 특성을 보여주고 있으며 최종 결과가 디랙-델타(Dirac-delta) 함수인 것을 알 수 있다. 특히 모듈레이션 시퀀스  $m(k)$ 가 일정한 위상(phase)을 가지는 시퀀스인 경우 언제나 상기 자기상관 특성이 유지된다는 데에 특징이 있다.

【수학식 6】

$$\begin{aligned}
 ad(d) &= \sum_k \exp\left(\frac{j\pi M}{N} (k+d)(k+d+1) + \frac{j2\pi\delta}{N} (k+d)\right) \\
 &\quad \exp\left(-\frac{j\pi M}{N} k(k+1) - \frac{j2\pi\delta}{N} k\right) \\
 &= \sum_k \exp\left(\frac{j2\pi M}{N} (2dk + d(d+1)) + \frac{j2\pi\delta}{N} d\right) \\
 &= \exp\left(\frac{j2\pi\delta}{N} d\right) \sum_k \exp\left(\frac{j\pi M}{N} (2dk + d(d+1))\right) = \begin{cases} 1 & d=0 \\ 0 & d \neq 0 \end{cases}
 \end{aligned}$$

<75>

<76> 또한, 다음의 수식 7은  $p(k)$ 의 상호상관 특성을 보여주고 있다.



【수학식 7】

$$\begin{aligned}
 cc(d) &= \sum_k \exp\left(\frac{j\pi(M+x)}{N} (k+d)(k+d+1) + \frac{j2\pi\delta}{N} (k+d)\right) \\
 &\quad \exp\left(-\frac{j\pi M}{N} k(k+1) - \frac{j2\pi\delta}{N} k\right) \\
 &= \sum_k \exp\left(\frac{j\pi x}{N} (k+d)(k+d+1)\right) \\
 &\quad \exp\left(\frac{j\pi M}{N} (k+d)(k+d+1) + \frac{j2\pi\delta}{N} (k+d)\right) \\
 &\quad \exp\left(-\frac{j\pi M}{N} k(k+1) - \frac{j2\pi\delta}{N} k\right) \\
 &= \sum_k \exp\left(\frac{j\pi x}{N} (k+d)(k+d+1)\right) \\
 &\quad \exp\left(\frac{j\pi M}{N} (2dk + d(d+1)) + \frac{j2\pi\delta}{N} d\right) \\
 &= \exp\left(\frac{j\pi M}{N} d(d+1)\right) \sum_k \exp\left(\frac{j\pi x}{N} (k+d)(k+d+1)\right) \\
 &\quad \exp\left(\frac{j2\pi d M}{N} k\right)
 \end{aligned}$$

<77>

<78> 여기서 수학식 7은 수학식 6과 유사한 것으로 보이나, 서메이션(summation) 항을 살펴보면 자기상관의 경우 단순한 지수(exponential) 합으로 나타나는 데 비해, 상호상관의 경우에는 두 시퀀스의 곱으로 나타나는 것을 알 수 있다. 그 중에서 첫 번째 항은 시드(seed) 값이 x인 또 다른 CAZAC 시퀀스이고, 두 번째 항은 단순한 지수 함수이다. 이로부터 두 시퀀스의 곱의 합은 지수 함수의 계수를 구하는 것과

같고, 그 값은 시드 값이 x인 CAZAC 시퀀스를 주파수 영역으로 변환하고 그 중에서 지수의 주파수 위치에서 값을 추출하는 것과 동일하다.

<79> CAZAC 시퀀스는 자기상관이 디랙=델타(Dirac-delta) 특성을 가지고 있기 때문에 푸리에 변환을 거치면 변환된 영역에서도 상수 크기(constant amplitude)에 디랙-델타의 자기상관 특성을 유지한다. 이로 인해 주파수 영역에서 특정 위치의 값을 추출하는 경우 그 크기는 1로서 동일하고 위상만이 상이하게 된다. 따라서, 수식 7에 이와 같은 내용을 추가하여 상호상관을 구하면 다음의 도 8과 같이 간략하게 표현할 수 있다.

【수학식 8】

$$\begin{aligned}
 cc(d) &= \exp\left(\frac{j\pi M}{N}d(d+1) + \frac{j2\pi\delta}{N}d\right) \sum_k \exp\left(\frac{j\pi x}{N}(k+d)(k+d+1)\right) \\
 &\quad \exp\left(\frac{j2\pi dM}{N}k\right) \\
 &= \exp\left(\frac{j\pi M}{N}d(d+1) + \frac{j2\pi\delta}{N}d\right) C(dM/N; x)
 \end{aligned}$$

<80>

<81> 여기서, C(dM/N;x)는 크기가 언제나 1이고 지수 텀(exponential)도 크기가 1이기 때문에 상호상관은 항상 1로 고정됨을 알 수 있다.

<82> 결국, 수식 5와 같이 생성된 시퀀스는 종래 CAZAC 시퀀스의 특성을 그대로 유지하면서 코드의 개수가 늘어나는 효과를 가지게 된다. 이는 지수 텀을 곱하는 영역에서의 결과는 푸리에 변환된 영역에서 순환지연(circular shift)을 적용한 것

과 동일하며, 이는 곧 시간 영역에서 지수 시퀀스(exponential sequence)를 곱하는 것이 주파수 영역에서 순환지연을 수행하는 것과 동일함을 의미한다.

<83> 즉, 시드 값이 동일한 두 시퀀스  $p(k;M,N,d1)$ 과  $p(k;M,N,d2)$ 의 상관성(correlation)을 구해보면, 상호상관에 있어서 딜레이  $d$ 가  $d1-d2$ 가 되는 지점에서 임펄스(impulse)가 발생함을 알 수 있다. 이와 같은 개선된 시퀀스의 설계는 CAZAC 시퀀스를 순환지연(circular shift)한 것과 동일한 결과를 가지나, 이를 위해 푸리에 변환 및 순환지연을 적용하고 다시 푸리에 역변환을 수행할 필요 없이 두 개의 지수식(exponential)을 곱하는 간단한 절차만으로 구현할 수 있다는 점에서 본 실시예의 의미가 있다.

<84> 이하에서는 종래의 코드 시퀀스에 소정의 데이터 처리를 가하여 프리앰블의 데이터 전송 신뢰도를 높이는 방법(제2, 3 실시예) 및 데이터가 동시에 전송될 때 코드 시퀀스의 길이 자체를 확장하는 방법(제4, 5 실시예)에 대해 살펴보기로 한다. 여기서, 상기 코드 시퀀스로 CAZAC 시퀀스가 사용되는 경우 제2 내지 제5 실시예에는 제1 실시예에 의해 확장된 CAZAC 시퀀스가 사용되는 것이 바람직하나, 반드시 이에 한하는 것은 아니며 종래의 CAZAC 시퀀스가 그대로 적용될 수도 있다.

<85> 우선, 제2 실시예 내지 제5 실시예에서 공통적으로 적용되는 전송 데이터 즉, 프리앰블의 구조를 살펴보기로 한다.

<86> 3GPP LTE에서 논의되는 통신 시스템에서는 수신측이 전송 데이터를 용이하게 검출할 수 있도록 동일한 시퀀스를 두 번 이상 반복하여 전송한다. 따라서, 수신측에서는 전송받은 시퀀스의 종류에 상관없이 반복 패턴만을 검출하면 되므로 RACH에

접근하는 단말의 시간 위치를 간단하게 알아낼 수 있다.

<87> 또한, 직교주파수분할 전송방식에서는 신호의 전송에 있어서 다중경로 (Multipath)에 대한 보상을 위해 OFDM 심볼의 마지막 부분을 복제하여 OFDM 심볼의 앞에 붙이는 CP(Cyclic prefix)를 사용한다. 따라서, 상기 OFDM 심볼이 반복되는 두 개의 프리앰블로 이루어지는 경우 후위에 있는 프리앰블의 일부를 심볼의 맨 처음 부분에 CP로 복제함으로써 해당 프리앰블에 대하여 다중경로의 보상이 이루어지도록 할 수 있다. 이와 같은 프리앰블의 구조를 도 9에서 확인할 수 있다.

<88> 여기서, 시퀀스를 반복 전송하지 아니하고 단일 시퀀스에 CP를 첨부하여 전송하더라도 심벌간 간섭(Inter-Symbol Interference)은 발생하지 않으므로 주파수 영역에서 소정의 수신 알고리즘을 구현하는 데에는 지장이 없다. 그러나, 반복 전송도 하지 아니하고 CP마저 첨부하지 않는 채 수신측에서 시간 영역에서 수신 알고리즘을 구현하는 경우, RACH에 접근하는 단말을 구별하기 위해서는 모든 종류의 코드 시퀀스를 검색해야 하는 부담이 있으므로 본 발명의 프리앰블은 되도록 반복 패턴의 구조로 구현되는 것이 바람직하다.

<89> 아래의 제2 내지 제5 실시예는 도 9의 프리앰블 구조를 이루는 반복 시퀀스 하나에 대한 데이터 처리 방법을 논의하고 있다. 이들 실시예에서 수신측에 전송하는 데이터는 상기 도 9의 프리앰블 구조가 될 수도 있고 일부가 생략되는(반복 전송을 하지 않거나, CP가 첨부되지 않은) 구조가 될 수도 있다. 또한, 데이터 전송에 이용되는 코드 시퀀스로서 CAZAC 시퀀스를 가정하였으나 반드시 이에 한하는 것은 아니며, 이진 하다마드 코드, 골드 코드 등과 같이 전송 특성이 우수한 시퀀스

라면 어느 것이든지 상기 코드 시퀀스로 사용될 수 있다.

<90> <제2 실시예>

<91> 일반적으로 데이터를 전송하기 위해서는 데이터를 구성하는 전송 신호에 식별 가능한 표식을 남겨야 하는데, 본 실시예에서는 그러한 표식으로 켈레화 (conjugation)을 이용한다. 켈레화된 전송 신호와 다른 전송 신호는 서로간에 위상의 변화폭이 매우 크므로 전송 신호간 간섭의 영향이 덜하여 채널의 영향에도 불구하고 데이터 전송의 신뢰성을 높일 수 있다. 상기 켈레화를 도 10을 참고로 설명하면 다음과 같다.

<92> 도면에서 보듯, 전송할 데이터를 전송 신호의 종류에 따라 소정 개수(이때면 4개)의 블록으로 구분하는 경우, 1의 값을 가지는 블록에 대해 해당 CAZAC 시퀀스를 켈레화하여 전송하고 나머지 0의 값을 가지는 블록은 그대로 전송한다. 이때, 상기 CAZAC 시퀀스에서 켈레화되는 부분은 전송 데이터의 길이에 상응하는 긴 길이의 단일 CAZAC 시퀀스 중에서 1의 값을 가지는 특정 블록에 해당하는 일부가 켈레화될 수도 있고, 전송 데이터의 각 블록 길이에 상응하는 짧은 길이의 다수의 CAZAC 시퀀스 중에서 1의 값을 가지는 특정 블록에 해당하는 CAZAC 시퀀스가 켈레화될 수도 있다.

<93> 한편, 수신측에서는 전송받은 전체 시퀀스에 켈레화된 부분이 없도록 변환하여 원본 데이터를 복호화한다. 구체적인 수신 과정을 도 11을 참고로 설명하면 다음과 같다.

<94> 송신측에서는 전송 데이터의 1번 블록에 대하여 차후 레퍼런스로 이용될 수

이것이 그물화된 시퀀스를 이용하여 데이터 전송하는 과정은 도 12를 참고로 설명  
 문에 상기 제2 실시예에 비해 노이즈나 채널의 영향을 덜 받는 특징이 있다. 이와  
 에 대해 동일한 시퀀스 ID(제1 시퀀스의 ID 또는 제2 시퀀스의 ID)를 검색하기 때  
 1 시퀀스와 제2 시퀀스를 묶어 그물으로 취급한다. 이 경우, 수신측에서는 각 물  
 스(제1 시퀀스) 및 물들 값 '1'을 위한 시퀀스(제2 시퀀스) 두 가지로 구분하고, 제  
 시예에서는 하나의 물들을 표시하기 위한 시퀀스의 종류를 물들 값 '0'에 대한 시퀀  
 제2 실시예에서는 시퀀스 자체에 변형은 가하여 데이터를 전송하지만, 물들

<96>

<제3 실시예>

<95>

물들에까지 부호화를 수행하면 최종적인 원본 데이터가 복호화된다.  
 크를 측정하여 두 피크 중 큰 쪽을 채택한다(S1110). 이와 같은 방식으로 마지막  
 화가 수행된 경우(S1108) 및 클레화가 수행되지 않은 경우(S1109)에 대해 각각 피  
 역시 3면 물들의 시퀀스가 클레화된 상태인지 물명하므로 해당 물들에 대해 클레  
 후(S1107), 1면 물들 내지 3면 물들을 함께 사용하여 피크를 측정하는데, 이 경우  
 쪽을 채택한다(S1106). 다음으로, 1면 내지 3면 물들에 대한 시퀀스 ID를 파악한  
 클레화가 수행되지 않은 경우(S1105) 각각에 대해 피크를 측정하여 두 피크 중 큰  
 클레화된 상태인지 물명하므로 해당 물들에 대해 클레화가 수행된 경우(S1104) 및  
 물들과 2면 물들을 함께 사용하여 피크를 측정하는데, 이때 2면 물들의 시퀀스가  
 (S1102). 다음으로, 1면 및 2면 물들에 대한 시퀀스 ID를 파악한 후(S1103), 1면  
 시퀀스 ID를 파악한 후(S1101), 해당 물들만을 가지고 피크(peak)를 측정한다  
 있도록 항상 0의 값을 할당한다. 따라서, 수신측에서는 수신된 1면 물들에 대하여

하면 다음과 같다.

<97> 즉, 모든 시퀀스는 두 개의 서브 시퀀스(제1 시퀀스 및 제2 시퀀스)를 묶어서 하나의 그룹 " $\{c_0(k;M_i), c_1(k;M_j)\}$ "으로 표시된다( $i$ 와  $j$ 는 서로 다른 정수). 여기서,  $c_0(k;M_i)$ 는 블록값(또는 비트값) 0을 위한 제1 시퀀스이며,  $c_1(k;M_j)$ 는 블록값 1을 위한 제2 시퀀스이다. 이때, 상기 그룹을 이루는 각 서브 시퀀스는 전송 데이터의 길이에 상응하는 긴 길이의 CAZAC 시퀀스가 사용될 수도 있고, 전송 데이터의 각 블록 길이에 상응하는 짧은 길이의 CAZAC 시퀀스가 사용될 수도 있다.

<98> 한편, 수신측에서는 각 블록의 시퀀스 ID를 파악하고, 파악된 시퀀스 ID들로 이루어진 시퀀스 ID 세트로부터 각 블록에 대한 시퀀스의 종류(제1 시퀀스인지 제2 시퀀스인지)를 파악한다. 이때, 상기 각 블록에 대한 시퀀스의 종류를 그룹 ID로 표현할 수 있다. 즉, 본 실시예에서는 각 블록의 코드값으로 0, 1을 표현할 수 있다고 가정하였으므로 각 블록에 대한 시퀀스의 종류 또는 그룹 ID의 종류는 2가지가 된다. 그룹 ID를 통해 각 블록의 코드값을 복원해 낼 수 있다. 이와 같은 복호화 과정을 도 13을 참고로 상세하게 설명하면 다음과 같다.

<99> 수신측에서는 시퀀스가 수신되면 해당 시퀀스를 구성하는 각 블록들의 시퀀스 ID를 파악하고(S1301), 이렇게 파악된 시퀀스 ID들로 구성되는 시퀀스 ID 세트에 대해 피크(peak)를 측정한다(S1302). 여기서, 발생 빈도가 높은 두 피크를 선택하여(S1303) 해당 피크를 발생시키는 시퀀스를 각각 상기 그룹을 구성하는 제1 시퀀스 및 제2 시퀀스로 파악한다. 이때, 제1 시퀀스 및 제2 시퀀스를 각각 소정의

그룹 ID로 표현하면, 코드값 0을 가리키는 제1 그룹 ID와 코드값 1을 가리키는 제2 그룹 ID로 구분할 수 있다. 결국, 상기 S1303 단계를 통해 각 블록의 그룹 ID를 파악할 수 있고(S1304), 이를 통해 각 블록의 코드값을 찾아낼 수 있게 된다(S1308).

<100>            만약, 복호화 과정에서 오류가 발생하여 그룹 ID를 파악할 수 없는 시퀀스 ID들이 존재하는 경우, 해당 시퀀스 ID들의 세트에 대하여만 다시 피크를 탐색하고(S1305) 그 중 유력한 두 피크를 검색하여(S1306) 그로부터 그룹 ID를 다시 파악한다(S1307). 이어서, 파악된 그룹 ID들로 부터 해당 블록의 코드값을 찾아낼 수 있다(S1308).

<101>            <제4 실시예>

<102>            제3 실시예를 좀 더 확장하면 하나의 그룹을 통해 전달할 수 있는 데이터의 총비트수를 증가시킬 수 있다. 예를 들어 제3 실시예에서와 같이 2개의 시퀀스를 하나의 그룹으로 정하는 경우 블록당 1비트의 데이터를 전송할 수 있고, 4개의 시퀀스를 하나의 그룹으로 정하는 경우 블록당 2비트의 데이터를 전송할 수 있으며, 8개의 시퀀스를 하나의 그룹으로 정하는 경우라면 블록당 3비트의 데이터를 전송할 수 있다. 다만, 다수의 시퀀스를 그룹 지어서 하나의 세트로 정의하기 때문에 각 시퀀스의 길이가 짧다면 그에 비례하여 선택 가능한 그룹의 수도 줄어들게 되는 문제점이 있다.

<103>            따라서, 선택 가능한 그룹을 늘리기 위해 시퀀스의 길이를 확장시킬 필요성이 있으며 이를 위해 본 실시예에서는 각 블록에 대한 시퀀스의 길이를 확장시키되 각 시퀀스들을 다중으로 중첩시켜 전송하고, 또한 중첩되는 각각의 시퀀스 사이에



전송 딜레이를 두어 독립성이 유지되도록 한다. 이와 같은 딜레이 전송 방식을 도 14를 참조하여 설명하면 다음과 같다.

<104> 도 14에서는 각 블록에 2비트의 데이터값이 주어지는 경우를 특히 예시하고 있다. 따라서, 각 블록에 대한 시퀀스 그룹은 서로 다른 4개의 CAZAC 시퀀스로 구성된다. 여기서 상기 시퀀스 그룹을 구성하는 각 CAZAC 시퀀스는 4가지 경우의 값을 구별시켜야 하므로 그에 따라 그룹 크기도 커져야 하지만, 그 경우 각 기지국이 사용할 수 있는 그룹의 개수가 줄어드는 문제가 발생한다. 따라서, 도 14에서 보듯이 각 CAZAC 시퀀스의 길이를 필요한 만큼 확장시키되, 데이터 전송시에 각각의 CAZAC 시퀀스에 소정의 딜레이를 가하여 전송함으로써 각 CAZAC 시퀀스 간에 독립성을 유지시킨다.

<105> 한편, 수신측에서는 각 CAZAC 시퀀스가 시간/주파수 영역에서 나타나는 순서에 근거하여 해당 블록의 ID를 파악하며, 해당 블록 ID로부터 코드값을 복호해 내는 방법은 제3 실시예와 대동소이하다. 이하, 도 15를 참고로 수신측에서의 데이터 복호화 과정을 상세히 설명하기로 한다.

<106> 수신측에서는 시퀀스가 수신되면 해당 시퀀스를 구성하는 각 블록들의 시퀀스 ID를 파악하고(S1501), 이렇게 파악된 시퀀스 ID들로 구성되는 시퀀스 ID 세트에 대해 피크(peak)를 측정한다(S1502). 본 실시예에서는 하나의 블록이 표현하는 비트수가 2개이므로 00,01,10,11를 표현하기 위한 제1 시퀀스, 제2 시퀀스, 제3 시퀀스, 제4 시퀀스가 하나의 그룹을 형성하므로, 상기 측정 결과 발생 빈도가 높은 4개의 피크를 선택하여야 한다(S1503). 여기서, 선택된 각 피크들은 시간/주파수

영역에서 나타나는 순서에 따라 각각 제1 시퀀스, 제2 시퀀스, 제3 시퀀스, 제4 시퀀스로 매핑된다. 또한, 제1 시퀀스 내지 제4 시퀀스를 각각 소정의 그룹 ID로 표현하면, 코드값 00을 가리키는 제1 그룹 ID, 코드값 01을 가리키는 제2 그룹 ID, 코드값 10을 가리키는 제3 그룹 ID, 코드값 11을 가리키는 제4 그룹 ID로 구분할 수 있다. 결국, 상기 S1503 단계를 통해 각 블록의 그룹 ID를 파악할 수 있고 (S154), 이를 통해 각 블록의 코드값을 찾아낼 수 있게 된다(S1508).

<107> 만약, 복호화 과정에서 오류가 발생하여 그룹 ID를 파악할 수 없는 시퀀스 ID들이 존재하는 경우, 해당 시퀀스 ID들의 세트에 대하여만 다시 피크를 탐색하고 (S1505) 그 중 유력한 4개의 피크를 검색하여(S1506) 그로부터 그룹 ID를 다시 파악한다(S1507). 이어서, 파악된 그룹 ID들로 부터 해당 블록의 코드값을 찾아낼 수 있다(S1508).

<108> <제5 실시예>

<109> 제3 실시예 및 제4 실시예를 한층 더 확장하면 PPM(Pulse Position Modulation)을 통해 신호의 위치를 변화시킴으로써 시퀀스의 길이를 논리적으로 확장할 수 있다. 본래 PPM은 상대적인 펄스의 지연을 가지면서 데이터를 전송하는 기법이지만 시퀀스의 시작 위치를 기반으로 PPM을 적용한다. 본 실시예를 도 16을 참고하여 설명하면 다음과 같다.

<110> 기지국은 전송될 데이터의 비트수가 결정되면, 해당 데이터의 전송에 사용할 시퀀스를 선택하고 해당 시퀀스에 PPM을 적용하기 위한 블록의 길이 및 각 블록을 구성하는 구간의 길이를 결정한다. 원칙적으로 프리앰블을 생성할 때는 각 블록에

해당하는 시퀀스를 각각 별도로 생성해야 하지만, 본 실시예에서는 동일한 시퀀스에 대하여 해당 시퀀스를 구성하는 특정 블록 내의 특정 구간까지의 길이만큼 순환지연(circular shift)이 적용되므로, 각 시퀀스는 본래 동일한 것임에도 불구하고 상기 순환지연에 의해 서로 구분된다는 점에 특징이 있다.

<111> 예를 들어, 하나의 시퀀스를 4개의 블록(블록1~블록4)으로 구분하고 각 블록 별로 2bit를 표현한다고 가정하면 "00, 01, 10, 11"의 값을 표현하기 위해 각 블록은 다시 4개의 구간(구간1~구간4)으로 나누어져야 한다. 이때, 하나의 블록에 포함된 4개의 구간은 해당 블록에 상응하는 시퀀스에 대한 순환지연의 시작 구분 위치로 이용된다. 만약, 전송할 프리앰블의 총 길이가 256 이라 하면, 블록1은 0~63, 블록2는 64~127, 블록3은 128~195, 블록4는 196~255까지의 순환지연 값을 가질 수 있다. 상기 프리앰블의 전송에 사용할 특정 시퀀스가 결정되고 블록1을 통해 "0 0"을 전송하는 경우 블록1의 구간1(0~15)에 시작 위치가 오도록 시퀀스1을 순환지연시키고, 블록2에 "1 0"을 전송하는 경우 블록2의 구간3(96~111)에 시작 위치가 오도록 시퀀스2를 순환지연시킨다. 이런 식으로 나머지 블록에 대해서도 순환지연을 적용한 후 각 시퀀스(시퀀스1~시퀀스4)를 하나로 취합하여 하나의 프리앰블을 생성한다.

<112> 한편, 수신측에서는 전송받은 시퀀스를 데이터 처리하여 해당 시퀀스를 구성하는 각각의 서브 시퀀스(시퀀스1~시퀀스4)를 구분해내고 구분된 각 시퀀스에 대한 시작 위치를 찾아냄으로써 데이터를 복호화한다. 이를 도 17을 참고로 상세히 설명하면 다음과 같다.

<113> 수신측에 시퀀스가 수신되면(S1701) 해당 시퀀스의 ID를 검출하고(S1703), 검출된 결과를 이용하여 수신 신호(수신된 시퀀스) 전체에 대해 소정의 데이터 처리로 코릴레이션(correlation)을 수행한다(full correlation)(S1705). 이때, 상기 시퀀스 ID의 검출을 위해 전체 검색(full search) 알고리즘 또는 차이값 검색(differential search) 알고리즘이 사용될 수 있다.

<114> 수신된 신호는 송신측에서 다수의 시퀀스를 취합한 것이기 때문에 상기 코릴레이션(correlation) 과정을 거친 신호는 다수의 피크를 포함한다. 본 실시예에서는 4개의 피크가 검출되는데, 이와 같이 검출된 각 피크에 대하여 블록1~블록4 중 어떤 블록에 해당하는지, 그리고 해당 블록의 어떤 구간에 해당하는지를 판독함으로써(S1709) 원본 데이터의 비트 순서와 비트값을 복호화할 수 있다(S1711).

<115> 이상, RACH를 통해 프리앰블 시퀀스와 메시지를 효과적으로 전송하는 방법에 대해 살펴보았다. 마지막으로, 사용자 단말(User Equipment, UE)이 기지국(Node-B)에 프리앰블을 전송하여 양자 간에 동기화를 수행하는 과정을 두 가지 실시예로 구분하여 살펴보기로 한다. 이와 같은 두 가지 실시예에서 기지국으로 전송되는 프리앰블은 상기에서 설명한 제2 실시예 내지 제5 실시예 중 어느 하나의 방법을 통해 전송될 수 있으며, 여기에 제1 실시예가 선택적으로 더 적용될 수 있다.

<116> 첫 번째는 사용자 단말이 기지국에 한 번의 접근으로 동기화되는 방식이다. 즉, 사용자 단말이 기지국으로 프리앰블과 동기화에 필요한 정보를 포함하는 메시지를 전송하면(S1801), 기지국은 사용자 단말로 타이밍 정보를 전송함(S1803)과 동시에 업링크 데이터 전송을 위한 자원을 할당하고(S1805), 사용자 단말은 할당된

자원을 통해 업링크 데이터를 기지국에 전송한다(S1807).

<117> 두 번째는 동기화를 위해 사용자 단말이 기지국에 두 번 접근하는 방식이다. 즉, 사용자 단말이 기지국으로 프리앰블을 전송하면(S1811), 그에 따라 기지국은 사용자 단말로 타이밍 정보를 전송함과 동시에 스케줄링 요청을 위한 자원을 할당한다(S1813). 사용자 단말은 상기 할당받은 자원을 통해 기지국에 스케줄링 요청을 위한 메시지를 전송하고(S1815), 이를 접수한 기지국은 다시 사용자 단말에 업링크 데이터 전송을 위한 자원을 할당한다(S1817). 이와 같이 두 번째로 할당된 자원을 통해 사용자 단말은 기지국으로 업링크 데이터를 전송한다(S1819).

<118> 이상에서 설명한 본 발명은, 본 발명이 속하는 기술분야에서 통상의 지식을 가진 자에 있어 본 발명의 기술적 사상을 벗어나지 않는 범위 내에서 여러 가지 치환, 변형 및 변경이 가능하므로 전술한 실시예 및 첨부된 도면에 의해 한정되는 것이 아니다.

#### 【발명의 효과】

<119> 본 발명에 의하면, 랜덤 액세스 채널에서 코드 시퀀스의 종래 장점을 그대로 유지하면서 해당 시퀀스의 전체 길이를 모두 활용할 수 있으므로 데이터 전송을 보다 효율적으로 수행할 수 있다. 또한, 코드 시퀀스에 소정의 데이터 처리를 가함으로써 전송할 정보량을 증대시키는 한편 노이즈나 채널에 강해지도록 할 수 있다.

**【특허청구범위】**

**【청구항 1】**

코드 시퀀스를 확장하여 데이터를 전송하는 방법에 있어서,  
데이터 전송에 사용 가능한 코드 수가 추가되도록 상기 코드 시퀀스를 데이터 처리하는 단계; 및  
상기 데이터 처리된 코드 시퀀스로 데이터를 수신측에 전송하는 단계를 포함하는 랜덤 액세스 채널을 통한 데이터 송신 방법.

**【청구항 2】**

제1항에 있어서,  
상기 코드 시퀀스는 CAZAC(Constant Amplitude Zero Autocorrelation) 시퀀스인 것을 특징으로 하는 랜덤 액세스 채널을 통한 데이터 송신 방법.

**【청구항 3】**

제2항에 있어서,  
상기 데이터 처리는 상기 CAZAC 시퀀스에 소정의 지수(exponential) 시퀀스를 곱함으로써 수행되는 것을 특징으로 하는 랜덤 액세스 채널을 통한 데이터 송신 방법.

**【청구항 4】**

제3항에 있어서,  
상기 데이터 처리는 해당 코드 시퀀스가 자기상관성(auto-correlation) 및

상호상관성(cross-correlation)을 그대로 유지하도록 수행되는 것을 특징으로 하는 랜덤 액세스 채널을 통한 데이터 송신 방법.

**【청구항 5】**

제1항 내지 제4항 중 어느 한 항에 있어서,

상기 코드 시퀀스는 프리앰블(preamble)로 이용되는 것을 특징으로 하는 랜덤 액세스 채널을 통한 데이터 송신 방법.

**【청구항 6】**

데이터 전송을 위한 코드 시퀀스를 확장하는 방법에 있어서,

상기 데이터를 구성하는 각 블록의 비트값에 따라 해당 블록에 상응하는 코드 시퀀스에 소정의 데이터 처리를 수행하는 단계; 및

상기 데이터 처리된 코드 시퀀스를 수신측에 전송하는 단계

를 포함하는 랜덤 액세스 채널을 통한 데이터 송신 방법.

**【청구항 7】**

제6항에 있어서,

상기 코드 시퀀스로 CAZAC(Constant Amplitude Zero Autocorrelation) 시퀀스가 이용되는 것을 특징으로 하는 랜덤 액세스 채널을 통한 데이터 송신 방법.

**【청구항 8】**

제7항에 있어서, 상기 코드 시퀀스의 데이터 처리는

상기 데이터를 구성하는 특정 블록의 비트값이 1인 경우, 해당 블록에 상응

하는 CAZAC 시퀀스를 켄레화(conjugation)하는 것임을 특징으로 하는 랜덤 액세스 채널을 통한 데이터 송신 방법.

**【청구항 9】**

제8항에 있어서,

긴 길이의 단일 CAZAC 시퀀스에 있어서 비트값이 1인 블록에 상응하는 일부 분이 켄레화(conjugation)되는 것임을 특징으로 하는 랜덤 액세스 채널을 통한 데이터 송신 방법.

**【청구항 10】**

제8항에 있어서,

짧은 길이의 다수의 CAZAC 시퀀스 중에서 비트값이 1인 블록에 상응하는 특정 CAZAC 시퀀스가 켄레화(conjugation)되는 것임을 특징으로 하는 랜덤 액세스 채널을 통한 데이터 송신 방법.

**【청구항 11】**

전송 데이터를 구성하는 각 블록의 비트값에 따라 켄레화(conjugation)가 수행되어 전송된 코드 시퀀스를 복호화하는 방법에 있어서,

수신된 데이터에 있어서, 첫 번째 블록에 대한 초기 피크(peak)를 추정하는 제1단계;

피크 추정이 수행된 블록과 다음 순번의 블록에 대해 피크(peak)를 추정하는 제2단계;



마지막 순번의 블록에 이르기까지 상기 제2단계를 반복하는 제3단계  
를 포함하는 랜덤 액세스 채널을 통한 데이터 수신 방법.

**【청구항 12】**

제11항에 있어서,

상기 첫 번째 블록은 항상 0으로 설정되어 수신되는 것을 특징으로 하는 랜  
덤 액세스 채널을 통한 데이터 수신 방법.

**【청구항 13】**

제12항에 있어서, 상기 제2단계는

피크 추정이 수행된 블록과 다음 순번의 블록에 대해 켈레화(conjugation)되  
었음을 전제로 제1피크(peak)를 추정하는 제2-1단계;

동일한 블록들에 대해 켈레화(conjugation)가 되지 않았음을 전제로 제2피크  
(peak)를 추정하는 제2-2단계; 및

상기 제1피크와 제2피크 중 큰 쪽을 해당 블록들의 피크로 결정하는 제2-3단  
계를 포함하는 랜덤 액세스 채널을 통한 데이터 수신 방법.

**【청구항 14】**

데이터 전송을 위한 코드 시퀀스를 확장하는 방법에 있어서,

상기 데이터를 구성하는 각 블록의 값에 따라 특정 시퀀스가 선택되는 단계;

및

상기 선택된 시퀀스들로 이루어진 코드 시퀀스를 수신측에 전송하는 단계

를 포함하는 랜덤 액세스 채널을 통한 데이터 송신 방법.

**【청구항 15】**

제14항에 있어서,

상기 코드 시퀀스로 CAZAC(Constant Amplitude Zero Autocorrelation) 시퀀스가 이용되는 것을 특징으로 하는 랜덤 액세스 채널을 통한 데이터 송신 방법.

**【청구항 16】**

제15항에 있어서,

상기 코드 시퀀스는 상기 데이터를 구성하는 각 블록의 비트수  $n(n=1, 2, 3, \dots)$ 에 따라  $2^n$ 개의 서로 다른 시퀀스를 포함하는 그룹으로 이루어지며,

상기 특정 시퀀스의 선택은 각 블록의 비트값에 상응하는 특정 시퀀스를 상기 그룹에서 선택하는 것임을 특징으로 하는 랜덤 액세스 채널을 통한 데이터 송신 방법.

**【청구항 17】**

제16항에 있어서,

상기 선택된 각 시퀀스가 서로 독립성을 유지하면서 중첩되도록 데이터 처리를 수행하는 단계를 더 포함하는 랜덤 액세스 채널을 통한 데이터 송신 방법.

**【청구항 18】**

제17항에 있어서,

상기 선택된 각 시퀀스는 소정 간격의 딜레이를 두고 순차적으로 중첩되도록

데이터 처리되는 것을 특징으로 하는 랜덤 액세스 채널을 통한 데이터 송신 방법.

**【청구항 19】**

제16항 또는 제17항에 있어서,

상기 그룹에 포함되는 시퀀스는 전체 블록 길이의 단일 CAZAC 시퀀스가 사용되는 것을 특징으로 하는 랜덤 액세스 채널을 통한 데이터 송신 방법.

**【청구항 20】**

제16항 또는 제17항에 있어서,

상기 그룹에 포함되는 시퀀스는 단일 블록 길이의 짧은 CAZAC 시퀀스가 사용되는 것을 특징으로 하는 랜덤 액세스 채널을 통한 데이터 송신 방법.

**【청구항 21】**

그룹화된 시퀀스 중 특정 시퀀스의 선택을 통해 확장되는 코드 시퀀스를 이용하여 전송된 데이터를 복호화하는 방법에 있어서,

수신된 데이터의 블록별 시퀀스 ID(sequence ID)를 파악하는 단계;

상기 파악된 코드 시퀀스 ID들의 세트로부터 각 블록의 그룹 ID(group ID)를 파악하는 단계; 및

상기 파악된 그룹 ID로부터 데이터값을 복호화하는 단계

를 포함하는 랜덤 액세스 채널을 통한 데이터 수신 방법.

**【청구항 22】**

제21항에 있어서, 상기 그룹 ID 파악 단계는

상기 파악된 코드 시퀀스 ID들의 세트로부터 피크(peak)를 측정하는 단계;  
및

상기 측정된 피크 중 발생 빈도가 높은 2개의 피크로부터 각 블록의 그룹 ID  
를 파악하는 단계

를 포함하는 랜덤 액세스 채널을 통한 데이터 수신 방법.

**【청구항 23】**

제22항에 있어서,

그룹 ID가 파악되지 않은 코드 시퀀스 ID들의 세트에 대하여 상기 피크 추정  
단계를 반복함으로써 그룹 ID를 재파악하는 단계를 더 포함하는 랜덤 액세스 채널  
을 통한 데이터 수신 방법.

**【청구항 24】**

제21항에 있어서, 상기 그룹 ID 파악 단계는

각 코드 시퀀스 ID들의 세트에 대하여 피크(peak)를 측정하는 단계; 및

상기 측정된 피크 중 발생 빈도가 높은  $2^n$  ( $n=1,2,3,\dots$ )개의 피크로부터 각  
블록의 그룹 ID를 파악하는 단계

를 포함하는 랜덤 액세스 채널을 통한 데이터 수신 방법.

**【청구항 25】**

제24항에 있어서,

그룹 ID가 파악되지 않은 코드 시퀀스 ID들의 세트에 대하여 상기 피크 추정

단계를 반복함으로써 그룹 ID를 재파악하는 단계를 더 포함하는 랜덤 액세스 채널을 통한 데이터 수신 방법.

**【청구항 26】**

데이터 전송을 위한 코드 시퀀스를 확장하는 방법에 있어서,

상기 데이터를 구성하는 각 블록에 상응하는 시퀀스들이 해당 블록의 값을 표시하도록 각각의 시퀀스를 데이터 처리하는 단계; 및

상기 데이터 처리된 각 시퀀스를 중첩하여 수신측으로 전송하는 단계

를 포함하는 랜덤 액세스 채널을 통한 데이터 송신 방법.

**【청구항 27】**

제26항에 있어서,

상기 코드 시퀀스로 CAZAC(Constant Amplitude Zero Autocorrelation) 시퀀스가 이용되는 것을 특징으로 하는 랜덤 액세스 채널을 통한 데이터 송신 방법.

**【청구항 28】**

제27항에 있어서,

상기 전송 데이터를 구성하는 각 블록은 해당 블록의 비트수  $n(n=1, 2, 3, \dots)$ 에 따라  $2^n$ 개의 구간으로 구분되고,

상기 데이터 처리는 특정 블록의 특정 구간이 시작점이 되도록 해당 블록에 상응하는 시퀀스를 변조(modulation)하는 것임을 특징으로 하는

**【청구항 29】**

제28항에 있어서,

상기 변조 방법으로 PPM(Pulse Position Modulation)이 이용되는 것을 특징으로 하는 랜덤 액세스 채널을 통한 데이터 송신 방법.

**【청구항 30】**

전송 데이터를 구성하는 블록에 대한 시퀀스 각각에 대해 PPM을 수행하여 중첩시킨 데이터를 수신하고 이를 복호화하는 방법에 있어서,

수신된 데이터에 대한 시퀀스 ID를 검출하는 단계;

상기 검출된 시퀀스 ID에 해당하는 미리 준비된 시퀀스를 이용하여 수신 데이터를 코렐레이션(correlation) 하는 단계;

상기 코렐레이션된 데이터로부터 해당 데이터를 구성하는 블록 개수만큼의 피크(peak)를 측정하는 단계; 및

상기 측정된 피크를 이용하여 각 블록에 대한 데이터값을 복호화하는 단계

를 포함하는 랜덤 액세스 채널을 통한 데이터 수신 방법.

**【청구항 31】**

제30항에 있어서,

상기 시퀀스로 CAZAC(Constant Amplitude Zero Autocorrelation) 시퀀스가 이용되는 것을 특징으로 하는 랜덤 액세스 채널을 통한 데이터 송신 방법.

【청구항 32】

제30항 또는 제31항에 있어서, 상기 데이터값 복호화 단계는

측정된 각 피크가 어떤 블록의 어떤 구간에 속하는지를 판독함으로써 데이터 비트의 순서와 데이터 비트의 내용을 복호화하는 것을 특징으로 하는 랜덤 액세스 채널을 통한 데이터 송신 방법.

【도면】

【도 1】

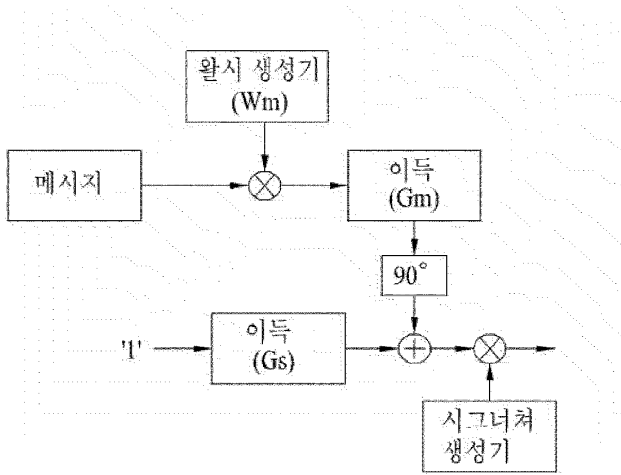



【도 2】

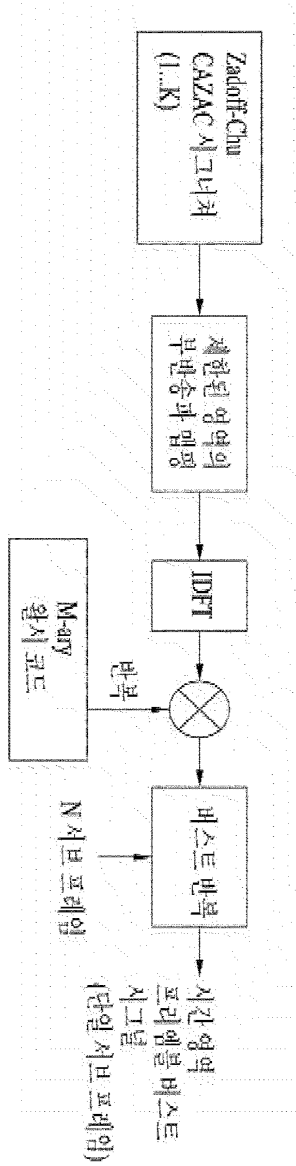

【도 3a】

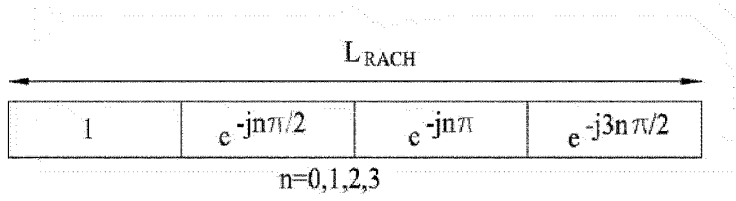

【도 3b】

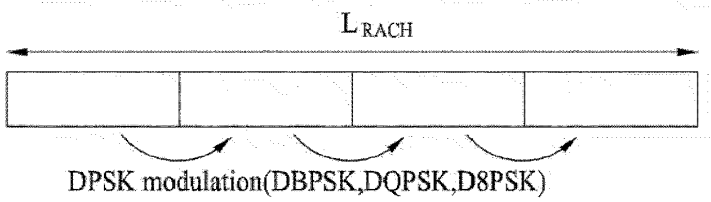

【도 4a】

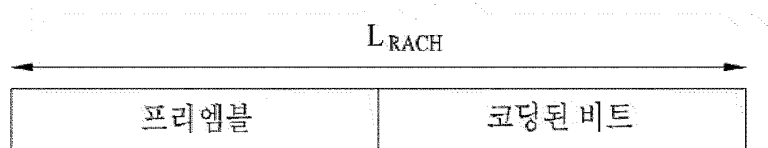

【도 4b】

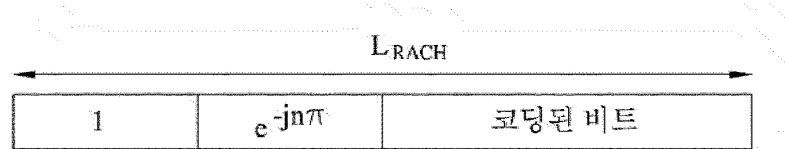

【도 5】

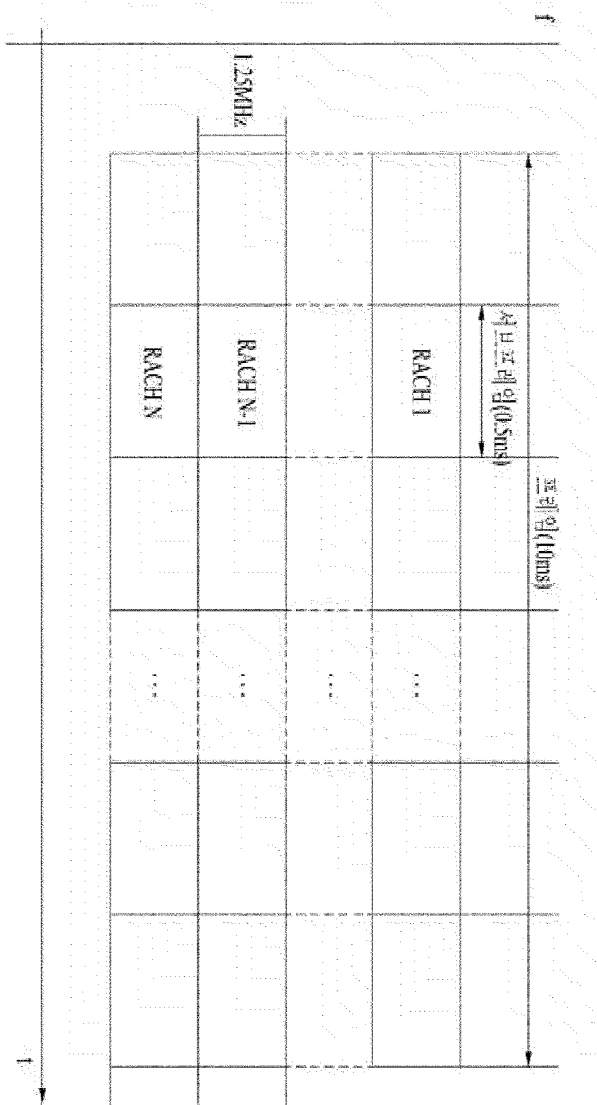

【도 6a】

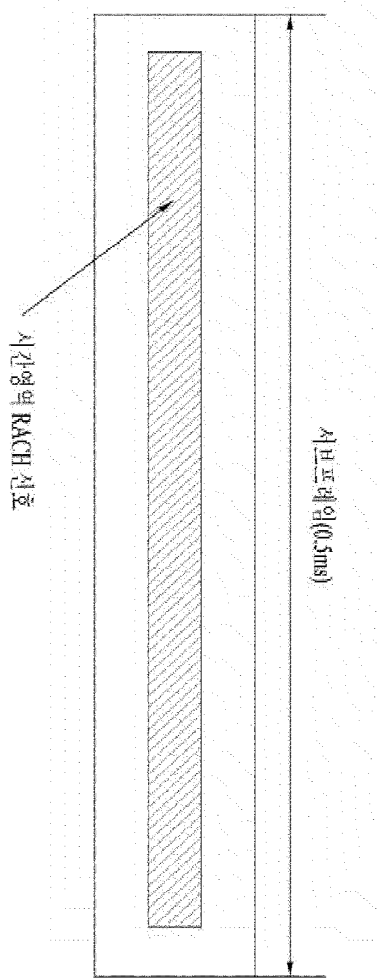

【도 6b】

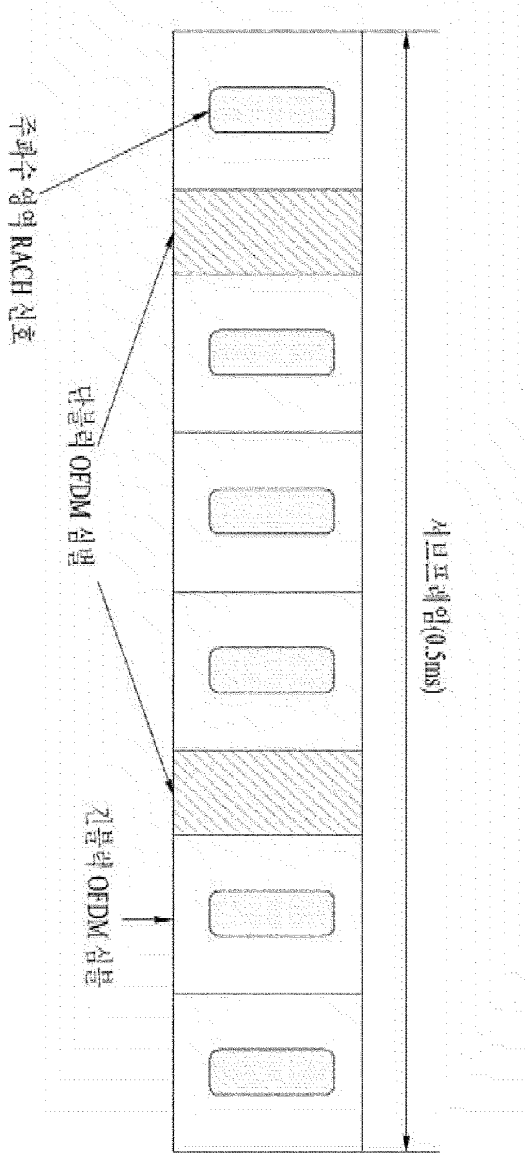

【도 7】

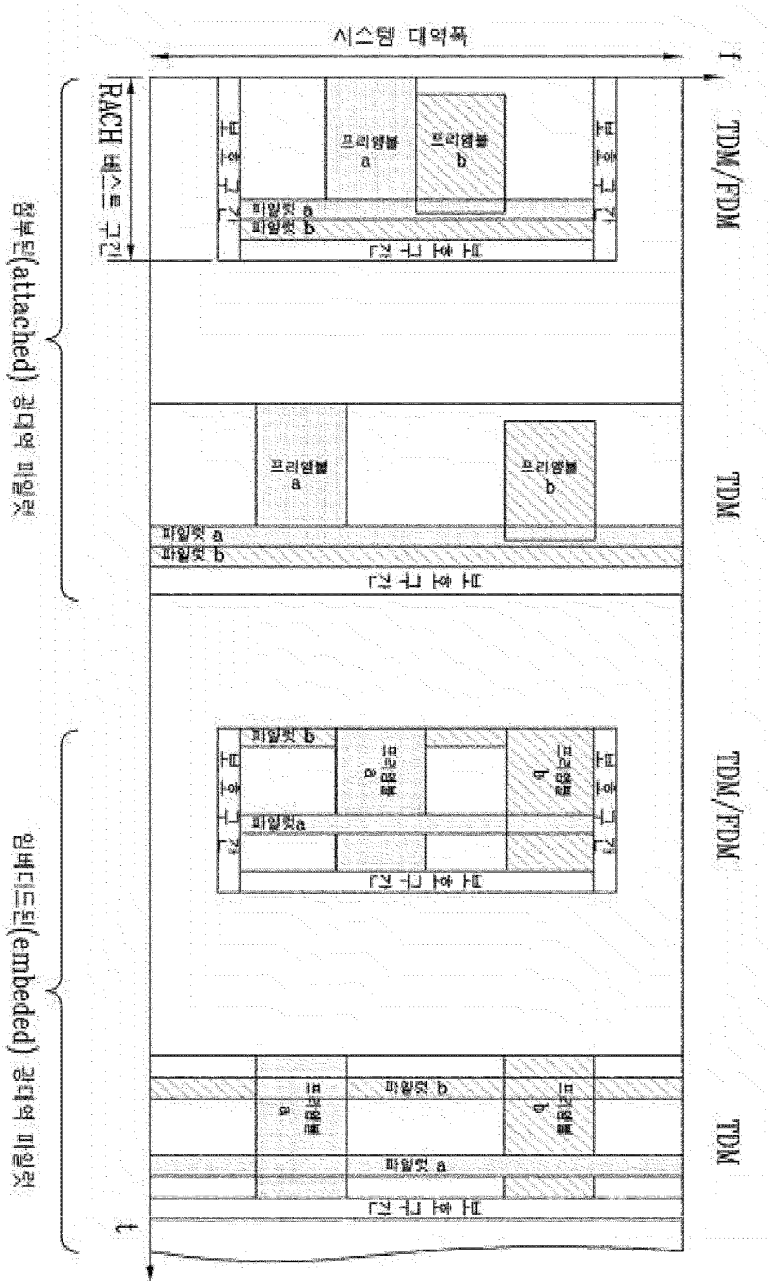

【图 8a】

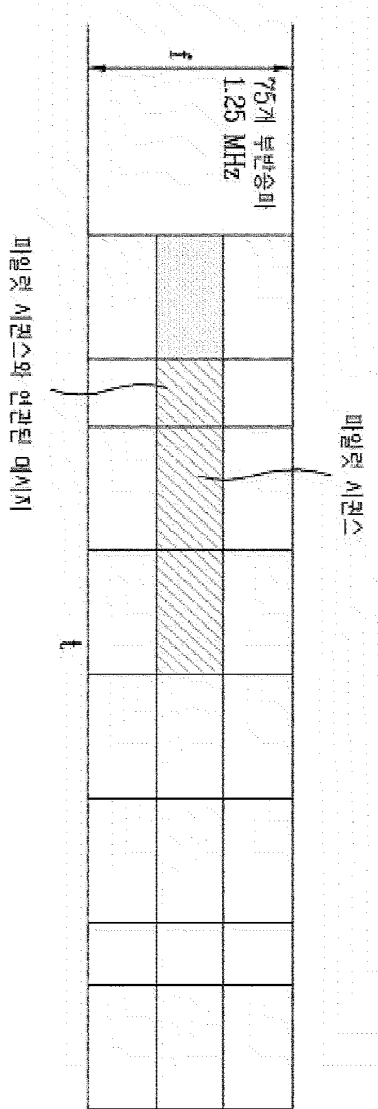

【도 8b】

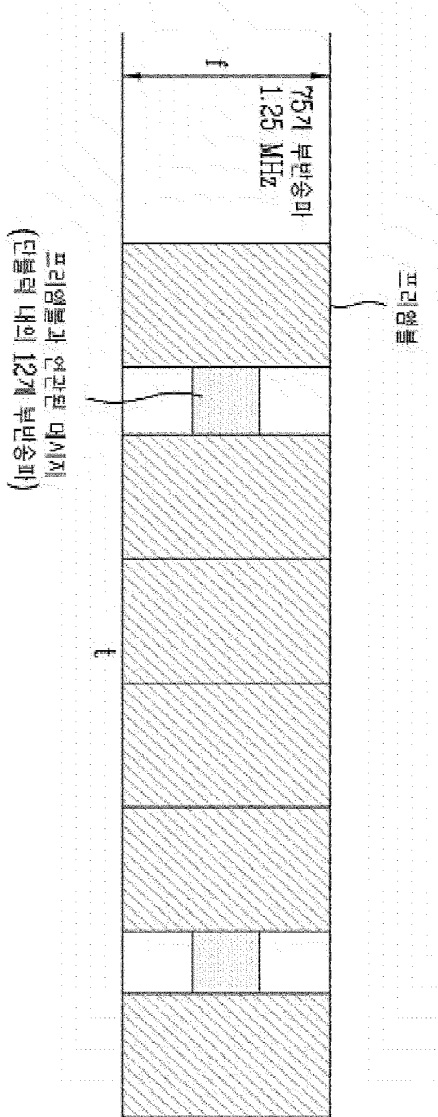



【도 9】

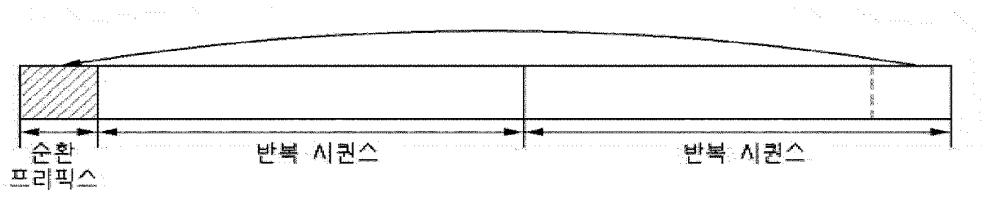

【도 10】

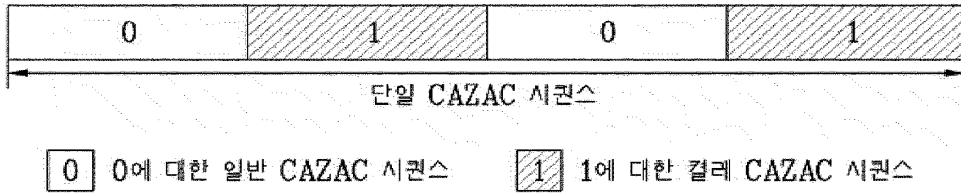

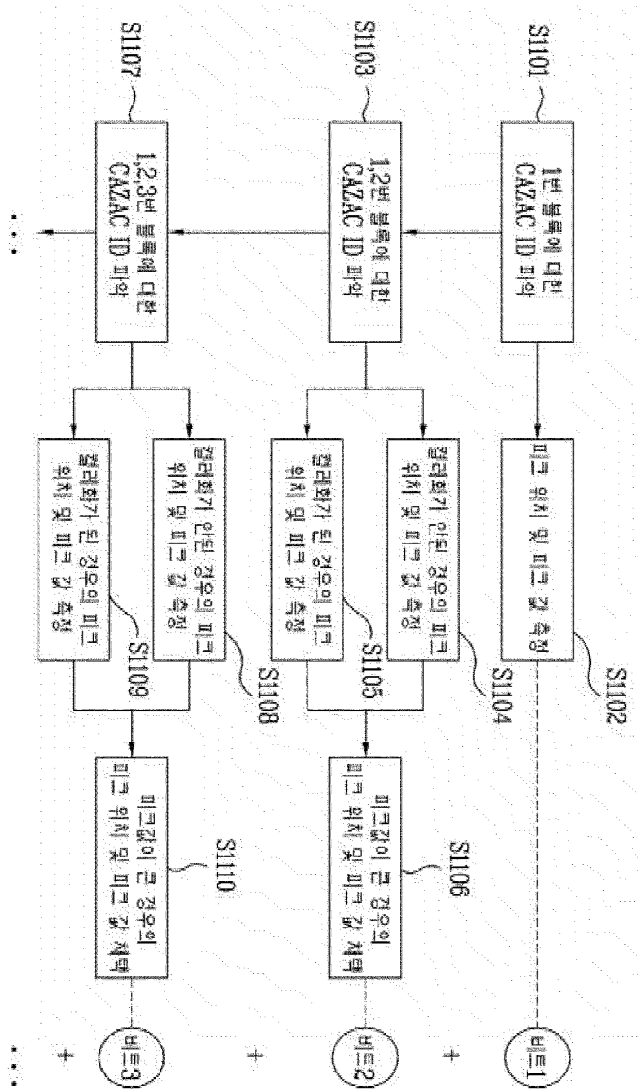

【도 12】

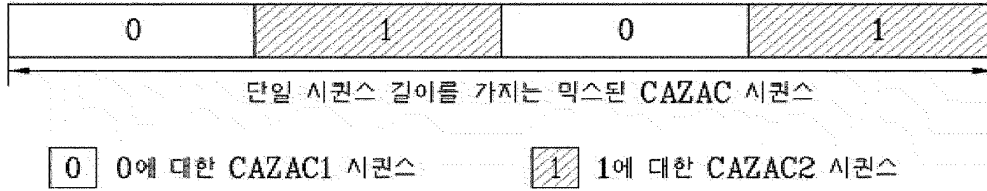

【도 13】

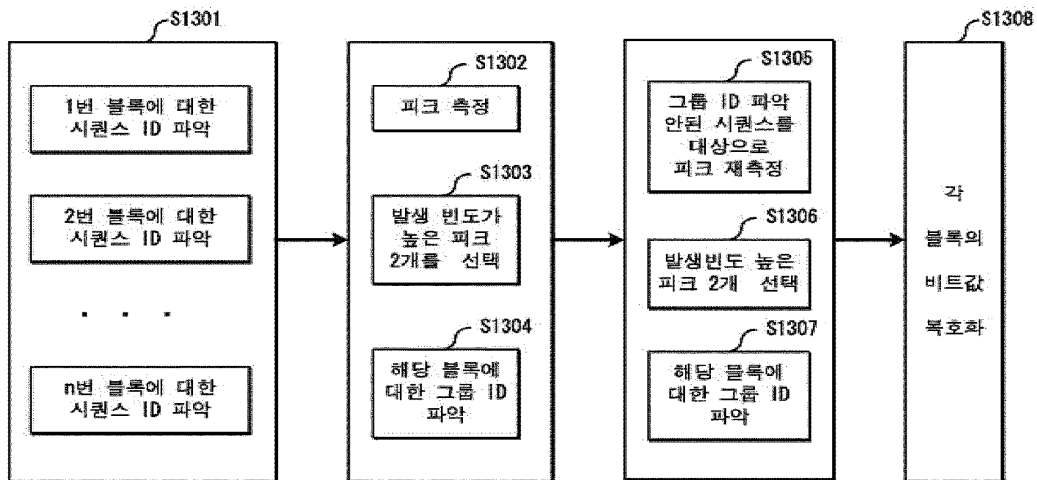

【도 14】

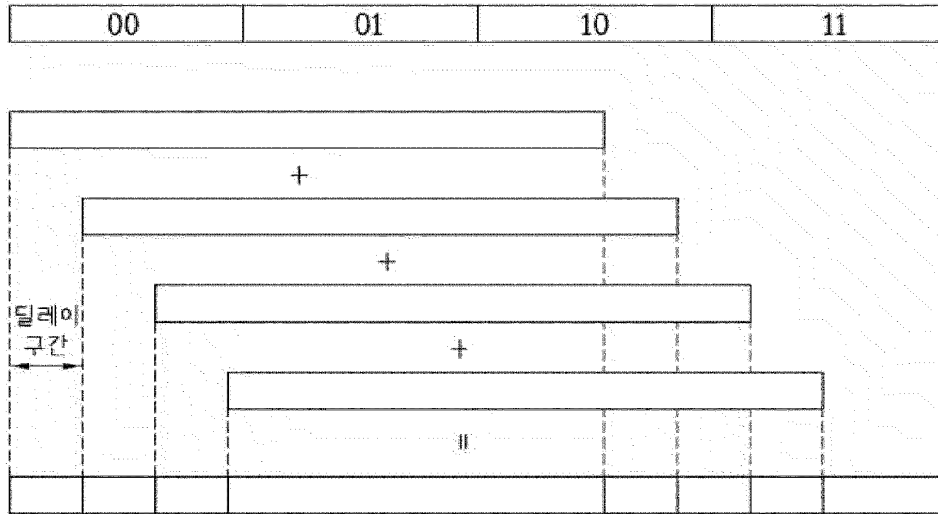

【도 15】

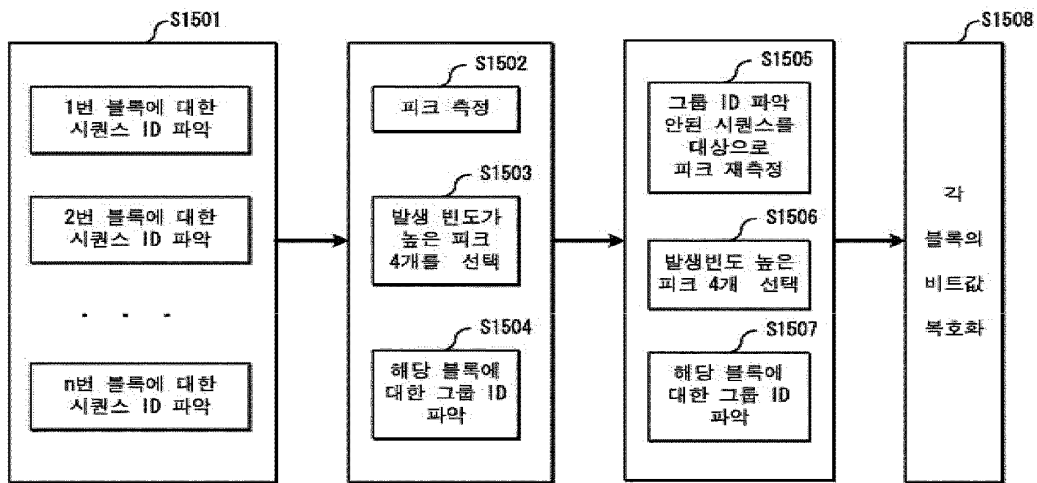

【도 16】

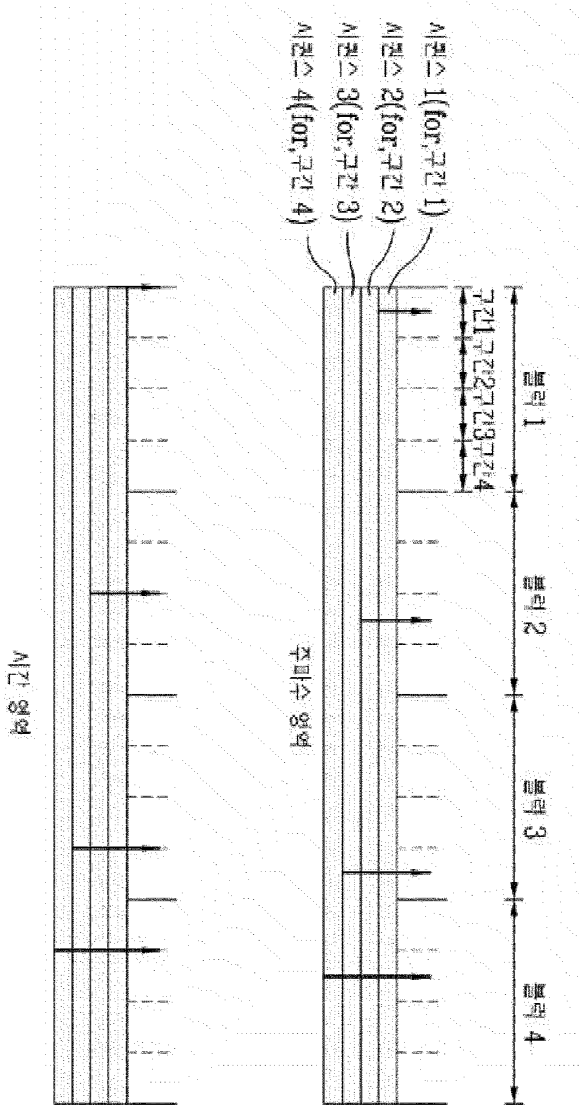

【도 17】

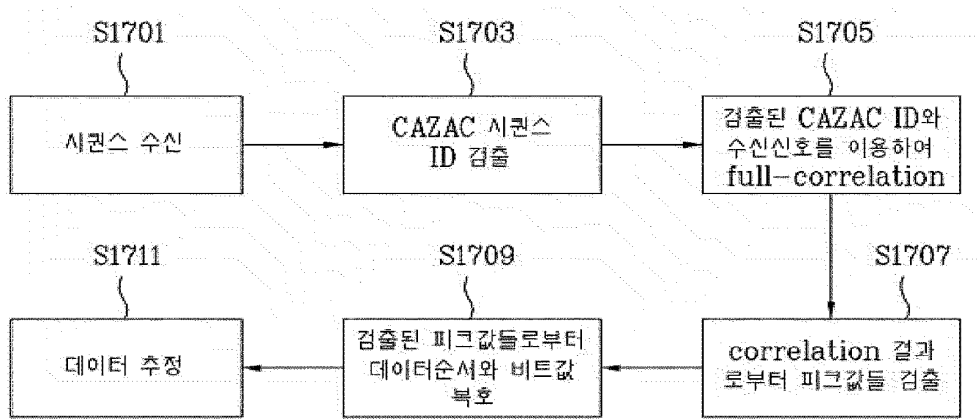

【도 18a】

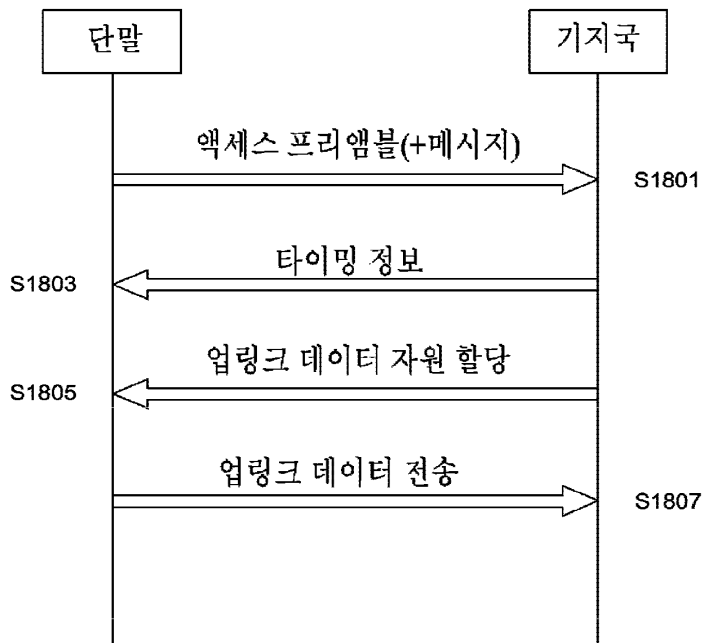

【도 18b】

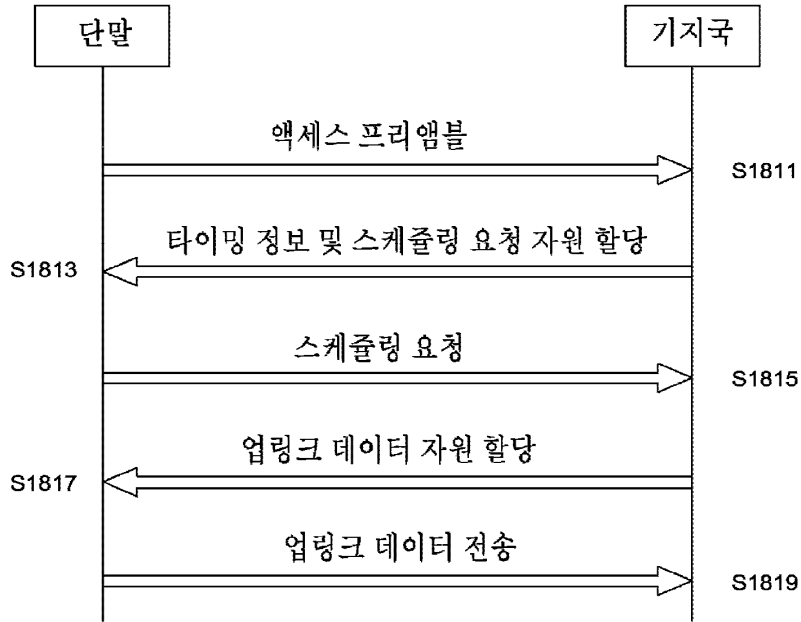

IN THE UNITED STATES PATENT AND TRADEMARK OFFICE

In re application of:  
Yeong Hyeon KWON et al.

Art Unit: 1632

Examiner: Not yet assigned

Serial No.: 12/303,947

Filed: December 8, 2008

Confirmation No. 1730

For: METHOD OF TRANSMITTING DATA IN A  
MOBILE COMMUNICATION SYSTEM

**PRELIMINARY AMENDMENT**

Mail Stop  
Commissioner for Patents  
P.O. Box 1450  
Alexandria, VA 22313-1450

Dear Sir:

Prior to initial examination on the merits, please amend the above-identified application as follows below. If you have any questions, please direct further correspondence to Customer Number 035884 and the undersigned attorney.



REMARKS

With this paper, claims 1-30 have been canceled without prejudice and new claims 31-44 have been added. Applicant submits that support for the new claims is found in the specification as originally filed and that no new matter has been added.

Applicant respectfully requests a prompt examination and allowance by the Examiner. If the Examiner has any questions regarding the subject matter submitted herein, please contact the undersigned attorney at the phone number listed below.

Applicant requests that all deficits and credits in regards to this filing be referenced to Deposit Account No. 502290 order 2101-3596.

Respectfully submitted,

LEE, HONG, DEGERMAN, KANG & WAIMEY

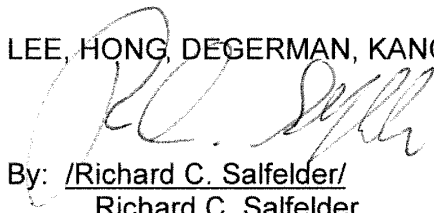

By: /Richard C. Salfelder/  
Richard C. Salfelder  
Registration No. 51,127  
Attorney for Applicant

Date: January 21, 2009

Customer No. 035884

AMENDMENTS TO THE CLAIMS:

Please cancel claims 1-30 without prejudice and add new claims 31-44 as follows:

1-30. Canceled.

31. (New) A method of transmitting a preamble sequence in a mobile communication system, the method comprising:

generating said preamble sequence by repeating a specific sequence at least one time and concatenating a cyclic prefix (CP) to a front end of said repeated sequence, said CP being identical to a part of a rear end of said specific sequence; and transmitting said preamble sequence to a receiving side on a random access channel.

32. (New) The method of claim 31, further comprising generating said specific sequence from a CAZAC (Constant Amplitude Zero Auto Correlation) sequence.

33. (New) The method of claim 32, further comprising applying a cyclic shift to said specific sequence generated from said CAZAC.

34. (New) The method of claim 33, wherein a value of said applied cyclic shift is determined as an integer value of a predetermined circular shift unit.

35. (New) The method of claim 33, wherein a value of said applied cyclic shift is used as additional information.

36. (New) The method of claim 33, wherein applying said cyclic shift comprises multiplying said specific sequence by an exponential sequence.

37. (New) The method of claim 31, further comprising generating said specific sequence by combining at least two code sequences mapped with at least one information bit, respectively.

38. (New) A transmitter for transmitting a preamble sequence in a mobile communication system, the transmitter comprising:

means for generating said preamble sequence by repeating a specific sequence at least one time and concatenating a cyclic prefix (CP) to a front end of said repeated sequence, said cyclic prefix being identical to a rear end of said specific sequence; and

means for transmitting said preamble sequence to a receiving side on a random access channel.

39. (New) The transmitter of claim 38, wherein said means for generating said preamble are configured to generate said specific sequence from a CAZAC (Constant Amplitude Zero Auto Correlation) sequence.

40. (New) The transmitter of claim 39, wherein said means for generating said preamble are configured to apply a cyclic shift to said specific sequence generated from said CAZAC.

41. (New) The transmitter of claim 40, wherein a value of said applied cyclic shift is determined as an integer value of a predetermined circular shift unit.

42. (New) The transmitter of claim 39, wherein a value of said applied cyclic shift is used as additional information.

43. (New) The transmitter of claim 39, wherein said means for generating said preamble are configured to apply a cyclic shift by multiplying said specific sequence by an exponential sequence.

44. (New) The transmitter of claim 38, wherein said means for generating said preamble are configured to generate said specific sequence by combining at least two code sequences mapped with at least one information bit, respectively.

## Electronic Acknowledgement Receipt

<b>EFS ID:</b>	4653416
<b>Application Number:</b>	12303947
<b>International Application Number:</b>	
<b>Confirmation Number:</b>	1730
<b>Title of Invention:</b>	METHOD OF TRANSMITTING DATA IN A MOBILE COMMUNICATION SYSTEM
<b>First Named Inventor/Applicant Name:</b>	Yeong Hyeon Kwon
<b>Customer Number:</b>	35884
<b>Filer:</b>	Richard C. Salfelder/Maggie Wen
<b>Filer Authorized By:</b>	Richard C. Salfelder
<b>Attorney Docket Number:</b>	2101-3596
<b>Receipt Date:</b>	21-JAN-2009
<b>Filing Date:</b>	
<b>Time Stamp:</b>	20:23:38
<b>Application Type:</b>	U.S. National Stage under 35 USC 371

### Payment information:

Submitted with Payment	no
------------------------	----

### File Listing:

Document Number	Document Description	File Name	File Size(Bytes)/ Message Digest	Multi Part /.zip	Pages (if appl.)
1		2101-3596_PA_filed_01212009.pdf	240973 <small>d969f5dd6a09d8fa74ee8c0ee409cf089bc8ce0d</small>	yes	6

**EVOLVED-0001886**

ZTE/HTC

Exhibit 1005-0241

<b>Multipart Description/PDF files in .zip description</b>		
<b>Document Description</b>	<b>Start</b>	<b>End</b>
Miscellaneous Incoming Letter	1	1
Preliminary Amendment	2	2
Claims	3	5
Applicant Arguments/Remarks Made in an Amendment	6	6

**Warnings:**

**Information:**

<b>Total Files Size (in bytes):</b>	240973
-------------------------------------	--------

**This Acknowledgement Receipt evidences receipt on the noted date by the USPTO of the indicated documents, characterized by the applicant, and including page counts, where applicable. It serves as evidence of receipt similar to a Post Card, as described in MPEP 503.**

**New Applications Under 35 U.S.C. 111**

**If a new application is being filed and the application includes the necessary components for a filing date (see 37 CFR 1.53(b)-(d) and MPEP 506), a Filing Receipt (37 CFR 1.54) will be issued in due course and the date shown on this Acknowledgement Receipt will establish the filing date of the application.**

**National Stage of an International Application under 35 U.S.C. 371**

**If a timely submission to enter the national stage of an international application is compliant with the conditions of 35 U.S.C. 371 and other applicable requirements a Form PCT/DO/EO/903 indicating acceptance of the application as a national stage submission under 35 U.S.C. 371 will be issued in addition to the Filing Receipt, in due course.**

**New International Application Filed with the USPTO as a Receiving Office**

**If a new international application is being filed and the international application includes the necessary components for an international filing date (see PCT Article 11 and MPEP 1810), a Notification of the International Application Number and of the International Filing Date (Form PCT/RO/105) will be issued in due course, subject to prescriptions concerning national security, and the date shown on this Acknowledgement Receipt will establish the international filing date of the application.**

Customer No. 035884

PATENT  
Attorney Docket: 2101-3596

In re application of:  
Yeong Hyeon KWON et al.  
Serial No: 12/303,947  
Filed: December 8, 2008  
For: METHOD OF TRANSMITTING DATA IN A  
MOBILE COMMUNICATION SYSTEM

Art Unit: 1632  
Examiner: Not yet assigned  
Confirmation No.: 1730

Mail Stop Amendment  
Commissioner for Patents  
P.O. Box 1450  
Alexandria, VA 22313-1450

Sir:  
Transmitted herewith is a Preliminary Amendment in the above-identified application.

- A petition for extension of time for \_\_ month(s) is enclosed.
- A Request for Continued Examination (RCE) is enclosed.
- \_\_ sheet(s) of replacement drawing(s) is/are enclosed.
- An information disclosure statement in accordance with 37 CFR 1.56 and 1.97 is enclosed.
- No additional fee is required.

The fee has been calculated as shown below:

	(Col. 1) CLAIMS REMAINING AFTER AMENDMENT		(Col. 2) HIGHEST NUMBER PREVIOUSLY PAID FOR	(Col. 3) PRESENT EXTRA*	LG/SM \$ ENTITY FEE	ADD'L FEE DUE
TOTAL CLAIMS FEE	14	-	31 **	0	LG=\$52 SM=\$26	\$52 \$ 0
INDEPENDENT CLAIMS FEE	2	-	7 ***	0	LG=\$220 SM=\$110	\$220 \$ 0
FIRST PRESENTATION OF MULTIPLE DEPENDENT CLAIMS					LARGE ENTITY FEE = \$390 SMALL ENTITY FEE = \$195	\$ 0
<b>TOTAL</b>						<b>\$ 0</b>

\* If the entry in Col. 1 is less than the entry in Col. 2, write "0" in Col. 3.  
 \*\* If the "Highest Number Previously Paid For" IN THIS SPACE is less than 20, write "20" in this space.  
 \*\*\* If the "Highest Number Previously Paid For" IN THIS SPACE is less than 3, write "3" in this space. The "Highest Number Previously Paid For" (Total or Independent) is the highest number found from the equivalent box on Col. 1 of a prior amendment or the number of claims originally filed.

- A check in the amount of \$ \_\_\_\_ to cover the filing fee is enclosed.
- A check in the amount of \$ \_\_\_\_ to cover the extension fee is enclosed.
- A check in the amount of \$ \_\_\_\_ to cover the information disclosure statement fee is enclosed.
- A check in the amount of \$ \_\_\_\_ to cover the petition fee is enclosed.
- The Commissioner is hereby authorized to charge payment of the following fees associated with this communication or credit any overpayment to Deposit Account No. 502290.
  - The amount of \$ \_\_\_\_ for the filing fee.
  - The amount of \$ \_\_\_\_ for the extension fee.
  - The amount of \$ \_\_\_\_ for the RCE fee.
  - Any filing fees under 37 CFR 1.16 for the presentation of extra claims.
  - Any patent application processing fees under 37 CFR 1.17.

Respectfully submitted,  
Lee, Hong, Degerman, Kang & Waimey

Date: January 21, 2009

By: Richard C. Salfelder  
Richard C. Salfelder, Esq.  
Registration No. 51,127  
Attorney for Applicant(s)

Customer #035884

EVOLVED-0001888

ZTE/HTC  
Exhibit 1005-0243

Under the Paperwork Reduction Act of 1995, no persons are required to respond to a collection of information unless it displays a valid OMB control number.

<b>PATENT APPLICATION FEE DETERMINATION RECORD</b> Substitute for Form PTO-875				Application or Docket Number <b>12/303,947</b>		Filing Date <b>07/07/2010</b>		<input checked="" type="checkbox"/> To be Mailed						
<b>APPLICATION AS FILED – PART I</b>						<b>OTHER THAN</b>								
(Column 1)			(Column 2)			SMALL ENTITY <input type="checkbox"/>		OR		SMALL ENTITY				
FOR	NUMBER FILED	NUMBER EXTRA	RATE (\$)	FEE (\$)	OR	RATE (\$)	FEE (\$)							
<input type="checkbox"/> BASIC FEE <small>(37 CFR 1.16(a), (b), or (c))</small>	N/A	N/A	N/A			N/A								
<input type="checkbox"/> SEARCH FEE <small>(37 CFR 1.16(k), (l), or (m))</small>	N/A	N/A	N/A			N/A								
<input type="checkbox"/> EXAMINATION FEE <small>(37 CFR 1.16(o), (p), or (q))</small>	N/A	N/A	N/A			N/A								
TOTAL CLAIMS <small>(37 CFR 1.16(j))</small>	minus 20 =	*	X \$ =		OR	X \$ =								
INDEPENDENT CLAIMS <small>(37 CFR 1.16(h))</small>	minus 3 =	*	X \$ =			X \$ =								
<input type="checkbox"/> APPLICATION SIZE FEE <small>(37 CFR 1.16(s))</small>	If the specification and drawings exceed 100 sheets of paper, the application size fee due is \$250 (\$125 for small entity) for each additional 50 sheets or fraction thereof. See 35 U.S.C. 41(a)(1)(G) and 37 CFR 1.16(s).													
<input type="checkbox"/> MULTIPLE DEPENDENT CLAIM PRESENT <small>(37 CFR 1.16(j))</small>														
* If the difference in column 1 is less than zero, enter "0" in column 2.														
<b>APPLICATION AS AMENDED – PART II</b>						<b>OTHER THAN</b>								
(Column 1)			(Column 2)			(Column 3)			SMALL ENTITY		OR		SMALL ENTITY	
AMENDMENT	<b>01/21/2009</b>	CLAIMS REMAINING AFTER AMENDMENT	HIGHEST NUMBER PREVIOUSLY PAID FOR	PRESENT EXTRA	RATE (\$)	ADDITIONAL FEE (\$)	OR	RATE (\$)	ADDITIONAL FEE (\$)					
	<small>Total (37 CFR 1.16(i))</small>	* 14	Minus	** 20	= 0	X \$ =		OR	X \$52=	0				
	<small>Independent (37 CFR 1.16(h))</small>	* 2	Minus	***3	= 0	X \$ =		OR	X \$220=	0				
	<input type="checkbox"/> Application Size Fee <small>(37 CFR 1.16(s))</small>													
	<input type="checkbox"/> FIRST PRESENTATION OF MULTIPLE DEPENDENT CLAIM <small>(37 CFR 1.16(j))</small>													
						TOTAL ADD'L FEE		OR	TOTAL ADD'L FEE	0				
AMENDMENT	CLAIMS REMAINING AFTER AMENDMENT	HIGHEST NUMBER PREVIOUSLY PAID FOR	PRESENT EXTRA	RATE (\$)	ADDITIONAL FEE (\$)	OR	RATE (\$)	ADDITIONAL FEE (\$)						
	<small>Total (37 CFR 1.16(i))</small>	*	Minus	**	=	X \$ =		OR	X \$ =					
	<small>Independent (37 CFR 1.16(h))</small>	*	Minus	***	=	X \$ =		OR	X \$ =					
	<input type="checkbox"/> Application Size Fee <small>(37 CFR 1.16(s))</small>													
	<input type="checkbox"/> FIRST PRESENTATION OF MULTIPLE DEPENDENT CLAIM <small>(37 CFR 1.16(j))</small>													
						TOTAL ADD'L FEE		OR	TOTAL ADD'L FEE					
* If the entry in column 1 is less than the entry in column 2, write "0" in column 3.														
** If the "Highest Number Previously Paid For" IN THIS SPACE is less than 20, enter "20".														
*** If the "Highest Number Previously Paid For" IN THIS SPACE is less than 3, enter "3".														
The "Highest Number Previously Paid For" (Total or Independent) is the highest number found in the appropriate box in column 1.														

Legal Instrument Examiner:  
/KATRINA HARLING/

This collection of information is required by 37 CFR 1.16. The information is required to obtain or retain a benefit by the public which is to file (and by the USPTO to process) an application. Confidentiality is governed by 35 U.S.C. 122 and 37 CFR 1.14. This collection is estimated to take 12 minutes to complete, including gathering, preparing, and submitting the completed application form to the USPTO. Time will vary depending upon the individual case. Any comments on the amount of time you require to complete this form and/or suggestions for reducing this burden, should be sent to the Chief Information Officer, U.S. Patent and Trademark Office, U.S. Department of Commerce, P.O. Box 1450, Alexandria, VA 22313-1450. DO NOT SEND FEES OR COMPLETED FORMS TO THIS ADDRESS. **SEND TO: Commissioner for Patents, P.O. Box 1450, Alexandria, VA 22313-1450.**

If you need assistance in completing the form, call 1-800-PTO-9199 and select option 2.



<b>INFORMATION DISCLOSURE STATEMENT BY APPLICANT</b> ( Not for submission under 37 CFR 1.99)	Application Number	12303947
	Filing Date	
	First Named Inventor	Yeong Hyeon Kwon
	Art Unit	1632
	Examiner Name	
	Attorney Docket Number	2101-3596

U.S.PATENTS							Remove	
Examiner Initial*	Cite No	Patent Number	Kind Code <sup>1</sup>	Issue Date	Name of Patentee or Applicant of cited Document	Pages,Columns,Lines where Relevant Passages or Relevant Figures Appear		
	1							
If you wish to add additional U.S. Patent citation information please click the Add button.							Add	
U.S.PATENT APPLICATION PUBLICATIONS							Remove	
Examiner Initial*	Cite No	Publication Number	Kind Code <sup>1</sup>	Publication Date	Name of Patentee or Applicant of cited Document	Pages,Columns,Lines where Relevant Passages or Relevant Figures Appear		
	1	20050286409	A1	2005-12-29	Yoon et al.			
If you wish to add additional U.S. Published Application citation information please click the Add button.							Add	
FOREIGN PATENT DOCUMENTS							Remove	
Examiner Initial*	Cite No	Foreign Document Number <sup>3</sup>	Country Code <sup>2</sup> j	Kind Code <sup>4</sup>	Publication Date	Name of Patentee or Applicant of cited Document	Pages,Columns,Lines where Relevant Passages or Relevant Figures Appear	T <sup>5</sup>
	1	1996037079	WO	A1	1996-11-21	QUALCOMM INC.		<input type="checkbox"/>
	2	2001/011909	WO	A1	2001-02-15	KONINKLIJKE PHILIPS ELECTRONICS N.V.		<input type="checkbox"/>
If you wish to add additional Foreign Patent Document citation information please click the Add button.							Add	
NON-PATENT LITERATURE DOCUMENTS							Remove	

<b>INFORMATION DISCLOSURE STATEMENT BY APPLICANT</b> ( Not for submission under 37 CFR 1.99)	Application Number		12303947	
	Filing Date			
	First Named Inventor	Yeong Hyeon Kwon		
	Art Unit	1632		
	Examiner Name			
	Attorney Docket Number		2101-3596	

Examiner Initials*	Cite No	Include name of the author (in CAPITAL LETTERS), title of the article (when appropriate), title of the item (book, magazine, journal, serial, symposium, catalog, etc), date, pages(s), volume-issue number(s), publisher, city and/or country where published.	T <sup>5</sup>
	1		<input type="checkbox"/>

If you wish to add additional non-patent literature document citation information please click the Add button

**EXAMINER SIGNATURE**

Examiner Signature		Date Considered	
--------------------	--	-----------------	--

\*EXAMINER: Initial if reference considered, whether or not citation is in conformance with MPEP 609. Draw line through a citation if not in conformance and not considered. Include copy of this form with next communication to applicant.

<sup>1</sup> See Kind Codes of USPTO Patent Documents at [www.USPTO.GOV](http://www.USPTO.GOV) or MPEP 901.04. <sup>2</sup> Enter office that issued the document, by the two-letter code (WIPO Standard ST.3). <sup>3</sup> For Japanese patent documents, the indication of the year of the reign of the Emperor must precede the serial number of the patent document. <sup>4</sup> Kind of document by the appropriate symbols as indicated on the document under WIPO Standard ST.16 if possible. <sup>5</sup> Applicant is to place a check mark here if English language translation is attached.

<b>INFORMATION DISCLOSURE STATEMENT BY APPLICANT</b> ( Not for submission under 37 CFR 1.99)	Application Number	12303947
	Filing Date	
	First Named Inventor	Yeong Hyeon Kwon
	Art Unit	1632
	Examiner Name	
	Attorney Docket Number	2101-3596

**CERTIFICATION STATEMENT**

Please see 37 CFR 1.97 and 1.98 to make the appropriate selection(s):

That each item of information contained in the information disclosure statement was first cited in any communication from a foreign patent office in a counterpart foreign application not more than three months prior to the filing of the information disclosure statement. See 37 CFR 1.97(e)(1).

**OR**

That no item of information contained in the information disclosure statement was cited in a communication from a foreign patent office in a counterpart foreign application, and, to the knowledge of the person signing the certification after making reasonable inquiry, no item of information contained in the information disclosure statement was known to any individual designated in 37 CFR 1.56(c) more than three months prior to the filing of the information disclosure statement. See 37 CFR 1.97(e)(2).

See attached certification statement.

Fee set forth in 37 CFR 1.17 (p) has been submitted herewith.

None

**SIGNATURE**

A signature of the applicant or representative is required in accordance with CFR 1.33, 10.18. Please see CFR 1.4(d) for the form of the signature.

Signature	/Harry S. Lee/	Date (YYYY-MM-DD)	2009-07-17
Name/Print	Harry S. Lee	Registration Number	56,814

This collection of information is required by 37 CFR 1.97 and 1.98. The information is required to obtain or retain a benefit by the public which is to file (and by the USPTO to process) an application. Confidentiality is governed by 35 U.S.C. 122 and 37 CFR 1.14. This collection is estimated to take 1 hour to complete, including gathering, preparing and submitting the completed application form to the USPTO. Time will vary depending upon the individual case. Any comments on the amount of time you require to complete this form and/or suggestions for reducing this burden, should be sent to the Chief Information Officer, U.S. Patent and Trademark Office, U.S. Department of Commerce, P.O. Box 1450, Alexandria, VA 22313-1450. **DO NOT SEND FEES OR COMPLETED FORMS TO THIS ADDRESS. SEND TO: Commissioner for Patents, P.O. Box 1450, Alexandria, VA 22313-1450.**

## Privacy Act Statement

The Privacy Act of 1974 (P.L. 93-579) requires that you be given certain information in connection with your submission of the attached form related to a patent application or patent. Accordingly, pursuant to the requirements of the Act, please be advised that: (1) the general authority for the collection of this information is 35 U.S.C. 2(b)(2); (2) furnishing of the information solicited is voluntary; and (3) the principal purpose for which the information is used by the U.S. Patent and Trademark Office is to process and/or examine your submission related to a patent application or patent. If you do not furnish the requested information, the U.S. Patent and Trademark Office may not be able to process and/or examine your submission, which may result in termination of proceedings or abandonment of the application or expiration of the patent.

The information provided by you in this form will be subject to the following routine uses:

1. The information on this form will be treated confidentially to the extent allowed under the Freedom of Information Act (5 U.S.C. 552) and the Privacy Act (5 U.S.C. 552a). Records from this system of records may be disclosed to the Department of Justice to determine whether the Freedom of Information Act requires disclosure of these records.
2. A record from this system of records may be disclosed, as a routine use, in the course of presenting evidence to a court, magistrate, or administrative tribunal, including disclosures to opposing counsel in the course of settlement negotiations.
3. A record in this system of records may be disclosed, as a routine use, to a Member of Congress submitting a request involving an individual, to whom the record pertains, when the individual has requested assistance from the Member with respect to the subject matter of the record.
4. A record in this system of records may be disclosed, as a routine use, to a contractor of the Agency having need for the information in order to perform a contract. Recipients of information shall be required to comply with the requirements of the Privacy Act of 1974, as amended, pursuant to 5 U.S.C. 552a(m).
5. A record related to an International Application filed under the Patent Cooperation Treaty in this system of records may be disclosed, as a routine use, to the International Bureau of the World Intellectual Property Organization, pursuant to the Patent Cooperation Treaty.
6. A record in this system of records may be disclosed, as a routine use, to another federal agency for purposes of National Security review (35 U.S.C. 181) and for review pursuant to the Atomic Energy Act (42 U.S.C. 218(c)).
7. A record from this system of records may be disclosed, as a routine use, to the Administrator, General Services, or his/her designee, during an inspection of records conducted by GSA as part of that agency's responsibility to recommend improvements in records management practices and programs, under authority of 44 U.S.C. 2904 and 2906. Such disclosure shall be made in accordance with the GSA regulations governing inspection of records for this purpose, and any other relevant (i.e., GSA or Commerce) directive. Such disclosure shall not be used to make determinations about individuals.
8. A record from this system of records may be disclosed, as a routine use, to the public after either publication of the application pursuant to 35 U.S.C. 122(b) or issuance of a patent pursuant to 35 U.S.C. 151. Further, a record may be disclosed, subject to the limitations of 37 CFR 1.14, as a routine use, to the public if the record was filed in an application which became abandoned or in which the proceedings were terminated and which application is referenced by either a published application, an application open to public inspections or an issued patent.
9. A record from this system of records may be disclosed, as a routine use, to a Federal, State, or local law enforcement agency, if the USPTO becomes aware of a violation or potential violation of law or regulation.

## Electronic Acknowledgement Receipt

<b>EFS ID:</b>	5725860
<b>Application Number:</b>	12303947
<b>International Application Number:</b>	
<b>Confirmation Number:</b>	1730
<b>Title of Invention:</b>	METHOD OF TRANSMITTING DATA IN A MOBILE COMMUNICATION SYSTEM
<b>First Named Inventor/Applicant Name:</b>	Yeong Hyeon Kwon
<b>Customer Number:</b>	35884
<b>Filer:</b>	Harry Sung Lee
<b>Filer Authorized By:</b>	
<b>Attorney Docket Number:</b>	2101-3596
<b>Receipt Date:</b>	17-JUL-2009
<b>Filing Date:</b>	
<b>Time Stamp:</b>	16:44:53
<b>Application Type:</b>	U.S. National Stage under 35 USC 371

### Payment information:

Submitted with Payment	no
------------------------	----

### File Listing:

Document Number	Document Description	File Name	File Size(Bytes)/ Message Digest	Multi Part /.zip	Pages (if appl.)
1	Foreign Reference	2101-3596_F1.pdf	3306351 <small>bee7bbfd255ac25e9275863af60ac6f13ed97f04</small>	no	78

### Warnings:

### Information:

**EVOLVED-0001894**

ZTE/HTC  
Exhibit 1005-0249

2	Foreign Reference	2101-3596_F2.pdf	764950 a552e41e344876e09f788d61808dfc69d9fdbc6	no	20
<b>Warnings:</b>					
<b>Information:</b>					
3	Information Disclosure Statement (IDS) Filed (SB/08)	IDS_1449_2101-3596.pdf	608326 82864c94643be507cf3448c1707a176dbee38c85	no	4
<b>Warnings:</b>					
<b>Information:</b>					
<b>Total Files Size (in bytes):</b>				4679627	
<p><b>This Acknowledgement Receipt evidences receipt on the noted date by the USPTO of the indicated documents, characterized by the applicant, and including page counts, where applicable. It serves as evidence of receipt similar to a Post Card, as described in MPEP 503.</b></p> <p><b><u>New Applications Under 35 U.S.C. 111</u></b> If a new application is being filed and the application includes the necessary components for a filing date (see 37 CFR 1.53(b)-(d) and MPEP 506), a Filing Receipt (37 CFR 1.54) will be issued in due course and the date shown on this Acknowledgement Receipt will establish the filing date of the application.</p> <p><b><u>National Stage of an International Application under 35 U.S.C. 371</u></b> If a timely submission to enter the national stage of an international application is compliant with the conditions of 35 U.S.C. 371 and other applicable requirements a Form PCT/DO/EO/903 indicating acceptance of the application as a national stage submission under 35 U.S.C. 371 will be issued in addition to the Filing Receipt, in due course.</p> <p><b><u>New International Application Filed with the USPTO as a Receiving Office</u></b> If a new international application is being filed and the international application includes the necessary components for an international filing date (see PCT Article 11 and MPEP 1810), a Notification of the International Application Number and of the International Filing Date (Form PCT/RO/105) will be issued in due course, subject to prescriptions concerning national security, and the date shown on this Acknowledgement Receipt will establish the international filing date of the application.</p>					

PCT

WORLD INTELLECTUAL PROPERTY ORGANIZATION  
International Bureau



INTERNATIONAL APPLICATION PUBLISHED UNDER THE PATENT COOPERATION TREATY (PCT)

(51) International Patent Classification <sup>6</sup> : <b>H04Q 7/22</b>	<b>A1</b>	(11) International Publication Number: <b>WO 96/37079</b>
		(43) International Publication Date: 21 November 1996 (21.11.96)
(21) International Application Number: PCT/US96/06930	(81) Designated States: AL, AM, AT, AU, AZ, BB, BG, BR, BY, CA, CH, CN, CZ, DE, DK, EE, ES, FI, GB, GE, HU, IS, JP, KE, KG, KP, KR, KZ, LK, LR, LS, LT, LU, LV, MD, MG, MK, MN, MW, MX, NO, NZ, PL, PT, RO, RU, SD, SE, SG, SI, SK, TJ, TM, TR, TT, UA, UG, UZ, VN, ARIPO patent (KE, LS, MW, SD, SZ, UG), Eurasian patent (AM, AZ, BY, KG, KZ, MD, RU, TJ, TM), European patent (AT, BE, CH, DE, DK, ES, FI, FR, GB, GR, IE, IT, LU, MC, NL, PT, SE), OAPI patent (BF, BJ, CF, CG, CI, CM, GA, GN, ML, MR, NE, SN, TD, TG).	
(22) International Filing Date: 17 May 1996 (17.05.96)		
(30) Priority Data: 412,648 17 May 1995 (17.05.95) US		
(71) Applicant: QUALCOMM INCORPORATED [US/US]; 6455 Lusk Boulevard, San Diego, CA 92121 (US).		
(72) Inventor: QUICK, Roy, F.; 4502 Del Monte Avenue, San Diego, CA 92107 (US).		
(74) Agents: MILLER, Russell, B. et al.; Qualcomm Incorporated, 6455 Lusk Boulevard, San Diego, CA 92121 (US).		
<p><b>Published</b> With international search report. Before the expiration of the time limit for amending the claims and to be republished in the event of the receipt of amendments.</p>		

(54) Title: RANDOM ACCESS COMMUNICATIONS CHANNEL FOR DATA SERVICES

(57) Abstract

In a digital communication system for communicating digital information (100), the digital communication system having a forward link (120) and a reverse link (130), a system and method for communicating a data packet. The system comprises a communicating transceiver (202), from among a number of digital transceivers (102), for sending the data packet on a random access channel (208) over the reverse link and for receiving the digital information from the forward link. The system also comprises a base station (108) for receiving the data packet on the random access channel (208) from the reverse link (130) and for sending the digital information over the forward link (120). The digital transceivers (102) share the random access channel (208). The digital transceivers (102) have a bandwidth demand. The system (100) may also include a dedicated channel (214) for communicating the data packet between the communicating transceiver (202) and the base station (108) and a processor (212) for switching from the random access channel (208) to the dedicated channel (214) when the bandwidth demand exceeds a first threshold, and for switching from the dedicated channel (214) to the random access channel (208) when the bandwidth demand drops below a second threshold. The system is well suited for use in CDMA applications.

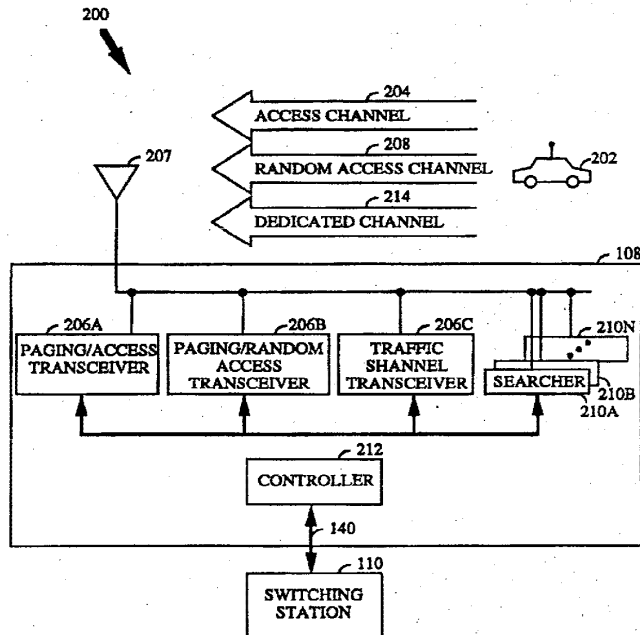

**FOR THE PURPOSES OF INFORMATION ONLY**

Codes used to identify States party to the PCT on the front pages of pamphlets publishing international applications under the PCT.

AM	Armenia	GB	United Kingdom	MW	Malawi
AT	Austria	GE	Georgia	MX	Mexico
AU	Australia	GN	Guinea	NE	Niger
BB	Barbados	GR	Greece	NL	Netherlands
BE	Belgium	HU	Hungary	NO	Norway
BF	Burkina Faso	IE	Ireland	NZ	New Zealand
BG	Bulgaria	IT	Italy	PL	Poland
BJ	Benin	JP	Japan	PT	Portugal
BR	Brazil	KE	Kenya	RO	Romania
BY	Belarus	KG	Kyrgyzstan	RU	Russian Federation
CA	Canada	KP	Democratic People's Republic of Korea	SD	Sudan
CF	Central African Republic	KR	Republic of Korea	SE	Sweden
CG	Congo	KZ	Kazakhstan	SG	Singapore
CH	Switzerland	LI	Liechtenstein	SI	Slovenia
CI	Côte d'Ivoire	LK	Sri Lanka	SK	Slovakia
CM	Cameroon	LR	Liberia	SN	Senegal
CN	China	LT	Lithuania	SZ	Swaziland
CS	Czechoslovakia	LU	Luxembourg	TD	Chad
CZ	Czech Republic	LV	Latvia	TG	Togo
DE	Germany	MC	Monaco	TJ	Tajikistan
DK	Denmark	MD	Republic of Moldova	TT	Trinidad and Tobago
EE	Estonia	MG	Madagascar	UA	Ukraine
ES	Spain	ML	Mali	UG	Uganda
FI	Finland	MN	Mongolia	US	United States of America
FR	France	MR	Mauritania	UZ	Uzbekistan
GA	Gabon			VN	Viet Nam



## RANDOM ACCESS COMMUNICATIONS CHANNEL FOR DATA SERVICES

### BACKGROUND OF THE INVENTION

5

#### I. Field of the Invention

The present invention relates to a random access communications channel for data services. More particularly, the present invention relates to a method for sharing the resources of existing channels in a cellular telephone communications system among a large number of packet data users, each having a variable and unpredictable demand for transmission resources.

#### 15 II. Description of the Related Art

Cellular telephone systems have traditionally provided voice services, patterned on the land telephone system model. In that model, a user places a call by requesting a connection between one telephone terminal and another such terminal. Once the connection is established, it remains in place until the calling party or the called party requests that the connection be released. While the connection is established, the telephone system dedicates system resources, such as trunk bandwidth, to the call. The resources are dedicated at all times, regardless of whether the callers talk or are silent. The system resources are not shared among calls.

The land telephone model is followed in conventional cellular systems. For example, two systems that follow that model are the Advanced Mobile Phone System ("AMPS") cellular system, described in "Mobile Station/Land Station Compatibility Specification," ANSI/EIA/TIA-553 (September 1993), and the time division multiple access ("TDMA") system, described in "Cellular System Dual-Mode Mobile Station/Base Station Compatibility Standard," EIA/TIA/IS-54-B (September 1992). The code division multiple access ("CDMA") cellular system, described in "Mobile Station/Base Station Compatibility Standard for Dual-Mode Wideband Spread Spectrum Cellular System," TIA/EIA/IS-95, Telecommunications

Industry Association (July 1993), allows sharing of radio bandwidth, but follows the land telephone model for connections between the mobile switching center ("MSC") and the public switched telephone network ("PSTN").

5           The CDMA system described above uses a 1.23 MHz bandwidth to serve multiple calls, using a CDMA scheme. Each user is assigned a unique code. All user terminals sharing the radio channel transmit simultaneously, and the receivers use the unique code to identify and decode a signal from the terminal that is to be received. The process is  
10 limited by the interference generated by the other transmitters. So long as the desired signal can be maintained sufficiently strong relative to the total interference, the signal can be successfully demodulated. When the number of users exceeds the CDMA channel's capacity, however, the necessary signal strength cannot be maintained. This CDMA cellular system provides  
15 for a total of 64 forward link channels per cell in each 1.23 MHz band. Experiments have shown that such a system can support more than 60 simultaneous calls per cell in the 1.23 MHz bandwidth under benign propagation and interference conditions.

          The CDMA cellular telephone system also provides a means of  
20 serving a large population of cellular telephone units, most of which are idle, i.e., not involved in a call. These idle units monitor a special control channel known as the "Paging Channel," which continuously transmits system information and paging messages. Paging messages are used to inform a mobile terminal that a caller wishes to establish a call connection  
25 to the mobile. Each Paging Channel has one or more associated "Access Channels." The Access Channels use multiple-access protocols, by which the mobile terminals transmit call requests (originations) and answer paging messages. When a connection is established, the cellular base station assigns the mobile station a dedicated "Traffic Channel" to carry the voice  
30 information for the duration of the call.

          The CDMA system was designed to exploit the idleness of the mobile terminals. If this were not so, the number of mobile terminals supported would be limited to fewer than 64 per cell, because of the limited number of

channels provided in the system design. Because most terminals are idle, the system can support several orders of magnitude more mobile terminals per cell, thereby justifying the choice of 64 channels as an upper limit.

5 Users of packet data services often utilize system resources in a manner that varies over the course of the packet data session. File transfers, e-mail, and information retrieval are examples of packet data services that follow this pattern. For these services, a few packets are sent while the user selects the file, e-mail, or other information to be retrieved, then a long sequence of packets is sent or received while the information is transferred.

10 In other types of data packet services, only a few packets are sent during an exchange of data, and the exchanges occur on an irregular basis. Examples of such services include: credit verification, message and paging services, order entry, and delivery routing.

15 The manner in which these two types of data packet services utilize resources suggests that a packet service should provide two basic service modes. First, for those cases where large amounts of data are to be transferred, a service mode should be available that optimizes the data throughput. Second, for cases where packet transmission is infrequent and irregular, dedicating a channel assignment to each user would be wasteful of system resources, because the dedicated channels would be unused most of the time. For this second case, then, a service mode should be available that optimizes the sharing of resources, i.e., optimizing channel usage. It should be possible for a packet service to switch between the two modes in response to usage demand.

25 Conventional cellular systems, including CDMA, however, have neither the capability to efficiently and effectively handle both types of data packet services, nor the capability to switch between the two. While the CDMA Traffic Channels do provide dedicated channel assignments and can thus be used to handle high-throughput packet service to prevent the throughput reduction resulting from channel sharing, they are inefficient for low throughput, irregular and infrequent data packet transmissions. Thus, a multiple-access protocol is required for a service mode that optimizes sharing of resources.

30

Despite providing multiple-access protocols, the existing CDMA Paging and Access Channels operate in a manner that is not well suited to data packet services. For example, those channels can support only a small packet size, which reduces the effective throughput of the channel because each packet contains header information as overhead. This overhead occupies a greater fraction of the available channel bandwidth when the packets are small.

Furthermore, the Paging and Access Channels cannot support long packet sizes because of their access methods. The Access Channel provides no power control feedback that would allow the base station to maintain the mobile terminal's signal strength in an acceptable range during a prolonged transmission. Instead, mobile terminals simply transmit messages repeatedly, with increased transmit power on successive attempts, until the base station acknowledges reception of the message. Because longer messages are more susceptible to errors caused by interference or fading, the mobile terminal's power level may reach very high levels when attempting to send a long message. This would result in excessive interference to other users during the transmission. On the Paging Channel, moreover, long packets cannot be supported because of the structure of the channel. Messages are limited to a maximum of 255 octets, and no mechanism exists for fragmenting longer messages.

The Access Channel also is incapable of identifying multiple propagation paths. On Traffic Channels, each of the mobile terminals has a unique spreading code that is used by the base station to identify and exploit multiple propagation paths, using a signal combining method. On the Access Channel, in contrast, all mobile terminals use the same spreading code for transmissions, making multiple propagation paths indistinguishable from transmissions from other mobile terminals.

In some present systems, it is possible to provide connectionless data services, based on the delivery of individual data packets from many users who transmit data packets in bursts. Such services preferably do not utilize fixed allocations of communication resources and allow the sharing of such resources among multiple users. In many present communications

systems, and in particular digital cellular systems and CDMA cellular, however, no capability exists to provide for communication of data packets from many bursty users. In such systems, efficient support for connectionless data services requires changes in the access methods used on the radio channel and in the land network.

Therefore, a need exists for a random access data packet channel that can share communication channel resources among a large number of bursty packet data users, each having a variable and unpredictable demand for transmission resources, and for a way to switch between such a random access channel and a dedicated data channel. A need also exists for a coding scheme that can be used to identify users on the random access channel and a scheme for overlaying the random access channel with control channels.

#### SUMMARY OF THE INVENTION

Accordingly, the present invention is directed to a random access channel for packet data services in a wireless communications system that substantially obviates one or more of the problems due to the limitations and disadvantages of the related art.

Additional features and advantages of the invention will be set forth in the description that follows and in part will be apparent from the description, or may be learned by practice of the invention. The objectives and other advantages of the invention will be realized and attained by the apparatus particularly pointed out in the written description and claims of this application, as well as the appended drawings.

To achieve these and other advantages, and in accordance with the purpose of the invention as embodied and broadly described herein, in a digital communication system for communicating digital information, the digital communication system having a forward link and a reverse link, the invention is a system for communicating a digital data packet. The system of the present invention comprises digital transceivers for sending the digital data packet on a random access channel over the reverse link and for receiving the digital information from the forward link. The system further

comprises a digital base station for receiving the digital data packet on the random access channel from the reverse link and for sending the digital information over the forward link, wherein the digital transceivers make packet service requests on the random access channel and thereby share the random access channel.

In another aspect, in a digital communication system for communicating digital information, the digital communication system having a forward link and a reverse link, the present invention is a method for communicating a digital data packet. The method comprises sending the digital data packet on a random access channel over the reverse link and receiving the digital information from the forward link by a number of digital transceivers. The method further comprises receiving the digital data packet on the random access channel from the reverse link and sending the digital information over the forward link by a digital base station, wherein the digital transceivers make packet service requests on the random access channel and thereby share the random access channel.

In another aspect, in a digital communication system for communicating digital information, the digital communication system having a digital transceiver and a digital base station, the digital transceiver having a bandwidth demand, the present invention is a system for communicating digital data packets. The system of the present invention comprises a random access channel and a dedicated channel for communicating the digital data packets between the digital transceiver and the digital base station. The system further comprises a processor for switching from the random access channel to the dedicated channel if the bandwidth demand exceeds a first threshold level and from the dedicated channel to the random access channel if the bandwidth demand below a second threshold level and/or if the digital transceiver is highly mobile, frequently moving from the coverage area of one base station to the coverage area of another.

In yet another aspect, in a digital communication system having a broadcast channel for communicating system information and an access channel for making access requests, the system information including

5 paging messages, the digital communication system including a plurality of transceivers each having a specific long code, the present invention is a system for communicating a digital data packet. In the system of the present invention, a communicating transceiver from among the plurality of transceivers initializes a packet service request, requests a searcher reservation on the access channel, and sends the digital data packet over a random access channel using the specific long code corresponding to the communicating transceiver to obtain a coded digital data packet. The system comprises a base station, including a plurality of searchers and a controller for locating a free searcher from the plurality of searchers and for sending to the free searcher the specific long code corresponding to the communicating transceiver. Further, the base station assigns the free searcher to the communicating transceiver and receives the coded digital data packet from the communicating transceiver over the random access channel. The plurality of transceivers share the random access channel.

10 In all of the systems and methods described above and in the following description, the digital data can be communicated over the digital cellular communications system using code division multiple access (CDMA). CDMA is a spread spectrum method of multiplexing transmissions by encoding the transmissions so that they are each distinctive. CDMA multiplexing permit a larger number of transceivers (i.e., mobile telephone units) to communicate within a communication network than would other wise be possible without this spread spectrum technique.

25 It is to be understood that both the foregoing general description and the following detailed description are exemplary and explanatory only and are not restrictive of the invention, as claimed.

30 The accompanying drawings are included to provide a further understanding of the invention and are incorporated in and constitute a part of this specification, to illustrate the embodiments of the invention, and, together with the description, to explain the principles of the invention.

**BRIEF DESCRIPTION OF THE DRAWINGS**

The features, objects, and advantages of the present invention will become more apparent from the detailed description set forth below when  
5 taken in conjunction with the drawings in which like reference characters identify correspondingly throughout and wherein:

Figure 1 is a schematic overview of an exemplary mobile cellular telephone system.

10 Figure 2 is a schematic overview of the process of searcher reservation in accordance with the present invention.

Figure 3 is a schematic overview of the process of switching between a random access channel and a dedicated channel for reverse link communications in accordance with the present invention.

15 Figure 4 illustrates a Long Code Mask used on a forward link Packet/Paging Channel.

Figure 5A and Figure 5B illustrates the structure of the forward link Packet/Paging Channel in accordance with the present invention.

Figure 6A and Figure 6B illustrates the structure of the Packet Subchannel of the Packet/Paging Channel of the present invention.

20 Figures 7A-7C illustrate the half-frame structure of the Packet Subchannel of the present invention.

Figure 8 shows the structure of messages sent on the Packet Subchannel.

25 Figure 9 illustrates the synchronization of a random access channel (or Reverse Packet Channel) in accordance with the present invention.

Figure 10 illustrates the structure of transmissions sent on the Reverse Packet Channel of the present invention.

Figure 11 illustrates the message portion of a transmission sent on the Reverse Packet Channel of the present invention.

30 Figures 12A-12C are flow diagrams illustrating an exemplary mobile station searcher management scheme in accordance with the present invention.



Figures 13A-13E are flow diagrams illustrating an exemplary base station searcher management scheme in accordance with the present invention.

## DETAILED DESCRIPTION OF THE PREFERRED EMBODIMENTS

5

Reference will now be made in detail to the present preferred embodiments of the invention, examples of which are illustrated in the accompanying drawings. Wherever possible, the same reference numerals will be used throughout the drawings to refer to the same or like parts.

10

In accordance with the present invention, in a digital communication system for communicating digital information having a forward link and a reverse link, a system and method are provided for communicating digital data packets. The system comprises digital transceivers, for example, mobile cellular telephones, for sending the digital data packets on a random access channel over the reverse link and for receiving digital information from the forward link. The system also comprises a digital base station for receiving the digital data packet on the random access channel from the reverse link and for sending digital information over the forward link. The digital transceivers make packet service requests on and thereby share the random access channel.

15

20

### I. SYSTEM DESIGN

#### A. Applications

25

An exemplary embodiment of a terrestrial digital cellular mobile telephone system in which the present invention may be embodied is illustrated in Figure 1 and designated generally by reference numeral 100. The digital communication system illustrated in Figure 1 may utilize TDMA, CDMA, or other digital modulation techniques in communications between the remote user units 102,104 (which may be fixed or mobile and may also be referred to as mobile stations) and the cell-sites (or base stations) 108. For the remainder of this description, the terms "cell-site" and "base station" will both be used to refer to terrestrial transceivers that communicate over-the-air with remote and/or mobile units. It is not

30

intended, however, that the present invention be limited to cellular systems and thus to cell-sites. Cellular systems in large cities may have hundreds or thousands of mobile telephones 102 and many cell-sites 108. Nevertheless, the present system is not limited to mobile telephones 102 and may be used  
5 to interconnect a fixed position cellular communications device 104. For example, a cellular transceiver 104 can be supplied at a building in order to send and receive data and/or voice communications between some device in the building and a switching station 110 that collects the data. Transmissions from the cell-sites 108 to the remote user units 102, 104 are  
10 sent on a forward link 120, while transmissions in the opposite direction are sent on a reverse link 130. The cell sites 108 are coupled to the switching station 110 via backhaul 140 or may be linked to the switching station 110 over-the-air.

An example of such a use would be a company that has many  
15 vending machines throughout a wide area and that needs to monitor the requirements of those vending machines. The vending machines could be equipped with a digital cellular transceiver 104 that can send and receive data to and from the switching station 110, including whether the machine is empty, which slots are empty, whether the supply is running low, and  
20 whether the machine has malfunctioned. In such an application, the vending machines would not need to communicate large amounts of data at any one time, but rather only short packets, such as status reports and malfunctions, and then only sporadically. With many vending machines needing to communicate data packets to the switching station 110, and vice  
25 versa, it would be inefficient and impractical to have the vending machines communicate over a dedicated communication channel, in which system resources would be dedicated to each vending machine that required channel time.

A more efficient approach is to provide a random access channel over  
30 which the vending machines can communicate with the switching station 110. With a random access channel, the vending machines could request channel time only when they need it. Because the vending machines require channel time only infrequently and briefly, literally thousands of

vending machines could share a single random access channel without significant transmission delays due to the random access channel being busy.

Another application in which a random access channel on a digital cellular system is useful would be where a fleet of taxicabs reports information back to a dispatcher. Each taxicab must keep the dispatcher apprised, for example, of the cab's location and availability and must monitor requests for service. As with the vending machine example, many cabs must communicate with the dispatcher, but only with data packets that are sent sporadically. Accordingly, in this example as well, a random access channel would more efficiently serve the communications needs of the taxicab fleet and dispatcher than would a dedicated data channel. Furthermore, the cabs could be equipped with a voice/data transceiver so that they can communicate by voice with the dispatcher when needed and send and receive data from the dispatcher. Communicating both voice and data over the same system is made possible by the use of a digital system, for in such systems both the voice and data transmissions are in digital format.

Therefore, in accordance with the present invention, a system for communicating short digital data packets over a random access channel is provided within the system 100 of Figure 1. An additional feature of the system of the present invention is the ability to send digital data packets over a dedicated data channel in the system 100. To facilitate sending digital data packets over the random access and dedicated channels, the present invention includes means for switching between the random access and dedicated data channels, depending on the bandwidth demand of the user (or mobile unit) that is communicating data packets. The details of the present invention, including the means for switching between the random access and dedicated data channels, will be described in detail below.

While applicable to any digital communications system, the system of the present invention is particularly well suited to the use of CDMA techniques. In a CDMA system, a "User Specific Long Code" is used to encode data and voice transmissions sent over the system. As used herein, the term User Specific Long Code (or Long Code) may refer to a general

spreading code used for encoding transmissions. The use of User Specific Long Codes is a spread spectrum technique by which the data and voice transmissions are altered in such a way as to allow one user's data or voice to be distinguished from that of other users. Thus, User Specific Long Codes  
5 are a means of identifying one system user from many users and extracting that one user's data from the sum of the data of all the other users.

As embodied herein, User Specific Long Codes are selected such that they are uncorrelated over one modulation symbol time. Two long codes are uncorrelated if the result of exclusive-or-ing them results in an equal  
10 number of 1's and 0's when statistically averaged. For example, the following are orthogonal: 0110 and 0101, because  $0110 \text{ XOR } 0101 = 0011$ , i.e., an equal number of 1's and 0's. Long Codes generated as temporal shifts of maximal-length shift register sequences are an example of a means for producing uncorrelated codes. The Long Codes are generated such that they  
15 have long periods; i.e., the pattern of Long Codes repeats very infrequently. For example, if a Long Code is 42 bits long, the period will be  $2^{42}-1$ . Because data sent by one of many users on the system must be distinguishable from all other users' data, the Long Codes must appear totally random, so that two users will not have the same Long Code. A long period for the Long  
20 Codes, such as a period of  $2^{42}-1$  accomplishes this goal, because with such a long period, the Long Codes repeat very infrequently. In practice, then, having such a long period, the Long Codes are, on average, uncorrelated over one information bit time. The use of orthogonal Long Codes is well-known to those skilled in the art.

25 In accordance with the present invention, a searcher and a demodulation element in response to commands from a controller unit, acquire and demodulate a user's information signal. A searcher element is a sliding correlator receiver that continually scans a time domain window in search of a particular user's information signal. In a system with  
30 multiple demodulation elements, a searcher element may also scan a set of time offsets around the nominal arrival of the signal in search of multipath signals that have developed. Typically, the controller directs the searcher to scan the received signal from the base station antenna and correlate the

received signal with a known PN spreading sequence (or Long Code) associated with a particular mobile transmitter. Methods for implementing correlators for this purpose are well known to those skilled in the art.

In one embodiment, illustrated in FIG. 2, demodulators 206A-206C  
5 are permanently assigned to receive signals for paging/access, paging/random-access and traffic channel functions, respectively. The corresponding searchers 210A-210N may be assigned and desassigned to demodulators 206A-206C as required by controller 212 and communicated over interconnection bus 214. Generally, a searcher is assigned to search for  
10 a User Specific Long Code only when the user (or transceiver) initiates a data transmission session. The searcher to demodulator assignment scheme, which will be detailed later, enables relatively few searchers to provide service to potentially thousands of users. It should also be noted that demodulator elements 206A-206C could also be assigned, preferably also  
15 under the control of controller 212, to receive signals for purposes other than those listed previously.

In a CDMA system, each transceiver has its own personal, permanent Long Code, and each cell site 108 has searchers that search for transmissions using specific Long Codes. (Long Codes need not be permanent, however, as  
20 they can be dynamically assigned by the cell site 108, generating a private long code.) Although a user can transmit data at any time, for the data to be received by the cell site 108, the cell site 108 must assign a searcher to the Long Code corresponding to that user's transceiver. As noted above, many users (perhaps thousands) may be attempting to transmit data packets to a  
25 single cell site 108 via a random access channel. With so many users, if each had its own personal searcher seeking only that user's Long Code, the system would require literally thousands of searchers to handle all the users.

Therefore, in the present invention, each user must be assigned a  
30 searcher before data transmitted by that user can be received by the base station. Referring to Figure 2, when a system user 202 has data to send to the switching station 110, the user 202 makes a packet data transmission request on a standard Access Channel 204, which serves the system on the

reverse link, i.e., from the users 202 to the cell site 108. Although each Access Channel 204 in the system has its own particular Long Code, each user 202 has a priori knowledge of that Long Code and thus uses that Long Code to transmit over the Access Channel 204 to an paging/access channel  
5 transceiver 206A in the cell site 108 and gain access to the cell site 108, the transmission being collected at the cell site 108 by an antenna 207 that is coupled to transceiver 206A. Based on this Access Channel transmission, the cell site 108 learns of the user's 202 request to access the random access channel 208 and thereby transmits packet data over paging/random access  
10 transceiver 206B. The user 202 is assigned (i.e., granted access) to the random access channel 208.

The user 202 then sends a signal over the Access Channel to the paging/random access transceiver 206B requesting that a searcher 210 be assigned to the user 202. The transceiver 206B sends a signal to a controller  
15 212, asking the controller 212 to locate a free searcher from among the available searchers 210 that can be assigned to the user 202. The controller 212 examines the searchers 210 and locates a free searcher (i.e., one that is not presently assigned to another user) from among the searchers 210. Once the controller 212 locates the free searcher, it assigns the free searcher to the  
20 user 202. In the cell site 108, which has a priori knowledge of each user's Specific Long Code, the transceiver 206B sends the user's 202 Long Code to the controller 212, which relays the Long Code to the free searcher.

The free searcher assigned to the user 202 can now begin searching for data packets transmitted by the user 202. The free searcher, however, has no  
25 information on when the user 202 will transmit data packets. The free searcher, therefore, simply begins searching for signals encoded with the user's 202 Long Code. If the free searcher detects multiple signals with that user's Long Code, the free searcher is thus receiving multipath signals and treats them accordingly, e.g., combining those signals to maximize the  
30 effective signal-to-noise ratio for the user 202, as described below.

Accordingly, the uniqueness of the Long Codes is used by the cell-sites 108 to identify and exploit multiple propagation paths using a signal combining method. When a signal is sent between the user 202 and a cell-

site 108, the signal will likely take several propagation paths, resulting in several versions of the same signal arriving at the cell-site 108 at slightly different times. Multipath effects occur when, for example, the signal is reflected off buildings or other structures between the transmitter and the receiver. By using a specific Long Code for each of the users transmitting data, if the cell-site 108 receives several signals, it can distinguish the transmissions of one user from those of other users. Consequently, the cell-site 108 can distinguish multipath signals from the particular user of interest from those sent by other users. The cell site 108, using a signal combining method, can take the multiple signals from the one user and combine them to combat multipath fading by using all the energy available at the receiving antenna 207 and by preventing the multiple paths from combining destructively (i.e., out of phase). Signal combining methods are well known to those skilled in the art.

Thus, the user 202 must obtain a searcher assignment before the transceiver 206B will receive data packets from the user 202. As a result, because each system user does not have its own permanently assigned and unique searcher, each user need not have its own personal searcher, thereby reducing the number of searchers 210 required at each cell site 108. There need only be sufficient searchers 210 to handle the anticipated user load on the system, which is a function of the anticipated maximum number of total data packet users that will attempt to simultaneously send data packet transmissions. If this maximum number of users is exceeded, i.e., all channel(s) for communicating data packets are busy, any user that receives a busy signal will be placed in a queue to be assigned a free searcher. The user 202 does not have to place a request for the free searcher each time it has data to send. Rather, the searcher reservation scheme of the present invention will leave the free searcher assigned to the user 202 between data packets sent by user 202. The searcher reservation scheme of the present invention, which uses a priority assignment algorithm to handle outstanding requests from users to reserve a searcher, will be described in detail below.

On both random access and dedicated data channels, the power level of the signal being transmitted can be controlled in order to optimize the efficiency of the transmission and to maintain a sufficient power level so as to prevent losing any of the data being transmitted. In communications systems, a minimum threshold power level exists for data transmissions. When the power level of a signal falls below that threshold level, the cell-site 108 will be unable to read the data, resulting in data loss. On the other hand, when the strength of a signal significantly exceeds the minimum threshold power level, the signal will interfere with other signals being transmitted within the system, also resulting in data loss. Accordingly, it is not only desirable, but imperative, to control the power level of signals being transmitted over a communications system.

Various power control systems are well known in the art that are compatible with systems that communicate via spread spectrum techniques, such as CDMA. Two such systems are disclosed in U.S. Patent Nos. 5,056,109 and 5,257,283, which are assigned to the assignee of the present invention. In those systems, and with reference to Figure 1, cell-site 108 transmitted signal power is measured as received by the remote unit (e.g., reference numeral 102 or 104), and the transmitted power is adjusted at the unit in an opposite manner with respect to increases and decreases in received signal power. Additionally, a power control feedback scheme may be used. In that scheme, at the cell-site 108 communicating with the remote unit 102, the transmitted power from the remote unit 102 is measured as received at the cell-site 108. A command signal is generated at the cell-site 108 and transmitted to the remote unit 102 for adjusting the transmission power of the remote unit 102 corresponding to deviations in the cell-site 108 received signal power. The feedback scheme is used to adjust the remote unit's 102 transmission power so as to arrive at the cell-site 108 at a desired power level.

In CDMA systems, for example, Traffic Channels are provided to handle certain transmissions between remote units 102 and cell sites 108. Such transmissions include voice and data signals. A CDMA system may also incorporate the random access channel of the present invention, which



is used to handle data packets transmitted between the remote units 102 and the cell sites 108. In accordance with the present invention, it is preferable to use the same power control method, on both the Traffic Channels and the random access channels. The use of Long Codes on the random access  
5 channels makes it possible to identify the power level of individual users and therefore makes it possible to control their power levels.

As noted above, in accordance with the present invention, and with reference to Figure 2, both a random access channel 208 and a dedicated data channel 214 can be implemented within the same communication system.  
10 Both the random access 208 and dedicated 214 channels can be used to transmit data packets. A system having many users 202 that communicate data can have both types of channels 208, 214 and thereby accommodate a wide variety of data services. Thus, when a user 202 has a large amount of data to be transferred to the home base 110, a channel assignment is  
15 dedicated to the user 202. Only the user 202 assigned to the dedicated channel 214 will be permitted to transmit data over that channel, until the user 202 completes its data transfer. On the other hand, when a user 202 transmits bursts of data, it is preferable to have those bursts sent over a random access channel 208 shared by many users and accessed by request  
20 when bursty transmissions must be made.

With reference to Figure 3, a processor 302, located in switching station 110, may be provided that controls switching between the dedicated channel (or Traffic Channel) 214 and the random access channel 208. Typically, a switching station 110 collects communication information  
25 306A-306N from the respective base station units 108A-108N. The bandwidth demand, which is included in communication information 306A-306N, is then utilized by processor 302 to determine, by a method described later, when switching between the dedicated channel 214 and the random access channel 208 is appropriate for each mobile station associated  
30 with base station units 108A-108N. Alternatively, processor 302 may determine that all the mobile stations are to switch simultaneously from dedicated channel 214 to random access channel 208 and vice-versa.

In the system of the present invention, a first threshold level, which relates to bandwidth demand, is set that determines when the processor 302 will switch a user 202, who is communicating with a cell site 108 over the random access channel 208, from the random access channel 208 to the Traffic Channel 214. As illustrated, the processor 302 may be located at switching station 110. Alternatively, processor 302 could be located at each individual cell site (not shown). In either implementation, the processor 302 may cause a switching signal, preferably over paging channel 304, to be sent the user 202, causing the user 202 to switch between the random access channel 208 and the dedicated (or Traffic) channel 214. As noted above, this first threshold level is based on a bandwidth demand of the user 202. When the bandwidth demand of the user 202 exceeds the first threshold level, the processor 302 switches the user 202 from the random access channel 208 to the Traffic Channel 214.

Conversely, a second threshold level is set that determines when the processor 302 will switch the user 202, who is communicating with the cell site 108 over the Traffic Channel 214, from the Traffic Channel 214 to the random access channel 208. This second threshold level is also based on the bandwidth demand of the user 202, and when the bandwidth demand of the user 202 drops below the second threshold level, the processor 302 switches the user 202 from the Traffic Channel 214 to the random access channel 208. As previously mentioned, the processor 302 may cause a switching signal, preferably over paging channel 304, to be sent to user 202, causing the user 202 to switch between the dedicated (or Traffic) channel 214 and the random access channel 208. Each threshold level may be adjusted independently.

As embodied herein, on the reverse link 130, the random access channel is associated with a TIA/EIA/IS-95 Paging Channel, with one or more Data Packet Channels per Paging Channel. To multiplex data packet transmissions from remote units 102 with transmissions by other remote units on the reverse link 130, the User Specific Long Codes are used.

## II. RANDOM ACCESS CHANNEL DESIGN

With reference to Figures 4-11, the channel design of the random access channel of the present invention will be described, referring

specifically to the CDMA environment and to cellular systems having mobile stations communicating with base stations. It is to be understood, however, that most of the random access channel design described herein is not limited to CDMA, but rather is applicable in other digital communications systems, including TDMA. Moreover, it should be understood that the random access channel design described herein is not limited to cellular applications or to mobile stations. First, the channel design of the random access channel forward link will be described. The channel design of the reverse link will then be described.

10           A.     The Forward Link Channel

The forward link random access channel for carrying packet data can be considered a subchannel of a combined cellular paging and packet data channel on the CDMA forward link. An example of a cellular paging channel is the CDMA Paging Channel defined in TIA/EIA/IS-95. The CDMA Paging Channel is used for communication from the cell site 108 to the mobile station 104 for such purposes as broadcasting system overhead information, locating the mobile, assigning a Traffic Channel, and other signaling for system control purposes.

Various ways exist for defining a subchannel of a forward link CDMA channel. Some cellular systems pre-define data subchannels as logical subchannels in a continuous or bursty paging channel data stream. The CDMA Paging Channel (TIA/EIA/IS-95) can support a subchannel by defining a special message type that carries packet data. This method can be used without changes to the IS-95 Paging Channel procedures for Paging Channel assignment and other call control. This method, however, can be expected to provide impaired performance for the random access channel because the packet subchannel must compete with other Paging Channel messages for the Paging Channel data bandwidth. When other messages are lengthy, random access channel messages will be delayed. This delay will reduce the timeliness of busy/idle channel state feedback to the mobile stations 102, 104, thereby reducing the efficiency of channel sharing among users. To mitigate this impairment, an alternative implementation is used in the present invention.

Preferably, the CDMA random access channel is defined as a subchannel of a new set of paging and packet data channels, using a format that differs from the IS-95 Paging Channel format in such a way that normal cellular paging channel functions do not interfere with random access channel data. The new random access channels are referred to herein as Packet/Paging Channels. The Packet/Paging Channel of the present invention will now be described, with initial reference to the physical layer of the Packet/Paging Channel, and then its structure.

#### 1. Physical Layer

10 The modulation characteristics of the Packet/Paging Channel are the same as that of a CDMA Paging Channel, as defined in § 7.1.3 of TIA/EIA/IS-95, with the following three exceptions. First, there can be 0 to 7 Packet/Paging Channels on a forward CDMA channel, using Walsh codes starting with Walsh code 33 through 39, in sequence. The number of  
15 Packet/Paging Channels is identical to the number of Paging Channels, as broadcast in the PAGE\_CHAN field of the TIA/EIA/IS-95 "System Parameters Message." Walsh codes 33-39 are selected because they are related to the CDMA Paging Channel Walsh codes through a simple transformation, namely, inversion of the last 32 bits of the 64-bit code  
20 sequence. This pairing of Paging Channels and Packet/Paging Channels may be advantageous if aggregated channels are used for higher-rate services. Any other pairing can be used, however, without substantially changing the nature of the present invention.

Second, the Packet/Paging Channel has a power control subchannel.  
25 This power control subchannel is identical to that of a CDMA Forward Traffic Channel, as described in § 7.1.3.1.7 of TIA/EIA/IS-95. The power control subchannel is active only when reverse packet channel data are being received.

Third, with reference to Figure 4, the Packet/Paging Channel is  
30 scrambled using a Packet/Paging Channel Long Code mask 400. Preferably, the mask follows the parameters of the mask shown in Figure 4. Thus, as illustrated, the Long Code mask 400 contains 42 bits (bits 0 through 41). The first portion 402 of the Long Code mask 400 is nine bits long (i.e., bits 0-8)

and constitutes a Pilot Pseudo-Noise (Pilot\_PN) sequence offset index for the forward link CDMA channel. The Pilot PN sequence offset index is as defined in TIA/EIA/IS-95 § 7.1.3.2.1. The second portion 404 of the Long Code mask 400 is 12 bits long (bits 9-20), each bit being a zero. The third  
5 portion 406 of the Long Code mask 400 is Packet/Paging Channel number, which is three bits long (bits 21-23) and identifies the number of the specific Packet/Paging Channel, each of which is assigned a unique number. The Packet/Paging Channel Number is in the range from 1 to 7, corresponding to the Walsh Code 33-39 assigned to the Packet/Paging Channel, in order.  
10 The fourth portion 408 is five bits long (bits 24-28), each bit being a zero. Finally, the fifth portion 410 of the Long Code mask 400 is 14 bits long (bits 29-41). The 14 bits of the fifth portion 410 are selected to ensure that the same Long Code is not used for any other type of CDMA channel. They are selected arbitrarily to be different from ordinary Paging and Access  
15 Channels, and the specific value may be varied without affecting the present invention.

## 2. Structure

The structure of the forward link of the Packet/Paging Channel will be described with reference to Figure 5A and Figure 5B. The structure of the  
20 forward link Packet/Paging Channel slots 502, frames 504, and half-frames 506 is similar to that of IS-95 Paging Channels. The Packet/Paging Channel is divided into 80 millisecond ("ms") slots. The slots 502 are grouped into cycles of 2048 slots (163.84 seconds) referred to as maximum slot cycles. Each maximum slot cycle begins at the start of the frame 508 when System Time,  
25 in units of 80 ms, modulo 2048 is zero. The slots of each maximum slot cycle are numbered from 0 to 2047, as shown in Figure 5A and Figure 5B. A mobile station operating in the slotted mode monitors the Paging Channel using a slot cycle with a length that is a submultiple of the maximum slot cycle length (see § 6.6.2.1.1.3 of TIA/EIA/IS-95).

30 Each 80 ms slot 502 comprises four Packet/Paging Channel frames 510, each of the four frames being 20 ms in length. Each 20 ms long Packet/Paging Channel frame 504 is divided into 10 ms long Packet/Paging Channel half-frames 506. Alternating half-frames contain Paging

Subchannel and Packet Subchannel data. The first half frame in each Packet/Paging Channel frame 504 is a Paging Subchannel half-frame 512, while the second half-frame in each Packet/Paging Channel frame 504 is Packet Subchannel half-frame 514. The length of the frames 504, the timing sequence of the half-frames 506, and the division of frames 504 into two  
5 half-frames of equal size is of no consequence to the invention. Thus, the frames 504 can have a different length than that specified, the timing sequence can be different, and the half-frames need not be of equal size.

Figure 5A and Figure 5B also shows the structure of the Paging Subchannel half-frames 512. The structure of these half-frames 512 is nearly  
10 identical to that described in TIA/EIA/IS-95, except that successive alternating half-frames are shown in Figure 5A and Figure 5B as concatenated to form the Paging Subchannel data stream, rather than adjacent half-frames as in TIA/EIA/IS-95. The Paging Subchannel structure  
15 is shown for reference only, however, because the structure of the Paging Subchannel is of no consequence to the invention, and any other Paging Subchannel structure can be used. The messages and protocols of the Paging Subchannel in the preferred embodiment of the present invention are identical to those of the CDMA Paging Channel, as defined in TIA/EIA/IS-  
20 95.

Figure 6A and Figure 6B illustrates the structure of the half-frames 602 comprising the Packet Subchannel. The Packet Subchannel is a continuous bit stream within which Packet Subchannel message capsules begin and end without regard to frame or half-frame boundaries. A Packet  
25 Subchannel message capsule 604 comprises one Packet Subchannel message plus framing and Cyclic Redundancy Check (CRC), an error detection code, as shown by reference numeral 606. CRC is explained in TIA/EIA/IS-95 § 7.7.2.2.2, which defines the 30-bit CRC for the Paging Channel. The Packet Subchannel could be designed similarly.

30 The structure of a Packet Subchannel half-frame 602 is shown in Figures 7A-7C. As illustrated in Figure 7A, each Packet Subchannel half-frame 602 contains a busy/idle bit 702 and a half-frame body 704. Referring to Figure 7B, if the busy/idle bit 702 is set to zero, the half-frame body con-

tains only Packet Subchannel Message Data 706. When the busy/idle bit 702 is set to zero, the channel is idle and thus open for communication, and, as illustrated in Figure 7B, the Packet Subchannel Message Data is 95 bits long. The 95 bit length, however, is only exemplary; other Packet Subchannel Message Data lengths can be selected. On the other hand, as illustrated in Figure 7C, if the busy/idle bit 702 is set to one, meaning the channel is busy, the half-frame body 704 contains a current user identifier (User ID) 708 (15 bits long) and Packet Subchannel Message Data 710 (shown as 80 bits long). Again, these bit lengths are only exemplary.

10 User IDs are local to a Packet/Paging Channel. That is, the same User ID may be used for different mobile stations on different Packet/Paging Channels. A single Packet/Paging Channel is identified by its Walsh code and the PN sequence offset of the forward CDMA channel (PILOT\_PN, as shown in Figure 4).

15 Packet Subchannel messages 606 have a structure such as that shown in Figure 8. At the beginning of the message is a flag octet 802, which may be standard "01111110" flag used in "High-Level Data Link Control" (HDLC) framing, as defined in "Data Communication--High-Level Data Link Control Procedures--Consolidation of Elements of Procedures," International Organization for Standardization ("ISO"), ISO-4335, 1984. Standard HDLC rules for zero insertion and deletion are used to prevent data between flags from being interpreted as flags. The field 804 is a 30-bit Frame Check Sequence (FCS), which is the CRC described in TIA/EIA/IS-95 § 7.7.2.2.2. Other framing and frame check methods may be used in accordance with the present invention. The Message Text field 806 holds the data packet being transmitted and has a maximum length of 2048 octets. The message also includes a message type 808, an 8-bit message identifier. Finally, at the end of the message is a second flag octet 810, the same as the flag octet 802 described above. Those skilled in the art will recognize that this message structure is only exemplary.

### 3. Signaling

To support the Packet/Paging Channel, two Paging Channel message types are used: Packet/Paging Channel Assignment and Packet/Paging

Channel Overhead. These messages can be sent on any CDMA Paging Channel, including those defined in TIA/EIA/IS-95 and the Paging Subchannel of the Packet/Paging Channels of the present invention.

5 The Packet/Paging Channel Assignment message is sent by a base station to assign or deassign a mobile station to the Packet/Paging Channel. Implementations can also include the ability to assign mobile stations to a particular Packet/Paging Channel. The Packet/Paging Channel Assignment message contains a Mobile Station Identifier (MSID), which can be a mobile identification number (MIN), electronic serial number (ESN), or other  
10 identifier in the format defined in IS-95. The Assignment message also contains an ASSIGN\_TYPE field, which indicates to which type of channel, a Paging Channel or Packet/Paging Channel, the base station is assigning the mobile station. For example, if ASSIGN\_TYPE = 0, then the mobile is being assigned to the Paging Channel; if ASSIGN\_TYPE = 1, then the mobile is  
15 being assigned to the Packet/Paging Channel. Finally, the Packet/Paging Channel Assignment message contains a CHANNEL field, which contains an optional CDMA frequency channel number assigned by the base station.

The Packet/Paging Channel Overhead message is sent by the base station to control global parameters related to the Packet/Paging Channel.  
20 The Packet/Paging Channel Overhead message contains a MAX\_LEN parameter, which indicates the number of octets permitted in a reverse packet channel transmission burst. The burst may consist of one or more reverse packet channel messages, but the total burst length must not exceed the value of the MAX\_LEN parameter. The default value for MAX\_LEN is  
25 2047 octets. The Packet/Paging Channel Overhead message also contains a LOCATION\_CTRL field, which provides information concerning location of the mobile unit. For example, if LOCATION\_CTRL = 0, the base station may rely on IS-95 registration methods to locate the mobile station. If  
30 LOCATION\_CTRL = 1, the mobile station transmits a Packet/Paging Channel Request Message after every idle handoff. The methods of mobile station location will be described in detail below.

Two Packet Subchannel message types may be used in this invention to support the Packet/Paging Channel: User ID Assignment messages and



Packet Delivery messages. The User ID Assignment message consists of the two types of information in the Message Text field of the Packet Subchannel message. First is a User ID field, which is a 15-bit number identifying a mobile station or broadcast message. User IDs 0-15 are reserved for special uses, as defined in the procedures below. The base station may assign other User IDs to individual mobile stations, permitting them to transmit on the Reverse Packet Channel. The second type of information is a mobile station identifier (MSID), which constitutes an MIN, ESN or other identifier, in the formats defined in IS-95.

The Packet Delivery message consists of three types of information in the Message Text field of the Packet Subchannel message. The first is an ID\_TYPE field, with the value "0" indicating a User ID and the value "1" indicating a MSID. The second type of information is an identifier, which can be either a User ID or MSID, according to the value of ID\_TYPE. UID and MSID are as defined for the User ID Assignment message. The third type of information is the packet data being transmitted (DATA field). The format and contents of the DATA field are not important to the present invention. In the preferred implementation, however, the contents of this field are in accordance with the Internet Point-to-Point Protocol (PPP) as defined in Internet RFC 1661.

#### **B. The Reverse Link Channel**

The reverse link channel of the random access channel will now be described. For convenience, it will be referred to herein as the Reverse Packet Channel. The physical layer, synchronization, structure, and signaling of the Reverse Packet Channel will be described.

##### **1. Physical Layer**

The Reverse Packet Channel of the present invention is identical to the CDMA Access Channel defined in §§ 6.1.2 and 6.1.3 of TIA/EIA/IS-95, with four exceptions. First, the Reverse Packet Channel is addressed by long code PN, using the Public Long Code Mask based on mobile station Electronic Serial Number (ESN), as for CDMA Reverse Traffic Channels (see Figure 6.1.3.1.8-2 of TIA/EIA/IS-95). Such addressing permits identification and signal level measurement of transmissions from individual mobile

stations and thus also provides the ability to use multipath diversity reception and to use closed-loop reverse link power control on the Reverse Packet Channels.

Second, one Reverse Packet Channel exists per assigned User ID.  
5 Third, the reverse link transmit power is determined as for a CDMA Reverse Traffic Channel, using the open and closed loop procedures defined in §§ 6.1.2.3 and 6.1.2.4 of TIA/EIA/IS-95. Fourth, the synchronization and structure of the Reverse Packet Channel are as defined in the following descriptions and therefore corresponding sections §§ 6.6.3.1.1 and 6.7.1.1 of  
10 TIA/EIA/IS-95 do not apply.

## 2. Synchronization

The timing of Reverse Packet Channel transmissions will be described with reference to Figure 9. Figure 9 illustrates the timing of the Reverse Packet Channel 902 with respect to the forward link Packet/Paging  
15 Channel 904 described in detail above. As can be seen, the Reverse Packet Channel 902 has a preamble 906 and a packet data message field 908. The Packet/Paging Channel 904 has a Paging Subchannel half-frame 910 (which repeats periodically) and a Packet Subchannel half-frame 912 (which also repeats periodically). A frame 914 of the Packet/Paging Channel 904  
20 comprises the Paging Subchannel half-frame 910 and the Packet Subchannel half-frame 912. At the beginning of each Packet Subchannel half-frame 912 of the Packet/Paging Channel 904 is a busy-idle bit 916, which indicates to the mobile stations monitoring the Packet/Paging Channel 904 whether it is available for communication or busy.

25 The preamble 906 of the Reverse Packet Channel 902 is the same as for the CDMA Access Channel. The length of the preamble 906 is the same as that of a CDMA Access Channel burst, which is broadcast in the PAM\_SIZ field of the *Access Parameters Message*, as defined in TIA/EIA/IS-95 § 7.7.2.3.2.2. In Figure 9, the preamble 906 of the Reverse Packet Channel  
30 902 is shown as one CDMA frame in length.

Mobile stations without User ID assignments cannot transmit on the Reverse Packet Channel 902. The mobile station with a User ID assignment may begin sending the preamble 906 of the Reverse Packet Channel 902 after

the end of a frame 914 containing a busy/idle bit of "0" (see reference numeral 916). The first preamble frame 906 is aligned exactly with the frame boundary 918, but the mobile station transmitter is not enabled until the preceding Packet/Paging Channel frame 920 has been decoded and deinterleaved, and the state of its busy/idle bit 922 has been determined.

If busy/idle bit 922 is "1", the mobile station does not enable the transmitter, discards the preamble frame 906, and waits until a subsequent Packet/Paging Channel frame for its next attempt to transmit. Randomization techniques, such as exponential backoff, are well known to those skilled in the art as methods of selecting the frame for the next attempt in order to minimize the likelihood of simultaneous transmissions (collisions) from multiple mobile stations.

If the busy/idle bit 922 is "0", as shown in Figure 9, the mobile station enables its transmitter and continues sending the preamble 906 for the number of frames indicated in the PAM\_SIZ field of the *Access Parameters Message*. At the end of the preamble transmission, the mobile station begins transmitting Reverse Packet Channel data in the packet data message field 908.

When the base station detects a preamble transmission from a mobile station having an assigned User ID on a Packet/Paging Channel, it sets the busy/idle bit to "1" (see reference numeral 924) and places the User ID of the mobile station being received in the UID field 926 of the Packet Channel half-frame.

Transmitting mobile stations observe the busy/idle bit 924 and the UID field 926 in each Packet Subchannel half-frame 912 following the end of the Reverse Packet Channel preamble 906. The mobile station disables the transmitter and schedules a retransmission of the packet data 908 if either of the following two error indications occurs prior to the end of the Reverse Packet Channel 902 data transmission. The first error indication occurs when the busy/idle bit 924 is set to "0". The second error indication occurs when the busy/idle bit 924 is set to "1" and the UID field 926 does not contain the User ID assigned to the mobile station. For this second error indication, a User ID of "0" can be used by the base station to force all

mobiles monitoring the Packet/Paging Channel 904 to stop transmitting. This method is also used to indicate that an error has been detected in receiving the packet data 908 from the mobile.

The base station keeps the busy/idle flag set to "1" for two frames following the end of the mobile station's packet data transmission. The User ID in these frames is the User ID of the mobile station if no errors were detected during transmission, or "0" if errors occurred. The base station considers the transmission ended after any of the following: (1) when the base station has received the end of the data part of the transmission, as determined from a length field (see Figure 10) of the reverse packet data transmission, or (2) at the end of the first frame in which a reception error is detected, or (3) at the end of the first frame during which the mobile station was commanded to cease transmission.

The transmitting mobile station also observes the busy/idle flag for two frames following the end of transmission. If either of the two error indications (see above) occurs, the mobile station assumes that the reception was not successful and reschedules the transmission.

### 3. Structure

The structure of Reverse Packet Channel transmissions 1000 is illustrated in Figure 10. As shown in Figure 10, Reverse Packet Channel transmissions 1000 have a preamble 1002, a length field 1004, a message field 1006, and a padding field 1008. The preamble 1002 is as discussed above with respect to synchronization of the Reverse Packet Channel. The length field 1004 contains the number of CDMA frames that will be transmitted by the mobile station in this transmission. The message part 1006 of the transmission may contain one or more Reverse Packet Channel messages, having the format shown below. The padding field 1008 consists of all zeros and is added to the end of the message field 1006 to make the transmission span an integer number of CDMA frames. The size of the padding field 1008 is determined by the size of the message field 1006 after zero insertion.

With reference to Figure 11, the message field 1006 of the Reverse Packet Channel transmission 1000 contains one or more instances of message structure, which is the same as for the forward Packet Subchannel.

As illustrated in Figure 11, the message structure of the message field 1006 comprises five fields: a first flag field 1102, a message type field 1104, a message text field 1106, an Frame Check Sequence (FCS) field 1108, and a second flag field 1110. As shown, the first and second flag fields 1102, 1110 are each 8-bit fields. The first flag field 1102, however, can be omitted for the first message in a Reverse Packet Channel transmission. Only one flag field is required between successive messages in a transmission. The message type field 1104 is an 8-bit field, and the FCS field 1108 is 16-bits. Finally, the message text field 1106 is at most 2048 octets long, although it may be shorter. All indicated field sizes, however, are before zero insertion.

#### 4. Signaling

To support the random access channel of the present invention, the mobile stations signal the base stations on Access Channels. Various Access Channel message types are used to support the random access channel, including Packet/Paging Channel Requests and User ID Requests. These messages are sent on the Access Channel selected by the mobile station. Neither of these messages is considered an "implicit registration," as defined in IS-95. The Reverse Packet Channel uses Packet Submit message types, as described herein.

Furthermore, it is assumed that Access Channel messages, such as *Origination Messages*, can be sent on the Reverse Packet Channel as well as on the CDMA Access Channel. This allows the use of the Reverse Packet Channel for more efficient transmission of call control messages, especially for *Origination Messages*, whose length may be restricted on the Access Channel, requiring an *Origination Continuation Message* to complete the transmission of all dialed digits.

### III. OPERATING PROCEDURES

#### A. Packet/Paging and Access Channel Selection

In Packet/Paging Channel selection, mobile stations and base stations select the Packet/Paging Channel in the same manner as selection of the Paging Channel in TIA/EIA/IS-95 § 6.6.2.2.1.2. The Walsh code for the selected Packet/Paging Channel is the Paging Channel Walsh code plus 32.

In Access Channel selection, when monitoring the Packet/Paging Channel, mobile stations making access attempts use the same Access Channel as would be used for accesses when monitoring the corresponding Paging Channel. Access Channel selection is described in TIA/EIA/IS-95 § 6.6.3.1.1.2.

Figure 12A illustrates Packet/Paging Channel selection. After a mobile station begins the process of obtaining a Packet/Paging Channel (Step 1202), the mobile station's IS-95 control processor generates a Connect Indication signal (Step 1204), indicating that the mobile station is connected to the IS-95 Paging Channel, which is then monitored by the mobile station. The mobile station then sends a Packet/Paging Channel Request Message on the Access Channel (Step 1206) to the base station and enters an Assignment Wait State 1208, in which the mobile station awaits assignment by the base station to a Packet/Paging Channel. If the mobile station receives no answer to the Packet/Paging Channel Request Message, the control portion of the mobile station generates a Timeout Message (Step 1216), which causes the mobile to leave the Assignment Wait State 1208 and to send another Packet/Paging Channel Request Message (Step 1206). The mobile station then reenters the Assignment Wait State 1208. If, however, the base station answers the mobile station's Packet/Paging Channel Request Message and sends a Packet/Paging Channel Assignment on the Paging Channel (Step 1210), the mobile station deletes any previous searcher reservation by setting the User ID to zero and sets the Wait List Flag to False (Step 1212), which indicates that the mobile station is not on the base station's Wait List awaiting a free searcher. The mobile station then enters the Idle State 1214 and monitors the assigned Packet/Paging Channel.

#### B. Slotted Paging Mode

When using the Packet/Paging Channel of the present invention, mobile stations that do not have a User ID assignment may operate in the slotted paging mode. This is done according to the requirements of TIA/EIA/IS-95 § 6.6.2.1.1. Use of the slotting paging mode provides battery savings during periods when no packet data are being sent or received by the mobile stations.

### C. Searcher Management

Acquisition of packet transmissions on the Reverse Packet Channel is performed by a functional entities called "searchers," which are located at base stations and which were described above with reference to Figures 1 and 2. The searcher entity is a correlator that continually scans the received signal from the base station antenna, seeking to detect the presence of a reverse channel signal by examining the correlation between the received signal and the known PN spreading sequence (or Long Code) of a mobile transmitter. Methods for implementing correlators for this purpose are well known to those skilled in the art. The searcher looks for a Long Code corresponding to a particular mobile station and that is known to the searcher, as well as preamble data that is also known to the searcher.

The searcher's task is complicated by uncertainty in the delay between the signal emanating from the transmitter and reaching the receiver's antenna. This uncertainty is the result of timing synchronization error and variability in the distance from transmitter to receiver. These factors are inherent in a mobile communication system and cannot be eliminated without a great increase in system cost and complexity. As a result of this uncertainty, a searcher must try a large number of possible timing offsets when seeking a transmitted signal. Since each correlation attempt at a distinct offset requires the collection and integration of signal samples, the searcher hardware and/or software needed for the process is made considerably more complex. Moreover, the time to perform the correlation suggests that a single searcher generally cannot seek more than one PN spreading sequence at a time. Consequently, if there are many possible transmitters, each with a distinct PN sequence to be searched, then in general many searchers are needed.

On the IS-95 Access Channel, the need for many searchers is mitigated by having all mobile stations on a given Access Channel use the same PN spreading sequence (i.e., Long Code). This reduces the number of searchers required, but makes it impossible to resolve transmissions from different mobile stations that transmit simultaneously. (In a CDMA system, if different PN sequences are used, transmissions can be resolved using the

processing gain inherent in CDMA.) The inability to resolve transmissions from different mobiles transmitting simultaneously has the following disadvantages: (1) Transmissions from different mobile stations cannot be distinguished from multipath arrivals of the signal from the same mobile station, and, therefore, it is not possible to combine multipath energy. This results in considerable degradation of the sensitivity of the base station's receiver. (2) Mobile station identity cannot be established until the message is fully received and decoded. This prevents using closed-loop power control for Access Channel transmissions and prevents fast feedback to the mobile station about success or failure of the access attempt. These disadvantages reduce the efficiency of the reverse link by requiring more mobile station transmit power to provide fade margin and by making it impossible to quickly terminate mobile station transmissions if errors are detected by the receiver.

The Reverse Packet Channel described herein eliminates these problems by using a mobile station-specific PN sequence (i.e., a Mobile Specific Long Code) for reverse transmissions. From the discussion above, it is clear that the disadvantages of the Access Channel are mitigated by this approach, but at the cost of requiring a searcher for each mobile station that may transmit on the Reverse Packet Channel. Because searcher hardware and/or software will not generally be an unlimited resource, it is necessary to provide a means for sharing a limited number of searchers among all the mobile stations that use a given Reverse Packet Channel.

Two known methods are available for searcher sharing. The first method is polling, wherein the base station sends a poll to each mobile station in turn, giving permission to transmit. This method may be the most efficient for a single searcher, but is inefficient when many searchers are available. The second method is searcher reservation, which is a method used in the present invention, wherein mobile stations use the Access Channel to request searcher assignment and only transmit on the Reverse Packet Channel when a searcher has been reserved.

#### 1. Mobile Station Searcher Management



The mobile station procedures for searcher management will now be described with reference to Figures 12A-12C. Before entering the searcher management procedures, a mobile station first obtains a Packet/Paging Channel Assignment from the base station. This was described above with reference to Figure 12A. As illustrated in Figure 12A, to enter the Mobile Station Idle State 1214, or after an idle handoff, the mobile station is first connected to and then monitors the IS-95 Paging Channel (Step 1204). The mobile station sends a Packet Channel Request Message on the Access Channel (Step 1206) and enters the Assignment Wait State 1208. If the base station does not respond with a Packet/Paging Channel Assignment Message within a set amount of time, the control portion of the mobile station generates a time out signal (Step 1216), indicating that the base station has not responded, and causing the mobile station to send another Packet Channel Request Message (Step 1206). If, however, the base station does respond and assigns the mobile station to a Packet/Paging Channel (Step 1210), the mobile deletes any previous searcher reservation, sets the User ID to zero and the Wait List Flag to false (Step 1212) and enters the Idle State 1214. The mobile station then monitors the assigned Packet/Paging Channel.

Referring now to Figure 12B, when in the Idle State 1214, mobile stations monitor the Packet/Paging Channel at all times while assigned to such a channel, including when transmitting. As a result, when in the Idle State 1214, the mobile station may receive a User ID Assignment Message from the base station on the Packet/Paging Channel causing the mobile to delete its searcher reservation and User ID assignment. For example, if the mobile station receives a User ID Assignment Message from the base station that contains the mobile station's assigned User ID, but with an MSID that does not match the mobile station's MSID (Step 1254), the mobile station will examine the received User ID (Step 1256). If the received User ID is not equal to the currently assigned User ID (the "<> UID" branch of Step 1256), the mobile station simply reenters the Idle State 1214. If the received User ID is equal to the currently assigned User ID (the "==" UID" branch of Step 1256), the mobile station deletes the searcher reservation and sets the User

ID equal to zero (Step 1258). It then reenters the Idle State 1214. Similarly, if the mobile station receives a User ID Assignment Message from the base station containing the mobile's MSID and a User ID of zero (Step 1260), the mobile station sets its User ID equal to the received User ID and deletes its searcher reservation (Step 1262). Again, it reenters the Idle State 1214.

5 Mobile stations use the following procedure for reserving searchers and sending packet data on the Reverse Packet Channel when in the Idle State 1214. When a mobile station has packet data to send (Step 1218), it must be determined whether its has a searcher reservation (Step 1220). If the User ID is less than or equal to 15, as shown in Step 1220, the mobile station does not have a searcher reservation, and it must then be determined whether the mobile is on the base station Wait List (Step 1222). If it is on the Wait List (i.e., WtList Flag = TRUE), the mobile station is placed in the User ID Wait State 1226. If, on the other hand, the mobile station is not on the wait list (i.e., WtList Flag = FALSE), the mobile sends a User ID Request Message on the Access Channel (Step 1224) and then enters the User ID Wait State 1226.

10 As illustrated in Figure 12C, once in the User ID Wait State 1226, the mobile station awaits assignment of a User ID from the base station. The control portion of the mobile station monitors the time that the mobile has been in the User ID Wait State 1226 without receiving a User ID assignment, and if that time exceeds some set amount, the control generates a timeout signal (Step 1228). The mobile station then sends another User ID Request Message to the base station on the Access Channel (Step 1230), and the mobile station returns to the User ID Wait State 1226.

15 If the timeout is not exceeded, and the mobile station receives a User ID assignment from the base station on the Packet/Paging Channel (Step 1232), the mobile station has a searcher reservation and can transmit data packets. The mobile station sets its User ID with the User ID received from the base station (Step 1234). The mobile can then send packet data on the Reverse Packet Channel (Step 1236). The mobile station monitors whether packet data transmissions are successful (Step 1238). If transmission was successful (the "TRUE" branch), the mobile station sets the Wait List Flag to

"TRUE" (Step 1240) and enters the Idle State 1214. If, on the other hand, transmission was unsuccessful (the "FALSE" branch), the mobile station sets the Wait List Flag to "FALSE" and the User ID to zero (Step 1242). The mobile then sends another User ID Request Message on the Access Channel  
5 (Step 1244) and reenters the User ID Wait State 1226.

Referring back to Figure 12B, if the User ID received by the mobile station is greater than 15 (see Step 1220), the mobile station already has a User ID and can send packet data. The mobile sends its packet data on the Reverse Packet Channel (Step 1246). It then checks whether transmission  
10 was successful (Step 1248). If successful, the Wait List Flag is set to "TRUE" (Step 1250), and the mobile reenters the Idle State 1214. If unsuccessful, the Wait List Flag is set to "FALSE" and the User ID to zero (Step 1252). Thus, with reference to Figure 9, the mobile station deletes its searcher reservation if the Packet Subchannel busy/idle flag 916 of the Packet/Paging Channel 904  
15 is not set to busy following transmission of a preamble 906 on the Reverse Packet Channel 902. The mobile station then executes Steps 1222-1226 described above.

If the mobile station had successfully transmitted a packet on the Reverse Packet Channel after making a deleted searcher reservation, the  
20 mobile station will be placed on the base station's waiting list and need not request a new reservation when it has data to send. Instead, it may wait for the base station's automatic reassignment, which normally occurs at the end of a waiting period. If the mobile station had not successfully transmitted a packet on the Reverse Packet Channel after making the searcher reservation  
25 just deleted, the mobile station requests a new reservation when it has data to send.

## 2. Base Station Searcher Management

With reference to Figures 13A-13E, the base station searcher management procedures will be described. Referring to Figure 13A, after  
30 initialization (Step 1302), the base station awaits a Packet Channel Request Message sent by a mobile station over the Access Channel (Step 1304). When the base station receives such a message, it sends a Packet Channel Assignment Message over the Paging Channel (Step 1306) to the mobile

station. The base station then enters the Idle State (Step 1308), in which it awaits a User ID request from the mobile station. Presumably, both the mobile and base stations are in the Idle State at this point waiting for a User ID request. Upon receiving a User ID Request Message from the mobile station on the Access Channel (Step 1310), the base station examines the User ID list (Step 1312), looking for an idle searcher.

At this point, the base station begins searcher management procedures. If the base station receives a User ID Request Message from a mobile station when a searcher is idle (i.e., when the User ID list is "NOT EMPTY" in Step 1312), the searcher is assigned to the mobile station, a User ID for the mobile station is selected, and the base station sends a User ID Assignment Message to the mobile station on the Packet/Paging Channel (Step 1314). The base station may verify the mobile station's identity and its permission to use packet data services prior to assigning a User ID. Upon sending the User ID to the mobile station, the base station management procedure enters the Active State 1316, and the searcher begins searching for transmissions from the mobile station encoded with its User Specific Long Code. If, however, the base station receives a User ID Request Message from the mobile station when no searcher is idle (i.e., when the User ID list is "EMPTY" in Step 1312), the base station places the mobile station on a Wait List (Step 1318) and sets the Wait List Flag to "FALSE". The base station then enters the Wait State 1320, and both the mobile station and base station wait for an available User ID.

Referring now to Figure 13B, the base station may exit the Wait State 1320 under at least two circumstances. First, when a searcher becomes available, a User ID notification signal is generated by a base station global searcher control (Step 1322), notifying the base station of the available User ID. The base station then reassigns the available searcher to the waiting mobile station and sends a User ID Assignment Message on the Packet/Paging Channel to the waiting mobile station (Step 1324). The mobile station then enters the Active State 1316.

Second, when the waiting mobile exceeds its wait time, as determined by the base station global searcher control, a Wait Time Exceeded signal is

generated by the global searcher control procedure (Step 1326). The base station then examines the User ID list to determine whether or not it is empty (Step 1328). If the User ID list is not empty, the base station reassigns the searcher to the waiting mobile station, executes Step 1324, and then enters the Active State 1316. If the User ID list is empty (Step 1328), a Ready Notification Signal is sent to the global searcher control (Step 1330) indicating that the mobile has exceeded its wait time and that no available User ID exists. The base station then enters the Ready State 1332, which indicates a greater urgency for the mobile to receive a User ID. When a User ID becomes available, the global searcher control then generates a User ID Notification Signal (Step 1334), notifying the base station of the available User ID. The base station then reassigns the searcher from a mobile having an assigned User ID that exceeds its usage allocation, in accordance with its assigned relative priority, to the waiting mobile station. The base station sends a User ID Assignment Message on the Packet/Paging Channel to the waiting mobile station (Step 1336). The mobile station then enters the Active State 1316.

Base stations can use the same User ID previously assigned, or can use a new User ID. If a new User ID is used, the base station must send a separate User ID assignment message to the mobile whose searcher has been reassigned, revoking the User ID assignment. If, however, the revoked mobile station had successfully transmitted a data packet since receiving the User ID assignment being revoked, the base station automatically places the revoked mobile station on the Wait List. The base station will later reassign the revoked mobile station a User ID in accordance with Wait List priority.

Various methods can be used to manage the priority list for waiting and User ID-assigned mobiles, but in the preferred embodiment, the following procedure is used. For each mobile station, a base station maintains four elements that determine the priority order in which User ID assignments are made: (1) Wait time, which is the time elapsed since the mobile station has been placed on the Wait List. (2) Idle time, which is the time since the last successful transmission from a mobile station that has a User ID assignment. (3) Assignment time, which is the time since the

mobile station was assigned a User ID. (4) Mobile subscriber priority level, in accordance with the subscribed grade of service for the mobile station user. A wait-time threshold, which is shorter for higher priority levels, an idle-time threshold, which is longer for higher priority levels, and an assignment-time threshold, which is longer for higher priority levels, are all associated with each subscriber priority level. The wait-time threshold is fixed, because it must agree with the mobile station's wait-time threshold, and the latter is not controllable by the base station. Idle-time thresholds and assignment-time thresholds, on the other hand, can be varied by the base station in response to traffic load.

The base station controls the assignment of User IDs to those mobile stations assigned to the Packet/Paging Channel. If the base station is in the Wait State 1320 and a searcher becomes available, the base station sends a User ID Assignment message to the mobile that has exceeded its wait time threshold by the greatest amount (see Step 1322).

Referring now to Figure 13C, if any mobile station on the Wait List exceeds its wait-time threshold, the base station will reassign a searcher from active mobile stations (see Step 1316) according to the following procedure:

(1) If no active mobile station (i.e., mobile stations having a User ID assignment) has exceeded its idle-time threshold, nor has any active mobile station exceeded its assignment-time threshold, the base station does not reassign any searchers from active mobile stations to waiting mobile stations. The base station generates a data Tx/Rx Notification signal (Step 1338) and resets the idle timer and sets the Wait List Flag to "TRUE" (Step 1340). The base station then returns to the Active State 1316.

(2) If any mobile station having a UID assignment has exceeded its assignment-time threshold (Step 1342), the base station will reassign the searcher of the mobile station that has exceeded its assignment-time threshold by the maximum amount (Step 1344). This continues until either there are no more mobiles in the Wait List that have exceeded their wait-time thresholds, or there are no more mobiles with User ID assignments that have exceeded their assignment time thresholds. If the mobile

being examined for assignment time age (Step 1344) is not the oldest active, the base station enters the Assignment Timeout State 1346. If, on the other hand, the mobile being examined is the oldest active, its User ID is revoked by the base station sending a User ID Deassignment Message to the mobile  
5 on the Packet/Paging Channel (Step 1348). The base station global searcher management control then sends a User ID Notification Message to the next waiting mobile station (Step 1350), and the Wait List Flag is examined (Step 1352). If the Wait List Flag is FALSE, meaning the mobile is on the Wait List, the base station enters the Idle State (Step 1354). If the Wait List Flag is  
10 TRUE, meaning the mobile is not now on the Wait List, the Wait List Flag is reset to FALSE (Step 1356), and the base station enters the Wait State 1320.

(3) If there remain mobile stations on the Wait List that have exceeded their wait-time thresholds, and there are mobiles having idle times that exceed their idle-time thresholds (Step 1358), the base station will  
15 continue reassigning searchers from the pool of such mobiles, beginning with the mobile station that has exceeded its idle-time threshold by the greatest amount (Step 1360). This continues until either there are no more mobiles in the Wait List that have exceeded their wait-time thresholds, or there are no more mobiles with User ID assignments that have exceeded  
20 their idle time thresholds. When the oldest active idle mobile (i.e., the one that most exceeds its idle time) is located, the same procedures are followed as when the oldest active assigned mobile is located (in Step 1344). If the mobile being examined is not the oldest active idle mobile, then the base station goes to the Idle Timeout State 1362.

25 The mobile station also measures its own wait time, and has a wait-time threshold, which varies with the subscriber priority level. The mobile station's wait-time threshold should be greater than the wait-time threshold used by the base station to allow time for the base station's reassignment process to be completed before the mobile station's wait-time threshold is  
30 exceeded. If a mobile station's measured wait time exceeds the mobile station wait-time threshold and the mobile station has data to send, the mobile station sends a User ID Request Message and resets the wait time to zero.

With reference to Figure 13D, exit from the Idle Timeout State 1362 will be described. As described above, when an active mobile station is examined (in Step 1360) that is not the oldest active idle mobile, the base station enters the Idle Timeout State 1362. At this point, the base station will continue to examine the status of the mobile stations. The base station global searcher control sends a Ready Notification Message to the oldest active idle mobile station (Step 1364). That mobile station's User ID is then revoked via a User ID Deassignment Message sent on the Packet/Paging Channel (Step 1368), and a User ID notification signal is generated by the global searcher control for the next waiting mobile (Step 1370). The Wait List Flag is then examined (Step 1372). If the Wait List Flag is FALSE, meaning the mobile station is on the Wait List, the base station goes to the Idle State 1354. If the Wait List Flag is TRUE, however, meaning the mobile is not on the Wait List, the Wait List Flag is reset to FALSE (Step 1374), and the base station enters the Wait State 1320.

When the base station is in the Idle Timeout State 1362, if the assignment time of a mobile is exceeded (Step 1376), meaning the mobile has had its User ID for too long, the base station enters the Assignment Timeout State 1346. Moreover, when in the Idle Timeout State 1362, the global searcher control generates Data Tx/Rx Notification Messages (Step 1378) that cause the Idle Timer to be reset and the Wait List Flag to be set to TRUE (Step 1380), indicating that the mobile station is not on the Wait List. The base station then enters the Active State 1316.

With reference to Figure 13E, the base station Assignment Timeout State 1346 will be described. The base station may send a Ready Notification Message to its global searcher control (Step 1382), indicating that the oldest active assigned mobile station is about to have its searcher reservation revoked. The base station then revokes that mobile station's User ID by sending a User ID Deassignment Message to the mobile on the Packet/Paging Channel (Step 1386), and a User ID Notification Message is sent by the global searcher control to the next waiting mobile (Step 1388). The Wait List Flag is then examined (Step 1390). If the Wait List Flag is FALSE, the base station enters the Idle State 1354. If the Wait List Flag is



TRUE, the Wait List Flag is reset to FALSE (Step 1392), and the base station returns to the Wait State 1320.

Further, in the Assignment Timeout State 1346, the global searcher control generates a Data Tx/Rx Notification Message (Step 1394) when a  
5 mobile is transmitting or receiving data. The Wait List Flag is then set to TRUE (Step 1396), and the base station returns to the Assignment Timeout State 1346.

#### D. Mobile Station Location

When a base station has packet data to transmit to a mobile station,  
10 two basic methods may be used to deliver the packet data: (1) The base station may rely on IS-95 registration methods to locate the mobile station. With this method, the base station can either page the mobile station to determine its current cell/sector location before transmitting the packet data, or can simply transmit the packet data throughout the location area of  
15 the mobile. (2) The base station may require the mobile station to transmit a Packet/Paging Channel Request Message after every idle handoff, thereby providing exact location information (to the cell/sector) for the mobile at all times.

The first of these methods minimizes the Access Channel traffic  
20 generated by the mobile station, at the cost of an increase in Paging Subchannel traffic and a possible delay in packet delivery. The first method may be a desirable method for high-mobility mobile stations. The second method minimizes delay for most packets at the cost of increased Access Channel traffic. It may be the best approach for low-mobility mobile  
25 stations.

When using the first method, the base station sets the LOCATION\_CTRL field (described above) in a Packet/Paging Channel Overhead Message to "0". The mobile then performs only IS-95 registration as a means of location and packet delivery.

30 When using the second method, the base station sets the LOCATION\_CTRL field in the Packet/Paging Channel Overhead Message to "1". The mobile station sends a Packet/Paging Channel Request Message

after every idle handoff. The mobile station also performs IS-95 registration, as required according to the normal IS-95 procedures.

#### E. Traffic Channel Management

While packet data services are in progress, a mobile station can  
5 commence or end operation on a CDMA Traffic Channel at any time. This  
is done by using the channel assignment, channel release, and related  
procedures defined in TIA/EIA/IS-95. Herein, reference will be made to the  
CDMA Traffic Channel. It is to be understood, however, that in general it is  
preferable to use a dedicated channel to send transmissions that exceed the  
10 bandwidth of the random access channel (e.g., non-bursty, lengthy, or  
continuous transmissions) between the base station and mobile station.  
The Traffic Channel referenced in the remainder of this section is merely an  
exemplary dedicated channel. This section describes the process for  
switching or transitioning between a dedicated channel (or Traffic Channel)  
15 and the random access channel of the present invention when conditions  
dictate that a transition is beneficial. For convenience, the dedicated  
channel will be described with specific reference to the Traffic Channel.  
This process was described above in less detail with respect to Figure 3.

Either the base station or mobile station may initiate the Traffic  
20 Channel assignment process. A mobile station initiates the Traffic Channel  
assignment process by sending an IS-95 *Origination Message* on either the  
access Channel or Reverse Packet Channel. A base station can initiate a  
Traffic Channel assignment by directly assigning a Traffic Channel, or by  
sending a *Page Message* to the mobile station prior to the assignment.

25 The base station uses the following procedure to determine when to  
initiate transitions between the Packet/Paging Channel and Traffic  
Channels:

- (1) If, over a period of time, packet data sent to a mobile or  
received from a mobile station exceed a predetermined threshold level, the  
30 base station assigns the mobile station to a CDMA Traffic Channel. This  
procedure addresses the problem that packet data usage may exceed the  
capacity of the Packet/Paging Channel or the Reverse Packet Channel under

circumstances where users transfer large amounts of data, or carry out an extended session with frequent exchanges of data packets.

(2) If the mobile station user or the base station sets up a second call appearance (e.g., a voice call simultaneous with packet data service) where a Traffic Channel is necessary to carry the new call appearance, the base station assigns the mobile station to a CDMA Traffic Channel.

(3) If the mobile station is in motion and undergoes a rapid succession of handoffs or signal fades, the base station assigns the mobile station to a CDMA Traffic Channel. It will be advantageous to use a Traffic Channel under such circumstances so that connectivity is maintained (e.g., using the soft handoff feature of CDMA cellular) without excessive Access Channel activity to re-establish Packet/Paging Channel assignments.

(4) When a mobile station's Traffic Channel utilization falls below a configured level, the base station releases the Traffic Channel. Criteria for determining when to release the Traffic Channel include idle time (time since the last packet was sent or received), user priority, and mobility history (rapid succession of handoffs or signal fades).

Mobile stations can request assignment to a CDMA Traffic Channel by sending a CDMA *Origination Message* instead of a Paging/Packet Channel Request when initiating packet data service. Mobile stations can also establish their own criteria for making the transition between Traffic Channel and Packet/Paging Channels, so long as the resulting procedures do not conflict with the base station's procedures.

#### 25 IV. CONCLUSION

The present invention provides the capacity to communicate data packets in a digital communication system over a random access channel. In CDMA systems, the invention uses Long Codes to encode the data packets and searchers that recognize the Long Codes for acquisition of packet data on the reverse link, permitting multiple users of the system to share random access channels. The present invention provides procedures for managing the searchers. As a result, many users who transmit infrequently and in small bursts can share the resources of the random access channel without

the need to have a channel dedicated to each user for transmission of its data packets, thereby increasing efficiency in the system and reducing system and subscriber costs. The ability to track the location of mobile units communicating with the base station is also a feature of this invention.

5           Furthermore, the present invention provides means for switching or transitioning between the random access channel and a dedicated channel. The random access channel of the present invention is designed to handle bursty data transmissions. A dedicated channel, on the other hand, is dedicated to the user for the duration of its transmission sequence and is  
10           used, for example, when the user has a large amount of data to send or is transmitting continuously with little or no break between data transmissions. In accordance with the present invention, both types of channels may be provided as well as the ability to transition between them when conditions dictate. Threshold levels can be established for  
15           determining when to transition in either direction (i.e., from the random access channel to the dedicated channel and vice versa). When these threshold levels are met, the user is transitioned to the appropriate channel for transmission of data. In this way, the present invention keeps the random access channel open for bursty users, while providing users with  
20           large volume or continuous data a channel by which to communicate their data. Thus, the random access channel is not overburdened and rendered ineffective for its intended purpose.

          The design of the random access channel may be different for the forward link and the reverse link. On the forward link, a Packet/Paging  
25           Channel is provided incorporating both a Packet Subchannel and a Paging Subchannel. This permits the base station to transmit packet data to a remote user. On the reverse link, a Reverse Packet Channel is provided that handles packet data from remote users so that the data can be sent to the base station.

30           The previous description of the preferred embodiments is provided to enable any person skilled in the art to make or use the present invention. The various modifications to these embodiments will be readily apparent to

those skilled in the art, and the generic principles defined herein may be applied to other embodiments without the use of the inventive faculty. Thus, the present invention is not intended to be limited to the embodiments shown herein but is to be accorded the widest scope consistent  
5 with the principles and novel features disclosed herein.

10 I CLAIM:

## CLAIMS

1. In a digital communication system for communicating digital  
2 information, said digital communication system having a forward link and  
a reverse link, a system for communicating a data packet, comprising:  
4 a communicating transceiver, from among a plurality of transceivers,  
for sending said data packet on a random access channel over said reverse  
6 link and for receiving said digital information from said forward link; and  
a base station for receiving said data packet on said random access  
8 channel from said reverse link and for sending said digital information  
over said forward link;  
10 wherein said plurality of transceivers share said random access  
channel.
2. The system recited in claim 1 wherein each of the plurality of  
2 digital transceivers has a long code and the base station has a searcher; and  
wherein the communicating transceiver requests reservation of said  
4 searcher and sends the data packet over the random access channel on the  
reverse link using said long code corresponding to the communicating  
6 transceiver to obtain an encoded data packet, said searcher recognizing said  
encoded data packet as being sent by the communicating transceiver based  
8 on said long code corresponding to the communicating transceiver.
3. The system recited in claim 1 wherein the digital  
2 communication system includes a broadcast channel for communicating  
paging and control messages over the forward link; and wherein the digital  
4 information is interleaved with said paging and control messages on said  
broadcast channel.
4. The system recited in claim 3 wherein the digital  
2 communication system is a CDMA communication system, and wherein  
the broadcast channel and a forward data packet channel are combined to  
4 obtain a Packet/Paging Channel on the forward link, said Packet/Paging  
Channel including a Packet Subchannel and a Paging Subchannel.

5. The system recited in claim 4 wherein the Packet/Paging  
2 Channel has a power control subchannel for controlling a power level of  
the data packet when the data packet is being received by the base station.

6. The system recited in claim 1, further comprising a dedicated  
2 channel for communicating the data packet.

7. The system recited in claim 6 wherein each of the plurality of  
2 digital transceivers has a bandwidth demand, the system further comprising  
a processor for switching from the random access channel to the dedicated  
4 channel when said bandwidth demand exceeds a first threshold level.

8. The system recited in claim 7 wherein the processor switches  
2 from the dedicated channel to the random access channel when the  
bandwidth demand drops below a second threshold level.

9. The system recited in claim 6 wherein the digital  
2 communication system is a cellular system having a network of individual  
cell sites and an active mobile transceiver from among the plurality of  
4 digital transceivers is communicating on the random access channel, the  
system further comprising a processor for switching said active mobile  
6 transceiver from the random access channel to the dedicated channel if said  
active mobile transceiver is undergoing a succession of handoffs between  
8 individual cell sites within said network of individual cell sites.

10. The system recited in claim 1 wherein the digital  
2 communication system includes a broadcast channel for communicating  
system information and an access channel for making access requests, said  
4 system information including paging messages;

wherein the communicating transceiver sends a searcher request  
6 message on said access channel and encodes the data packet using a specific  
long code corresponding to the communicating transceiver to obtain an  
8 encoded data packet, the random access channel comprising a Reverse  
Packet Channel, the communicating transceiver sending said encoded data  
10 packet on said Reverse Packet Channel; and

wherein the base station assigns a searcher to the  
12 communicating transceiver in response to said searcher request message  
and sends a searcher assignment to the communicating transceiver.

11. The system recited in claim 10 wherein the base station  
2 includes a plurality of searchers for locating the encoded data packet based  
on the specific long code; and wherein the base station includes a controller  
4 for locating an idle searcher from said plurality of searchers and for sending  
the specific long code to said idle searcher.

12. The system recited in claim 10 wherein the digital  
2 communication system includes a Packet/Paging Channel on the forward  
link; wherein the communicating transceiver sends a Packet/Paging  
4 Channel Request Message to the base station on the access channel; and  
wherein the base station assigns the communicating transceiver to said  
6 Packet/Paging Channel in response to receiving said Packet/Paging Channel  
Request Message.

13. The system recited in claim 10 wherein the base station  
2 includes a plurality of searchers for locating the encoded data packet based  
on the specific long code; wherein the base station has a searcher assignment  
4 waiting list; and wherein if the base station is unable to locate an idle  
searcher from said plurality of searchers, the base station places the  
6 communicating transceiver on said searcher assignment waiting list.

14. The system recited in claim 13 wherein when one of the  
2 plurality of searchers becomes a new idle searcher, the base station removes  
the communicating transceiver from the searcher assignment waiting list  
4 and assigns the communicating transceiver to said new idle searcher.

15. The system recited in claim 14 wherein each of the plurality of  
2 transceivers has a priority level; wherein an assigned transceiver has an  
assignment to one of the plurality of searchers; and wherein when said  
4 priority level of said assigned transceiver becomes lower than said priority  
level of the communicating transceiver, the base station revokes said  
6 assignment from said assigned transceiver resulting in a revoked  
transceiver and assigns the communicating transceiver to said one searcher.

16. In a digital communication system for communicating digital  
2 information, said digital communication system having a forward link and  
a reverse link, a method for communicating a data packet, comprising:  
4 first sending said data packet on a random access channel over  
said reverse link by a communicating transceiver from among a plurality of



- 6 digital transceivers, said plurality of digital transceivers sharing said  
random access channel;
- 8 first receiving said data packet on said random access channel from  
said reverse link by a base station;
- 10 second sending said digital information over said forward link by said  
base station; and
- 12 second receiving said digital information from said forward link by  
said communicating transceiver.

17. The method recited in claim 16 wherein each of the plurality of  
2 digital transceivers has a specific long code and the base station has a  
searcher; the method further comprising:
- 4 requesting reservation of said searcher by the communicating  
transceiver;
- 6 providing to said searcher said specific long code corresponding to the  
communicating transceiver; and
- 8 encoding the data packet being sent on the random access  
channel with said specific long code corresponding to the communicating  
10 transceiver to obtain an encoded data packet, said searcher recognizing said  
encoded data packet as being sent by the communicating transceiver based  
12 on said corresponding specific long code being provided to said searcher.

18. The method recited in claim 16, further comprising first  
2 communicating a paging message and a control message on a broadcast  
channel over the forward link; and interleaving the digital information  
4 with said paging message and said control message on said broadcast  
channel.

19. The method recited in claim 18 wherein the digital  
2 communication system is a CDMA communication system, the method  
further comprising combining the broadcast channel and a data packet  
4 channel to obtain a Packet/Paging Channel on the forward link, said  
Packet/Paging Channel including a Packet Subchannel and a Paging  
6 Subchannel.

20. The method recited in claim 19, further comprising  
2 controlling, via a power control subchannel on the Packet/Paging Channel,  
a power level of the data packet when sending the data packet to the base  
4 station.

21. The method recited in claim 16, further comprising  
2 communicating the data packet from the communicating transceiver to the  
base station over a dedicated channel.

22. The method recited in claim 21 wherein each of the plurality of  
2 transceivers has a bandwidth demand, the method further comprising first  
switching from the random access channel to the dedicated channel when  
4 said bandwidth demand exceeds a first threshold level.

23. The method recited in claim 22, further comprising second  
2 switching from the dedicated channel to the random access channel when  
the bandwidth demand drops below a second threshold level.

24. The method recited in claim 21 wherein the digital  
2 communication system is a cellular system having a network of individual  
cell sites; and wherein an active mobile transceiver from among the  
4 plurality of digital transceivers is communicating on the random access  
channel, the method further comprising switching said active mobile  
6 transceiver from the random access channel to the dedicated channel if said  
active mobile transceiver is undergoing a succession of handoffs between  
8 individual cell sites within said network of individual cell sites.

25. The method recited in claim 16 wherein the digital  
2 communication system includes a broadcast channel for communicating  
system information and an access channel for making access requests, said  
4 system information including paging messages, and wherein the random  
access channel comprises a Reverse Packet Channel, the method further  
6 comprising:

third sending a searcher request message on said access channel by the  
8 communicating transceiver;

first assigning a searcher to the communicating transceiver by the  
10 base station in response to said searcher request message;

fourth sending a searcher assignment to the communicating  
12 transceiver by the base station; and

encoding the data packet using a specific long code corresponding to  
14 the communicating transceiver to obtain an encoded data packet;

wherein the first sending step includes transmitting said encoded  
16 data packet on said Reverse Packet Channel over the reverse link.

26. The method recited in claim 25, further comprising locating an  
2 idle searcher from a among plurality of searchers; and fifth sending the  
specific long code to said idle searcher.

27. The method recited in claim 25 wherein the digital  
2 communication system includes a Packet/Paging Channel, the method  
further comprising fifth sending a Packet/Paging Channel Request Message  
4 to the base station on the access channel; and second assigning the  
communicating transceiver to said Packet/Paging Channel in response to  
6 receiving said Packet/Paging Channel Request Message.

28. The method recited in claim 25 wherein the base station  
2 includes a plurality of searchers for locating the encoded data packet based  
on the specific long code; and wherein the base station has a searcher  
4 assignment waiting list, the method further comprising placing the  
communicating transceiver on said searcher assignment list if the base  
6 station is unable to locate an idle searcher from among said plurality of  
searchers.

29. The method recited in claim 28, the method further  
2 comprising removing the communicating transceiver from the searcher  
assignment waiting list and second assigning the communicating  
4 transceiver to a new idle searcher.

30. The method recited in claim 29 wherein each of the plurality of  
2 transceivers has a priority level; and wherein an assigned transceiver has an  
assignment to one of the plurality of searchers, the method further  
4 comprising, when said priority level of said assigned transceiver becomes  
lower than said priority level of the communicating transceiver, first  
6 revoking said assignment from said assigned transceiver resulting in a  
revoked transceiver and third assigning the communicating transceiver to  
8 said one searcher.

31. In a digital communication system for communicating  
2 information, said digital communication system including a digital  
transceiver and a base station, said digital transceiver having a bandwidth  
4 demand, a system for data communications, comprising:

6 a random access channel for communicating a data packet between  
said digital transceiver and said base station;  
8 a dedicated channel for communicating said data packet between said  
digital transceiver and said base station; and  
10 a processor for switching from said random access channel to said  
dedicated channel when said bandwidth demand exceeds a first threshold,  
and for switching from said dedicated channel to said random access  
12 channel when said bandwidth demand drops below a second threshold.

32. The system recited in claim 31 wherein the information is  
2 communicated over the digital communication system using code division  
multiple access (CDMA); and wherein the data packet comprises a CDMA  
4 data packet.

33. In a digital communication system for communicating  
2 information, said digital communication system including a digital  
transceiver and a base station, said digital transceiver having a bandwidth  
4 demand, a method for data communications, comprising:  
6 first transmitting a data packet from said digital transceiver to said  
base station over a random access channel;  
8 second transmitting said data packet from said digital transceiver to  
said base station over a dedicated channel;  
10 first switching from said random access channel to said dedicated  
channel when said bandwidth demand exceeds a first threshold; and  
12 second switching from said dedicated channel to said random access  
channel when said bandwidth demand drops below a second threshold.

34. The method recited in claim 33 wherein the information is  
2 communicated over the digital cellular communication system using code  
division multiple access (CDMA); and wherein the data packet comprises a  
4 CDMA data packet.

35. In a digital communication system for communicating  
2 information, said digital communication system having a forward link and  
a reverse link and having a broadcast channel and an access channel, a  
4 system for communicating a data packet, comprising:  
6 a base station for transmitting said data packet on a Packet/Paging  
Channel over said forward link and for determining a location of a mobile

digital transceiver, said mobile digital transceiver receiving said data packet  
8 from said Packet/Paging Channel over said forward link.

36. The system recited in claim 35 wherein the base station sends a  
2 paging message on the broadcast channel over the forward link to  
determine the location of the mobile digital transceiver before transmitting  
4 the data packet.

37. The system recited in claim 35 wherein the location of the  
2 mobile digital transceiver is within an area; and wherein the base station  
transmits the data packet on the Packet/Paging Channel over the forward  
4 link throughout said area.

38. The system recited in claim 35 wherein the system includes a  
2 plurality of base stations each having a handoff region; wherein a handoff  
occurs each time the mobile digital transceiver moves from said handoff  
4 region of one of said plurality of base stations to said handoff region of  
another of said plurality of base stations; and wherein the mobile digital  
6 transceiver sends a request message to the base station on the access channel  
over the reverse link after each said handoff to provide the location of the  
8 mobile digital transceiver.

39. In a digital communication system for communicating  
2 information, said digital communication system having a forward link and  
a reverse link and having a broadcast channel and an access channel, a  
4 method for communicating a data packet, comprising:  
transmitting said data packet on a Packet/Paging Channel over said  
6 forward link by a base station; and  
receiving said data packet from said Packet/Paging Channel over said  
8 forward link by a mobile digital transceiver;  
determining a location of said mobile digital transceiver while  
10 transmitting said data packet.

40. The method recited in claim 39, further comprising sending a  
2 paging message on the broadcast channel over the forward link by the base  
station to determine the location of the mobile digital transceiver before  
4 transmitting the data packet.

41. The method recited in claim 39 wherein the location of the  
2 mobile digital transceiver is within an area; wherein the transmitting step  
includes sending the data packet on the Packet/Paging Channel over the  
4 forward link throughout said area.

42. The method recited in claim 39 wherein the system includes a  
2 plurality of base stations each having a handoff region; wherein a handoff  
occurs each time the mobile digital transceiver moves from said handoff  
4 region of one of said plurality of base stations to said handoff region of  
another of said plurality of base stations, the method further comprising  
6 sending a request message to the base station on the access channel over the  
reverse link after each said handoff to provide the location of the mobile  
8 digital transceiver.

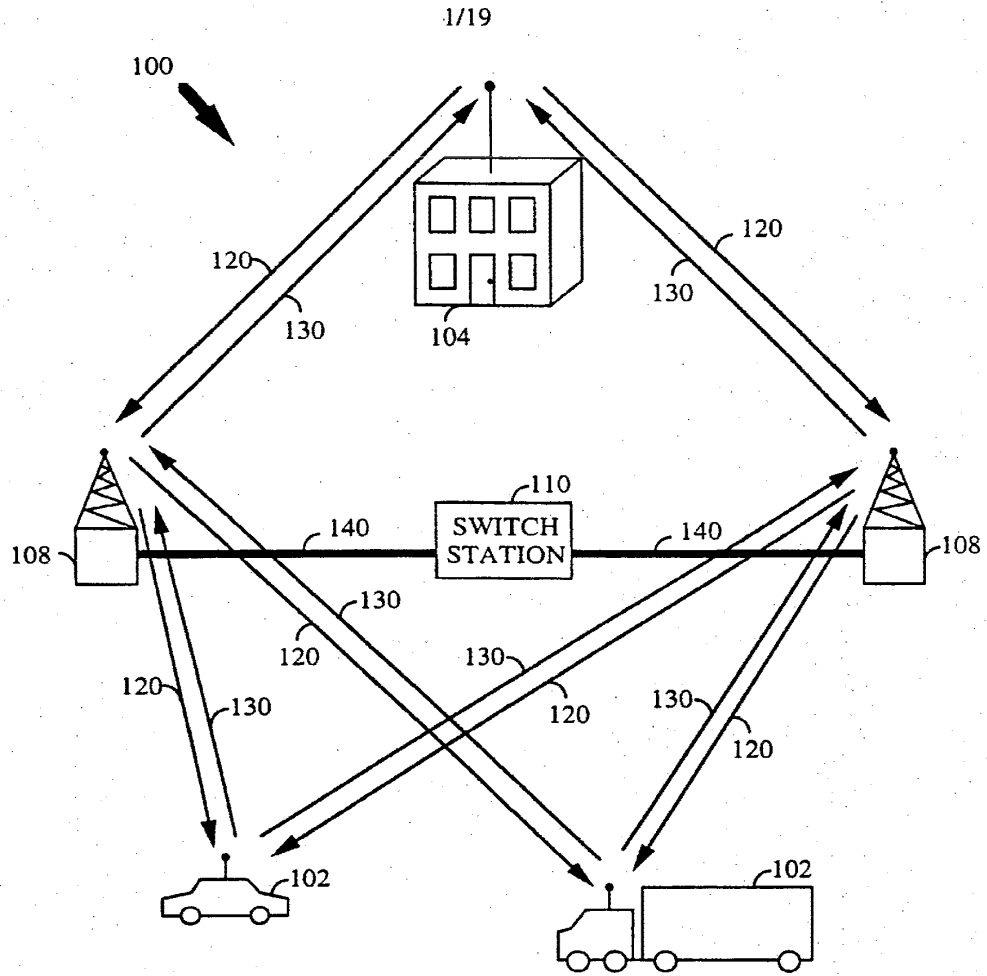

FIG. 1

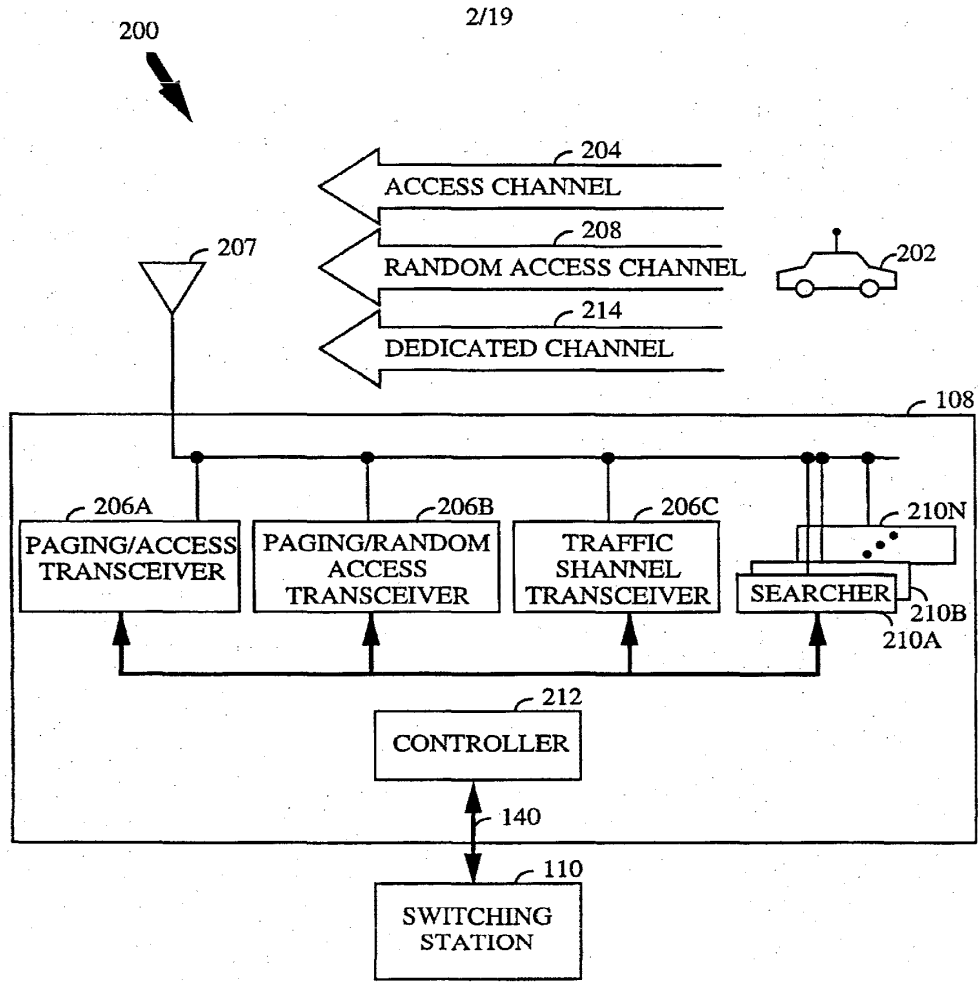

FIG. 2

**SUBSTITUTE SHEET (RULE 26)**



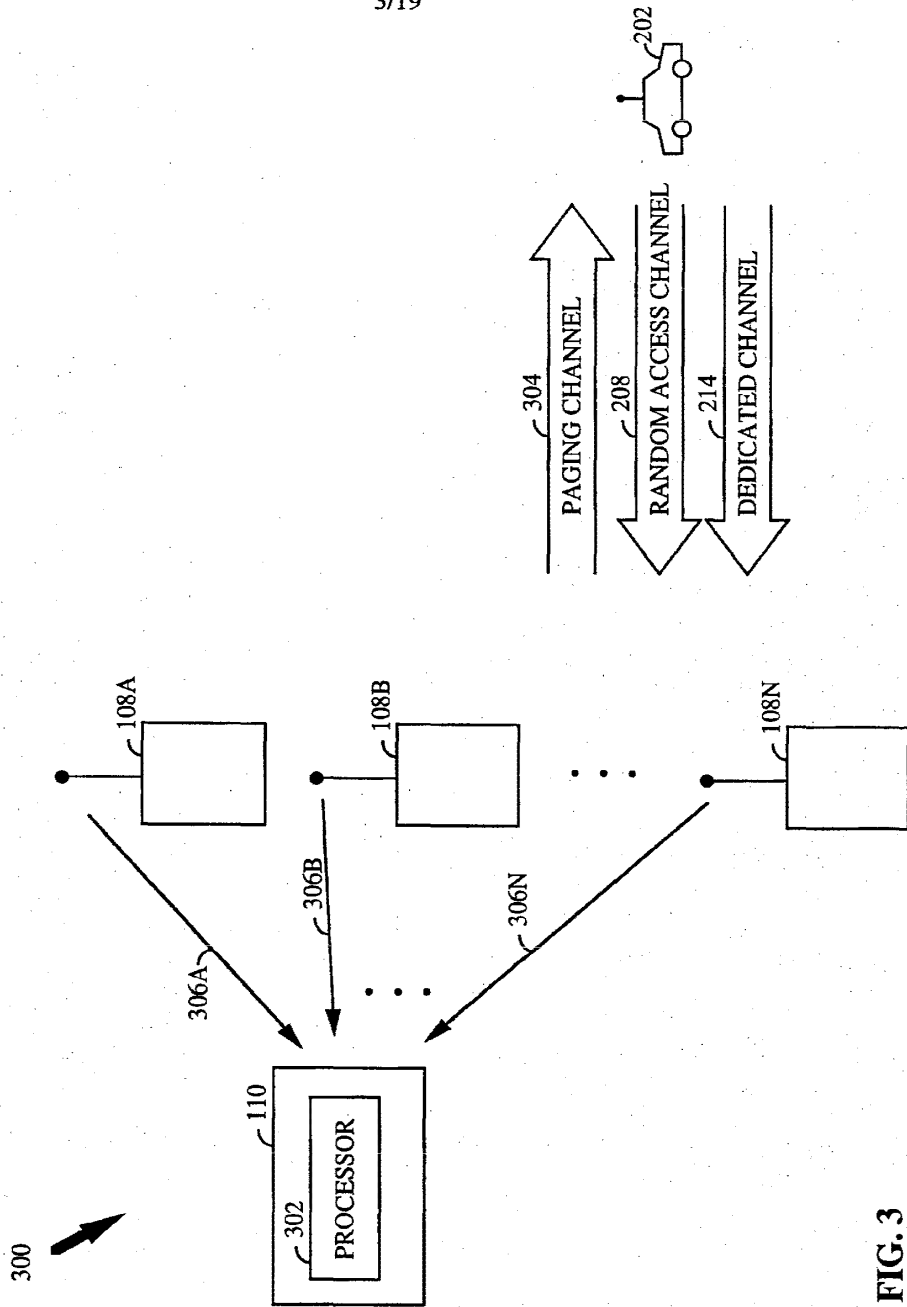

FIG. 3

**SUBSTITUTE SHEET (RULE 26)**

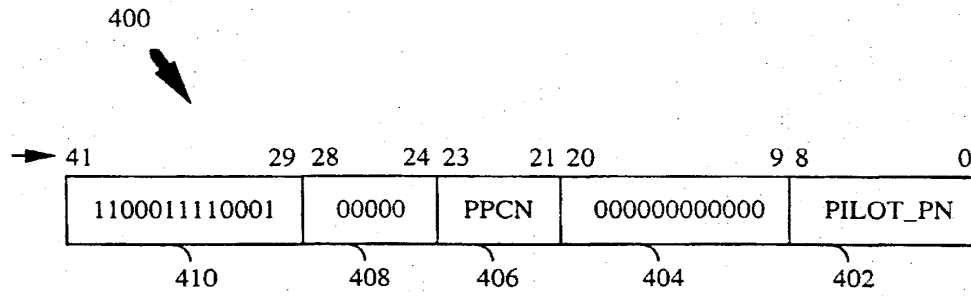
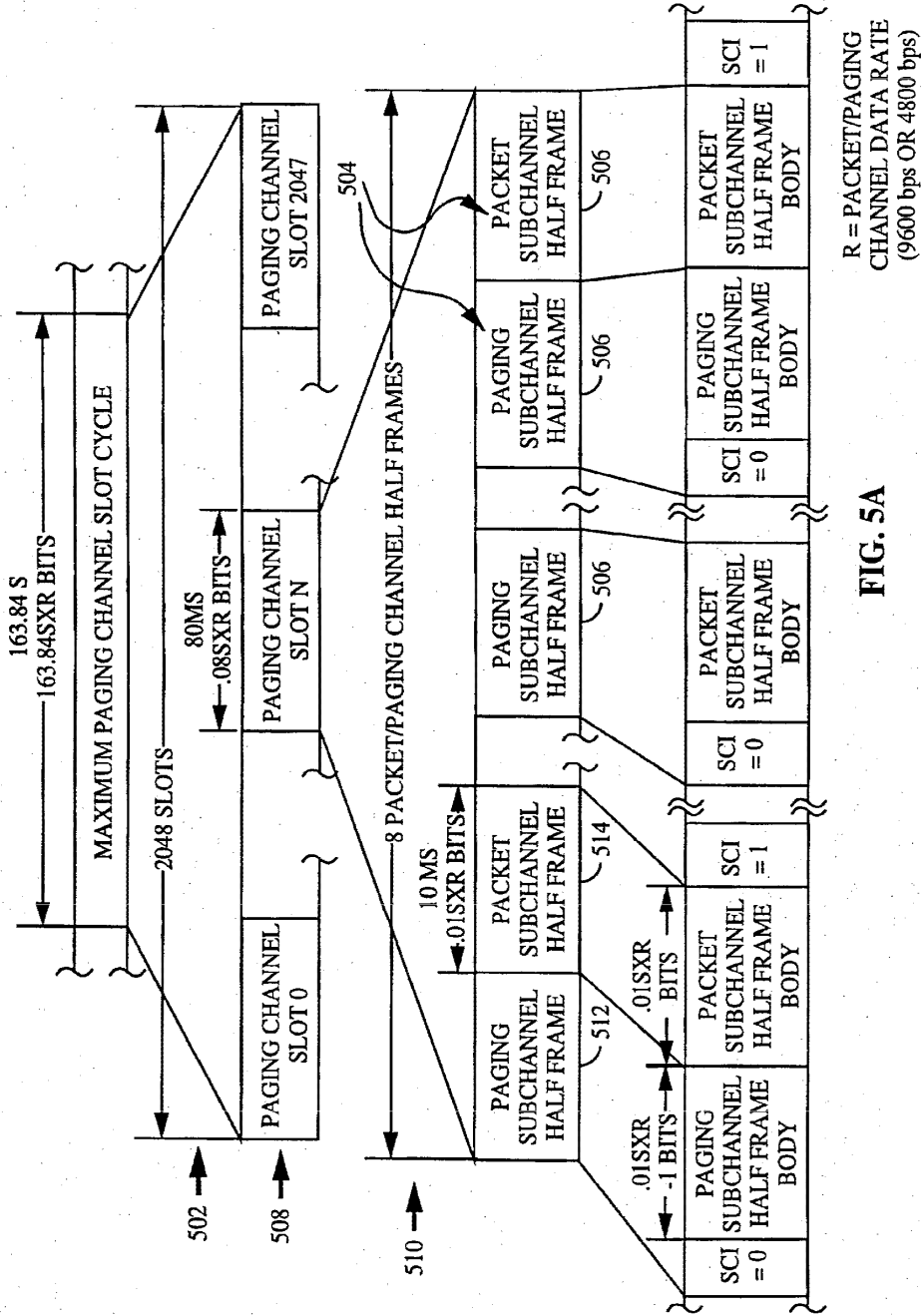

FIG. 4



R = PACKET/PAGING CHANNEL DATA RATE (9600 bps OR 4800 bps)

FIG. 5A

**SUBSTITUTE SHEET (RULE 26)**

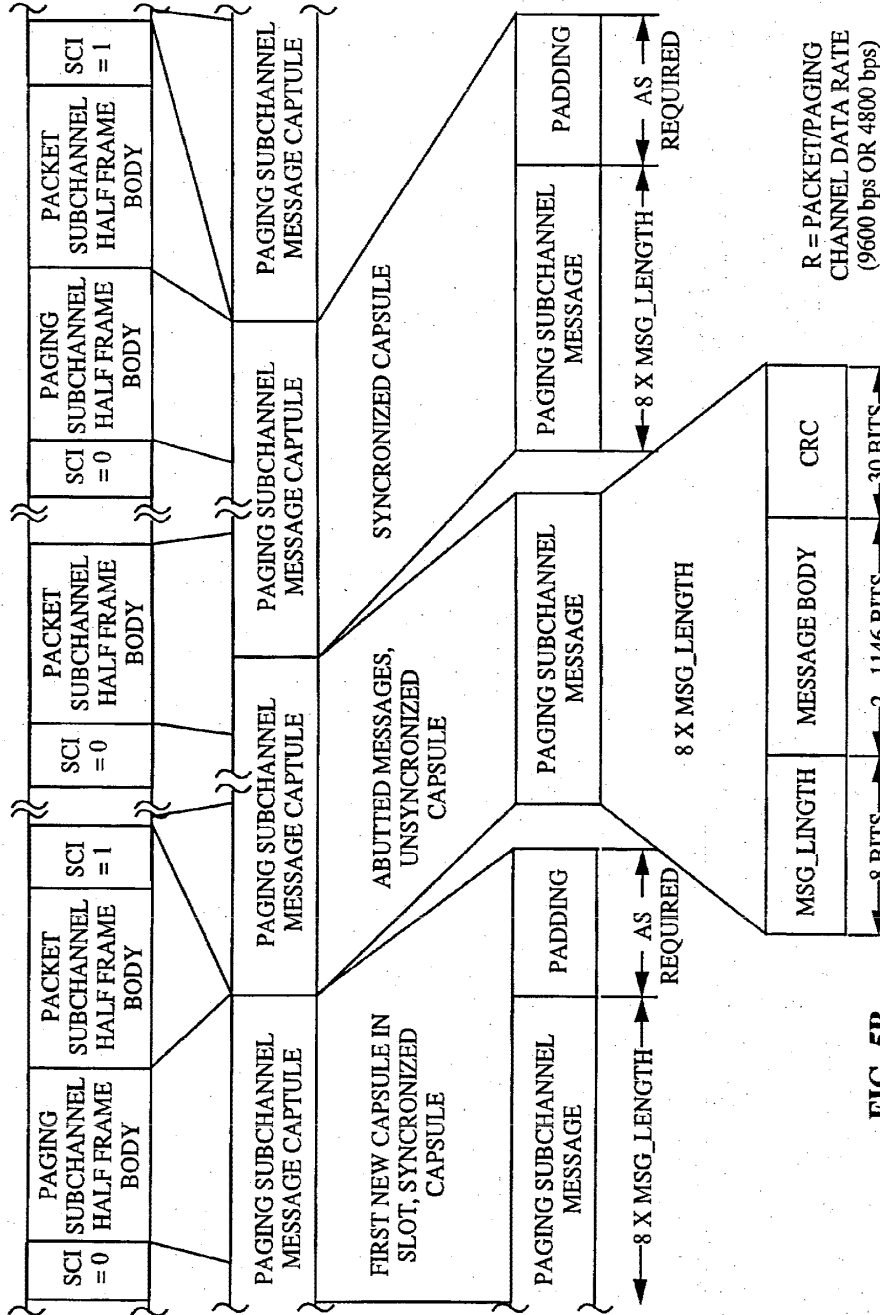

FIG. 5B

**SUBSTITUTE SHEET (RULE 26)**

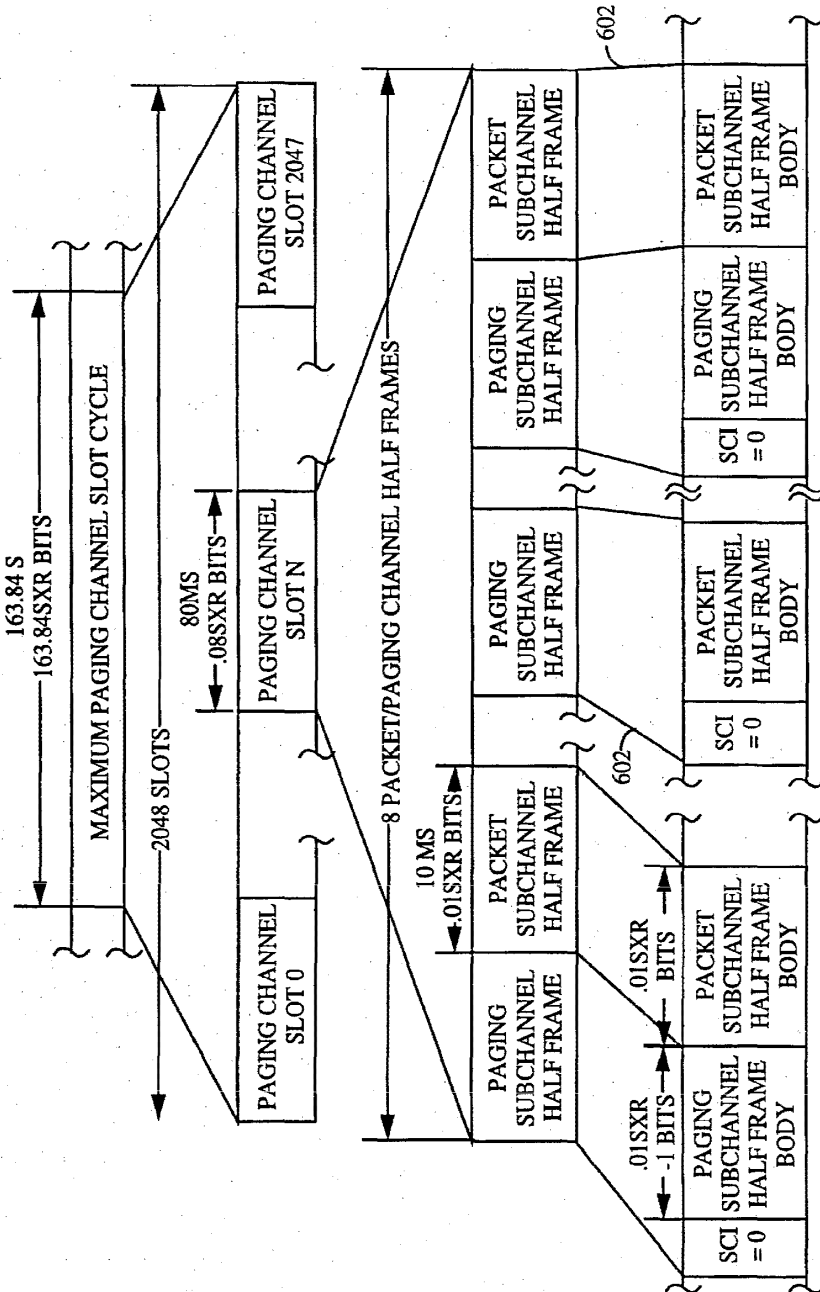

FIG. 6A

**SUBSTITUTE SHEET (RULE 26)**

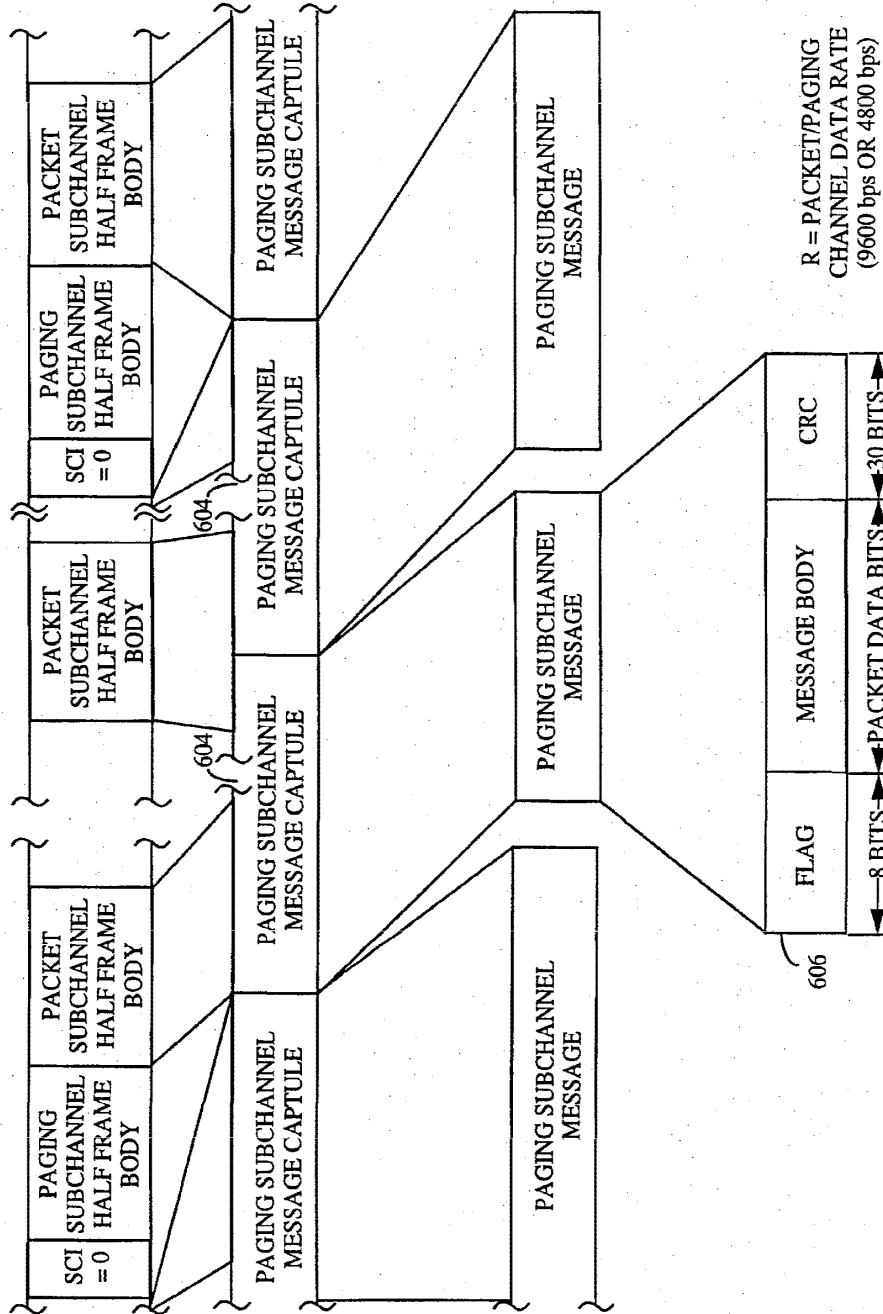

FIG. 6B

SUBSTITUTE SHEET (RULE 26)

FIG. 7A

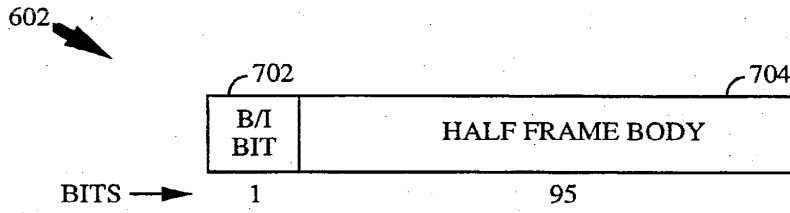

FIG. 7B

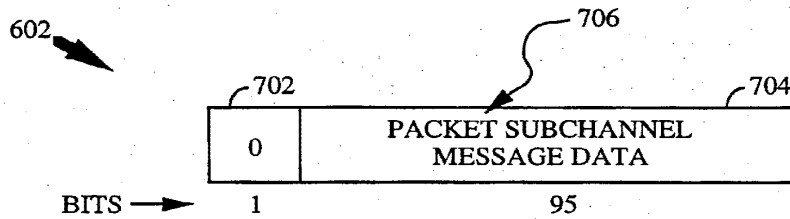
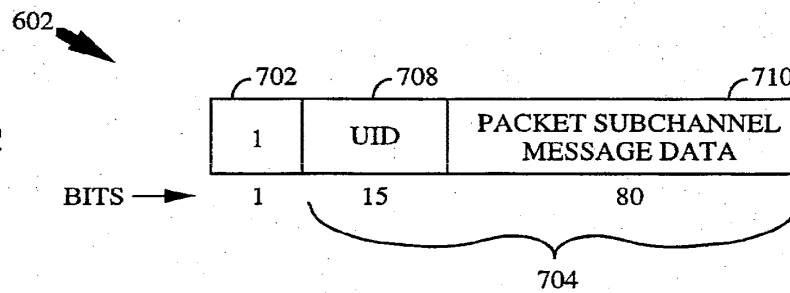

FIG. 7C



**SUBSTITUTE SHEET (RULE 26)**

10/19

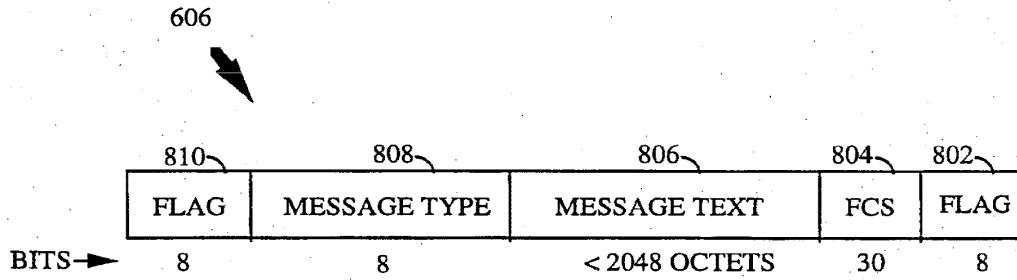
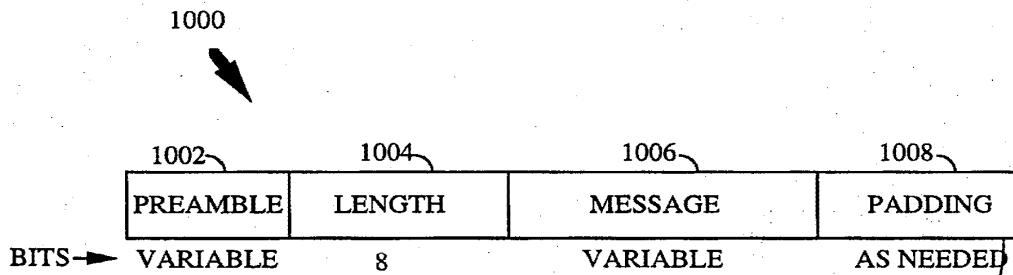

FIG. 8



BUILD IN  
EXTRA SPACE

FIG. 10

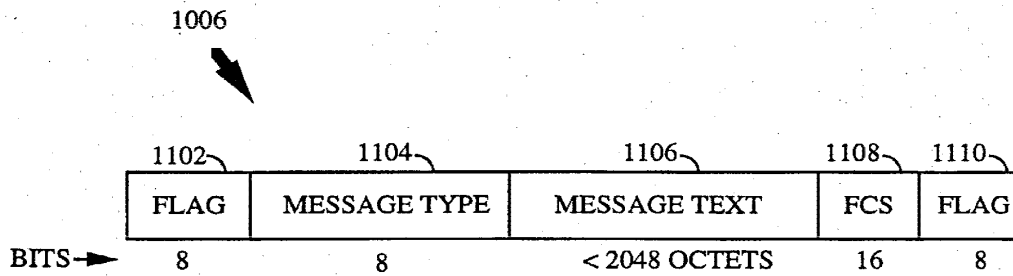

FIG. 11

**SUBSTITUTE SHEET (RULE 26)**



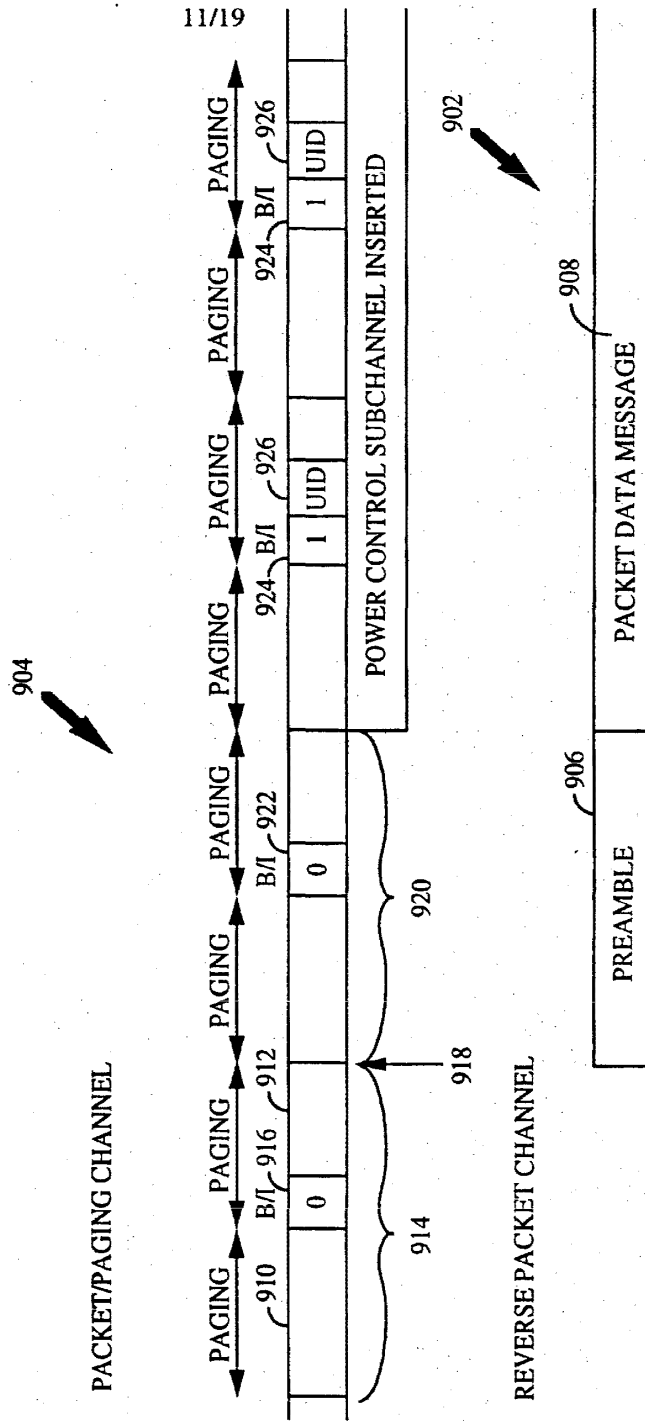

FIG. 9

12/19

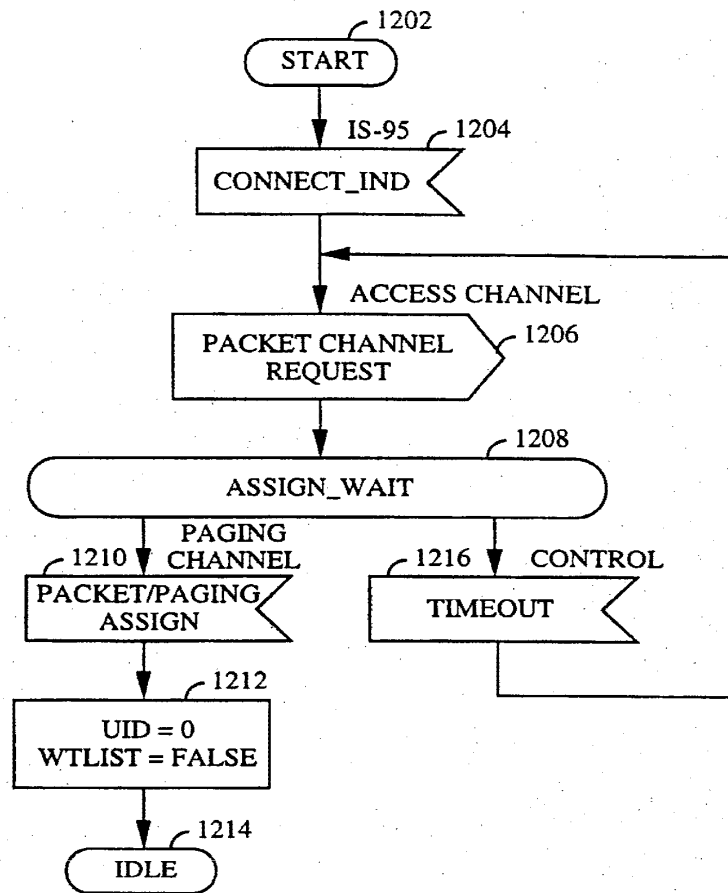
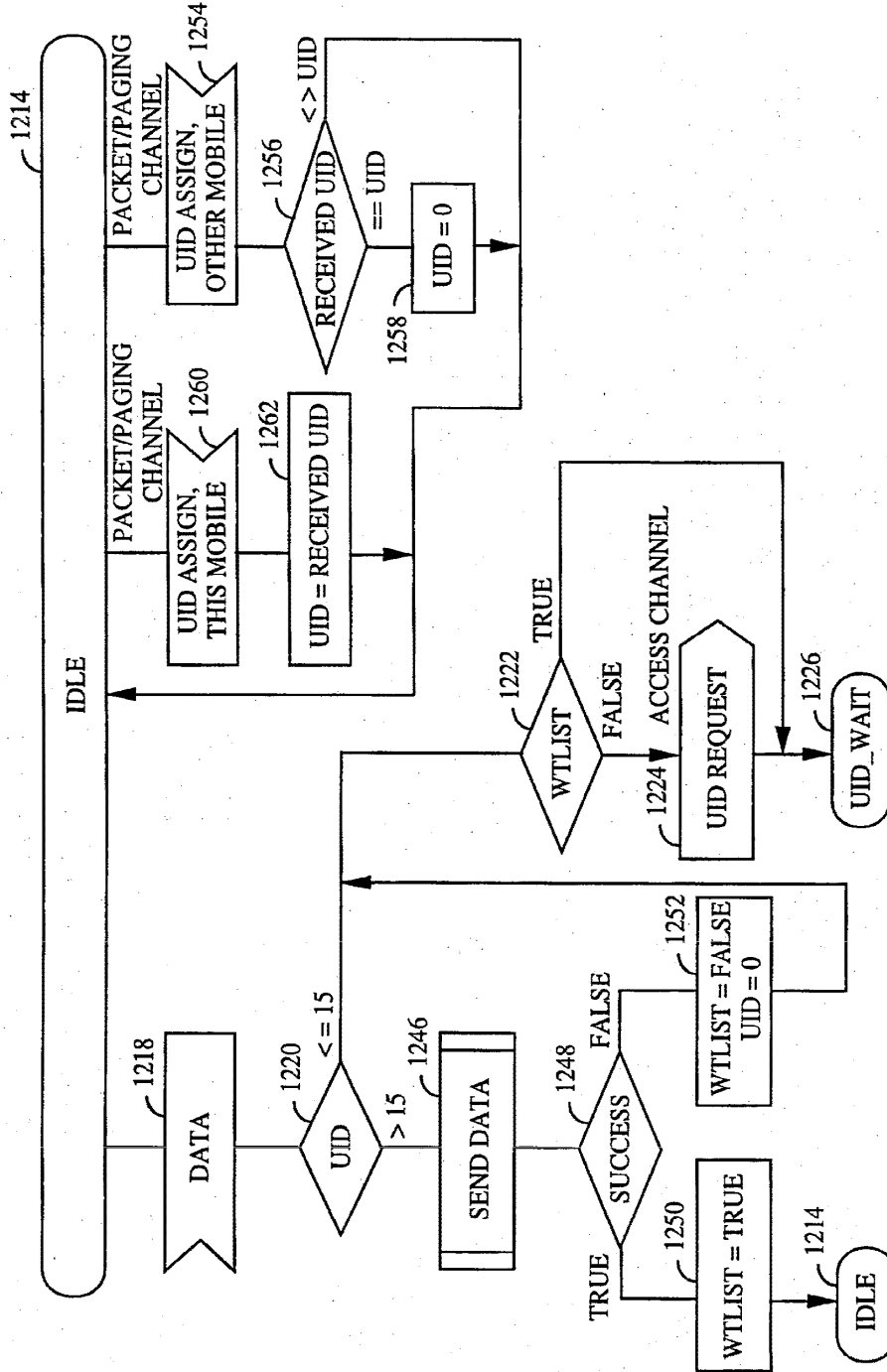

FIG. 12A

FIG. 12B



SUBSTITUTE SHEET (RULE 26)

FIG. 12C

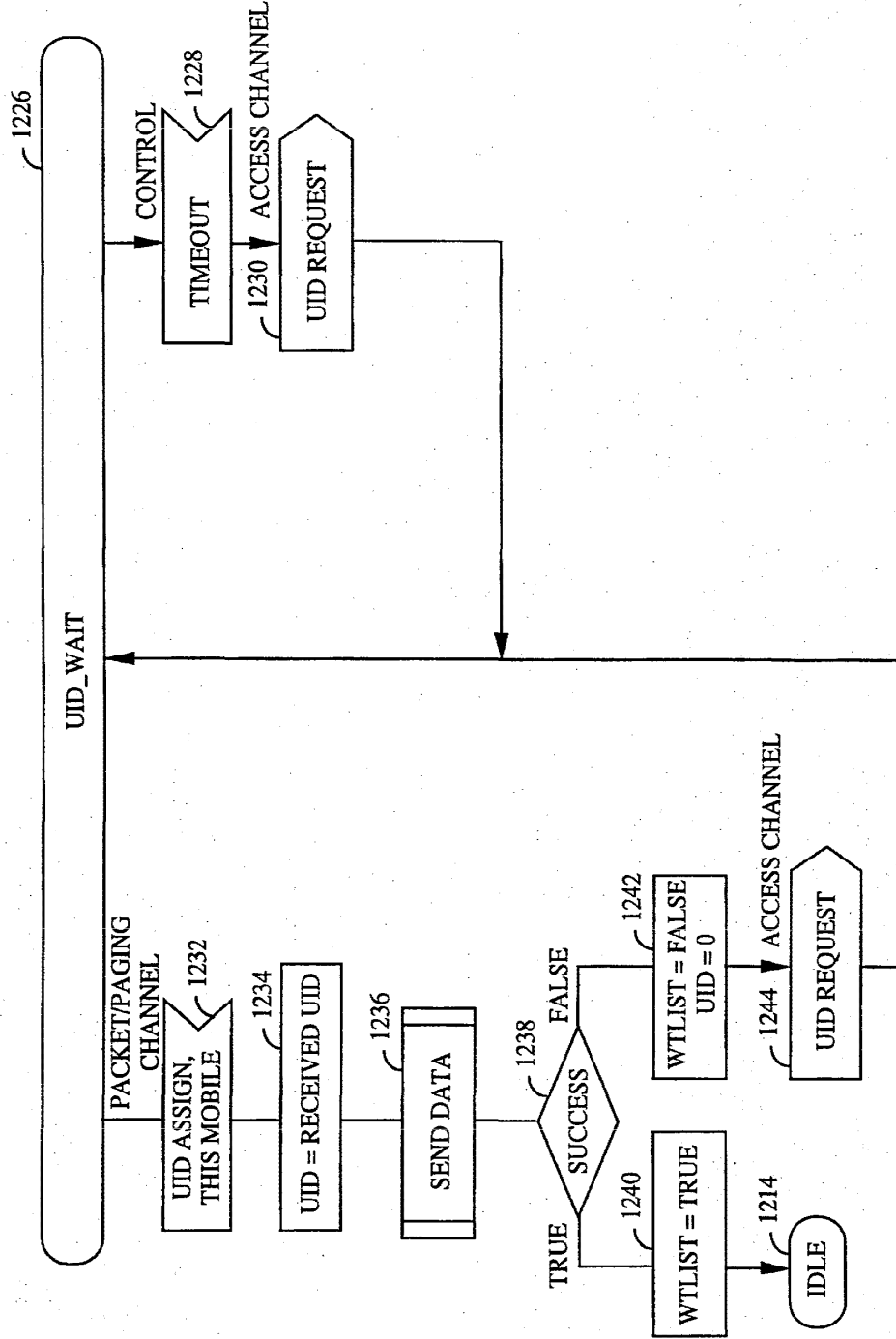

**SUBSTITUTE SHEET (RULE 26)**

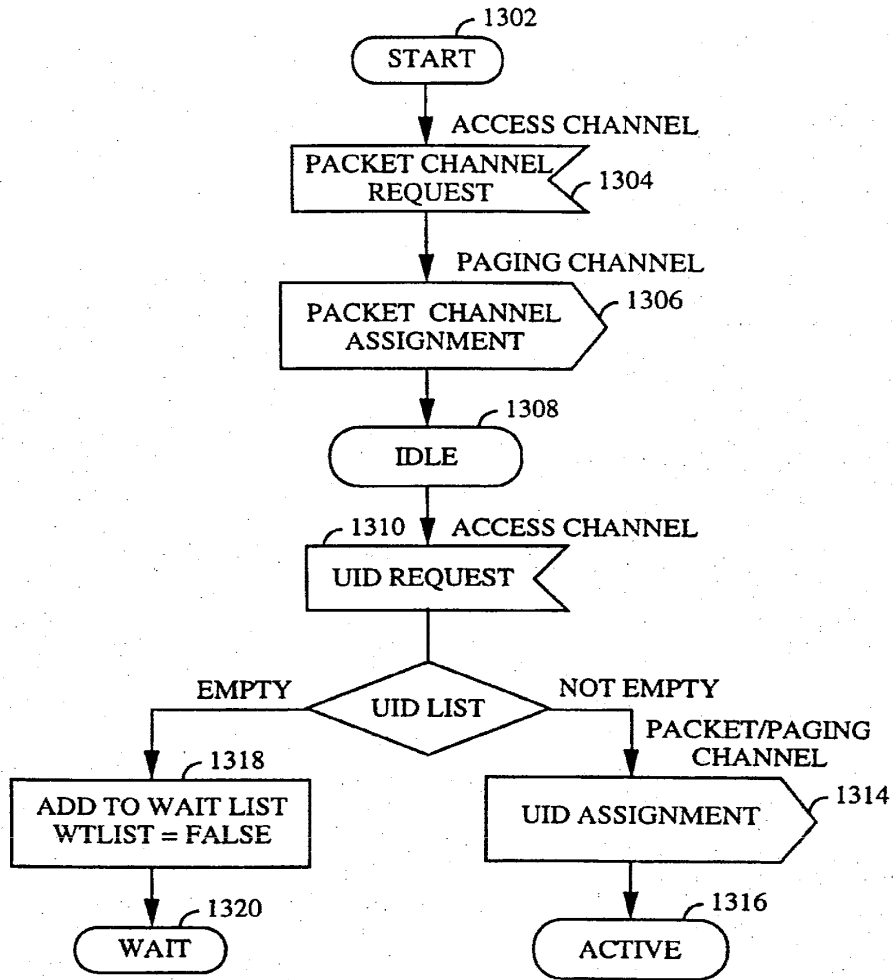

FIG. 13A

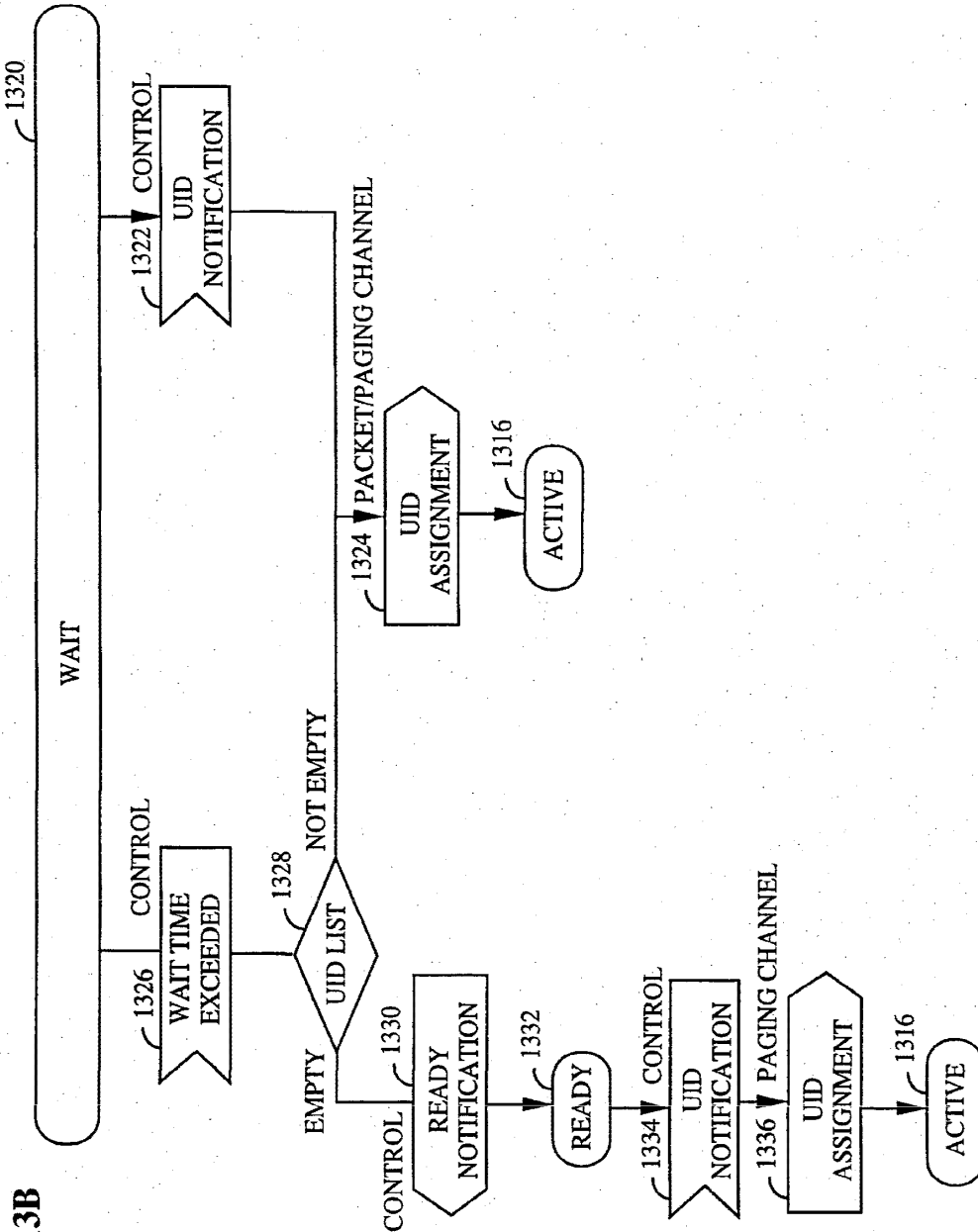
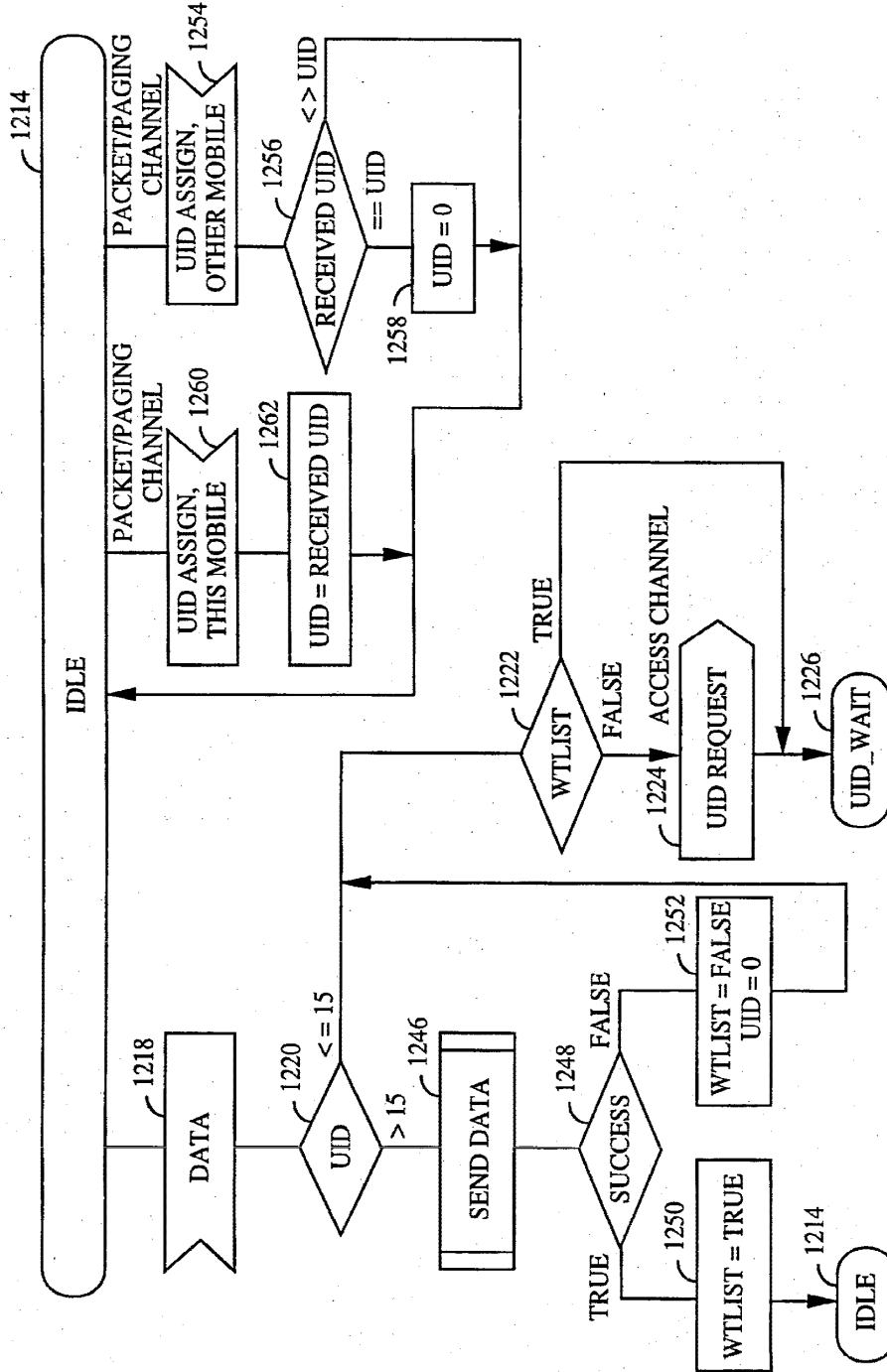

FIG. 13B

SUBSTITUTE SHEET (RULE 26)

FIG. 12B



SUBSTITUTE SHEET (RULE 26)

FIG. 12C

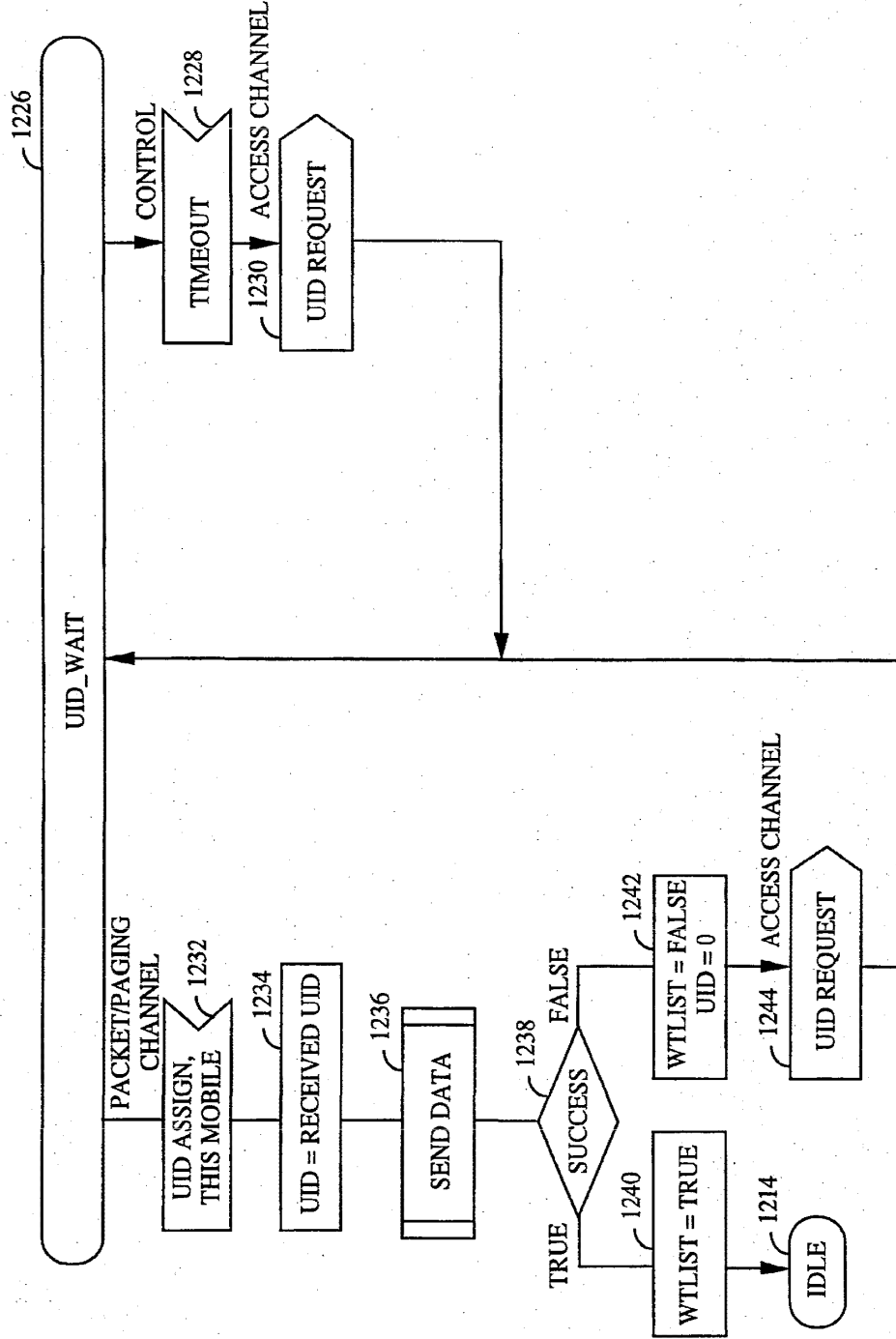

**SUBSTITUTE SHEET (RULE 26)**



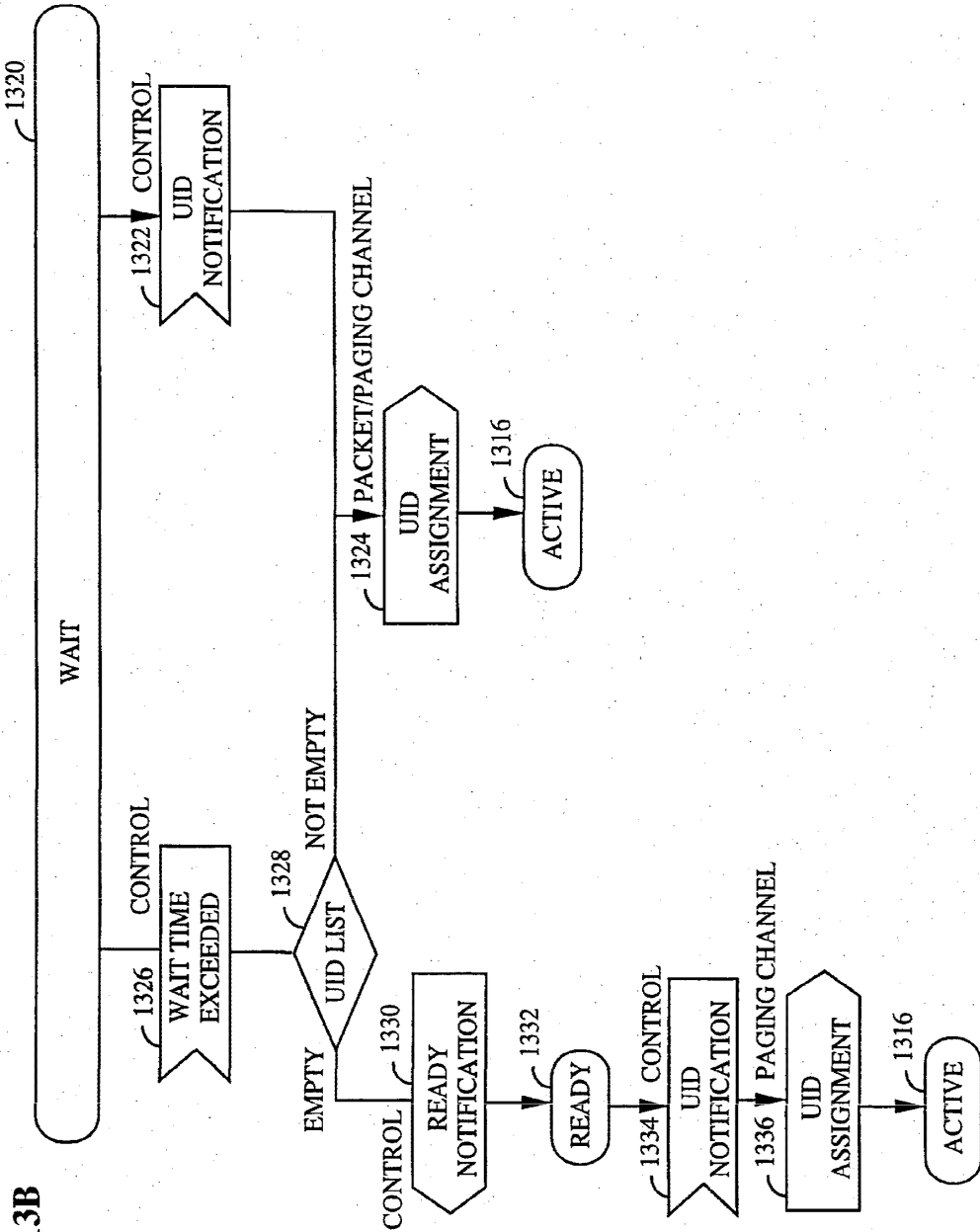

FIG. 13B

SUBSTITUTE SHEET (RULE 26)

FIG. 13C

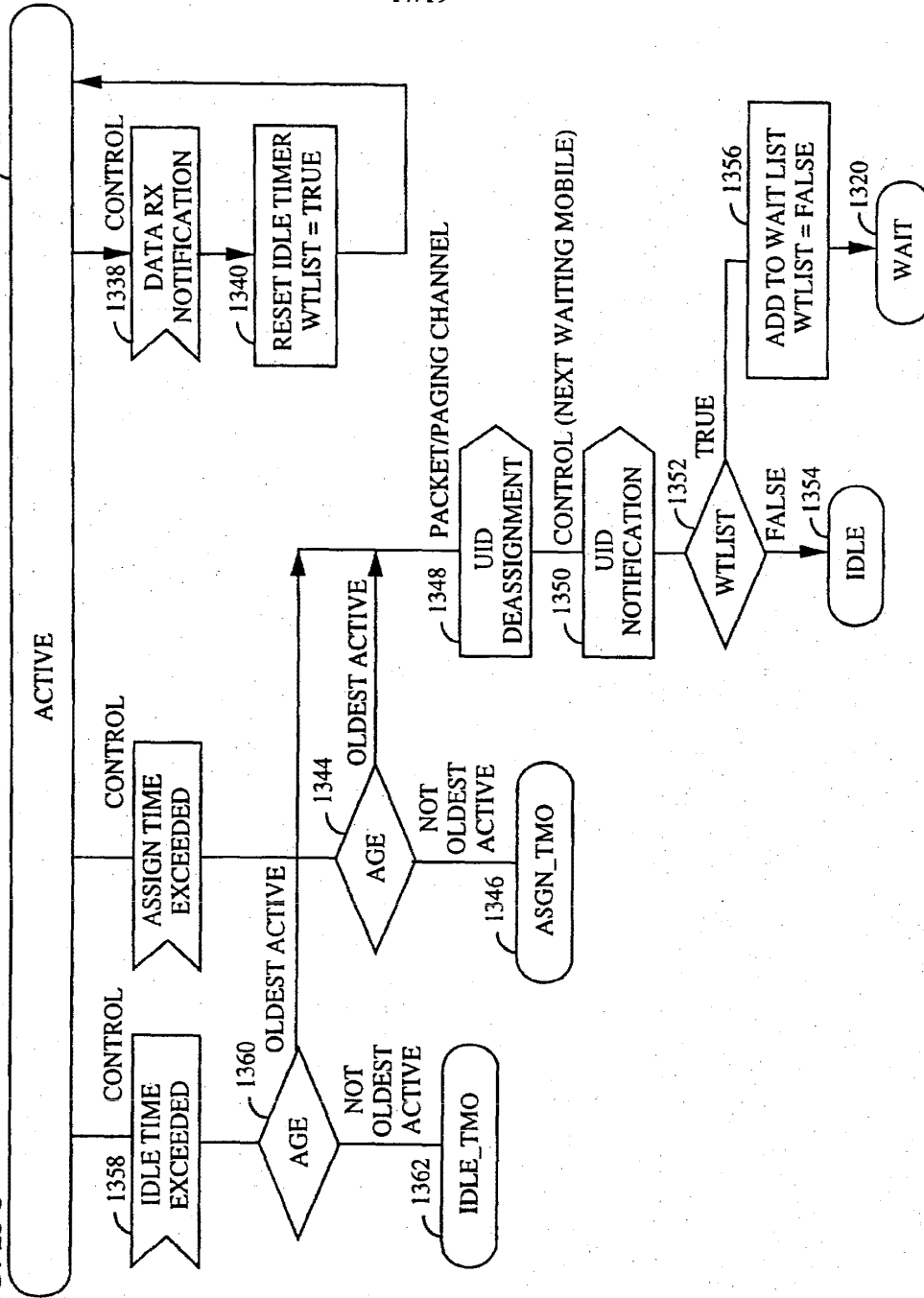

FIG. 13D

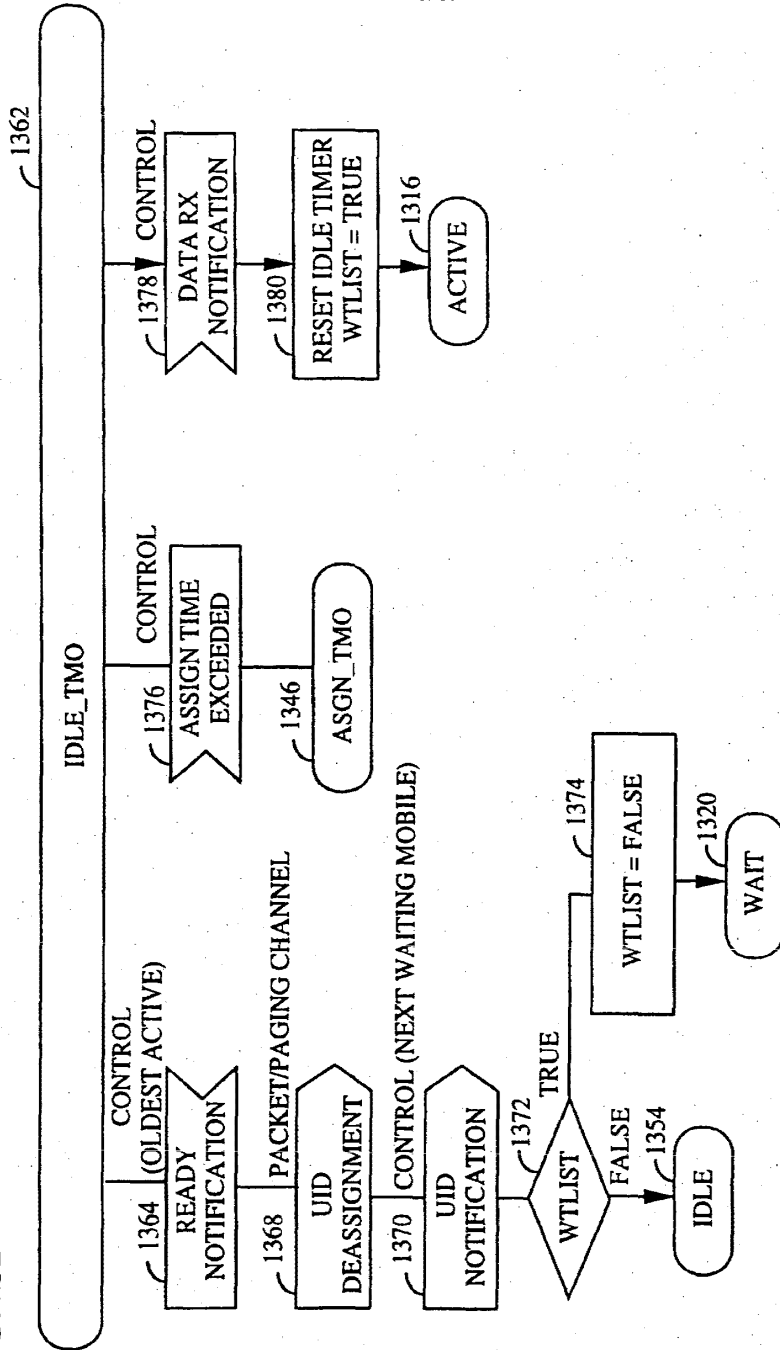
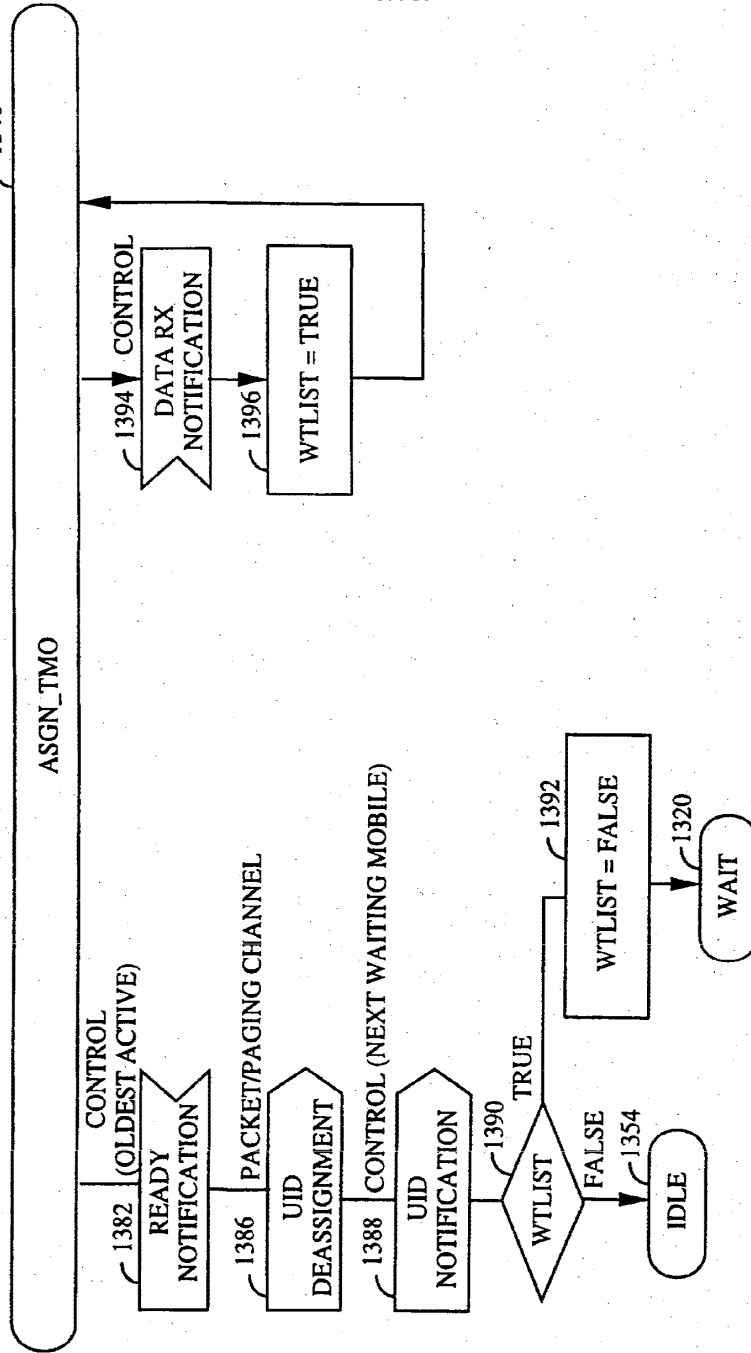

FIG. 13E



**INTERNATIONAL SEARCH REPORT**

International Application No  
PCT/US 96/06930

<b>A. CLASSIFICATION OF SUBJECT MATTER</b> IPC 6 H04Q7/22		
According to International Patent Classification (IPC) or to both national classification and IPC		
<b>B. FIELDS SEARCHED</b> Minimum documentation searched (classification system followed by classification symbols) IPC 6 H04B H04Q		
Documentation searched other than minimum documentation to the extent that such documents are included in the fields searched		
Electronic data base consulted during the international search (name of data base and, where practical, search terms used)		
<b>C. DOCUMENTS CONSIDERED TO BE RELEVANT</b>		
Category *	Citation of document, with indication, where appropriate, of the relevant passages	Relevant to claim No.
X	ISS '95. XV INTERNATIONAL SWITCHING SYMPOSIUM. WORLD TELECOMMUNICATIONS CONGRESS. ADVANCED SWITCHING TECHNOLOGIES FOR UNIVERSAL TELECOMMUNICATIONS AT THE BEGINNING OF THE 21ST. CENTURY. BERLIN, DE, APRIL 23 - 28, 1995, vol. 1, VERBAND DEUTSCHER ELEKTROTECHNIKER (VDE) ET AL, pages 246-250, XP000495573	1,3,6, 16,18, 21, 35-37, 39-41
A	BIANCHI G ET AL: "DYNAMIC CHANNEL ALLOCATION PROCEDURES FOR PACKET DATA SERVICES OVER GSM NETWORKS" see page 246, right-hand column, line 22 - page 247, right-hand column, line 26 --- -/--	9,24
<input checked="" type="checkbox"/> Further documents are listed in the continuation of box C.		
<input checked="" type="checkbox"/> Patent family members are listed in annex.		
* Special categories of cited documents :		
*A* document defining the general state of the art which is not considered to be of particular relevance *E* earlier document but published on or after the international filing date *L* document which may throw doubts on priority claim(s) or which is cited to establish the publication date of another citation or other special reason (as specified) *O* document referring to an oral disclosure, use, exhibition or other means *P* document published prior to the international filing date but later than the priority date claimed		*T* later document published after the international filing date or priority date and not in conflict with the application but cited to understand the principle or theory underlying the invention *X* document of particular relevance; the claimed invention cannot be considered novel or cannot be considered to involve an inventive step when the document is taken alone *Y* document of particular relevance; the claimed invention cannot be considered to involve an inventive step when the document is combined with one or more other such documents, such combination being obvious to a person skilled in the art. *&* document member of the same patent family
Date of the actual completion of the international search  25 September 1996		Date of mailing of the international search report  - 8. 10. 96
Name and mailing address of the ISA European Patent Office, P.B. 5818 Patentlaan 2 NL - 2280 HV Rijswijk Tel. (+ 31-70) 340-2040, Tx. 31 651 epo nl, Fax: (+ 31-70) 340-3016		Authorized officer  Behringer, L.V.

Form PCT/ISA/210 (second sheet) (July 1992)

INTERNATIONAL SEARCH REPORT

Internal Application No  
PCT/US 96/06930

C.(Continuation) DOCUMENTS CONSIDERED TO BE RELEVANT		
Category *	Citation of document, with indication, where appropriate, of the relevant passages	Relevant to claim No.
X	ISS '95. XV INTERNATIONAL SWITCHING SYMPOSIUM. WORLD TELECOMMUNICATIONS CONGRESS. ADVANCED SWITCHING TECHNOLOGIES FOR UNIVERSAL TELECOMMUNICATIONS AT THE BEGINNING OF THE 21ST. CENTURY. BERLIN, DE, APR. 23 - 28, 1995, vol. 1, pages 36-40, XP000495534 MADEMANN F: "GENERAL PACKET RADIO SERVICE - A PACKET MODE SERVICE WITHIN THE GSM"	1,6,16, 21,35,39
A	see page 36, left-hand column, line 31 - right-hand column, line 4 see page 37, right-hand column, line 8 - page 38, left-hand column, line 9	31,33
X	EP,A,0 642 283 (NOKIA MOBILE PHONES LTD. ET AL.) 8 March 1995	1,3,6, 16,18, 21,35-38
A	see page 3, line 44 - page 11, line 15	7,9,10, 12,22, 24,25, 27,31, 33,39-42
X	WO,A,94 05095 (NOKIA TELECOMMUNICATIONS OY ET AL.) 3 March 1994 see page 8, line 33 - page 10, line 7	1,3,16, 18

1

**INTERNATIONAL SEARCH REPORT**

Information on patent family members

International Application No PCT/US 96/06930
---

Patent document cited in search report	Publication date	Patent family member(s)	Publication date
EP-A-0642283	08-03-95	FI-A- 933894	07-03-95
		JP-A- 7170579	04-07-95
WO-A-9405095	03-03-94	FI-A- 923669	15-02-94
		AU-B- 665454	04-01-96
		AU-A- 4711293	15-03-94
		EP-A- 0611502	24-08-94
		JP-T- 7500236	05-01-95
		NO-A- 941330	13-06-94

Form PCT/ISA/210 (patent family annex) (July 1992)

(12) INTERNATIONAL APPLICATION PUBLISHED UNDER THE PATENT COOPERATION TREATY (PCT)

(19) World Intellectual Property Organization  
International Bureau



(43) International Publication Date  
15 February 2001 (15.02.2001)

PCT

(10) International Publication Number  
WO 01/11909 A1

- (51) International Patent Classification<sup>7</sup>: H04Q 7/38 (74) Agent: TANGENA, Antonius, G.; Internationaal Octrooibureau B.V., Prof. Holstlaan 6, NL-5656 AA Eindhoven (NL).
- (21) International Application Number: PCT/EP00/07461
- (22) International Filing Date: 1 August 2000 (01.08.2000) (81) Designated States (national): CN, JP, KR.
- (25) Filing Language: English (84) Designated States (regional): European patent (AT, BE, CH, CY, DE, DK, ES, FI, FR, GB, GR, IE, IT, LU, MC, NL, PT, SE).
- (26) Publication Language: English
- (30) Priority Data: 9918349.3 5 August 1999 (05.08.1999) GB **Published:**  
— With international search report.
- (71) Applicant: KONINKLIJKE PHILIPS ELECTRONICS N.V. [NL/NL]; Groenewoudseweg 1, NL-5621 BA Eindhoven (NL). *For two-letter codes and other abbreviations, refer to the "Guidance Notes on Codes and Abbreviations" appearing at the beginning of each regular issue of the PCT Gazette.*
- (72) Inventors: MOULSLEY, Timothy, J.; Prof. Holstlaan 6, NL-5656 AA Eindhoven (NL). HUNT, Bernard; Prof. Holstlaan 6, NL-5656 AA Eindhoven (NL).

(54) Title: RANDOM ACCESS CHANNEL OPTIMISATION

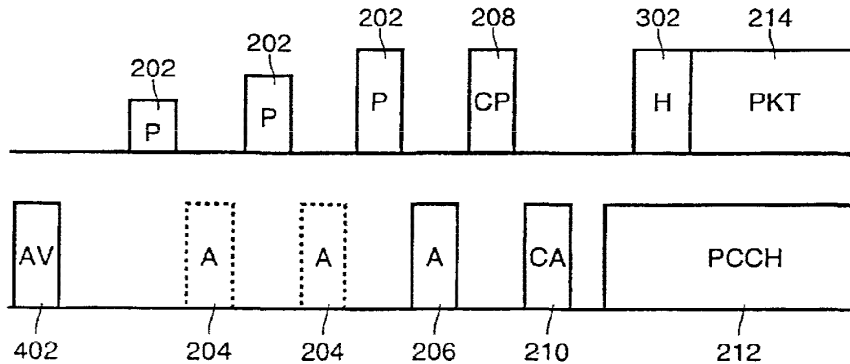

(57) **Abstract:** A radio communication system has a random access channel for the transmission of data (214) from a secondary station to a primary station. Such a channel is intended for use by secondary stations having data (214) to transmit to a primary station while not actually engaged in a call. Before the transmission of its data (214), a secondary station transmits a message (302) which provides information on the length of the data transmission (214), and may include format information relating to the data (214). This scheme is particularly effective when combined with a scheme signalling availability of random access channel resources, for example by use of an availability (AV) message (402). In this case a primary station can signal future availability of resources which are currently in use.

WO 01/11909 A1



## DESCRIPTION

## RANDOM ACCESS CHANNEL OPTIMISATION

Technical Field

5           The present invention relates to a radio communication system having a random access channel for the transmission of data from a secondary station to a primary station, and further relates to primary and secondary stations for use in such a system and to a method of operating such a system. While the present specification describes a system with particular reference to the  
10 emerging Universal Mobile Telecommunication System (UMTS), it is to be understood that the techniques described are equally applicable to use in other mobile radio systems. In this specification the term random access channel refers to the logical channel on which random access transmissions take place, which would typically consist of a number of distinct physical  
15 channels.

Background Art

          A random access channel is a normal component of a radio communication system, enabling a Mobile Station (MS) to send short messages to a Base Station (BS). Applications include signalling to the BS  
20 when the MS is turned on, sending a packet of data to the BS when the MS may not be engaged in a call, and requesting the BS to allocate a resource for the MS to use.

          In a system where mobile stations often have a requirement to send packets of data to the BS when not actually engaged in a call it is  
25 advantageous to provide a random access packet channel with similar characteristics to a standard random access channel but intended for the transmission of small and medium sized packets from a MS to the BS.

          In an embodiment of a such a scheme being developed for UMTS, there are a number of random access packet channels available to a MS. A  
30 request for access to a packet channel sent by the MS is encoded with a randomly-chosen signature, which corresponds to a packet channel resource.

If a suitable channel is available for use, the BS allocates it to the requesting MS.

Disclosure of Invention

5 An object of the present invention is to provide a random access channel having improved resource utilisation.

According to a first aspect of the present invention there is provided a radio communication system having a random access channel for the transmission of data from a secondary station to a primary station, wherein the secondary station has means for transmitting, before the transmission of the data, a message including an indication of the quantity of data to be transmitted and the primary station has means for determining from the received message when the data transmission will end.

10 According to a second aspect of the present invention there is provided a primary station for use in a radio communication system having a random access channel for the transmission of data from a secondary station to the primary station, wherein means are provided for receiving from the secondary station, before the transmission of the data, a message including an indication of the quantity of data to be transmitted, and for determining from the received message when the data transmission will end.

15 According to a third aspect of the present invention there is provided a secondary station for use in a radio communication system having a random access channel for the transmission of data to a primary station, wherein means are provided for transmitting, before the transmission of the data, a message including an indication of the quantity of data to be transmitted.

20 According to a fourth aspect of the present invention there is provided a method of operating a radio communication system having a random access channel for the transmission of data from a secondary station to a primary station, characterised by the secondary station transmitting, before the transmission of the data, a message including an indication of the quantity of data to be transmitted, and by the primary station determining from the received message when the data transmission will end.

### Brief Description of Drawings

Embodiments of the present invention will now be described, by way of example, with reference to the accompanying drawings, wherein:

Figure 1 is a block schematic diagram of a radio communication system;

Figure 2 illustrates a basic random access packet channel scheme;

Figure 3 illustrates an enhanced random access packet channel scheme having a packet header;

Figure 4 illustrates a further enhanced random access packet channel scheme having a packet channel availability message; and

Figure 5 is a flow chart illustrating a method in accordance with the present invention for transmitting a packet header on a random access packet channel.

In the drawings the same reference numerals have been used to indicate corresponding features.

### Modes for Carrying Out the Invention

Referring to Figure 1, a radio communication system comprises a primary station (BS) 100 and a plurality of secondary stations (MS) 110. The BS 100 comprises a microcontroller ( $\mu$ C) 102, transceiver means (Tx/Rx) 104 connected to antenna means 106, power control means (PC) 107 for altering the transmitted power level, and connection means 108 for connection to the PSTN or other suitable network. Each MS 110 comprises a microcontroller ( $\mu$ C) 112, transceiver means (Tx/Rx) 114 connected to antenna means 116, and power control means (PC) 118 for altering the transmitted power level. Communication from BS 100 to MS 110 takes place on a downlink channel 122, while communication from MS 110 to BS 100 takes place on an uplink channel 124.

A basic scheme for a random access packet channel operating in a frequency division duplex system is shown in Figure 2, with the uplink channel 124 drawn above the downlink channel 122. In an access phase, the MS 110 first transmits a preamble (P) 202, encoded with a signature randomly chosen from a set of 16 possible signatures, at a low power level in a particular access

slot. A signature is a signal characterised by its scrambling code and channelisation code modulated by a specific bit sequence. A mutually orthogonal set of signatures can be obtained by defining a set of mutually orthogonal bit sequences for the modulation. Hence, a different set of signatures can be obtained by changing the scrambling code or the channelisation code (i.e. the physical channel), or by using a different mutually orthogonal set of bit sequences. Alternatively a larger set of signatures may be defined in such a way as to have low cross correlations, rather than strict orthogonality. Although the present specification refers to sets of 16 signatures different implementations may use sets having different numbers of signatures.

In this basic scheme the choice of preamble signature for encoding the access preamble 202 determines the physical channel requested by the MS 110, with each preamble signature corresponding to a limited number of uplink and downlink channels. If the BS 100 receives and decodes the preamble correctly it transmits a preamble acknowledgement (A) 206. In the example shown in Figure 2, after the first preamble 202 is transmitted no acknowledgement is returned in the slot 204 allocated for it (which might typically be 1ms in length). The MS 110 therefore transmits another preamble 202 at a higher power level. Again no acknowledgement is received in the slot 204, so the MS 110 transmits another preamble 202 at a still higher power. This is received and decoded by the BS 100, which transmits an acknowledgement 206 and thereby completes the access phase.

As well as informing the MS 110 that its preamble 202 has been received, the acknowledgement 206 may be positive, to signal that the requested channels are free, or negative, to signal that they are in use and access is denied to the MS 110. A negative acknowledgement (NACK) may be indicated by the BS 100 inverting the phase of the signature (with respect to some reference or pilot signal). Alternatively, some of the signatures used by the BS 100 for acknowledgement may also be used as a NACK.

The BS 100 will only transmit one acknowledgement for each access slot, however many preambles 202 were transmitted. One basis for the selection could be to acknowledge the preamble 202 received with the highest

power. The initial power level at which a MS 110 transmits the preamble 202 is typically determined by the MS 110 using open loop power control, so that a MS 110 is not at a disadvantage compared to another MS 110 nearer to the BS 100. If more than one preamble 202 was transmitted but each preamble  
5 was encoded with a different signature then each MS 110 will know whether or not its preamble 202 was received correctly. However, it is possible that more than one MS 110 selected the same signature, and therefore believes that its preamble 202 has been received. If each of these mobile stations 110 begins to transmit its data the result will be a collision, with none of the data likely to  
10 be received correctly.

To reduce the chances of this happening, a contention resolution phase follows the transmission of an acknowledgement 206 which indicated that the requested channels were free. Each MS 110 which transmitted a preamble 202 encoded with a signature corresponding to that acknowledged by the BS  
15 100 now transmits a further contention resolution preamble (CP) 208. This preamble 208 is encoded with a signature randomly selected from another set of 16 possible signatures. This set may be different from the set used for the access preamble 202 (either by changing the set of modulating bit sequences, the scrambling code or the channelisation code), or alternatively the set of  
20 signatures may be shared between access and contention resolution phases. The BS 100 then issues a contention resolution acknowledgement (CA) 210 corresponding to the selected preamble 208, for example that received with the highest power, which acknowledgement 210 enables the MS 110 to transmit its data. Hence, if more than one MS 110 selected the same access  
25 preamble 202 the chance of the same contention resolution preamble 208 also being selected is small.

After this contention resolution phase the BS 100 begins transmission of a Physical Control CHannel (PCCH) 212, which includes power control information to instruct the MS 110 to adjust its transmission power as  
30 necessary, and the MS 110 transmits one or more data packets (PKT) 214 on the allocated packet channel, which is normally on a different physical channel to those used for the preamble transmissions. The PCCH 212 may begin

simultaneously with the transmission of the data 214, or may precede it sufficiently for closed loop power control to be established before the data transmission.

5 A problem with the basic scheme described above is that the MS 110 does not provide any information to the BS 100 about the length of the data packets 214 that it will transmit. The BS 100 therefore has to detect the end of transmission by the MS 110 using blind detection, for example by detecting the position of a correctly decoded CRC (Cyclic Redundancy Check). A further source of inefficiency with the basic scheme is that format information relating to the packet is broadcast concurrently with the data packets 214, even if it does not change during transmission of the packets 214. The format information may for example include details of error control coding and puncturing applied to the data, as well as details of multiplex arrangements if there is more than one transport channel contributing to the packet.

15 An improved scheme in accordance with the present invention, which solves the above problem, is illustrated in Figure 3. Before the MS 110 transmits the data packets 214 it transmits a packet header (H) 302, which contains information on the length of the packets 214. The presence of the header 302 reduces the complexity of the BS 100, which no longer has to make a blind estimate to determine the end of the data packets 214.

20 The header 302 also improves resource utilisation in a number of ways. Firstly, the BS 100 can stop transmission of the PCCH 212 at the known end of the data packets 214, rather than having to continue its transmission until the end of the data packets 214 is detected. Secondly, the BS 100 can reassign packet channel resources as soon as they become available, without the extra delay caused by looking for the end of the data packets 214. Thirdly, the BS 100 can pre-assign a packet channel to a MS 110 if it is known that the channel will be available by the time the MS 110 has completed the access and contention resolution phases.

30 Knowledge of the end time of the transmission of data packets 214 by the MS 110 also improves ARQ (Automatic Repeat reQuest) performance. This is because the BS 100 would otherwise have some difficulty in

differentiating between the normal end of a packet (requiring no retransmission) and significantly corrupt reception (requiring retransmission). It would also be possible for the BS 100 to signal the required retransmissions at the end of the packet transmissions and keep the channel allocated for these retransmissions. However, this behaviour conflicts with the pre-assignment of channels by the BS 100 and therefore may not be preferred.

The efficiency of the system is further improved if the MS 110 also transmits in the header 302 the format information relating to the data packets 214. This information no longer has to be transmitted on a control channel for the duration of the data packets 214, thereby reducing the load on the control channel. Other information could also be included in the header, for example a checksum for the data packets 214 to enable the BS 100 to confirm their correct reception.

Further advantages of a scheme in accordance with the present invention are found in conjunction with an improved scheme in which the availability of packet channel resources is signalled by the BS 100. One such scheme, disclosed in more detail in our co-pending UK patent application 9921548.5 (our reference PHB 34390), combined with the scheme of the present invention, is illustrated in Figure 4. In this combined scheme the BS 100 repeatedly broadcasts a packet channel availability (AV) message 402, which informs a MS 110 about the resources currently available. Broadcasting the AV message 402 once per frame is a reasonable compromise between downlink overhead and delay, since the overall transmission delay will be dominated by the time taken to transmit the data packets 214, typically a few frames.

This and other similar schemes solve the problem that a MS 110 may be denied access to a packet channel resource corresponding to its selected preamble signature, even though other suitable resources may be available, making it likely that a MS 110 will spend significant time waiting for a resource to become available. When combined with the scheme of the present invention, as illustrated in Figure 4, the BS 100 use the AV message 402 to signal availability of a packet channel resource which will become available by

the time that the signalling and any subsequent access attempts are made, even though it is not available at the time of the AV message 402. Hence the packet channel resource can be used more efficiently because the periods during which no MS 110 is transmitting on a particular packet channel are reduced in length.

A disadvantage of a scheme in accordance with the present invention is that the length of the message transmitted by the MS 110 (now including both the header 302 and data packets 214) is slightly increased. However, the amount of extra data to be transmitted is minimal. For example, to signal the length of the data packets 214 a MS 110 would preferably indicate the number of frames of data. Hence a 4 bit message could indicate up to 16 frames of data, which corresponds to 9.6kb at the lowest bit rate of 60kbps. Even after the addition of error coding to protect the information, for example repetition coding or a simple block code, the overhead is minimal. Similarly, the format information would typically only require a few bits, perhaps 10.

The average delay for packet transmission will not in practice be increased since resources are allocated more efficiently. Also, the minimal extra power cost to a MS 110 of transmitting the header 302 is at least partly offset by other savings in power in a system in which packet channel availability is signalled. One saving comes from a reduction in the time for which a MS 110 has to monitor the system before attempting access. Another saving comes because the MS 110 only has to transmit the format information once, in the header 302, instead of repeatedly while the data packets 214 are transmitted.

A flow chart summarising a method in accordance with the present invention for a MS 110 broadcasting a packet header 302 is shown in Figure 5. The method starts, at step 502, with a MS 110 having data for transmission on the random access packet channel. The MS 110 receives, at step 504, the AV message 402 which gives information on available resources (for example channels and/or bit rates).

The MS 110 determines, at step 506, whether the required resource is available. If it is not, then the process restarts at step 504. If the available bit



rate is sufficient, the MS 110 can proceed. Before proceeding the MS 110 may wait for a short random back-off period, preferably of up to one frame, to reduce the probability of excessive collisions if a number of MSs 110 simultaneously determine that the same resource is free.

5           When it proceeds, the MS 110 selects an available resource and sets its transmission power to a minimum power level. The MS 110 then transmits, at step 508, an access preamble 202 encoded using a signature corresponding to the selected resource. Next the MS 110 determines, at step 510, whether it has received an acknowledgement 206 from the BS 100. If no  
10 acknowledgement is received the MS 110 increases its transmission power, at step 512, and returns to step 508. If an acknowledgement is received the MS 110 determines, at step 514, whether the acknowledgement was positive, in which case the process continues, or negative, in which case the MS 110 waits for a random back-off period and returns to step 504.

15           Next the MS 110, at step 516, transmits a contention resolution preamble 208 using a randomly selected signature. The BS 100 acknowledges at most one of the contention resolution preambles 208 and, if appropriate, at the same time indicates the channelisation code for the PCCH 212 and the scrambling code for the uplink packet channel. Finally, the MS 110 determines,  
20 at step 518, whether it received a contention resolution acknowledgement 210 from the BS 110. If a CA 210 was received the MS 110 is able to proceed to transmit, at steps 520 and 522, its packet header 302 and data packets 214 on the assigned channel, after which the method ends at step 524. If no CA 210 was received, the MS 110 waits for a random back-off period and returns to  
25 step 504. In this case it is preferable for the MS 110 to keep its transmission power set to the same level as that for the original preamble 202 that appeared to be acknowledged by the BS 100.

          The present invention also has applications to other random access channel schemes. In general, it is applicable to any such scheme where a MS  
30 110 is allowed to transmit data having a duration longer than one frame (10ms in UMTS).

As well as its application in a FDD system as described above, the present invention could be applied in other types of communication system. For example, it could be used in a Time Division Multiple Access (TDMA) system provided that the uplink transmissions take place in different time slots  
5 to the downlink transmissions.

The embodiments described above relate to packet transmission. However, the same principles can equally well be applied to a system in which circuits are set up for data transmission.

From reading the present disclosure, other modifications will be  
10 apparent to persons skilled in the art. Such modifications may involve other features which are already known in the design, manufacture and use of radio communication systems and component parts thereof, and which may be used instead of or in addition to features already described herein. Although claims have been formulated in this application to particular combinations of features,  
15 it should be understood that the scope of the disclosure of the present application also includes any novel feature or any novel combination of features disclosed herein either explicitly or implicitly or any generalisation thereof, whether or not it relates to the same invention as presently claimed in any claim and whether or not it mitigates any or all of the same technical  
20 problems as does the present invention. The applicants hereby give notice that new claims may be formulated to such features and/or combinations of features during the prosecution of the present application or of any further application derived therefrom.

In the present specification and claims the word "a" or "an" preceding  
25 an element does not exclude the presence of a plurality of such elements. Further, the word "comprising" does not exclude the presence of other elements or steps than those listed.

#### Industrial Applicability

The present invention is applicable to a range of radio  
30 communication systems, for example UMTS.

## CLAIMS

1. A radio communication system having a random access channel for the transmission of data from a secondary station to a primary station, wherein the secondary station has means for transmitting, before the transmission of the data, a message including an indication of the quantity of data to be transmitted and the primary station has means for determining from the received message when the data transmission will end.
2. A system as claimed in claim 1, characterised in that the random access channel is adapted for transmission of data in packets.
3. A primary station for use in a radio communication system having a random access channel for the transmission of data from a secondary station to the primary station, wherein means are provided for receiving from the secondary station, before the transmission of the data, a message including an indication of the quantity of data to be transmitted, and for determining from the received message when the data transmission will end.
4. A primary station as claimed in claim 3, characterised in that means are provided for transmitting a control channel, including power control information, during data transmission and for ending transmission of the control channel at the indicated end of the data transmission.
5. A primary station as claimed in claim 3 or 4, characterised in that means are provided for assigning a random access channel resource to a secondary station while the resource is in use, having determined that it will be available by the time that the secondary station has completed its request for the use of that resource.
6. A primary station as claimed in any one of claims 3 to 5, characterised in that means are provided for signalling the availability of

random access channel resources to secondary stations and means for signalling the availability of a resource that is currently in use but which will be available by the time that a secondary station has completed its request for use of that resource.

5

7. A secondary station for use in a radio communication system having a random access channel for the transmission of data to a primary station, wherein means are provided for transmitting, before the transmission of the data, a message including an indication of the quantity of data to be transmitted.

10

8. A secondary station as claimed in claim 7, characterised in that means are provided for including format information relating to the data transmission in the message.

15

9. A method of operating a radio communication system having a random access channel for the transmission of data from a secondary station to a primary station, characterised by the secondary station transmitting, before the transmission of the data, a message including an indication of the quantity of data to be transmitted, and by the primary station determining from the received message when the data transmission will end.

20

10. A method as claimed in claim 9, characterised by the secondary station including format information relating to the data transmission in the message.

25

11. A method as claimed in claim 9 or 10, characterised by the primary station transmitting a control channel, including power control information, during data transmission and ending transmission of the control channel at the indicated end of the data transmission.

30

12. A method as claimed in any one of claims 9 to 11, characterised by the primary station signalling the availability of random access channel resources to the secondary stations and signalling the availability of a resource that is currently in use but which will be available by the time that a secondary station has completed its request for use of that resource.

1/3

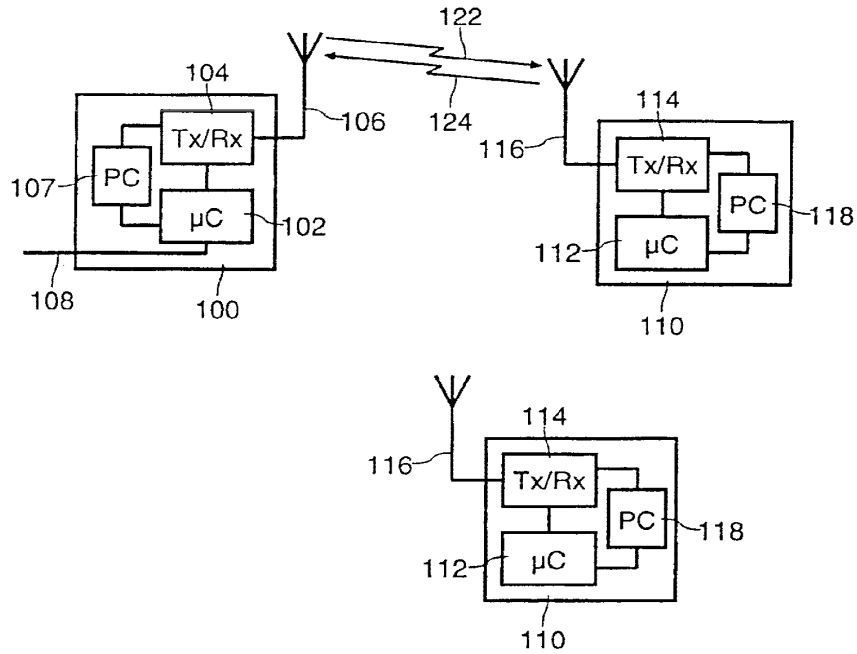

FIG. 1

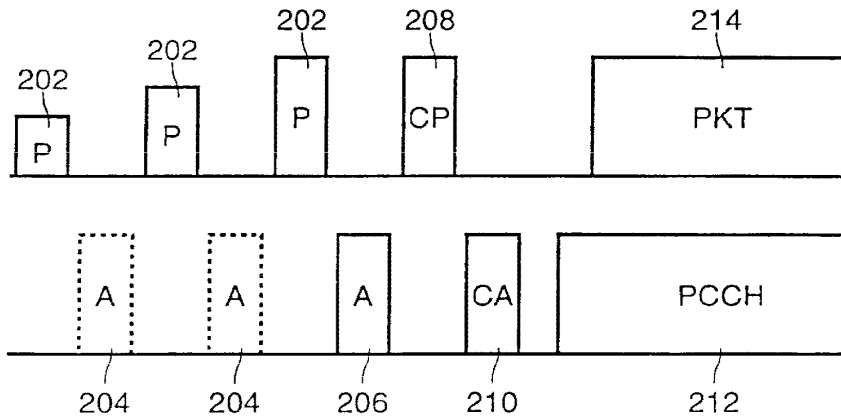

FIG. 2

2/3

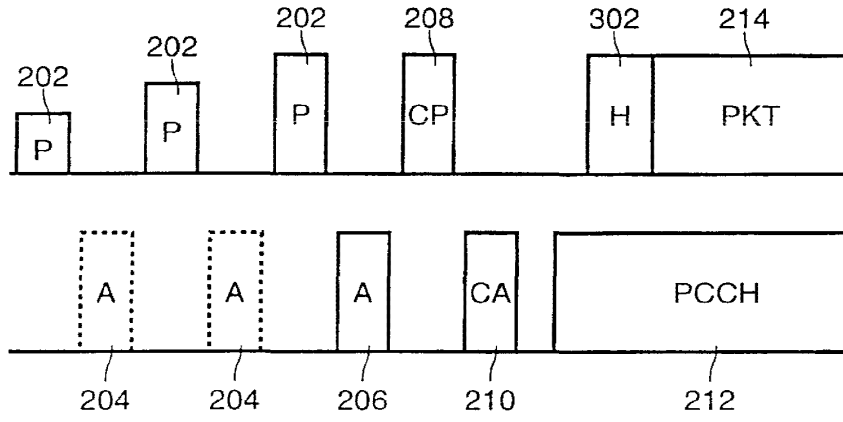

FIG. 3

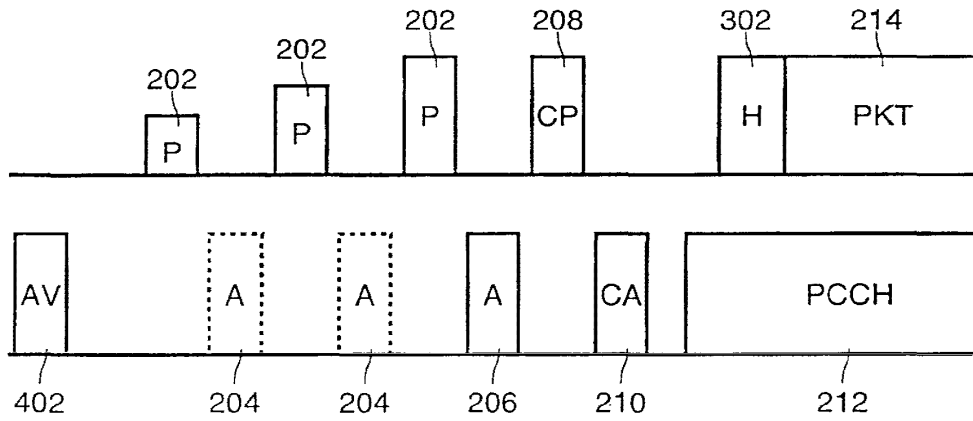

FIG. 4

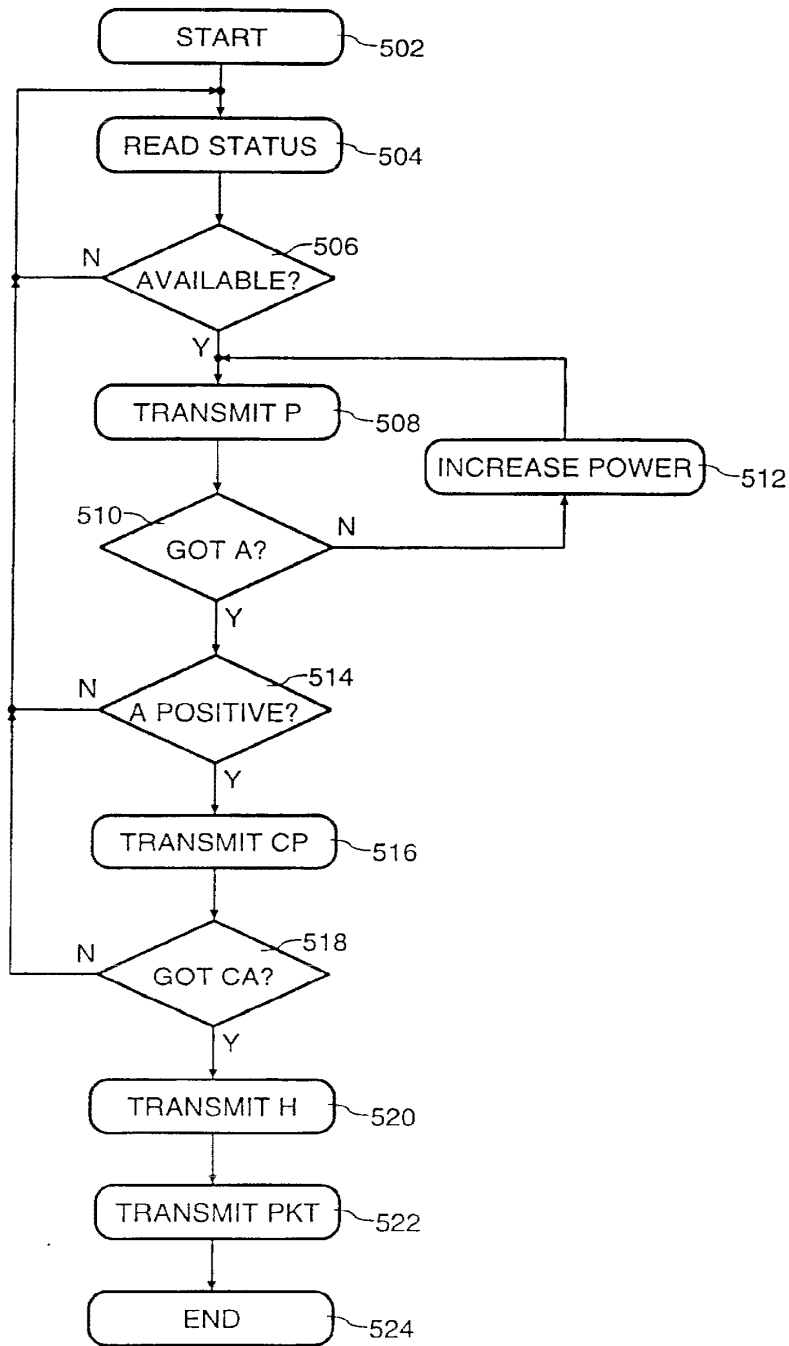

FIG. 5



INTERNATIONAL SEARCH REPORT

International Application No  
PCT/EP 00/07461

<b>A. CLASSIFICATION OF SUBJECT MATTER</b> IPC 7 H04Q7/38		
According to International Patent Classification (IPC) or to both national classification and IPC		
<b>B. FIELDS SEARCHED</b> Minimum documentation searched (classification system followed by classification symbols) IPC 7 H04Q		
Documentation searched other than minimum documentation to the extent that such documents are included in the fields searched		
Electronic data base consulted during the international search (name of data base and, where practical, search terms used) EPO-Internal		
<b>C. DOCUMENTS CONSIDERED TO BE RELEVANT</b>		
Category *	Citation of document, with indication, where appropriate, of the relevant passages	Relevant to claim No.
X	UMEDA N ET AL: "IDLE-SIGNAL CASTING MULTIPLE ACCESS WITH PARTIAL ECHO (ICMA-PE) FORMOBILE PACKET COMMUNICATIONS" ELECTRONICS & COMMUNICATIONS IN JAPAN, PART I - COMMUNICATIONS,US,SCRIPTA TECHNICA. NEW YORK, vol. 77, no. 4, 1 April 1994 (1994-04-01), pages 92-102, XP000445332 ISSN: 8756-6621	1-3,6,7,9
Y		5,8,10,12
A	page 93, right-hand column, line 42 -page 94, left-hand column, line 5 --- -/--	4,11
<input checked="" type="checkbox"/> Further documents are listed in the continuation of box C.		
<input checked="" type="checkbox"/> Patent family members are listed in annex.		
* Special categories of cited documents:		
*A* document defining the general state of the art which is not considered to be of particular relevance *E* earlier document but published on or after the international filing date *L* document which may throw doubts on priority claim(s) or which is cited to establish the publication date of another citation or other special reason (as specified) *O* document referring to an oral disclosure, use, exhibition or other means *P* document published prior to the international filing date but later than the priority date claimed *T* later document published after the international filing date or priority date and not in conflict with the application but cited to understand the principle or theory underlying the invention *X* document of particular relevance: the claimed invention cannot be considered novel or cannot be considered to involve an inventive step when the document is taken alone *Y* document of particular relevance: the claimed invention cannot be considered to involve an inventive step when the document is combined with one or more other such documents, such combination being obvious to a person skilled in the art. *&* document member of the same patent family		
Date of the actual completion of the international search 10 November 2000		Date of mailing of the international search report 24/11/2000
Name and mailing address of the ISA European Patent Office, P.B. 5818 Patentlaan 2 NL - 2280 HV Rijswijk Tel. (+31-70) 340-2040, Tx. 31 651 epo.nl Fax: (+31-70) 340-3016		Authorized officer Bernedo Azpiri, P

2

Form PCT/ISA/210 (second sheet) (July 1992)

INTERNATIONAL SEARCH REPORT

International Application No  
PCT/EP 00/07461

C.(Continuation) DOCUMENTS CONSIDERED TO BE RELEVANT		
Category *	Citation of document, with indication, where appropriate, of the relevant passages	Relevant to claim No.
Y	WO 99 13600 A (ERICSSON TELEFON AB L M) 18 March 1999 (1999-03-18) page 4, line 15 - line 22 page 6, line 6 - line 28 -----	5,12
Y	US 5 734 645 A (HOFF ANDERS ET AL) 31 March 1998 (1998-03-31) column 10, line 30 - line 45 -----	8,10

**INTERNATIONAL SEARCH REPORT**

Information on patent family members

International Application No

PCT/EP 00/07461

Patent document cited in search report	Publication date	Patent family member(s)	Publication date
WO 9913600 A	18-03-1999	AU 9099398 A	29-03-1999
		BR 9812168 A	18-07-2000
		EP 1013008 A	28-06-2000
US 5734645 A	31-03-1998	US 5603081 A	11-02-1997
		AU 681730 B	04-09-1997
		AU 1048095 A	23-05-1995
		BR 9405927 A	05-12-1995
		CA 2152946 A	11-05-1995
		CN 1116888 A	14-02-1996
		EP 0677222 A	18-10-1995
		FI 953264 A	30-06-1995
		JP 8508627 T	10-09-1996
		NZ 276272 A	27-04-1998
		NZ 329740 A	28-05-1999
		NZ 329741 A	28-05-1999
		WO 9512934 A	11-05-1995
		US 5655215 A	05-08-1997
		US 5923649 A	13-07-1999
		AU 680071 B	17-07-1997
		AU 1048395 A	23-05-1995
		AU 691850 B	28-05-1998
		AU 1087495 A	23-05-1995
		AU 685885 B	29-01-1998
		AU 1087695 A	23-05-1995
		AU 695892 B	27-08-1998
		AU 2079997 A	24-07-1997
		AU 720332 B	25-05-2000
		AU 2358897 A	14-08-1997
		AU 690924 B	07-05-1998
		AU 7757094 A	18-05-1995
		AU 7865898 A	15-10-1998
		AU 7865998 A	01-10-1998
		AU 697210 B	01-10-1998
		AU 8131394 A	23-05-1995
		AU 681721 B	04-09-1997
		AU 8131494 A	23-05-1995
BR 9404316 A	04-07-1995		
BR 9405702 A	28-11-1995		
BR 9405703 A	28-11-1995		
BR 9405704 A	28-11-1995		
BR 9405705 A	28-11-1995		
BR 9405743 A	05-12-1995		
CA 2134695 A	02-05-1995		
CA 2152942 A	11-05-1995		
CA 2152943 A	11-05-1995		
CA 2152944 A	11-05-1995		
CA 2152945 A	11-05-1995		
CA 2152947 A	11-05-1995		
CN 1112345 A	22-11-1995		
CN 1117329 A	21-02-1996		
CN 1117330 A	21-02-1996		
CN 1117331 A	21-02-1996		
CN 1124074 A	05-06-1996		

Form PCT/ISA/210 (patent family annex) (July 1992)

**EVOLVED-0001993**

ZTE/HTC

Exhibit 1005-0351

MULTIPLE DEPENDENT CLAIM  
 FEE CALCULATION SHEET  
 (FOR USE WITH FORM PTO-875)

SERIAL NO. 12/303,947  
 APPLICANT(S)

FILING DATE

CLAIMS

	AS FILED		AFTER 1 <sup>st</sup> AMENDMENT		AFTER 2 <sup>nd</sup> AMENDMENT	
	IND.	DEP.	IND.	DEP.	IND.	DEP.
1	1					
2		1				
3		2				
4	1					
5		1				
6	1					
7		1				
8		1				
9		1				
10	1					
11		1				
12		1				
13		1				
14		1				
15		1				
16	1					
17		1				
18	1					
19		1				
20		1				
21		1				
22		1				
23		1				
24	1					
25		1				
26		1				
27		1				
28		1				
29		1				
30		1				
31			1			
32				1		
33				1		
34				1		
35				1		
36				1		
37				1		
38			1			
39				1		
40				1		
41				1		
42				1		
43				1		
44				1		
45				1		
46				1		
47				1		
48				1		
49				1		
50				1		
TOTAL IND.		↓	2	↓		↓
TOTAL DEP.		←	12	←		←
TOTAL CLAIMS			14			

	AS FILED		AFTER 1 <sup>st</sup> AMENDMENT		AFTER 2 <sup>nd</sup> AMENDMENT	
	IND.	DEP.	IND.	DEP.	IND.	DEP.
51						
52						
53						
54						
55						
56						
57						
58						
59						
60						
61						
62						
63						
64						
65						
66						
67						
68						
69						
70						
71						
72						
73						
74						
75						
76						
77						
78						
79						
80						
81						
82						
83						
84						
85						
86						
87						
88						
89						
90						
91						
92						
93						
94						
95						
96						
97						
98						
99						
100						
TOTAL IND.		↓		↓		↓
TOTAL DEP.		←		←		←
TOTAL CLAIMS						

EVOLVED-0001994

**PATENT APPLICATION FEE DETERMINATION RECORD**

Effective October 2, 2008

Application or Docket Number

*12/303,947*

**CLAIMS AS FILED - PART I**

		(Column 1)	(Column 2)	SMALL ENTITY		OR	LARGE ENTITY	
U.S. NATIONAL STAGE FEES				RATE	FEE		RATE	FEE
BASIC FEE		\$330/ \$165		BASIC FEE		OR	BASIC FEE	<i>330</i>
EXAMINATION FEE		\$220/ \$110		EXAM. FEE			EXAM. FEE	<i>220</i>
SEARCH FEE		\$430/ \$215		SEARCH FEE			SEARCH FEE	<i>430</i>
FEE FOR EXTRA SPEC. PGS.		minus 100 =	/ 50 =	X \$ 135 =			X \$ 270 =	
TOTAL CHARGEABLE CLAIMS		<i>14</i> minus 20 =		X \$ 26 =		OR	X \$ 52 =	
INDEPENDENT CLAIMS		<i>2</i> minus 3 =		X \$ 110 =		OR	X \$ 220 =	
MULTIPLE DEPENDENT CLAIM PRESENT			<input type="checkbox"/>	+ \$ 195 =		OR	+ \$ 390 =	
				TOTAL		OR	TOTAL	<i>980</i>

\* If the difference in column 1 is less than zero, enter "0" in column 2

**CLAIMS AS AMENDED - PART II**

		(Column 1)	(Column 2)	(Column 3)	SMALL ENTITY		OR	OTHER THAN SMALL ENTITY	
AMENDMENT A		CLAIMS REMAINING AFTER AMENDMENT	HIGHEST NUMBER PREVIOUSLY PAID FOR	PRESENT EXTRA	RATE	ADDITIONAL FEE		RATE	ADDITIONAL FEE
	Total		Minus	**	X \$ 26 =		OR	X \$ 52 =	
	Independent		Minus	***	X \$ 110 =		OR	X \$ 220 =	
FIRST PRESENTATION OF MULTIPLE DEPENDENT CLAIM			<input type="checkbox"/>		+ \$ 195 =		OR	+ \$ 390 =	
					TOTAL ADDIT. FEE		OR	TOTAL ADDIT. FEE	

		(Column 1)	(Column 2)	(Column 3)	SMALL ENTITY		OR	OTHER THAN SMALL ENTITY	
AMENDMENT B		CLAIMS REMAINING AFTER AMENDMENT	HIGHEST NUMBER PREVIOUSLY PAID FOR	PRESENT EXTRA	RATE	ADDITIONAL FEE		RATE	ADDITIONAL FEE
	Total		Minus	**	X \$ 26 =		OR	X \$ 52 =	
	Independent		Minus	***	X \$ 110 =		OR	X \$ 220 =	
FIRST PRESENTATION OF MULTIPLE DEPENDENT CLAIM			<input type="checkbox"/>		+ \$ 195 =		OR	+ \$ 390 =	
					TOTAL ADDIT. FEE		OR	TOTAL ADDIT. FEE	

\* If the entry in column 1 is less than the entry in column 2, write "0" in column 3.

\*\* If the "Highest Number Previously Paid For" IN THIS SPACE is less than '20', enter "20".

\*\*\* If the "Highest Number Previously Paid For" IN THIS SPACE is less than '3', enter "3".

The "Highest Number Previously Paid For" (Total or Independent) is the highest number found in the appropriate box in column 1.



UNITED STATES PATENT AND TRADEMARK OFFICE

UNITED STATES DEPARTMENT OF COMMERCE
United States Patent and Trademark Office
Address: COMMISSIONER FOR PATENTS
P.O. Box 1450
Alexandria, Virginia 22313-1450
www.uspto.gov

Table with 3 columns: U.S. APPLICATION NUMBER NO. (12/303,947), FIRST NAMED APPLICANT (Yeong Hyeon Kwon), ATTY. DOCKET NO. (2101-3596)

35884
LEE, HONG, DEGERMAN, KANG & WAIMEY
660 S. FIGUEROA STREET
Suite 2300
LOS ANGELES, CA 90017

Table with 2 columns: INTERNATIONAL APPLICATION NO. (PCT/KR07/02784), L.A. FILING DATE (06/08/2007), PRIORITY DATE (06/09/2006)

CONFIRMATION NO. 1730
371 FORMALITIES LETTER



Date Mailed: 05/07/2010

NOTIFICATION OF MISSING REQUIREMENTS UNDER 35 U.S.C. 371
IN THE UNITED STATES DESIGNATED/ELECTED OFFICE (DO/EO/US)

The following items have been submitted by the applicant or the IB to the United States Patent and Trademark Office as an Elected Office (37 CFR 1.495):

- Priority Document
• Copy of the International Application filed on 12/08/2008
• Copy of the International Search Report filed on 12/08/2008
• Preliminary Amendments filed on 01/21/2009
• Information Disclosure Statements filed on 07/17/2009
• U.S. Basic National Fees filed on 12/08/2008

The applicant needs to satisfy supplemental fees problems indicated below.

The following items MUST be furnished within the period set forth below in order to complete the requirements for acceptance under 35 U.S.C. 371:

- Oath or declaration of the inventors, in compliance with 37 CFR 1.497(a) and (b), identifying the application by the International application number and international filing date.
• To avoid abandonment, a surcharge (for late submission of filing fee, search fee, examination fee or oath or declaration) as set forth in 37 CFR 1.492(h) of \$130 for a non-small entity, must be submitted with the missing items identified in this letter.

SUMMARY OF FEES DUE:

Total additional fees required for this application is \$130 for a Large Entity:

- \$130 Surcharge.
• This application clearly fails to comply with the requirements of 37 CFR. 1.821-1.825. Applicant's attention is directed to the final rulemaking notice published at 55 FR 18230 (May 1, 1990), and 1114 OG 29 (May 15, 1990). If the effective filing date is on or after July 1, 1998, see the final rulemaking notice published at 63 FR 29620 (June 1, 1998) and 1211 OG 82 (June 23, 1998). If the effective filing date is on or after September 8, 2000, see the final rulemaking notice published in the Federal Register at 65 FR 54604 (September 8, 2000) and 1238 OG 145 (September 19, 2000). Applicant must provide an initial computer readable form (CRF) copy of the "Sequence Listing", an initial paper or compact disc copy of the "Sequence Listing", as well as an amendment specifically directing its entry into the application. Applicant must also provide a statement that the content of the sequence listing information recorded in computer readable form is identical to the written (on paper or compact disc) sequence listing and, where applicable, includes no new matter, as required by 37 CFR 1.821(e), 1.821(f), 1.821(g), 1.825(b), or 1.825(d). If applicant desires the sequence

listing in the instant application to be identical with that of another application on file in the U.S. Patent and Trademark Office, such request in accordance with 37 CFR 1.821(e) may be submitted in lieu of a new CRF.

- A copy of the "Sequence Listing" in computer readable form has not been submitted as required by 37 CFR 1.821(e). If the effective filing date is on or after September 8, 2000, see the final rulemaking notice published in the Federal Register at 65 FR 54604 (September 8, 2000) and 1238 OG 145 (September 19, 2000). Applicant must provide an initial computer readable form (CRF) copy of the "Sequence Listing" and a statement that the content of the sequence listing information recorded in computer readable form is identical to the written (on paper or compact disc) sequence listing and, where applicable, includes no new matter, as required by 37 CFR 1.821(e), 1.821(f), 1.821(g), 1.825(b), or 1.825(d). If applicant desires the sequence listing in the instant application to be identical with that of another application on file in the U.S. Patent and Trademark Office, such request in accordance with 37 CFR 1.821(e) may be submitted in lieu of a new CRF.

Applicant is cautioned that correction of the above items may cause the specification and drawings page count to exceed 100 pages. If the specification and drawings exceed 100 pages, applicant will need to submit the required application size fee.

**For questions regarding compliance to 37 CFR 1.821-1.825 requirements, please contact:**

- For Rules Interpretation, call (571) 272-0951
- For Patent Software Program Help, call Patent EBC at 1-866-217-9197 or directly at 703-305-3028 / 703-308-6845 between the hours of 6 a.m. and 12 midnight, Monday through Friday, EST.
- Send e-mail correspondence for Patent Software Program Help @ [ebc@uspto.gov](mailto:ebc@uspto.gov)

**ALL OF THE ITEMS SET FORTH ABOVE MUST BE SUBMITTED WITHIN TWO (2) MONTHS FROM THE DATE OF THIS NOTICE OR BY 32 MONTHS FROM THE PRIORITY DATE FOR THE APPLICATION, WHICHEVER IS LATER. FAILURE TO PROPERLY RESPOND WILL RESULT IN ABANDONMENT.**

The time period set above may be extended by filing a petition and fee for extension of time under the provisions of 37 CFR 1.136(a).

Applicant is reminded that any communications to the United States Patent and Trademark Office must be mailed to the address given in the heading and include the U.S. application no. shown above (37 CFR 1.5)

Registered users of EFS-Web may alternatively submit their reply to this notice via EFS-Web.  
<https://sportal.uspto.gov/authenticate/AuthenticateUserLocalEPF.html>

For more information about EFS-Web please call the USPTO Electronic Business Center at **1-866-217-9197** or visit our website at <http://www.uspto.gov/ebc>.

**If you are not using EFS-Web to submit your reply, you must include a copy of this notice.**

NADINE V CLARK

---

Telephone: (703) 756-1411

## Electronic Patent Application Fee Transmittal

<b>Application Number:</b>	12303947
<b>Filing Date:</b>	
<b>Title of Invention:</b>	METHOD OF TRANSMITTING DATA IN A MOBILE COMMUNICATION SYSTEM
<b>First Named Inventor/Applicant Name:</b>	Yeong Hyeon Kwon
<b>Filer:</b>	Harry Sung Lee/Maggie Wen
<b>Attorney Docket Number:</b>	2101-3596

Filed as Large Entity

### U.S. National Stage under 35 USC 371 Filing Fees

Description	Fee Code	Quantity	Amount	Sub-Total in USD(\$)
<b>Basic Filing:</b>				
<b>Pages:</b>				
<b>Claims:</b>				
<b>Miscellaneous-Filing:</b>				
Oath/decl > 30 months from priority date	1617	1	130	130

**Petition:**

**Patent-Appeals-and-Interference:**

**Post-Allowance-and-Post-Issuance:**

**Extension-of-Time:**

**EVOLVED-0001998**

ZTE/HTC  
Exhibit 1005-0356



Description	Fee Code	Quantity	Amount	Sub-Total in USD(\$)
<b>Miscellaneous:</b>				
<b>Total in USD (\$)</b>				<b>130</b>

**DECLARATION  
and POWER OF ATTORNEY**

- ORIGINAL
- CONTINUATION-IN-PART
- DIVISIONAL

As a below named inventor, I declare that the information given herein is true, that I believe that I am the original, first and sole inventor (if only one name is listed as 1 below) or an original, first and joint inventor (if plural names are listed below) of the subject matter which is claimed and for which a patent is sought on the invention entitled:

**METHOD OF TRANSMITTING DATA IN A MOBILE COMMUNICATION SYSTEM**

the specification of which is attached hereto unless the following box is checked:

was filed on December 8, 2008 as United States Application Number 12/303,947.

My residence, post office address and citizenship are as stated below next to my name. I acknowledge my duty to disclose information, which is material to the patentability of this application in accordance with Title 37, Code of Federal Regulations § 1.56. I hereby state that I have reviewed and understand the contents of the above identified specification, including the claims, as amended by any amendment referred to above. I hereby claim foreign priority benefits under Title 35, United States Code, § 119 OR 365(b) of any foreign application(s) for patent or inventor's certificate, or 365(a) of any PCT international application which designated at least one country other than the United States of America, listed below and have also identified below any foreign application for patent or inventor's certificate, or any PCT international application having a filing date before that of the application on which priority is claimed:

**PRIOR FOREIGN APPLICATION(S)**

COUNTRY	APPLICATION NUMBER	DATE OF FILING Month Day Year	PRIORITY CLAIMED UNDER 35 U.S.C. 119
PCT	PCT/KR2007/002784	June 8, 2007	YES
Korea	10-2006-0052167	June 9, 2006	YES
Korea	10-2006-0057488	June 26, 2006	YES

I hereby claim the benefit under Title 35, United States Code, §119 of any United States application(s) listed below and, insofar as the subject matter of each of the claims of this application is not disclosed in the prior United States application in the manner provided by the first paragraph of Title 35, United States Code § 112, I acknowledge the duty to disclose material information as defined in Title 37, Code of Federal Regulations, § 1.56 which occurred between the filing date of the prior application and the national or PCT international filing date of this application.

(Application Serial No.)

(Filing Date)

(Status)

**POWER OF ATTORNEY:** As a named Inventor, I hereby appoint the following attorney(s) and/or Agent(s) to prosecute this application and transact all business in the Patent and Trademark Office connected therewith:

**THE ATTORNEYS ASSOCIATED WITH CUSTOMER NO. 035884**

SEND  
CORRESPONDENCE  
TO:

Jonathan Y. Kang, Esq.  
**LEE, HONG, DEGERMAN, KANG & WAIMEY** TELEPHONE NO.: (213) 623-2221  
At the address associated with FAX NO.: (213) 623-2211/8601  
Customer No. 35884

1	Name of Inventor	Residence: CITY	STATE or COUNTRY
	Yeong Hyeon KWON	Gyeonggi-do	Republic of Korea
	Mailing Address	CITIZENSHIP	
	LG Institute, Hogye 1-dong, Dongan-gu, Anyang-si, Gyeonggi-do, 431-080 Republic of Korea	Republic of Korea	
2	Name of Inventor	Residence: CITY	STATE or COUNTRY
	Seung Hee HAN	Gyeonggi-do	Republic of Korea
	Mailing Address	CITIZENSHIP	
	LG Institute, Hogye 1-dong, Dongan-gu, Anyang-si, Gyeonggi-do, 431-080 Republic of Korea	Republic of Korea	
3	Name of Inventor	Residence: CITY	STATE or COUNTRY
	Hyun Hwa PARK	Gyeonggi-do	Republic of Korea
	Mailing Address	CITIZENSHIP	
	LG Institute, Hogye 1-dong, Dongan-gu, Anyang-si, Gyeonggi-do, 431-080 Republic of Korea	Republic of Korea	
4	Name of Inventor	Residence: CITY	STATE or COUNTRY
	Dong Cheol KIM	Gyeonggi-do	Republic of Korea
	Mailing Address	CITIZENSHIP	
	LG Institute, Hogye 1-dong, Dongan-gu, Anyang-si, Gyeonggi-do, 431-080 Republic of Korea	Republic of Korea	
5	Name of Inventor	Residence: CITY	STATE or COUNTRY
	Hyun Woo LEE	Gyeonggi-do	Republic of Korea
	Mailing Address	CITIZENSHIP	
	LG Institute, Hogye 1-dong, Dongan-gu, Anyang-si, Gyeonggi-do, 431-080 Republic of Korea	Republic of Korea	
6	Name of Inventor	Residence: CITY	STATE or COUNTRY
	Min Seok NOH	Gyeonggi-do	Republic of Korea
	Mailing Address	CITIZENSHIP	
	LG Institute, Hogye 1-dong, Dongan-gu, Anyang-si, Gyeonggi-do, 431-080 Republic of Korea	Republic of Korea	

I further declare that all statements made herein of my own knowledge are true and that all statements made on

information and belief are believed to be true; and further that these statements were made with the knowledge that willful false statements and the like so made are punishable by fine or imprisonment, or both, under Section 1001 of Title 18 of the United States Code, and that such willful false statements may jeopardize the validity of the application or any patent issuing thereon.

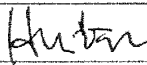
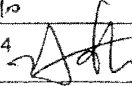
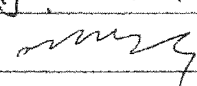
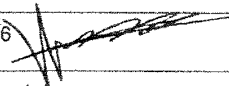
SIGNATURE OF INVENTOR 1	SIGNATURE OF INVENTOR 2 
DATE	DATE 6th, July, 2010
SIGNATURE OF INVENTOR 3 	SIGNATURE OF INVENTOR 4 
DATE 6th, July, 2010.	DATE 6th, July, 2010
SIGNATURE OF INVENTOR 5 	SIGNATURE OF INVENTOR 6 
DATE 6th, July, 2010	DATE 6th, July, 2010

**DECLARATION  
and POWER OF ATTORNEY**

- ORIGINAL
- CONTINUATION-IN-PART
- DIVISIONAL

As a below named inventor, I declare that the information given herein is true, that I believe that I am the original, first and sole inventor (if only one name is listed as 1 below) or an original, first and joint inventor (if plural names are listed below) of the subject matter which is claimed and for which a patent is sought on the invention entitled:

**METHOD OF TRANSMITTING DATA IN A MOBILE COMMUNICATION SYSTEM**

the specification of which is attached hereto unless the following box is checked:

was filed on December 8, 2008 as United States Application Number 12/303,947.

My residence, post office address and citizenship are as stated below next to my name. I acknowledge my duty to disclose information, which is material to the patentability of this application in accordance with Title 37, Code of Federal Regulations § 1.56. I hereby state that I have reviewed and understand the contents of the above identified specification, including the claims, as amended by any amendment referred to above. I hereby claim foreign priority benefits under Title 35, United States Code, § 119 OR 365(b) of any foreign application(s) for patent or inventor's certificate, or 365(a) of any PCT international application which designated at least one country other than the United States of America, listed below and have also identified below any foreign application for patent or inventor's certificate, or any PCT international application having a filing date before that of the application on which priority is claimed:

PRIOR FOREIGN APPLICATION(S)

COUNTRY	APPLICATION NUMBER	DATE OF FILING Month Day Year	PRIORITY CLAIMED UNDER 35 U.S.C. 119
PCT	PCT/KR2007/002784	June 8, 2007	YES
Korea	10-2006-0052167	June 9, 2006	YES
Korea	10-2006-0057488	June 26, 2006	YES

I hereby claim the benefit under Title 35, United States Code, §119 of any United States application(s) listed below and, insofar as the subject matter of each of the claims of this application is not disclosed in the prior United States application in the manner provided by the first paragraph of Title 35, United States Code § 112, I acknowledge the duty to disclose material information as defined in Title 37, Code of Federal Regulations, § 1.56 which occurred between the filing date of the prior application and the national or PCT international filing date of this application.

(Application Serial No.)	(Filing Date)	(Status)
--------------------------	---------------	----------

**POWER OF ATTORNEY:** As a named Inventor, I hereby appoint the following attorney(s) and/or Agent(s) to prosecute this application and transact all business in the Patent and Trademark Office connected therewith:

**THE ATTORNEYS ASSOCIATED WITH CUSTOMER NO. 035884**

SEND  
CORRESPONDENCE  
TO:

Jonathan Y. Kang, Esq.  
**LEE, HONG, DEGERMAN, KANG &  
WAIMEY**  
At the address associated with  
Customer No. 35884

TELEPHONE NO.: (213) 623-2221  
FAX NO.: (213) 623-2211/8601

1	Name of Inventor	Residence: CITY	STATE or COUNTRY
	Yeong Hyeon KWON	Gyeonggi-do	Republic of Korea
	Mailing Address		CITIZENSHIP
	LG Institute, Hogye 1-dong, Dongan-gu, Anyang-si, Gyeonggi-do, 431-080 Republic of Korea		Republic of Korea
2	Name of Inventor	Residence: CITY	STATE or COUNTRY
	Seung Hee HAN	Gyeonggi-do	Republic of Korea
	Mailing Address		CITIZENSHIP
	LG Institute, Hogye 1-dong, Dongan-gu, Anyang-si, Gyeonggi-do, 431-080 Republic of Korea		Republic of Korea
3	Name of Inventor	Residence: CITY	STATE or COUNTRY
	Hyun Hwa PARK	Gyeonggi-do	Republic of Korea
	Mailing Address		CITIZENSHIP
	LG Institute, Hogye 1-dong, Dongan-gu, Anyang-si, Gyeonggi-do, 431-080 Republic of Korea		Republic of Korea
4	Name of Inventor	Residence: CITY	STATE or COUNTRY
	Dong Cheol KIM	Gyeonggi-do	Republic of Korea
	Mailing Address		CITIZENSHIP
	LG Institute, Hogye 1-dong, Dongan-gu, Anyang-si, Gyeonggi-do, 431-080 Republic of Korea		Republic of Korea
5	Name of Inventor	Residence: CITY	STATE or COUNTRY
	Hyun Woo LEE	Gyeonggi-do	Republic of Korea
	Mailing Address		CITIZENSHIP
	LG Institute, Hogye 1-dong, Dongan-gu, Anyang-si, Gyeonggi-do, 431-080 Republic of Korea		Republic of Korea
6	Name of Inventor	Residence: CITY	STATE or COUNTRY
	Min Seok NOH	Gyeonggi-do	Republic of Korea
	Mailing Address		CITIZENSHIP
	LG Institute, Hogye 1-dong, Dongan-gu, Anyang-si, Gyeonggi-do, 431-080 Republic of Korea		Republic of Korea

I further declare that all statements made herein of my own knowledge are true and that all statements made on information and belief are believed to be true; and further that these statements were made with the knowledge that willful false statements and the like so made are punishable by fine or imprisonment, or both, under Section 1001 of Title 18 of the United States Code, and that such willful false statements may jeopardize the validity of the application or any patent issuing thereon.

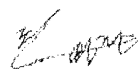
SIGNATURE OF INVENTOR 1 	SIGNATURE OF INVENTOR 2
DATE 2010.6.20	DATE
SIGNATURE OF INVENTOR 3	SIGNATURE OF INVENTOR 4
DATE	DATE
SIGNATURE OF INVENTOR 5	SIGNATURE OF INVENTOR 6
DATE	DATE

IN THE UNITED STATES PATENT AND TRADEMARK OFFICE

In re application of:  
Kwon et al.  
Serial No: 12/303,947  
Filed: December 8, 2008  
For: METHOD OF TRANSMITTING DATA IN A  
MOBILE COMMUNICATION SYSTEM

Art Unit: -  
Examiner: -  
Confirmation No. 1730

TRANSMITTAL OF MISSING PARTS

Mail Stop Missing Parts  
Commissioner for Patents  
P. O. Box 1450  
Alexandria, VA 22313-1450

Dear Sir:

In response to the "Notification of Missing Requirements under 35 U.S.C. 371" dated May 7, 2010 for the above-identified application, enclosed herewith is:

1. A signed Declaration and Power of Attorney.

Furthermore, please note that a copy of "Sequence Listing" in compliance to 37 CFR 1.821-1.825 requirements is not applicable to this application since this application does not include any nucleotide/amino acid sequence. Therefore, applicant is not submitting a copy of the "Sequence Listing" in computer readable form for the application.

To the extent necessary, a petition for an extension of time under 37 C.F.R. 1.136 is hereby made. Please charge any additional fees due or credit any overpayment in connection with the filing of this concurrent and future replies, including extension of time fees, to Deposit Account 502290.

Respectfully submitted,

LEE, HONG, DEGERMAN, KANG & WAIMEY

Date: July 7, 2010

Customer No. 035884

By: /Harry S. Lee/   
Harry S. Lee  
Registration No. 56,814



## Electronic Acknowledgement Receipt

<b>EFS ID:</b>	7971170
<b>Application Number:</b>	12303947
<b>International Application Number:</b>	
<b>Confirmation Number:</b>	1730
<b>Title of Invention:</b>	METHOD OF TRANSMITTING DATA IN A MOBILE COMMUNICATION SYSTEM
<b>First Named Inventor/Applicant Name:</b>	Yeong Hyeon Kwon
<b>Customer Number:</b>	35884
<b>Filer:</b>	Harry Sung Lee/Maggie Wen
<b>Filer Authorized By:</b>	Harry Sung Lee
<b>Attorney Docket Number:</b>	2101-3596
<b>Receipt Date:</b>	07-JUL-2010
<b>Filing Date:</b>	
<b>Time Stamp:</b>	19:13:20
<b>Application Type:</b>	U.S. National Stage under 35 USC 371

### Payment information:

Submitted with Payment	yes
Payment Type	Deposit Account
Payment was successfully received in RAM	\$ 130
RAM confirmation Number	5097
Deposit Account	502290
Authorized User	

The Director of the USPTO is hereby authorized to charge indicated fees and credit any overpayment as follows:

Charge any Additional Fees required under 37 C.F.R. 1.492 (National application filing, search, and examination fees)

Charge any Additional Fees required under 37 C.F.R. Section 1.17 (Patent application and reexamination processing fees)

**EVOLVED-0002007**

ZTE/HTC

Exhibit 1005-0365

**File Listing:**

Document Number	Document Description	File Name	File Size(Bytes)/ Message Digest	Multi Part /.zip	Pages (if appl.)
1		2101-3596_MP.pdf	686024 9a52fc4a8c6577794c1dd0f689c7561e4eeb81c	yes	7
<b>Multipart Description/PDF files in .zip description</b>					
	<b>Document Description</b>		<b>Start</b>	<b>End</b>	
	Applicant Response to Pre-Exam Formalities Notice		1	1	
	Oath or Declaration filed		2	7	

**Warnings:**

**Information:**

2	Fee Worksheet (PTO-875)	fee-info.pdf	30340 ead1a82488c9d77bfaaa64407721bd6f18c532ba	no	2
---	-------------------------	--------------	---	----	---

**Warnings:**

**Information:**

**Total Files Size (in bytes):** 716364

**This Acknowledgement Receipt evidences receipt on the noted date by the USPTO of the indicated documents, characterized by the applicant, and including page counts, where applicable. It serves as evidence of receipt similar to a Post Card, as described in MPEP 503.**

**New Applications Under 35 U.S.C. 111**

**If a new application is being filed and the application includes the necessary components for a filing date (see 37 CFR 1.53(b)-(d) and MPEP 506), a Filing Receipt (37 CFR 1.54) will be issued in due course and the date shown on this Acknowledgement Receipt will establish the filing date of the application.**

**National Stage of an International Application under 35 U.S.C. 371**

**If a timely submission to enter the national stage of an international application is compliant with the conditions of 35 U.S.C. 371 and other applicable requirements a Form PCT/DO/EO/903 indicating acceptance of the application as a national stage submission under 35 U.S.C. 371 will be issued in addition to the Filing Receipt, in due course.**

**New International Application Filed with the USPTO as a Receiving Office**

**If a new international application is being filed and the international application includes the necessary components for an international filing date (see PCT Article 11 and MPEP 1810), a Notification of the International Application Number and of the International Filing Date (Form PCT/RO/105) will be issued in due course, subject to prescriptions concerning national security, and the date shown on this Acknowledgement Receipt will establish the international filing date of the application.**



UNITED STATES PATENT AND TRADEMARK OFFICE

UNITED STATES DEPARTMENT OF COMMERCE
United States Patent and Trademark Office
Address: COMMISSIONER FOR PATENTS
P.O. Box 1450
Alexandria, Virginia 22313-1450
www.uspto.gov

Table with 3 columns: U.S. APPLICATION NUMBER NO. (12/303,947), FIRST NAMED APPLICANT (Yeong Hyeon Kwon), ATTY. DOCKET NO. (2101-3596)

35884
LEE, HONG, DEGERMAN, KANG & WAIMEY
660 S. FIGUEROA STREET
Suite 2300
LOS ANGELES, CA 90017

Table with 2 columns: INTERNATIONAL APPLICATION NO. (PCT/KR07/02784), L.A. FILING DATE (06/08/2007), PRIORITY DATE (06/09/2006)

CONFIRMATION NO. 1730
371 ACCEPTANCE LETTER



Date Mailed: 08/16/2010

NOTICE OF ACCEPTANCE OF APPLICATION UNDER 35 U.S.C 371 AND 37 CFR 1.495

The applicant is hereby advised that the United States Patent and Trademark Office in its capacity as a Designated / Elected Office (37 CFR 1.495), has determined that the above identified international application has met the requirements of 35 U.S.C. 371, and is ACCEPTED for national patentability examination in the United States Patent and Trademark Office.

The United States Application Number assigned to the application is shown above and the relevant dates are:

Table with 2 columns: DATE OF RECEIPT OF 35 U.S.C. 371(c)(1), (c)(2) and (c)(4) REQUIREMENTS (07/07/2010), DATE OF COMPLETION OF ALL 35 U.S.C. 371 REQUIREMENTS (07/07/2010)

A Filing Receipt (PTO-103X) will be issued for the present application in due course. THE DATE APPEARING ON THE FILING RECEIPT AS THE " FILING DATE" IS THE DATE ON WHICH THE LAST OF THE 35 U.S.C. 371 (c)(1), (c)(2) and (c)(4) REQUIREMENTS HAS BEEN RECEIVED IN THE OFFICE. THIS DATE IS SHOWN ABOVE. The filing date of the above identified application is the international filing date of the international application (Article 11(3) and 35 U.S.C. 363). Once the Filing Receipt has been received, send all correspondence to the Group Art Unit designated thereon.

The following items have been received:

- Copy of the International Application filed on 12/08/2008
• Copy of the International Search Report filed on 12/08/2008
• Preliminary Amendments filed on 01/21/2009
• Information Disclosure Statements filed on 07/17/2009
• Oath or Declaration filed on 07/07/2010
• U.S. Basic National Fees filed on 12/08/2008

Applicant is reminded that any communications to the United States Patent and Trademark Office must be mailed to the address given in the heading and include the U.S. application no. shown above (37 CFR 1.5)

NINA D BUTLER

Telephone: (703) 756-1446



UNITED STATES PATENT AND TRADEMARK OFFICE

UNITED STATES DEPARTMENT OF COMMERCE
United States Patent and Trademark Office
Address: COMMISSIONER FOR PATENTS
P.O. Box 1450
Alexandria, Virginia 22313-1450
www.uspto.gov

Table with 8 columns: APPLICATION NUMBER, FILING or 371(c) DATE, GRP ART UNIT, FIL FEE REC'D, ATTY.DOCKET.NO, TOT CLAIMS, IND CLAIMS. Values: 12/303,947, 07/07/2010, 1632, 1110, 2101-3596, 14, 2

CONFIRMATION NO. 1730

FILING RECEIPT

35884
LEE, HONG, DEGERMAN, KANG & WAIMEY
660 S. FIGUEROA STREET
Suite 2300
LOS ANGELES, CA 90017



Date Mailed: 08/16/2010

Receipt is acknowledged of this non-provisional patent application. The application will be taken up for examination in due course. Applicant will be notified as to the results of the examination. Any correspondence concerning the application must include the following identification information: the U.S. APPLICATION NUMBER, FILING DATE, NAME OF APPLICANT, and TITLE OF INVENTION. Fees transmitted by check or draft are subject to collection. Please verify the accuracy of the data presented on this receipt. If an error is noted on this Filing Receipt, please submit a written request for a Filing Receipt Correction. Please provide a copy of this Filing Receipt with the changes noted thereon. If you received a "Notice to File Missing Parts" for this application, please submit any corrections to this Filing Receipt with your reply to the Notice. When the USPTO processes the reply to the Notice, the USPTO will generate another Filing Receipt incorporating the requested corrections

Applicant(s)

Yeong Hyeon Kwon, Gyeonggi-do, KOREA, REPUBLIC OF;
Seung Hee Han, Gyeonggi-do, KOREA, REPUBLIC OF;
Hyun Hwa Park, Gyeonggi-do, KOREA, REPUBLIC OF;
Dong Cheol Kim, Gyeonggi-do, KOREA, REPUBLIC OF;
Hyun Woo Lee, Gyeonggi-do, KOREA, REPUBLIC OF;
Min Seok Noh, Gyeonggi-do, KOREA, REPUBLIC OF;

Power of Attorney: The patent practitioners associated with Customer Number 35884

Domestic Priority data as claimed by applicant

This application is a 371 of PCT/KR07/02784 06/08/2007

Foreign Applications

REPUBLIC OF KOREA 10-2006-0052167 06/09/2006
REPUBLIC OF KOREA 10-2006-0057488 06/26/2006

If Required, Foreign Filing License Granted: 08/11/2010

The country code and number of your priority application, to be used for filing abroad under the Paris Convention, is US 12/303,947

Projected Publication Date: 11/25/2010

Non-Publication Request: No

Early Publication Request: No

**Title**

METHOD OF TRANSMITTING DATA IN A MOBILE COMMUNICATION SYSTEM

**Preliminary Class**

435

**PROTECTING YOUR INVENTION OUTSIDE THE UNITED STATES**

Since the rights granted by a U.S. patent extend only throughout the territory of the United States and have no effect in a foreign country, an inventor who wishes patent protection in another country must apply for a patent in a specific country or in regional patent offices. Applicants may wish to consider the filing of an international application under the Patent Cooperation Treaty (PCT). An international (PCT) application generally has the same effect as a regular national patent application in each PCT-member country. The PCT process **simplifies** the filing of patent applications on the same invention in member countries, but **does not result** in a grant of "an international patent" and does not eliminate the need of applicants to file additional documents and fees in countries where patent protection is desired.

Almost every country has its own patent law, and a person desiring a patent in a particular country must make an application for patent in that country in accordance with its particular laws. Since the laws of many countries differ in various respects from the patent law of the United States, applicants are advised to seek guidance from specific foreign countries to ensure that patent rights are not lost prematurely.

Applicants also are advised that in the case of inventions made in the United States, the Director of the USPTO must issue a license before applicants can apply for a patent in a foreign country. The filing of a U.S. patent application serves as a request for a foreign filing license. The application's filing receipt contains further information and guidance as to the status of applicant's license for foreign filing.

Applicants may wish to consult the USPTO booklet, "General Information Concerning Patents" (specifically, the section entitled "Treaties and Foreign Patents") for more information on timeframes and deadlines for filing foreign patent applications. The guide is available either by contacting the USPTO Contact Center at 800-786-9199, or it can be viewed on the USPTO website at <http://www.uspto.gov/web/offices/pac/doc/general/index.html>.

For information on preventing theft of your intellectual property (patents, trademarks and copyrights), you may wish to consult the U.S. Government website, <http://www.stopfakes.gov>. Part of a Department of Commerce initiative, this website includes self-help "toolkits" giving innovators guidance on how to protect intellectual property in specific countries such as China, Korea and Mexico. For questions regarding patent enforcement issues, applicants may call the U.S. Government hotline at 1-866-999-HALT (1-866-999-4158).

**LICENSE FOR FOREIGN FILING UNDER****Title 35, United States Code, Section 184****Title 37, Code of Federal Regulations, 5.11 & 5.15****GRANTED**

The applicant has been granted a license under 35 U.S.C. 184, if the phrase "IF REQUIRED, FOREIGN FILING LICENSE GRANTED" followed by a date appears on this form. Such licenses are issued in all applications where the conditions for issuance of a license have been met, regardless of whether or not a license may be required as

page 2 of 3

**EVOLVED-0002011**

ZTE/HTC

Exhibit 1005-0369

set forth in 37 CFR 5.15. The scope and limitations of this license are set forth in 37 CFR 5.15(a) unless an earlier license has been issued under 37 CFR 5.15(b). The license is subject to revocation upon written notification. The date indicated is the effective date of the license, unless an earlier license of similar scope has been granted under 37 CFR 5.13 or 5.14.

This license is to be retained by the licensee and may be used at any time on or after the effective date thereof unless it is revoked. This license is automatically transferred to any related applications(s) filed under 37 CFR 1.53(d). This license is not retroactive.

The grant of a license does not in any way lessen the responsibility of a licensee for the security of the subject matter as imposed by any Government contract or the provisions of existing laws relating to espionage and the national security or the export of technical data. Licensees should apprise themselves of current regulations especially with respect to certain countries, of other agencies, particularly the Office of Defense Trade Controls, Department of State (with respect to Arms, Munitions and Implements of War (22 CFR 121-128)); the Bureau of Industry and Security, Department of Commerce (15 CFR parts 730-774); the Office of Foreign Assets Control, Department of Treasury (31 CFR Parts 500+) and the Department of Energy.

**NOT GRANTED**

No license under 35 U.S.C. 184 has been granted at this time, if the phrase "IF REQUIRED, FOREIGN FILING LICENSE GRANTED" DOES NOT appear on this form. Applicant may still petition for a license under 37 CFR 5.12, if a license is desired before the expiration of 6 months from the filing date of the application. If 6 months has lapsed from the filing date of this application and the licensee has not received any indication of a secrecy order under 35 U.S.C. 181, the licensee may foreign file the application pursuant to 37 CFR 5.15(b).



UNITED STATES PATENT AND TRADEMARK OFFICE

UNITED STATES DEPARTMENT OF COMMERCE
United States Patent and Trademark Office
Address: COMMISSIONER FOR PATENTS
P.O. Box 1450
Alexandria, Virginia 22313-1450
www.uspto.gov

Table with 4 columns: APPLICATION NUMBER (12/303,947), FILING OR 371(C) DATE (07/07/2010), FIRST NAMED APPLICANT (Yeong Hyeon Kwon), ATTY. DOCKET NO./TITLE (2101-3596)

CONFIRMATION NO. 1730

PUBLICATION NOTICE

35884
LEE, HONG, DEGERMAN, KANG & WAIMEY
660 S. FIGUEROA STREET
Suite 2300
LOS ANGELES, CA 90017



Title:METHOD OF TRANSMITTING DATA IN A MOBILE COMMUNICATION SYSTEM

Publication No.US-2010-0296436-A1

Publication Date:11/25/2010

NOTICE OF PUBLICATION OF APPLICATION

The above-identified application will be electronically published as a patent application publication pursuant to 37 CFR 1.211, et seq. The patent application publication number and publication date are set forth above.

The publication may be accessed through the USPTO's publically available Searchable Databases via the Internet at www.uspto.gov. The direct link to access the publication is currently http://www.uspto.gov/patft/.

The publication process established by the Office does not provide for mailing a copy of the publication to applicant. A copy of the publication may be obtained from the Office upon payment of the appropriate fee set forth in 37 CFR 1.19(a)(1). Orders for copies of patent application publications are handled by the USPTO's Office of Public Records. The Office of Public Records can be reached by telephone at (703) 308-9726 or (800) 972-6382, by facsimile at (703) 305-8759, by mail addressed to the United States Patent and Trademark Office, Office of Public Records, Alexandria, VA 22313-1450 or via the Internet.

In addition, information on the status of the application, including the mailing date of Office actions and the dates of receipt of correspondence filed in the Office, may also be accessed via the Internet through the Patent Electronic Business Center at www.uspto.gov using the public side of the Patent Application Information and Retrieval (PAIR) system. The direct link to access this status information is currently http://pair.uspto.gov/. Prior to publication, such status information is confidential and may only be obtained by applicant using the private side of PAIR.

Further assistance in electronically accessing the publication, or about PAIR, is available by calling the Patent Electronic Business Center at 1-866-217-9197.

Office of Data Management, Application Assistance Unit (571) 272-4000, or (571) 272-4200, or 1-888-786-0101

<b>Search Notes</b>  	<b>Application/Control No.</b> 12303947	<b>Applicant(s)/Patent Under Reexamination</b> KWON ET AL.
	<b>Examiner</b> SHRIPAL KHAJURIA	<b>Art Unit</b> 2478

<b>SEARCHED</b>			
<b>Class</b>	<b>Subclass</b>	<b>Date</b>	<b>Examiner</b>
370	328	9/7/2011	skk

<b>SEARCH NOTES</b>		
<b>Search Notes</b>	<b>Date</b>	<b>Examiner</b>
Text search of East (USPat, USPG_Pub, JPO, EPO, Derwent, IBM_TDB) and Inventor search	9/7/2011	skk

<b>INTERFERENCE SEARCH</b>			
<b>Class</b>	<b>Subclass</b>	<b>Date</b>	<b>Examiner</b>

--	--



<b>Notice of References Cited</b>	Application/Control No. 12/303,947	Applicant(s)/Patent Under Reexamination KWON ET AL.	
	Examiner SHRIPAL KHAJURIA	Art Unit 2478	Page 1 of 1

**U.S. PATENT DOCUMENTS**

*	Document Number Country Code-Number-Kind Code	Date MM-YYYY	Name	Classification
*	A US-2006/0153282 A1	07-2006	Jung et al.	375/146
B	US-			
C	US-			
D	US-			
E	US-			
F	US-			
G	US-			
H	US-			
I	US-			
J	US-			
K	US-			
L	US-			
M	US-			

**FOREIGN PATENT DOCUMENTS**

*	Document Number Country Code-Number-Kind Code	Date MM-YYYY	Country	Name	Classification
N					
O					
P					
Q					
R					
S					
T					

**NON-PATENT DOCUMENTS**

*	Include as applicable: Author, Title Date, Publisher, Edition or Volume, Pertinent Pages)
U	
V	
W	
X	

\*A copy of this reference is not being furnished with this Office action. (See MPEP § 707.05(a).)  
Dates in MM-YYYY format are publication dates. Classifications may be US or foreign.



UNITED STATES PATENT AND TRADEMARK OFFICE

UNITED STATES DEPARTMENT OF COMMERCE  
United States Patent and Trademark Office  
Address: COMMISSIONER FOR PATENTS  
P.O. Box 1450  
Alexandria, Virginia 22313-1450  
www.uspto.gov

APPLICATION NO.	FILING DATE	FIRST NAMED INVENTOR	ATTORNEY DOCKET NO.	CONFIRMATION NO.
12/303,947	07/07/2010	Yeong Hyeon Kwon	2101-3596	1730

35884 7590 09/16/2011  
LEE, HONG, DEGERMAN, KANG & WAIMEY  
660 S. FIGUEROA STREET  
Suite 2300  
LOS ANGELES, CA 90017

EXAMINER  
KHAJURIA, SHRIPAL K

ART UNIT	PAPER NUMBER
2478	

NOTIFICATION DATE	DELIVERY MODE
09/16/2011	ELECTRONIC

**Please find below and/or attached an Office communication concerning this application or proceeding.**

The time period for reply, if any, is set in the attached communication.

Notice of the Office communication was sent electronically on above-indicated "Notification Date" to the following e-mail address(es):

uspto@lhlaw.com  
ip.lhlaw@gmail.com  
ip.lhlaw@live.com

<b>Office Action Summary</b>	<b>Application No.</b>	<b>Applicant(s)</b>	
	12/303,947	KWON ET AL.	
	<b>Examiner</b>	<b>Art Unit</b>	
	SHRIPAL KHAJURIA	2478	

-- The MAILING DATE of this communication appears on the cover sheet with the correspondence address --

**Period for Reply**

A SHORTENED STATUTORY PERIOD FOR REPLY IS SET TO EXPIRE 3 MONTH(S) OR THIRTY (30) DAYS, WHICHEVER IS LONGER, FROM THE MAILING DATE OF THIS COMMUNICATION.

- Extensions of time may be available under the provisions of 37 CFR 1.136(a). In no event, however, may a reply be timely filed after SIX (6) MONTHS from the mailing date of this communication.
- If NO period for reply is specified above, the maximum statutory period will apply and will expire SIX (6) MONTHS from the mailing date of this communication.
- Failure to reply within the set or extended period for reply will, by statute, cause the application to become ABANDONED (35 U.S.C. § 133). Any reply received by the Office later than three months after the mailing date of this communication, even if timely filed, may reduce any earned patent term adjustment. See 37 CFR 1.704(b).

**Status**

- 1)  Responsive to communication(s) filed on 21 January 2009.
- 2a)  This action is **FINAL**.
- 2b)  This action is non-final.
- 3)  An election was made by the applicant in response to a restriction requirement set forth during the interview on \_\_\_\_\_; the restriction requirement and election have been incorporated into this action.
- 4)  Since this application is in condition for allowance except for formal matters, prosecution as to the merits is closed in accordance with the practice under *Ex parte Quayle*, 1935 C.D. 11, 453 O.G. 213.

**Disposition of Claims**

- 5)  Claim(s) 31-44 is/are pending in the application.
  - 5a) Of the above claim(s) \_\_\_\_\_ is/are withdrawn from consideration.
- 6)  Claim(s) \_\_\_\_\_ is/are allowed.
- 7)  Claim(s) 31-44 is/are rejected.
- 8)  Claim(s) \_\_\_\_\_ is/are objected to.
- 9)  Claim(s) \_\_\_\_\_ are subject to restriction and/or election requirement.

**Application Papers**

- 10)  The specification is objected to by the Examiner.
- 11)  The drawing(s) filed on 08 December 2008 is/are: a)  accepted or b)  objected to by the Examiner.
  - Applicant may not request that any objection to the drawing(s) be held in abeyance. See 37 CFR 1.85(a).
  - Replacement drawing sheet(s) including the correction is required if the drawing(s) is objected to. See 37 CFR 1.121(d).
- 12)  The oath or declaration is objected to by the Examiner. Note the attached Office Action or form PTO-152.

**Priority under 35 U.S.C. § 119**

- 13)  Acknowledgment is made of a claim for foreign priority under 35 U.S.C. § 119(a)-(d) or (f).
    - a)  All    b)  Some \*    c)  None of:
      - 1.  Certified copies of the priority documents have been received.
      - 2.  Certified copies of the priority documents have been received in Application No. \_\_\_\_\_.
      - 3.  Copies of the certified copies of the priority documents have been received in this National Stage application from the International Bureau (PCT Rule 17.2(a)).
- \* See the attached detailed Office action for a list of the certified copies not received.

**Attachment(s)**

- 1)  Notice of References Cited (PTO-892)
- 2)  Notice of Draftsperson's Patent Drawing Review (PTO-948)
- 3)  Information Disclosure Statement(s) (PTO/SB/08)  
Paper No(s)/Mail Date 7/17/09
- 4)  Interview Summary (PTO-413)  
Paper No(s)/Mail Date. \_\_\_\_\_
- 5)  Notice of Informal Patent Application
- 6)  Other: \_\_\_\_\_

**DETAILED ACTION**

***Claim Rejections - 35 USC § 102***

1. The following is a quotation of the appropriate paragraphs of 35 U.S.C. 102 that form the basis for the rejections under this section made in this Office action:

A person shall be entitled to a patent unless –

(e) the invention was described in (1) an application for patent, published under section 122(b), by another filed in the United States before the invention by the applicant for patent or (2) a patent granted on an application for patent by another filed in the United States before the invention by the applicant for patent, except that an international application filed under the treaty defined in section 351(a) shall have the effects for purposes of this subsection of an application filed in the United States only if the international application designated the United States and was published under Article 21(2) of such treaty in the English language.

2. Claims 31-44 are rejected under 35 U.S.C. 102(b) as being anticipated by Jung et al US (20060153282).

a. Regarding claim 1, Jung et al teaches a method of transmitting a preamble sequence in a mobile communication system (see paragraph [0003], the preamble is transmitted), the method comprising: generating said preamble sequence by repeating a specific sequence at least one time and concatenating a cyclic prefix (CP) to a front end of said repeated sequence (see paragraphs [0064] and [0068], the first or last part of the OFDM symbol is copied and repeatedly placed), said CP being identical to a part of a rear end of said specific sequence (see paragraph [0068], the OFDM symbol is copied); and transmitting said preamble sequence to a receiving side on a random access channel (see paragraph [0069], the preamble is transmitted in every frame).

- b. Regarding claim 32, Jung et al teaches further comprising generating said specific sequence from a CAZAC (Constant Amplitude Zero Auto Correlation) sequence (see paragraph [0045]).
- c. Regarding claim 33, Jung et al teaches further comprising applying a cyclic shift to said specific sequence generated from said CAZAC (see paragraph [0048]).
- d. Regarding claim 34, Jung et al teaches wherein a value of said applied cyclic shift is determined as an integer value of a predetermined circular shift unit (see paragraph [0048]).
- e. Regarding claim 35, Jung et al teaches wherein a value of said applied cyclic shift is used as additional information (see paragraph [0068]).
- f. Regarding claim 36, Jung et al teaches wherein applying said cyclic shift comprises multiplying said specific sequence by an exponential sequence (see paragraph [0048] and equation 1).
- g. Regarding claim 37, Jung et al teaches further comprising generating said specific sequence by combining at least two code sequences mapped with at least one information bit, respectively (see paragraph [0043]).
- h. Regarding claim 38, Jung et al teaches a transmitter for transmitting a preamble sequence in a mobile communication system (see paragraph [0025], a method of transmitting a preamble from a transmitter is disclosed), the transmitter comprising: means for generating said preamble sequence by repeating a specific sequence at least one time and concatenating a cyclic prefix

(CP) to a front end of said repeated sequence (see paragraphs [0064] and [0068], the first or last part of the OFDM symbol is copied and repeatedly placed), said cyclic prefix being identical to a rear end of said specific sequence (see paragraph [0068], the OFDM symbol is copied); and means for transmitting said preamble sequence to a receiving side on a random access channel (see paragraph [0069], the preamble is transmitted in every frame).

i. Regarding claim 39, Jung et al teaches wherein said means for generating said preamble are configured to generate said specific sequence from a CAZAC (Constant Amplitude Zero Auto Correlation) sequence (see paragraph [0045]).

j. Regarding claim 40, Jung et al teaches wherein said means for generating said preamble are configured to apply a cyclic shift to said specific sequence generated from said CAZAC (see paragraph [0048]).

k. Regarding claim 41, Jung et al teaches wherein a value of said applied cyclic shift is determined as an integer value of a predetermined circular shift unit (see paragraph [0048]).

l. Regarding claim 42, Jung et al teaches wherein a value of said applied cyclic shift is used as additional information (see paragraph [0068]).

m. Regarding claim 43, Jung et al teaches wherein said means for generating said preamble are configured to apply a cyclic shift by multiplying said specific sequence by an exponential sequence (see paragraph [0048] and equation 1).

n. Regarding claim 44, Jung et al teaches wherein said means for generating said preamble are configured to generate said specific sequence by combining at

least two code sequences mapped with at least one information bit, respectively  
(see paragraph [0043]).

### ***Conclusion***

Any inquiry concerning this communication or earlier communications from the examiner should be directed to SHRIPAL KHAJURIA whose telephone number is (571)270-5662. The examiner can normally be reached on Monday - Friday, 10:00AM-6:30PM EST.

If attempts to reach the examiner by telephone are unsuccessful, the examiner's supervisor, Jeffrey Pwu can be reached on (571)272-6798. The fax phone number for the organization where this application or proceeding is assigned is 571-273-8300.

Information regarding the status of an application may be obtained from the Patent Application Information Retrieval (PAIR) system. Status information for published applications may be obtained from either Private PAIR or Public PAIR. Status information for unpublished applications is available through Private PAIR only. For more information about the PAIR system, see <http://pair-direct.uspto.gov>. Should you have questions on access to the Private PAIR system, contact the Electronic Business Center (EBC) at 866-217-9197 (toll-free). If you would like assistance from a USPTO Customer Service Representative or access to the automated information system, call 800-786-9199 (IN USA OR CANADA) or 571-272-1000.

Application/Control Number: 12/303,947  
Art Unit: 2478

Page 6

/S. K./  
Examiner, Art Unit 2478

/Jeffrey Pwu/  
Supervisory Patent Examiner, Art Unit 2478



Receipt date: 07/17/2009

12303947 - GAI: 2478

Doc code: IDS

Approved for use through 11/30/2008. OMB 0651-0031

Doc description: Information Disclosure Statement (IDS) Filed

U.S. Patent and Trademark Office; U.S. DEPARTMENT OF COMMERCE

Under the Paperwork Reduction Act of 1995, no persons are required to respond to a collection of information unless it contains a valid OMB control number.

<b>INFORMATION DISCLOSURE STATEMENT BY APPLICANT</b> ( Not for submission under 37 CFR 1.99)	Application Number	12303947
	Filing Date	
	First Named Inventor	Yeong Hyeon Kwon
	Art Unit	1632
	Examiner Name	
	Attorney Docket Number	2101-3596

**U.S. PATENTS** [Remove](#)

Examiner Initial*	Cite No	Patent Number	Kind Code <sup>1</sup>	Issue Date	Name of Patentee or Applicant of cited Document	Pages, Columns, Lines where Relevant Passages or Relevant Figures Appear
	1					

If you wish to add additional U.S. Patent citation information please click the Add button. [Add](#)

**U.S. PATENT APPLICATION PUBLICATIONS** [Remove](#)

Examiner Initial*	Cite No	Publication Number	Kind Code <sup>1</sup>	Publication Date	Name of Patentee or Applicant of cited Document	Pages, Columns, Lines where Relevant Passages or Relevant Figures Appear
/S.K./	1	20050286409	A1	2005-12-29	Yoon et al.	

If you wish to add additional U.S. Published Application citation information please click the Add button. [Add](#)

**FOREIGN PATENT DOCUMENTS** [Remove](#)

Examiner Initial*	Cite No	Foreign Document Number <sup>3</sup>	Country Code <sup>2</sup> i	Kind Code <sup>4</sup>	Publication Date	Name of Patentee or Applicant of cited Document	Pages, Columns, Lines where Relevant Passages or Relevant Figures Appear	T <sup>5</sup>
/S.K./	1	1996037079	WO	A1	1996-11-21	QUALCOMM INC.		<input type="checkbox"/>
/S.K./	2	2001/011909	WO	A1	2001-02-15	KONINKLIJKE PHILIPS ELECTRONICS N.V.		<input type="checkbox"/>

If you wish to add additional Foreign Patent Document citation information please click the Add button. [Add](#)

**NON-PATENT LITERATURE DOCUMENTS** [Remove](#)

<b>INFORMATION DISCLOSURE STATEMENT BY APPLICANT</b> ( Not for submission under 37 CFR 1.99)	Application Number		12303947	12303947 - GAU: 2478
	Filing Date			
	First Named Inventor	Yeong Hyeon Kwon		
	Art Unit	1632		
	Examiner Name			
	Attorney Docket Number	2101-3596		

Examiner Initials*	Cite No	Include name of the author (in CAPITAL LETTERS), title of the article (when appropriate), title of the item (book, magazine, journal, serial, symposium, catalog, etc), date, pages(s), volume-issue number(s), publisher, city and/or country where published.	T <sup>5</sup>
	1		<input type="checkbox"/>

If you wish to add additional non-patent literature document citation information please click the Add button

**EXAMINER SIGNATURE**

Examiner Signature	/Shripal Khajuria/	Date Considered	09/06/2011
--------------------	--------------------	-----------------	------------

\*EXAMINER: Initial if reference considered, whether or not citation is in conformance with MPEP 609. Draw line through a citation if not in conformance and not considered. Include copy of this form with next communication to applicant.

<sup>1</sup> See Kind Codes of USPTO Patent Documents at [www.USPTO.GOV](http://www.USPTO.GOV) or MPEP 901.04. <sup>2</sup> Enter office that issued the document, by the two-letter code (WIPO Standard ST.3). <sup>3</sup> For Japanese patent documents, the indication of the year of the reign of the Emperor must precede the serial number of the patent document. <sup>4</sup> Kind of document by the appropriate symbols as indicated on the document under WIPO Standard ST.16 if possible. <sup>5</sup> Applicant is to place a check mark here if English language translation is attached.

<b>INFORMATION DISCLOSURE STATEMENT BY APPLICANT</b> ( Not for submission under 37 CFR 1.99)	Application Number	12303947	12303947 - GAU: 2478
	Filing Date		
	First Named Inventor	Yeong Hyeon Kwon	
	Art Unit	1632	
	Examiner Name		
	Attorney Docket Number	2101-3596	

**CERTIFICATION STATEMENT**

Please see 37 CFR 1.97 and 1.98 to make the appropriate selection(s):

That each item of information contained in the information disclosure statement was first cited in any communication from a foreign patent office in a counterpart foreign application not more than three months prior to the filing of the information disclosure statement. See 37 CFR 1.97(e)(1).

**OR**

That no item of information contained in the information disclosure statement was cited in a communication from a foreign patent office in a counterpart foreign application, and, to the knowledge of the person signing the certification after making reasonable inquiry, no item of information contained in the information disclosure statement was known to any individual designated in 37 CFR 1.56(c) more than three months prior to the filing of the information disclosure statement. See 37 CFR 1.97(e)(2).

- See attached certification statement.
- Fee set forth in 37 CFR 1.17 (p) has been submitted herewith.
- None

**SIGNATURE**

A signature of the applicant or representative is required in accordance with CFR 1.33, 10.18. Please see CFR 1.4(d) for the form of the signature.

Signature	/Harry S. Lee/	Date (YYYY-MM-DD)	2009-07-17
Name/Print	Harry S. Lee	Registration Number	56,814

This collection of information is required by 37 CFR 1.97 and 1.98. The information is required to obtain or retain a benefit by the public which is to file (and by the USPTO to process) an application. Confidentiality is governed by 35 U.S.C. 122 and 37 CFR 1.14. This collection is estimated to take 1 hour to complete, including gathering, preparing and submitting the completed application form to the USPTO. Time will vary depending upon the individual case. Any comments on the amount of time you require to complete this form and/or suggestions for reducing this burden, should be sent to the Chief Information Officer, U.S. Patent and Trademark Office, U.S. Department of Commerce, P.O. Box 1450, Alexandria, VA 22313-1450. **DO NOT SEND FEES OR COMPLETED FORMS TO THIS ADDRESS. SEND TO: Commissioner for Patents, P.O. Box 1450, Alexandria, VA 22313-1450.**

**Privacy Act Statement**

The Privacy Act of 1974 (P.L. 93-579) requires that you be given certain information in connection with your submission of the attached form related to a patent application or patent. Accordingly, pursuant to the requirements of the Act, please be advised that: (1) the general authority for the collection of this information is 35 U.S.C. 2(b)(2); (2) furnishing of the information solicited is voluntary; and (3) the principal purpose for which the information is used by the U.S. Patent and Trademark Office is to process and/or examine your submission related to a patent application or patent. If you do not furnish the requested information, the U.S. Patent and Trademark Office may not be able to process and/or examine your submission, which may result in termination of proceedings or abandonment of the application or expiration of the patent.

The information provided by you in this form will be subject to the following routine uses:

1. The information on this form will be treated confidentially to the extent allowed under the Freedom of Information Act (5 U.S.C. 552) and the Privacy Act (5 U.S.C. 552a). Records from this system of records may be disclosed to the Department of Justice to determine whether the Freedom of Information Act requires disclosure of these records.
2. A record from this system of records may be disclosed, as a routine use, in the course of presenting evidence to a court, magistrate, or administrative tribunal, including disclosures to opposing counsel in the course of settlement negotiations.
3. A record in this system of records may be disclosed, as a routine use, to a Member of Congress submitting a request involving an individual, to whom the record pertains, when the individual has requested assistance from the Member with respect to the subject matter of the record.
4. A record in this system of records may be disclosed, as a routine use, to a contractor of the Agency having need for the information in order to perform a contract. Recipients of information shall be required to comply with the requirements of the Privacy Act of 1974, as amended, pursuant to 5 U.S.C. 552a(m).
5. A record related to an International Application filed under the Patent Cooperation Treaty in this system of records may be disclosed, as a routine use, to the International Bureau of the World Intellectual Property Organization, pursuant to the Patent Cooperation Treaty.
6. A record in this system of records may be disclosed, as a routine use, to another federal agency for purposes of National Security review (35 U.S.C. 181) and for review pursuant to the Atomic Energy Act (42 U.S.C. 218(c)).
7. A record from this system of records may be disclosed, as a routine use, to the Administrator, General Services, or his/her designee, during an inspection of records conducted by GSA as part of that agency's responsibility to recommend improvements in records management practices and programs, under authority of 44 U.S.C. 2904 and 2906. Such disclosure shall be made in accordance with the GSA regulations governing inspection of records for this purpose, and any other relevant (i.e., GSA or Commerce) directive. Such disclosure shall not be used to make determinations about individuals.
8. A record from this system of records may be disclosed, as a routine use, to the public after either publication of the application pursuant to 35 U.S.C. 122(b) or issuance of a patent pursuant to 35 U.S.C. 151. Further, a record may be disclosed, subject to the limitations of 37 CFR 1.14, as a routine use, to the public if the record was filed in an application which became abandoned or in which the proceedings were terminated and which application is referenced by either a published application, an application open to public inspections or an issued patent.
9. A record from this system of records may be disclosed, as a routine use, to a Federal, State, or local law enforcement agency, if the USPTO becomes aware of a violation or potential violation of law or regulation.

<b>Index of Claims</b>  	<b>Application/Control No.</b> 12303947	<b>Applicant(s)/Patent Under Reexamination</b> KWON ET AL.
	<b>Examiner</b> SHRIPAL KHAJURIA	<b>Art Unit</b> 2478

✓	<b>Rejected</b>	-	<b>Cancelled</b>	N	<b>Non-Elected</b>	A	<b>Appeal</b>
=	<b>Allowed</b>	÷	<b>Restricted</b>	I	<b>Interference</b>	O	<b>Objected</b>

<input type="checkbox"/> Claims renumbered in the same order as presented by applicant		<input type="checkbox"/> CPA		<input type="checkbox"/> T.D.		<input type="checkbox"/> R.1.47			
CLAIM		DATE							
Final	Original	09/07/2011							
	31	✓							
	32	✓							
	33	✓							
	34	✓							
	35	✓							
	36	✓							
	37	✓							
	38	✓							
	39	✓							
	40	✓							
	41	✓							
	42	✓							
	43	✓							
	44	✓							

**UNITED STATES PATENT AND TRADEMARK OFFICE**

UNITED STATES DEPARTMENT OF COMMERCE  
 United States Patent and Trademark Office  
 Address: COMMISSIONER FOR PATENTS  
 P.O. Box 1450  
 Alexandria, Virginia 22313-1450  
 www.uspto.gov

**BIB DATA SHEET**
**CONFIRMATION NO. 1730**

SERIAL NUMBER	FILING or 371(c) DATE RULE	CLASS	GROUP ART UNIT	ATTORNEY DOCKET NO.		
12/303,947	07/07/2010	370	2478	2101-3596		
<b>APPLICANTS</b> Yeong Hyeon Kwon, Gyeonggi-do, KOREA, REPUBLIC OF; Seung Hee Han, Gyeonggi-do, KOREA, REPUBLIC OF; Hyun Hwa Park, Gyeonggi-do, KOREA, REPUBLIC OF; Dong Cheol Kim, Gyeonggi-do, KOREA, REPUBLIC OF; Hyun Woo Lee, Gyeonggi-do, KOREA, REPUBLIC OF; Min Seok Noh, Gyeonggi-do, KOREA, REPUBLIC OF;						
<b>** CONTINUING DATA *****</b> This application is a 371 of PCT/KR07/02784 06/08/2007 <b>** FOREIGN APPLICATIONS *****</b> REPUBLIC OF KOREA 10-2006-0052167 06/09/2006 REPUBLIC OF KOREA 10-2006-0057488 06/26/2006 <b>** IF REQUIRED, FOREIGN FILING LICENSE GRANTED **</b> 08/11/2010						
Foreign Priority claimed <input checked="" type="checkbox"/> Yes <input type="checkbox"/> No 35 USC 119(a-d) conditions met <input checked="" type="checkbox"/> Yes <input type="checkbox"/> No Verified and /SHRIPAL K Acknowledged KHAJURIA/ Examiner's Signature		<input type="checkbox"/> Met after Allowance Initials	<b>STATE OR COUNTRY</b> KOREA, REPUBLIC OF	<b>SHEETS DRAWINGS</b> 22	<b>TOTAL CLAIMS</b> 14	<b>INDEPENDENT CLAIMS</b> 2
<b>ADDRESS</b> LEE, HONG, DEGERMAN, KANG & WAIMEY 660 S. FIGUEROA STREET Suite 2300 LOS ANGELES, CA 90017 UNITED STATES						
<b>TITLE</b> METHOD OF TRANSMITTING DATA IN A MOBILE COMMUNICATION SYSTEM						
<b>FILING FEE RECEIVED</b> 1110	FEES: Authority has been given in Paper No. _____ to charge/credit DEPOSIT ACCOUNT No. _____ for following:		<input type="checkbox"/> All Fees <input type="checkbox"/> 1.16 Fees (Filing) <input type="checkbox"/> 1.17 Fees (Processing Ext. of time) <input type="checkbox"/> 1.18 Fees (Issue) <input type="checkbox"/> Other _____ <input type="checkbox"/> Credit			

**EAST Search History****EAST Search History (Prior Art)**

Ref #	Hits	Search Query	DBs	Default Operator	Plurals	Time Stamp
S1	7734	(370/328).CCLS.	US-PGPUB; USPAT; USOCR	OR	OFF	2011/09/01 18:00
S2	13808	kwon.in.	US-PGPUB; USPAT; USOCR	OR	OFF	2011/09/01 18:08
S3	27622	han.in.	US-PGPUB; USPAT; USOCR	OR	OFF	2011/09/01 18:08
S4	52224	park.in.	US-PGPUB; USPAT; USOCR	OR	OFF	2011/09/01 18:08
S5	117541	kim.in.	US-PGPUB; USPAT; USOCR	OR	OFF	2011/09/01 18:08
S6	185530	lee.in.	US-PGPUB; USPAT; USOCR	OR	OFF	2011/09/01 18:08
S7	1736	noh.in.	US-PGPUB; USPAT; USOCR	OR	OFF	2011/09/01 18:08
S8	4	(S2 S3 S4 S5 S6 S7) and (preamble same prefix same repeated).clm.	US-PGPUB; USPAT; USOCR	OR	OFF	2011/09/01 18:08
S9	1	("20050286409").PN.	US-PGPUB; USPAT; USOCR	OR	OFF	2011/09/01 19:55
S10	463	cyclic near prefix and preamble same repeat\$3	US-PGPUB; USPAT; USOCR	OR	OFF	2011/09/07 10:52
S11	51	cyclic near prefix and preamble same repeat\$3 and CAZAC	US-PGPUB; USPAT; USOCR	OR	OFF	2011/09/07 10:52

**EAST Search History (Interference)**

&lt; This search history is empty &gt;

9/ 7/ 2011 9:46:44 PM

C:\ Documents and Settings\ skhajuria\ My Documents\ EAST\ Workspaces\ 12303947.wsp

## Electronic Acknowledgement Receipt

<b>EFS ID:</b>	11305692
<b>Application Number:</b>	12303947
<b>International Application Number:</b>	
<b>Confirmation Number:</b>	1730
<b>Title of Invention:</b>	METHOD OF TRANSMITTING DATA IN A MOBILE COMMUNICATION SYSTEM
<b>First Named Inventor/Applicant Name:</b>	Yeong Hyeon Kwon
<b>Customer Number:</b>	35884
<b>Filer:</b>	Harry Sung Lee/Neeti Rajput
<b>Filer Authorized By:</b>	Harry Sung Lee
<b>Attorney Docket Number:</b>	2101-3596
<b>Receipt Date:</b>	31-OCT-2011
<b>Filing Date:</b>	07-JUL-2010
<b>Time Stamp:</b>	19:22:13
<b>Application Type:</b>	U.S. National Stage under 35 USC 371

### Payment information:

Submitted with Payment	no
------------------------	----

### File Listing:

Document Number	Document Description	File Name	File Size(Bytes)/ Message Digest	Multi Part /.zip	Pages (if appl.)
1	Information Disclosure Statement (IDS) Form (SB08)	2101-3596_101811_IDSform.pdf	612267 af896a81af1184f65ec388e5c3bf63d4dda d125	no	4

### Warnings:

### Information:

**EVOLVED-0002030**

ZTE/HTC

Exhibit 1005-0388



A U.S. Patent Number Citation or a U.S. Publication Number Citation is required in the Information Disclosure Statement (IDS) form for autoloading of data into USPTO systems. You may remove the form to add the required data in order to correct the Informational Message if you are citing U.S. References. If you chose not to include U.S. References, the image of the form will be processed and be made available within the Image File Wrapper (IFW) system. However, no data will be extracted from this form. Any additional data such as Foreign Patent Documents or Non Patent Literature will be manually reviewed and keyed into USPTO systems.

2	Foreign Reference	WO2005011128.pdf	18286748	no	113
			ffb701ce916b0d6dc3892a37e674862170a354		

**Warnings:**

**Information:**

3	Foreign Reference	WO2006015108.pdf	3533196	no	34
			bd409cfc6df1a34417374c617538163f4fae3888		

**Warnings:**

**Information:**

<b>Total Files Size (in bytes):</b>	22432211
-------------------------------------	----------

**This Acknowledgement Receipt evidences receipt on the noted date by the USPTO of the indicated documents, characterized by the applicant, and including page counts, where applicable. It serves as evidence of receipt similar to a Post Card, as described in MPEP 503.**

**New Applications Under 35 U.S.C. 111**

If a new application is being filed and the application includes the necessary components for a filing date (see 37 CFR 1.53(b)-(d) and MPEP 506), a Filing Receipt (37 CFR 1.54) will be issued in due course and the date shown on this Acknowledgement Receipt will establish the filing date of the application.

**National Stage of an International Application under 35 U.S.C. 371**

If a timely submission to enter the national stage of an international application is compliant with the conditions of 35 U.S.C. 371 and other applicable requirements a Form PCT/DO/EO/903 indicating acceptance of the application as a national stage submission under 35 U.S.C. 371 will be issued in addition to the Filing Receipt, in due course.

**New International Application Filed with the USPTO as a Receiving Office**

If a new international application is being filed and the international application includes the necessary components for an international filing date (see PCT Article 11 and MPEP 1810), a Notification of the International Application Number and of the International Filing Date (Form PCT/RO/105) will be issued in due course, subject to prescriptions concerning national security, and the date shown on this Acknowledgement Receipt will establish the international filing date of the application.

(19) World Intellectual Property Organization  
International Bureau



(43) International Publication Date  
9 February 2006 (09.02.2006)

PCT

(10) International Publication Number  
**WO 2006/015108 A2**

- (51) International Patent Classification:  
*H04K 1/10* (2006.01)
- (21) International Application Number:  
PCT/US2005/026766
- (22) International Filing Date: 27 July 2005 (27.07.2005)
- (25) Filing Language: English
- (26) Publication Language: English
- (30) Priority Data:  
60/591,894 27 July 2004 (27.07.2004) US
- (63) Related by continuation (CON) or continuation-in-part (CIP) to earlier application:  
US 60/591,894 (CIP)  
Filed on 27 July 2004 (27.07.2004)
- (71) Applicant (for all designated States except US): **ZTE SAN DIEGO, INC.** [US/US]; 10105 Pacific Heights Boulevard, Suite 250, San Diego, CA 92121 (US).
- (72) Inventors; and
- (75) Inventors/Applicants (for US only): **HOU, Jason** [—/US]; 10105 Pacific Heights Boulevard, Suite 250, San Diego, CA 92130 (US). **WANG, Jing** [—/US]; 10105 Pacific Heights Boulevard, Suite 250, San Diego, CA 92121 (US). **CAI, Sean** [—/US]; 10105 Pacific Heights

Boulevard, Suite 250, San Diego, CA 92121 (US). **FENG, Dazi** [ /US]; 10105 Pacific Heights Boulevard, Suite 250, San Diego, CA 92121 (US). **FANG, Yonggang** [CA/US]; 5228 Quaker Hill Lane, San Diego, CA 92130 (US). **YANG, Yunsong** [—/US]; 1015 Pacific Heights Boulevard, Suite 250, San Diego, CA 92121 (US).

- (74) Agent: **AI, Bing**; Fish & Richardson P.C., 12390 El Camino Real, San Diego, CA 92130 (US).
- (81) Designated States (unless otherwise indicated, for every kind of national protection available): AF, AG, AL, AM, AT, AU, AZ, BA, BB, BG, BR, BW, BY, BZ, CA, CH, CN, CO, CR, CU, CZ, DE, DK, DM, DZ, EC, EE, EG, ES, FI, GB, GD, GE, GH, GM, HR, HU, ID, IL, IN, IS, JP, KE, KG, KM, KP, KR, KZ, LC, LK, LR, LS, LT, LU, LV, MA, MD, MG, MK, MN, MW, MX, MZ, NA, NG, NI, NO, NZ, OM, PG, PH, PL, PT, RO, RU, SC, SD, SE, SG, SK, SL, SM, SY, TJ, TM, TN, TR, TT, TZ, UA, UG, US (patent), UZ, VC, VN, YU, ZA, ZM, ZW.
- (84) Designated States (unless otherwise indicated, for every kind of regional protection available): ARIPO (BW, GH, GM, KE, LS, MW, MZ, NA, SD, SL, SZ, TZ, UG, ZM, ZW), Eurasian (AM, AZ, BY, KG, KZ, MD, RU, TJ, TM), European (AT, BE, BG, CH, CY, CZ, DE, DK, EE, ES, FI, FR, GB, GR, HU, IE, IS, IT, LT, LU, LV, MC, NL, PL, PT,

[Continued on next page]

(54) Title: TRANSMISSION AND RECEPTION OF REFERENCE PREAMBLE SIGNALS IN OFDMA OR OFDM COMMUNICATION SYSTEMS

WO 2006/015108 A2

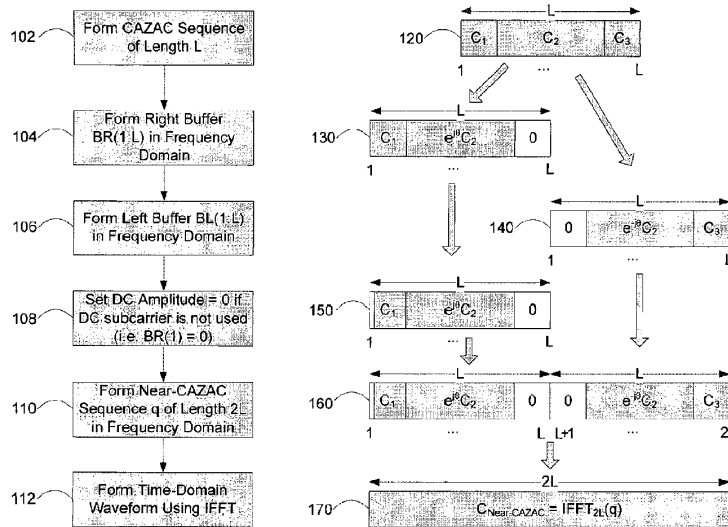

(57) Abstract: Techniques for generating preamble sequences for OFDM and OFDMA communication systems based on CAZAC sequences with desired properties of constant amplitudes (CA) and zero autocorrelation (ZAC). Such preamble sequences may be used for synchronization and identification of individual transmitters. For example, the OFDMA symbol is constructed using a CAZAC sequence in the frequency-domain and the resulting time-domain waveform is a near-CAZAC sequence.

WO 2006/015108 A2



RO, SE, SI, SK, TR), OAPI (BF, BJ, CF, CG, CI, CM, GA, GN, GQ, GW, ML, MR, NE, SN, TD, TG).

*For two-letter codes and other abbreviations, refer to the "Guidance Notes on Codes and Abbreviations" appearing at the beginning of each regular issue of the PCT Gazette.*

**Published:**

— *without international search report and to be republished upon receipt of that report*

**EVOLVED-0002033**

ZTE/HTC

Exhibit 1005-0391

**TRANSMISSION AND RECEPTION OF REFERENCE PREAMBLE SIGNALS IN  
OFDMA OR OFDM COMMUNICATION SYSTEMS**

CROSS REFERENCE TO RELATED APPLICATION

5 [0001] This application claims the benefit of provisional  
U.S. application Serial No. 60/591,894, entitled "METHOD FOR  
THE TRANSMISSION AND RECEPTION OF REFERENCE PREAMBLE SIGNALS  
IN AN OFDMA SYSTEM" and filed July 27, 2004, which is  
incorporated herein by reference in its entirety for all  
10 purposes.

BACKGROUND

[0002] This application relates to orthogonal frequency  
division multiplexing (OFDM) and orthogonal frequency  
division multiple access (OFDMA) communication systems, and  
15 more particularly to generation and transmission of preamble  
signals for fast cell searching, time-synchronization, and  
correcting initial frequency offset in an OFDM or OFDMA  
communication system.

[0003] OFDM and OFDMA systems may be used in various  
20 telecommunication systems, including wired and wireless  
communication systems, to provide various types of  
communication services, such as voice and data. A wireless  
communication system covers a certain geographic area by  
dividing the area into a plurality of cells, which can be  
25 further divided into two or more sectors. The base  
stations, which conceptually locate at the center of  
respective cells of their coverage, transmit information to  
the mobile subscriber stations (MSS) via downlink (DL) radio  
signals. A mobile station is also known as the mobile  
30 station (MS), the subscriber station (SS), or the wireless  
station. The mobile stations transmit information to their  
serving base stations via uplink (UL) radio signals.

[0004] The downlink radio signals from the base stations to  
mobile stations may include voice or data traffic signals or  
35 both. In addition, the base stations generally need to  
transmit preamble signals in their downlink radio signals to

identify to the mobile stations the corresponding cells and corresponding segments in the cells to which the downlink radio signals are directed. Such a preamble signal from a base station allows a mobile station to synchronize its  
5 receiver in both time and frequency with the observed downlink signal and to acquire the identity, such as IDcell and Segment, of the base station that transmits the downlink signal.

**[0005]** IEEE 802.16 OFDMA has been developed to provide  
10 wireless communications based on an orthogonal frequency division multiple access (OFDMA) modulation technique. In the DL preambles currently defined in IEEE 802.16 OFDMA, the MSSs store predefined and handcrafted pseudo-noise (PN) like sequences for identifying IDcell numbers and segment numbers  
15 of the adjacent cells. In operation, a MSS captures the preamble symbols in received downlink signals and correlate the preamble in each received downlink signal with the stored pseudo-noise (PN) like sequences to determine IDcell and Segment of a specific sector for that received downlink  
20 signal. These preamble sequences are handcrafted in advance and are processed by the MSS one at a time. There are more than 100 such sequences in some implementations of the current IEEE 802.16 OFDMA. Performing the cross-correlation with such a large number of preamble sequences can be time  
25 consuming and increase the hardware costs. In addition, MSSs store the entire set of preamble sequences and this storage further increases the hardware cost.

**[0006]** One important performance parameter of the preambles is the peak-to-average-power-ratio (PAPR). To reduce the  
30 system cost, the PAPR for the preamble should be as small as possible. It is well known that OFDM usually has a relative higher PAPR ratio than other modulations. This is especially important for a preamble because the preamble is transmitted in every frame.

## SUMMARY

[0007] This application provides, among others, techniques for generating preamble sequences for OFDM and OFDMA communication systems based on CAZAC sequences with desired  
5 properties of constant amplitudes (CA) and zero autocorrelation (ZAC).

[0008] In one implementation, a method for communications based on OFDM or OFDMA is described to include selecting an initial CAZAC sequence; modifying the initial CAZAC sequence  
10 to generate a modified sequence which has frequency guard bands; and using the modified sequence as part of a preamble of a downlink signal from a base station to a mobile station.

[0009] In another implementation, a method for  
15 communications based on OFDM or OFDMA is described to include selecting a CAZAC sequence of a length  $L$  in frequency which includes spectral components in first, second and third sequential portions in frequency, and modifying the CAZAC sequence to produce a first modified sequence. The  
20 modification includes setting amplitudes of spectral components in the first portion of the CAZAC sequence to zeros and adding a first phase shift on spectral components of the second portion of the CAZAC sequence, without changing the third portion. The CAZAC sequence is then modified to produce  
25 a second modified sequence by setting amplitudes of spectral components in the third portion of the CAZAC sequence to zeros and adding a second phase shift spectral components of the second portion of the CAZAC sequence, without changing the first portion. The first and second modified sequences are  
30 then combined to form a combined sequence in frequency of a length  $2L$ . The first portion from the first modified sequence is positioned next to the third portion from the second modified sequence in the combined sequence. An inverse fast Fourier transform is then performed on the combined sequence  
35 to generate a first preamble sequence in time for OFDM and OFDMA communication.

**[0010]** In another implementation, a method for communications based on OFDM or OFDMA is disclosed to include sub sampling a preamble signal in a downlink signal received at a mobile station receiver to create a frequency overlap and to minimize a variation in amplitude, extracting an order of signal components in the preamble signal to identify at least a base station at which the downlink signal is generated. The preamble signal is generated from an initial CAZAC sequence to preserve properties of the initial CAZAC sequence and has frequency guard bands.

**[0011]** In some applications, the techniques described here may be used to provide the downlink (DL) preamble design to allow for a structural generation of preamble sequences to facilitate fast cell searching, simple time-synchronization and correction of initial frequency offset. The new DL preamble design is based on CAZAC sequences. The IDcell and Segment parameters are encoded as the code phase of the CAZAC sequence in the frequency domain or the code phase of the near-CAZAC sequence in the time domain.

**[0012]** These and other implementations and their variations, enhancements are described in greater detail in the attached drawings, the detailed description and the claims.

25 BRIEF DESCRIPTION OF THE DRAWINGS

**[0013]** FIG. 1A illustrates the processing steps of one exemplary method of construction of a preamble sequence.

**[0014]** FIG. 1B illustrates the resulting sequence of each processing step of the exemplary method shown in FIG.1A.

30 **[0015]** FIG. 2A shows an example of using the cyclic shift of initial CAZAC sequence in the frequency domain to generate two new initial CAZAC sequences in the frequency domain.

**[0016]** FIG. 2B shows an example of using the cyclic shift of the preamble sequence in the time domain to generate two new preamble sequences in the time domain.

[0017] FIG. 3 shows an example of a 3-tier cell design used in various OFDM or OFDMA systems.

[0018] FIG. 4 shows an example of the subcarrier allocations in the frequency domain of the preamble sequence in segment 0.

[0019] FIG. 5 shows the corresponding amplitude of the waveform in the time domain that corresponds to the example in FIG. 4.

[0020] FIG. 6 shows the time waveform of the result of matched filtering of the CAZAC sequence (spaced by symbols) without channel distortion.

[0021] FIG. 7 shows the result of matched filtering of the CAZAC sequence in a multipath fading environment.

15 DETAILED DESCRIPTION

[0022] Designing a set of preambles with good correlation property and low PAPR is a difficult task because these two requirements tend to be conflicting. A family of mathematically well studied sequences known as CAZAC sequences has the desired properties of a constant amplitude (CA) (representing the lowest PAPR) and zero autocorrelation (ZAC). Well-known examples of CAZAC sequences include Chu and Frank-Zadoff sequences.

[0023] A Chu sequence is defined as

25

$$c(n) = \exp(j\theta_{chu}(n)), n = 0, 1, \dots, L-1 \quad (1)$$

where the phase in Chu sequences is

30

$$\theta_{chu}(n) = \frac{\pi n^2}{L} \quad (2)$$

and  $L$  is the length of the sequence and can be any positive integer. The Frank-Zadoff sequences are also defined in (1) but the phase is defined as



$$\theta_{frank}(n = p + q\sqrt{L}) = \frac{2\pi pq}{\sqrt{L}}, \tag{3}$$

where  $p = 0, 1, \dots, \sqrt{L} - 1$  and  $q = 0, 1, \dots, \sqrt{L} - 1$ , and  $L$  is the length of the sequence and can be the square of any positive integer.

**[0024]** Let  $\mathbf{c} = [c_{L-1}, c_{L-2}, \dots, c_0]^T$  be a CAZAC sequence and define the cyclic shift operator matrix  $\mathbf{M}$  as

$$\mathbf{M} = [\mathbf{e}_1 \ \mathbf{e}_2 \ \dots \ \mathbf{e}_{L-1} \ \mathbf{e}_0], \tag{4}$$

10

where  $\mathbf{e}_k$  is a standard basis vector of length  $L$ . For example,  $\mathbf{e}_k$  can be an all zero vector except the  $k$ -th element of unity. Define the circulant matrix  $\mathbf{C}$  of the CAZAC sequence as

15

$$\begin{aligned} \mathbf{C} &= \text{Circ}\{\mathbf{c}\} \\ &= [\mathbf{c} \ \mathbf{M}\mathbf{c} \ \dots \ \mathbf{M}^{L-1}\mathbf{c}] = \begin{bmatrix} c_{L-1} & c_0 & c_1 & \dots & c_{L-2} \\ c_{L-2} & c_{L-1} & c_0 & \dots & c_{L-3} \\ c_{L-3} & c_{L-2} & c_{L-1} & \dots & c_{L-4} \\ \vdots & \vdots & \vdots & \vdots & \vdots \\ c_0 & c_1 & c_2 & \dots & c_{L-1} \end{bmatrix} \end{aligned} \tag{5}$$

**[0025]** Define a  $L \times L$  Fourier matrix as

$$\mathbf{F}_L = \frac{1}{\sqrt{L}} \begin{bmatrix} 1 & 1 & \dots & 1 \\ 1 & \omega & \dots & \omega^{L-1} \\ \cdot & \cdot & \dots & \cdot \\ 1 & \omega^{L-1} & \dots & \omega^{(L-1)(L-1)} \end{bmatrix}_{L \times L} \tag{6}$$

20

where  $\omega = \exp(-j2\pi/L)$ . It can be shown that a circulant matrix can be uniquely expressed as

$$\mathbf{C} = \mathbf{F}_L^H \mathbf{\Lambda}_c \mathbf{F}_L, \tag{7}$$

25

where  $\Lambda_c = \text{diag}\{g_0, g_1, \dots, g_{L-1}\}$  is the eigen matrix of the circulant matrix and  $(\bullet)^H$  denote the Hermitian transpose.

[0026] A zero-autocorrelation sequence is characterized by its identity autocorrelation matrix, or

$$\Phi_C = CC^H = \mathbf{I}_{L \times L} = \mathbf{F}_L^H \Lambda_c \Lambda_c^H \mathbf{F}_L. \quad (8)$$

[0027] Equation (8) can be used to derive the following:

$$\Lambda_c \Lambda_c^H = \text{diag}\{|g_0|^2, |g_1|^2, \dots, |g_{L-1}|^2\} = \mathbf{F}_L \mathbf{F}_L^H = \mathbf{I}_{L \times L} \quad (9)$$

[0028] In other words, eigenvalues of a circulant matrix have equal amplitudes, or  $|g_k| = \text{const}, k = 0, \dots, L-1$ . Furthermore, these eigenvalues constitute the frequency spectral components of the ZAC sequence as is evident in the following equation,

$$\mathbf{c} = \mathbf{C}\mathbf{e}_0 = \mathbf{F}_L^H \Lambda_c \mathbf{F}_L \mathbf{e}_0 = \frac{1}{\sqrt{L}} \mathbf{F}_L^H \mathbf{g}, \quad (10)$$

where  $\mathbf{e}_0$  is the last column vector of  $\mathbf{M}$ , defined in Equation (4), and  $\mathbf{g} = [g_0, g_1, \dots, g_{L-1}]^T$  is the column vector formed by the eigenvalues of  $\mathbf{C}$ .

[0029] **Property 1: If  $\mathbf{c}$  is a CAZAC sequence, then its frequency domain spectral components also form a CAZAC sequence (necessary condition).**

[0030] Proof:

[0031] Let  $\Lambda_M$  be the eigen matrix of the cyclic shift operator matrix  $\mathbf{M}$  defined in Equation (4). It can be proved that  $\Lambda_M = \text{diag}\{1, \omega, \omega^2, \dots, \omega^{L-1}\}, \omega = e^{-j2\pi/L}$ . Because  $\mathbf{M}$  is a real matrix, the following expression can be obtained:

$$\mathbf{M} = \mathbf{F}_L^H \Lambda_M \mathbf{F}_L = \mathbf{F}_L \Lambda_M^H \mathbf{F}_L^H. \quad (11)$$

For  $k=0, \dots, L-1$ , the following can be written:

$$\begin{aligned} \mathbf{g}^H (\mathbf{M}^k \mathbf{g}) &= \mathbf{L} \mathbf{c}^H \mathbf{F}_L^H \mathbf{M}^k \mathbf{F}_L \mathbf{c} = \mathbf{L} \mathbf{c}^H (\Lambda_M^k)^H \mathbf{c} \\ &= L \sum_{n=0}^{L-1} \omega^{-kn} |c(n)|^2 = L \delta(k), \end{aligned} \quad (12)$$

Therefore, the column vector  $\mathbf{g}$  is a ZAC sequence. The eigenvalues of the circulant matrix  $\mathbf{C}$  of a CAZAC sequence have equal amplitudes. With Equation (12) it is proven that the  $\mathbf{g} = [g_0, g_1, \dots, g_{L-1}]^T$  sequence is a CAZAC sequence.

**[0032] Property 2: If  $\mathbf{g} = [g_0, g_1, \dots, g_{L-1}]^T$  is a CAZAC sequence in the frequency domain, then its corresponding time-domain sequence is also a CAZAC sequence (sufficient condition).**

**[0033] Proof:**

**[0034]** Equations (10) and (11) can be used to derive the following:

$$\mathbf{c}^H \mathbf{M}^k \mathbf{c} = \frac{1}{L} \mathbf{g}^H \mathbf{F}_L \mathbf{M}^k \mathbf{F}_L^H \mathbf{g} = \frac{1}{L} \mathbf{g}^H \Lambda_M^k \mathbf{g} = \frac{1}{L} \sum_{k=0}^{L-1} \omega^k = \delta(k) \quad (13)$$

This shows that the time-domain sequence possesses ZAC property.

**[0035]** From Equation (10),  $\mathbf{g}$  can be written as

$$\mathbf{g} = \sqrt{L} \mathbf{F}_L \mathbf{c} \quad (14)$$

**[0036]** Because  $\mathbf{g}$  is a CAZAC sequence, the following can be derived:

$$\delta(k) = \mathbf{g}^H \mathbf{M}^k \mathbf{g} = \mathbf{L} \mathbf{c}^H \mathbf{F}_L^H \mathbf{F}_L (\Lambda_M^H)^k \mathbf{F}_L^H \mathbf{F}_L \mathbf{c} = L \sum_{n=0}^{L-1} |c_n|^2 \omega^{-kn}, k = 0, 1, \dots, L-1. \quad (15)$$

**[0037]** Rewriting Equation (15) in matrix form yields the following:

$$\begin{bmatrix} 1 \\ 0 \\ \vdots \\ 0 \end{bmatrix} = L \begin{bmatrix} 1 & 1 & \dots & 1 \\ 1 & \omega^{-1} & \dots & \omega^{-(L-1)} \\ \vdots & \vdots & \dots & \vdots \\ 1 & \omega^{-(L-1)} & \dots & \omega^{-(L-1)(L-1)} \end{bmatrix} \begin{bmatrix} |c_0|^2 \\ |c_1|^2 \\ \vdots \\ |c_{L-1}|^2 \end{bmatrix} \quad (16)$$

Solving Equation (16) leads to the following:

$$5 \quad |c_k|^2 = \frac{1}{L}, k = 0, 1, \dots, L-1. \quad (17)$$

Therefore, the corresponding sequence in the time domain is also a CAZAC sequence.

**[0038]** From Property 1 and Property 2, the desired properties of the constant-amplitude and zero-  
 10 autocorrelation of a CAZAC sequence are preserved in both time and frequency domain. Therefore, a CAZAC sequence can be used for time and frequency synchronization and channel estimation by the mobile station receiver. However, due to guard bands and channel selective filtering in the IEEE  
 15 802.16 OFDMA system, a CAZAC sequence may not be directly used to construct a preamble, because such a CAZAC sequence does not have proper breaks and voids in frequency to meeting the transmit frequency spectrum mask for the guard bands and channel selective filtering.

20 **[0039]** In several exemplary implementations described below, a CAZAC sequence, such as the Chu or Frank-Zadoff sequence, can be modified in the frequency domain to generate a modified CAZAC sequence in the frequency domain that satisfies the IEEE 802.16 transmit frequency spectrum  
 25 mask for the guard bands and channel selective filtering. The modified CAZAC sequence is no longer a mathematically perfect CAZAC sequence but is a near-CAZAC sequence whose amplitudes are nearly constant and the autocorrelation is nearly a delta function. This modified CAZAC sequence is  
 30 transformed into the time domain under an inverse FFT to produce the desired preamble sequences for an OFDM or OFDMA