

Facilities of the Videotex Service - A Blueprint for Evolution

Among the agreements reached in CCITT Study Group I was a first list of the "facilities of the videotex service" which, in addition to simple information retrieval and its preparation for that purpose, provides for a set of advanced facilities including (among others) terminal-to-terminal communications, telesoftware, and transactional services. Clearly, videotex is expected to evolve rapidly into a total package of services available to the user via a single relatively inexpensive terminal on his premises.

The actual services to be included in the given offering will depend equally on the perceived demand and on the capability of the technology to present the information in a satisfactory form and in a cost-effective manner for each application. The challenge of standardization is to foster the development of a healthy service as early as possible without stifling the innovation so necessary to the ultimate goal of a mature network providing a diverse range of services to as broad a market base as possible. The approach adopted by the CCITT was first to recognize the principal technologies on an equal basis, and then to attempt to extract the elements and concepts common to all. For example, graphic models based on mosaic, geometric, photographic and dynamically redefinable character set (DRCS) concepts were given equal status, and their common characteristics were defined as "attributes."

Attributes - the Key to Compatible Exchange of Graphical Information

Having recognized the validity of the principal coding techniques (alpha, mosaic, - geometric, - photographic, - DRCS) the problem faced by the Editor's Group on Recommendation Fb was to somehow provide a framework for a converging evolution of the national systems without a priori biasing of the Recommendations in favour of one system or another. This was especially important in view of the lack of representative international market data for a service still in its infancy.

The result of the Fb Editor's group's deliberations was a generalization of the "attribute" concept (formerly used in a narrower sense to apply to character-oriented systems only) whereby the emphasis was placed on the displayed information as it appears to the terminal user, regardless of the technique used to generate that information on the display. Attributes include colour, textual character size, overlay of concealed information, flashing, and shading textures for lines and surfaces.

A particularly significant example was the definition of the concepts of "foreground" and "background" in the treatment of alphanumeric text in a manner acceptable to proponents of both alpha-geometric and alpha-mosaic systems. In the alpha-mosaic concept, "background" had been considered to refer only to the small rectangular area forming a character cell or location on the display. In the alpha-geometric concept, the background consists of the net result of all previously displayed information on the whole screen which could include an unlimited number of updates or overlays on the same page of information. This more generalized treatment, while posing some conceptual difficulties for the advocates of character-oriented systems, provides for a continuously updatable display using page - store techniques. Such a display is used in Telidon to provide for variety in the presentation of educational and other information and allows the effect of motion to be created on the display. The initial difference of views was resolved by the realization that the different concepts of "foreground" and "background" were not so much characteristic of the mosaic versus geometric systems as to character-oriented versus picture-element-oriented (or page store) display memories, and it is the interest of all concerned to hold the door open to further enhancements to the pioneer systems, as well as recognizing the capabilities of the more sophisticated of today's systems.

Successive Enhancement or Pre-Planned Evolution -
A Converging Path?

In addition to the previous example of foreground/background treatment, it was recognized that other attributes of alpha-mosaic systems could and should be enhanced in the near future. Items in this category include display resolution (witness DRCS), number of colours (by extended or downloaded control sets), random access on the screen to the character level by row/column addressing), and perhaps someday, motion. The recommendation Fb allows for all of these capabilities whether as features of currently available systems such as Telidon, or as enhancements to alpha-mosaic systems. Some characteristics (such as high resolution display) are currently available on an alpha-photographic system called CAPTAIN in Japan, and others might presumably be added by a process of enhancement.

Given the heavy investment by a few countries in pioneer alpha-mosaic technology, Canada sees this trend to enhanced first-generation technology as a welcome one for two reasons:

First, it reinforces the original design assumptions which provided for the more sophisticated features of Telidon from the very beginning. It is clear that the sponsors of first generation alpha-mosaic systems now see the need for such features as high resolution graphics, random updates to the display, and more colour capability.

Second, it raises the hope that conversion algorithms can be adopted to allow interworking between alpha-geometric and enhanced alpha-mosaic systems at the network or data base level, since with DRCS the alpha-mosaic terminals would potentially be able to display Telidon pages, though with considerably less efficiency, a restricted sequence of presentation, and perhaps without an exact rendering of motion sequences. Certainly, if automated devices can someday be developed to generate DRCS pages from hard copy, the same algorithms should apply equally to alpha-geometric or alpha-photographic pages retrieved from a foreign data bank and held temporarily in a page - store memory for conversion.

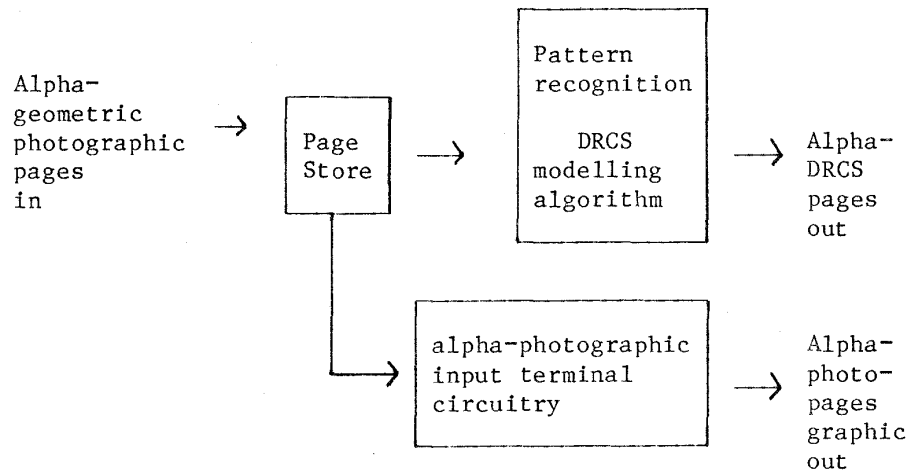

Such a conversion process could involve the generation of a new character set for each alpha-geometric or alpha-photographic page received, a problem comparable in some respects to the PAL - NTSC conversion of live television signals, but considerably more tolerant of processing delays. Presumably, the above assumptions apply to conversions from alpha-mosaic/DRCS formats to alpha-geometric formats, though within the higher transmission efficiency of the alpha-geometric system in the receiving network.

Background to Canada's Choice of an Alpha-Geometric/
Alpha Photographic Coding Standard for Telidon

The Canadian Videotex Consultative Committee, an advisory body with multi-sectoral representatives, recommended a field trial standards freeze based on Telidon's alpha-geometric/photographic technology until 1982 based on its superiority for information preparation, data base and network operation, and terminal cost/performance considerations. These various aspects will be addressed in detail below.

1) Information Preparation: Arising as it does from computer graphics technology, alpha-geometric technology offers more promise for the efficient creation of pages than alpha-mosaic technology. Early models of the Telidon Information Provider terminal demonstrated their potential for high page throughput at Telecom '79 using a computer-aided manual input technique and joy-stick or light-pen for the generation of graphics. The geometric code is also highly suitable for the computer generation of data in graphical form without human intervention. Many data bases already exist which contain suitable data for use with this technique. Alpha-photographic systems are also in a good position to draw upon highly developed data acquisition techniques based on facsimile technology.

On the other hand, alpha-mosaic/DRCS input systems will require a very subtle and complex modelling process for the identification of the optimum character set for a given page of graphical information. This is bound to permanently impact on the throughput and efficiency even of automated alpha-DRCS page preparation systems which are not yet in sight from a

commercial standpoint. In the authors' opinion, the best strategy for an information provider who must serve an alpha-mosaic or alpha-DRCS market is to use alpha-geometric (and in some cases, alpha-photographic) page creation devices with their superior throughput and graphical editing capabilities, converting the result automatically through such a device as that in the previous illustration. The information provider could thus serve all major videotex markets by maintaining a data base primarily in alpha-geometric format and converting to alpha-mosaic, DRCS, or photographic format as required. In addition to achieving higher preparation throughput, he would also be better prepared for future growth into higher resolution systems and for the advent of terminal-to-terminal communication using computer graphics techniques. A side benefit would be reduced storage requirements (about 400-500 bytes average per page with Telidon) in his data bank.

2) Data Base Considerations: The two main data base considerations are obsolescence of stored data due to technological change, and operational cost. In the authors' opinion, alpha-geometric systems offer the best alternative for the operation of data bases because stored data is unlikely to be obsoleted by the development of improved terminals. Perhaps the greatest advantages of the geometric approach relate to operating cost. A lower average byte count per page can be expected to reduce storage costs, but more importance can be attached to the ability of both low-resolution and high-resolution terminals to use the same pages of information, eliminating the necessity to store and maintain several versions of the same page (for instance, for ordinary mosaic, smoothed graphic mosaic, and alpha-DRCS terminals). The dialogue between data base and terminal to establish the terminal's characteristics at the beginning of the session would also be simplified for the geometric case, and the processing overhead to select the appropriate version of each page to match the terminal's characteristics could be eliminated. The execution of DRCS down-load sequences could also be expected to add materially to processing overhead and possibly reduce the number of user terminals to be supported simultaneously by the data base computer, as well as loading the network. A yet unexplored area for DRCS techniques is the problem of updating existing pages on the data base. This process will require either that a new down-load sequence be provided with each page, or that single special character sets be defined for all future pages in the same section of the data base.

3) Network Considerations: Assuming transparency in the network, the comparison problem reduces itself to one of network operating cost on a per-page basis. This cost has two major components, namely, the cost of transmission of the page itself, and the cost of any overhead functions. The actual number of bytes per page in the geometric system could be expected to be lower, as mentioned above. In addition, there would be no need for the overhead consumed by the DRCS download sequence. This overhead could be expected to reach serious proportions as the user browses through different actions of the data base, necessitating frequent download sequences. Of course, this problem could be minimized by restricting the use of the DRCS technique to certain pages, with all the attendant complexities of planning the data base structure and context. It therefore seems to us that the DRCS technique may be useful in the short term for countries already firmly on the mosaic standard and who wish to communicate in some relatively small non-Latin alphabets (Kanji and Kana not included), but that the improvement in graphics performance it offers is, in general, not sufficient to justify the additional overhead and complexity which would be imposed on the network and data base. The alpha-geometric system can perform all of these functions much more simply without the limitations. For instance, ordinary Telidon terminals can receive Kanji, Kana and other non-Latin characters without a prior character set definition simply by drawing the characters. Characters can be written in an order vertically or from right to left as is normal for some non-Latin languages.

4) Terminal Considerations: It has been rightly pointed out by the advocates of alpha-mosaic systems that it is essential that the terminal be as inexpensive as possible, given the function it is to perform. What we are now witnessing seems to be a process of successive enhancement to the basic alpha-mosaic terminal to add new attributes and capabilities in an attempt to compete with alpha-geometric and alpha-photographic systems for a perceived set of requirements. We have seen proposals to enhance the graphics resolution via DRCS, and other enhancements such as row-column addressing and telesoftware. Each new enhancement will render obsolescent a generation of existing alpha-mosaic terminals and will also force a resultant fragmentation of the data base and terminal market. For instance, if only business terminals have DRCS, the businessman will be unable to work at home using his domestic set. More significantly, each new enhancement will require a new module in the terminal, increasing its costs.

Hand assembled full resolution Telidon terminals using only commonly available semiconductors are now being built and sold for about \$1800 (U.S.) with firm quotations of \$1000 (U.S.) by the end of 1980. The reducing cost of memory and custom VLSI techniques are expected to rapidly reduce this cost to a few hundred dollars in the next few years.

On the other hand, enhancements to mosaic terminals will tend to drive the terminal cost up as well as obsoleting the previous models. It should also be pointed out that these enhancements generally do not go as far as the basic geometric system in terms of performance. For instance, DRCS offers one choice of resolution related to the standard television screen, while geometric coding can compatibly drive a range of displays including ultra-high resolution displays such as are being considered for future digital television standards. Another example would be the capability to display motion, which has not yet been proposed for the alpha-mosaic standard.

5) General Considerations: Viewed from a broad perspective, Telidon was chosen because it offered a wider range of features on a more cost-effective basis and with a simpler, more powerful conceptual base than the alternative systems. Not only is the comparison favourable in the short term, but it is expected to swing even more strongly in favour of Telidon as technology marches on. If anything, Telidon terminals will become simpler as well as less expensive and it will be possible to improve network performance by off-loading still more processing into the terminal, reducing the load on the data base and the network. This trend is in contrast to the increasing complexity of the networks, data bases, and input systems which will be required to support enhanced alpha-mosaic systems.

Conclusions:

We welcome the adoption of international standards which recognize all valid techniques for videotex communication, since the market place will decide the most suitable in the long term. Recent developments in enhancements to first generation systems confirm Canada's initial decision to start with a second generation system.

Prestel User Market Research

K Watson
Videotex Consultant
Eastel Services
England

Keith Watson, one of the second generation of Prestel speakers, has spent about 20 years in the newspaper and publishing advertising environment sees clearly the need for I.Ps to define their market and then satisfy these needs.

Copyright © 1980 by Online Conferences Ltd.

There appears to be a considerable need both at home, and from an information collection viewpoint from overseas organisations interested in developing a videotex system for credible end user research. As a typical Prestel I.P. we at Eastel have defined areas of future potential to develop when building our database and have structured our planning in accordance with these definitions, but this is largely on guess work.

Our investigations have found no effective research programme. There are however some active programmes known to us and two major examples are now discussed.

The Post Office Market Test Trial was designed nearly three years ago, not as a package for oversease use, but principally as documented on-going information. This would be utilised to assist the Post Office to refine their database instructions and routeing tree structures to suit the markets need.

Coupled with a sub-set of information to be made available to Information Providers it is giving details of frame accesses, the use and popularity of various areas of the database, length of time in use as well as the time of day subsidised users were accessing data. This is the extent of the Post Office contribution to build a marketable database which to be fair is a commendable effort, utilising great amounts of time and resulting in huge benefits to constructing sound index's in Prestel.

This much needed exercise encountered problems from the start with the scarcity of user sets proving to be one of the most persistent.

The emphasis seems to have changed within the Post Office who have advanced to new areas of specialist research.

Plans for research in a live macro market situation appear uncertain, if indeed, the Post Office feel that their neutral rôle as information carriers, is within their brief to research this ultimate stage of development.

Back in 1978, Fintel placed a number of sponsored user sets into the premises of some of their prime customers. This initial evaluation proved to become a useful foundation to future in depth user research for Fintel. A series of questionnaires evolved to discover information relevant to the business user market. Feedback thus gained has proved valuable to Fintel in

database building decision making, although this can hardly be considered a quantifiable sample, and was never considered as serious from sales research.

Defining the Need

Although the Viewdata world is full of qualitative judgements, and educated guesses, no one has yet constructed a reliable research programme to define precisely what information can best be carried by this new medium, and what the marketplace expects and requires from the information presented.

Undoubtedly many applications will be discovered depending upon the environment. Closed user groups, inhouse message systems and semi intelligent stock control devices, are all specific uses that have been defined and can be explored within specific locations.

But the service that the majority of U.K. Information Providers, the U.K. Post Office and the majority of overseas services are gearing themselves towards is a broad based residential market. Indeed this has been defined as the prime area of potential for all areas of our own Eastel operation, defensively, both as a consultancy and a directory publisher.

The imminent need for research of the residential segment in a free market situation is strong and should receive more support if it is to be sensibly exploited.

The unique free market position created by the development of this medium will prove to become a valuable adjunct of meaningful research.

Information Providers are the key to the success of Prestel.

Without a marketable database that the user wants, the manufacturer will not be able to retail his sets and the Post Office will not recoup money invested in developing the system.

It is vital to all parties concerned that every Information Provider defines his market and market expectations and matches them to his inputting resource and information capability.

New needs for information will constantly be identified as the market develops - and these needs have to be assessed, monitored and acted upon with the constraints of the continuously changing Prestel environment.

Prestel as a publishing medium:
the elements of success or failure

Rex Winsbury
Viewdata Director

Fintel Ltd.
London

The editing techniques, publishing schedules, economics, usage patterns, competitive environment, and professional skills involved in making a commercial success of Prestel or other viewdata systems are quite different to traditional publishing on paper. Viewdata is not an 'electronic clone' of the original paper products, but a new 'publication' in its own right, with its own rules. Therefore an open and enquiring mind is called for about what to publish in the electronic medium, with an offensive rather than defensive approach. The elements of being a 'Prestel publisher' are also surprisingly varied. A new market breeds new business opportunities and new business organisations to meet them.

Copyright © 1980 by Online Conferences Ltd.

A. What are the motives to become an 'electronic publisher'?

Many of these apply to all Information Providers to Prestel and to other viewdata systems. But they have especial force for a 'traditional' publisher of newspapers, magazines etc, and even more so for a publisher of business information. They are as follows:-

1. A basic instinct that much business and financial information is being computerised, and that computer-based distribution systems will increasingly be a bread-and-butter means whereby business people, not to mention civil servants and others in the office context, will get their information. Whether this will in due course cut into sales of traditional paper-based products, or whether it will be an addition to it, as business life gets more complex and demanding, is a matter of argument. It is noticeable, for example, that over the last two years or so the statistical content of the Financial Times - that is, material which most readily transfers to the computer - has been considerably increased in response to reader demand. It may be that there is a general process going on, a demand for more and more accurate data, which will be fulfilled in a number of ways. But obviously, one must also be prepared in the long term for some impact on sales of paper products.

2. However this process works out, it is clear that electronic publishing, however defined, offers a clear chance for business diversification, for business and other publishers. This is a simple commercial opportunity, which might have been carrier pigeons or smoke signals, but just happens to be electronic transmission of data. It is simply a new market opening up.

3. By the same logic, it is clear that if one company does not step in and exploit this opportunity, others will. Market forces operate here as elsewhere, and there must therefore be a defensive element as well as an offensive element. It should be remembered that there is no prior definition of who can, and cannot, be an electronic publisher. New entrants, or entrants from other walks of life, enter the arena. The landscape looks different from paper publishing, and quite rightly, it is a chance for entrepreneurial challenges to arise.

4. For a newspaper company, operating in the Fleet Street environment in particular, it is a chance to explore the potential of new technology at arms length from, though not totally away from, the familiar restrictions of the

immediate newspaper environment. By world standards, Fleet Street is in a technological sense extremely backward. This is not the place to argue why this is so, or whether it matters, or how long it can last. But it is a fact, and viewdata represents a useful opportunity to keep pace with computer systems by other means.

5. Prestel/viewdata is also a means and opportunity for exploring new combinations of people and skills. Like many other industries, the newspaper industry is fairly tightly demarcated between unionised functions, e.g. journalists, compositors, clerical staff, library staff. At Fintel, we have never made any secret of our intention to mix together people from different background into one single team, with cross-fertilisation of skills and attitudes. It has been one of the most rewarding aspects of what we have done, to see how people, free of formal restrictions on what they can do, branch out and develop in unexpected ways.

6. Viewdata systems enable their participants to explore and evaluate the concept of the database. This is a much wider concept than Prestel or viewdata itself, and is applicable to many computer systems. Many newspaper and other publishing companies are moving into this field, seeing themselves more and more as 'information companies': but it can be expensive, and is certainly a novel, even foreign territory to those more familiar with year-books or late editions. Viewdata is an easy, relatively cheap and accessible way of exploring the database concept with a view to future decisions on investment, outlets, commercial policy in this new but developing field.

7. A further motive is to explore the relationship between viewdata systems and other electronic systems. As more and more activities, from letter writing to typesetting, from business forecasting to games, fall under the spell of the computer, so the relative role of viewdata will develop and change. Is it, for example, basically a vehicle for data held elsewhere - a distribution and marketing tool? Or is it (also) a vehicle for original material, or an original repository from which other computer systems can draw? In short, what is viewdata's place in the general electronic environment? An electronic publisher needs to know.

8. By becoming involved in Prestel/viewdata early in the game, a publisher has a chance to influence the development of the medium in ways favourable to himself, and to the commercial future of the medium as he sees it.

Traditional publishing disciplines and constraints do apply, mutatis mutandis, to electronic publishing as well.

9. Early participation is also a business opportunity to set up, or try to set up, a viewdata 'hot shop', with an all-round capacity in viewdata matters. There is some reason to suppose that the market will only sustain a limited number of these specialist viewdata companies offering a complete range of viewdata services (defined below), and that it may be the early birds that catch this particular worm. While viewdata is too young, and changing too quickly, to make dogmatic statements, I doubt whether the idea of every Prestel user being an Information Provider, and vice versa, will ever be more than partially true. As with paper publishing (which in theory any organisation or individual can do) there will tend to emerge in practice a limited group of specialist companies with the skills, people, premises and experience to handle a wide range of products on behalf of other people.

This is not a complete list of motives: not all apply to everyone. Each publisher has to make his own decision whether the balance lies for or against participation in Prestel/viewdata. For the Financial Times/Extel, the balance was quite clearly in favour: hence the creation of Fintel Ltd.

B. What then are the components of an electronic publishing business in the full sense that I have mentioned above?

Again, they will vary from case to case, but based on our own experience, in which we began with the simple notion of being an Information Provider and developed from there, the components might be as follows:-

1. An open mind about what to publish in the new medium. Clearly, your existing data must be your starting point. But too many newspaper, magazine and book publishers see viewdata as some sort of 'electronic clone' of their original paper publication, or as a poor man's version of it. Worse, they see viewdata just as a trailer or taste for the 'main' publication, or as an advertisement for it. This is not only excessively defensive and unimaginative: it is also courting disaster, because the Prestel/viewdata audience will surely not accept in the long run second-hand, derivative, cut-down versions of what may anyway be cheaper to buy elsewhere. Whatever you publish on viewdata, has to be right and convincing in viewdata terms: it may in many cases be very different from what your home publications look like. In short, it is a new publication, to be looked at with a fresh mind.

2. At this early stage, it may also imply a diversified viewdata publication, that is flexible and to a degree disposable. No one can yet pretend to have found the right product or product mix for Prestel/viewdata. Therefore it is necessary to hedge one's bets, try out alternatives, with ways of measuring the success or failure of those alternatives. Again an open but experimental mind is called for.

3. Just as the viewdatabase may be diversified, so should the people be diverse. This point has been mentioned in the previous section. But it is still too early to say whether the journalist's eye, the computer person's eye, the librarian's eye, the graphic artist's eye, the book publisher's eye, or any other eye, will perceive the best uses of viewdata - or whether it is a pooling of all those and other perceptions. Again, it is necessary to hedge one's bets.

4. By a similar logic, the outlets for a specialist viewdata company must be diverse. For a UK company, of course the Prestel system must be his primary focus of interest, especially at this stage of viewdata development. But viewdata promises to be a world-wide phenomenon, in which national boundaries become increasingly meaningless as the technology, and international standards for it, are evolved. Somedata is very parochial: but a surprising amount is not, provided that the person in the other country can have easy and cheap access to it. The world is your oyster as a viewdata publisher, far more immediately and dramatically than with paper publications, even allowing for language barriers.

5. But the most important component is what results from these diversified people, outlets and attitudes, and that is a diverse range of activities that go to make an all-round specialist viewdata publishing business. This range of activities may clearly vary from case to case, but might include the following:-

- simple information services on Prestel or other viewdata systems: in other words, the original Information Provider role, which is probably the cornerstone for the rest.
- advertising and marketing services that march along side of the main information services, and are offered, as are all advertising outlets, to third parties such as companies, public organisations etc., to make use of for a fee.
- contract work for others, taking their data and converting it into viewdata frames, for a price.

- consultancy, advising others on what is, and is not, possible on viewdata systems given the nature of their original material.
 - technical development work, devising 'add-on' systems that answer to the information handling needs of particular IPs, oneself included.
 - conferences and seminars, both to make money and to propagate the Prestel/viewdata message.
 - market research, both one's own, and for others on a contract basis.
 - sale of data frames to other, perhaps overseas, Information Providers for use on other viewdata systems. Being already in viewdata format, such material is readily recorded and transferred, at a negotiated price.
 - help with, and contract work for, Closed User Groups, private viewdata systems etc.
 - becoming a direct Information Provider to viewdata systems in other countries, and offering contract services for, and to, those other countries also.
- C. Having therefore become an electronic publisher, what are the broad considerations that govern - or limit - the type of information service that may be offered on Prestel, or indeed on any other viewdata system?

These may be summarised as follows:-

1. The viewdata screen is a narrow window on a large world. The screen size has severe implications for editing techniques: the narrow window effect has strong implications for indexing, routing, database structure and other means for guiding the user round the information offer. Unless the material is susceptible both to the editing techniques implied, and to the database structure implied, then it is not suitable for Prestel.
2. Prestel is a mixed medium of text, figures and graphics. This makes it unusual, if not indeed unique, both in the world of television and in the world of computers. Maximising the use of these facilities, and finding the most judicious mix between them, is the art of the Prestel professional editor. Clearly the mix may vary from IP to IP, but the aim must be to exploit the unique advantages of a viewdata system, of which this range of display possibilities is the most important.
3. The ability to put a price on each separate page of information is also a unique feature, both in TV terms and computer terms. I refer to it as 'unbundling' in the computer sense. Most products in publishing are bought

for some one-off sum, a cover price or annual subscription or, in the case of BBC T.V., an annual licence fee. But Prestel is bought item by item, page by page, and the price can vary from page to page, and can be changed for any given page. There is therefore a flexibility of pricing - and purchasing - especially given the facility to go off into a Closed User Group with yet other pricing methods, that is unknown elsewhere.

4. There is, as already mentioned, a quite new competitive environment. The fact that you are an established publisher of a certain type of information on paper, while it puts you in a strong position, does not guarantee you a similar position on Prestel, simply because the different medium opens up the possibility of others challenging your position. This in itself can be a strong motive towards putting up certain types of material, to establish a position, always remembering that the competition may come from unexpected, even unwelcome sources.

5. One fundamental conceptual problem is whether viewdata is most suitable for highly volatile information, such as today's news and the latest market prices, or for relatively static information, such as train times, restaurant guides etc. A related question is whether the commercial objective should be to have a smaller number of pages that change frequently, or a larger number of pages that change infrequently, if at all. Maybe Prestel can do both. If so, it will show remarkable versatility. The fact that pages are not automatically updated on the screen means that there is a limitation on Prestel's ability to be a hot news medium: compare for example the Stock Exchange TOPIC system, which is a viewdata system but has automatic continuous update.

6. Is Prestel a medium for hard facts only? Figures, dates times, addresses, prices. Or is it also a medium for debate, opinion, argument, controversy?

The limitations of the screen size mean that Prestel is not suitable for extended amounts of text. You cannot put a novel onto Prestel, nor yet a full length feature in the magazine sense of feature. So if Prestel is a medium for opinion, they have to be succinct opinions, statements of position, rather than reasoned cases. The whole question of whether people will genuinely read Prestel, as opposed to taking in salient figures and words at one glance at each screenful, is an important one and difficult to decide until people have got more used to using the TV screen for these types of purposes. But what it certainly emphasises is the point made previously, that a

Prestel information service cannot be regarded as some sort of 'electronic clone' of the printed publication. The style, usage pattern, and economics are quite different. Another way of stating the question is whether people will browse through Prestel, or go in to find a specific bit of information and either get it or not get, in a hit-or-miss manner.

7. And what is the role of advertising and promotional material of other sorts?

Advertising itself does not fit traditional notions or patterns when applied to Prestel. But most traditional publishing, not to mention television, is heavily subsidised by advertising revenue. Can a similar subsidy be expected for Prestel? How big a proportion of the information that people view can be paid for, sponsored, or advertising of some sort, without those people being 'turned off' the medium? If it makes the information free, or nearly so, perhaps the answer is, 100 per cent, provided that the suppliers use their commonsense about the credibility and reliability of the information they put up. But perhaps there will be, must be, information services that are 'pure' editorial, paid for at full cost by the user, especially the business user. It will be interesting to see the balance that emerges between the two approaches to the philosophy and economics of Prestel publishing.

8. Most of these considerations will get a different answer depending on whether Prestel is successful in the business market or in the residential market, or in both: and will get different answer from a business IP compared to a residential IP. Broadly, business is used to paying for information as a resource, but the man and woman in the home is not: people in business are used to searching for information as a skill, but the man and woman in the home are not. Arguably, the most natural technical application of Prestel is to the mass market, given that TV sets and telephones are mass market objects (even though, in the case of the telephone, not everyone in the UK has one by any means): but the economics and user skills required for Prestel may push it more in the specialist and/or business direction.

9. Lastly, a case can be made out for saying that Prestel will only take off in a big way, with high usage, when the buying and selling mechanism via the response frame, and the message facility, turn it into a much more active and novel medium, rather than the simple information medium that it basically is at present. Perhaps the information

content will be the marzipan on the cake, the basic cake being the quite new and exciting ways that people can communicate with each other, and do their shopping, travel bookings and so on.

In short therefore, Prestel sits at the cross-roads and cross-over point between paper-based and electronic publishing. The medium is new, but many of the editorial and marketing decisions are more akin to those traditional publishing, in the sense of what information to market, to whom, and at what price. That really is the challenge of Prestel.

Electronic Publishing and the Government

Sir John Barran

Central Office of Information

United Kingdom

The advent of viewdata systems presents governments with a new method of providing information for the citizen. But there will be problems, and it will be necessary to rethink the relationship of publisher and user in this novel context.

Copyright © 1980 by Online Conferences Ltd.

It was nearly four years ago that the British Government became interested in the possibilities of Viewdata as a means of communicating with the public, and set up the Unit which I head to investigate the possibilities of this new medium.

The Central Office of Information, as you may know, is responsible for the production and distribution of every kind of information material required by Government departments in the United Kingdom.

We spend £20 million every year in all media running campaigns on subjects running from Road Safety to the Microprocessor Awareness Campaign. And our print orders for brochures or leaflets frequently run into tens of millions. So, when this new medium came along it was natural that we should want to look at it extremely closely.

The main aspects of viewdata which we find attractive are -

- a) It is universal - potentially it will be possible to have a set in every home and office.
- b) Its capacity is virtually unlimited - so eventually all Government information might be on it.
- c) It is permanent - material put in the system remains available for ever.
- d) It can be changed immediately - so all data can be up-to-the minute.
- e) It is available day and night - so the user can access it when he needs the information.
- f) It is interactive - so that the user can respond to the information, can ask for more, or can criticise it.
- g) It is cheap for the Information Provider - once data is in the system thousands (or millions) of users can look at it at no extra cost.

This means therefore that any individual - whether he is working in an office or pausing between TV programmes in his own home - will be able to have access to exactly the facts which he personally wants, at the moment he needs them, and within seconds. And this means that it is ideal for many applications of Government information.

In consequence of this the House of Commons and the House of Lords and twenty Government organisations are already putting material into the system and the COI is acting as a co-ordinator and a catalyst in this enterprise.

In brief, the material going on is -

Parliament - details of how the two Houses operate, committees currently sitting; and upcoming debates for the week.

Ministry of Agriculture, Fisheries & Food - advice to farmers.

British Overseas Trade Board - advice to exporters.

Central Film Library - catalogue and booking service.

Central Office of Information - general indexing and cross-indexing.

Central Statistical Office - main economic indicators; and other key statistics.

Careers and Occupational Information Centre - advice on how to choose a career.

Department of Education & Science - educational material.

Department of Environment - planning permission procedure; housing grants.

Department of Industry - support and grants for industry. Small businessman's database.

Department of Health & Social Security - social security benefits.

Health Education Council - health advice (including how to give up smoking).

Health and Safety Executive - regulations on safety at work.

HM Stationery Office - latest publications.

Lord Chancellor's Office - legal aid and advice schemes.

Inland Revenue - tax details.

Professional and Executive Register - professional job vacancies.

Department of Trade - regulations. Shipping information.

Meteorological Office - weather forecasts and details - world wide.

Office of Fair Trading - consumer rights and laws.

Property Services Agency - material for the building industry.

This, of course, is only a beginning, since eventually it will be necessary to include material covering every aspect of government work.

Now, in this novel involvement in Electronic Publishing, what are the problems and what new approaches are we having to make?

Well, first I think there is a question of the universality of the database. For obvious reasons it has hitherto been necessary to divide government activity up into packets and label them "Environment" or "Industry" or "Health" simply in order to be able to handle the subjects at all. But since Prestel is a random access system it is possible (in theory) to go from any frame to any other at will. This means that if an individual wishes to (say) build a small factory, then he will want to find out the planning requirements, and the safety regulations, and then see whether he can get a grant towards the costs - which involves three separate departments. But inside Prestel he can simply tap all this information in one sequence - provided someone has put it there and taken the trouble to ensure the proper cross-indexing between these different topics. This is where the COI comes in, for we are trying to co-ordinate a Government database by (amongst other things) inserting lists of all departments and their areas of responsibility, and a subject index with an indication of which departments are involved - and then trying to ensure that departments cross-index appropriately amongst themselves.

And beyond the departments, we must also interlink with local authority databases, with other non-governmental Information Providers - and with other non-Prestel databases, via the same system.

This is why we are such enthusiastic members of AVIP (The Association of Viewdata Information Providers) and of IVIPA (the International Association) - since we believe that all IPs have many basic common interests, and a need to co-ordinate their activities and be aware of each others work and needs.

A difficult problem is that of cost - for there is no doubt that many of those who we would wish to reach will be unable to acquire viewdata sets for years; if ever. So we are looking into the whole question of Public Access Sets - encouraging their introduction into Libraries, Citizens Advice Bureaux, Town Halls and, naturally, Post Offices. The cost of the data, too, is not going to be insignificant. Even if much Government data is going to be free itself, the cost of accessing it will be quite high - and perhaps a deterrent. The Public are just not used to paying for specific pieces of information, and will have to learn to value them according to their needs - as they might do in selecting and buying a magazine or book. This means too that Information Providers will have to experiment with all sorts of different pricing formulas before hitting on the optimum one for them. In the long run however, it surely must be more economic to

buy information bit by bit - instead of purchasing a packet of it knowing that 80% of it will probably be useless to you.

In Britain, Prestel, of course, is very much a selling medium as well, and much of the material on it will be direct sell or advertising, so the question arises of whether it is necessary to control this medium and if so, how? You cannot monitor several hundreds of thousands of frames, any one of which can be altered at a minute's notice; so at the moment we are relying on a special Code of Practice developed by AVIP and applicable to their membership. This seems to be a reasonable solution at present, since at least 85% of the frames in the database are put in by AVIP members. But as the system grows there will be more potential mavericks and then we may be in trouble.

And in connection with advertising, what will be the role of Agencies in this new medium? For the individual company can put up its own data from the office without the need of intermediaries - and with no 15% to pay for the service.

Another potential danger is the threat to security and privacy. Can unauthorised people gain access to Closed User Groups - or other forms of protected data? And what will be the effect of having, for the first time, some kind of universal storage system, accessible from millions of sets?

There is little Closed User Group material in the database at present but this will grow in the future - especially when it becomes possible to reach non-Prestel databases through the system. We are not sure yet how secure these CUGs can really be made; and if you couple this with the fact that there will be a great deal of buying and selling on the system using credit cards, there could be a strong risk that (for example) non-Prestel data might be improperly looked at, and the results used to affect people's credit-worthiness, or to misuse their existing credit facilities.

A final point of major significance is that the user will be able to respond to the material he comes across. Not just by enabling him to order goods, or printed matter - but by giving him the chance to comment on what he is being offered. In the government sector this means the possibility of the public actually saying what they think about specific regulations or policy decisions, and perhaps influencing political decision-making by indicating their preference from a menu of possible courses of action. Not just at election time, but throughout the life of a Government it should be feasible to get the opinion of individuals or companies or households on a whole range of vital subjects.

As the system evolves we will begin to see the role of the Government Information Services and the whole concept of "Publishing" information having to be redefined. No longer will Government

information simply be handed out in small packages labelled "campaigns" because it is too expensive to promote everything, all through the year - nor will it always be necessary to print and promote large batches of "brochures". Instead basic "information" will come to be regarded as a resource to which the citizen has access at all times, and into which he dips whenever he has a specific need.

Of course, books and magazines for entertainment will never be seriously affected, (any more than they have been by television) since viewdata is not a "reading" medium - but the marketing of hard facts will need to be entirely rethought.

Let there be no mistake - this new medium is here and now. The wise publisher should therefore regard it as a second string to his bow, and attempt to integrate it with his current activities (for example by advertising each medium in the other) thus adding significantly to his freedom of action and to his potential customers.

PRESTEL AND THE LAW

Dr. Stephen Castell

Director

Infolex Services Ltd.

England

Prestel will have a particular impact on the Law, from two main directions:

- as a major forerunner of new electronic publishing systems designed with mass public appeal, it may bring about re-evaluation of current legal concepts, norms and precedents to cope with potential conflicts arising from the status and use of these new media;
- as a cheap and practical means of disseminating and retrieving highly-specialised legal information, it offers to the busy practising lawyer a fundamentally new research tool, and method of professional communication.

Examples and illustrations are presented to support this view, leading to the conclusion that Prestel's impact on the Law will itself be only one aspect of the increasing perception of the concept "Information, The Resource".

Copyright © 1980 by Online Conferences Ltd.

1. INTRODUCTION

I intend in this paper to show that Prestel, as one of the principal forerunners of essentially new public 'electronic publishing' and 'mass communication/information' systems - themselves the first significant vehicles for widespread appreciation of the power and implications of the whole novel (and increasingly 'silicon-chip-based') mix of computer, communications, office and industrial automation, hardware and software, which we now term Information Technology - will have an important impact on the Law, its practice and preoccupations, in two distinct but connected ways:

- first, in the need for the definition of a number of new legal concepts and normative procedures (or re-interpretation of old ones) to deal with the potential legal problems arising from business and domestic transactions carried out through or related to use of Prestel and other new electronic media;
- secondly, in the direct use of Prestel by practising lawyers as a professional business tool for both legal research or information retrieval, and as a new business communication path for day-to-day interaction with other legal practitioners, and possibly clients.

With regard to the first of these two aspects, a most important point is perhaps that Prestel is, indeed, only one forerunner of a number of new publicly-available Information Technology products and services designed with mass appeal, which will increasingly demand new evaluation and definition of legal concepts and norms. (In that sense, this paper's title might rather have been "Information Technology and the Law"). Attention is focussed on viewdata, and in particular the British Post Office's Prestel viewdata service, precisely because it is the first of its kind to be practically and commercially available in the public arena and may already have begun to highlight some of the potential new legal problems and considerations to come.

With regard to the second aspect, it is Prestel itself, in its own right, with its own unique characteristics, style, status, 'communications reach' and information offerings for the practising lawyer, which is the focus for attention. I shall illustrate Prestel's existing ability to assist the practising lawyer by providing him with a cost-effective legal updating system, as well as its future information and communication potential in the legal sector.

I incidentally define 'the Law' in this paper where necessary as being that of British Jurisprudence and Practice; many of the aspects covered, however, have applicability to law as defined and practised internationally.

2. THE IMPACT OF PRESTEL ON LEGAL CONCEPTS AND NORMS

2.1 BACKGROUND

The evolution and development of legal concepts and, indeed, that of the concept of the Law itself, is intimately bound up with the evolution and development of the concepts of 'rights' and the 'protection' of those rights, together with the evolution and development of normative administrative and judicial procedures for resolution of the conflicts that arise when such rights are perceived by the relevant parties as being infringed or in some way threatened.

The methodology of this legal-conceptual development and evolutionary process varies from country to country and, within a country, from jurisdiction to jurisdiction, and is invariably closely connected with the wider social, political, commercial, industrial, economic and educational developments taking place: the truism is that where change occurs, there legal concepts and norms almost invariably come to reflect such change. This receives its most solid embodiment in the phenomenon of Statute Law - or 'national rule book' - whether drawn up at the whim of, say, military dictatorship or as a result of free debate in the Chamber of a democratically-elected Parliament.

I would not care to comment on the rate of evolution of legal concepts and norms compared with that of appropriate precepts of other professional disciplines, but I think it is apparent that, in the UK at least, this rate has been increasing dramatically within the last decade, since, for example, successive governments have sought to impose social and political direction by use of Statute, and, furthermore, much of this and other types of Statute have of late become to be what the cynic might call 'prototype law', leaving the UK Courts to lick it into 'production' shape - all of which can imply fairly frequent and vigorous modifications of legal concepts and norms.

My contention is, however, that 'we ain't seen nothin' yet', and, because of the rapid developments in Information Technology and, more importantly, because these developments, by virtue of certain unique and profound properties of Information Technology compared with other technologies of the 20th. Century, carry with them wide social, political, commercial, industrial, economic and educational implications, the Law may well pass through its own 'Future Shock' Wave wherein a wide range of currently accepted legal concepts, norms and precedents will suddenly, and in parallel, be challenged.

Does my contention have more than a grain of truth in it ? And, if it does, where will the first breachings of legal conceptual walls by Information Technology developmental implications take place ?

I feel, in this VIEWDATA '80 Conference, we need look no further for a positive answer to the first question, and indicators for illustrative answers to the second, than the British Post Office's PRESTEL, the world's first public viewdata service.

2.2 AREAS OF IMPACT

Prestel itself, in common with an increasing number of other Information Technology products and services designed with mass appeal, defies simple definition and itself requires new conceptualising. For example, by focussing on the various component parts of the system in turn, it may variously be regarded as:

- a publishing medium
- the publication itself
- the means of production of the published text
- the content of the publication
- an (electronic) information system
- an (electronic) communication system
- an intelligent device for searching publications
- a game
- a computer
- an (educational) toy
- 'the fifth TV channel'
- a computerised databank
- an advertising hoarding.

It may well be that Prestel has a legal status for any one of these definitions quite different from that for any other.

For example, if it is to be regarded as a 'publication', then the legal concepts evolved over the years to cover the rights of those involved with 'publications' (which includes authors, publishers, printers, the subjects of written material, advertisers, etc.), and the normative legal procedures developed for resolving conflicts over these rights, are the correct ones to apply. Thus, under this view of the legal status of Prestel, the legal concept of 'publication', and thus what conditions, for example, have to be satisfied for there, in Law, to have taken place an 'act of publication' would hold sway.

I personally doubt, however, whether these existing concepts and norms cover a 'publication' whose pages are capable of infinite and variable partial or complete - and almost instantaneous - 're-publication' any moment of the day, and where no permanent record is available of earlier published versions. Whatever my personal view, it is the point of this paper that one can foresee that the issue of whether the well-established concepts and norms of 'publication' do indeed adequately cover Prestel will increasingly impact the practice and administration of the relevant areas of the Law.

A further example in relation to 'publication' is the established 'intellectual property' right of copyright, which over the years has evolved, as a result of substantial development by way of commercial practice and precedent, into a well-understood concept of legal protection.

The view is currently being taken, it would generally seem, that filled Prestel frames, in content and form, are automatically covered by the well-established norms and precedents of this existing copyright concept. Indeed we ourselves as a company naturally express our hope that this is the case: but to make our position clear, viewers of our frames are reminded of the legal protection we assume is afforded to the intellectual property which our database on Prestel represents to us, by our stating 'Copyright', and the date, in something approaching the hitherto generally accepted fashion, at the top of each of our Prestel frames. As a 'Closed User Group' subscription-based service on Prestel, we furthermore expect to achieve additional protection in knowing precisely who is authorised to view our frames in the first place and, secondly, in requiring certain agreements about the nature of the use of the information by the viewer when he first signs up as a subscriber, as part of his membership 'terms and conditions'.

Whether or not every Prestel Information Provider will have to go to such lengths (and whether, if he does, it will ultimately afford him his assumed 'copyright' protection) is in my view, however, not yet proven, and is likely to come in for increased discussion among electronic publishers and users alike, not to mention legal challenge. When one considers that in the more usual 'open-frame' Prestel situation, the 'viewer' could now easily be an 'intelligent' - and powerful - machine in the form of a microcomputer, capable of scanning through and 'viewing' hundreds of Prestel database frames in a short time, storing their contents in its own disc memory, doing 'intellectual work' on this locally stored database according to previously programmed instructions (together with perhaps the

merging and sorting of some other, even proprietary, data), and finally re-transmitting via some distinct electronic publishing network its own (or its owners' own !) marketable 'information product', it is not at all clear whether the Prestel Information Provider could even suspect, detect or inspect such a perceived infringement of copyright, much less whether the Courts would support subsequent attempts to protect his rights.

This is not to say that such attempts will not be made - to my own knowledge, one such potential microcomputer manufacturer has already been threatened (albeit gently) with legal action, by lawyers acting on behalf of a Prestel Information Provider, if the product is put on the market as a 'processor' of Prestel frames, without prior consultation with their clients.

One could go on with similar illustrative examples covering a number of other concepts like: 'duty of care'; 'product' liability; civil, criminal and 'bad taste' liabilities; 'ownership'/'privacy' of information, etc.. As a final example from a related area, the vexed issue of computer software protection has of late come in for a great deal of discussion, with at least one draft Parliamentary Bill, a Green Paper, and a judgement in the Courts giving the protection as that of a 'performing' right, as for musical works: all of this further emphasises the point that a difficult period of rapid evolution of new concepts lies ahead.

I do not pretend to have a simple prescription for an optimum resolution of such forthcoming problems. My suggestion would however be that we look at the nature of Information itself for a key to adequate new conceptualising. The characteristics of Information have always been there, it is only now, with all the many possibilities and implications of Information Technology, that their full power is beginning to be appreciated. I would suggest therefore that, under the pressure, perhaps, of the public development of a radical mass information system like Prestel, we may have to consider the possibility of a new legal concept which I call quite simply an Information Right.

Without having the time here to develop this idea, I would just say that when one begins to glimpse the importance of establishing such an Information Right, almost immediately one also, paradoxically, begins to appreciate the importance of outlawing such a concept !

I will briefly return to the concept of an 'Information Right' and why we should or should not look to the impact of Prestel on the development of legal concepts and norms to deliver a conceptually new 'Information Right' in the concluding remarks of this paper, when I hope to a certain extent to draw the two halves of the presentation together under the general observation 'The Perception of Information as The Resource'.

3. THE IMPACT OF PRESTEL ON LEGAL PRACTICE AND RESEARCH

3.1 OVERVIEW

In this Section I wish to describe the uses of Prestel, as it exists today, as a research and communications tool in assisting the legal practitioner in his practice of the Law.

I will carry this out as follows:

- describe briefly the UK's first commercially-available computer-assisted legal information retrieval service provided through Prestel UK by my company Infolex Services Limited, one of the original Prestel Information Providers. I shall try and give an account of its activities to date, and its plans for the future;
- contrast how Prestel meets the information needs of the UK legal profession compared for example with other full-text retrieval services (e.g. LEXIS, EUROLEX, WESTLAW);
- outline other potential uses of Prestel as it exists today in assisting the practising lawyer in both information retrieval, and as a communication channel.

3.2 INFOLEX: THE CLARUS AND STALUS DATABASES ON PRESTEL

INFOLEX is one of the first Prestel Information Providers, and was specifically formed to provide computerised legal information retrieval and other communications services for practising lawyers, which it does on a Prestel Closed User Group subscription basis to a total market of perhaps 15,000 British legal researchers of the type envisaged.

The principal occupant of INFOLEX's frames on Prestel UK is CLARUS, a Case Law Report Updating Service, giving over 2,000 up-to-date references to legal precedents and judgements arising from British Court Decisions as reported in the well-known, standard and respected law reporting journals published in England (e.g. All England Law Reports, Weekly Law Reports, Times Law Reports). Abstraction began in May 1977 and covers five of the major reporting sources.

The case references are presented on the Prestel frames in a form very familiar to UK lawyers, and are easily retrieved by use of a unique 200-term INFOLEX Index structured over the viewdata frames with a businesslike 'no frills' presentational philosophy in order to meet the objective of a practical, cheap and fast updating service for the busy professional legal researcher. INFOLEX has also begun development on Prestel of its second main database STALUS, a STATute Law Updating Service, with initial coverage of an important piece of UK legislation, The Consumer Credit Act 1974.

The usefulness of the INFOLEX service depends on the scope of material covered, the depth of reporting (and case summaries, to supplement bald references, for example, are in the process of being added to CLARUS), and the 'finesse' of the Index. It is proving of practical benefit to lawyers and indeed others, at an economic price - borne out by the spread of legal research interests represented by the initial INFOLEX subscribers and users, which include private firms of solicitors, corporate lawyers, local and central government legal departments, chartered surveyors, bankers and legal educationalists.

To put the development of INFOLEX in context, it may be noted that it is the first such commercially-available computer-assisted legal information retrieval system to be launched in the UK. Full-text computer-based legal retrieval systems such as LEXIS and WESTLAW, together with a newcomer, EUROLEX, based on the STATUS retrieval software developed in Britain several years ago, are being launched by other operators in the UK in 1980.

In addition, it is worth noting that the seminal report 'A National Law Library - the Way Ahead', published in February 1978 by the innovatory UK Society for Computers & Law, has been followed up by the establishment of a company, The National Law Library Ltd., which is currently carefully considering alternative strategies and features of an optimum computer-based service for the UK legal profession. It has recently been touring many of the Local Law Societies in England demonstrating the features of on-line retrieval systems, like INFOLEX and others, to the 'grass roots' of the profession and seeking comment and feedback on the profession's practical needs in this area.

Quite apart from the aspect of cost, it is of interest to contrast other features of the INFOLEX service mounted on Prestel with those of some of the full-text retrieval services mentioned above, and their relevance to the busy practising lawyer's information needs:

a) 'Reference', not 'full-text': several research studies seem to support the view that most businessmen and professionals in commercial life prefer fast and reliable access to top-quality sourcing of primary information, rather than an electronically-available database of the primary information itself 'on his desk at the touch of a button...' (even Prestel, paradoxically, like the specialist full-text services, may thus come to be used most by the trained 'mid-user' - even though INFOLEX's CLARUS and other databases mounted on it have been simply designed for the 'end-user').

b) 'Update', not 'Archival': In preparing the report 'A National Law Library - the Way Ahead', already referred to, the Society for Computers & Law drew heavily on the work of Professor Colin Campbell, Dean of the Faculty of Law at Queen's University of Belfast, who has carried out much research on the information needs of UK lawyers and the implied desirable features of a national, computer-assisted information service: in particular, on page 22 of the report: 'As Professor Campbell's researches have disclosed, the rate of change in the law has made the obtaining of up-to-date information the United Kingdom lawyer's principal legal research difficulty...The overridingly important factor is that a computer-assisted legal information service can offer an effective up-dating facility'.

c) 'Esoteric' or unusual reference sources, not just 'standard texts': To quote again from the same report (page 21): '...fringe and ephemeral information (journal articles, circulars and white papers) may be of more value to users than core information (Statutes and Law Reports) if only because ephemeral information carries the seeds of future developments, but is not formally organised and is therefore difficult to trace!.

One of the beauties of using Prestel to mount the INFOLEX service is that the economics of disseminating information via this medium make it very easy to play host to small, ultra-specialist legal databases, sometimes even provided by customers of the service themselves. Furthermore, there is a range of other Prestel Information Providers (e.g. Benn Brothers, Butterworths, Fintel, Mills & Allen) supplying information to the Prestel UK Public Service of complementary interest and value to lawyers. Finally, there is at least one legal-oriented information service (LEXTEL) mounted on a private viewdata service in the UK again offering information areas of additional interest to lawyers. All of these are of course very likely to be obtainable through the same viewdata TV set - whereas the full-text services referred to earlier doubtless between them use several types of computer terminal, possibly having differing communications protocols and probably accessing quite distinct computer hardware. The economics of operating such full-text services are furthermore likely to make it difficult to mount any but the largest of standard, heavily-used text sources.

3.3 OTHER USES FOR PRESTEL IN THE LEGAL PROFESSION

Prestel has the easy knack of bringing out in all those who approach it a host of exciting suggestions for application to many walks of industrial, commercial and professional life, and the legal sector is no exception in this.

For example, apart from the 'professional knowledge system' of legal information retrieval like CLARUS and STALUS, one could think of a host of 'directory-type' information of interest to lawyers, like lists of enquiry agents, forensic scientists, costs draftsmen, consultants and other service agencies (LEXTEL is, incidentally, already offering some of this via mn-Prestel viewdata).

Again, up-to-date technical information such as scales of fees, procedural check-lists and standard forms and precedents seem a 'natural' for the medium.

Once one has a Closed User Group subscription-based private 'club' of members, one may furthermore more readily provide information on that touchiest of topics - personalities. A 'Personal Reference' database (just limited, for example, to references to press reports - particularly those in Private Eye ? - giving the personalities involved in news stories, indexed by individual's name) might well be a valuable check-point for solicitors (and, indeed, bankers and other professionals) for credit - and credibility - rating of new clients and their projects.

Another area is that of the administration of the legal process. Such dynamic information as Daily Court Lists and Forward Litigation Diaries might, in the right circumstances, be brought onto the medium.

Finally, there is a whole range of office administration application areas, from overall 'matter' filing-systems to debt-collection progress-reporting, for which a large firm or corporate legal department might consider installing an in-house private viewdata system.

No doubt the best of these and many other future applications will emerge as Prestel evolves, proliferates and progresses - INFOLEX certainly intends to be doing its fair share, where appropriate, to bring this about.

4. THE PERCEPTION OF INFORMATION AS THE RESOURCE

The conclusion reached earlier that Prestel may well have the effect of helping to bring about the emergence of a new legal concept which might be termed an 'Information Right', and the later demonstration of Prestel's power to assist the lawyer with many of the information and communication needs of his professional practice, are, in my view, but two examples of the way in which the perception of Information itself as a crucial resource - as crucial in business and society generally as financial capital, energy or labour - will increasingly be convincingly demonstrated.

I would like to go further than this and support the now oft-stated claim that Information will come to be seen as The Resource.

John McHale, in his book 'The Changing Information Environment', put the argument succinctly:

"Human physical survival is based on the availability of material resources, the energy with which we convert these into objects of common utility, and the knowledge which informs and advances this process.

Material and energy resources are dependent on being recognised as such. That is, they are...determined by the state of our information about our physical environment. For example, most of the industrial resources presently in use were not even conceptually recognised as such a hundred years ago. Aluminium was a scarce metallic curiosity, radioactivity a laboratory phenomenon, and many of our present key metals were regarded as waste impurities in other ores. Our material resources and capacities are dependent on the way we view our environment: they are ultimately as we conceive them to be.

Information and knowledge have, therefore, several unique properties which do not pertain to other forms of resources. All other resources are dependent upon them for their evaluation and utilisation..... Information and knowledge, as resources in themselves, are not reduced or lessened by increased use or wider sharing - rather they may gain in the process....

Our core concepts of wealth and power are still tied closely to value systems derived from pre-industrial societies in which... survival was marginal and competitive....Most of our political, economic, and social systems still operate on this latent model. Survival in these pre-industrial terms was essentially a zero-sum game - the winners only secured advantage if their opponents lost!

"...In the new information environment many of these older conceptual models and values may not only be wholly obsolete but may endanger the over-all maintenance and the quality of our society.

The new social wealth generated by 'information as a resource' will certainly be even less dependent upon the older forms of land, material possession and the ownership and control of physical property....

Who knows what, becomes more important than who has what. This could lead to shifts in policy decision-making and control functions in various institutional sectors - which now come to be associated with the new wealth and power inherent in information/communications technologies...."

It is the immeasurable implications of such conclusions which give to Information and Information Technology their massive impact potential. Prestel is in the vanguard of 'Information for The Masses': my belief is that its impact may well be greatest, and soonest, on our legal professions, since it is the Law, whether in its social, political or commercial embodiment, which will have to deal soonest with many of the effects of the mass perception of the concept: Information, The Resource.

REFERENCES

The Infolex 'National Law Library', Dr. Stephen Castell.

The Law Librarian, 10, 2, August 1979, pages 23-26

The Changing Information Environment, John McHale.

Elek Books Ltd., London, 1976. ISBN 0 236 40052 5

'A National Law Library - the Way Ahead', Society for Computers and Law, February 1979. ISBN 0 906122 02 3. Obtainable from Administrative Secretary, 11 High Street, Milton, Nr. Abingdon, OXON.

STC's Approach to In-house Viewdata Systems

F.A. Heys
Viewdata Project Manager, STC Ltd

R.E. Cooke, H.W. Toze and R.L. Williams
Standard Telecommunication Laboratories Ltd

U.K.

Private viewdata systems have been implemented in both STC and in STL on Honeywell and IBM mainframe computers respectively. Besides describing the hardware and programs required to achieve this, the paper also refers to their applications. The reasons for using mainframes rather than dedicated minicomputer systems together with the ways in which the basic viewdata terminal may be enhanced to make better use of such private systems are discussed.

Copyright © 1980 by Online Conferences Ltd.

1. INTRODUCTION

In this paper we shall describe how two private viewdata systems have been implemented on mainframe computers (IBM and Honeywell). We shall explain the reasons why this approach was adopted as opposed to using stand alone minicomputer systems and also comment on some of the implications of using viewdata with existing D.P. systems on the terminal requirements if full advantage is to be taken of the combination.

2. WHY HAVE A PRIVATE VIEWDATA SYSTEM?

We took the decision to have our own private viewdata system in 1976. At that time it was not clear how viewdata would develop; indeed, whether it would ever become a public service. What did seem clear to us was that if it were to be successful, the initial impact would be among business users, and such users were likely to want their viewdata terminal not only to retrieve data on a public service, but also give them the same ease in accessing their own computer held data. Questions of privacy, control over the operation of the system and vulnerability to tariffing were likely to influence organisations to have their data stored on their own computer rather than the Post Office's. Although our main interest in viewdata was as a potential supplier of terminals for business users, we thought it worth gaining experience in setting up a system which could be developed for our own use and could be of interest to our customers.

There were other more immediate reasons for having our own system

- to provide a test bed for use in the development and manufacture of terminals (we could not rely on a P.O. computer being available whenever we wanted it)
- to provide a system for marketing demonstrations, which again would provide a back up to the P.O. system
- we also thought that the widespread use of viewdata in the office would also lead to use of the terminal for other functions such as message services. A viewdata system at our research centre could prove a useful experimental tool in 'office-of-the-future' studies.

3. HOW SHOULD THE PRIVATE SYSTEM BE IMPLEMENTED ?

The key choice in setting up a system was whether to use existing mainframe computers within the Company or whether to have a completely separate system on a minicomputer. As our expectation of the success or otherwise of viewdata was not clear we did not wish to invest a lot of money in setting up the systems. We wanted the cheapest possible solution which mirrored the facilities of the P.O. system as closely as possible. While there are technical problems in using a mainframe, the system specification and programming costs on that were much less than the cost of buying and programming a dedicated minicomputer. We also had the people with the appropriate programming skills available to the Company, and the technical ability to design and build any special interface hardware that might be required.

Looking further into the future, using our mainframes with an existing company database would make it easier to transform such data into viewdata format than if data had to be transferred across to a separate computer.

Hence, we decided on two mainframe systems, one on a Honeywell 6060 at our main manufacturing site and one on an IBM 370 at our research laboratories. (These have subsequently been replaced by a Honeywell 66/40 and Amdahl V7 respectively.) The next two sections describe how they have been implemented.

4. HONEYWELL VIEWDATA SYSTEM

The three main difficulties to be overcome in setting up this system were

- (a) the computer input/output ports normally operate at the same speed for both transmission and reception of data, whereas viewdata terminals transmit and receive data asymmetrically.
- (b) data transmitted to the computer is normally expected to have an 'end-of-data' character (Carriage Return) at the end of each line, whereas normal viewdata input allows for action on a single input digit.
- (c) users of the timesharing system have to identify themselves, which system and program they wish to use etc. This involves input of alphabetical characters as well as numeric, whereas the simple viewdata terminal has only a numeric keypad. Users also expect to be able to access the viewdata program automatically as with the P.O. system simply by dialling the

appropriate telephone number.

The solution to these problems was to provide a special interface box (Viewdata Interface Conversion Equipment, or 'VICE') between the front end processor (Datanet 66/32) on the mainframe and the access telephone line for viewdata. (See Figure 1)

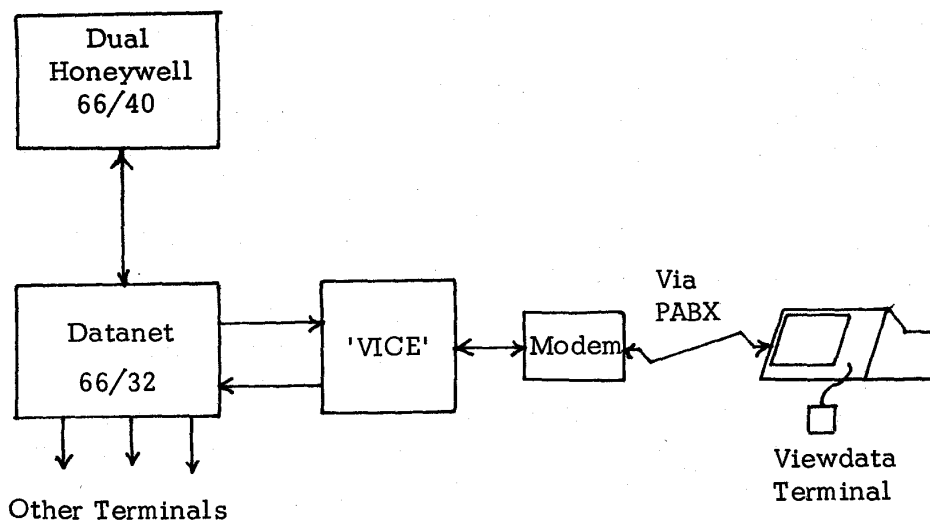

Fig. 1 STC Honeywell Viewdata System

This box performs the following functions

- (a) acts as a buffer for data input from standard viewdata terminals retransmitting it to the computer at 1200b/sec. together with the carriage return character.
- (b) echoes back the input characters to the terminal as they are entered. The effect is that the terminal appears to the computer to be a teletype terminal operating at 1200b/sec. but occupying two sub-channels on the Datanet, in order to give duplex operation, whereas the computer appears to be like the P.O. viewdata system as far as user terminals are concerned.

To achieve this mode of operation without having to change any operating software on the mainframe, a couple of concessions to depart from the P.O. system were allowed:-

- (a) every input from a user must be terminated by the '~~/~~' character to signal to the VICE box that the input is complete and should be transmitted on to the computer.
- (b) the output from the computer is transmitted as blocks of four lines at a time; the user can interrupt the computer at the end of each block rather than at any time during the transmission.

Neither of these limitations has been found to be a serious disadvantage. There are two viewdata application programs on the Honeywell machine, both of which are loaded only when required.

The main program is for information retrieval and operates as for the P.O. system with the exception mentioned above. Users have security classifications which permit them to access only those main branches of the database 'tree' for which they have authority. There is one master user who is allowed to enter (and delete) new user numbers and change data access authorities. It runs as a stand alone slave program under GCOS.

There is no on-line data entry facility in this program. Instead, there is a separate data entry and editing program which is run in batch mode. Data to be entered is keyed from specially designed punching forms.

For this system, Honeywell support staff designed and built the VICE box and programmed the system to our specification. (Assembler was used for the retrieval program and COBOL 64 for the database loader).

The system was installed by mid 1977 with one access line although the program was written to cater for up to 10 simultaneous users. It has not been extended yet as there were very few terminals available to use on the system until the beginning of this year. As anticipated, its main use has been for marketing purposes and was invaluable when one of our associate companies wished to give an extensive demonstration at the time when the P.O. were replacing their pilot trial computer by the market trial machine, and we could not use the P.O. database.

5. IBM VIEWDATA SYSTEM

The IBM based Viewdata system was initially set up more as an experimental tool. The difficulties of connecting a standard

viewdata terminal to an IBM mainframe are very similar to those encountered with the Honeywell system. In the same way, the solution was to provide a special interface box between the front end processor (initially IBM 3705 but currently ITT 3805) on the mainframe and the modem terminating the access telephone line. The interface box was designed and built at the research laboratory and experiments carried out to determine the functions which were necessary. Both duplex and half-duplex operation were tried and we reached the conclusion that half-duplex is satisfactory for information retrieval purposes and has the big advantage of only occupying one sub-channel on the 3705 for each accessing terminal. Additionally the interface box provides the function of speed conversion, so that data input from standard viewdata terminals at 75 baud is buffered and re-transmitted to the computer at 1200 baud. To the central computer the viewdata terminal then looks like an asynchronous teletype device operating at 1200 baud in either direction.

The interface differs from the Honeywell 'VICE' box in having a simpler design. The limitations imposed on the user are:-

- (a) the input commands are not displayed on the terminal since there is no echo back feature,
- (b) every input must be terminated by a ~~/~~ character to signal to the 3705 that the message is complete,
- (c) output from the computer cannot be interrupted; the user must wait until the complete frame is output.

These limitations, apparently quite restrictive, are found not to be such a problem in practice. The input commands are only ever a few characters and can be compared with dialling a telephone for which there is normally no display of digits entered. If a page number is mis-keyed it is immediately apparent from the number shown on the page which is displayed immediately. (Note, that we have found with keypads which are connected directly to a terminal, users rarely look at the screen. It is more of a problem with remote control keypads where there is a much higher probability of the set not responding to key depressions.) If the page number is not found or if the command is in any way invalid, the complete input message is returned with an appropriate error message.

The lack of an interrupt facility is similarly not a serious difficulty. With most frames there is a significant amount of blank space so the software compresses the data in order to reduce transmission time. In practice we found that a user would almost always be ready to interrupt only in the latter stages of transmission and that the lack of an interrupt facility was not a significant delay.

The software developed for this system is all mainframe based. There would be advantages in implementing some functions in the front end processor but this would have required changes to manufacturer's software with the resulting difficulties of maintenance and upgrade.

The software structure is shown in Figs. 2 and 3. The viewdata telecommunications task runs in a dedicated partition under VS1 and provides terminal control, data retrieval and response frame processing functions. The terminal control is done via channel program and not via a standard access method in order to allow more flexibility for experimentation.

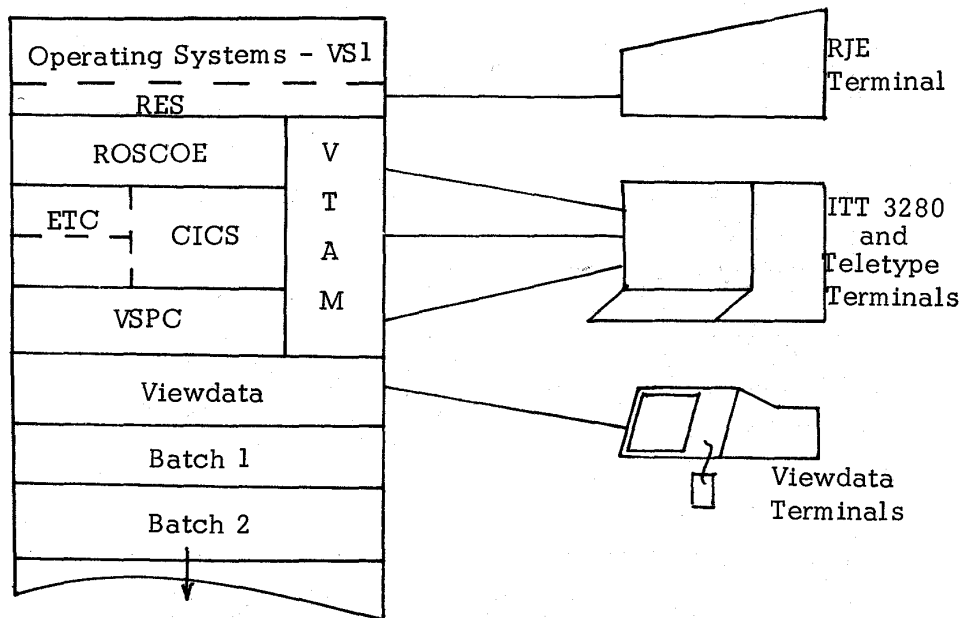

Fig. 2 STL IBM Viewdata System - Software Environment

The commands for information retrieval operate as for the P.O. system with the exceptions mentioned above. In addition the software caters for data held in 80 characters/row format as well as 40 characters. This has been used in conjunction with an experimental terminal developed in the laboratories and described in section 6 below.

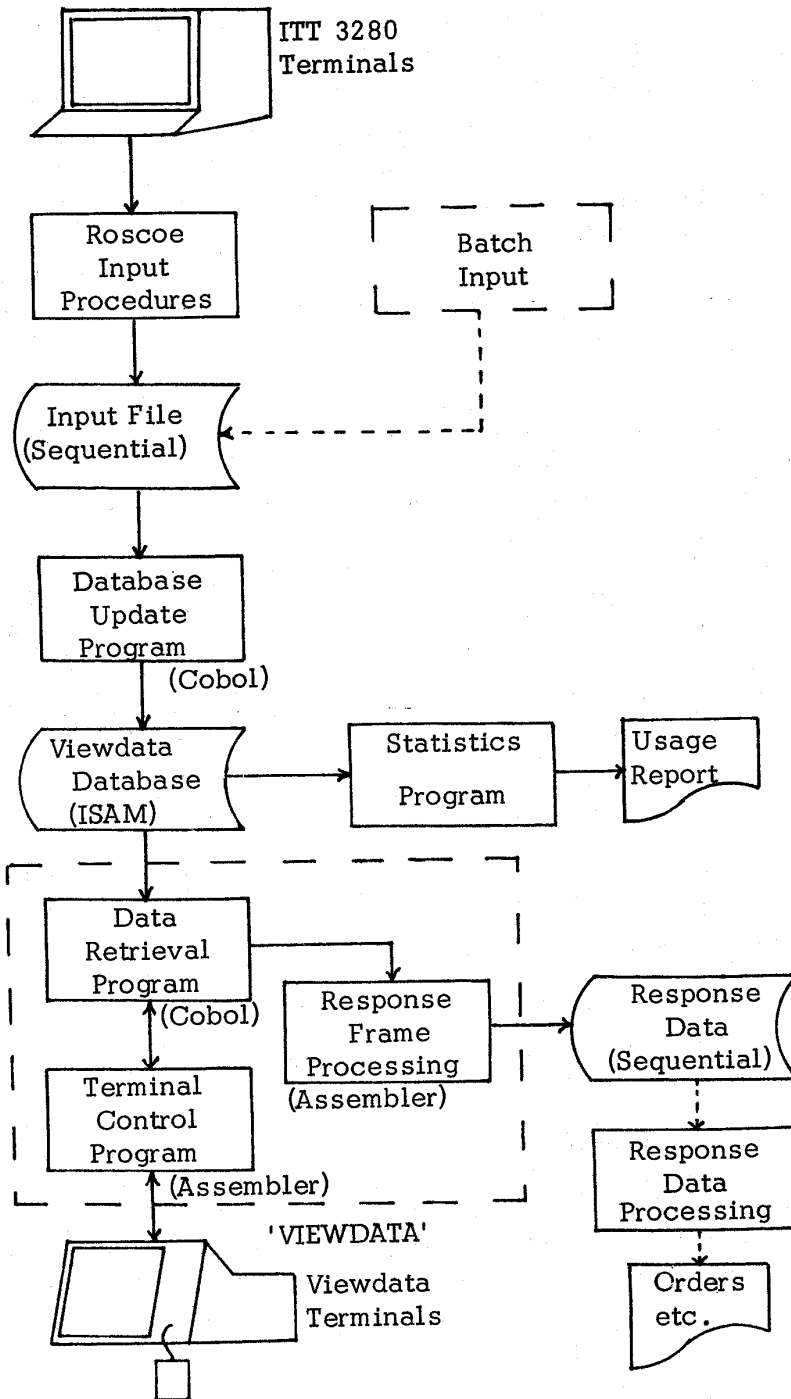

Fig. 3 STL IBM Viewdata System - Software Structure

Closed user groups are implemented and access can be controlled at the level of individual frames. An interesting feature is that, dependant on the access key, a user can be signed in to a main branch of the database 'tree' without having to go via the main index. This latter facility has been used where a multi-lingual database is required and allows a user to be directed to a section of the database in his native language.

The response frame facility allows a user to interact with information displayed on the screen. Up to ten response fields can be defined on the screen. Each response from the user is recorded on a file for subsequent batch processing.

Data is entered into the system on IBM 3270 compatible VDU's (actually ITT 3280) via a timesharing system. Both ROSCOE and TSO have been used. The ROSCOE data entry facility has been set up using formatted screens to provide a simplified environment enabling easy use by non-computer personnel. The Information Provider has available the functions to enter, amend, overwrite, copy or delete frames of information. At the end of the session he signs off and a computer job is then automatically submitted to update the main viewdata database. The update job is run in a 'hotshot' partition so that updates can be effected within a few minutes and simultaneous with information retrieval operations.

The IBM based viewdata system was developed at STL during 1977. The software will cater for up to 48 simultaneous users but the system has not been run with more than 3 terminals. It has been installed at a number of sites and used for demonstration purposes. The system runs with either VSI or MVS operating systems.

6. PRIVATE SYSTEMS AND TERMINAL DESIGN

In parallel with the programme of work on the IBM based viewdata system, an experimental model of an enhanced viewdata terminal was built. This followed the original work on our initial Prestel terminal, the Novatel*, which now exists as a fully engineered product. Extensive discussions were held with the various departments in the laboratories to define the applications to which a private system could be put and a major limitation was the restriction of having only 40 characters per row in a conventional viewdata system. To overcome this, the terminal incorporates an alternative 80 character/row display facility as a switchable option. This option can either be manually selected or else be triggered automatically by the database response.

* A trade mark of STC Ltd

In addition to the standard Prestel features the terminal also incorporates an upgraded modem to allow two-way communications at 1200 bauds, and in connection with this, an auto answer facility, linked to a cassette recorder.

This allows a direct terminal to terminal message facility, with automatic storage of received messages at the terminal rather than in the computer centre.

Probing in depth business viewdata requirements it is apparent that terminals to a straightforward Prestel specification can meet only a portion of the market requirements. The extent of enhancement must depend on cost effectiveness and operational efficiency; however, the general breadth and nature of information handling requirements point to a multifunction multi standard terminal which as a minimum allows alternative display formats commensurate with the 'data' to be displayed, together with a direct terminal-terminal communication capability. Multi-access to local in-house and public data bases is seen as an inevitable requirement, although as suggested in preceding sections of this paper these may reasonably be expected to conform to Prestel protocols. Recognising the extent and effectiveness of the telex service the interworking of such terminals with the telex network is also a likely requirement although alternative solutions exist. In up-stream products compatibility with word processing requirements is probable, and to a degree such facilities are almost certain to be included to support the message mode of operation.

7. CONCLUSIONS

When we first decided to implement these systems we were unsure about whether a demand for viewdata systems would emerge. In fact, we have found both systems to have been well worthwhile. As we have not had a large number of viewdata terminals available, there has been little point in actively trying to set up a genuine live information retrieval system but we are certain that this will be seriously considered now that terminals are starting to appear in our manager's offices. As yet, the dedicated minicomputer systems are quite expensive, and will require to have a large number of terminals to cost justify them in comparison with a conventional VDU system if the terminals are only to be used for that one purpose. The main-frame system is a much cheaper approach for small systems if you already have a computer with spare capacity, and is particularly suitable for pilot trials where the longer term use of the private viewdata system is uncertain.

IVS-3 as a Private Viewdata System

Alan R. Haines
Viewdata Division Manager

Systems Designers Limited
UK

Private Viewdata Systems are emerging as a strong growth market alongside public viewdata service.

This paper describes the opportunities that a Private Viewdata System creates for two-way communications with employees, agents, dealers and groups of people with a common information interest. Issues such as security and privacy, cost of ownership and operation, compatibility and interchange with public viewdata and the relationship with existing data processing systems are discussed.

The paper is illustrated throughout by examples from one of the most recently introduced private viewdata products, the IVS-3 Viewdata System.

IVS-3 is a Trademark of AREGON Limited

Copyright © 1980 by Online Conferences Ltd.

1. INTRODUCTION

Viewdata technology has now come out of the experimental stage, through pilot trials, market trials and, in the UK, is spreading to the regions to begin a full public service.

Viewdata terminal manufacture, slow to start at first, is moving into mass production and new ranges of high quality sets are becoming available. Although £900 is still a considerable price to pay for a viewdata TV in the home, it represents a bargain for the business user. He would be hard pressed to buy a simple visual display unit and rent a suitable 1200 baud modem during its lifetime at this price. Where else can he get upper and lower case text, seven colours, background colour, double height characters and mosaic graphics at anywhere near the price?

Of even greater importance, the medium is particularly easy to use; there is no understanding needed of computer terminals or modem operation. Pressing a button achieves the connection of a viewdata TV down an ordinary telephone line to the viewdata service. Information can be retrieved just as easily by pressing a single button corresponding to a menu choice on the screen.

All this opens up applications to whole new groups of people in business who would never have felt at ease with, or seen the value of using a computer database.

But why, if a public viewdata service has begun and viewdata terminals are available to rent or purchase, introduce the idea of a Private Viewdata System? The next section looks at the requirements for a Private Viewdata System.

2. THE REQUIREMENTS FOR A PRIVATE VIEWDATA SYSTEM

Typical commercial applications of viewdata require upwards of 15,000 frames to be economically justified. This represents about 10% of the entire information frame holding on a public service. Clearly, to dedicate such a high proportion of disk space and access ports to a set of data which is of interest to the employees or agents of a single company, is not a sensible use of a public resource.

Furthermore the rental of space for 15,000 frames on a public system is by no means cheap. On a three year contract basis including rental of a Closed User Group it could cost £51,000 per annum. An entire private viewdata resource with 16 ports for access and 50,000 frames can cost considerably less than this to own and operate per year. Section 9 gives more details on costs.

Business customers demand security and privacy. A public service can offer the protection of a Closed User Group where other users are excluded from accessing the data but, in the final analysis, many organisations will only consider holding private, confidential and commercially important information on a resource which they control.

Nevertheless the major reason for purchase of a Private Viewdata System still remains in the more advanced features it can offer to business and commercial markets. For example, the IVS-3 Viewdata System provides all the facilities of the public viewdata service; information retrieval, an on-line editor and a bulk update facility for accepting large numbers of frames formatted by the Langton Information Systems PREVIEW package.

But it goes much further.

IVS-3 provides the editing user with a set of facilities that increase his productivity in creating and updating frames; it provides for insertion and deletion of text, operation in a vertical as well as horizontal direction and block movements of text or graphics about the screen.

IVS-3 offers a facility for collecting orders, bookings or purchases from a viewdata terminal by means of fill-in-the-blanks forms. The orders are checked for accuracy and made available as a printed report or as a machine readable file for processing by existing computer equipment.

Every information provider can make his frames open access or protected. Within protected frames there are six security zones for increasingly sensitive data.

Every user on IVS-3 has his own Mailbox so that he can communicate with other users at remote or local sites.

Finally IVS-3 has a bulk unload facility so that frames prepared locally can be transmitted to the public viewdata service or to another private viewdata system.

3. THE IN-HOUSE BUSINESS VIEWDATA SYSTEM

The equipment required for an in-house system is a minicomputer; disk storage units to hold viewdata frames, a set of ports to communicate with viewdata terminals and a number of modems, one for each port to be dialled by a remote viewdata terminal. In addition there is a real-time software executive and viewdata application software.

The IVS-3 product uses the PDP-11/34 minicomputer for 4 to 16 ports and the PDP-11/44 or 11/70 minicomputer for 16 to 32 ports or more. 5000 to 1 million frames of information can be held on a single system depending on the disk storage unit used. The physical size of the equipment for small configurations is about the bulk of a filing cabinet with a console keyboard printer standing alongside.

These components together provide a business with a new information and communications medium. In its first application it is an electronic publishing medium. It can be used to keep staff informed on procedures, company benefits and regulations. It can be used to hold safety information and keep an historical record. It can be used for personnel information: job vacancies, job descriptions, grades, allowances and career development plans. It can be a self-teaching medium to learn a new procedure or method or diagnose a fault in a system. It can communicate product descriptions, prices, technical specification, availability and terms and conditions.

But Private Viewdata is not just an information dissemination medium, it is also an information gathering medium. We see examples in the next section.

4. COMMUNICATING WITH RETAIL OUTLETS

A Private Viewdata System is ideal for communicating with retail outlets. There are many examples of where it is being considered:-

- * Banks with branches
- * Building Societies with their High Street shops
- * Breweries with licensed premises
- * Mail-Order companies with their agents in the home
- * Car Manufacturers with their dealers for quotas and parts

The information retrieval side of viewdata carries the marketing and selling information about the product or service on offer. Orders or requests or management returns or market intelligence data can be transmitted back by simply filling in an entry on a form on the viewdata screen.

5. SELLING INFORMATION TO A COMMON INTEREST GROUP

Another application of a private viewdata system is for the information provider company that has data of value to sell over and over again to a known group of users.

Travel Agents
Estate Agents
Financial Information for the city
Legal Information for the legal
profession

The low cost of a viewdata terminal, coupled with its ease of use, graphic and colour capability create new business venture possibilities for companies with data to sell.

The IVS-3 Viewdata System gathers accounting information on user sessions that can be used to generate bills.

6. COMPATIBILITY AND INTERCHANGE WITH PUBLIC
VIEWDATA SERVICE

It is important that private viewdata systems conform to the standards of public viewdata services in three areas:-

1. Terminal Standard
2. Database Standard
3. File Interchange Standard for Bulk Updating

The Terminal Standard is particularly important to ensure that manufacturing reaches mass production volumes and the price benefits are available to both private and public markets. IVS-3 Viewdata supports both Mark I and II viewdata terminals so that the same terminal can access IVS-3 and switch over to the public service for a random enquiry. Ideally the terminal should contain two or more hardware identifiers to correspond with its stored telephone numbers for autodialling.

The Database Standard is also important so that design and structuring of frames can follow the same rules in public and private systems. IVS-3 Viewdata follows all the standards set by the UK public service for nine digit pages numbers, 26 frames to the page and ten choices which point to the first frame of a page.

The File Interchange Standard allows frames prepared on a private system to be transmitted to the public system. IVS-3 Viewdata supports this standard so that it can accept Bulk Update files created by the Langton Information Systems PREVIEW package or transmit bulk frames to a public system or indeed any other IVS-3 system.

7. RELATIONSHIP WITH EXISTING DATA
PROCESSING SYSTEMS

In many applications a private viewdata system will have little in common with existing data processing equipment. It may well be procured by that new breed of person, the Communications Manager, who has responsibility for Word Processing, Facsimile and Copiers, Voice and Data Communications. It will probably break new ground in bringing an information retrieval service to a group of people who have never had such a facility before.

But many organisations and Data Processing Managers will see a Private Viewdata System as a 'friendly face' to existing mainframe computers. It can be used to publish bulk reports normally held on computer listing paper. It can collect orders and bookings from remote viewdata terminals and pass them for processing to existing order-processing applications on the mainframe. Clearly it is only a small step to creating an interactive link between a private viewdata system and mainframe where a customer in a bank or at home can interrogate his account balance held on a mainframe and receive the answer back at his viewdata terminal.

8. CONTROLLING A PRIVATE VIEWDATA SYSTEM

There are four categories of people involved with a Private Viewdata System:-

1. Users at Viewdata terminals
2. Editing users at an editing terminal
3. System Manager at a viewdata terminal
4. Operator at central console of the minicomputer

The previous sections have described the features and facilities available to the first two categories, the users and the editors. But no viewdata system is complete unless it is well controlled and that is the job of the System Manager and the Operator.

In the IVS-3 product, the Operator has little to do except turn the minicomputer on at the beginning of a period of service and turn it off at the end. He is also responsible for archiving the database.

The primary responsibility of the System Manager is to register new Information Providers, allocate them a page range on the database, set an upper limit to the number of frames they can create within the page range and agree the Name or Title that appears on the left hand side of the top line of each frame. In the IVS-3 product the System Manager, has the opportunity of keeping centralised control or delegating some of his privileges. He can delegate the privilege of registering new users and editors, with permissions to access particular sets of protected information. This works in a hierarchical way so that no-one can give away more privilege or permission than he himself possesses.

The System Manager is also responsible for the level of service that the viewdata system offers. The IVS-3 product helps him by recording on a statistical file how busy the ports are throughout the day, the session beginning time and duration of each viewdata call along with user identity and number of accesses to the database, a series of performance measures including response times throughout the day and the activity on particular parts of the database.

The System Manager has available to him with IVS-3 an Accounting Package that summaries user sessions over any desired period and a Statistics and Performance Package that creates viewdata frames or printer output giving port loading, response times, transaction rates and database activity over any period of analysis.

9. COSTS OF OWNERSHIP AND OPERATION

To give some examples of cost for a private viewdata system, a specific configuration has been chosen, a 16 port system. A 16 port viewdata system can support 16 or more viewdata terminals depending on the way users call the system; if they remain connected all day than it will only support 16 terminals; if they make three five minute calls each hour (i.e. 15 minutes session time each hour) then it will support around 64 terminals. Options for both 15,000 frames and 50,000 frames are considered.

A typical annual budget for owning and operating an IVS-3 16 port system is shown in Table 1. For 50,000 frames the total annual cost is about £45,000; 50% of this goes on hardware; its maintenance, modems, telephone lines, floor space and environment; a further 30% goes on labour cost to manage the viewdata centre; the final 20% is for IVS-3 software. This gives an annual cost per frame of 90p.

For comparison, Table 2, shows the cost of obtaining this resource from the public viewdata service; at the 15,000 frame level the private system is about half the cost; at the 50,000 frame level it is a quarter of the cost of the public service.

Note that two sets of costs have to be added to those in Tables 1 and 2.

- a) Viewdata terminal purchase or rental along with telephone charges to access the viewdata centre.
- b) Editing costs

ANNUAL BUDGET FOR IVS-3 16 PORT SYSTEM

	15,000 frames	50,000 frames
1. Minicomputer Hardware (Capital cost written off over 3 years).	9,300	13,000
2. Maintenance of hardware (10% per year)	2,800	3,900
3. 16 x Modems (at £120 each per year)	1,920	1,920
4. 16 x Telephone lines (at £50 each per year)	800	800
5. Floor space + Environment (100 sq. ft at £15 per sq ft)	1,500	1,500
6. System Manager + Operator (a total of 1 man year) including overheads	15,000	15,000
7. IVS-3 Software (Lease of £28,000 over 3 years)	9,300	9,300
	<hr/>	<hr/>
TOTAL	£40,620	£45,420
	<hr/>	<hr/>
Cost per frame	£2.70	90p

TABLE 1

ANNUAL BUDGET FOR ACCESSING PUBLIC SERVICE

	15,000 frames	50,000 frames
1. Rental of frames (£3 per frame on 3 year contract)	£45,000	£150,000
2. Registration of Information Provider (based on 3-year contract)	£3,000	£3,000
3. Rental of single Closed User Group (based on 3-year contract)	£3,000	£3,000
4. Connect Time Charges (Based on 16 ports occupied 4 hours per day for 200 days at 3p per minute)	£23,040	£23,040
5. Business User Charge (Based on 32 terminals at £12 per quarter)	1,536	1,536
	<hr/>	<hr/>
TOTAL	£75,576	£180,576
	<hr/>	<hr/>
Cost per frame	£5	£3.60

TABLE 2

10. THE FUTURE OF PRIVATE VIEWDATA SYSTEMS

Even as private organisations install their first viewdata systems, the future directions are being established.

There is a demand for viewdata systems to grow in a compatible way to support 100, 200, 300 and 400 ports of terminal connection with the service provided on ultra-reliable and failsafe equipment.

Viewdata terminals are by today's standards relatively dumb. There is an opportunity for terminal manufacturers to add intelligence for many viewdata functions e.g. in support of data collection, mailbox and editing.

Private viewdata systems cry out for connection to packet switched networks. Already in the USA, Systems Designers Limited have installed a viewdata system connected to the Telenet X25 packet switch network so that a viewdata terminal can be connected from any major city in the United States for the cost of a local telephone call and a low, distance independent packet charge (50 cents for a 1000 packets.) This same technology of network is currently being installed by the British Post Office in the UK as PSS.

Industry specific viewdata systems are under development as front ends to existing databases, examples include the Financial, Airline Reservation and Travel markets.

Private systems need to come closer to public service viewdata. Already the scene is being set in West Germany where Systems Designers Limited, with AREGON are developing X25 packet switch links for the Deutsche Bundespost which will allow a viewdata terminal accessing Bildschirmtext to pass through a Gateway and access information on a private database.

PRESTEL, THE PRIVATE SYSTEM OR BOTH?

Speaker: M.G. Smith,
Marketing Director,
Intext.

I don't suppose the inventor of the motorcar realised the huge diversity of vehicles which would result from his invention. With viewdata the same diversification is already apparent, although the first public viewdata service, Prestel, marketed by the British Post Office has only recently opened.

Already three private viewdata systems are in the market place offering different facilities in a number of key areas. Already the whole question of which particular system will fit a particular need is becoming more complex.

The essential criteria for each organisation are, however, the same. Which systems fits its' needs best, provides the most effective solution to its problem and minimises its' costs? The main areas which need to be investigated can be summarised as facilities, computer system or frame costs, editing and updating facilities, communications media and the type of receivers required.

The most important area of facilities concerns the tools to enable the database to be structured. Prestel and the GEC system allow more flexibility on the routing frames, but less flexibility than the Philips' system in the design of information frames. All systems currently allow response frames and telesoftware to be handled. The private systems allow a greater degree of control over user access. While both private and public systems allow a similar type of billing, there are obviously advantages in terms of flexibility in development from having your own private system. System and frame costs need to be evaluated. For a private system one needs to consider the total system costs, e.g. processors, ports, disk capacity, any special software requirements and the peripherals as well as the ongoing costs of the staff to support the computer. In the case of a public service, such as Prestel, the costing is simpler, in essence the cost of renting frames from the supplier and any special facility charges such as that for Closed User Groups.

Copyright © 1980 by Online Conferences Ltd.

It has been estimated that on cost grounds, it is probably worthwhile considering a private system if there is a requirement for more than 40,000 frames, but there are other factors which could be more important. For example, a special need for extra security or other special software features on the system the client requires.

A third consideration is that of editing. The Post Office currently supply on-line editing equipment and are developing access arrangements for bulk updating of the information from either an 'intelligent' terminal or direct from the customers computer. Both private systems support enhanced form of on-line editing with text editing capabilities and, no doubt, shortly bulk update procedures will be developed to enable intelligent editing terminals to be connected.

An important element of the cost equation is the editing cost. It is not uncommon that the key cost item for a customer who is considering using a public service is running the editing operation. Editing costs include both the cost of the people involved, the cost of the equipment and most importantly, the cost of the time spent on the telephone network and for access to the computer ports.

The costs for access by users to the computer can also be important. On a public service the objective is that user access costs should predominantly be at local call rates, although in the immediate future this will not be possible in all cases. The Post Office intend to cover the main parts of the country by March 1982. Therefore, in the short term a number of users of a Prestel information service may need to dial over trunk routes. Looking at a private system, there are a number of cost reduction techniques which could be considered. Can the system work totally using the company's own internal communications network, thus reducing the cost of access to the marginal cost of utilisation of that network? Can access be made by leased circuit to reduce costs? Looking at the more distant future, can affective use be made of packet switching techniques (a key feature of these being their distance independent tariffs)?

The client needs to consider the type of receivers he is going to place with the users of his information service. Perhaps the first thing to consider is where the receivers are to be located and the type of operation he envisages. Are they to be used on desks or is the receiver envisaged as a common facility in a large office accessed by a number of different people? The receivers can show information in either colour or black and white. Relatively, the cost saving of a black and white system is fairly small. If the receiver is to be sited on a desk, obviously screen size will

be important. Will either Teletext or broadcast TV be required? In some cases, it may not be desirable that access to these services is available as it may detract from the main purpose of placing the receiver in a particular location.

Peripherals can also be attached to receivers and in some cases, it may be very important that hard-copy is available from the receiver.

These briefly are the main areas for consideration when building up a picture of the right type of system for an individual application. From experience, there are three main approaches to date:

- (1) to use Prestel first as a sub-IP, then later as a full-IP.
- (2) to use a private system probably after use of Prestel or a Bureau.
- (3) to use both systems with bulk transfer to Prestel.

- The last approach could be a particularly significant development.

Having built up a picture of the required task and the best type of system to suit that task, one needs to test that it is, in fact, doing the job which was originally intended. The effectiveness of a viewdata system can be measured against a number of different criteria. Viewdata can be used as a means of increasing the sales of a company, as a promotional tool, to improve communications, to reduce costs and lastly and perhaps most excitingly, can be used to create a whole new business opportunity for a company. Each case must be analysed individually and from experience to-date, the answers are not always as apparent as seemed at first. In future we can expect more public services to be developed and more private systems to be announced. The increase of choice while bringing with it the need for more complex evaluation of the best solution to each problem, also brings with it the opportunities for better solutions.

With the invention of the car, a wide range of purpose designed vehicles resulted from the first motorized carriage. Similarly, in future developments of the viewdata concept can be expected to offer far greater appeal than the initial designs we now use.

BRITAINS TELETEXT SERVICES ARE A COMMERCIAL SUCCESS

BY: Gwyn Morgan
Manager, Engineering Promotions,
British Broadcasting Corporation

A few months ago, on Christmas Day, around 100,000 viewers were able to read, if they chose to, the subtitles that were broadcast with the traditional message from Her Majesty the Queen to the Commonwealth, and they had much more to read and enjoy as well. There were special Christmas season puzzles and quizzes, there was a Bingo competition, there was a serial thriller that ran for 10 days over the Christmas period and chronicled the adventures of Motley Purvis and his quest for the missing dragon's teeth necklace. And of course, throughout the Christmas period, as at any other time of the year, CEEFAX continued to provide its up-to-the-minute service of news, sport, finance, weather, farming advice and much much more.

Teletext in Britain is now on the rising slope of that "S" shaped sales curve that most products follow. In the first four years of the life of CEEFAX, up to August 1978, some 4,500 teletext sets were sold. Less than 18 months later (Christmas 1979) the figure had risen to more than 40,000 receivers in Britain. Sales during 1980 will easily reach 150,000 sets and the Henley Centre for

Copyright © 1980 by Online Conferences Ltd.

forecasting has predicted 8,000,000 receivers by 1985. There are now four companies in Britain who make teletext decoder chips and modules and their prices, when reflected in High Street sales, are no longer any barrier to sales. Most people in Britain rent their television sets and the extra rental cost of a teletext receiver is less than the price of one packet of cigarettes a week.

1.1 BEGINNINGS

The BBC first announced its ideas for CEEFAX in 1972 after a number of feasibility studies. Within months of that announcement the BBC, ITV and the British television receiver industry formed the group that devised the original specification for teletext that we published in May 1974. Some minor changes were made to that specification and published some two years later¹ but the key parameters in the design of teletext that came out of the intensive experimental work during 1973 and the early part of 1974, still apply to the teletext system that is broadcast in Britain today and most of those original parameters will remain valid for many years to come. In particular the synchronous transmission technique adopted for teletext has been crucial to its early development and will remain important in future adaptations of the system.

The British television industry has now gained considerable experience in integrating digital circuitry into largely analogue receivers. All levels of the industry from the broadcaster through to the aerial installer and the man who maintains domestic receivers have had to learn about digital broadcasting.

1.2 THE CEEFAX SERVICE NOW

From its early beginnings in 1974, when editor Colin McIntyre was

the first and only teletext journalist, the service has built up to the point where there are now some 21 journalists in the BBC CEEFAX unit. They keep the service up-to-date for at least 18 hours of every day throughout the year. The first editor arrives at 6 a.m. and the last man leaves at midnight or later. For most of the year, up-to-date CEEFAX is available before the majority of Britons have risen from their beds. Certainly, a businessman can check how the major Far Eastern markets fared in trading during the British nighttime and up to about 10 or 11 p.m. the same businessman can follow the movements of Wall Street until it closes.

Horse racing enthusiasts can read tips in the morning and the results of every Jockey Club meeting in the afternoon. On an August Bank Holiday in Britain there may be as many as 17 different race meetings providing some 100 individual race results. Even on a busy day like that CEEFAX will publish many of those results within two minutes of the end of each race, giving the first, second and third horses as well as the odds and any other special comments. Conventional broadcasting on radio and television would lose its audience very quickly if it tried to read out the results of 100 horse races in succession.

News is an obvious contender for space in CEEFAX simply because it can broadcast it so very quickly. CEEFAX is fortunate in that it is part of the complete BBC news-gathering organisation, with newsrooms throughout Britain and correspondents in many parts of the world. For CEEFAX, the news does not have to wait for the half-hourly bulletins on radio or the much scarcer television bulletins; instead it can be on the air within two minutes of the story breaking in London. A viewer in Yorkshire, some 250 miles away from the BBC newsroom in London, once saw a

police chase end in a car crash outside his television rental shop. He saw the news of that chase break as a CEEFAX news flash only 4½ minutes after the sounds of the crash had died away.

Though the primary services on CEEFAX have a clear mass audience, it does not have to be the kind of broadcasting that serves only mass needs. CEEFAX can be more specialised than other forms of broadcasting for more of the time. There are always at least six pages of statistics, prices and disease warnings for farmers. At busy times of the year there are often as many as 10 pages of crop-disease warnings alone, to tell farmers what to look out for and how to cope with it.

Equally, in the finance world, CEEFAX picks out any shares which move unexpectedly or move by more than a penny or so. Viewers who have teletext sets can see the change in one of their own shares in the morning, follow it hour by hour during the day and, if they are sufficiently worried by 2 o'clock, can ask their stockbroker to do something about it.

But CEEFAX today is not all about serious things. It has many fun and feature pages. In general the BBC1 CEEFAX magazine is used to carry all the up-to-the-minute material while the magazine on BBC2 is used for background and feature material. It has jokes and puzzles, advice and consumer affairs, book reviews, record reviews, theatre reviews, a 'What's On' section and much more.

2.0 SUBTITLING

When the service that has now become CEEFAX was first developed at the BBC Designs Department, it was thought of, in fact, as

two services. "Teledata" for the ordinary pages that we take for granted now, and "Teletitles" for optional subtitling for the deaf. It soon became obvious that these services could be offered within the same CEEFAX transmission. Optional subtitling or "closed caption" is now a regular, and growing part of the CEEFAX operation.

Already CEEFAX has broadcast two kinds of subtitles. In September 1979 it broadcast subtitles for 'Quietly in Switzerland', a programme in the 'World About Us' series on BBC. The subtitling service was billed in the Radio Times and much written about in the Press. The subtitles for 'Quietly in Switzerland' were carefully edited, much in the fashion of foreign film subtitles, a technique we call "Edited Full Subtitling". Another television programme for which CEEFAX broadcast full subtitles was the Queen's Christmas message to the Commonwealth on the 25th December 1979. This was the first time ever that deaf people would have been able to read the Queen's Christmas message as it was broadcast.

Following on from Quietly in Switzerland, CEEFAX broadcast subtitles for a popular quiz show called "Blankety Blank". Blankety Blank is a fast-moving, unscripted quiz game in which much of the entertainment value lies in the fast repartee between the presenter and the stars that appear on the show. It is very unlikely that full subtitles could ever be broadcast for Blankety Blank. There would be many occasions when presenter, Terry Wogan, might appear on the screen but the hearing audience would be laughing at some comment made by perhaps one of the female stars on the show, off camera. For someone who can hear the voices, there is no confusion but for someone left only with the subtitles there could be enormous confusion.

At the same time, Blankety Blank is a particularly frustrating programme for the deaf because they can read part of it already. Answers to questions in the programme are written on cards and held up before the camera. The problem is that though the deaf can see the answers to the questions, they do not know what the questions were. So for Blankety Blank, CEEFAX broadcast only the questions, the answers and the names and other details of the contestants.

The kind of subtitles broadcast for Blankety Blank have been called 'summary' subtitles or 'precis' subtitles and though they take less time to prepare than full subtitles, they still require some five hours of preparation time for a single half hour transmission, a ratio of 10:1.

2.1 EDITORIAL COST

The real problem with subtitling is the cost of preparation. Teletext makes it possible to broadcast subtitles for the deaf for all television programmes all the time. It even makes it possible to broadcast subtitles in several languages at the same time. Technically, the problems of broadcasting subtitles have already been solved. The financial problems remain but the BBC is adding a third method of subtitle preparation to the two it has already used and this might provide a solution.

The three preparation techniques that the BBC is currently involved with are summarised below:-

A. EDITED FULL SUBTITLES

The first technique has been pioneered by Bill Northwood, the BBC's expert on subtitling for the deaf. His technique is editorially the most sophisticated form of subtitling. To prepare these

subtitles an editor first has to obtain a script for the finished programme and very often this has to be specially typed. Next he has to spend many hours inspecting the film or video tape and painstakingly editing the written version of the dialogue and relating it to the pictures. He must decide in precisely which frame the subtitles appear and disappear and the position of each subtitle on the screen. Finally, the editor has to transfer the text of the subtitles and the frame numbers onto a floppy disc with the help of a mini-computer. When the programme is broadcast and, as the film or video tape runs, the frame number counter or video tape time-code triggers the start and finish of each subtitle. The text stored on the floppy disc is read out by another mini-computer and passed on to the CEEFAX computer system which inserts the subtitle into the transmission.

This method can take up to 30 hours to prepare the subtitles for a single one-hour television programme. It produces subtitles that are easy to understand and can be read quickly enough to leave time to watch the action on the screen, but the inevitable expense of preparing subtitles this way limits the extent of the service that can be provided.

B. PRECIS OR SUMMARY SUBTITLES

For this the operator examines the television programme and prepares summary descriptions of the action in each scene or writes down the key facts such as quiz questions and answers. Each summary subtitle is written into a part of the CEEFAX computer store and finally cued manually when the television programme is broadcast by referring to a stop watch. CEEFAX journalist Carol Robertson has used this technique for a series of plays and for a series of quiz shows. Though it provides considerably less information for the deaf than other forms of subtitle preparation it can nevertheless help their

enjoyment of the programme enormously. But even though this method takes less time than edited full subtitling, it still takes some 10 hours to prepare the summary subtitle for a single one-hour programme.

C. PALANTYPE SUBTITLING

Palantype subtitling can provide 'instant' subtitles. This is a method being developed at the moment jointly by the BBC and Leicester Polytechnic. It uses the Palantype mechanical-shorthand keyboard of the kind normally used for court reporting. A Palantype operator can follow speech at up to 200 words per minute. Bill Hawkins of the BBC Designs Department and Lyndon Thomas of Leicester Polytechnic, have developed a way in which signals from a Palantype keyboard are passed to a transcription computer which can turn the shorthand codes into full English. Lyndon Thomas has developed a computer program which uses a dictionary of around 80,000 words and which can translate the shorthand codes into full written English with an accuracy, on average, of more than 95 per cent.

However, like other systems of subtitling Palantype subtitling has its own idiosyncrasies. It may be that having every word of the dialogue written on the screen may not leave enough time for the viewer to enjoy the programme. And Palantype subtitling is inevitably delayed by about five seconds behind the dialogue because the operator must hear the dialogue before typing the shorthand codes and the computer must store at least one line of subtitles before the text can be broadcast.

However, Palantype subtitling could offer a way of providing nearly one hour of subtitling output for every one hour of operator time and it could be a way of subtitling live television programmes. It has its disadvantages but they may well be

outweighed by the benefit it offers the deaf and hard-of-hearing.

2.2 TECHNICAL REQUIREMENTS FOR SUBTITLED TRANSMISSIONS

CEEFAX can broadcast subtitles with no delay at all. They can be broadcast with one frame accuracy. Most subtitles have only one or two lines and can be accommodated in a single field-blanking period. The occasional three-line subtitles are broadcast at the moment with two subtitles in one frame period and the third in the succeeding one.

It is statistically likely that subtitles have to be broadcast during the transmission of a conventional page. The CEEFAX computer system will do this by inserting a new header row in the transmission, automatically setting the subtitle control bit as it does so. Once the new header for a subtitle page has been sent, the subtitle text follows on subsequent data lines. The computer then broadcasts a new header for the page that was interrupted and the remainder of the interrupted page is transmitted.

At the moment the CEEFAX computer system is arranged to accept two sources of subtitling input. Full subtitles are broadcast too rapidly in succession to be left to a manual control and so the data and frame numbers for full subtitling are broadcast from a floppy disc under the control of a mini-computer.

The equipment accepts frame numbers for a telecine or time-code from a video tape machine and uses these to trigger the output of subtitles. The subtitles can not only be broadcast instantly but can be removed from the viewer's screen equally quickly so that the time that the subtitle remains on the viewer's screen is under the full control of the subtitle editor.

The technical arrangements for summary subtitling are different. Here the subtitles are entered into a part of the CEEFAX computer store that is set aside for the purpose. For transmission the subtitles are cued manually. As each subtitle is cued a preview monitor allows the operator to see the current subtitle and the next one. In general the next subtitle will be a blank but there are occasions when one subtitle will lead straight into another. Many television programmes have no final script and rather than do the cuing by following the dialogue, summary subtitles can be cued perfectly well by stop watch.

3.0 CEEFAX COMPUTER SYSTEM

When CEEFAX was under trial in 1973 and 1974 and for the first few months of the CEEFAX editorial service during 1974 and the early part of 1975, the service was limited to 32 pages stored in a core store transmission unit which was independent of the visual display units (VDU's) and had to be fed by paper tape carried from the editorial office to the transmission unit about 100 feet away. In 1975 CEEFAX took delivery of its first proper computer-controlled transmission unit based on an alpha LSI2 mini-computer and a single disc store. The simple system was adapted and developed during the early years of CEEFAX and it ran the service with up to 6 VDU's until June 1979. In 1979 BBC engineers completed the installation of a new computer system whose design has benefited from four years of editorial and engineering experience in broadcasting teletext.

The new computer system is operated by three PDP11/34 mini-computers, each with its own disc storage (Figure 1). The first computer (known as system A), handles input from up to 14 VDU's and provides library storage for ten thousand pages.

It has two 14-megabyte disc-stores that are fed with identical inputs so that if one of the disc fails or suffers a head-crash, the operation continues and no data is lost.

System A passes its information on to each of two identical output systems (system B and system C), each with one PDP11/34 computer and two 5-megabyte disc stores. One of the two output systems is in operation at any moment but if it fails for any reason, the output system takes over immediately. Each output system needs two disc stores because Teletext calls for fast data extraction. The data transmission rate within a data line is nearly 7 megabits /second and if the system is to be able to access pages quickly enough to feed up to 8 data lines in every 625-line picture on two independent television channels it needs two disc stores.

The data rate is also high in relation to mini-computer operating speeds and this is the reason for the independent input computer system. This allows the input system to provide the editors with quite sophisticated facilities.

Of the 10,000 pages that can be stored in the input system, 5,000 of them are devoted to a fully-indexed library. An editor who feels that a particular page is worth storing can give that page one or several titles and ask the computer to place the page on file and insert the name or names of the page into the correct alphabetical position in the index. To find a page an editor can scan the index to look for its name or number and can call it onto his screen either by entering the number or the name.

The system also allows editors to prepare magazines of pages in advance and it allows virtually every page in a magazine to have as many as a 99 sub-pages or rolling pages. The sub-pages can be

prepared as complete groups and inserted into the output as a group. The system also allows the editor to check the way that pages roll over before he inserts the group and to set the time that each page should remain on the screen before being overwritten by the next in the group.

The input and output systems also have the capacity for time-coded pages. Minute-by-minute slots are available so that one day CEEFAX could increase its output enormously by simply taking a particular page number and broadcasting different information in specified one-minute time-slots during the day. The only application that is being used for this at the moment is the "Alarm-Clock" page which allows the viewer to remind himself of an important time by presetting his decoder to interrupt the ordinary television picture at any particular time during television broadcasting hours.

The computer system also allows the editors to assign different magazines to the output in various combinations and it allows them to preset their commands for action at some future time. This could mean a complete change of magazine at midnight or it could be automatic removal of individual pages during the day. For example, television programme listings are prepared as sets of sub-pages in advance and broadcast from the start of CEEFAX in the early morning. As the day progresses and some parts of the day's programmes have passed, individual sub-pages are removed automatically and the remaining sub-pages are re-numbered as 1 of 4, then 1 of 3, then 1 of 2, automatically.

The system also accepts telex messages sent to CEEFAX and allows editors to call them up on a VDU, colour them, check them and put them on the air with the minimum effort consistent with the need for editorial control.

One VDU is linked to a black and white television camera, and allows ordinary pictures to be converted to CEEFAX-style graphics at the flick of a switch. It also has a light-pen that allows the editors to amend the graphics, simply by writing on the screen. Each output system has a separate, BBC designed, MSF clock receiver. To make the best use of the accuracy available, extra header rows are broadcast, to ensure that the time shown on CEEFAX receivers is accurate to one fiftieth of a second.

4.0 TELETEXT FOR THE FUTURE

But if teletext is getting a successful launch in Britain and if the technology has already been mastered, to what extent will today's teletext system restrict future freedoms in this kind of broadcasting. I believe the answer to that question is simply 'none'. Chambers has already shown how the existing teletext specification can be amended to allow for a whole list of enhancements. His list includes:-

- *Extended latin alphabet as well as simultaneous transmission of other alphabets;
- *Improved graphics extending right through to a full grey scale full definition image of better quality than the existing television picture service;
- *Underlining text;
- *Telesoftware;
- *Labelling of television and radio programmes with an option for pre-programmed control of radio, television and hi-fi equipment. He has also introduced a concept of 'linked pages' which enable a multi-page teletext decoder to acquire several related pages and have them ready for instant viewing when the viewer decides to select them.

All these enhancements can be broadcast in a compatible fashion so that a decoder to the enhanced standard will receive the existing

CEEFAX output normally, while a transmission on the enhanced standard can be received correctly on existing teletext decoders provided no new feature is included in the page. New features would simply be omitted on a decoder of the existing standard and appear as a space.

From the point of view of the broadcaster there is no reason why these developments could not be incorporated immediately because for him the costs will be small but any developments from the basic UK teletext standard will cost more to the viewer and a crucial factor in getting any new broadcasting service taken up rapidly by a mass audience is that the initial costs must be as small as possible. The British teletext system achieves this criterion with great ingenuity and success. Even now there are many new services that could be incorporated into existing teletext transmissions without in any way changing the operating standard.

For example UK teletext can specify more than 2½ million different page addresses and there is no reason why these could not be used for a "mass teletext" service in which chain stores and other organisations with numerous outlets throughout a country could send messages in code from headquarters and area offices to all of their branches at *the same instant*. This kind of mass telex has never before been possible. Mini-computers are becoming far more widespread and it is now quite fashionable to own your own small data bank if you are a solicitor or a travel agent. The existing teletext transmission format could be used to broadcast data to terminals throughout the country, to update timetables, for legal information and much more and it would do so far more efficiently than any other technique.

Another development of teletext that is already well under way in this country is telesoftware, where the teletext page becomes a computer programme. A teletext decoder fitted additionally with a

microprocessor can then become an interactive unit; the user and his 'intelligent' television set can play games, or he can be educated by programmed-learning, or make income tax calculations, or do any other kind of operation that might be handled by a small computer. The big advantage here is that the cost of this small computer is little more than the cost of a teletext decoder which is made in huge quantities for a mass audience and uses a mass-produced commercial television set for the display.

4.1 THE MARKETING STRATEGY

Since UK teletext is well established and is able to provide a new kind of broadcasting at an attractive cost, other countries looking into teletext broadcasting would do well to consider adopting the UK format. The most important thing in a teletext service is not the technology but the "software", in other words, the application that the service is put to, and this needs enormous experience and practice by journalists and broadcasters who have to get used to writing on the television screen. They also have to identify new sources of information and rethink old ones to make best use of the speed with which teletext can operate.

The whole information network in a country needs to be rejigged to make best use of teletext and it can take years for organisations to adapt to the new freedoms that teletext provides. It makes good sense to get into teletext as soon as possible and get the information providers, the broadcasters and the audience, used to this kind of service. When they know what it is all about they will be far better placed to demand the standards for future systems. It also makes good sense to introduce this new kind of broadcasting in a form that initially costs as little as possible to the user. The costs of UK teletext are known, the costs of other systems will certainly be greater but by how much can only be guessed.

In five to ten years from now the costs of storage will again have fallen considerably. It makes sense to build any new standard around the use of a full picture-quality store in every television receiver (i.e. a memory of at least 3 megabits) The display format for that system could be universal, even if it was necessary to devise different transmission formats for different continents and different carrier systems. It makes no sense at this stage to develop a multiplicity of standards each offering something slightly different. What is needed is not a hesitant hop but a planned leap to a very advanced format that will take full advantage of future cost projection - much as Chambers has already proposed.

ACKNOWLEDGEMENT

The author is grateful to the Director of Engineering of the BBC for his permission to publish this paper and for the work of his colleagues and friends in the BBC, the IBA, the British Television Receiver Industry and UK Semi-Conductor Companies for giving him plenty to write about.

¹ Broadcast Teletext Specification, September 1976.
Published jointly by the BBC, the IBA and BREMA.

Fig 1
New Ceefax Computer System

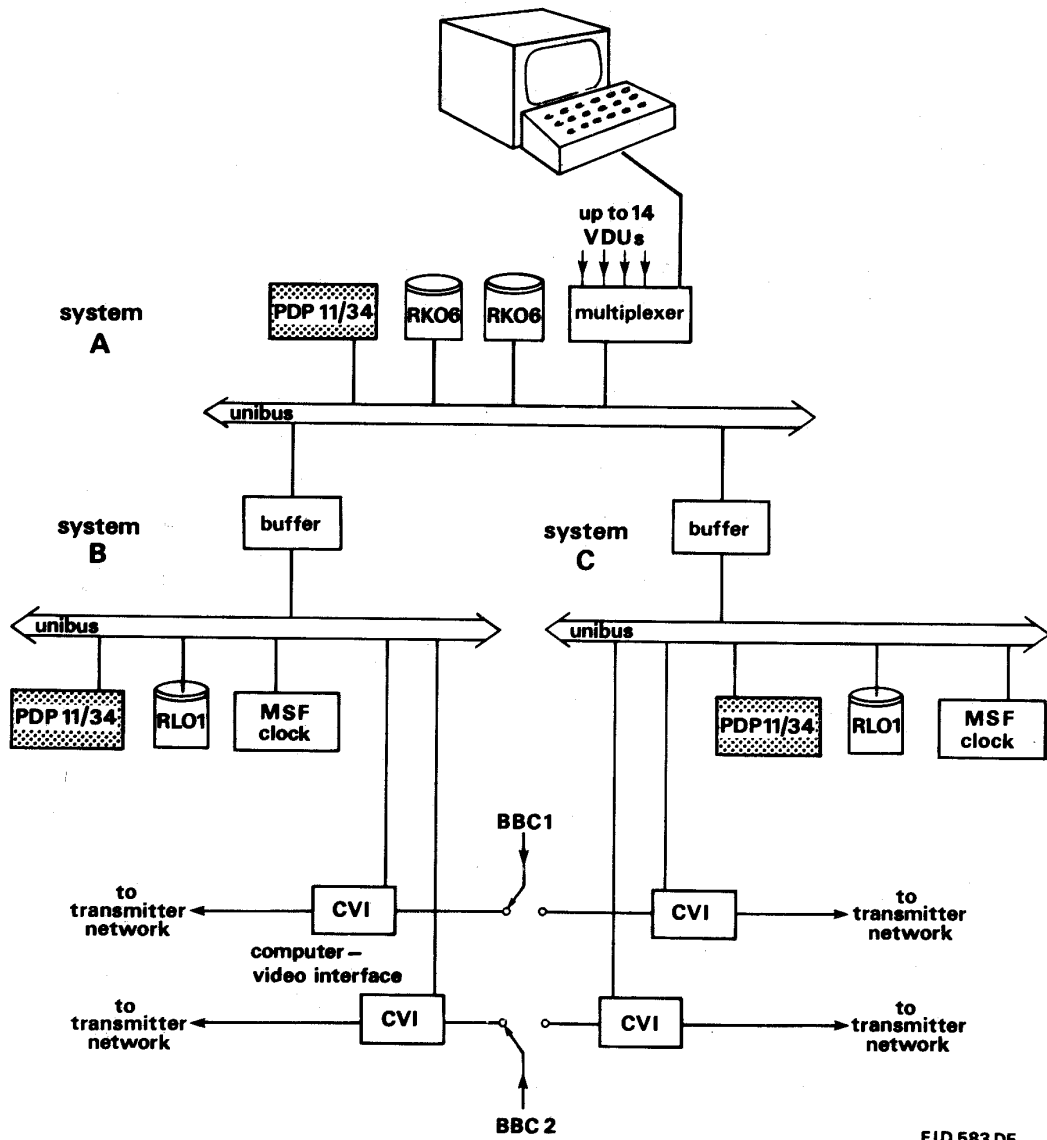

EID 583 DF

Broadcast Text Information in France

B. MARTI

Head of Department

"Audiovisual Terminal and Systems"

The broadcast ANTIOPE system, and the DIDON data transmission are described and the historical reasons of such a choice are given. The service aspects, dealt with in detail in another session, are mentioned but the accent is on technical and industrial items; details on terminal design considerations introduce the choices made by LSI manufacturers.

Copyright © 1980 by Online Conferences Ltd.

1. HISTORY

The story of broadcast text information in France starts in late 1973. At that time, the Teletext system was beginning to be known and a short study showed that it required at least detailed amendments to be applicable in France. After the first pressure to experiment with it, as it is, a demonstration made by ITT to push the UK Teletext is completely convincing: the inability of the system at that stage to display correctly the French writing, which requires at least 120 different alphanumeric characters, must lead to a study of the French version of Teletext. This study was allocated to the CCETT, a small laboratory of less than a hundred people (its staff has now grown to 250), owned jointly by PTT administration and by the ORTF, the former broadcast authority. This study center was already in charge of digital television, CATV, and data networks. It was involved in the design of a PTT packet switching network (now operating under the name of Transpac). In fact the problem presented to CCETT is more complex and complete: please, study the possible applications of data broadcasting e.g. text transmission on the screen, remote control of videocassette recorders, applications for pay-TV broadcast facsimile, etc.

Thus, the technical decision was obvious for people already involved in data network design: first constitute a data broadcast network, then (or in parallel) define services using data transmission. The data network has been given the code name of DIDON (for Diffusion de DONnees or data broadcasting) and the different services studies to be used either on this DIDON or on other data networks were called ANTIOPE (Acquisition Numerique et Televisualisation d'Images Organisees en Pages d'Ecriture for "Digital acquisition and television display of frames organised in the form of written pages"), EPEOS (for automatic recording of labelled programs, under the editor's control), DISCRET (for scrambled television), and later on there appeared a study on broadcast facsimile, broadcast Teletex, which are the broadcast equivalent of already known CCITT services, and on audiography which combines sound and handwritten information displayed on a TV screen.

ANTIOPE on DIDON was first presented in late 1976 simultaneously in Moscow, USSR in an exhibition devoted to the preparation for the Olympic Games (Sport 76) and in Cannes at the Vidcom.

ANTIOPE on telephone line through a switched data network was presented, under the name of TITAN, at the Internationale Funkausstellung of Berlin in August 1977.

Since then, standardization work has been carried out and services have been opened in France, ANTIOPE is or has been experimented with in several countries (USA, USSR, SWITZERLAND, ITALY).

The DIDON concept has been standardized in three different configurations within EBU, the ANTIOPE system has evolved from its experimental configuration and a compromise adopted by most European countries is

on its way to be standardized by CEPT and CCITT.

2. THE DIDON SYSTEM (ref. 1)

The basis of DIDON is a data-multiplexing organisation. Each packet occupies the active duration of one line. A packet is composed of a header and a data block. The header contains information which allows a given terminal to recognise the packet. The operation of the DIDON system is:

- 1) assembly of data into packets
- 2) labelling the packets as a function of the origin of the data contained in the packet
- 3) broadcasting of packets
- 4) selection of the packets by the receiving equipment

The packet header consists of two parts - the synchronizing part and the prefix.

The synchronizing part allows a two-level resynchronization:

- the bit level which consists of the resynchronization of the receiver bit frequency oscillator. A clock run-in sequence composed of alternating logical 1 to 0 is used for this purpose
- The byte level which allows reassembly of the data into octets for further processing. For this purpose the third header is searched by successive bit shifting until a reference configuration of 8 bits is obtained. Careful choice of this framing code assures synchronisation even when an error bit is present

The prefix determines the packet procedure. A packet procedure is a set of rules which defines the nature and the use of the prefix bytes. Three packet procedures are available, in compliance with EBU recommendation GT V2 106. The three packet procedures provide digital channel identification (1, 2 or 3 octets depending on the procedure). Two procedures make use of a format byte to specify the size of the data block. One of these two includes a continuity index used to verify that no packet has been lost between this one and the preceding one.

Upper level procedures are defined: the channel procedures. A channel procedure is a set of rules defining links between packets in order to create digital channels. Only one channel procedure is used at the present time. It is characterized by a constant value for the packet identified and by the use of the continuity index for cyclic sequencing.

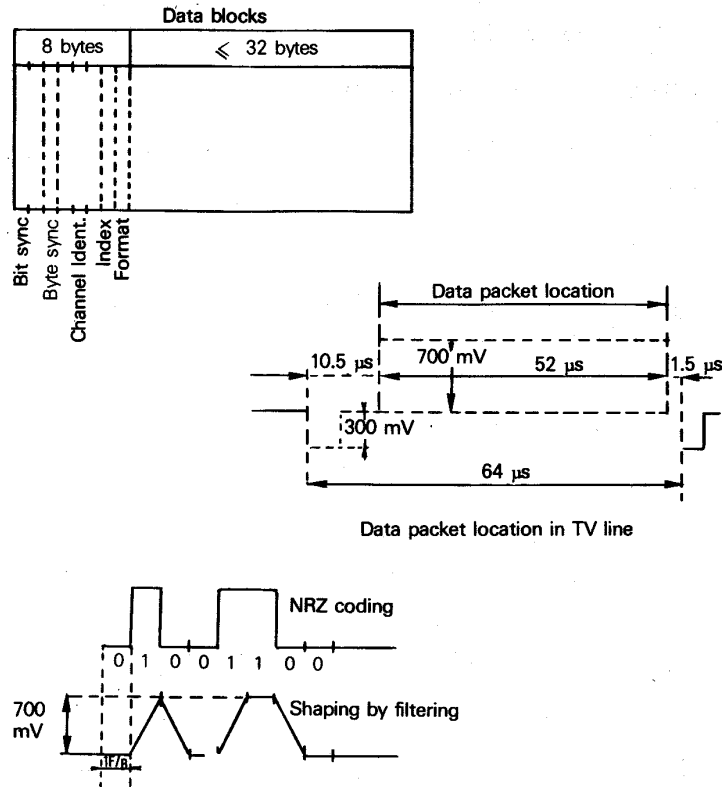

Fig 1 : The DIDON packet structure

3. THE ANTIOPE SYSTEM

The ANTIOPE system is mainly a language for the description of pages. This language, after lengthy international discussions, has been seriously modified from the first stage described in early papers (2) (3) to reach an international agreement. Work has been undertaken within ISO, CEPT, CCITT mainly but also within EBU and the ANTIOPE language in its new version is described in the draft s.g CCITT recommendation.

The main principles of the language are as follows:

- character oriented - a page is described as a number location, having a given address in the page.

- explicit description - the description of a page makes use of several coding items
- displayable characters
- format effectors and information separators (a page is considered as a record or a set of records, a row or a paragraph as a unit)
- display controls

Only the displayable characters are associated with an address in the page. Format effectors allows this address to be changed without printing. Display controls modify the presentation of subsequent displayable characters by adding colour or other attributes without any influence on the address.

The explicit description allows for different levels of terminal implementation without giving rise to any modification of the coded message. Thus the system guards against obsolescence of information sources. Upward compatibility is preserved : simple terminals with a reduced set of possibilities are possible and more sophisticated terminals may display information initially designed for simpler ones, the latter displaying information initially designed for enhanced terminals with minor degradations, of the same nature than, for example, the impairments brought by black and white TV sets on a colour picture signal.

- ISO defined architecture for character set extension

The experience has shown that the number of symbols of any nature required, only for latin alphabet based on European language is around 300. It is not easy to implement them all into a terminal although perfectly possible. But it is dangerous to have a coded representation which differs from one country to another. Linguistic works (4) and ISO works (5) have lead to a coded representation which is unique whatever the language involved and which allows easy fall back representations of characters not implemented in a given terminal. This method, known as "two page solution" or "composition method" makes use of a twin character set represented in Fig. 2 on a 8 bits configuration.

More details about the standardization will be given in session "International Videotex Standards".

One of the main consequences of all these options is the possibility of different levels of compatible terminals. The only constraints to fit the possibilities of a given family of terminals are of an editorial nature. The different terminals vary mainly by the amount of memory they have in the data acquisition part and the display part.

b	0	0	0	0	0	0	0	0	1	1	1	1	1	1	1	1
b	0	0	0	0	1	1	1	1	0	0	0	0	1	1	1	1
b	0	0	1	1	0	0	1	1	0	0	1	1	0	0	1	1
b	0	1	0	1	0	1	0	1	0	1	0	1	0	1	0	1
	00	01	02	03	04	05	06	07	08	09	10	11	12	13	14	15
b	b	b	b													
0	0	0	0	00												
0	0	0	1	01												
0	0	1	0	02												
0	0	1	1	03												
0	1	0	0	04												
0	1	0	1	05												
0	1	1	0	06												
0	1	1	1	07												
1	0	0	0	08												
1	0	0	1	09												
1	0	1	0	10												
1	0	1	1	11												
1	1	0	0	12												
1	1	0	1	13												
1	1	1	0	14												
1	1	1	1	15												

Fig. 2 : Part 1 and 2 of the international alphabetic character set

4. TERMINAL DESIGN CONSIDERATION AND INDUSTRIAL IMPLEMENTATION

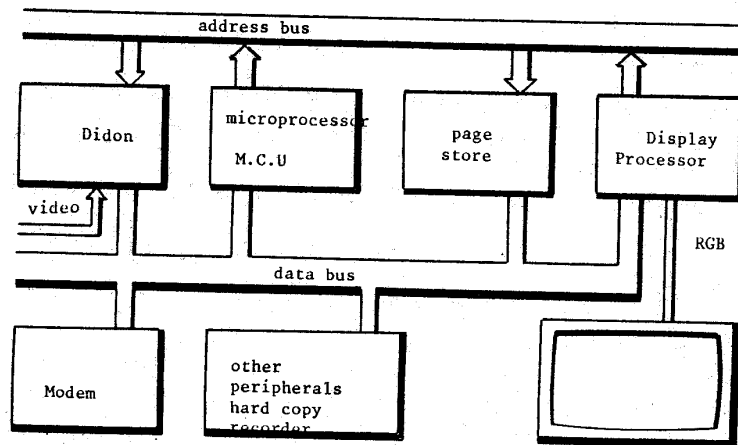

Fig 3 : The general structure of an Antiope receiver

Fig. 3 shows the general structure of ANTIOPE / DIDON receivers. Incoming data from the video are demodulated and demultiplexed. Data that are selected from the total flow are sent into a buffer. When some data are ready, the microprocessor interprets it and transfers the result into the page memory : this is later organised into a format of a word per displayed character. The word length may vary depending on implementation from 8 bits per word to up to 20 bits per word or more. Current implementations use a 16 bpw configuration. The choice made defines an internal display oriented language, particular to the terminal which does not need to be standardized.

The page memory is read out completely every field at a rate of roughly one character per microsecond. In fact every character is read out once every 10 consecutive lines. The information is used by a character generator and makes up an output video signal whose attributes may only be taken into account on a space, because the corresponding memory word corresponds to a character position having no defined shape. This mode of display is known as serial attribute display and no terminal of that level has been manufactured in France, for the following reasons:

- The cost/quality ratio is higher than for parallel terminals or compromise terminals, the lowered cost in memory being negligible and the added complexity in fast logic being important
- The visual impairment for freely composed pages is important
- The editing constraints required to fit the capability of that family of terminals without degradation (the same constraints as for Teletext or Viewdata UK systems) have been rejected by information providers

In between these two extremes is a generation of terminals having 16 bits per memory word. The internal language reserves a unique (or sometimes twin) character code for defining those attributes which become "serial" while other attributes stay parallel. Fig. 4 shows the internal display language adopted as a basis for this family of terminals. LSI designed for ANTIOPE and most of the industrial or prototype designs are of that kind.

Three manufacturers are involved in France, in designing LSI for DIDON ANTIOPE, namely RTC, a Philips subsidiary EFCIS, a Thomson subsidiary and TIF (Texas Instruments France). Their design of DIDON chips are almost identical: one bipolar linear circuit (video input processor VIP) receives the video signal, reconstructs the clock information and slices the data. A N-MOS digital circuit (SEV) receives serial data and clocks and reconstructs 8 bit bytes, looks after the channel address, the format and delivers to the output data from a select channel. RTC and EFCIS SEV are, in addition, operating a Ram buffer as an intermediate FIFO to the microprocessor bus, while this function is performed in another way in the Texas set.

kind of char. / bit	0 1 2 3 4 5 6	7 8 9	10 11 12	13 14 15
alpha	shape adress	fore ground colour	size polarity	flash character
mosaic	d°	d°	back ground colour	flash 0 1
delimiter	delimiter code	d°	back ground colour	lining box conceal

Fig 4 : Internal language of 16 bits terminals

The video display processor is the main difference between these 3 competitors.

In the RTC implementation, the VDP is split into two chips

- ATIC (the timing chain)
- AROM (character generator and video output)

The architecture is a copy of a principle scheme.

In accessing the bus, the priority is to the microprocessor only when it sweeps out the page store. In the other cases, the priority is to the display processor.

The microprocessor may use the bus throughout TV lines corresponding to teletext blanking (52 lines per field for 21 rows in 525 lines systems), and every other line for some 20 μ s (only 40 to 44 are used for display). This allows up to 1 character to be written into the page memory every line. This gives a maximum speed of 5 data packets per field, which is enough for "field blanking applications"; the technology chosen for both circuits is N-MOS, ATIC and AROM are 28 pins DIL circuits. They will be available in mid 1980.

In the EFCIS model, the VDP is split into two chips

- GEC (character generator and interface with microprocessor bus)
- VIC (timing chain, video output)

The memory bus and the microprocessor bus are isolated. The memory is driven on an internal 16 bits bus by the VIC.

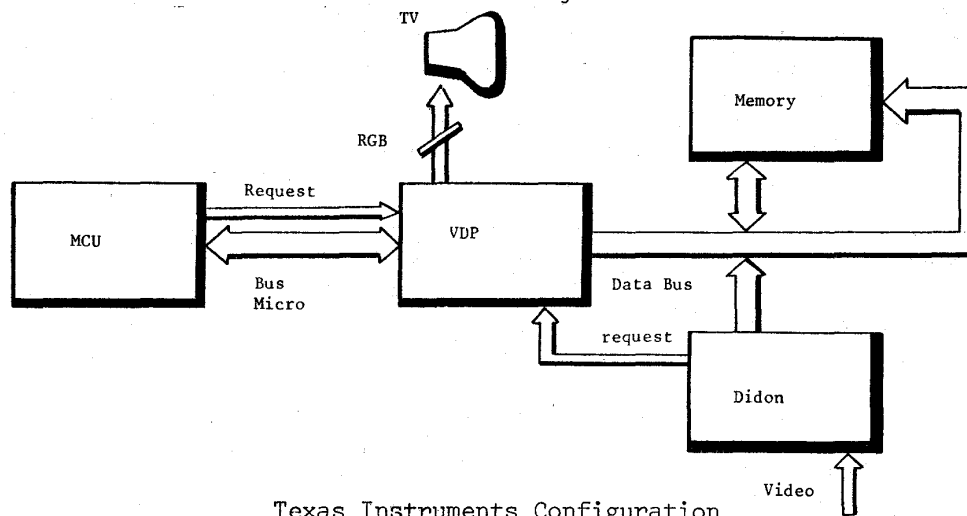

Two bidirectional 8 bits registers interface the display system with the microprocessor with 3 control signals (R/W for read or write operations; A/B for the register accessed, C/D if the content of the "mail box" register is data or a control). A communication instruction set allows the microprocessor to control the VIC which generates all addresses for the page store operations. The write addresses are generated according to the instructions received. The off screen attributes (screen attributes) are also communicated as VIC controls. A busy signal indicates that the mail box has not yet been read out by the VIC and that the microprocessor should not write it again. The first samples will be available in mid 1980 in CMOS/SOS technology. A N.MOS redesign is under production and is due to be on the market in mid 1981. Memory used are standard 1k X 4 or 1k X 8 300 ns cycle time. A complete interactive system requires 4 memory chips, 1 microprocessor, 1 modem, 1 GEC, 1 VIC i.e. 8 chips. A complete broadcast system requires in addition 2 Didon circuits and the buffer ie 11 chips for a complete broadcast interactive decoder.

In the TIF configuration, the VDP is complete on one chip. As for the EFCIS system, the microprocessor bus and the memory bus are isolated but, here, the memory is accessed, on a direct memory access basis not only by the VDP and, through its control, by the MCU, but also by the DIDON. The memory cycles are shared between these three devices and the delay for requests from MCU are at most 1 microsecond.

The memory size depends on application and vary from 4 to 64 k bytes. When the memory size is greater than 32 k, the VDP has the opportunity of using it as a screen mapping memory : thus, this chip is compatible with future geometric systems. The minimum size of 4 k contains the page RAM, the character ROM (or RAM for DRCS) and DIDON buffer. The allocation of different memory parts is dynamically controlled by the MCV. The VDP is a N-MOS chip to be available by mid 1981. A combined RAM-ROM chip for simplest applications is foreseen so that a simple interactive decoder will contain 4 chips (VDP, memory, MCU of TMS 1000 family, modem) and simplest broadcast applications (limited to less than 4 lines per field per magazine) will require 5 chips (VDP, memory, MCU, DIDON chips).

5. SERVICE CONSIDERATIONS AND FUTURE DEVELOPMENTS

The services currently implemented in France will be described in detail in the session "Current Videotex Developments in France".

The first public service opened was provided by the Stock Exchange Society in May 1977 and became a commercial service in October 1979 with several hundred paying subscribers. Ten other services, generally not provided by usual TV programming societies, are now on the air. Many other are projected.

Technically, extension to dynamically redefinable character sets for other alphabets (Arabic, Russian) or writing (Chinese, Korean) and for fine graphics are being experimented with. A geometric extension is also under study, based on the telewriting system already marketed in audioconferencing systems. Interworking with interactive ANTIOPE and mixed modes are experimented with (Diode project : request by telephone and multipage broadcast).

Although almost unknown 4 years ago and often joked about as being a "new secam" ANTIOPE's charms are making many conquests all around the world : a healthy concept, simple design, maximum use of current components and flexibility, a bet on microprocessors and their popularity. Its many advantages are slowly overcoming the original sin of being late in regard to Teletext, and of being French.

LIST OF REFERENCES

- (1) Y. NOIREL
- (1) DIDON, système de diffusion de données par paquets
Revue Française de radiodiffusion n° 40 - Oct. 76
- (2) B. MARTI, M. MAUDUIT
Antiope, système français de Télétex
- (3) C. SCHWARTZ, B. MARTI, A. POIGNET
Spécifications provisoires du système de Télétex Antiope
Revue Radiodiffusion et Télévision n° 47 Avril/Mai 77.
- (4) MULLER et autres problèmes linguistiques du Télétex
doct. UER GT1 N° 30 (CCETT TSA/T/14/1977)
- (5) ISO TC97 SC2 WG4 N° 108 et autres.

VIDEOTEL

An Extension of the Use of the Display Equipment of a Prestel TV
set for the Travel Industry

J. F. COURTNEY

DIRECTOR

Courtney Sears Marketing Ltd

England

With half of all British travel agents installing TV sets in their offices, this offers a ready made point of sale vehicle to be exploited by the principals whose products are sold through those outlets.

However, this is just a means to an end. The development of Video technology could mean a revolution in the way travel agents sell and display their products and train their staff.

Copyright © 1980 by Online Conferences Ltd.

Never before has the retail travel agent's business been so complex. The required knowledge of products and prices is a nightmare, and a tangled web of regulations, which is subject to continual change.

Coupled with this, travel agents trading in inclusive tours are being threatened by specialised companies backed by the latest technology selling direct to the public.

It is small wonder that travel agents, in trying to solve these problems, have turned to technology.

My hope is that the introduction of computerisation for the retailer will be so successful that the travel agent can concentrate on the tasks that this industry so desperately needs - that of expanding the travel and leisure markets in the face of the fierce competition for discretionary income. What has been so sad about the "direct sell" issue, has been the parochial attitudes of the retailers in rising to meet this challenge.

That is why there is a danger in turning to technology as a panacea for all the problems that beset a travel agent today. The current technological stampede in our industry would appear to be an accountants dream - masses of information instantly available at the touch of a button. Management of the business made easy, with instant ticket returns, instant mailing lists, instant availability lists, and soon instant bookings and instant tickets. All transactions recorded and safely stored.

But I would remind the accountants, the organisation and method men, and the business managers of the industry that we are in a business to sell a product that, at the point of sale, cannot be seen, touched, or sampled, and the motivation that leads individuals to buy the products we market and sell are many and varied.

In my view, it is an absolute necessity for the travel industry to provide, at all levels of marketing, the dreams, and if you like, the "sizzle" that is associated with travel and holidays.

This is perhaps a long winded way of saying that in your search for technological advancement in the industry, don't forget the ingredients that form an essential part of the product, and it is these ingredients that should be used to expand the existing market.

It was this philosophy that formed the basis for the concept of Videotel, coupled with opportunism to the growth of TV receivers in travel agencies, and the use of audio-visual forms by principals.

By the end of 1980 it is projected that at least 2,000 retail agents will have Prestel type equipment installed in their offices. However the initial use of the computer provided information will be limited, thus the display will remain unused for a large porportion of the working day, and it will certainly be blank at night, after shop hours.

Tour operators, airlines, tourist boards and shipping companies have libraries of promotional films, audio-visual, slide presentations and advertising material available. Thus the retailer has the hardware, and the principal the software.

Videotel is a method by which these two sides can be brought together in order to provide exciting display material for use by the retailer.

The costs for both principal and retailer are marginal. The retailer, who has already incurred the cost of the computer link and the visual display, can hire a Videotel player at special rates and receive a new tape of promotional material every month. The principal has already incurred the heavy cost of production of his promotional or advertising material, the cost of transfer of this material to a video-cassette is small. By using Videotel, the principal not only extends the life of his promotional/advertising material, but also ensures its use to a committed audience.



ILLUSTRATION 1

The Videotel programme consists of 3 hours of travel films linked by travel-related advertising spots.

The Programme is split up as follows:- 4 minute sections of travel films linked with 30 second spots of travel-related advertising. The material for transfer to a master tape can be provided in any of the following forms:-

Film, slides or video tape

Programme time can be bought in 4 minute sections in the following ways:

- 1) 4 minutes of advertisements which will be spread through the 3 hours
- 2) 4 minutes of film edited from a major production
- 3) 4 minutes of an audio/visual slide presentation transferred to tape
- 4) A specially produced video-tape programme of 4 minutes

The first experimental tape produced by Videotel and now playing in 100 retail travel agency outlets was made up of a mixture of all of the above.

Butlins took a 4 minute section of the '7 Days in Butlinland' film and used their 1980 Butlinit commercial to introduce and complete their section of the programme. British Rail, on the other hand, used their in-house facilities to make a special film, using slides to illustrate the Rail-Air link facilities that are available. P & O Cruises used an edited audio-visual programme that had already been produced to promote the 'Around the World Cruise' programme. Air France and Qantas used material from promotional films. Medina Holidays used their already existing video programme on their 1980 summer programme.

The Irish Tourist Board, Bord Faite, and AER Lingus linked to take an 8-minute section of the tape to feature Ireland, and the holidays available to the holidaymaker. Other principals buying space were Air Jamaica, Alitalia, the National Tourist Board of Greece, the Jersey Tourist Board, P & O Ferries, Pitt & Scott, Seaspeed, Thomson Holidays, T.W.A., Wales Tourist Board and Lever Bros.

The travel agent has been provided with a lively and informative programme which enables him to give an additional service to his client and gives the client an awareness of the range of products available through the retail outlet.

Videotel can be used in a variety of ways. It can be run silently either in the shop, or in the window. Each continuous 4 minute section of the tape is appropriately captioned. Videotel can provide the agent with a method of showing a client a product in which he has indicated a special interest, each section of the tape is identified by a programmed index and can be selected by means of a counter built into the V.H.S. machine. The tape can then be played to the client with sound.

The Videotel tapes are cross-referenced to the appropriate Prestel pages thus once a client has seen the product in which he is interested, the retail agent can, at the touch of a button, go back on-line to retrieve the latest information on availability, prices and special offers relating to that product.

Thus for the retail travel agent who is already committed to the expense of hardware, 'Videotel' provides a method by which that hardware is kept in constant use. The computer link is obviously not a requirement for this use of Videotel. Any travel agent can rent a Videotel package of television plus V.H.S player which operates independently of the computer link.

The principals gain by the repeated use of their promotional/ advertising material to buyers and also ensure that travel agency staff have a good knowledge of their product.

The monthly up-date of the Videotel programme ensures that the medium maintains its freshness and enables the principal to ensure that information on the latest product development, special promotions, etc., are immediately available to the buyer and retailer.

Videotel also provides the perfect medium for staff training. The Air Transport and Travel Industries Training Board is the first to recognise the advantage of making available programmes in video cassette form to the retail outlets. A.T.T.I.T.B. training film sets out to enable staff to differentiate between features of a product and benefits to particular customers, and to demonstrate to staff how to use selling phrases stressing the benefits of a product to a customer.

The basis is a conversation between two Branch Managers of the same retail agency. John is worried because his turnover is not increasing at the same rate as other offices despite the office always being busy.

A flashback to a sales conversation in John's office enables Peter to pinpoint an obvious reason. This leads into suggestions on training of staff with particular emphasis on the difference between Features of a product and Benefits to customers, when matched to specific needs.

A recall of a transaction in Peter's office highlights the use of benefit statements in overcoming objections and selling a holiday to a customer.

In order to encourage this use of Videotel, those principals who buy 4 minute sections of the tape will be offered the facility of transferring their existing training programme to videotape.

With the envisaged growth of video players in the home and the continued rise in the cost of print productions, it is envisaged that by mid 1980 the retail travel agent will be provided with cassetted brochures and a library of cassettes for loan to the client.

The improvement in video technology and the introduction of video disco into the U.K. should ensure that the cost of this type of production is kept low. This will improve the conversion rate from that obtained by use of the traditional printed disposable brochure.

Videotel has originated in the travel industry because of the availability of the hardware, however, its extension into other retail outlets, such as D.I.Y., toys, sports equipment etc., is obvious. The retailer and customer benefit from exposure to informative and interesting point of sale and the manufacturer from the display of his product range at the retail outlet.

THE PLACE OF VIEWDATA IN RELATION TO OTHER
COMMUNICATIONS TECHNIQUES IN THE TRAVEL INDUSTRY:
A PERSONAL VIEW

D M ADAMS
A MONTGOMERY-SMITH

THOMAS COOK GROUP LTD
PETERBOROUGH
ENGLAND

Copyright © 1980 by Online Conferences Ltd.

1. INTRODUCTION

If one is to gain a reasonable perspective on the possible use of Prestel, or Viewdata in general, in the travel industry, one needs also to have a view of the use of competing technologies for communication. And if one is to gain an understanding of the place of communications in the travel industry one needs to understand first the business imperatives that pressure travel companies into spending money on communications at all.

We therefore decided that the most helpful way to approach our subject was from a wider discussion of the travel business - or at least the business of selling travel - which is where the relevant communications technologies are to be seen developing. We shall then consider in turn the main business relationships, and which methods of communication are succeeding or might succeed in future. Among those methods we shall see a place for Viewdata, and possibly for Prestel itself.

The phrase 'a personal view' forms part of the title to our paper because we thought it might be interesting to speculate on how major companies in the business might exploit the technological opportunities available to them. As technical specialists we do not represent the views of Thomas Cook, nor those of any other major companies in the business. Our speculations are based entirely on extrapolations from information in the public domain, and carry no imprimatur whatsoever.

2. BUSINESS RELATIONSHIPS IN THE TRAVEL INDUSTRY, AND PRESENT METHODS OF COMMUNICATION

Figure 1 illustrates the main business relationships on the retail side of the travel business.

2.1 Scheduled Air

Scheduled air is probably the most significant travel product. It is sold mainly through travel agents. A figure of 71 per cent has been quoted as the proportion of British Airway's UK business sold through agents. Agents sell to two fairly distinct classes of customer. Business houses generally buy services over the telephone and on credit. Private tourists generally buy services in person and pay cash. At present the bulk of scheduled air is bought by business travellers at more or less full fare. But British Airways expect this pattern to change in the coming decade, with most of the traffic growth being tourist, until the overwhelming majority of air travellers are tourists paying less than a standard list-price fare.

Airlines also sell direct to the customer. For instance, British Airways have 'implants', that is members of their own staff resident on the customer's premises, in many mainly governmental or quasi-governmental organisations.

Consider now the communications aspect of this situation. All significant airlines have on-line computerised reservations systems. Where they are selling direct to the customer, the implant salesman or salesman in the shop has his own terminal connected directly on leased lines to the reservation system. In both cases the salesman can offer a first class immediate service, and the line cost is relatively unimportant in these high volume airline outlets.

On the other hand, until recently the agent has been in a much less happy position. He has not had an airline reservation terminal because British Airways, whose terminals are the only ones worth having in Britain, would only supply one complete with a British Airways operator at a prohibitive cost. Thus, making a reservation through an agent has involved personal or telephone contact between the customer and agent, followed by (voice) telephone contact between the agent and airline, followed by further agent-customer contact. Because airlines do not always answer their telephones promptly (one American airline has a device to play you soothing music for the hour or so you need to wait), and because the customer's desired itinerary is not always available, this process is usually iterative, time-consuming, expensive and thoroughly unproductive.

2.2 Inclusive Tours

Inclusive tours, or package holidays, are also predominantly sold through agents. The customers are obviously mainly tourists paying cash.

The larger tour operators have computer reservation systems. However, terminals are not found on agents premises. One reason for this is that a terminal connected to one tour operator would be of little use - one cannot book a Thomsons holiday through Horizon's system in the way one can book an Air France flight through a British Airways terminal. Another is confidentiality - tour operators are nervous of having their competitors know just how much they have sold. A third reason is that tour operator reservation systems differ so much that no one could remember how to operate more than one or two.

The results for holidays are even more chaotic than for scheduled air. The business is highly seasonal, with a peak booking period in January. In a good year all tour operator switchboards remain jammed for the month. Later in the season there is a different problem. It is possible to get through the tour operators' switchboards all right, but so few holidays are left that it is necessary to make numerous telephone calls.

As with air there is no element of direct sell. Some of this is actioned by the customer telephoning or calling on the tour operator directly. Perhaps more is done by mail order, but the snag, of course, is the difficulty of offering alternatives when the first choice is sold out.

2.3 Other Kinds of Traffic

Other kinds of traffic - rail, ferry, car hire, hotel, etc - present fewer problems. In general the products are less specific and load factors lower, so that there is not the same need to make reservations interactively, and for most of these other traffics a lower proportion of business is done through agents.

A popular method of making bookings for these other traffics is 'sell and report'. The agent is regularly given, for instance, an updated list of ferry sailings on which there is capacity. He can sell tickets for these freely, simply notifying the operator by post that he has done so.

However, some of these traffics do present major problems. Perhaps the most difficult are British Rail and hotels. It is not usually necessary to reserve a rail seat. But on those services where it is necessary, it is mighty difficult because

BR do not yet have a computerised reservation system, and there are sometimes difficulties in getting through their switchboards. There is no integrated computer inventory of hotel beds which can be interrogated and there is a shortage of capacity in major cities such as Tokyo, New York and London. From the agent's point of view the difficulty of making a reservation is aggravated by the relatively small revenue he can collect on these kinds of traffic anyway.

3. ELEMENTS OF A SOLUTION

The ideal is to have a single terminal which shows availability of all travel products, and allows bookings to be made and immediately confirmed. The terminal, for which a visual display device based on a cathode ray tube is probably the most convenient available technology, should have attached to it printing machinery to produce tickets, itineraries and other accounting paperwork.

Depending on where you fit in the business - customer, agent or principal (airline, tour operator, etc) - you will add a few twists of your own. The agent wants:

Comprehensiveness, with all significant travel products included

Lack of bias, so that he can easily find, for instance, all the holidays available from any operator in Ibiza in the first week of June

Reasonable ease of use, so that a typical member of his staff can use it given say two weeks' training; however it should not be so easy that a customer can use it without the agent to hold his hand!

Reliability, because once he has this tool he will become totally dependent on it

Acceptable cost, with a price structure which does not penalise heavy use.

The principal:

Is quite happy if his competitors' products cannot be accessed

Is less concerned about lack of bias - he wants his product to be the easy one to select

Does not want others finding out commercially sensitive information about his load factors

Is unsure about ease of use; it depends on who he wants to use the equipment, and also on whether there is a significant cost penalty in keeping his reservation system reasonably efficient.

As for the customer, who knows what he wants? As employees of a travel agency we would like to think that the customer wants an easy to use device to help him make a preliminary selection, but would rather the agent handled the difficult booking bit. In reality, some customers probably no more want any kind of terminal than they wanted

decimalisation, metrication, or any of the other cancers of the modern world. Some will use terminals in the way the agent hopes. Others will want to use them comprehensively to make their own travel arrangements. Any who use terminals at all will want:

Reasonably low and, most important, predictable cost; they will favour a cost structure with low standing charges and payment by usage

Exceptional ease of use, not because they are fools but because they are occasional users and are not prepared to undergo any training.

How do we get from where we are today to something that comes near meeting these requirements? The elements of a solution include:

Front end processors to make systems compatible

Packet switching

Prestel to show availability

Private Viewdata systems for reservations and confidential information.

4. FRONT END PROCESSORS TO PROVIDE AIR RESERVATIONS TO AGENTS:
TRAVICOM

As mentioned earlier, British Airways will not provide their own reservation terminals at reasonable cost to agents. In taking this stand they have behaved differently from other major airlines. For instance, Lufthansa in Germany, Air France, American and United Airlines in the States, all rent terminals. In doing so they have not only provided a needed service and made money out of it, but outside the States anyway, managed to implant systems that are heavily biased towards showing their own flights.

What British Airways, and British Caledonian, have done instead is to take stakes, now 55 per cent and 17 per cent respectively, in a operation called Travicom.

Travicom (Figure 2), is effectively a front end processor allowing a single terminal on the agent's desk to access any of the major airlines' reservation systems. The Travicom processor allows the agent to input messages in one defined syntax, and converts them as necessary to the syntaxes of the individual airlines. The responses are not converted, but since in the main they are in clear English rather than code, that matters little. The processor also handles protocol conversion.

There is an enormous waiting list for the system but the larger agents in the London and Manchester areas now have it installed.

Consider how well the Travicom system meets the objectives discussed earlier:

The system is reasonably comprehensive for air, although it is less effective than many individual airline systems at giving additional information, especially on fares.

The system is unbiased in the sense that the user has a free choice of which biased system to select; however this falls short of being a totally unbiased system: there is no way you can request seat availability from London to New York and get a straight list including British Airways, TWA, Pan Am, Iran Air, etc.

The system is easy enough for an agent to use, but does require two weeks' training for an already experienced travel salesman.

The reliability is pretty well as good as the airlines it connects to.

The cost is a straight rental of about £3000 a year for each terminal, depending on location and size of installation; this

is over twice the cost of reservation sets in the States, and only affordable by fairly large agencies.

In our view it might have been better if British Airways had simply rented out their own reservation sets and put the schedules of other airlines into their system. The cost would have been lower; BA could have benefited from some more or less subtle bias; more ancillary information could have been made available; and the system would have been ready several years earlier.

The conventional wisdom is that Travicom is the system we have, and the investment in it makes it unlikely that British Airways will rush into anything else. The system is totally incompatible with Viewdata, and making it compatible is somewhere between very difficult and impossible. Thus it is unlikely the customer will ever get his hands on it directly, and he only benefits because the agent gives him a better service.

However, it is interesting to speculate on what British Airways could do if they chose. They already put some flight schedules up on Prestel. This is convenient for both the private customer and the agent without Travicom. We see no technical reason why BA could not develop an easy to use Viewdata-compatible version of their reservation system. Of course, it would be expensive to convert all the syntax to be compatible with the Viewdata terminal, but not anything like as expensive as doing it for Travicom, which would effectively mean doing it for all airlines.

If they did develop such a system the obvious market would be business houses. They could provide Viewdata sets to be operated by the customer's own staff. Payment could be by BA's own credit card. Ticketing would be no problem. Air Canada already operate a system whereby the customer writes out his own ticket at the airport and validates it by running it through a credit card machine. Who needs tickets anyway? Provided the customer can identify himself at the airport, and has an itinerary stored in the computer, that should suffice.

The only reason we can see why BA might hold back from such a course is that, in the medium term, the customer who would use it is the business house. Since the perceived trend is towards a higher proportion of leisure travellers, BA need the agents' goodwill to maintain or increase their share of that market. However, if in due course the population of Viewdata sets among households with the disposable income to indulge in leisure travel becomes adequate, there might be some in the inner councils of the airline who would consider the risk worthwhile.

5. INCLUSIVE TOURS

As mentioned earlier, most of the larger tour operators have computer reservation systems. But there is no equivalent to Travicom for holidays. One good and sufficient reason for this lack is the technical difficulty. The airline systems are all very similar - after all most of them derive from one original IBM system, and the airlines have excellent technical liaison, which they use to maintain high quality inter-computer communications.

The tour operators, on the other hand, have an astonishing variety of systems, each with its own pedigree. For instance, Sovereign/Enterprise, as part of British Airways, not surprisingly has a system that looks much like an airline system. Thomas Cook have a system whose style is more 'fill in the form' and which, incidentally, superficially has much greater resemblance to use of Prestel response frame. The other operators have equally all invented their own approach.

In this situation we took the view that the sort of front-end processor device that Travicom use for air would probably not be technically possible for holidays. We also took the view that the price Travicom charge for their equipment, which is not particularly excessive in view of the development cost, would not be acceptable to the much larger number of agents, selling holidays - 4500, against 2500 licensed to sell air tickets.

In the short term Thomas Cook, in common with several other major tour operators, are displaying holiday availability on Prestel. This is a very useful service late in the season, when the problem is to find any suitable holiday at all. But it is less use in the peak booking period, when all the holidays are available anyway. There is some debate about whether these Prestel frames should be made available only to a closed user group within the trade. At the moment that question is somewhat academic as there are few domestic Viewdata sets installed. But it does not seem self-evident to us that restricting these frames will benefit the agency business. What is probably a more sensible and certainly very shrewd move is Thomsons' restricting their frames to agents who have been trained how to use them by Thomsons staff.

In the longer term the tour operators need to provide agents with an on-line reservations capability. To this end all the leading tour operators are collaborating in an organisation called the Holiday Systems Group, to agree 'linguistic' standards for private Viewdata systems which each can then implement in his own computer system. In our view, once a reasonable standard is agreed, at least some operators will find it commercially worthwhile to implement; and once some have the others will need to follow.

Of course, once tour operators have reservation systems which can be accessed from Viewdata TV's, they have a commercial decision to make on whether to use this facility to promote sales direct to the public rather than through agents. The commercial risk an operator would take in doing so would be the same as that arising from selling direct now using conventional mail order techniques: the adverse reaction of the retail trade. It seems certain to us that some operators will consider that risk worth taking.

6. PULLING IT ALL TOGETHER

We are seeing the development of two incompatible communications technologies in the travel trade: Travicom for air, and Prestel/Viewdata for inclusive tours. We have not given much consideration in this paper to other traffics, but those which currently use 'sell and report', such as ferries, are ideally suited to Prestel. Thus it is not surprising to see that Sealink are taking the major initiative in pushing Prestel in the travel trade.

However, this situation is a long way from the ideal we considered earlier:

Neither Travicom nor Prestel/Viewdata is comprehensive on its own; and it is not very practical or economical to use two competing systems side by side.

Travicom is expensive and likely to become more so as it uses leased Post Office lines; Prestel/Viewdata is also likely to be expensive for the heavy user, with its dial-up calls.

In addition, the emergence of viable video disks presents exciting opportunities for combining the information functions we have been considering so far with the really effective sales promotion impact of moving colour pictures.

Let us consider three ways in which these various technologies are likely to be put together to create communication facilities for selling travel.

6.1 Basic Operations in Larger Travel Agencies

This is the area where we see least scope for Viewdata in its present form. Figure 3 shows the kind of network we think likely. Data transmission will be by leased line for short distances, and by packet switching for longer distances, or where Post Office policy on third party message switching precludes the use of leased lines. Prestel possibly features as a commercially available database, provided it can be accessed by leased line or packet switching. Indeed, since it is the Post Office itself that is pushing the retail travel trade into packet switching, it would be somewhat odd if they did not make Prestel compatible with it in due course.

The terminals need to be special purpose multi-function devices. In particular they will need switchable column widths of at least 40, 64 and 80 characters - switchable line depths of 16 and 24 lines; and probably character sets switchable between Prestel's and some other. It is slightly surprising to us that multi-function terminals along these lines are not

already becoming available, as much of the necessary technology is in use already in hobby computers (at hobbyist prices as well). Colour would be an attractive extra, but not worth significant additional cost for this application.

6.2 Small Agencies and Private Homes

The smaller agent tends primarily to sell holidays and holiday-related transport, such as on cross-Channel ferries. He is thus less concerned with connecting to air reservation systems, does not have the need for an airline-compatible terminal and is not under 'political' pressure to use packet switching. Both the smaller agent and the private consumer will spend less on communications than the larger agent, and below some breakeven point in the region of £2500 a year dial-up calls are likely to be more economical than packet switching. Finally, the small agent will be very concerned about the cost of his terminal, and the private consumer quite unwilling to buy special purpose equipment at all.

Thus we see Viewdata as an ideal technology in these two market sectors. How will access split between Prestel and private Viewdata systems? Where the requirement is for information retrieval without real-time reservation, Prestel offers a suitable service. In this role it would only be displaced by a private Viewdata service if its cost, including the user's own telephone bill, significantly exceeded what competitors could offer, or if there were some defect in its service, such as excessive unreliability or insufficient capacity.

Where there is a need for real-time updating of inventories, as is the case with reservations for most holidays, Prestel does not currently offer suitable facilities. We think the major tour operators will develop private Viewdata systems, each then having its own holiday inventory on its own computer. Prestel could be developed to offer competitive or complimentary (eg message switching) facilities. But why should the Post Office bother, when private Viewdata systems will generate plenty of straightforward telephone revenue?

If we have this mix of Prestel and private Viewdata, the small agent or domestic consumer will first access Prestel to see what holidays are available from what operators at a price he can afford, and then redial, this time possibly needing to make a trunk call, to access the tour operator's own system so that he can make a reservation. Clearly we have a need for Viewdata sets capable of automatic dialling to a much larger range of numbers than currently envisaged.

6.3 Integration with Videodisk

The use of terminals we have visualised so far in the agent has been one where the terminal is kept behind the counter and used simply as a productivity aid. The use we have visualised in the home has been analogous to filling in a mail order form, but without the need to put it in the post. In neither case does the terminal play a significant part in the selling, ie persuading the customer to buy the product.

Now imagine a terminal, in quality colour, with a split screen. On the upper half a nubile lady in appropriate state of undress disports herself on the beach; on the lower half is a conventional text form with suitable prompts such as 'when do you want to go' and 'enter credit card number here'.

In concept we have here a combination of the persuading power of television advertising, and the convenience of Viewdata as a communications medium.

However, actually making it happen is not trivially easy. The band-width required to transmit a quality moving picture is of the order of 6 MHertz - which is slightly out of line with the 1200 baud transmission rate used in Viewdata. Although telecommunications are getting cheaper, it seems to us unlikely that providing that much band-width to private homes at not much greater cost than present facilities can feature in the Post Office's immediate plans.

For the agent a possible solution is to store the movie video on disk and to integrate the devices as shown conceptually in Figure 4. The video disk contains promotional material on the holidays and other leisure travel products on sale. The screen sits on the counter or table, where it can be seen by the salesman and potential customer. The salesman controls what appears on the screen from his keyboard. He can mix and interchange material from the video disk, Prestel and other Viewdata systems, and his local minicomputer.

Such a system exists in prototype in North America: it is not a wild pipe-dream. Using tape instead of disk, and without such sophisticated means of control, similar systems exist in the UK. Potentially, it could become the dominant selling mechanism for leisure travel. Incidentally, for the foreseeable future, the technology is affordable and accessible to the agent doing a significant volume of business, and not to the domestic user.

6.4 Summary

The pace of technological advance is beyond the ability of the travel trade to use it. Technological advances such as Viewdata will not themselves determine or even significantly influence the shape of the trade. What will significantly influence the shape of the trade is the imagination and energy of the organisations in it in exploiting the technologies as they become available. The only people who can be reasonably sure to benefit without much hard work are the travellers themselves.

FIGURE 1
BUSINESS RELATIONSHIPS IN RETAIL TRAVEL

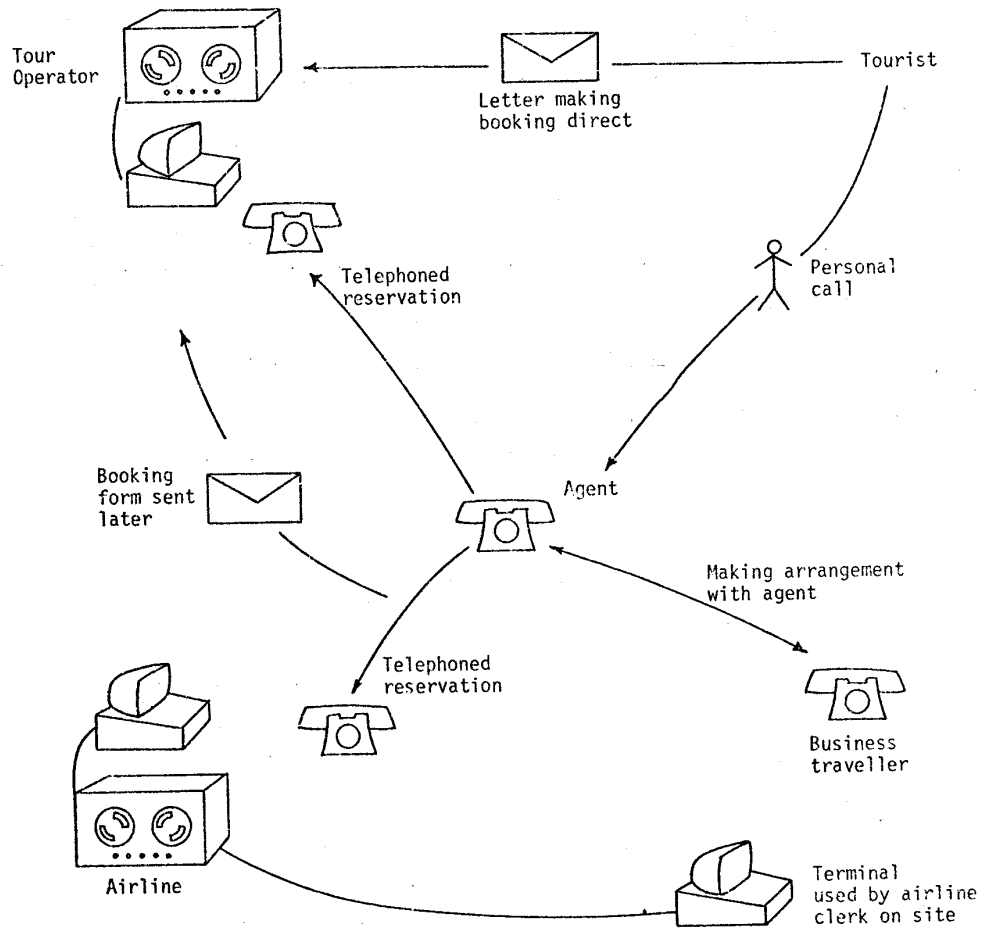

FIGURE 2

TRAVICOM

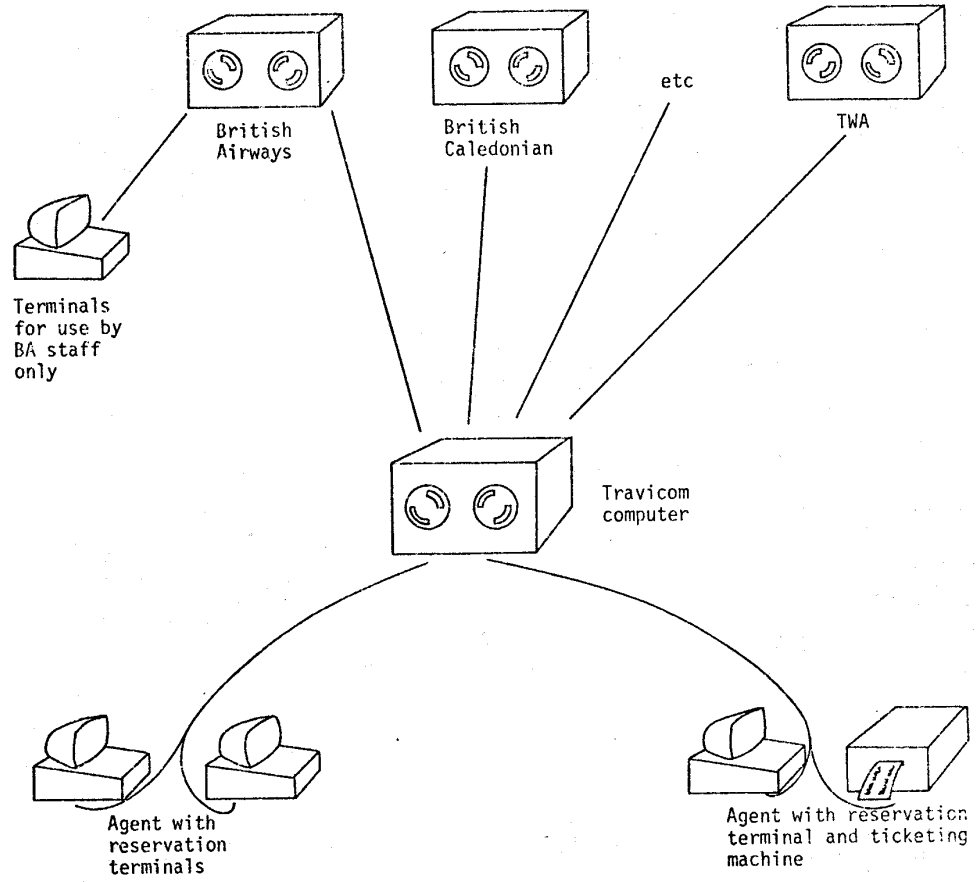

FIGURE 3

NETWORK FOR LARGER TRAVEL AGENCY

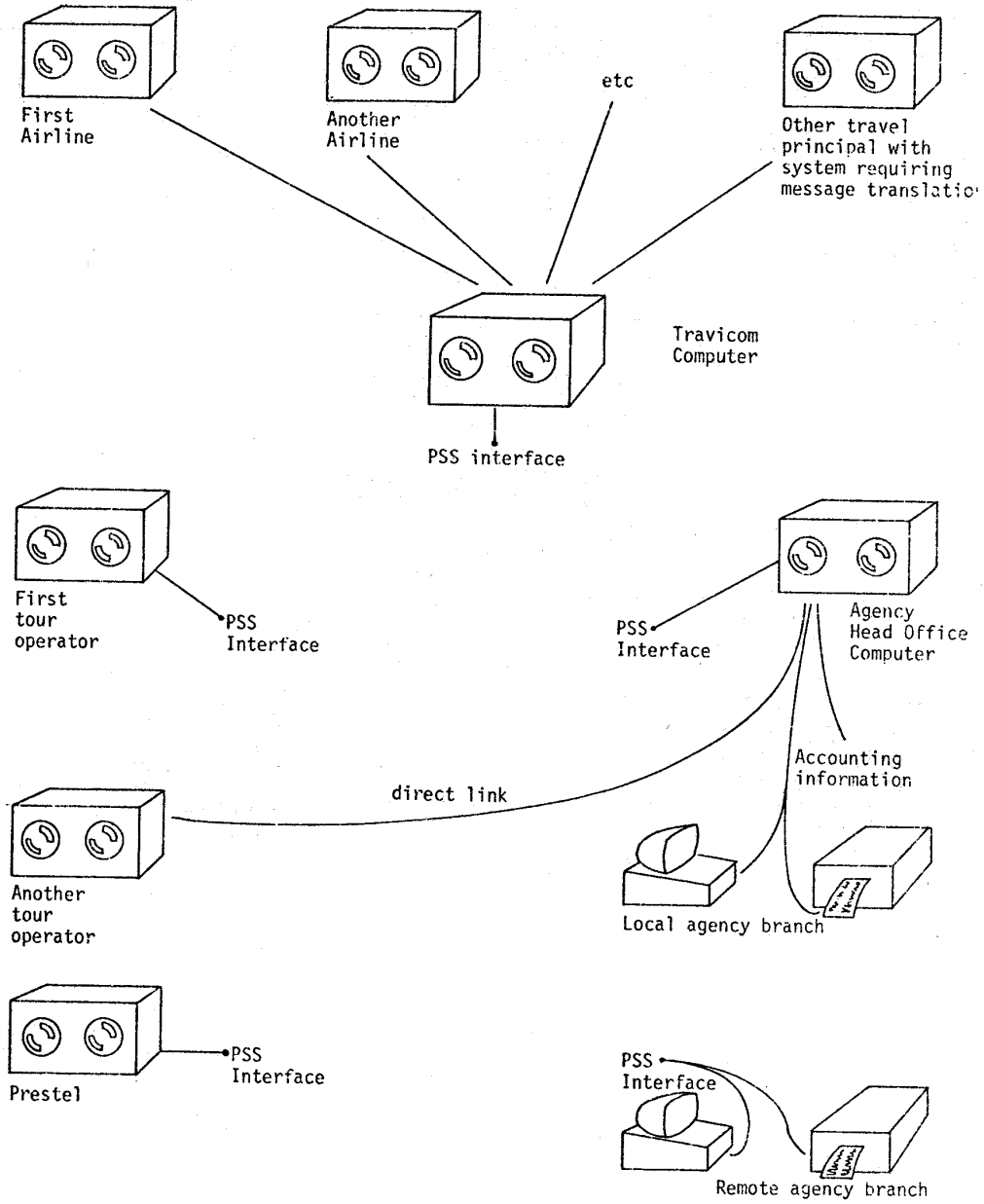
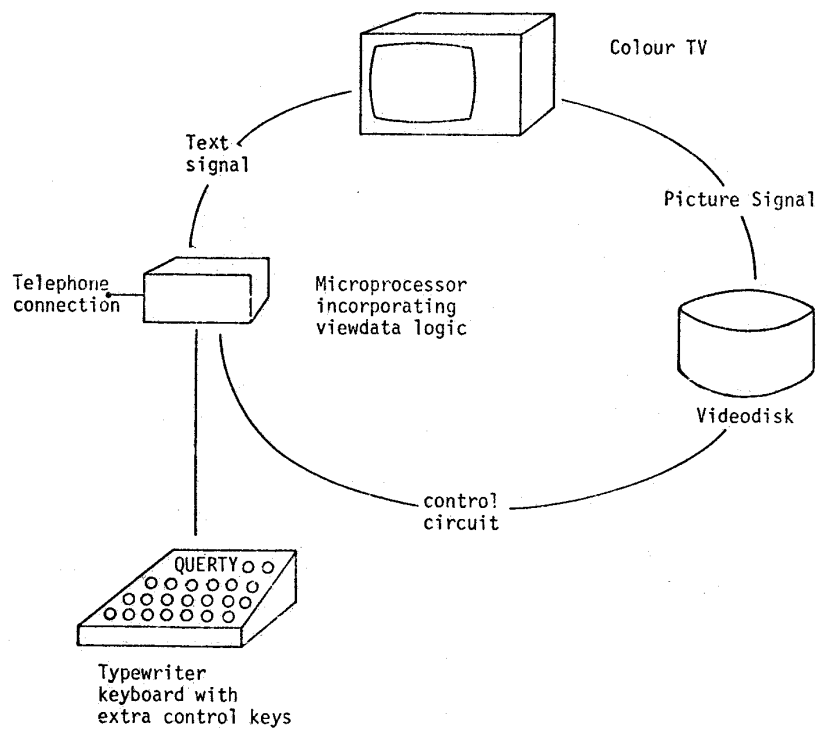

FIGURE 4
INTEGRATED TRAVEL SELLING STATION



The use of MicroCobol for Telesoftware

E. C. Sedman
Viewdata Manager
CAP-CPP MicroProducts Ltd
England

The concept of Telesoftware is described with particular reference to its implementation using MicroCobol - a machine invariant programming language developed by CAP-CPP.

Examples are given both of the use of on-line programs as an enhancement to the standard viewdata facilities, and also examples of the types of program that could be distributed by telesoftware but run in "stand alone" mode.

Copyright © 1980 by Online Conferences Ltd.

1. INTRODUCTION

The Concept of Telesoftware

When viewdata was invented a few years ago, no-one could foresee how rapidly microelectronics was going to develop. The result has been that except for a few of the very earliest sets, all viewdata receivers are built around a set of chips, rather than discrete logic circuits. Some of these chips are in fact general-purpose, programmable, microprocessors. The pressure is still very strong to minimise the number of components, and hence the cost, for the mass market domestic sets, but the marginal cost of providing additional capabilities is not high, and a number of "intelligent" sets are now being developed.

Such intelligent viewdata receivers give the capability to carry out more complex operations than are available with a standard terminal. For example, it is possible to process the data that is received, rather than just to display it, and it is also possible to reprogram the device to perform different functions.

Now a reprogrammable device requires a means of getting the programs into it. But with viewdata we are talking about a terminal connected to the telephone network. So why don't we use the network itself to distribute, not just data, but also the programs (software). This is the principle of telesoftware: the distribution of software via a communication medium, in this case the telephone.

But telesoftware is not just an interesting technical idea: there is also a need for it. As the cost of hardware has been coming down rapidly there has not been a corresponding fall in the cost of developing and maintaining software, which remains labour intensive and therefore increases with inflation. However, there is an alternative way to reduce the selling price, and this is to sell many copies of the same software. The ideal way to achieve this is to have a means of distribution whereby the software supplier can set up a single copy of a program which is updated when necessary. Purchasers can take copies paying a usage charge each time they do so. This is precisely the facility that telesoftware can provide.

Compatibility

With the standard Prestel system, it is already possible to purchase terminals from many different suppliers, but all displaying information in the same way. When we come to tele-

software we again want to achieve the same results, i.e. we want to have a single version of a program, stored on Prestel, and capable of being brought down and executed in a range of different terminals.

This is an extremely difficult problem to solve. Even with standard terminals, characters look different depending on the display chips used, and there is at least one inconsistency in interpretation of control characters (see Prestel pages 33822 and 3382262). With software there is much greater scope for inconsistency because the basic instructions are different between different processors.

The problem has been solved completely in the implementation of MicroCobol, which is a programming language designed to be portable over a wide range of machines. Programs are compiled to an intermediate code which is then interpreted identically on different processors. Even more significantly, the same result is obtained from a program which is in error, so it does not matter what machine is used to test out the program, the effect is always the same.

MicroCobol

The MicroCobol language¹ has been designed specifically for business applications on microcomputers. Some of its features are:-

Based on COBOL, the most commonly used language for business data processing, but modified to make it suitable for interactive use on small machines (rather than batch mainframe operations) and also extended to include modern structured programming constructs. It is a language designed for professional programmers (unlike BASIC for example) but there is a large population of such programmers capable of using it with minimal retraining.

MicroCobol incorporates a powerful disk-based operating system with extensive file handling capabilities. It requires at least one and preferably two disks, the minimum being floppy disks of quarter megabyte capacity. Minimum memory is 48K, but 64K is an advantage.

Thus MicroCobol is suitable for an intelligent business viewdata terminal, rather than the lowest cost device for the domestic

user. As a very rough figure, we would expect the cost of such a terminal to be about twice the cost of a high quality standard viewdata terminal, if produced in similar numbers. The early users are therefore expected to be large business organisations with a need for distributed computing power, but it is expected to spread to smaller businesses, and eventually to very small businesses such as the corner shop.

2. THE MECHANISM OF TELESOFTWARE

Data Format

As a starting point for our telesoftware development work we assumed that we could operate with no changes at all to the central software of Prestel. Although it was not by any means certain that this would be a valid assumption, it has proved to be so. Obviously, there would have been problems and delays if we had needed changes at the centre, but a more important point is the fact that our telesoftware will now work on any viewdata system which uses protocols similar to Prestel. Hence, our marketplace includes private as well as public viewdata systems.

Prestel works on 7 data bits plus parity which is probably the least convenient format for a computer language based on an eight bit byte. For simplicity our initial work was based on transmitting a pair of hexadecimal characters for each byte of program (i.e. using only 4 bits per character.) This gave a maximum of about 410 bytes per frame after allowing for control information. Further developments have achieved greater packing densities by recognising multiple repetitions of the same character, and by allowing most ascii characters to be transmitted as a single 7 bit character.

Another serious deficiency of Prestel from this point of view is the lack of an "end of transmission" character, but this is overcome by having our own "end" sequence.

The length of the transmission at 960 characters is longer than would normally be expected, so we allowed for shorter units. However, the overhead is minimised with longer "records", and we find the full length to be satisfactory from the point of view of error frequency, so this is what we use.

Error Detection

Unlike telesoftware broadcast by teletext, we can take a very

simplistic approach to errors. Because of teletext's delays between successive transmissions, they make every effort to correct transmission errors, by the use of Hamming codes. We simply detect errors, and request retransmission of the frame in error. Checking consists of the parity check on each character, a checksum on the line of control information on each frame, a checksum on the data characters on each frame, and an overall checksum for the entire program, to ensure that we have not got out of step in reading the frames.

We considered the desirability of a more complex cyclic redundancy check, but came to the conclusion that the error rate at which the simple checksum is inadequate, is such that the time taken to transmit a program would be unacceptably long due to the number of retransmissions needed. In practice we see very few errors in transmission; remember that we are always using a local call. The program tries each frame up to three times, and if the error persists the operator is given the choice of trying again or abandoning the run.

Anti Piracy Protection

If companies are going to invest in the development of programs and supply them via public viewdata services, they need protection against unauthorised copying of the programs. The first level of protection with MicroCobol arises from the fact that programs are distributed not in source form, but in a version of the intermediate code. Some languages, such as Basic, are normally saved in source form, or in an intermediate language which is very similar to the source. In these cases it would be very easy for a customer to copy down the frames containing the program, and manipulate them to produce his own version. In fact he could even view the frames and simply rekey them if that were easier.

While we cannot, of course, protect programs completely against the equivalent of the dedicated "phone freak", we can ensure that a significant amount of time and effort would be required to break the codes that we insert. And in the business environment to which MicroCobol programs are addressed, time is money. We have therefore included a number of complicating factors, one of which is an expiry date.

The program provider specifies a retention period which is stored on the first frame of the program. It can be unspecified, in which case the program is available indefinitely. Otherwise

the operating system adds the retention period to the current date, and sets up an expiry date. Any attempt to run the program after the expiry date will fail with an appropriate message.

As a further extension one of the frames could be a response frame. The date and time provided by Prestel give a unique identifier for the program, and the response frame identifies the purchaser. So if a "pirate" copy turns up its origin can be traced.

Practical Use

The telesoftware mechanism is in fact a general file transfer mechanism. Not just programs, but also data files can be transferred in the same way. Successive frames are used, called down by sending # and if more than 26 are required, route 0 from the z frame gives the first frame of another page.

From the user's point of view, he finds the program he wants via the normal menu selection process. The instructions on how to operate the program are also on Prestel, routed to in the normal way. Charging is via the normal Prestel frame charge, specified by the program provider, and collected on the user's bill in the same way as all his other information charges.

The major restriction that we can see on telesoftware is its speed. Assuming we can completely overlap the reading of a frame with the processing of the preceding one, the transfer rate is about 8 seconds per frame, i.e. $7\frac{1}{2}$ frames per minute. Depending on the packing density we can achieve this is likely to give up to about 4K bytes per minute, i.e. 5 minutes for a typical program of 20K bytes. This should be acceptable, but if we want to transfer a suite of programs, say the sales ledger occupying about a quarter of a million bytes, the time taken will not be less than an hour.

While it would be possible to bring down a suite of programs of this size during lunch, say, it does not seem very practicable. Until we have significantly faster transmission speeds, we therefore believe that telesoftware will be used only for individual programs and for amendments and updates to suites of programs, which will continue to be purchased initially by some other means, for example a floppy disk sent by the post. However, we envisage that the use of response frames, and in the future a message service, will play an important part in the remote

support and maintenance of software.

3. EXTENSIONS TO VIEWDATA

So far we have only considered the means by which telesoftware operates. But what can we do with it?

Having brought down a program we can go off-line, and treat the terminal as a completely stand-alone machine. However, let us consider first some of the possible applications of the intelligent terminal when on-line to the viewdata centre, so that it is used in effect to extend the viewdata capabilities.

Improved Access Methods

With Prestel, the standard method of accessing data is via a series of menu selections. The simplicity of this approach and the ease with which it can be learnt and used is probably the greatest strength of the viewdata concept. However, it does mean that there can often be a large number of accesses before getting to the desired frame. This can be seen as a clear weakness of the system, which will be particularly serious for someone who needs to use the system frequently.

It is also possible to go directly to a specific page, but of course it is necessary to know in advance the page number for the information required. This knowledge can be achieved by an intelligent terminal which makes use of an index; for example, to select a railway timetable given the starting point and destination.

The idea is that the index will be stored on Prestel by the IP to whose information it refers. Thus it will be kept up-to-date and called down only when needed. Alternatively, the index could be brought down onto local disk storage if required frequently. In this latter case it would be necessary to provide a means of checking to ensure that the index on disk had not got out of date and out of step with the data.

Although the simplest approach is to obtain and display a complete frame of data, it is possible to be more selective, only displaying a particular part of the data; for example a specific train time.

The problem with the use of keywords etc is that their intro-

duction removes some of the simplicity of the original idea. It is very important not to introduce the complexities of an elaborate data base system with its own special language. The preferred approach is to have a number of simple retrieval programs, each specific to a particular requirement. If the user requires access to data not covered in this way, he can always use the standard "menu" approach. Thus we can add to the viewdata capabilities without undue complication and without removing existing facilities.

Processing of Data

Having retrieved data from Prestel as indicated above, it is a straightforward extension to want to process that data. Obviously this is easier if the information is displayed in a fixed format, as the program will then know exactly where to find a particular item. It is, however, also possible to scan the information looking for a particular key, and so find an item of data from a relatively free-format frame.

Much of the data that is already on Prestel would be of greater value if it were possible to perform calculations directly on it. For example, it would be possible to calculate the current value of a portfolio of shares by accessing the stock exchange prices of each.

A second use for this idea is in conjunction with closed user groups, using Prestel as a communication medium. For example, the head office could put up current price lists on Prestel for use by subsidiary companies or retail outlets. These latter could in turn use the response frame facility to send back orders.

Input Validation

The concept of response frames is a very important and useful extension to viewdata. However, as currently implemented it has the serious weakness that no validity checking takes place on the "messages" that are sent from the user to the IP. This means that if, say, alpha characters are included in what should be numeric data, it is only when the IP views the completed response frame that the error is seen.

A program running in an intelligent terminal can overcome this problem by checking the data as it is entered, and only transmitting valid data.

A good example of this is an order entry system in which checks can be carried out for valid item numbers and the availability of stock. In addition, the operator has an opportunity to reject entries if he realises that he has made an error. Finally, in transmitting the response frame the terminal can check that the correct characters are echoed, and in the event of line errors can transmit the whole frame again, without the operator having to re-enter it.

I. P. Usage

There are already on the market a number of special purpose intelligent editing terminals for information providers. These are programmed to perform one particular job. The big advantage of telesoftware is that a general purpose intelligent terminal can be reprogrammed via the viewdata network to perform a range of different jobs. Examples include:

- * Processing Response Frames. For example, with the order entry system mentioned earlier the information provider's machine could automatically process the orders, producing invoices, despatch notes etc and update central stock levels. Note than one should try not to develop this idea too far: Prestel is not sufficiently responsive to accept orders for individual items such as in a seat reservation system. On the other hand, it is much better than mail order.
- * Updating of Frames. In the order entry example it would be possible to update Prestel automatically to indicate changes in stock availability.
- * Processing of Frame Information. It is possible to interrogate frames automatically on a regular basis, to check the counts of the number of times accessed.
- * Editing. Off-line editing facilities can be provided, either in a general way, or specific to a particular I. P.'s requirements.

So the intelligent terminal can perform a wide range of tasks for both the Prestel user and the information provider.

4. END USER COMPUTING

So far we have been referring to an intelligent terminal attached to a viewdata network. However, by virtue of its intelligence, such a device is also capable of operating as a stand-alone machine, off-line from the network. In this mode the user is not paying a time based charge, either for connection to a central system or for a telephone call. Instead he can run his own program entirely in his own time.

Furthermore, because colour and graphics are available as standard from viewdata chip sets, we have a relatively low-cost device with these features. It seems likely that colour will soon come to be the standard for displaying information in the office in the same way that colour television has taken over in the home. Thus, when combined with the distribution facilities of telesoftware, we have the ideal device for taking computing power to the end user.

In this section we consider just a few of the possible business applications.

Local Viewdata

The development of a full private viewdata system is a non-trivial task if one is to handle closed user groups, response frames, etc, and provide full accounting facilities. On the other hand, a simple retrieval system using viewdata protocols can be implemented very easily on a microprocessor based intelligent terminal with a suitable file store. And because of the great advantage of simplicity of use, this will be an attractive way to hold data.

A standard, single density, floppy disk can hold about 200 frames and can be carried around conveniently. It is possible to provide a password system for security protection but much greater protection is provided by the fact that the user can simply remove his disk and take it away with him.

Because we are working with a system with a local intelligence we can do things that are not possible with Prestel. Firstly we can write directly into the display memory instead of using a serial link. This means that instead of taking up to eight seconds to fill the screen it can be done virtually instantaneously.

Another important feature is the ability to modify parts of the

screen, rather than displaying a whole page at a time. We can use this to create dynamic visuals, and, particularly in conjunction with the use of colour, provide more interest through the use of movement on the screen.

Finally we can pre-program sequences of displays. In this way the device can be used as an aid to presentations, or to provide a continuous display facility.

Training

Computer assisted learning is an important topic in its own right. Usually it involves terminals on a mainframe computer, and is particularly relevant where there is a shortage of suitable teachers, or where the students need to fit in training between other tasks, for example when on shift work.

Prestel terminals with colour and graphics, can also be used, and with intelligent terminals used off-line, there is no usage charge. Prestel telesoftware can be used as the distribution medium or a private viewdata system can be used, so this will be particularly valuable for a company with scattered employees: maintenance engineers for example. And the fact that the program runs off-line after being brought down is an important psychological advantage to the slower student: it is not costing extra money if he takes his time. Furthermore, the intelligent viewdata terminal will be less expensive than most graphics terminals currently in use for CAL. So we are suggesting a very cost-effective solution.

The dynamic visuals of our local viewdata system can provide an interesting and effective medium for putting across basic concepts and the menu selection technique allows for multiple choice questions in progress tests. The system keeps a count of the routes taken, and the teacher can subsequently analyse the performance of individual students, and also the effectiveness of the course as a whole. Standard tools have been created to facilitate the production of training courses by teachers without a knowledge of computer programming, so again the end users will interact directly with the terminal.

Business Graphics

The graphics capability of a viewdata terminal is not of a high enough quality to produce high resolution pictures, but it is very suitable for producing diagrams such as bar charts and histograms, especially when use is made of the colour facilities.

The intelligent viewdata terminal with a file store is therefore an excellent device for an end user to store financial information which he can call up and display in a format of his own choice.

For example one could compare different sets of figures on the same graph, plotting differences or ratios. It is possible to request further details for one particular set of results that appears to be anomalous; for example getting monthly figures for a particular year. And it is also possible for the user to save a particular display for future reference.

All this can be provided via an easy-to-use interface, so that the system is "user friendly". As an example of this we can provide a "help" facility whereby the user can be prompted with a choice of possible actions at any point, by pressing a particular key. Another example is the user's ability to select his own colours, since we have found from experience that a choice of colours that suits one person can be found tiring by another.

Other Uses

Clearly there is a wide range of other possible applications for an intelligent terminal. The ones highlighted above have been examples where the special viewdata characteristics are important, but as a general purpose computer there is the full range of business applications, which would apply both to subsidiary branches of large companies and also to the hundreds of thousands of small businesses.

The viewdata standard of 40 characters per line is something of a restriction, since most small business computers have an 80 character VDU, and most business applications are programmed accordingly. It is possible to rewrite the programs to use the more restricted screen width, and we have done that in some cases. However, the answer is likely to come from hardware advances. Coloured terminals are being developed that are capable of displaying either 40 or 80 characters per line. An intelligent version of one of these would be software switchable between 40 character "viewdata" format and 80 character "business terminal" format, in the same way that the present terminal is switchable between the viewdata "page-at-a-time" and computer "scrolling" modes. And it would be possible to go further and use standard Prestel protocols for distribution of programs which were capable of using high resolution graphics.

So with telesoftware there is enormous potential for further development of the viewdata concept. MicroCobol is specifically aimed at the business market, but when the cost of terminals becomes low enough the potential of telesoftware for the distribution of home entertainment and educational programs will be enormous. However the opportunities and problems associated with the development of that market are still to be explored.

5. CONCLUSIONS

This paper has attempted to give an indication of the concept and possible uses of telesoftware in business applications, but has not been in any way an exhaustive study of the topic.

It is felt that most business users of viewdata systems will require some degree of intelligence in their terminals, and many will need some local file store. For these, telesoftware offers the ability to extend the capabilities of viewdata while still retaining the advantages of the original concept.

References

1. A. d'Agapeyeff "A platform for true program portability with examples from MicroCobol", Fourth International Conference on Software Engineering, Munich, September 1979.
-

Broadcast Telesoftware: Experience with ORACLE

John Hedger
System Coordinator

ORACLE (ITCA)
U.K.

The existing teletext decoder can easily be transformed into a home computer system capable of receiving software from teletext transmissions. Over the past two years ITV has broadcast experimental telesoftware programs on ORACLE and, using a specially designed Mullard receiver, has been able to demonstrate the use of this novel teletext application. Practical experience of the terminal and its design constraints are discussed, followed by an analysis of current thinking on future applications of telesoftware, including its possible exploitation in a commercial market and its likely interaction with Prestel.

Copyright © 1980 by Online Conferences Ltd.

1. Introduction:

ORACLE has been broadcast by ITV as a broadcast teletext (1) service to the public since 1975. As well as being a very efficient transmission medium for text and simple graphic data, it was soon realised that the system could be adapted to distribute computer software programs for home computers. Additionally, current teletext decoder technology has already furnished existing teletext receivers with most of the 'building blocks' required for home computer applications: memory, colour visual display, keypad input, etc. By adding the intelligence of a microprocessor plus extra memory, a standard teletext decoder could be transformed into a simple personal computer with an ability to receive its programs from off-air teletext. The user would have merely to select pages of teletext data which would carry the programs represented by teletext characters. Once a desired program had been received in the terminal, it could be executed by the microprocessor, utilising the colour VDU built into the decoder as output and the numeric keypad, normally used for set control and teletext page selection, as an input device.

This, in its rawest form, is the concept of broadcast telesoftware; a concept which represents a very cost-effective approach to personal computing, since once a user has purchased a telesoftware-adapted decoder, the telesoftware programs are totally free of charge. Additionally, programs can be kept up-to-date with any changes in precisely the same way as existing teletext pages are updated. But perhaps most of all, for perhaps the first time in the evolution of home computer technology, the user is not presented with a daunting and complex item of costly hardware - instead, he sees simply a television set with certain 'extra' capabilities - nothing that is likely to frighten him off even if he has never used a 'computer' before in his life!

2. An experimental terminal:

By the end of 1977 much had already been written and discussed on the subject of broadcast telesoftware and it was clear to us at ITV that the system could provide an important addition to our ORACLE system. However, at this time, no hardware had been produced in order to test the idea and prove its viability. So ITV together with Mullard Ltd. (who had been closely involved with developments of the teletext and viewdata systems) embarked upon a joint experiment to design and construct a very simple telesoftware receiver for evaluation using the ORACLE system to broadcast the trial software programs. The hardware was built at the Mullard Applications Laboratory, Mitcham.

Since at this stage there existed no specification for broadcast telesoftware, the design of the terminal and the strategy for encoding and transmitting the experimental program software had to be based upon entirely standard teletext techniques. The terminal itself was intended purely as a demonstration item and never as a definitive implementation of telesoftware, and it was built in a very short space of time. However, any shortcomings in its design and construction have subsequently been far outweighed by its immense value at exhibitions and conferences for the past two years as an excellent demonstration of the telesoftware concept.

2.1 Terminal Design:

The prototype terminal consists of three major parts; the TV receiver with ultrasonic remote control facilities; a teletext decoder module and purpose-built computer module. For convenience the two latter items were mounted outside the receiver in a separate box, together with their power supplies. Fig. 1, shows a block diagram of the terminal overall design.

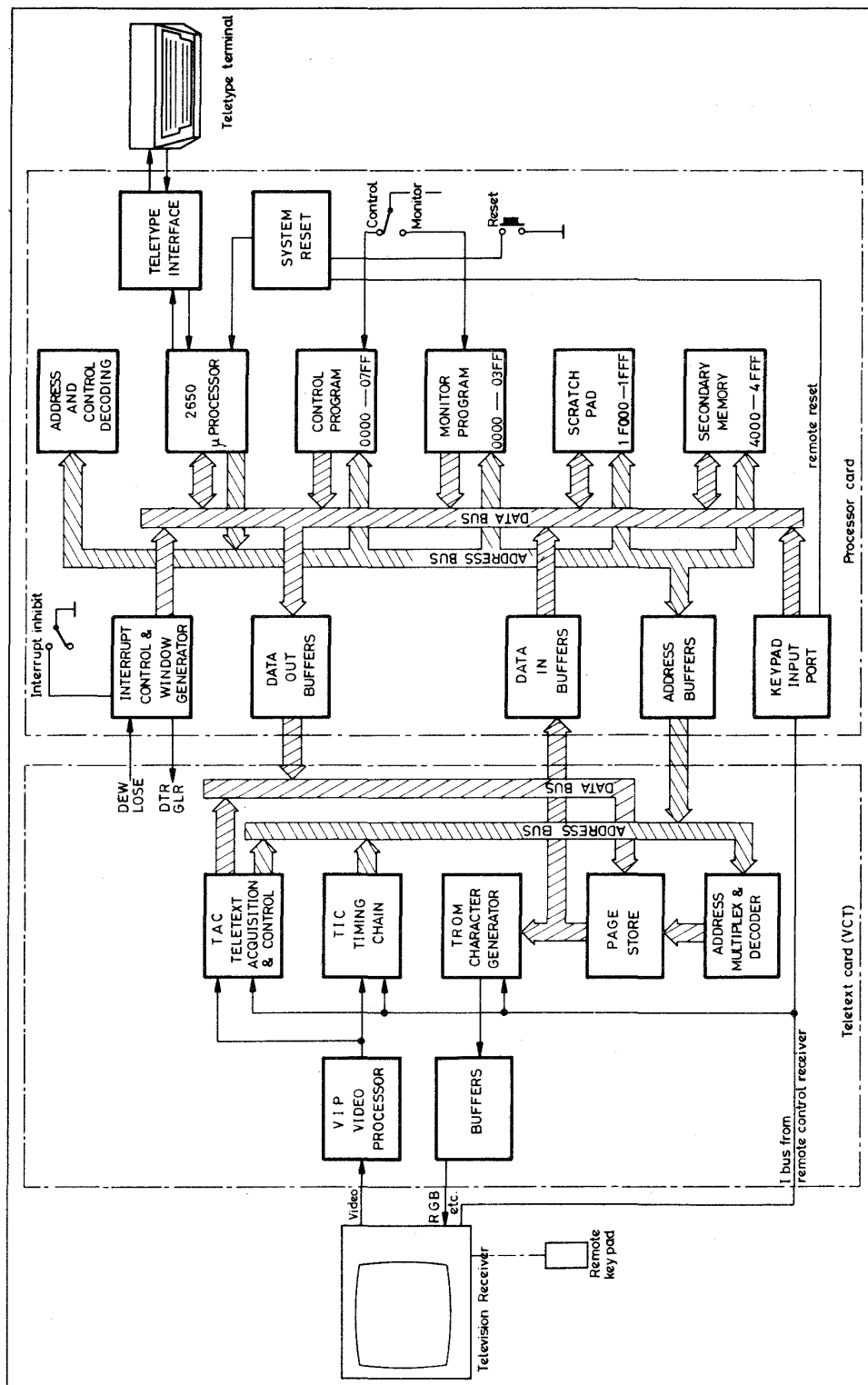

FIG. 1. TELESOFTWARE DEMONSTRATION SYSTEM - SIMPLIFIED BLOCK DIAGRAM

The teletext module contains a standard Mullard production teletext chipset and is of the Viewdata-compatible type. This allows data and address lines to and from its page store to be accessible to an external module, in this case, the microprocessor. The computer module contains a Signetics 2650 type microprocessor together with its associated random-access memory and other components which together form the local micro-computer facility.

The microprocessor has access to the teletext decoder page store (read-write) which consists of RAM normally used exclusively for storage of a single teletext page. In addition, there is a scratchpad of 256 of RAM used as a buffer store for telesoftware program data between the page store (where it is originally received) and secondary memory (main microprocessor memory) which is a further 4k bytes of RAM. A control program is held on 2k bytes of erasable PROM and is responsible for validation of incoming teletsoftware data, transferring valid data to secondary memory via the scratchpad, re-reading incorrectly received data on a subsequent transmission of the teletext page, and going to the start of the program when it has been received completely. The teletext keypad commands are taken to an inport port on the micro-

processor, enabling it to be used as a command and data-entry device.

2.2. Operation:

No action takes place until a page containing telesoftware data is received in the page store. Until this point the terminal behaves exactly like a normal teletext/television receiver, storing and displaying pages as required. In this mode, the microprocessor is simply scanning any page loaded into the page-store for a special sequence of characters which identifies the page as containing telesoftware data.

Once such a page is loaded, the microprocessor will upon recognition perform various error checks upon the data before loading verified data into the appropriate portion of secondary memory. This process will be repeated until all such pages forming the complete program have been received and verified. In the event of errors being detected, their position on the page is stored in a table and such bytes are re-received and re-tested on a subsequent pass. Since errors are unlikely to occur again in precisely the same place, the chances of obtaining a perfect program after a second page transmission are good.

2.3. The Telesoftware Page Format:

As already mentioned, the whole experiment was deliberately based upon the use of **standard teletext technology** and this included the use of display characters to represent bytes of computer software. For this reason means had to be derived to add further measure of protection to the data, since clearly no errors could be tolerated in a program which could not be detected by the microprocessor.

Thus the strategy chosen was to derive a single 8 bit byte from every two teletext characters. Eliminating non-displayed control characters caused 2 bits from the available 14 to be redundant, leaving 12 usable bits, 8 of these made up the software byte while the other 4

were used as Hamming code (2) checkbits. A block-check character was also included giving a further measure of protection. Thus by these means the microprocessor could detect errors via the existing teletext parity checks (character displayed as a space) Hamming check and block-check. It will be noted that using the Hamming code protection in this way it would theoretically be possible to recover from single-bit errors, although this facility was not included in the original terminal design.

A special sequence of characters was used to identify the page containing telesoftware data, followed by a comment field (Row 01). The next row was used to send control and status information, such as program size and address, and this data, consisting of 16 teletext characters, was repeated further along the row (Row 02) to give a 'second chance' should the first occurrence be received incorrectly. The remainder of the page contained program data. By utilising this form of encoding, the maximum program which could be carried by each teletext page is 420 bytes. However, the redundancy is somewhat outweighed by the fact that in two years of demonstration use, the terminal has never failed to detect an erroneously received program!

3. Experimental Programs:

Clearly such a hardware device would have been rather academic without some practical software programs with which to demonstrate it. Four such programs were originally developed, and these have been broadcast since early 1978 on the ORACLE system. They are broadcast as machine-code for the 2650 microprocessor, since this represented the most convenient method available at the time the terminal was conceived.

It was intended that these programs should represent some typical uses of a possible future broadcast telesoftware facility.

NATIONWIDE BUILDING SOCIETY

MORTGAGE CALCULATION

<ordinary repayment mortgage>

To compute your monthly repayments
complete the following questionnaire
using keys 0 to 9. Key * for next line.

SUM BORROWED <up to 99999> £13500

INTEREST <currently 12.00%> 12.00%

TERM < 5 to 35 years > 25years

GROSS MONTHLY REPAYMENTS WILL BE

£143.45

To start again key *

Fig 2. Mortgage Calculation Program.

The most popular of these is the Mortgage Calculator (Fig 2.). This program calculates monthly mortgage repayments based on term, sum borrowed and current interest rates. The interest rate forms part of the program, while the other items (conveniently numerical) are input by the user on the keypad. The whole point here is that whenever the interest rates changed it was possible to change the broadcast version of the program accordingly so that whenever anyone subsequently accessed the program it would give fully up-to-date results.

There is an Insurance Quotations program, prepared for us by the Automobile Association and designed to give the user a quotation for car-insurance based upon numeric responses to questions of the type found on normal proposal forms. Although the program was obviously limited in its range of vehicles covered, it served to show what might be possible from a commercial viewpoint in a real system.

Even at this early stage it was felt that telesoftware

could become a very useful educational tool, and so a simple computer-aided learning program was included. This aimed to teach an example of first-aid, using multiple-choice techniques already extensively employed in traditional C.A.L. programs. The presentation seemed to benefit greatly from the colour-display, which is not normally available when C.A.L. programs are executed on traditional computer systems.

Finally, a number-guessing game was included.

Although all crude, these programs served to excite interest in broadcast telesoftware and to enable us to isolate some of the major applications areas for the future. Some of these are discussed.

4.1. Assessment Programs:

The first logical group of applications programs might be termed 'assessment' and would include areas such as mortgage and tax calculation, social security benefits etc. These are mainly question-and-answer in nature, with the program performing various types of calculations on the data which the user provides. Some examples would need only the basic numeric input (where the existing keypad would suffice) but others requiring actual textual input, would demand a full alphanumeric keyboard facility. Use of the full keyboard, while it might seem rather daunting at first, has the advantage of not inhibiting user-response so much as would having to design programs around numeric-only input.

Another characteristic about this group of applications is their high text-storage demands. Generally, even quite complex calculation routines will be exceeded in their requirements for memory by the associated text, often by a factor of several times. This has to be borne in mind if RAM is the only feasible storage medium which the terminal has available.

A distinct advantage of the broadcast telesoftware approach is that the user is afforded total security with respect to the data he might input during the course

of a program run. Since the terminal has clearly no means of communicating such data to the outside world, the user can have total privacy assured: a factor which might well be particularly applicable to the tax-calculation example already mentioned!

4.2. Calculations:

Calculations on telesoftware could be far more complex than those often associated with pocket calculators since a program can be configured to handle very specific calculations which would otherwise have to be laboriously programmed manually. For example, a program to calculate the most efficient form of central heating in a home. The system could also be applied to metric conversion, gas and electricity consumption, investment etc.

4.3. Games:

Games on telesoftware would tend to break down into two further groups; reasoning and dexterity. Games of reasoning are ideally suited to the basic system, and would not normally require more than the basic keypad. Even games such as chess become quite practical when high-definition graphics are considered. Dexterity games on the other hand raise different problems. These are the kind usually associated with traditional plug-in video games hardware, and would demand external devices such as joysticks and paddles with which to control the games. Timing of games would also become necessary and also a distinction between games in which the terminal merely 'manages' a game between two opponents and games in which one or more players actually compete against the terminal itself.

The over-riding advantage with telesoftware is that a single terminal can encompass such a variety of different games which may be altered from day to day by the broadcaster. In this way, telesoftware becomes highly attractive compared with the traditional rather limited hardware offered by existing video games manufacturers, since however many different games a user may access he never pays a penny for any of them!

4.4. Education:

Education is likely to be a major application area for the system, and one which is already receiving priority within ITV. It can be effective at many levels, but seems particularly relevant to the increasing trend towards education in the home. It is extremely cost-effective as a means of free software distribution and imposes no limit upon the number of 'pupils' who may access a given program simultaneously. Many subjects already covered by traditional C.A.L. techniques can and have been translated directly into telesoftware implementation, and with the use of higher-definition graphics, subject material previously limited to specialised displays (such as geometry) become feasible with telesoftware. However, in order to be really effective in terms of diversity and complexity required, a telesoftware education service would have to occupy a significant portion of a teletext database, a situation which becomes feasible through use of further field-blanking lines than at present. The use of time-coded pages already specified for teletext is also possible and would enormously increase the number of programs able to be transmitted throughout a day without a direct access-time penalty.

The Department of Industry has funded a telesoftware evaluation project for 1980 which is being conducted by Brighton Polytechnic in conjunction with both ITV and BBC teletext authorities. The project will provide for a number of telesoftware terminals to be placed and used within schools and should give an excellent opportunity to evaluate the possible uses of the system in a 'real' environment.

4.5. Database Broadcasting:

Sounding rather like a contradiction in terms, this group is best explained by an example. Suppose telesoftware receivers are located at point-of-sale in stores and shops. A small program is loaded into each terminal at the start of the working day and throughout the day an updated list of lost or stolen credit card numbers is broadcast via teletext and used by the terminals to

update internal lists. The shopkeeper, when presented with a 'dubious' credit card has simply to key its number into his terminal. The program then tries to match this number with one from its latest broadcast list and if it succeeds, a suitable message would appear suggesting that the shopkeeper take appropriate measures; otherwise the transaction proceeds normally. Such a service would be entirely free to the shopkeeper and would be capable of instant nationwide update via the teletext systems.

This example illustrates the concept of the broadcast database, which is particularly relevant where the total amount of data is fairly small but subject to very frequent updating. Depending upon the application, all or part of the database can be held in the terminal after it has been broadcast, leading to very rapid local searches through the data. Future applications of this system might include transmission of catalogues and price lists. By natural extension, the idea of the broadcast closed-user group is also technically possible, though it would almost certainly be questionable legally, being described as 'narrowcasting' rather than public broadcasting.

4.6. Enhanced Teletext Usage:

The addition of intelligence to the teletext receiver also opens up new means by which the user can make more effective use of the broadcast data and access it more efficiently. For example, data could be searched automatically using keywords such as NEWS, CRICKET, SHARE PRICES etc., instead of via the current index system. It is also possible for other telesoftware programs to make use of teletext data within their calculations, for example, a program designed to tell the user whether it is more beneficial to use cash, travellers cheques or credit cards when visiting a particular country would depend upon current exchange rates. By deriving such data from teletext not only is it acquired conveniently but also in its most up-to-date form.

Telesoftware will also provide means for extending the character-set capabilities of the current teletext

system and also for high-definition graphics displays generated within the terminal. Additionally, while not being used for the storage/execution of telesoftware programs, the microprocessor memory could be used to store normal teletext pages within the terminal, allowing the user rapid access to these.

5.1. Software Considerations:

The experimental terminal utilised machine-code-transmitted programs for purely practical reasons. This method is compact and convenient when dealing with a single terminal employing a known microprocessor and instruction set, but of course, allows no portability between different microprocessors. Such a system were it imposed as a standard for telesoftware, would be impractical and restrictive.

It would be more desirable to employ a transmission method using a high-level programming language and to use a resident interpreter within each terminal to execute such a code. With this approach, only the interpreter needs to be specific to a particular microprocessor; programs themselves are machine independent. By transmission of compacted source-code in such a high-level language, the total amount of bytes per program can be effectively reduced. This factor is crucial in telesoftware since the longer the program is transmitted, the longer the user must wait until the software is loaded from the teletext system.

Thus a suitable high-level language must be identified and defined. Such a language, as well as being able to be capable of a high degree of source code compaction, must also be able to be extended to permit the specialised screen-handling and other peculiarities inherent in telesoftware. ITV's research to date (3) has pointed to a modified form of BASIC as being most appropriate for this purpose, and some experimentation involving BASIC is already under way, although no final conclusions have been reached.

5.2. Program Integrity:

Since the concept of telesoftware is to provide the inexperienced user with the means to use sophisticated and complex computer techniques in a very simple way, there can be no accepted computer 'operating system' involving commands such as RUN or OLD nor can there be error messages such as ERROR AT LINE 250 ATTEMPT TO DIVIDE BY ZERO. Such jargon would be meaningless and probably offensive to the average telesoftware user. Instead, programs must be subjected to strict quality-control checks prior to their transmission on-air so that 'bugs' are totally avoided and terminals never produce obscure or meaningless information.

However, clearly there will be a significant minority of users who already have some knowledge of computing and would wish to create and modify programs on their terminal. If such users accept that their terminals must by definition be more complex (and consequently more expensive) than average, by design of the language in which programs are written as a defined subset of a more comprehensive language (incorporating program development aids), such users could theoretically modify certain broadcast programs as well as being able to use their terminals for their own programming. This concept is still being evaluated.

6. Commercial Exploitation:

As already indicated by some of the preceding examples, broadcast telesoftware is capable of being applied in such a way as to become revenue-producing for ITV. But the actual means by which the system can be exploited commercially are less obvious than with a Prestel-borne system. No means exist for charging the user directly for the provision of software, nor can he be charged for the actual reception facility since this is already included in his TV licence fee.

However, many exciting possibilities do exist. By using the database techniques already described and applying it to catalogues, prices therein could be kept constantly

up-to-date and the terminal will work out the V.A.T! No matter how quickly the information were changed, the broadcast system could communicate the data nationwide almost instantly. Telesoftware games could provide a novel way of promoting a service or product, while with classified advertising, the user will no longer have to pore through the pages of newspapers advertising, nor even through the pages of ORACLE - instead his terminal will take over the job of laborious searching for a specific item. All the user has to do will be to input to the terminal the particular product, price, colour, size, etc., in which he is interested. And the terminal isn't likely to miss any bargains!

However, most of the marketing ideas have not been able to be tested to date, since at the time of writing, permission has yet to be granted for ORACLE to commence taking paid advertising on the system.

7. Future Development:

Much work of a broadly technical nature is now underway to establish standards for the next generation of teletext and these will include the implementation of telesoftware facilities. In designing terminals for telesoftware, a very careful line will have to be drawn between flexibility and economics. A highly flexible system would inhibit growth of a market, whilst a rigidly-defined approach would start off being economic but grow increasingly restrictive as demands became more complex and hardware even cheaper!

However, there are two over-riding factors which tele-software designers must bear in mind for the future: Firstly, all the new tricks must still preserve the compatibility with earlier generations of teletext and not render existing hardware obsolete overnight!! Secondly, it is essential that telesoftware on broadcast teletext and telesoftware on Prestel should not take divergent paths and end up incompatible. Such a situation would be unproductive and unnecessary. It has been suggested that broadcast telesoftware enables

teletext to compete in certain areas with services offered on prestel, and that because it is a free service, could threaten the prestel system in some ways. Certainly in the early days there will be inevitable competition, especially in the domestic market, where teletext, being a free service is already establishing itself effectively.

However, if one looks beyond these early days when both systems are seeking to establish themselves, a more likely conclusion can be reached. The purely interactive capabilities of prestel such as electronic fund-transfer, are precisely those which broadcast telesoftware by definition cannot cope with. In a similar way, demands of the prestel system for the same items of data simultaneously by more than a few hundred users would overload not only the prestel computers but the telephone system itself! Clearly, as both types of service become part of our daily work and leisure routines, demands are bound to be made which neither system in isolation can handle effectively. Exploiting the particular advantages of both types of system in combination will produce a very efficient and potentially exciting information technology, a step which can only benefit the user by the diversity of services which could be made available to him. Without compatibility between the two systems at the telesoftware level, such a step would be almost impossible!

8. Conclusions:

The experimental work carried out so far has shown broadcast telesoftware to be an elegant and cost-effective means of providing useful and entertaining computer facilities to the inexperienced user through the medium of teletext. With mass-production, a teletext decoder/TV set equipped with a basic telesoftware facility would be likely to cost an extra £50 as compared with the same set but teletext-only. This cost represents a once-and-for-all payment since software for the terminal remains entirely free throughout its life. The cost of adding other peripherals (floppy disks, printers etc.) to the basic telesoftware unit would be

TELETEXT IN THE FEDERAL REPUBLIC OF GERMANY

Present Situation and Prospects

by

Ulrich Messerschmid

Director

Institut für Rundfunktechnik, Munich

In the Federal Republic of Germany Teletext is still in the stage of technical developments, demonstrations and field trials. Some experience has been gained from the International Radio and TV-Fairs, Berlin 1977 and 1979, however the technical field trials showed a rather close correlation of picture quality and teletext failure rate. To support international standardisation, field trials comparing the geared and asynchronous systems are being carried out now. Some new developments will facilitate the combination of different services and the subtitling process.

Copyright © 1980 by Online Conferences Ltd.

1. INTRODUCTION

Five years ago some experts of the British broadcasting companies together with some German colleagues organised the first field trial of teletext. The signals were distributed by the Bavarian Wendelstein transmitter in the region near Munich. This was the first teletext activity in my country, if the term 'Teletext' is used for the now well-known distribution system of coded texts and graphics in the vertical interval of a TV signal. Earlier German proposals dealt with the distribution of subtitles only and these more confined systems were abandoned after the appearance of the more universal teletext system.

Four years ago, in January 1976, the commission for the development and extension of the German systems of telecommunications (Kommission für den Ausbau des technischen Kommunikationssystems, KtK) published its final report, which stated: Videotext (teletext) is a new form of telecommunication which, technically, can be realised in existing networks, at low cost.

Since that time the possibility of a teletext service in Germany has been lively discussed in many political groups, particularly within the broadcasting companies and the associations of the newspaper and journal publishers.

2. TELETEXT IN THE POLITICAL DISCUSSION

There are three main arguments in the extended discussion of the past years.

The broadcasters together with a vast majority of the German Bundeslander declare that teletext, technically as well as legally, is a broadcast service and therefore should be run by the broadcasting companies.

The Publishers claim that teletext is an electronic form of a newspaper, intended for reading, and composed of pages with information. For that reason they want to run this new service themselves, or, at least, to be granted access to this new form of telecommunication, which is much quicker than distribution of printed material.

The political parties in the Federal Republic of Germany discuss the teletext issue in the larger framework of new technologies in communications.

One political group pleads for extended tests and trials prior to any introduction of new services. The tests and trials are expected to impart knowledge which is needed to evaluate the social impact and implications. This demand leads to a slowing down of development - not technically, but with respect to the beginning of real services. Some parts of this political group even think that a pause might be opportune.

Another political group wants to hand over the teletext services to private companies, or more or less directly to the newspaper publishers.

There are fine prospects at the moment for a compromise. In the experimental service, intended to start in summer 1980, the teletext programme is planned to include some pages edited by the newspaper publishers and giving a preview on the headlines of the latest newspapers or of the issues of the following day.

3. TECHNICAL FIELD TRIALS

3.1 MEASURING PROCEDURE

In 1978, the German broadcasters, together with the IRT, Munich carried out a very large measuring campaign to find out what degree of coverage could be expected from a teletext service with the British system. More than 1,300 measuring points have been evaluated, including all frequency bands (I, III, IV/V) and all three programmes.

For such a large number of measuring sites we had to establish a rather simple measuring procedure. It consisted in simply attenuating the incoming signal until the so-called error-threshold was reached. This threshold between an error-free teletext picture and an unusable disturbed teletext picture was found with a surprisingly high degree of exactness and reproductive capability, due to the fact that digital signals break down rather sharply at a certain degree of impairment. A special test picture was used (Fig. 1), which contains the complete set of alphanumerical characters as well as all display colours and uses all display control functions. The character pair 'blank' and 'zero' in the third and fourth position in each row contains single bit positive and negative pulses (0000100,11110111). The sequences '8 NT' and 'G 1 + ' contain complementary sequences of pulses, which are 3, 2 and 1 bit wide (Fig. 2). These combinations of characters support an oscilloscopic evaluation of the wave-form.

As you can see from figure 3, 72% of the measuring points had a quality of the received normal colour TV picture equal to or better than 3 = fair on the CCIR quality rating scale. 77% of the measured points showed an error-free teletext reception which is 5% more than



fig. 1

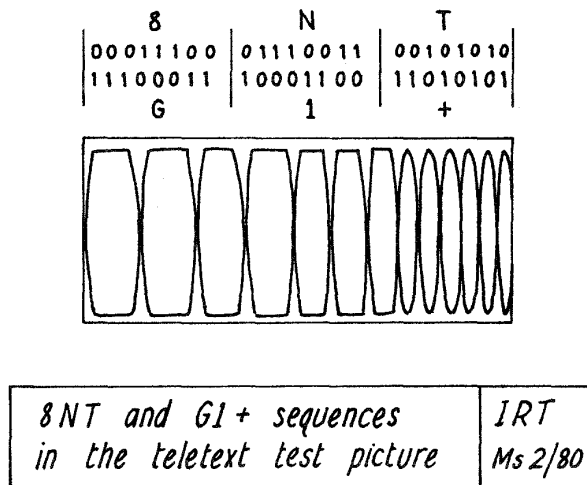

fig. 2

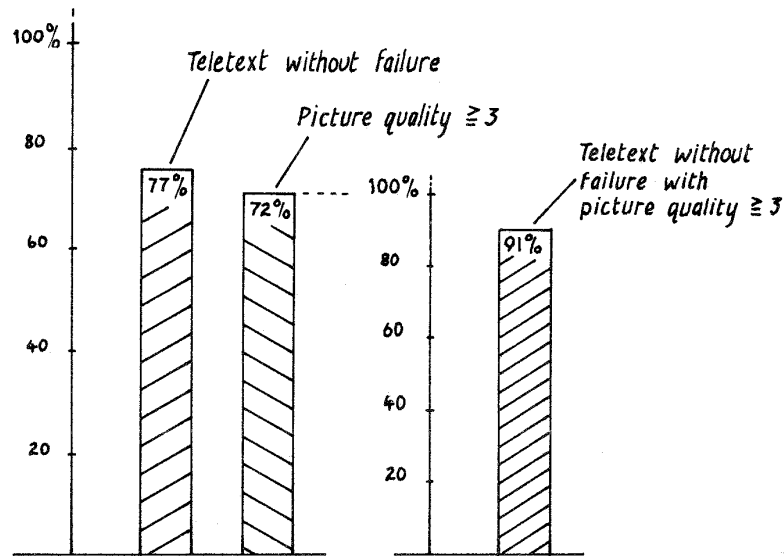

fig. 3

RESULTS OF TELETEXT FIELD TRIALS	IRT
1350 measured points, antenna 10 m.	Ms 2/80

for an excellent, good or fair colour picture. Nevertheless, due to the statistical distribution of the different kinds of impairment, 9% of those measurement points with a picture quality of ≥ 3 failed with teletext.

In addition to these measurements in the field, 270 measurements were taken at the sockets of antenna installations in private households. (Fig. 4). In this case, slightly better results were gained for the teletext reception as well as for the quality of the colour picture. Only 6% of those teletext receptions failed, which belonged to a picture quality ≥ 3 .

A rather interesting result of our measuring campaign is given in Fig. 5. It shows the correlation between the distribution of the picture quality and the teletext failure rate r_f . Looking more closely at these results, we find that, depending on the amount of colour pictures rated as 'fair', 'good' or 'excellent', the failure rate r_f rose from 5 to 11%. This becomes quite evident in the following three examples.

10% fair, 45% good, 45% excellent makes $r_f = 5\%$

33% fair, 33% good, 33% excellent makes $r_f = 8\%$

60% fair, 20% good, 20% excellent makes $r_f = 11\%$

To sum up: teletext with the rather high bit rate of the British system of 6.9 mbit/s should work in our country for those sites where the TV reception is satisfactory, if we do not expect a coverage of 100%. It depends on the nature of the teletext service whether this might be tolerated. Subtitles, for instance, would be more critical and demanding than a rather independent information service.

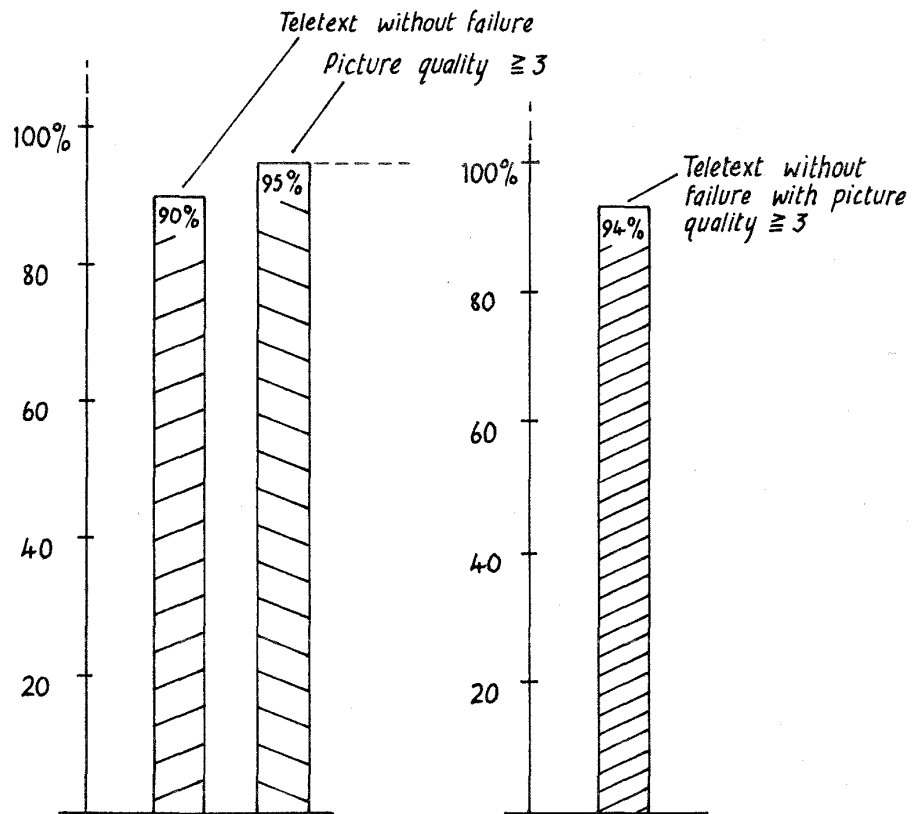

<p>TELETEXT TRIALS AT ANTENNA INSTALLATIONS IN HOUSEHOLDS 272 measured points.</p>	<p>IRT Ms 2/80</p>
--	------------------------

fig. 4

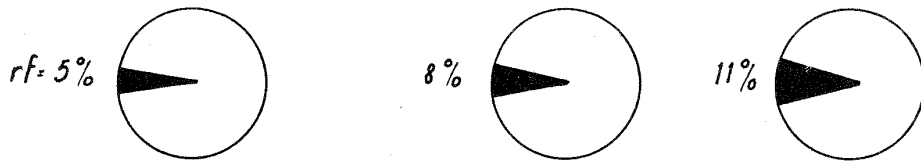
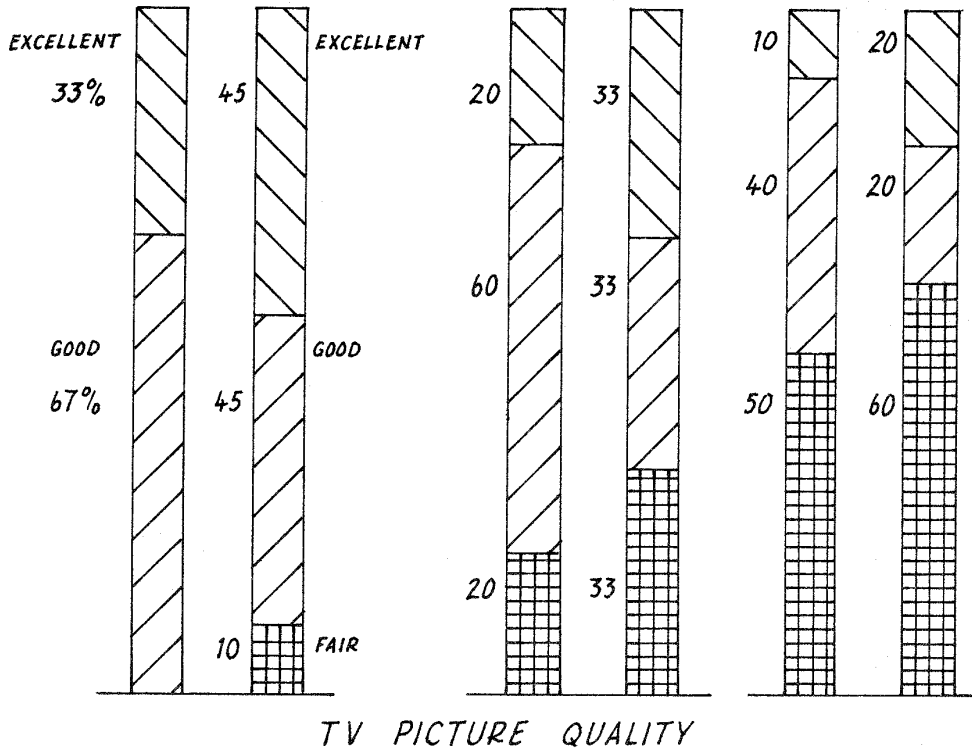

TELETEXT FAILURE RATE

CORRELATION BETWEEN COLOUR PICTURE QUALITY AND TELETEXT FAILURE RATE <i>rf</i>	IRT Ms 2/80
--	----------------

fig. 5

We intend to carry out field trials with the ANTIOPE system this year. From the results gained in Italy and Switzerland a slightly higher coverage is expected, if the bit rate is reduced from 6.9 to 6.2 mbit/s. Furthermore, the ANTIOPE system seems to offer a more specific scale of protection levels.

4. DEMONSTRATIONS AT THE INTERNATIONAL RADIO AND TELEVISION FAIRS, BERLIN 1977 AND 1979

In both events, IFA '77 and IFA '79, ARD and ZDF demonstrated the possibilities of teletext not as a new medium but as a supplementary television service. The main idea was to present actual news (politics, culture, sports) as well as information related to the sound and television programmes. The demonstrations, therefore, included subtitling for the hearing-impaired people, subtitling in foreign languages, subtitling in German for foreign feature films, teletext question and answer pages for didactic previews of sound and TV programmes, and additional information on current television programmes, such as staff lists, biographical remarks, data on special features of the performance and time of origin of a play or of a piece of music.

The demonstrations in Berlin provided very valuable experiences with respect to the two main editing criteria of a teletext service: the graphical design of a page and the concise linguistic styling. Both characteristics are closely related; it is not advisable to use more than five rows per paragraph and more than three paragraphs per page. The use of different colours is very helpful in structuring a text. For the technical facilities in the teletext studio, located behind a large glass pane, the IRT in Munich provided the main parts of the equipment and engineering support. The teletext computer (partly of British origin) was able to transmit complicated sequences of teletext pages in order to allow for variable access times for the different kinds of pages. At IFA 1977 an average of 150 basic pages with a rather large number of additional multi-pages was inserted in two lines of the vertical interval. This resulted in access times from 10 to 60 seconds. As a result of the experiences gained at IFA '77, the number of pages at IFA '79 was reduced to 75 basic pages and a rather small number of additional multi-pages. Thus, the average access time could be lowered down to 15 seconds (10 seconds for the frequently used and up to 30 seconds for the less frequently used pages). We think that a sufficiently low access time is one of the fundamentals with respect to the acceptance of the service.

In 1977 the demonstration was more or less confined to the exhibition halls and to the town of Berlin, whereas in 1979 the teletext signals were radiated by the whole first and second television network all over the Federal Republic of Germany.

At both Radio and Television Fairs (IFA '77 and IFA '79) our French colleagues demonstrated their ANTIOPE system, and the German newspaper publisher organised a demonstration of the so-called Bildschirmzeitung. Those demonstrations were confined to the special booths themselves, whereas the ARD/ZDF signals were received at many television sets at the various booths of the television set manufacturers.

5. CAPACITY AND ACCESS TIME

As already mentioned, a sufficiently high capacity together with a low access time are vital characteristics of a successful service. The capacity i.e. the number n of pages in a service, depends on the following factors: the bit rate f_b , the average use of page expressed as the relation of the number of used rows r_m to r_{max} , the cycling time t_z , which is equal to the maximum access time, the number i of data lines used in the vertical interval, and a factor k specific to the system and dependent among others on the prefix. For UK teletext with $k = 0,3$ mbit the number of pages is determined by

$$n = f_b \cdot \left(\frac{r_{max}}{r_m} \right) \cdot t_z \cdot i \cdot k$$

As shown in figure 6, with $\frac{r_{max}}{r_m} = 24 \div 20$, 75 pages are possible with a cycling time of 15 seconds in two data lines, and 375 pages in 10 data lines. These 10 lines will be available within the next 5 to 6 years.

6. EXISTING TELETEXT FACILITIES

In Germany (FRG) there exist the teletext generating and editing system capable of transmitting eight magazines with graduated access times, used in Berlin 1977 and 1978 and the system intended for the experimental service 1980/81.

In addition, a subtitling system has been developed in the IRT, (figure 7).

The whole subtitling process can be divided in the three sections formulating, editing, and timed insertion.

The f o r m u l a t i n g is done by means of a 3/4 inch video tape recorder. The tape on this recorder carries not only the normal TV programme (picture and sound) but also the EBU time code for television tape recordings. This time code is displayed in a section of the television picture on the monitor. In the process of formulating the subtitles, the stop motion and slow motion capability of the 3/4 inch VTR machine is used extensively.

Subsequently there follows the editing of the subtitles on a data terminal connected to a minicomputer. This computer controls the transmission of character codes and display codes, checks the text display with respect to colour as well as single or double height, and the length of the subtitle and its distribution in one or two rows, and adjusts the text in the middle of a row or, optionally, lefthand or righthand flush. Furthermore, the computer programme is designed for correction of texts or time codes. The final product of the editing is a record of the complete subtitles and time codes on a data cassette.

The time insertion (figure 8) of the subtitles is done by comparing the time codes from the one-inch or two-inch video tape recorder with the subtitle from the data cassette. Via microcomputer this comparison controls the insertion of the teletext subtitle data, which are fed to the teletext studio computer. This computer, for its part, incorporates the subtitles with first priority in the teletext sequence ready for insertion in the video signal from the VTR.

In the first stage of development the software of the teletext studio computer had not yet been adapted to priority insertion of subtitles, therefore - by means of a simple interruption - the subtitle signal was fed to the vertical interval inserter (VIS) directly.

7. FUTURE DEVELOPMENTS OF EQUIPMENT

The federal structure of the broadcasting system in Germany lends itself to various possibilities for the exchange and combination of teletext pages coming from different sources. One possibility of doing so is the use of different data lines in the vertical interval. Another possibility consists in connecting two or more teletext computers by means of data transfer.

For some application, however, a third possibility might offer considerable advantages. It consists in combining pre-determined parts of two teletext sources by means of a so-called teletext combiner.

This combiner is being developed at the IRT and is scheduled to work as described in figure 9. All the incoming teletext pages of the two sources are stored in a random access memory. The main task in developing the combiner is the design of an appropriate software for the control of this store. It has

- to incorporate subtitles with first order priority and programme related pages with second order priority
- to exchange predefined pages
- to suppress some other predefined pages
- to combine predetermined parts of the incoming services.

We hope that this kind of equipment will be helpful in building up

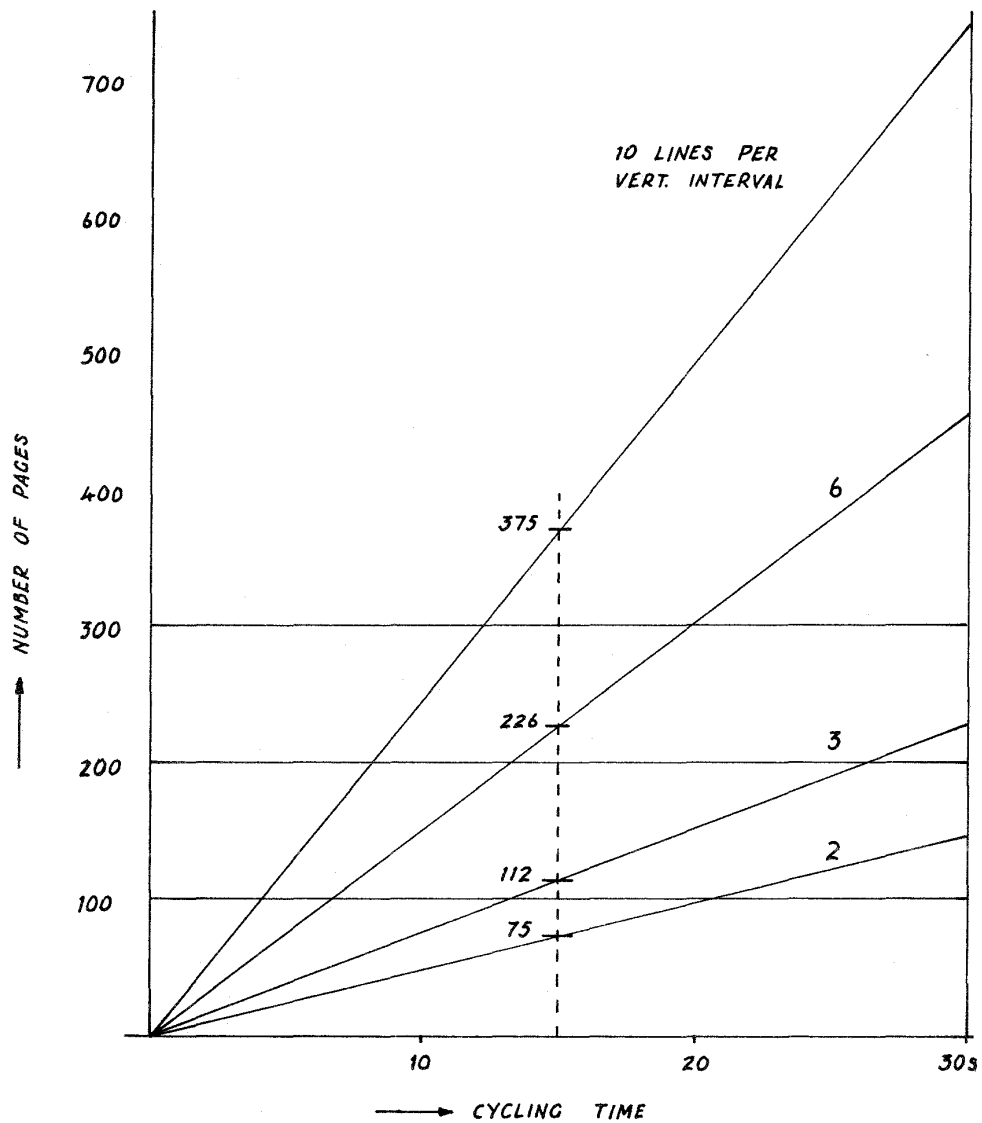

<i>CAPACITY OF A TELETEXT SERVICE</i>	<i>IRT</i> <i>Ms 2/80</i>
---------------------------------------	------------------------------

fig. 6

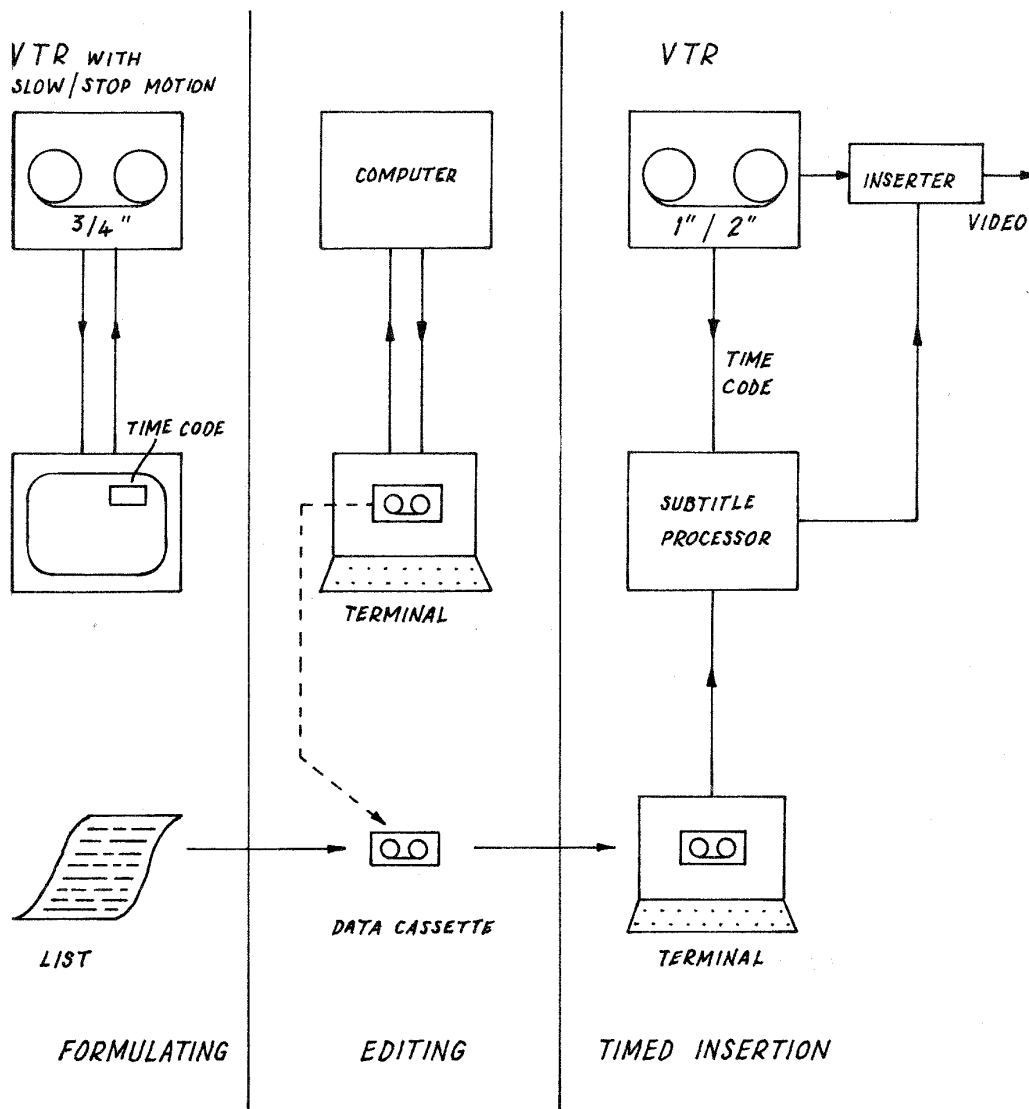

SUBTITLING WITH TELETEXT IRT - SYSTEM	IRT Ms 2/80
--	----------------

fig. 7

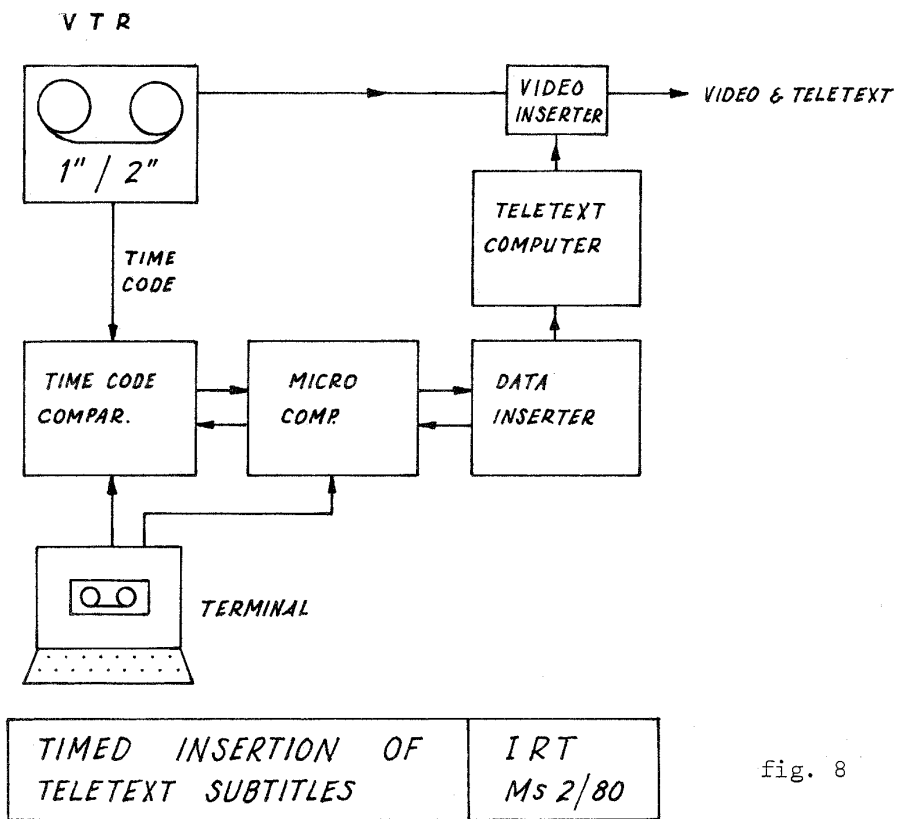

fig. 8

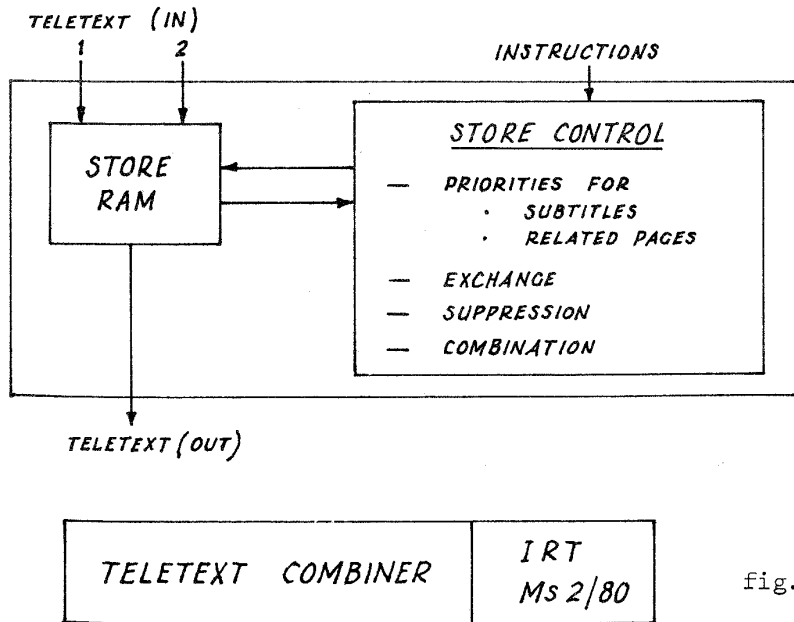

fig. 9

future structures of teletext services with central, regional, and local components.

8. CABLETEXT

In cable systems it will be possible to use a whole TV channel for teletext distribution. One approach to such a system is to use exactly the same coding and transmission techniques as for teletext. Another approach being discussed in Germany recommends the use of normal data transmission methods without referring to TV lines. In the latter case a bi-directional type of service could be established for dialling up pages out of a large central computer store.

A third approach lying in between the two other ones, maintains the structure of the TV fields with line-and-field-synchronising pulses and uses the number of TV lines as an additional means of addressing the large number of pages distributed in a cabletext system.

9. DEVELOPMENT OF STANDARDS

In this very short review I do not intend to depict all the details of the rather complicated discussion of standards for broadcast teletext and for the closely related interactive teletext systems. Therefore I shall confine myself to some very brief remarks.

The large field trials and demonstrations have been executed with the British "geared" system. In 1979 a national version of the basic character set had been chosen which renders all the German Umlauts and special characters, such as ß and §. But in doing so, we did not intend to make a final choice. Therefore we now started field trials with the second group of teletext systems, i.e. with a non-geared asynchronous ANTIOPE system.

In any case, a final broadcast teletext system should provide all the accented letters and special characters standardised by ISO. If a geared system is introduced in our country, an appropriate compatible extension of UK teletext is needed. Up to now two different solutions for such an extension have been discussed in Germany. Both proposals are using the additional addressing capability of the 'blind' rows from number 24 onwards.

The first proposal, called multi-page solution, provides up to 16 character sets, which are either dedicated for one single language each or for groups of related languages. Thus, all the characters needed in one word without spaces are found in one set. An additional set evoked by the control characters switch-in (SI) and switch-out (SO) contains all the special character and mathematical signs.

Although offering a technically sound solution, it is very difficult to standardise the multi-page system, because a large number of national character sets would have to be defined.

Therefore, the second proposal, the Polyglot system developed in the Netherlands, has a better chance. As shown in fig. 10, the polyglot proposal uses not only odd parity but also even parity codes. In the additional 'blind' addressing rows (number 24, 25, 26,...) the addresses of all those bytes are transmitted which make use of the even parity. Thereby four additional character sets are available: one set for lower-case accented letters,

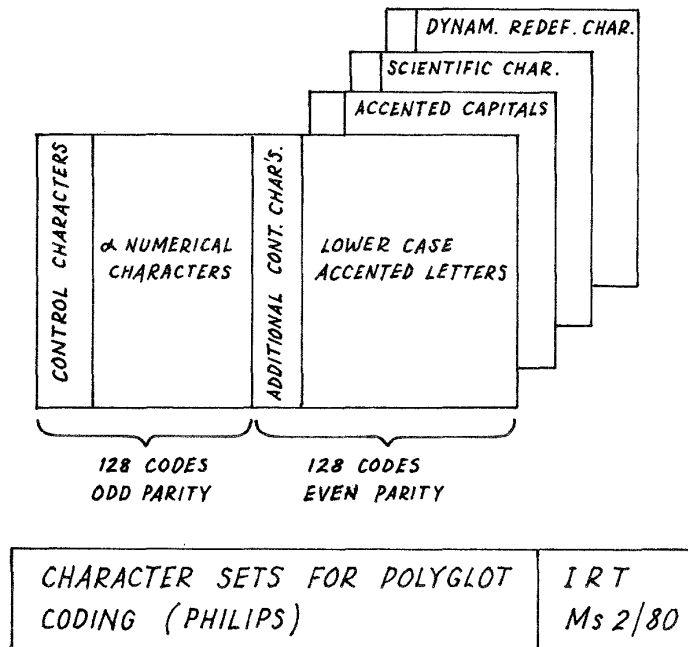

fig. 10

one for accented capitals, one set for scientific characters, and the fourth set for dynamically refined characters (DRC). In this way a parity check is possible for all the characters, although the eighth bit is used for the transmission of information.

Finally, I want to stress once more that in the question of standards in the Federal Republic of Germany no final decision has been taken, and all efforts are directed towards a European system agreed to by all countries. If this cannot be achieved in the first step, we want to introduce a system which at least is supported by a large majority of the European countries.

A Videotex Trial

S. Berkman
Marketing Project Manager

American Telephone and
Telegraph Company

United States

Since Videotex has been a technology driven service, it is necessary to evaluate the customer needs. Is there a customer need? What is that need? What is the customers Willingness to Pay? Trialing can answer these questions and many more.

Knight-Ridder Newspaper and AT&T signed an agreement to jointly sponsor a Videotex Trial in Coral Gables, Florida in the spring of 1980. The Bell System is responsible for communications, terminals, installation, maintenance, and management of the operations of the trial. Knight-Ridder is responsible for providing the computer, development and maintenance of the software, and the design and content of the database.

Copyright © 1980 by Online Conferences Ltd.

A VIDEOTEX TRIAL

Before Videotex can become a viable service in the United States, the problem of which comes first, the terminal or the database, must be resolved. Why would a terminal manufacturer develop and offer, on the market place, a terminal to access databases if no databases exist? Or why would a potential database provider develop a database if there were no terminals to access that database? Trialing activity helps solve the which came first dilemma, the chicken or the egg. It allows hands-on experience and provides the necessary knowledge to make economic business decisions to go forward with database development or terminal development.

The next question is, How will Videotex get started in the United States? There are 160 million privately owned television sets in our country. Will these owners go out and buy new television sets with all the necessary electronics built in to allow access into databases? Or will there be a modification kit which will allow a television set owner to have a repairman completely modify their television set by building the electronics into their existing set? Or will there be an adaptor type terminal which would require a television set modification to allow the signal input into the red-green-blue cathod ray tube guns? Or will this adaptor type terminal utilize the antenna for the signal input (something like TV games)? All of these questions remain unanswered. And there are many more.

What about the human interface? I have had two personal experiences which I will relate to you to identify this serious concern. My family purchased an electronic game and we installed this exciting new electronic game in our family room and had many hours of fun playing with it. But let's take a look at that installation. We attached the signal input wire to the television antenna attachment on the back of the television set and strung the wires across the floor in front of the television set. Then, for power, we plugged into an electrical outlet with that wire lying across the floor in front of the television set. And with all of this, the control unit was attached to the other end of those wires and it was also in front of the television set. When the evening hour became late, it was time to go to bed. What do we do with all of these wires, and control units, and game cartridges? Well, the first night, we left them there on the floor so our playing electronic games could continue the next day. The question still remained, what do we do with all of these wires, and control units, and cartridges?

The second experience was bringing a small computer into my home. My 10 year old son and I set the computer up on a table in the family room. Again, we had several hours of fun, but when it was time to retire for the evening, my wife said to me, "You're not going to leave that there, are you?" What do you do with this kind of electronic hardware?

The point is, we need to study, in the human factors area, how a customer will be able to live with, or co-exist with Videotex. Trialing activity will provide some of the answers.

Let us turn our attention for the moment to Videotex standards. There is one school of thought, that a critical mass of information is required for Videotex to be of value to the consumer. If this is true, the worst of all conditions would be for each database to require its own unique terminal. It is hard to conceptualize that any consumer would invest in more than one Videotex terminal to allow access to more than one database. The best of all conditions would be for all terminals to be able to access all databases, and all databases be able to be accessed by all terminals. This will not happen unless a United States standard is developed to allow it to happen. Trialing activities will allow both database providers and terminal manufacturers to solidify their desired standards.

There is not much disagreement that Videotex is a technology-driven service. But, we must not ignore the consumer. Is Videotex meeting a customer need? What is the customer's need? What is the customer's "Willingness to Pay?" What features does the customer want in the terminal? What database content is desired by the customer? All of these questions and the ones addressed earlier need to have answers and Concept Trial and Market trials are the way to get those answers.

In January, 1979, Knight-Ridder Newspapers, Incorporated, publishers of the Miami Herald and AT&T signed an agreement to jointly sponsor a Videotex trial. The Bell System is responsible for all communications, terminals, installation, maintenance and management of the operations of the trial.

There are two terminals involved in the trial. First, a Frame Creation Terminal which is utilized by Knight-Ridder to design and input frames into their database. Second, a Customer Terminal which will be used by the trial participants. Both terminals were designed by the Bell Telephone Laboratories, and manufactured by Western Electric Company specifically for use in the Videotex Concept Trial.

The Customer Terminal has both a full alphanumeric keyboard and a wireless numeric pad. Both input devices have built-in telephone functions. The display is an RCA Color Television receiver modified for R-G-B input and disabled for broadcast signals. The display characteristics are 40 characters per line, 20 lines of text, a 5 x 7 character matrix with horizontal half rounding resulting in a 10 x 7 character matrix in a 12 x 10 field, and a block 2 x 3 graphics matrix filling the entire 12 x 10 field. Colors are 16 selected from a possible 512 and special features are flashing, conceal and reveal, and field lock and unlock. The Character repertoire includes 96 ASCII characters, 64 2 x 3 block mosaic graphics, and 94 characters reserved for down loaded character sets. One of these sets is for

graphics characters. The transmission protocol is half duplex, reversible, 1,200 baud asynchronous channel with backward channel for supervisory use. The protocol is a version of the ANSI x3.28 standard using block transmission.

Knight-Ridder is responsible for the content and structure of the database which is called Viewtron. To accomplish this, Knight-Ridder established a subsidiary known as Viewdata Corporation of America. Viewdata Corporation has arranged for two kinds of outside participants. One group is providing basic news and information services. These information providers include:

The Miami Herald	American Cancer Society
Consumer's Union	Addison-Wesley Publishers
Congressional Quarterly	Universal Press Syndicate
MacMillian Publishing	The Economist of London
Associated Press	

The other group consists of commercial participants and include:

Eastern Airlines	Service Merchandise
Sears, Roebuck & Co.	Cousins Associates Realty
B. Dalton Booksellers	Shell's City Liquor Store
Grand Union	Official Airline Guide
Southeast Banking Corp.	AAA World Wide Travel Agency
Goldberg's Marine	J. C. Penney
Shell Oil Co.	Spec' Music
Bass Tickets	

The overall objective of the trial is to ascertain preliminary consumer acceptance of Videotex services through actual consumer experience. The technical objectives are to provide in-the-field terminal and database evaluation. The trial information goals are many of the previously identified questions in this paper as well as information associated with usage.

The trial will be conducted in Coral Gables, Florida. It will start in the May/June, 1980 time frame and will run for a period of 6 months. There will be 30 terminals installed in separate residences for approximately 3 weeks. Those terminals will be moved until 160

residences are involved. The Viewtron database will contain more than 10,000 frames of information and will include but not be limited to

- Local and national news
- Sports
- Weather
- Calendar of events
- Airline information
- Consumer comparisons
- Educational courses
- Ordering merchandise and tickets
- Entertainment guide

Now, I would like to show you some examples of frames in the Viewtron database. I believe you will be most impressed by the use of color and layout for attractiveness and ease of reading. Also, be aware of the mosaic graphics utilizing a downloaded graphics character set. (Figs. 1 - 9)

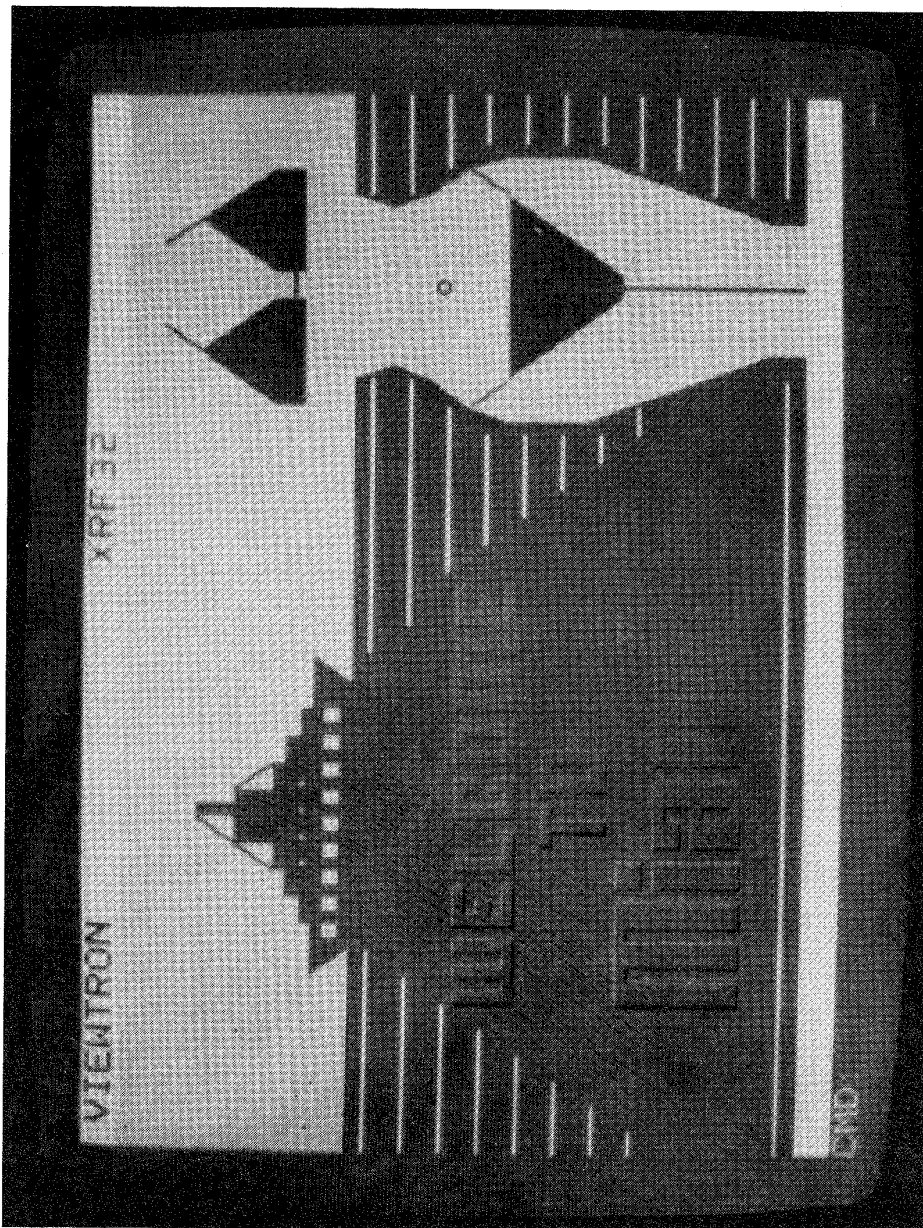



Fig. 2.

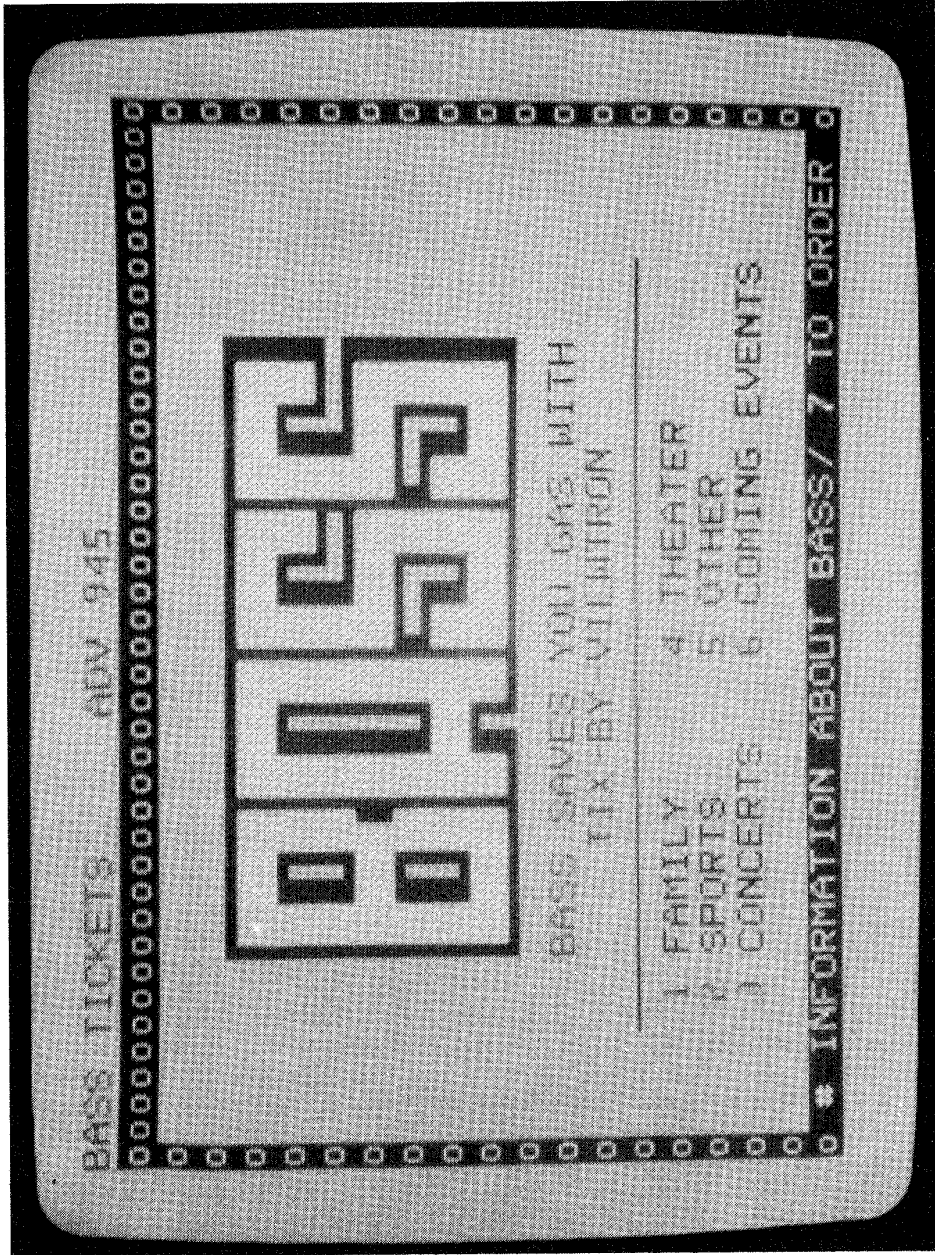

Fig. 3.

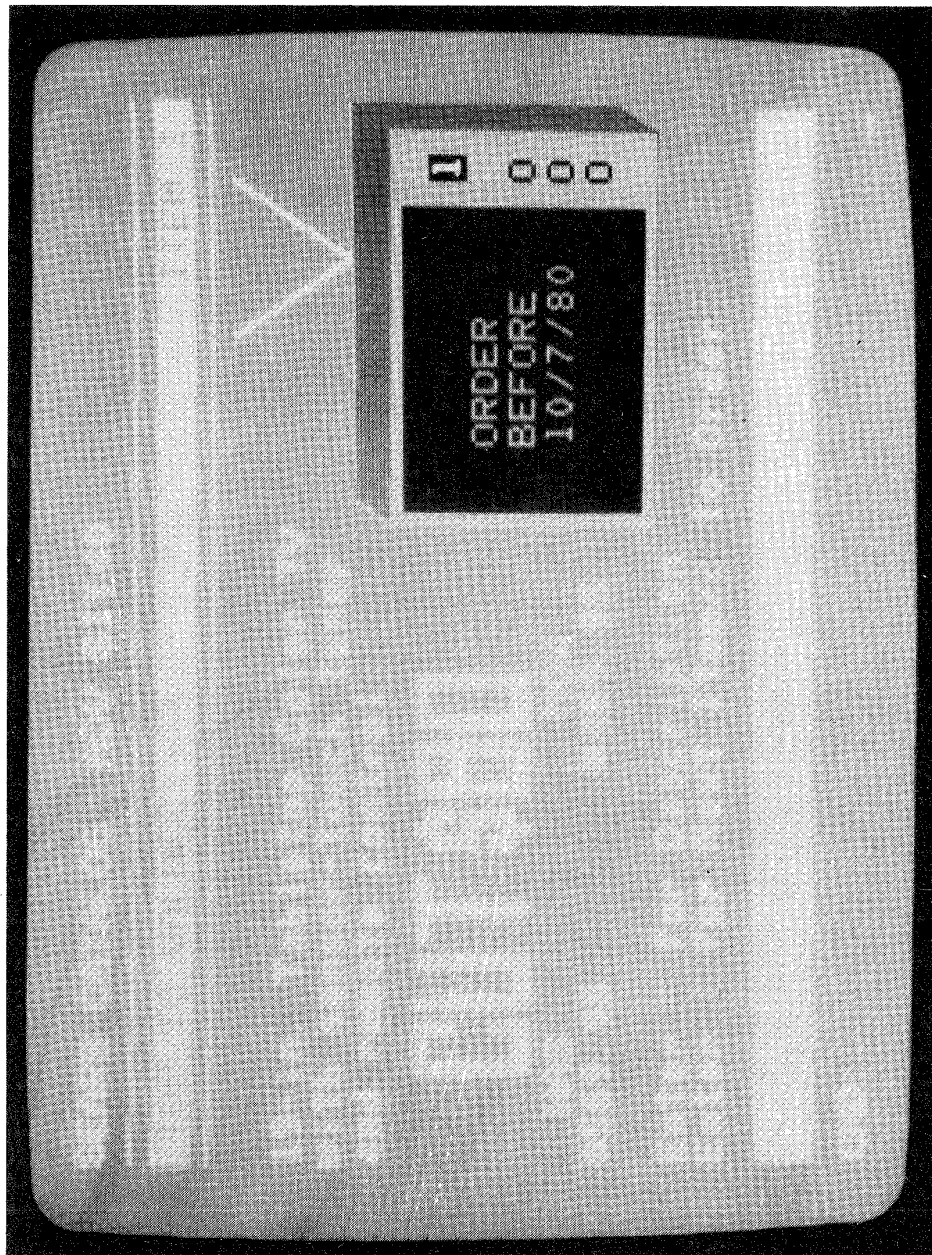
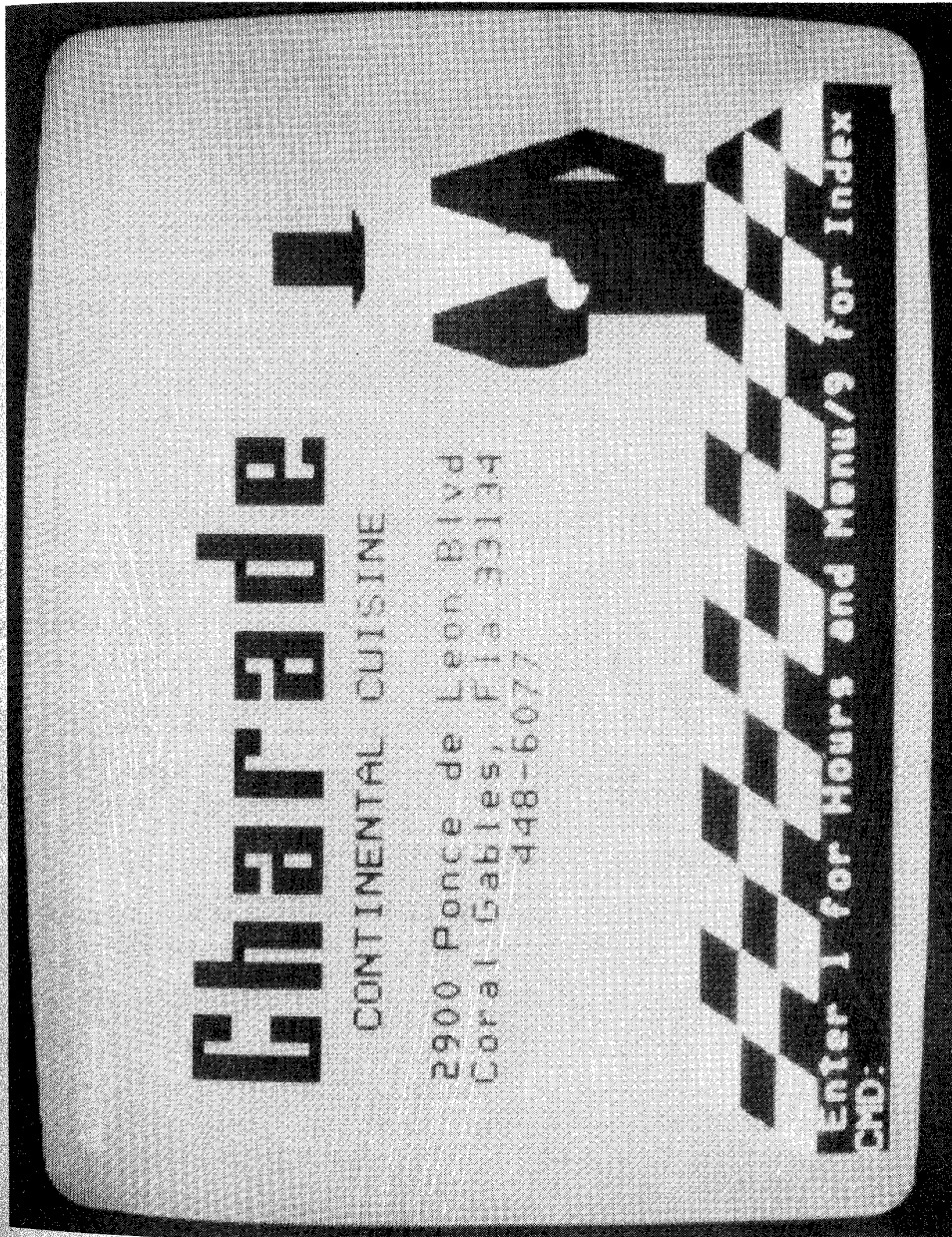

Fig. 4.



Fig. 5.



Charade I
CONTINENTAL CUISINE
2900 Ponce de Leon Blvd
Coral Gables, Fla 33134
448-6077

Enter I for Hours and Menu/9 for Index
END.

Fig. 6.

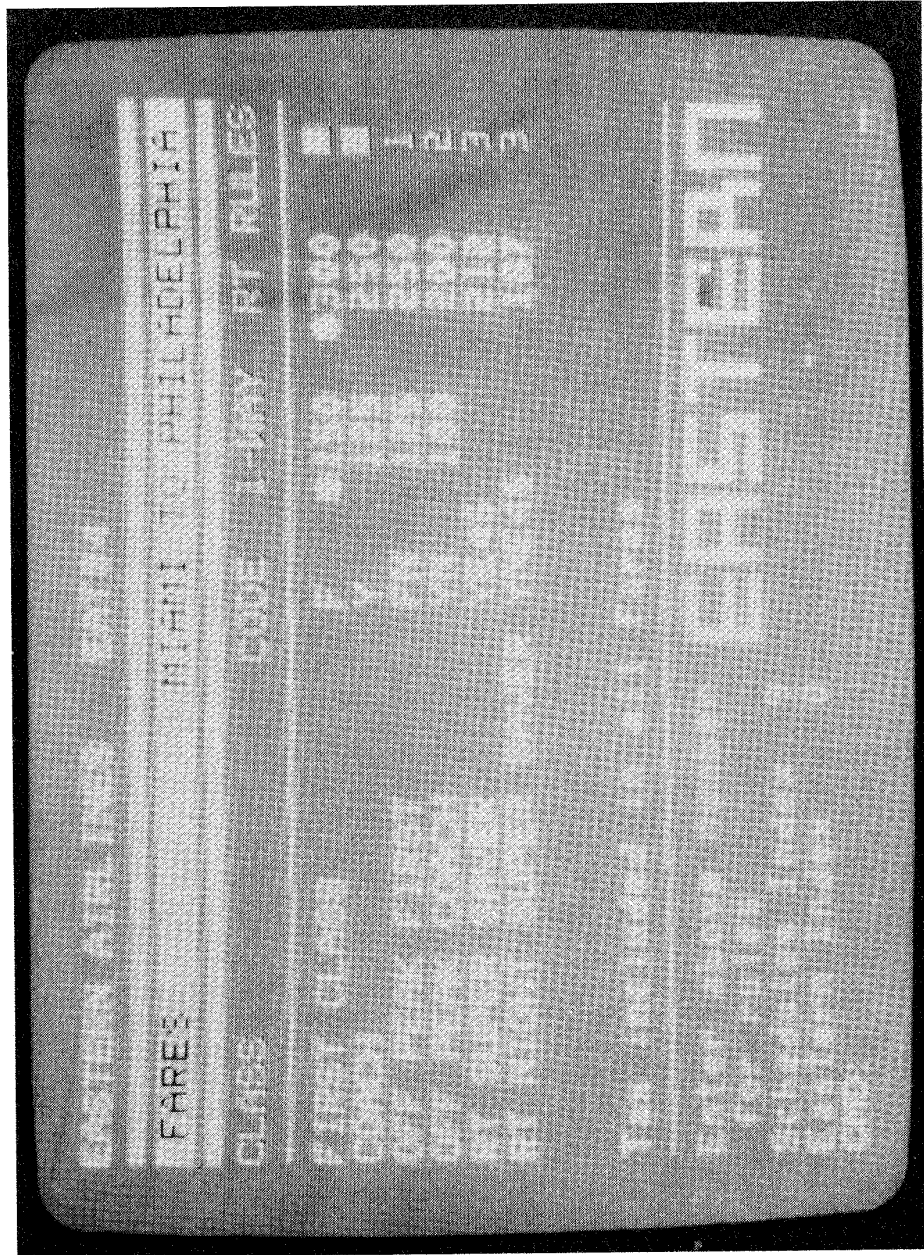

Fig. 7.

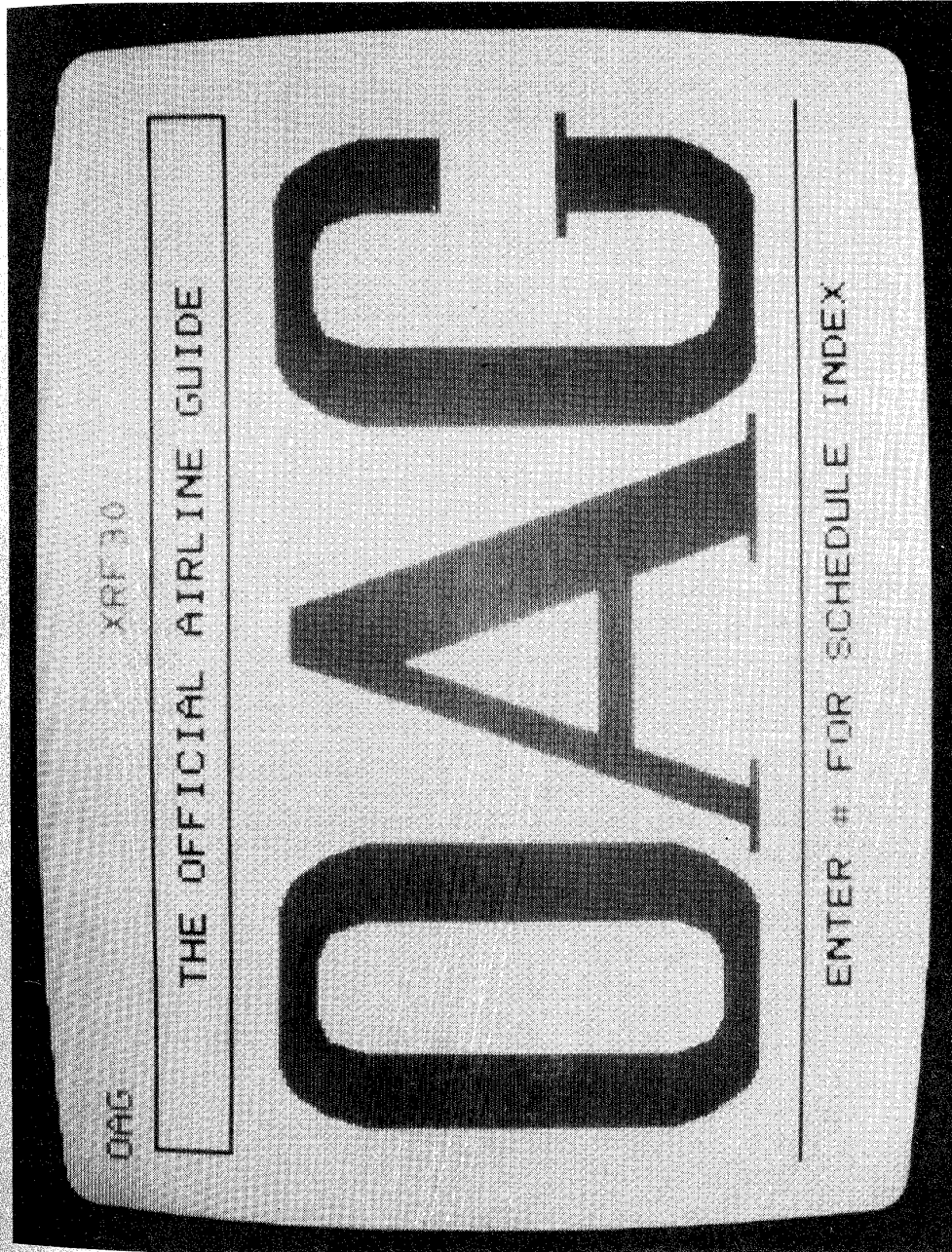

Fig. 8.



Fig.9.

THE COMMON SENSE OF
TRYING OUT VIDEOTEX

Robert Johansen
Institute for the Future
USA

Copyright © 1980 by Online Conferences Ltd.

THE COMMON SENSE OF TRYING OUT VIDEOTEX

One of the most haunting questions that emerged from a major workshop on videotex in the U.S. was: "Does anyone know how to 'try out' this medium?" The resounding answer from this active group of 40 experts was, quite simply, "no."

Of course, a key issue here is defining what is meant by 'trying out' videotex: What constitutes a 'good' test of this new medium? The most straightforward criteria would concentrate on whether the results of the test provided accurate information on which to base decisions regarding future applications. If the information is not accurate, it may be worse than having no information. If the information is accurate but irrelevant to future decisions, the trial is of value only for academic reasons. 'Trying out' videotex should result in practical lessons regarding future efforts with this medium.

At the Institute for the Future, we have been wrestling for over a year with the problems of trying out videotex and for over ten years with similar problems of trying out other new media. We offer here a few guidelines that have grown out of our own experience and discussions with colleagues; we offer them as a 'common sense' approach to trying out videotex in various settings.

BE SPECIFIC ABOUT WHAT YOU ARE TESTING; 'TRYING OUT VIDEOTEX' IS NOT SPECIFIC ENOUGH

Videotex is not a single medium; it is a generic class of media. The particular services to be tested should be defined as specifically as possible, preferably in terms of basic functions to be performed (.e.g. data base access of financial information for banks; data base access of travel schedules and other information for travel agents; electronic message service for remotely located branch offices; entertainment packages for pre-teenage children. Videotex must also be positioned vis-à-vis potentially competing media, such as videodiscs. The point is that in order to try out videotex, you must concretely define what 'videotex' you will test. In a real sense, there is no such thing as videotex per se; it is just being invented, and field tests are a place where the inventions are coming to life.

MAKE SURE THAT, WHEN THE TEST IS OVER, YOU WILL KNOW WHAT HAPPENED

This suggestion seems so obvious that no one remembers to do it. Videotex creates a very complex information environment, and much of what goes on is likely to be difficult to trace accurately. The basic resources here are: (1) Usage statistics. Videotex systems create rich opportunities for unobtrusive user tracking without violating privacy. Statistics such as amount of time using the system, times of day when the system is used, usage frequencies for specific services, and other such measures could all be important. Such tracking systems must be carefully designed and selectively implemented, however, or the result will be a fog of numbers.

(2). User reactions. Somehow the reactions of users should be systematically recorded, whether by questionnaires, interviews, or some other method. Social science expertise can be useful here in designing the right approach to collecting reactions in each particular situation. (3) Observation. Skilled observers can add much to videotex test. Imagine that the test is creating a strange new information "culture" and send an anthropologist in to study the evolving natives. The organizer of the test should be sure to specify in advance what sorts of information would be most useful as output from the observation. (4) Interpretation. Instincts and judgments are going to be critical in a videotex test. Trusted people of insight (by your definition) should add wisdom to interpreting the test results.

I am not suggesting that every videotex trial needs to be organized like an academic research project. Certainly varied levels of complexity are possible depending on the purposes of the trial. Some minimal level of tracking procedures will always be mandatory, however, to have an accurate idea what happened.

DISTINGUISH BETWEEN FIRST USES AND FUTURE USES

The current literature on telecommunications is filled with examples that reveal the evolutionary nature of new system usage. The evolutionary steps in the development of videotex are far from clear. While data base access is typically cited as the central use of videotex, a growing number of people are suggesting that it will not be marketable to general home users for some time. Services such as home security, fire protection, medical emergency, electronic mail, financial transactions, or entertainment/games may be stepping stone services that could lead to the development of more sophisticated systems. It is also probable that a number of surprise users will emerge. Videotex tests need to be clear about what kind of evolutionary path of services is being tested.

PUT A PREMIUM ON EXPLORING STYLES OF INFORMATION PRESENTATION AND INTERACTION

Videotex systems are creating the demand for a new breed of information artists who have unique skills in presenting information via these new media. Tests of videotex must take account of this fluid state and should encourage exploration of a wide variety of information presentation styles. The interaction between users and the system is part of this puzzle, and both linear and nonlinear response sequences seem worthy of exploration. In fact, the users themselves can help; encourage them to think of themselves more as test pilots than guinea pigs. Playfulness is likely to pay off in videotex tests.

Simply dumping the contents of current media into a videotex system is destined for failure. A most exciting newspaper article may be deadlly dull on a videotex screen. The kinds of skills needed to present

information effectively over videotex are hybrid skills, just as videotex is a hybrid medium. There are new constraints for writers, but a new freedom within these limits. Graphics and design skills are also important, as is a creativity in allowing the user ease of movement through the various parts of the system. These new information artists are just beginning to emerge, and their development ought to be nurtured as a precious videotex resource.

MAKE THE INCENTIVES DURING THE TEST AS SIMILAR
AS POSSIBLE TO A REAL-WORLD, FULL-SCALE SERVICE

The goal here is realism in an unreal setting; the point is to simulate reality. If a test user loves the medium because he is the only one in his neighbourhood to have a terminal, for instance, one must be cautious about generalising from the test results. Or, if the test is so short that you only see the novelty reaction to a new toy, you may be missing important information. The perspective of the user is critical here: Are the incentives and motivations for the user during the test the same sorts of incentives and motivations that would be encountered in a full-scale service?

CONSIDER PRICING OPTIONS AND POLICIES VERY CAREFULLY

Pricing is likely to be a key variable in any test. There are a wide variety of ways to pay for videotex (e.g., by page, by connect hours). If test participants are given free usage, they are likely to be more exploratory but less practical. Experience with Prestel and other systems raises the question of just what is learned from giving people free access to a new medium. According to the general wisdom, tests that incur no costs to the users offer little insight into what would happen with a real service for which people had to pay. Yet videotex trials continue to be organized on a no-cost-to-users basis. Certainly the burdens of tariff filings for approval of test rates and other red tape provide major disincentives. However, clever alternatives in pricing might be possible to at least get some insight into economics of use. For instance, even if actual pricing is not possible, one could still track individual usage and assign a hypothetical cost to each user. Mock bills could be sent to test participants showing what their usage might have cost, with questionnaire items to get their reactions. Admittedly, such results would be limited but they would be considerably better than a test that learns nothing about how users react to pricing options.

Assuming some pricing scheme is possible for a test, a far better approach would be to include alternative approaches to pricing as one of the key variables in the test. Sub-samples of users, for instance, might use the system according to different cost formulas; their usage and reactions could then be compared. Pricing seems likely to be a critical variable in the development of videotex, whether or not field trials gather information about its effects.

BE WARY OF FIELD TESTING IN A VACUUM

Proprietary instincts are often at work in the design of videotex trials. The organization running the test wants, of course, to reap the primary benefits. It is also not anxious to have potential failures casting negative tones on its corporate policies. While understandable, such instincts can be tragically self-defeating in a field like videotex. The technology - most importantly - the understanding of markets are changing very rapidly. Isolated field tests with little exchange of learning will almost certainly slow the evolution of videotex and greatly increase the risk for each test organizer. Exchange of perspectives is important at all stages of videotex trials, from design to implementation to interpretation of results. The U.S., already a latecomer in the videotex field, may become a leading example of how not to organize videotex trials. The experiments now under way are primarily private experiments with few exchanges in perspectives. Neither government nor private foundations are encouraging such exchanges or attempting to synthesize the various findings. Federal agencies are leaving videotex up to the market, while the individual corporations involved in the tests are both secretive and focused on their own specific interests. The result could easily be a very slow process of learning, for the individual corporations and for the nation as a whole.

For users who avoid such an inward-facing style, videotex creates the opportunity - indeed the necessity - for new types of collaboration. Videotex is a hybrid medium that brings together perspectives often not matched before. Making it work will require orchestration of the skills of journalists, designers, computer scientists, equipment manufacturers, telephone planners, and others. Isolated groups who attempt to go it alone in the videotex area seem far less promising than imaginative joint ventures.

DO NOT ASSUME THAT THE TECHNOLOGY WILL
BE AVAILABLE AT THE PRICE YOU EXPECT

In this realm, the common sense of videotex is the same as the common sense of trials with other new technologies: much can and will go wrong. Extra time and skilled troubleshooters are the answers here, since videotex is a long way from off-the-shelf equipment. Also, the \$25 decoder promised in a few years time is not here for 1980; assume that whatever price estimates you get are low and hope that they are not too low.

KEEP YOUR PROMISES REALISTIC,
AND KEEP YOUR PROMISES

In spite of the inglorious history of computer oversells, videotex is already falling into the same trap. Today is not the time for morning talk show promises of fingertip access to all the world's information. Is it really necessary to ground a videotex trial in grandiose promises that will almost certainly never be achieved? Plenty of realistic

possibilities can be suggested, and these should be the basis of videotex water testing. Why oversell?

Not overselling, however, does not mean that one should not sell. Indeed, promotion of new systems is critical. During a videotex test, attracting new users may be less important than keeping the ones that sign up. User support services must be very good, including as much guidance and general hand holding as the users feel they need. Aids such as printed directories might prove very important, just as they have with Prestel. This user support operation must be carefully organized and very visible to new users as a helping hand whenever they need it. While convincing ad copy will be one part of promotion, user support will almost certainly be more important, as well as more difficult. The most effective early promotion of videotex will come from keeping the promises you make about the system's capabilities.

SUMMARY

This paper capsules a few common sense guidelines that are beginning to sort themselves out of the myriad videotex trials, conferences, and studies. When such rules become obvious to those at the leading edge of the field, it will be time for rethinking and stretching the common sense into more adventuresome possibilities. At this point, however, even the common sense of trying out videotex is adventuresome enough.

REFERENCES

Electronic Meetings, Robert Johansen, Jacques Vallee, Kathleen Spangler, Reading, M.A. Addison-Wesley, 1979.

Viewdata - Implications for Education

M.H.Aston
Deputy Director
Advisory Unit for Computer Based Education
United Kingdom

New technologies have traditionally been difficult for educationalists to incorporate into teaching strategies. Prestel (the Post Office viewdata system) offers an opportunity to stimulate learning in excess of many previous developments.

Can education respond to the challenge?

Copyright © 1980 by Online Conferences Ltd.

PREAMBLE

New technologies have always provided educationalists with tremendous opportunities, but they have rarely been grasped successfully. The impact of television in the classroom is difficult to assess, but its effect in the home has been highly significant in changing social patterns and family life. Viewdata, by fusing the power of the computer, the telephone and television provides the greatest opportunity to stimulate learning since the introduction of the printed word. Are we ready and able to accept this challenge? Stringent economies in the education sector have created major problems for any institution wishing to become a Prestel user, let alone an Information Provider and thus to assist in the shaping of the provision. Nevertheless, much work is being done and this paper takes note of current activities and points to possible future developments.

The role of computers in the educative process is still a subject for much discussion. What is certain is that their role is increasing and it is possible to see how a partnership of people and machines can enhance this process (see fig.i)

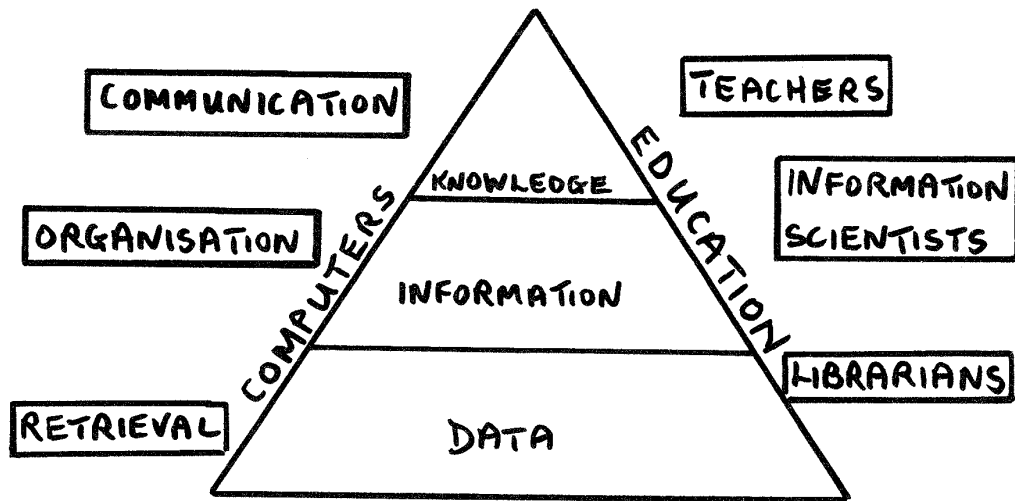

Fig.i - The Education Process

Major changes are expected to take place in the education system in the United Kingdom, and no doubt in other countries as well, by the end of this century. Resources will need to be shared, particularly with the Third World. Our largest resource is information. Information could become the currency for survival. Education will concentrate more heavily on the processes which need to take place to change data into information and information into knowledge.

An illustration of this process might be helpful.

If we take an object such as a London Yellow Pages Telephone Directory, to the child of two, it is a book full of data. To the child of seven, it is a book containing information which can be used in association with the telephone. To an educated adult it is a directory which can be searched in a number of different ways and can offer a strategy for buying, selling, obtaining a service etc.

How is Viewdata playing its part in this process?

VIEWDATA AS A PROCESSOR

Data is being processed in a variety of ways. The screen size constrains the formatting of words and sentences and the amount of data that can be perceived by the user at any one time. The graphics facility and colour further constrain the visual impact. The number of frames rented by an IP is often insufficient to allow all the necessary data to be displayed, thus forcing the IP to be highly selective. There are a number of software packages available which process raw data into a viewdata format. The decimal hierarchical structure imposed on the data further tightens the whole system. To a casual observer, all these constraints may paint a gloomy picture, although if other media are observed in the same way, the constraints may seem even worse, e.g. microfilm, videotape etc.

In practice, skills are developed which use all the advantages of the media - television is a classic example. It started as a filmed radio service and now its applications are far too many to mention in this paper.

Viewdata is still at the electronic magazine stage. No one can foresee its role in the future, but the signs are that it could have the same kind of impact on society as television itself.

VIEWDATA AND PRESTEL

At the outset, the designers of the viewdata system (led by Sam Fedida) decided to make the user interface as simple as possible. If it was

to be a truly public service, everyone should be able to cope with the technology. The current 10 - choice tree structure is simple to use and scores highly on that count. More sophisticated users are frustrated by the lack of a keyword search facility, the absence of interaction and the poor indexing on the system. As a retrieval system, we have to judge it by its content and ease of access. Both of these factors can be improved by the Information Providers and it is certain that, given more time and experience indexing, content and routing will all give less cause for complaint. In experiments with young children of primary school age, no difficulties were encountered in using the system. A few children have been given the opportunity of designing and entering Prestel frames containing both text and graphics and the results are very encouraging. We must ask the question - will children have an opportunity to run their own IP channel, comparable to a T.V. series such as Sesame Street?

It is largely as an information service that Prestel has been used by Education so far. At both the local and national level, there is a need for a better service for the teacher, the pupil, and the parent. A list of questions might illustrate what is available be it rather patchy, on the database at the moment.

What can I learn?

Where can I learn?

What do I need to know before I start?

What resources will I need?

Can I obtain financial help?

What kind of career is open to me?

Is there a suitable job for me?

What about research?

What are my rights?

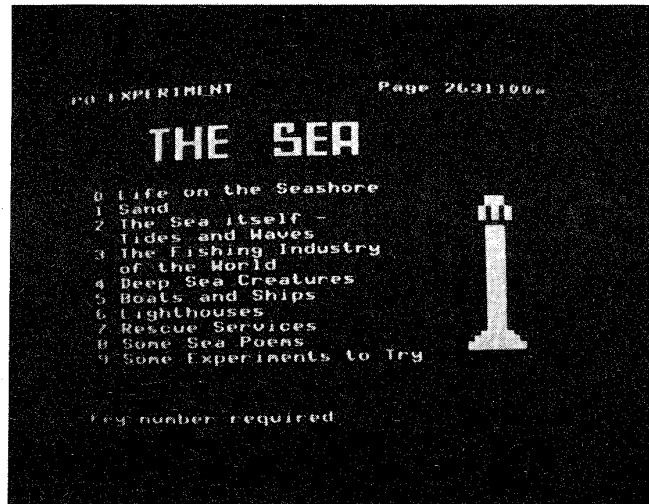

Fig.ii - Resources for the Pupil

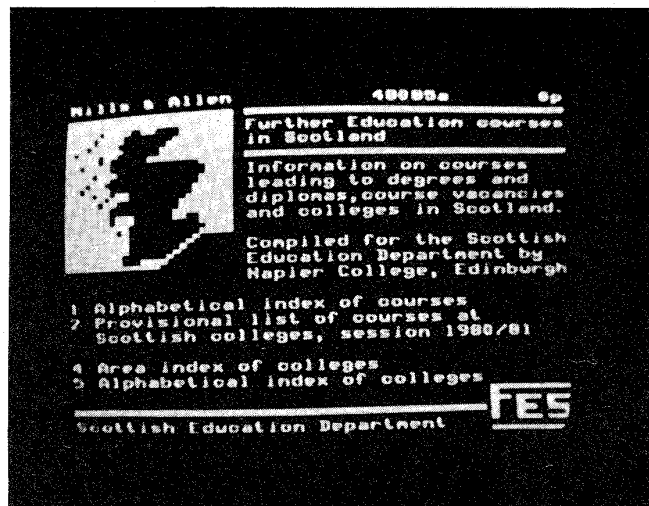

Fig.iii - Further Education

Fig. iv
Resources for
Parents

Mills & Allen	480271a	98
Parents' Questions Answered		
Sex education - where & when	11	
Religious education - compulsory? ..	12	
Parents' rights in school selection ..	13	
Bullying - what to do about it	14	
Punishment - the legal position	15	
Claiming for lost property	16	
School uniform - the legal position ..	21	
My child is a poor speller	22	
My child is backward in reading	23	
CSE and O levels - the difference ..	24	
Exam results - rights of appeal	25	
above choices 1p		
Main index to		
SCHOOLS FOR THE 80s		
by Sue Marling ..	9	

A great deal of learning takes place today through the tackling of assignments, be it young children following up a theme (see fig.ii) or post graduates completing a thesis. Many public examinations rest heavily on project assessment, particularly in the business education field. Prestel can often be the first line of research. Currently, the Council for Educational Technology is offering an umbrella service for education and is attempting to rationalise and index educational data on the system.

VIEWDATA AND KNOWLEDGE

We gain knowledge by sifting and collating information and by experience Viewdata can offer a controlled learning experience. One IP has attempted a programmed learning approach in teaching on-line retrieval using Dialog and one of the Lockheed databases.

```

P1RA                               0100000a  01
SEARCH PROBLEM:
An article on pellets by an author
whose surname only, Mostyn, is known.

EXPAND Mostyn to find what other terms
occur nearby. It is necessary to search
the author index by EXPAND AUTHOR
so enter:
? EAU-MOSTYN
The response includes:
E1 AU-ROSS, H.----- 2
E2 AU-ROSS, H.H.----- 4
+
E6 AU-MOSTYN
E7 AU-MOSTYN, H.----- 5
E8 AU-MOSTYN, H.P.----- 22
+
E20 AU-MOTTRAM, R.D.----- 3
SELECT E7 and E8 now for searching:
? SE7, E <
+
Insert the missing number

```

Fig.v

Programmed
Learning
On-line bibliographic
searching

Another offers electronic debates backed up by facts and figures if the user requests them.

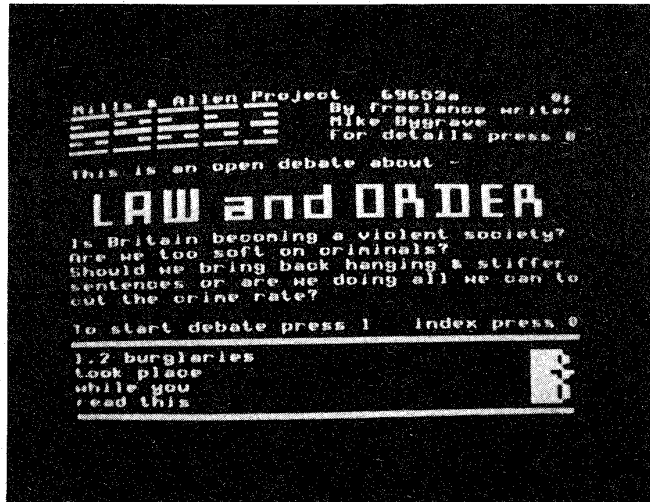

Fig. vi Debate on Law and Order

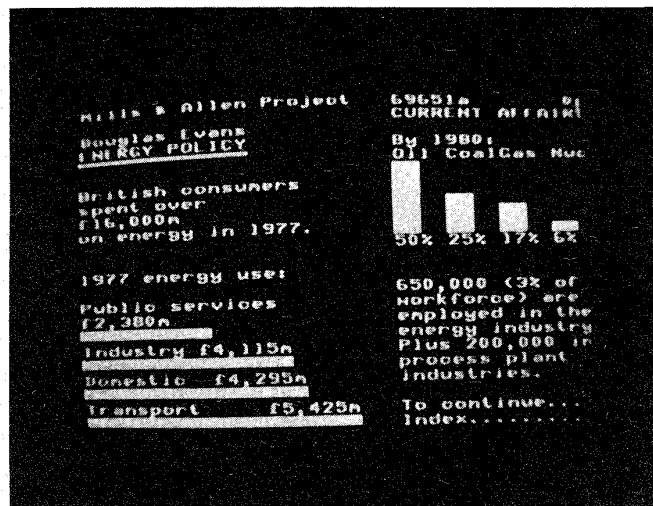

Fig. vii Debate on Energy - Back-up Figures
Experiments by the P.O. Research group at Martlesham have included simulations, multiple choice testing and graded quizzes. This kind of activity is not available on the public system yet, but interactive learning must feature high on the list of future developments.

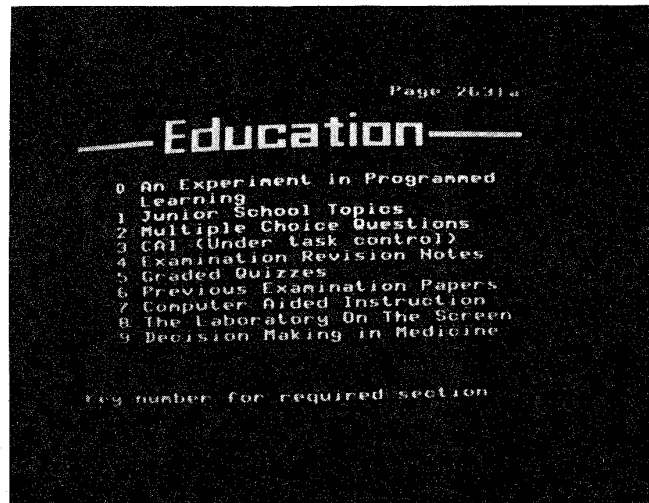

Fig. vii P.O. Experimental Education Index

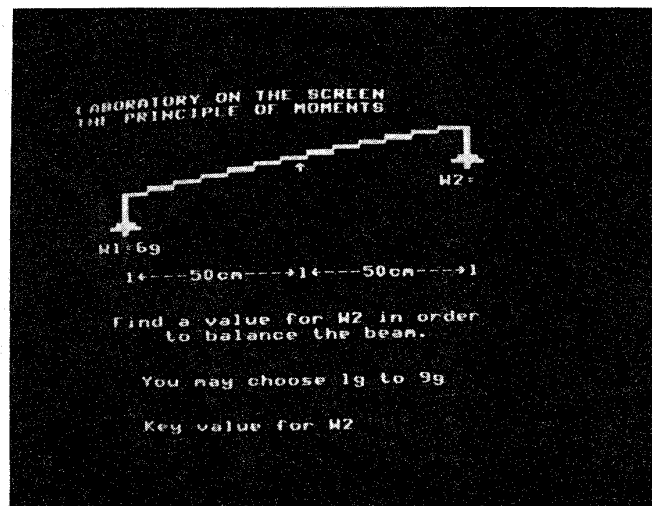

Fig. viii Interactive Laboratory on the Screen

Index frames will indicate what is available, aims and objectives of the package, levels of approach, when last enhancement took place and how much the package will cost. Users will be able to download the software onto their microcomputers and run the packages off-line. Databanks associated with a variety of subjects will also be made available for interrogation.

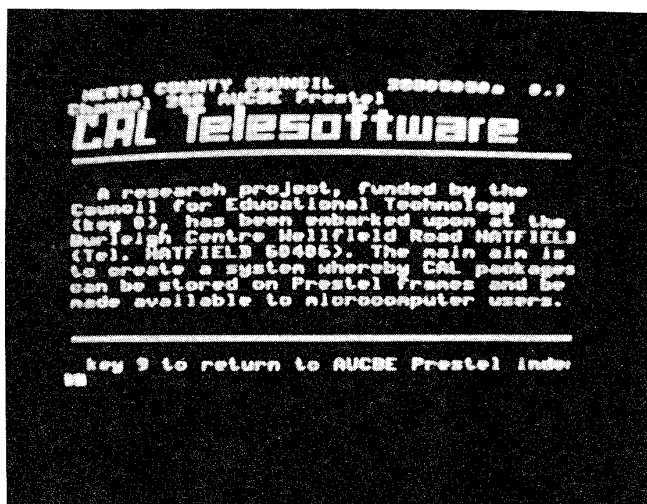

Fig. x Telesoftware Research at Hatfield

The implications are far-reaching and we are very conscious of past failures in the use of educational technology. Viewdata and microcomputers together suggest such a power for educational innovation that we must harness it for our own good.

A Public Broadcaster's View of
Teletext in the United States

Hartford Gunn
Senior Vice President and Manager
KCET
USA

Gregory W. Harper
Teletext Consultant
USA

We cannot automatically assume that a system that provides a valuable service in Europe will provide an equally valuable service in the U.S. The information communication environments are different. Instead of a hardware-related text-broadcasting system, the U.S. should have a flexible data transmitting system that could be used with sophisticated decoders or even home computers. Some, perhaps most, of the content should be program-related.

Copyright © 1980 by Online Conferences Ltd.

Broadcast teletext is coming to the U.S. and coming soon -- that much is certain. The enthusiasm we feel for the vast possibilities of this important technology is rapidly catching on all across the country. Broadcasters have a serious interest in it. CBS, for example, in association with Electronic Industries Association, has conducted experiments at its station KMOX in St. Louis that establish beyond doubt that teletext is feasible in the U.S. And, as we shall explain, KCET, the member station of the Public Broadcasting Service in Los Angeles, will soon be conducting some rather different experiments of its own.

The question American broadcasters and regulators must face now is how teletext will be applied in the U.S. The applications are virtually limitless. Which ones are chosen will determine the future of the technology -- how quickly it is put into use, where, and by whom. We have learned a great deal from observing how it has been applied elsewhere. We are learning more every day. Our conclusion, based on these observations and on our own knowledge and research, is that the way teletext is applied in the U.S. ought to be -- must be -- different.

This conclusion reflects in part the existing American information marketplace. Thanks to our efficient telephone system, Americans have access to vast data bases through computer terminals. Many businesses and now some private individuals can call on data bases as general as Telecomputing Corporation of America's "The Source," a Prestel-like service using standard computer terminals or home computers, or as complex as the one offered by "LEXIS," a computerized key-word file-search system used by attorneys to research legal cases.

Even television is playing a role in the information marketplace. Apart from the numerous channels broadcasting a wide variety of entertainment and news, a relatively new service, cable television, covering the nation by satellite, is growing rapidly. Largely because the cable operators need to fill their excess cable space, they have have programmed full band-width video channels with scrolling text, each channel devoted to a different topic. For example, Channel C in New York carries program guide information. Another channel has up-to-the-minute news from Reuters. Still another channel has stock market quotes. A fourth and fifth are programmed with competitive prices of consumer goods. A service called UPI News-time uses slow-scan television not only to bring audio reports on the day's happenings, but also to provide newspaper-quality pictures of the events.

Ted Turner in Atlanta is ready to inaugurate what could be the ultimate in information delivery: a twenty-

four-hour broadcast news program with news, weather, and sports from around the world and distributed across the U.S. via satellite. Naturally one cannot forget the radio with its round-the-clock news stations and all-day sports.

The regular telephone also gives access to the time, weather, stock market quotes, your daily horoscope, or even a joke to brighten your day.

Americans are besieged by tons of printed matter every day. Almost every organization, from the smallest church group to the largest corporation, sends out newsletters. Most professions have dozens of specialized journals addressing issues important only to that field. Of course hobbyists are served by tremendous amounts of information, from how-to-do-it shows on cable television or videocassette to literally thousands of monthly magazines.

As one can see, information is not lacking to the American consumer. Take, for example, the rotating full-page text of the cable system. Each page is on the screen for twenty seconds: ten to write it on, ten to read it. A twenty-page cycle would take about six-and-a-half minutes for the viewer to read if he wanted to read it all. This compares favorably with a teletext system with an average access time of fifteen seconds per page; but of course the advantage of teletext is that you can get the information when you request it and it doesn't take up a full band-width channel.

We are not saying there's no advantage to teletext. But we are saying we cannot automatically assume that a system that provides a valuable service in Europe will provide an equally valuable service in the United States. The information communication environment is different.

You may be excused for wondering if we believe that broadcast teletext has any future at all in the U.S. We do. The idea of stretching the present television system to provide a new service is extremely attractive. The technology is there, and it will happen just as surely as broadcasting itself happened. What strikes us, when we consider the possibilities embodied in this idea, is that to broadcast a certain number of pages over and over again in the vertical interval is a waste of spectrum. We are convinced that a carefully chosen American system must, and can, avoid this.

And so what is the answer? How should teletext be applied in the U.S.? After long study and consideration, we believe that the best application is a mixture of general information for the viewer and program-related teletext -- a truly new service, and one that really puts the technology to work.

With program-related teletext, the viewer tunes in not only a show, but also a specific teletext broadcast that goes with it. The actual content of these teletext broadcasts we will come to; but first note the immediate advantages of program-related teletext: it adds something to the program, it uses the spectrum more efficiently because it is broadcasting something new with each new program (and in fact can use the spectrum far more efficiently than this, as we will show), and it is brand new to the U.S., not a variation on an existing service.

Specifically, we can foresee a teletext system on KCET that would operate on three levels, all of which could operate simultaneously. Level 1 would be a very small magazine of revolving pages, say 10 or 15. It would be broadcast constantly and would include the day's (or week's) program schedule, general information and local news, and other information about KCET.

Level 2 would be program-related notes. The possibilities here are both obvious and exciting. On news broadcasts, the viewer would be able to read more details about subjects in which he had a particular interest. For example, we have had floods in California and the Federal government is going to offer aid. But what kind of aid? To whom? Where do you get the kind for you? What's the telephone number? All of this would be available. On opera broadcasts, the viewer could call up detailed program notes, just as if he were watching in person. The possibilities for sports programs are also interesting. So great is the American sports fan's appetite for statistics that a teletext service packed with statistics related to the event being broadcast would surely be an instant success. These are just three examples of what could be done with Level 2, program-related notes. It's clear that one could program interesting, useful notes for every program on the air.

Level 3 is the most intriguing. It is viewer interaction with the program. In its simplest form, viewers could be given a multiple-choice question, with each choice corresponding to a teletext page. When the viewer pushes the number representing the answer of his choice, he sees whether he was right and, if he was wrong, an explanation of why. Since only a few pages would need to be broadcast, and only at the precise moment in the program when they were needed, access to any one of them would be virtually instantaneous.

Another means of interaction is somewhat more complex and requires a more sophisticated decoder. Suppose, as an example, that your daughter is learning the word "smile" on the children's program Sesame Street, but she has not quite got it. She asks the set for help.

It not only spells the word letter by letter, it pronounces it for her as well. Or imagine an episode of the popular American public television program on the stock market and American economy Wall Street Week on the subject of how an investor should analyze his portfolio. As the guest explains what to do, the viewer is actually doing it at home with raw data and software supplied via teletext. Obviously this interaction is accomplished through software downloaded at the user end. This assumes that the teletext decoder will be connected not only to the television set, but also to the home computer -- and why not? Why should we assume that the decoder will be built into the television set at all? It may very well make sense to put it into the home computer instead, or even to put the computer into the television set, especially with the type of infinitely flexible teletext we advocate.

Yet another possible means of interaction would involve software provided on cassettes through stores or by schools. The software would be activated by the teletext signal. This way, viewers at different educational levels could use different software and thus interact with the same program in different ways, according to their age and ability.

As public broadcasters, we would like to put special emphasis on the educational value of interaction. It is well known that children spend an enormous amount of time watching television -- hours every day, on average. On public television we have always tried at least to make it time well spent. But there is not much doubt that the big advances in education come when the child feels personal involvement with the lesson -- when they interact. This, in our minds, is what makes the potential of Level 3 so exciting.

This is the end we're working toward. But what is the means of getting there? We have looked at every existing teletext system that we know of and have been impressed by them all, and each one has its own advantages. We have been interested in those approaches that have been designed not solely as a system for transmitting text, but rather as a data-transmitting system. In our minds the system should not be shackled by its hardware. It should not care what data are transmitted over it. The system we envision should be a transparent system so that all types of data can pass through it.

The French have developed a system that involves some software processing at the user end. Because the user has a microprocessor with memory, it isn't necessary to send pages of text over and over again, but rather only once. After that, the broadcaster need send only updates of pages, leaving the rest of the time free for a wide range of additional services. A flexible and expandable

system will be the key.

We think that the graphics in any U.S. system are very important. We are very encouraged by the progress of the Canadians in refining the graphics capability of teletext. We are also encouraged by the capabilities of the free-form French system, which they call teleécriture. It allows a user to draw on a pad -- or write, scribble, diagram, chart, as he wishes -- and transmits these graphics accurately to the viewer. The advantages of this system are obvious. Our long-term goal, after all, is to communicate freely, not in pre-defined shapes but in any of the infinite ways that express what we want to express. We believe that the day will come when there will be a wide variety of input and output devices for the teletext service. Already being tested are devices such as electronic writing pads, full alphanumeric key boards, and even audio control.

Another important characteristic of any U.S. teletext system will be its ability to caption a program in multiple languages. We believe that the U.S. is rapidly approaching a bilingual status, the two languages being English and Spanish. Much of the southwest and some of the larger cities elsewhere are becoming increasingly bilingual. Further, there are also many hearing-impaired viewers who would benefit from captions. The Public Broadcasting Service was a pioneer in developing a closed captioning system for the hearing impaired, and we are very proud of it. We think the next step is using teletext. Captions in three or four different languages could be sent simultaneously, with the viewer selecting a language simply by selecting a teletext page number. The color of the caption could change to define who was speaking. With flexible graphics it would even be possible to create speech balloons on the screen of the type used in cartoons; and to go one step further, one could, through the use of teleécriture, write the words in the balloons in such a way as to express feelings.

All these services are very interesting, but we must not lose sight of the issue of cost to the consumer. What we are looking for is a system that can start at a low cost and easily expand to meet these and future needs.

At the same time as we address the many options for broadcast teletext, it is essential that we recognize the broadcasting environment of the United States. There are special problems in our country because our broadcasting system is much different from Europe's. It developed not as a government broadcasting system but as a private enterprise with limited government regulation. The broadcasting stations in a given locality are not on the same tower. They operate at different powers, from different heights and are aimed in many directions. Some are in the VHF band, others in the UHF band. Standards

for manufacturing receivers have been extremely broad. Our first step must therefore be to test the technical parameters of the various teletext systems in the U.S.

At KCET, our efforts take three forms. First, we are conducting tests to find out which lines in the vertical interval are available to use for teletext. Because of different set manufacturers' designs, there is some uncertainty about this. Second, we are bringing together experts to find out what sort of educational uses teletext would have in actual practice. Third, KCET will start a working, flexible, program related teletext system in Los Angeles in late 1980. We will explore the link between present teletext decoders and the home computer. We hope to show that with a properly designed system one can broadcast tens of thousands of pages, taking full advantage of the technology, and not just one or two hundred. We will gather the response of the viewers and report it.

Without proper care, teletext could become much like those single-function electronic games that were so popular a few years ago. Most of them have been thrown away by now, and for a good reason: the users got bored. Teletext in the U.S. must be infinitely flexible from the beginning; otherwise, it won't be around much longer than those primitive games.

We believe that a system that places the emphasis on the transmission of data instead of text, a system that has the capability of refined graphics, that is easily expandable, that is micro-processor-based and compatible with interactive video text is, in our opinion, the system most appropriate to the communications needs of the United States.

VIDEOTEX SERVICES: NETWORK AND TERMINAL ALTERNATIVES*

A.M. Chitnis and J.M. Costa

Bell-Northern Research

Canada

ABSTRACT

Videotex has provisionally become the generic name for interactive systems offering visual information services using a suitably modified or augmented home TV set, telephone and/or data networks, and videotex service centres. This paper starts by briefly introducing the videotex system concept and service possibilities. Examples of existing systems are also given. The main body of the paper considers two areas where new technology has a key role in videotex: in the network of service centres and communications facilities, and in the terminals, both at the information provider's end and at the consumer's end. The trade-offs between multiple-format databases, source coding, terminal complexity and compatibility are examined. The possible solutions to terminal design range from a single, rigid design to an arbitrary combination method. The paper proposes a Layered Capability Structure (LCS) which promotes an evolutionary approach to terminal design.

Copyright © 1980 by Online Conferences Ltd.

I. INTRODUCTION

Videotex has provisionally become the generic name for interactive systems offering visual information services using a suitably modified or augmented home TV set, telephone and/or data networks, and videotex service centres. The user interacts with the system via a hand-held keypad or a keyboard. Data is retrieved interactively from videotex centres through telephone and/or data networks, and characters and graphics are displayed on the screen of the TV set.

Videotex services are being tested in a number of countries including Canada (e.g. Bell Canada's VISTA** [1] and Communications Canada's TELIDON [2]), the U.S.A. (e.g. Department of Agriculture's GREEN THUMB), England (e.g. BPO's PRESTEL), France (e.g. CCETT's TELETEL), West Germany, The Netherlands, Denmark, Finland, Sweden, Spain, Switzerland, Hong Kong, and Japan (e.g. CAPTAINS). Information retrieval seems to be generally accepted as the introductory service but other interactive services are possible. Once the system becomes popular it will open the door to other opportunities, including interest matching, messaging, commercial transactions, questionnaires, personal databases, calculations, computer games, education and software distribution.

The expected increasing demand for videotex services will require an expanding network of service centres. This is the subject of Section II, where the logical format of a long term videotex network is presented.

In Section III the terminal features are examined. These will depend on the type of information to be marketed such as: textual, graphic, imagery, and aural.

Finally, the terminal design, both at the information provider's end and at the consumer's end are analyzed in Sections IV and V, respectively. The trade-offs between multiple-format databases, source coding, terminal complexity, and compatibility are examined.

II. VIDEOTEX SERVICE NETWORK PLANS

The early videotex systems have put all the intelligence in the network and centralized facilities but little or none in the terminals. With the declining costs of memory and processing power, the cost-efficiency factor can be improved by distributing the processing and storage functions. For example, in the case of information retrieval, the information providers can use stand-alone terminals to create and edit pages, and then set up temporary connections to the videotex network in order to update the centralized databases. Furthermore, an independent service/information provider could own and maintain his own database while the public videotex

network provides the interface capabilities such as: identity verification, communications, intelligent routing and billing. This concept supports the creation of an intelligent network to provide widespread retail outlets for independent databases. Indeed, a hierarchy of videotex centres could be formed with customers connected to the lower end and information suppliers higher up in the hierarchy depending on the nature of their information and their customer location.

A modular approach to the design of the videotex network is therefore shown in Figure 1. Growth in system capacity is achieved by adding new modules to the system rather than by increasing the size and complexity of a single centralized facility. This proposal is based on our ongoing studies of the optimum growth strategy for the intelligent network.

The videotex service can be functionally divided into two parts: the meta-service and the specific services. The videotex meta-service is provided by the backbone network of videotex nodes in Figure 1. The interconnected videotex nodes are functionally similar to a network of nodal computers [3, p. 63]. Videotex nodes give customers local access to the videotex system and provide communication interfaces (e.g. character echoing and communication error handling), the billing mechanisms, and the intelligent routing of requests to specific service centres matching customer needs. Specific services are provided by service networks as shown in Figure 1.

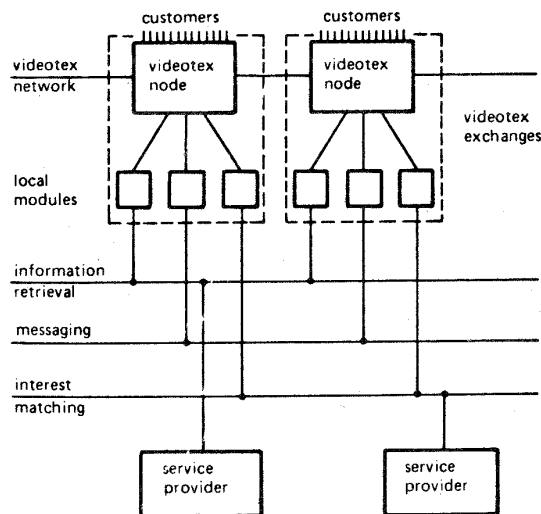

Figure 1. Long Term Logical Videotex Network.

Some services, partially at least, may be offered locally by modules adjoining the videotex nodes. This combination of each videotex node and its local serving and routing modules will be referred to here as a videotex exchange. It must be emphasized that the diagram in Figure 1 represents a logical division rather than a definite physical implementation. The choice of the actual communication links which will be appropriate in each case will be made on the basis of the above needs as well as other technical and economic criteria. Also the system is evolutionary. Most probably all the functions, including services, will be initially provided at the videotex exchanges (e.g. in a market trial configuration). However, as soon as a particular service attains a significant penetration and becomes better defined and quantified, a separate (dedicated) database or processor could provide that service in an optimum way. In order to yield a cost-effective system it will be important to combine these service offerings in such a way that the system utilization is maximized (e.g. offer both interactive and batch services).

III. TERMINAL FEATURES

The terminal features and design alternatives depend on the type of information to be marketed (e.g. textual, graphic, photographic, and aural). The coding of that information is also important. The ideal goal is a flexible coding scheme compatible with terminals of different characteristics. It remains to be seen whether this compatibility is required by the videotex market and whether it can be economically realized in the technical design.

At the transmission and display levels there are at least five types of visual information:

- 1) General text: This mode is used to transmit textual data of the general variety. General (or free-form) text can be re-formatted at the display without loss of meaning.
- 2) Positional text: This kind of text cannot be reformatted or moved on the display. Positional text is found in tabulated data and in annotations accompanying graphics. Positional text may also be used to compose simple pictures (e.g. histograms and block diagrams) which are aptly described as 'typewriter graphics'.
- 3) Mosaic graphics: This kind of graphics is exemplified by Prestel and Teletel, where each alphanumeric character rectangle is divided into six cells (arranged in 2 horizontal by 3 vertical format). The cells in each character rectangle can be displayed with any combination of two colours, known as the foreground and background colours.
- 4) Geometric graphics: Geometric graphics are drawings created in terms of geometric primitives, such as point, line, arc, rectangle,

and polygon. Telidon [2] and certain terminal-to-terminal visual communications systems [4], [5], are examples of systems using geometric graphics.

5) Photographic Imagery: Real world scenes which cannot adequately be represented by the previous schemes can be coded in a pel-by-pel format. Single-frame colour images can be represented by digitally encoding either the red, green and blue components of the scene individually or by digitally coding the NTSC composite video signal.

In addition, there are a number of display features that have to be determined such as the number of columns and the number of rows, and the number of pels or pixels (picture elements). These features are basically determined by the bandwidth of the TV set and the number of TV lines in the display area as well as the viewing distance ratio (viewing distance/picture height). Modified TV sets (RGB input) offer much greater bandwidth and colour saturation than unmodified TV sets (RF input). In the remainder of this section we discuss these issues. The numerical values suggested here are meant to stimulate discussion rather than to be accepted as definite standards.

Since most Latin-alphabet countries, such as England, France and West Germany, have adopted forty (40) alphanumeric characters per row, it is preferable to use this value to ease exchange of information with these countries. This holds true whether such international transactions are done via international gateways and/or conversion centres or by direct access by the customer.

A 5x7 dot matrix is normally used to represent upper case English characters. For lower case character representation, two additional rows of dots allow for descenders in letters such as g, j, p, q, and y. If we include one dot space between rows and also between characters, the resulting character rectangle is 6x10 pels. With forty (40) alphanumeric characters per row, and a total character rectangle width of 6 pels, 240 pels will have to be resolved on the display. There is no bandwidth limitation problem with terminals having RGB input. However, if the system is to work with unmodified TV sets (which have limited RF and IF bandwidth, a horizontal overscan of 10% to 20% and a vertical overscan of 10% to 17%), the picture quality may be marginal. The total scan-line period on 525-line TV sets is 62.5 μ s, while the active scan-line duration is about 50 μ s. In the worst case of 20% overscan, the displayed information must be confined to the central 40 μ s of the active scan-line duration. This results in a fundamental pel frequency of 3 MHz (=240 x 1/40 x 1/2) which is probably acceptable in most monochrome TV sets but may cause some cross-colour problems in a colour TV set. The seriousness of this problem (if any) needs to be determined by experiment.

The number of rows in the display is basically determined by the number of lines in the display area. In a 525-line TV system, there are about 480 active lines (about 45 lines being used up in the field

flyback intervals). Since two fields are interlaced to make up a frame, about 240 lines are theoretically available in each field. Assuming the worst case vertical overscan of 17%, about 200 scan-lines are visible in each field. If 10 scan-lines are used per alphanumeric row, 200 scan-lines per field leads to exactly 20 rows of alphanumeric characters. It is well known that interlace techniques do not decrease flicker as successfully with high-contrast graphic and alphanumeric displays as with low-contrast, continuous tone images [6]. Consequently, in order to reduce flicker, it may be desirable to superimpose the two fields of each frame rather than to interlace them.

The alphanumeric capacity of the screen is thus provisionally established as 40 columns x 20 rows (=800 characters per frame). The geometric capacity of the screen has already been shown to be 240 pels x 200 scan-lines (per field). As far as mosaic graphics are concerned, each character position can be subdivided in several alternative ways. In order to retain nearly square mosaic cells which are believed to produce images more appealing to the eye, and also to maintain compatibility with existing systems such as Prestel and Antiope, a 2 horizontal x 3 vertical subdivision would be preferable. The mosaic capability of the display would thus be 80 horizontal (=40 columns x 2) and 60 vertical (= 20 rows x 3).

The legibility of text [7] depends very strongly on the viewing distance ratio, which is defined as the distance from the viewer to the display divided by the height of the display. Studies have shown that if 20 rows of text are to be read comfortably for long periods of time, the viewing distance ratio should not exceed 8.5. This is believed to be acceptable based on our observations of typical domestic viewing situations.

Since videotex at present is a TV-based service, aimed at the home TV audience (who may be reluctant to adjust their furniture to receive videotex), the legibility of a 20-row display should prove to be acceptable to the majority of viewers. Any further reduction in the number of rows (and columns) of text is unlikely to find favour with the information providers, because of the difficulty in conveying enough information when the number of characters in the display is reduced. In order to cater to those viewers with poor vision or too great a viewing distance ratio, the terminal manufacturer could provide an optional double-height zoom ability (which has been tried out in Europe). With this type of feature, the viewer presses a button on his keypad so that the top-half (upper 10 rows) of the frame is expanded to fill the display (although the width of the display does not change). A second push on the button shows him the lower 10 rows, while a third push restores the 20-row display.

IV. CUSTOMER TERMINAL DESIGN FACTORS

In the previous section we have discussed the various types of visual information that a videotex terminal should be able to handle. Since videotex systems are just starting to appear and the market is still unknown, it would be expensive and risky to attempt to provide them all at once. Consequently an evolution strategy is necessary for terminal design. The purpose of this section is to discuss such a strategy.

The preferred terminal design strategy is a flexible one, so as not to place undue constraints on the service features which may be offered in the future. Ideally there should be a maximum of forward and reverse compatibility between terminals and databases. Forward compatibility means that present day terminals can receive and decode expected future information within the limits of their capability. Backward compatibility means that the system must be designed so that future terminals can access old data. In addition there should be a maximum of upward and downward compatibility between terminals and databases. Upward compatibility means that low-feature terminals should be able to display as well as possible any information from a sophisticated database. Downward compatibility means that sophisticated terminals should be able to access simple data. These are logically desirable objectives although there is at present some doubt whether the business objectives of videotex services will encourage such extreme flexibility. A very successful example of maximum compatibility is television signal standards which allow both monochrome and colour television receivers to display monochrome and colour television programmes.

There is at present much international and national activity aimed at developing standards for videotex. Unfortunately the details of the applications and the needs and size of the videotex market are unclear. There is also much controversy about the perceived cost-benefits of features such as simple graphics, sophisticated graphics, colour, grey-scale, animation, audio, etc.

The foregoing discussion rules out the choice of a single, rigid terminal realization, because of its lack of flexibility. At the other end of the scale, an arbitrary combination method would allow terminal designers and service centres to offer any combination of features. However, this scenario could soon become chaotic as terminal manufacturers and service providers pursued specific market segments.

In order to steer a middle path between inflexibility and fragmentation, it is proposed here that the visual feature capabilities of a videotex system should be arranged in a Layered Capability Structure (LCS) as shown in Figure 2. This structure strikes a balance between a single, rigid realization and a multitude of embodiments. This will give the vendor and consumer some freedom

of choice without creating confusion (and high costs) in the marketplace. Indeed, given N feature capabilities, the arbitrary combination method could result in M (where M= 2 raised to the Nth power) different types of terminals, generally incompatible with each other. On the other hand, the Layered Capability Structure yields only N different types of terminals with a maximum of forward and upward compatibility.

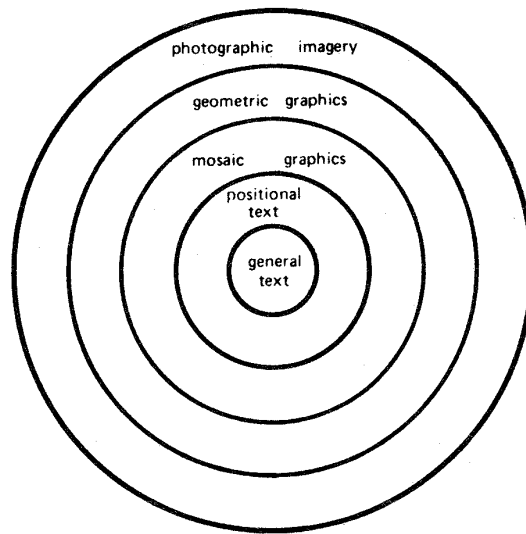

Figure 2. Layered Capability Structure for Visual Information.

The Layered Capability Structure could, for example, consist of a hierarchy of five (5) types of videotex terminal structures, namely:

- A. General text only
- B. Type A + Positional text
- C. Type B + Mosaic graphics
- D. Type C + Geometric graphics
- E. Type D + Photographic imagery

In practice, these different terminal categories may represent evolutionary phases or a range of terminals that may be available simultaneously in the marketplace. It is important to note that the initial offering can be made at any level desired. Features can subsequently be added to (or subtracted from) future terminal offerings depending upon the results of market trials, cost

projections, etc. The Layered Capability Structure can be extended upwards to include animation and even perhaps motion-video. Non-visual features such as audio can be added to any layer of the structure, although additional standards would be needed eventually to cover these areas.

The Layered Capability Structure approach has three major advantages:

- 1) Every high featured terminal becomes downward compatible with all terminals of lower features than itself. The customer who trades up to a high featured terminal can therefore still invoke (if he so desires) any of the previously familiar features or material.
- 2) The extra cost of this downward compatibility is borne by the higher featured terminals where it is less perceptible. Moreover, the higher featured terminal may be able to implement a low-featured terminal capability more readily and cheaply than can the low featured terminal, since it already incorporates more sophisticated components (such as microprocessors and bit-map memories in the case of type D terminals).
- 3) The information provider has a clear idea of the size and capabilities of the terminal population which can receive any information he creates. This interworking relationship between terminal population and database is shown in Figure 3. The lower the level of features that an information provider employs when creating his database, the larger is the terminal population which can access it. In this way, an information provider can strike a balance between the potential market for his product and its visual appeal.

It should be noted from Figure 3 that geometric graphics can be displayed by a type C terminal (which is normally a mosaic terminal) if a PDI-to-mosaic converter is used (either in the terminal or at the database). The feasibility and cost of such a converter are yet to be determined. Also, the quality of the mosaic pictures produced by such a conversion process must be evaluated. Similarly, photographic imagery can be displayed on a Type D terminal (which is normally text, mosaic and geometric) if a photographic-to-bit-map decoder is employed (either in the terminal or at the database); the bit-map memory required for a photographic display is already present in the Type D terminal.

The Layered Capability Structure can also assist the information providers, whose investment in videotex will be continually growing. For example, the information provider can indicate that, say, only a type D terminal should be able to receive pages that he has created. Or, he might be able to denote which segments of information on a page are general text, positional text, mosaic graphics, etc. In the latter case, any terminal could access the page and would display information within the limits of its capabilities.

terminal type	Terminal capabilities	Type of information in database				
		General text	Positional text	Mosaic graphics	Geometric graphics	Photographic imagery
A	General text	yes				
B	General text Positional text	yes	yes			
C	General text Positional text Mosaic graphics	yes	yes	yes	yes (1)	
D	General text Positional text Mosaic graphics Geometric graphics	yes	yes	yes	yes (2)	yes (2)
E	General text Positional text Mosaic graphics Geometric graphics Photographic imagery	yes	yes	yes	yes	yes

(1) If geometric to mosaic converter is used.

(2) If a photographic decoder is used. Note that geometric terminal already has bit-map memory.

Figure 3. Interworking relationship between Layered Capability Structure terminals and type of information in database.

The Layered Capability Structure encourages the concept of modular television, similar to present day component hi-fi audio systems. Indeed, component television receivers with inputs and outputs at standardized baseband frequencies not only separate the tuning unit from the display but are also more suitable for peripheral devices and provide the means of gradual expansion for future home terminals [8].

In terms of today's situation, the following examples may be appropriate for each of the categories of terminals:

TYPE A: General text. For example, computer terminals, TWX printers, certain special purpose terminals (e.g. for the deaf [9]), and home computers [10]. All of these terminals can in principle receive and transmit general text information to a videotex database (although some transcoding might be required).

TYPE B: Type A + Positional text. The terminals mentioned under type A are suitable if their display dimensions exceed (or equal) 20 rows and 40 columns (as proposed in Section III).

TYPE C: Type B + Mosaic graphics. Examples of these terminals are the current versions of the Vista, Prestel and Teletel terminals, and some home computers [10].

TYPE D: Type C + Geometric. The Telidon terminal and some home computers have geometric capabilities. If a mosaic-to-bit-map converter were added (in software or in hardware) these could function as Type D terminals.

TYPE E: Type D + Photographic. This type of terminal today is only available for specialized applications. Further research is necessary to optimize the encoding techniques and to bring costs down to a level acceptable to the general public.

Finally, the Layered Capability Structure helps considerably in the design of the videotex network. Since the videotex exchange is the common access point for terminals of diverse characteristics, the conversation between the user and the exchange should be in text only. The desired services and information accessed through the exchange, however, can contain mosaic, geometric or photographic features at the discretion of the service providers.

V. INFORMATION PROVIDERS TERMINAL

In the previous sections we have described the network of service centres necessary to support videotex and the design philosophy for the customer terminals. The final key element in the system (in reality it is the first, especially in information retrieval applications) is the means of creating and editing the database. As these operations are labour intensive, it is essential to simplify them and so reduce labour costs by using the appropriate information provider terminal. Initial capital investment in well-optimized information supplier terminals will result in the creation of more attractive pages, ease of editing and reduced overall costs.

It is expected that in this area also, the Layered Capability Structure could be applied profitably. Good text-editing facilities will be essential since text is expected to form the major portion of the database material. However, there will be an increasing demand for simplified creation and editing of graphics (mosaic, geometric and photographic).

Considerable software development will also be required to produce simple and flexible methods of cataloguing and indexing the prepared pages into a coherent structure. There are several storage-and-retrieval methods ranging from simple menu-selections in a tree-structured database to logical operations on keywords in a totally inverted database. While many of these considerations belong to the database area, they will nevertheless have a significant influence on the design of the information providers' terminal.

VI. CONCLUSION

Two principal technical areas of importance in videotex have been considered.

Firstly, a logical network evolution strategy for videotex has briefly been proposed which can accommodate increasing numbers of users and services. Introductory systems will be centralized at distinct nodes (videotex exchanges). However, in the long term the network will evolve towards a decentralized (distributed) system. The result will be an intelligent network providing the access and transportation vehicle to a number of different services.

A Layered Capability Structure has been proposed regarding the visual features of videotex terminals. This strategy for terminal evolution proposes a hierarchy of five (5) types of videotex terminals to display general text, positional text, mosaic graphics, geometric graphics, and photographic imagery.

ACKNOWLEDGEMENTS

The authors gratefully acknowledge the invaluable comments of A.H. Marsh and C. Thompson.

REFERENCES

- [1] "Vista** gives television a new face", Telesis, Vol. 6, No. 1, pp. 29-31, February 1979.
- [2] D. Wright, "TELIDON - Is there a good market for a good technology?", In Search, Vol. VI, No. 1, pp. 1-17, Winter 1979.
- [3] L.D. Woods, "Distributed processing in manufacturing", Datamation, Vol. 23, No. 10, pp. 60-63, October 1977.
- [4] G.B. Thompson and M. Westelman, "Scribblephone - Extending man's powers of communication", Telesis, Vol. 1, No. 3, pp. 74-79, September 1968.
- [5] "Conversational graphics via Scribblephone", Telesis, Vol. 3, No. 5, p. 158, January/February 1974.
- [6] R.E. Holmes, "Generation display in detail -- now what?", Optical Spectra, Vol. 12, No. 6, pp. 47-50, June 1978.
- [7] CANADA, "Visibility of textual presentation on videotex display screens", COM VIII-No. 113-E, International Telegraph and Telephone Consultative Committee (CCITT), March 1979.

- [8] J.R. Storey, "Terminals for future home services received via wideband networks", in Proceedings of the CCTA Conference, Canadian Cable Television Association, Montreal, Canada, pp. IV-84 to IV-94, May 1978.
- [9] "BNR develops communication aid for the deaf", Telesis, Vol. 5, No. 5, p. 160, October 1977.
- [10] A.M. Chitnis, A.H. Marsh and W.D. Sawyer, "The home computer: toy or tool?", in Proceedings of the International Conference on Communications, Toronto, Canada, June 4-7, 1978, pp. 38.1.1 to 38.1.6.

* This paper was previously published in IEEE Transactions on Consumer Electronics, Vol. CE-25, No. 3, pp. 269-278, July 1979.

** Trademark of Bell Canada.

Appropriate Technology for Text Broadcasting

Eric Somers
Electronic Text/Graphics Consultant
U. S. A.

The structure of electronic text systems are analyzed according to criteria of social and educational utility. In the first section of the paper the communicative capabilities of standard radio and television broadcasting are discussed and compared to those of print. Current teletext and viewdata implementations are examined according to these same capabilities. A model structure is proposed for an electronic text system having greater utility.

The second section proposes an implementation of the "ideal" model. The transmission technology uses FM and TV subcarrier channels. The receiver contains processing and storage capability. The transmission technology is explained and the design criteria for a suitable receiving terminal are outlined.

Copyright © 1980 by Online Conferences Ltd.

In studying the history of communications, one can identify an initial stage of development of a particular medium during which the technology itself attracts more interest and attention than does the content of the information to be communicated, or than do considerations of the impact the new technology may have upon peoples and cultures. Teletext broadcasting is in this stage. Competing systems are usually compared on the basis of small technical details, and larger, more important, questions about the utility of a system in the context of world broadcasting and cultural enrichment are usually ignored.

The first section of this paper discusses several questions of cultural and epistemological utility related to the design of electronic text systems in general. In the second section, a system of text broadcasting utilizing FM subchannels is proposed and discussed in relationship to the values presented in the first section.

§1. INFORMATION TECHNOLOGY AND COMMUNICATIONS CONTENT

Although the acceptance of new inventions is often influenced heavily by economic and promotional factors, questions of appropriate technology considered in a social context are by no means trivial. Once a technology comes into widespread use and huge economic commitments are made to a certain way of doing things, that technology becomes immanentized. The basic structure of the technology may be identified with the medium as a whole to such an extent that deficiencies are accepted as an integral part of the medium and the value of improvements may be unrecognized or questioned. Even when change is regarded as desirable, it may be deemed too expensive or wasteful.

Presumably, teletext and viewdata services are intended to augment standard television and radio broadcast services, so an understanding of the role of teletext broadcasting must be considered in light of what standard radio and television communications can and cannot do.

The content of broadcast programming can be divided into content that is largely behavioral and content that is largely abstract. Behavioral content is the observation of the behavior of human beings, whether in a fictional or actual context. All of the performing arts, as well as many news features and documentary programs can be said to possess mainly behavioral information.

Abstract content deals with the domain of ideas and knowledge considered apart from the personality or behavior of the people who are purveyors of that information. Abstract information can deal with human behavior as a topic, but the behavior discussed is not that of the person doing the communicating. Thus a critical analysis of the artistic contributions of an actor may be abstract information, while the performance of a play in which the actor appears is behavioral communication.

One should avoid the oversimplification of saying that behavioral content is "entertainment" and abstract content is "information." The informational value of entertainment in communicating societal norms and values has long been recognized, as has the role of entertainment in social agenda setting. [1] Also, many so-called "informational" programs are really valued more for their behavioral content than for their abstract content. An example would be an interview with a famous author. Few authors can express themselves as clearly on television as they can in print, and time restrictions on a television broadcast almost never allow for a detailed explication of ideas, yet many viewers who never read an author's published work are eager to watch an interview. These people seem more interested in "meeting" noted people via television than in coming to grips with the information that made such people famous.

It is impossible to deny the value of radio and television in communicating behavioral information. (I use the term "information" in its most general sense to mean anything communicated.) The electronic media have become the most popular forms of entertainment ever developed. But the structural bias of the media is weighted so heavily in favor of behavioral, rather than abstract, content that abstract information is crowded out. Political leaders, for example, are now elected more on the basis of their emotional media "images" than on the basis of their political ideology or problem solving strategy.

Indeed, many scholars are questioning the ability of radio and television to communicate abstract information. [6] High levels of abstract learning seem to require that the cognition of abstract data be separated from the personality of the communicator, that the receiver (i. e. the viewer or listener) have control over the selection and flow of information he or she receives, and that the receiver have access to a wide variety of information. [9]

None of these three criteria are met by radio or television except

on a superficial level. The examples of politicians and authors mentioned above indicate the problem of communicating abstract ideas apart from behavioral content. But radio and television do even less well in trying to meet the other two criteria.

The viewer has virtually no control over the selection and flow of broadcast information. A slight measure of control can be obtained by a viewer using some kind of video or aural tape recording system, but searching for data on a tape is far more difficult and slow than scanning a book or periodical. Also, except for certain types of graphic information, the rate of information flow is extremely slow. A half hour of newspaper reading will convey more information of an abstract analytical nature than will a half hour news broadcast. It is the behavioral content of a television news report, the sense of making the viewer an "eyewitness" to human events, that is the attraction.

The quantity of information available from the electronic media is also very small in comparison to printed forms. The information broadcast on all radio and TV stations in any given time period represents only a tiny fraction of the information published in print.

The distinction between the way information is communicated by print and by the electronic media can be looked at still another way. Marshall McLuhan [7] and others have noted that television communication bears a striking formal similarity to pre-literate "tribal" communication and thinking, rather than to communication and intellectual processes of literate man.

One difference is that of group participation as distinct from individual activity. In primitive tribal communications virtually all information is communicated in a group situation. The flow of information is a function of the group dynamics involved, and a member whose ideas threaten the group can be effectively controlled by the values and norms of the group. At worst, the maverick might be totally ostracized by the group and then he is cut off from communicated information. The abstract information cannot be separated from the human behavior of those doing the communicating.

Writing allows for some separation of information from group participation, in that libraries and other information stores can be developed. However, handwritten books are expensive and such information stores cannot be open to everyone. So only a small

number of people in a given society can benefit from using stored handwritten information.

The printing press permits a flow of information to virtually all individuals. A person can collect and use printed information without belonging to a group or submitting to group values. The reader has control over the information he receives, and is free to develop and espouse any ideas whatever. Of course, political authorities can take steps to suppress an idea once expressed, but the printed word allows for the development and expression of "irrational" (in terms of group norms) ideas, whatever the outcome.

Watching television is a kind of group activity in which participation rather than contemplation or reflection is the primary requirement for gaining the information offered. As in the tribal group, a single individual has little control over the information he receives, and unlike in a print oriented society, he has little means of expressing (to other members of the group of "television viewers") an idea he may have.

In fact, the whole issue of "public access" is a recurrent one in the field of television. But what is often overlooked is that the more heavily involved a person becomes in trying to express an idea via television, the less individual the process. Television broadcasting is by nature a group activity, and the presentation of ideas over television involves one in a group dynamic that can influence the content of what is to be communicated.

In addition, we saw earlier the problem of separating abstract information from behavioral content in a television presentation. This content "clothes" the abstract information with behavioral norms, even if there is every intent to broadcast "pure" abstract data.

The differences we have been discussing can also be understood in another context. Groups behave in a continuous fashion, and in group communication, intellectual development is controlled by the continuous nature of human behavior. But new ideas and inventions tend to be the result of discontinuous processes -- a kind of alienation -- whether self-imposed or forced.

Eric Hoffer has noted the tremendous creative and intellectual contributions of alienated immigrant populations to the growth of the United States. [5] An otherwise ordinary middle class suddenly thrust into an alien environment, but an environment that allows

for the development of individual values rather than requiring immediate assimilation, becomes a class of inventors, scholars, artists, etc.

Print allows for a separation of the discontinuous world of the mind from the continuous world of behavior. The result is that print media are best suited to intellectually stimulating a population. Participatory, or behavior oriented media, such as television, are best for controlling a population. That is why television has changed politics and the marketing of products, but why the "golden age" of low cost mass education by television has never really arrived. And this explains why student populations attending schools where reading has been largely replaced by classroom lectures, discussion and film/TV viewing (all participatory forms of communication) achieve a lower level of learning, literacy, and creativity, than is achieved by students attending schools that follow a traditional structured print oriented curriculum.

Where do viewdata and teletext systems fit into this analysis of communication forms? The alphabetic nature of electronic text systems might easily lead the casual observer to believe that electronic text communication bring the cultural advantages of print communications to the world of electronic media. Indeed, this is possible, but the major thesis of this paper is that, perhaps contrary to intuition, most electronic text systems proposed to date model tribal participatory communications more closely than discontinuous print communications. Furthermore, it can be shown that an "idealized" form of teletext broadcasting would be stronger, not weaker, than interactive viewdata systems, in terms of the values we have been discussing.

Taking a look first at existing teletext systems, we see a structure in which the user can select "pages" of text from a continuous datastream. Since the pages are transmitted sequentially, and the receiving terminal "grabs" a single page at a time from the datastream, some systems have waiting periods (from the time a page is selected until it appears) as long as 25 seconds.

The pages are designed for reproduction on an ordinary low resolution home television set and usually consist of no more than 24 lines of 40 characters each. Obviously, many people can read one page faster than they may have to wait to get another one. And the total number of pages which can be accommodated by this type of system is limited by the necessity of retransmitting each page continuously.