



[54] MATERIALS AND METHODS FOR ETCHING SILICIDES, POLYCRYSTALLINE SILICON AND POLYCIDES

[75] Inventors: David N. Wang, Cupertino; Mei Chang, San Jose; T. K. Leong, deceased, late of Santa Clara, all of Calif.; Peter P. Leong, executor, Vancouver, Canada

[73] Assignee: Applied Materials, Inc., Santa Clara, Calif.

[21] Appl. No.: 778,326

[22] Filed: Oct. 17, 1991

Related U.S. Application Data

[60] Division of Ser. No. 443,811, Nov. 29, 1989, Pat. No. 5,112,435, which is a continuation of Ser. No. 185,256, Apr. 19, 1988, abandoned, which is a continuation of Ser. No. 786,783, Oct. 11, 1985, abandoned.

[51] Int. Cl.⁵ H01L 21/302

[52] U.S. Cl. 252/79.3; 156/643; 156/646; 156/656; 156/657; 156/662

[58] Field of Search 156/643, 646, 656, 657, 156/662; 252/79.3

[56] References Cited

U.S. PATENT DOCUMENTS

3,951,709	4/1976	Jacob	156/643
4,203,800	5/1980	Kitcher et al.	156/643
4,478,678	10/1984	Watanabe	156/643
4,543,597	9/1985	Shibata	156/643 X
4,615,764	10/1986	Bobbio et al.	156/643

Primary Examiner—Thi Dang
Attorney, Agent, or Firm—Philip A. Dalton

[57] ABSTRACT

Gas chemistry and a related RIE mode process is described for etching silicides of the refractory metals titanium, tantalum, tungsten and aluminum and for etching composites of these silicides on polycrystalline silicon layers. BCl₃ is added to the HCl/Cl₂ gas chemistry used for the polysilicon etch along with additives selected from fluorinated gases and oxygen to satisfy the multiple requirement of the two-step silicide-polysilicon etch process, including the silicide-to-polysilicon etch ratio requirement.

9 Claims, 11 Drawing Sheets

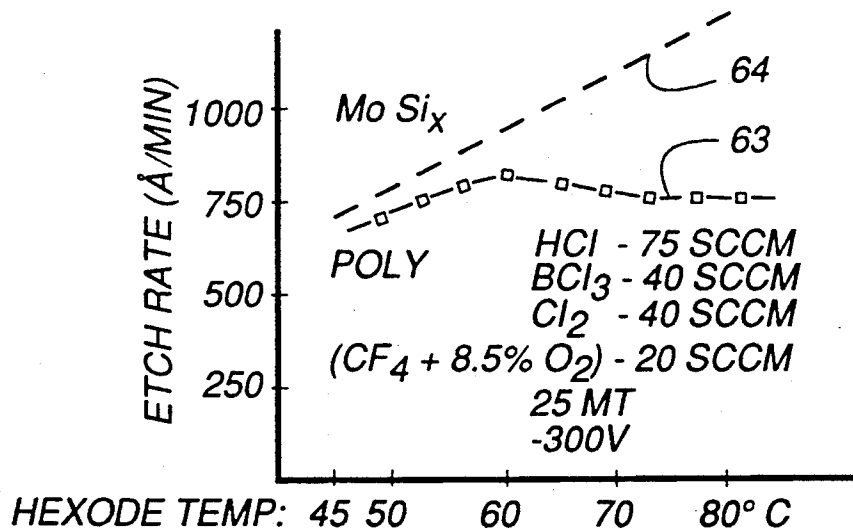

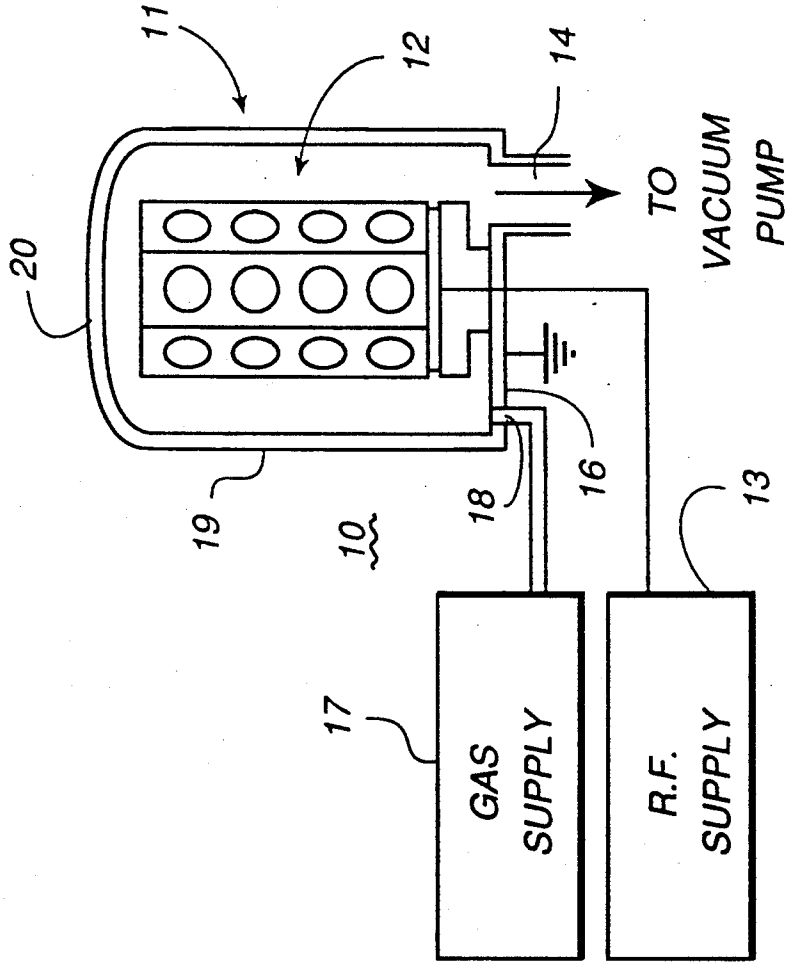

Figure 1

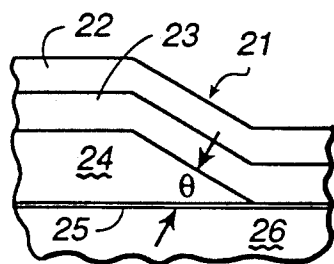

Figure 2

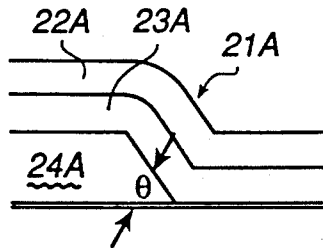

Figure 2A

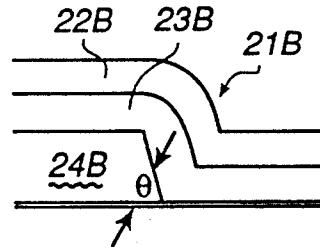

Figure 2B

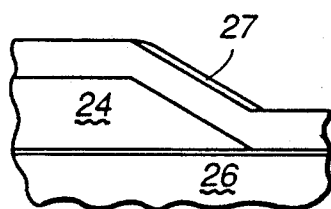

Figure 3

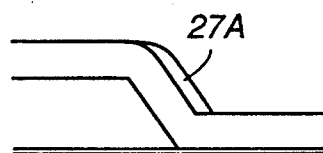

Figure 3A

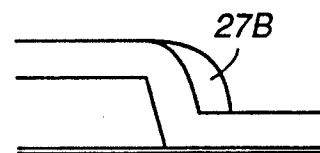

Figure 3B

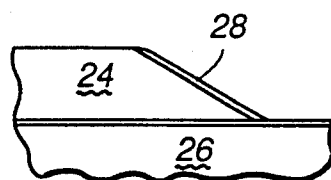

Figure 4

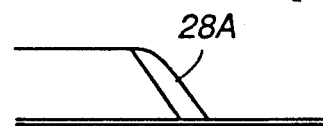

Figure 4A

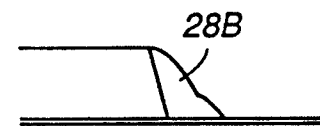

Figure 4B

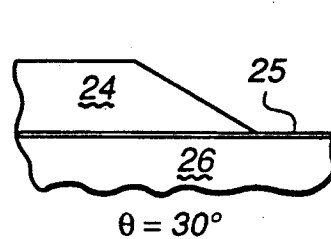

Figure 5

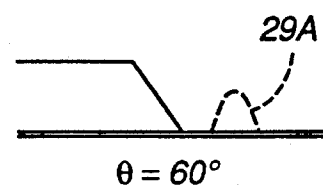

Figure 5A

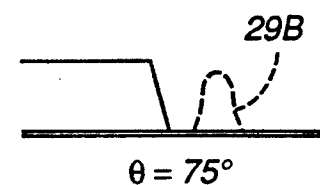

Figure 5B

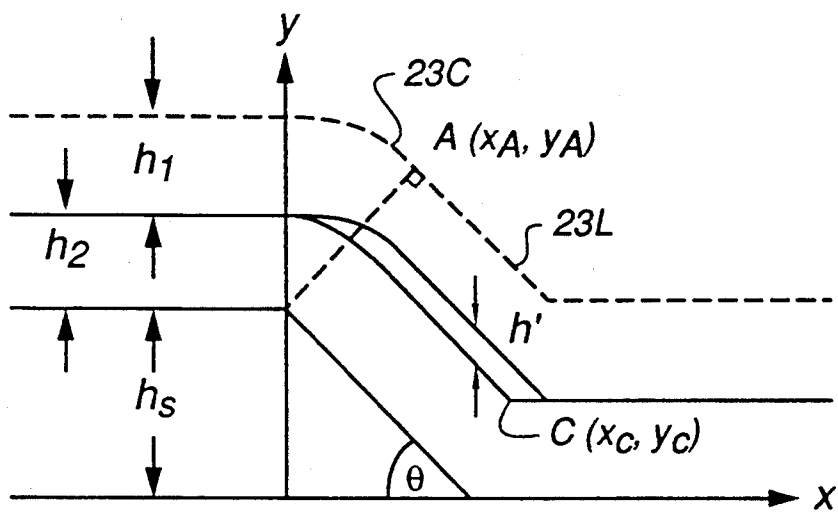

Figure 6

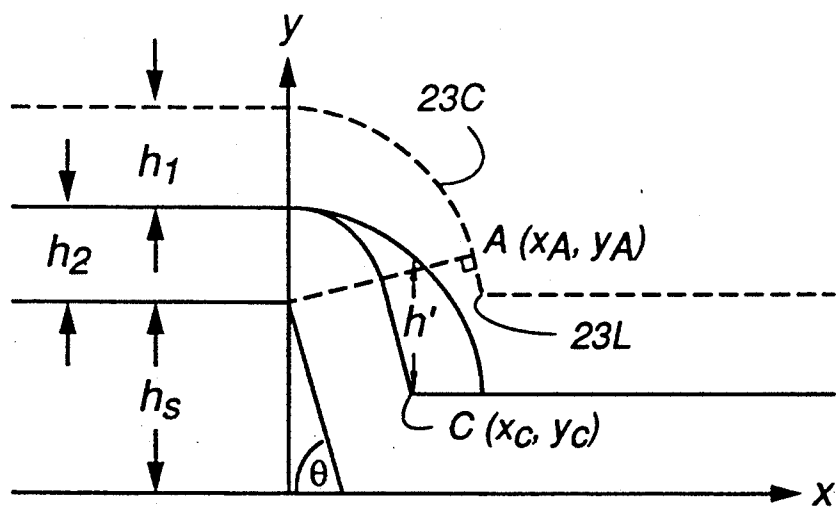

Figure 7

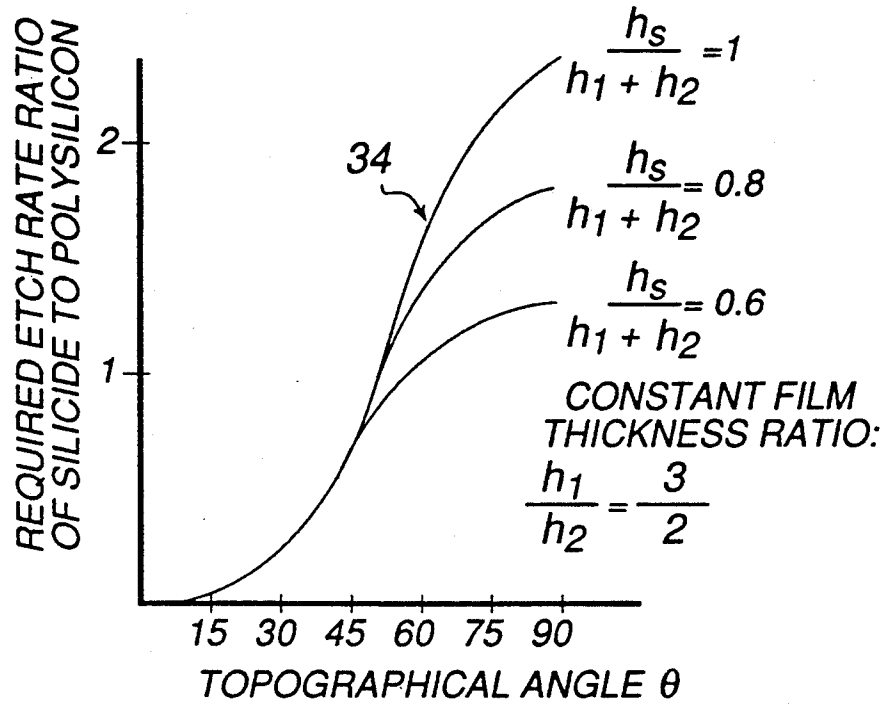

Figure 8

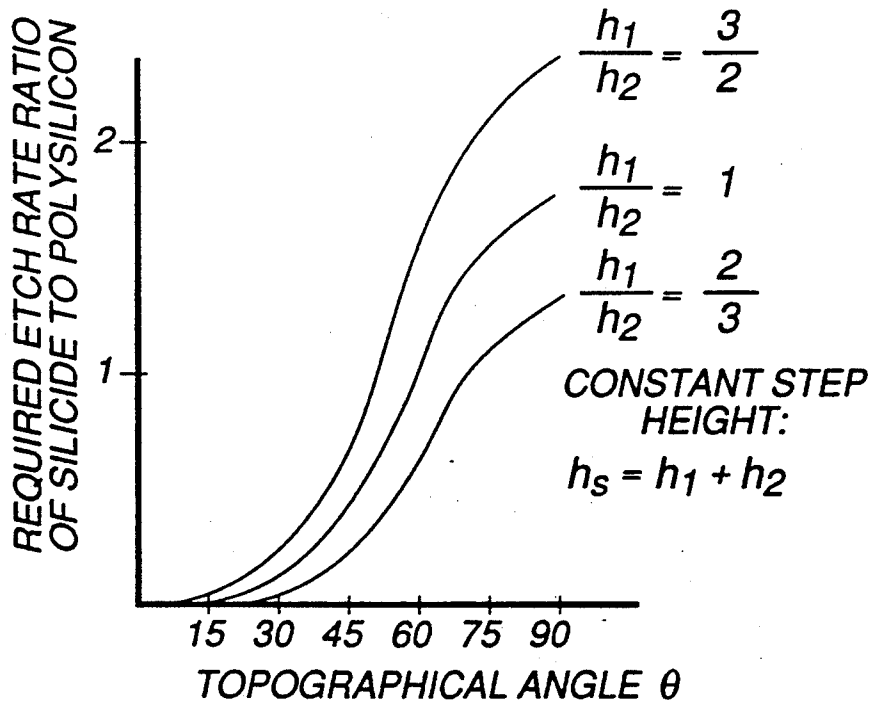

Figure 9

Explore Litigation Insights

Docket Alarm provides insights to develop a more informed litigation strategy and the peace of mind of knowing you're on top of things.

Real-Time Litigation Alerts



Keep your litigation team up-to-date with **real-time alerts** and advanced team management tools built for the enterprise, all while greatly reducing PACER spend.

Our comprehensive service means we can handle Federal, State, and Administrative courts across the country.

Advanced Docket Research



With over 230 million records, Docket Alarm's cloud-native docket research platform finds what other services can't. Coverage includes Federal, State, plus PTAB, TTAB, ITC and NLRB decisions, all in one place.

Identify arguments that have been successful in the past with full text, pinpoint searching. Link to case law cited within any court document via Fastcase.

Analytics At Your Fingertips



Learn what happened the last time a particular judge, opposing counsel or company faced cases similar to yours.

Advanced out-of-the-box PTAB and TTAB analytics are always at your fingertips.

API

Docket Alarm offers a powerful API (application programming interface) to developers that want to integrate case filings into their apps.

LAW FIRMS

Build custom dashboards for your attorneys and clients with live data direct from the court.

Automate many repetitive legal tasks like conflict checks, document management, and marketing.

FINANCIAL INSTITUTIONS

Litigation and bankruptcy checks for companies and debtors.

E-DISCOVERY AND LEGAL VENDORS

Sync your system to PACER to automate legal marketing.