

BAR CODE LABEL



# U.S. PATENT APPLICATION

SERIAL NUMBER

08/566,029

FILING DATE

12/01/95

CLASS

280

GROUP ART UNIT

3106

APPLICANT

ROBERT J. CASHLER, KOKOMO, IN.

\*\*CONTINUING DATA\*\*\*\*\*  
VERIFIED

\*\*FOREIGN/PCT APPLICATIONS\*\*\*\*\*  
VERIFIED

FOREIGN FILING LICENSE GRANTED 02/21/96

STATE OR COUNTRY

IN

SHEETS DRAWING

4

TOTAL CLAIMS

22

INDEPENDENT CLAIMS

2

FILING FEE RECEIVED

\$794.00

ATTORNEY DOCKET NO.

H-195546

ADDRESS

MARK A NAVARRE  
DELCO ELECTRONICS CORPORATION  
P O BOX 9005  
ERC BUILDING MAIL STOP D 32  
KOKOMO IN 46904

TITLE

METHOD OF INHIBITING OR ALLOWING AIRBAG DEPLOYMENT

This is to certify that annexed hereto is a true copy from the records of the United States Patent and Trademark Office of the application which is identified above.

By authority of the  
COMMISSIONER OF PATENTS AND TRADEMARKS

Date

Certifying Officer

5732375

FIG - 1

0.G. FIG. 8	CLASS	SUBCLASS
BY	701	45
DRAFTSMAN		

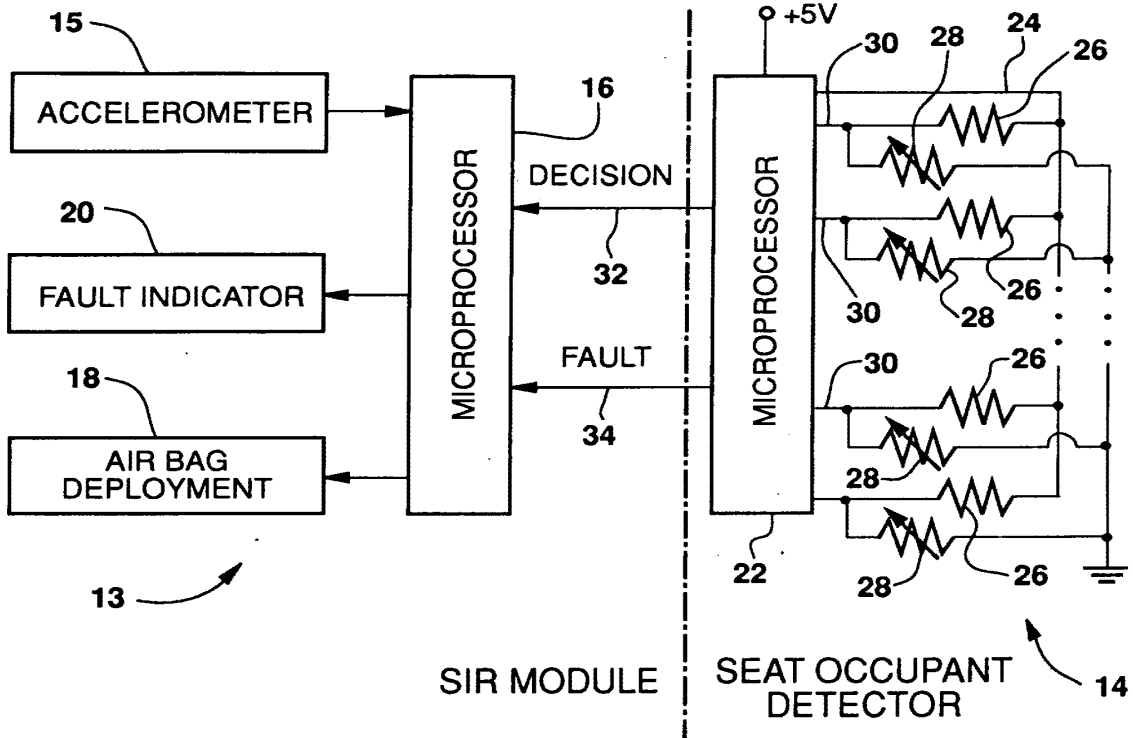
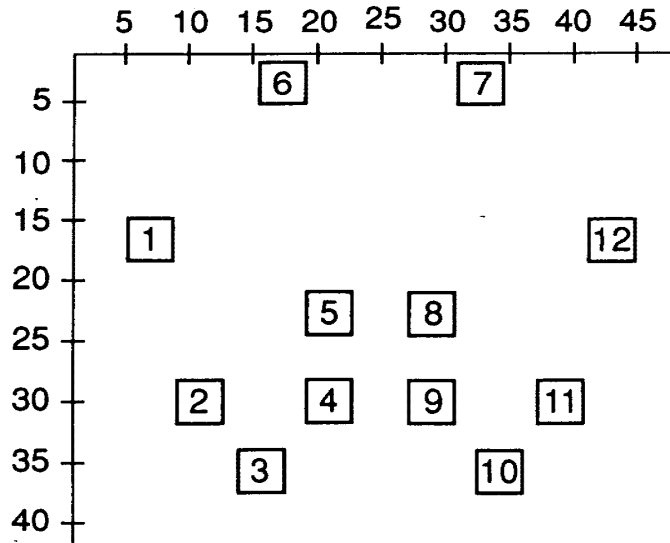

FIG - 2



DESIGNED BY	O.G. FIG.	
DRAFTSMAN	CLASS	SUBCLASS

FIG - 3

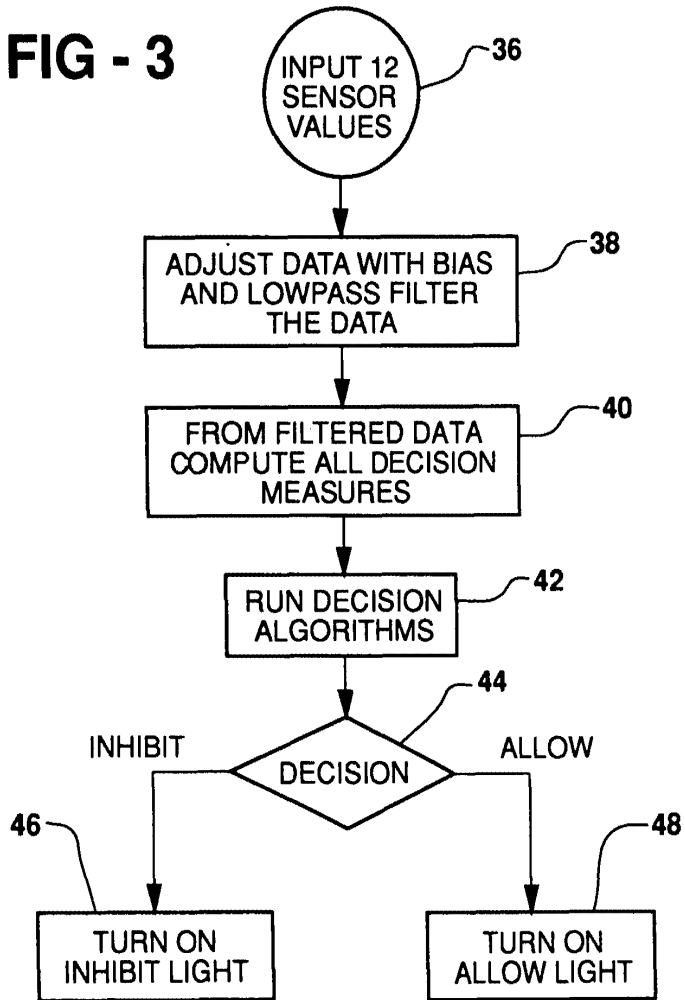
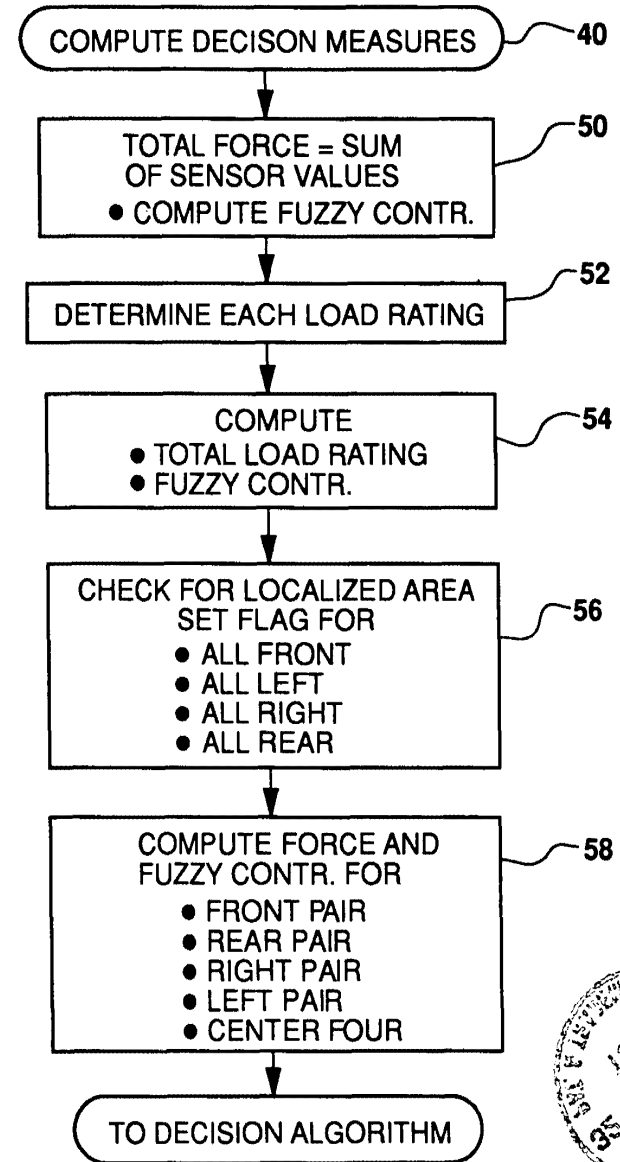

FIG - 4



O.G. FIG.	CLASS	SUBCLASS
	BY	DEPARTMENT

FORCE OR LOAD  
FUZZY  
CONTRIBUTION

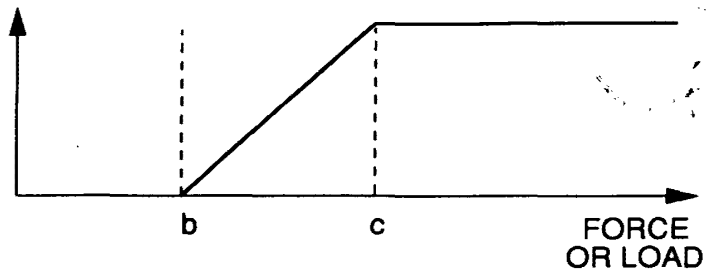

FIG - 5

LOAD RATING

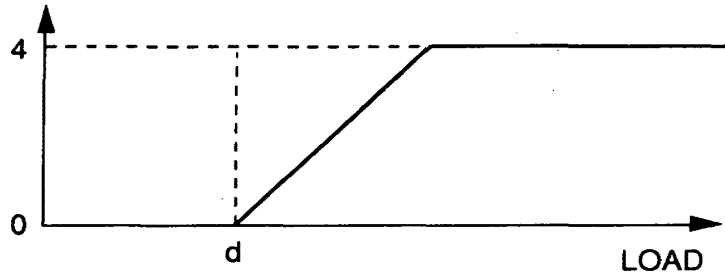

FIG - 6

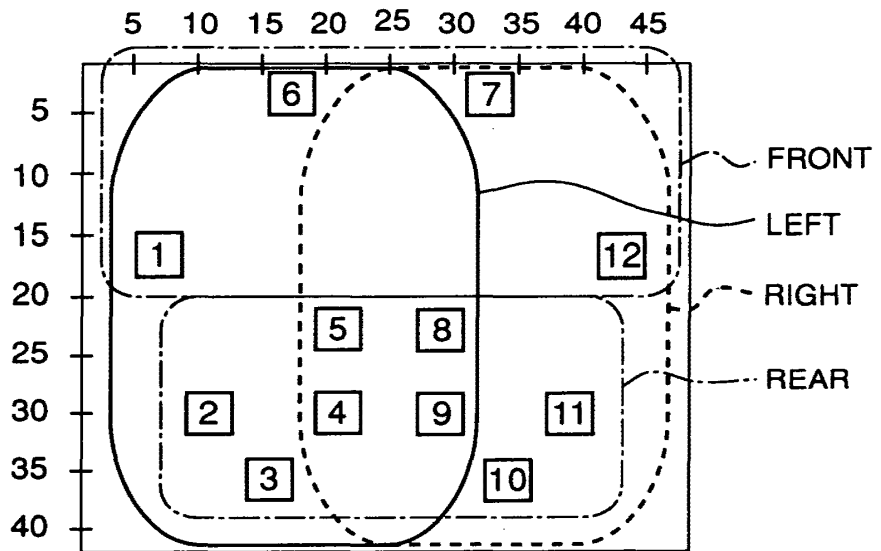
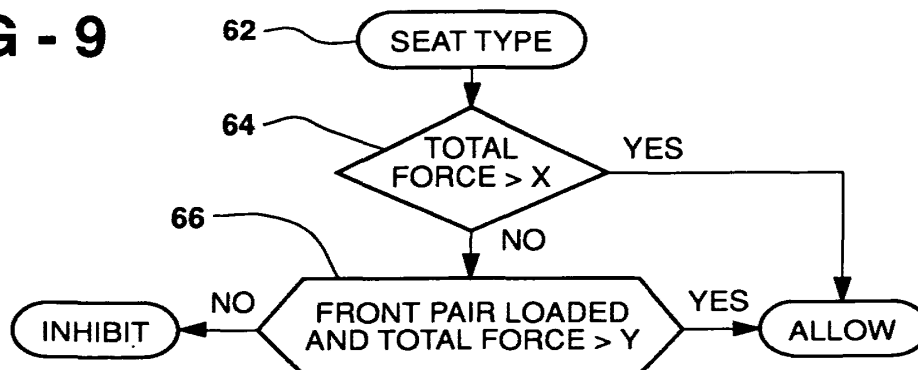

FIG - 7

FIG - 9



O.G. FIG. 8  
CLASS. SUBCLASS  
701 45  
BY  
OPERATION

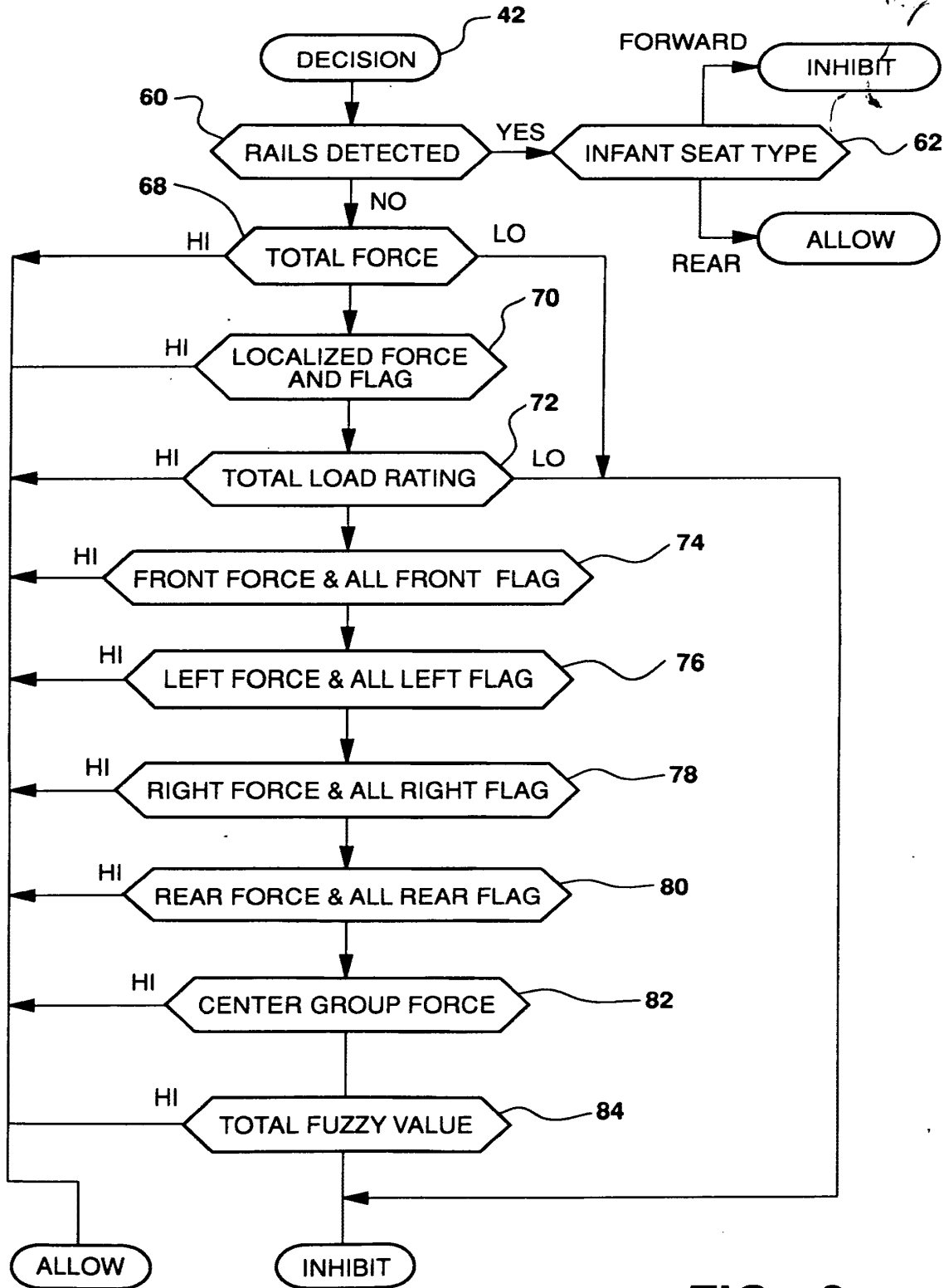

FIG - 8

# Explore Litigation Insights

Docket Alarm provides insights to develop a more informed litigation strategy and the peace of mind of knowing you're on top of things.

## Real-Time Litigation Alerts



Keep your litigation team up-to-date with **real-time alerts** and advanced team management tools built for the enterprise, all while greatly reducing PACER spend.

Our comprehensive service means we can handle Federal, State, and Administrative courts across the country.

## Advanced Docket Research



With over 230 million records, Docket Alarm's cloud-native docket research platform finds what other services can't. Coverage includes Federal, State, plus PTAB, TTAB, ITC and NLRB decisions, all in one place.

Identify arguments that have been successful in the past with full text, pinpoint searching. Link to case law cited within any court document via Fastcase.

## Analytics At Your Fingertips



Learn what happened the last time a particular judge, opposing counsel or company faced cases similar to yours.

Advanced out-of-the-box PTAB and TTAB analytics are always at your fingertips.

## API

Docket Alarm offers a powerful API (application programming interface) to developers that want to integrate case filings into their apps.

## LAW FIRMS

Build custom dashboards for your attorneys and clients with live data direct from the court.

Automate many repetitive legal tasks like conflict checks, document management, and marketing.

## FINANCIAL INSTITUTIONS

Litigation and bankruptcy checks for companies and debtors.

## E-DISCOVERY AND LEGAL VENDORS

Sync your system to PACER to automate legal marketing.