



US 20050037055A1

(19) **United States**

(12) **Patent Application Publication** (10) **Pub. No.: US 2005/0037055 A1**

Yang et al.

(43) **Pub. Date: Feb. 17, 2005**

(54) **POLYETHYLENE OXIDE-BASED FILMS AND DRUG DELIVERY SYSTEMS MADE THEREFROM**

(60) Provisional application No. 60/473,902, filed on May 28, 2003. Provisional application No. 60/443,741, filed on Jan. 30, 2003. Provisional application No. 60/371,940, filed on Apr. 11, 2002.

(75) Inventors: **Robert K. Yang**, Flushing, NY (US); **Richard C. Fuisz**, McLean, VA (US); **Gary L. Myers**, Kingsport, TN (US); **Joseph M. Fuisz**, Washington, DC (US)

(30) **Foreign Application Priority Data**

Sep. 27, 2002 (US)..... EU552991707

Correspondence Address:
HOFFMANN & BARON, LLP
6900 JERICHO TURNPIKE
SYOSSET, NY 11791 (US)

Publication Classification

(51) **Int. Cl.⁷** **B29C 47/00**; A61K 9/70
(52) **U.S. Cl.** **424/443**; 264/176.1

(73) Assignee: **MonoSolRx LLC.**

(57) **ABSTRACT**

(21) Appl. No.: **10/856,176**

(22) Filed: **May 28, 2004**

Related U.S. Application Data

(63) Continuation-in-part of application No. 10/768,809, filed on Jan. 30, 2004, and which is a continuation-in-part of application No. PCT/US02/32575, filed on Oct. 11, 2002, and which is a continuation-in-part of application No. PCT/US02/32594, filed on Oct. 11, 2002, and which is a continuation-in-part of application No. PCT/US02/32542, filed on Oct. 11, 2002.

The invention relates to the film products and methods of their preparation that demonstrate a non-self-aggregating uniform heterogeneity. Desirably, the films disintegrate in water and may be formed by a controlled drying process, or other process that maintains the required uniformity of the film. The films contain a polymer component, which includes polyethylene oxide optionally blended with hydrophilic cellulosic polymers. Desirably, the films also contain a pharmaceutical and/or cosmetic active agent with no more than a 10% variance of the active agent pharmaceutical and/or cosmetic active agent per unit area of the film.

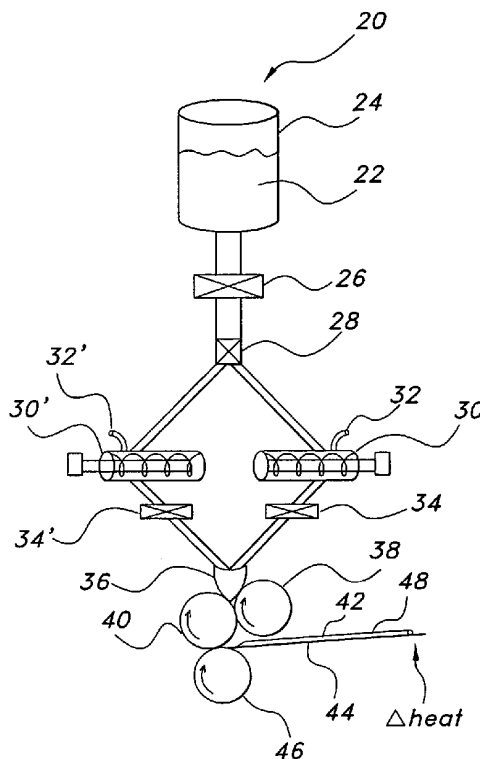

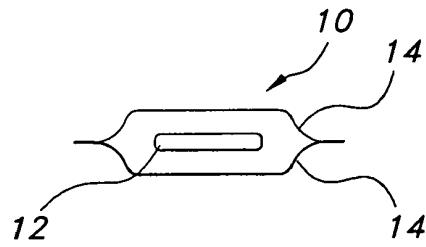

FIG. 1

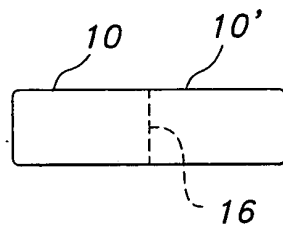

FIG. 2

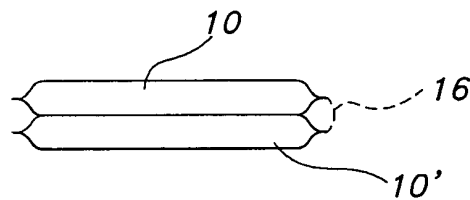

FIG. 3

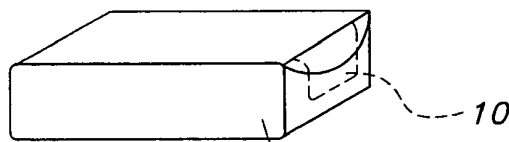

FIG. 4

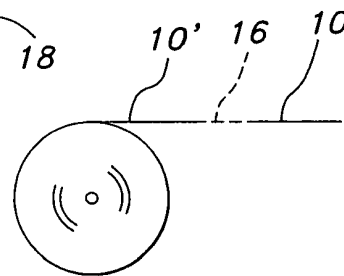

FIG. 5

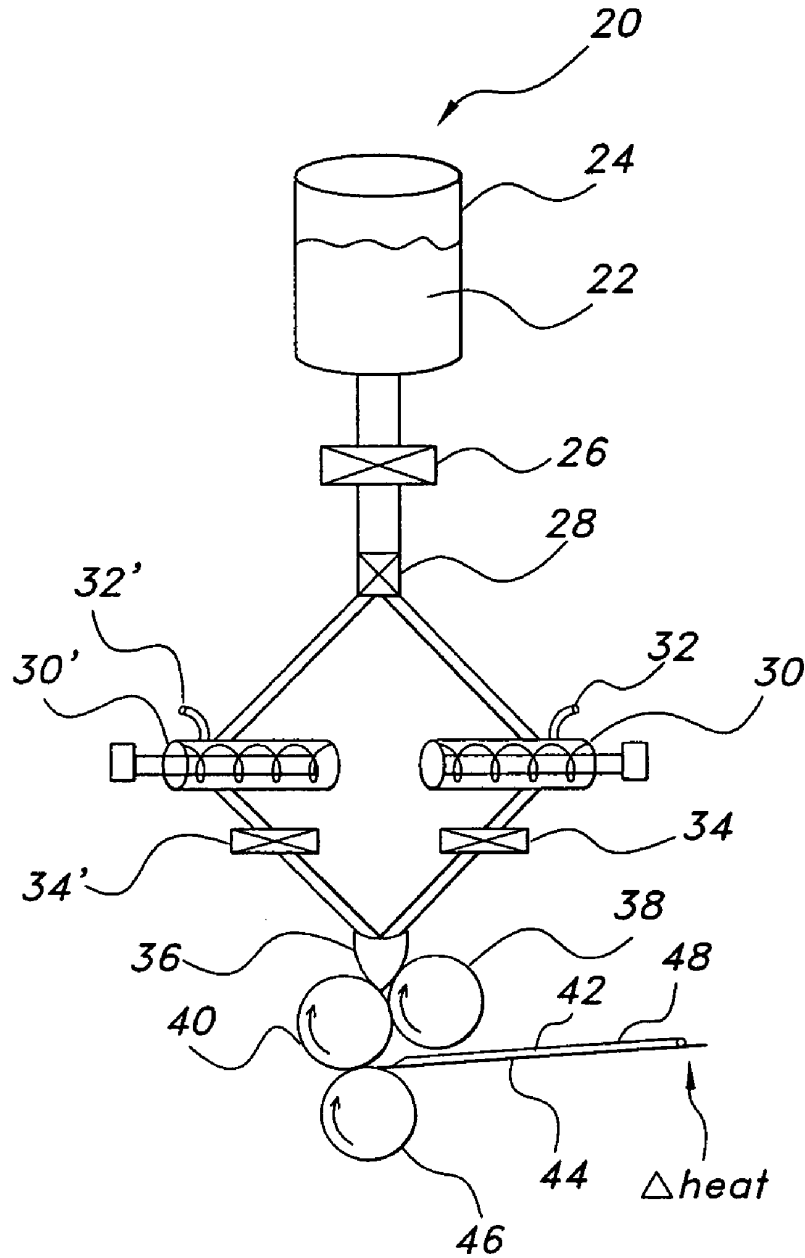

FIG. 6

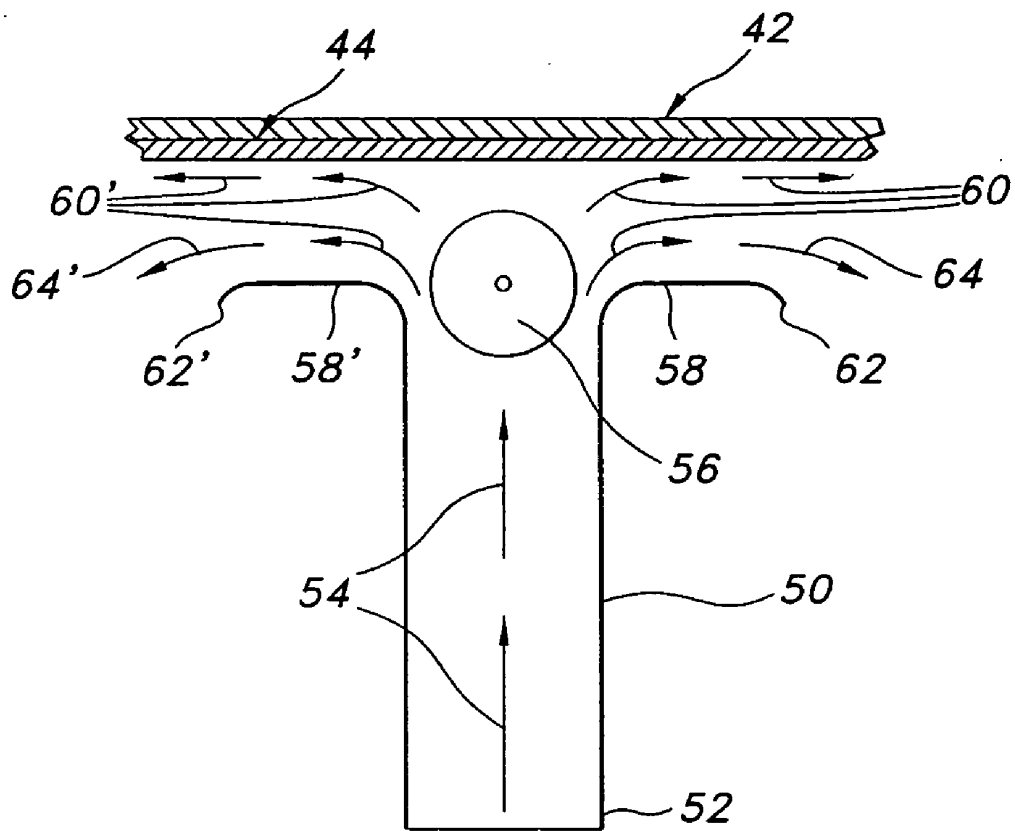

FIG. 7

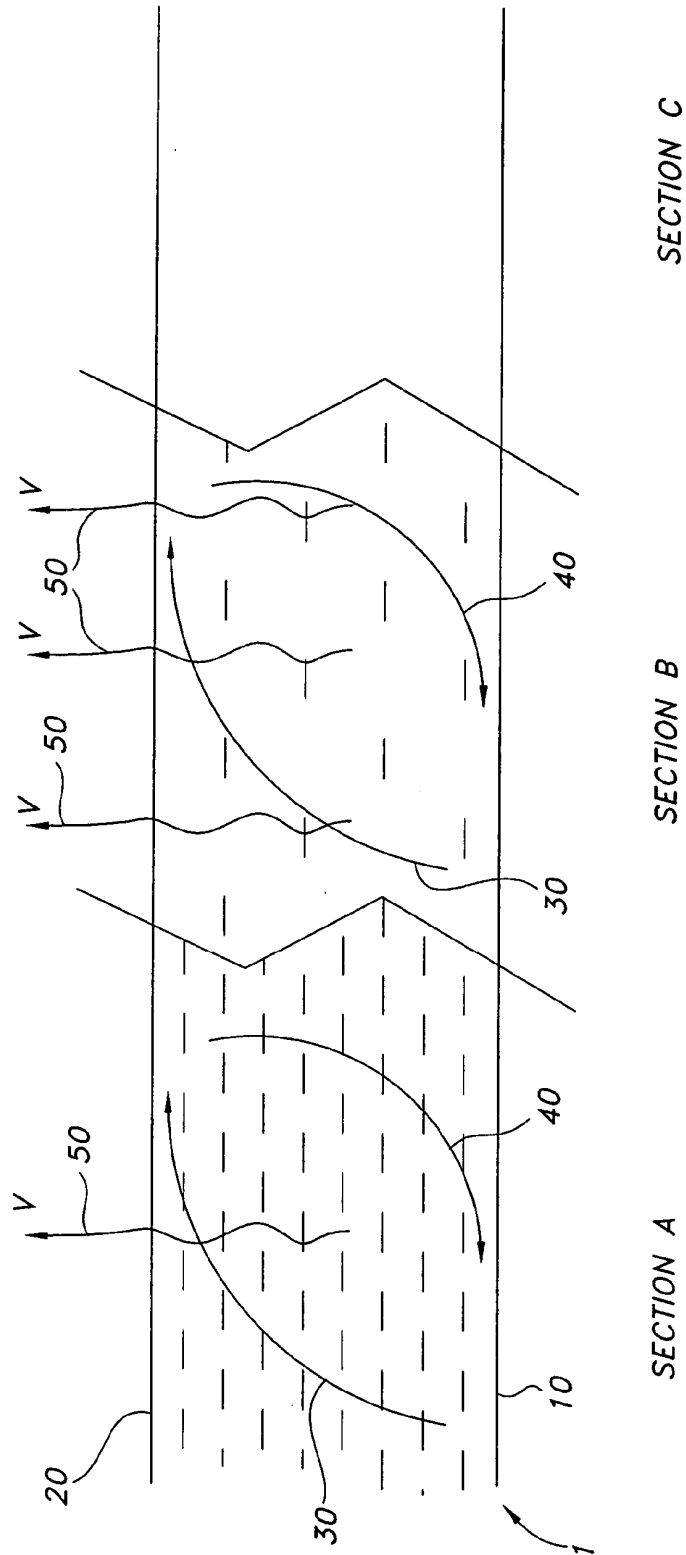

FIG. 8

Explore Litigation Insights

Docket Alarm provides insights to develop a more informed litigation strategy and the peace of mind of knowing you're on top of things.

Real-Time Litigation Alerts



Keep your litigation team up-to-date with **real-time alerts** and advanced team management tools built for the enterprise, all while greatly reducing PACER spend.

Our comprehensive service means we can handle Federal, State, and Administrative courts across the country.

Advanced Docket Research



With over 230 million records, Docket Alarm's cloud-native docket research platform finds what other services can't. Coverage includes Federal, State, plus PTAB, TTAB, ITC and NLRB decisions, all in one place.

Identify arguments that have been successful in the past with full text, pinpoint searching. Link to case law cited within any court document via Fastcase.

Analytics At Your Fingertips



Learn what happened the last time a particular judge, opposing counsel or company faced cases similar to yours.

Advanced out-of-the-box PTAB and TTAB analytics are always at your fingertips.

API

Docket Alarm offers a powerful API (application programming interface) to developers that want to integrate case filings into their apps.

LAW FIRMS

Build custom dashboards for your attorneys and clients with live data direct from the court.

Automate many repetitive legal tasks like conflict checks, document management, and marketing.

FINANCIAL INSTITUTIONS

Litigation and bankruptcy checks for companies and debtors.

E-DISCOVERY AND LEGAL VENDORS

Sync your system to PACER to automate legal marketing.