



(12) **United States Patent**
Thomas

(10) **Patent No.:** **US 6,401,118 B1**
(45) **Date of Patent:** **Jun. 4, 2002**

(54) **METHOD AND COMPUTER PROGRAM PRODUCT FOR AN ONLINE MONITORING SEARCH ENGINE**

(75) Inventor: **Jason B. Thomas**, Arlington, VA (US)

(73) Assignee: **Online Monitoring Services**, Alexandria, VA (US)

(*) Notice: Subject to any disclaimer, the term of this patent is extended or adjusted under 35 U.S.C. 154(b) by 0 days.

5,995,961	A	*	11/1999	Levy et al.	707/4
6,006,217	A	*	12/1999	Lumsden	707/2
6,009,422	A	*	12/1999	Ciccarelli	707/4
6,009,459	A	*	12/1999	Belfiore et al.	709/203
6,018,733	A	*	1/2000	Kirsch et al.	707/3
6,092,182	A	*	2/2000	Nehab et al.	707/523
6,041,326	A	*	3/2000	Amro et al.	707/10
6,078,914	A	*	6/2000	Redfern	707/3
6,078,917	A	*	6/2000	Paulsen, Jr. et al.	707/6
6,094,649	A	*	7/2000	Bowen et al.	707/3
6,098,065	A	*	8/2000	Skillen et al.	707/3
6,102,969	A	*	8/2000	Christianson et al.	717/8
6,112,202	A	*	8/2000	Kleinberg	707/5

* cited by examiner

(21) Appl. No.: **09/133,374**

(22) Filed: **Aug. 13, 1998**

Related U.S. Application Data

(60) Provisional application No. 60/091,164, filed on Jun. 30, 1998.

(51) **Int. Cl.**⁷ **G06F 11/30**; G06F 17/00

(52) **U.S. Cl.** **709/224**; 709/203; 709/217; 709/219; 709/226; 707/5; 707/4

(58) **Field of Search** 709/223, 222, 709/225, 226, 203, 217, 219; 707/5, 4, 3, 2, 1

(56) **References Cited**

U.S. PATENT DOCUMENTS

5,659,732	A	*	8/1997	Kirsch	707/5
5,845,278	A	*	12/1998	Kirsch et al.	707/3
5,864,845	A	*	1/1999	Voorhees et al.	707/5
5,864,846	A	*	1/1999	Voorhees et al.	707/5
5,873,107	A	*	2/1999	Borovoy et al.	707/501
5,913,208	A	*	6/1999	Brown et al.	707/3
5,913,215	A	*	6/1999	Rubinstein et al.	707/10
5,920,859	A	*	7/1999	Li	707/5
5,924,090	A	*	7/1999	Krellenstein	707/5
5,933,822	A	*	8/1999	Braden-Harder et al.	707/5
5,983,216	A	*	11/1999	Kirsch et al.	707/2
5,987,446	A	*	11/1999	Corey et al.	707/3
5,991,751	A	*	11/1999	Rivette et al.	707/1

Primary Examiner—Glenton B. Burgess
Assistant Examiner—Abdullah E. Salad
(74) *Attorney, Agent, or Firm*—Piper Marbury Rudnick & Wolfe, LLP; Steven B. Kelber

(57) **ABSTRACT**

An online monitoring search engine. The invention is a system, method and computer program product that allows an organization, company, or the like to monitor the Internet (or any computer network) for violations of their intellectual property (e.g., patent, trademark or copyright infringement), or monitor how persons on the Internet view their business, products and/or services. The system includes a Web server for receiving search requests and criteria from users on a Web client and a server for searching the Internet for URL's that contain contents matching the search criteria, thereby compiling a list of offending URL's. The system also includes a file system for storing contents from each of the offending URL's and a relational database for allowing the server to perform queries of the content in order to produce a report. The method involves receiving search criteria from a user, searching the Internet, downloading offending contents, and then archiving and scoring the contents. The method also obtains contact information for each registrant of the offending URL's and produces a report for the user.

18 Claims, 12 Drawing Sheets

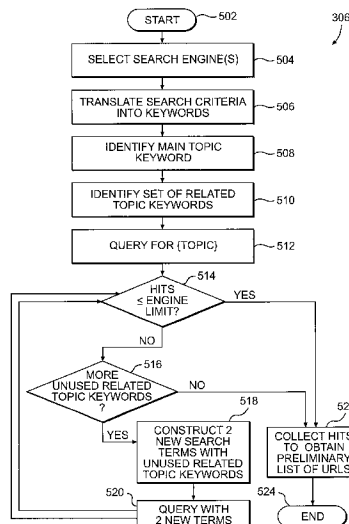

Plaid Technologies Inc.
Exhibit 1016

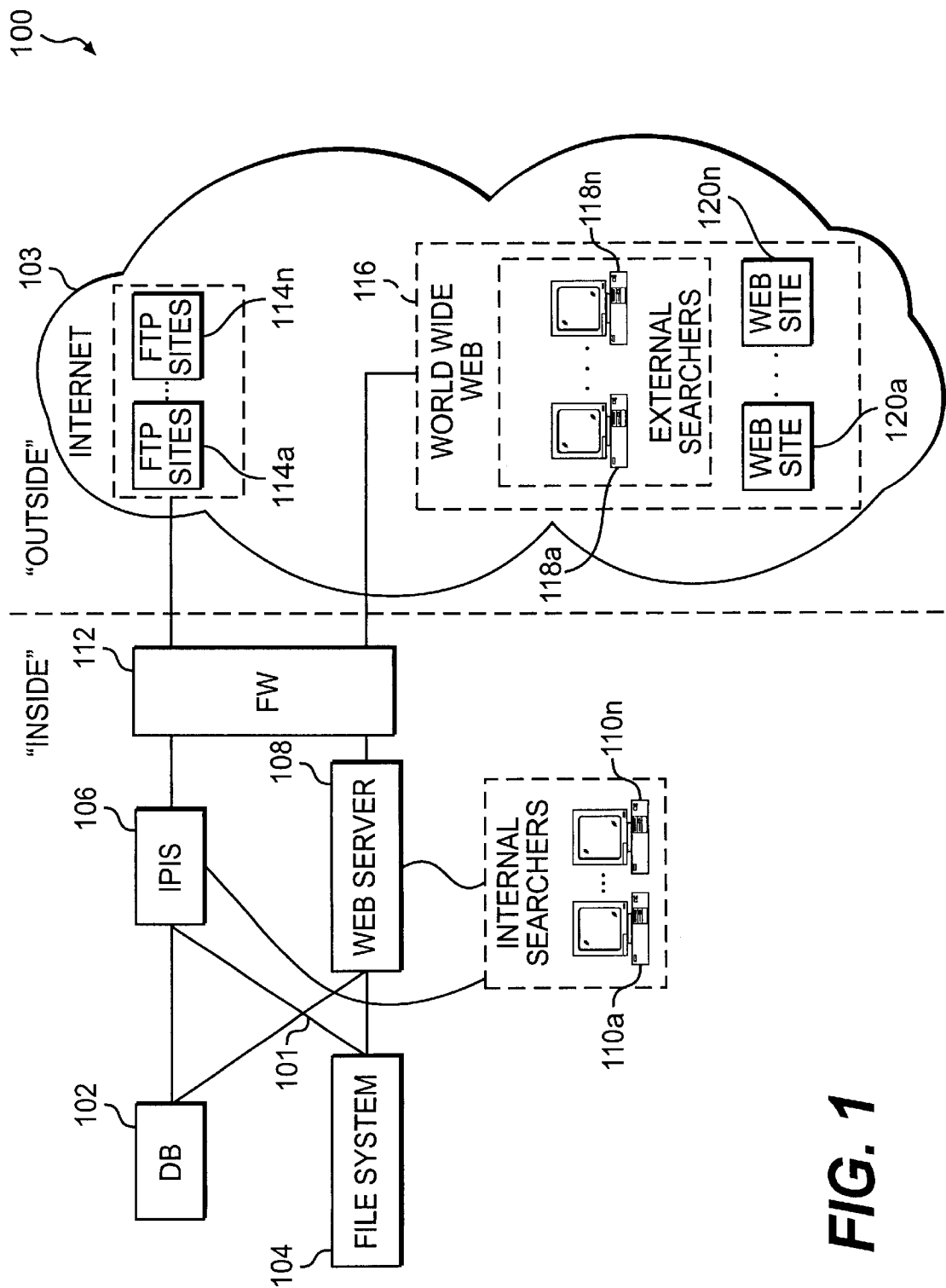

FIG. 1

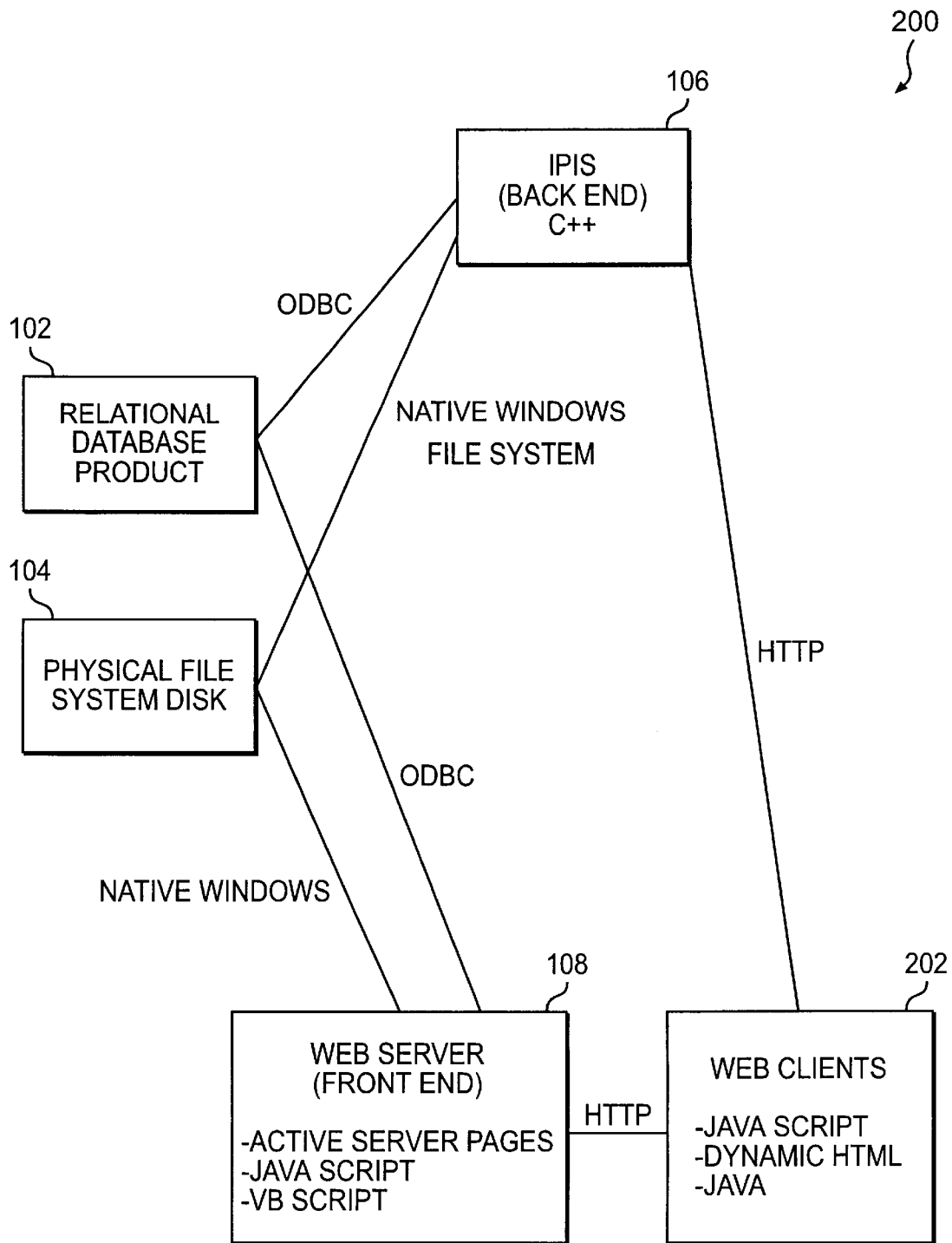

FIG. 2

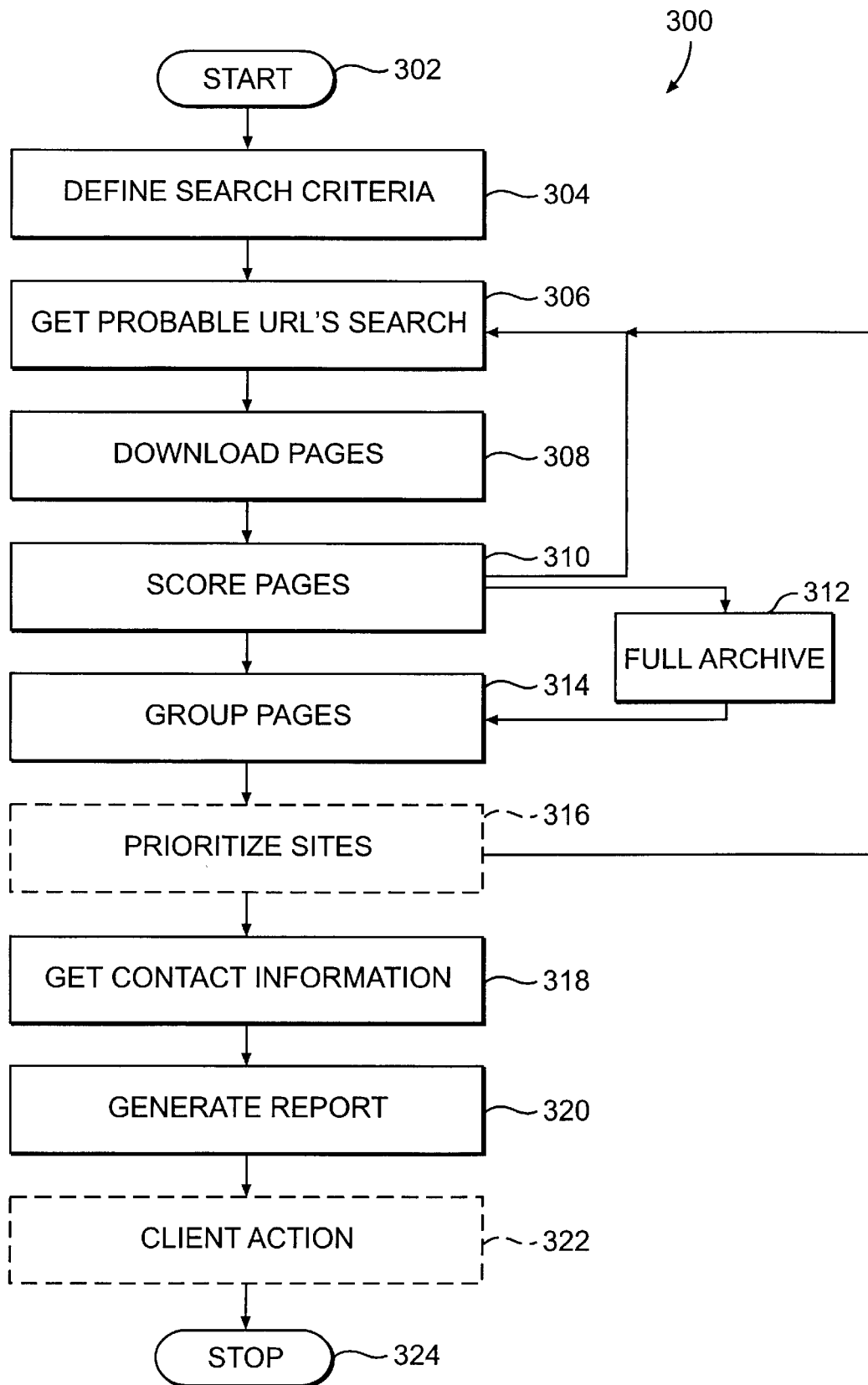

FIG. 3

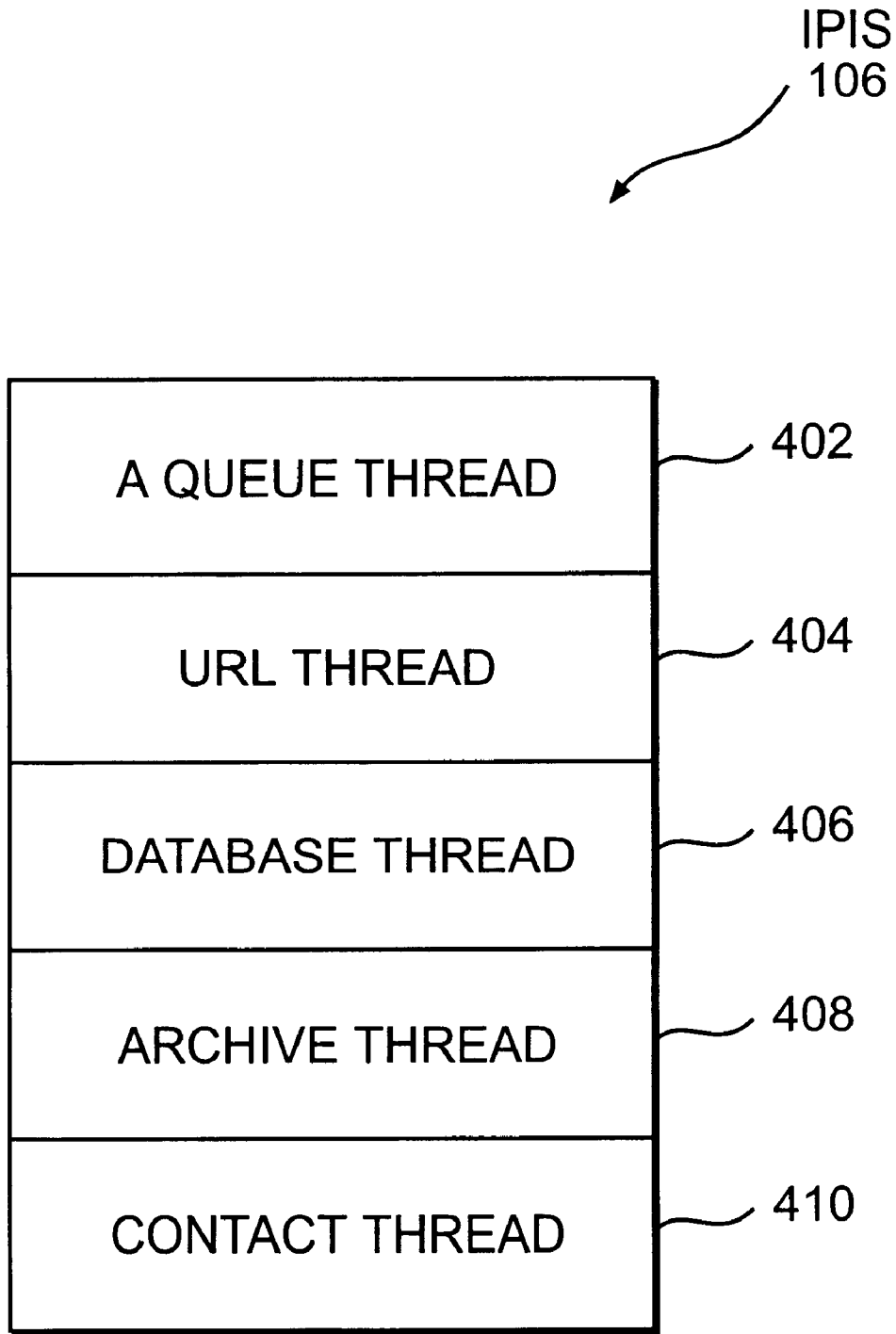

FIG. 4

Explore Litigation Insights

Docket Alarm provides insights to develop a more informed litigation strategy and the peace of mind of knowing you're on top of things.

Real-Time Litigation Alerts



Keep your litigation team up-to-date with **real-time alerts** and advanced team management tools built for the enterprise, all while greatly reducing PACER spend.

Our comprehensive service means we can handle Federal, State, and Administrative courts across the country.

Advanced Docket Research



With over 230 million records, Docket Alarm's cloud-native docket research platform finds what other services can't. Coverage includes Federal, State, plus PTAB, TTAB, ITC and NLRB decisions, all in one place.

Identify arguments that have been successful in the past with full text, pinpoint searching. Link to case law cited within any court document via Fastcase.

Analytics At Your Fingertips



Learn what happened the last time a particular judge, opposing counsel or company faced cases similar to yours.

Advanced out-of-the-box PTAB and TTAB analytics are always at your fingertips.

API

Docket Alarm offers a powerful API (application programming interface) to developers that want to integrate case filings into their apps.

LAW FIRMS

Build custom dashboards for your attorneys and clients with live data direct from the court.

Automate many repetitive legal tasks like conflict checks, document management, and marketing.

FINANCIAL INSTITUTIONS

Litigation and bankruptcy checks for companies and debtors.

E-DISCOVERY AND LEGAL VENDORS

Sync your system to PACER to automate legal marketing.