



US008214097B2

(12) **United States Patent**
Severinsky et al.

(10) **Patent No.:** **US 8,214,097 B2**
(45) **Date of Patent:** **Jul. 3, 2012**

(54) **HYBRID VEHICLES**

(58) **Field of Classification Search** 340/988-996
See application file for complete search history.

(75) Inventors: **Alex J. Severinsky**, Washington, DC (US); **Theodore Louckes**, Holly, MI (US)

(56) **References Cited**

(73) Assignees: **PAICE LLC**, Bonita Springs, FL (US); **The Abell Foundation, Inc.**, Baltimore, MD (US), (part ownership interest)

U.S. PATENT DOCUMENTS
5,343,970 A * 9/1994 Severinsky 180/65.25
5,483,939 A * 1/1996 Kamura et al. 123/492
5,695,722 A * 12/1997 Myers et al. 422/174
5,806,617 A * 9/1998 Yamaguchi 180/65.235

(*) Notice: Subject to any disclaimer, the term of this patent is extended or adjusted under 35 U.S.C. 154(b) by 0 days.

OTHER PUBLICATIONS

(21) Appl. No.: **13/065,704**

Sutherland, A State Language for the Sequencing in a Hybrid Electric Vehicle, IEEE Trans. Ind. Elec., vol. 1E-30, No. 4, 318-322 (1983).
Somuah, A Microcomputer-Controlled Powertrain for a Hybrid Vehicle, IEEE Trans. Ind. Elec., vol. 1E-30, No. 2, 126-131 (1983).
Bose, A Microcomputer-Based Propulsion Conro System of a Hybrid Electric Vehicle, IEEE Trans. Ind. Elec., vol. 1E-31, No. 1, 61-68 (1983).

(22) Filed: **Mar. 29, 2011**

* cited by examiner

(65) **Prior Publication Data**

US 2011/0190971 A1 Aug. 4, 2011

Related U.S. Application Data

Primary Examiner — James Trammell
Assistant Examiner — Muhammad Shafi
(74) *Attorney, Agent, or Firm* — Michael de Angeli

(60) Division of application No. 12/320,600, filed on Jan. 29, 2009, now abandoned, which is a division of application No. 11/459,458, filed on Jul. 24, 2006, now Pat. No. 7,520,353, which is a division of application No. 10/382,577, filed on Mar. 7, 2003, now Pat. No. 7,104,347, which is a division of application No. 09/822,866, filed on Apr. 2, 2001, now Pat. No. 6,544,088, which is a continuation-in-part of application No. 09/264,817, filed on Mar. 9, 1999, now Pat. No. 6,209,672, said application No. 10/382,577 is a continuation-in-part of application No. 09/392,743, filed on Sep. 9, 1999, now Pat. No. 6,338,391.

(60) Provisional application No. 60/100,095, filed on Sep. 14, 1998, provisional application No. 60/122,296, filed on Mar. 1, 1999.

(51) **Int. Cl.**
G05D 3/00 (2006.01)
G05D 1/00 (2006.01)
B60K 6/20 (2007.10)

(57) **ABSTRACT**

A hybrid vehicle comprises an internal combustion engine, a traction motor, a starter motor, and a battery bank, all controlled by a microprocessor in accordance with the vehicle's instantaneous torque demands so that the engine is run only under conditions of high efficiency, typically only when the load is at least equal to 30% of the engine's maximum torque output. In some embodiments, a turbocharger may be provided, activated only when the load exceeds the engine's maximum torque output for an extended period; a two-speed transmission may further be provided, to further broaden the vehicle's load range. A hybrid brake system provides regenerative braking, with mechanical braking available in the event the battery bank is fully charged, in emergencies, or at rest; a control mechanism is provided to control the brake system to provide linear brake feel under varying circumstances.

(52) **U.S. Cl.** **701/22; 701/84; 180/65.21**

39 Claims, 17 Drawing Sheets

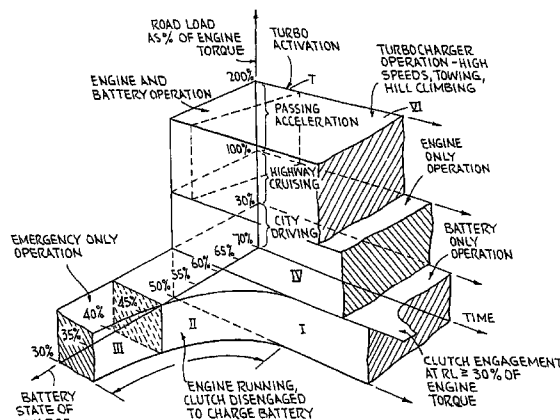

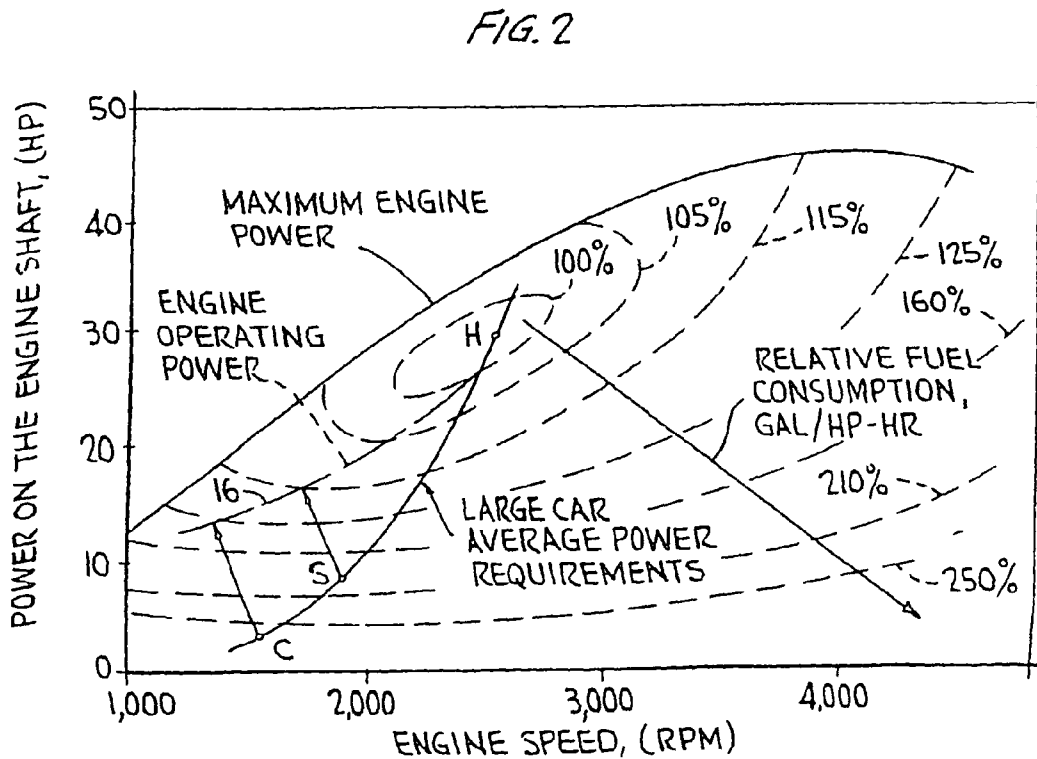
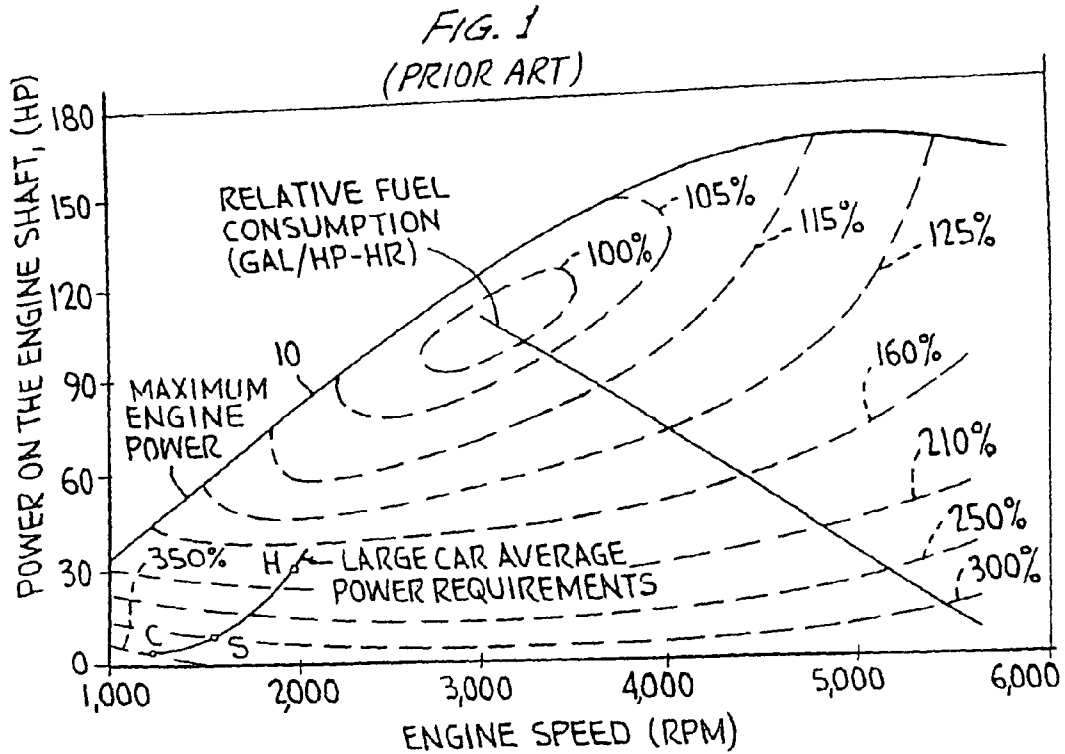

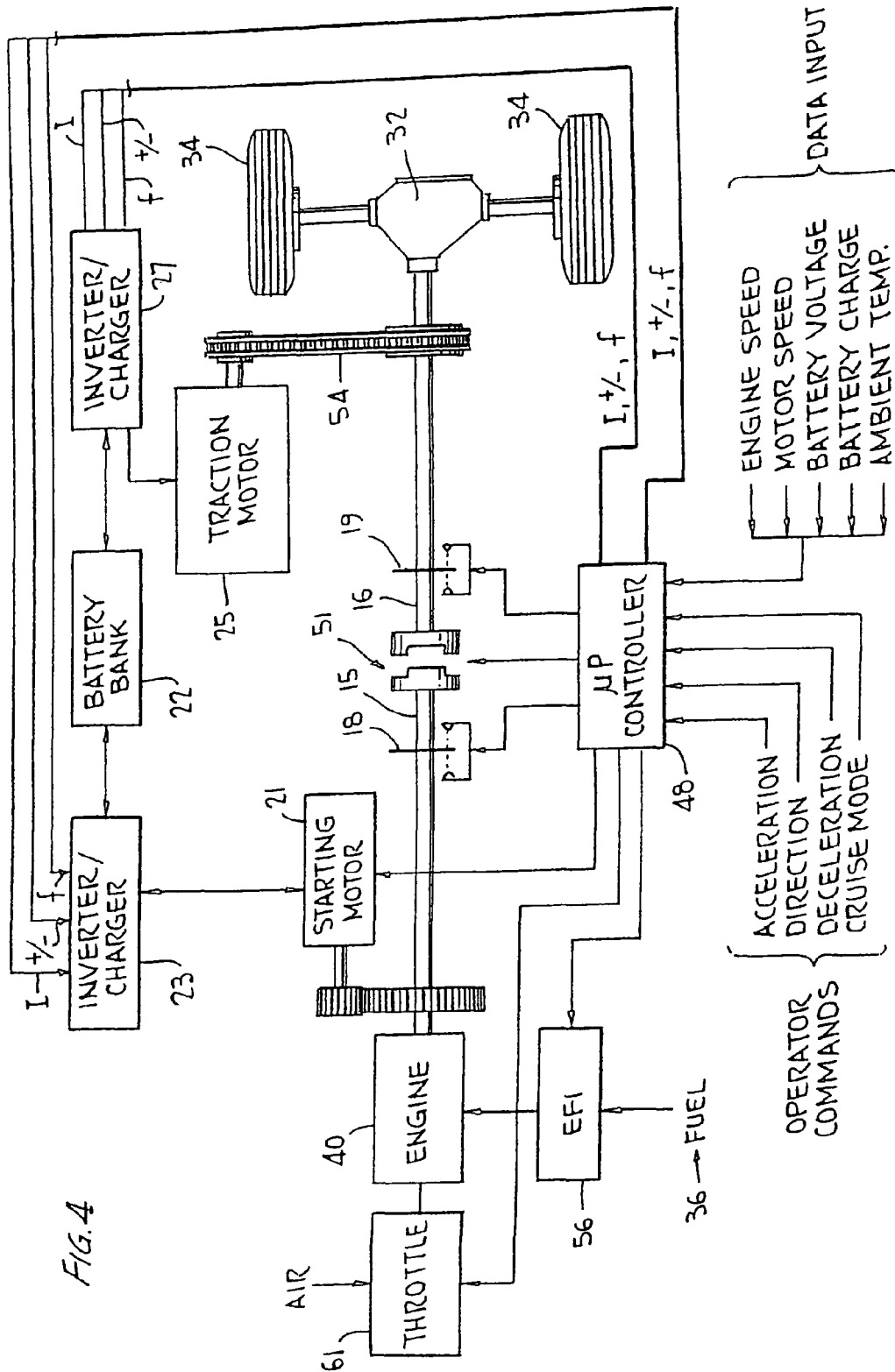
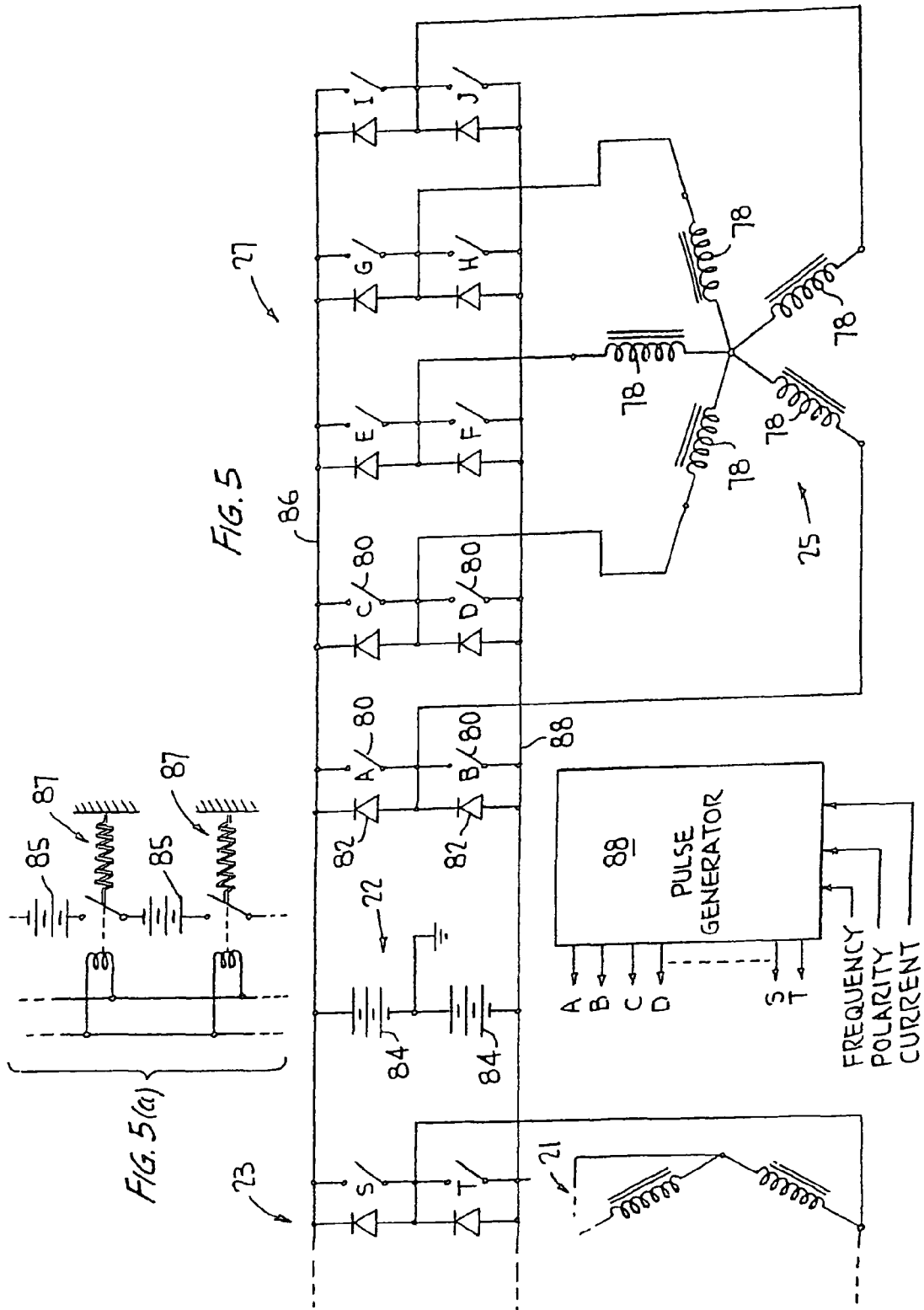

Fig. 4



Explore Litigation Insights

Docket Alarm provides insights to develop a more informed litigation strategy and the peace of mind of knowing you're on top of things.

Real-Time Litigation Alerts



Keep your litigation team up-to-date with **real-time alerts** and advanced team management tools built for the enterprise, all while greatly reducing PACER spend.

Our comprehensive service means we can handle Federal, State, and Administrative courts across the country.

Advanced Docket Research



With over 230 million records, Docket Alarm's cloud-native docket research platform finds what other services can't. Coverage includes Federal, State, plus PTAB, TTAB, ITC and NLRB decisions, all in one place.

Identify arguments that have been successful in the past with full text, pinpoint searching. Link to case law cited within any court document via Fastcase.

Analytics At Your Fingertips



Learn what happened the last time a particular judge, opposing counsel or company faced cases similar to yours.

Advanced out-of-the-box PTAB and TTAB analytics are always at your fingertips.

API

Docket Alarm offers a powerful API (application programming interface) to developers that want to integrate case filings into their apps.

LAW FIRMS

Build custom dashboards for your attorneys and clients with live data direct from the court.

Automate many repetitive legal tasks like conflict checks, document management, and marketing.

FINANCIAL INSTITUTIONS

Litigation and bankruptcy checks for companies and debtors.

E-DISCOVERY AND LEGAL VENDORS

Sync your system to PACER to automate legal marketing.