

**LG Electronics Inc.,**  
*Petitioner*

V.

**Core Wireless Licensing S.A.R.L.,**  
*Patent Owner*

---

Case Nos. IPR2015-01984

**Petitioner's Demonstratives**

# The '020 and '476 Patents

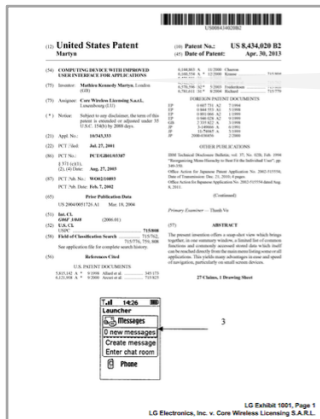

**COMPUTING DEVICE WITH IMPROVED USER INTERFACE FOR APPLICATIONS**

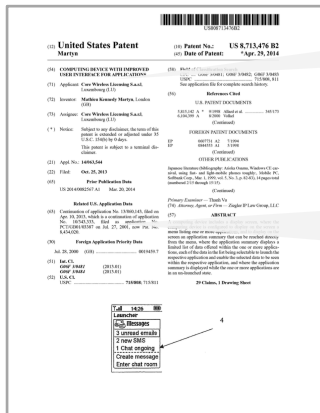

**COMPUTING DEVICE WITH IMPROVED USER INTERFACE FOR APPLICATIONS**

Continuation of application No. 13/860,143, filed on Apr. 10, 2013, which is a continuation of application No. 10/343,333, filed as application No. PCT/GB01/03387 on Jul. 27, 2001, now Pat. No. 8,434,020.

# The '020 and '476 Patents

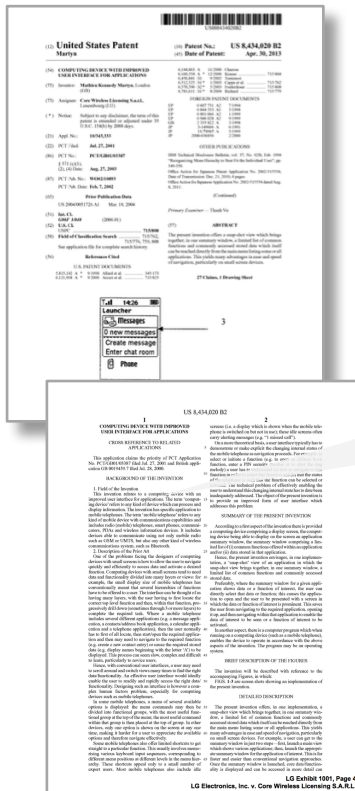

1. Field of the Invention  
This invention relates to a computing device with an improved user interface for applications. The term 'comput-

1:12-15

# The '020 and '476 Patents

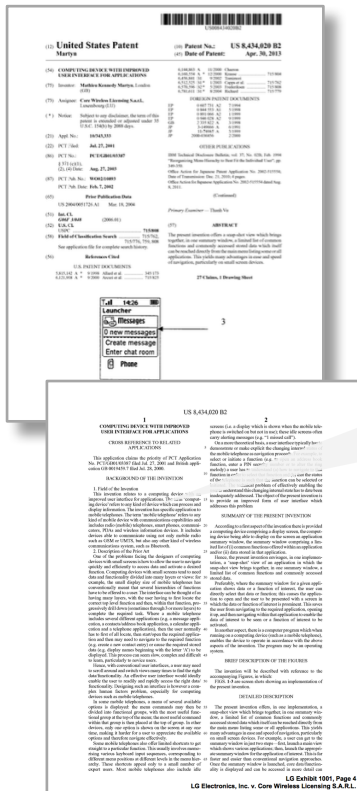

2. Description of the Prior Art  
 One of the problems facing the designers of computing devices with small screens is how to allow the user to navigate quickly and efficiently to access data and activate a desired function. Computing devices with small screens tend to need

1:25-29

# The '020 Patent

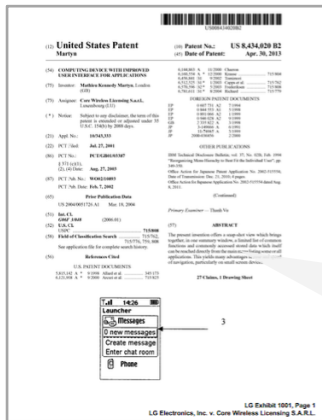

(57)

## ABSTRACT

The present invention offers a snap-shot view which brings together, in one summary window, a limited list of common functions and commonly accessed stored data which itself can be reached directly from the main menu listing some or all applications. This yields many advantages in ease and speed of navigation, particularly on small screen devices.

'020 Patent at Abstract.

# Blanchard

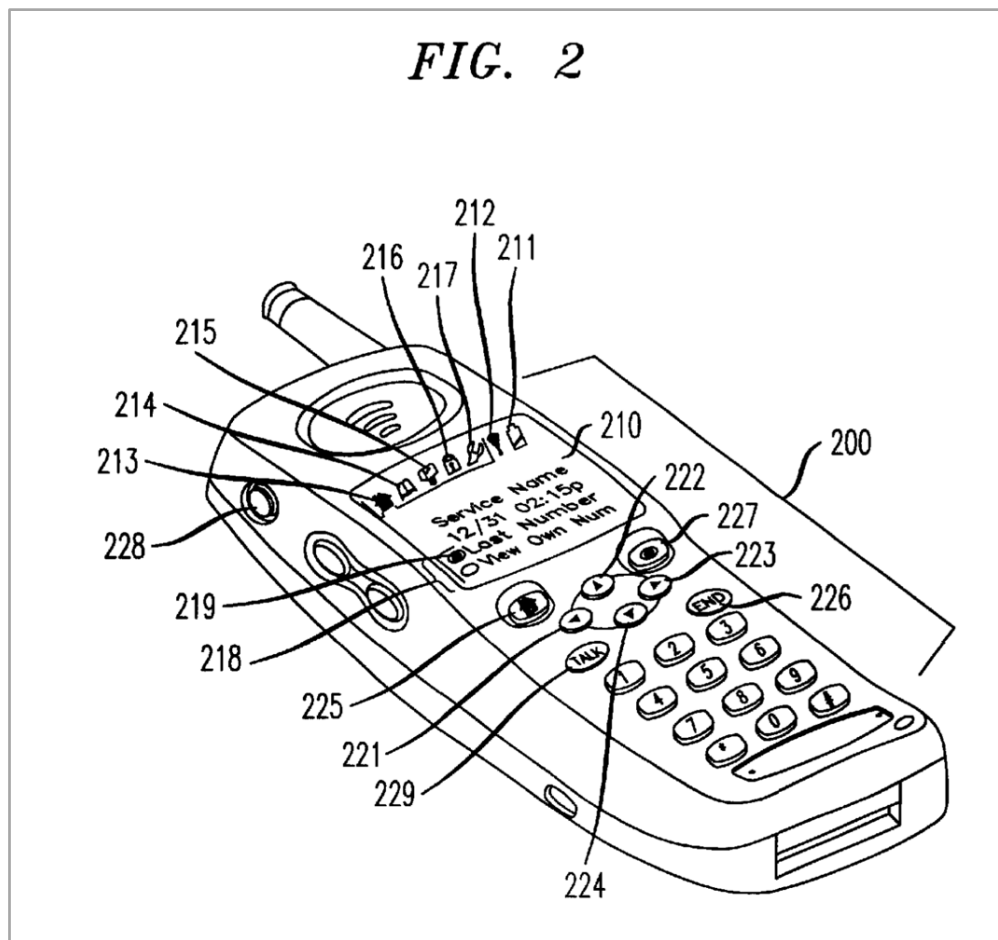

# Blanchard

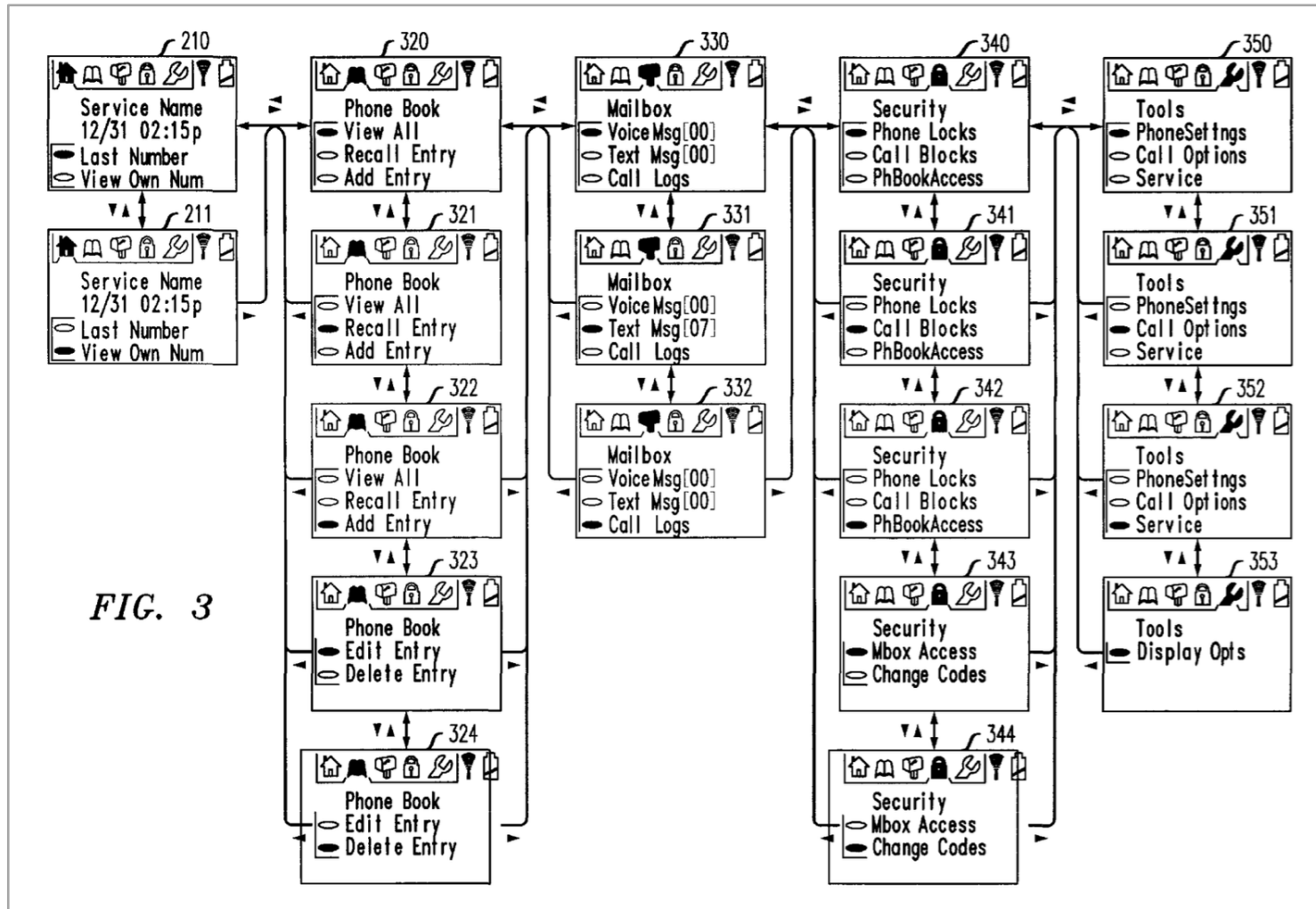
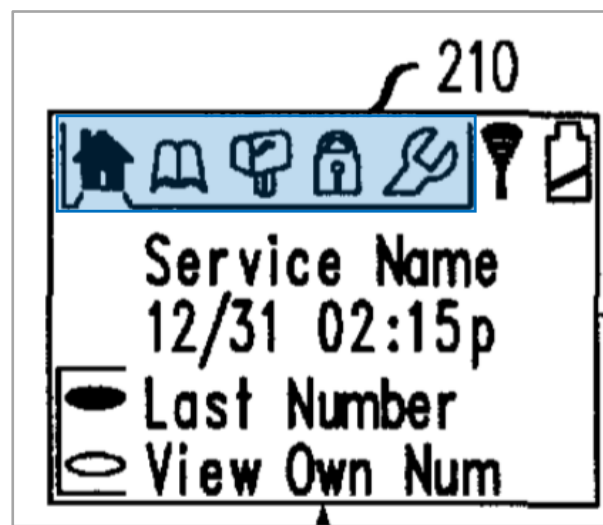
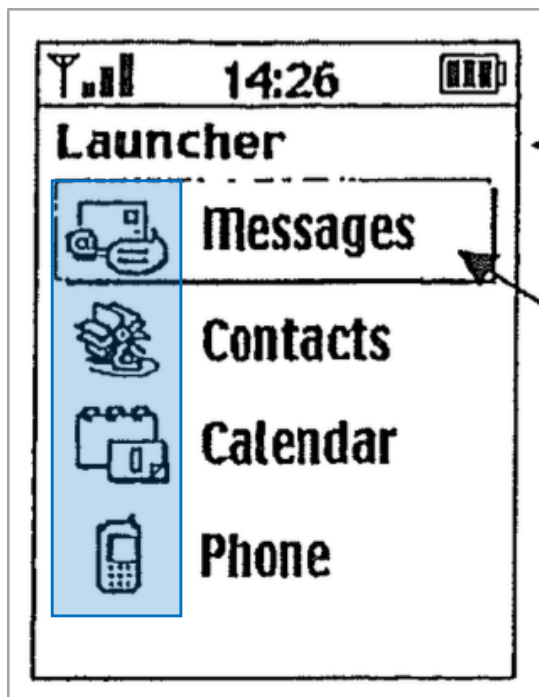

Fig. 3

# '020 Patent vs. Blanchard





# '020 Patent vs. Blanchard

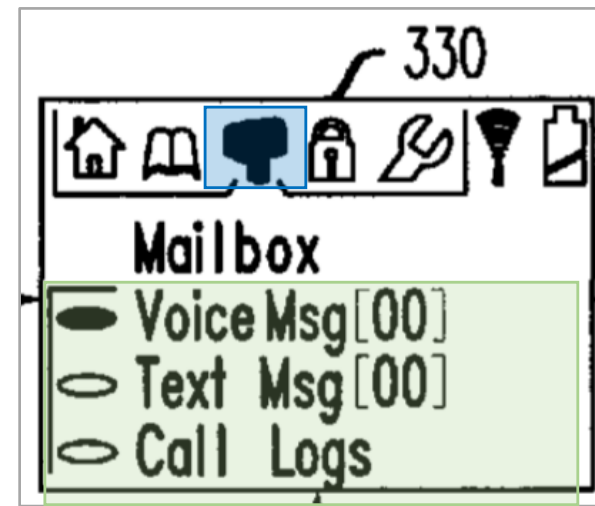

Reply (Paper 23) at 12; Petition (Paper 1) at 15.

# Disputed Issues

020

(1)

1. A computing device comprising a display screen, the computing device being configured to display on the screen a main menu listing at least a first application, and additionally being configured to display on the screen an application summary window that can be reached directly from the main menu, wherein the application summary window displays a limited list of at least one function offered within the first application, each function in the list being selectable to launch the first application and initiate the selected function, and wherein the application summary window is displayed while the application is in an un-launched state.

# '020 Patent vs. Blanchard

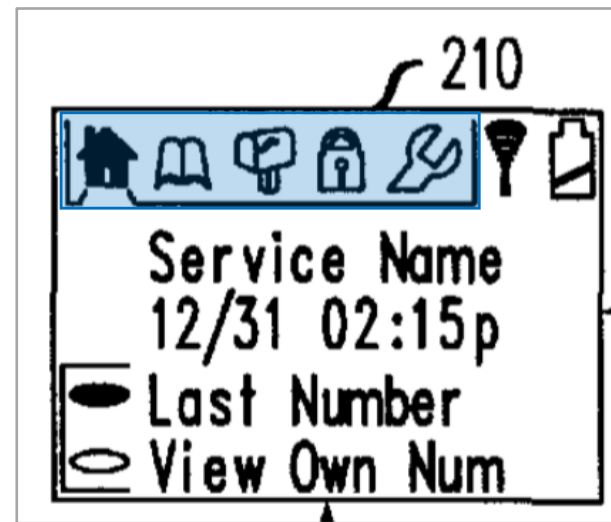
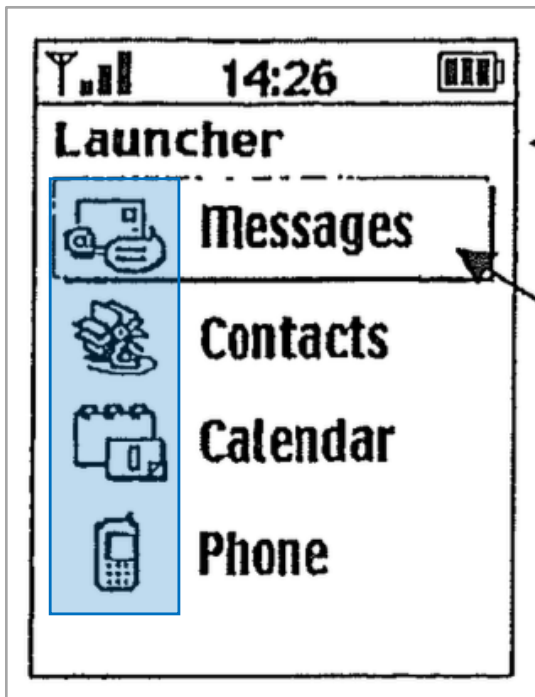

# Blanchard

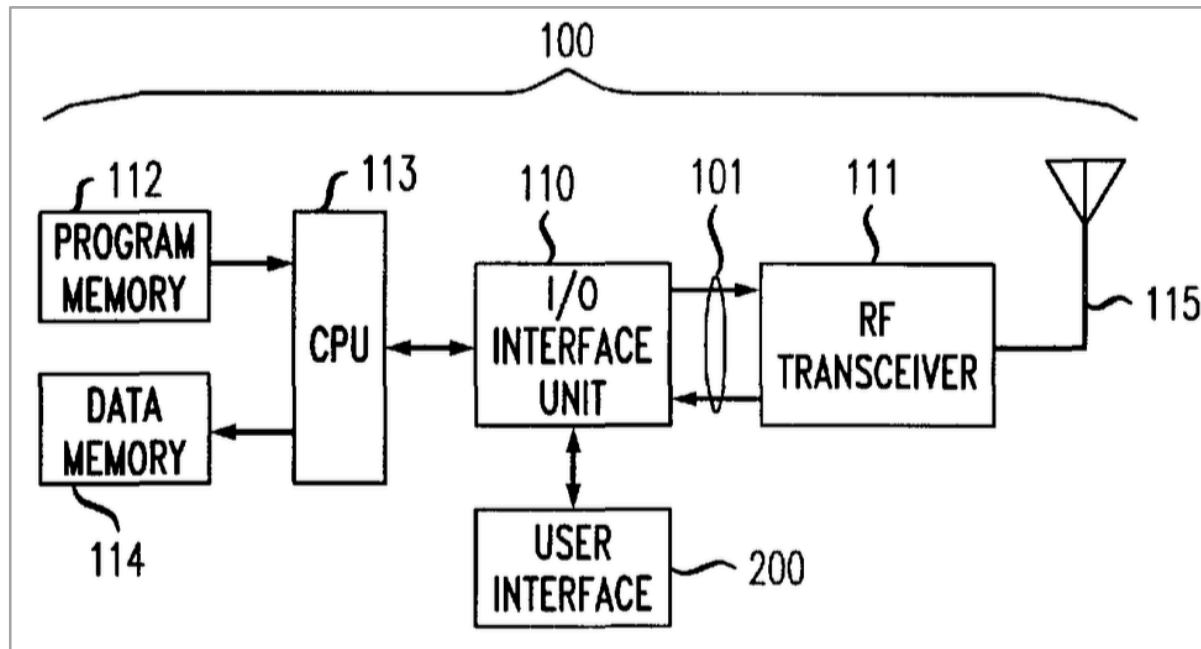

Fig.1

# Blanchard

---

The terminal **100** also includes a program memory **112** which provides instructions to a central processor unit (CPU) **113** for controlling the various operating features and functions originating at the terminal. This program memory **112** contains data for interpreting a plurality of codes representative of various control signals received from the base unit **120** and for generating codes to be transmitted to the base unit **120**. A data memory **114** is utilized by the CPU **113** for storing and accessing data associated with performing the various functions and features programmed in the program memory **112**. In the described embodiment, CPU

**2:52-62**

# “Application”

- stationary appliance.
- application** (1) The use to which a computer system is put; for example, a payroll application, an airline application, or a network application. (C) 610.2-1987, 610.5-1990w
- (2) The use of capabilities provided by an information system specific to the satisfaction of a set of user requirements. *Note:* These capabilities include hardware, software, and data. (C/PA) 14252-1996
- (3) When the User Portability Utilities Option is supported, requirements associated with the term *application* also shall be interpreted to include the actions of the user who is interacting with the system by entering shell command language statements from a terminal. (C/PA) 2003.2-1996
- (4) A software program consisting of one or more processes and supporting functions. (PE/SUB) 1379-1997
- (5) A computer program that performs some desired function. (C) 1003.5-1999
- application-association** (1) A cooperative relationship between two applications.

Ex. 1014 (IEEE Dict.) at 3

# “Application”

(C/PA) 1238.1-1994w  
**application software** (1) Software designed to fulfill specific needs of a user; for example, software for navigation, payroll, or process control. *Contrast:* support software; system software. (C) 610.12-1990  
(2) Software that is specific to an application and is composed of programs, data, and documentation. (C/PA) 14252-1996

(C) 1003.5-1999  
**application program** (1) A computer program that is used for a specific application. (C) 610.5-1990w  
(2) A program executed with the processor in user mode. *Note:* Statements made in this document regarding application programs may be inapplicable to programs (for example, debuggers) that have access to privileged processor state (e.g., as stored in a memory-image dump). (C/MM) 1754-1994  
**application program interface (API)**

Ex. 1014 (IEEE Dict.) at 3

# “Application”

---

system software (software) Software designed to facilitate the operation and maintenance of a computer system and its associated programs; for example, operating systems, assemblers, utilities. *Contrast:* application software. *See also:* support software. (C) 610.12-1990



# “Application” – Patent Owner’s Position

Specifically, as of July 2000, it was understood by a POSITA that an “application” referred to application-level architecture, with the application implemented on top of an operating system layer. Denning at ¶¶ 23, 33. Further, as of July 2000, a POSITA would have understood an “application” to be packaged software for performing user functions, arranged in an application layer and able to access APIs of an operating system. *Id.* at ¶ 33. In this manner, the broadest

PO Response (#24) at 20-21

Further, the ‘020 patent’s disclosure that an “application” may be in an un-launched state informs a POSITA that the disclosed device operating system permits multiple threads of execution. Denning at ¶ 23. For example, the ‘020

PO Response (#24) at 19

17



# '020 Patent

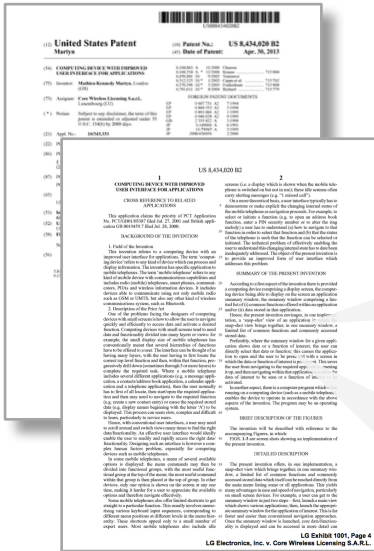

Hence, the present invention envisages, in one implementation, a 'snap-shot' view of an application in which the snap-shot view brings together, in one summary window, a limited list of common functions and commonly accessed stored data.

Preferably, where the summary window for a given application shows data or a function of interest, the user can directly select that data or function; this causes the application to open and the user to be presented with a screen in which the data or function of interest is prominent. This saves the user from navigating to the required application, opening it up, and then navigating within that application to enable the data of interest to be seen or a function of interest to be activated.

2:26-39

# Claims 16 and 17, '020 Patent

---

**16.** A computer program product comprising a computer-readable storage medium having computer-readable code embodied in the medium which, when running on a computing device, causes the computing device to display on a screen of the device a main menu listing at least a first application, and additionally causes the device to display on the screen an application summary window that can be reached directly from the main menu, wherein the summary window displays a limited list of at least one function offered within the first application, each function in the list being selectable to launch the first application and initiate the selected function, and wherein the application summary window is displayed while the application is in an unlaunched state.

**17.** The computer program product of claim **16**, wherein said computer-readable code comprises an operating system program.

# '020 Patent

---

A further possible feature is that the constituency of the App Snapshot may vary with the actions of the user. For example, if the mobile telephone has an active Calendar application, and the user opens the App Snapshot for Contacts, then the Contacts App Snapshot may include contact information for parties in the previously or currently open Calendar application. But if the user opened the Contacts App Snapshot when the Phone application was current, then the Contacts App Snapshot may instead include contact information of the most called party, or a missed call party, or a party whose call the user is auto-replying to.

# Dr. Rhyne

---

35. Even if the '020 specification actually stated that the Calendar application was required to be “open” while the Contacts App Snapshot is displayed, that would not mean that the device was necessarily required to be able to perform “multiple threads of execution,” nor would it mean that the Calendar application necessarily had an “active thread of execution.” A single-threaded processor could display an App Snapshot on top of a window from an “open” (but currently suspended) Calendar application.

**Ex. 1015 at ¶45**

# Blanchard

---

such systems utilize a variety of hardware and programming techniques, no attempt is made to describe the details of the program used to control the telephone terminal. However, the present invention must be blended into the overall structure of the system in which it is used and must be tailored to mesh with other features and operations of the system. Thus, in order to avoid confusion and in order to

5:14-20

# Dr. Rhyne

---

of the '020 and '476 patents). Blanchard is focused on describing a user interface and, hence, is intentionally silent regarding the specifics of the “hardware and programming techniques” used to implement that user interface. *See* Blanchard at 5:13-16. A person of ordinary skill would recognize from this that Blanchard’s user interface should be implemented using known “hardware and programming techniques,” which as of July 2000 included “applications layered on top of an operating system.”

**Ex. 1015 at ¶ 9**



# Mr. Denning

8           A       In the monolithic program, there are  
9 going to be many different functions bundled  
10 together or features bundled together into one  
11 code body. As we look up Blanchard, just going

19 those. In an application operating system  
20 architecture it would be completely conceivable to  
21 have a separate application for tools and a  
22 separate application for mailbox. That is an

1 example of what is done with the '020 patent.

2           Q       Prior to the filing of the '020 patent,  
3 were both of those options known to a person of  
4 ordinary skill in the art for use in a mobile  
5 telephone?

6                   MR. HELGE: Object to form.

7                   THE WITNESS: Yes.

**Ex. 1016 at 55:2-7**

# '020 Patent

## 2. Description of the Prior Art

have to be offered to a user. The interface can be thought of as having many layers, with the user having to first locate the correct top level function and then, within that function, progressively drill down (sometimes through 3 or more layers) to complete the required task. Where a mobile telephone includes several different applications (e.g. a message application, a contacts/address book application, a calendar application and a telephone application), then the user normally has to first of all locate, then start/open the required application and then may need to navigate to the required function (e.g. create a new contact entry) or cause the required stored

1:33-43

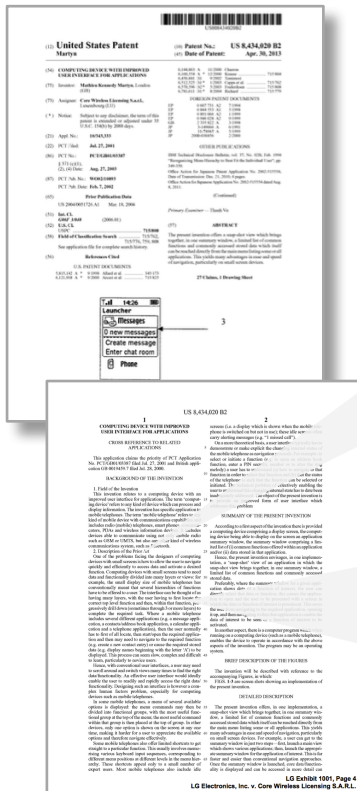

# Patent Owner's Preliminary Response (12-28-2015)

---

“[T]he user of Blanchard’s display can take only one action with respect to the applications listed on the menu (i.e., phone book, mail box, lock and tool applications). From the applications listed on the menu, the only action the user can take ...”

**Paper #6 (2015-01984) at 21.**

“In Blanchard, menu options presented in response to highlighting a top row icon of a menu are the only means by which the associated application may be invoked.”

**Paper #6 (2015-01985) at 9.**

# Patent Owner's Preliminary Response (12-28-2015)

---

“Because a user can take only one action with respect to the **applications** listed on a menu, this action must be interpreted as the launching of the application.”

**Paper #6 (2015-01985) at 9-10.**

“For each **application icon** shown in a top row of the display, a number of functions are available. As a user navigates between top-row application icons, the displayed menu changes to present the functions associated with the highlighted icon.”

**Paper #6 (2015-01985) at 11.**

# Patent Owner's Litigation Admissions (5-31-2016)

---

“The menus displayed in Blanchard do not summarize the application; they represent the actual application itself, not the separate application summary window claimed by the Martyn patents.”

**Ex. 1008 at p.2**

“[W]hen a user is navigating the various options disclosed in Blanchard, he is actually navigating within the application itself (and thus the application is also not in an unlaunched state, as explained below)”

**Ex. 1008 at p.3**

# Oommen

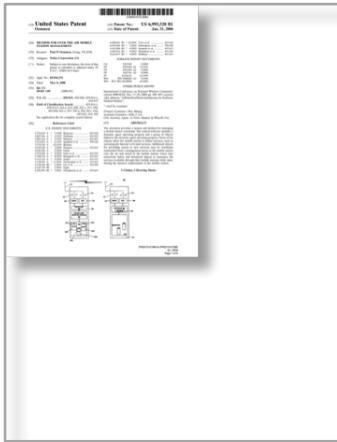

(10) **Patent No.:**      **US 6,993,328 B1**

(75) **Inventor:**    **Paul P. Oommen, Irving, TX (US)**

(73) **Assignee:**    **Nokia Corporation (FI)**

(22) **Filed:**        **May 8, 2000**

Therefore, there exists a need for a system and method that allows consumers to conveniently receive updates to the software installed on their mobile stations and to have

**1:58-60**

# Oommen

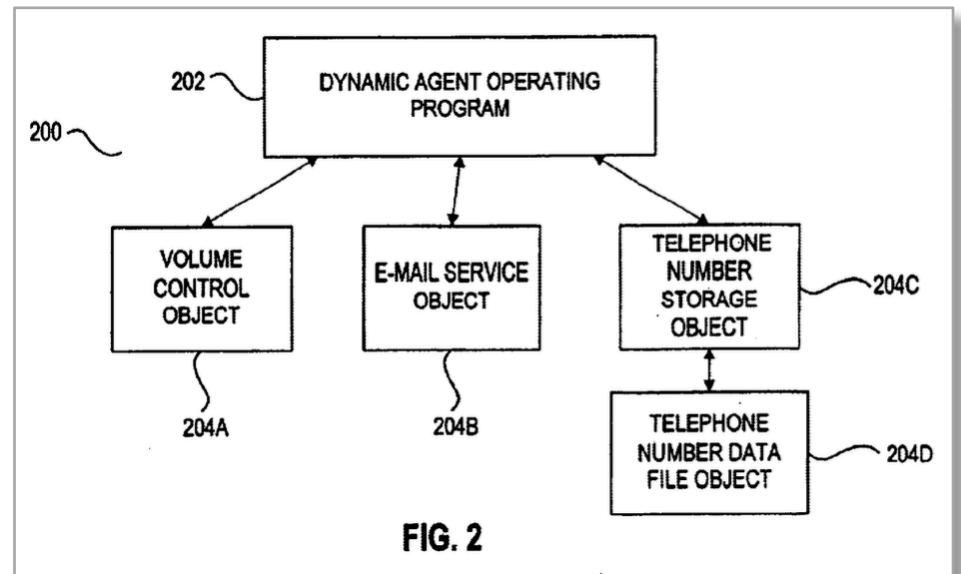
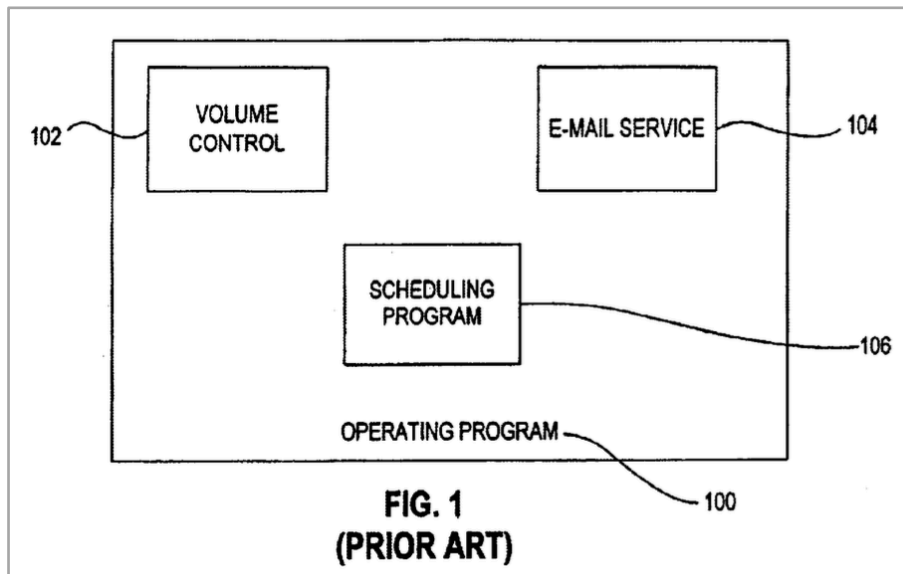

# Oommen



particular, conventional operating program **100** is a monolithic program while control program **200** is a dynamic agent operating program **202** linked to a group of objects. One of the advantages of a non-monolithic control program is that it facilitates over the air updating of services offered to users. Instead of replacing the entire operating program when a new service is being offered, only a portion of control program **200** is required to be changed which makes it more practical and convenient to make such changes via a wireless network. In an illustrative example, a user may update the software used to send and receive E-mail messages by downloading a new E-mail service object to replace E-mail service object **204B**. Furthermore, a user may configure

**3:20-30**



# Oommen



be deleted. For example, mobile station **302** may display a list that includes “E-mail program version 1.4—1 MB.” The user may free up 1 MB of memory by deleting the E-mail program object.

**5:28-31**

load decisions. For example, the user may wish to download a new scheduling program object that has a size of 500 KB. If the user has less than 500 KB of free memory, the user will have to scroll through the list of current objects and determine which objects to delete to free up enough memory. Of course, some objects may be identified as essential and will never be deleted. In one embodiment, at least some of the

**5:36-42**

# Ericsson R380s

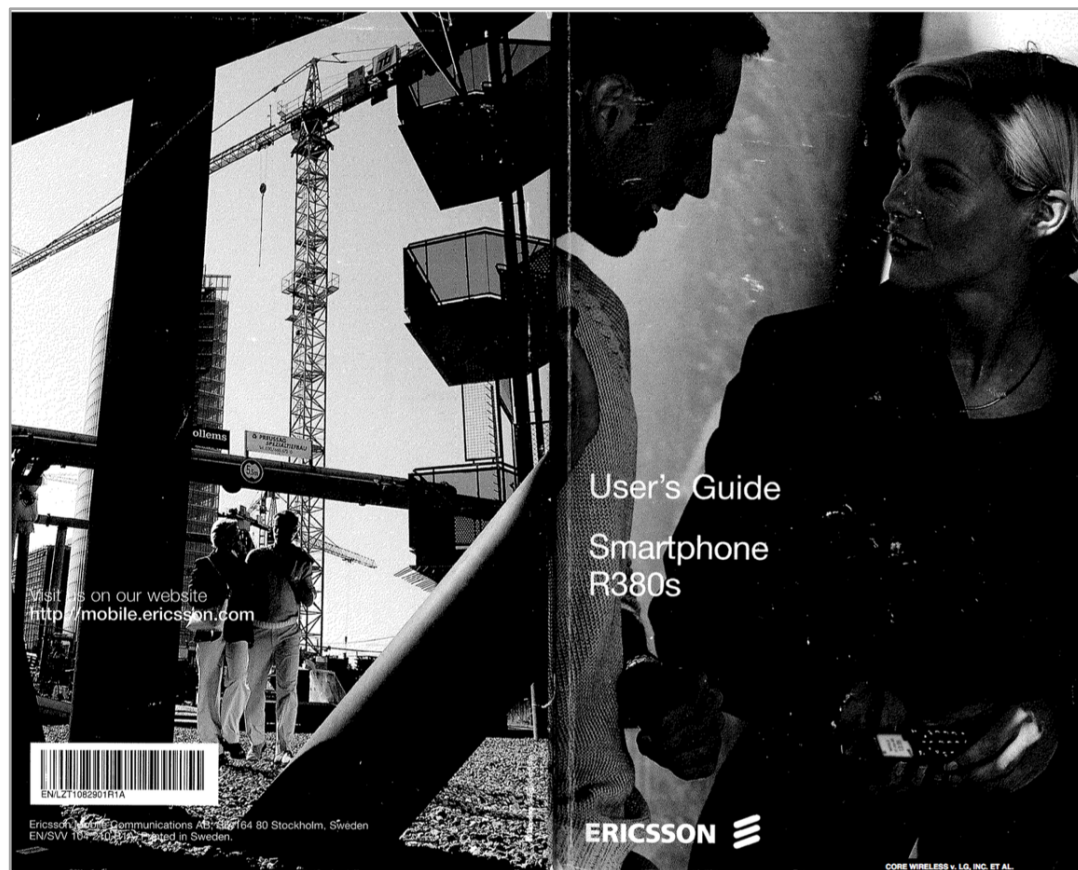

Ex. 1011 at 1

# Ericsson R380s



## Ericsson R380s

### User's Manual

First edition (June 2000)

This manual is published by  
Ericsson Mobile Communications  
AB, without any warranty.

Ex. 1011 at 3

# Ericsson R380s

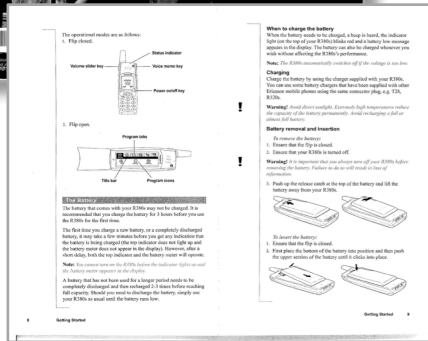

©Copyright Symbian Ltd, 2000.

All rights reserved. The R380s contains the EPOC32 operating system and software, and Ericsson EPOC Connect 1.x contains the EPOC32 CONNECT software that is the copyrighted work of Symbian Ltd, London, England.

Ex. 1011 at 99

# Ericsson R380s

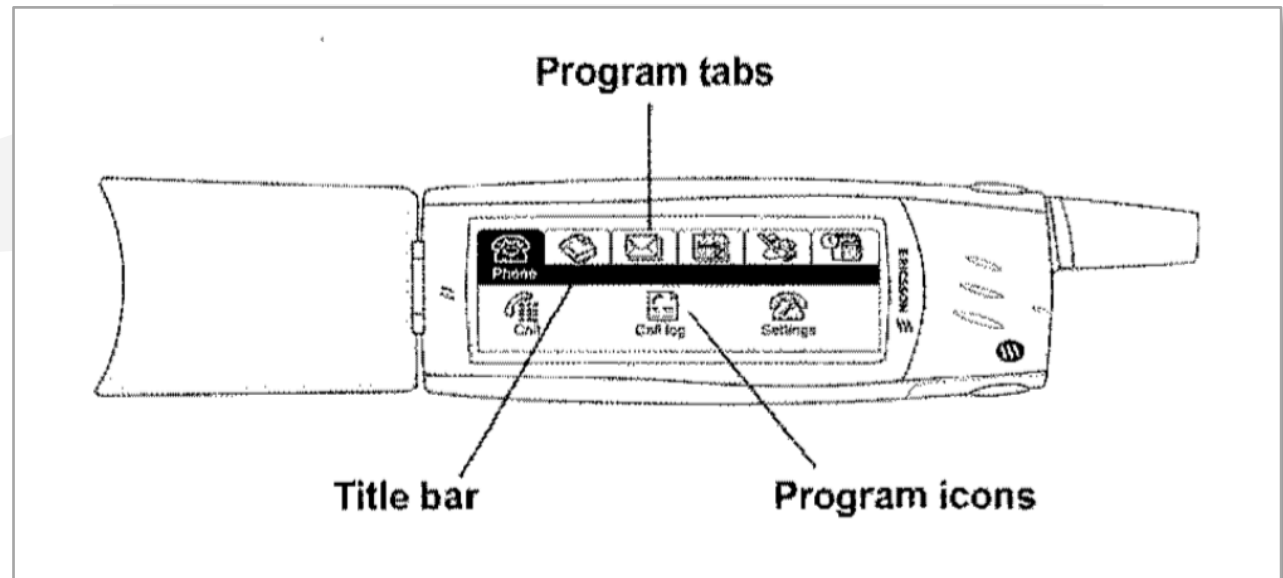
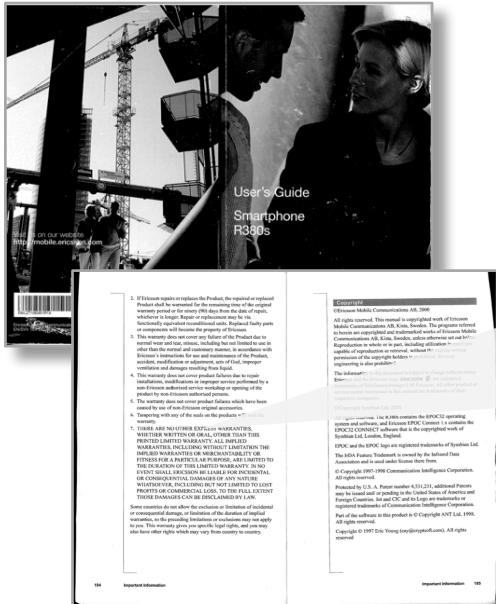

Ex. 1011 at 6

# Ericsson R380s

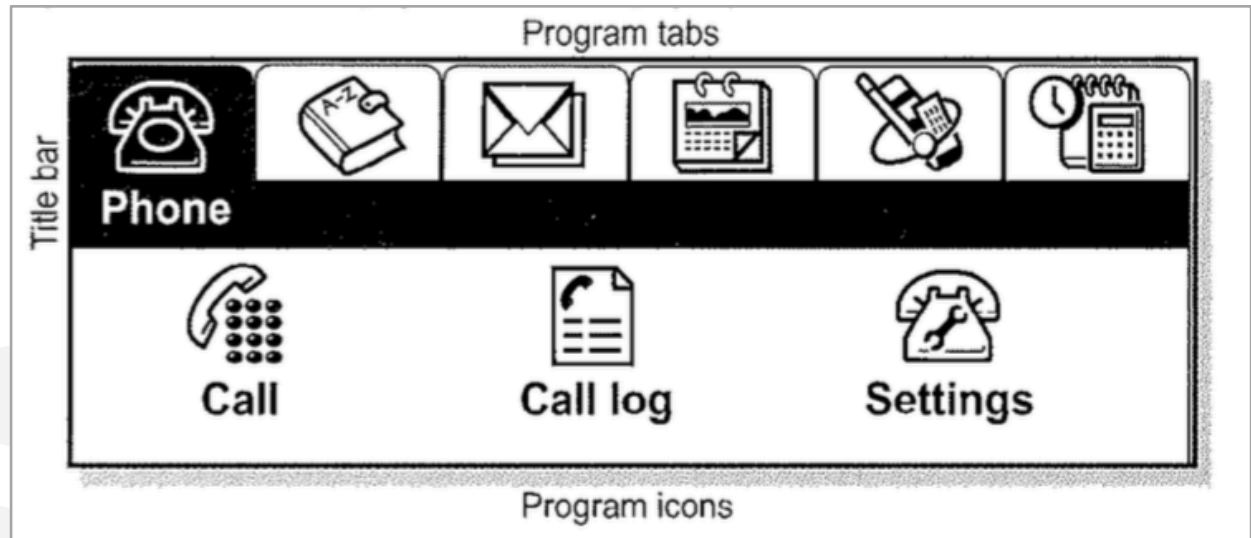

- **Program icons**, which start the different functions available within each program tab and are located in the lower section of the screen.

Ex. 1011 at 9

# Exhibit 1010



Ex. 1010 at 1

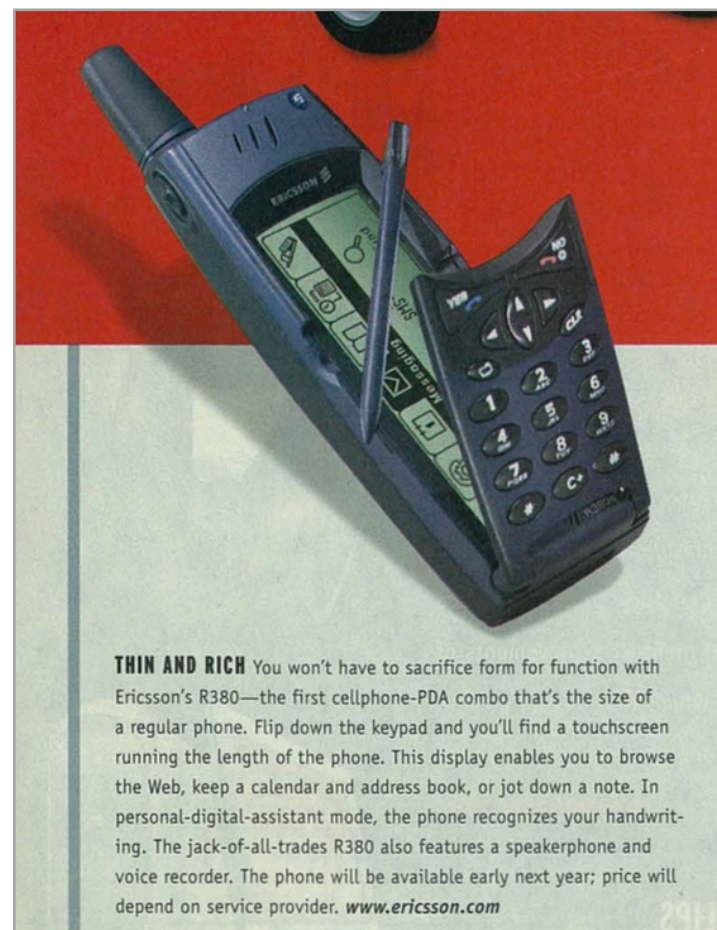

Ex. 1010 at 3

# Exhibit 1012



18th March 1999 - Ericsson unveiled today the Ericsson R380, a small-sized dual band mobile phone with in-built PDA (Personal Digital Assistant) functionality. The R380 is based on the EPOC operating system and features all required communications tools as well as calendar, in-built modem and a full graphic display with touch screen. The Ericsson R380 is based on new technology and design platforms and is one of two WAP-enabled and EPOC-based products that Ericsson unveils at CeBIT, the other being the mobile companion MC218.

Ex. 1012 at 1



# Exhibit 1013



## Ericsson launches Psion-like communicator

Peter Clarke

3/18/1999 04:12 PM EST

Post a comment

NO RATINGS  
LOGIN TO RATE

Tweet 0



8+1 0

HANNOVER, Germany — Ericsson launched the R380 dual-band smart phone at CeBit Thursday (March 18) based in part on Psion plc's Series 5 handheld computer and featuring the EPOC operating system of Symbian plc, Ericsson's joint-venture subsidiary.

Ex. 1013 at 1

# “Reached Directly”

020

(2)

1. A computing device comprising a display screen, the computing device being configured to display on the screen a main menu listing at least a first application, and additionally being configured to display on the screen an application summary window that can be reached directly from the main menu, wherein the application summary window displays a limited list of at least one function offered within the first application, each function in the list being selectable to launch the first application and initiate the selected function, and wherein the application summary window is displayed while the application is in an un-launched state.

# '020 Patent vs. Blanchard

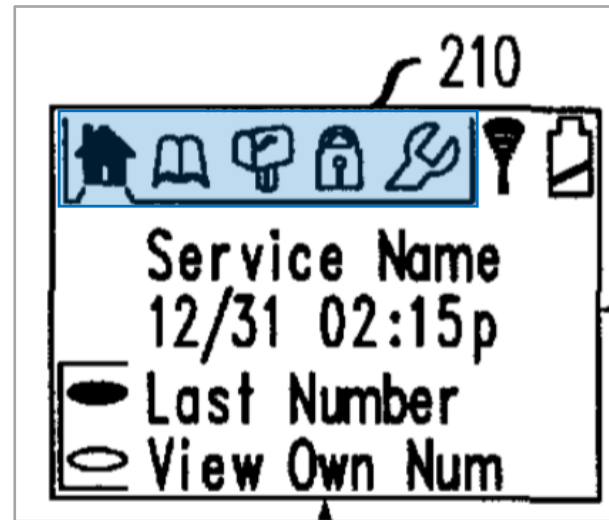
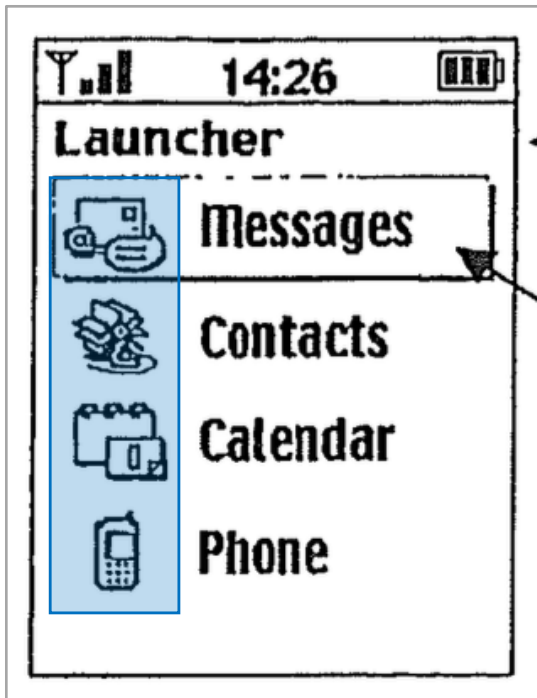

# '020 Patent vs. Blanchard

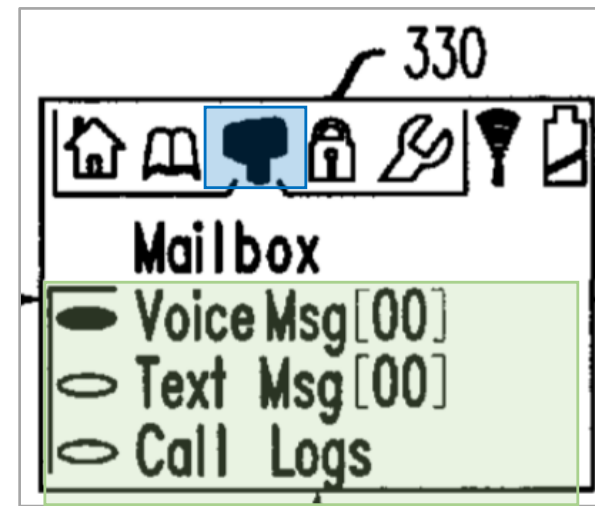

# Blanchard

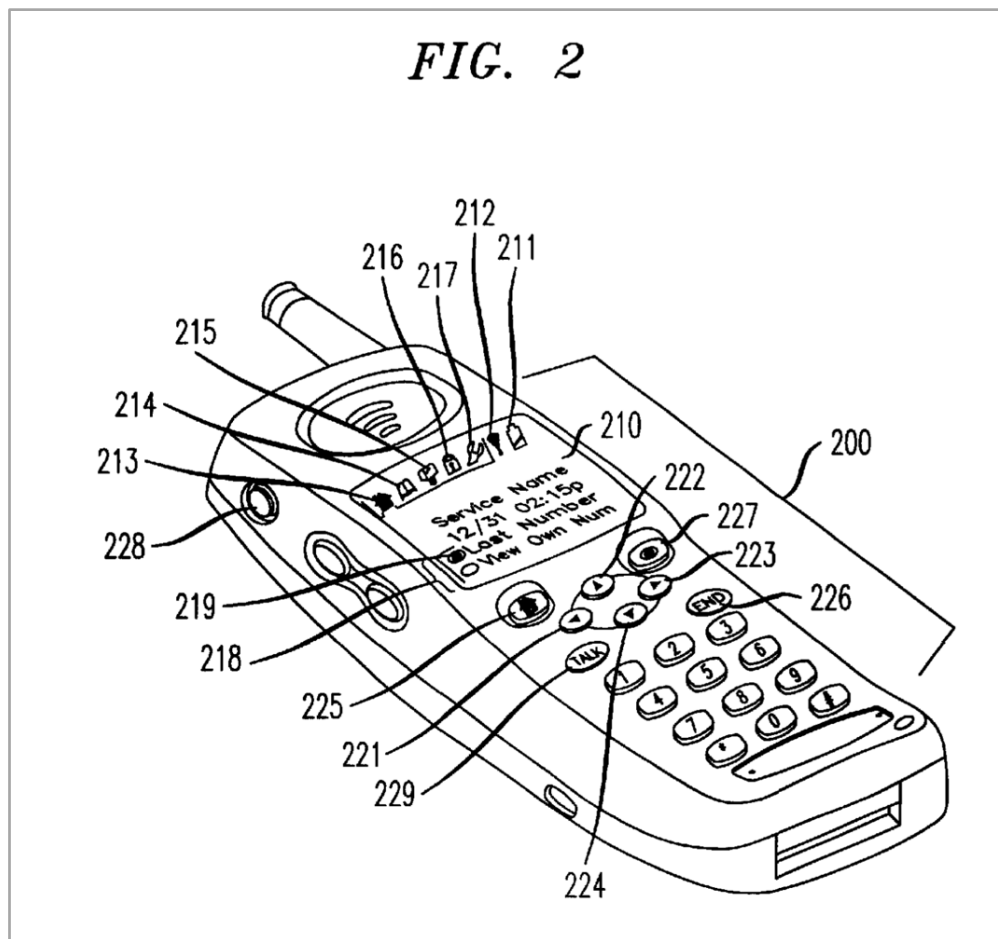

# Blanchard

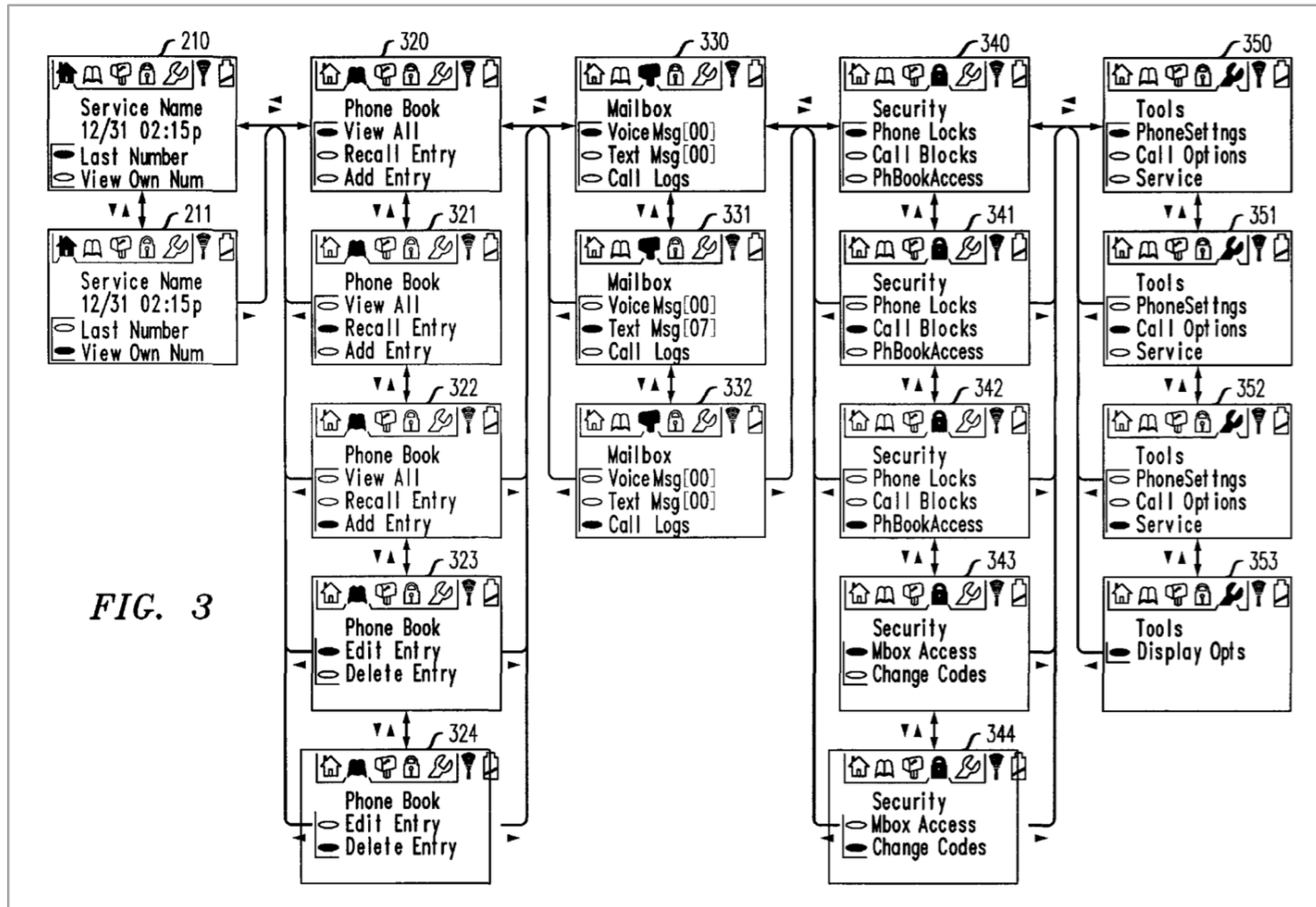

Fig. 3

# “Limited List”

020

1. A computing device comprising a display screen, the computing device being configured to display on the screen a main menu listing at least a first application, and additionally being configured to display on the screen an application summary window that can be reached directly from the main menu, wherein the application summary window displays a **limited list** of at least one function offered within the first application, each function in the list being selectable to launch the first application and initiate the selected function, and wherein the application summary window is displayed while the application is in an un-launched state.







# Claim 5, '020 Patent

---

**5.** The computing device of claim 1 in which the user can define what functionality and/or stored data types are of interest to that user for the summary window for an application.

# Claim 6, '020 Patent

---

**6.** The computing device of claim 1 in which the functionality and/or stored data types for a summary window for a given application varies with the environment of the device.

# Claim 7, '020 Patent

---

7. The computing device of claim 1 in which the functionality and/or stored data types for a summary window for a given application varies with the actions of the user.

# Blanchard

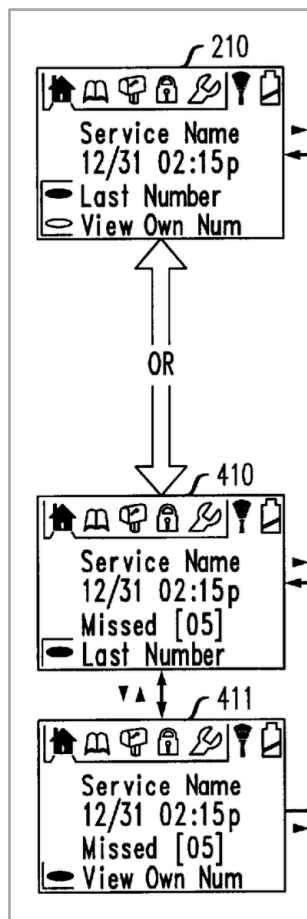

**Fig. 4**

# Blanchard

---

In achieving this advantageous operation, the terminal includes suitable coding for assigning a priority to either the status or header-type information or to the menu type-item information. In response to this priority coding which is assigned for each of the display screens, the desired information is suitably displayed in each of the display screens. The advantage of this arrangement is that it provides a very flexible manner in organizing and presenting information.

**6:65-7:5**

**END**

---

# Claim 1, '476 Patent

1. A computing device comprising a display screen, the computing device being configured to display on the screen a menu listing one or more applications, and additionally being configured to display on the screen an application summary that can be reached directly from the menu, wherein the application summary displays a limited list of data offered within the one or more applications, each of the data in the list being selectable to launch the respective application and enable the selected data to be seen within the respective application, and wherein the application summary is displayed while the one or more applications are in an un-launched state.



# Claim 1, '020 Patent

1. A computing device comprising a display screen, the computing device being configured to display on the screen a main menu listing at least a first application, and additionally being configured to display on the screen an application summary window that can be reached directly from the main menu, wherein the application summary window displays a limited list of at least one function offered within the first application, each function in the list being selectable to launch the first application and initiate the selected function, and wherein the application summary window is displayed while the application is in an un-launched state.

# Instituted Grounds

---

ORDERED that an *inter partes* review is instituted on the basis that Petitioner has shown a reasonable likelihood that claims 1, 2, 5–8, 10, 11, 13, and 16 of the '020 patent are unpatentable as obvious under 35 U.S.C. § 103(a) over Blanchard;

ORDERED that an *inter partes* review is instituted on the basis that Petitioner has shown a reasonable likelihood that claims 1, 4–6, 8, 9, 20, 26, 27, and 29 of the '476 patent are unpatentable as obvious under 35 U.S.C. § 103(a) over Blanchard;

# Blanchard

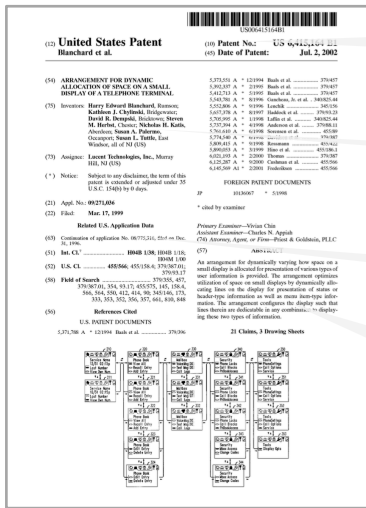

(10) Patent No.: **US 6,415,164 B1**

(75) Inventors: **Harry Edward Blanchard, Rumson;**

(63) Continuation of application No. 08/775,316, filed on Dec. 31, 1996.

(57) **ABSTRACT**

An arrangement for dynamically varying how space on a small display is allocated for presentation of various types of user information is provided. The arrangement optimizes utilization of space on small displays by dynamically allo-

# Blanchard

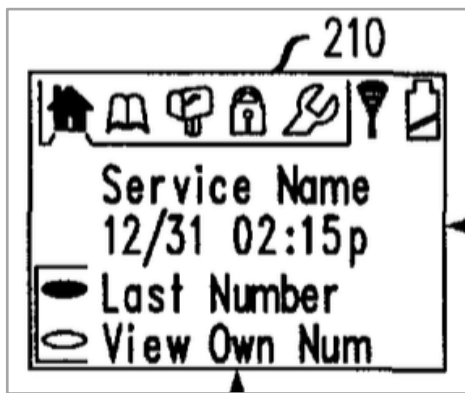

Fig. 3

The screen display changes dynamically as the user performs functions and makes selections via the Select key 227. Shown in the display 210 is just one menu screen in the hierarchically arranged menu. The illustrated entry is one of possible original starting screens or the “Home Screen”

3:44-48

# Blanchard

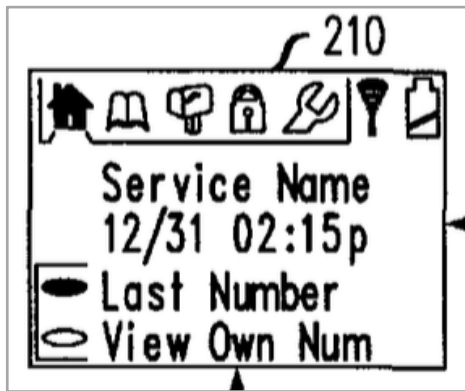

Fig. 3

choices or item type information to the user. The user may press the Select key **227** to activate one of these options when the darkened oval is positioned next to the desired option. By way of example, in screen **210**, pressing the Select key **227** redials the last number previously dialed.

6:42-46

# Oommen

---

particular, conventional operating program **100** is a monolithic program while control program **200** is a dynamic agent operating program **202** linked to a group of objects. One of the advantages of a non-monolithic control program is that it facilitates over the air updating of services offered to users. Instead of replacing the entire operating program when a new service is being offered, only a portion of control program **200** is required to be changed which makes it more practical and convenient to make such changes via a wireless network. In an illustrative example, a user may update the software used to send and receive E-mail messages by downloading a new E-mail service object to replace E-mail service object **204B**. Furthermore, a user may configure

**3:20-30**

# '020 Patent

---

The present invention can also be used in systems which do not have a concept of separate applications as such. Then, the snapshot views are then views of commonly used functions and/or data, selected by the system designer, user or through a machine learning process.

# Mr. Denning

18 Certainly that is very similar to the '020 patent  
19 figure 1 where we have messages, contacts,  
20 calendar and phone. I would say those are  
21 top-level functions.

22 BY MR. BROWN:

1 Q And those are common top-level functions  
2 in mobile phones at the relevant time, July 2000,  
3 right?

4 MR. HELGE: Object to form.

5 THE WITNESS: They appear to be common  
6 between the '020, the Oommen reference and  
7 Blanchard.



# Mr. Denning

13 Q If you go back to figure 3 in Blanchard,  
14 is it correct that selecting any one of the  
15 functions that's shown in figure 3 would call some  
16 sort of set of instructions within the phone?

17 MR. HELGE: Object to form.

18 THE WITNESS: Did you ask me, if I select  
19 any one of the menu items here, that, in selecting  
20 that, some code is called?

21 BY MR. BROWN:

22 Q Sure. Is that correct?

1 A Yes.

Ex. 1016 at 27:13-28:1

# Mr. Denning

---

11           Q     And you are willing to say that every  
12 menu item has some code that is called when the  
13 item is selected?

14           A     Yes.

**Ex. 1016 at 24:11-14**