



US005737394A

United States Patent [19]

[11] Patent Number: **5,737,394**

Anderson et al.

[45] Date of Patent: **Apr. 7, 1998**

[54] **PORTABLE TELEPHONE APPARATUS HAVING A PLURALITY OF SELECTABLE FUNCTIONS ACTIVATED BY THE USE OF DEDICATED AND/OR SOFT KEYS**

5,557,659	9/1996	Hlyde-Thomson	379/88
5,568,536	10/1996	Tiller et al.	379/58
5,568,540	10/1996	Greco et al.	379/89
5,581,593	12/1996	Engelke et al.	379/52

OTHER PUBLICATIONS

[75] Inventors: **Geoffrey T. Anderson**, San Diego, Calif.; **Sophie Klym**, Lincoln Park, N.J.; **Andrew Todd Zidel**, Hawthorne, N.J.; **Masaaki Akahane**, Mahwah, N.J.; **Eduardo Sciammarella**, Hoboken, N.J.

“Displayphone: Telephone and Terminal Combine in a Compact Desk-Top Unit”, Rod Adkins et al., *Telesis* (Canada), 1982-four, pp. 2-7.

“Smart Phones”, Christopher O’Malley, *Popular Science*, Jan. 1992, pp. 70-73 & 94.

[73] Assignees: **Sony Corporation**, Tokyo, Japan; **Sony Electronics**, Park Ridge, N.J.

“The Future is Now”, *Popular Science*, Jan. 1995, pp. 68-73, 81 & 82.

Primary Examiner—Thomas W. Brown

Attorney, Agent, or Firm—William S. Frommer; Alvin Sinderbrand

[21] Appl. No.: **597,292**

[22] Filed: **Feb. 6, 1996**

[51] Int. Cl.⁶ **H04M 1/56**; H04M 11/08

[52] U.S. Cl. **379/88**; 379/93.17; 379/396; 379/354; 455/412

[58] Field of Search 379/89, 88, 59, 379/96, 110, 354, 396, 57, 67, 93.17, 93.18, 110.01, 142; 455/412, 426, 413

[57] ABSTRACT

A telephone apparatus having a plurality of dedicated keys, a plurality of changeable keys each having at least one respective dedicated function associated therewith, and a display for displaying a plurality of lines of data. The telephone apparatus is adapted to perform a plurality of main functions including so-called menu, message, pad and book functions. Each of such main functions may be directly accessed by depressing only one of the keys. Further, the telephone apparatus enables messages, including voicemail and text data messages, to be received and stored therein. Messages or responses to received messages may be produced and transmitted from the telephone apparatus.

[56] References Cited

U.S. PATENT DOCUMENTS

5,425,077	6/1995	Tsoi	379/58
5,463,676	10/1995	Ohsawa	379/67
5,479,476	12/1995	Finke-Anlauff	379/58
5,483,577	1/1996	Gulick	379/67
5,487,104	1/1996	Baals et al.	379/96
5,526,407	6/1996	Russell et al.	379/89

26 Claims, 15 Drawing Sheets

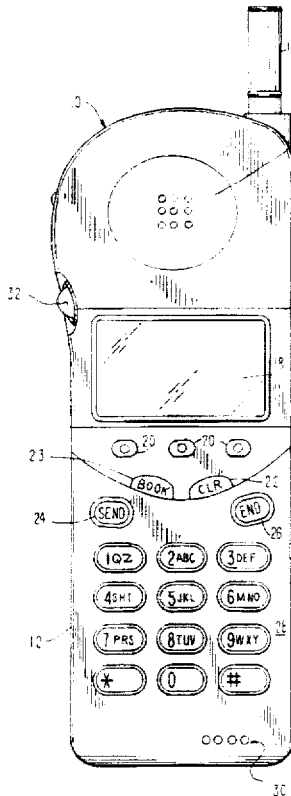

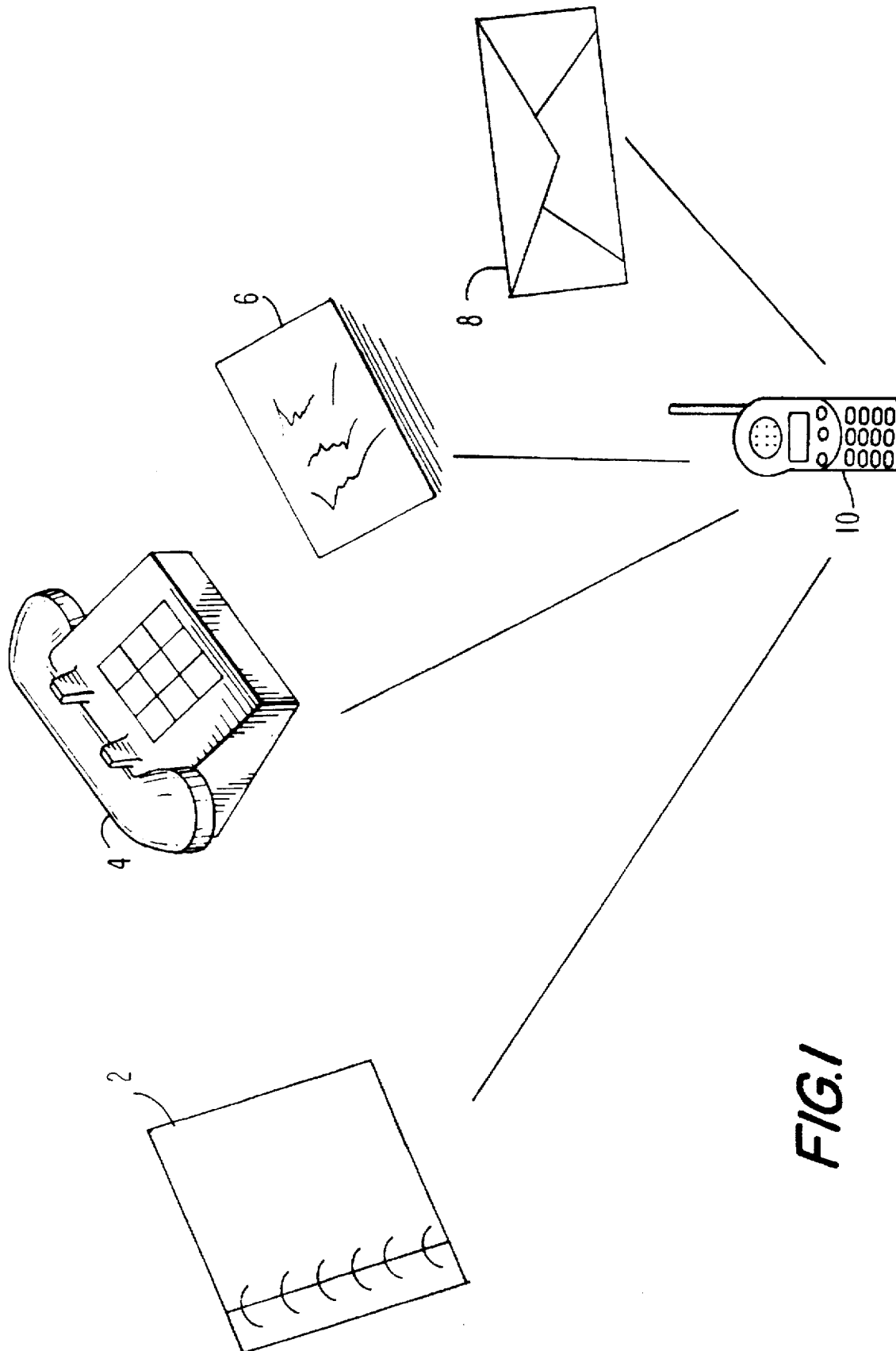

FIG. 1

FIG. 2A

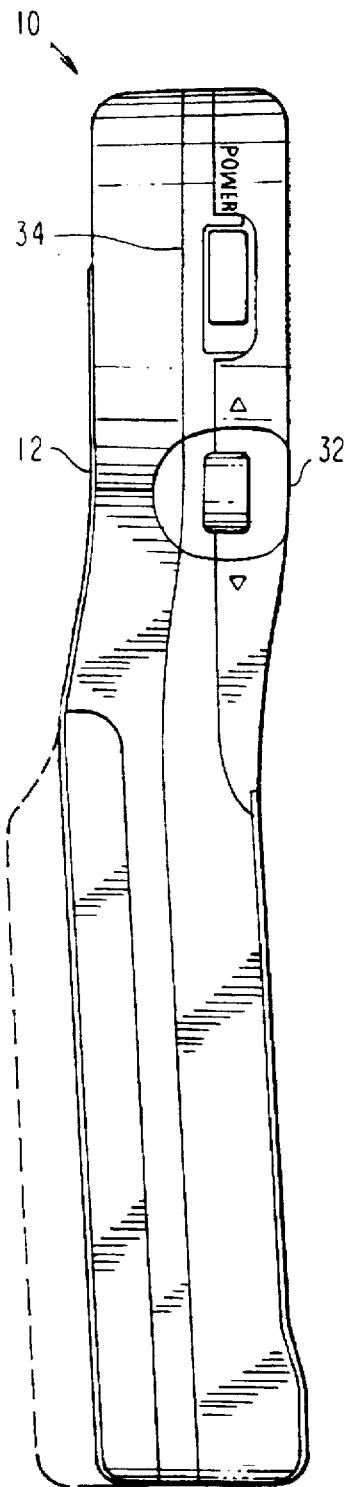
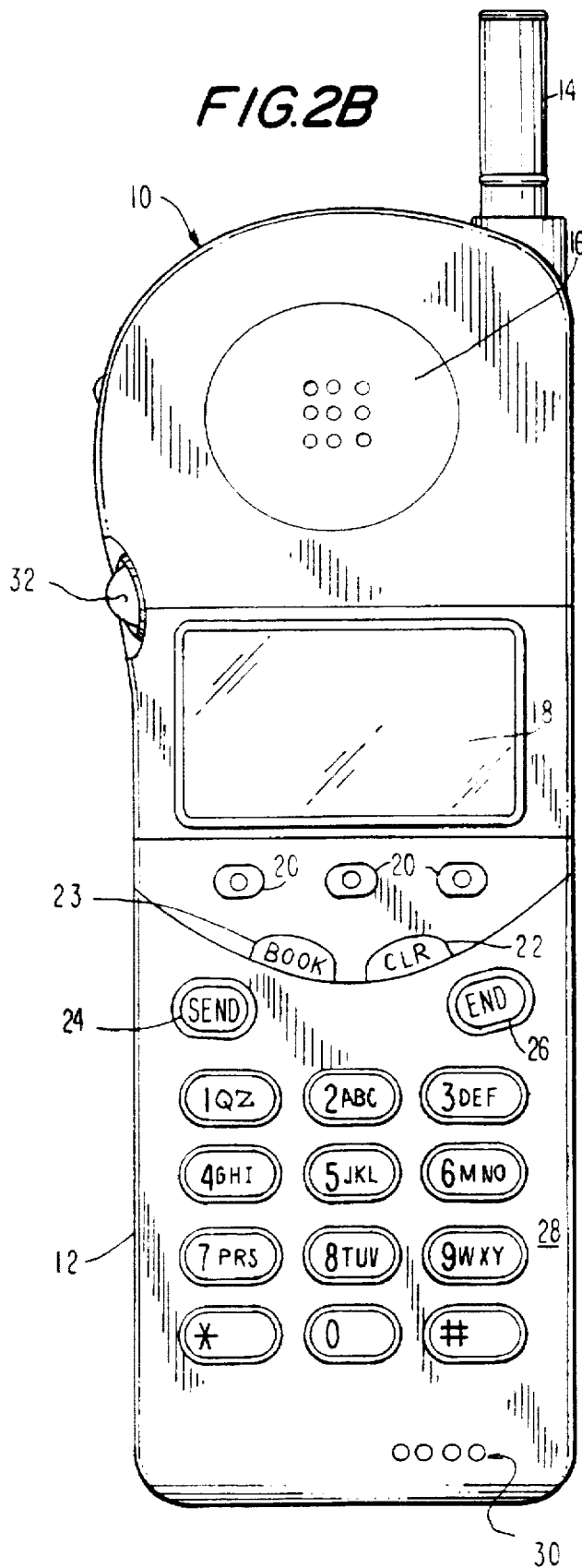

FIG. 2B



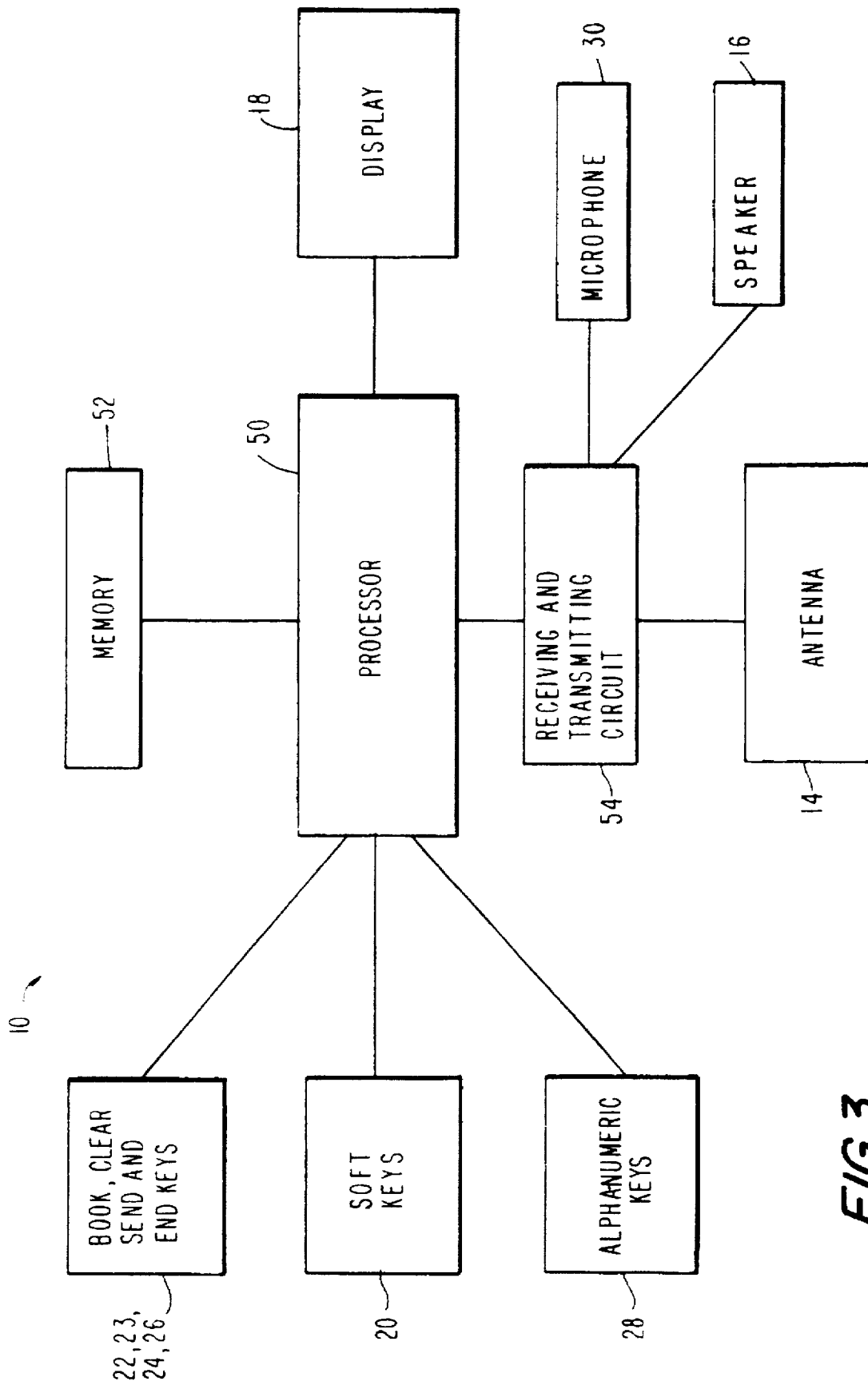

FIG. 3

FIG. 4

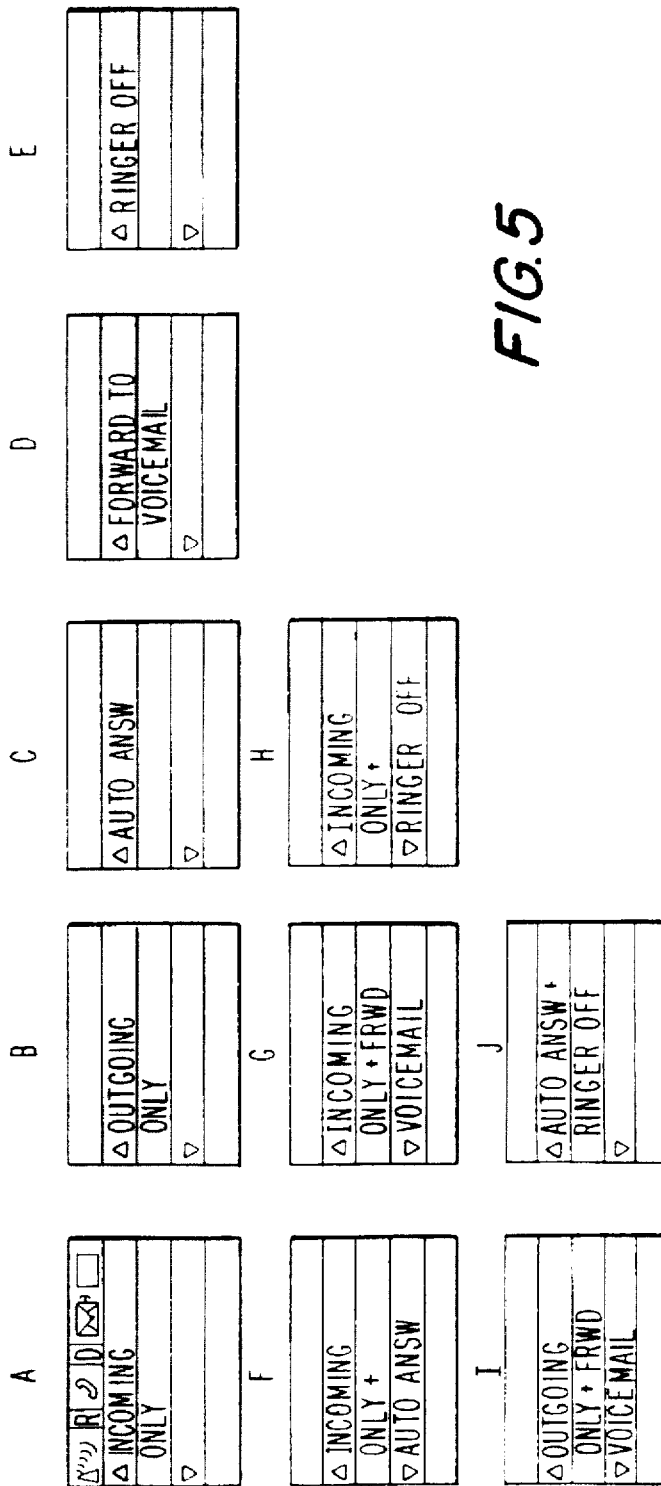
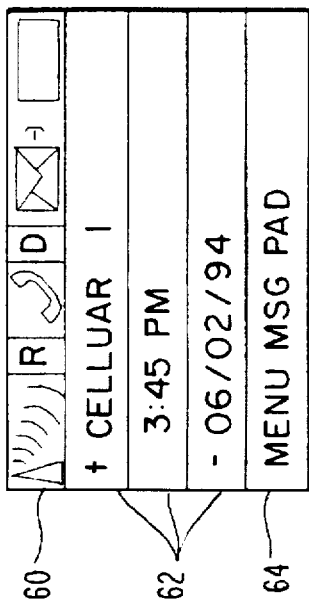

FIG. 5

Explore Litigation Insights

Docket Alarm provides insights to develop a more informed litigation strategy and the peace of mind of knowing you're on top of things.

Real-Time Litigation Alerts



Keep your litigation team up-to-date with **real-time alerts** and advanced team management tools built for the enterprise, all while greatly reducing PACER spend.

Our comprehensive service means we can handle Federal, State, and Administrative courts across the country.

Advanced Docket Research



With over 230 million records, Docket Alarm's cloud-native docket research platform finds what other services can't. Coverage includes Federal, State, plus PTAB, TTAB, ITC and NLRB decisions, all in one place.

Identify arguments that have been successful in the past with full text, pinpoint searching. Link to case law cited within any court document via Fastcase.

Analytics At Your Fingertips



Learn what happened the last time a particular judge, opposing counsel or company faced cases similar to yours.

Advanced out-of-the-box PTAB and TTAB analytics are always at your fingertips.

API

Docket Alarm offers a powerful API (application programming interface) to developers that want to integrate case filings into their apps.

LAW FIRMS

Build custom dashboards for your attorneys and clients with live data direct from the court.

Automate many repetitive legal tasks like conflict checks, document management, and marketing.

FINANCIAL INSTITUTIONS

Litigation and bankruptcy checks for companies and debtors.

E-DISCOVERY AND LEGAL VENDORS

Sync your system to PACER to automate legal marketing.