



US005370683A

United States Patent [19]

[11] Patent Number: **5,370,683**

Fontaine

[45] Date of Patent: **Dec. 6, 1994**

[54] **VASCULAR STENT**

[75] Inventor: **Arthur B. Fontaine**, Fresno, Calif.

[73] Assignee: **Cook Incorporated**, Bloomington, Ind.

[21] Appl. No.: **192,064**

[22] Filed: **Feb. 4, 1994**

5,015,253	5/1991	MacGregor .	
5,019,090	5/1991	Pinchuk	606/194
5,135,536	8/1992	Hillstead	623/1
5,161,547	11/1992	Tower	606/198
5,163,958	11/1992	Pinchuk	606/198
5,314,472	5/1994	Fontaine	623/1

Primary Examiner—C. Fred Rosenbaum
Assistant Examiner—N. Kent Gring
Attorney, Agent, or Firm—Richard J. Godlewski

Related U.S. Application Data

[63] Continuation of Ser. No. 858,304, Mar. 25, 1992, abandoned.

[51] Int. Cl.⁵ **A61F 2/06**

[52] U.S. Cl. **623/1; 606/198; 623/12**

[58] Field of Search **606/198, 200; 623/1, 623/11, 12, 900**

[57] **ABSTRACT**

A vascular stent for reducing hemodynamic disturbances caused by angioplasty. The stent is formed from a single filament of low memory biocompatible material having a series of U-shaped bends. The filament is wrapped around a mandril, in a circular fashion, in order to align the curved portions of each bend which may then be connected. The stent provides a maximum amount of structural support for the lumen while minimizing hemodynamic disturbances inside the lumen.

[56] **References Cited**

U.S. PATENT DOCUMENTS

4,776,337 10/1988 Palmaz .

14 Claims, 6 Drawing Sheets

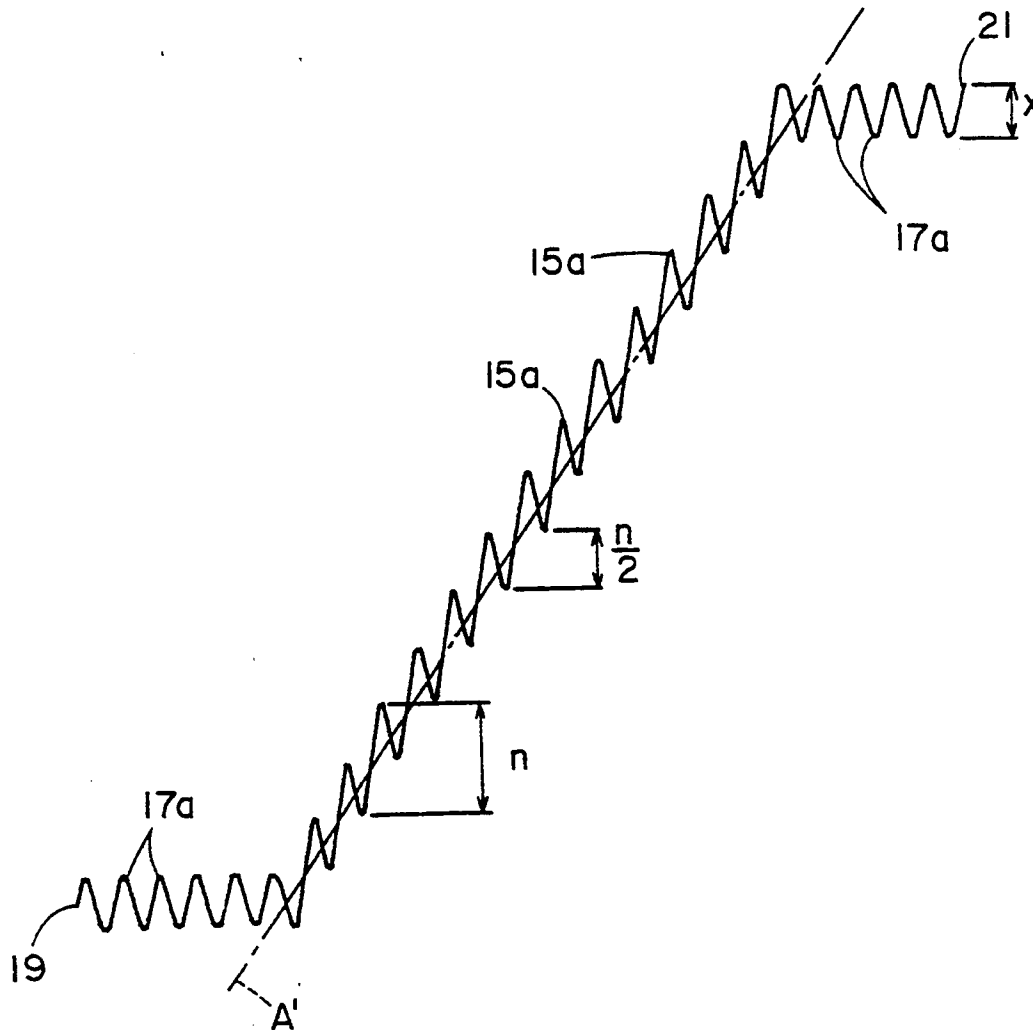

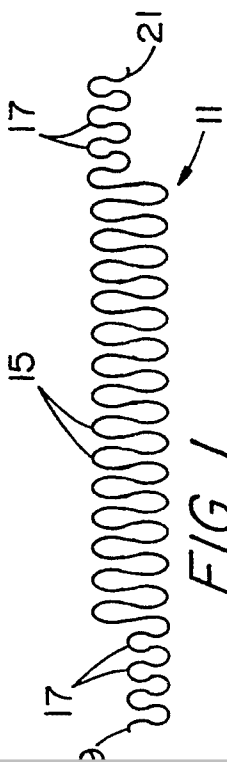

FIG. 1

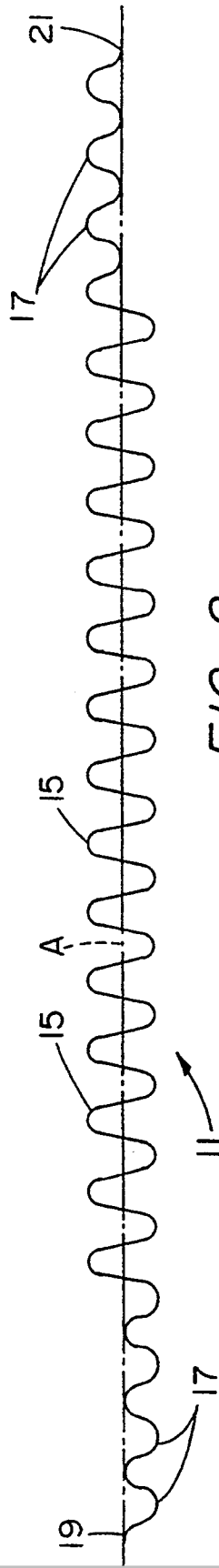

FIG. 2

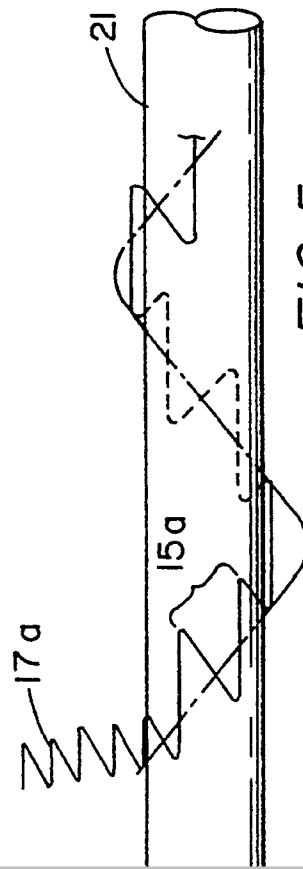

FIG. 5

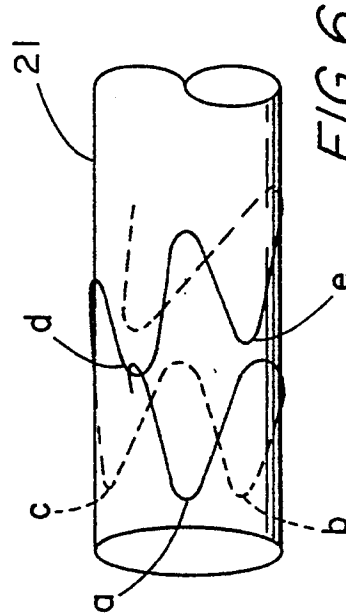
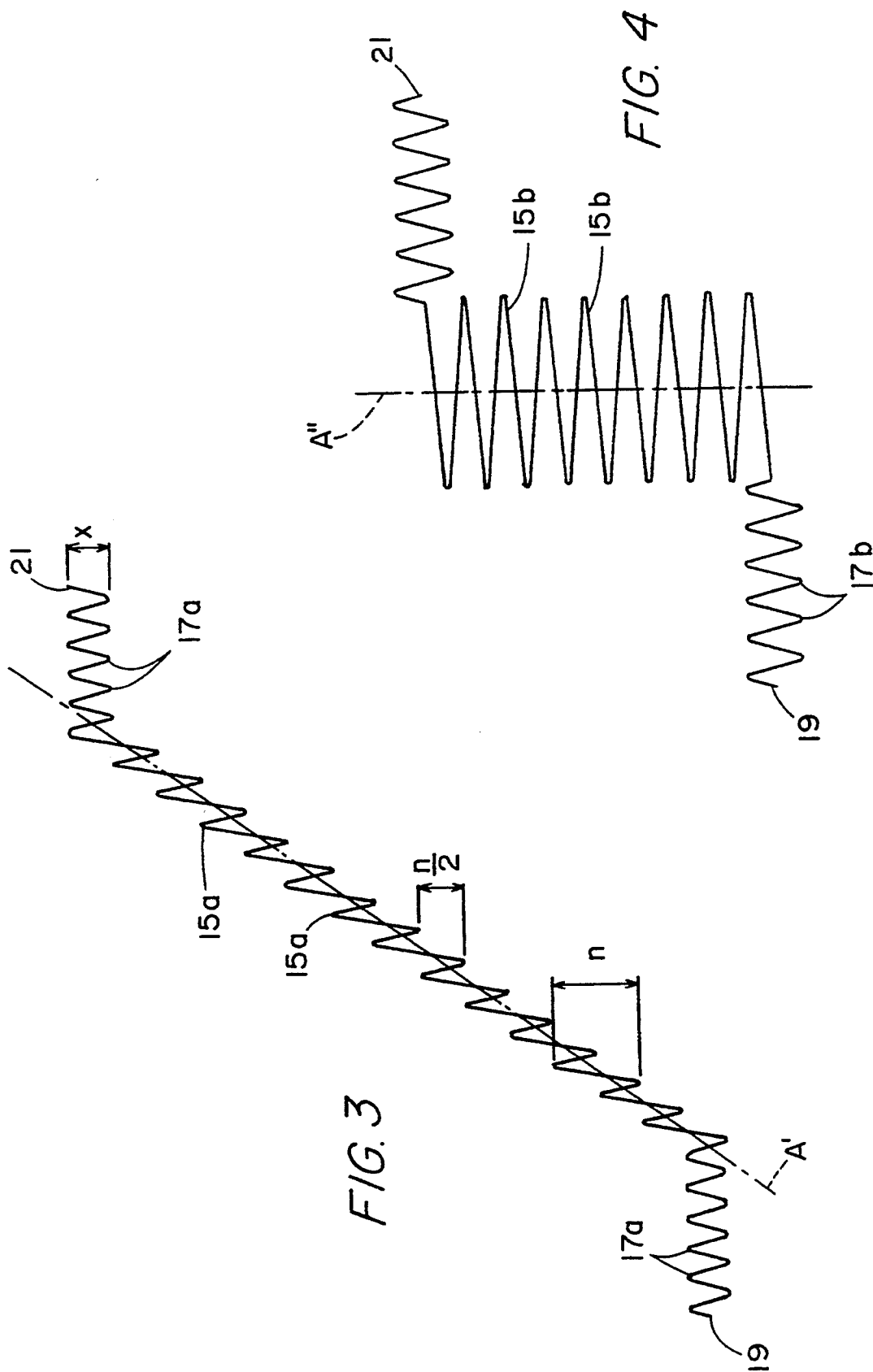
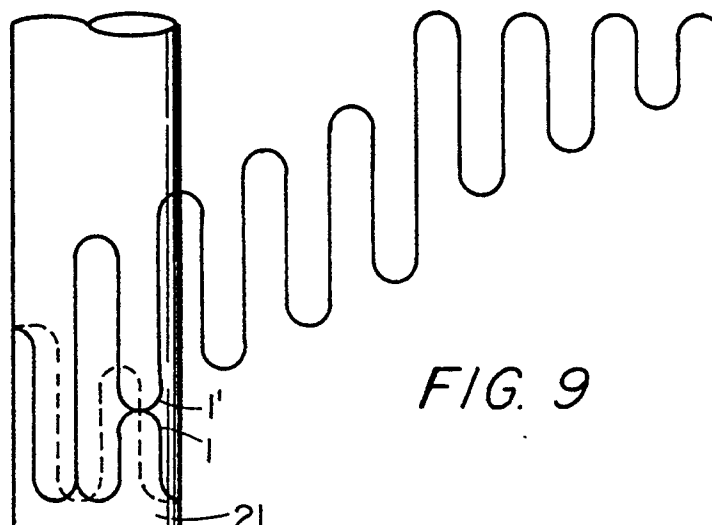
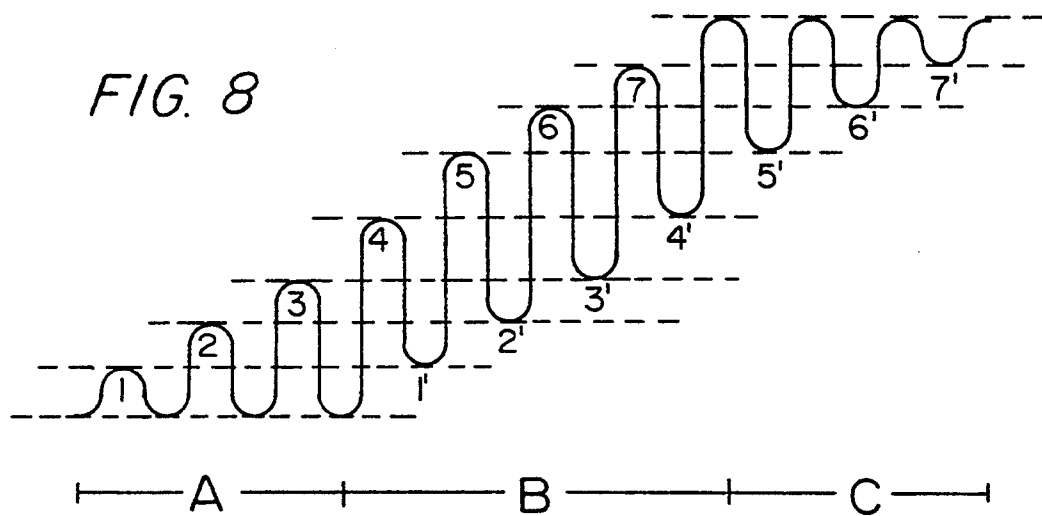
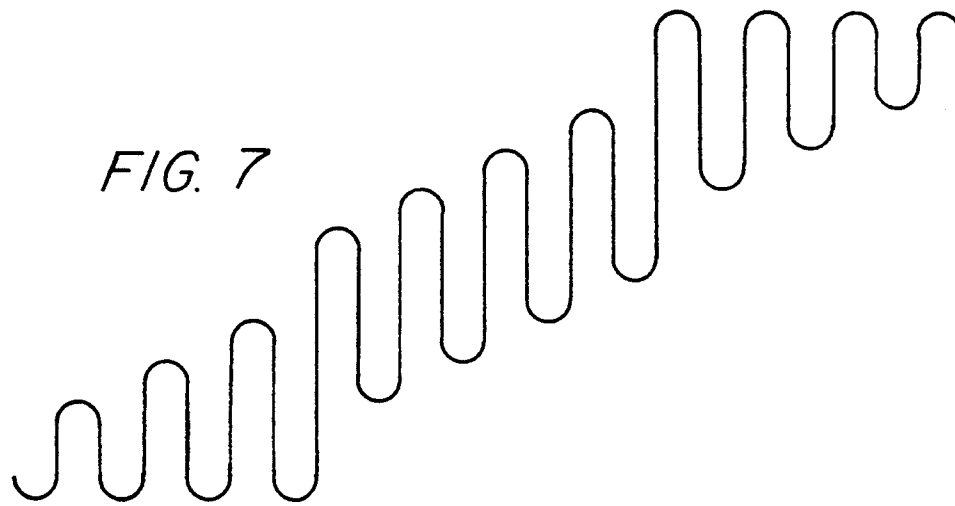

FIG. 6





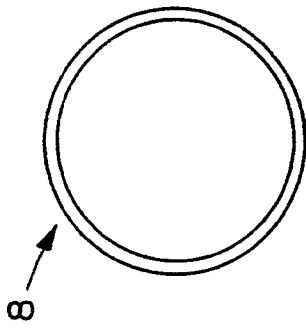

FIG. 12

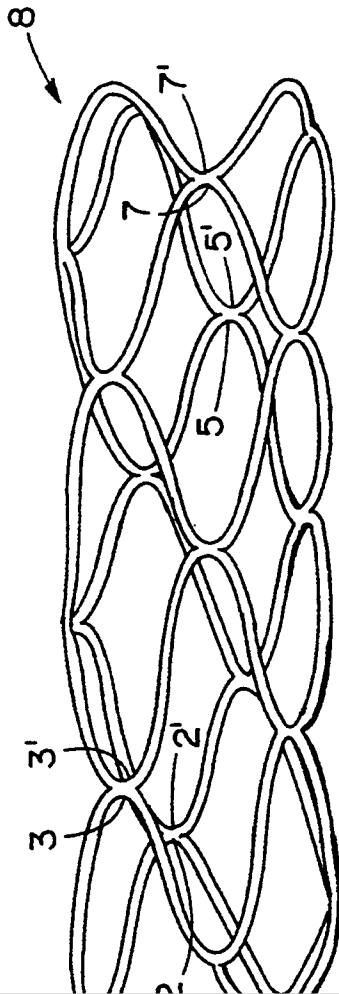

FIG. 10

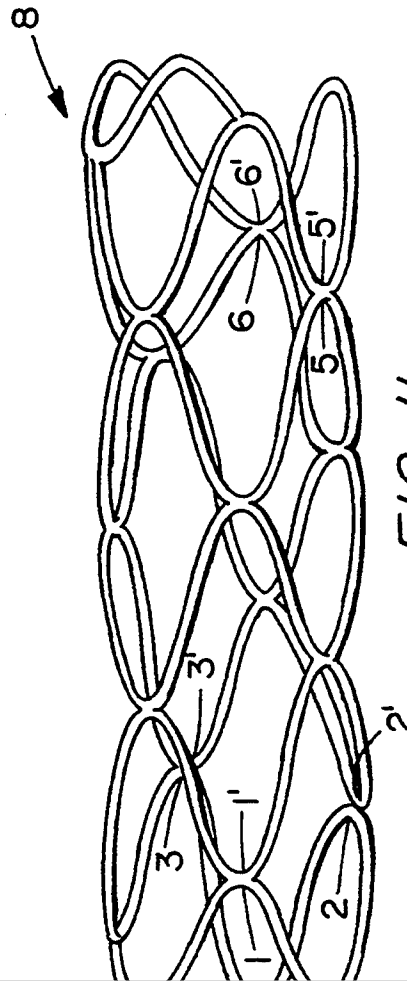

FIG. 11

Explore Litigation Insights

Docket Alarm provides insights to develop a more informed litigation strategy and the peace of mind of knowing you're on top of things.

Real-Time Litigation Alerts



Keep your litigation team up-to-date with **real-time alerts** and advanced team management tools built for the enterprise, all while greatly reducing PACER spend.

Our comprehensive service means we can handle Federal, State, and Administrative courts across the country.

Advanced Docket Research



With over 230 million records, Docket Alarm's cloud-native docket research platform finds what other services can't. Coverage includes Federal, State, plus PTAB, TTAB, ITC and NLRB decisions, all in one place.

Identify arguments that have been successful in the past with full text, pinpoint searching. Link to case law cited within any court document via Fastcase.

Analytics At Your Fingertips



Learn what happened the last time a particular judge, opposing counsel or company faced cases similar to yours.

Advanced out-of-the-box PTAB and TTAB analytics are always at your fingertips.

API

Docket Alarm offers a powerful API (application programming interface) to developers that want to integrate case filings into their apps.

LAW FIRMS

Build custom dashboards for your attorneys and clients with live data direct from the court.

Automate many repetitive legal tasks like conflict checks, document management, and marketing.

FINANCIAL INSTITUTIONS

Litigation and bankruptcy checks for companies and debtors.

E-DISCOVERY AND LEGAL VENDORS

Sync your system to PACER to automate legal marketing.