



- [54] **CELLULAR TELEPHONE LOCATION SYSTEM**
- [75] Inventors: **Louise A. Stilp, Broomall, Pa.; Curtis A. Knight, Washington, D.C.; John C. Webber, Herndon, Va.**
- [73] Assignee: **Associated RT, Inc., Pittsburgh, Pa.**
- [21] Appl. No.: **59,248**
- [22] Filed: **May 7, 1993**
- [51] Int. Cl.⁵ **G01S 1/24; G01S 3/02; H04M 11/00**
- [52] U.S. Cl. **342/387; 342/457; 379/58**
- [58] Field of Search **342/387, 457, 35; 379/58, 59, 60, 62; 364/449**

| | | | |
|-----------|---------|-----------------------|---------|
| 5,008,679 | 4/1991 | Effland et al. | 342/353 |
| 5,023,809 | 6/1991 | Spackman et al. | 364/516 |
| 5,023,900 | 6/1991 | Taylor et al. | 379/32 |
| 5,055,851 | 10/1991 | Sheffer | 342/457 |
| 5,095,500 | 3/1992 | Taylor et al. | 379/32 |
| 5,101,501 | 3/1992 | Gilhousen et al. | 455/33 |
| 5,126,748 | 6/1992 | Ames et al. | 342/353 |
| 5,128,623 | 7/1992 | Gilmore | 328/1 |
| 5,153,902 | 10/1992 | Buhl et al. | 379/60 |
| 5,166,694 | 11/1992 | Russell et al. | 342/457 |
| 5,208,756 | 5/1993 | Song | 364/449 |
| 5,218,618 | 6/1993 | Sagey | 342/457 |

FOREIGN PATENT DOCUMENTS

WO93/06685 9/1992 PCT Int'l Appl. .

OTHER PUBLICATIONS

Smith, William W., "Passive Location of Mobile Cellular Telephone Terminals," IEEE, 1991, pp. 221-225.

Primary Examiner—Gregory C. Issing
Attorney, Agent, or Firm—Woodcock Washburn Kurtz Mackiewicz & Norris

[57] ABSTRACT

A cellular telephone location system for automatically recording the location of one or more mobile cellular telephones comprises three or more cell site systems 12. Each cell site system is located at a cell site of a cellular telephone system. Each cell site system includes an antenna that may be mounted on the same tower or building as the antenna employed by the cellular telephone system and equipment that may be housed in the equipment enclosure of the corresponding cell site. The cell site systems are coupled via T1 communication links 14 to a central site 16. The central site may be collocated with the cellular telephone system's MTSO. The central site 16 is further coupled to a database 20, which may be remotely located from the central site and made available to subscribers.

45 Claims, 15 Drawing Sheets

[56] References Cited

U.S. PATENT DOCUMENTS

| | | | |
|-----------|---------|------------------------|------------|
| 3,384,891 | 5/1968 | Anderson | 343/6.5 |
| 3,646,580 | 2/1972 | Fuller et al. | 342/457 |
| 3,680,121 | 7/1972 | Anderson et al. | 342/387 |
| 4,177,466 | 12/1979 | Reagan | 343/112 TC |
| 4,297,701 | 10/1981 | Henriques | 343/6.5 LC |
| 4,433,335 | 2/1984 | Wind | 343/463 |
| 4,596,988 | 6/1986 | Wanka | 343/457 |
| 4,638,321 | 1/1987 | Drogin | 342/444 |
| 4,639,733 | 1/1987 | King et al. | 342/424 |
| 4,651,156 | 3/1987 | Martinez | 342/457 |
| 4,651,157 | 3/1987 | Gray et al. | 342/457 |
| 4,728,959 | 3/1988 | Maloney et al. | 342/457 |
| 4,740,792 | 4/1988 | Sagey et al. | 342/457 |
| 4,742,357 | 5/1988 | Rackley | 342/463 |
| 4,791,572 | 12/1988 | Green, III et al. | 364/449 |
| 4,797,679 | 1/1989 | Cusdin et al. | 342/387 |
| 4,818,998 | 4/1989 | Apsell et al. | 342/44 |
| 4,870,422 | 9/1989 | Counselman, III | 342/357 |
| 4,888,593 | 12/1989 | Friedman et al. | 342/387 |
| 4,891,650 | 1/1990 | Sheffer | 342/457 |
| 4,908,629 | 3/1990 | Apsell et al. | 342/457 |
| 4,926,161 | 5/1990 | Cupp | 340/572 |
| 4,975,710 | 12/1990 | Baghdady | 342/442 |
| 5,003,317 | 3/1991 | Gray et al. | 342/457 |

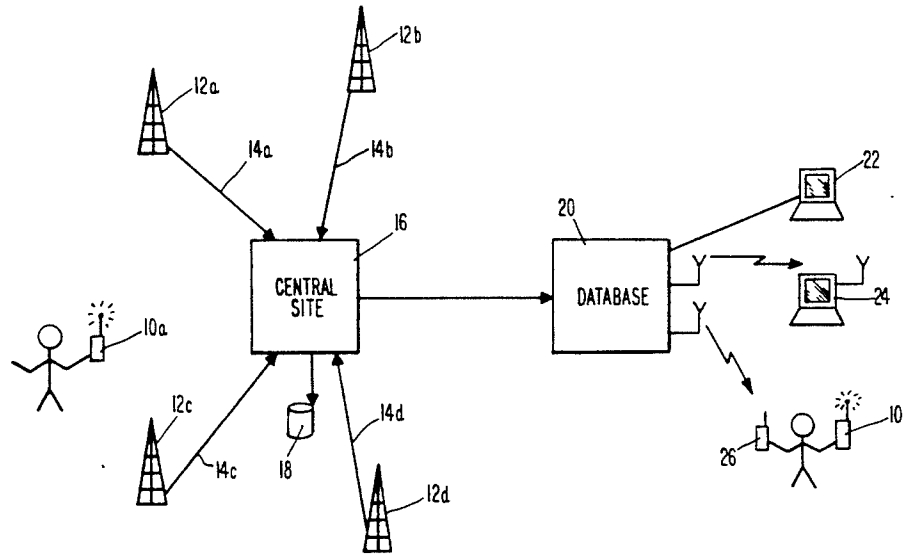

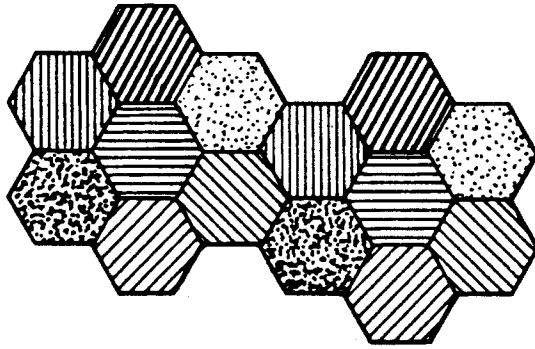

PRIOR ART

Fig. 1A

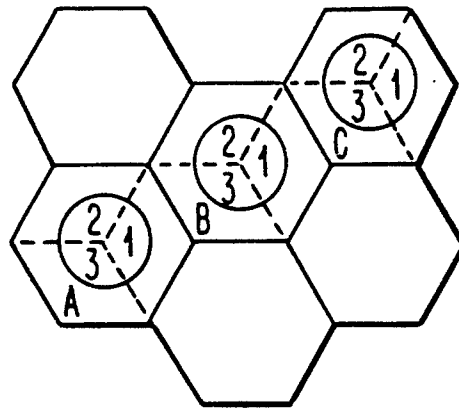

PRIOR ART

Fig. 1B

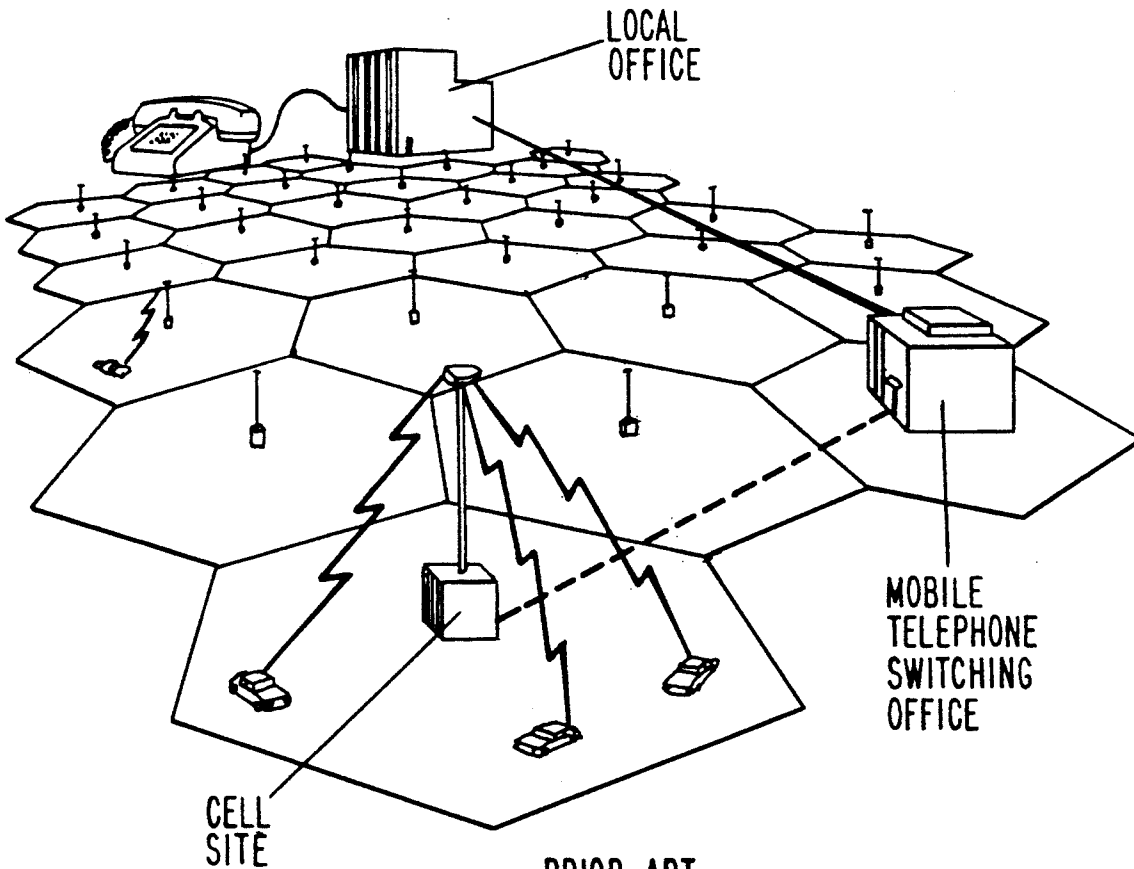

PRIOR ART

Fig. 1C

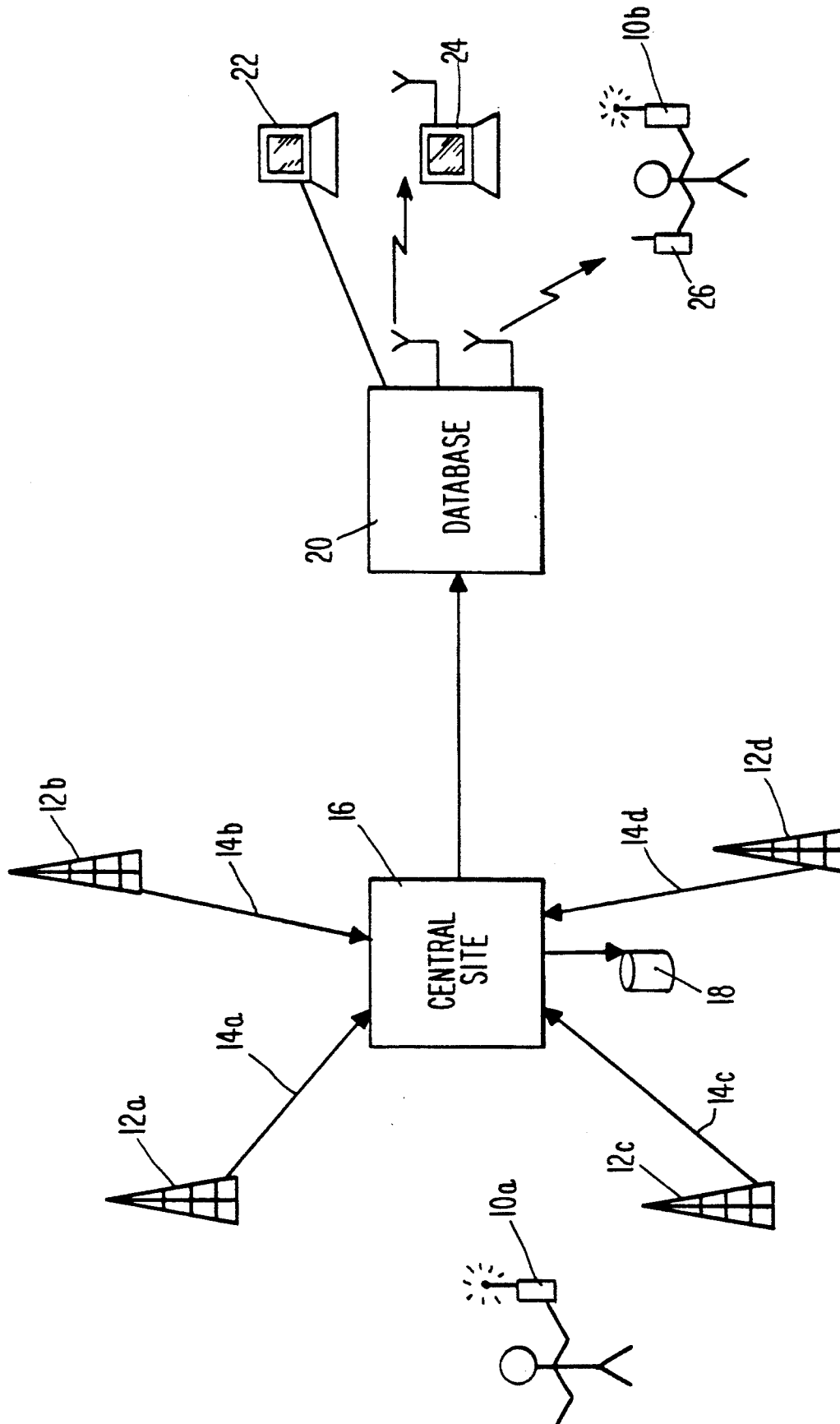

Fig. 2

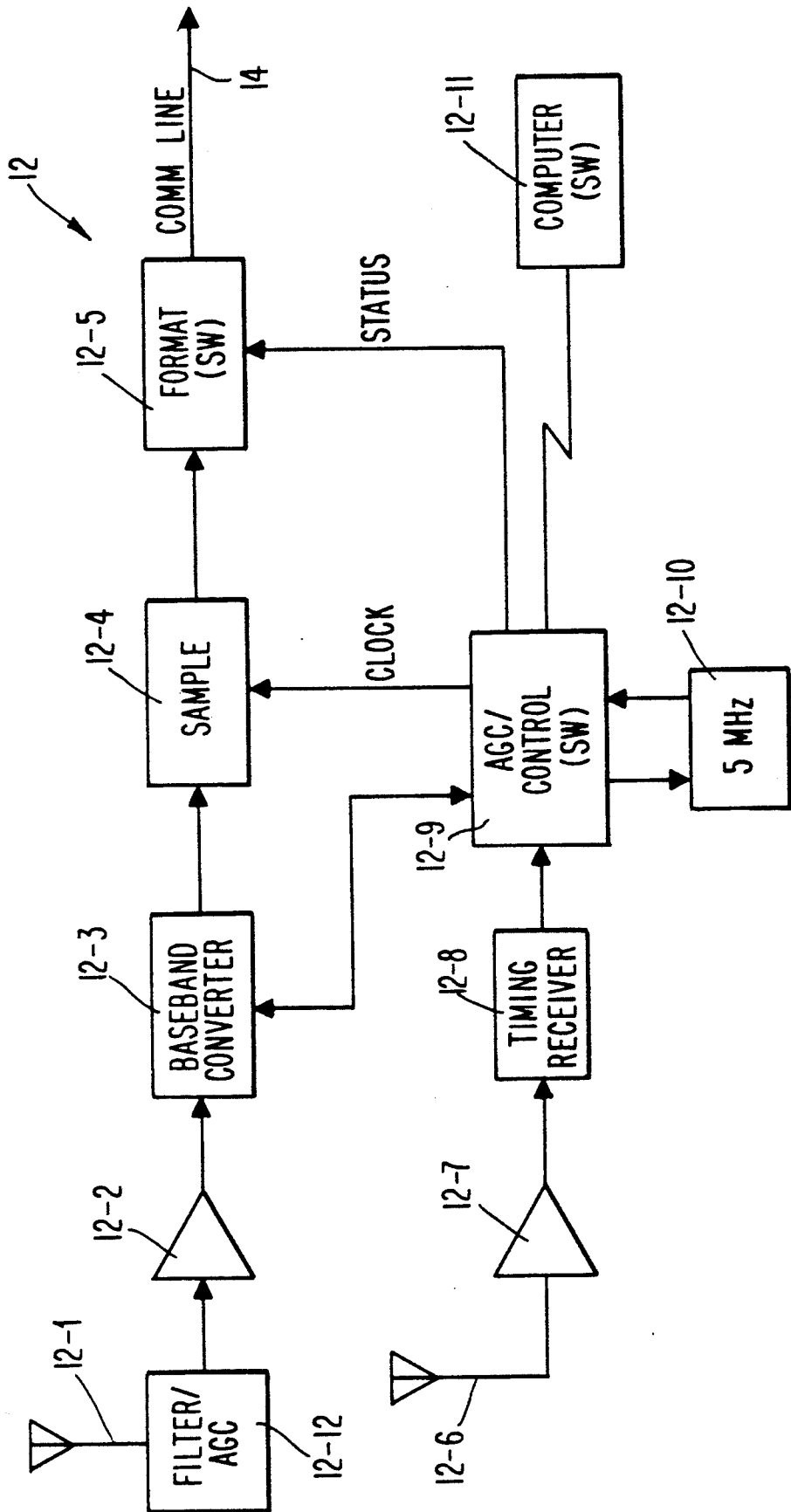
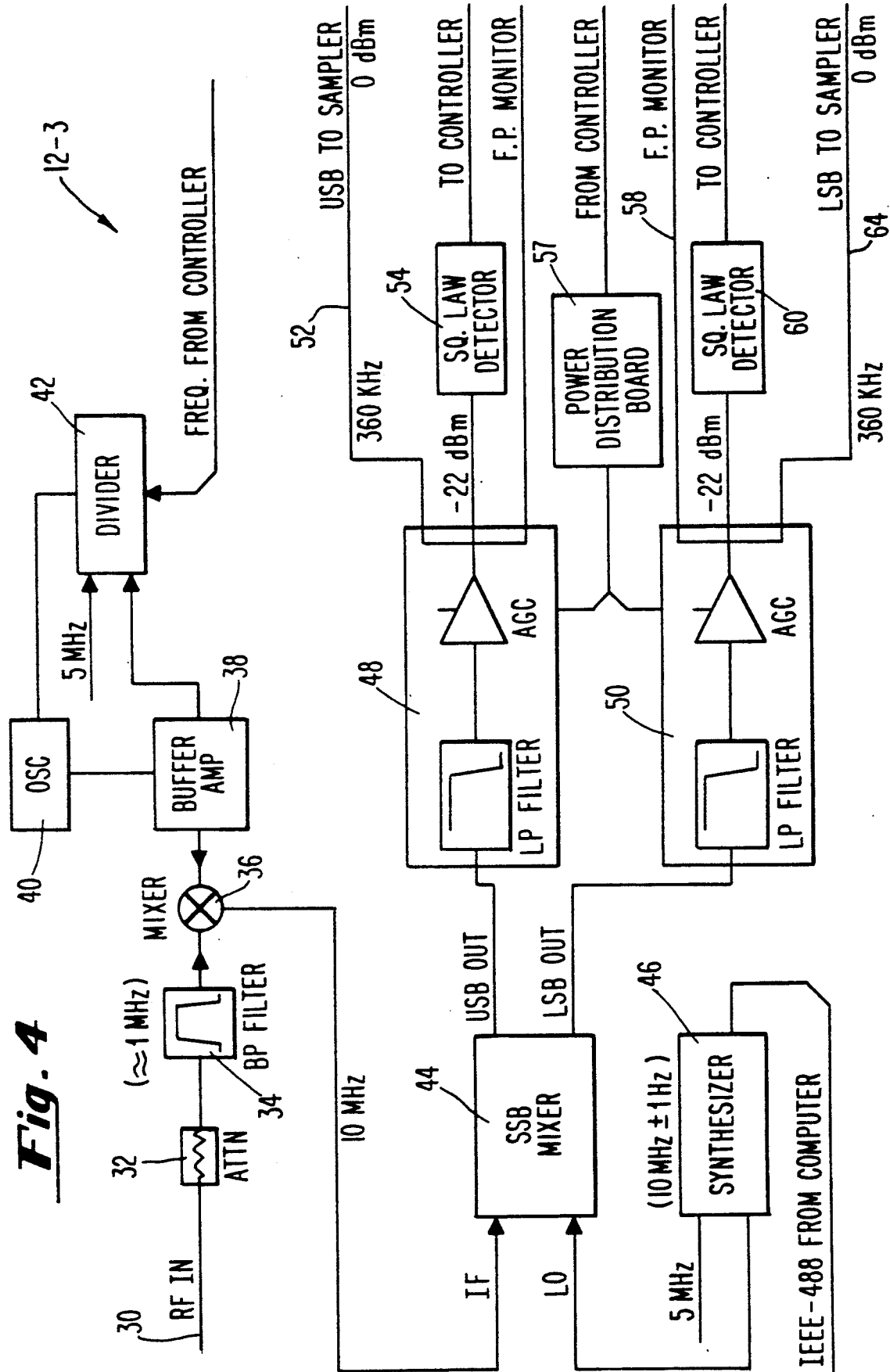

Fig. 3

Fig. 4



Explore Litigation Insights

Docket Alarm provides insights to develop a more informed litigation strategy and the peace of mind of knowing you're on top of things.

Real-Time Litigation Alerts



Keep your litigation team up-to-date with **real-time alerts** and advanced team management tools built for the enterprise, all while greatly reducing PACER spend.

Our comprehensive service means we can handle Federal, State, and Administrative courts across the country.

Advanced Docket Research



With over 230 million records, Docket Alarm's cloud-native docket research platform finds what other services can't. Coverage includes Federal, State, plus PTAB, TTAB, ITC and NLRB decisions, all in one place.

Identify arguments that have been successful in the past with full text, pinpoint searching. Link to case law cited within any court document via Fastcase.

Analytics At Your Fingertips



Learn what happened the last time a particular judge, opposing counsel or company faced cases similar to yours.

Advanced out-of-the-box PTAB and TTAB analytics are always at your fingertips.

API

Docket Alarm offers a powerful API (application programming interface) to developers that want to integrate case filings into their apps.

LAW FIRMS

Build custom dashboards for your attorneys and clients with live data direct from the court.

Automate many repetitive legal tasks like conflict checks, document management, and marketing.

FINANCIAL INSTITUTIONS

Litigation and bankruptcy checks for companies and debtors.

E-DISCOVERY AND LEGAL VENDORS

Sync your system to PACER to automate legal marketing.