



US005584556A

United States Patent [19]

Yokoyama et al.

[11] Patent Number: **5,584,556**

[45] Date of Patent: **Dec. 17, 1996**

[54] **SURFACE LIGHT SOURCE DEVICE**

[75] Inventors: **Kazuaki Yokoyama**, Saitama-ken;
Tsuyoshi Ishikawa, Tokyo-to, both of
Japan

[73] Assignee: **Enplas Corporation**, Kawaguchi, Japan

4,811,507	3/1989	Blanchet	362/31
5,005,108	4/1991	Pristash et al.	362/26
5,040,098	8/1991	Tanaka et al.	362/31
5,046,826	9/1991	Iwamoto et al.	362/31
5,057,974	10/1991	Mizobe	362/26
5,070,431	12/1991	Kitazawa et al.	362/31
5,227,773	7/1993	Wu et al.	362/31

[21] Appl. No.: **982,942**

[22] Filed: **Nov. 30, 1992**

FOREIGN PATENT DOCUMENTS

834837	3/1952	Germany	362/31
331782	3/1991	Japan .	
3189679	8/1991	Japan .	

[30] Foreign Application Priority Data

Nov. 28, 1991	[JP]	Japan	3-105334 U
Dec. 2, 1991	[JP]	Japan	3-341747
Feb. 20, 1992	[JP]	Japan	4-016237 U
Mar. 25, 1992	[JP]	Japan	4-024601 U
Mar. 25, 1992	[JP]	Japan	4-024608 U
Oct. 9, 1992	[JP]	Japan	4-296666

Primary Examiner—Ira S. Lazarus
Assistant Examiner—Alan B. Cariaso
Attorney, Agent, or Firm—Cushman, Darby & Cushman

[51] **Int. Cl.⁶** **F21V 8/00**

[52] **U.S. Cl.** **362/31; 362/26; 362/327;**
362/330; 385/901; 349/62

[58] **Field of Search** 362/26, 27, 31,
362/327, 330, 331, 333, 339; 359/49, 48;
385/901, 129, 130, 131

[57] ABSTRACT

A surface light source device which comprises a light-conducting member consisting of a sheet of transparent material, a linear light source disposed adjacent to an edge surface of the light-conducting member, a diffusion plate disposed on a front surface of the light-conducting member and a reflective plate disposed on a rear side of the light-conducting member. The rear surface of the light-conducting member has depressions or projections. These depressions or projections have rough surfaces. By selecting the shape of the depressions or projections, and controlling the roughness of the rough surfaces, an enhanced uniform brightness distribution is provided.

[56] References Cited

U.S. PATENT DOCUMENTS

2,242,872	5/1941	Rolph	362/330
4,373,282	2/1983	Wragg	362/31

30 Claims, 9 Drawing Sheets

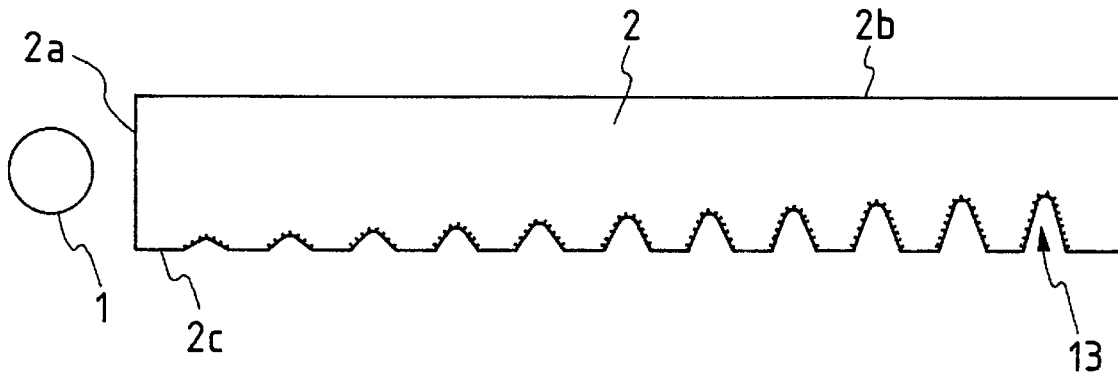

FIG. 1 PRIOR ART

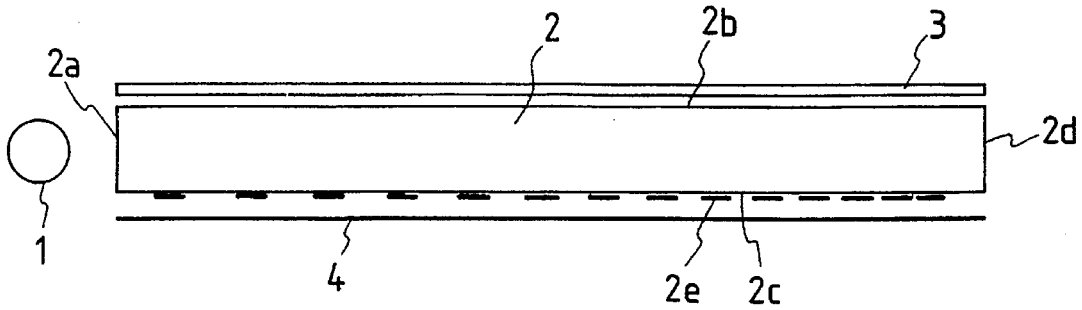

FIG. 2

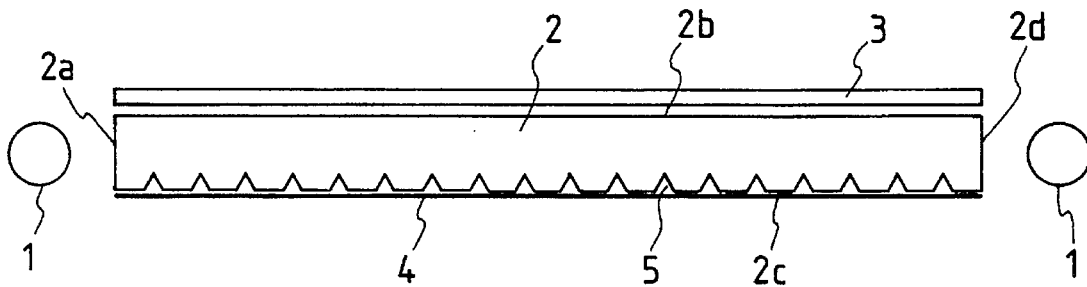

FIG. 3

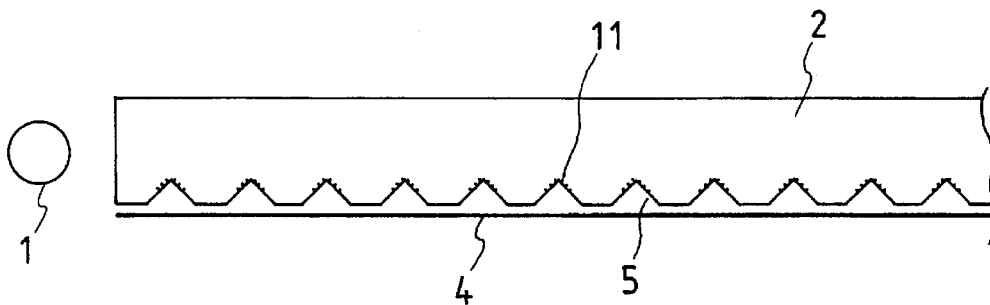

FIG. 4

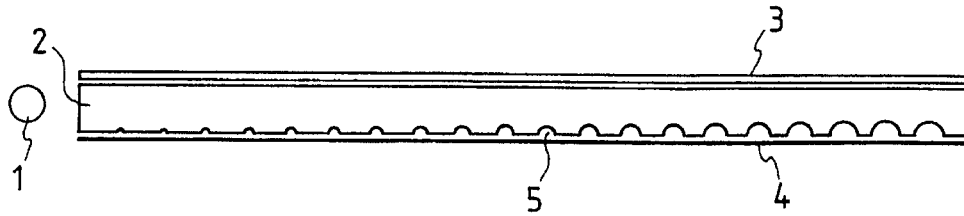

FIG. 5

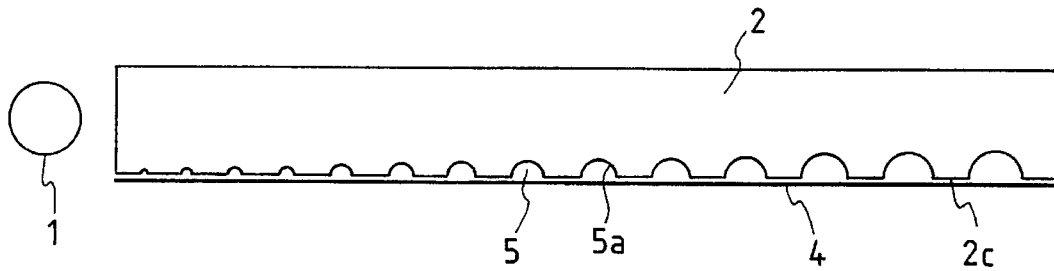

FIG. 6

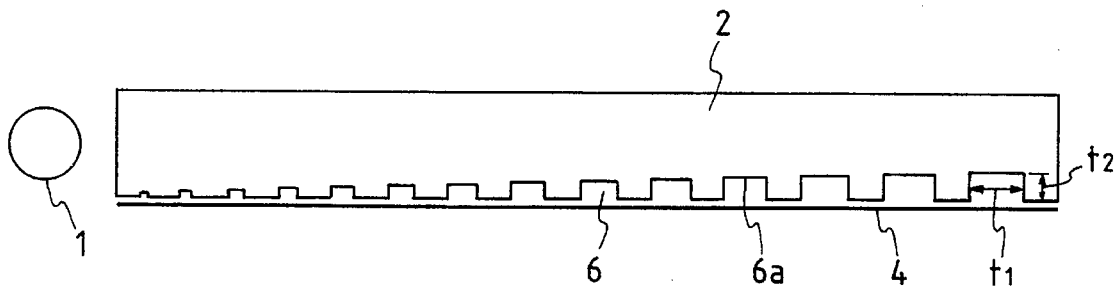

FIG. 7

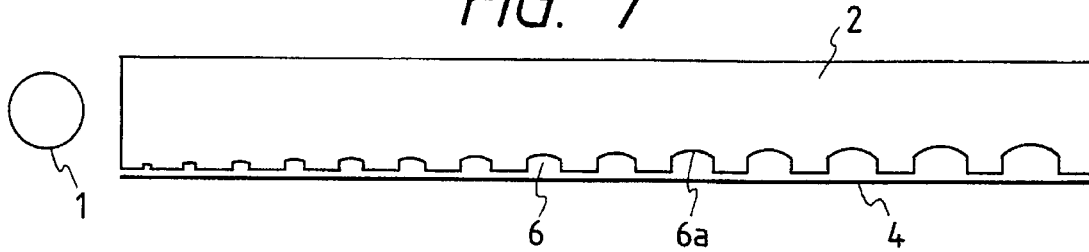

FIG. 8

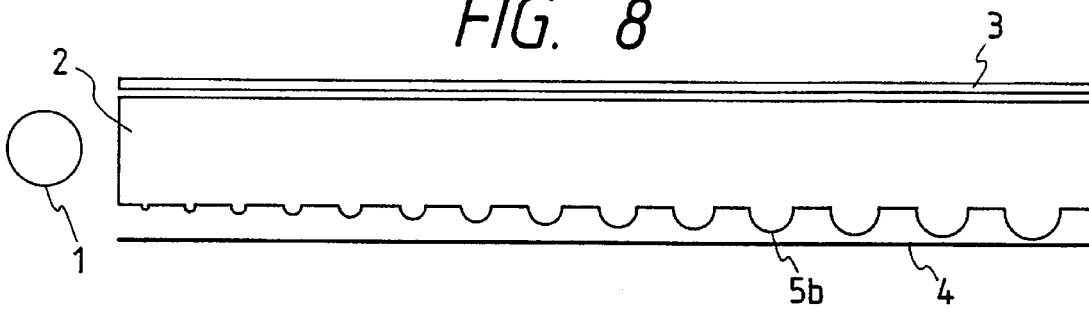

FIG. 9

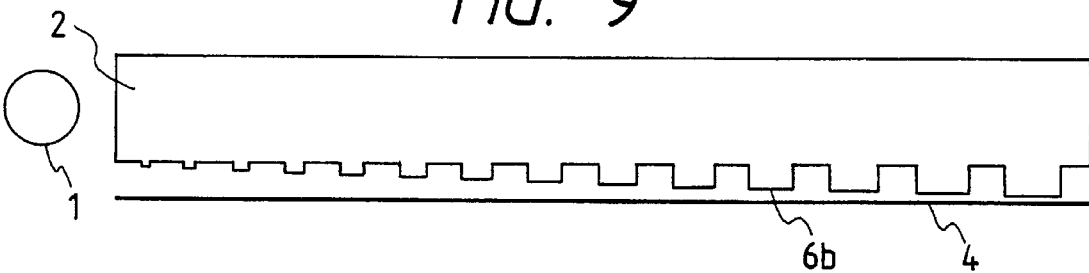

FIG. 10

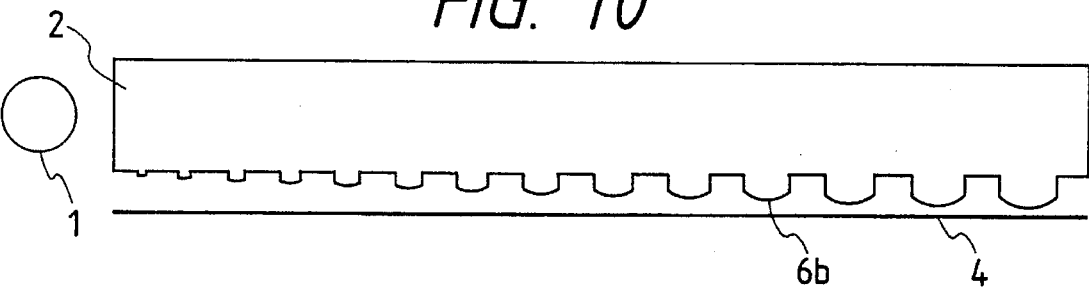

FIG. 11

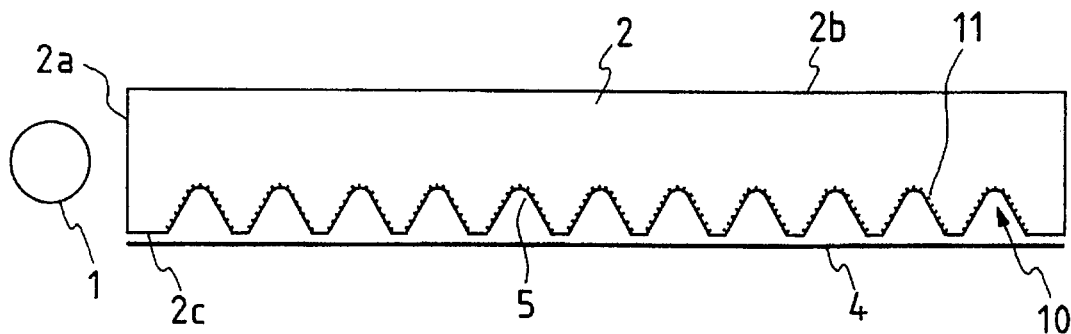

FIG. 12

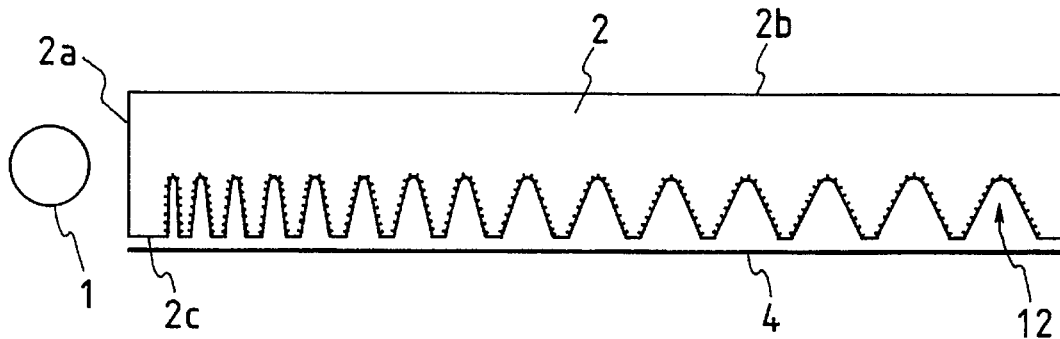
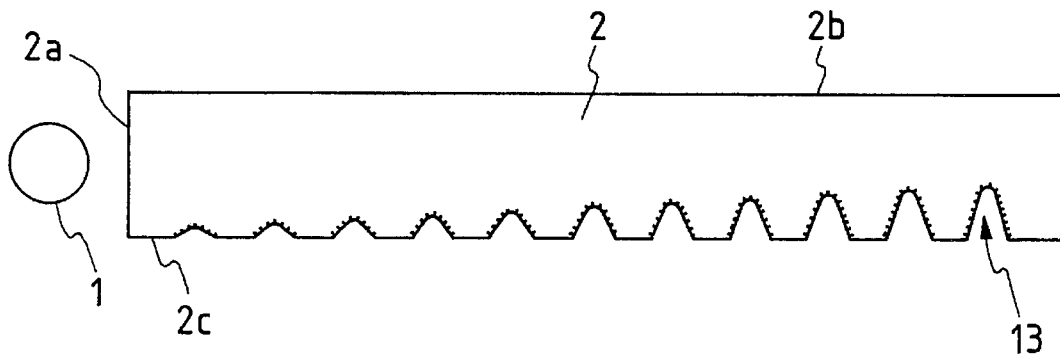

FIG. 13



Explore Litigation Insights

Docket Alarm provides insights to develop a more informed litigation strategy and the peace of mind of knowing you're on top of things.

Real-Time Litigation Alerts



Keep your litigation team up-to-date with **real-time alerts** and advanced team management tools built for the enterprise, all while greatly reducing PACER spend.

Our comprehensive service means we can handle Federal, State, and Administrative courts across the country.

Advanced Docket Research



With over 230 million records, Docket Alarm's cloud-native docket research platform finds what other services can't. Coverage includes Federal, State, plus PTAB, TTAB, ITC and NLRB decisions, all in one place.

Identify arguments that have been successful in the past with full text, pinpoint searching. Link to case law cited within any court document via Fastcase.

Analytics At Your Fingertips



Learn what happened the last time a particular judge, opposing counsel or company faced cases similar to yours.

Advanced out-of-the-box PTAB and TTAB analytics are always at your fingertips.

API

Docket Alarm offers a powerful API (application programming interface) to developers that want to integrate case filings into their apps.

LAW FIRMS

Build custom dashboards for your attorneys and clients with live data direct from the court.

Automate many repetitive legal tasks like conflict checks, document management, and marketing.

FINANCIAL INSTITUTIONS

Litigation and bankruptcy checks for companies and debtors.

E-DISCOVERY AND LEGAL VENDORS

Sync your system to PACER to automate legal marketing.