



[54] EXPANDABLE HOME AUTOMATION SYSTEM

4,665,544 5/1987 Honda et al. .... 379/104  
4,728,949 3/1988 Platte et al. .... 340/825.37

[75] Inventors: Reuel O. Launey, Arlington, Va.; Peter A. Grendler, Silver Spring, Md.; Donald L. Packham, Fort Lauderdale, Fla.; James M. Battaglia, Kettering; Howard E. Levine, Adelphi, both of Md.

Primary Examiner—Jerry Smith  
Assistant Examiner—Paul Gordon  
Attorney, Agent, or Firm—Dickstein, Shapiro & Morin

[73] Assignee: Custom Command Systems, College Park, Md.

[57] ABSTRACT

[21] Appl. No.: 304,300

A system for and a method of providing an expandable home automation controller is disclosed which supports multiple numbers and multiple different types of data communications with both appliances and subsystems within the home as well as systems external to the home. The system is based upon a central processor, such as a microprocessor-based computer, and is connected by means of a data bus to control the various products and subsystems within a home or commercial building, such as lighting systems, security systems, various sensors, multiple external terminals, as well as to allow for the input of commands by a variety of means such as touchscreens, voice recognition systems, telephones, custom switches or any device capable of providing an input to a computer system. The system functions can be readily controlled by the user utilizing a high resolution graphics display and associated touch-screen interface.

[22] Filed: Jan. 31, 1989

[51] Int. Cl.<sup>5</sup> ..... G05B 15/02

[52] U.S. Cl. .... 364/188; 364/189; 340/825.37; 379/102

[58] Field of Search ..... 364/200, 900, 188, 189, 364/513.5; 379/102, 104, 79; 340/825.37, 825.69; 219/10.55 B, 506; 319/46, 47, 97, 98

[56] References Cited

U.S. PATENT DOCUMENTS

4,503,288	3/1985	Kessler	179/2 DP
4,513,189	4/1989	Ueda et al.	219/10.55 B
4,520,576	6/1985	Vander Molen	34/45
4,521,645	6/1985	Carroll	379/98
4,663,775	5/1987	Olek	379/24

20 Claims, 45 Drawing Sheets

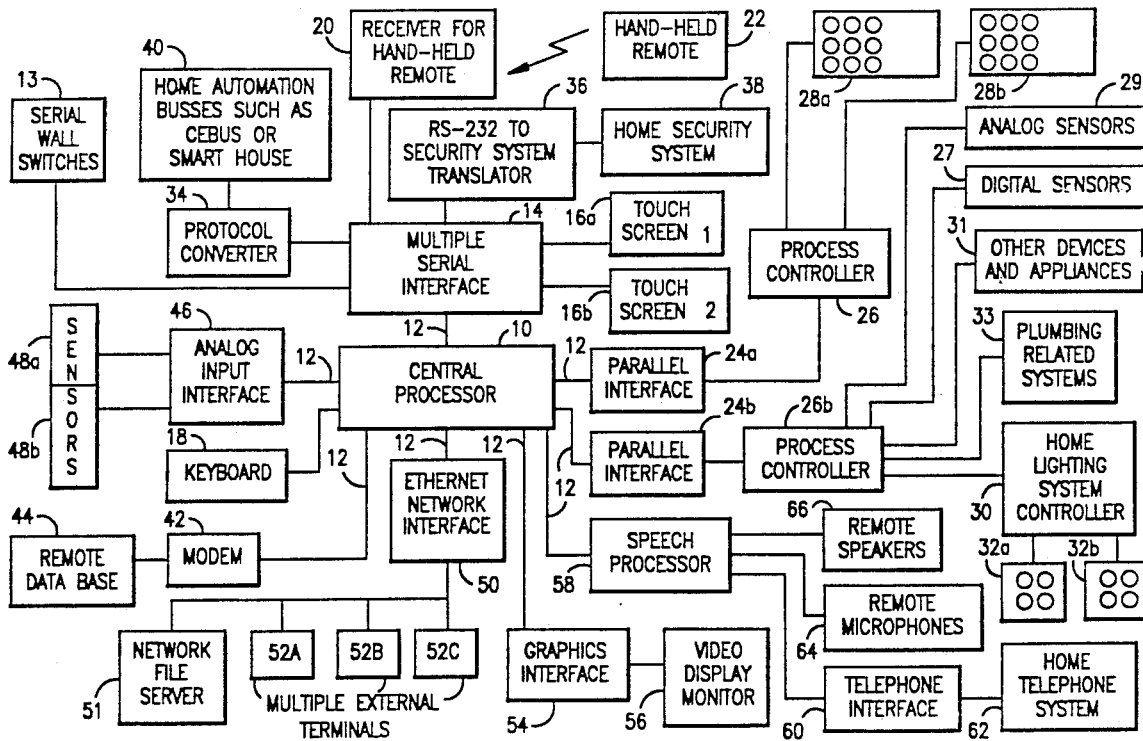

FIG. 1

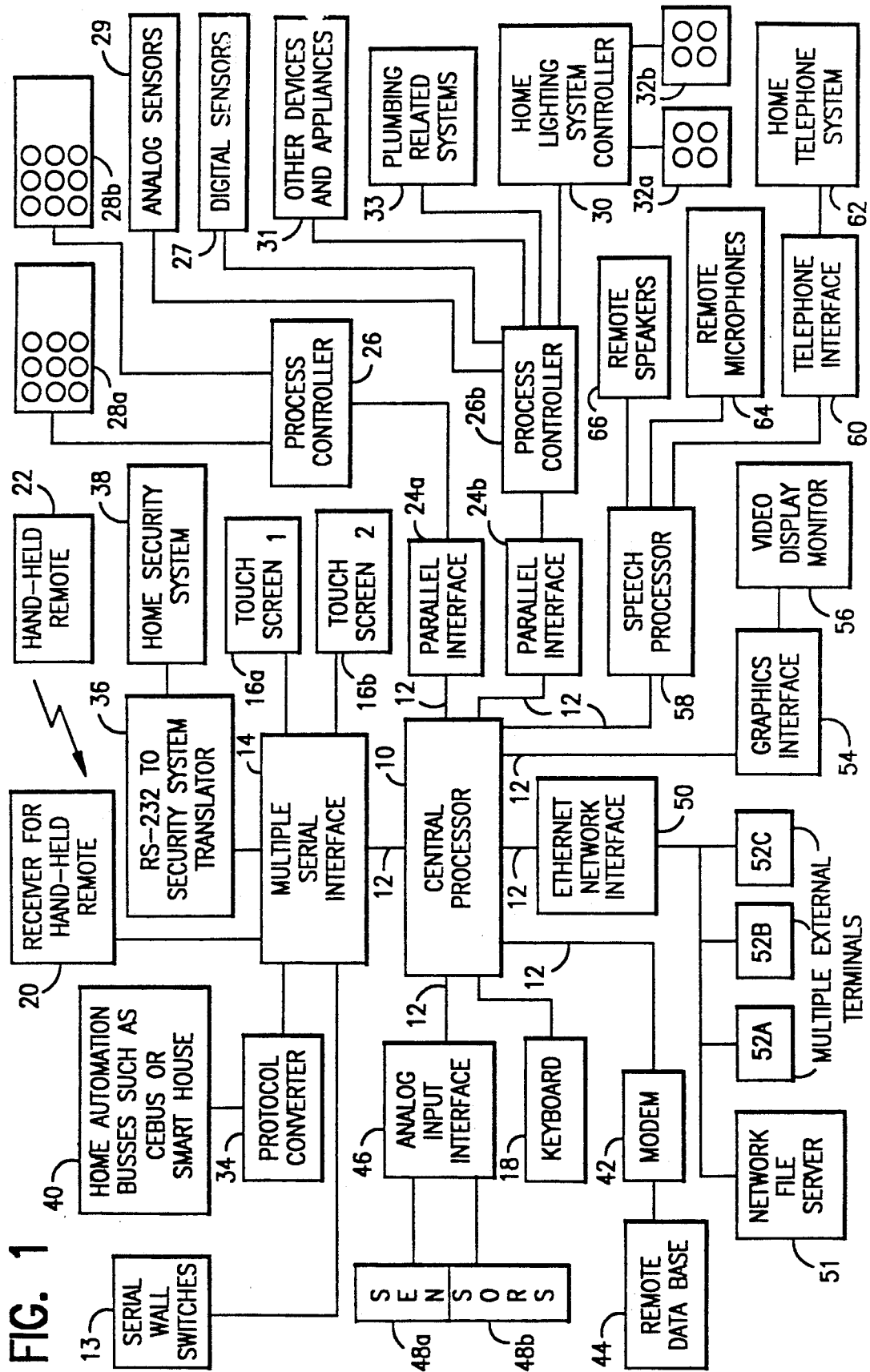
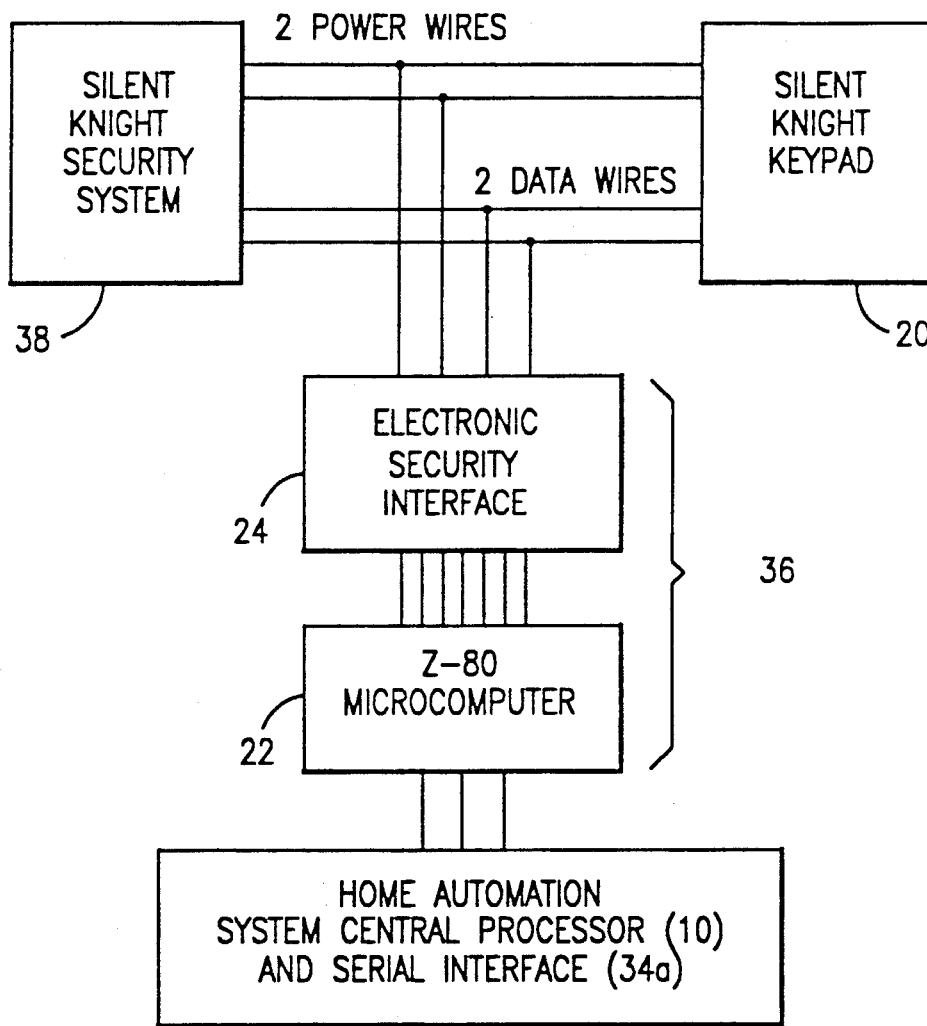

FIG. 2



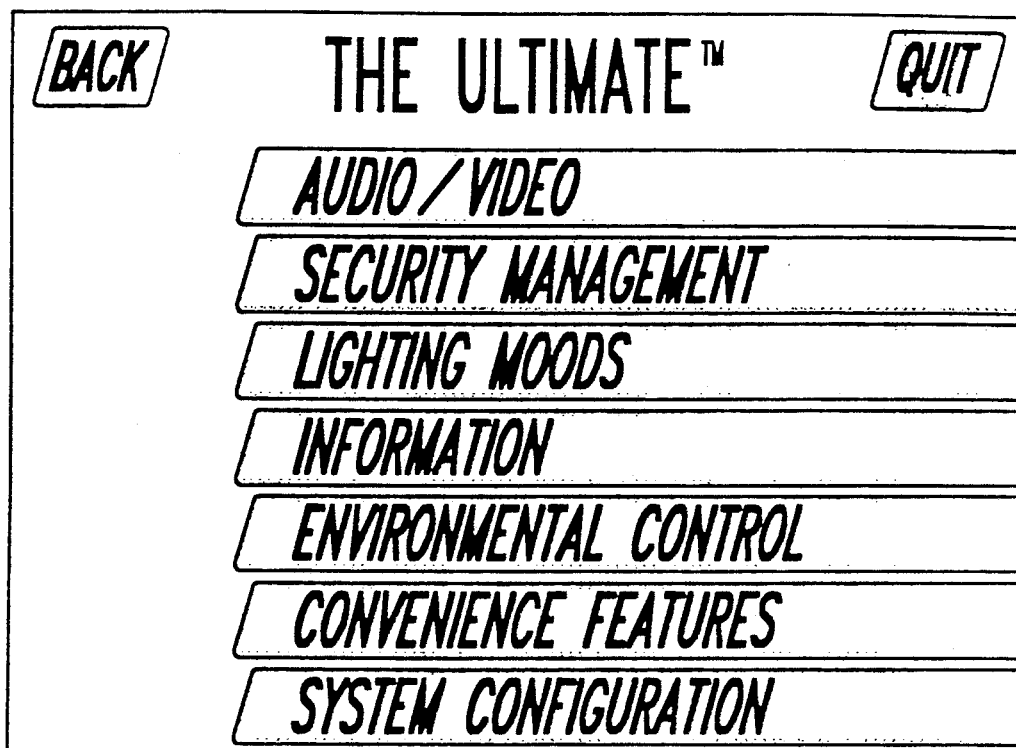

FIG. 3A

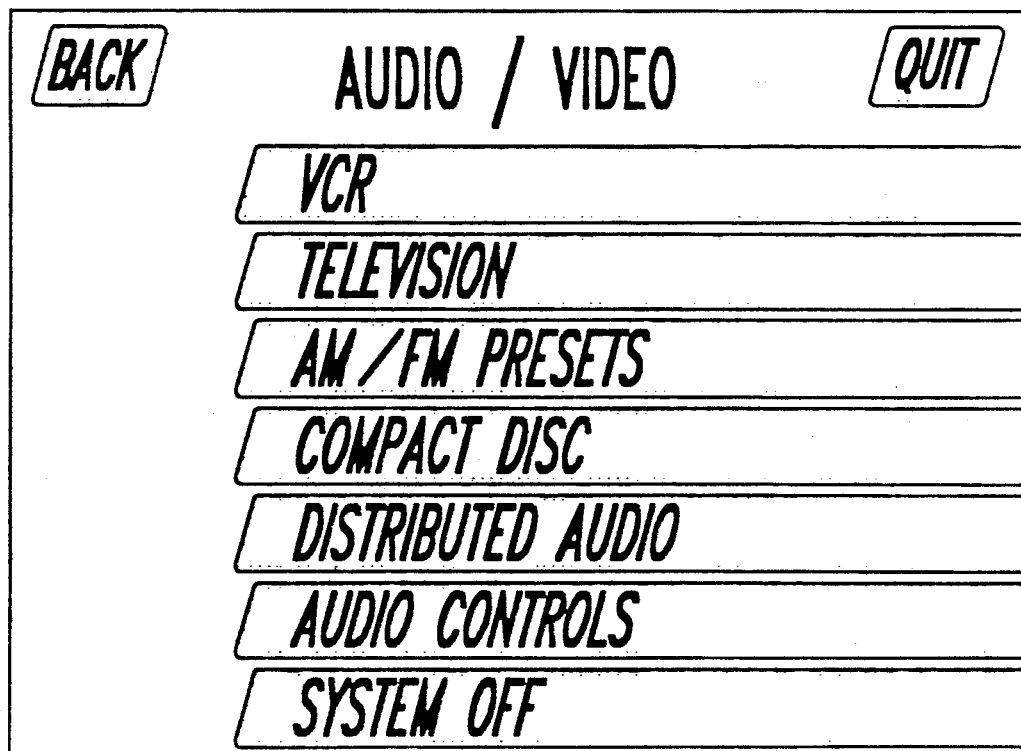

FIG. 3B

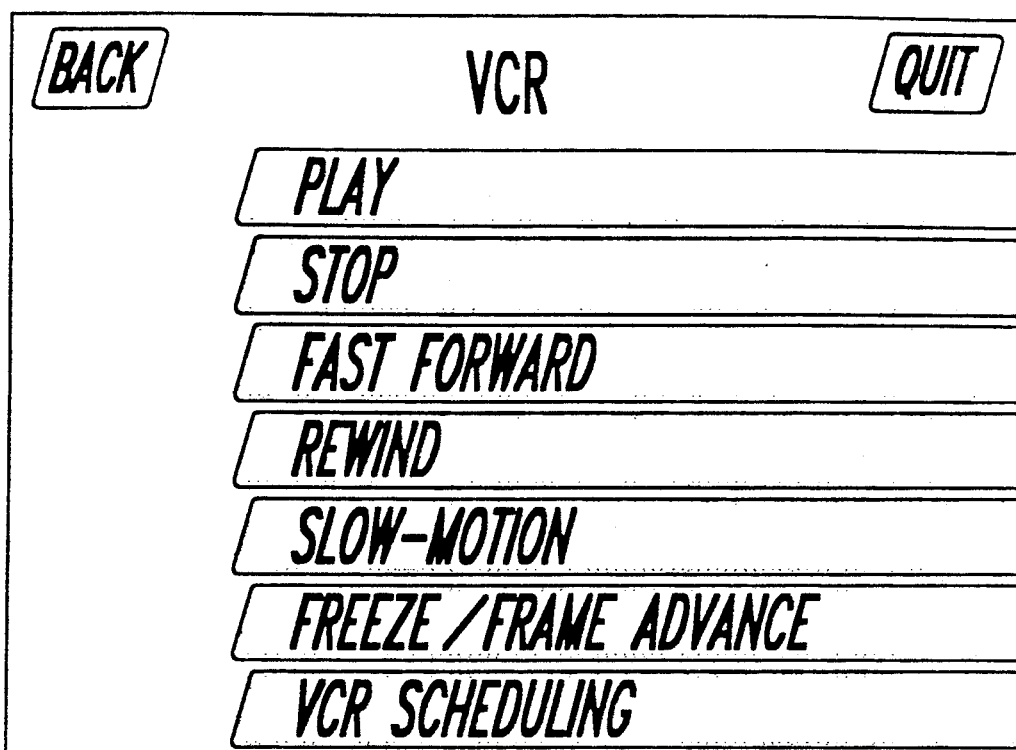

FIG. 3C

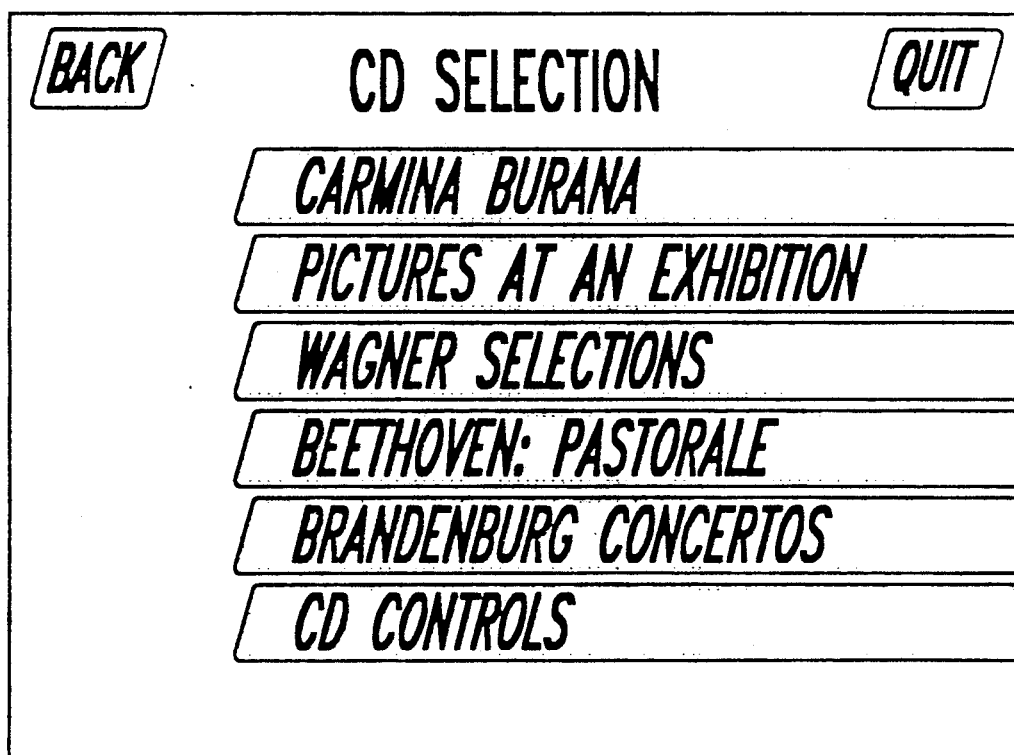

FIG. 3D

# Explore Litigation Insights

Docket Alarm provides insights to develop a more informed litigation strategy and the peace of mind of knowing you're on top of things.

## Real-Time Litigation Alerts



Keep your litigation team up-to-date with **real-time alerts** and advanced team management tools built for the enterprise, all while greatly reducing PACER spend.

Our comprehensive service means we can handle Federal, State, and Administrative courts across the country.

## Advanced Docket Research



With over 230 million records, Docket Alarm's cloud-native docket research platform finds what other services can't. Coverage includes Federal, State, plus PTAB, TTAB, ITC and NLRB decisions, all in one place.

Identify arguments that have been successful in the past with full text, pinpoint searching. Link to case law cited within any court document via Fastcase.

## Analytics At Your Fingertips



Learn what happened the last time a particular judge, opposing counsel or company faced cases similar to yours.

Advanced out-of-the-box PTAB and TTAB analytics are always at your fingertips.

## API

Docket Alarm offers a powerful API (application programming interface) to developers that want to integrate case filings into their apps.

## LAW FIRMS

Build custom dashboards for your attorneys and clients with live data direct from the court.

Automate many repetitive legal tasks like conflict checks, document management, and marketing.

## FINANCIAL INSTITUTIONS

Litigation and bankruptcy checks for companies and debtors.

## E-DISCOVERY AND LEGAL VENDORS

Sync your system to PACER to automate legal marketing.