



US005461372A

United States Patent [19]

[11] Patent Number: **5,461,372**

Busak et al.

[45] Date of Patent: **Oct. 24, 1995**

[54] **SYSTEM AND METHOD FOR MODIFYING SECURITY IN A SECURITY SYSTEM**

4,287,939	9/1981	Pohl et al.	340/825.22
4,639,610	8/1987	Dietrich	340/515
4,755,792	7/1988	Pezzolo et al.	340/531
4,772,876	9/1988	Laud	340/531
4,808,995	2/1989	Clark et al.	340/825.32
4,931,769	9/1990	Phillips et al.	340/541

[75] Inventors: **Steven J. Busak**, Laguna Niguel; **Allen F. V. Buskirk**, Fountain Valley; **Mark R. Walther**, Laguna Hills, all of Calif.

[73] Assignee: **Honeywell Inc.**, Minneapolis, Minn.

FOREIGN PATENT DOCUMENTS

2150333 6/1985 United Kingdom .

[21] Appl. No.: **6,223**

Primary Examiner—Michael Horabik
Attorney, Agent, or Firm—Robert B. Leonard

[22] Filed: **Jan. 19, 1993**

[51] Int. Cl.⁶ **G09B 13/00**

[52] U.S. Cl. **340/825.31; 340/825.32; 379/95; 379/103**

[58] Field of Search 340/825.31, 825.32, 340/825.22, 825.37, 541, 531, 825.36, 506, 533, 538, 532, 542; 379/95, 103, 37, 39, 42

[57] ABSTRACT

A system and method for modifying security levels within a security system. External modifications are allowed only if the security of a point is increased.

[56] References Cited

U.S. PATENT DOCUMENTS

3,925,763 12/1975 Wadhvani et al. 340/825.36

7 Claims, 10 Drawing Sheets

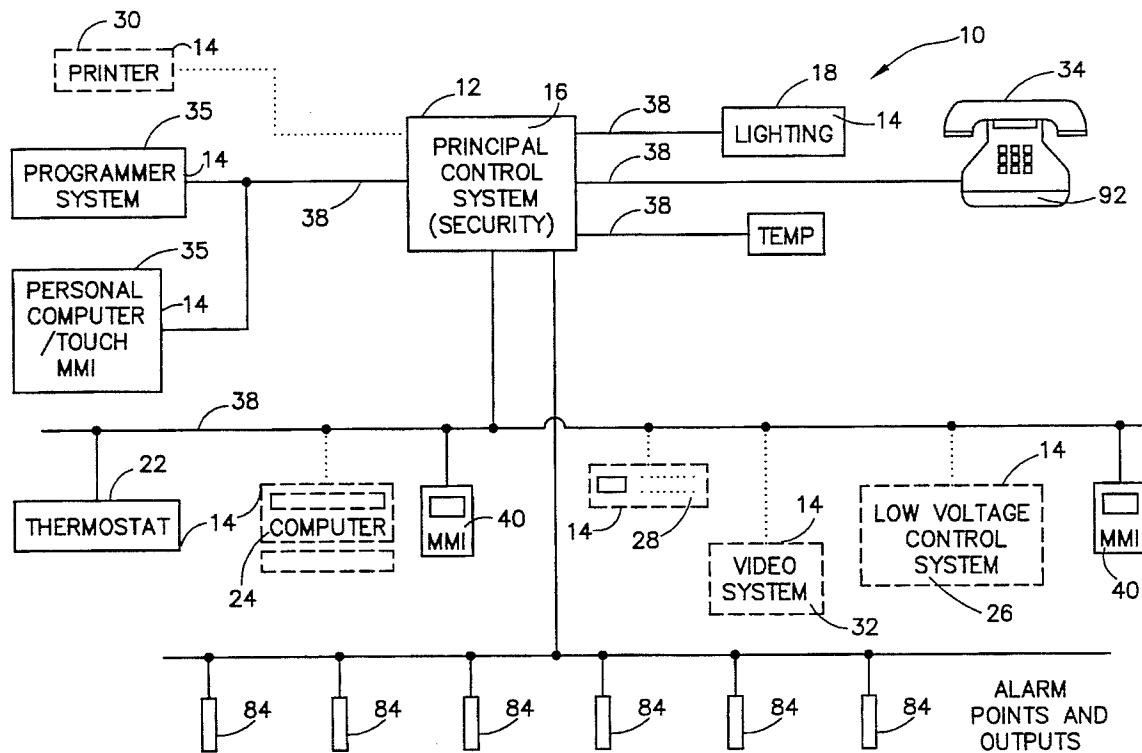

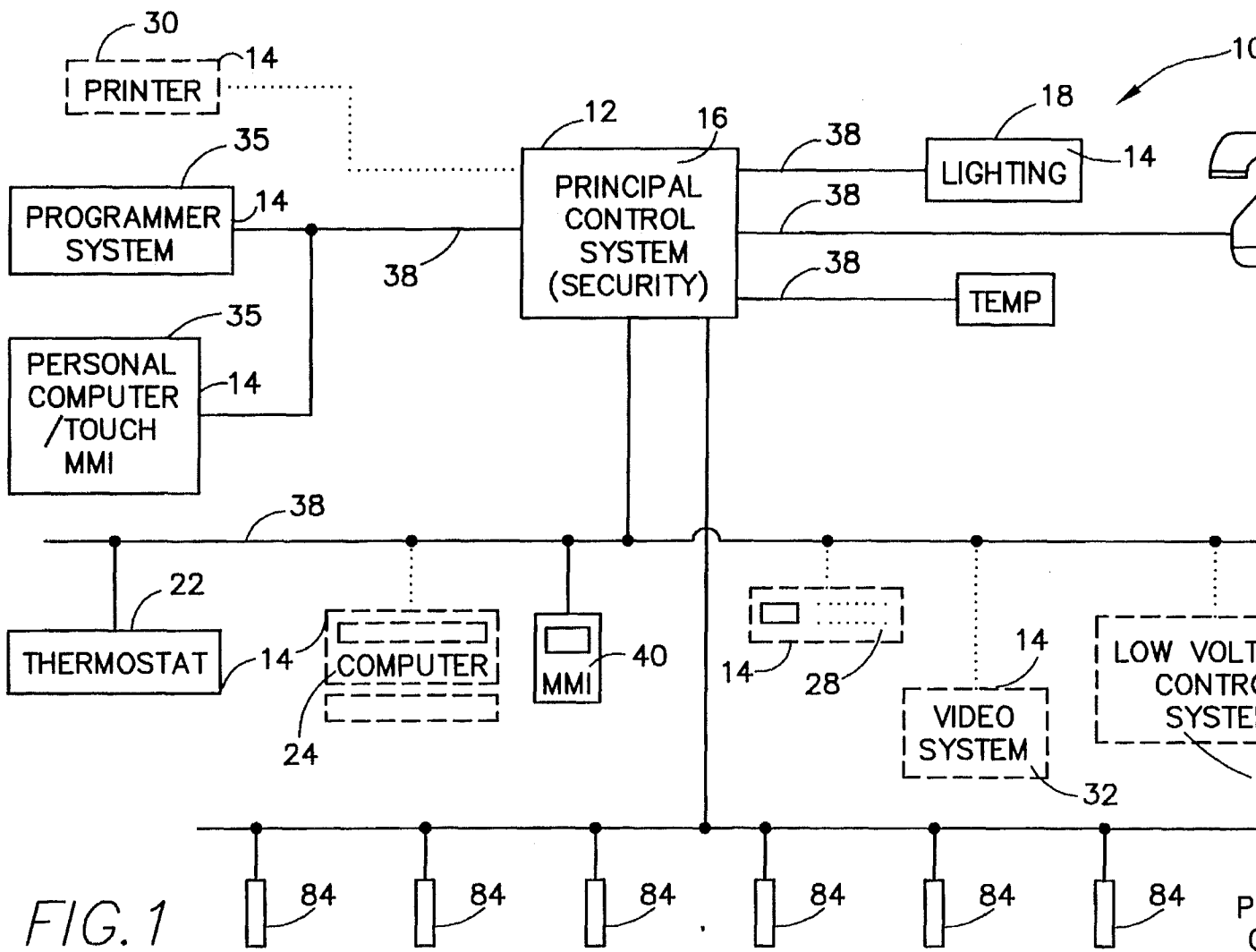

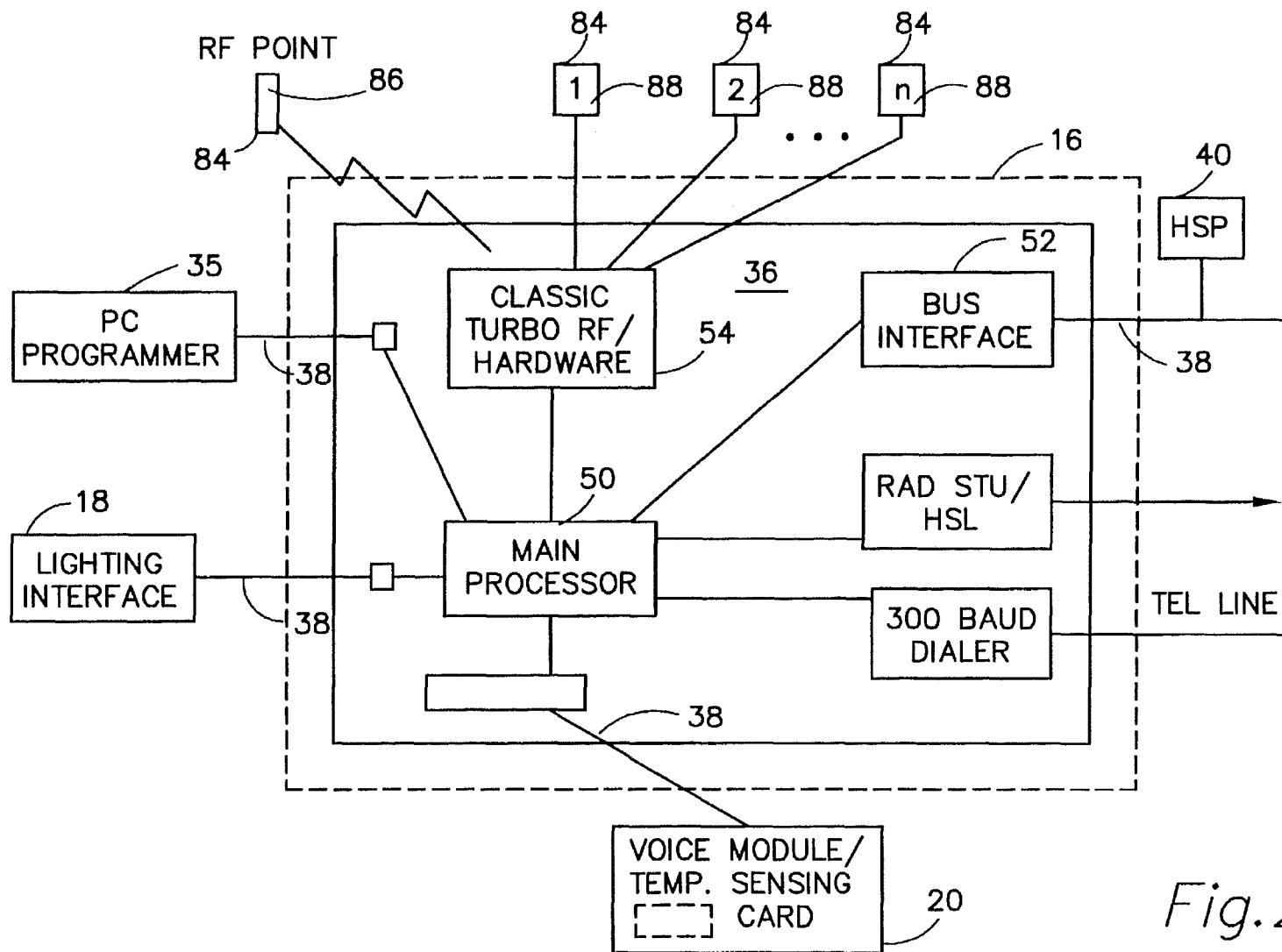

Fig. 2

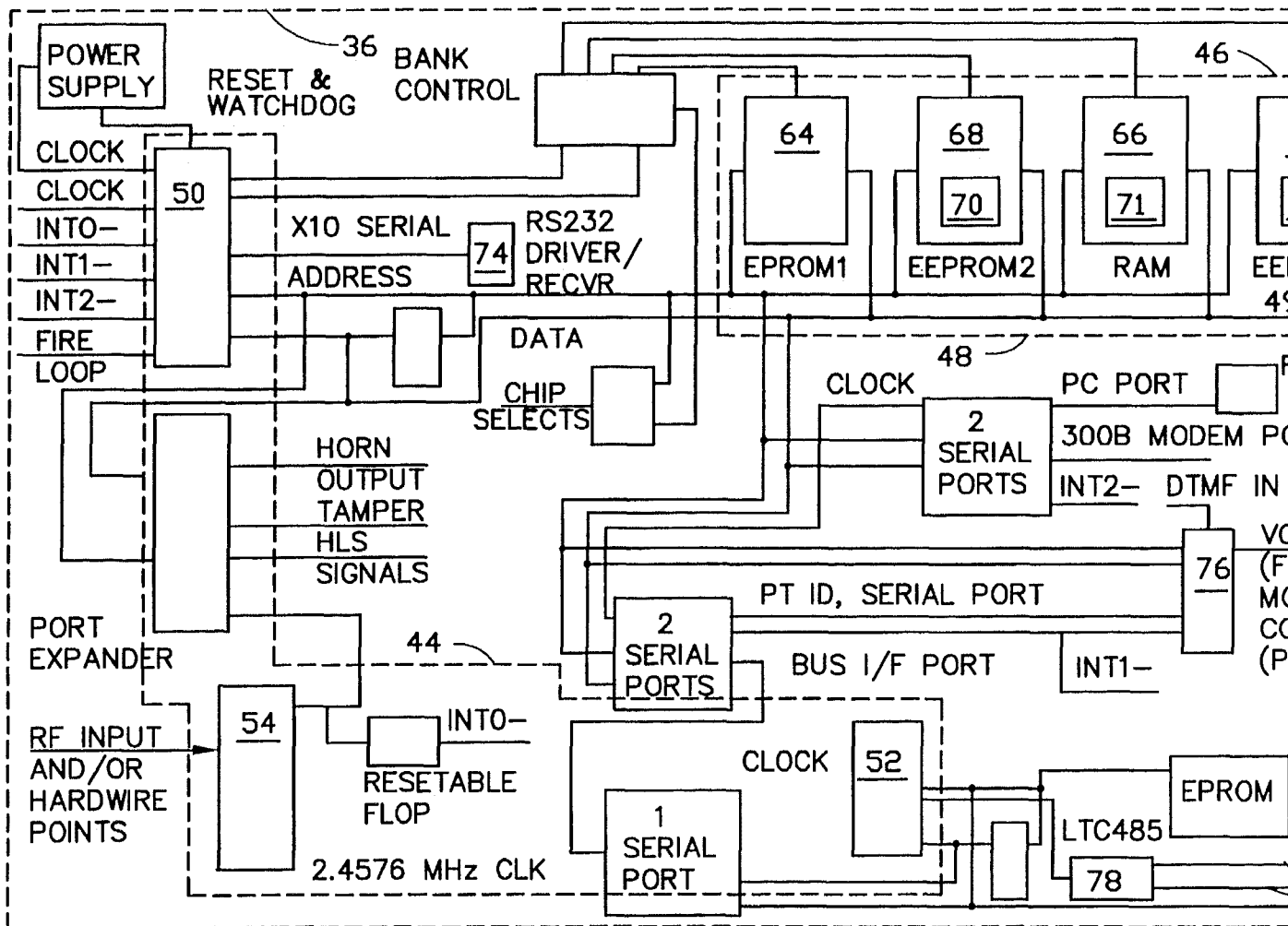

Fig. 3a

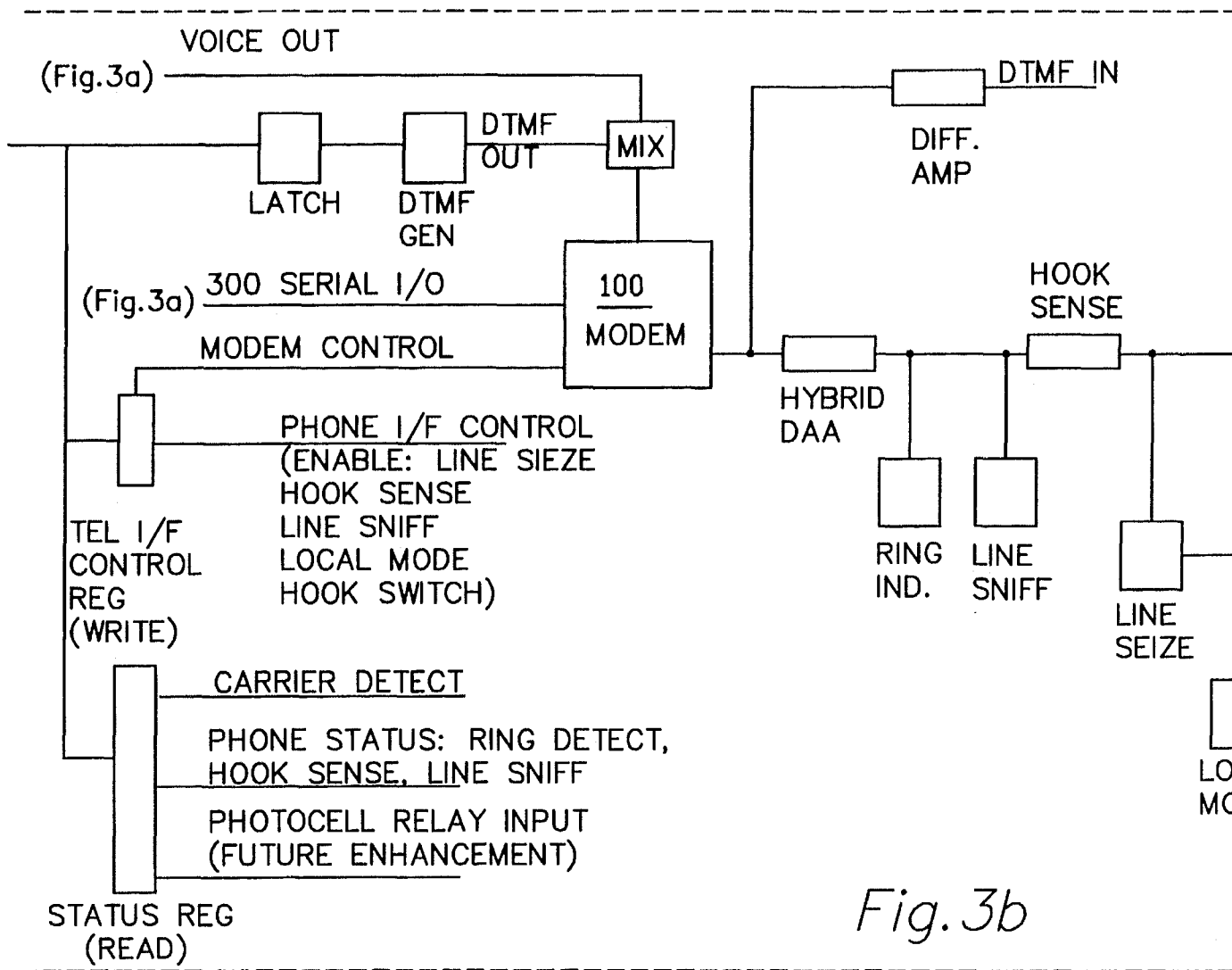

Fig. 3b

Explore Litigation Insights

Docket Alarm provides insights to develop a more informed litigation strategy and the peace of mind of knowing you're on top of things.

Real-Time Litigation Alerts



Keep your litigation team up-to-date with **real-time alerts** and advanced team management tools built for the enterprise, all while greatly reducing PACER spend.

Our comprehensive service means we can handle Federal, State, and Administrative courts across the country.

Advanced Docket Research



With over 230 million records, Docket Alarm's cloud-native docket research platform finds what other services can't. Coverage includes Federal, State, plus PTAB, TTAB, ITC and NLRB decisions, all in one place.

Identify arguments that have been successful in the past with full text, pinpoint searching. Link to case law cited within any court document via Fastcase.

Analytics At Your Fingertips



Learn what happened the last time a particular judge, opposing counsel or company faced cases similar to yours.

Advanced out-of-the-box PTAB and TTAB analytics are always at your fingertips.

API

Docket Alarm offers a powerful API (application programming interface) to developers that want to integrate case filings into their apps.

LAW FIRMS

Build custom dashboards for your attorneys and clients with live data direct from the court.

Automate many repetitive legal tasks like conflict checks, document management, and marketing.

FINANCIAL INSTITUTIONS

Litigation and bankruptcy checks for companies and debtors.

E-DISCOVERY AND LEGAL VENDORS

Sync your system to PACER to automate legal marketing.