



US006563769B1

(12) **United States Patent**
Van Der Meulen

(10) **Patent No.:** **US 6,563,769 B1**
(45) **Date of Patent:** **May 13, 2003**

(54) **VIRTUAL JUKEBOX**

(75) Inventor: **Pieter Van Der Meulen**, Sunnyvale, CA (US)

(73) Assignee: **Koninklijke Philips Electronics N.V.**, Eindhoven (NL)

(*) Notice: Subject to any disclaimer, the term of this patent is extended or adjusted under 35 U.S.C. 154(b) by 0 days.

(21) Appl. No.: **09/326,506**

(22) Filed: **Jun. 4, 1999**

Related U.S. Application Data

(60) Provisional application No. 60/088,912, filed on Jun. 11, 1998, and provisional application No. 60/093,656, filed on Jul. 22, 1998.

(51) **Int. Cl.**⁷ **G11B 17/22**

(52) **U.S. Cl.** **369/30.06; 707/104.1**

(58) **Field of Search** 369/30.06, 30.28, 369/34.01, 30.2, 30.29, 30.3, 30.23, 30.09, 30.08, 30.26, 30.64; 700/234; 707/104.1; 710/17, 39; 709/217

(56) **References Cited**

U.S. PATENT DOCUMENTS

5,530,899 A	6/1996	MacDonald	395/837
5,616,876 A	4/1997	Cluts	84/609
5,924,275 A *	7/1999	Cohen et al.	
5,930,768 A *	7/1999	Hooban	

6,011,758 A *	1/2000	Dockes et al.
6,128,625 A *	10/2000	Yankowski
6,175,537 B1 *	1/2001	Fleming, III
6,226,235 B1 *	5/2001	Wehmeyer
6,243,328 B1 *	6/2001	Fenner et al.
6,421,305 B1 *	7/2002	Gioscia et al.
6,430,117 B2 *	8/2002	Zimmer

* cited by examiner

Primary Examiner—Ali Neyzari

(74) *Attorney, Agent, or Firm*—Jeroen Heuvelman

(57) **ABSTRACT**

A collection management system, or virtual jukebox, is provided for a collection of recordings that is independent of the physical media upon which the material is recorded. The system forms a part of a network that includes storage media and playback devices, and provides an easy to use system for collection cataloging, archiving, and retrieval. In a preferred embodiment, a collection management system resides on a consumer electronic (CE) device, or a personal or home computer (PC), and the collection includes recordings that are stored on one or more hard drives associated with the CE device or the PC. The collection management system includes a user interface that facilitates the retrieval of recordings for playback from one or more storage devices, based on an individual selection of genre, author, and so on. By storing the recordings on a hard disc drive or other mass storage device with an associated disk operating system, immediate access is available to each recording on the drive, and additional drives can be added to the system as new material is added to the collection.

11 Claims, 5 Drawing Sheets

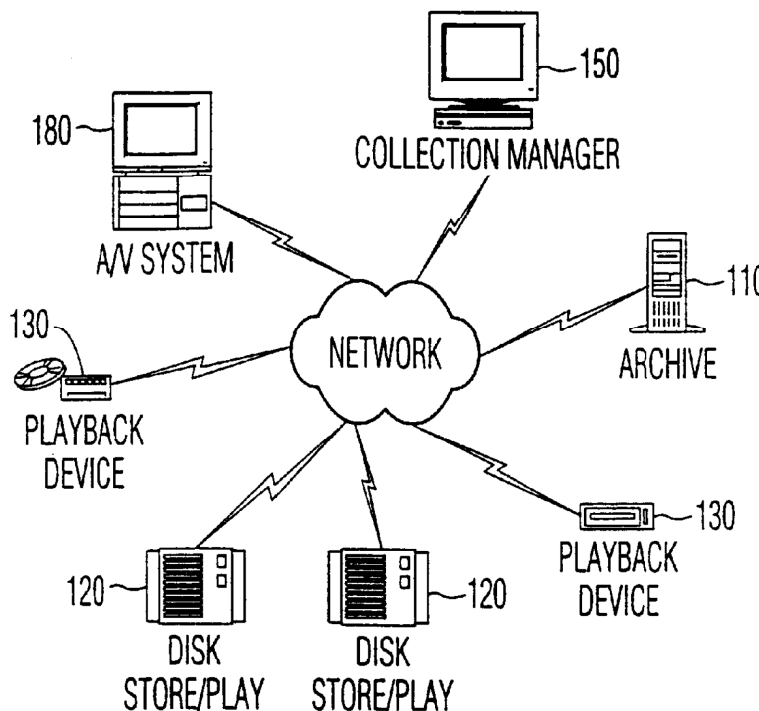

FIG. 1

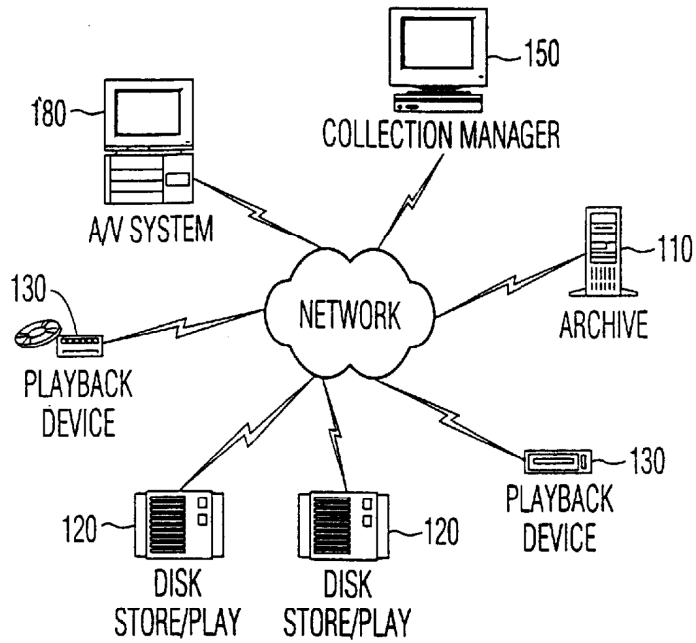
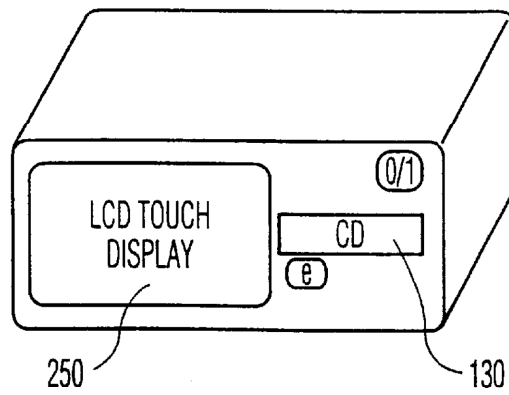
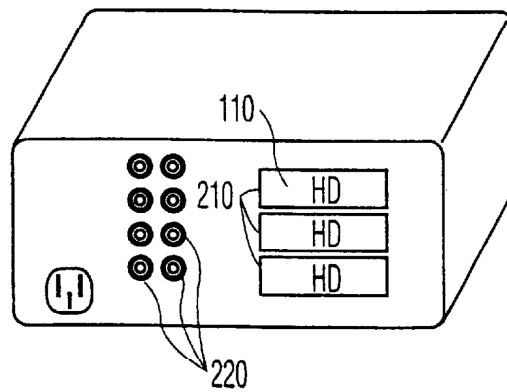

FIG. 2A



200

FIG. 2B



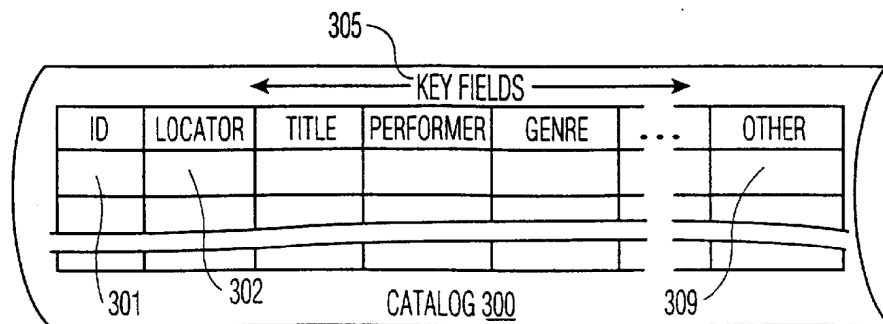

FIG. 3

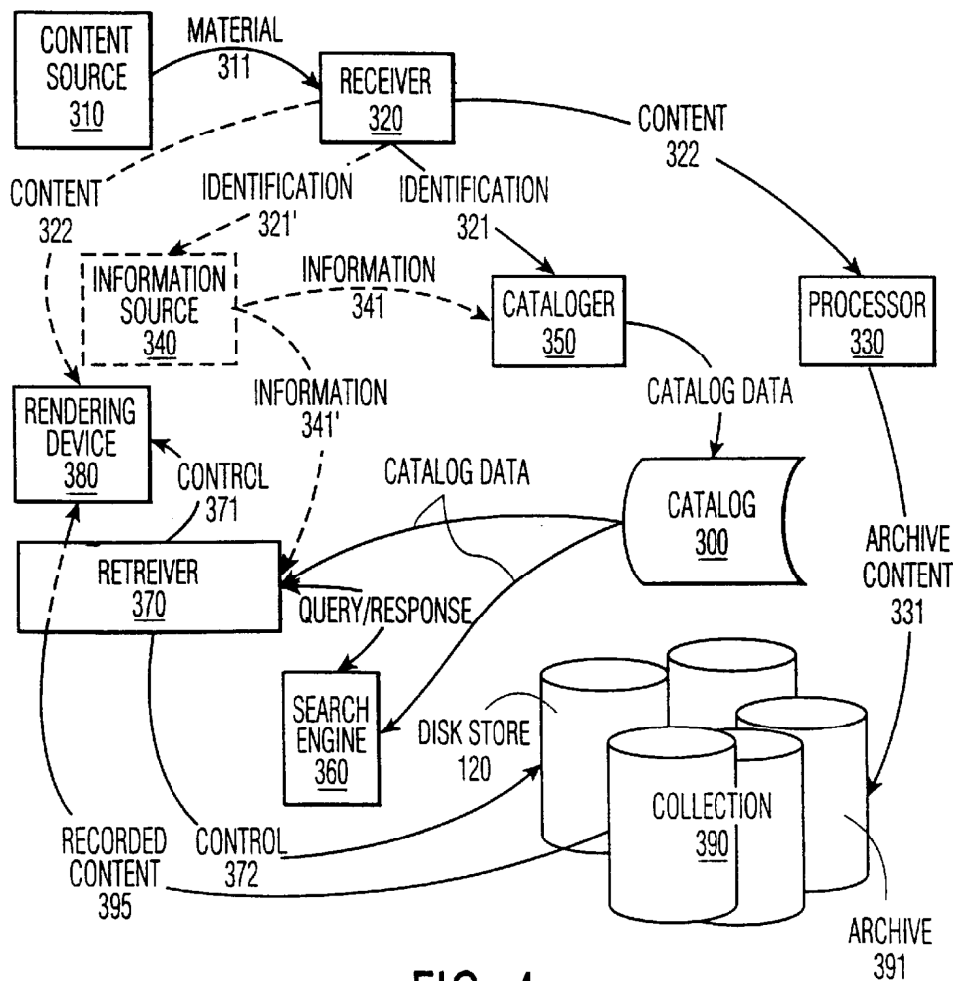

FIG. 4

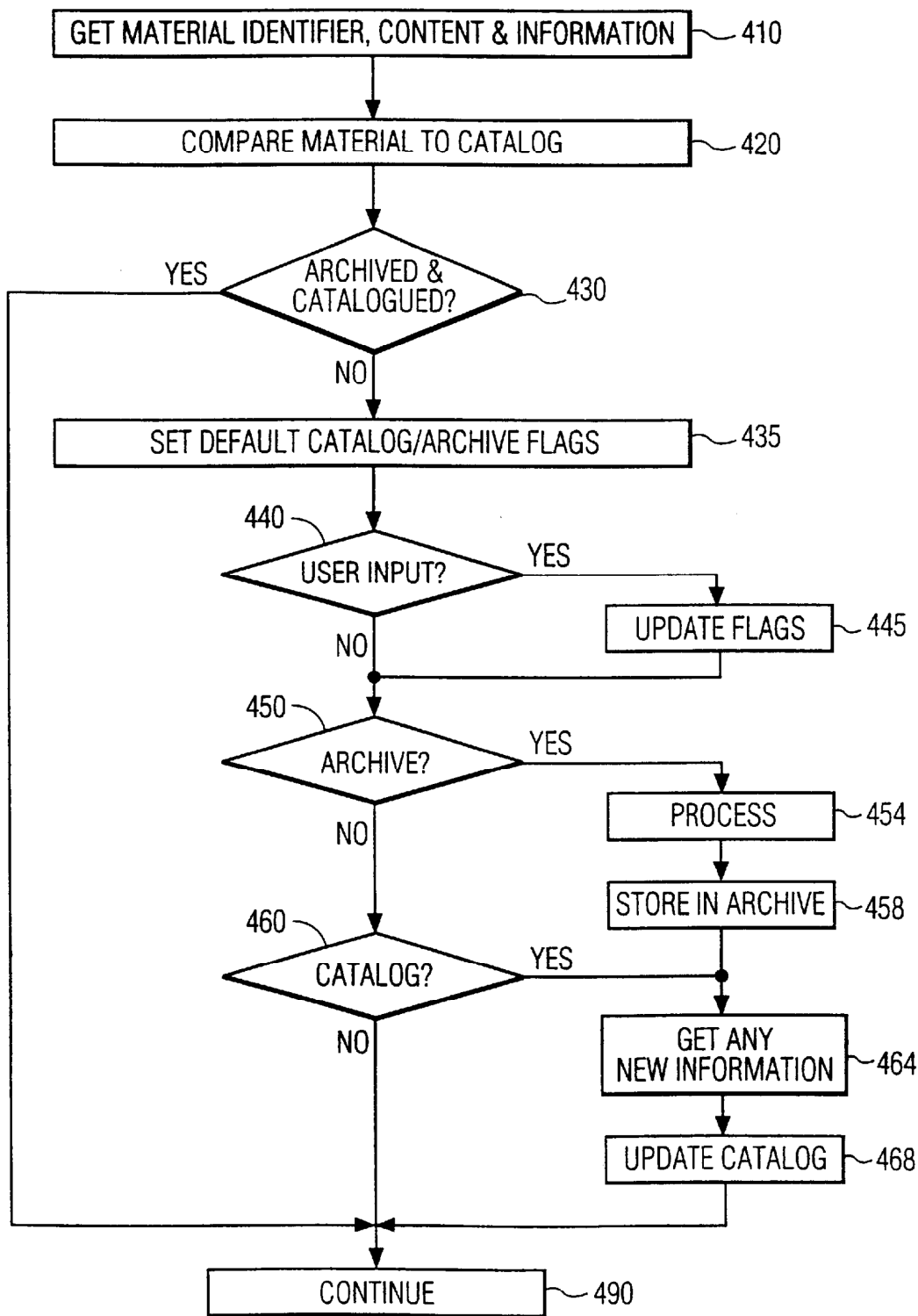

FIG. 5

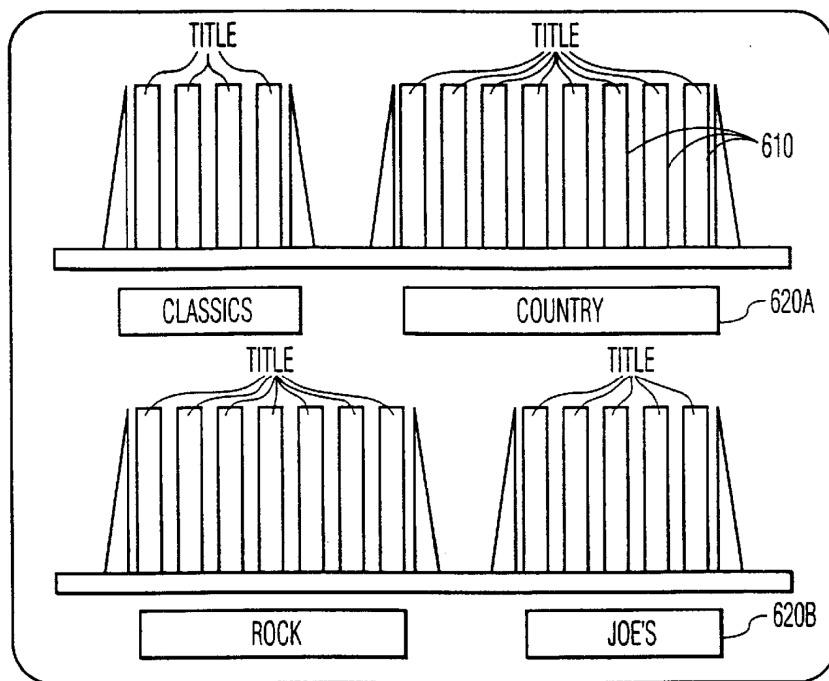

FIG. 6A

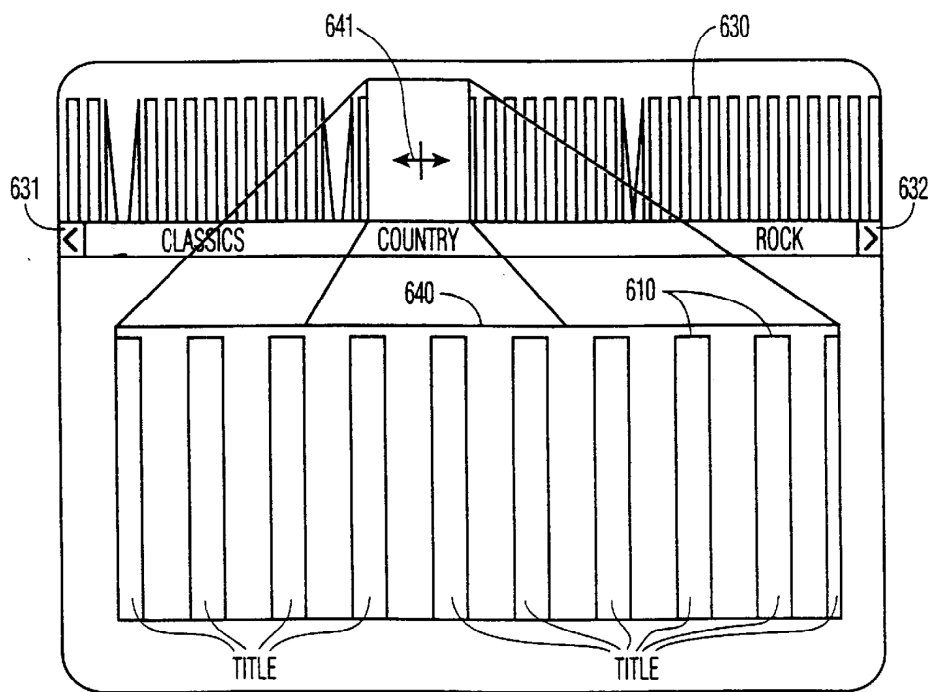

FIG. 6B

Explore Litigation Insights

Docket Alarm provides insights to develop a more informed litigation strategy and the peace of mind of knowing you're on top of things.

Real-Time Litigation Alerts



Keep your litigation team up-to-date with **real-time alerts** and advanced team management tools built for the enterprise, all while greatly reducing PACER spend.

Our comprehensive service means we can handle Federal, State, and Administrative courts across the country.

Advanced Docket Research



With over 230 million records, Docket Alarm's cloud-native docket research platform finds what other services can't. Coverage includes Federal, State, plus PTAB, TTAB, ITC and NLRB decisions, all in one place.

Identify arguments that have been successful in the past with full text, pinpoint searching. Link to case law cited within any court document via Fastcase.

Analytics At Your Fingertips



Learn what happened the last time a particular judge, opposing counsel or company faced cases similar to yours.

Advanced out-of-the-box PTAB and TTAB analytics are always at your fingertips.

API

Docket Alarm offers a powerful API (application programming interface) to developers that want to integrate case filings into their apps.

LAW FIRMS

Build custom dashboards for your attorneys and clients with live data direct from the court.

Automate many repetitive legal tasks like conflict checks, document management, and marketing.

FINANCIAL INSTITUTIONS

Litigation and bankruptcy checks for companies and debtors.

E-DISCOVERY AND LEGAL VENDORS

Sync your system to PACER to automate legal marketing.