

[54] COLOR IMAGE PICK-UP APPARATUS

[75] Inventors: Itsuzo Sato, Chigasaki; Kazushige Ooi, Sagamihara; Kikuo Saito, Yokohama; Yasuo Takemura, Tokyo; Toshihiro Shinohara, Yokohama, all of Japan

[73] Assignee: Tokyo Shibaura Denki Kabushiki Kaisha, Kanagawa, Japan

[21] Appl. No.: 301,440

[22] Filed: Sep. 11, 1981

[30] Foreign Application Priority Data

Oct. 7, 1980 [JP] Japan 55-139369

[51] Int. Cl.³ H04N 9/04

[52] U.S. Cl. 358/44

[58] Field of Search 358/41, 37, 40, 44

[56] References Cited

U.S. PATENT DOCUMENTS

4,339,771 7/1982 Morishita et al. 358/44 X

FOREIGN PATENT DOCUMENTS

54-116837 9/1979 Japan 358/44

OTHER PUBLICATIONS

I.E.E.E. Transactions on Electron Devices vol. ED-25, No. 2, Feb. 1978.

Primary Examiner—Robert L. Richardson
Attorney, Agent, or Firm—Cushman, Darby & Cushman

[57] ABSTRACT

A color image pick-up apparatus using a single planar array of solid state light-sensitive elements with a color mosaic filter. The color mosaic filter is made up of three types of elements occurring in repeating patterns which are such that luminance-type elements occur at every other element portion along both of two orthogonal direction. The signal corresponding to luminance is separated from the output signal of the solid state light-sensitive elements and delayed for one horizontal scanning period. The high frequency component of the delayed signal is extracted. The extracted high frequency component signal is added to the signal corresponding to luminance which is succeeding produced from the solid state light-sensitive elements.

9 Claims, 13 Drawing Figures

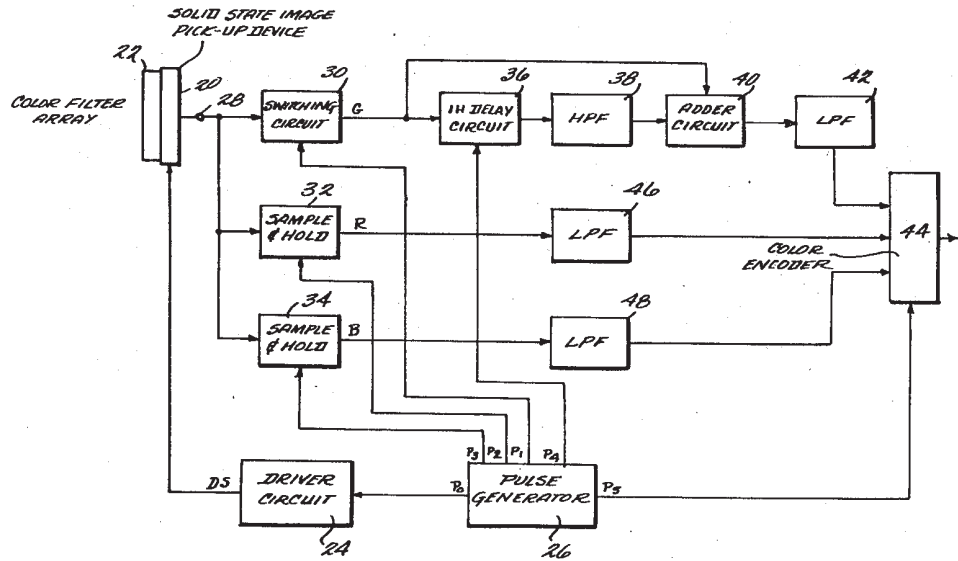

VALEO EXHIBIT 1018
Valeo v. Magna
IPR2015-_____

FIG. 1

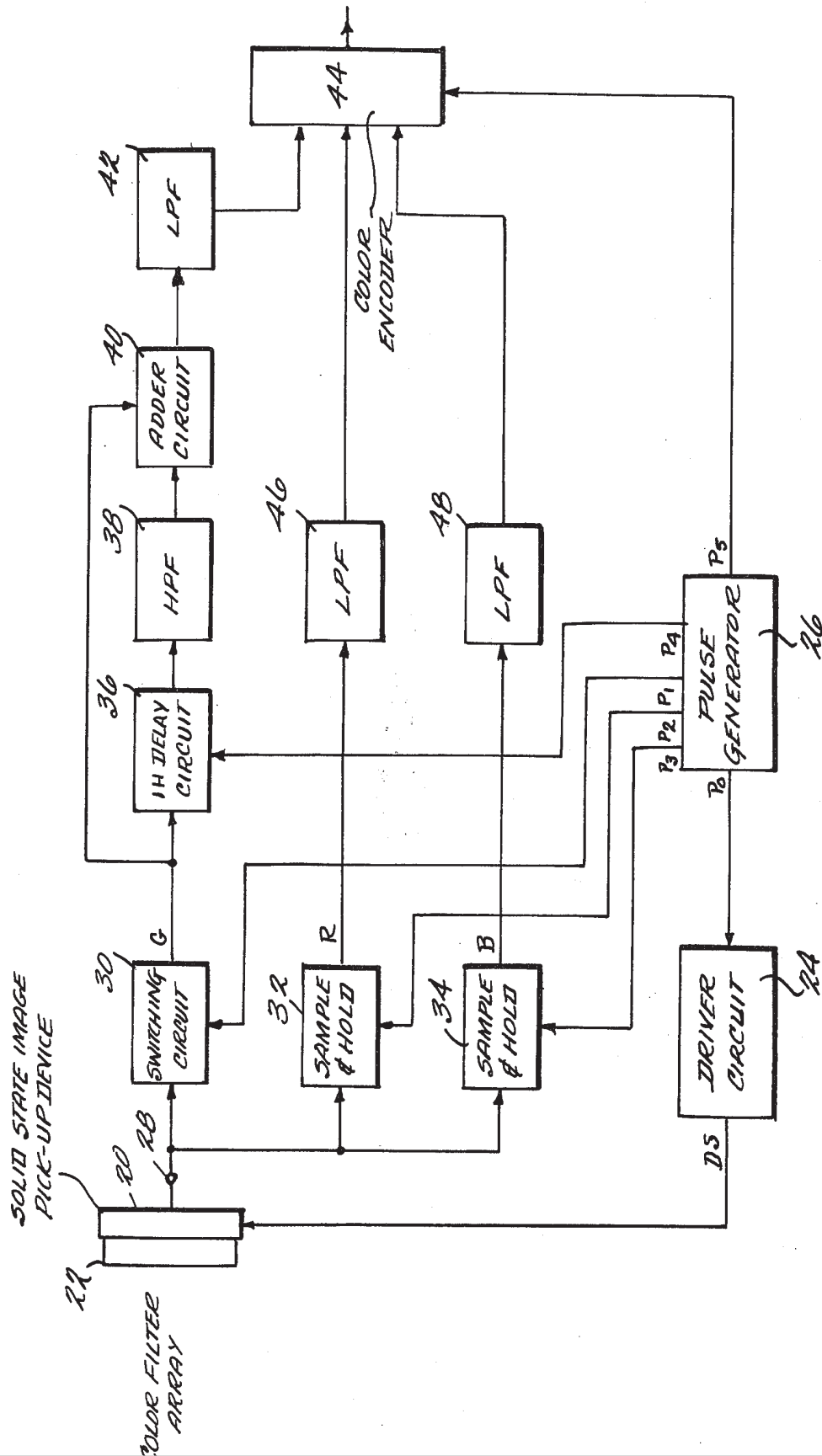

FIG. 2

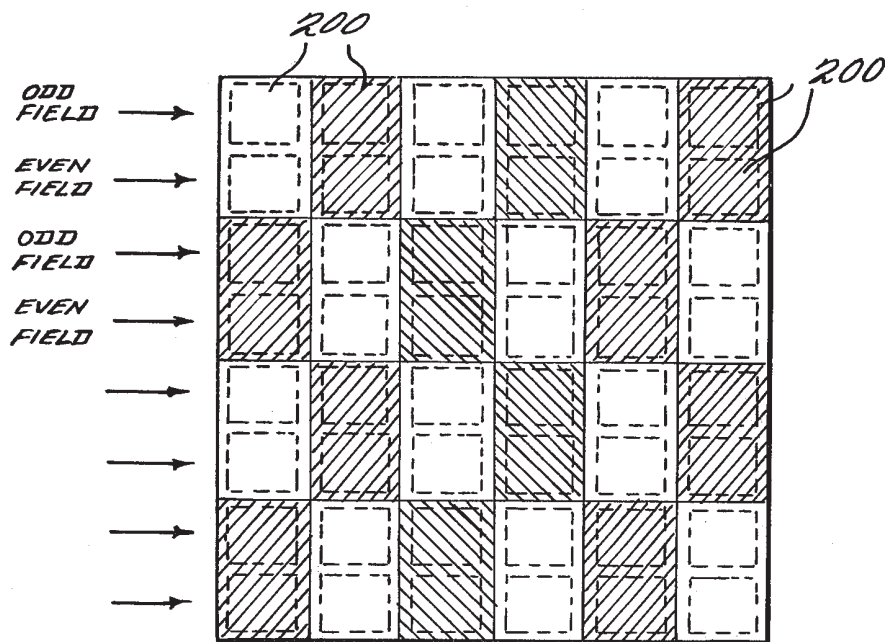

FIG. 3A

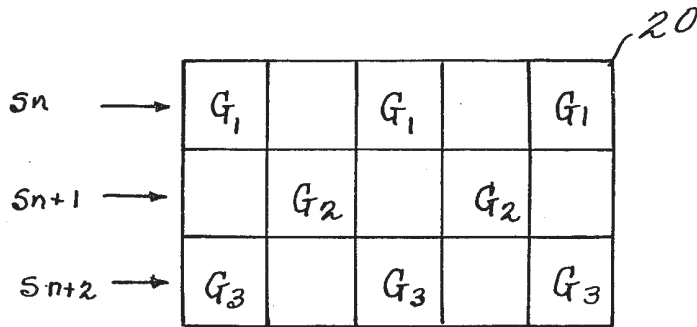

FIG. 3B

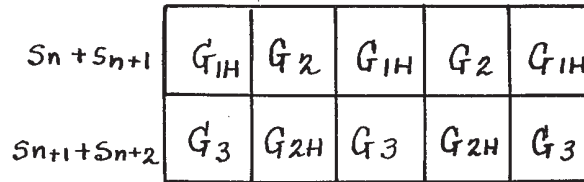

FIG. 4A

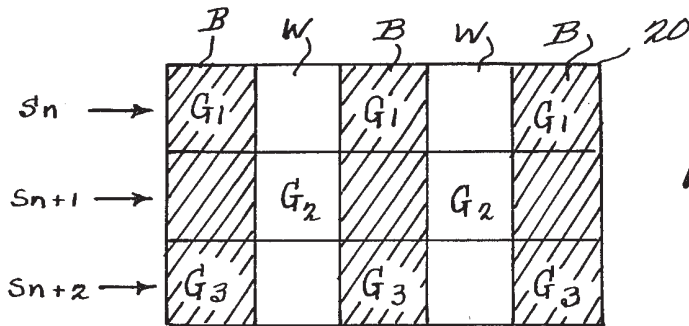
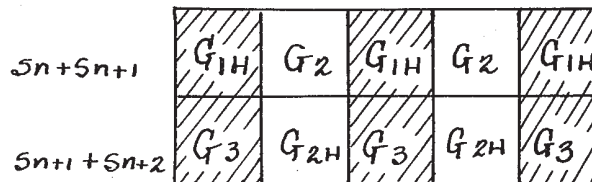

FIG. 4B



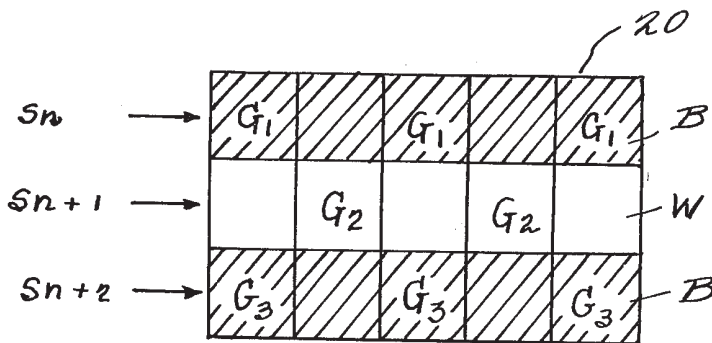

FIG. 5A

FIG. 5B

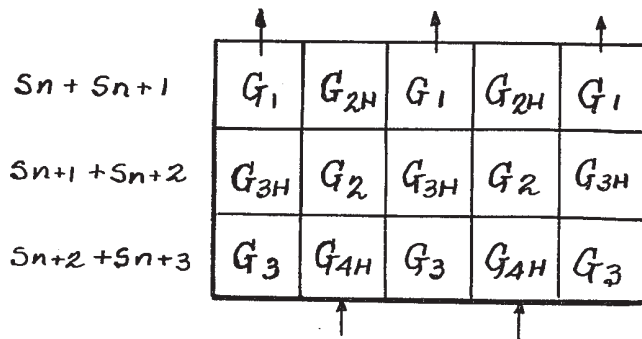
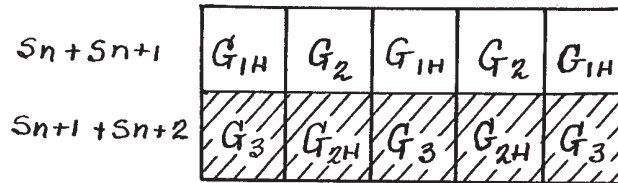

FIG. 7

Explore Litigation Insights

Docket Alarm provides insights to develop a more informed litigation strategy and the peace of mind of knowing you're on top of things.

Real-Time Litigation Alerts



Keep your litigation team up-to-date with **real-time alerts** and advanced team management tools built for the enterprise, all while greatly reducing PACER spend.

Our comprehensive service means we can handle Federal, State, and Administrative courts across the country.

Advanced Docket Research



With over 230 million records, Docket Alarm's cloud-native docket research platform finds what other services can't. Coverage includes Federal, State, plus PTAB, TTAB, ITC and NLRB decisions, all in one place.

Identify arguments that have been successful in the past with full text, pinpoint searching. Link to case law cited within any court document via Fastcase.

Analytics At Your Fingertips



Learn what happened the last time a particular judge, opposing counsel or company faced cases similar to yours.

Advanced out-of-the-box PTAB and TTAB analytics are always at your fingertips.

API

Docket Alarm offers a powerful API (application programming interface) to developers that want to integrate case filings into their apps.

LAW FIRMS

Build custom dashboards for your attorneys and clients with live data direct from the court.

Automate many repetitive legal tasks like conflict checks, document management, and marketing.

FINANCIAL INSTITUTIONS

Litigation and bankruptcy checks for companies and debtors.

E-DISCOVERY AND LEGAL VENDORS

Sync your system to PACER to automate legal marketing.