



US005533110A

United States Patent [19]
Pinard et al.

[11] **Patent Number:** **5,533,110**
[45] **Date of Patent:** **Jul. 2, 1996**

[54] **HUMAN MACHINE INTERFACE FOR TELEPHONE FEATURE INVOCATION**

Assistant Examiner—Scott Wolinsky
Attorney, Agent, or Firm—Charles E. Wands

[75] Inventors: **Deborah L. Pinard; Eliana M. O. Peres; Ronald A. Evans**, all of Kanata, Canada

[57] **ABSTRACT**

[73] Assignee: **Mitel Corporation**, Canada

A method of providing a visual indication to a first communication connection (CC) subscriber of the status of a telephone CC comprising the steps of providing an icon on a display that represents the first CC subscriber, providing a call setup icon on a display representing a command to set up a CC, dragging the icon representing the first CC subscriber to the call setup icon, automatically displaying a directory of subscribers, dragging an identity of a second CC subscriber from the directory to the call setup icon, establishing a CC between communication apparatus used by the first subscriber and communication apparatus used by the second CC subscriber via subscriber's lines, changing the identity of the call setup icon to a call icon, displaying an icon representing the second CC subscriber in the call icon, and displaying a new call setup icon, whereby icons representing CC subscribers of a call in progress are both represented and are visually discernible by the first CC subscriber in the call icon.

[21] Appl. No.: **346,600**

[22] Filed: **Nov. 29, 1994**

[51] **Int. Cl.**⁶ **H04M 3/42**

[52] **U.S. Cl.** **379/201; 379/202; 379/96; 379/112; 379/393**

[58] **Field of Search** **379/201, 202, 379/204, 203, 205, 112, 96, 393; 370/62, 110.1**

[56] **References Cited**

U.S. PATENT DOCUMENTS

5,195,086 3/1993 Baumgartner et al. 370/62
5,406,307 4/1995 Hirayama et al. 345/120

Primary Examiner—Jeffery Hofsass

19 Claims, 8 Drawing Sheets

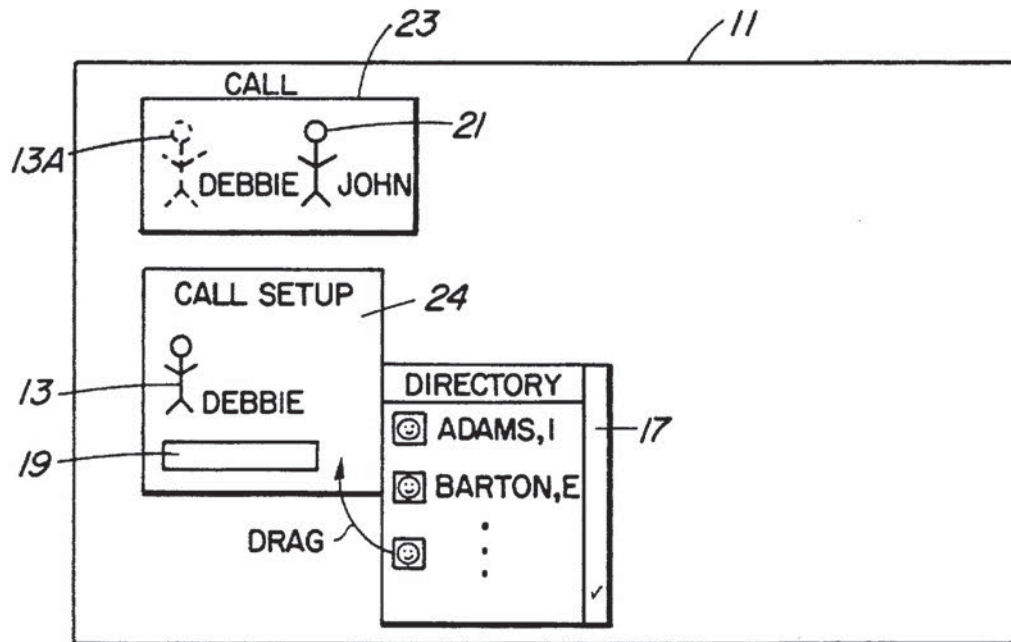

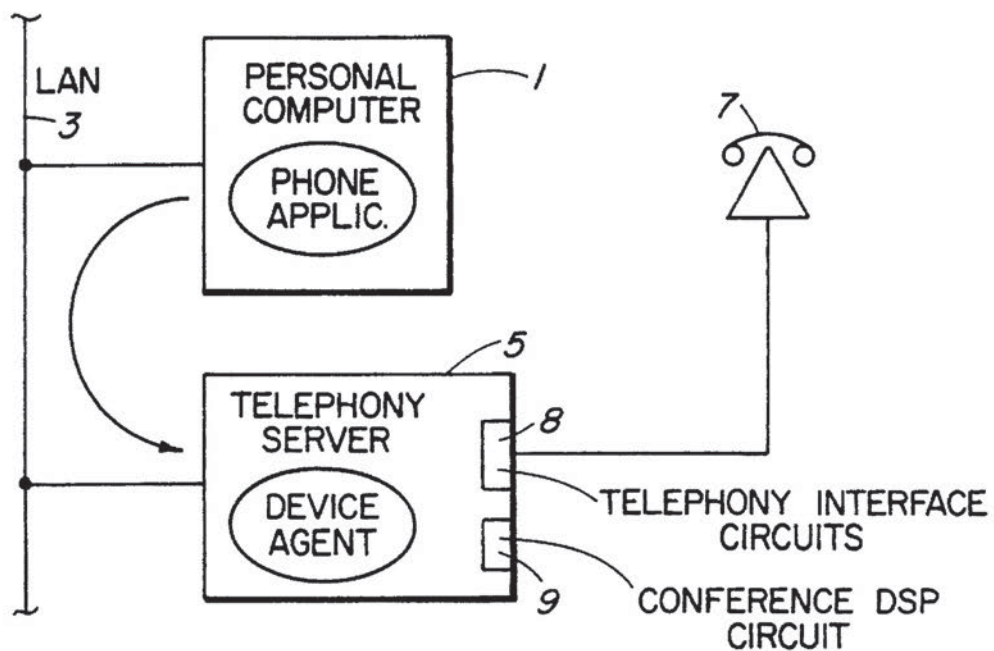

FIG. 1

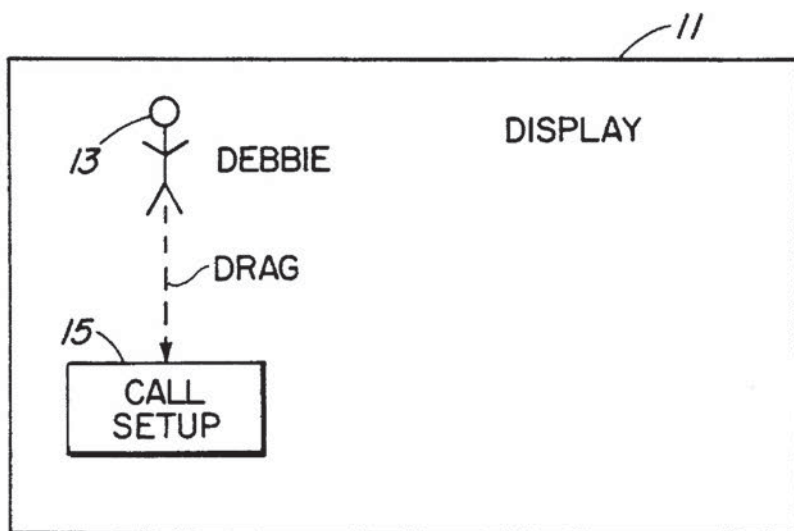

FIG. 2

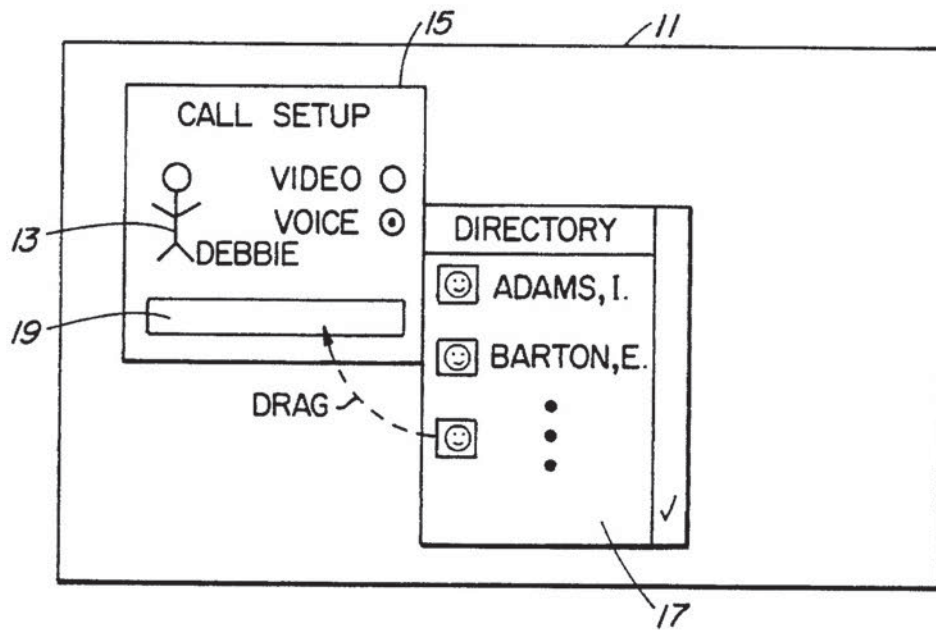

FIG. 3

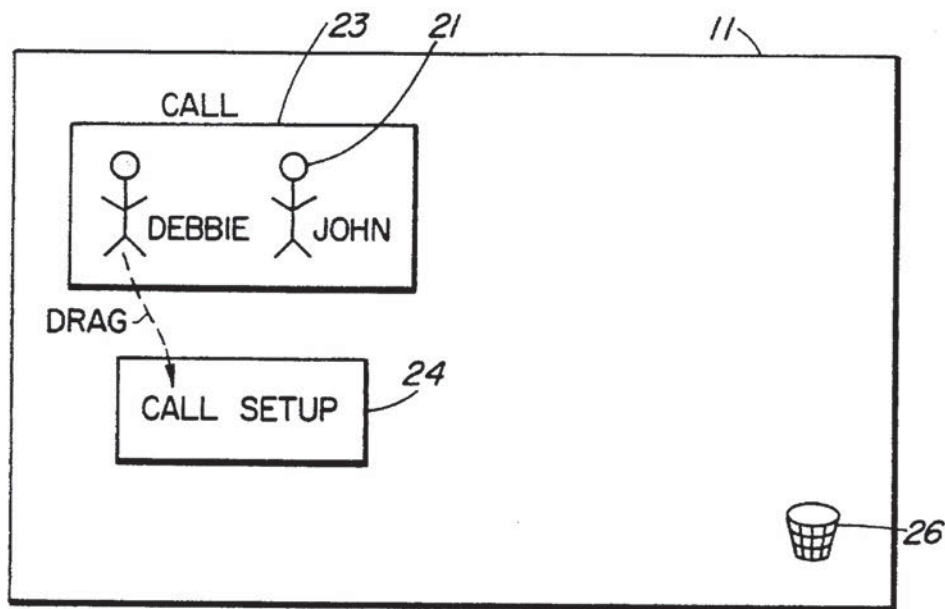

FIG. 4

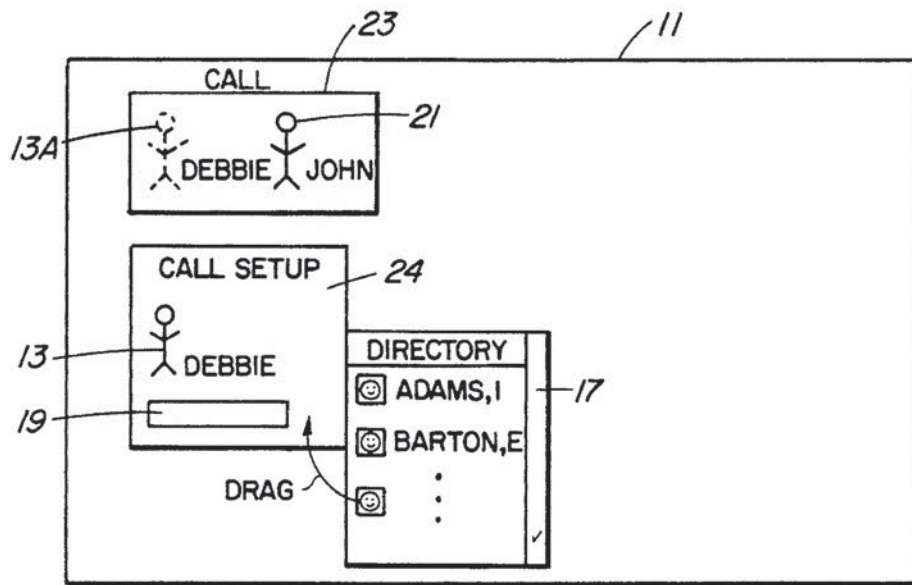

FIG. 5

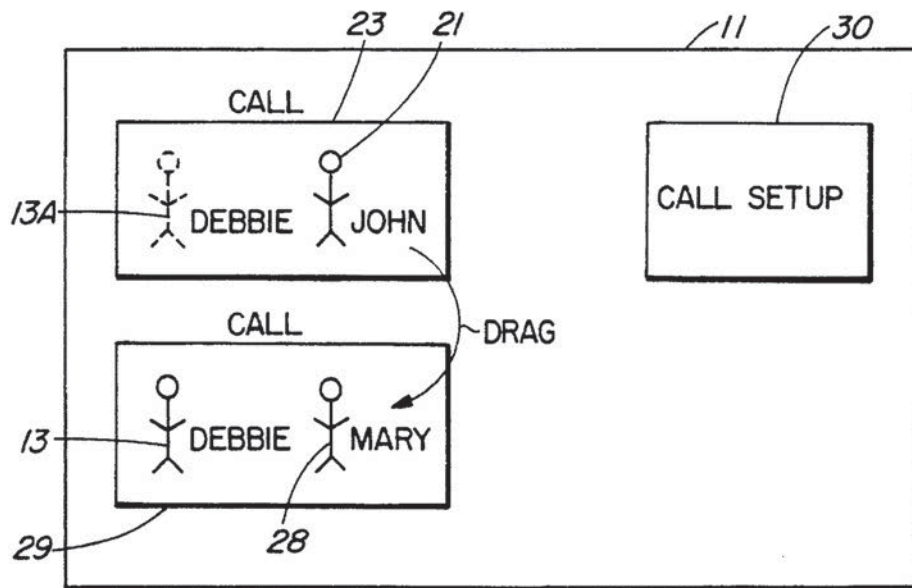

FIG. 6

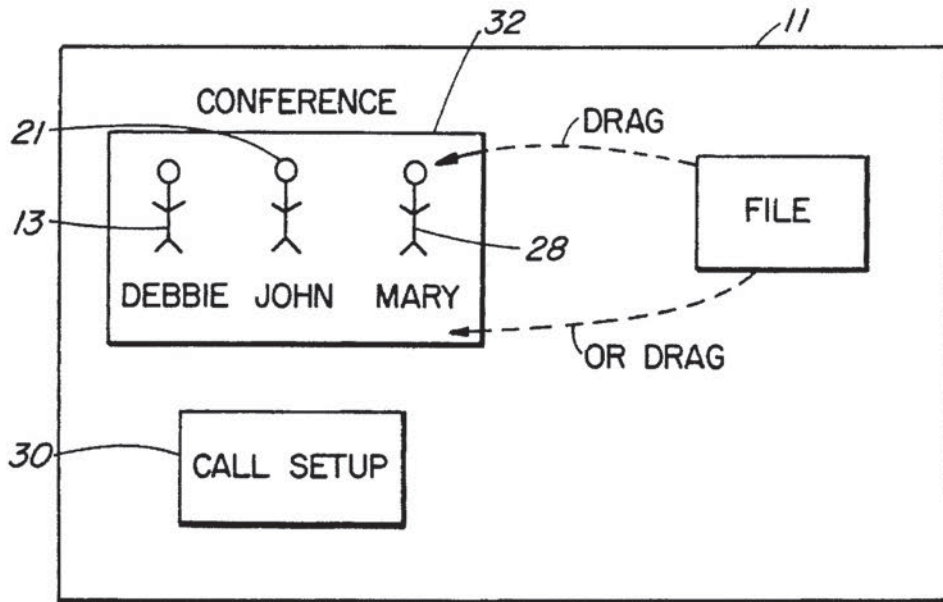

FIG. 7

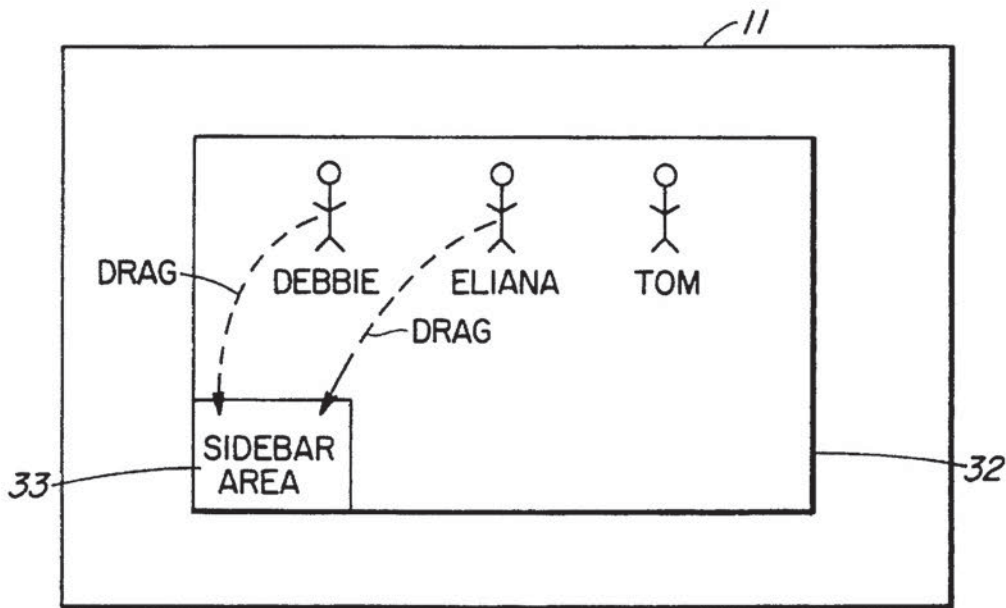

FIG. 7A

Explore Litigation Insights

Docket Alarm provides insights to develop a more informed litigation strategy and the peace of mind of knowing you're on top of things.

Real-Time Litigation Alerts



Keep your litigation team up-to-date with **real-time alerts** and advanced team management tools built for the enterprise, all while greatly reducing PACER spend.

Our comprehensive service means we can handle Federal, State, and Administrative courts across the country.

Advanced Docket Research



With over 230 million records, Docket Alarm's cloud-native docket research platform finds what other services can't. Coverage includes Federal, State, plus PTAB, TTAB, ITC and NLRB decisions, all in one place.

Identify arguments that have been successful in the past with full text, pinpoint searching. Link to case law cited within any court document via Fastcase.

Analytics At Your Fingertips



Learn what happened the last time a particular judge, opposing counsel or company faced cases similar to yours.

Advanced out-of-the-box PTAB and TTAB analytics are always at your fingertips.

API

Docket Alarm offers a powerful API (application programming interface) to developers that want to integrate case filings into their apps.

LAW FIRMS

Build custom dashboards for your attorneys and clients with live data direct from the court.

Automate many repetitive legal tasks like conflict checks, document management, and marketing.

FINANCIAL INSTITUTIONS

Litigation and bankruptcy checks for companies and debtors.

E-DISCOVERY AND LEGAL VENDORS

Sync your system to PACER to automate legal marketing.