



US006012007A

United States Patent [19]

[11] Patent Number: **6,012,007**

Fortune et al.

[45] Date of Patent: **Jan. 4, 2000**

- [54] **OCCUPANT DETECTION METHOD AND APPARATUS FOR AIR BAG SYSTEM**
- [75] Inventors: **Duane Donald Fortune**, Lebanon;
Robert John Cashler, Kokomo, both of Ind.
- [73] Assignee: **Delphi Technologies, Inc.**, Troy, Mich.
- [21] Appl. No.: **08/868,338**
- [22] Filed: **Jun. 3, 1997**

- [56] **References Cited**
- U.S. PATENT DOCUMENTS
- 5,430,649 7/1995 Cashler et al. 364/424.05
- 5,732,375 3/1998 Cashler 701/45

Primary Examiner—William A. Cuchlinski, Jr.
Assistant Examiner—Yonel Beaulieu
Attorney, Agent, or Firm—Jimmy L. Funke

[57] ABSTRACT

Pressure sensors on the bottom surface of a seat cushion respond to occupant weight. A microprocessor evaluates the sensor outputs according to total force, load rating, long term average, sensor groups and a fuzzy measure to discriminate between large and small occupants and allow air bag deployment for large but not small occupants. Allow and inhibit decisions are filtered avoid sudden response to transient pressure changes on the seat. When a large occupant is positively detected, an allow decision is locked in place as long as total force exceeds a threshold.

Related U.S. Application Data

- [63] Continuation-in-part of application No. 08/566,029, Dec. 1, 1995, Pat. No. 5,732,375.
- [51] **Int. Cl.⁷** **B60R 21/12**; B60R 21/32
- [52] **U.S. Cl.** **701/45**; 701/46; 340/436; 180/271; 180/273; 280/730.1; 280/735; 307/9.1
- [58] **Field of Search** 701/45, 46; 340/438, 340/436; 180/271, 273; 280/730.1-735; 307/9.1

27 Claims, 5 Drawing Sheets

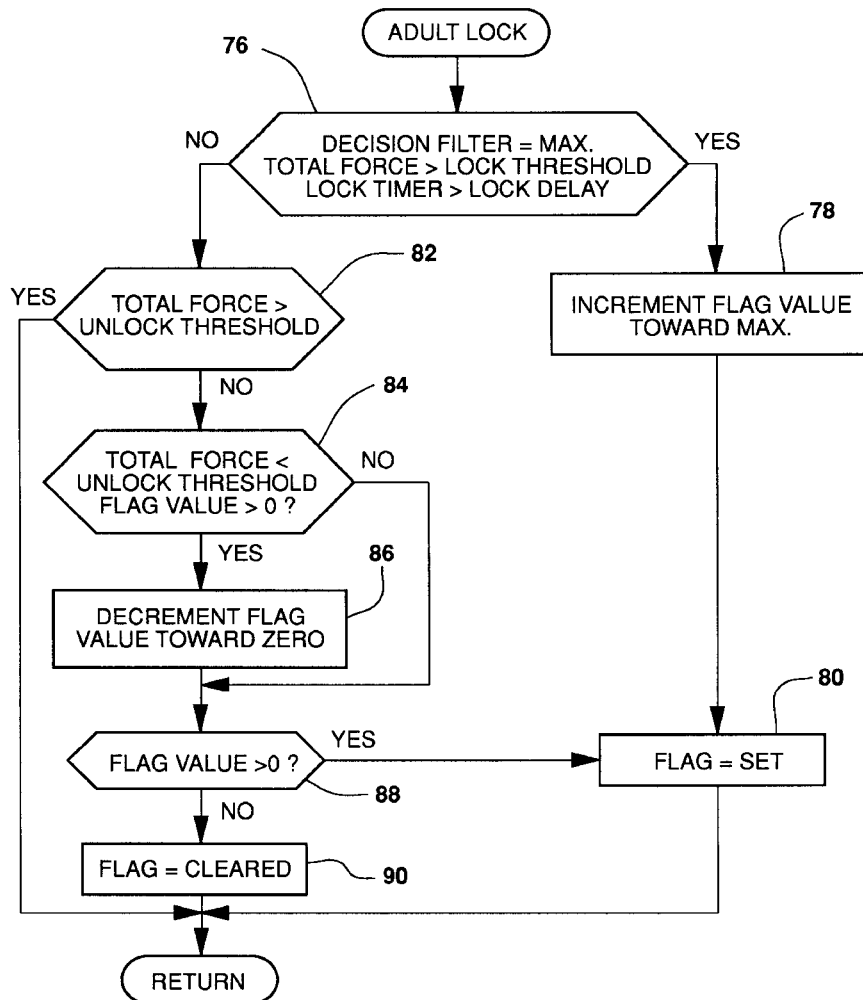

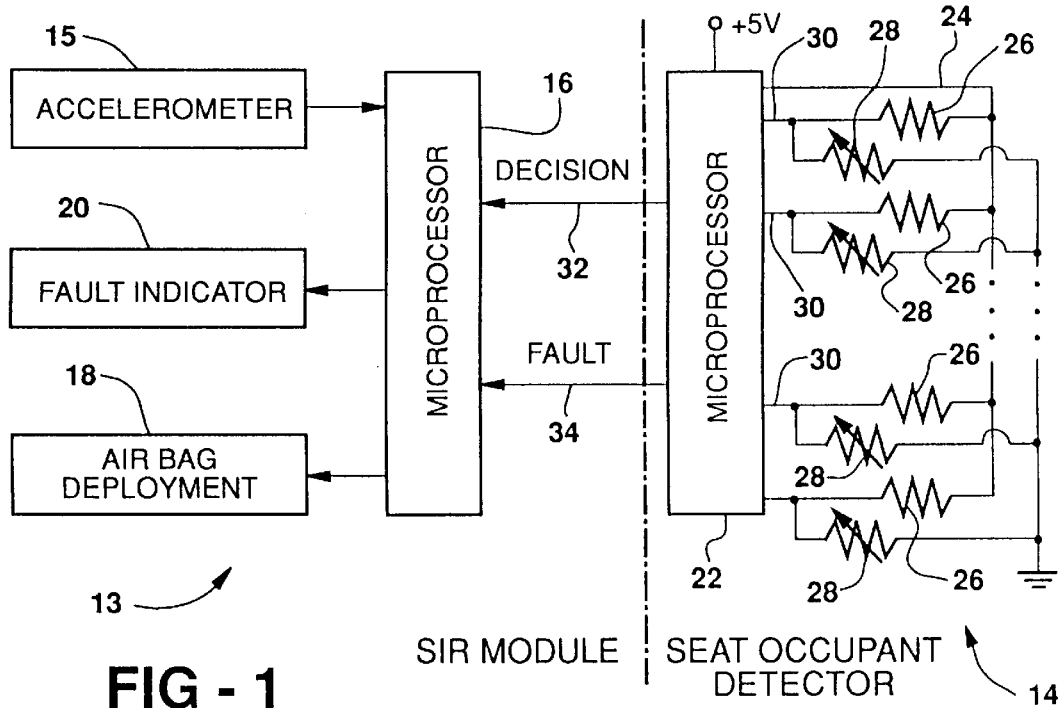

FIG - 1
PRIOR ART

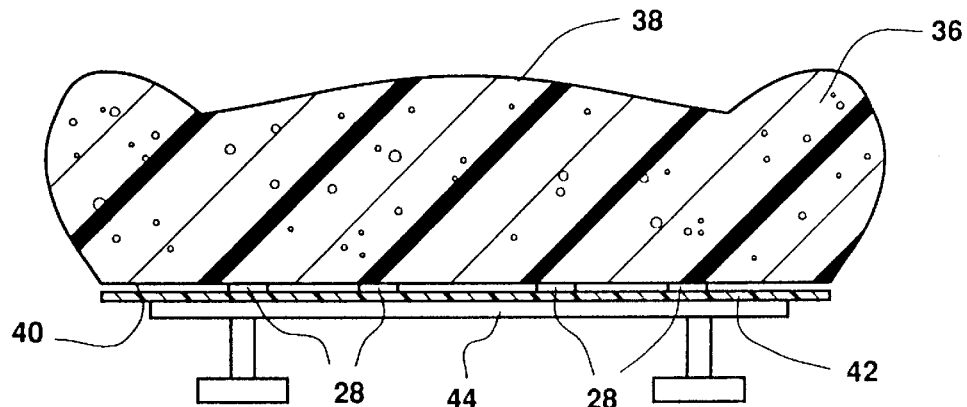

FIG - 2

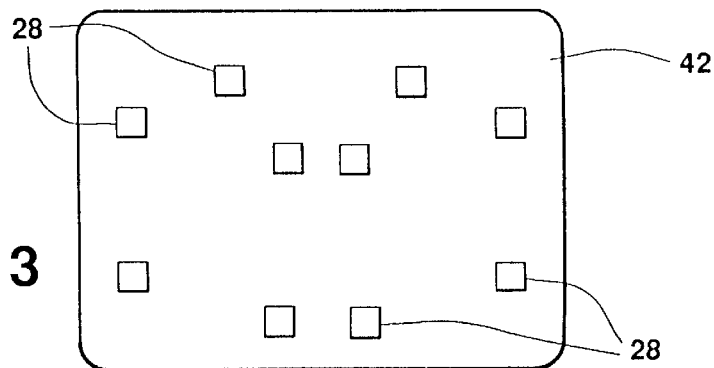

FIG - 3

FIG - 4

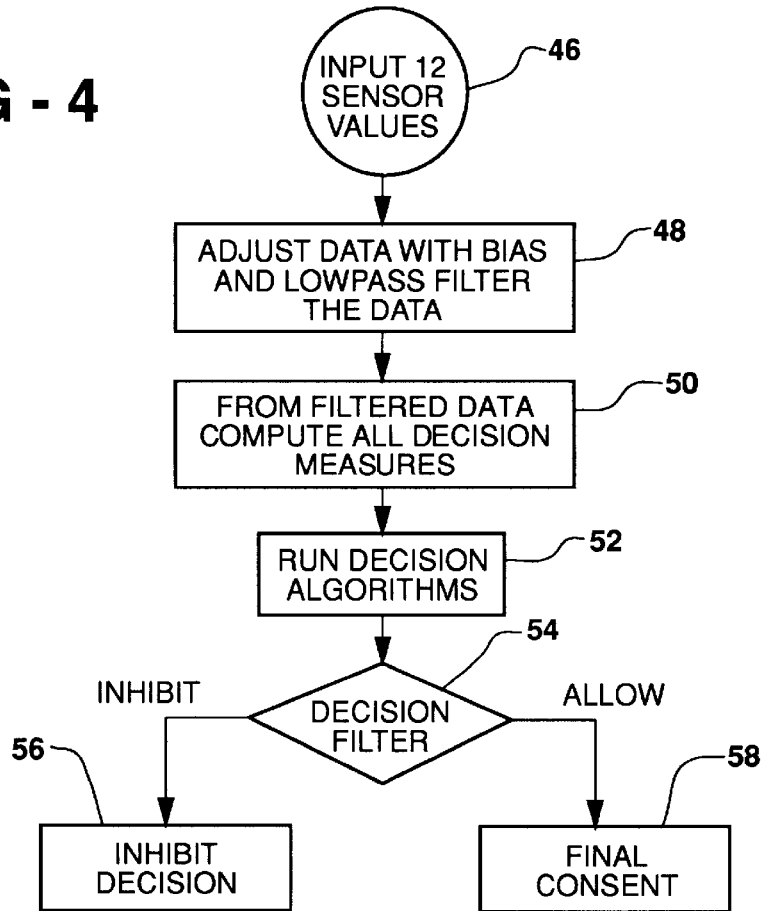

FIG - 5

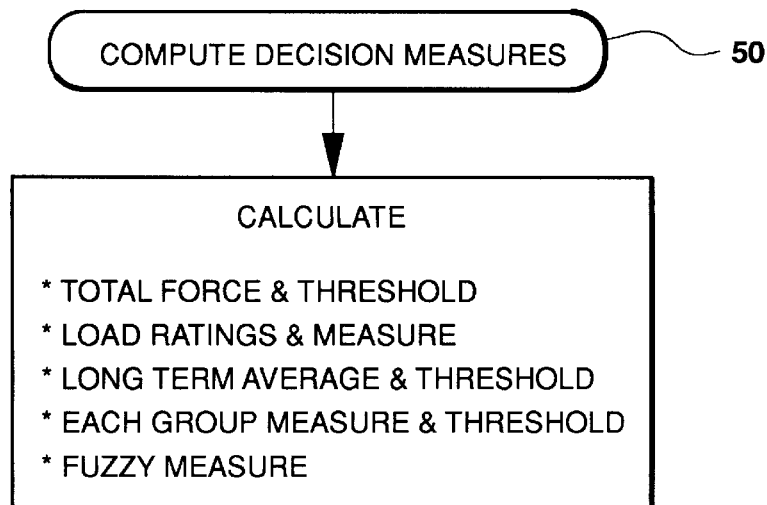

FIG - 6

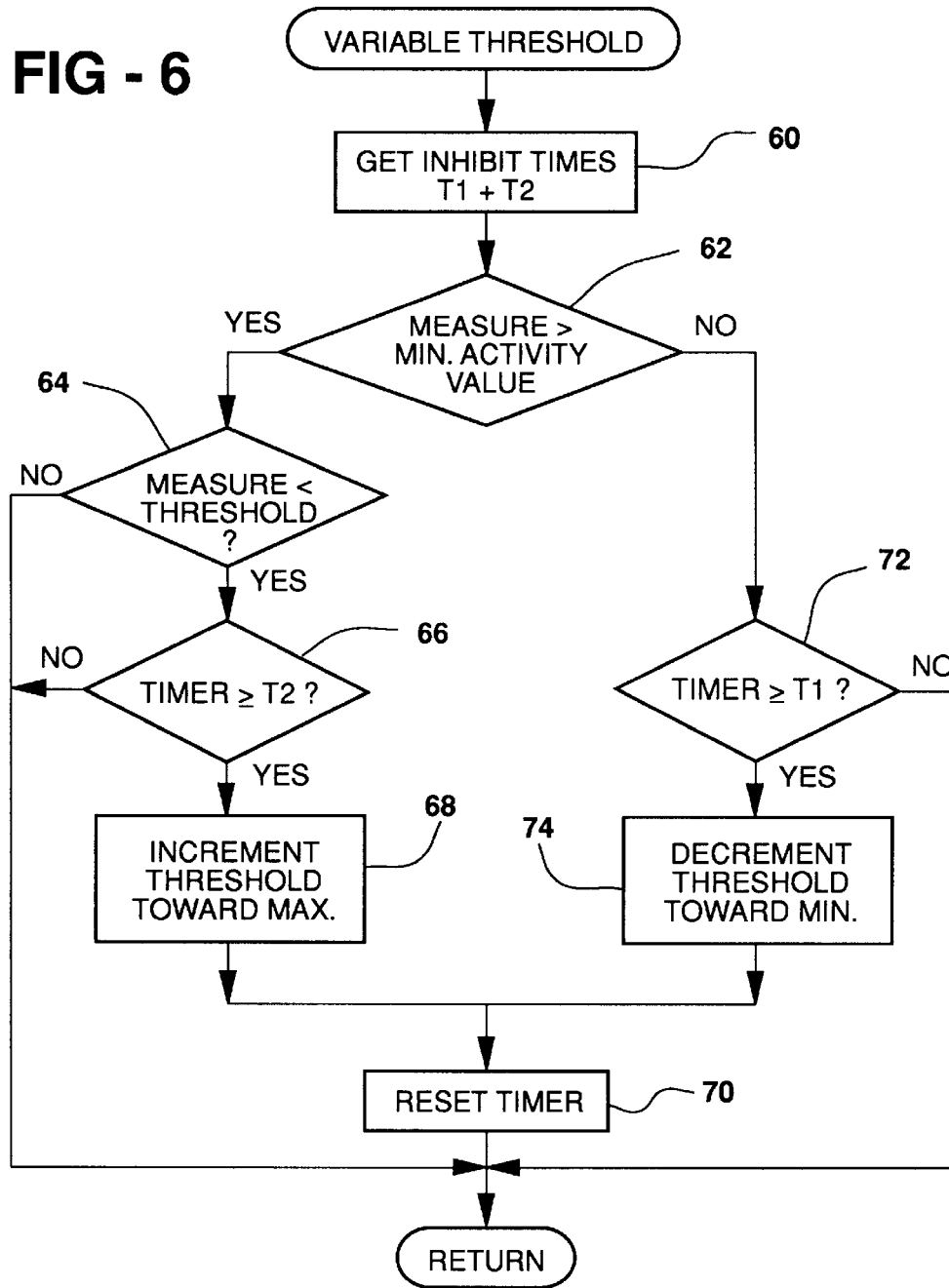
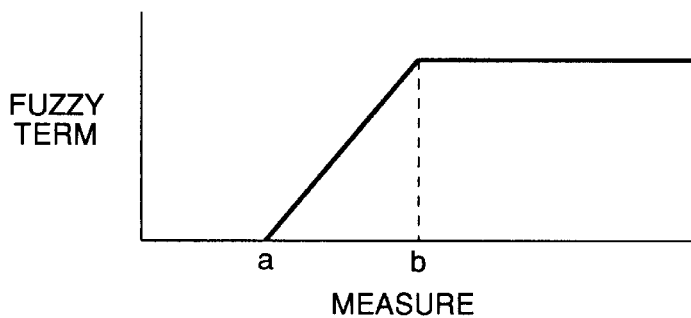
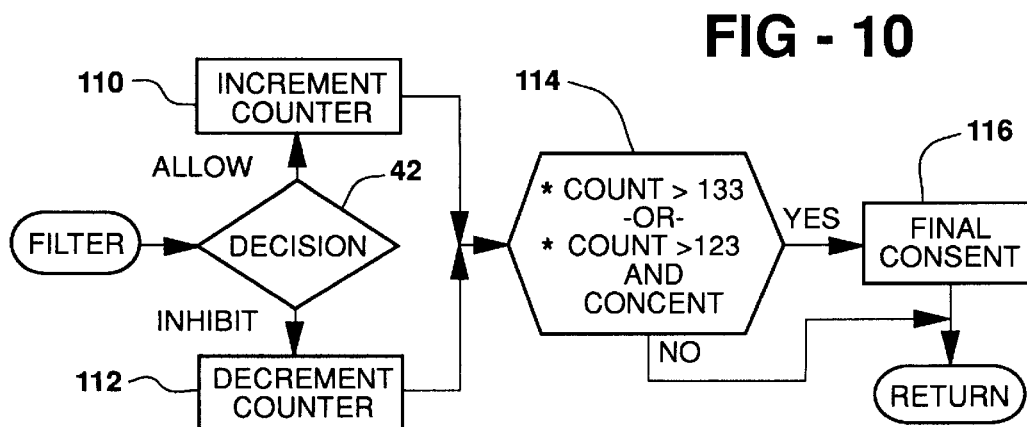
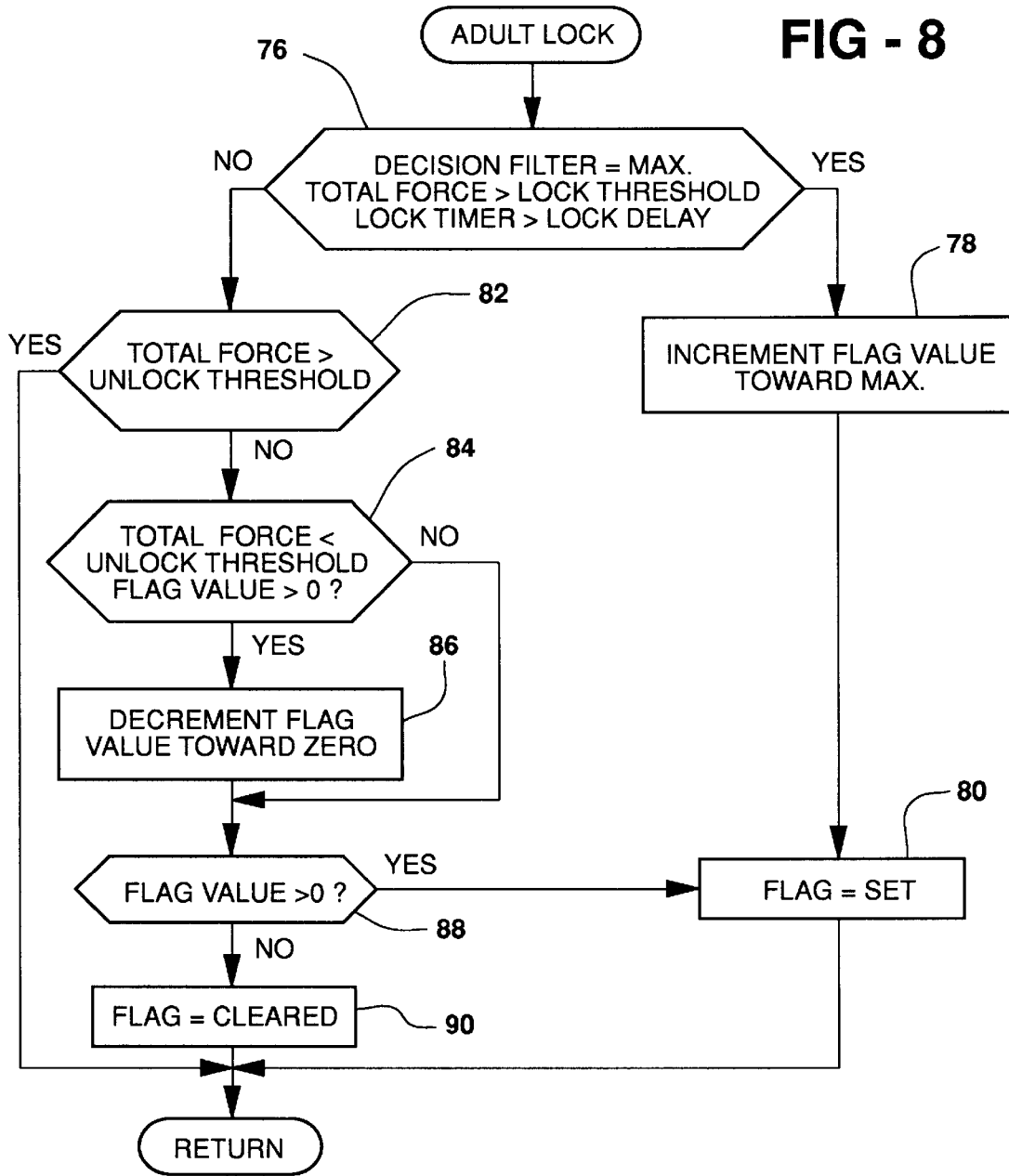

FIG - 7





Explore Litigation Insights

Docket Alarm provides insights to develop a more informed litigation strategy and the peace of mind of knowing you're on top of things.

Real-Time Litigation Alerts



Keep your litigation team up-to-date with **real-time alerts** and advanced team management tools built for the enterprise, all while greatly reducing PACER spend.

Our comprehensive service means we can handle Federal, State, and Administrative courts across the country.

Advanced Docket Research



With over 230 million records, Docket Alarm's cloud-native docket research platform finds what other services can't. Coverage includes Federal, State, plus PTAB, TTAB, ITC and NLRB decisions, all in one place.

Identify arguments that have been successful in the past with full text, pinpoint searching. Link to case law cited within any court document via Fastcase.

Analytics At Your Fingertips



Learn what happened the last time a particular judge, opposing counsel or company faced cases similar to yours.

Advanced out-of-the-box PTAB and TTAB analytics are always at your fingertips.

API

Docket Alarm offers a powerful API (application programming interface) to developers that want to integrate case filings into their apps.

LAW FIRMS

Build custom dashboards for your attorneys and clients with live data direct from the court.

Automate many repetitive legal tasks like conflict checks, document management, and marketing.

FINANCIAL INSTITUTIONS

Litigation and bankruptcy checks for companies and debtors.

E-DISCOVERY AND LEGAL VENDORS

Sync your system to PACER to automate legal marketing.