

F I F T H E D I T I O N

# ANALYTICAL CHEMISTRY

---

---

**GARY D. CHRISTIAN**

University of Washington



**JOHN WILEY & SONS, INC.**

New York

•

Chichester

•

Brisbane

•

Toronto

•

Singapore

**SENJU EXHIBIT 2279**

**LUPIN v. SENJU**

**IPR2015-01099**

ACQUISITIONS EDITOR Nedah Rose  
MARKETING MANAGER Catherine Faduska  
PRODUCTION EDITOR Marcia Craig  
DESIGNER Laura Nicholls  
MANUFACTURING MANAGER Inez Pettis  
ILLUSTRATION SUPERVISOR Jamie Perea  
COVER PHOTO Ellen Schuster/The Image Bank

This book was set in 10/12 Times Roman by The Clarinda Company and printed and bound by Hamilton Printing Company. The cover was printed by Phoenix Color Corp.

Recognizing the importance of preserving what has been written, it is a policy of John Wiley & Sons, Inc. to have books of enduring value published in the United States printed on acid-free paper, and we exert our best efforts to that end.

Copyright © 1994, by John Wiley & Sons, Inc.

All rights reserved. Published simultaneously in Canada.

Reproduction or translation of any part of this work beyond that permitted by Sections 107 and 108 of the 1976 United States Copyright Act without the permission of the copyright owner is unlawful. Requests for permission or further information should be addressed to the Permissions Department, John Wiley & Sons, Inc.

*Library of Congress Cataloging in Publication Data:*

Christian, Gary D.

Analytical chemistry / Gary D. Christian. — 5th ed.  
p. cm.

Includes indexes.

ISBN 0-471-59761-9

1. Chemistry, Analytic—Quantitative. I. Title.

QD101.2.C57 1994

545—dc20

93-32933

CIP

Printed in the United States of America

10 9 8 7 6 5 4

## SPECTROMETRY

---

---

Visible spectrometry is probably the most widely used analytical technique.

Spectrometry, particularly in the visible region of the electromagnetic spectrum, is one of the most widely used methods of analysis. It is very widely used in clinical chemistry and environmental laboratories because many substances can be selectively converted to a colored derivative. The instrumentation is readily available and generally fairly easy to operate. In this chapter, we (1) describe the absorption of radiation by molecules and its relation to molecular structure; (2) make quantitative calculations, relating the amount of radiation absorbed to the concentration of an absorbing analyte; and (3) describe the instrumentation required for making measurements. Measurements can be made in the infrared, visible, and ultraviolet regions of the spectrum. The wavelength region of choice will depend upon factors such as availability of instruments, whether the analyte is colored or can be converted to a colored derivative, whether it contains functional groups that absorb in the ultraviolet or infrared regions, and whether other absorbing species are present in the solution. Infrared spectrometry is generally less suited for quantitative measurements but better suited for qualitative or fingerprinting information than are ultraviolet (UV) and visible spectrometry. Visible spectrometers are generally less expensive and more available than UV spectrometers.

We also describe a related technique, fluorescence spectrometry, in which the amount of light emitted upon excitation is related to the concentration. This is an extremely sensitive analytical technique.

## 14.1 INTERACTION OF ELECTROMAGNETIC RADIATION WITH MATTER

In spectrometric methods, the sample solution absorbs electromagnetic radiation from an appropriate source, and the amount absorbed is related to the concentration of the analyte in the solution. A solution containing copper ions is blue because it absorbs the complementary color yellow from white light and transmits the remaining blue light (see Table 14.1 below). The more concentrated the copper solution, the more yellow light is absorbed and the deeper the resulting blue color of the solution. In a spectrometric method, the amount of this yellow light absorbed would be measured and related to the concentration. We can obtain a better understanding of absorption spectrometry from a consideration of the electromagnetic spectrum and how molecules absorb radiation.

Spectrometry is based on the absorption of photons by the analyte.

### The Electromagnetic Spectrum

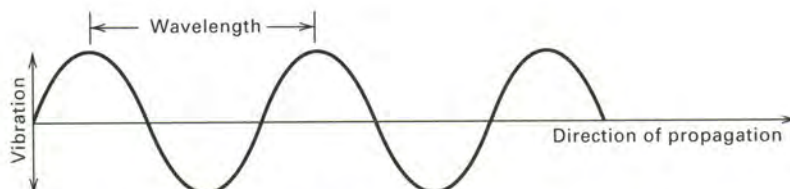
Electromagnetic radiation, for our purposes, can be considered a form of radiant energy that is propagated as a transverse wave. It vibrates perpendicular to the direction of propagation and this imparts a wave motion to the radiation, as illustrated in Figure 14.1. The wave is described either in terms of its **wavelength**, the distance of one complete cycle, or in terms of the **frequency**, the number of cycles passing a fixed point per unit time. The reciprocal of the wavelength is called the **wavenumber** and is the number of waves in a unit length or distance per cycle.

Wavelength, frequency, and wavenumber are interrelated.

**TABLE 14.1**

**Colors of Different Wavelength Regions**

<i>Wavelength Absorbed, nm</i>	<i>Absorbed Color</i>	<i>Transmitted Color (Complement)</i>
380–450	Violet	Yellow-green
450–495	Blue	Yellow
495–570	Green	Violet
570–590	Yellow	Blue
590–620	Orange	Green-blue
620–750	Red	Blue-green



**FIGURE 14.1** Wave motion of electromagnetic radiation.

The relationship between the wavelength and frequency is

$$\lambda = \frac{c}{\nu} \quad (14.1)$$

where  $\lambda$  is the wavelength in centimeters (cm),<sup>1</sup>  $\nu$  is the frequency in reciprocal seconds (s<sup>-1</sup>), or hertz (Hz), and  $c$  is the velocity of light ( $3 \times 10^{10}$  cm/s). The wavenumber is represented by  $\bar{\nu}$ , in cm<sup>-1</sup>:

$$\bar{\nu} = \frac{1}{\lambda} = \frac{\nu}{c} \quad (14.2)$$

The wavelength of electromagnetic radiation varies from a few angstroms to several meters. The units used to describe the wavelength are as follows:

$$\begin{aligned} \text{\AA} &= \text{angstrom} = 10^{-10} \text{ meter} = 10^{-8} \text{ centimeter} = 10^{-4} \text{ micrometer} \\ \text{nm} &= \text{nanometer} = 10^{-9} \text{ meter} = 10 \text{ angstroms} = 10^{-3} \text{ micrometer} \\ \mu\text{m} &= \text{micrometer} = 10^{-6} \text{ meter} = 10^4 \text{ angstroms} \end{aligned}$$

Wavelengths in the ultraviolet and visible regions are on the order of nanometers. In the infrared region, they are micrometers, but the reciprocal of wavelength is often used (wavenumbers, in cm<sup>-1</sup>).

The wavelength unit preferred for the **ultraviolet** and **visible** regions of the spectrum is nanometer, while the unit micrometer is preferred for the **infrared** region.<sup>2</sup> In this last case, wavenumbers are often used in place of wavelength, and the unit is cm<sup>-1</sup>. See below for a definition of the ultraviolet, visible, and infrared regions of the spectrum.

Electromagnetic radiation possesses a certain amount of energy. The energy of a unit of radiation, called the **photon**, is related to the frequency or wavelength by

$$E = h\nu = \frac{hc}{\lambda} \quad (14.3)$$

Shorter wavelengths have greater energy. That is why ultraviolet radiation from the sun burns you!

where  $E$  is the energy of the photon in ergs and  $h$  is Planck's constant,  $6.62 \times 10^{-34}$  J-s. It is apparent, then, that *the shorter the wavelength or the greater the frequency, the greater the energy.*

As indicated above, the electromagnetic spectrum is arbitrarily broken down into different regions according to wavelength. The various regions of the spec-

<sup>1</sup>More correctly, the units are centimeters per cycle for wavelength and cycles per second for frequency, but the cycles unit is often assumed. In place of cycles/s, the unit **hertz** (Hz) is now commonly used.

<sup>2</sup>Nanometer (nm) is the preferred term over millimicron (m $\mu$ ), the unit used extensively prior to this. In the infrared region, micrometer ( $\mu\text{m}$ ) is the preferred term in place of the previously used term micron ( $\mu$ ).

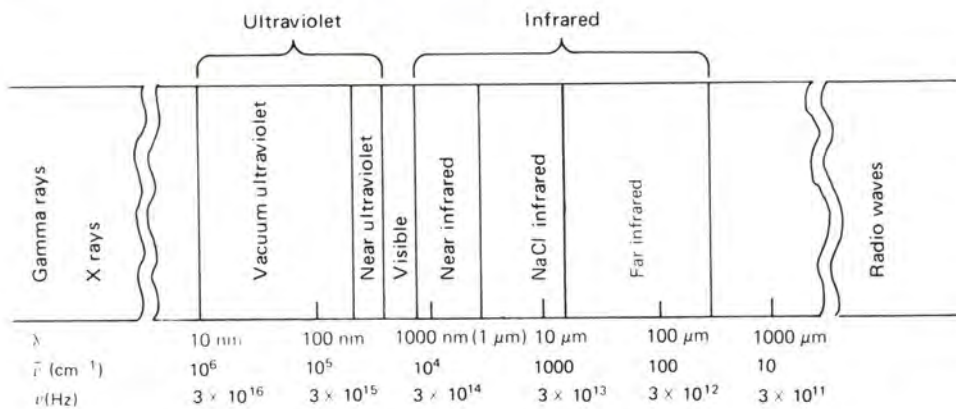


FIGURE 14.2 The electromagnetic spectrum.

We see only a very small portion of electromagnetic radiation.

trum are shown in Figure 14.2. We will not be concerned with the gamma-ray and X-ray regions in this chapter, although these high-energy radiations can be used in principle in the same manner as lower-energy radiations. The *ultraviolet* region extends from about 10 to 380 nm, but the most analytically useful region is from 200 to 380 nm, called the **near-ultraviolet region**. Below 200 nm, the air absorbs appreciably and so the instruments are operated under a vacuum; hence, this wavelength region is called the **vacuum-ultraviolet region**. The **visible region** is actually a very small part of the electromagnetic spectrum, and it is the region of wavelengths that can be seen by the human eye, that is, where the light appears as a color. The visible region extends from the near-ultraviolet region (380 nm) to about 780 nm. The **infrared region** extends from about 0.78  $\mu\text{m}$  (780 nm) to 300  $\mu\text{m}$ , but the range from 2.5 to 15  $\mu\text{m}$  is the most frequently used for analysis. The 0.8- to 2.5- $\mu\text{m}$  range is known as the **near-infrared region**, the 2.5- to 16- $\mu\text{m}$  region as the **mid- or NaCl-infrared region**, and longer wavelengths as the **far-infrared region**. We shall not be concerned with lower-energy radiation (radio or microwave) in this chapter. Nuclear magnetic resonance spectroscopy involves the interaction of low-energy microwave radiation with the nuclei of atoms.

### The Absorption of Radiation

A qualitative picture of the absorption of radiation can be obtained by considering the absorption of light in the visible region. We “see” objects as colored because they transmit or reflect only a portion of the light in this region. When polychromatic light (white light), which contains the whole spectrum of wavelengths in the visible region, is passed through an object, the object will absorb certain of the wavelengths, leaving the unabsorbed wavelengths to be transmitted. These residual transmitted wavelengths will be seen as a color. This color is **complementary** to the absorbed colors. In a similar manner, opaque objects will absorb certain wavelengths, leaving a residual color to be reflected and “seen.”

Table 14.1 summarizes the approximate colors associated with different wavelengths in the visible spectrum. As an example, a solution of potassium permanganate absorbs light in the green region of the spectrum with an absorption maximum of 525 nm, and the solution is purple.

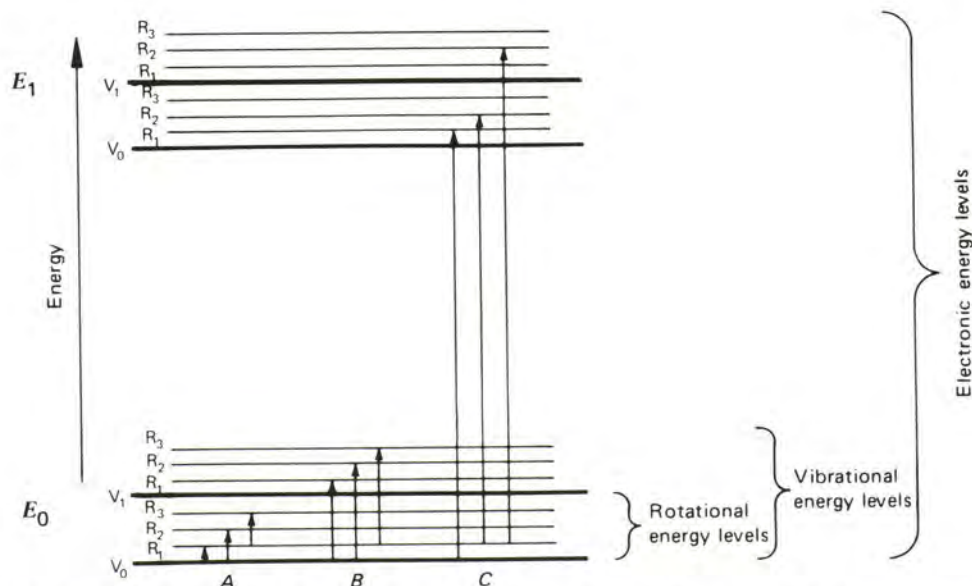
The color of an object we see is due to the wavelengths transmitted or reflected. The other wavelengths are absorbed.

There are three basic processes by which a molecule can absorb radiation; all involve raising the molecule to a higher internal energy level, the increase in energy being equal to the energy of the absorbed radiation ( $h\nu$ ). The three types of internal energy are **quantized**; that is, they exist at discrete levels. First, the molecule rotates about various axes, the energy of rotation being at definite energy levels, so the molecule may absorb radiation and be raised to a higher rotational energy level, in a **rotational transition**. Second, the atoms or groups of atoms within a molecule vibrate relative to each other, and the energy of this vibration occurs at definite quantized levels. The molecule may then absorb a discrete amount of energy and be raised to a higher vibrational energy level, in a **vibrational transition**. Third, the electrons of a molecule may be raised to a higher electron energy, corresponding to an **electronic transition**.

A molecule absorbs a photon by undergoing an energy transition exactly equal to the energy of the photon. The photon must have the right energy for this quantized transition.

Since each of these internal energy transitions is quantized, they will occur only at *definite wavelengths* corresponding to an energy  $h\nu$  equal to the quantized jump in the internal energy. There are, however, many *different* possible energy levels for each type of transition, and several wavelengths may be absorbed. The transitions can be illustrated by an energy level diagram like that in Figure 14.3. The relative energy levels of the three transition processes are in the order electronic > vibrational > rotational, each being about an order of magnitude different in its energy level. Rotational transitions thus can take place at very low energies (long wavelengths, that is, the microwave or far-infrared region), but vibrational transitions require higher energies in the near-infrared region, while electronic transitions require still higher energies (in the visible and ultraviolet regions).

Purely rotational transitions can occur in the **far-infrared** and **microwave** regions (ca. 100  $\mu\text{m}$  to 10 cm), where the energy is insufficient to cause vibrational



**FIGURE 14.3** Energy level diagram illustrating energy changes associated with absorption of electromagnetic radiation: A, pure rotational changes (far infrared); B, rotational–vibrational changes (near infrared); C, rotational–vibrational–electronic transitions (visible and ultraviolet).  $E_0$  is electronic ground state and  $E_1$  is first electronic excited state.

or electronic transitions. The molecule, at room temperature, is usually in its lowest electronic energy state, called the **ground state** ( $E_0$ ). Thus, the pure rotational transition will occur at the ground-state electronic level (*A* in Figure 14.3), although it is also possible to have an appreciable population of **excited states** of the molecule. When only rotational transitions occur, discrete absorption *lines* will occur in the spectrum, the wavelength of each line corresponding to a particular transition. Hence, fundamental information can be obtained about rotational energy levels of molecules. This region has been of little use analytically, however.

As the energy is increased (the wavelength decreased), vibrational transitions occur *in addition* to the rotational transitions, with different combinations of vibrational-rotational transitions. *Each* rotational level of the lowest vibrational level can be excited to different rotational levels of the excited vibrational level (*B* in Figure 14.3). In addition, there may be several different excited vibrational levels, each with a number of rotational levels. This leads to numerous discrete transitions. The result is a spectrum of *peaks* or "envelopes" of unresolved fine structure. The wavelengths at which these peaks occur can be related to vibrational modes within the molecule. These occur in the mid- and far-infrared regions. Some typical infrared spectra are shown in Figure 14.4.

At still higher energies (visible and ultraviolet wavelengths), different levels of electronic transition take place, and rotational and vibrational transitions are superimposed on these (*C* in Figure 14.3). This results in an even larger number of possible transitions. Although all the transitions occur in quantized steps corresponding to discrete wavelengths, these individual wavelengths are too numerous and too close to resolve into the individual lines or vibrational peaks, and the net result is a spectrum of broad *bands* of absorbed wavelengths. Typical visible and ultraviolet spectra are shown in Figure 14.5 and 14.6.

Not all molecules can absorb in the infrared region. For absorption to occur, there must be a *change in the dipole moment (polarity) of the molecule*. A diatomic molecule must have a permanent dipole (polar covalent bond in which a pair of electrons is shared unequally) in order to absorb, but larger molecules do not. For example, nitrogen,  $\text{N}\equiv\text{N}$ , cannot exhibit a dipole and will not absorb in the infrared region. An unsymmetrical diatomic molecule such as carbon monoxide does have a permanent dipole and hence will absorb. Carbon dioxide,  $\text{O}=\text{C}=\text{O}$ , does not have a permanent dipole, but by vibration it may exhibit a dipole moment. Thus, in the vibration mode  $\text{O}\rightarrow\text{C}\leftarrow\text{O}$ , there is symmetry and no dipole moment. But in the mode  $\text{O}\leftarrow\text{C}\leftarrow\text{O}$ , there is a dipole moment and the molecule can absorb infrared radiation, that is, via an induced dipole. The types of absorbing groups and molecules for the infrared and other wavelength regions will be discussed below.

Our discussions have been confined to molecules, since nearly all absorbing species in solution are molecular in nature. In the case of single atoms (which occur in a flame or an electric arc) that do not vibrate or rotate, only electronic transitions occur. These occur as sharp lines corresponding to definite transitions and will be the subject of discussion in the next chapter.

The lifetimes of excited states of molecules are rather short, and the molecules will lose their energy of excitation and drop back down to the ground state. However, rather than emitting this energy as a photon of the same wavelength as absorbed, most of them will be deactivated by collisional processes in which the

Rotational transitions occur at very long wavelengths (low energy, far infrared). Sharp line spectra are recorded.

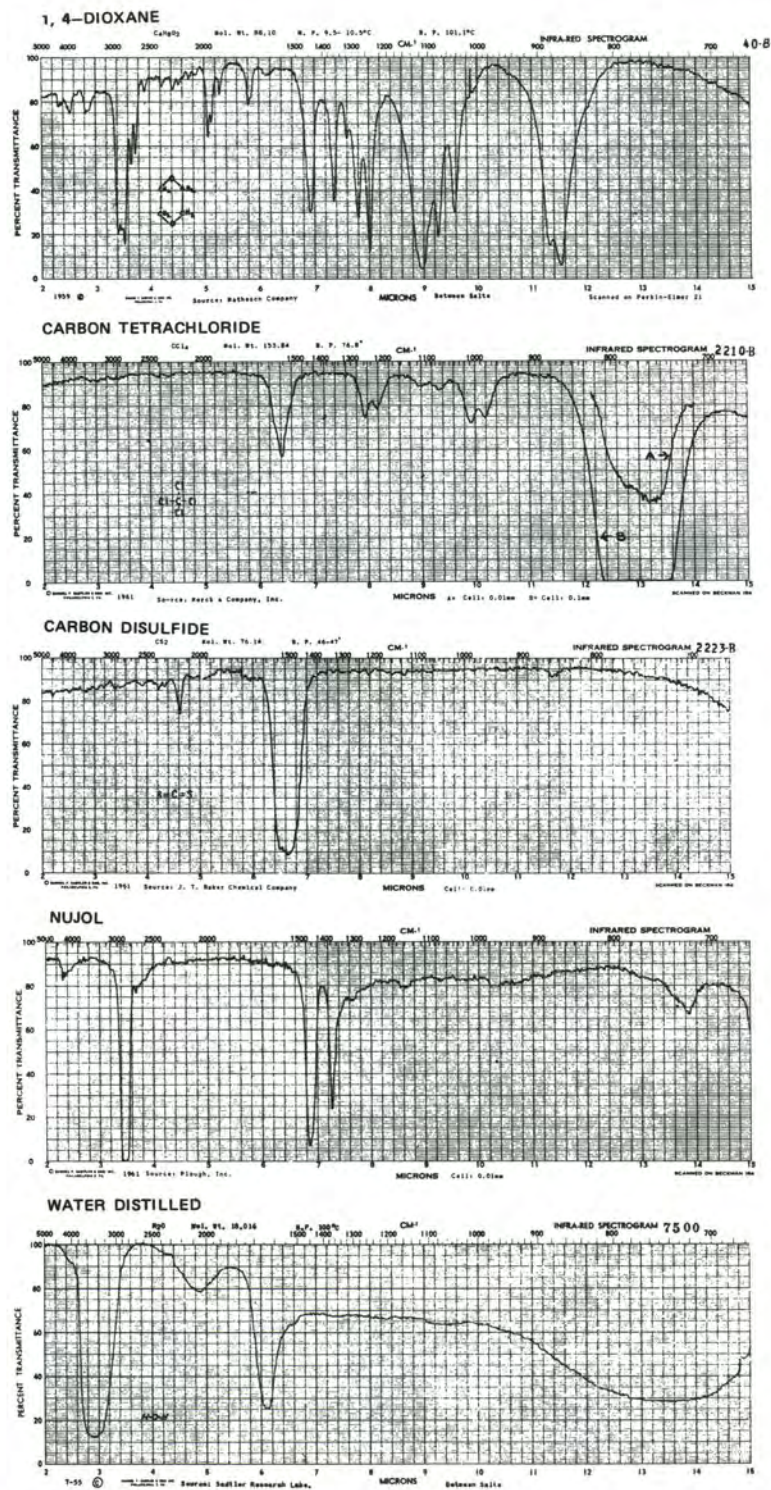
Vibrational transitions are also discrete. But the overlaid rotational transitions result in a "smeared" spectrum of unresolved lines.

Discrete electronic transitions (visible and ultraviolet regions) are superimposed on vibrational and rotational transitions. The spectra are even more "smeared."

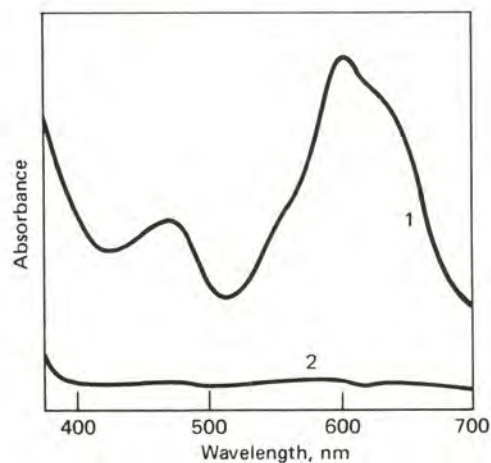
The molecule must undergo a change in dipole moment in order to absorb infrared radiation.

Single atoms only undergo electronic transitions. So the spectra are sharp lines.

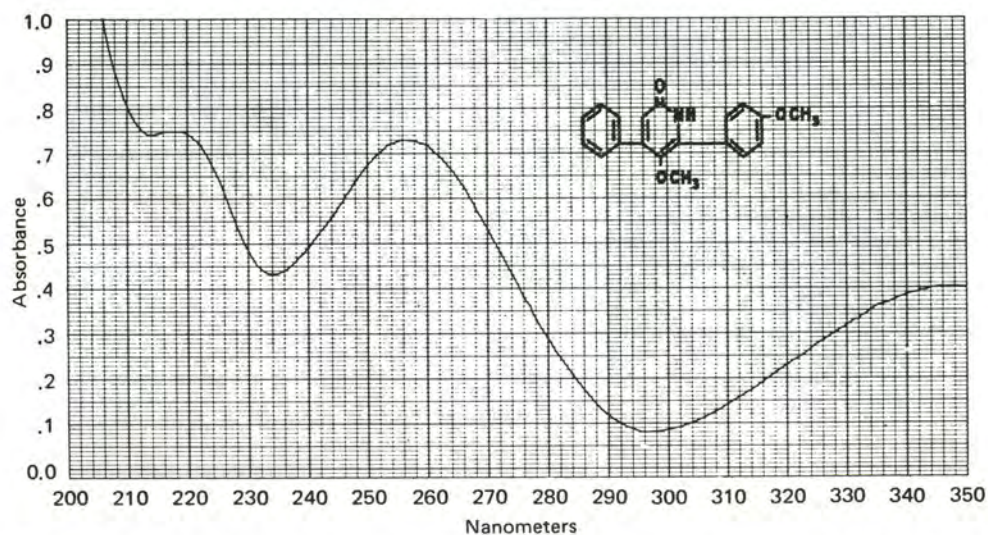




**FIGURE 14.4** Typical infrared spectra. (From *26 Frequently Used Spectra for the Infrared Spectroscopist*, Standard Spectra-Midget Edition. Copyright © Sadtler Research Laboratories, Inc. Permission for the publication herein of Sadtler Standard Spectra © has been granted, and all rights are reserved by Sadtler Research Laboratories, Inc.)



**FIGURE 14.5** Typical visible absorption spectrum. Tartaric acid reacted with  $\beta$ -naphthol in sulfuric acid. 1, Sample; 2, Blank. From G. D. Christian, *Talanta*, **16** (1969) 255. (Reproduced by permission of Pergamon Press, Ltd.)



**FIGURE 14.6** Typical ultraviolet spectrum. 5-Methoxy-6-(*p*-methoxyphenyl)-4-phenyl-2(1*H*)-pyridone in methanol. (From *Sadtler Standard Spectra-u.v.* Copyright© Sadtler Research Laboratories, Inc., 1963. Permission for the publication herein of Sadtler Standard Spectra® has been granted and all rights are reserved by Sadtler Research Laboratories, Inc.)

energy is lost as heat; the heat will be too small to be detected in most cases. This is the reason for a solution or a substance being colored. If the light were reemitted, then it would appear colorless.<sup>3</sup> In some cases, light will be emitted, usually at longer wavelengths; we discuss this more under the topic "Fluorescence."

Molecules lose most of the energy from absorbing radiation as heat, via collisional processes, that is, by increasing the kinetic energy of the collided molecules.

<sup>3</sup>With unidirectional parallel radiation, the solution should still appear colored, however, because the emitted light would be emitted as a point source in all directions.

## 14.2 ELECTRONIC SPECTRA AND MOLECULAR STRUCTURE

The electronic transitions that take place in the visible and ultraviolet regions of the spectrum are due to the absorption of radiation by specific types of groups, bonds, and functional groups within the molecule. The wavelength of absorption and the intensity are dependent on the type. The wavelength of absorption is a measure of the energy required for the transition. Its intensity is dependent on the probability of the transition occurring when the electronic system and the radiation interact and on the polarity of the excited state.

### Kinds of Transitions

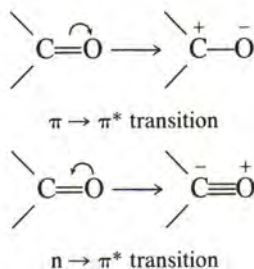
$\pi$  (double or triple bond) and  $n$  (outer-shell) electrons are responsible for most UV and visible electron transitions.

Electrons in a molecule can be classified into four different types. (1) Closed-shell electrons that are not involved in bonding. These have very high excitation energies and do not contribute to absorption in the visible or UV regions. (2) Covalent single-bond electrons ( $\sigma$ , or sigma, electrons). These also possess too high an excitation energy to contribute to absorption of visible or UV radiation (e.g., single-valence bonds in saturated hydrocarbons,  $-\text{CH}_2-\text{CH}_2-$ ). (3) Paired nonbonding outer-shell electrons ( $n$  electrons), such as those on N, O, S, and halogens. These are less tightly held than  $\sigma$  electrons and can be excited by visible or UV radiation. (4) Electrons in  $\pi$  (pi) orbitals, for example, in double or triple bonds. These are the most readily excited and are responsible for a majority of electronic spectra in the visible and UV regions.

Excited electrons go into antibonding ( $\pi^*$  or  $\sigma^*$ ) orbitals. Most transitions above 200 nm are  $\pi \rightarrow \pi^*$  or  $n \rightarrow \pi^*$ .

Electrons reside in orbitals. A molecule also possesses normally *unoccupied orbitals* called **antibonding orbitals**; these correspond to excited-state energy levels and are either  $\sigma^*$  or  $\pi^*$  orbitals. Hence, absorption of radiation results in an electronic transition to an antibonding orbital. The most common transitions are from  $\pi$  or  $n$  orbitals to antibonding  $\pi^*$  orbitals, and these are represented by  $\pi \rightarrow \pi^*$  and  $n \rightarrow \pi^*$  transitions, indicating a transition to an excited  $\pi^*$  state. The nonbonding  $n$  electron can also be promoted, at very short wavelengths, to an antibonding  $\sigma^*$  state:  $n \rightarrow \sigma^*$ . These occur at wavelengths less than 200 nm.

Examples of  $\pi \rightarrow \pi^*$  and  $n \rightarrow \pi^*$  transitions occur in ketones ( $\text{R}-\overset{\text{O}}{\parallel}{\text{C}}-\text{R}'$ ). Representing the electronic transitions by valence bond structures, we can write



Acetone, for example, exhibits a high-intensity  $\pi \rightarrow \pi^*$  transition and a low-intensity  $n \rightarrow \pi^*$  transition in its absorption spectrum. An example of  $n \rightarrow \pi^*$  transition occurs in ethers ( $\text{R}-\text{O}-\text{R}'$ ). Since this occurs below 200 nm, ethers as well as thioethers ( $\text{R}-\text{S}-\text{R}'$ ), disulfides ( $\text{R}-\text{S}-\text{S}-\text{R}$ ), alkyl amines ( $\text{R}-\text{NH}_2$ ),

and alkyl halides (R—X) are transparent in the visible and UV regions; that is, they have no absorption bands in these regions.

The relative intensity of an absorption band can be represented by its **molar absorptivity**,  $\epsilon$ , which is really a measure of the probability of the electron transition taking place. Molar absorptivity is proportional to the fraction of radiation absorbed at a given wavelength and will be described quantitatively below when we discuss Beer's law. For our purposes now, we can simply state that it represents the *absorbance* of radiation passing through a 1 M solution of 1-cm depth, where absorbance is  $-\log$  fraction of radiation transmitted.

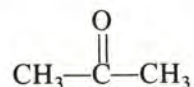
The probability of  $\pi \rightarrow \pi^*$  transitions is greater than for  $n \rightarrow \pi^*$  transitions, and so the intensities of the absorption bands are greater for the former. Molar absorptivities at the band maximum for  $\pi \rightarrow \pi^*$  transitions are typically 1000 to 100,000, while for  $n \rightarrow \pi^*$  transitions they are less than 1000;  $\epsilon$  is a direct measure of the intensities of the bands.

### Absorption by Isolated Chromophores

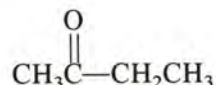
The absorbing groups in a molecule are called **chromophores**. A molecule containing a chromophore is called a **chromogen**. An **auxochrome** does not itself absorb radiation, but, if present in a molecule, it can enhance the absorption by a chromophore or shift the wavelength of absorption when attached to the chromophore. Examples are hydroxyl groups, amino groups, and halogens. These possess unshared ( $n$ ) electrons that can interact with the  $\pi$  electrons in the chromophore ( $n-\pi$  conjugation).

Spectral changes can be classed as follows: (1) **bathochromic shift**—absorption maximum shifted to longer wavelength, (2) **hypsochromic shift**—absorption maximum shifted to shorter wavelength, (3) **hyperchromism**—an increase in molar absorptivity, and (4) **hypochromism**—a decrease in molar absorptivity.

In principle, the spectrum due to a chromophore is not markedly affected by minor structural changes elsewhere in the molecule. For example, acetone,



and 2-butanone,



give spectra similar in shape and intensity. If the alteration is major or is very close to the chromophore, then changes can be expected.

Similarly, the spectral effects of two isolated chromophores in a molecule (separated by at least two single bonds) are, in principle, independent and are additive. Hence, in the molecule  $\text{CH}_3\text{CH}_2\text{CNS}$ , an absorption maximum due to the CNS group occurs at 245 nm with an  $\epsilon$  of 800. In the molecule  $\text{SNCCCH}_2\text{CH}_2\text{CH}_2\text{CNS}$ , an absorption maximum occurs at 247 nm, with approximately double the intensity ( $\epsilon = 2000$ ). Interaction between chromophores may perturb the electronic energy levels and alter the spectrum.

**TABLE 14.2**  
**Electronic Absorption Bands for Representative Chromophores<sup>a</sup>**

Chromophore	System	$\lambda_{max}$	$\epsilon_{max}$
Amine	—NH <sub>2</sub>	195	2,800
Ethylene	—C=C—	190	8,000
Ketone	$\begin{array}{c} \diagdown \\ \text{C}=\text{O} \\ \diagup \end{array}$	195	1,000
		270–285	18–30
Aldehyde	—CHO	210	Strong
		280–300	11–18
Nitro	—NO <sub>2</sub>	210	Strong
Nitrite	—ONO	220–230	1,000–2,000
		300–400	10
Azo	—N=N—	285–400	3–25
Benzene		184	46,700
		202	6,900
		255	170
		220	112,000
Naphthalene		275	5,600
		312	175
		252	199,000
Anthracene		375	7,900

<sup>a</sup>From M. M. Willard, L. L. Merritt, and J. A. Dean, *Instrumental Methods of Analysis*, 4th ed. Copyright © 1948, 1951, 1958, 1965, by Litton Educational Publishing, Inc., by permission of Van Nostrand Reinhold Company.

Table 14.2 lists some common chromophores and their approximate wavelengths of maximum absorption.

It should be noted that exact wavelengths of an absorption band and the probability of absorption (intensity) cannot be calculated, and the analyst always runs standards under carefully specified conditions (temperature, solvent, concentration, instrument type, etc.). Modern instruments may have databases of standard spectra, and standard catalogues of spectra are available for reference.

### Absorption by Conjugated Chromophores


Where multiple (e.g., double, triple) bonds are separated by just one single bond each, they are said to be conjugated. The  $\pi$  orbitals overlap, which decreases the energy gap between adjacent orbitals. The result is a bathochromic shift in the absorption spectrum and generally an increase in the intensity. The greater the degree of conjugation (i.e., several alternating double, or triple, and single bonds), the greater the shift. Conjugation of multiple bonds with nonbonding electrons

( $n-\pi$  conjugation) also results in spectral changes, for example,  $\begin{array}{c} \diagdown \\ \text{C}=\text{CH}-\text{NO}_2 \\ \diagup \end{array}$ .

### Absorption by Aromatic Compounds

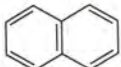
Aromatic systems (containing phenyl or benzene groups) exhibit conjugation. The spectra are somewhat different, however, than in other conjugated systems, being

Aromatic compounds are good absorbers of UV radiation.


more complex. Benzene, , absorbs strongly at 200 nm ( $\epsilon_{\max} = 6900$ ) with a

weaker band at 230–270 nm ( $\epsilon_{\max} = 170$ ); see Figure 14.7. The weaker band exhibits considerable fine structure, each peak being due to the influence of vibrational sublevels on the electronic transitions.

As substituted groups are added to the benzene ring, a smoothing of the fine structure generally results, with a bathochromic shift and an increase in intensity. Hydroxy ( $-\text{OH}$ ), methoxy ( $-\text{OCH}_3$ ), amino ( $-\text{NH}_2$ ), nitro ( $-\text{NO}_2$ ), and aldehydic ( $-\text{CHO}$ ) groups, for example, increase the absorption about tenfold; this large effect is due to  $n-\pi$  conjugation. Halogens and methyl ( $-\text{CH}_3$ ) groups act as auxochromes.

Polynuclear aromatic compounds (fused benzene rings), for example, naphthalene, , have increased conjugation and so absorb at longer wave-

lengths. Naphthacene (four rings) has an absorption maximum at 470 nm (visible) and is yellow, and pentacene (five rings) has an absorption maximum at 575 nm and is blue (see Table 14.1).

In polyphenyl compounds, , para-linked molecules (1,6 positions, as shown) are capable of resonance interactions (conjugation) over the entire system, and increased numbers of para-linked rings result in bathochromic shifts (e.g., from 250 nm to 320 nm in going from  $n = 0$  to  $n = 4$ ). In meta-linked molecules (1,3 positions), however, such conjugation is not possible and no ap-

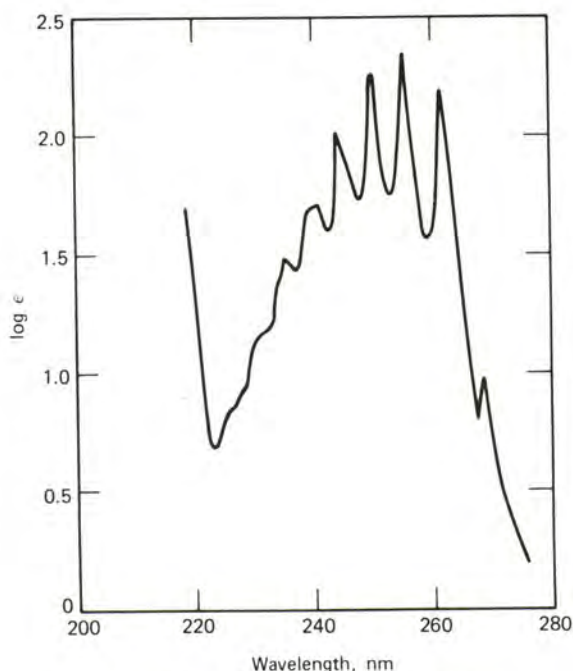



FIGURE 14.7 Ultraviolet spectrum of benzene.

preciable shift occurs up to  $n = 16$ . The intensity of absorption increases, however, due to the additive effects of the identical chromophores.

Many heterocyclic aromatic compounds, for example, pyridine, , absorb in the UV region, and added substituents will cause spectral changes as for phenyl compounds.

Indicator dyes used for acid–base titrations and redox titrations (Chapters 7 and 12) are extensively conjugated systems and therefore absorb in the visible region. Loss or addition of a proton or an electron will markedly change the electron distribution and hence the color.

An absorbing derivative of a nonabsorbing analyte can often be prepared.

If a compound (organic or inorganic) does not absorb in the ultraviolet or visible region, it may be possible to prepare a derivative of it that does. For example, proteins will form a colored complex with copper(II) (biuret reagent). Metals form highly colored chelates with many of the organic precipitating reagents listed in Table 5.2 in Chapter 5, as well as with others. These may be dissolved or extracted (Chapter 16) in an organic solvent such as ethylene chloride and the color of the solution measured spectrometrically. The mechanism of absorption of radiation by inorganic compounds is described below.

Spectrometric measurements in the visible region or the ultraviolet region (particularly the former) are widely employed in clinical chemistry, frequently by forming a derivative or reaction product that is colored and can be related to the test substance. For example, creatinine in blood is reacted with picrate ion in alkaline solution to form a colored product that absorbs at 490 nm. Iron is reacted with bathophenanthroline and measured at 535 nm; inorganic phosphate is reacted with molybdenum(VI) and the complex formed is reduced to form “molybdenum blue” (a +5 species) that absorbs at 660 nm; and uric acid is oxidized with alkaline phosphotungstate, and the blue reduction product of phosphotungstate is measured at 680 nm. Ultraviolet measurements include the determination of barbiturates in alkaline solution at 252 nm, and the monitoring of many enzyme reactions by following the change in absorbance at 340 nm due to changes in the reduced form of nicotinamide adenine dinucleotide (NADH), a common reactant or product in enzyme reactions. Clinical measurements are discussed in more detail in Chapter 19.

### Inorganic Compounds

The absorption of ultraviolet or visible radiation by a metal complex can be ascribed to one or more of the following transitions: (1) *excitation of the metal ion*, (2) *excitation of the ligand*, or (3) *charge transfer transition*. Excitation of the metal ion in a complex usually has a very low molar absorptivity ( $\epsilon$ ), on the order of 1 to 100, and is not useful for quantitative analysis. Most ligands used are organic chelating agents that exhibit the absorption properties discussed above, that is, can undergo  $\pi \rightarrow \pi^*$  and  $n \rightarrow \pi^*$  transitions. Complexation with a metal ion is similar to protonation of the molecule and will result in a change in the wavelength and intensity of absorption. These changes are slight in most cases.

The intense color of metal chelates is frequently due to charge transfer transitions. This is simply the movement of electrons from the metal ion to the ligand, or vice versa. Such transitions include promotion of electrons from  $\pi$  levels in the ligand or from  $\sigma$  bonding orbitals to the unoccupied orbitals of the metal ion, or promotion of  $\sigma$ -bonded electrons to unoccupied  $\pi$  orbitals of the ligand.

When such transitions occur, a redox reaction actually occurs between the metal ion and the ligand. Usually, the metal ion is reduced and the ligand is oxidized, and the wavelength (energy) of maximum absorption is related to the ease with which the exchange occurs. A metal ion in a lower oxidation state, complexed with a high electron affinity ligand, may be oxidized without destroying the complex. An important example is the 1,10-phenanthroline chelate of iron(II).

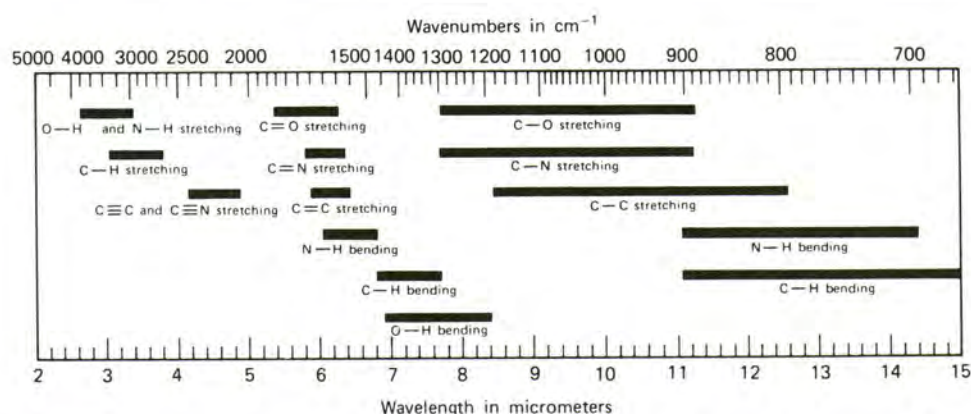
Charge transfer transitions are extremely intense, with  $\epsilon$  values typically 10,000 to 100,000; they occur in either the visible or UV regions. The intensity (ease of charge transfer) is increased by increasing the extent of conjugation in the ligand. Metal complexes of this type are intensely colored due to their high absorption and are well suited for the detection and measurement of trace concentration of metals.

Charge transfer transitions between a metal ion and complexing ligand are very intense.

### 14.3 INFRARED ABSORPTION AND MOLECULAR STRUCTURE

Absorbing (vibrating) groups in the infrared region absorb within a certain wavelength region, and the exact wavelength will be influenced by neighboring groups. The absorption peaks are much sharper than in the ultraviolet or visible regions, however, and easier to identify. In addition, each molecule will have a complete absorption spectrum unique to that molecule, and so a "fingerprint" of the molecule is obtained. See, for example, the top spectrum in Figure 14.4. Catalogues of infrared spectra are available for a large number of compounds for comparison purposes. See the references at the end of the chapter. Mixtures of absorbing compounds will, of course, exhibit the combined spectra of compounds. Even so, it is often possible to identify the individual compounds from the absorption peaks of specific groups on the molecules. Figure 14.8 summarizes regions where certain types of groups absorb. Absorption in the 6- to 15- $\mu\text{m}$  region is very dependent on the molecular environment, and this is called the **fingerprint region**. A molecule can be identified by a comparison of its unique absorption in this region with catalogued known spectra.

The IR region is the "fingerprint" region.



**FIGURE 14.8** Simple correlations of group vibrations to regions of infrared absorption. (From R. T. Conley, *Infrared Spectroscopy*, 2nd ed. Boston: Allyn and Bacon, Inc., 1972. Reproduced by permission of Allyn and Bacon, Inc.)



Although the most important use of infrared spectroscopy is in identification and structure analysis, it is useful for quantitative analysis of complex mixtures of similar compounds because some absorption peaks for each compound will occur at a definite and selective wavelength, with intensities proportional to the concentration of absorbing species.

#### 14.4 NEAR-INFRARED SPECTROMETRY

The mid-infrared region (mid-IR) (1.5–25  $\mu\text{m}$ ) is widely used for qualitative purposes because of the fine structure information of the spectra. Quantitative analysis is more limited because of the necessity of diluting samples to make measurements and the difficulty in finding solvents that do not absorb in the regions of interest. The region of the spectrum from 0.75  $\mu\text{m}$  to 2.5  $\mu\text{m}$  (750–2500 nm) is called the **near-infrared** region (NIR region). Absorption bands in this region are weak and rather featureless but are useful for nondestructive quantitative measurements, for example, for analysis of solid samples. They are due to vibrational **overtones** and **combination bands**, which are *forbidden transitions* of low probability and hence the reason they are weak. These are related to fundamental vibrations in the mid-IR. Excitation of a molecule from the ground vibrational state to a higher vibrational state, where the vibrational quantum number  $\nu$  is  $\geq 2$ , results in overtone absorptions. Thus, the first overtone band results from a  $\nu = 0$  to  $\nu = 2$  transition, while the second and third overtones result from a  $\nu = 0$  to  $\nu = 3$ , and a  $\nu = 0$  to  $\nu = 4$  transition, respectively. Combination absorption bands arise when two different molecular vibrations are excited simultaneously. The intensity of overtone bands decreases by approximately one order of magnitude for each successive overtone. Absorption in the NIR is due mainly to C—H, O—H, and N—H bond stretching and bending motions.

The NIR region can be further subdivided into the short-wavelength NIR (750–1100 nm) and the long-wavelength NIR (1100–2500 nm). These subdivisions are based solely on the types of detectors used for the two regions (silicon detectors for the former and PbS, InGaAs, or germanium detectors for the latter). Absorbances are generally weaker in the short wavelength NIR region. So a 1–10 cm path length may be used for this, while a shorter 1–10 mm cell may be required for the long-wavelength NIR. This is an important distinction, because the longer path length will give a more representative measurement of the sample. NIR absorption, in general, is 10–1000 times less intense than in the mid-IR region, and so samples are usually run “neat” as powders, slurries, or solutions, with no dilution. In the mid-IR, samples are usually diluted, in the form of KBr pellets, thin films, mulls, or solutions, and cell path lengths are limited to between 15  $\mu\text{m}$  and 1 mm.

While near-IR spectra are rather featureless and have low absorption, the signal-to-noise ratio is high due to intense radiation sources, high radiation throughput, and sensitive detectors in near-IR spectrometers. The operating noise range for the mid-IR is typically in the milliabsorbance range, while near-IR detectors operate at microabsorbance noise levels, 1000 times lower (see definition of absorbance, which follows). Hence, with proper calibration, excellent quantitative results can be achieved. Because of its penetration of undiluted samples and the ability to use relatively long path length cells, NIR is useful for

NIR absorption is useful for nondestructive quantitative measurements. For example, the protein content of grains can be rapidly measured.

nondestructive and rapid measurements of more representative samples. However, the low resolution of the technique limited its use for many years until the advent of laboratory computers and the development of statistical (chemometric) techniques to "train" instruments to recognize and resolve analyte spectra in a complex sample matrix. In essence, calibrating standards containing the analyte at different concentrations in the sample matrix are used as training sets from whose spectra the instrument's computer software is able to extract the analyte spectrum and prepare a calibration curve. Generally, the entire spectrum is measured simultaneously (see Instrumentation, below) and hundreds or thousands of wavelengths are used to extract the spectrum.

## 14.5 SOLVENTS FOR SPECTROMETRY

Obviously, the solvent used to prepare the sample must not absorb appreciably in the wavelength region where the measurement is being made. In the visible region, this is no problem. There are many colorless solvents and, of course, water is used for inorganic substances. Water can be used in the ultraviolet region. Many substances measured in the ultraviolet region are organic compounds that are insoluble in water and so an organic solvent must be used. Table 14.3 lists a number of solvents for use in the ultraviolet region. The cutoff point is the lowest wavelength at which the absorbance (see below) approaches unity, using a 1-cm cell with water as the reference. These solvents can all be used at least up to the visible region.

The choice of solvent will sometimes affect the spectrum in the ultraviolet region due to solvent-solute interactions. In going from a nonpolar to a polar

**TABLE 14.3**

**Lower Transparency Limit of Solvents in the Ultraviolet Region**

<i>Solvent</i>	<i>Cutoff Point, nm<sup>a</sup></i>	<i>Solvent</i>	<i>Cutoff Point, nm<sup>a</sup></i>
Water	200	Dichloromethane	233
Ethanol (95%)	205	Butyl ether	235
Acetonitrile	210	Chloroform	245
Cyclohexane	210	Ethyl propionate	255
Cyclopentane	210	Methyl formate	260
Heptane	210	Carbon tetrachloride	265
Hexane	210	<i>N,N</i> -Dimethylformamide	270
Methanol	210	Benzene	280
Pentane	210	Toluene	285
Isopropyl alcohol	210	<i>m</i> -Xylene	290
Isooctane	215	Pyridine	305
Dioxane	220	Acetone	330
Diethyl ether	220	Bromoform	360
Glycerol	220	Carbon disulfide	380
1,2-Dichloroethane	230	Nitromethane	380

<sup>a</sup>Wavelength at which the absorbance is unity for a 1-cm cell, with water as the reference.

Transparent solvents in the IR region are limited. Rather concentrated solutions of the sample must often be used.

solvent, loss of fine structure may occur and the wavelength of maximum absorption may shift (either bathochromic or hypsochromic, depending on the nature of the transition and the type of solute–solvent interactions).

The problem of finding a suitable solvent is more serious in the infrared region, where it is difficult to find one that is completely transparent. The use of either carbon tetrachloride or carbon disulfide (health effects aside) will cover the most widely used region of 2.5 to 15  $\mu\text{m}$  (see Figure 14.4). Water exhibits strong absorption bands in the infrared region, and it can be employed only for certain portions of the spectrum. Also, special cell materials compatible with water must be used; rock salt is usually used in cells for infrared measurements because glass absorbs the radiation, but rock salt would dissolve in water. The solvents must be moisture-free if rock salt cells are used.

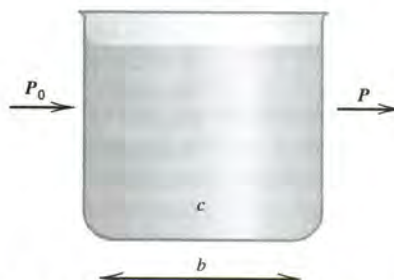
## 14.6 QUANTITATIVE CALCULATIONS

The fraction of radiation absorbed by a solution of an absorbing analyte can be quantitatively related to its concentration. Here, we present calculations for single species and for mixtures of absorbing species.

### Beer's Law

This is not a beverage law, although it applies to the absorption of radiation by beer (to make it yellow)!

The amount of monochromatic radiation absorbed by a sample is described by the Beer-Bouguer-Lambert law, commonly called **Beer's law**. Consider the absorption of monochromatic radiation as in Figure 14.9. Incident radiation of radiant power  $P_0$  passes through a solution of an absorbing species at concentration  $c$  and path length  $b$ , and the emergent (transmitted) radiation has radiant power  $P$ . This radiant power is the quantity measured by spectrometric detectors. Bouguer in 1729 and Lambert in 1760 recognized that when electromagnetic energy is absorbed, the power of the transmitted energy decreases geometrically (exponentially). Assume, for example, that 25% of the radiant energy in Figure 14.9 is absorbed in a path length of  $b$ . Twenty-five percent of the remaining energy (25% of  $0.75P_0$ ) will be absorbed in the next path length  $b$ , leaving 56.25% as the emergent radiation. Twenty-five percent of this would be absorbed in another path



**FIGURE 14.9** Absorption of radiation.  $P_0$  = power of incident radiation,  $P$  = power of transmitted radiation,  $c$  = concentration,  $b$  = path length.

length of  $b$ , and so on, so that an infinite path length would be required to absorb all the radiant energy. Since the fraction of radiant energy transmitted decays exponentially with path length, we can write it in exponential form:

$$T = \frac{P}{P_0} = 10^{-kb} \quad (14.4)$$

where  $k$  is a constant and  $T$  is called the **transmittance**, the fraction of radiant energy transmitted. Putting this in logarithmic form,

$$\log T = \log \frac{P}{P_0} = -kb \quad (14.5)$$

In 1852, Beer and Bernard each stated that a similar law holds for the dependence of  $T$  on the concentration,  $c$ :

$$T = \frac{P}{P_0} = 10^{-k'c} \quad (14.6)$$

where  $k'$  is a new constant, or

$$\log T = \log \frac{P}{P_0} = -k'c \quad (14.7)$$

Combining these two laws, we have "Beer's" law, which describes the dependence of  $T$  on both the path length and the concentration.

$$T = \frac{P}{P_0} = 10^{-abc} \quad (14.8)$$

where  $a$  is a combined constant of  $k$  and  $k'$ , and

$$\log T = \log \frac{P}{P_0} = -abc \quad (14.9)$$

It is more convenient to omit the negative sign on the right-hand side of the equation and to define a new term, **absorbance**:

$$A = -\log T = \log \frac{1}{T} = \log \frac{P_0}{P} = abc \quad (14.10)$$

where  $A$  is the absorbance. This is the common form of Beer's law. Note that it is the *absorbance* that is directly proportional to the concentration.

Beer's law is as simple as abc!

The percent transmittance is given by

$$\% T = \frac{P}{P_0} \times 100 \quad (14.11)$$

Equation 14.10 can be rearranged. Since  $T = \% T/100$ ,

$$A = \log \frac{100}{\% T} = \log 100 - \log \% T$$

Or

$A = 2.00 - \log \% T$ <p style="text-align: center;">and</p> $\% T = \text{antilog}(2.00 - A)$	(14.12)
---	---------

The path length  $b$  in Equation 14.10 is expressed in centimeters and the concentration  $c$  in grams per liter. The constant  $a$  is called the **absorptivity** and is dependent on the wavelength and the nature of the absorbing material. In an absorption spectrum, the absorbance varies with wavelength in direct proportion to  $a$  ( $b$  and  $c$  are held constant). The product of the absorptivity and the molecular weight of the absorbing species is called the **molar absorptivity**  $\epsilon$ . Thus,

$A = \epsilon bc$	(14.13)
-------------------	---------

where  $c$  is now in *moles per liter*. The cell path length in ultraviolet and visible spectrophotometry is often 1 cm;  $\epsilon$  has the units  $\text{cm}^{-1} \text{mol}^{-1} \text{L}$ , while  $a$  has the units  $\text{cm}^{-1} \text{g}^{-1} \text{L}$ . The absorptivity  $a$  may be used with units other than g/L and, for example, concentrations may be expressed in ppm. But the recommended units for publication are as just described. Beer's law holds strictly for monochromatic radiation, since the absorptivity varies with wavelength.

We have used the symbols and terminology recommended by the journal *Analytical Chemistry*. Other terms—such as optical density (OD) in place of absor-

**TABLE 14.4**

**Spectrometry Nomenclature**

<i>Recommended Name</i>	<i>Older Names or Symbols</i>
Absorbance ( $A$ )	Optical density (OD), extinction, absorbancy
Absorptivity ( $a$ )	Extinction coefficient, absorbancy index, absorbing index
Path length ( $b$ )	$l$ or $d$
Transmittance ( $T$ )	Transmittancy, transmission
Wavelength (nm)	$m\mu$ (millicron)

The absorptivity varies with wavelength and represents the absorption spectrum.

$$a = \text{cm}^{-1} \text{g}^{-1} \text{L}$$

$$\epsilon = \text{cm}^{-1} \text{mol}^{-1} \text{L}$$

There are many Beer's law symbols and terms in the literature. Here are some of them.

bance, and extinction coefficient in place of absorptivity—may appear, especially in the older literature, but their use is not now recommended. Table 14.4 lists some of the older nomenclature.

**EXAMPLE 14.1** A sample in a 1.0-cm cell is determined with a spectrometer to transmit 80% light at a certain wavelength. If the absorptivity of this substance at this wavelength is 2.0, what is the concentration of the substance?

**Solution**

The percent transmittance is 80%, and so  $T = 0.80$ :

$$\log \frac{1}{0.80} = 2.0 \text{ cm}^{-1} \text{ L} \times 1.0 \text{ cm} \times c$$

$$\log 1.25 = 2.0 \text{ g}^{-1} \text{ L} \times c$$

$$c = \frac{0.10}{2.0} = 0.050 \text{ g/L}$$

$T$  is unitless. Check dimensional units.

**EXAMPLE 14.2** A solution containing 1.00 mg ion (as the thiocyanate complex) in 100 mL was observed to transmit 70.0% of the incident light compared to an appropriate blank. (a) What is the absorbance of the solution at this wavelength? (b) What fraction of light would be transmitted by a solution of iron four times as concentrated?

**Solution**

(a)  $T = 0.700$

$$A = \log \frac{1}{0.700} = \log 1.43 = 0.155$$

(b)  $0.155 = ab(0.0100 \text{ g/L})$

$$ab = 15.5 \text{ L/g}$$

Therefore,

$$A = 15.5 \text{ L/g} (4 \times 0.0100 \text{ g/L}) = 0.620$$

$$\log \frac{1}{T} = 0.620$$

$$T = 0.240$$

The absorbance of the new solution could have been calculated more directly:

$$\frac{A_1}{A_2} = \frac{abc_1}{abc_2} = \frac{c_1}{c_2}$$

$$A_2 = A_1 \times \frac{c_2}{c_1} = 0.155 \times \frac{4}{1} = 0.620$$

**EXAMPLE 14.3** Amines,  $\text{RNH}_2$ , react with picric acid to form amine picrates which absorb strongly at 359 nm ( $\epsilon = 1.25 \times 10^4$ ). An unknown amine (0.1155 g) is dissolved in water and diluted to 100 mL. If this solution exhibits an absorbance of 0.454 at 359 nm using a 1.00-cm cell, what is the formula weight of the amine? What is a probable formula?

**Solution**

$$A = \epsilon bc$$

$$0.454 = 1.25 \times 10^4 \text{ cm}^{-1} \text{ mol}^{-1} \text{ L} \times 1.00 \text{ cm} \times c$$

$$c = 3.63 \times 10^{-5} \text{ mol/L}$$

$$\frac{(3.63 \times 10^{-5} \text{ mol/L})(0.250 \text{ L})}{1.00 \text{ mL}} \times 100 \text{ mL} = 9.08 \times 10^{-4} \text{ mol in original flask}$$

$$\frac{0.1155 \text{ g}}{9.08 \times 10^{-4} \text{ mol}} = 127.2 \text{ g/mol}$$

The formula weight of chloroaniline,  $\text{ClC}_6\text{H}_4\text{NH}_2$ , is 127.6, and so this is the probable amine.

**EXAMPLE 14.4** Chloroaniline in a sample is determined as the amine picrate as described in Example 14.3. A 0.0265-g sample is reacted with picric acid and diluted to 1 L. The solution exhibits an absorbance of 0.368 in a 1-cm cell. What is the percentage chloroaniline in the sample?

**Solution**

$$A = \epsilon bc$$

$$0.368 = 1.2 \times 10^4 \text{ cm}^{-1} \text{ mol}^{-1} \text{ L} \times 1.00 \text{ cm} \times c$$

$$c = 2.94 \times 10^{-5} \text{ mol/L}$$

$$(2.94 \times 10^{-5} \text{ mol/L})(127.6 \text{ g/mol}) = 3.75 \times 10^{-3} \text{ g chloroaniline}$$

$$\frac{3.75 \times 10^{-3} \text{ g}}{2.65 \times 10^{-2} \text{ g}} \times 100\% = 15.0\%$$

### Mixtures

It is possible to make quantitative calculations when two absorbing species in solution have overlapping spectra. It is apparent from Beer's law that the total absorbance  $A$  at a given wavelength will be equal to the sum of the absorbances of all absorbing species. For two absorbing species, then, if  $c$  is in grams per liter,

$$A = a_x b c_x + a_y b c_y$$

(14.14)

or if  $c$  is in moles per liter,

$$A = \epsilon_x b c_x + \epsilon_y b c_y \quad (14.15)$$

The absorbances of individual absorbing species are additive.

where the subscripts refer to substances  $x$  and  $y$ , respectively.

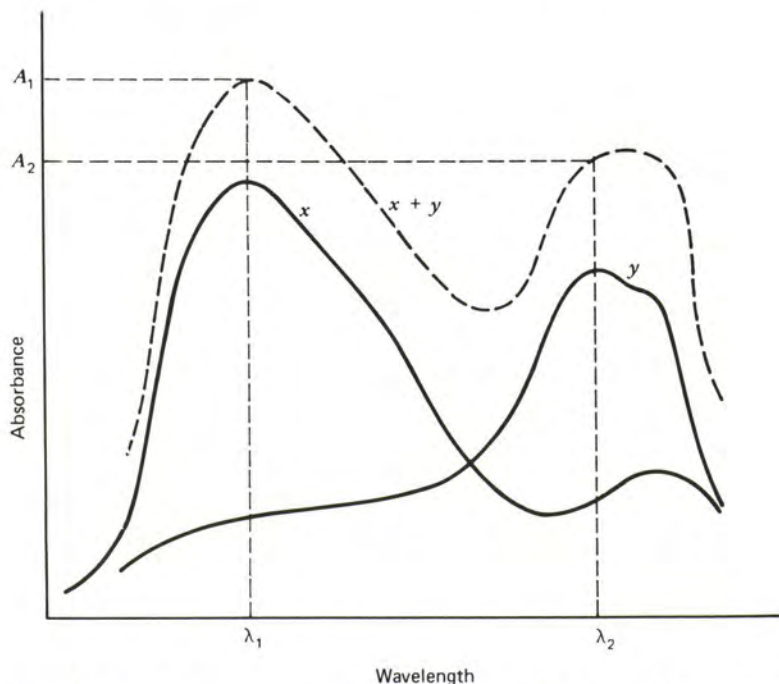
Consider, for example, the determination of substances  $x$  and  $y$  whose individual absorption spectra at their given concentration would appear as the solid curves in Figure 14.10, and the combined spectrum of the mixture is the dashed curve. Since there are two unknowns, two measurements will have to be made. The technique is to choose two wavelengths for measurement, one occurring at the absorption maximum for  $x$  ( $\lambda_1$  in the figure) and the other at the maximum for  $y$  ( $\lambda_2$  in the figure). We can write, then,

$$A_1 = A_{x1} + A_{y1} = \epsilon_{x1} b c_x + \epsilon_{y1} b c_y \quad (14.16)$$

$$A_2 = A_{x2} + A_{y2} = \epsilon_{x2} b c_x + \epsilon_{y2} b c_y \quad (14.17)$$

where  $A_1$  and  $A_2$  are the absorbances at wavelengths 1 and 2, respectively (for the mixture);  $A_{x1}$  and  $A_{y1}$  are the absorbances contributed by  $x$  and  $y$ , respectively, at wavelength 1; and  $A_{x2}$  and  $A_{y2}$  are the absorbances contributed by  $x$  and  $y$ , respectively, at wavelength 2. Similarly,  $\epsilon_{x1}$  and  $\epsilon_{y1}$  are the molar absorptivities of  $x$  and  $y$ , respectively, at wavelength 1; while  $\epsilon_{x2}$  and  $\epsilon_{y2}$  are the molar absorptivities of  $x$  and  $y$ , respectively, at wavelength 2. These molar absorptivities are determined by making absorbance measurements on pure solutions (known molar

We have two unknowns ( $C_x$  and  $C_y$ ). We need to write two equations that can be solved simultaneously.



**FIGURE 14.10** Absorption spectra of pure substances  $x$  and  $y$  of a mixture of  $x$  and  $y$  at the same concentrations.



concentrations) of  $x$  and  $y$  at wavelengths 1 and 2. So  $C_x$  and  $C_y$  become the only two unknowns in Equations 14.16 and 14.17, and they can be calculated from the solution of the two simultaneous equations.

**EXAMPLE 14.5** Potassium dichromate and potassium permanganate have overlapping absorption spectra in 1 M  $\text{H}_2\text{SO}_4$ .  $\text{K}_2\text{Cr}_2\text{O}_7$  has an absorption maximum at 440 nm, and  $\text{KMnO}_4$  has a band at 545 nm (the maximum is actually at 525 nm, but the longer wavelength is generally used where interference from  $\text{K}_2\text{Cr}_2\text{O}_7$  is less). A mixture is analyzed by measuring the absorbance at these two wavelengths with the following results:  $A_{440} = 0.405$ ,  $A_{545} = 0.712$  in a 1-cm cell (approximate; exact length not known). The absorbances of pure solutions of  $\text{K}_2\text{Cr}_2\text{O}_7$  ( $1.00 \times 10^{-3} \text{ M}$ ) and  $\text{KMnO}_4$  ( $2.00 \times 10^{-4} \text{ M}$ ) in 1 M  $\text{H}_2\text{SO}_4$ , using the same cell gave the following results:  $A_{\text{Cr},440} = 0.374$ ,  $A_{\text{Cr},545} = 0.009$ ,  $A_{\text{Mn},440} = 0.019$ ,  $A_{\text{Mn},545} = 0.475$ . Calculate the concentrations of dichromate and permanganate in the sample solution.

**Solution**

The path length  $b$  is not known precisely; but since the same cell is used in all measurements, it is constant. We can calculate the product  $\epsilon b$  from the calibration measurements and use this constant in calculations (call the constant  $k$ ):

$$0.374 = k_{\text{Cr},440} \times 1.00 \times 10^{-3}; \quad k_{\text{Cr},440} = 374$$

$$0.009 = k_{\text{Cr},545} \times 1.00 \times 10^{-3}; \quad k_{\text{Cr},545} = 9$$

$$0.019 = k_{\text{Mn},440} \times 2.00 \times 10^{-4}; \quad k_{\text{Mn},440} = 95$$

$$0.475 = k_{\text{Mn},545} \times 2.00 \times 10^{-4}; \quad k_{\text{Mn},545} = 2.38 \times 10^3$$

$$A_{440} = k_{\text{Cr},440}[\text{Cr}_2\text{O}_7^{2-}] + k_{\text{Mn},440}[\text{MnO}_4^-]$$

$$A_{545} = k_{\text{Cr},545}[\text{Cr}_2\text{O}_7^{2-}] + k_{\text{Mn},545}[\text{MnO}_4^-]$$

$$0.405 = 374[\text{Cr}_2\text{O}_7^{2-}] + 95[\text{MnO}_4^-]$$

$$0.712 = 9[\text{Cr}_2\text{O}_7^{2-}] + 2.38 \times 10^3[\text{MnO}_4^-]$$

Solving simultaneously,

$$[\text{Cr}_2\text{O}_7^{2-}] = 1.01 \times 10^{-3} \text{ M}; \quad [\text{MnO}_4^-] = 2.95 \times 10^{-4} \text{ M}$$

Note that for Cr at 545 nm, where it overlaps the main Mn peak, the absorbance was measured to only one figure, since it was so small. This is fine. The smaller the necessary correction, the better. Ideally, it should be zero.

If the two spectral curves overlap only at one of the wavelengths, the solution becomes simpler. For example, if the spectrum of  $x$  does not overlap with that of  $y$  at wavelength 2, the concentration of  $y$  can be determined from a single measurement at wavelength 2, just as if it were not in a mixture. The concentration of  $x$  can then be calculated from the absorbance at wavelength 1 by subtracting the contribution of  $y$  to the absorbance at that wavelength, that is, from Equation 14.16. The molar absorptivity of  $y$  must, of course, be determined at wavelength

If the path length is held fixed, it becomes part of the constant.

1. If there is no overlap of either spectrum at the wavelength of measurement (usually at maximum absorbance), then each substance can be determined in the usual manner.

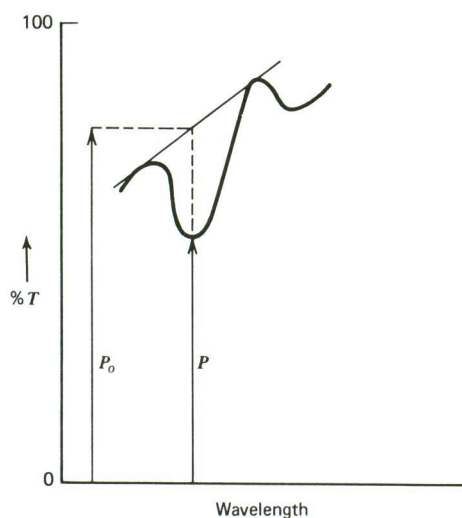
In making these difference measurements, we have assumed that Beer's law holds over the concentration ranges encountered. If one substance is much more concentrated than the other, then its absorbance may be large at both wavelengths compared to that of the other substance, with the result that the determination of this other substance will not be very accurate.

Modern digital instruments that record the entire spectrum of a solution often incorporate mathematical algorithms that will compute the concentrations of several different analytes with overlapping spectra, by utilizing the absorbance values at many different wavelengths (to overestimate the data and improve the confidence) and perform the simultaneous equation calculations by computer. See diode array spectrometers in Section 14.9.

With multiple wavelength measurements, we may analyze for a half dozen or more components! See Section 14.9 and Figure 14.25.

### Quantitative Measurements from Infrared Spectra

Infrared instruments usually record the percent transmittance as a function of wavelength. The presence of scattered radiation, especially at higher concentrations in infrared work, makes direct application of Beer's law difficult. Also, due to rather weak sources, it is necessary to use relatively wide slits (which give rise to apparent deviations from Beer's law—see below). Therefore, empirical methods are usually employed in quantitative infrared analysis, keeping experimental conditions constant. The **baseline** or **ratio method** is often used, and this is illustrated in Figure 14.11. A peak is chosen that does not fall too close to others of the test substance or of other substances. A straight line is drawn at the base of the band, and  $P$  and  $P_0$  are measured at the absorption peak. (The curve is upside down from the usual absorption spectrum, because transmittance is recorded against wavelength.)  $\log P_0/P$  is plotted against concentration in the usual manner. Unknowns are compared against standards run under the same instrumental



**FIGURE 14.11** The baseline method for quantitative determination in the infrared region of the spectrum.

conditions. This technique minimizes relative errors which are in proportion to the sample size, but it does not eliminate simple additive errors, such as those that offset the baseline.

## 14.7 PRINCIPLES OF INSTRUMENTATION

A *spectrometer* is an instrument that will resolve polychromatic radiation into different wavelengths. A block diagram of a spectrometer is shown in Figure 14.12. All spectrometers require (1) a **source** of continuous radiation over the wavelengths of interest, (2) a **monochromator** for selecting a narrow band of wavelengths from the source spectrum, (3) a **detector**, or transducer, for converting radiant energy into electrical energy, and (4) a device to read out the response of the detector. The sample may precede or follow the monochromator. Each of these, except the readout device, will vary depending on the wavelength region.

The types of instrument components will depend on the wavelength region.

### Sources

The source should have a readily detectable output of radiation over the wavelength region for which the instrument is designed to operate. No source, however, has a constant spectral output. The most commonly employed source for the **visible** region is a *tungsten filament incandescent lamp*. The spectral output of a typical filament bulb is illustrated in Figure 14.13. The useful wavelength range is from about 325 or 350 nm to 3  $\mu\text{m}$ , so it can also be used in the near-ultraviolet and near-infrared regions. The wavelength of maximum emission can be shifted to shorter wavelengths by increasing the voltage to the lamp and hence the temperature of the filament, but its lifetime is shortened. For this reason, a stable, regulated power supply is required to power the lamp. This is true for sources for other regions of the spectrum also. Sometimes, a 6-V storage battery is used as the voltage source.

Sources for:  
 VIS—incandescent lamp  
 UV—H<sub>2</sub> or D<sub>2</sub> discharge tube  
 IR—rare earth oxide or silicon carbide glowers

For the **ultraviolet** region, a low-pressure *hydrogen* or *deuterium discharge tube* is generally used as the source. Each of these can be used from 185 to about 375 nm, but the deuterium source has about three times the spectral output of the hydrogen source. Ultraviolet sources must have a quartz window, because glass is not transparent to ultraviolet radiation. They are frequently water-cooled to dissipate the heat generated.

**Infrared** radiation is essentially heat, and so hot wires, light bulbs, or glowing ceramics are used as sources. The energy distribution from the black body sources tends to peak at about 100–2000 nm (near-IR) and then tails off in the mid-IR. Infrared spectrometers usually operate from about 2 to 15  $\mu\text{m}$ , and because of the relatively low-intensity radiation in this region, relatively large slits

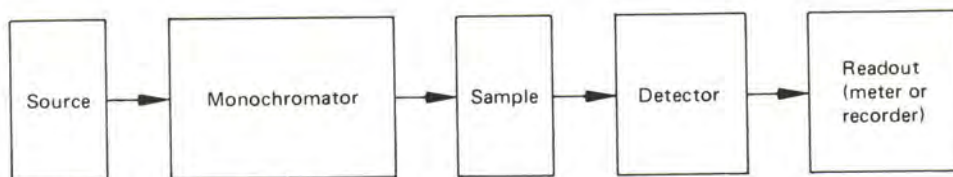
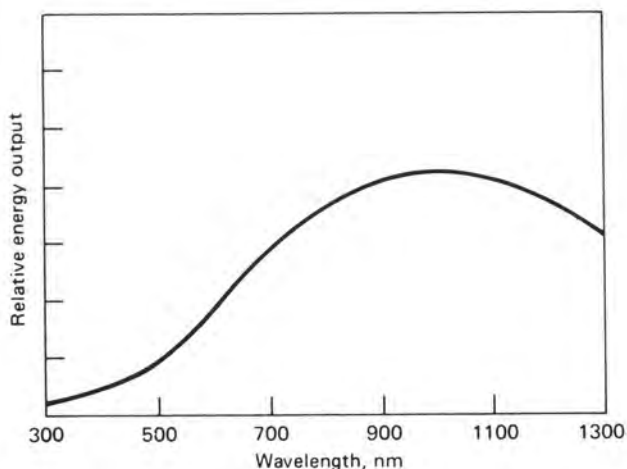


FIGURE 14.12 Block diagram of a spectrometer.



**FIGURE 14.13** Intensity of radiation as a function of wavelength for a typical tungsten bulb at 3000 K.

are used to increase the light throughput. But this degrades the wavelength resolution. For this reason, an interferometer is preferred for its increased throughput (see Fourier transform infrared instrument below). A typical infrared source is the *Nernst glower*. This is a rod consisting of a mixture of rare earth oxides. It has a negative temperature coefficient of resistance and is nonconducting at room temperature. Therefore, it must be heated to excite the element to emit radiation, but once in operation it becomes conducting and furnishes maximum radiation at about  $1.4 \mu\text{m}$ , or  $7100 \text{ cm}^{-1}$  (1500 to 2000°C). Another infrared source is the *Globar*. This is a rod of sintered silicon carbide heated to about 1300 to 1700°C. Its maximum radiation occurs at about  $1.9 \mu\text{m}$  ( $5200 \text{ cm}^{-1}$ ), and it must be water-cooled. The Globar is a less intense source than the Nernst glower, but it is more satisfactory for wavelengths longer than  $15 \mu\text{m}$  because its intensity decreases less rapidly. IR sources have no protection from the atmosphere, as no satisfactory envelope material exists.

In **fluorescence spectrometry**, the intensity of fluorescence is proportional to the intensity of the radiation source (see Fluorometry below). Various continuum UV sources are used to excite fluorescence (see below). But the use of lasers has gained in importance because these monochromatic radiation sources can have high relative intensities. Table 14.5 lists the wavelength and power characteristics of some common laser sources. Only those that lase in the ultraviolet region are generally useful for exciting fluorescence. The nitrogen laser (337.1 nm), which can only be operated in a pulsed mode (rather than continuous wave or CW mode), is useful for pumping tunable dye lasers. Dye lasers contain solutions of organic compounds that exhibit fluorescence in the UV, visible, or infrared regions. They can generally be tuned over a range of wavelengths of 20 to 50 nm. Tuned lasers are also useful as sources in absorption spectrometry because they provide good resolution (about 1 nm) and high throughput, although they tend to be less stable than continuum sources. Tunable lasers are available from about 265 nm to 800 nm. Several dyes are needed to cover a wide wavelength range.

Lasers are intense monochromatic sources, good as fluorescence sources.

We shall see below how the instruments can be adjusted to account for the variations in source intensity with wavelength as well as for the variation in detector sensitivity with wavelength.

**TABLE 14.5**  
**Characteristics of Common Lasers**

<i>Laser</i>	<i>Wavelength, nm</i>	<i>Power, W</i>
<i>Ionic crystal</i>		
Ruby <sup>a</sup>	694.3	1–10 MW
Nd: YAG <sup>a</sup>	1064.0	25 MW (8–9 ns)
<i>Gas</i>		
He-Ne	632.8	0.001–0.05
He-Cd	441.6	0.05
	325.0	0.01
Ar <sup>+</sup>	514.5	7.5
	496.6	2.5
	488.0	6.0
	476.5	2.5
	465.8	7.0
	457.9	1.3
	333.6–363.8 (4 lines)	3.0
Kr <sup>+</sup>	752.5	1.2
	647.1	3.5
	530.9	1.5
	482.5	0.4
	468.0	0.5
	413.1	1.8
	406.7	0.9
	337.5–356.4 (3 lines)	2.0
Nitrogen <sup>a</sup>	337.1	200 kW (300 ps)

<sup>a</sup>Operated in pulsed mode; values given are peak power (pulse width).

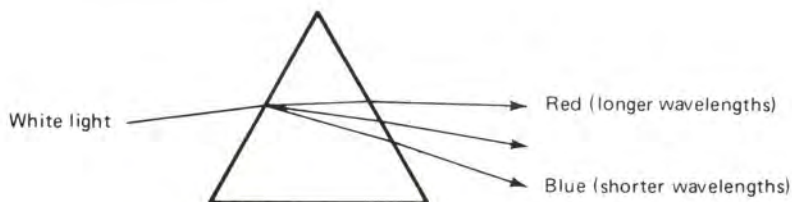
From G. D. Christian and J. E. O'Reilly, *Instrumental Analysis*, 2nd ed., Boston: Allyn and Bacon, Inc., 1986. Reproduced by permission of Allyn and Bacon, Inc.

## Monochromators

A monochromator consists chiefly of *lenses* or mirrors to focus the radiation, entrance and exit *slits* to restrict unwanted radiation and help control the spectral purity of the radiation emitted from the monochromator, and a *dispersing medium* to “separate” the wavelengths of the polychromatic radiation from the source. There are two basic types of dispersing elements, the *prism* and the *diffraction grating*. Various types of optical filters may also be used to select specific wavelengths.

**1. Prisms.** When electromagnetic radiation passes through a prism, it is refracted, because the index of refraction of the prism material is different from that in air. The index of refraction depends on the wavelength and, therefore, so does the degree of refraction. Shorter wavelengths are refracted more than longer wavelengths. The effect of refraction is to “spread” the wavelengths apart into different wavelengths (Figure 14.14). By rotation of the prism, different wavelengths of the spectrum can be made to pass through an exit slit and through the sample. A prism works satisfactorily in the ultraviolet and visible regions and can also be used in the infrared region. However, because of its **nonlinear dispersion**,

Dispersion by prisms is good at short wavelengths, poor at long wavelengths (IR).



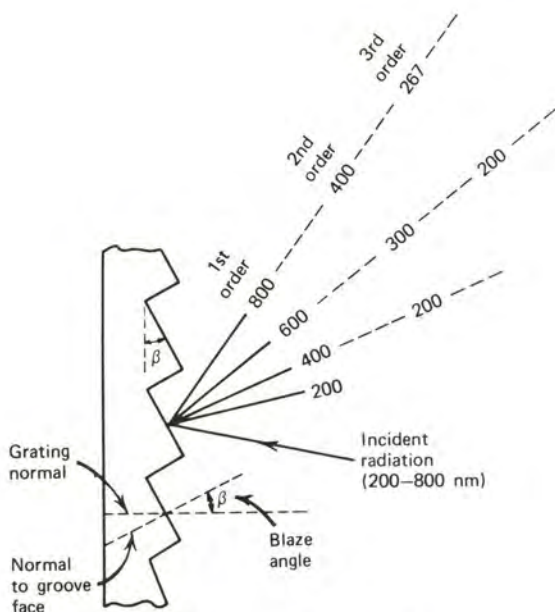
**FIGURE 14.14** Dispersion of polychromatic light by a prism.

it works more effectively for the shorter wavelengths. Glass prisms and lenses can be used in the visible region, but quartz or fused silica must be used in the ultraviolet region. The latter can also be used in the visible region.

In the infrared region, glass and fused silica transmit very little, and the prisms and other optics must be made from large crystals of alkali or alkaline earth halides, which are transparent to infrared radiation. Sodium chloride (rock salt) is used in most instruments and is useful for the entire region from 2.5 to 15.4  $\mu\text{m}$  (4000 to 650  $\text{cm}^{-1}$ ). For longer wavelengths, KBr (10 to 25  $\mu\text{m}$ ) or CsI (10 to 38  $\mu\text{m}$ ) can be used. These (and the monochromator compartment) must be kept dry.

**2. Diffraction Gratings.** These consist of a large number of parallel lines (grooves) ruled on a highly polished surface such as aluminum, about 15,000 to 30,000 per inch for the ultraviolet and visible regions and 1500 to 2500 per inch for the infrared region. The grooves act as scattering centers for rays impinging on the grating. The result is equal dispersion of all wavelengths of a given order, that is, **linear dispersion** (Figure 14.15). The resolving power depends on the number of ruled grooves, but generally the resolving power of gratings is better than that of prisms, and they can be used in all regions of the spectrum. They are particularly

Dispersion by gratings is independent of wavelength, but the intensity varies with wavelength.



**FIGURE 14.15** Diffraction of radiation from a grating.

well suited for the infrared region because of their equal dispersion of the long wavelengths. Gratings are difficult to prepare and original gratings are expensive. However, many **replica gratings** can be prepared from an original grating. This is done by coating the grating with a film of an epoxy resin that, after setting, is stripped off to yield the replica. It is made reflective by aluminizing the surface. These replica gratings are much less expensive and are even used in small inexpensive instruments.

The intensity of radiation reflected by a grating varies with the wavelength, the wavelength of maximum intensity being dependent on the angle from which the radiation is reflected from the surface of the groove in the blazed grating. Hence, gratings are blazed at specific angles for specific wavelength regions, and one blazed for the blue region would be poor for an infrared spectrometer. Gratings also will produce radiation at *multiples* of the incident radiation (see Figure 14.15). These multiples are called **higher orders** of the radiation. The primary order is called the first order, twice the wavelength is the second order, three times the wavelength is the third order, and so on. So a grating produces first-order spectra, second-order spectra, and so on. The higher order spectra are more greatly dispersed and the resolution increased. Because of the occurrence of higher orders, radiation at wavelengths less than the spectral region must be filtered out, or else its higher orders will overlap the radiation of interest. This can be accomplished with various types of optical filters (see below) that pass radiation only above a certain wavelength. For example, if incident radiation from a radiating sample (replaces the source on a spectrophotometer) in the 400- to 700-nm range is being dispersed and measured (e.g., fluorescence), any radiation by the sample at, for example, 325 nm, would have a second order at 650 nm, which would overlap first-order radiation at 650 nm. This can be filtered out by placing a filter between the radiating sample and the grating that blocks radiation of  $\leq 400$  nm in the path of the incident beam; then the 325-nm radiation will not reach the grating.

Ruled gratings have a problem of "ghosting" associated with periodic errors in the ruling engine drive screws, particularly if the gratings are used with high-intensity radiation sources (e.g., in fluorescence instruments—see below). This stray light is greatly reduced with **holographic gratings**. These are manufactured by exposing a photoresist layer, on a suitable substrate, to the interference pattern produced by two monochromatic laser beams, followed by photographic development to produce grooves, and then a reflective coating process. The smoother line profile results in reduced light scatter. Also, these gratings can be produced on curved surfaces and used to collimate light, eliminating mirrors or lenses that result in loss of light. The cost of these gratings is significantly higher than that of the more conventional type, but they are finding use in spectrometers used for measurement of radiating samples such as in fluorescence analysis.

**3. Optical Filters.** Various types of optical filters may be used to isolate certain wavelengths of light. There are narrow-bandpass filters, sharp-cut filters, and interference filters. The first two are usually made of glass and contain chemicals (dyes) that absorb all radiation except that desired to be passed. The sharp-cut filters absorb all radiation up to a specified wavelength, and pass radiation at longer wavelengths.

Interference filters consist of two layers of glass on whose inner surfaces a thin semitransparent film of metal is deposited and an inner layer of a transparent material such as quartz or calcium fluoride. Radiation striking the filter exhibits

Higher orders are better dispersed.

In fluorescence, higher order radiation from a shorter emitting (primary) wavelength may overlap a longer primary wavelength that is being measured. The shorter primary radiation must be filtered before reaching the grating. See also Section 14.8, single-beam spectrometers.

destructive interference, except for a narrow band of radiation for which the filter is designed to transmit. The bandwidth of the filters decreases as the transmitted radiation increases.

## Cells

The cell holding the sample (usually a solution) must, of course, be transparent in the wavelength region being measured. The materials described above for the optics are used for the cell material in instruments designed for the various regions of the spectrum.

The cells for use in **visible** and **ultraviolet** spectrometers are usually cuvettes 1 cm thick (*internal* distance between parallel walls). These are illustrated in Figure 14.16. For **infrared** instruments, various assorted cells are used. The most common is a cell of sodium chloride windows. Fixed-thickness cells are available for these purposes and are the most commonly used. The solvent, of course, must not attack the windows of the cell. Sodium chloride cells must be protected from atmospheric moisture (stored in desiccators) and moist solvents. They require periodic polishing to remove "fogging" due to moisture contamination. Silver chloride windows are often used for wet samples or aqueous solutions. These are soft and will gradually darken due to exposure to visible light.

Table 14.6 lists the properties of several infrared transmitting materials. The short path lengths required in infrared spectrometry are difficult to reproduce, especially when the windows must be repolished, and so quantitative analysis is not as accurate in this region. Use of an internal standard helps. The path length of the empty cell can be measured from the interference fringe patterns. See Reference 11 at the end of the chapter. Variable path length cells are also available in thicknesses from about 0.002 to 3 mm.

When samples exist as pure liquids, they are usually run without dilution ("neat") in the infrared region, as is often the case when an organic chemist is trying to identify or confirm the structure of an unknown or new compound. For this purpose, the cell length must be short in order to keep the absorbance within the optimum region, generally path lengths of 0.01 to 0.05 mm. If a solution of the sample is to be prepared, a fairly high concentration is usually run, because no solvent is completely transparent in the infrared region, and this will keep the solvent absorbance minimal. So again, short path lengths are required, generally 0.1 mm or less.

Cells for:  
UV—quartz  
VIS—glass, quartz  
IR—salt crystals

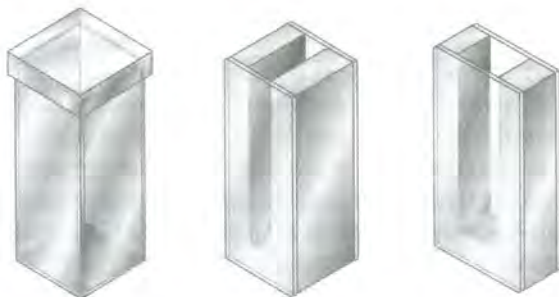


FIGURE 14.16 Some typical UV and visible absorption cells.

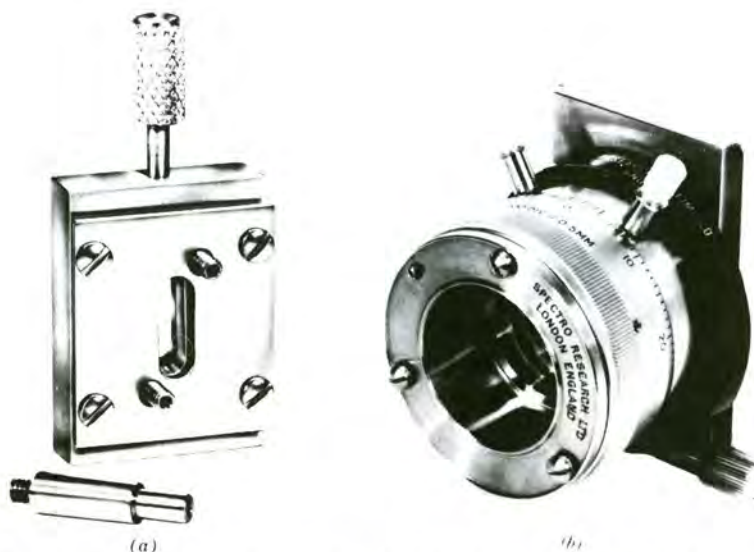


TABLE 14.6

## Properties of Infrared Materials

Material	Useful Range, $\text{cm}^{-1}$	General Properties
NaCl	40,000–625	Hygroscopic, water soluble, low cost, most commonly used material.
KCl	40,000–500	Hygroscopic, water soluble.
KBr	40,000–400	Hygroscopic, water soluble, slightly higher in cost than NaCl and more hygroscopic.
CsBr	40,000–250	Hygroscopic, water soluble.
CsI	40,000–200	Very hygroscopic, water soluble, good for lower wavenumber studies.
LiF	83,333–1425	Slightly soluble in water, good UV material.
CaF <sub>2</sub>	77,000–1110	Insoluble in water, resists most acids and alkalis.
BaF <sub>2</sub>	67,000–870	Insoluble in water, brittle, soluble in acids and NH <sub>4</sub> Cl.
AgCl	10,000–400	Insoluble in water, corrosive to metals. Darkens upon exposure to short-wavelength visible light. Store in dark.
AgBr	22,000–333	Insoluble in water, corrosive to metals. Darkens upon exposure to short-wavelength visible light. Store in dark.
KRS-5	16,600–285	Insoluble in water, highly toxic, soluble in bases, soft, good for ATR work.
ZnS	50,000–760	Insoluble in water, normal acids and bases, brittle.
ZnSe	20,000–500	Insoluble in water, normal acids and bases, brittle.
Ge	5000–560	Brittle, high index of refraction.
Si	83,333–1430 400–30	Insoluble in most acids and bases.
UV Quartz	56,800–3700	Unaffected by water and most solvents.
IR Quartz	40,000–3000	Unaffected by water and most solvents.
Polyethylene	625–10	Low-cost material for far-IR work.

Adapted from McCarthy Scientific Co. Catalogue 489, with permission.



**FIGURE 14.17** Typical infrared cells. (a) Fixed path cell. (Courtesy of Barnes Engineering Co.) (b) Variable path length cell. (Courtesy of Wilks Scientific Corporation.)

Solids are often not sufficiently soluble in the available solvents to give a high enough concentration to measure in the infrared region. However, powders may be run as a suspension or thick slurry (mull) in a viscous liquid having about the same index of refraction in order to reduce light scattering. The sample is ground in the liquid, which is often Nujol, a mineral oil (see Figure 14.4). Chlorofluorocarbon greases are useful when the Nujol masks any C—H bands present. The mull technique is useful for qualitative analysis, but it is difficult to reproduce for quantitative work. Samples may also be ground with KBr (which is transparent in the infrared region) and pressed into a pellet for mounting for measurement.

Gases may be analyzed by infrared spectrometry, and for this purpose a long-path cell is used, usually 10 cm in length, although cells as long as 20 m and up have been used in special applications. Some typical infrared cells are shown in Figure 14.17.

### Detectors

Again, the detectors will also vary with the wavelength region to be measured. A **phototube** (or photocell) is commonly used in the *ultraviolet* and *visible regions*. This consists of a photoemissive cathode and an anode. A high voltage is impressed between the anode and cathode. When a photon enters the window of the tube and strikes the cathode, an electron is emitted and attracted to the anode, causing current to flow that can be amplified and measured. The response of the photoemissive material is wavelength dependent, and different phototubes are available for different regions of the spectrum. For example, one may be used for the blue and ultraviolet portions and a second for the red portion of the spectrum.

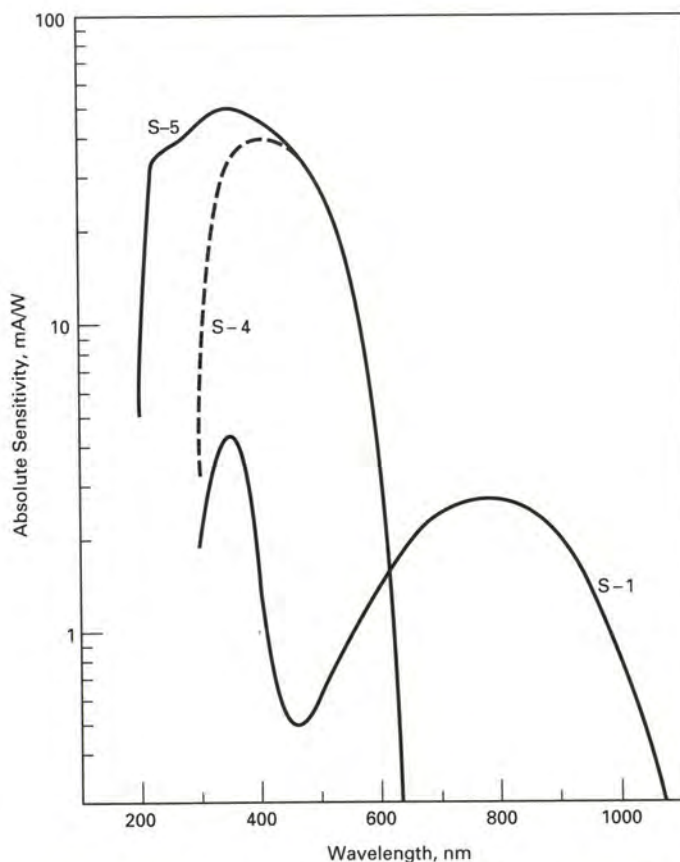
A **photomultiplier tube** is more sensitive than a phototube for the *visible* and *ultraviolet regions*. This is essentially several successive phototubes built into one envelope. It consists of a series of electrodes (dynodes), each at a more positive potential (50 to 90 V) than the one before it. When a primary electron is emitted

Detectors for:

UV—phototube, PM tube, diode array

VIS—phototube, PM tube, diode array

IR—thermocouples, bolometers, thermistors



**FIGURE 14.18** Some spectral responses of photomultipliers. S-5 = RCA 1P28; S-4 = RCA 1P21; S-1 = RCA 7102. (From G. D. Christian and J. E. O'Reilly, *Instrumental Analysis*, 2nd ed. Boston: Allyn and Bacon, Inc., 1986. Reproduced by permission of Allyn and Bacon, Inc.)

from the photoemissive cathode by a photon, it is accelerated toward the next photoemissive electrode, where it releases many more secondary electrons. These, in turn, are accelerated to the next electrode where each secondary electron releases more electrons, and so on, up to about 10 stages of amplification. The electrons are finally collected by the anode. The final output of the photomultiplier tube may, in turn, be electronically amplified.

Again, different photomultiplier tubes have different response characteristics, depending on the wavelength. Figure 14.18 illustrates the response characteristics of some typical photomultiplier tubes with different photoemissive cathode surfaces. The 1P28 (S-5 surface) tube is the most popular because it can be used in both the ultraviolet and visible regions (e.g., in a UV-visible spectrometer). A 1-S surface is needed for the red region. Because of the greater sensitivity of photomultiplier tubes, less intense radiation is required and narrower slit widths can be used for better resolution of the wavelengths.

Photomultiplier tubes have also been developed with response limited to the ultraviolet region (160 to 320 nm), the so-called **solar-blind photomultipliers**. They are helpful in reducing stray light effects from visible radiation and are useful as *UV detectors* in nondispersive systems.



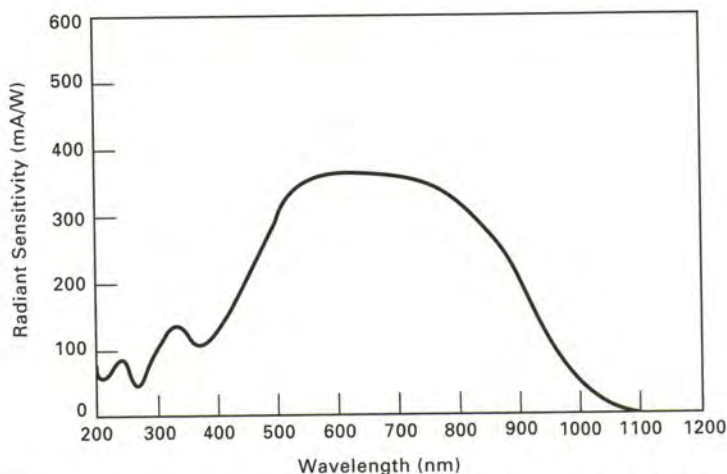
**FIGURE 14.19** Photo of 1024 element diode arrays. Courtesy of Hamatsu Photonics, K. K.

Diode array detectors are used in spectrometers that record an entire spectrum simultaneously (see Section 14.9). A **diode array** consists of a series of hundreds of silicon photodiodes positioned side-by-side on a single silicon crystal or chip. Each has an associated storage capacitor which collects and integrates the photocurrent generated when photons strike the photodiode. They are read by periodical discharging, taking from 5 to 100 msec to read an entire array. If radiation dispersed into its different wavelengths falls on the surface area of the diode array, a spectrum can be recorded. A photograph of diode arrays is shown in Figure 14.19. They consist of 1024 diode elements in a space of a couple of centimeters. The spectral response of a silicon diode array is that of silicon, about 180 to 1100 nm; that is, ultraviolet to near infrared. See Figure 14.20. This range is wider than for photomultiplier tubes and the quantum efficiency is higher. The design of a diode array spectrometer is described in Section 14.9.

Diode arrays can record an entire spectrum at once, from UV to near-IR.

Spectrometers that use phototubes or photomultiplier tubes (or diode arrays) as detectors are generally called **spectrophotometers**, and the corresponding measurement is called **spectrophotometry**. More strictly speaking, the journal *Analytical Chemistry* defines a spectrophotometer as a spectrometer that measures the

A spectrophotometer is a double-beam spectrometer that measures absorbance directly.



**FIGURE 14.20** Typical spectral response of a diode array. (From M. Kendall-Tobias, *Am Lab.*, March, 1989, p. 102. Reproduced by permission of International Scientific Communications, Inc.)

*ratio* of the radiant power of two beams, that is,  $P/P_0$ , and so it can record absorbance. The two beams may be measured simultaneously or separately, as in a double-beam or a single-beam instrument—see below. Phototube and photomultiplier instruments in practice are almost always used in this manner. An exception is when the radiation source is replaced by a radiating sample whose spectrum and intensity are to be measured, as in fluorescence spectrometry—see below. If the prism or grating monochromator in a spectrophotometer is replaced by an optical filter that passes a narrow band of wavelengths, the instrument may be called a photometer.

As with sources, detectors used in the ultraviolet and visible regions do not work in the infrared region. But *infrared* radiation possesses the property of heat, and heat detectors that transduce heat into an electrical signal can be used. Thermocouples and bolometers are used as detectors. A **thermocouple** consists of two dissimilar metal wires connected at two points. When a temperature difference exists between the two points, a potential difference is developed, which can be measured. One of the junctions, then, is placed in the path of the light from the monochromator. **Bolometers** and **thermistors** are materials whose *resistance* is temperature dependent. Their change in resistance is measured in a Wheatstone bridge circuit. The advantage of these over thermocouples is the more rapid response time (4 ms, compared with 60 ms), and thus improved resolution and faster scanning rates can be accomplished. The response of thermal detectors is essentially independent of the wavelengths measured.

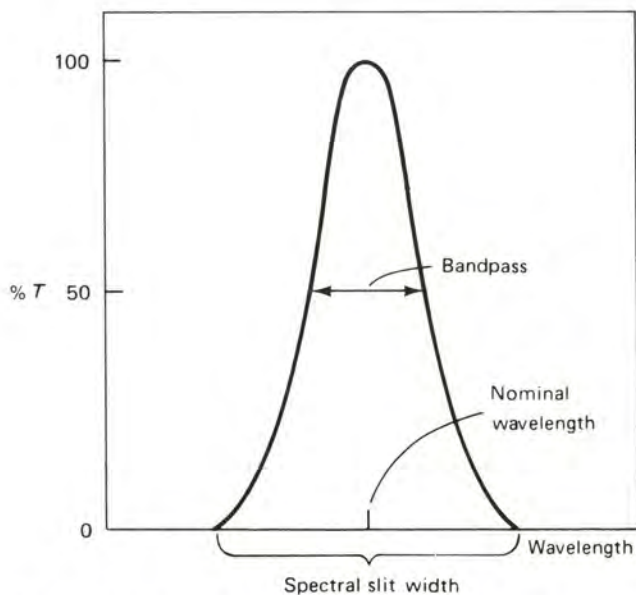
### Slit Width

We mentioned above that it is impossible to obtain spectrally pure wavelengths from a monochromator. Instead, a **band** of wavelengths emanates from the monochromator and the width of this band will depend on both the dispersion of the grating or prism and the exit slit width. The dispersive power of a prism depends on the wavelength and on the material from which it is made, as well as on its geometrical design, while that of a grating depends on the number of grooves per inch. Dispersion is also increased as the distance to the slit is increased.

After the radiation has been dispersed, a certain portion of it will fall on the exit slit, and the width of this slit determines how broad a band of wavelengths the sample and detector will see. Figure 14.21 depicts the distribution of wavelengths leaving the slit. The **nominal wavelength** is that set on the instrument and is the wavelength of maximum intensity passed by the slit. The intensity of radiation at wavelengths on each side of this decreases, and the width of the band of wavelengths passed at one-half the intensity of the nominal wavelength is the **spectral bandwidth**, or **bandpass**. The **spectral slit width** is theoretically twice the spectral bandwidth (Figure 14.21 is theoretically an isosceles triangle), and this is a measure of the total wavelength spread that is passed by the slit. Note that the spectral slit width is *not* the same as the mechanical slit width, which may vary from a few micrometers to a millimeter or more (the spectral slit width is the band of radiation passed by the mechanical slit and is measured in units of wavelength). Seventy-five percent of the radiation intensity is theoretically contained within the wavelengths of the spectral band width.

If the intensity of the source and the sensitivity of the detector are sufficient, the spectral purity can be improved (the bandpass decreased) by decreasing the slit width. The decrease may not be linear, however, and a limit is reached due to

The radiation passed by a slit is not monochromatic.



**FIGURE 14.21** Distribution of wavelengths leaving the slit of a monochromator.

aberrations in the optics and diffraction effects caused by the slit at very narrow widths. The diffraction effectively increases the spectral slit width. In actual practice, the sensitivity limit of the instrument is usually reached before diffraction effects become too serious.

The bandwidth or the spectral slit width is essentially constant with a grating dispersing element for all wavelengths of a given spectral order at a constant slit width setting. This is not so with a prism, because of the variation of dispersion with changing wavelength. The bandwidth will be smaller at shorter wavelengths and larger at longer wavelengths.

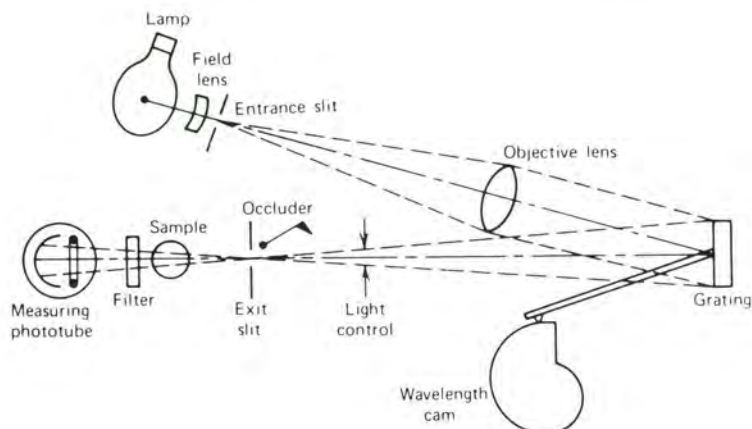
The bandwidth varies with wavelength with a prism, but is constant with a grating.

## 14.8 TYPES OF INSTRUMENTS

Although all spectrometric instruments have the basic design presented in Figure 14.12, there are many variations depending on the manufacturer, the wavelength regions for which the instrument is designed, the resolution required, and so on. It is beyond the scope of our discussion to go into these, but we will indicate a few of the important general types of design and the general operation of a spectrometer.

### Single-Beam Spectrometers

These are the most common student spectrometers, since they are less expensive than more sophisticated instruments, and excellent results can be obtained with them. A diagram of the popular Bausch and Lomb Spectronic 20 spectrophotometer (phototube instrument) is shown in Figure 14.22. It consists of a tungsten lamp visible-light source and an inexpensive replica grating of 600 grooves per



**FIGURE 14.22** Optical diagram of the Bausch and Lomb Spectronic 20 spectrophotometer (top view). (Courtesy of Bausch and Lomb, Inc.)

Higher order radiation from the grating must be filtered.

millimeter to disperse the radiation, ranging in wavelength from 330 to 950 nm. The exit slit allows a band of 20 nm of radiation to pass. If the wavelength is set at 480 nm, for example, radiation from 470 to 490 nm passes through the exit slit. By turning the wavelength cam, the grating is rotated to change the band of 20 nm of wavelengths passing through the exit slit (the path of only one 20-nm band is shown after reflection from the grating in the figure). The filter removes second-order and higher orders of diffraction from the grating that may pass the slit (stray light). The selection of the filter depends on what radiation must be restricted. For most applications, a cutoff-type filter is used that passes radiation below a certain wavelength where measurements are to be made, but not longer wavelengths where higher orders may appear. Narrower-range filters may be better for some applications, for example, **a red filter to remove any nonred light so the detector sees essentially pure red** (see below).

Any radiation not absorbed by the sample falls on the detector, where the intensity is converted to an electrical signal that is amplified and read on a meter. The measuring phototube for the visible region has maximum response at 400 nm, with only 5% of this response at 625 nm. Measurements above 625 nm are best made by substituting a red-sensitive phototube (RCA 6953) along with a red filter to remove second-order diffraction from the grating (it passes the desired red radiation but not undesired higher orders).

We have illustrated that the spectral intensity of the sources and the spectral response of the detectors are dependent on the wavelength. Therefore, some means must be employed to adjust the electrical output of the detector to the same magnitude at all wavelengths. This can be accomplished by one of two ways: by adjusting the slit width to allow more or less light to fall on the detector, or by adjusting the gain on the detector (the amount of amplification of the signal).

A single-beam instrument will have a shutter that can be placed in front of the detector so that no light reaches it. This is the occluder in the Spectronic 20, and it drops into place whenever there is no measuring cell placed in the instrument. With the shutter in position, a "dark current" adjusting knob is used to set the scale reading to zero percent transmittance (infinite absorbance). The **dark current** is a small current that may flow in the absence of light, owing to thermal emission of electrons from the cathode of the phototube. In the above operation,

Some current flows in the detector, even when no radiation falls on it. This is the "dark current."

the dark current is set to zero scale reading by effectively changing the voltage on the tube. Now, the cell filled with solvent is placed in the beam path and the shutter is opened. By means of a slit width control to adjust the amount of radiation passed or a "sensitivity" knob (gain control), the output of the detector is adjusted so that the scale reading is 100% transmittance (zero absorbance). The dark current and 100% transmittance adjustments are usually repeated to make certain the adjustment of one has not changed the other. The instrument scale is now calibrated and it is ready to read an unknown absorbance. *The above operations must be repeated at each wavelength.*

Each time a series of samples is run, the absorbance of one or more blank solutions<sup>4</sup> is read versus pure solvent; and, if appreciable ( $\geq 0.01$  A with a Spectronic 20), this is subtracted from all analyte solution readings. Actually, if the blank solution is essentially colorless (i.e., its absorbance is small), this solution is often used in place of the solvent for adjusting the 100% transmittance reading. Any blank absorbance is then automatically corrected for (subtracted). This method should only be used if the blank reading is small and has been demonstrated to be constant. A large blank reading would be more likely to be variable, and it would require a large gain on the detector, causing an increase in the noise level. An advantage of zeroing the instrument with the blank is that one reading, which always contains some experimental error, is eliminated. If this technique is used, it would be a good practice to check the zero with all the blank solutions to make sure the blank is constant.

### Double-Beam Spectrometers

These are in practice rather complex instruments, but they have a number of advantages. They are used largely as recording instruments, that is, instruments that automatically vary the wavelength and record the absorbance as a function of wavelength. The instrument has two light paths, one for the sample and one for the blank or reference. In a typical setup, the beam from the source strikes a vibrating or rotating mirror that alternately passes the beam through the reference cell and the sample cell and, from each, to the detector. In effect, the detector alternately sees the reference and the sample beam and the output of the detector is proportional to the ratio of the intensities of the two beams ( $P/P_0$ ).

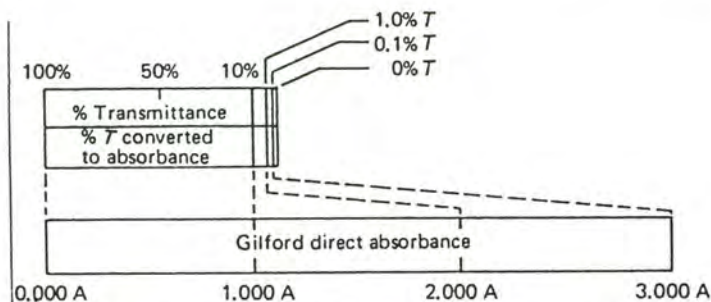
The output is an alternating signal whose frequency is equal to that of the vibrating or rotating mirror. An ac amplifier is used to amplify this signal, and stray dc signals are not recorded. The wavelength is changed by a motor that drives the dispersing element at a constant rate, and the slit is continually adjusted by a servomotor to keep the energy from the reference beam at a constant value; that is, it automatically adjusts to 100% transmittance through the reference cell (which usually contains the blank or the solvent).

This is a simplified discussion of a double-beam instrument. There are variations on this design and operation, but it illustrates the utility of these instruments. They are very useful for qualitative work in which the entire spectrum is required, and they automatically compensate for absorbance by the blank, as well as for drifts in source intensity.

Double-beam spectrometers can automatically scan the wavelength and record the spectrum

<sup>4</sup>This contains all reagents used in the sample, but no analyte.





**FIGURE 14.23** Illustration of expansion of the high end of the absorbance scale in the Gilford spectrophotometer. (Reproduced by permission of Gilford Instrument Laboratories, Inc.)

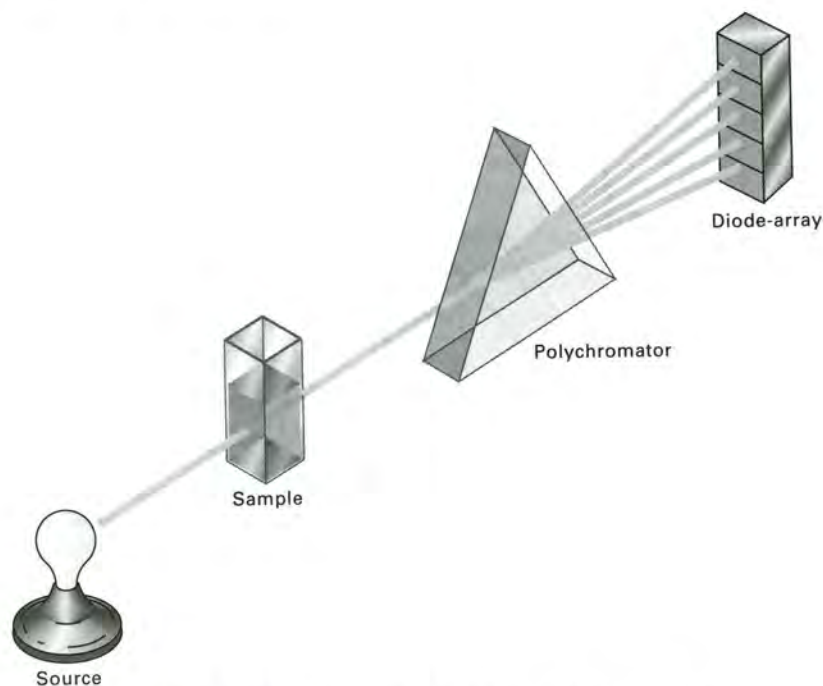
### High-Absorbance-Range Spectrophotometers

We shall see below in discussing the spectrophotometric error that, for most accurate measurements, the absorbance reading of spectrometric measurements using conventional spectrophotometers should be between 0.1 and 1.0 or 1.5 absorbance units. Top-line model spectrophotometers utilize feedback mechanisms and stabilizing electronics that allow measurements of absorbance up to 3 units. For example, an automatic photomultiplier feedback circuit adjusts the voltage applied to the dynodes (electrodes) of a photomultiplier (PM) tube in inverse relation to the amount of light falling on the cathode. Hence, for high light levels, the sensitivity of the PM tube is decreased, while with low light levels, it is increased. An essentially constant-current flow in the tube results. This feedback arrangement permits operation of the phototube at an extremely low anode output current regardless of the amount of light impinging on the photocathode. The voltage required to maintain this anode current constant is the source of the output signal. In effect, the high end of the absorbance scale is expanded over that of conventional instruments. Such expansion is illustrated in Figure 14.23. The chief source of spectrometric errors usually comes in reading the compressed scale above 1 absorbance unit, but in these instruments, this portion of the scale is expanded.

## 14.9 DIODE ARRAY SPECTROMETERS

In diode array spectrometers, there is no exit slit, and all dispersed wavelengths that fall on the array are recorded simultaneously.

In discussing detectors, we mentioned the use of photodiode array detectors for recording an entire spectrum in a few milliseconds. The basic design of a diode array-based spectrometer is shown in Figure 14.24. The use of an exit slit to isolate a given wavelength is eliminated, and the dispersed light is allowed to fall on the face of the diode array detector. Each diode, in effect, acts as an exit slit of a monochromator. Resolution is limited by the element size of the diode array, but generally, the spatial resolution is about twice the size of a single element.



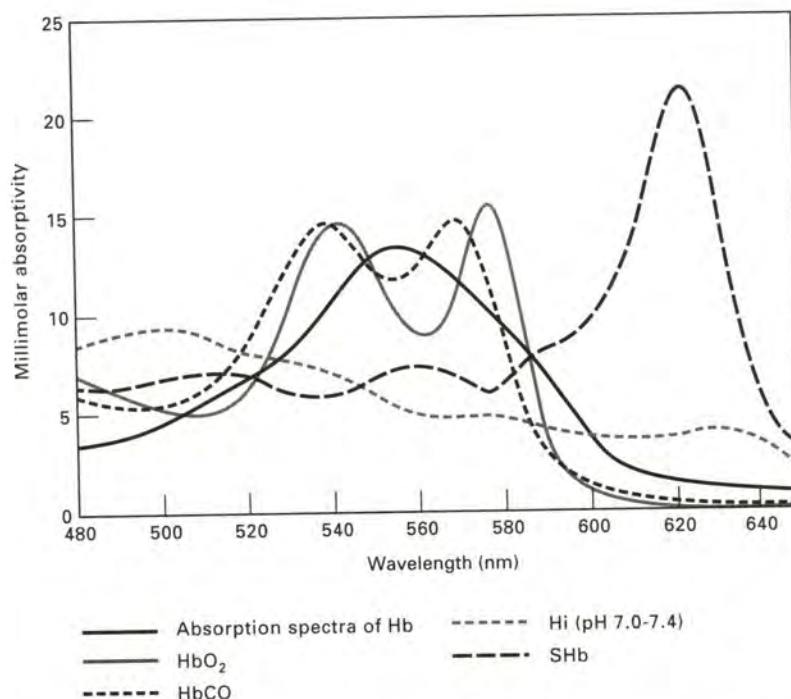
**FIGURE 14.24** Schematic of a diode array spectrometer.

Diode spectrometers are very useful for the analysis of mixtures of absorbing species whose spectra overlap. The conventional simultaneous equation approach for analyzing mixtures is limited to two or three components (absorbance is measured at two or three wavelengths) in which the spectra are substantially different. With the diode array spectrometer, the absorbance at many points can be measured, using data on the sides of absorption bands as well as at absorption maxima. This method of “overdetermination,” in which more measurement points than analytes are obtained, improves the reliability of quantitative measurements, allowing six or more constituents to be determined, or simple mixtures of components with similar spectra. An example of a multicomponent analysis is shown in Figure 14.25 for the simultaneous measurement of five hemoglobins. The five spectra were quantitatively resolved by comparing against standard spectra of each compound stored in the computer memory.

The ability of diode array spectrometers to acquire data rapidly also allows the use of measurement statistics to improve the quantitative data. For example, ten measurements can be made at each point in one second, from which the standard deviation of each point is obtained. The instrument’s computer then weights the data points in a least-squares fit, based on their precisions. This “maximum likelihood” method minimizes the effect of bad data points on the quantitative calculations.

The measurement precision is improved by averaging many measurements.

Another useful feature of diode array spectrometers is the ability to make kinetic measurements. An entire spectrum can be acquired rapidly, and several spectra can be readily obtained to provide kinetic data. This is especially valuable when spectral information is important in interpreting results. Such measurements are nearly impossible with wavelength scanning instruments.



**Note:** Hb = hemoglobin, HbO<sub>2</sub> = oxyhemoglobin, HbCO = carboxyhemoglobin, Hi = methemoglobin, SHb = sulfhemoglobin.

**FIGURE 14.25** Millimolar absorptivities in  $\text{mmol}^{-1} \text{L cm}^{-1}$ . (From A. Zwart, A. Buursma, E. J. van Kampen, and W. G. Zijlstra, *Clin. Chem.*, **30**, (1984) 373. Reproduced by permission.)

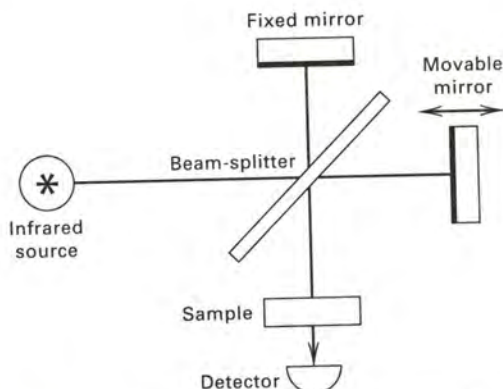
## 14.10 FOURIER TRANSFORM INFRARED SPECTROMETERS

FTIR spectrometers have largely replaced dispersive IR spectrometers.

Conventional infrared spectrometers are known as **dispersive instruments**. With the advent of computer- and microprocessor-based instruments, these have been largely replaced by Fourier transform infrared (FTIR) spectrometers, which possess a number of advantages. Rather than a grating monochromator, an FTIR instrument employs an interferometer to obtain a spectrum.

The basis of an interferometer instrument is illustrated in Figure 14.26. Radiation from a conventional IR source is split into two paths by a beam-splitter, one path going to a fixed position mirror, and the other to a moving mirror. When the beams are reflected, one is slightly displaced (out of phase) from the other since it travels a smaller (or greater) distance due to the moving mirror, and they recombine to produce an interference pattern (of all wavelengths in the beam) before passing through the sample. The sample sees all wavelengths simultaneously, and the interference pattern changes with time as the mirror is continuously scanned at a linear velocity. The result of absorption of the radiation by the sample is a spectrum in the *time domain*, called an *interferogram*, that is, absorption intensity as a function of the optical path difference between the two beams. This is converted, using a computer, into the frequency domain via a mathematical operation known as a *Fourier transformation* (hence the name *Fourier transform infrared spectrometer*). A conventional appearing infrared spectrum results.

An interferogram is a spectrum in the time domain. Fourier transformation converts it to the frequency domain.



**FIGURE 14.26** Schematic of an interferometer for FTIR spectrometry.

The advantages of an interferometer instrument is that there is greater throughput (Jacquinot's advantage) since all the radiation is passed. That is, the sample sees all wavelengths at all times, instead of a small portion at a time. This results in increased signal-to-noise ratio. In addition, a *multiplex advantage* ( Fellgett's advantage) results because the interferometer measures all IR frequencies simultaneously, and so a spectrum with resolution comparable to or better than that with a grating is obtained in a few seconds.

The principles of interferometers and Fourier transformation have been known for over a century, but practical applications had to await the advent of high-speed digital computer techniques.

Advantages of FTIR spectrometers: greater throughput, increased signal-to-noise ratio, simultaneous measurement of all wavelengths.

## 14.11 NEAR-IR INSTRUMENTS

Radiation sources for near-IR instruments are operated at typically 2500–3000 K, compared to 1700 K in the mid-IR region, resulting in about ten times more intense radiation and improved signal-to-noise ratios. This is possible because the IR radiation of typical sources tails off in the mid-IR region and the maximum intensity shifts further into the near-IR region as the temperature is increased. The higher temperature results in weaker mid-IR radiation, but is beneficial in the near-IR region.

A lead sulfide (PbS) detector is most commonly used in the near-IR, and is roughly 100 times more sensitive than mid-IR detectors. The combination of intense radiation sources and sensitive detectors results in very low noise levels, on the order of microabsorbance units.

NIR sources are more intense and detectors more sensitive than for the mid-IR region, so noise levels are 1000-fold lower.

## 14.12 SPECTROMETRIC ERROR

There will always be a certain amount of error or irreproducibility in reading an absorbance or transmittance scale. Uncertainty in the reading will depend on a number of instrumental factors and on the region of the scale being read, and hence on the concentration.

It is difficult to precisely measure either very small or very large decreases in absorbance.

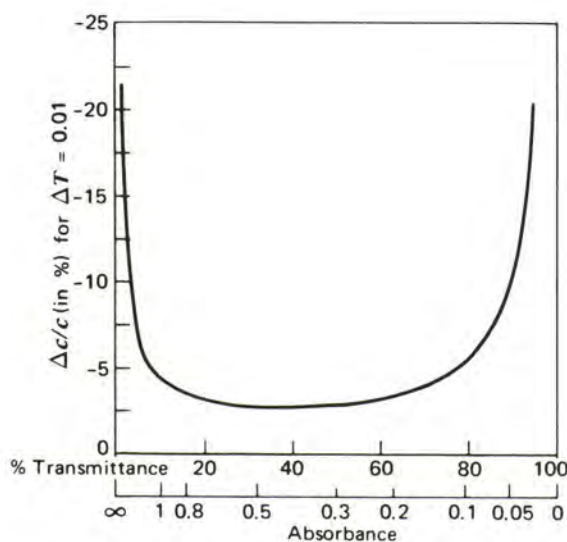
It is probably obvious to you that if the sample absorbs only a very small amount of the light, an appreciable *relative* error may result in reading the small decrease in transmittance. At the other extreme, if the sample absorbs nearly all the light, an extremely stable instrument would be required to read the large decrease in the transmittance accurately. There is, therefore, some optimum transmittance or absorbance where the relative error in making the reading will be minimal.

The transmittance for minimum relative error can be derived from Beer's law by calculus, assuming that the error results essentially from the uncertainty in reading the instrument scale and the absolute error in reading the transmittance is constant, independent of the value of the transmittance. The result is the prediction that the minimum relative error in the concentration theoretically occurs when  $T = 0.368$  or  $A = 0.434$ .

Figure 14.27 illustrates the dependence of the relative error on the transmittance, calculated for a constant error of  $0.01 T$  in reading the scale. It is evident from the figure that, while the minimum occurs at  $36.8\% T$ , a nearly constant minimum error occurs over the range of  $20$  to  $65\% T$  ( $0.7$  to  $0.2 A$ ). The percent transmittance should fall within  $10$  to  $80\% T$  ( $A = 1$  to  $0.1$ ) in order to prevent large errors in spectrophotometric readings. Hence, samples should be diluted (or concentrated), and standard solutions prepared, so that the absorbance falls within the optimal range.

The absorbance should fall in the  $0.1-1$  range.

Figure 14.27 in practice approximates the error only for instruments with "Johnson" or *thermal noise-limited detectors*, such as photoconductive detectors like CdS or PbS detectors ( $400$  to  $3500$  nm) or thermocouples, bolometers, and Golay detectors in the infrared region. Johnson noise is produced by random thermal motion in resistance circuit elements. With phototubes and photomultiplier-type detectors (photoemissive detectors, ultraviolet to visible range), thermal noise becomes insignificant as compared to "shot noise." Shot noise is the random fluctuation of the electron current from an electron-emitting surface (i.e.,



**FIGURE 14.27** Relative concentration error as a function of transmittance for a 1% uncertainty in %T.

across a junction from cathode to anode), and in PM tubes that is amplified and becomes the noise-limiting fluctuation. In instruments with these detectors, the absolute error is not constant at all values of  $T$ , and the expressions for the spectrophotometric error become more complicated. It has been calculated that, for these cases, the minimal error should occur at  $T = 0.136$  or  $A = 0.87$ . These instruments have a working range of about 0.1 to 1.5  $A$ .

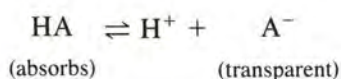
### 14.13 DEVIATION FROM BEER'S LAW

It cannot always be assumed that Beer's law will apply, that is, that a linear plot of absorbance versus concentration will occur. Deviations from Beer's law occur as the result of chemical and instrumental factors. Most "deviations" from Beer's law are really only "apparent" deviations, because if the factors causing nonlinearity are accounted for, the true or corrected absorbance-versus-concentration curve will be linear. True deviations from Beer's law will occur when the concentration is so high that the index of refraction of the solution is changed from that of the blank. A similar situation would apply for mixtures of organic solvents with water, and so the blank solvent composition should closely match that of the sample. The solvent may also have an effect on the absorptivity of the analyte.

Deviations from Beer's law results in nonlinear calibration curves, especially at higher concentrations.

#### Chemical Deviations

Chemical causes for nonlinearity occur when nonsymmetrical chemical equilibria exist. An example is a weak acid that absorbs at a particular wavelength but has an anion that does not:



The ratio of the acid form to the salt form will, of course, depend on the pH (Chapter 6). So long as the solution is buffered or is very acid, this ratio will remain constant at all concentrations of the acid. However, in unbuffered solution, the degree of ionization will increase as the acid is diluted, that is, the above equilibrium will shift to the right. Thus, a smaller fraction of the species exists in the acid form available for absorption for dilute solutions of the acid, causing apparent deviations from Beer's law. The result will be a positive deviation from linearity at higher concentrations (where the fraction dissociated is smaller). If the anion form were the absorbing species, then the deviation would be negative. Similar arguments apply to colored (absorbing) metal ion complexes or chelates in the absence of a large excess of the complexing agent. That is, in the absence of excess complexing agent, the degree of dissociation of the complex will increase as the complex is diluted. Here, the situation may be extremely complicated, because the complex may dissociate stepwise into successive complexes that may or may not absorb at the wavelength of measurement. pH also becomes a consideration in these equilibria.

Apparent deviations may also occur when the substance can exist as a dimer as well as a monomer. Again, the equilibrium depends on the concentration. An

example is the absorbance by methylene blue, which exhibits a negative deviation at higher concentrations due to association of the methylene blue.

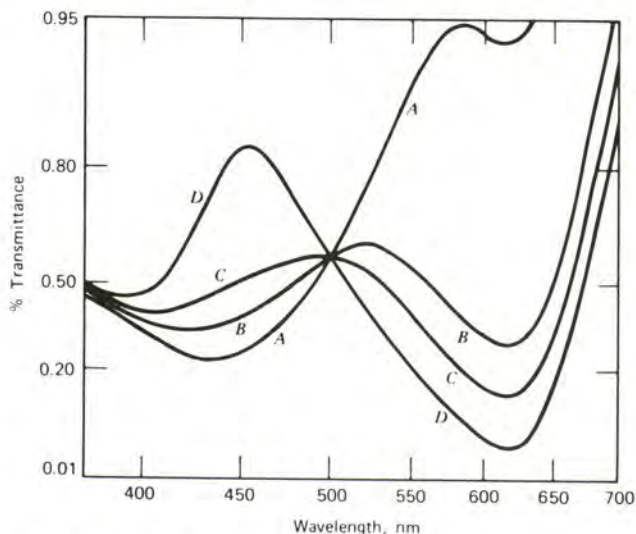
The best way to minimize chemical deviations from Beer's law is by adequate buffering of the pH, adding a large excess of complexing agent, ionic strength adjustment, and so forth. Preparation of a calibration curve over the measurement range will correct for most deviations.

If both species of a chemical equilibrium absorb, and if there is some overlap of their absorption curves, the wavelength at which this occurs is called the **isosbestic point**, and the molar absorptivity of both species is the same. Such a point is illustrated in Figure 14.28. The spectra are plotted at different pH values since the pH generally causes the shift in the equilibrium. Obviously, the effect of pH could be eliminated by making measurements at the isosbestic point, but the sensitivity is decreased. By making the solution either very acid or very alkaline, one species predominates and the sensitivity is increased by measuring at this condition.

The existence of an isosbestic point is a necessary (although not sufficient) condition to prove that there are only two absorbing substances in equilibrium with overlapping absorption bands. If both of the absorbing species follow Beer's law, then the absorption spectra of all equilibrium mixtures will intersect at a fixed wavelength. For example, the different colored forms of indicators in equilibrium (e.g., the red and yellow forms of methyl orange) often exhibit an isosbestic point, supporting evidence that two and only two colored species participate in the equilibrium.

### Instrumental Deviations

The basic assumption in applying Beer's law is that monochromatic light is used. We have seen in the discussions above that it is impossible to extract monochromatic radiation from a continuum source. Instead, a band of radiation is passed,



**FIGURE 14.28** Illustration of an isosbestic point of bromthymol blue (501 nm). (A) pH 5.45. (B) pH 6.95. (C) pH 7.50. (D) pH 11.60.

The absorptivity of all species is the same at the isosbestic point.

the width of which depends on the dispersing element and the slit width. In an absorption spectrum, different wavelengths are absorbed to a different degree; that is, the absorptivity changes with wavelength. At a wavelength corresponding to a fairly broad maximum on the spectrum, the band of wavelengths will all be absorbed to nearly the same extent. However, on a steep portion of the spectrum, they will be absorbed to different degrees. The slope of the spectrum increases as the concentration is increased, with the result that the fractions of the amounts of each wavelength absorbed may change, particularly if the instrument setting should drift over the period of the measurement. So a negative deviation in the absorbance-versus-concentration plot will be observed. The greater the slope of the spectrum, the greater is the deviation.

Obviously, it is advantageous to make the measurement on an absorption peak whenever possible, in order to minimize this curvature, as well as to obtain maximum sensitivity. Because a band of wavelengths is passed, the absorptivity at a given wavelength may vary somewhat from one instrument to another, depending on the resolution, slit width, and sharpness of the absorption maximum. Therefore, you should check the absorptivity and linearity on your instrument rather than rely on reported absorptivities. It is common practice to prepare calibration curves of absorbance versus concentration rather than to rely on direct calculations of concentration from Beer's law.

The absorptivity at a given wavelength may vary from instrument to instrument. Therefore, always run a standard.

If there is a second (interfering) absorbing species whose spectrum overlaps with that of the test substance, nonlinearity of the total absorbance as a function of the test substance concentration will result. It may be possible to account for this in preparation of the calibration curve by adding the interfering compound to standards at the same concentration as in the samples. This will obviously work only if the concentration of the interfering compound is essentially constant, and the concentration should be relatively small. Otherwise, simultaneous analysis as described earlier will be required.

Other instrumental factors that may contribute to deviations from Beer's law include stray radiation entering the monochromator and being detected, internal reflections of the radiation within the monochromator, and mismatched cells (in terms of path length) used for different analyte solutions or used in double-beam instruments (when there is appreciable absorbance by the blank or solvent in the reference cell). Stray light (any detected light that is not absorbed by the sample or is outside the bandwidth of the selected wavelength) becomes especially limiting at high absorbances and eventually causes deviation from linearity. Noise resulting from stray light also becomes a major contributor to the spectrometric error or imprecision at high absorbances.

Stray light is the most common cause of negative deviation from Beer's law. For Beer's law, the light falling on the detector goes to zero at infinite concentration (all the light is absorbed). But this is impossible when stray light falls on the detector.

Nonuniform cell thickness can affect a quantitative analysis. This is potentially a problem, especially in infrared spectrometry, where cell spacers are used. Air bubbles can affect the path length and stray light, and it is important to eliminate these bubbles, again especially in the infrared cells.

## 14.14 FLUOROMETRY

Fluorometric analysis is extremely sensitive and is used widely by biochemists, clinical chemists, and analytical chemists in general.



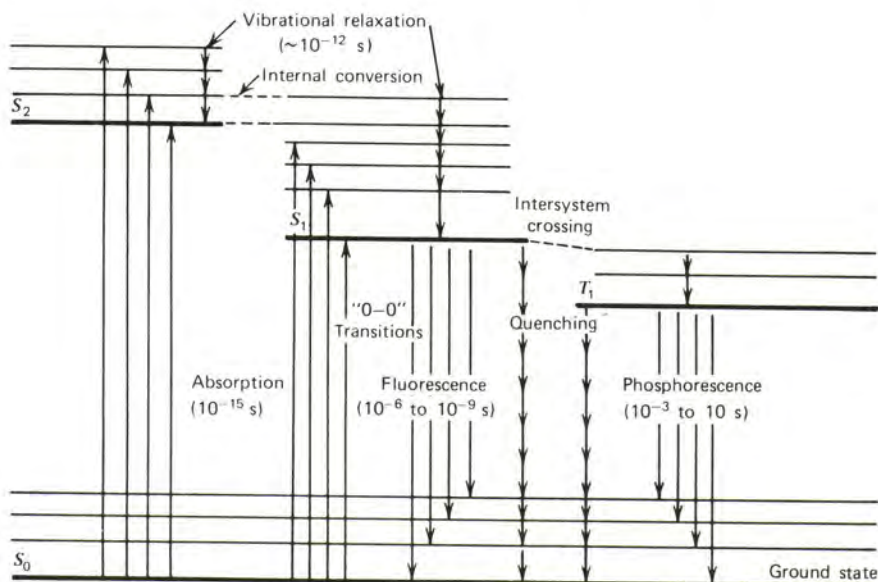
## Principles of Fluorescence

Some molecules that absorb UV radiation lose only part of the absorbed energy by collisions. The rest is reemitted as radiation at longer wavelengths.

When a molecule absorbs electromagnetic energy, this energy is usually lost as heat, as the molecule is deactivated via collisional processes. With certain molecules (ca. 5 to 10%), however, particularly when absorbing high-energy radiation such as UV radiation, only part of the energy is lost via collisions, and then the electron drops back to the ground state by emitting a photon of lower energy (longer wavelength) than was absorbed. Refer to Figure 14.29.

A molecule at room temperature normally resides in the ground state. The ground state is usually a **singlet state** ( $S_0$ ), with all electrons paired. Electrons that occupy the same molecular orbital must be "paired," that is, have opposite spins. In a singlet state, the electrons are paired. If electrons have the same spin, they are "unpaired" and the molecule is in a **triplet state**. Singlet and triplet states refer to the **multiplicity** of the molecule. The process leading to the emission of a fluorescent photon begins with the absorption of a photon (a process that takes  $10^{-15}$  s) by the fluorophore, resulting in an electronic transition to a higher-energy (excited) state. In most organic molecules at room temperature, this absorption corresponds to a transition from the lowest vibrational level of the ground state to one of the vibrational levels of the first or second electronic excited state to the same multiplicity ( $S_1$ ,  $S_2$ ). The spacing of the vibrational levels and rotational levels in these higher electronic states gives rise to the absorption spectrum of the molecule.

If the transition is to an electronic state higher than  $S_1$ , a process of **internal conversion** rapidly takes place. It is thought that the excited molecule passes from the vibrational level of this higher electronic state to a high vibrational level of  $S_1$  that is isoenergetic with the original excited state. Collision with solvent molecules at this point rapidly removes the excess energy from the higher vibrational level of  $S_1$ ; this process is called **vibrational relaxation**. These energy de-



**FIGURE 14.29** Energy level diagram showing absorption processes, relaxation processes, and their rates.

gradation processes (internal conversion and vibrational relaxation) occur rapidly ( $\sim 10^{-12}$  s). Because of this rapid energy loss, emission fluorescence from higher states than the first excited state is rare.

Once the molecule reaches the first excited singlet, internal conversion to the ground state is a relatively slow process. Thus, decay of the first excited state by emission of a photon can effectively compete with other decay processes. This emission process is **fluorescence**. Generally, fluorescence emission occurs very rapidly after excitation ( $10^{-6}$  to  $10^{-9}$  s). Consequently, it is not possible for the eye to perceive fluorescence emission after removal of the excitation source. Because fluorescence occurs from the lowest excited state, the fluorescence spectrum, that is, the wavelengths of emitted radiation, is independent of the wavelength of excitation. The intensity of emitted radiation, however, will be proportional to the intensity of incident radiation (i.e., the number of photons absorbed).

Another feature of excitation and emission transitions is that the longest wavelength of excitation corresponds to the shortest wavelength of emission. This is the "0-0" band correspond to the transitions between the 0 vibrational level of  $S_0$  and the 0 vibrational level of  $S_1$  (Figure 14.29).

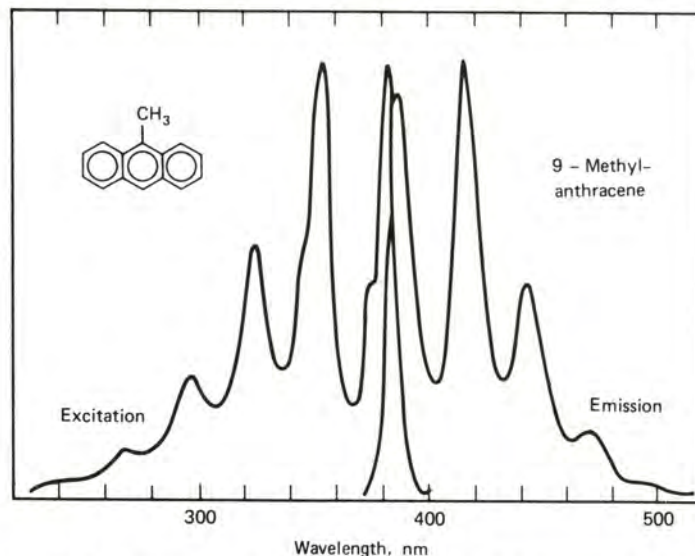
While the molecule is in the excited state, it is possible for one electron to reverse its spin, and the molecule transfers to a lower-energy triplet state by a process called **intersystem crossing**. Through the processes of internal conversion and vibrational relaxation, the molecule then rapidly attains the lowest vibrational level of the first excited triplet ( $T_1$ ). From here, the molecule can return to the ground state  $S_0$  by emission of a photon. This emission is referred to as **phosphorescence**. Since transitions between states of different multiplicity are "forbidden,"  $T_1$  has a much longer lifetime than  $S_1$  and phosphorescence is much longer-lived than fluorescence ( $>10^{-4}$  s). Consequently, one can quite often perceive an "afterglow" in phosphorescence when the excitation source is removed. In addition, because of its relatively long life, radiationless processes can complete more effectively with phosphorescence than fluorescence. For this reason, phosphorescence is not normally observed from solutions due to collisions with the solvent or with oxygen. Phosphorescence measurements are made by cooling samples to liquid nitrogen temperature ( $-196^\circ\text{C}$ ) to freeze them and minimize collision with other molecules. Solid samples will also phosphoresce, and many inorganic minerals exhibit long-lived phosphorescence. Studies have been made in which molecules in solution are adsorbed on a solid support from which they can phosphoresce.

A typical excitation and emission spectrum of a fluorescing molecule is shown in Figure 14.30. The excitation spectrum usually corresponds closely in shape to the absorption spectrum of the molecule. There is frequently (but not necessarily) a close relationship between the structure of the excitation spectrum and the structure of the emission spectrum. In many relatively large molecules, the vibrational spacings of the excited states, especially  $S_1$ , are very similar to those in  $S_0$ . Thus, the form of the emission spectrum resulting from decay to the various  $S_0$  vibrational levels tends to be a "mirror image" of the excitation spectrum arising from excitation to the various vibrational levels in the excited state, such as  $S_1$ . Substructure, of course, results also from different rotational levels at each vibrational level.

The longest wavelength of absorption and the shortest wavelength of fluorescence tend to be the same (the "0-0" transition in Figure 14.29). More typically, however, this is not the case due to solvation differences between the excited

The wavelengths of emitted radiation are independent of the wavelength of excitation. Their intensities are dependent, though.

Phosphorescence is longer lived than fluorescence, and it may continue after the excitation source is turned off.



**FIGURE 14.30** Excitation and emission spectra of a fluorescing molecule.

molecule and the ground-state molecule. The heats of solvation of each are different, which results in a decrease in the energy of the emitted photon by an amount equal to these two heats of solvation.

Only those molecules that will absorb radiation, usually ultraviolet radiation, can fluoresce, and of those that do absorb, only about 5 to 10% fluoresce. This is an advantage when considering possible interference in fluorescence. The emitted radiation may be in the ultraviolet region, especially if the compound absorbs at less than 300 nm, but it is usually in the visible region. It is the emitted radiation that is measured and related to concentration.

### Chemical Structure and Fluorescence

In principle, any molecule that absorbs ultraviolet radiation could fluoresce. There are many reasons why they do not; but we will not go into these, other than to point out, in general, what types of substances may be expected to fluoresce.

First of all, the greater the absorption by a molecule, the greater its fluorescence intensity. Many aromatic and heterocyclic compounds fluoresce, particularly if they contain certain substituted groups. Compounds with multiple conjugated double bonds are favorable to fluorescence. One or more electron-donating groups such as  $-\text{OH}$ ,  $-\text{NH}_2$ , and  $-\text{OCH}_3$  enhances the fluorescence. Polycyclic compounds such as vitamin K, purines, and nucleosides and conjugated polyenes such as vitamin A are fluorescent. Groups such as  $-\text{NO}_2$ ,  $-\text{COOH}$ ,  $-\text{CH}_2\text{COOH}$ ,  $-\text{Br}$ ,  $-\text{I}$ , and azo groups tend to *inhibit* fluorescence. The nature of other substituents may alter the degree of fluorescence. The fluorescence of many molecules is greatly pH dependent because only the ionized or un-ionized form may be fluorescent. For example, phenol,  $\text{C}_6\text{H}_5\text{OH}$ , is fluorescent but its anion,  $\text{C}_6\text{H}_5\text{O}^-$ , is not.

If a compound is nonfluorescent, it may be converted to a fluorescent derivative. For example, nonfluorescent steroids may be converted to fluorescent com-

pounds by dehydration with concentrated sulfuric acid. These cyclic alcohols are converted to phenols. Similarly, dibasic acids, such as malic acid, may be reacted with  $\beta$ -naphthol in concentrated sulfuric acid to form a fluorescing derivative. C. E. White and co-workers have developed fluorometric methods for many metals by forming chelates with organic compounds (see Reference 26). Antibodies may be made to fluoresce by condensing them with fluorescein isocyanate, which reacts with the free amino groups of the proteins. NADH, the reduced form of nicotinamide adenine dinucleotide, fluoresces. It is a product or reactant (cofactor) in many enzyme reactions (see Chapter 18), and its fluorescence serves as the basis of the sensitive assay of enzymes and their substrates. Most amino acids do not fluoresce, but fluorescent derivatives are formed by reaction with dansyl chloride.

### Fluorescence Quenching

One difficulty frequently encountered in fluorescence is that of **fluorescence quenching** by many substances. These are substances that, in effect, compete for the electronic excitation energy and decrease the quantum yield (the efficiency of conversion of absorbed radiation to fluorescent radiation—see below). Iodide ion is an extremely effective quencher. Iodide and bromide substituent groups decrease the quantum yield. Substances such as this may be determined indirectly by measuring the extent of fluorescence quenching. Some molecules do not fluoresce because they may have a bond whose dissociation energy is less than that of the radiation. In other words, a molecular bond may be broken, preventing fluorescence.

Quenching of fluorescence is often a problem in quantitative measurements.

A colored species in solution with the fluorescing species may interfere by absorbing the fluorescent radiation. This is the so-called “**inner-filter**” effect. For example, in sodium carbonate solution, potassium dichromate exhibits absorption peaks at 245 and 348 nm. These overlap with the excitation (275 nm) and emission (350 nm) peaks for tryptophan and would interfere. The inner-filter effect can also arise from too high a concentration of the fluorophore itself. Some of the analyte molecules will reabsorb the emitted radiation of others (see the discussion of fluorescence intensity and concentration below).

### Practical Considerations in Fluorometry

For reasons more apparent below, fluorometric analysis is extremely sensitive, and determinations at the part-per-billion level are common. In fact, the technique is limited to low concentrations. The high sensitivity presents problems not normally encountered with more concentrated solutions. Dilute solutions are less stable. Similar deterioration may occur in more concentrated solutions, but it is a negligible percentage of the sample. Adsorption onto the surfaces of the containers is a serious problem. Organic substances at less than 1 ppm are especially adsorbed onto glass surfaces from organic solvents. Addition of a small amount of a more polar solvent may help. In analysis of blood samples, a protein-free filtrate is usually prepared. Some trace organics may be adsorbed onto the freshly precipitated protein, and this possibility should always be checked.

Oxidation of trace substances can be a problem. For example, traces of peroxides in ether used for solvent extraction of organic substances may cause oxidation of the test substance. Even dissolved oxygen is sometimes a problem at

these concentrations. Appreciable photodecomposition is more likely to occur at low concentrations, and so dilute solutions of labile compounds should be protected from light. Photodecomposition can be a serious problem in the fluorescence measurement because the energy of the exciting radiation may cause the substance to decompose. A high-intensity source is used (see below) which adds to the danger of photodecomposition. The measurement should, therefore, be made rapidly. Another reason for making measurements rapidly is to minimize increased collisional deactivation as the solution is heated by the source.

### Relationship Between Concentration and Fluorescence Intensity

Fluorescence intensity is proportional to the intensity of the source. Absorbance, on the other hand, is independent of it.

It can be readily derived from Beer's law (Problem 48) that the fluorescence intensity  $F$  is given by

$$F = \phi P_0(1 - 10^{-abc}) \quad (14.18)$$

where  $\phi$  is the **quantum yield**, a proportionality constant and a measure of the fraction of absorbed photons that are converted into fluorescent photons. The quantum yield is, therefore, less than or equal to unity. The other terms in the equation are the same as for Beer's law. It is evident from the equation that if the product  $abc$  is large, the term  $10^{-abc}$  becomes negligible compared to 1, and  $F$  becomes constant:

$$F = \phi P_0 \quad (14.19)$$

On the other hand, if  $abc$  is small ( $\leq 0.01$ ), it can be shown<sup>5</sup> by expanding Equation 14.18 that as a good approximation,

$$F = 2.303\phi P_0 abc \quad (14.20)$$

For low concentrations, fluorescence intensity becomes directly proportional to the concentration.

Thus, for low concentrations, the fluorescence intensity is directly proportional to the concentration. Also, it is proportional to the intensity of the incident radiation.

This equation generally holds for concentrations up to a few parts per million, depending on the substance. At higher concentrations, the fluorescence intensity may decrease with increasing concentration. The reason can be visualized as follows. In dilute solutions, the absorbed radiation is distributed equally through the entire depth of the solution. But at higher concentrations, the first part of the solution in the path will absorb more of the radiation. So the equation holds only when most of the radiation goes through the solution, when more than about 92% is transmitted.

<sup>5</sup>It is known that  $e^{-x} = 1 - x + x^2/2! \dots$  and that  $10^{-x} = e^{-2.303x}$ . Therefore,  $1 - e^{-2.303abc} = 1 - [1 - 2.303abc + (2.303abc)^2/2! \dots]$ . The squared term and higher-order terms can be neglected if  $abc \leq 0.01$ , and so the expanded term reduces to  $2.303abc$ . This is a Taylor expansion series.

## Fluorescence Instrumentation

For fluorescence measurements, it is necessary to separate the emitted radiation from the incident radiation. This is most easily done by measuring the fluorescence at right angles to the incident radiation. The fluorescence radiation is emitted in all directions, but the incident radiation passes straight through the solution.

A simple fluorometer design is illustrated in Figure 14.31. An ultraviolet source is required. Most fluorescing molecules absorb ultraviolet radiation over a band of wavelengths, and so a simple line source is sufficient for many applications. Such a source is a mercury vapor lamp. A spark is passed through mercury vapor at low pressure, and principal lines are emitted at 2537, 3650, 5200 (green), 5800 (yellow), and 7800 (red) Å. **Wavelengths shorter than 3000 Å are harmful to the eyes**, and one must never look directly at a short-wavelength UV source. The mercury vapor itself absorbs most of the 2537-Å radiation (self-absorption), and a blue filter in the envelope of the lamp may be added to remove most of the visible light. The 3650-Å line is thus the one used primarily for the activation. A high-pressure xenon arc (a continuum source) is usually used as the source in more sophisticated instruments that will scan the spectrum (spectrofluorometers). The lamp pressure is 7 atm at 25°C and 35 atm at operating temperatures. Take care!

In the simple instrument in Figure 14.31, a primary filter (Filter 1) is used to filter out the wavelengths close to the wavelength of the emission because, in practice, some radiation is scattered. The primary filter allows the passage of only the wavelength of excitation. The secondary filter (Filter 2) passes the wavelength of emission but not the wavelength of excitation (which may be scattered). Glass will pass appreciable amounts of the 3650-Å line, and so some instruments employ glass cuvetts and filters. However, it is better to use quartz (special nonfluorescing grades are available). This simple setup is satisfactory for many purposes.

We can see why fluorometric methods are so sensitive if we compare them with absorption spectrometry. In absorption methods, the difference between two finite signals,  $P_0$  and  $P$ , is measured. The sensitivity is then governed by the ability to distinguish between these two, which is dependent on the stability of the instrument, among other factors. In fluorescence, however, we measure the difference between zero and a finite number, and so, in principle, the limit of de-

Fluorescence measurements are 1000-fold more sensitive than absorbance measurements. Absorbance is like weighing a ship and captain and subtracting the ship's weight to get the captain's weight ( $P = P_0 - p$ ). In fluorescence, we measure only the captain.

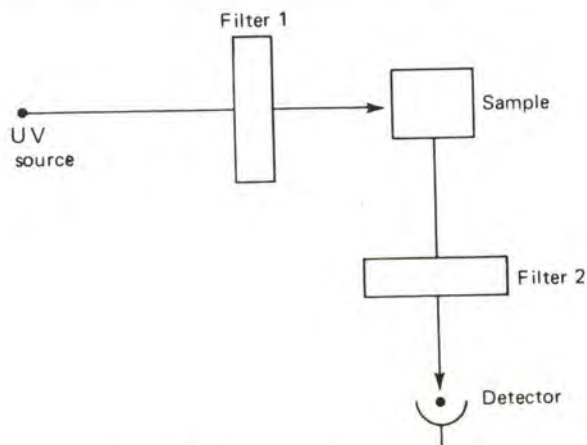


FIGURE 14.31 A simple fluorometer design.

Filter 1 removes wavelengths that would pass Filter 2 and appear as fluorescence. Filter 2 removes scattered excitation wavelengths and passes the fluorescence.

In a spectrofluorometer, the filters are replaced with scanning monochromators. Either the excitation spectrum (similar to the absorbance spectrum) or the emission spectrum may be recorded.

tection is governed by the intensity of the source and the sensitivity and stability of the detector (the “shot noise”). Also, in fluorescence, the signal depends linearly on concentration, and a much wider dynamic range of concentration can be measured; a dynamic range of  $10^3$  to  $10^4$  is not uncommon. In addition to the enhanced sensitivity, much wider ranges of concentrations can be measured; a 1000-fold or greater range is not uncommon.

In a **spectrofluorometer**, the measurement is also made at right angles to the direction of the incident radiation. But instead of using filters, the instrument incorporates two monochromators, one to select the wavelength of excitation and one to select the wavelength of fluorescence. The wavelength of excitation from a continuum source can be scanned and the fluorescence measured at a set wavelength to give a spectrum of the excitation wavelengths. This allows the establishment of the wavelength of maximum excitation. Then, by setting the excitation wavelength for maximum excitation, the emission wavelength can be scanned to establish the wavelength of maximum emission. When this spectrum is scanned, there is usually a “scatter peak” corresponding to the wavelength of excitation.

In spectrofluorometers, it is difficult to correct for variations in intensity from the source or response of the detector at different wavelengths, and calibration curves are generally prepared under a given set of conditions. Since the source intensity or detector response may vary from day to day, the instrument is usually calibrated by measuring the fluorescence of a standard solution and adjusting the gain to bring the instrument reading to the same value. A dilute solution of quinine in dilute sulfuric acid is usually used as the calibrating standard.

Sometimes it is desirable to obtain “absolute” spectra of a fluorescing compound to calculate quantum efficiencies for different transitions. This would require point-by-point correction for variations in the recorded signal due to variations in the instrumental parameters. Commercial instruments are available that will provide “corrected spectra.” These adjust for variation in the source intensity with wavelength, so the sample is irradiated with constant energy, and they also correct for variations of the detector response. The recorded emission spectrum is presented directly in quanta of photons emitted per unit bandwidth.

## 14.15 OPTICAL SENSORS: FIBER OPTICS

Fiber-optic cables allow the sample to be far removed from the spectrometer.

There has been a great deal of interest in recent years in developing optically based sensors that function much as electrochemical sensors (Chapter 13) do. These have been made possible with the advent of fiber-optic cables that transmit light along a flexible cable (waveguide) or “light pipe.” Optical fibers were developed for the communications industry, and are capable of transmitting light over long distances, but have proven valuable for transmitting light to spectrometers and for developing analyte-selective sensors by coupling appropriate chemistries to the fibers. Through the use of optical fibers, a sample need not be brought to the spectrometer, because light can be transmitted to and returned from the sample via the cables.

### Fiber-Optic Properties

The construction of a fiber-optic cable is illustrated in Figure 14.32. It consists of a cylindrical *core* that acts as the waveguide, surrounded by a *cladding* material

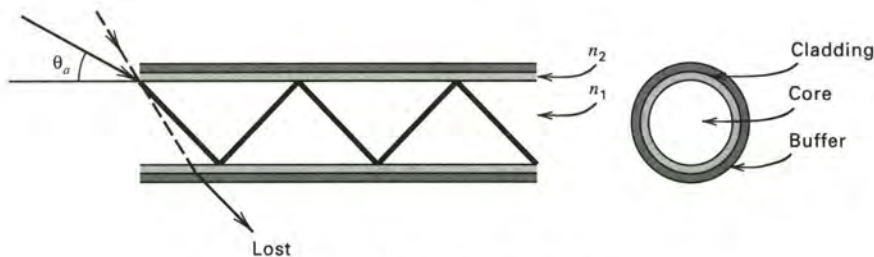


FIGURE 14.32 Fiber-optic structure.

of higher index of refraction, and a protective buffer layer. Light is transmitted along the core by total internal reflection at the core–cladding interface. The angle of acceptance,  $\theta_a$ , is the greatest angle of radiation that will be totally reflected for a given core–cladding refractive index difference. Any light entering at an angle greater than  $\theta$  will not be transmitted, and  $\theta_a$  defines the fiber's numerical aperture, NA:

$$NA = n_{\text{ext}} \sin \theta_a = \sqrt{n_1^2 - n_2^2} \quad (14.21)$$

where  $n_2$  is the refractive index of the cladding,  $n_1$  is that of the core, and  $n_{\text{ext}}$  is that of the external medium.

Manufacturers typically provide numerical aperture data for different fibers. Another property usually provided is the light loss per unit length for different wavelengths. A spectral curve is given that shows attenuation versus wavelength. Attenuation is usually expressed in decibels per kilometer (db/km), and is given by

$$\text{db} = 10 \log \frac{P_0}{P} \quad (14.22)$$

where  $P_0$  is the input intensity and  $P$  the output intensity. Thus, the attenuation for silica-based fibers at 850 nm is in the order of 10 db/km. Note that db = 10 × absorbance. So a 10 m (0.01 km) fiber would exhibit an absorbance of 0.01 (0.1 db attenuation), corresponding to 97.7% transmittance.

Fiber optics may be purchased that transmit radiation from the ultraviolet (190 nm) to the infrared ( $\geq 5 \mu\text{m}$ ), but each has a limited range. Table 14.7 lists some of the materials used and their properties. Plastic and compound glass materials are used for short distances in the visible region, while silica fibers can be used from the UV through the near-IR (2.3  $\mu\text{m}$ ) regions, but they are most costly. Fluoride and calcogenide glasses extend farther into the infrared.

In coupling fiber optics to spectrometers, there is a tradeoff between increased numerical aperture to collect more light and the collection angle of the spectrometer itself, which is usually limiting. That is, light collected with a numerical aperture greater than that for the spectrometer limit will not be seen by the spectrometer. See Reference 29 for a discussion of design considerations for fiber optic/spectrometer coupling.

Fiber optics may be used as probes for conventional spectrophotometric and fluorescence measurements. Light must be transmitted from a radiation source to the sample and back to the spectrometer. While there are couplers and designs that allow light to be both transmitted and received by a single fiber, usually a *bifurcated fiber* cable is used. This consists of two fibers in one casing, split at the

With bifurcated cables, one is used to transmit the source radiation and the other is used to receive the absorbed or fluorescent radiation.



**TABLE 14.7**  
Fiber-Optic Materials\*

Core	Cladding	Buffer	Core Sizes, $\mu\text{m}$	NA	Typical Attenuation, db/km	Useful Wavelength Range
Compound glass	Compound glass	None	15-75	0.5-0.8	800	Visible
Plastic	Fluoropolymer	None	100-2000	0.5-0.6	200	Visible
Silica	Silicone	Nylon	50-1000	0.2-0.5	10-15	200 nm-2.3 $\mu\text{m}$
	Fluoropolymer	Teflon				
	Doped silica					

\*Adapted from M. J. Webb, *Spectroscopy*, 4 (1989) 9.

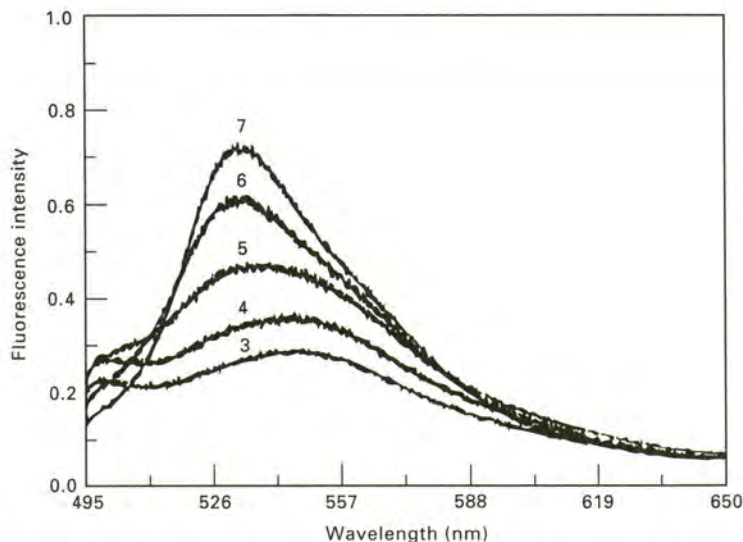
end that goes to the radiation source and the spectrometer. Often, the cables consist of a bundle of several dozen small fibers, and half are randomly separated from the other at one end. For absorbance measurements, a small mirror is mounted (attached to the cable) a few millimeters from the end of the fiber. The source radiation penetrates the sample solution and is reflected back to the fiber for collection and transmission to the spectrometer. The radiation path length is twice the distance between the fiber and the mirror.

Fluorescence measurements are made in a similar fashion, but without the mirror. Radiation emitting from the end of the fiber in the shape of a cone excites fluorescence in the sample solution, which is collected by the return cable (the amount depends on the numerical aperture) and sent to the spectrometer. Often, a laser radiation source is used to provide good fluorescence intensity.

### Fiber-Optic Sensors

We can convert fiber-optic probes into selective absorbance- or fluorescence-based sensors by immobilizing appropriate reagents on the end of a fiber-optic cable. These possess the advantage over electrochemical sensors in that a reference electrode (and salt bridge) is not needed, and electromagnetic radiation will not influence the response. For example, a fluorometric pH sensor may be prepared by chemically immobilizing the indicator fluorescein isothiocyanate (FITC) on a porous glass bead and attaching this to the end of the fiber with epoxy. The FITC fluorescence spectrum changes with pH (Figure 14.33) over the range of about pH 3 to 7, centered around  $pK$  of the indicator. The fluorescence intensity measured at the fluorescence maximum is related to the pH via a calibration curve. The calibration curve will be sigmoid-shaped since it in effect represents a titration of the indicator. See References 35 and 36 for a discussion of the limitations of fiber-optic sensors for measuring pH and ionic activity.

Optical sensors do not have the requirement and associated difficulties of a reference electrode.



**FIGURE 14.33** Fluorescence spectra of FITC immobilized on a porous glass bead at pH 3, 4, 5, 6, and 7. [From M-R. S. Fuh, L. W. Burgess, T. Hirschfeld, G. D. Christian, and F. Wang, *Analyst*, **112** (1987) 1159. Reproduced by permission.]

If an enzyme, for example, penicillinase, is immobilized along with an appropriate indicator, then the sensor is converted into a biosensor for measuring penicillin. The enzyme catalyzes the hydrolysis of penicillin to produce penicilloic acid, which causes a pH decrease.

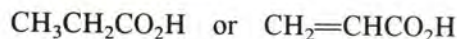
Fiber-optic sensors have been developed for oxygen, CO<sub>2</sub>, alkali metals, and other analytes. In order for these to function, the indicator chemistry must be reversible.

## QUESTIONS

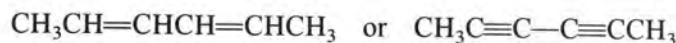
### Absorption of Radiation

- Describe the absorption phenomena taking place in the far-infrared, mid-infrared, and visible-ultraviolet regions of the spectrum.
- What types of electrons in a molecule are generally involved in the absorption of UV or visible radiation?
- What are the most frequent electronic transitions during absorption of electromagnetic radiation? Which results in more intense absorption? Give examples of compounds that exhibit each.
- What is a necessary criterion for absorption to occur in the infrared region?
- What types of molecular vibration are associated with infrared absorption?
- What distinguishes near-infrared absorption from mid-infrared absorption? What are its primary advantages?
- Define the following terms: chromophore, auxochrome, bathochromic shift, hypsochromic shift, hyperchromism, and hypochromism.
- Which of the following pairs of compounds is likely to absorb radiation at the longer wavelength and with greater intensity?

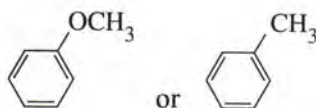
(a)



(b)

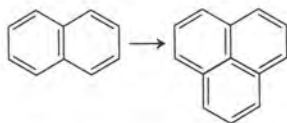


(c)

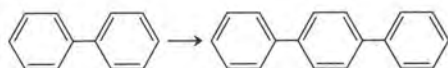


- In the following pairs of compounds, describe whether there should be an increase in the wavelength of maximum absorption and whether there should be an increase in absorption intensity in going from the first compound to the second:

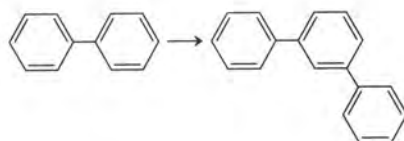
(a)



(b)



(c)



10. Why do acid–base indicators change color in going from acid to alkaline solution?

11. What are the mechanisms by which a metal complex can absorb radiation?

### Quantitative Relationships

12. Define absorption, absorbance, percent transmittance, and transmittance.

13. Define absorptivity and molar absorptivity.

14. Why is a calibration curve likely to be linear over a wider range of concentrations at the wavelength of maximum absorption compared to a wavelength on a shoulder of the absorption curve?

15. List some solvents that can be used in the ultraviolet, visible, and infrared regions, respectively. Give any wavelength restrictions.

16. What is an isosbestic point?

17. Describe and compare different causes for deviations from Beer's law. Distinguish between real and apparent deviations.

### Instrumentation

18. Describe radiation sources and detectors for the ultraviolet, visible, and infrared regions of the spectrum.

19. Distinguish between the two types of monochromators (light dispersers) used in spectrophotometers and list the advantages and disadvantages of each.

20. Discuss the effect of the slit width on the resolution of a spectrophotometer and the adherence to Beer's law. Compare it with the spectral slit width.

21. Compare the operations of a single-beam spectrophotometer, a double-beam spectrophotometer, and a high-absorbance spectrophotometer.

22. Given the weak absorption in the near-infrared region, why do near-infrared instruments function with reasonable sensitivity?
23. Describe the operation of a diode array spectrometer.
24. Describe the operation of an interferometer. What are its advantages?
25. Referring to Figure 14.28, what would be the color of an acid solution and an alkaline solution at maximum absorption? What color filter would be most applicable for the analysis of each in a filter colorimeter? (A filter replaces the prism and slit arrangement).

### Fluorescence

26. Describe the principles of fluorescence. Why is fluorescence generally more sensitive than absorption measurements?
27. Under what conditions is fluorescence intensity proportional to concentration?
28. Describe the instrumentation required for fluorescence analysis. What is a primary filter? A secondary filter?
29. Suggest an experiment by which you could determine iodide ion by fluorescence.

---

### PROBLEMS

#### Wavelength/Frequency/Energy

30. Express the wavelength 2500 Å in micrometers and nanometers.
31. Convert the wavelength 4000 Å into frequency (Hz) and into wavenumbers ( $\text{cm}^{-1}$ ).
32. The most widely used wavelength region for infrared analysis is about 2 to 15  $\mu\text{m}$ . Express this range in angstroms and in wavenumbers.
33. One mole of photons (Avogadro's number of photons) is called an *einstein* of radiation. Calculate the energy, in calories, of one einstein of radiation at 3000 Å.

#### Beer's Law

34. Several spectrophotometers have scales that are read either in absorbance or in percent transmittance. What would be the absorbance reading at 20% *T*? At 80% *T*? What would the transmittance reading be at 0.25 absorbance? At 1.00 absorbance?
35. A 20-ppm solution of a DNA molecule (unknown molecular weight) isolated from *Escherichia coli* was found to give an absorbance of 0.80 in a 2-cm cell. Calculate the absorptivity of the molecule.
36. A compound of formula weight 280 absorbed 65.0% of the radiation at a certain wavelength in a 2-cm cell at a concentration of 15.0  $\mu\text{g/mL}$ . Calculate its molar absorptivity at the wavelength.

37. Titanium is reacted with hydrogen peroxide in 1 *M* sulfuric acid to form a colored complex. If a  $2.00 \times 10^{-5}$  *M* solution absorbs 31.5% of the radiation at 415 nm, what would be (a) the absorbance and (b) the transmittance and percent absorption for a  $6.00 \times 10^{-5}$  *M* solution?
38. A compound of formula weight 180 has an absorptivity of  $286 \text{ cm}^{-1} \text{ g}^{-1} \text{ L}$ . What is its molar absorptivity?
39. Aniline,  $\text{C}_6\text{H}_5\text{NH}_2$ , when reacted with picric acid gives a derivative with an absorptivity of  $134 \text{ cm}^{-1} \text{ g}^{-1} \text{ L}$  at 359 nm. What would be the absorbance of a  $1.00 \times 10^{-4}$  *M* solution of reacted aniline in a 1.00-cm cell?

### Quantitative Measurements

40. The drug tolbutamine (f. wt. = 270) has a molar absorptivity of 703 at 262 nm. One tablet is dissolved in water and diluted to a volume of 2 L. If the solution exhibits an absorbance in the UV region at 262 nm equal to 0.687 in a 1-cm cell, how many grams tolbutamine are contained in the tablet?
41. Amines (weak base) form salts with picric acid (trinitrophenol), and all amine picrates exhibit an absorption maximum at 359 nm with a molar absorptivity of  $1.25 \times 10^4$ . A 0.200-g sample of aniline,  $\text{C}_6\text{H}_5\text{NH}_2$ , is dissolved in 500 mL water. A 25.0-mL aliquot is reacted with picric acid in a 250-mL volumetric flask and diluted to volume. A 10.0-mL aliquot of this is diluted to 100 mL and the absorbance read at 359 nm in a 1-cm cell. If the absorbance is 0.425, what is the percent purity of the aniline?
42. Phosphorus in urine can be determined by treating with molybdenum(VI) and then reducing the phosphomolybdo complex with aminoaphtholsulfonic acid to give the characteristic molybdenum blue color. This absorbs at 690 nm. A patient excreted 1270 mL urine in 24 hours, and the pH of the urine was 6.5. A 1.00-mL aliquot of the urine was treated with molybdate reagent and aminonaphtholsulfonic acid and was diluted to a volume of 50.0 mL. A series of phosphate standards was similarly treated. The absorbance of the solutions at 690 nm, measured against a blank, were as follows:

Solution	Absorbance
1.00 ppm P	0.205
2.00 ppm P	0.410
3.00 ppm P	0.615
4.00 ppm P	0.820
Urine sample	0.625

- (a) Calculate the number of grams phosphorus excreted per day.  
 (b) Calculate the phosphate concentration in the urine as millimoles per liter.  
 (c) Calculate the ratio of  $\text{HPO}_4^{2-}$  to  $\text{H}_2\text{PO}_4^-$  in the sample:

$$K_1 = 1.1 \times 10^{-2}; \quad K_2 = 7.5 \times 10^{-8}; \quad K_3 = 4.8 \times 10^{-13}$$

43. Iron(II) is determined spectrophotometrically by reacting with 1,10-phenanthroline to produce a complex that absorbs strongly at 510 nm. A stock standard iron(II) solution is prepared by dissolving 0.0702 g ferrous ammonium sulfate,  $\text{Fe}(\text{NH}_4)_2\text{SO}_4 \cdot 6\text{H}_2\text{O}$ , in water in a 1-L volumetric flask, adding 2.5 mL  $\text{H}_2\text{SO}_4$ , and diluting to volume. A series of working standards is prepared by transferring 1.00-, 2.00-, 5.00-, and 10.00-mL aliquots of the stock solution to separate 100-mL volumetric flasks and adding hydroxylammonium chloride solution to reduce any iron(III) to iron(II), followed by phenanthroline solution and then dilution to volume with water. A sample is added to a 100-mL volumetric flask and treated in the same way. A blank is prepared by adding the same amount of reagents to a 100-mL volumetric flask and diluting to volume. If the following absorbance readings measured against the blank are obtained at 510 nm, how many milligrams iron are in the sample?

Solution	A
Standard 1	0.081
Standard 2	0.171
Standard 3	0.432
Standard 4	0.857
Sample	0.463

44. Nitrate nitrogen in water is determined by reacting with phenoldisulfonic acid to give a yellow color with an absorption maximum at 410 nm. A 100-mL sample that has been stabilized by adding 0.8 mL  $\text{H}_2\text{SO}_4/\text{L}$  is treated with silver sulfate to precipitate chloride ion, which interferes. The precipitate is filtered and washed (washings added to filtered sample). The sample solution is adjusted to pH 7 with dilute NaOH and evaporated just to dryness. The residue is treated with 2.0 mL phenoldisulfonic acid solution and heated in a hot water bath to aid dissolution. Twenty milliliters distilled water and 6 mL ammonia are added to develop the maximum color, and the clear solution is transferred to a 50-mL volumetric flask and diluted to volume and distilled water. A blank is prepared using the same volume of reagents, starting with the disulfonic acid step. A standard nitrate solution is prepared by dissolving 0.722 g anhydrous  $\text{KNO}_3$  and diluting to 1 L. A standard addition calibration is performed by spiking a separate 100-mL portion of sample with 1.00 mL of the standard solution and carrying through the entire procedure. The following absorbance readings were obtained: blank, 0.032; sample, 0.270; sample plus standard, 0.854. What is the concentration of nitrate nitrogen in the sample in parts per million?

45. Two colorless species, A and B, react to form a colored complex AB that absorbs at 550 nm with a molar absorptivity of 450. The dissociation constant for the complex is  $6.00 \times 10^{-4}$ . What would the absorbance of a solution, prepared by mixing equal volumes of 0.0100 M solutions of A and B in a 1.00-cm cell, be at 550 nm?

### Mixtures

46. Compounds A and B absorb in the ultraviolet region. A exhibits an absorption maximum at 267 nm ( $a = 157$ ) and a tailing shoulder at 312 nm ( $a = 12.6$ ). B has an absorption maximum at 312 nm ( $a = 186$ ) and does not absorb at 267 nm. A solution containing the two compounds exhibits absorbances (using a 1-cm cell) of

0.726 and 0.544 at 267 and 312 nm, respectively. What are the concentrations of A and B in mg/L?

47. Titanium(IV) and vanadium(V) form colored complexes when treated with hydrogen peroxide in 1 M sulfuric acid. The titanium complex has an absorption maximum at 415 nm, and the vanadium complex has an absorption maximum at 455 nm. A  $1.00 \times 10^{-3}$  M solution of the titanium complex exhibits an absorbance of 0.805 at 415 nm and of 0.465 at 455 nm, while a  $1.00 \times 10^{-2}$  M solution of the vanadium complex exhibits absorbances of 0.400 and 0.600 at 415 and 455 nm, respectively. A 1.000-g sample of an alloy containing titanium and vanadium was dissolved, treated with excess hydrogen peroxide, and diluted to a final volume of 100 mL. The absorbance of the solution was 0.685 at 415 nm and 0.513 at 455 nm. What were the percentages of titanium and vanadium in the alloy?

### Fluorescence

48. Derive Equation 14.18 relating fluorescence intensity to concentration.

---

## RECOMMENDED REFERENCES

### General

1. L. Delaey and O. Arkens, "The Acronyms Used in the World of Spectrometry, Microscopy and Diffractometry. I. Compilation and Classification. II. Glossary of Abbreviation," *Spectrochim. Acta*, Part B, **36B** (1981) 351 and 361.
2. D. F. Swinehart, "The Beer-Lambert Law," *J. Chem. Ed.*, **39**, 333 (1962).
3. J. D. Winfordner, *Spectrochemical Methods of Analysis*. New York: Wiley-Interscience, 1971.
4. H. L. C. Meuzelaar and T. L. Isenhour, eds., *Computer-Enhanced Analytical Spectroscopy*. New York: Plenum Publishing Co., Vol. I, 1987, Vol. II, 1990.

### Colorimetry/Spectrophotometry

5. D. F. Boltz and J. A. Howell, *Colorimetric Determination of Nonmetals*. New York: Wiley-Interscience, 1978.
6. G. H. Morrison and H. Freiser, *Solvent Extraction in Analytical Chemistry*. New York: John Wiley & Sons, 1975, pp. 189–247.
7. E. B. Sandell and H. Onishi, *Photometric Determination of Traces of Metals. General Aspects*. New York: Wiley-Interscience, 1978.
8. R. M. Silverstein, G. C. Bassler, and T. C. Morrillo, *Spectrometric Identification of Organic Compounds*, 5th ed. New York: John Wiley & Sons, 1991.
9. D. W. Brown, A. J. Floyd, and M. Sainsbury, *Organic Spectroscopy*. New York: John Wiley & Sons, Inc., 1988.
10. G. D. Christian and J. B. Callis, eds., *Trace Analysis: Spectroscopic Methods for Molecules*. New York: John Wiley & Sons, Inc., 1986.
11. R. T. Conley, *Infrared Spectroscopy*, 2nd. ed. Boston: Allyn and Bacon, 1972.
12. P. R. Griffiths, *Fourier Transform Infrared Spectrometry*, 2nd ed. New York: John Wiley & Sons, Inc., 1986.
13. M. W. MacKenzie, ed., *Advances in Applied Fourier Transform Infrared Spectroscopy*. New York: John Wiley & Sons, Inc., 1988.



### Catalogued Spectra

14. *Catalogue of Infrared Spectral Data*. Washington, D.C.: American Petroleum Institute, Research Project 44. Multivolume series started in 1943 and continuing to the present date.
15. *Catalogue of Ultraviolet Spectral Data*. Washington, D.C.: American Petroleum Institute, Research Project 44. Multivolume series started in 1945 and continuing to the present date.
16. "Infrared Prism Spectra," in *The Sadtler Standard Spectra*, Vols. 1–36; "Standard Infrared Grating Spectra," in *The Sadtler Standard Spectra*, Vols. 1–16. Philadelphia: Sadtler Research Laboratories.
17. L. Lang, ed., *Absorption Spectra in the Ultraviolet and Visible Regions*, Vols. 1–23. New York: Academic Press, 1961–1979.
18. *U. V. Atlas of Organic Compounds*, Vols. I–V. London: Butterworths, 1966–1971.
19. "Ultraviolet Spectra," in *The Sadtler Standard Spectra*, Vol. 1–62. Philadelphia: Sadtler Research Laboratories. A comprehensive catalog of ultraviolet spectra of organic compounds.
20. D. L. Hansen, *The Spouse Collection of Spectra. I. Polymers, II. Solvents by Cylindrical Internal Reflectance, III. Surface Active Agents, IV. Common Solvents—Condensed Phase, Vapor Phase and Mass Spectra*. Amsterdam: Elsevier Science Publishers, 1987–1988. Peak table search software available for each.
21. *IR Mentor*. Philadelphia: Bio-Rad, Sadtler Division, 1992. Computer functional group search program for FTIR.

### Fluorometry

22. "Fluorometric Analysis," *Anal. Chem.*, Biannual Reviews, alternate years.
23. G. G. Guilbault, *Practical Fluorescence*, 2nd ed. New York: Marcel Dekker, 1990.
24. S. Udenfriend, *Fluorescence Assay in Biology and Medicine*, 2 volumes. New York: Academic Press, 1962, 1979.
25. E. L. Wehry, ed., *Modern Fluorescence Spectroscopy*, 1–4. New York: Plenum Publishing Corp., 1976–1981.
26. C. E. White and R. J. Argauer, *Fluorescence Analysis: A Practical Approach*. New York: Marcel Dekker, 1970.
27. P. E. Stanley and L. J. Kricka, eds., *Bioluminescence and Chemiluminescence. Current Status*. New York: John Wiley & Sons, Inc., 1991.
28. R. J. Hurtubise, *Phosphorimetry. Theory, Instrumentation and Applications*. New York: VCH Publishers, Inc., 1990.

### Fiber Optics

29. M. J. Webb, "Practical Considerations When Using Fiber Optics with Spectrometers," *Spectroscopy*, **4** (1989) 9.
30. W. R. Seitz, "Chemical Sensors Based on Fiber Optics," *Anal. Chem.*, **56** (1984) 16A.
31. W. R. Seitz, "Chemical Sensors Based on Immobilized Indicators and Fiber Optics," *CRC Crit. Rev. Anal. Chem.*, **19** (1988) 135.
32. M. S. Abel-Latif, A. Suleiman, and G. G. Guilbault, "Fiber Optic Sensors: Recent Developments," *Anal. Lett.*, **23** (1990) 375.
33. O. S. Wolfbeis, ed., *Fiber Optic Chemical Sensors and Biosensors*. Boca Raton, FL: CRC Press, Inc., 1990.

34. A. P. Turner, I. Karube, and G. S. Wilson, eds., *Biosensors*. Oxford: Oxford University Press, 1987.
35. J. Janata, "Do Optical Fibers Really Measure pH?" *Anal. Chem.*, **59** (1987) 1351.
36. J. Janata, "Ion Optrodes," *Anal. Chem.*, **64** (1992) 921A.
37. J. Janata, *Principles of Chemical Sensors*. New York: Plenum Publishing Co., 1989.
38. L. W. Burgess, M.-R. S. Fuh, and G. D. Christian, "Use of Analytical Fluorescence with Fiber Optics," in *Progress in Analytical Luminescence*, ASTM STP 1009, P. Eastwood and L. J. Cline-Love, eds. Philadelphia: American Society for Testing and Materials, 1988.
39. M. A. Arnold, "Fiber-Optic Chemical Sensors," *Anal. Chem.*, **64** (1992) 1015A.