

QTCENG EXHIBIT 1025

PART 1



US006421753C1

(12) **EX PARTE REEXAMINATION CERTIFICATE** (5468th)
United States Patent
Hoesle et al. (10) **Number:** **US 6,421,753 C1**
(45) **Certificate Issued:** **Aug. 1, 2006**

(54) **STORAGE ROUTER AND METHOD FOR PROVIDING VIRTUAL LOCAL STORAGE**

5,257,386 A 10/1993 Saito
5,345,565 A * 9/1994 Jibbe et al. 710/316
5,347,384 A 9/1994 McReynolds et al.
5,394,526 A * 2/1995 Crouse et al. 709/219
5,414,820 A 5/1995 McFarland et al.

(75) **Inventors:** **Geoffrey B. Hoesle**, Austin, TX (US);
Jeffrey T. Russell, Cibolo, TX (US)

(73) **Assignee:** **Crossworlds Software**, Burlingame, CA (US)

(Continued)

Reexamination Request:

No. 90/007,124, Jul. 19, 2004

Reexamination Certificate for:

Patent No.: **6,421,753**
Issued: **Jul. 16, 2002**
Appl. No.: **09/354,682**
Filed: **Jul. 15, 1999**

FOREIGN PATENT DOCUMENTS

EP 0810530 A2 12/1997
EP 0827059 A2 3/1998
GB 2296798 A 7/1996
GB 2297636 A 8/1996
GB 2341715 3/2000
JP 6301607 10/1994
JP 8-230895 9/1996
WO WO 99/34297 A1 7/1999

OTHER PUBLICATIONS

Petal: Distributed Virtual Disks, Edward K. Lee and Chandramohan A. Thekkath, ACM SIGPLAN Notices, vol. 31, Issue 9, Sep. 1996, pp. 84-92.*

Related U.S. Application Data

(63) Continuation of application No. 09/001,799, filed on Dec. 31, 1997, now Pat. No. 5,941,972.

(51) **Int. Cl.**
G06F 13/00 (2006.01)

(52) **U.S. Cl.** **710/315**; 710/2; 710/8; 710/36; 710/105; 710/305; 710/308; 711/112

(58) **Field of Classification Search** 710/129, 710/1-5, 8-13, 36-38, 100-101, 105, 305-316; 714/42; 711/100, 112, 113
See application file for complete search history.

(56) **References Cited**

U.S. PATENT DOCUMENTS

3,082,406 A 3/1963 Stevens
4,092,732 A 5/1978 Ouchi
4,695,948 A 9/1987 Blevins et al.
4,751,635 A 6/1988 Kret
4,864,532 A 9/1989 Reeve et al.
4,947,367 A 8/1990 Chang et al.
5,072,378 A 12/1991 Manka
5,163,131 A 11/1992 Row et al.
5,239,632 A 8/1993 Larner
5,239,643 A 8/1993 Blount et al.

(Continued)

Primary Examiner—Dov Popovici

(57) **ABSTRACT**

A storage router (56) and storage network (50) provide virtual local storage on remote SCSI storage devices (60, 62, 64) to Fiber Channel devices. A plurality of Fiber Channel devices, such as workstations, (58), are connected to a Fiber Channel transport medium (52), and a plurality of SCSI storage devices (60, 62, 64) are connected to a SCSI bus transport medium (54). The storage router (56) interfaces between the Fiber Channel transport medium (52) and the SCSI bus transport medium (54). The storage router (56) maps between the workstations (58) and the SCSI storage devices (60, 62, 64) and implements access controls for storage space on the SCSI storage devices (60, 62, 64). The storage router (56) then allows access from the workstations (58) to the SCSI storage devices (60, 62, 64) using native low level, block protocol in accordance with the mapping and the access controls.

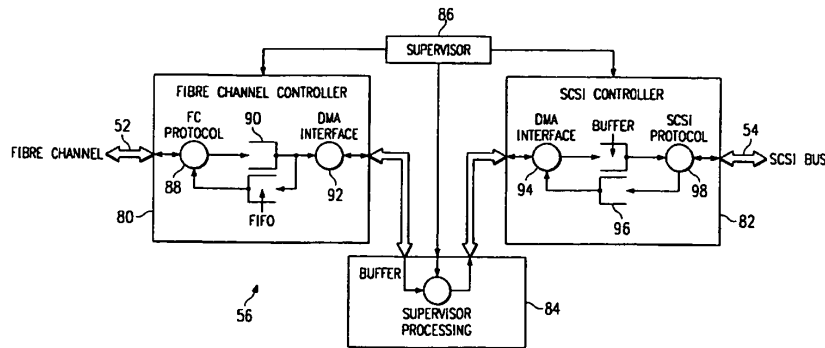

U.S. PATENT DOCUMENTS

| | | | | |
|-----------|----|----------|-------------------|---------|
| 5,423,044 | A | 6/1995 | Sutton et al. | |
| 5,465,382 | A | 11/1995 | Day, III et al. | |
| 5,530,845 | A | 6/1996 | Hiatt et al. | |
| 5,535,352 | A | 7/1996 | Bridges et al. | |
| 5,581,714 | A | 12/1996 | Amini et al. | |
| 5,596,562 | A | 1/1997 | Chen | |
| 5,596,736 | A | 1/1997 | Kerns | |
| 5,598,541 | A | 1/1997 | Malladi | |
| 5,634,111 | A | * 5/1997 | Oeda et al. | 711/153 |
| 5,680,556 | A | 10/1997 | Begun et al. | |
| 5,701,491 | A | 12/1997 | Dunn et al. | |
| 5,712,976 | A | 1/1998 | Falcon et al. | |
| 5,729,705 | A | 3/1998 | Weber | |
| 5,743,847 | A | 4/1998 | Nakamura et al. | |
| 5,751,975 | A | 5/1998 | Gillespie et al. | |
| 5,774,683 | A | 6/1998 | Gulick | |
| 5,845,107 | A | 12/1998 | Fisch et al. | |
| 5,857,080 | A | 1/1999 | Jander et al. | |
| 5,864,653 | A | 1/1999 | Tavallaei et al. | |
| 5,867,648 | A | 2/1999 | Foth et al. | |
| 5,884,027 | A | 3/1999 | Garbus et al. | |
| 5,913,045 | A | 6/1999 | Gillespie et al. | |
| 5,923,557 | A | 7/1999 | Eidson | |
| 5,941,969 | A | 8/1999 | Ram et al. | |
| 5,953,511 | A | 9/1999 | Sescilia et al. | |
| 5,974,530 | A | 10/1999 | Young | |
| 5,978,379 | A | 11/1999 | Chan et al. | |
| 5,991,797 | A | 11/1999 | Futral et al. | |
| 6,000,020 | A | 12/1999 | Chin et al. | |
| 6,021,451 | A | 2/2000 | Bell et al. | |
| 6,065,087 | A | 5/2000 | Keaveny et al. | |
| 6,070,253 | A | 5/2000 | Tavallaei et al. | |
| 6,131,119 | A | 10/2000 | Fukui | |
| 6,134,617 | A | 10/2000 | Weber | |
| 6,141,737 | A | 10/2000 | Krantz et al. | |
| 6,145,006 | A | 11/2000 | Vishlitsky et al. | |
| 6,209,023 | B1 | 3/2001 | Dimitroff et al. | |
| 6,223,266 | B1 | 4/2001 | Sartore | |
| 6,260,120 | B1 | 7/2001 | Blumenau et al. | |
| 6,330,629 | B1 | 12/2001 | Kondo et al. | |
| 6,341,315 | B1 | 1/2002 | Arroyo et al. | |
| 6,343,324 | B1 | 1/2002 | Hubis et al. | |
| 6,363,462 | B1 | 3/2002 | Bergsten | |
| 6,421,753 | B1 | 7/2002 | Hoesse et al. | |
| 6,425,035 | B1 | 7/2002 | Hoesse et al. | |
| 6,425,036 | B1 | 7/2002 | Hoesse et al. | |
| 6,484,245 | B1 | 11/2002 | Sanada et al. | |
| 6,529,996 | B1 | 3/2003 | Nguyen et al. | |

OTHER PUBLICATIONS

Systems Architecture Using Fibre Channel, Roger Cummings, Twelfth IEEE Symposium on Mass Storage Systems, copyright 1993, IEEE. pp. 251–256.*
 Fibre Channel and ATM: The Physical Layers, Jerry Quam, WESCON/94, published Sep. 27–29, 1994. pp. 648–652.*
 CRD–5500 SCSI Raid Controller User’s Manual CMD Technology, Inc. pp. 1–1 to 6–25, revised Nov. 21, 1996.
 Black Box, SCSI Fiberoptic Extender, Single–Ended, Product Insert, 2 pages, 1996.
 CRD–5500, Raid Disk Array Controller Product Insert, pp. 1–5.
 CRD–5500, SCSI Raid Controller OEM Manual, Rev. 1.3, Feb. 26, 1996, pp. 1–54.
 Raidtec FibreArray and Raidtec FlexArray UltraRAID Systems, Windows IT Pro Article, Oct. 1997.

DIGITAL Storage Works, HSZ70 Array Controller. HSOE Version 7.0 EK–HSZ70–CG. A01. Digital Equipment Corporation, Maynard, Massachusetts.
 DIGITAL StorageWorks HSZ270 Array Controller HSOE Version 7.0 EK–HSZ270–RM. A01. CLI Reference Manual.
 DIGITAL StorageWorks, Using Your HSZ70 Array Controller in a SCSI Controller Shelf (DS–BA356–M Series), User’s Guide, pp. 1–1 through A–5 with index, Jan. 1998.
 DIGITAL StorageWorks HSG80 Array Controller ACS Version 8.0 (User’s Guide) Jan. 1998.
 DIGITAL StorageWorks HSZ70 Array Controller HSOE Version 7.0 EK–HSZ70–SV. A01.
 Emerson, “Ancor Communications: Performance evaluation of switched fibre channel I/O system using—FCP for SCSI” Feb. 1, 1995, IEEE, pp. 479–484.
 IBM Technical Publication: Magstar and IBM 3590 High Performance Tape Subsystem Technical Guide, Nov. 1996, pp. 1–269.
 Guide to Sharing and Partitioning IBM Tape Library Dataservers, Nov. 1996, IBM, International Technical Support Organization, San Jose Center.
 Misc. Reference Manual Pages, SunOS 5.09.
 Block–Based Distributed File Systems, Anthony J. McGregor, Jul. 1997.
 InfoServer 100 System Operations Guide, First Edition Digital Equipment Corporation, 1990.
 S.P. Joshi, “Ethernet controller chip interfaces with variety of 16–bit processors,” electronic Design, Hayden Publishing Co., Inc., Rochelle Park, NJ, Oct. 14, 1982, pp. 193–200.
 DP5380 Asynchronous SCSI Interface, National Semiconductor Corporation, Arlington, TX, May 1989, pp. 1–32.
 Johnson, D.B., et al., The Peregrine High Performance RPC System, Software–Practice and Experience, 23(2):201–21, Feb. 1993.
 InfoServer 150—Installation and Owner’s Guide, EK–INFSV–0M–001, Digital Equipment Corporation, Maynard, Massachusetts 1991, Chapters 1 and 2.
 InfoServer 150VXT Photograph.
 Pictures of internal components of the InfoServer 150, taken from <http://bindarydinosaurs.couk/Museum/Digital/infoserver/infoserver.php> in Nov. 2004.
 Simplest Migration to Fibre Channel Technology, Article, Digital Equipment Corporation, Nov. 10, 1997, published on PR Newswire.
 Compaq StorageWorks HSG80 Array Controller ACS Version 8.3 (Maintenance and Service Guide) Nov. 1998.
 Compaq StorageWorks HSG80 Array Controller ACS Version 8.3 (Configuration and CLI Reference Guide) Nov. 1998.
 Office Action dated Jan. 21, 2003 for 10/174,720.
 Office Action dated Feb. 27, 2001 for 09/354,682.
 Office Action dated Aug. 11, 2000 for 09/354,682.
 Office Action dated Dec. 16, 1999 for 09/354,682.
 Office Action dated Nov. 6, 2002 for 10/023,786.
 Office Action dated Jan. 21, 2003 for 10/081,110.
 Office Action dated Jan. 27, 2005 in 10/658,163, Feb. 27, 2005.
 Office Action in Ex Parte Reexamination 90/007,127, mailed 02/07/05, Feb. 7, 2005.
 Office Action in Ex Parte Reexamination 90/007,126, mailed 02/07/05, Feb. 7, 2005.
 Office Action in Ex Parte Reexamination 90/007,125, mailed Feb. 7, 2005.

- Office Action in Ex Parte Reexamination 90/007,124, mailed Feb. 7, 2005.
- Office Action in Ex Parte Reexamination 90/007,123, mailed 0207/05, Feb. 7, 2005.
- European Office Action issued Apr. 1, 2004 in Application No. 98966104.6-2413.
- Defendant's First Supplemental Trial Exhibit List, *Crossroads Systems, Inc. v. Chaparral Network Storage, Inc.*, C.A. No. A-00CA-217-SS (W.D. Tex. 2001). (CD-Rom).
- Defendant's Third Supplemental Trial Exhibit List, *Crossroads Systems, Inc. v. Pathlight Technology, Inc.*, C.A. No. A-00CA-248-SS (W.D. Tex. 2001). (CD-Rom).
- Defendant's Trial Exhibits, *Crossroads Systems, Inc. v. Pathlight Technology, Inc.*, C.A. No. A-00CA-248-SS (W.D. Tex. 2001). (CD-Rom).
- Defendants' Trial Exhibits, *Crossroads Systems, Inc. v. Chaparral Network Storage, Inc.*, C.A. No. A-00CA-217-SS (W.D. Tex. 2001). (CD-Rom).
- Defendant Chapparral Network Storage, Inc.'s First Supplemental Trial Exhibit List (D1 through D271) (CD-ROM Chaparral Exhibits ExList_Def), Sep. 2, 2001.
- Defendant Pathlight Technology Inc.'s Third Supplemental Trial Exhibit List (CD-ROM Pathlight Exhibits ExList_Def).
- Plaintiff's Fourth Amended Trial Exhibit List, *Crossroads Systems, Inc. v. Chaparral Network Storage, Inc.*, C.A. No. A-00CA-217-SS (W.D. Tex. 2001) (CD-Rom), Sep. 11, 2001.
- Plaintiff's Revised Trial Exhibit List, *Crossroads Systems, Inc. v. Pathlight Technology, Inc.*, C.A. No. A-00CA-248-SS (W.D. Tex. 2001). (CD-Rom).
- Plaintiff's Trial Exhibits, *Crossroads Systems, Inc. v. Chaparral Networks Storage, Inc.*, C.A. No. A-00CA-217-SS (W.D. Tex. 2001) (CD-Rom).
- Plaintiff's Fourth Amended Trial Exhibit List (CD-ROM Chaparral Exhibits ExList_Plaintiff), Sep. 11, 2001.
- Plaintiff's Revised Trial Exhibit List (CD-ROM Pathlight Exhibits ExList_Plaintiff).
- Trial Transcripts, *Crossroads Systems, Inc. v. Chaparral Network Storage, Inc.*, C.A. No. A-00CA-217-SS (W.D. Tex. 2001) (CD-Rom).
- Trial Transcripts, *Crossroads Systems, Inc. v. Pathlight Technology, Inc.*, C.A. No. A-00CA-248-SS (W.D. Tex. 2001). (CD-Rom).
- Trial Exhibits and Transcripts, *Crossroads v. Chaparral*, Civil Action No. A-00CA-21755, W.D. Tex. 2000 (CD-Rom and hard copy printouts).
- Snively, "Sun Microsystem Computer Corporation: Implementing a fibre optic channel SCSI transport" 1994 IEEE, Feb. 28, 1994, pp. 78-82.
- Datasheet for CrossPoint 4100 Fibre Channel to SCSI Router (Dedek Ex 41 (ANCT 117-120)) (CD-ROM Chaparral Exhibits D012).
- Symbios Logic—Software Interface Specification Series 3 SCSI RAID Controller Software Release 02.xx (Engelbrecht Ex 2 (LSI 1421-1658)) (CD-ROM Chaparral Exhibits D013), Dec. 3, 1997.
- Press Release—Symbios Logic to Demonstrate Strong Support for Fibre Channel at Fall Comdex (Engelbrecht 12 (LSI 2785-86)) (CD-ROM Chaparral Exhibits D016), Nov. 13, 1996.
- OEM Datasheet on the 3701 Controller (Engelbrecht 13 (LSI 01837-38)) (CD-ROM Chaparral Exhibits D017), Jun. 17, 1905.
- Nondisclosure Agreement Between Adaptec and Crossroads Dated Oct. 17, 1996 (Quisenberry Ex 25 (CRDS 8196)) (CD-ROM Chaparral Exhibits D020).
- Organizational Presentation on the External Storage Group (Lavan Ex 1 (CNS 182242-255)) (CD-ROM Chaparral Exhibits D021), Apr. 11, 1996.
- Bridge. C, Bridge Between SCSI-2 and SCSI-3 FCP (Fibre Channel Protocol) (CD-ROM Chaparral Exhibits P214).
- Bridge Phase II Architecture Presentation (Lavan Ex 2 (CNS 182287-295)) (CD-ROM Chaparral Exhibits D022), Apr. 12, 1996.
- Attendees/Action Items from Apr. 12, 1996 Meeting at BTC (Lavan Ex 3 (CNS 182241)) (CD-ROM Chaparral Exhibits D023).
- Brooklyn Hardware Engineering Requirements Documents, Revision 1.4 (Lavan Ex 4 (CNS 178188-211)) (CD-ROM Chaparral Exhibits D024) by Pecone, May 26, 1996.
- Brooklyn Single-Ended SCSI Raid BRIDGE Controller Hardware OEM Manual, Revision 2.1 (Lavan EX 5 (CNS 177169-191)) (CD-ROM Chaparral Exhibits D025), Mar. 21, 1996.
- Coronado Hardware Engineering Requirements Document, Revision 0.0 (Lavan Ex 7 (CNS 176917-932)) (CD-ROM Chaparral Exhibits D027) by O'Dell, Sep. 30, 1996.
- ESS/FPG Organization (Lavan Ex 8 (CNS 178639-652)) (CD-ROM Chaparral Exhibits D028), Dec. 6, 1996.
- Adaptec MCS ESS Presents: Intelligent External I/O Raid Controllers "Bridge" Strategy (Lavan Ex 9 (CNS 178606-638)). (CD-ROM Chaparral Exhibits D029), Feb. 6, 1996.
- AEC-7313 Fibre Channel Daughter Board (for Brooklyn) Engineering Specification, Revision 1.0 (Lavan Ex 10 (CNS 176830-850)) (CD-ROM Chaparral Exhibits D030), Feb. 27, 1997.
- Bill of Material (Lavan Ex 14 (CNS 177211-214)) (CD-ROM Chaparral Exhibits D034), Jul. 24, 1997.
- AEC-. 4412B, AEC-7412/B2 External RAID Controller Hardware OEM Manual, Revision 2.0 (Lavan Ex 15 (CNS 177082-123)) (CD-ROM Chaparral Exhibits D035), Jun. 27, 1997.
- Coronado II, AEC-7312A Fibre Channel Daughter (for Brooklyn) Hardware Specification, Revision 1.2 (Lavan Ex 16 (CNS 177192-210)) (CD-ROM Chaparral Exhibits D037) by Tom Yang, Jul. 18, 1997.
- AEC-4412B, AEC7412/3B External RAID Controller Hardware OEM Manual, Revision 3.0. (Lavan Ex 17 (CNS 177124-165)) (CD-ROM Chaparral Exhibits D036), Aug. 25, 1997.
- Memo Dated Aug. 15, 1997 to AEC-7312A Evaluation Unit Customers re: B001 Release Notes (Lavan Ex 18 (CNS 182878-879)) (CD-ROM Chaparral Exhibits D038).
- Brooklyn Main Board (AES-0302) MES Schedule (Lavan Ex 19 (CNS 177759-763)) (CD-ROM Chaparral Exhibits D039), Feb. 11, 1997.
- News Release—Adaptec Adds Fibre Channel Option to its External RAID Controller Family (Lavan Ex 20 (CNS 182932-934)) (CD-ROM Chaparral Exhibits D040), May. 6, 1997.
- AEC-4412B/7412B User's Guide, Rev. A (Lavan Ex 21) (CD-ROM Chaparral Exhibits D041), Jun. 19, 1905.
- Data Book—AIC-7895 PCI Bus Master Single Chip SCSI Host Adapter (Davies Ex 1 (CNS 182944-64)) (CD-ROM Chaparral Exhibits D046), May 21, 1996.

- Data Book—AIC-1160 Fibre Channel Host Adapter ASIC (Davies Ex 2 (CNS 181800-825)) (CD-ROM Chaparral Exhibits D047), Jun. 18, 1905.
- Viking RAID Software (Davies Ex 3 (CNS 180969-181026)) (CD-ROM Chaparral Exhibits D048), Jun. 18, 1905.
- Header File with Structure Definitions (Davies Ex 4 (CNS 180009-018)) (CD-ROM Chaparral Exhibits D049), Aug. 8, 1996.
- C++ SourceCode for the SCSI Command Handler (Davies Ex 5 (CNS 179136-168)) (CD-ROM Chaparral Exhibits D050), Aug. 8, 1996.
- Header File Data Structure (Davies Ex 6 (CNS 179997-180008)) (CD-ROM Chaparral Exhibits D051), Jan. 2, 1997.
- SCSI Command Handler (Davies Ex 7 (CNS 179676-719)) (CD-ROM Chaparral Exhibits D052), Jan. 2, 1997.
- Coronado: Fibre Channel to SCSI Intelligent RAID Controller Product Brief (Kalwitz Ex 1 (CNS 182804-805)) (CD-ROM Chaparral Exhibits D053).
- Bill of Material (Kalwitz Ex 2 (CNS 181632-633)) (CD-ROM Chaparral Exhibits D054), Mar. 17, 1997.
- Emails Dated Jan. 13-Mar. 31, 1997 from P. Collins to Mo re: Status Reports (Kalwitz Ex 3 (CNS 182501-511)) (CD-ROM Chaparral Exhibits D055).
- Hardware Schematics for the Fibre Channel Daughtercard Coronado (Kalwitz Ex 4 (CNS 181639-648)) (CD-ROM Chaparral Exhibits D056).
- Adaptec Schematics re AAC-340 (Kalwitz Ex 14 (CNS 177215-251)) (CD-ROM Chaparral Exhibits D057).
- Bridge Product Line Review (Manzanares Ex 3 (CNS 177307-336)) (CD-ROM Chaparral Exhibits D058).
- AEC Bridge Series Products—Adaptec External Controller RAID Products Pre-Release Draft, v.6 (Manzanares Ex 4 (CNS 174632-653)) (CD-ROM Chaparral Exhibits D059), Oct. 28, 1997.
- Hewlett-Packard Roseville Site Property Pass for Brian Smith (Dunning Ex 14 (HP 489)) (CD-ROM Chaparral Exhibits D078), Nov. 7, 1996.
- Distribution Agreement Between Hewlett-Packard and Crossroads (Dunning Ex 15 (HP 326-33)) (CD-ROM Chaparral Exhibits D079).
- HPFC-5000 Tachyon User's Manuel, First Edition (PTI 172419-839) (CD-ROM Chaparral Exhibits D084), May 1, 1996.
- X3T10 994D—(Draft) Information Technology: SCSI-3 Architecture Model, Rev. 1.8 (PTI 165977) (CD-ROM Chaparral Exhibits D087).
- X3T10 Project 1047D: Information Technology—SCSI-3 Controller Commands (SSC), Rev. 6c (PTI 166400-546) (CD-ROM Chaparral Exhibits D088), Sep. 3, 1996.
- X3T10 995D—(Draft) SCSI-3 Primary Commands, Rev. 11 (Wanamaker Ex 5 (PTI 166050-229)) (CD-ROM Chaparral Exhibits D089), Nov. 13, 1996.
- VBAR Volume Backup and Restore (CRDS 12200-202) (CD-ROM Chaparral Exhibits D099).
- Preliminary Product Literature for Infinity Commstor's Fibre Channel to SCSI Protocol Bridge (Smith Ex 11; Quisenberry Ex 31 (SPLO 428-30)) (CD-ROM Chaparral Exhibits D143), Aug. 19, 1996.
- Letter dated Jul. 12, 1996 from J. Boykin to B. Smith re: Purchase Order for Evaluation Units from Crossroads (Smith Ex 24) CRDS 8556-57) (CD-ROM Chaparral Exhibits D144).
- CrossPoint 4100 Fibre Channel to SCSI Router Preliminary Datasheet (Hulsey Ex 9 (CRDS 16129-130)) (CD-ROM Chaparral Exhibits D145), Nov. 1, 1996.
- CrossPoint 4400 Fibre Channel to SCSI Router Preliminary Datasheet (Bardach Ex. 9, Quisenberry Ex 33 (CRDS 25606-607)) (CD-ROM Chaparral Exhibits D153), Nov. 1, 1996.
- Fax Dated Jul. 22, 1996 from L. Petti to B. Smith re: Purchase Order from Data General for FC2S Fibre to Channel SCSI Protocol Bridge Model 11 (Smith Ex 25; Quisenberry Ex 23; Bardach Ex 11 (CRDS 8552-55; 8558)) (CD-ROM Chaparral Exhibits D155).
- Email Dated Dec. 20, 1996 from J. Boykin to B. Smith re: Purchase Order for Betas in Feb. and Mar. (Hoese Ex 16, Quisenberry Ex 25; Bardach Ex 12 (CRDS 13644-650)) (CD-ROM Chaparral Exhibits D156).
- Infinity Commstor Fibre Channel Demo for Fall Comdex, 1996 (Hoese Ex 15, Bardach Ex 13 (CRDS 27415)) (CD-ROM Chaparral Exhibits D157).
- Fax Dated Dec. 19, 1996 from B. Bardach to T. Rarich re: Purchase Order Information (Bardach Ex 14; Smith Ex 16 (CRDS 4460)) (CD-ROM Chaparral Exhibits D158).
- Miscellaneous Documents Regarding Comdex (Quisenberry Ex 2 (CRDS 27415-465)) (CD-ROM Chaparral Exhibits D165).
- CrossPoint 4100 Fibre Channel to SCSI Router Preliminary Datasheet (Quisenberry) Ex 3 (CRDS 4933-34) (CD-ROM Chaparral Exhibits D166) (CD-ROM Chaparral Exhibits D166).
- CrossPoint 4400 Fibre to Channel to SCSI Router Preliminary Datasheet; Crossroads Company and Product Overview (Quisenberry Ex 4 (CRDS 25606; 16136)) (CD-ROM Chaparral Exhibits D167).
- Crossroads Purchase Order Log (Quisenberry Ex 9 (CRDS 14061-062)) (CD-ROM Chaparral Exhibits D172).
- RAID Manager 5 with RDAC 5 for UNIX V.4 User's Guide (LSI-01854) (CD-ROM Chaparral Exhibits P062), Sep. 1, 1996.
- Letter dated May 12, 1997 from Alan G. Leal to Barbara Bardach enclosing the original OEM License and Purchase Agreement between Hewlett-Packard Company and Crossroads Systems, Inc. (CRDS 02057) (CD-ROM Chaparral Exhibits P130).
- CR4x00 Product Specification (CRDS 43929) (CD-ROM Chaparral Exhibits P267), Jun. 1, 1998.
- Symbios Logic—Hardware Functional Specification for the Symbios Logic Series 3 Fibre Channel Disk Array Controller Model 3701 (Engelbrecht Ex 3 (LSI-1659-1733)) (CD-ROM Pathlight Exhibits D074).
- Report of the Working Group on Storage I/O for Large Scale Computing; Department of Computer Science Duke University: CS-1996-21 (PTI 173330-347). (CD-ROM Pathlight Exhibits D098).
- Brian Allison's 1999 Third Quarter Sales Plan (PDX 38) (CNS 022120-132)) (CD-ROM Pathlight Exhibits D201), Jun. 5, 2001.
- Brooklyn SCSI-SCSI Intelligent External RAID Bridge Definition Phase External Documentation (CD-ROM Pathlight Exhibits D129).

* cited by examiner

1
EX PARTE
REEXAMINATION CERTIFICATE
ISSUED UNDER 35 U.S.C. 307

NO AMENDMENTS HAVE BEEN MADE TO
THE PATENT

2
AS A RESULT OF REEXAMINATION, IT HAS BEEN
DETERMINED THAT:

5 The patentability of claims 1-8 is confirmed.

* * * * *

THIS PAGE BLANK (USPTO)

● PRINTER RUSH ●

(PTO ASSISTANCE)

| | | |
|--------------------------------|--------------------------------|---------------------|
| Application : <u>90/007124</u> | Examiner : <u>Chen</u> | GAU : <u>2182</u> |
| From: <u>T. McGill</u> | Location: <u>(IDC) FMF FDC</u> | Date: <u>3-7-04</u> |

Tracking #: 10421753 Week Date: 12-5-05

| DOC CODE | DOC DATE | MISCELLANEOUS |
|--|----------------|--|
| <input checked="" type="checkbox"/> 1449 | <u>5-25-05</u> | <input type="checkbox"/> Continuing Data |
| <input type="checkbox"/> IDS | _____ | <input type="checkbox"/> Foreign Priority |
| <input type="checkbox"/> CLM | _____ | <input type="checkbox"/> Document Legibility |
| <input type="checkbox"/> IIFW | _____ | <input type="checkbox"/> Fees |
| <input type="checkbox"/> SRFW | _____ | <input type="checkbox"/> Other |
| <input type="checkbox"/> DRW | _____ | |
| <input type="checkbox"/> OATH | _____ | |
| <input type="checkbox"/> 312 | _____ | |
| <input type="checkbox"/> SPEC | _____ | |

[RUSH] MESSAGE: PTO-1449 dated 5-25-05 page 5 of 11
Other Reference Cite No. C2 date
in document box does not match date
in date box.
thank you

[XRUSH] RESPONSE: _____

INITIALS: _____

NOTE: This form will be included as part of the official USPTO record, with the Response document coded as XRUSH.
 REV 10/04

Re-Exam

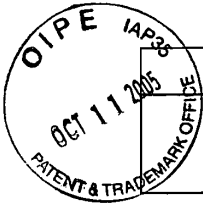

IN THE UNITED STATES PATENT AND TRADEMARK OFFICE

CERTIFICATE OF SERVICE UNDER
37 C.F.R. 1.248

Atty. Docket No.
CROSS1121-15

| | |
|---|----------------------------------|
| Applicant Geoffrey B. Hoese, et al. | |
| Reexamination Control No. 90/007,124 | Date Filed 07/19/2004 |
| Title Storage Router and Method for Providing Virtual Local Storage | |
| Group Art Unit 2182 | Examiner Chen, Alan S. |

Applicant hereby serves the Comments On Statement of Reasons for Patentability and/or Confirmation in the above referenced case to:

Larry E. Severin
Wang, Hartmann & Gibbs, PC
1301 Dove Street, #1050
Newport Beach, CA 92660

As per 35 U.S.C. §1.248 service is made via first class mail, certified, R.R.R. on October 7, 2005.

Respectfully submitted,

Sprinkle IP Law Group

John L. Adair
Reg. No. 48,828

Dated: October 7, 2005

1301 W. 25th Street, Suite 408
Austin, Texas 78705
Tel. (512) 637-9223
Fax. (512) 371-9088

Enclosures

| | |
|---|---|
| IN THE UNITED STATES PATENT AND TRADEMARK OFFICE | |
| Comments On Statement of Reasons for Patentability and/or Confirmation | Atty. Docket No. CROSS1121-15 |
| Applicants Goeffrey B. Hoese, et al. | |
| Reexamination Control No. 90/007,124 | Date Filed 07/19/2004 |
| Title Storage Router and Method for Providing Virtual Local Storage | |
| Group Art Unit 2182 | Examiner Chen, Alan S. |

Commissioner for Patents
P.O. Box 1450
Alexandria, VA 22313-1450

Dear Sir:

| |
|---|
| <u>Certificate of Mailing Under 37 C.F.R. §1.8</u> |
| I hereby certify that this correspondence is being deposited with the United States Postal Service as First Class Mail in an envelope addressed to Commissioner for Patents, P.O. Box 1450, Alexandria, VA 22312-1450 on October 7, 2005. |
|  Signature |
| Julie H. Blackard Printed Name |

Applicants appreciate the Examiner's allowance of or confirmation of Claims 1-8 of United States Patent No. 6,421,753. Applicants submit the record as a whole makes evident the reasons for allowance and that there are additional reasons for patentability not enumerated by the Examiner. While Applicants agree with the Examiner's reasons for patentability to the extent such reasons are consistent with the record as a whole (as Applicants understand them to be), Applicants do not acquiesce or agree to any characterization of the claims that place unwarranted limitations or interpretations upon the claims, especially to the extent such limitations or interpretations are inconsistent with the claim language, specification or prior prosecution history in this case.

These "Comments on Statement of Reasons for Patentability and/or Confirmation" was served via First Class Mail, Certified, R.R.R. on October 7, 2005 to Larry E. Severin of Wang, Hartmann & Gibbs, PC, 1301 Dove Street, #1050, Newport Beach, CA 92660.

The Director of the U.S. Patent and Trademark Office is hereby authorized to charge any fees or credit any overpayments to Deposit Account No. 50-3183 of Sprinkle IP Law Group.

Respectfully submitted,

Sprinkle IP Law Group
Attorneys for Applicant



John L. Adair
Reg. No. 48,828

Date: October 7, 2005

1301 W. 25th Street, Suite 408
Austin, TX 78705
Tel. (512) 637-9223
Fax. (512) 371-9088



UNITED STATES PATENT AND TRADEMARK OFFICE

UNITED STATES DEPARTMENT OF COMMERCE
United States Patent and Trademark Office
Address: COMMISSIONER FOR PATENTS
P.O. Box 1450
Alexandria, Virginia 22313-1450
www.uspto.gov

| APPLICATION NO. | FILING DATE | FIRST NAMED INVENTOR | ATTORNEY DOCKET NO. | CONFIRMATION NO. |
|-----------------|-------------|----------------------|---------------------|------------------|
| 90/007,124 | 07/19/2004 | 6421753 | 1006-8930 | 2295 |

44654 7590 09/23/2005
SPRINKLE IP LAW GROUP
1301 W. 25TH STREET
SUITE 408
AUSTIN, TX 78705

EXAMINER

CHEN, ALAN

ART UNIT PAPER NUMBER

2182

DATE MAILED: 09/23/2005

Please find below and/or attached an Office communication concerning this application or proceeding.



UNITED STATES DEPARTMENT OF COMMERCE
Patent and Trademark Office

Address: ASSISTANT COMMISSIONER FOR PATENTS
Washington, D.C. 20231

| APPLICATION NO./ CONTROL NO. | FILING DATE | FIRST NAMED INVENTOR / PATENT IN REEXAMINATION | ATTORNEY DOCKET NO. |
|---------------------------------|-------------|---|---------------------|
| 90/007,124 | 07/19/2004 | 6421753 | 1006-8930 |

Larry E. Severin
Wang, Hartman & Gibbs, PC
1301 Dove Street
Suite 1050
Newport Beach, CA 92660

EXAMINER

CHEN, ALAN

| | |
|----------|-------|
| ART UNIT | PAPER |
|----------|-------|

2182

DATE MAILED: *9-23-05*

Please find below and/or attached an Office communication concerning this application or proceeding.

Commissioner of Patents and Trademarks

CC: SPRINKLE IP LAW GROUP
1301 W. 25th Street
Suite 408
Austin, TX 78705

| | | | |
|---|----------------------------------|--|--|
| Notice of Intent to Issue Ex Parte Reexamination Certificate | Control No. 90/007,124 | Patent Under Reexamination 6421753 | |
| | Examiner Alan S. Chen | Art Unit 2182 | |

-- The MAILING DATE of this communication appears on the cover sheet with the correspondence address --

1. Prosecution on the merits is (or remains) closed in this *ex parte* reexamination proceeding. This proceeding is subject to reopening at the initiative of the Office or upon petition. Cf. 37 CFR 1.313(a). A Certificate will be issued in view of
 - (a) Patent owner's communication(s) filed: 22 July 2005.
 - (b) Patent owner's late response filed: _____.
 - (c) Patent owner's failure to file an appropriate response to the Office action mailed: _____.
 - (d) Patent owner's failure to timely file an Appeal Brief (37 CFR 41.31).
 - (e) Other: _____.

Status of *Ex Parte* Reexamination:

 - (f) Change in the Specification: Yes No
 - (g) Change in the Drawing(s): Yes No
 - (h) Status of the Claim(s):
 - (1) Patent claim(s) confirmed: 1-8.
 - (2) Patent claim(s) amended (including dependent on amended claim(s)): _____
 - (3) Patent claim(s) cancelled: _____.
 - (4) Newly presented claim(s) patentable: _____.
 - (5) Newly presented cancelled claims: _____.
2. Note the attached statement of reasons for patentability and/or confirmation. Any comments considered necessary by patent owner regarding reasons for patentability and/or confirmation must be submitted promptly to avoid processing delays. Such submission(s) should be labeled: "Comments On Statement of Reasons for Patentability and/or Confirmation."
3. Note attached NOTICE OF REFERENCES CITED (PTO-892).
4. Note attached LIST OF REFERENCES CITED (PTO-1449 or PTO/SB/08).
5. The drawing correction request filed on _____ is: approved disapproved.
6. Acknowledgment is made of the priority claim under 35 U.S.C. § 119(a)-(d) or (f).
 - a) All b) Some* c) None of the certified copies have
 - been received.
 - not been received.
 - been filed in Application No. _____.
 - been filed in reexamination Control No. _____.
 - been received by the International Bureau in PCT Application No. _____.

* Certified copies not received: _____.
7. Note attached Examiner's Amendment.
8. Note attached Interview Summary (PTO-474).
9. Other: _____.

cc: Requester (if third party requester)

U.S. Patent and Trademark Office
PTOL-469 (Rev.9-04)

Notice of Intent to Issue Ex Parte Reexamination Certificate

Part of Paper No 09162005

REEXAMINATION
REASONS FOR PATENTABILITY / CONFIRMATION

Reexamination Control No. 90/007,124

Attachment to Paper No. 09162005.

Art Unit 2182.

ASC Claims 1-8 are ^{confirmed} allowed.

The prior art disclosed by the patent owner and cited by the Examiner fail to teach or suggest, alone or in combination, all the limitations of the independent claims (claims 1 and 4), particularly the map/mapping feature which is a one-to-one correspondence, as given in a simple table, the map physically resident on a router, whereby the router forms the connection between two separate entities over different transport mediums, such that neither entity determines where data is to be sent, but rather, the router solely dictates where the data will be sent; also the "NLLBP" feature referring to a fundamental low level protocol defined by a specification/standard that is well known to one of ordinary skill in the art, where the NLLBP is used at the router for communications with both the first and second transport medium. The SCSI protocol/standard is considered a NLLBP. TCP/IP, e.g., used in Ethernet communications, however, is not considered to be a NLLBP.



(Examiner's Signature)

PTOL-476 (Rev. 03-98)

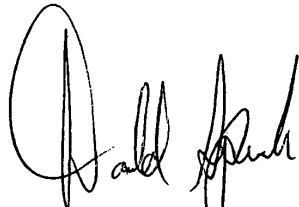

DONALD SPARKS
SUPERVISORY PATENT EXAMINER

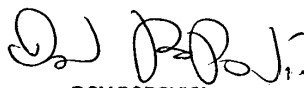

DOV POPOVICI
SUPERVISORY PATENT EXAMINER
TECHNOLOGY CENTER 2100



KIM HUYNH
PRIMARY EXAMINER

| | | |
|---|---------------------------------------|---|
| Reexamination  | Application/Control No. 90/007,124 | Applicant(s)/Patent Under Reexamination 6421753 |
| | Certificate Date | Certificate Number |

| |
|---|
| Requester Correspondence Address: <input type="checkbox"/> Patent Owner <input type="checkbox"/> Third Party |
| |

| | | |
|---|--|--|
| LITIGATION REVIEW <input checked="" type="checkbox"/> | <i>ASC</i> <small>(examiner initials)</small> | <i>09/19/05</i> <small>(date)</small> |
| Case Name | Director Initials | |
| <i>None</i> | | |
| | | |
| | | |
| | | |
| | | |

| COPENDING OFFICE PROCEEDINGS | |
|------------------------------|--------|
| TYPE OF PROCEEDING | NUMBER |
| 1. | |
| 2. | |
| 3. | |
| 4. | |

| | | | |
|--|-------------------------|---|--|
| Issue Classification  | Application/Control No. | Applicant(s)/Patent under Reexamination | |
| | 90/007,124 | 6421753 | |
| | Examiner | Art Unit | |
| | Alan S. Chen | 2182 | |

| ISSUE CLASSIFICATION | | | | | | | | | | |
|------------------------------|----------|---|---|--------------------|-----------------------------------|---|----|-----|-----|-----|
| ORIGINAL | | | | CROSS REFERENCE(S) | | | | | | |
| CLASS | SUBCLASS | | | CLASS | SUBCLASS (ONE SUBCLASS PER BLOCK) | | | | | |
| 710 | 315 | | | 710 | 2 | 8 | 36 | 105 | 305 | 308 |
| INTERNATIONAL CLASSIFICATION | | | | 711 | 112 | | | | | |
| G | 0 | 6 | F | 13/00 | | | | | | |
| | | | | / | | | | | | |
| | | | | / | | | | | | |
| | | | | / | | | | | | |
| | | | | / | | | | | | |

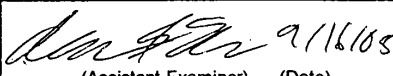
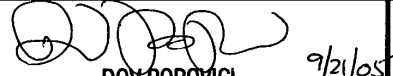
| | | | | | | |
|--|---|--|---------------------|-----------------|---|---|
|  (Assistant Examiner) (Date) 9/16/05 |  DOV POPOVICI SUPERVISORY PATENT EXAMINER TECHNOLOGY CENTER 2100 (Primary Examiner) (Date) 9/21/05 | Total Claims Allowed: 8 <table border="1" style="width: 100%;"> <tr> <td>O.G. Print Claim(s)</td> <td>O.G. Print Fig.</td> </tr> <tr> <td style="text-align: center;">1</td> <td style="text-align: center;">5</td> </tr> </table> | O.G. Print Claim(s) | O.G. Print Fig. | 1 | 5 |
| O.G. Print Claim(s) | O.G. Print Fig. | | | | | |
| 1 | 5 | | | | | |
| (Legal Instruments Examiner) (Date) | | | | | | |

| <input type="checkbox"/> Claims renumbered in the same order as presented by applicant | | | | | | | | | | | | <input type="checkbox"/> CPA | | <input type="checkbox"/> T.D. | | <input type="checkbox"/> R.1.47 | |
|--|----------|-------|----------|-------|----------|-------|----------|-------|----------|-------|----------|------------------------------|----------|-------------------------------|----------|---------------------------------|--|
| Final | Original | Final | Original | Final | Original | Final | Original | Final | Original | Final | Original | Final | Original | Final | Original | | |
| 1 | 1 | | 31 | | 61 | | 91 | | 121 | | 151 | | 181 | | | | |
| 2 | 2 | | 32 | | 62 | | 92 | | 122 | | 152 | | 182 | | | | |
| 3 | 3 | | 33 | | 63 | | 93 | | 123 | | 153 | | 183 | | | | |
| 4 | 4 | | 34 | | 64 | | 94 | | 124 | | 154 | | 184 | | | | |
| 5 | 5 | | 35 | | 65 | | 95 | | 125 | | 155 | | 185 | | | | |
| 6 | 6 | | 36 | | 66 | | 96 | | 126 | | 156 | | 186 | | | | |
| 7 | 7 | | 37 | | 67 | | 97 | | 127 | | 157 | | 187 | | | | |
| 8 | 8 | | 38 | | 68 | | 98 | | 128 | | 158 | | 188 | | | | |
| | 9 | | 39 | | 69 | | 99 | | 129 | | 159 | | 189 | | | | |
| | 10 | | 40 | | 70 | | 100 | | 130 | | 160 | | 190 | | | | |
| | 11 | | 41 | | 71 | | 101 | | 131 | | 161 | | 191 | | | | |
| | 12 | | 42 | | 72 | | 102 | | 132 | | 162 | | 192 | | | | |
| | 13 | | 43 | | 73 | | 103 | | 133 | | 163 | | 193 | | | | |
| | 14 | | 44 | | 74 | | 104 | | 134 | | 164 | | 194 | | | | |
| | 15 | | 45 | | 75 | | 105 | | 135 | | 165 | | 195 | | | | |
| | 16 | | 46 | | 76 | | 106 | | 136 | | 166 | | 196 | | | | |
| | 17 | | 47 | | 77 | | 107 | | 137 | | 167 | | 197 | | | | |
| | 18 | | 48 | | 78 | | 108 | | 138 | | 168 | | 198 | | | | |
| | 19 | | 49 | | 79 | | 109 | | 139 | | 169 | | 199 | | | | |
| | 20 | | 50 | | 80 | | 110 | | 140 | | 170 | | 200 | | | | |
| | 21 | | 51 | | 81 | | 111 | | 141 | | 171 | | 201 | | | | |
| | 22 | | 52 | | 82 | | 112 | | 142 | | 172 | | 202 | | | | |
| | 23 | | 53 | | 83 | | 113 | | 143 | | 173 | | 203 | | | | |
| | 24 | | 54 | | 84 | | 114 | | 144 | | 174 | | 204 | | | | |
| | 25 | | 55 | | 85 | | 115 | | 145 | | 175 | | 205 | | | | |
| | 26 | | 56 | | 86 | | 116 | | 146 | | 176 | | 206 | | | | |
| | 27 | | 57 | | 87 | | 117 | | 147 | | 177 | | 207 | | | | |
| | 28 | | 58 | | 88 | | 118 | | 148 | | 178 | | 208 | | | | |
| | 29 | | 59 | | 89 | | 119 | | 149 | | 179 | | 209 | | | | |
| | 30 | | 60 | | 90 | | 120 | | 150 | | 180 | | 210 | | | | |

Index of Claims



Application No.

90/007,124

Examiner

Fritz M Fleming

Applicant(s)

6421753

Art Unit

2182

| | |
|---|----------|
| ✓ | Rejected |
| = | Allowed |

| | |
|---|--------------------------------|
| - | (Through numeral) Cancelled |
| + | Restricted |

| | |
|---|--------------|
| N | Non-Elected |
| I | Interference |

| | |
|---|----------|
| A | Appeal |
| O | Objected |

| Claim | | Date |
|-------|----------|------|
| Final | Original | |
| 1 | 1 | |
| 2 | 2 | |
| 3 | 3 | |
| 4 | 4 | |
| 5 | 5 | |
| 6 | 6 | |
| 7 | 7 | |
| 8 | 8 | |
| 9 | | |
| 10 | | |
| 11 | | |
| 12 | | |
| 13 | | |
| 14 | | |
| 15 | | |
| 16 | | |
| 17 | | |
| 18 | | |
| 19 | | |
| 20 | | |
| 21 | | |
| 22 | | |
| 23 | | |
| 24 | | |
| 25 | | |
| 26 | | |
| 27 | | |
| 28 | | |
| 29 | | |
| 30 | | |
| 31 | | |
| 32 | | |
| 33 | | |
| 34 | | |
| 35 | | |
| 36 | | |
| 37 | | |
| 38 | | |
| 39 | | |
| 40 | | |
| 41 | | |
| 42 | | |
| 43 | | |
| 44 | | |
| 45 | | |
| 46 | | |
| 47 | | |
| 48 | | |
| 49 | | |
| 50 | | |

| Claim | | Date |
|-------|----------|------|
| Final | Original | |
| 51 | | |
| 52 | | |
| 53 | | |
| 54 | | |
| 55 | | |
| 56 | | |
| 57 | | |
| 58 | | |
| 59 | | |
| 60 | | |
| 61 | | |
| 62 | | |
| 63 | | |
| 64 | | |
| 65 | | |
| 66 | | |
| 67 | | |
| 68 | | |
| 69 | | |
| 70 | | |
| 71 | | |
| 72 | | |
| 73 | | |
| 74 | | |
| 75 | | |
| 76 | | |
| 77 | | |
| 78 | | |
| 79 | | |
| 80 | | |
| 81 | | |
| 82 | | |
| 83 | | |
| 84 | | |
| 85 | | |
| 86 | | |
| 87 | | |
| 88 | | |
| 89 | | |
| 90 | | |
| 91 | | |
| 92 | | |
| 93 | | |
| 94 | | |
| 95 | | |
| 96 | | |
| 97 | | |
| 98 | | |
| 99 | | |
| 100 | | |

| Claim | | Date |
|-------|----------|------|
| Final | Original | |
| 101 | | |
| 102 | | |
| 103 | | |
| 104 | | |
| 105 | | |
| 106 | | |
| 107 | | |
| 108 | | |
| 109 | | |
| 110 | | |
| 111 | | |
| 112 | | |
| 113 | | |
| 114 | | |
| 115 | | |
| 116 | | |
| 117 | | |
| 118 | | |
| 119 | | |
| 120 | | |
| 121 | | |
| 122 | | |
| 123 | | |
| 124 | | |
| 125 | | |
| 126 | | |
| 127 | | |
| 128 | | |
| 129 | | |
| 130 | | |
| 131 | | |
| 132 | | |
| 133 | | |
| 134 | | |
| 135 | | |
| 136 | | |
| 137 | | |
| 138 | | |
| 139 | | |
| 140 | | |
| 141 | | |
| 142 | | |
| 143 | | |
| 144 | | |
| 145 | | |
| 146 | | |
| 147 | | |
| 148 | | |
| 149 | | |
| 150 | | |

Best Available Copy

| | |
|--|--|
| IN THE UNITED STATES PATENT AND TRADEMARK OFFICE | |
| SUBMISSION OF REFERENCES TO COMPLETE RECORD BY APPLICANTS | Atty. Docket No. (Opt.) CROSS1121-15 |

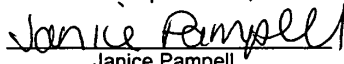

Commissioner for Patents
P.O. Box 1450
Alexandria, VA 22313

| | |
|---|------------------------------|
| Applicants Geoffrey B. Hoese et al. | |
| Application Number 90/007,124 | Filed 07/19/2004 |
| For Storage Router and Method for Providing Virtual Local Storage | |
| Group Art Unit 2182 | Examiner Alan Chen |
| Certification Under 37 C.F.R. §1.8 | |
| I hereby certify that this document is being deposited with the United States Postal Service as First Class Mail in an box addressed to: Commissioner for Patents, P.O. Box 1450, Alexandria, VA 22313 on September 8, 2005. | |
|  Janice Pampell | |

To complete the record, Applicants respectfully submit hard copies of references previously submitted on CD-ROM with an IDS dated March 24, 2005 (the "March 24 IDS"). This submission is made simply to complete the file record and is not a new IDS as the references were already provided on CD-ROM and reviewed by Examiner Fritz Fleming (a copy of the March 24 IDS was initialed by Examiner Fleming indicating that he reviewed the references).

Respectfully submitted,

Sprinkle IP Law Group
Attorneys for Applicants

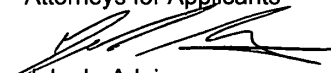
John L. Adair
Reg. No. 48,828

Dated: September 8, 2005

1301 W. 25th Street, Suite 408
Austin, TX 78705
T. 512-637-9223 / F. 512-371-9088

09/05/2001 Chaparral Trial - Day 2

1 UNITED STATES DISTRICT COURT WESTERN DISTRICT OF TEXA
2 WESTERN DIVISION

3 CROSSROADS SYSTEMS,) Docket No. A 00-CA-217 SS (TEXAS), INC., A TE
4 CORPORATION))
5 vs.) Austin, Texas)
6 CHAPARRAL NETWORK) STORAGE, INC., A)
7 DELAWARE CORPORATION) September 5, 2001

8 TRANSCRIPT OF TRIAL ON THE MERITS
9 BEFORE THE HONORABLE SAM SPARKS Volume 2 of 6

10

11 APPEARANCES:

12 For the Plaintiff: Mr. Alan D. Albright
13 Mr. John Allcock
14 Mr. John Giust
15 401 B Street, Suite 1700

16

17 For the Defendant: Mr. David D. Bahler
18 Mr. Stephen D. Dellett
19 Fulbright & Jaworksi
20 Austin, Texas 78701

21 Court Reporter: Lily Iva Reznik, RPR, CRR
22 200 W. 8th Street
23 (512)916-5564

24

25 Proceedings recorded by mechanical stenography, transcript produced by c

09/05/2001 Chaparral Trial - Day 2

| | I N D E X | | | |
|----|-----------------------|-------|----------|-------------------|
| | Direct | Cross | Redirect | RecrossWitnesses: |
| 1 | | | | |
| 2 | | | | |
| 3 | | | | |
| 4 | Brian R. Smith | | 4 | 15 |
| 5 | Ted Neman | 18 | 19 | |
| 6 | John R. Middleton | 20 | 30 | 35 |
| 7 | Brian Bianchi | 37 | 38 | |
| 8 | Geoffry B. Hoese | 54 | 77 | 84 96 |
| 9 | Jeffry Russell | 99 | 107 | 115 116 |
| 10 | Keith Arroyo | 118 | 121 | |
| 11 | Robert Selinger | 132 | | |
| 12 | Michael Gluck | 144 | | |
| 13 | Jerry L. Walker | 171 | 205 | |
| 14 | | | | |
| 15 | | | | Page |
| 16 | Proceedings Adjourned | | | 214 |
| 17 | | | | |
| 18 | | | | |
| 19 | | | | |
| 20 | | | | |
| 21 | | | | |
| 22 | | | | |
| 23 | | | | |
| 24 | | | | |
| 25 | | | | |

09/05/2001 Chaparral Trial - Day 2

| | E X H I B I T S | |
|----|-----------------------------------|----------|
| | Offered | Admitted |
| 1 | | |
| 2 | | |
| 3 | Plaintiff's | |
| 4 | #7 Fax | 68 69 |
| 5 | #264 Verrazano Specification | 29 30 |
| 6 | #267 CP4X00 Product Specification | 29 30 |
| 7 | #268 Verrazano Hardware Document | 29 30 |
| 8 | | |
| 9 | | |
| 10 | | |
| 11 | | |
| 12 | | |
| 13 | | |
| 14 | | |
| 15 | | |
| 16 | | |
| 17 | | |
| 18 | | |
| 19 | | |
| 20 | | |
| 21 | | |
| 22 | | |
| 23 | | |
| 24 | | |
| 25 | | |

1 THE COURT: Counsel, anything before we bring in the
2 jury?

3 MR. BAHLER: Nothing from defendant.

4 MR. ALBRIGHT: No, sir.

5 THE COURT: All right. Bring them in.

6 (Jury present.)

7 THE COURT: Members of the jury, as you left last
8 night until this morning, has anyone attempted to talk to you
9 about this case?

10 THE JURORS: No.

11 THE COURT: Have you talked to anybody about the case?

12 THE JURORS: No.

13 THE COURT: And have you learned anything at all about
14 the case outside the presence of each one another and this
15 courtroom?

16 THE JURORS: No.

17 THE COURT: All right. Show negative responses to all
18 questions by all jurors. Thank you. And I believe the
19 witness is yours, Mr. Albright.

20 MR. ALBRIGHT: Yes, sir. Thank you, sir.

21 THE COURT: Mr. Smith, you're still under oath, sir.

22 RE-DIRECT EXAMINATION

23 BY MR. ALBRIGHT:

24 Q. Mr. Smith, during the course of Mr. Bahler's
25 cross-examination, you saw a number of products that were

09/05/2001 Chaparral Trial - Day 2

1 generally from the 1996 time period or, at least, designed for
2 products. Do you recall him asking you questions about that?

3 A. Yes.

4 Q. Throughout the myriad of different companies' projected
5 products, did anything that we saw yesterday have any software
6 in it?

7 A. There were just hardware diagrams.

8 Q. Explain to the jury, if you would, please, sir, what you
9 mean by the fact they were hardware diagrams as opposed to
10 having software.

11 A. The different blocks that were shown on the diagrams
12 represented hardware chips that were used and connected
13 together.

14 Q. In anything that Mr. Bahler showed the jury yesterday and
15 asked you about, would there have been anything in any of
16 those products or conceptions of products that would have
17 allowed access control to take place?

18 A. I don't believe so.

19 Q. And why wouldn't any of them have been able to provide for
20 access control?

21 A. They didn't show the software would have been running.

22 Q. Okay. Not only that show software, did it even have the
23 capability of having software?

24 A. My understanding they did not.

25 Q. Do you recall when it was that the two Jeffs, Jeff Russell

09/05/2001 Chaparral Trial - Day 2

1 and Geoff Hoese, invented the concept of access controls?

2 A. As I remember, it was the spring of '97.

3 Q. If I could have Exhibit D-140, please. Mr. Smith,
4 yesterday, Mr. Bahler showed Exhibit D-140 to the jury and
5 asked you questions about it. These are your handwritten
6 notes, correct, sir?

7 A. Yes.

8 Q. And I got the impression as I was listening to his
9 questions that he was asking you about a product that you had
10 actually seen at Adaptec, is that correct, was back in this
11 time period when you were looking at stuff at Adaptec, was
12 there actually a product there?

13 A. As I recall, I only saw presentation.

14 Q. And would you tell the jury you only saw a presentation of
15 what was at Adaptec, what do you mean, sir?

16 A. A set of slides that we looked at yesterday to represent
17 what they hoped to have someday.

18 Q. So there was nothing finished at Adaptec during this time
19 period?

20 A. That's correct, as I recall.

21 Q. And there certainly wasn't anything like the jury could
22 see there where there's actually a box or anything like that
23 that you were able to look at?

24 A. That's how I remember, yes.

25 Q. This is a slide presentation sort of what we're looking at

09/05/2001 Chaparral Trial - Day 2

1 now?

2 A. Correct.

3 Q. Okay. Whatever it was that you were looking at in terms
4 of that slide presentation, was there anything in anything
5 that Adaptec showed you that had the kind of software in it
6 that could provide for access controls?

7 A. I don't recall that.

8 Q. And was there any software at all in what you were looking
9 at at Adaptec?

10 A. There were two descriptions of it, as I remember.

11 Q. Do you recall whether there was ever an actual Coronado
12 product at Adaptec, Coronado product that got finished in '96
13 or '97?

14 A. I don't recall that either.

15 Q. Mr. Bahler also talked to you about the Mux product. Do
16 you recall that yesterday, multiplexer?

17 A. Yes.

18 Q. Was there a finished Mux product that was ready to be sold
19 in 1996?

20 A. There was not.

21 Q. What was there in 1996 that could be called a Mux?

22 A. Prototypes and pre-betas.

23 Q. Well, I'm not certain the jury's familiar with the term
24 pre-beta. What is a beta unit in your industry?

25 A. A device that would be able to be sold to the general

09/05/2001 Chaparral Trial - Day 2

1 public. Would not have either some of the features in it or
2 some of the certifications under the FCC Rules of Products and
3 what their emissions can be.

4 Q. Okay. So by beta unit, you're saying something that's not
5 for sale?

6 A. Not sellable.

7 Q. Not sellable. And when we talk about the Mux product, you
8 describe those as a pre beta. What does that mean?

9 A. That they were devices that didn't have the latest
10 hardware, as I remember, what would eventually be sold.

11 Q. These Mux products that you received from Hewlett Packard,
12 can you ever pay for them?

13 A. The first 15 or so we did not.

14 Q. What did you do with those first 15?

15 A. We used them to test functionality and then, we returned
16 them.

17 Q. So you didn't buy them and you didn't keep them?

18 A. That's correct.

19 Q. And just so the jury understands, when you received those
20 first 15, was that in 1997?

21 A. I believe it was early '97.

22 Q. Okay. Let's finish up with the Mux product so the jury
23 understands. Could any of the Mux product perform access
24 controls?

25 A. As I understand them, no.

09/05/2001 Chaparral Trial - Day 2

1 Q. And why would they not be able to perform access controls?

2 A. I believe they were pretty much hardware from the Fibre
3 Channel side to the SCSI side.

4 Q. The software wasn't there?

5 A. The software wasn't there to do functions like access
6 controls, as I remember.

7 Q. Mr. Smith, I've put up on the screen for the jury D-158.
8 You were asked a question about this. Mr. Smith, we're
9 looking at D-158, and there's a particular portion of it. If
10 you would look at the third paragraph down, please, sir, it
11 references a no charge PO?

12 A. Yes.

13 Q. Should reflect the \$17,000 price. Would you tell the jury
14 what an evaluation PO is, please, sir?

15 A. It's a document that allows potential customers who want
16 to evaluate or look at a product that is not sellable to be
17 able to receive it, look at it, I believe, for 60 days and
18 then, return it back to the original designer of the product.

19 Q. Was there anyone back in this time period that was going
20 to pay you all \$17,000?

21 A. No. That was really a fictional price put on for standard
22 practice in the industry.

23 Q. I just want to make sure the jury understands because
24 you've talked a couple of times about fictional prices. Why
25 does a company like Crossroads when they send out these type

09/05/2001 Chaparral Trial - Day 2

1 of evaluation units, why you put a fictional price on it?

2 A. It's just industry standard practice in the OEM
3 relationship where you're selling to another party at some
4 point to put that -- to strap a price to it.

5 Q. What are you expecting to do to pay that money or send the
6 money back?

7 A. Our expectation is we would receive all of that product
8 back.

9 Q. And in this case, do you recall whether or not you
10 received them back?

11 A. I don't recall whether we ever sent it to them, but as I
12 recall, we did receive all of our betas back.

13 Q. Chaparral is in, roughly, the same business as you all,
14 correct?

15 A. Yes.

16 Q. Router industry? Do you expect that they would have the
17 same practice of sending out evaluation or beta units?

18 A. I would expect that.

19 Q. Same type that are not for sale, they're just evaluation
20 units?

21 A. I would have that expectation.

22 Q. And, for example, these products, were they under an MDA
23 when you send them out?

24 A. Very typically, yes. In fact, I don't recall any of them
25 not being under a non-disclosure agreement.

09/05/2001 Chaparral Trial - Day 2

1 Q. And what does a non-disclosure agreement provide?

2 A. It's typically an agreement between two parties possibly
3 more where they agree not to disclose to any other party what
4 the product is, or the intellectual property, or the concepts
5 that are being communicated are, and just to disclose those
6 between the two parties.

7 Q. So somebody has an MDA on it when it goes out to the
8 persons receiving it, is that a product that's been sold to
9 them?

10 A. Typically not. It's just under evaluation.

11 Q. I'm going to shift to -- just a quick discussion yesterday
12 you were asked about Clariion?

13 A. Yes.

14 Q. Do you recall that? And Mr. Bahler asked you questions
15 about whether or not Crossroads had made sales of products to
16 Clariion in 1996, do you recall that, sir?

17 A. Uh-huh.

18 Q. Was there a finished product in 1996 that Crossroads could
19 have sold to Clariion?

20 A. No.

21 Q. In 1997, did you sell a product to Clariion?

22 A. I don't recall ever selling anything to Clariion.

23 Q. Do you recall when Crossroads' first sale of a router was?

24 A. I do; it was in August of 1997 to Compaq.

25 Q. And how can you be certain that Crossroads didn't sell a

09/05/2001 Chaparral Trial - Day 2

1 product until August of 1997?

2 A. The reason I remember is because it came up during our
3 filing of registration in 1999 where we filed with the
4 Securities and Exchange Commission to go public. We had to
5 write and tell the public when was our first sale. We wrote
6 August of 1997.

7 Q. And is that a pretty important document that you file with
8 the Securities and Exchange Commission?

9 A. Very important, yes.

10 Q. Is it important to be truthful in that document?

11 A. It is, yes.

12 Q. Finally, we discussed yesterday, at some length, what was
13 called the Verrazano project. And Mr. Bahler put up -- and
14 I'm not going to try it again just so we can get finished here
15 -- put up basically a diagram that had some Tachyon chip and
16 some other parts.

17 Remember him highlighting them for the jury and
18 pointing out what was contained in the diagram?

19 A. Yes.

20 Q. Again, so the jury understands, were we looking at
21 hardware features or software features?

22 A. That was hardware block diagram.

23 Q. Was there any software anywhere in that diagram?

24 A. There was not.

25 Q. Could Mr. Bahler have highlighted anything in that diagram

1 that would have shown any software function at all?

2 A. No.

3 Q. Could he go through or could anyone go through the
4 Verrazano documents from 1996 and find anything in them that
5 discussed access controls?

6 A. I don't believe so.

7 Q. And could you find anything in the -- indicated the
8 software that would provide for access controls?

9 A. I don't believe so.

10 Q. With respect to the difference between -- and I'm going to
11 close with this -- but with respect to the difference between
12 the hardware and software features, in your basic
13 understanding, how does one develop as between the hardware
14 and the software development of these type of projects or
15 these type of routers?

16 A. We think of the hardware and software being at some levels
17 two distinct elements that work together. In fact, we talk to
18 our customers about how our software kind of works with our
19 hardware. I could even draw it if it made sense to do that.

20 Q. Judge, would he be permitted to walk over to the board?

21 THE COURT: He's permitted.

22 A. So when we talk to our customers, since I have a fairly
23 high level of understanding what we do, not too detailed, this
24 is how I try to communicate to our customers how our hardware
25 and our software work together. We think of it as essentially

1 kind of a pyramid where here at the low layers, we have
2 hardware.

3 And we talked about those things yesterday being the
4 Fibre Channel, chip, the SCSI chip, and the microprocessor.
5 Those are things that we put together to build our products.
6 They're the hardware elements of our product. Running on the
7 microprocessor software that runs in the microprocessor, we
8 have software here. That essentially configures and defines
9 how the unit is to run.

10 And we actually have some --

11 Q. (BY MR. ALBRIGHT) I was just going to --

12 A. We actually have some patents here we have been granted in
13 this space and some intellectual property that we have
14 uniquely discovered. And on top of that, we have additional
15 software that uses those services to provide even more
16 valuable functions, and I believe in what I tell my customers
17 is that access control and other features that we are able to
18 lift at this layer. We also have patents at this layer.

19 Q. So when you're describing for the jury what -- what Mr.
20 Bahler yesterday was asking you questions about what was in
21 the Verrazano project, what was he talking about in terms of
22 what's on that pyramid?

23 A. The block diagrams, they represent how the hardware
24 interconnected.

25 Q. And was the software performed the access control that you

1 have at the top of the pyramid, was that even conceived in
2 1996?

3 A. It was not and it's not contemplated in the diagram
4 either.

5 Q. Pass the witness.

6 RE-CROSS EXAMINATION

7 BY MR. BAHLER:

8 Q. Mr. Smith, we talked yesterday about the technology
9 demonstration at Comdex '96, right?

10 A. Yes.

11 Q. Now, that had Fibre Channel hosts connected on the Fibre
12 Channel side, right?

13 A. It did.

14 Q. And it had SCSI storage devices connected on the SCSI
15 side, right?

16 A. Yes, it did.

17 Q. And there were requests for data being transferred from
18 Fibre Channel hosts through the 4100 prototype product to the
19 SCSI storage devices, right?

20 A. Yes, at our technology demonstration.

21 Q. And there was data in the form of images you were showing
22 at the slide show, right?

23 A. That's correct.

24 Q. Data was being transferred from the SCSI storage devices
25 back through the 4100 prototype to the Fibre Channel host,

09/05/2001 Chaparral Trial - Day 2

1 right?

2 A. Yes, correct.

3 Q. And that all required software, didn't it, sir?

4 A. Yes, it did.

5 Q. So the prototype had software, right?

6 A. It did.

7 Q. The only thing that Mr. Albright asked you that was
8 missing was access control, right?

9 A. That's what he asked, yes.

10 Q. The \$17,000 that you were offering the Hewlett Packard Mux
11 to EMC, how did you arrive at that number, sir, \$17,000?

12 A. I don't recall specifically how we got there.

13 Q. That's what you were paying Hewlett Packard for the units,
14 right?

15 A. I don't recall that.

16 Q. You mentioned that you had sold the first 4100 unit to
17 Compaq in August of '97, right?

18 A. Yes.

19 Q. In fact, you'd sold a 4400 unit to Compaq in 1996, right?

20 A. I don't recall, sir, doing that.

21 Q. Let me show you what's been marked as Defendant's Exhibit
22 172, and, first of all, Mr. Smith, this is called a Crossroads
23 purchase order log, right, sir?

24 A. That's the title, yes.

25 Q. And it's dated -- it was updated July 21, 1997, right,

09/05/2001 Chaparral Trial - Day 2

1 sir?

2 A. That's correct.

3 Q. Okay. And on that purchase order log, there's some
4 entries for Compaq, right, just so we're clear what we're
5 talking about. I have the banner, the column headings over on
6 top of these Compaq entries. Now, this records a purchase
7 order received from Compaq in December 9th, 1996, right, sir?

8 A. Appears to be, yes.

9 Q. And it was for a CP 4400, right?

10 A. Correct.

11 Q. And the price was \$17,000, right?

12 A. Yes, and to the right it says evaluation period.

13 Q. That's right. And if it met with their approval, they
14 could keep it for \$17,000, right?

15 A. Again, industry practice to return the evaluation PO
16 products.

17 Q. Well, the second of those wasn't ever returned, was it?

18 A. I don't know.

19 Q. Well, let's look at the whole line here. All right.

20 That's a little hard to read, I suppose. Well, let's look at
21 the -- let's look at this part here. Let me call up this part
22 right here in more detail. It says need to follow up in that
23 column?

24 A. It does.

25 Q. That means as of August or July 1997, Compaq hadn't

09/05/2001 Chaparral Trial - Day 2

1 returned that product, right?

2 A. I don't know.

3 Q. Pass the witness.

4 THE COURT: Any further questions?

5 MR. ALBRIGHT: No, sir.

6 THE COURT: You may step down, Mr. Smith. You may
7 call your next witness.

8 MR. ALBRIGHT: Your Honor, we have an amazingly brief
9 deposition transcript that --

10 THE COURT: Members of the jury, a deposition
11 transcript is a product paper like the little book where a
12 witness has been sworn before a Court Reporter and the lawyers
13 have asked them questions, however, as the case may be, and
14 then, the testimony is read into the record.

15 You will consider this testimony just like any other
16 sworn testimony that you hear during the trial.

17 MR. ALBRIGHT: Your Honor, I only have two questions.
18 Would you prefer I just read the question and answer?

19 THE COURT: However you wish.

20 MR. ALBRIGHT: Okay. The witness, your Honor, was the
21 CFO of Chaparral, gentleman named Ted Neman, and the question
22 posed was: "What is an evaluation?" His answer: "It's a
23 unit that's sent out to a customer for the purposes of
24 evaluation to work in a particular configuration to see if the
25 customer would want to buy a particular product."

09/05/2001 Chaparral Trial - Day 2

1 Question: "Is that a product that Chaparral considers
2 it has sold?" The answer was "No."

3 THE COURT: Any testimony you wish to --

4 MR. DELLETT: Next question was: "And why not?"

5 Answer: "Because sometimes those units are returned. At the
6 time that they are sent out, we do not recognize revenue on
7 those. A customer might possibly purchase that after an
8 evaluation unit process, or the customer may send it back,
9 depending on if it works for their specific needs."

10 Question: "The adjusted revenue follows the same
11 process that you just told us about, correct?" Answer: "Not
12 -- initially, the evaluation unit is not counted as revenue.
13 If the customer elects to purchase it, then it -- then they
14 are billed, and it's recognized for revenue."

15 THE COURT: Any further testimony?

16 MR. ALBRIGHT: No, sir.

17 THE COURT: All right. You may call your next
18 witness.

19 MR. ALBRIGHT: Our next witness will be John
20 Middleton.

21 THE COURT: Come forward, please. This is Mrs. Sims.
22 She's going to administer an oath to you, sir.

23 (Witness was sworn.)

24 THE COURT: Walk around this column and have a seat,
25 please. Tell us your full name and spell your last, please.

09/05/2001 Chaparral Trial - Day 2

1 THE WITNESS: My name is John Rob Middleton,
2 M-I-D-D-L-E-T-O-N.

3 JOHN R. MIDDLETON, called by the Plaintiff, duly sworn.

4 DIRECT EXAMINATION

5 BY MR. ALBRIGHT:

6 Q. Mr. Middleton, would you introduce yourself to the jury,
7 please?

8 A. Yes, my name is John Middleton.

9 Q. And tell the jury why it is that you're here. When did
10 you go to work for Crossroads?

11 A. I was -- I went to work for Crossroads in February of
12 1997, and was a vice-president of engineering for a good deal
13 of that time, between February of '97 and January of 2001.

14 Q. You had the good fortune to retire in 2001?

15 A. Yes.

16 Q. Okay. When you were at Crossroads and you were working as
17 an engineer, we've heard the discussion in this courtroom
18 about the fact that there was hardware and that there's
19 software. Are you a hardware guy or a software guy?

20 A. My background is a hardware engineer.

21 Q. And would you tell the jury what that means, please, sir?

22 A. Hardware engineers design the circuit boards and
23 electronics that comprise computer products and software, on
24 the other hand, is the code that runs on the hardware.

25 Q. And so, with respect to the issue that is primary in this

09/05/2001 Chaparral Trial - Day 2

1 case with respect to the access control, is that something
2 that as a hardware engineer, you were particularly familiar
3 with or is that something that's more available to the
4 software engineer?

5 A. It's more of a software feature.

6 Q. With the caveat that you are a hardware engineer, not a
7 software engineer when you're at Crossroads and now, what was
8 your understanding of what was meant by the term LUN
9 management?

10 A. LUN management refers to a mechanism for allowing hosts to
11 access devices or parts of devices, or to not access --
12 restrict access to devices or parts of devices.

13 Q. And since I never really heard the word "host" till I
14 started on this case, could you let the jury know in more
15 simple terms what a host is?

16 A. Sure. It would be a computer that acts as a server that
17 accesses the data on the storage system.

18 Q. The jury's heard that the access control feature that
19 we've talked about or are talking about has not been in the
20 Crossroads products. Are you familiar with a product that has
21 recently come out from Crossroads?

22 A. I'm somewhat familiar with that product.

23 Q. Okay. And that would be the Catamaran product, right?

24 A. Yes.

25 Q. To your knowledge up to January of 2001, was the process

09/05/2001 Chaparral Trial - Day 2

1 at Crossroads, was the intent to put access -- the access
2 control feature into that product?

3 A. Yes, it was.

4 MR. BAHLER: Objection. Leading.

5 THE COURT: It is leading. Don't lead.

6 MR. ALBRIGHT: Yes, sir.

7 Q. (BY MR. ALBRIGHT) Why was Crossroads developing a new
8 product that included LUN management for access control?

9 A. In general, we were developing a new router platform for
10 the company, and in developing, we felt access to LUN
11 management, rather, was a valuable feature that would enhance
12 the value of the product.

13 Q. Had any customers shown interest in having LUN management?

14 A. Yes, we had a lot of customer interest in that feature.

15 Q. Okay. Would you tell the jury, please, we've been talking
16 about LUN management. Would you tell the jury what LUN stands
17 for?

18 A. LUN is logical unit number.

19 Q. Okay. And that being said, would you tell the jury what a
20 logical unit number is?

21 A. If you think of a storage device like a -- it can be
22 divided into a number of sections, and you can assign --
23 that's the physical device. You can divide the physical
24 device into logical units that appear to a computer as
25 physical units, but they're actually not at the physical

09/05/2001 Chaparral Trial - Day 2

1 level. So it's a way to divide a physical device into smaller
2 units.

3 Q. Okay. The jury heard during opening argument that
4 Crossroads for several years has marked its products with the
5 972 patent. Do you know why Crossroads -- let me ask you
6 this, first.

7 What responsibility did you, John Middleton, have for
8 putting a label on Crossroads products a year or two ago that
9 indicated that it was protected by the 972 patent?

10 A. As the head of the engineering department, it was
11 ultimately my decision to put that label on Crossroads'
12 products.

13 Q. And would you explain to the jury why it is that you
14 decided to put a label on the router product that Crossroads
15 was selling that had the 972 patent on it?

16 A. The 972 patent was one of the first patents that
17 Crossroads was awarded. We were proud of the patents, proud
18 of the product and wanted to mark the products appropriately
19 with the patent information.

20 Q. Did you personally ever do any analysis of any Crossroads
21 router product to determine if access control actually was in
22 the product?

23 A. Not a detailed analysis, no.

24 Q. Any kind of non-detailed analysis?

25 A. Yes, I did a general assessment.

09/05/2001 Chaparral Trial - Day 2

1 Q. Okay. And what kind -- when you say "general assessment,"
2 what did you do?

3 A. I spoke with other engineers at Crossroads.

4 Q. Okay. And one of those engineers you spoke to was Geoff
5 Hoese, who's one of the inventors, right?

6 A. Yes, I did speak to Geoff.

7 Q. And what did Mr. Hoese tell you to do with respect to
8 putting this label on the product?

9 A. He encouraged me to have someone besides himself make that
10 determination.

11 Q. So he gave you no advice?

12 A. Not about whether I should label the product, just about
13 how I should proceed with determining how to label the
14 product.

15 Q. Did you talk to anybody else?

16 A. I did speak to other people, yes.

17 Q. Anyone in particular that you remember?

18 A. I can recall Mr. Wanamaker.

19 Q. Who is Mr. Wanamaker?

20 A. He was one of the senior engineers at Crossroads.

21 Q. When you say that you spoke with Mr. Wanamaker, did you go
22 to Mr. Wanamaker, for example, and say, I'm thinking about
23 putting this label on the product? Is that a good idea? Is
24 the patent in the product? Or what type of conversation was
25 it?

09/05/2001 Chaparral Trial - Day 2

1 A. It was just a general conversation about whether the
2 patent was contained in the product, not about labeling,
3 specifically.

4 Q. Did Mr. Wanamaker, as far as you know, ever perform an
5 analysis himself of whether or not the Crossroads routers had
6 the access control feature that's in the --

7 A. Not to my knowledge.

8 Q. And you recall, so the jury understands, did he
9 affirmatively tell you the patent was in the products or did
10 he not tell you it wasn't? Tell the jury what it was,
11 basically, he told you.

12 A. Basically, he never gave me any information that made me
13 doubt that the patent was in the product.

14 Q. Okay. Mr. Middleton, you're a hardware engineer, correct?

15 A. Yes.

16 Q. What do you know about patent law?

17 A. Not a lot.

18 Q. Were you aware when you put this label on the product,
19 were you aware of the consequences of what would occur if you
20 put it on the product and the product did not have the
21 patented feature in it?

22 A. No, I was not.

23 Q. Were you aware of what would happen if you sent out a
24 product and it didn't have a label on it?

25 A. No.

09/05/2001 Chaparral Trial - Day 2

1 Q. Why did you put a label at all on the router product?

2 A. We felt like -- my understanding was that the product
3 contained a patent, it was proper to mark the product
4 accordingly.

5 Q. Okay. Mr. Bahler, during opening argument, stated that
6 because Crossroads put the label on it and because there was a
7 feature called reserve release in the router that Crossroads
8 was telling the world that that's what was patented.

9 Do you know at the time that you put the label on it
10 even whether or not the Crossroads product had that feature,
11 had the reserve release feature?

12 A. No, I don't.

13 Q. So when you decided to have the label put on it, were you
14 making a statement to the world as to whether or not you had a
15 belief whether this reserve release feature was what was
16 covered by the patent?

17 A. No, I was not.

18 Q. And as we sit here today, do you have an opinion as to
19 whether reserve release is what's covered by the patent?

20 A. Yes. I don't believe reserve release is what's covered by
21 the patent.

22 Q. But that's something that you've come to long after the
23 labeling issue, right?

24 A. Right.

25 Q. In other words, you just didn't consider it?

09/05/2001 Chaparral Trial - Day 2

1 A. No, I didn't.

2 Q. Your Honor, may we approach for a second?

3 THE COURT: Okay.

4 (At the Bench, on the record.)

5 MR. ALBRIGHT: The only thing I have left to do with
6 this witness, your Honor, is I wanted to have him identify for
7 purposes of admission some documents that Chaparral is opposed
8 to. Basically, these documents are documents that he'll
9 testify that he prepared.

10 Before submitting them, the relevance of them, the
11 relevance of them is that they go to the issue of when the
12 patent was conceived, which the defendant has put at issue
13 here and yesterday, their argument about the conception
14 argument, and these documents are relevant to that issue and
15 this is the gentleman that prepared them.

16 THE COURT: Well, can you give me a hint as to the
17 number of the document?

18 MR. BAHLER: Why don't you give me the number?

19 MR. ALBRIGHT: Sorry. 264, 267, 268.

20 MR. BAHLER: May I be heard?

21 THE COURT: Yes, sir.

22 MR. BAHLER: The relevance objection is that the
23 conception is a very unique patent law invention. It requires
24 not only a description of what's -- what the invention is --

25 THE COURT: Right.

09/05/2001 Chaparral Trial - Day 2

1 MR. BAHLER: -- but also requires the communication to
2 another.

3 THE COURT: Right.

4 MR. BAHLER: It also has to be prepared by the
5 inventors. I mean, conception by this gentleman is not --
6 these documents are basically not relevant to that issue if
7 that's what they're being offered for. They're simply not
8 relevant to that issue.

9 THE COURT: Well, this is an alleged invention that
10 was patented, was actually prepared by the witness, shows two
11 gentlemen, Hoese and Russell, in their employment with the
12 company, and I would think that any document that would tend
13 to show from that company would be relevant. So I would have
14 overruled the relevance objection.

15 MR. BAHLER: Thank you, your Honor.

16 MR. ALBRIGHT: Do you have any other objection?

17 MR. BAHLER: No.

18 MR. ALBRIGHT: Your Honor, I move for the admission of
19 264, Plaintiff's 264, 267 and 268.

20 THE COURT: Well, they haven't been identified for the
21 record.

22 MR. ALBRIGHT: May I approach, your Honor?

23 THE COURT: You don't need -- lawyers don't need my
24 permission to move in a courtroom. Members of the jury, many
25 judges require that. But I've got a bad back and after 30

09/05/2001 Chaparral Trial - Day 2

1 years, I wanted to move around the courtroom, and I didn't
2 like some little, old fat judge telling me I couldn't do it.
3 But I don't have that rule.

4 All right.

5 MR. ALBRIGHT: Thank you, sir.

6 Q. (BY MR. ALBRIGHT) Mr. Middleton, if you would identify for
7 the record what exhibit -- Plaintiff's Exhibit 264 is, please,
8 sir.

9 A. 264 is the Verrazano enclosure specification.

10 Q. And would you identify Exhibit 267, please, sir?

11 A. 267 is a CP 4X00 product specification.

12 THE COURT: CP what?

13 THE WITNESS: CP 4X00 product specification.

14 Q. (BY MR. ALBRIGHT) Would you identify what Plaintiff's
15 Exhibit 268 is, please, sir?

16 A. 268 is the Verrazano hardware architecture document.

17 Q. And what was your involvement with these three documents?

18 A. I wrote portions of these documents.

19 Q. Do you know if they were basically documents that were
20 created at or about the same time back in the time period as
21 to what they're dated?

22 A. These are in the -- '97, first half of '97.

23 Q. But they're true and correct copies of what you worked on?

24 A. Yes.

25 Q. I move for their admission, your Honor.

09/05/2001 Chaparral Trial - Day 2

1 MR. BAHLER: No objection.

2 THE COURT: 264, 67 and 268 are admitted.

3 MR. ALBRIGHT: Judge, we pass the witness.

4 MR. BAHLER: Your Honor, if I could correct, there was
5 an objection, but you've already ruled on that.

6 THE COURT: I ruled on the relevance.

7 MR. BAHLER: For what it's worth.

8 THE COURT: So the record will speak for itself.

9 CROSS-EXAMINATION

10 BY MR. BAHLER:

11 Q. Mr. Middleton, I've handed you what's been marked into
12 evidence as Defendant's Exhibit 123. I'll get it up on the
13 board. First page is up on the board. That's actually a
14 collection of exhibits, right, sir, or a collection of
15 drawings?

16 A. Yes, sir.

17 Q. All right, sir. And those are drawings of various
18 versions of the label that was applied to the 4100 and 4200
19 products, right?

20 A. These are labels that were applied to different versions
21 of the 4100 and 4200 product.

22 Q. Okay. Please turn to page 6 of that document. And this
23 is a label for the 4100, 4200 product, right, one of the
24 labels that were applied to those products, right?

25 A. Yes, sir.

09/05/2001 Chaparral Trial - Day 2

1 Q. Okay. And on that label was included the statement that
2 product was protected by U.S. Patent Number 972, that's the
3 patent in this case, right, sir?

4 A. Yes, it is.

5 Q. And if I understand your testimony, it was your decision
6 to add that patent number to that patent label, right, sir?

7 A. Yes, sir, it was.

8 Q. And after that, the label was actually applied to those
9 products, right?

10 A. Yes.

11 Q. Now, you mentioned several people that you talked to. You
12 talked to Mr. Hoese. He's one of the inventors before you
13 made the decision to apply that label, correct, sir?

14 A. Could you repeat that?

15 Q. You talked to Mr. Hoese before you made the decision to
16 apply that label, correct, sir?

17 A. Yes, I spoke to him before.

18 Q. And he didn't tell you not to put that patent number on
19 the product, did he, sir?

20 A. No, he didn't.

21 Q. And you talked to Mr. Wanamaker you mentioned, right, sir?

22 A. Yes.

23 Q. Mr. Wanamaker was a very special individual within
24 Crossroads, correct?

25 A. He was a senior engineer.

09/05/2001 Chaparral Trial - Day 2

1 Q. And, in fact, he was a member and active participant in
2 the Standard Setting Committee for the SCSI standards, right?

3 A. Yes.

4 Q. And you knew that, right?

5 A. Yes.

6 Q. And that's why you went to him, right?

7 A. Yes, it was.

8 Q. And he -- and based upon the conversation you had with
9 him, you decided and based upon the conversation you had with
10 him and based upon the conversation you had with Mr. Hoese,
11 you decided that the invention was in the 4100 and 4200
12 products, right?

13 A. I would say it was not based on Mr. Hoese's -- the
14 conversation with Mr. Hoese.

15 Q. Okay. At least it was based upon -- well, at least after
16 the conversation with Mr. Hoese and Mr. Wanamaker, you added
17 that patent label?

18 A. Yes.

19 Q. And the label was actually applied to the 4100 and 4200
20 products, correct, sir?

21 A. Yes, patent labels were applied.

22 Q. Okay. And this was about January or so of the year 2000,
23 right, sir?

24 A. I don't know that the -- exactly the labels were applied.

25 Q. Well, this one, in particular, is dated April 3rd, 2000,

09/05/2001 Chaparral Trial - Day 2

1 right?

2 A. Yes. The reason -- yes, that's true.

3 Q. So that's a little bit later, but if you back up -- if you
4 look in the package there, I don't have to display it, but if
5 you look in the package there, when you look at that date
6 which is the revision history, some go back into '99, some
7 even go back in -- or some are 2000, right, sir?

8 A. That's true.

9 Q. All right. So that label was in April 2000, in fact,
10 other labels with the 972 patent number were created once
11 before that, right, sir?

12 A. Right. That's when the labels were created.

13 Q. All right. And those labels were, in fact, applied to the
14 Crossroads products, right?

15 A. I believe they were.

16 Q. All right. Now, you left Crossroads in January 2000.
17 Well, first of all, back when you were deciding to put the
18 label on the product, was Crossroads thinking about suing
19 Chaparral?

20 A. I can't answer for --

21 Q. Were you aware of any intention on behalf of Crossroads to
22 sue Chaparral at that time?

23 A. No, I'm not.

24 Q. Now, you left Crossroads in January 2001, right, sir?

25 A. Yes.

09/05/2001 Chaparral Trial - Day 2

1 Q. Up until the time you left in January 2001, had anybody
2 ever expressed to you that within Crossroads that they thought
3 the patent number should not be applied to the Crossroads
4 products in accordance with the labels in Exhibit 123?

5 A. No, no one had given me that.

6 Q. Just so we're clear here, you were the director of
7 engineering, to begin with, and vice-president of engineering,
8 those jobs started in the fall of 1998, right?

9 A. I believe so, yes.

10 Q. And as director of engineering first and as vice-president
11 of engineering, you are in charge of all hardware and software
12 development within Crossroads, right?

13 A. Yes.

14 Q. Okay. And that continued all the way until the time you
15 left in January 2001, right, sir?

16 A. Yes.

17 Q. All right, sir. During any of that -- during any of the
18 time you were at Crossroads -- and you started there in
19 January '97, right, sir?

20 A. That's true.

21 Q. During any of that time, did Crossroads ever have in-house
22 a Chaparral product?

23 A. We did have a Chaparral product.

24 Q. Do you know what product that was, sir?

25 A. I don't know, though.

09/05/2001 Chaparral Trial - Day 2

1 Q. Was that at all unusual in this industry?

2 A. No. It's fairly typical.

3 Q. So the fact that there's nothing sinister about the fact
4 that Crossroads had a Chaparral product in its house?

5 A. I don't believe so.

6 Q. Right? And, in fact, there would be nothing sinister, as
7 far as you're concerned, with Chaparral having a Crossroads
8 product in its house either, right?

9 A. No, I don't believe so.

10 Q. Pass the witness.

11 RE-DIRECT EXAMINATION

12 BY MR. ALBRIGHT:

13 Q. Mr. Middleton, how old a man are you?

14 A. Pardon me?

15 Q. What's your age?

16 A. I'm 43.

17 Q. Forty-three. As a 43-year-old man, are you familiar with
18 the concept known as making a mistake?

19 A. Yes.

20 Q. I know it takes on some high importance in a courtroom
21 like this than there are small issues like the labeling seem
22 like they're a major importance?

23 THE COURT: Mr. Albright, do you have any questions,
24 sir?

25 MR. ALBRIGHT: Yes, sir. I apologize.

09/05/2001 Chaparral Trial - Day 2

1 Q. (BY MR. ALBRIGHT) Describe for the jury, if you would,
2 please, sir, what percentage of your time at Crossroads you
3 spent worrying about what label to put on its products.

4 A. I'd say very small percentage of time.

5 Q. That's all I have, your Honor.

6 THE COURT: Any further questions of this witness?

7 MR. BAHLER: No, your Honor.

8 THE COURT: You may step down. Thank you. May this
9 witness be excused, counsel?

10 MR. ALBRIGHT: Yes, sir.

11 THE COURT: You may be excused. You may call your
12 next witness.

13 MR. ALBRIGHT: Your Honor, we want to call Mr. Brian
14 Bianchi, B-I-A-N-C-H-I.

15 THE COURT: If you'd come forward, please. This is
16 Mrs. Sims. She's going to administer an oath to you, sir.

17 (Witness was sworn.)

18 THE COURT: You need to walk around this column and
19 have a seat up here in the blue chair. And if you would,
20 please, sir, tell us your full name and spell your last.

21 THE WITNESS: First name is Brian. My last name is
22 Bianchi, B-I-A-N-C-H-I.

23 BRIAN BIANCHI, called by the Plaintiff, duly sworn.

24

25

1
2
3
4
5
6
7
8
9
10
11
12
13
14
15
16
17
18
19
20
21
22
23
24
25

DIRECT EXAMINATION

BY MR. ALBRIGHT:

Q. Mr. Bianchi, would you introduce yourself to the jury, please?

A. My name is Brian Bianchi, Director of Software at Crossroads Systems.

Q. You met Mr. Middleton, who is a hardware engineer, and you're a software engineer?

A. That is correct.

Q. From your perspective, would you tell the jury what the difference is from your role as a software engineer and that of the hardware engineers?

A. My role is to really work on the -- to manage the firmware process and the firmware that runs on the router and controls the function of the router on the software perspective.

Q. There's a new product that's been released recently by Crossroads, correct?

A. That is correct.

Q. Would you tell the jury what the name of the new product is?

A. The new product is called Catamaran. It's also known as a Crossroads 8000 router.

Q. Does the new product that was just released for sale, does the new product have the LUN management feature as it's known as access control?

09/05/2001 Chaparral Trial - Day 2

1 A. Yes, it does.

2 Q. Are you generally familiar with what are known as SCSI
3 reserve commands as well as what's known as LUN mapping?

4 A. Generally, yes.

5 Q. Could you perform the LUN management or called access
6 control, could you perform that what is now in the Catamaran
7 through what are known as a function called SCSI reserve
8 release command?

9 A. No, you cannot.

10 Q. And are the SCSI reserve release commands, what has been
11 historically in the router products at Crossroads sold?

12 A. Yes, it is.

13 Q. Could you perform LUN management, the LUN management or
14 access control feature that's now in the Catamaran through
15 what's known as LUN, or logical unit number, mapping as you
16 understand?

17 A. Not as I understand it, no.

18 Q. Pass the witness, your Honor.

19 CROSS-EXAMINATION

20 BY MR. GARRETT:

21 Q. Good morning, Mr. Bianchi.

22 A. Good morning.

23 Q. My name is Mark Garrett. I represent Fulbright in this
24 case. I believe we've met before?

25 A. Yes, we have.

09/05/2001 Chaparral Trial - Day 2

1 Q. I just have a couple of questions about the Catamaran
2 product that you mentioned and, also, the LUN mapping that you
3 talked about. My first question is, what did you mean by LUN
4 mapping?

5 A. What is implemented in Catamaran is the ability to
6 restrict certain hosts from seeing the devices behind the
7 router.

8 Q. So when you referred to LUN mapping, were you referring to
9 what the Catamaran does or some other concept?

10 A. To what the Catamaran does.

11 Q. Okay. And so, are you saying that the Catamaran does not
12 do access control as you understand it?

13 A. I did not say that.

14 Q. Okay. But I think you said that -- maybe I was hearing
15 something differently, but you said LUN mapping does not do
16 what you understand Catamaran can do, right?

17 A. The terms are -- I'm getting confused on the terms between
18 what you asked and what Mr. Albright asked.

19 Q. Okay. Am I right or am I --

20 A. The LUN -- the SCSI LUN mapping commands that are part of
21 the standard are implemented in Catamaran, as well. And that,
22 I do not believe, based on my knowledge, can be -- can
23 implement the LUN management to use that term that is
24 implemented in Catamaran.

25 Q. So you're familiar, right now, with SCSI LUN mapping; is

09/05/2001 Chaparral Trial - Day 2

1 that right?

2 A. On the surface, yes, I am.

3 Q. Okay. And you're sure it's not what Catamaran does to
4 achieve what's called LUN management, right?

5 A. Based on my understanding in the standard, yes.

6 Q. Now, we talked a little bit -- you and I -- I took your
7 deposition outside this courtroom sometime ago, right?

8 A. That is correct.

9 Q. And I think we talked about your understanding of SCSI LUN
10 mapping at that time?

11 A. Correct.

12 Q. Do you remember that?

13 A. Yes, I do.

14 Q. Now, at that time, it was my understanding that you didn't
15 know whether the Catamaran product actually had SCSI LUN
16 mapping; is that right?

17 A. I believe that is correct, yes.

18 Q. And you moreover testified, I believe, that you didn't
19 know whether -- you didn't really understand SCSI LUN mapping.
20 Is that fair to say?

21 A. From what I remember my answer was, I'm not an expert in
22 that area, so I couldn't go into details that you were asking
23 about functionality.

24 Q. Right. But I did specifically ask you whether or not SCSI
25 LUN mapping was in Catamaran, right?

09/05/2001 Chaparral Trial - Day 2

1 A. I don't remember whether you asked me that or not.

2 Q. I apologize for the pause here, Mr. Bianchi. You just
3 kind of threw me off just a touch. Now, while I'm looking for
4 this, I believe Mr. Middleton earlier today -- and you weren't
5 in the courtroom, I understand that, when he testified, but he
6 discussed the fact that the Catamaran product can actually
7 control access between sections of devices. Is that your
8 understanding?

9 A. The Catamaran unit can control access to SCSI disk arrays,
10 for example, yes.

11 Q. Right. But it actually does it on a device-by-device
12 basis, right? Disk drive-by-disk drive and not portion of the
13 disk drive by a portion of the disk drive?

14 A. It is done at the LUN level, yes.

15 Q. Okay. We talked about LUN mapping pages, SCSI LUN mapping
16 pages during your deposition, and I believe I asked you if the
17 Catamaran device -- excuse me, the Catamaran device mapping
18 that's what actually performs the LUN management; is that
19 right?

20 A. Could you repeat the question?

21 Q. Sure. I don't mean to get you confused. The Catamaran
22 product has a feature called Catamaran device mapping, right?

23 A. Correct.

24 Q. Okay. And that's what's responsible for what's known as
25 LUN management, right?

1 A. Correct.

2 Q. Okay. Now, I asked you during the deposition if the
3 Catamaran device mapping in any way complies with the SEC
4 standard. And you understand that the SEC standard, all these
5 acronyms is actually a SCSI standard, right?

6 A. That is correct.

7 Q. Like the SCSI LUN mapping that we've been discussing?

8 A. (Moving head up and down.)

9 Q. If the Catamaran device mapping complies in any way with
10 the SEC standard suggested implementation of its LUN
11 mapping --

12 MR. ALBRIGHT: Your Honor, I would ask he ask a full
13 question as opposed to paraphrasing out of a deposition. I
14 believe it's appropriate to ask a question, and if he wants to
15 impeach him or cross him with that answer, that's fine. But
16 he's paraphrasing the question, and I want to make certain Mr.
17 Bianchi --

18 THE COURT: Is that an objection?

19 MR. ALBRIGHT: Yes, sir.

20 THE COURT: Restate your question.

21 Q. (BY MR. GARRETT) Yes, your Honor. Mr. Bianchi, does the
22 Catamaran products device mapping feature implement the SEC
23 standards suggested implementation of SCSI LUN mapping?

24 A. I guess I'm getting them as two separate things. There's
25 a device mapping which is part of the router we're calling LUN

09/05/2001 Chaparral Trial - Day 2

1 management. And there's a SCSI standard which is LUN mapping,
2 which is different than the device mapping that we're
3 referring to.

4 Q. So is the latter within a former?

5 A. My understanding is that they're independent.

6 Q. Okay. Does the Catamaran product actually have SCSI LUN
7 mapping in it?

8 A. To the best of my knowledge, it implements that portion of
9 the standard, yes.

10 Q. Now, let me ask you about the Catamaran device mapping.
11 First of all, is it true that there is only one active map
12 associated with a computer at a given time using Catamaran's
13 device map?

14 A. A given host has one map through the device, correct.

15 Q. And each device map that can be assigned with a different
16 host, it can assign access to different storage; is that
17 right?

18 A. Could you repeat the question?

19 Q. Sure. As I understand it, using device mapping, you can
20 have a computer and there can be a map within a Catamaran
21 product that actually has a list in a sense of storage devices
22 to which that computer gets to talk, right?

23 A. That is correct.

24 Q. And those lists, the information those maps can be set up
25 any way that somebody wants to set them up; is that right?

09/05/2001 Chaparral Trial - Day 2

1 A. Those maps are configured, yes.

2 Q. And so, the maps can have -- they could basically assign
3 access for a given computer to any different storage
4 combination --

5 A. That is correct.

6 Q. -- is that right? It's also my understanding that the
7 maps can be saved across power cycles and resets; is that
8 right?

9 A. That is correct.

10 Q. And this is the Catamaran device that we're talking about,
11 right?

12 A. Correct.

13 Q. Now, is it true that if a computer isn't mapped to a
14 particular storage device, if that storage device is not on
15 his map within the Catamaran device mapping, he doesn't get to
16 talk to that storage device; is that right?

17 A. That is correct.

18 Q. So there's no command that the computer can issue that
19 will actually get through to a storage device that's not on
20 his map, right?

21 A. That is correct.

22 Q. Is it also true that computers, they can't change their
23 maps in Catamaran device mapping to change who they get access
24 to, what storage devices?

25 A. The host cannot directly change the map.

09/05/2001 Chaparral Trial - Day 2

1 Q. And finally, the Catamaran device maps, they can be
2 altered by an operator or administrator; is that right?

3 A. That is correct.

4 Q. Thank you. Pass the witness.

5 MR. ALBRIGHT: No more questions.

6 THE COURT: You may step down, sir. Call your next
7 witness.

8 MR. ALBRIGHT: Your Honor, may we approach?

9 THE COURT: Sure.

10 (At the Bench, on the record.)

11 MR. ALBRIGHT: Your Honor, the next witness would be a
12 gentleman named Russ Bleakley, B-L-E-A-K-L-E-Y, and he would
13 be present by deposition, your Honor.

14 THE COURT: Okay.

15 MR. ALBRIGHT: And Mr. Bleakley is a former, first,
16 Crossroads and then, Chaparral employee who will testify about
17 certain issues, and defendant is going to object. I don't
18 know really what to say. If you want to read the section Mr.
19 Bahler's going to object to.

20 MR. BAHLER: Do you have them marked?

21 MR. ALBRIGHT: We do.

22 THE COURT: Why don't you tell me generally, then I'll
23 read it.

24 MR. BAHLER: Your Honor, this is Mr. Bleakley, first
25 of all, is not an employee of Chaparral any longer, so he

09/05/2001 Chaparral Trial - Day 2

1 wasn't a speaking agent, he wasn't speaking on our behalf. He
2 wasn't the 36 witnesses, is not in any way a party admission,
3 number one.

4 THE COURT: So at the time of the deposition, he
5 wasn't either of your client?

6 MR. BAHLER: Exactly, your Honor. And, in addition,
7 the statements that he made were -- this is just
8 black-and-white color television business. They said what do
9 you think about LUN zoning or LUN whatever it was. And he
10 said, well, it's like a color TV set. If you don't have it,
11 it's like a black-and-white TV set.

12 And, your Honor, this man is not qualified to render
13 that opinion. In addition, that's an opinion testimony by a
14 lay witness, and this is objectionable because it's opinion
15 testimony. Secondly, your Honor, during --

16 THE COURT: Wait, opinion by a lay -- has he been
17 designated as an expert witness?

18 MR. BAHLER: No, your Honor.

19 THE COURT: All right.

20 MR. BAHLER: In addition, your Honor, I don't have the
21 transcript with me, but the portion of the transcript that we
22 had counter-designated he admits he doesn't know anything
23 about LUN zoning. So he admitted that he doesn't even have a
24 basis to make that statement.

25 If you'd permit me to get the transcript from --

09/05/2001 Chaparral Trial - Day 2

1 THE COURT: It's probably a good idea. Members of the
2 jury, I'm going to give you a morning break. You'll have time
3 to stretch, go out, see if it's raining. Don't run away. Be
4 ready to come back.

5 (Jury not present.)

6 MR. ALBRIGHT: Mr. Bleakley had no ability to offer
7 these opinions --

8 THE COURT: Well, if he was so able and he wanted to
9 give an opinion, why wasn't he listed as an expert witness?

10 MR. ALBRIGHT: Your Honor, I think it's a perfectly
11 acceptable lay opinion of a person like Mr. Bleakley.

12 THE COURT: There are no lay opinions anymore.
13 They've changed the Rules of Evidence. You cannot give an
14 opinion anymore. And you read the notes behind the new rules,
15 and that was the whole point. You bring in an accountant to
16 get the professional nuts and bolts, and then, you ask them,
17 was this a well-managed company, you know, they used to allow
18 them to do that.

19 But all the bright stars and their wisdom have said
20 you're not going to do that anymore. If he's going to give an
21 opinion, test him out through Daubert.

22 MR. ALBRIGHT: Your Honor, it's not -- Mr. Bleakley is
23 a person who had to deal with a customer who they had promised
24 they would sell the LUN zoning to, and he had to deal with a
25 customer about having to take out the LUN zoning. And,

09/05/2001 Chaparral Trial - Day 2

1 basically, the questions were of what was the importance from
2 his perspective in his job of the LUN zoning.

3 THE COURT: And that's not an opinion?

4 MR. ALBRIGHT: Your Honor, it's going to be his
5 testimony as to why customers --

6 THE COURT: I'm not saying his opinion may not be
7 admissible, but if he's not listed as an expert and tested as
8 an expert, he can't give an opinion anymore. Let me read this
9 because I'm not sure I understand at all what y'all are
10 talking about.

11 MR. BAHLER: Your Honor, when you're finished reading,
12 I found that portion of the deposition that I'd like to read
13 to you.

14 THE COURT: All right.

15 MR. BAHLER: May I be heard, your Honor?

16 THE COURT: You may.

17 MR. BAHLER: Just so we're clear, the portion that
18 we're objecting to is from page 47, line 15 through page 48,
19 line 15, all right? Is that where y'all are reading?

20 THE COURT: I have been -- I don't know. Mine has
21 11.10.

22 MR. BAHLER: The objection we have specifically is to
23 page 47, line 15 to page --

24 THE COURT: You're looking at pages, and I'm
25 apparently looking at minutes.

09/05/2001 Chaparral Trial - Day 2

1 MR. BAHLER: Is this a video?

2 THE COURT: Okay. I've got a page. Go ahead now.

3 MR. BAHLER: Page 47, line 15 through page 48, line
4 15. That's the objection part.

5 THE COURT: All right.

6 MR. BAHLER: All right.

7 THE COURT: Your first objection?

8 MR. BAHLER: This is opinion testimony.

9 THE COURT: Well, I understand, but, I mean, I've got
10 some other things marked before that.

11 MR. BAHLER: This is the only objection we have to
12 this whole deposition.

13 THE COURT: Okay. Page 47. All right.

14 MR. BAHLER: 47, line 15 to 48, line 15. And this is
15 where he analogizes LUN zoning to this color TV,
16 black-and-white TV business, okay? On page 53, beginning at
17 line 9, and the following questions and answers were
18 propounded.

19 THE COURT: Well, before you're ready to read page 53,
20 as I understand it, you're objecting to the question. So
21 given the direction that SAN products are -- that's S-A-N --
22 products are headed in the LUN zoning feature as a feature
23 that will only -- that type of feature, not LUN zoning itself
24 necessarily, but that type of partitioning feature is
25 something that will only increase in value.

1 And there's an objection and the answer is yes.
2 Question, why is that? Objection. Question, for the same
3 reasons you just talked about. Further objections. Answer,
4 yes, as I think, yes, you need certain features as the
5 technology evolves. If you don't have them, then you've got a
6 black-and-white television and nobody wants it.

7 And the question, help me out there. What do you
8 mean? I mean, you have a black-and-white TV. Does that mean
9 other people have color TVs so no one wants a black-and-white
10 TV? Answer, right. Stereo on their television. Question,
11 that's the kind of feature LUN zoning is in your opinion?
12 Answer, yes, I think it's a preferred feature in a serious
13 storage network, yes.

14 All right. Now you can read it into the record your
15 basis for the objection.

16 MR. BAHLER: The basis for the objection is that
17 entire line of questioning seeks to elicit opinions. This is
18 a lay witness, not an expert witness. He's never been
19 designated as an expert, and he admitted so in his
20 cross-examination the following series of questions and
21 answers.

22 Question, are you familiar -- this is page 53
23 beginning line 9. Question, are you familiar with the
24 technical details of the LUN zoning feature? Answer, no. Are
25 you familiar with any of the code associated with the LUN

1 zoning feature? Answer, no. Are you familiar with the
2 function -- pardon? Are you familiar with the functionality
3 features? And it says functionality feature but what was said
4 was LUN zoning feature.

5 Question, Mr. Albright. Objection, leading. Answer,
6 no. And, again, I have never used it in a router, and to this
7 day at MacData, which is his present employer, I don't need to
8 use the LUN zoning feature in any of the product that was
9 there.

10 So this gentleman has no experience with this stuff at
11 all. He doesn't know anything about it. He was just --

12 THE COURT: Well, he's a salesman. I've read,
13 starting on page 4, all the way through to where you have
14 objected, and he's full of opinions as all salesmen are, but
15 none of them are admissible in my judgment, none, zero. I
16 wouldn't let any of the testimony of this gentleman in, but I
17 will sustain the objection to the opinion of black-and-white
18 color TVs.

19 If you'll hand that back to Mr. Albright. You may
20 make whatever record you want by bill, Mr. Albright. If
21 you're going to have opinions given, you've got to put them
22 down as an expert so that they can be tested. This person's
23 testing, he couldn't even get through a filter. All right.
24 Take five minutes.

25 (Recess.)

09/05/2001 Chaparral Trial - Day 2

1 THE COURT: All right. For the state of the record, I
2 only have one objection to the testimony and that objection is
3 sustained. Now, are you going to read the rest of it?

4 MR. ALBRIGHT: Not at this time, your Honor. We're
5 going to -- it causes some shifts --

6 THE COURT: That's fine. However you want to try it.
7 But on deposition, counsel, I appreciate getting it a little
8 in advance so that if I can read the transcript, it's helpful.
9 But sometimes you're just going to have to go ahead and start
10 reading the deposition and then, make your objections as we
11 go, because there are some facts in the testimony of this
12 gentleman Bleakley -- what an appropriate name -- from the
13 standpoint of facts.

14 He sold, he had trouble with his customers when none
15 was removed, but, you know, he can't testify they removed it
16 because of the lawsuit. He can't testify to all of these
17 opinions. But the fact of what happened, what he told the
18 company wouldn't be admissible.

19 And I could handle that on a question-and-answer basis
20 if -- but if you have a substantive issue, you better notify
21 me so that I can --

22 MR. ALBRIGHT: Your Honor, would you like a copy of
23 the deposition so you could follow along if it won't be
24 objected?

25 THE COURT: Are you going to do another deposition

1 now?

2 MR. ALBRIGHT: Yes, sir.

3 THE COURT: No. Just give me a heads up when you are
4 going to do that. All right. Bring the jury in.

5 (Jury present.)

6 THE COURT: Members of the jury, it occurred to me
7 when I took the break that I probably in my general remarks to
8 you at the beginning of the trial, I didn't talk to you about
9 bench conferences, and I need to do that.

10 The lawyers have the right to ask to approach, warn me
11 that there may be a train around the next turn that I need to
12 think about, but they're required to do that under the ethics
13 of the profession and representing their clients. And there's
14 only two ways for me to do that: One is for me to make you go
15 into the room and wait there and come out. Now, that may be
16 good exercise for you, but you'd be coming back and forth.

17 So we can do it up here. The Court Reporter has a
18 little microphone where she can hear everything and gets it on
19 the record. If you were thinking that Lily had mental
20 telepathy, it's not true, she's got electronics and so we can
21 save you time. That's what we're doing, but don't think
22 they're trying to hide anything. They're just trying to make
23 this as easy on you as possible and that's the reason we do
24 it. You may call your next witness.

25 MR. ALLCOCK: Thank you, your Honor. We would call to

09/05/2001 Chaparral Trial - Day 2

1 the stand Geoff Hoese.

2 THE COURT: If you'll be sworn, please, sir.

3 (Witness was sworn.)

4 THE COURT: Come around this little column and have a
5 seat, please, sir. And you need to tell us your full name and
6 spell your last.

7 THE WITNESS: Geoffrey Brian Hoese, H-O-E-S-E.

8 GEOFFRY B. HOESE, called by the Plaintiff, duly sworn.

9 DIRECT EXAMINATION

10 BY MR. ALLCOCK:

11 Q. Where do you live, Mr. Hoese?

12 A. I live in Austin.

13 Q. How long have you lived in Austin?

14 A. About 13 years.

15 Q. Have you ever worked for a company named Crossroads?

16 A. Yes.

17 Q. Over what time period did you work for the company named
18 Crossroads?

19 A. From the end of May 1996 through October of 2000.

20 Q. Let me hand you a notebook that has Exhibits 1, 4, 5 and 7
21 in it, and ask you to look at Exhibit 1. And, your Honor, I'm
22 putting the front page of Exhibit 1 on the screen for the
23 record.

24 THE COURT: Are these admitted already?

25 MR. ALLCOCK: Yes, all except for 7. There, I

1 believe, could be an objection to 7.

2 MR. BAHLER: There is.

3 THE COURT: All right.

4 Q. (BY MR. ALLCOCK) What is Exhibit 1?

5 A. It's a front page of U.S. patent.

6 Q. Are you the Geoff Hoese whose name appears on that patent?

7 A. I am.

8 Q. Who else is on there?

9 A. Jeffrey Russell.

10 Q. Two of you worked together on this?

11 A. Yes, we did.

12 Q. Could you tell the ladies and gentlemen of the jury just

13 briefly, basically, what you did on this invention and what

14 Mr. Russell did on the invention?

15 A. Well, we collaborated quite a bit on it in large part.

16 Mr. Russell was doing a good bit of the hardware design

17 involved, and I did a lot of the software, other architectural

18 pieces. Over the large part, there was a fair amount of

19 collaboration.

20 THE COURT: Now, you have a very soft voice, and these

21 two folks over there can't any more hear you than they can

22 know that the sun is out. So speak up under the microphone.

23 THE WITNESS: I will.

24 Q. (BY MR. ALLCOCK) Maybe you could get the mic a little

25 closer to you.

1 A. Do I need to repeat that?

2 Q. You can put that down. We'll get back to that in a
3 minute. What did you do? What was your job when you first
4 started at Crossroads in May of 1996?

5 A. When I first started at Crossroads, I was mainly involved
6 in trying to find areas to do products to provide connectivity
7 between Fibre Channel devices and storage devices.

8 Q. Did you have any experience in that kind of work before
9 you came to Crossroads?

10 A. Well, I had a fair amount of storage experience at
11 different companies and, also, working in networking industry
12 and development roles of previous companies and management
13 roles.

14 Q. Could you give the ladies and gentlemen of the jury a
15 little bit of an idea of the kinds of companies you worked for
16 and the kinds of things you did prior to Crossroads?

17 A. Immediately before coming to Crossroads, I managed the
18 network device driver development group at Compaq. Had spent
19 a couple of years there through their acquisition of Thomas
20 Conrad Corporation, where I did the same thing, managed the
21 development group, and was involved in development of device
22 drivers and software runs the network, adapters.

23 Q. Let me stop you right there. A device driver, is that
24 software?

25 A. Yes, it is.

09/05/2001 Chaparral Trial - Day 2

1 Q. And what does it do?

2 A. It interfaces the operating system to the external storage
3 devices or network devices as the case may be.

4 Q. And you said you ran a group?

5 A. Yes, I managed the group who did the development of those
6 device drivers.

7 Q. Okay. What did you do before that, sir?

8 A. I was with IBM in a variety of roles, mainly involved in
9 development of storage and networking software.

10 Q. Okay. And did you work in this storage area anywhere
11 before that?

12 A. Dell Computer Corporation prior to that, was involved in
13 various aspects of storage RAID devices, RAID controllers,
14 developing -- as a software developer, developing those sorts
15 of products.

16 Q. Okay. You're going to have to keep your voice up. What
17 is your educational background?

18 A. I was a philosophy major in school. I did not complete a
19 degree.

20 Q. Where did you go to school?

21 A. University of Southwestern Louisiana, which is now
22 University of Louisiana, Lafayette, and briefly at the
23 Louisiana State University.

24 Q. You say you were a philosophy major. When did you first
25 start writing software?

09/05/2001 Chaparral Trial - Day 2

1 A. I wrote my first software when I was in high school in the
2 mid-to-late '70s.

3 Q. How many other patents are issued to you other than the
4 972 patent, which is Exhibit 1?

5 A. I have five patents.

6 Q. What do you do now?

7 A. I worked in a technical advisory role as just a -- kind of
8 a consulting arrangement with start-up here in town. I have
9 some other involvement with other start-ups and am looking at
10 other roles that I may do in the future.

11 Q. Why did you leave Crossroads?

12 A. I spent a number of years there, you know, four years or
13 more working really hard, developing products, development
14 company, had a lot of time and effort I put into it and was
15 ready to take a break and look for something new to do.

16 Q. Okay. Can you explain your invention of the 972 patent
17 invention in your own words, sir?

18 A. The invention provides a method for connecting computers
19 to storage devices, providing that connectivity, the ability
20 to map storage between different devices, providing virtual
21 local storage and security management capabilities for those
22 devices.

23 Q. Well, what was the state-of-the-art at the time that you
24 came up with your invention? How were people doing that sort
25 of thing?

09/05/2001 Chaparral Trial - Day 2

1 A. Primarily through the use of network servers.

2 Q. Okay. Let me place before you Exhibit 537 and some --
3 it's a demonstrative that has not been objected to, your
4 Honor. Would this help in explaining what the
5 state-of-the-art was when you came up with your invention?

6 A. Sure. This diagram shows a network server connecting
7 multiple computers to multiple storage devices.

8 Q. Okay. I notice on the left, it's Fibre Channel. What is
9 that?

10 A. Fibre Channel is a serial transport medium, can carry
11 various protocols, storage data, network data at a high speed
12 interconnection between computers.

13 Q. And I notice it says S-C-S-I. Is that SCSI on the other
14 side?

15 A. That's correct.

16 Q. What is that?

17 A. SCSI is the -- a bus interconnect to connect storage
18 devices together, connecting storage devices to hosts, to
19 computers.

20 Q. And is that different than Fibre Channel?

21 A. Yes, it is.

22 Q. Now, what was the problem with the setup shown on Exhibit
23 537 as you saw it?

24 A. Well, the main problem is the network server is expensive
25 to maintain, it has various bottlenecks in transferring data

1 between these things, has to go through a lot of effort to
2 translate the data requests, get the data from one side to the
3 other.

4 Q. Okay. Let me show you Exhibit 567 again -- wrong one.
5 Exhibit 567 again, unobjected to demonstrative. What is this
6 bottleneck that you're talking about?

7 A. Well, what this shows is a network request coming from the
8 left side, all the computers would be hooked up here, putting
9 all these data requests into a network server. The network
10 server has to process those from higher level network
11 protocols to a more intrinsic method.

12 It has to translate them through a file system to
13 represent the data on the storage medium, then it has to send
14 those requests out after it's translated in the file system to
15 the storage devices to get the data, bring that data back, and
16 go through a reverse process of rebuilding those network
17 protocols to send the data back out. So that takes a lot of
18 time.

19 Q. So how did your invention improve on this basic situation?

20 A. Well, using the invention in this role, you basically have
21 the computers on the one side speaking their native low-level
22 block protocols that they communicate with to storage devices,
23 routing those through a storage router, and connecting those
24 devices to the actual storage without having to do the
25 translation from the -- through the network protocols or

1 translation through the file system.

2 Q. You mentioned a storage router. What is a router?

3 A. Router is the device that interconnects multiple
4 interfaces and sends that data according to mapping tables, to
5 different devices.

6 Q. And how is that different than a server?

7 A. Well, a server primarily can -- provides connection point
8 for multiple computers and represents the data locally. The
9 device is locally rather than passing that data directly
10 through, and so, it provides that interconnect point in such a
11 fashion that the -- it manages all those connections.

12 It manages the data as it appears there on the
13 computer, and it has to -- it has a file system that it has to
14 layer above the storage devices. It has the network
15 protocols, so it does a lot of protocol translation. So it's
16 providing the protocol translation between the similar devices
17 as well as the data representation through the file system
18 that's different.

19 Q. Okay. Let me show you Exhibit 545, graphics Exhibit 545.
20 And using that, can you explain the basic difference between a
21 router and a server?

22 A. Well, here we have all the computers, again, on the other
23 side connected by Fibre Channel to the router. The storage
24 devices on the right-hand side. When these computers, want to
25 talk to data, they're speaking -- they're seeing those devices

1 as storage devices directly.

2 They're not -- they're having to talk the same
3 protocol, they're not having to go through a different
4 protocol translation to talk to these devices. They're also
5 seeing that data represented directly. They're not seeing it
6 represented through a file system.

7 So when computer A wants to talk to device A and get
8 that data, he is reading and writing that data directly to
9 that device through the router, and the router handles the
10 interconnect to that device, but it doesn't have to do any
11 protocol translations or file system translations.

12 Q. So in the case of a router, there isn't that pileup that
13 occurs, it just kind of passes directly through; is that
14 right?

15 A. Correct.

16 Q. Now, is this your whole invention here?

17 A. No, it is not.

18 Q. What more did you do?

19 A. Well, the invention incorporates virtual local storage and
20 access controls that provide for the capability for the router
21 to virtually map the different storage devices to different
22 computing devices so that access can be controlled, visibility
23 of devices can be controlled differently for different
24 computers.

25 Q. What do you mean by access controls?

09/05/2001 Chaparral Trial - Day 2

1 A. Access controls in this sense, really, are the ability to
2 see a device to know whether it's there, to read, write or
3 modify data on that device to perform manipulation on that
4 device by a computer.

5 Q. What do you mean by virtual local storage?

6 A. Virtual local storage refers to in that the computers are
7 connected to the storage devices, and seeing that represented
8 in their native protocol, they see those devices. And through
9 the mapping and access control, they can see different devices
10 as though they are the devices that are local to the computer.

11 You have your hard drive in your computer, your
12 computer sees it as drive C, for example, the -- you know,
13 that your local drive, with the access controls in the router,
14 we can map the different drives to the different computers so
15 that they appear to be as that local storage differently to
16 the different computers.

17 Q. So then, with your invention that computer A would look at
18 that remote storage A and see it just as if it was in the box?

19 A. Yes.

20 Q. Let me show you exhibit -- graphics Exhibit 580. And
21 perhaps you could come down and explain to the ladies and
22 gentlemen of the jury, in more detail, this concept of access
23 controls.

24 A. Okay. What we have here are two computers and three
25 storage devices. These two computers are talking to the

09/05/2001 Chaparral Trial - Day 2

1 router, seeing the storage through the router, this map
2 through the router. In this case, drive A can see drives one
3 and drive three. He can't see drive two access control and
4 map so that this drive doesn't exist as far as A's concerned,
5 doesn't know it's there, can't see it, can't read or write to
6 it, doesn't know it exists.

7 Drive B, on the other hand, sees one and two, but not
8 three. So from drive A's perspective, this might be the C
9 drive, this might be the D drive.

10 Q. I think you said one and two. Did you mean to say one and
11 three?

12 A. Yes, I did. I'm sorry. One and three.

13 Q. For the record.

14 A. Drive B, on the other hand, would see this as a C drive
15 and this as the D drive. So they'd have common access to this
16 one drive, but this computer went to see X. The data,
17 wouldn't know the drive was there, wouldn't know the data was
18 there whatsoever.

19 Q. Okay. Stay right there. Let me place before you Exhibit
20 590, which is figure 3 of the patent with some color applied.
21 Could you explain your invention with respect to Exhibit 590?

22 A. Very similar drawing in concept, a little more schematic,
23 you know, technical drawing in that sense, but it shows
24 multiple computers connected to multiple storage. It
25 additionally shows that its storage device can have some

09/05/2001 Chaparral Trial - Day 2

1 subsection of storage. It can also leave out. So we can have
2 a storage device that is global to all these computers.

3 We can have restrictions such that only one or some
4 number of computers can have access to that storage. And we
5 can parse it out differently for different computers and
6 within the subsections of the storage device in the computers.

7 Q. We've heard the term LUN. What is a LUN?

8 A. A LUN is a term for a logical unit, which is the smallest
9 addressable unit in the storage device.

10 Q. Can you -- does this LUN concept have anything to do with
11 access controls?

12 A. Well, it is the base unit of access control that can be
13 allocated. So when a computer wants to talk to a storage
14 device, it can talk to a disk drive or that disk drive could
15 have multiple logical units within it, and those logical units
16 can be addressed separately. So the access control can apply
17 to the different logical units, or it can apply to the whole
18 storage device itself.

19 Q. So you -- and, again, this is for the record -- you
20 pointed to that kind of tower 62. Are there any LUNs in that
21 tower 62?

22 A. Right. The different elements A, B, C and D, listed in
23 62, represent the logical units in a single storage device.

24 Q. I see. And is there any other LUN shown on there?

25 A. Well, the global data represented in 60 and 64 in the

1 storage device as a whole is addressed as a logical unit.

2 It's not demonstrated here that that's broken out because of

3 the intent of the drawing was to show that you could address

4 it both by the logical units or by the whole thing.

5 Q. You can have a seat. So what's the basic advantage of

6 this over what came before?

7 A. Well, primarily, it's faster. It provides the -- a

8 similar set of capabilities that the network server will

9 provide without a lot of the overplay. So it's easier to

10 manage, in some respects. It's just better performance. It's

11 faster, cheaper.

12 Q. When did you invent this?

13 A. In March of '97.

14 Q. Can you turn to Exhibit 7. What is Exhibit 7?

15 A. Exhibit 7 is a concept document that I faxed to our patent

16 attorney at the time.

17 MR. BAHLER: Objection, your Honor. This is an

18 exhibit that is not yet in evidence.

19 THE COURT: He's just describing it. He hadn't

20 moved --

21 MR. BAHLER: He's getting into it a little bit more.

22 He's talking about the contents.

23 MR. ALLCOCK: I'm just going to ask foundational

24 questions.

25 THE COURT: All right.

09/05/2001 Chaparral Trial - Day 2

- 1 Q. (BY MR. ALLCOCK) So the cover is a fax page; is that
2 right?
- 3 A. That's correct.
- 4 Q. And is that in your handwriting?
- 5 A. Yes, it is.
- 6 Q. And it's to who?
- 7 A. To Anthony Peterman, who was a patent attorney working for
8 us at Crossroads.
- 9 Q. And it's from who?
- 10 A. From myself.
- 11 Q. Okay. And it's got his fax number on it?
- 12 A. Yes, it does.
- 13 Q. And it's got your phone number on it?
- 14 A. Yes, it does.
- 15 Q. And it's -- what's the date on the document?
- 16 A. 5-28-97.
- 17 Q. So did you fax this to Mr. Peterman on or about that day?
- 18 A. Yes, I did.
- 19 Q. And then, pages -- the next two pages of the document,
20 what are those?
- 21 A. Those are descriptions and drawings of the invention and
22 some of the state-of-the-art before the invention.
- 23 Q. And did you create those in your own hand?
- 24 A. Yes, I did.
- 25 Q. And was this done in the ordinary course of your business

09/05/2001 Chaparral Trial - Day 2

1 at Crossroads?

2 A. Yes.

3 Q. Offer Exhibit 7 in evidence, your Honor.

4 MR. BAHLER: Your Honor, may I ask one question on
5 voir dire?

6 THE COURT: You may.

7 VOIR DIRE EXAMINATION

8 BY MR. BAHLER:

9 Q. Mr. Hoese, does the fax machine at Crossroads put little
10 date lines at the top of faxes so you can tell when they're
11 faxed?

12 A. I believe most fax machines do that on the sent copy of
13 the fax, you know, on the recipient side, yeah.

14 Q. All right. And this is all in your handwriting, right?

15 A. Yes.

16 Q. You prepared this whole thing?

17 A. What it's typed with.

18 Q. And you prepared this whole thing?

19 A. Yes, I did.

20 Q. Did you fax it personally to Mr. Peterman?

21 A. I believe I did, yes.

22 MR. BAHLER: Your Honor, we have a relevance
23 objection. May we approach?

24 THE COURT: You may.

25 (At the Bench, on the record.)

1 MR. BAHLER: Your Honor, this is the conception
2 document. Conception requires not only that it be produced in
3 writing, but it be communicated to somebody else, and that
4 requires corroboration, also. Simply inventor testimony is
5 insufficient to make this document relevant for any purpose.

6 He's testified that he personally did it. That's not
7 good enough. That's not corroboration in accordance with the
8 law. And this document cannot possibly stand as a conception
9 document under any interpretation of the law, and therefore,
10 it's irrelevant to any issue in this case.

11 THE COURT: Well, that would be absurd law if that was
12 the law. Recipient could die, could never die. This witness'
13 credibility is in issue, but not the admissibility. So it is
14 admitted without -- overruled.

15 MR. BAHLER: Thank you, your Honor.

16 DIRECT EXAMINATION (Resumed)

17 BY MR. ALLCOCK:

18 Q. So referring, first, to the first page of the exhibit,
19 that's just a fax cover sheet that shows that you faxed it to
20 Peterman?

21 A. Yes.

22 Q. And he was the patent lawyer you were working with?

23 A. Correct.

24 Q. Okay. Then, on the next page, what is that generally
25 describing? I'm not going to go through it line-by-line.

09/05/2001 Chaparral Trial - Day 2

1 What is that generally describing?

2 A. The text basically describes state of what was available
3 at that point in time, what the -- the context of the problem
4 being addressed and the essentials of the concept, the
5 invention as a concept here, describes essentially what the
6 invention would do.

7 Q. Okay. I see down on the bottom, there's a block diagram.
8 Is that similar to one of the graphics that we looked at
9 earlier today?

10 A. It would be. It basically shows workstations connected
11 through a network server to storage devices.

12 Q. Okay. So you have four workstations and three remote
13 storage devices?

14 A. Correct.

15 Q. Is that black bar going through the middle, that's a Fibre
16 Channel?

17 A. It could be Fibre Channel, it could be an Ethernet
18 network. It's basically some network, a local area network
19 interconnecting the computers together.

20 Q. Okay. Now, looking at the next page, there are two
21 pictures on the next page. What is the top picture?

22 A. The top picture shows a storage router as opposed to the
23 network server interconnecting computers to storage devices.

24 Q. Okay. Now, does this show your invention?

25 A. No, it doesn't.

09/05/2001 Chaparral Trial - Day 2

1 Q. Is this similar to a graphic that we saw earlier today?

2 A. Sure. That's -- it's similar in that -- it's dissimilar
3 in that it shows by direction connections. It shows clients
4 on both sides of the storage router and storage on both sides
5 of the routers, but similar in that, it shows workstations
6 connected through the storage router to storage devices.

7 Q. So you have workstations and a storage router but no
8 access controls?

9 A. Correct.

10 Q. Okay. Now, the -- and why did you put this figure in
11 there? Why did you put drawing 2 in there?

12 A. It shows the state-of-the-art at the time.

13 Q. Okay. And now, finally to figure 3, which bears a
14 remarkable resemblance to figure 3 of the patent, what is that
15 depicting?

16 A. That depicts the invention which is the storage router
17 interconnecting the devices and incorporating these access
18 controls routing the virtual local storage.

19 Q. Now, I notice on the bottom, it says concept by Geoff
20 Hoese, March 22, 1997, first draft, May 15, 1997. Do you see
21 that?

22 A. Yes, I do.

23 Q. Did you write that?

24 A. Yes, I did.

25 Q. What does that mean?

09/05/2001 Chaparral Trial - Day 2

1 A. I had the idea, you know, the consolidated concept of
2 integrating these access controls with a storage router to
3 provide this type of alternative to the network server. It
4 occurred to me, came to me on the 22nd, it was a -- I
5 recognized it as a good enough idea that I immediately started
6 working on putting the concept together further and expressing
7 it --

8 Q. So it was a big moment?

9 A. Yeah.

10 Q. And so then, it took you a little while to write it up?

11 A. Yes.

12 Q. Okay. Could you look at Exhibits 4 and 5? What is
13 Exhibit 4?

14 A. Exhibit 4 is a presentation, a set of slides giving an
15 overview of Verrazano Fibre Channel-to-SCSI bridge concept.

16 Q. Who prepared these?

17 A. I believe I did for the most part.

18 Q. And approximately when were they prepared?

19 A. They're dated 6-19-96. It's probably accurate.

20 Q. Generally what do they show?

21 A. They show a Fibre Channel-to-SCSI bridge which provides
22 the basic connectivity between storage and host computers.
23 Doesn't necessarily provide for any kind of routing or access
24 control.

25 Q. Okay. You hadn't come up with that idea yet?

1 A. Correct.

2 Q. And then, if you look at Exhibit 5 -- look at page 2 of
3 Exhibit 5. What does that show?

4 A. Exhibit 5 is a document describing, again, the Verrazano
5 bridge characteristics, the -- it's an architecture document
6 that describes some of the characteristics we would look for
7 in designing a bridge product of this sort.

8 Q. And so, you were working on all aspects of this router in
9 this '96-'97 time frame; is that fair to say?

10 A. Yes, it is.

11 MR. BAHLER: Leading.

12 THE COURT: It is.

13 Q. (BY MR. ALLCOCK) What else were you working on other than
14 the access control feature in the '96-'97 time frame?

15 A. I was working on designing routers and bridges in detail
16 storage routers.

17 Q. You can put that down. We're going to switch topics. Did
18 any Crossroads product that was in place when you were at
19 Crossroads use the 972 invention?

20 A. No, it did not.

21 MR. BAHLER: Objection. Foundation.

22 (Last question read back.)

23 THE COURT: The objection's overruled.

24 A. No, it did not.

25 Q. (BY MR. ALLCOCK) Why not?

09/05/2001 Chaparral Trial - Day 2

1 A. We were a small, busy, growing company, trying to develop
2 these products. This was a more advanced feature of -- that
3 would be added into the product line, so we were getting our
4 core set of features in place, developing, you know, the core
5 essentials of the bridge router products, and so, we didn't
6 have necessarily the bandwidth to go do everything that we
7 wanted to do.

8 Q. Bandwidth means manpower?

9 A. Correct.

10 Q. And was there intent to put it in the product?

11 A. I think there -- I would have liked it in the product.
12 There was a general desire to get it there, but as far as
13 there being a broad overall intent, I'm not sure what that
14 really means.

15 Q. Did the Crossroads products -- how many other patents do
16 you have?

17 A. Five.

18 Q. Now, were you aware that any Crossroads products were
19 marked with this 972 patent number?

20 A. I became aware of that in the course of the depositions,
21 right.

22 Q. Did you know it while you worked there?

23 A. No, I did not.

24 Q. Was that right? Did the products have your invention in
25 it?

09/05/2001 Chaparral Trial - Day 2

1 A. No, they didn't.

2 Q. Did you have anything to do with putting that number on?

3 A. No, I didn't.

4 Q. Okay. Could you turn back to Exhibit 1 and, in
5 particular, figure 3. I'm just going to put that in the
6 background for a minute.

7 Did you attend Comdex in 1996 on behalf of Crossroads?

8 A. Yes, I did.

9 Q. What was shown at that -- at Comdex?

10 A. We had a technology demonstration showing connectivity
11 between a single computer and a single storage device.

12 Q. Did that have anything to do with your invention as shown
13 in figure 3?

14 A. No.

15 Q. Why not?

16 A. It didn't provide any routing. It was connectivity
17 between a single computer and a single storage device. Had no
18 routing, had no access controls, had no mapping.

19 Q. Had you even thought of access controls by the time of the
20 Comdex?

21 A. No, not at all.

22 Q. Now, had you heard of this HP Mux prior to your coming up
23 with your invention?

24 A. Yes, I did.

25 Q. What was your understanding of what that thing did?

09/05/2001 Chaparral Trial - Day 2

1 A. Well, it was a Mux. It was a multiplexer. It provided
2 connectivity between Fibre Channel hosts and storage devices.
3 It did so without mapping. It did so without access controls.

4 Q. Did that have anything to do with your invention?

5 A. No, it did not.

6 Q. If you flip up to figure 2, what is figure 2?

7 A. Figure 2 shows the storage router providing connectivity
8 between storage and computers as the previous document we
9 looked at, previous drawing we looked at.

10 Q. Was that your best understanding of the state-of-the-art
11 at the time?

12 A. Correct. That was the state-of-the-art prior to the
13 invention.

14 Q. Now, was this HP Mux closer to your invention than figure
15 2 or further away?

16 A. It was further away. It did not do what is described in
17 this diagram. It had less functional characteristics than the
18 diagram exhibits.

19 Q. How about the thing you showed at Comdex?

20 A. Much less.

21 Q. In your mind, Mr. Hoese, with reference to figure 3,
22 what's the significance of your invention?

23 A. Well, it provides these capabilities of access control,
24 virtual local storage that allows a network server essentially
25 to be replaced with a storage router.

09/05/2001 Chaparral Trial - Day 2

1 MR. ALLCOCK: I have no further questions of the
2 witness at this time, your Honor. Your Honor, for the record,
3 Exhibit 7 was admitted?

4 THE COURT: It's in evidence.

5 CROSS-EXAMINATION

6 BY MR. BAHLER:

7 Q. Mr. Hoese, let's go back to your patent just a second.
8 Let's take a look at -- I have up on the screen Defendant's
9 Exhibit 1, but it's the same as Plaintiff's Exhibit 1. So if
10 you have Plaintiff's Exhibit 1 there in front of you, that
11 will be fine for these purposes.

12 You just finished talking about figure 2, right?

13 A. Correct.

14 Q. And that's not your invention, right?

15 A. No, it isn't.

16 Q. That's in your opinion the state-of-the-art, right?

17 A. That's correct.

18 Q. Okay. Take a look at column three in your patent. And
19 there, beginning right about here, it starts a description of
20 figure 2, right?

21 A. Correct.

22 Q. Let me pull it out a little bit more. It says figure 2 is
23 a block diagram of one embodiment of a storage router
24 indicated generally and it continues, right, sir?

25 A. Correct.

1 Q. Back up just a second to the previous page. And you're
2 talking about brief description of the drawings, right?

3 A. Okay.

4 Q. You refer to figure 1 and you refer to figure 1 is a block
5 diagram of a conventional network that provides a storage
6 through a network server, right? That's how you characterized
7 figure 1, right, sir?

8 A. Uh-huh.

9 Q. And figure 2, you said figure 2 is a block diagram of one
10 embodiment of a storage router --

11 THE COURT: You keep saying "storage router," but it
12 says "storage network."

13 MR. BAHLER: You're right.

14 Q. (BY MR. BAHLER) Figure 2 is a block diagram of one
15 embodiment with a storage network that provides global access
16 and routing. That's what you told the Patent Office?

17 A. That's what it says.

18 Q. You didn't tell the Patent Office that figure 2 was
19 state-of-the-art, did you, sir?

20 A. I think that's implicit in the descriptions.

21 Q. You didn't call it conventional like you called figure 1,
22 did you, sir?

23 A. That's not the language that's there, no.

24 Q. They're just supposed to know that?

25 A. I think it's implicit in the text.

1 Q. Now, figure 3 is -- you describe figure 3, and that's what
2 in your opinion shows your invention, right?

3 A. That's correct.

4 Q. And you described figure 3, you say figure 3 is a block
5 diagram of one embodiment of a storage network with a storage
6 router that provides virtual local storage, right, sir?

7 A. Correct.

8 Q. You use similar language to the language you used to
9 describe figure 2, right?

10 A. I don't think it's apparently similar language. It shows
11 it provides additional capabilities.

12 Q. Well, the first ten words or so are exactly the same,
13 right?

14 A. Sure, yes.

15 Q. So when you're describing your invention with respect to
16 figure 3, you use exactly the same language to describe, at
17 least for the first ten words or so, to describe figure 2,
18 right?

19 A. As well as figure 1.

20 Q. And in your opinion, the Patent Office was supposed to
21 know that figure 2 was a state-of-the-art and was not your
22 invention, right?

23 A. Absolutely.

24 Q. Okay. Turn back to figure -- column 3, sir. And we just
25 talked a little bit about the beginning of the description of

1 figure 2, and then, it just -- the description continues down.
2 And in this vicinity -- and this is column 3, line about 45,
3 starting line about 45 -- it says, in storage network 30, any
4 workstation 36 or workstation 40 can access any storage device
5 or storage device 38 or storage device 42 through native
6 low-level block protocols and vice versa. That's how you
7 described figure 2, right?

8 A. Yes.

9 Q. And that's not your invention, is it, sir?

10 A. No, it is not.

11 Q. Okay. And then, you continued by saying the functionality
12 is enabled by the storage router 44 which routes requests and
13 data as a generic transport between Fibre Channel 32 and SCSI
14 bus 34. And it continues: Storage router 44 uses tables to
15 map devices from one medium to the other, et cetera, see that?

16 MR. ALLCOCK: Objection, your Honor. I believe that
17 misquotes the text. It says without any security access
18 controls. I think counsel possibly, unintentionally, skipped
19 over that.

20 Q. (BY MR. BAHLER) Well, Mr. Hoese, the point is, that
21 describes something that's not your invention either, right?

22 A. Correct.

23 Q. So something that routes using native low-level block
24 protocols and it maps between Fibre Channel hosts and SCSI
25 storage device, that's not your invention, is it, sir?

09/05/2001 Chaparral Trial - Day 2

1 A. Can you re -- can you say that again, please? I didn't
2 quite follow you.

3 Q. Figure -- well, figure 2 is not your invention, right,
4 sir?

5 A. Figure 2 is not my invention.

6 Q. And this description is in reference to figure 2, and this
7 description mentions native low-level block protocols and
8 mentions mapping, and you say figure 2 is not your invention?

9 A. That's correct.

10 Q. Okay. Please turn back to figures, particularly figure 5.
11 All right. Now, you mentioned -- well, first of all, figure 5
12 describes the router which is your invention, right?

13 A. Elements thereof.

14 Q. All right. Describes the hardware elements of your
15 invention, right?

16 A. Some of them.

17 Q. And included in there is a Fibre Channel controller,
18 right?

19 A. Correct.

20 Q. And, also, SCSI controller, right?

21 A. Correct.

22 Q. And supervisor unit which is a microprocessor, correct,
23 sir?

24 A. It very well could be, yes.

25 Q. And a buffer which is done at the bottom, right, sir?

09/05/2001 Chaparral Trial - Day 2

1 A. Yes.

2 Q. Now, you talked, a minute ago, with Mr. Allcock about the
3 Comdex show in 1996, right?

4 A. Yes.

5 Q. And that show had a box which is a mock-up of the 4100 box
6 sitting on a table, and it has cables coming out of that box
7 to a PC that was under the table, right?

8 A. I would not describe that as a mock-up of the 4100
9 product.

10 Q. But it had a box under the table and it has wires coming
11 out of the PC that was on the floor, right?

12 A. It had a PC interconnected to another PC, as I recall,
13 with external storage device connected to that, to the best of
14 my recollection.

15 Q. All right. Well, the one PC was a Fibre Channel host
16 acting as a Fibre Channel host, right?

17 A. I believe so.

18 Q. And the other PC was acting as the technology
19 demonstration for the router product, right, sir?

20 A. Yeah, it was acting as a technology demonstration for
21 connectivity to storage. I wouldn't say it was a router.

22 Q. Okay. All right. Well, in that technology demonstration,
23 there was a supervisor unit?

24 A. There was a processor, yeah, I don't know if that would be
25 characterized as a supervisor unit.

09/05/2001 Chaparral Trial - Day 2

- 1 Q. There was a microprocessor, right?
- 2 A. Yes, it was a PC.
- 3 Q. And on this figure, the supervisor unit is a
4 microprocessor, right?
- 5 A. Sure.
- 6 Q. And in that box, at Comdex '96 there was a Fibre Channel
7 controller?
- 8 A. Yes, there was.
- 9 Q. In fact, it was a Fibre Channel controller that Crossroads
10 had purchased from Hewlett Packard, right?
- 11 A. It was a Hewlett Packard controller. I don't know where
12 it was purchased.
- 13 Q. Okay. Hewlett Packard Tachyon controller, right?
- 14 A. I believe so.
- 15 Q. And you're familiar with the inside of that controller,
16 right?
- 17 A. I was at the time to some level.
- 18 Q. Okay. And inside that controller there was a first in,
19 first out memory, right?
- 20 A. I believe so.
- 21 Q. Just like shown in figure 5 of your patent, right?
- 22 A. Yeah.
- 23 Q. And there was a Fibre Channel protocol unit, right?
- 24 A. I believe so, yes.
- 25 Q. And just like shown in figure 5 of your patent, right?

1 A. Sure, yes.

2 Q. And there was a DMA, which stands for direct memory access
3 interface, in that, also, right?

4 A. I believe so.

5 Q. And that was all in the box that you had on -- at the
6 technology demonstration at Comdex '96, right?

7 A. Those are the basic components of the Tachyon controller,
8 yes.

9 Q. And also in that technology demonstration at Comdex '96
10 there was a SCSI controller, right, sir?

11 A. Yes, there was.

12 Q. And in that SCSI controller, there was a SCSI controller
13 that was purchased from Symbios Logic, right?

14 A. I believe so.

15 Q. That was the manufacturer, right?

16 A. Correct.

17 Q. And inside that SCSI controller there was a buffer, right?

18 A. Yes, there was.

19 Q. And that was in the SCSI controller in the box at Comdex
20 '96?

21 A. That is the basic component of the Symbios controller.

22 Q. And, also, there was a SCSI protocol unit, right?

23 A. Yes, there is.

24 Q. And there was a DMA interface in that chip in the box at
25 the technology demonstration at Comdex '96, right?

1 A. Yes.

2 Q. And also in that box was a buffer memory, right?

3 A. Correct, there was a buffer memory.

4 Q. And that's just like shown in figure 5, right?

5 A. Yes, it is.

6 Q. And the components that were in that technology
7 demonstration at Comdex '96 were hooked up just like you're
8 seeing in figure 5 of your patent?

9 A. These components. I would say that's a fair description
10 of how they were.

11 Q. All right, sir. Take a look at columns 4, 5 and 6 of your
12 patent. What I ended up doing here is I have the bottom of
13 column 5 and the top of column 6 --

14 MR. ALLCOCK: Your Honor, for the record, if we could
15 just have the line numbers, it might help if anybody reads
16 this later on.

17 MR. BAHLER: That's correct. It's column 5, line 63
18 through column 6, about line 7 or so.

19 Q. (BY MR. BAHLER) And, first of all, for context, Mr. Hoese,
20 in this portion of your patent, you're describing the details
21 that are in figure 3, right?

22 A. I don't know if that's the specific reference that these
23 are attributed to.

24 Q. Well, you're referring to -- actually, this is describing
25 figure 5, but you're referring -- figure 5 is presented in

09/05/2001 Chaparral Trial - Day 2

1 your patent at least as being part of figure 3, which is your
2 invention, right, sir?

3 A. I believe so, yes.

4 Q. And you told the Patent Office that one implementation of
5 that router includes the Hewlett Packard Tachyon chip, right?

6 A. Yeah.

7 Q. And that would be the Fibre Channel controller, right?

8 A. Yes.

9 Q. That's the same, exact chip that was in the technology
10 demonstration at Comdex 1996, right?

11 A. It may have been in a different step, but it was a very
12 similar chip.

13 Q. And can you tell the Patent Office the router, according
14 to your invention, includes the Intel i960 RP Microprocessor,
15 right?

16 A. Yes.

17 Q. And that's the supervising unit that's used in your
18 invention, at least that's what you told the Patent Office?

19 A. I think that's there.

20 Q. There was the Intel i960 processor in the technology
21 demonstration at Comdex '96, right?

22 A. I believe there was, yes.

23 Q. You also told the Patent Office that your invention
24 included the SCSI interface support fast 20 based on the
25 Symbios series of SCSI controllers, right? That's what you

09/05/2001 Chaparral Trial - Day 2

1 told the Patent Office was part of your router, right?

2 A. Correct --

3 Q. And that --

4 A. -- as it reads, yes.

5 Q. -- that, also, was the same chip that was in the

6 technology demonstration at Comdex 1996, right?

7 A. I believe so.

8 Q. All right. And just so we're clear about this technology

9 demonstration, Mr. Hoese, this box which connected to a Fibre

10 Channel host, right, sir?

11 A. It was connected to the computer with Fibre Channel --

12 Q. Okay. There was a Fibre Channel interface going to the

13 box, and that connected to this Fibre Channel controller in

14 the box, right?

15 A. Yes.

16 Q. Okay. And then -- and then, on the other side, there was

17 connected to the SCSI controller was a SCSI bus, right?

18 A. Correct.

19 Q. And connected to that SCSI bus were SCSI storage devices,

20 right, sir?

21 A. That's correct.

22 Q. And the SCSI -- Fibre Channel host was requesting data

23 from the SCSI storage devices, and those requests were passed

24 through the router that was in the technology demonstration at

25 Comdex '96, right?

09/05/2001 Chaparral Trial - Day 2

1 A. I would say there was not a router in that demonstration.

2 Q. I understand. Let me rephrase the question, then. Passed
3 through the technology demonstration to get to the SCSI
4 storage device, right?

5 A. Right. The technology demonstration was the unit as
6 described with these interfaces for a read-and-write request
7 from that PC to -- to and from that storage device.

8 Q. Right. And the read request would say give me a picture,
9 you were showing a slide show, right?

10 A. Yeah. I don't recall.

11 Q. Okay. Well, whenever it was. You were sending read
12 requests, and they'd pass through your technology
13 demonstration and go to the SCSI storage devices, right?

14 A. That's correct.

15 Q. And then, the SCSI storage device would read the data and
16 send that data back through the technology demonstration to
17 the Fibre Channel host, right?

18 A. Correct.

19 Q. And that router -- I'm sorry. The technology
20 demonstration acted to connect those two things, the Fibre
21 Channel host and the SCSI storage device, so that they could
22 communicate with one another, right?

23 A. I would describe that as a simple bridge, yeah. Bridge
24 the operations between that host and that storage device.

25 Q. All right. Now, you also mentioned in your examination by

09/05/2001 Chaparral Trial - Day 2

1 Mr. Allcock, you mentioned the Hewlett Packard Mux, right, HP

2 Mux?

3 A. Well, he mentioned it. I didn't mention it, he did.

4 Q. Well, it was covered, right, sir?

5 A. Yes.

6 Q. And the Hewlett Packard Mux, that stands for multiplexor,
7 right?

8 A. Correct.

9 Q. And it connected to multiple Fibre Channel hosts to
10 multiple SCSI storage device, right?

11 A. That's correct.

12 Q. One on one side, one on the other, right?

13 A. Yes.

14 Q. Okay. And inside the Hewlett Packard Mux, there was a
15 Hewlett Packard Tachyon Fibre Channel controller, right?

16 A. That's correct.

17 Q. And there was a microprocessor in there, too, that
18 supervised the function of the Hewlett Packard Mux, right?

19 A. That's correct.

20 Q. And there was a buffer memory, correct, sir?

21 A. Yes, there was.

22 Q. And there was a SCSI controller in there, too, right?

23 A. Yes, there was.

24 Q. And that was also -- that was a Symbios controller, right?

25 A. I believe so.

1 Q. All right. And the multiple Fibre Channel hosts could
2 read and write data to and from the SCSI storage devices
3 through the Hewlett Packard Mux, correct?

4 A. The computers attached on the Fibre Channel side could
5 read and write data to the storage devices on the other side,
6 that's correct.

7 Q. All right. And that's mapping, right?

8 A. No, not necessarily.

9 Q. Let's take a look at Plaintiff's Exhibit 7, real quick.
10 And this is this document that you contend memorializes the
11 conception of your invention. First of all, Mr. Hoeser, this
12 document doesn't include any sort of fax indication line at
13 the top that it was actually faxed to anyone, does it, sir?

14 A. I think this would be the sent copy rather than the
15 received copy.

16 Q. The received copy was received by Crossroads' patent
17 lawyers at the time, right?

18 A. Correct.

19 Q. It was a fella named Anthony Peterman, right?

20 A. That's correct.

21 Q. And at the time Mr. Peterman was working for a firm called
22 Baker Botts, right?

23 A. That's correct.

24 Q. And, actually, the main contact at Baker Botts was a fella
25 named Bill Hulsey, right?

09/05/2001 Chaparral Trial - Day 2

1 A. Yes.

2 Q. And Mr. Hulsey sent -- has since left Baker Botts and went
3 to Gray Cary, correct --

4 A. I --

5 Q. -- after that time? After you were sending this fax, Mr.
6 Hulsey left Baker Botts and went to Gray Cary, right?

7 A. I believe so, yes.

8 Q. And he took the file with him, there, right?

9 A. I don't have any knowledge of that.

10 Q. Okay. And although we had some pretty complete document
11 requests, Mr. Hoese, we never got a copy of this fax that
12 showed that it was received by anybody, correct?

13 MR. ALLCOCK: Your Honor, lacks foundation. How does
14 this witness know?

15 THE COURT: He can so state if he doesn't know. Do
16 you know one way or the other?

17 THE WITNESS: I have no idea.

18 Q. (BY MR. BAHLER) All right. In your experience with
19 facsimile machines, the received copy would have this
20 information at the top, right?

21 A. In general, I think that's correct.

22 Q. Received on such and such a date from such and such a
23 phone number, right?

24 A. That's typical.

25 Q. Okay. Let's take a look at the last page, particularly

09/05/2001 Chaparral Trial - Day 2

1 this line, consent by Geoff Hoese, March 22nd, 1997, first
2 draft, May 15th, 1997.

3 Now, you didn't write anything down at all about your
4 invention in this access control invention that you say you
5 made until March 15th, 1997, right?

6 A. Until March 15th, I hadn't --

7 Q. I'm sorry, until May 15th, 1997, correct, sir?

8 A. I had likely taken some notes or drawings on my white
9 board, that sort of thing.

10 Q. Okay. White board, you'd erase it later?

11 A. Yeah.

12 Q. Okay. And, once again, if those notes were still in
13 existence, they would have been produced in this case?

14 A. I presume so.

15 Q. Okay. So you didn't write -- you didn't write this
16 document -- the first draft of this document until May 15th of
17 '97, right, sir?

18 A. Yeah, that's when I saved off a copy of it as it were in
19 Word.

20 Q. Okay. And even assuming that it was received, it could
21 not possibly have been received before you sent it, which is
22 May 28th, '97, right? Even assuming it was received by
23 someone, right?

24 A. I'm confident it was received by somebody on that day.

25 Q. Okay. And, Mr. Hoese, you mentioned this marking issue,

09/05/2001 Chaparral Trial - Day 2

1 no matter how in your opinion, the 4100 product doesn't
2 include in your invention, right?

3 A. Correct.

4 Q. Now, Mr. Middleton consulted with you or talked to you
5 before he made the decision to put the patent label on the
6 4100 product, correct?

7 A. I don't recall any specific discussions about that.

8 Q. So if he does recall, you have no capability of saying
9 he's wrong, right?

10 A. Again, I don't remember discussing in any specific
11 labeling of products of patents.

12 Q. Okay.

13 A. I do remember that, you know, at some point, we had some
14 general concept discussions, but nothing specific.

15 Q. And during the entire time you were at Crossroads until
16 when did you say, October of 2000?

17 A. That was when I left, at the end of October 2000.

18 Q. You never expressed to anybody that you didn't think that
19 the Crossroads products that were in production at that time
20 should have that label on it. You didn't tell anybody that
21 you didn't think that was correct, right?

22 MR. ALLCOCK: Lacks foundation, your Honor.

23 THE COURT: The objection is overruled. You may
24 answer.

25 A. Again, I don't recall specifically any discussion about

1 labeling on any specific products. I don't recall that I gave
2 that opinion or not.

3 Q. (BY MR. BAHLER) And, Mr. Hoese, you were still working at
4 Crossroads in July of 2000, right?

5 A. Correct.

6 Q. And were you aware that Chaparral, during this case, asked
7 Crossroads to identify the products that were covered by the
8 patent in this case? Were you aware of that that happened?

9 A. No.

10 Q. And were you aware that in response to that request,
11 Crossroads answered, quote, Crossroads is still investigating
12 its sales of products which incorporate the inventions of the
13 972 patent. That was July 2000. Were you aware of that, sir?

14 A. I don't recall that, no.

15 Q. Did anybody come to you, the inventor, to see whether or
16 not the products were covered by the patent in this case when
17 answering this question?

18 A. It's possible. I don't specifically recall any of that,
19 no.

20 Q. Pass the witness, your Honor.

21 THE COURT: Any further question?

22 MR. ALLCOCK: A couple, your Honor.

23 RE-DIRECT EXAMINATION

24 BY MR. ALLCOCK:

25 Q. When you left Crossroads, did you know that the product

1 was labeled?

2 A. No, I did not.

3 Q. If you could look at column 2, at lines 42 through 52, it
4 talks about figure 2 having global access and figure 3
5 describing a storage router. Do you see that?

6 A. Yes.

7 Q. Is it clear to you that figure 3 is your invention and
8 figure 2 isn't?

9 MR. BAHLER: Objection. Relevance.

10 THE COURT: That objection is overruled.

11 A. It is very clear to me that that is a difference, yes.

12 Q. (BY MR. ALLCOCK) Could you read to the ladies and
13 gentlemen of the jury the title of the patent?

14 A. Storage router and method for providing virtual local
15 storage.

16 Q. Look at figure 5, if you would. Now, you were asked some
17 questions about hardware. Without software, what does the
18 device shown in figure 5 do?

19 A. Nothing, absolutely nothing. It would be non-functional
20 completely without that software.

21 Q. So in order for this to operate according to your
22 invention, what does it need?

23 A. It needs a substantial amount of software.

24 Q. And none of that software was in existence at Comdex or
25 with this HP Mux?

09/05/2001 Chaparral Trial - Day 2

1 A. That's correct.

2 Q. No further questions, your Honor.

3 RE-CROSS EXAMINATION

4 BY MR. BAHLER:

5 Q. Mr. Hoese, you're not telling the members of this jury
6 that the technology demonstration at Comdex '96 show had no
7 software in it, are you?

8 A. I didn't make that statement.

9 Q. Okay. So the statement that you just said, none of this
10 software, none of it was in the Comdex 1996 show is an
11 exaggeration, right, sir?

12 A. I don't feel that I exaggerated, but software -- I mean,
13 you know, some software is similar, it's possible that, you
14 know, some elements of a driver were similar between what
15 would be required for the invention. However, the software
16 required for the invention absolutely was not in the Comdex
17 technology demonstration.

18 Q. Software included in the Comdex 1996 show, at the very
19 least, included software that permitted Fibre Channel hosts to
20 communicate, to read and write data to SCSI storage devices,
21 right?

22 A. That is not necessarily the software. That software does
23 not enable the invention.

24 Q. That was in there, though, right?

25 A. Sure. There is software to do that. It was different

09/05/2001 Chaparral Trial - Day 2

1 software and would be -- may be required to implement the
2 invention. There was software that did that, though.

3 Q. So there was software in that prototype, right?

4 A. There was software in the prototype, yes.

5 Q. And, in fact, the prototype was working with native
6 low-level block protocols, too, right?

7 A. Yes, they use SCSI which is the name of the low-level
8 block protocol.

9 Q. Let me show you what's marked as Defendant's Exhibit 10.
10 Now, this is a declaration that you signed and was filed in
11 the Patent Office, right?

12 MR. ALLCOCK: Objection, your Honor. Beyond the scope
13 of my redirect.

14 THE COURT: It is. Sustain the objection.

15 Q. (BY MR. BAHLER) All right. Pass the witness.

16 THE COURT: May this witness be excused?

17 MR. ALLCOCK: He may, your Honor, subject to recall.

18 THE COURT: It will be up to the lawyers contacting
19 him.

20 Members of the jury, you've heard a lot of testimony.
21 Even though I don't normally give a lot of breaks, I'm going
22 to give you about a five-minute break, stretch, if any of you
23 need to use the facilities, clear your mind, come back for the
24 next witness.

25 (Jury not present.)

09/05/2001 Chaparral Trial - Day 2

1 THE COURT: Take a recess. What's next?

2 MR. ALLCOCK: Mr. Russell.

3 (Recess.)

4 THE COURT: All right, gentlemen. Let's come back. I
5 called the break for two reasons: You've got two jurors who
6 are down and seven jurors who are obviously not understanding
7 a word of what's going on, so I thought we'd let them get a
8 little exercise and maybe get a little bit more oxygen in
9 their blood, and spread the word among counsel that you don't
10 want to lose a jury.

11 Bring them in.

12 (Jury present.)

13 THE COURT: You may call your next witness.

14 MR. GIUST: Your Honor, Crossroads calls Jeffry
15 Russell.

16 THE COURT: If you'll come right here and be sworn,
17 please, sir.

18 (Witness was sworn.)

19 THE COURT: If you'll walk around this column and have
20 a seat. And if you'll tell us your full name and spell your
21 last, please.

22 THE WITNESS: My name's Jeffry Thomas Russell. My
23 last name's spelled R-U-S-S-E-L-L, and the first name is
24 J-E-F-F-R-Y.

25 JEFFRY RUSSELL, called by the Plaintiff, duly sworn.

09/05/2001 Chaparral Trial - Day 2

1 DIRECT EXAMINATION

2 BY MR. GIUST:

3 Q. Mr. Russell, where do you live?

4 A. I live in Austin, Texas.

5 Q. How long have you lived in Austin?

6 A. I've lived here about one year.

7 Q. Where have you resided before that?

8 A. Before that, I lived down in San Antonio for about five

9 years before that.

10 Q. Could you give us a brief description of your educational

11 background?

12 A. Sure. In 1988, I graduated with a Bachelor of Science in

13 Electrical Engineering from Marquette University. In 1991, I

14 got a Masters in Electrical Engineering from Purdue

15 University.

16 Q. Could you give us a background of your work history?

17 A. Sure. After I graduated from Purdue in '91, I got

18 recruited by IBM and moved down here to Austin, Texas, and at

19 IBM, I worked on designing local area network, adapters, and

20 that work involved designing circuit boards and designing

21 circuit chips themselves.

22 Q. Okay. Did there come a time when you worked at

23 Crossroads?

24 A. Yeah, in about 1995, some of the development activity that

25 I was interested in doing at IBM was coming to an end, and

09/05/2001 Chaparral Trial - Day 2

1 Brian Smith contacted me and invited me to come join Infinity
2 Comm Stor, which was the precursor to Crossroads Systems.

3 Q. What did you do when you arrived at Crossroads?

4 A. I was the first engineer so I came on board and worked on
5 a hardware project, and after that, I started developing
6 hardware platform for the CP 4100 Verrazano.

7 Q. And what do you do now?

8 A. My role there now is more of a architectural kind of
9 person which is someone who looks at technologies, new things
10 that could be wrapped into products and whatnot.

11 Q. You mentioned hardware. Could you give the jury an idea
12 of what hardware is?

13 A. Sure. The kinds of things I was designing at that time
14 are like what's inside of your PC. So if you've ever seen the
15 inside, there's a green circuit board and a lot of wires and
16 connectors and I put -- I figure out the kinds of chips to
17 use, the kind of connectors, the kind of power supplies that
18 have to be there, and put that all on there on the circuit
19 board.

20 Q. Let me show you a couple of exhibits, if I may. Show you
21 Exhibits 4 and 7. Just take a look at those. Before we talk
22 about that, though, let me put up on the screen Exhibit 1.
23 Have you ever seen Exhibit 1 before?

24 A. Yes, I have.

25 Q. And in what capacity?

09/05/2001 Chaparral Trial - Day 2

1 A. It's the patent that Geoff Hoese and I have for the
2 storage router for the virtual local storage.

3 Q. And you're the Jeffry Russell referred to on the front
4 page here?

5 A. Yes, I am.

6 Q. What did you do in connection with this invention of this
7 patent?

8 A. Well, Geoff and I collaborated on it to get the ideas
9 going, and I really brought the hardware expertise to the
10 whole collaboration process.

11 Q. What was the hardware that you designed to do?

12 A. The hardware does two main things: One, it provides all
13 the physical kinds of things that would have to hook up to the
14 outside world to specific connectors or protocols, and it also
15 provides all of the things you need to run software and then,
16 a lot of the higher level things that the router does is done
17 in software.

18 Q. How did you come up with this invention in Exhibit 1?

19 A. We, at that time, we looked around and saw that the way
20 storage is hooked up is through a network file server. And
21 there's a lot of overhead involved in having storage
22 implemented over a network like that, and so, we thought there
23 would be a better way to improve its efficiency.

24 Q. Are access controls important to this invention?

25 A. Yeah, it's the central part. It's what allows the mapping

09/05/2001 Chaparral Trial - Day 2

1 to occur so you can have the virtual local storage.

2 Q. Okay. When did you come up with this invention?

3 A. We started kicking around ideas in the mid-to-late 1997.

4 Q. What product were you working on at that time in
5 mid-to-late 1997?

6 A. That time, I was working on Verrazano, which is the
7 hardware part of the CP 4100.

8 Q. Okay. If you'd look in your folder to Exhibit 4, which is
9 already in evidence. Do you recognize what Exhibit 4 is?

10 A. Yes, I do.

11 Q. What is it?

12 A. It's the schematic diagram for the Verrazano hardware
13 platform, and this is what specifies how you would go put
14 together all the chips and pieces to make the circuit board.

15 Q. Does this exhibit show the hardware elements in an early
16 form that would be used in the 972 patent?

17 A. Yes, this is the basic hardware platform that we had in
18 mind to support the invention.

19 Q. Okay. What's the approximate date of the document, if you
20 could tell?

21 A. Well, from the first page, you could see that that
22 automatic date says, I think, January 22nd, 1997, and,
23 actually, the next page says January 31st, 1997. So, you
24 know, late January is when we finished up the first version of
25 this schematic when we went and tried to make a real piece of

09/05/2001 Chaparral Trial - Day 2

1 hardware from this.

2 Q. Is this the final schematic for the 972 invention, or was
3 there additional work that was done?

4 A. Oh, a lot more additional work. This was just the first
5 try of getting it to work, and when we did make it, it didn't
6 work. So it was refinement that had to go on.

7 Q. Okay. Did you put the 972 invention into the Crossroads
8 CP 4100 product?

9 A. No, we didn't.

10 Q. Why not?

11 A. Well, at that point, this was the very first product of
12 the small little company and everyone's busy running around
13 just trying to get the basic storage router kinds of things to
14 work, so adding that extra functionality of implementing the
15 virtual local storage and whatnot just wasn't prioritized.

16 Q. When did you come up with the idea of virtual local
17 storage along with Mr. Hoese?

18 A. We started that in mid-to-late 1997. I don't know the
19 exact date, but we --

20 Q. If you take a look at Exhibit 7, that folder there. Turn
21 to the second page entitled, network storage device with
22 routing and security controls. This is already in evidence.
23 Have you seen this page before?

24 A. Yes, I have.

25 Q. And flip to the next page. Can you see the next page, as

09/05/2001 Chaparral Trial - Day 2

1 well?

2 A. Yes.

3 Q. What do these two pages describe?

4 A. These were the first write-up of the idea for the
5 invention, so they're kind of a high-level view of what could
6 be happening, and the pictures kind of show how we were
7 talking about using the device and how it would be applied.

8 Q. Did you see these two pages on or at the date reflected in
9 the document, which is from March to May of 1997?

10 A. Yeah, it was during that time that Geoff and I first had
11 the first talks about, hey, this should be something we should
12 write up and try to patent. So this document was a write-up
13 of a very early stage of that. I'm not sure if we -- this
14 particular version was before we first talked about it or
15 right after, but it was just as the ideas were starting to
16 form.

17 Q. You mentioned that you work -- your work was in connection
18 with the hardware. Did you have any -- was this document
19 supplemental to that hardware to show other aspects of the
20 invention?

21 A. This is more showing like how you would use the whole
22 product when it's all put together. It's really not showing a
23 lot of details of the different hardware pieces.

24 Q. Let me take you back to Comdex in 1996. Was there a
25 technology demonstration at that Comdex by Crossroads?

1 A. Yes, there was.

2 Q. Were you there?

3 A. Yes, I was there.

4 Q. Okay. What did Crossroads show in this technology
5 demonstration?

6 A. We actually showed two things that we tried to make look
7 as one. The first thing was the technology demonstration
8 you're talking about, which was a PC, personal computer with
9 some different cards plugged in so it could hook up to things
10 like a host or a disk drive.

11 And then, we had some software running that
12 demonstrated the technology of hooking up SCSI and Fibre
13 Channel, the different protocols involved. And then, the
14 other thing that we were showing which, really, we're trying
15 to make it all look like one was a prototype of the enclosure
16 for the CP 4100.

17 And we put the prototype enclosure on top of a table,
18 and then, we had the cables that connected everything, sort of
19 going on top of the table, and connect together the PC under
20 the table.

21 Q. So was there any actual functioning circuit or anything
22 within the enclosure?

23 A. No, there wasn't. Alls it had inside was some connectors,
24 it had some -- a lot of epoxy and little blinking lights so
25 from the outside, there would be lights blinking as if it was

09/05/2001 Chaparral Trial - Day 2

1 doing something.

2 Q. What did the blinking lights signify, if anything?

3 A. That's just our prude engineer's way of trying to do some
4 kind of marketing. You know, standing in front of a table at
5 a show and lights are blinking, people usually come up and ask
6 what's going on.

7 Q. Okay. You mentioned there's something below the table.
8 People that came up by looking at the device in the table know
9 what was in the box below the table?

10 A. You wouldn't know what was in the box. If you looked
11 closely at the cables and everything, you'd see that there was
12 something under the table. And we weren't certainly trying to
13 hide the fact that there was a PC under the table.

14 Q. Did this technology demonstration use any aspect of the
15 972 invention?

16 A. No.

17 Q. Did the demonstration function as a bridge, at least?

18 A. I wouldn't even say it functioned as a bridge. It was
19 just a very early demonstration of, hey, we can make these two
20 different things talk to each other. I'd almost likened it to
21 if you wanted a car and you tried to show it off, you wanted
22 to sell it, and there was no engine, or something like that,
23 you could push it down the hill and it would look like a car
24 going down the hill, but it wouldn't look like much past that.
25 So it was early pieces of what could be in a bridge.

1 Q. No further questions.

2 CROSS-EXAMINATION

3 BY MR. GARRETT:

4 Q. Hi, Mr. Russell. Just a follow-up on something you just
5 talked about. You said that prototype didn't use any aspect
6 of the invention, right?

7 A. Yes.

8 Q. And I want to make sure that everybody understands what
9 you're talking about. There was an empty box on the table,
10 but actually, the guts of what was going on was under the
11 table, right?

12 A. There was something -- yeah, the technology demonstration
13 was under the table.

14 Q. And what was under the table certainly did use aspects of
15 the invention, correct?

16 A. The central aspect of the invention being access control,
17 there was nothing that would remotely look like that involved.

18 Q. You understand, though, do you not, that other aspects of
19 the invention include hardware?

20 A. Yes, I understand that.

21 Q. And those hardware elements were present in that
22 technology demonstration?

23 A. Yeah, there was very similar elements, especially with
24 things that would let you connect specifically to those
25 protocols.

09/05/2001 - Chaparral Trial - Day 2

1 Q. Okay. Now, I want to go back to the '96-'97 time frame
2 for a minute. When you and Mr. Hoese were coming up with your
3 invention, did you have any communications with Mr. Smith
4 about that process?

5 A. Not that I remember, no.

6 Q. Did he ever encourage you to protect what you considered
7 to be your ideas or your inventions by applying for patent
8 protection?

9 A. No, not specifically, you know, one-on-one.

10 Q. Did he ever encourage you to apply for the 972 patent?

11 A. Personally, no. I dealt mostly with Geoff Hoese.

12 Q. Did Mr. Smith ever tell you to make sure that the Patent
13 Office learned about that technology demonstration at Comdex
14 in 1996?

15 A. No.

16 Q. Did he ever tell you to tell the Patent Office to make
17 sure that they learned about the HP Mux?

18 A. No.

19 Q. Do you recognize what has been marked as Defendant's
20 Exhibit 145? Hopefully appearing on your screen.

21 A. Yes.

22 Q. Was this something that was shown at Comdex of 1996?

23 A. Yes, it is. It was a flyer that we had, table handout.

24 Q. That Crossroads passed out to people who came by?

25 A. Yes.

09/05/2001 Chaparral Trial - Day 2

1 Q. Is that right? Did Mr. Smith ever tell you to make sure
2 that the Patent Office learned about this piece of literature?

3 A. He never specifically said that, no.

4 Q. Now, as an inventor of the 972 patent, did you understand
5 that you had a duty of disclosure to the Patent Office?

6 A. Oh, yes.

7 Q. Okay. Did you ask your patent lawyer what that meant?

8 A. I didn't know if I asked the patent lawyer who was
9 involved in this, but just through general knowledge and
10 experience in the field, I was aware of that.

11 Q. Okay. Now, during the application process, did you make
12 any attempt to find out what the Patent Office knew about the
13 prior art to your invention?

14 A. Me personally, no.

15 Q. Did you ask your patent lawyer, or anybody else, to give
16 you copies of the patents that the Patent Office was looking
17 at when they were examining your application?

18 A. No, I never asked them to do that.

19 Q. Did you ever look at any of those patents?

20 A. I never saw any patents if there are any.

21 Q. So would it follow, then, that you didn't compare what was
22 shown at Comdex to the disclosures of any of those patents?

23 A. That would be comparing apples and oranges, so no.

24 Q. Would it also follow that you didn't compare what was in
25 this piece of literature, D-145, to the patents that the

09/05/2001 Chaparral Trial - Day 2

1 Patent Office had before it when it was examining your
2 application?

3 A. Specifically off this piece of paper, no.

4 Q. Okay. Did you tell the Patent Office about the Comdex
5 display in 1996?

6 A. Well, the Comdex display was just a technology
7 demonstration, so no. But elements of a storage router which
8 I think you're alluding to with this document here in front of
9 me are included in the patent application as kind of the
10 starting point of what a storage router is.

11 Q. Did you tell the Patent Office about Exhibit 145?

12 A. No.

13 Q. Did you tell the Patent Office about the HP Mux?

14 A. No.

15 Q. You testified earlier, when Mr. Giust was asking you some
16 questions, that access control is pretty important to the
17 invention, right?

18 A. Yes.

19 Q. Did anything that Crossroads built in 1997 have access
20 controls in them, according to you?

21 A. Nothing that I'm aware of, no.

22 Q. And Crossroads actually shipped some stuff or shipped some
23 products in 1997 to customers or prospective customers?

24 A. We shipped products in 1996 and '97 and ever since then,
25 yes.

09/05/2001 Chaparral Trial - Day 2

1 Q. Okay. Before you shipped those products, you had to build
2 them and make sure they worked, right?

3 A. Yes.

4 Q. I want to talk very briefly about the patent application
5 drafting process. Typically what happens is the inventors
6 work on an application, then they give it to their attorney,
7 right?

8 A. (Moving head up and down.)

9 Q. Now, do you recall when you saw the first draft of the 972
10 patent application?

11 A. Like I said, somewhere in the early-to-mid 1997 is my
12 recollection of when I saw things.

13 Q. But not a specific date?

14 A. No, I don't have the specific date in mind.

15 Q. Do you recall who created the draft that you saw?

16 A. Which draft are we talking about?

17 Q. The one that you saw in early-to-mid 1997?

18 A. I created the drafts, Geoff Hoese's created drafts. I
19 can't specifically answer that question without the draft
20 we're talking about.

21 Q. Then, do you have a clean recollection in your mind about
22 what it was you saw in mid-to -- early-to-mid 1997 as far as
23 the drafts?

24 A. My recollection is we got together, we collaborated on the
25 ideas, and we started to exchange draft documents. The

09/05/2001 Chaparral Trial - Day 2

1 previous piece of paper I looked at was one of those early
2 versions.

3 Q. Right.

4 A. And eventually, it turned into the final application we
5 submitted.

6 Q. Do you recall how many drafts you saw of the application
7 itself? I understand you and Mr. Giust talked about Exhibit
8 7, which was a document that Mr. Hoese created, but I'm
9 referring, more specifically, to an actual draft of the
10 application.

11 A. I don't know the exact number, but I think it was less
12 than five.

13 Q. Do you remember whether you revised the first draft that
14 you saw of the application?

15 A. I revised the draft. I don't know if it was the exact
16 first one I saw.

17 Q. Do you remember how long you looked at it?

18 A. I don't remember how long I looked at it. Something that
19 size would take me several hours to read to see what's in
20 there.

21 Q. Do you remember how quickly you looked at it once you got
22 it?

23 A. I don't specifically remember how quickly I looked at that
24 draft.

25 Q. But there was a 'gap,' wasn't there, I think -- well, was

09/05/2001 Chaparral Trial - Day 2

1 there a gap before -- after getting the draft and then,
2 actually taking some action and looking over it?

3 A. So we're talking about the time delay between it came in
4 my possession and I started looking at it?

5 Q. Yes.

6 A. I'm sure there was a delay.

7 Q. You're not sure how long that delay was, right?

8 A. No. It was a very busy time at Crossroads.

9 Q. Okay. You mentioned that there was a final draft
10 application, right?

11 A. Yes.

12 Q. Okay. You don't recall revising it, do you?

13 A. I don't know.

14 Q. Last question I have, Mr. Hoese -- or, excuse me, Mr.

15 Russell. Do you think your invention solved any problems that
16 existed in the prior art?

17 A. This is a fuzzy question because I'm not sure of the legal
18 definition of prior art, so could you just expand that a
19 little more?

20 Q. Well, what you and Mr. Hoese were dealing with was
21 something that hadn't come before, as you allege. And so, the
22 prior art is stuff that's old. Now, with that understanding,
23 can you answer the question?

24 A. Sure. We certainly solved a problem that existed in the
25 world. Was it something that someone had already solved

09/05/2001 Chaparral Trial - Day 2

1 already, we don't think so, no. Does that answer the
2 question?

3 Q. Well, it's not quite as clean as I'd like it. The
4 question was pretty simple: Do you think that your invention
5 solved any problems that existed in the prior art that was
6 old?

7 A. Our invention solved problems that we solved in the world,
8 yes. I'm uncomfortable with the prior art word because I
9 don't think I understand the definition.

10 Q. Did you understand it when we -- when I asked you this
11 question at your deposition?

12 A. I don't recall.

13 Q. Okay. See if I can refresh your memory. If you'll turn
14 with me to page 17, line 16. And the question I asked you
15 then was: Okay. Did your invention solve any problems that
16 existed in the prior art? Your counsel made some objections,
17 and I responded to his objections by saying: I'm not asking
18 for legal conclusions or expert opinions, Mr. Russell. I'm
19 just asking if you solved any problems that existed in the
20 prior art.

21 And do you see what your answer is on page 18, at the
22 top?

23 A. Yes, I see my answer.

24 Q. Could you read it, please?

25 A. Sure. It says, I don't think we solved a problem that

09/05/2001 Chaparral Trial - Day 2

1 existed in the prior art.

2 Q. Thank you. Pass the witness.

3 RE-DIRECT EXAMINATION

4 BY MR. GIUST:

5 Q. Mr. Russell, you said you solved problems that existed in
6 the world just a moment ago. Could you elaborate on that,
7 what you meant by that?

8 A. Sure. That was the initial problem that we saw to be
9 solved by the invention which is the way that storage was
10 hooked up remotely. So it was done through network file
11 servers across the network, and that's how you accessed
12 storage.

13 Q. Mr. Garrett just read you some of your deposition.
14 There's a lot of objections that your counsel had made about
15 legal mumbo-jumbo. Is that why you refused when he originally
16 asked you the question here today?

17 A. Definitely. I still think there's a legal definition
18 behind that, and I don't know if I'm really understanding
19 that.

20 Q. Okay. And then, Mr. Garrett asked you about drafts of the
21 patent applications, whether there were time delays between
22 various moments of receiving drafts. Would you be able to
23 answer the question better had he shown you copies of drafts
24 and relevant draft documents attached?

25 A. Oh, certainly. I personally didn't keep really good

09/05/2001 Chaparral Trial - Day 2

1 records about when I got a draft, or when I updated it, or how
2 long it's at my desk, so I really can't answer, specifically,
3 about that kind of stuff.

4 Q. Did you attend to those drafts as fast as you could given
5 your work load at the time?

6 A. Oh, yeah. At that point, as far as hardware design, there
7 was four, maybe five of us involved in designing and building
8 and getting it to work, and we were putting in, maybe, 70-hour
9 work weeks. So I'm sure if I got a draft of the patent, it
10 wasn't reviewed by the next morning because there was lots of
11 other things to prioritize.

12 Q. And Mr. Garrett mentioned something about disclosing
13 things to the Patent Office. Did you disclose all the
14 pertinent prior art you know of to the Patent Office?

15 A. Yeah. In my mind, the starting point for the invention is
16 a storage router, and so, the invention is built on top of
17 that. And, you know, things like the technology demo and some
18 of that literature, that's even more primitive than the
19 storage router.

20 Q. No further questions.

21 MR. GARRETT: One follow-up, your Honor.

22 RE-CROSS EXAMINATION

23 BY MR. GARRETT:

24 Q. Mr. Giust asked you if you had disclosed all the pertinent
25 prior art you know of to the Patent Office, right?

09/05/2001 Chaparral Trial - Day 2

1 A. Yes, he did ask me that.

2 Q. And you disclosed that to the Patent Office?

3 A. Well, on our application, we described what a storage
4 network is and storage router is. That's kind of the base
5 starting point. That's not the invention. So in my mind,
6 that covers the prior art of what a storage router is.

7 Q. So no other papers besides just your application?

8 A. I wasn't aware of any other kind of implementations of
9 this technology at that point. This was very new stuff.

10 Q. Is that a no?

11 A. Could you repeat the question, then?

12 Q. Yeah. Did you disclose any other papers to the Patent
13 Office besides your application?

14 A. I did not.

15 Q. Thanks.

16 MR. GIUST: No further questions.

17 THE COURT: You may step down, sir.

18 MR. GIUST: Your Honor, we reserve to right to call
19 Mr. Russell later.

20 THE COURT: Who is your next witness?

21 MR. GIUST: Next witness is Keith Arroyo.

22 THE COURT: How long do you anticipate?

23 MR. GIUST: Less than ten minutes.

24 THE COURT: All right. Call him. If you'll come down
25 here, please. This is Mrs. Sims. She's going to administer

09/05/2001 Chaparral Trial - Day 2

1 an oath to you.

2 (Witness was sworn.)

3 THE COURT: You may come up around this column and
4 have a seat. If you'll tell us, please, your full name and
5 spell your last.

6 THE WITNESS: My name's Keith Arroyo, and last name is
7 A-R-R-O-Y-O.

8 KEITH ARROYO, called by the Plaintiff, duly sworn.

9 DIRECT EXAMINATION

10 BY MR. GIUST:

11 Q. Mr. Arroyo, what kind of work do you do?

12 A. Do software development.

13 Q. What does that entail?

14 A. Basically designing, writing code and testing.

15 Q. How long have you been doing this?

16 A. I'd say for about 13 years.

17 Q. What companies have you worked for?

18 A. IBM, Thomas Conrad, Compaq and Crossroads Systems.

19 Q. What kind of work did you do at these companies?

20 A. I did software development.

21 Q. Approximately when did you start doing software
22 development?

23 A. I believe, like, '87.

24 THE COURT: Mr. Arroyo, you may need to talk into the
25 microphone.

1 THE WITNESS: Okay.

2 Q. (BY MR. GIUST) '87?

3 A. '87, yes.

4 Q. Have you had any other job responsibilities other than
5 writing software?

6 A. I did software assurance, quality assurance for IBM.

7 Q. Did there come a time when you wrote software for
8 Crossroads?

9 A. Yes.

10 Q. And when was that, approximately?

11 A. Sometime in '96 till I left.

12 Q. And when did you leave?

13 A. I believe it was '99, I'm not quite sure.

14 Q. Where did you go after you left Crossroads?

15 A. I went to SYSCO Systems.

16 Q. What types of work did you do at SYSCO?

17 A. Software development.

18 Q. What kind of code did you write for the Crossroads while
19 you were at Crossroads?

20 A. I wrote the router code.

21 Q. Are you aware of a technology demonstration that
22 Crossroads had shown at Comdex of 1996?

23 A. Yes.

24 Q. What did you do in connection with that demonstration?

25 A. I was -- I wrote part of the code that was used for the

1 demonstration.

2 Q. Okay. I'm going to show you Exhibit 214. Take a look at
3 that. It's already in evidence. Do you recognize Exhibit
4 214?

5 A. Yes, I do.

6 Q. Actually, I'm sorry, that's Plaintiff's Exhibit -- yeah,
7 that's Plaintiff's Exhibit 214. Now what is it? What is
8 Exhibit 214?

9 A. It's the original file that I wrote for Crossroads.

10 Q. Was that the file that was in the Comdex technology
11 demonstration?

12 A. It was -- this code was written for the demo -- the
13 product demonstration, yes.

14 Q. And how would you know that?

15 A. It has routines that were called that weren't in the
16 later-on version of this code. It also has hardware registers
17 that were only on -- that were used in this code that were
18 only used for the demonstration platform.

19 Q. Okay. How many Fibre Channel devices would this code
20 function with?

21 A. One.

22 Q. How many SCSI storage devices did the code function with?

23 A. One.

24 Q. Would the technology demonstration work as attendant with
25 more than one Fibre Channel device and more than one storage

09/05/2001 Chaparral Trial - Day 2

1 device?

2 A. We wouldn't work on the SCSI side because we had
3 hard-coded the address of the target SCSI device. And on the
4 Fibre Channel end, we hadn't written a code, we hadn't written
5 one Fibre Channel device on the workstation side. So does
6 that answer your question?

7 Q. So would it work?

8 A. No.

9 Q. Okay. Did this code have any type of access controls
10 between the one Fibre Channel device and the one SCSI device?

11 A. Access control like any kind of imitation of -- what do
12 you mean like?

13 Q. Did it have any way to limit access to the SCSI storage
14 device by the host?

15 A. No. I mean, if it's a well-formed command, SCSI command
16 and you go from -- or box to the SCSI target.

17 Q. So as long as it's receiving well-formed commands --

18 A. Right.

19 Q. -- it would work? Does that mean that the command is a
20 standard command?

21 A. Standard.

22 Q. Okay. That's all the questions, your Honor.

23 CROSS-EXAMINATION

24 BY MR. BAHLER:

25 Q. Mr. Arroyo, I'm holding in my hand Exhibit 214. This is

09/05/2001 Chaparral Trial - Day 2

1 the computer program that was in the technology demonstration
2 Comdex 1996, right?

3 A. Right.

4 Q. And did you disclose this to the Patent Office at any time
5 during the pendency of the 972 patent, sir?

6 A. I didn't disclose anything to any patent as far as this
7 file.

8 Q. There came a time when you did work on access controls for
9 Crossroads, right, sir?

10 A. Access controls as -- how do you define access control?

11 Q. Let's take a look at Plaintiff's Exhibit 129. I'm sorry,
12 Defendant's Exhibit 129. I have it on the screen there for
13 you, sir.

14 A. Uh-huh.

15 Q. Do you need a hard copy of that, too?

16 A. I don't need one yet.

17 Q. All right. This is a document that's dated October 22nd,
18 1997, right, sir?

19 A. Uh-huh.

20 Q. And it's entitled Compaq 4100 Shiner OEM requirements,
21 right?

22 A. Uh-huh.

23 Q. And you used those requirements -- well, at this time, you
24 were one of the -- well, you were the principal software
25 designer for the 4100 product, right?

09/05/2001 Chaparral Trial - Day 2

1 A. I wasn't the principal designer. I was with the group of
2 people that --

3 Q. Well, you were one of the designers that was working on
4 the 4100 product, right?

5 A. Yes, I was.

6 Q. And you were working on what was called the bridge code,
7 right?

8 A. Right.

9 Q. And that's the code that actually controls the function of
10 the router, right?

11 A. Controls some of the function of the router, yes.

12 Q. So you would have relied upon this while you were working
13 at Crossroads. You would have relied upon this requirements
14 document to guide your work, right?

15 A. I used -- I mean, if I remember this, I had to look -- I
16 guess I need to look at the hard copy of it.

17 Q. All right.

18 A. I didn't use this document per se, I matched the
19 requirements of it, but I didn't follow it. What number is
20 it?

21 Q. 129.

22 A. What was the question?

23 Q. You used this document in designing the bridge code for
24 the Shiner version of the 4100 product, right?

25 A. Well, I had to meet certain requirements that were -- that

09/05/2001 Chaparral Trial - Day 2

1 were on certain pages.

2 Q. Okay. Please turn within that document to page 10. It's
3 the tenth page. It doesn't have page ten on it. It's labeled
4 page 4 -- well --

5 A. Page 4.

6 Q. -- it is page 5 of that document.

7 A. Page 5, okay.

8 Q. Yes, sir. Do you have it?

9 A. Yes, I do.

10 Q. Listed in there are implementation of the SCSI reserve and
11 release command. That was a requirement for the Shiner 4100
12 version of the product, right, sir?

13 A. It was a requirement for Compaq.

14 Q. All right. And one of those requirements was that a
15 reserve command -- that's referring to a SCSI reserve command,
16 right, sir?

17 A. That's correct.

18 Q. And this is a requirement for the operation of the 4100
19 router, just so we're clear, right?

20 A. Yes.

21 Q. So it says, when a reserve command is received from an
22 initiator, that means when a reserve command is received by
23 the 4100 router from a Fibre Channel host, right?

24 A. Yes.

25 Q. And there is currently no reserve flag set for that LUN.

09/05/2001 Chaparral Trial - Day 2

1 That means the SCSI storage device, right?

2 A. Uh-huh.

3 Q. Okay. The CP 4100, 4100 router, right, will set the
4 reserve flag for that LUN, which means the SCSI storage
5 device, right, sir?

6 A. Yes.

7 Q. And store the worldwide name of the associated initiator.
8 In other words, what would happen, what was required was that
9 when a reserve command is received, the 4100 router would pay
10 attention to that initiator and would reserve the SCSI storage
11 device identified by that request to the requesting host,
12 right?

13 A. It would send a temporary --

14 Q. Set this flag, right?

15 A. Set the temporary flag, right.

16 Q. And then, after that, it says, if any command is received
17 which does not come from the initiator, that means the host,
18 right --

19 A. Uh-huh.

20 Q. -- which issued the reserve command, the CP 4100 will
21 return a reservation conflict status, right?

22 A. That's what the text says, yes.

23 Q. And that was a requirement for implementation of the SCSI
24 reserve command, right?

25 A. Yes.

09/05/2001 Chaparral Trial - Day 2

1 Q. And eventually, you did implement that function in the
2 Crossroads 4100 router, right?

3 A. I did, but I didn't -- I couldn't guarantee that would be
4 100 percent.

5 Q. Well, you implemented exactly what's stated in that
6 paragraph in the 4100 router, right?

7 A. That's true, but there's circumstances that other commands
8 can get to that target device that would be beyond my control.

9 Q. Mr. Arroyo, you implemented these functions in the 4100
10 router, right?

11 A. Yes.

12 Q. And this is dated October 1997, right?

13 A. I'm not sure when I wrote the code for it. That's when
14 the document --

15 Q. You are a programmer for 13 years, quite experienced,
16 right, sir?

17 A. Yes, sir.

18 Q. Did you finish that by the end of '97, three months later?

19 A. I don't think it was end of '97.

20 Q. Did you finish it by the end of '98?

21 A. Sometime.

22 Q. Fifteen months later?

23 A. Sometime it was -- the reserve release command is complex
24 in that you have to deal with a lot of events that can happen
25 on the Fibre Channel end and, also, on the SCSI end. So it's

09/05/2001 Chaparral Trial - Day 2

1 not like you can -- you know, you couldn't do it in a day.

2 You'd have to -- things would -- it's a progress of actually

3 getting a complete version of reserve release command to a

4 product, you know, product-ready state.

5 Q. Did you implement it by the end of 1998, 15 months --

6 A. I don't know if it's '98. I know it's before the end of

7 '99.

8 Q. So do you know for certain you implemented this function

9 as described here before the end of 1999 in the CP 4100

10 product, right?

11 A. I would say before '99, yes --

12 Q. And --

13 A. -- year end '99.

14 Q. The same code applies to the 4200 product, right?

15 A. Yes.

16 Q. Same base code.

17 A. Base code would be used.

18 Q. Same reserve support would have been in that same base

19 code by the end of 1999, right, sir?

20 A. Yes.

21 Q. And just to make sure we're clear here, this last sentence

22 I've highlighted said, if any command received which does not

23 come from the initiator which issued the command reserve CP

24 4100 will return a reservation conflict status. That means

25 when a command is received from a host that had not reserved

1 the reserved storage device, the CP 4100 will recognize that,
2 right?

3 A. Yes, but, I mean, it's not complete, actually, because
4 there's certain commands that will go through, even if the
5 reserve is in place.

6 Q. I'm asking about if the command is received -- this says
7 if any command is received which does not come from the
8 initiator which issued the reserve command, the CP 4100 will
9 return a reservation conflict. This doesn't say that there's
10 any command, right, sir?

11 A. Well, it's not actually correct. Only certain commands
12 are injected.

13 Q. The requirements by Compaq said any command, right?

14 A. Well, it was wrong.

15 Q. Should Compaq know what they wanted?

16 A. They should have. I mean, there's certain commands like,
17 for instance, the inquiry command. If one initiator issues
18 reserve, another initiator, another host computer issues an
19 inquiry, that inquiry can go through to the target device.

20 Q. And that would have been in conflict with the specific
21 requirements from Compaq, right?

22 A. Well, I think it was really a misunderstanding from their
23 part when they wrote the document that certain commands
24 actually will by the SCSI standard be allowed to go through
25 even though reserve command is in place.

09/05/2001 Chaparral Trial - Day 2

1 Q. Well, sir, let's finish this up. Just so we're clear,
2 there's a reservation in place and, let's say, a read request
3 comes through.

4 A. Uh-huh.

5 Q. The CP 4100?

6 A. Like what kind of read?

7 Q. Read from a piece of storage.

8 A. Like read the contents from this?

9 Q. Read this. Give me a picture, give me a document,
10 something like that. That's sort of the request came through.

11 A. Like a data type.

12 Q. Data request, that's fine.

13 A. From a disk itself.

14 Q. Exactly. And if there was a reservation in place by a
15 host that had not placed that -- that had not reserved that
16 storage, then the CP 4100 would not permit that access, right?

17 A. In most cases.

18 Q. It wouldn't permit that read, would it, sir?

19 A. If the target device hadn't restarted and if our router
20 hadn't been restarted, then that's true.

21 Q. All right. Wouldn't permit the access, right, sir?

22 A. Yes, under those conditions.

23 Q. And that's the way the SCSI reserve command acted to limit
24 access between Fibre Channel hosts and SCSI storage devices,
25 right?

1 A. Ask your question again.

2 Q. That's the way that the SCSI reserve command acted to
3 limit access between Fibre Channel hosts and SCSI storage
4 devices, right?

5 A. With those qualifications of events I couldn't control.
6 As far as on the target side, it would prevent, you know, that
7 one device from doing read or write command.

8 Q. So that's a yes, right?

9 A. Under those conditions, yes.

10 Q. Pass the witness.

11 MR. GIUST: No further questions, your Honor.

12 THE COURT: You may step down. Members of the jury,
13 I'm going to let you go to lunch. Please be back at 1:25,
14 ready to work, and remember the instructions I've given you.

15 (Jury not present.)

16 THE COURT: All right. 1:25.

17 (Lunch recess.)

18 THE COURT: All right. Counsel. Anything before we
19 bring in the jury?

20 MR. ALBRIGHT: No, sir.

21 MR. BAHLER: No. Hang on just a second. I have an
22 issue, in light of your Honor's admonition this morning, that
23 we need to give you a head's up regarding the depositions. We
24 took your Honor's comments to heart and considered some
25 additional stuff out of Mr. Bleakley's deposition that they

09/05/2001 Chaparral Trial - Day 2

1 had designated. They're not going to read it for some time,
2 but I thought I'd give your Honor an opportunity to review --

3 MR. ALBRIGHT: Your Honor, to save you some time, we
4 are not going to introduce the Bleakley deposition into the
5 record.

6 MR. BAHLER: Well, okay.

7 MR. ALBRIGHT: We heard your Honor's admonitions.

8 THE COURT: Well, sometimes it pays. Bring the jury
9 in.

10 (Jury present.)

11 THE COURT: Members of the jury, during the noon hour,
12 did anyone attempt to talk to you about this case?

13 THE JURORS: No.

14 THE COURT: Did you talk to anybody about the case?

15 THE JURORS: No.

16 THE COURT: Did you learn anything about the case
17 outside the presence of each other and this courtroom?

18 THE JURORS: No.

19 THE COURT: Did you get wet?

20 THE JURORS: No.

21 THE COURT: Show negative responses to all questions
22 by all jurors. You may call your next witness.

23 MR. ALLCOCK: Your Honor, we're going to play a couple
24 of videotapes. Mr. Bernstein's going to cue it up.

25 THE COURT: This is deposition -- videotaped

1 depositions?

2 MR. ALBRIGHT: Correct, sir.

3 THE COURT: Members of the jury, there are two ways to
4 take a deposition. One is by a Court Reporter, and they type
5 up the words, like you have heard it. The other is by a Court
6 Reporter with a videotape, and that's what you're about to
7 see. You should evaluate this testimony just as you would any
8 other witness. You may proceed.

9 MR. BERNSTEIN: Your Honor, we're going to show the
10 plaintiff's designation for the deposition of Robert Selinger
11 from July 26, 2001, and when that's completed we'll do --
12 we'll see the defendant's designations.

13 THE COURT: All right.

14 (Videotape played.)

15 Q. "Where are you currently employed?"

16 A. Chaparral.

17 Q. And what is your current position at Chaparral?

18 A. Executive Vice-president and Chief Technical Officer.

19 Q. As the Vice-president and Chief Technical Officer of
20 Chaparral, could you just generally describe what your
21 responsibilities are?

22 A. My general duties are focused on strategy in terms of
23 understanding and identifying long-term opportunities for the
24 company and the environment, meeting with customers on a
25 strategic basis, and then, guiding in terms of a road map our

09/05/2001 Chaparral Trial - Day 2

1 engineering and marketing activities.

2 Q. Okay. When was the first time you saw the 972 patent?

3 A. In approximately February of 2000.

4 Q. And how did you come about getting a copy of the 972
5 patent?

6 A. I don't recall if it was Jerry Walker or Dave Zinger, but
7 it was in the context of the consulting work.

8 Q. And do you know when Chaparral first saw a copy of the 972
9 patent?

10 A. Not by date, but it was in approximately that time frame.

11 Q. Okay. At some point in time, did Chaparral contact you
12 about doing an investigation into the 972 patent?

13 A. Yes.

14 Q. And when was this?

15 A. In, again, same time frame, February 2000.

16 Q. So, at some point in time, Chaparral contacted you about
17 doing an investigation into the 972 patent; is that correct?

18 A. Correct.

19 Q. At this initial meeting with Chaparral, did you discuss
20 LUN zoning?

21 A. Yes.

22 Q. So you have no recollection as to how or why LUN zoning
23 came up in that meeting?

24 A. Not specifically, other than, you know, the phrase appears
25 in the context of the patent.

09/05/2001 Chaparral Trial - Day 2

1 Q. Can you mark -- I have marked as an exhibit -- as Exhibit
2 305 document bearing dates No. CNS 174026 through CNS 4030,
3 Dr. Selinger. Could you take a look at this document?

4 A. Yes.

5 Q. Turning to the first page, CNS 174026, it appears to be a
6 February 29, 2000, an e-mail from you to Mike Gluck and Jerry
7 Walker at Chaparral. Did you write such an e-mail on February
8 29th?

9 A. Yes.

10 Q. And is this a true and correct copy of the e-mail and the
11 attachment that you sent to Mr. Walker and Mr. Gluck?

12 A. I believe so.

13 Q. In the subject heading, there's reference to Overpass dot,
14 dot, dot. Who is or what is overpass?

15 A. Overpass was a code name for Crossroads.

16 Q. Did you come up with that code name?

17 A. I believe so.

18 Q. How did you come up with -- or why did you come up with
19 that?

20 A. I don't recall who suggested it in terms of, well, just a
21 convenient phrase.

22 Q. Do you consider that more convenient than just using
23 Crossroads?

24 A. I guess it was probably a combination of Crossroads and
25 the patent. So it was a little bit more specific.

09/05/2001 Chaparral Trial - Day 2

1 Q. Okay. And this e-mail, is this the transmittal letter you
2 sent with your report on the 972 patent?

3 A. It was a work-in-progress, but yeah, it was a report as of
4 March 1st.

5 Q. For the benefit of the jury, can you please read the first
6 paragraph of your e-mail?

7 A. Here's my Overpass report. Don't shoot the messenger.
8 Probably the key inside is in the bottom half of page 2. And,
9 obviously, we can discuss this all tomorrow/Tuesday.

10 Q. I want to first take a look at the middle e-mail, which
11 appears to be an e-mail from Jerry Walker --

12 A. Yes.

13 Q. -- to you. In that e-mail, Jerry Walker is telling you to
14 pursue documented evidence that access controls was well-known
15 and practiced prior to December 31st, 1996; is that correct?

16 A. Yes.

17 Q. And did you ever pursue the documented evidence that
18 access control was well-known and practiced in the prior art
19 prior to December 31st, 1996?

20 A. I don't recall.

21 Q. You don't recall if you performed any additional research
22 into access controls?

23 A. I do not -- I do not recall if I did or not.

24 Q. Do you have a definition of the term access controls?

25 A. I didn't attempt to apply one or derive one.

09/05/2001 Chaparral Trial - Day 2

1 Q. Okay. Well, let me -- just to clarify. When you were
2 doing your research into the 972 patent, including your
3 research into whether there was prior art encompassing access
4 controls, you didn't have a definition for that term?

5 A. I didn't try and produce a limited definition or a
6 specific one.

7 Q. Okay. Do you know a Brian Smith who works at Crossroads?

8 A. I talked to him once, yeah.

9 Q. Have you ever met him?

10 A. Not to my knowledge.

11 Q. Okay. Now, you state that you talked to him one time. Do
12 you remember when that was?

13 A. Yes.

14 Q. And just for the record, you're referring to Exhibit 310?

15 A. Correct. So I believe I talked to him on February 28th.

16 Q. And you're referring to CNS 187017 in Exhibit 310?

17 A. Correct, sir.

18 Q. And are these your notes from the telephone conference you
19 had with Mr. Smith on February 28th, 2000?

20 A. Yes.

21 Q. Okay. And what did -- how long was your phone
22 conversation with Mr. Smith of Crossroads?

23 A. Don't recall exactly. I would guess it was 15 minutes or
24 so.

25 Q. Okay. And as of this date, February 28, 2000, were you a

09/05/2001 Chaparral Trial - Day 2

1 consultant for Chaparral?

2 A. Yes.

3 Q. You were being paid by Chaparral?

4 A. Yes, as a consultant.

5 Q. Yes. You were being paid by Chaparral as a consultant to
6 research and then, draft the report on Crossroads' 972 patent;
7 is that correct?

8 A. Among other things, yes.

9 Q. Okay. At any point during your conversation with Brian
10 Smith on February 28th, 2000 -- and I'm referring to the Brian
11 Smith of Crossroads -- did you tell him you were a consultant
12 to Chaparral?

13 A. No.

14 Q. At any point during your conversation with Brian Smith of
15 Crossroads on February 28th, 2000, did you tell him you were
16 being paid by Chaparral to research and draft a report on the
17 972 patent?

18 A. No.

19 Q. Isn't it true that you simply told Mr. Smith that you were
20 a consultant for a Fibre Channel company?

21 A. Approximately, yes.

22 Q. Okay. What did you and Mr. Smith discuss?

23 A. Basically, I was trying to determine initially whether or
24 not he was a -- one of the Brian Smiths I knew at IBM. There
25 were multiple. And I am not sure -- I think -- I'm not sure

1 we concluded that we knew each other. And then, I was trying
2 to understand what, you know, if they were open to
3 cross-licensing, and, you know, what they were going to do
4 with this patent, if it was something that was filed as part
5 of a window dressing for the IPO, or if they were serious
6 about it.

7 Q. Okay. And at no point during the conversation did you
8 identify yourself as a consultant for Chaparral?

9 MR. DELLETT: Objection. Asked and answered.

10 A. I agree.

11 Q. You agree with my statement?

12 A. I do not identify myself as Chaparral.

13 Q. Okay. And do you consider Pathlight and Chaparral --
14 excuse me. Do you consider Crossroads and Chaparral to be
15 competitors?

16 A. Yes.

17 Q. Okay. And just, again, I think I asked this, but I can't
18 remember. Crossroads is a competitor of Chaparral, correct?

19 A. Yes."

20 MR. BERNSTEIN: Your Honor, that concludes the
21 plaintiff's designation, and now we'll proceed with
22 defendant's designations.

23 THE COURT: All right.

24 Q. "Good morning, Dr. Selinger. Do you prefer Dr. Selinger,
25 Mr. Selinger?

09/05/2001 Chaparral Trial - Day 2

1 A. Bob is fine.

2 Q. Bob. I'll use Dr. Selinger.

3 A. Okay.

4 Q. And did they -- in the initial conversation, did they ask
5 for a written report summarizing your findings?

6 A. Yes. Actually, I'm not sure whether they asked for it or
7 whether it was something I prepared.

8 Q. Okay. During this conversation, did you discuss any
9 specific prior art?

10 A. Yes.

11 Q. And what was the prior art discussed at this -- and we're
12 talking about the initial meeting?

13 A. It appeared to me that the initial reading of the patent
14 was both very obvious as well as lots of prior art. So I
15 don't recall what the chronology of, you know, which meeting
16 or which discussion we discussed certain prior art but --

17 Q. Okay. Do you remember any of the specific prior art
18 discussed at that first meeting?

19 A. Not necessarily the first meeting. Like I said, I can't
20 remember which discussion included which prior art.

21 Q. Okay. Now, a second ago, you said that you believed or
22 you told Chaparral that the 972 patent was obvious?

23 A. Yes.

24 Q. And could you define for me the term obvious?

25 A. Obvious in the sense that an engineer that was familiar

09/05/2001 Chaparral Trial - Day 2

1 with SCSI and Fibre Channel and RAID technology would look at
2 this and say, there's nothing new or novel.

3 Q. What was discussed about LUN zoning?

4 A. I don't recall specifics.

5 Q. Generally, do you remember what -- why LUN zoning came up
6 in your conversation?

7 A. Not specifically.

8 Q. When you read the 972 patent and after you had discussed
9 LUN zoning with Chaparral, did you believe that if the patent
10 were to be held valid that Chaparral's LUN zoning feature
11 would infringe the 972 patent?

12 MR. DELLETT: Objection. Assumes facts not in
13 evidence.

14 A. I wasn't familiar with the details of the Chaparral
15 implementations.

16 Q. At the time of any of these conversations, do you know if
17 Chaparral actually had implemented LUN zoning into its
18 products?

19 A. I do not know for sure.

20 Q. Okay. Well, I know of at least another e-mail. And maybe
21 that's it and maybe it's not. We'll get there in a couple of
22 minutes?

23 Turning a page, CNS 174027 through 174030.

24 A. Uh-huh.

25 Q. And this is the actual report on the 972 patent that you

1 wrote?

2 A. Correct.

3 Q. And it's dated February 29, 2000?

4 A. Right.

5 Q. How much time did you spend writing this report?

6 A. I wouldn't know exactly. My guess is probably two or
7 three days, maybe, in terms of doing the research and writing
8 it.

9 Q. Well, let me ask you this, then: Did you ever pursue
10 documented evidence that access control was well-known in
11 practice in the prior art prior to December 31st, 1997 --
12 1996, excuse me, I apologize?

13 A. At this point, I probably would say yes, but it depends on
14 what definition of access control is.

15 Q. Well, let's --

16 A. The whole notion -- the patent itself was somewhat
17 ambiguous in terms of how much of the emphasis was on the
18 virtualization or any of the access controls and, therefore,
19 was a little bit hard to determine what prior art might apply.

20 Q. Okay. Well, let's use your unlimited, non-specific
21 description of access controls. And could you tell for the
22 jury what prior art you found dated prior to December 31st,
23 1996 that covered access controls?

24 MR. DELLETT: Objection. That calls for facts not in
25 evidence. Also, the question is vague and ambiguous because

1 the term access controls is undefined.

2 A. If I use a broad definition of access controls, then my
3 recollection was that a large number of the RAID products
4 already incorporated some type of access control.

5 Q. What type of access control?

6 A. Limiting host access to storage.

7 Q. And what products did that?

8 A. I think the Adaptec/Chaparral RAID products, the Sun
9 product, many of the mainframe products.

10 Q. Let me rephrase and maybe this will make it easier. What
11 steps has Chaparral taken to avoid infringement of the 972
12 patent?

13 A. I believe Chaparral has done considerable amount of
14 research into the 972 patent in the context of invalidity.
15 And part of it has been in the context of understanding what
16 -- you know, what possible portions might be infringing. I
17 haven't been part of that examination, so I'm not sure what
18 conclusions that may have reached or --

19 Q. And who did take part in those examinations?

20 A. Like I said, I think they would have been, probably, the
21 engineering folks: Al Permut, Tom Lavan, probably others.

22 Q. Okay. And --

23 A. You know, even Ian Davies.

24 Q. Do you know at any time any of those individuals reached a
25 conclusion that Chaparral infringed the 972 patent?

09/05/2001 Chaparral Trial - Day 2

1 A. I don't know if they did. My impression is that they
2 concluded that they did not.

3 Q. And do you know the reason -- any of the reasons why
4 Chaparral did not -- there was a belief that Chaparral did not
5 infringe the 972 patent?

6 A. I think it centered on this definition of what's access
7 control, and what is LUN zoning, and whether RAID was covered
8 or not.

9 Q. Okay.

10 A. So I understand and believe that there were a number of
11 ambiguities from my prior reading of it. There's a lot of
12 prior art. And so, I don't think -- nobody certainly felt
13 like there was a specific feature that was in violation.

14 Q. And what you believe to be the prior art, that's set forth
15 in your report from 2-29, as well as your follow-up e-mail
16 from March 4th, 2000?

17 A. Right. That's some of it.

18 Q. Okay.

19 A. Yeah, it's one of these where my approach was to initially
20 read the patent. It appeared to be something that was
21 obvious. Many of the claims appeared to have prior art. So I
22 started to do a few days of investigation, found a number of
23 prior art that predated either products or patents, predated
24 many of the claims.

25 And so, you know, since I was essentially a contract

09/05/2001 Chaparral Trial - Day 2

1 for hire, as I indicated, I think, in one of those e-mails,
2 you know, do you want me to keep searching or not, there seems
3 to be, at least, at face value a significant amount of prior
4 art that would have invalidated that patent.

5 Q. If you could turn to CNS 187011. It should be the second
6 page, dated 3-14-00. At the top, it states, Crossroads Claim
7 1-method plus access controls. What do you mean by that, that
8 phrase there?

9 A. What we were doing is basically looking at each of the
10 Crossroads' claims in terms of which prior art invalidated
11 those claims. So my belief was that the method invalidated
12 Crossroads' Claim 1.

13 Q. And do you know as of March 1st, 2000 whether Chaparral
14 had found prior art invalidating the 972, all claims of the
15 972 patent?

16 A. At that time, I know I was probably a significant part of
17 that investigation since the other report was dated March 1st,
18 and I thought I had found invalidity or prior art against most
19 of the claims, yes."

20 MR. BERNSTEIN: Your Honor, that completes Mr.
21 Selinger's deposition. Next, we have the deposition of
22 Michael Gluck from November 29 of 2000, and this is from
23 Volume 1 and this is the plaintiff's designation.

24 (Videotape played.)

25 Q. Would you tell me your name, please, sir?

09/05/2001 Chaparral Trial - Day 2

1 A. Michael J. Gluck.

2 Q. And, Mr. Gluck, where are you from? Where do you now
3 reside? Where do you live?

4 A. In Colorado.

5 Q. Okay. And what is your position with the company
6 Chaparral Network Storage, Inc?

7 A. President and COO.

8 Q. Mr. Gluck, how long have you been with Chaparral?

9 A. I'm one of the cofounders, since January '98.

10 Q. Does Chaparral with respect to these rack products that
11 we're talking about that Crossroads also has a competitive
12 device with, do you all compete in the same geographic areas
13 with Crossroads?

14 A. Yes, we do.

15 Q. And I'm going to -- I don't mean to keep wheeling around.
16 Let me direct you back to what we were talking about earlier,
17 when I was talking about competitive products.

18 A.. Okay.

19 Q. And you told me there were rack products that were
20 competitive between Crossroads and Chaparral?

21 A. Correct.

22 Q. Are there not also blade or board products that are
23 competitive between Chaparral and Crossroads?

24 A. I'm not aware of any announced Crossroads blade product.

25 Q. What about any rack products?

09/05/2001 Chaparral Trial - Day 2

1 A. Crossroads has rack products.

2 Q. And are any of those competitive with Chaparral products?

3 A. Yes.

4 Q. Okay. And with respect to those rack products, are those
5 -- are you basically going after the same customer base?

6 A. Yes.

7 Q. And is that same customer base in, roughly, the same
8 geographic areas?

9 A. Yes.

10 Q. Okay. Has Chaparral ever contemplated licensing that type
11 of technology to anyone?

12 A. Not that I'm aware of.

13 Q. Okay. And if you all have not contemplated doing it, I
14 take it is fair that you never have done it?

15 A. We have not done it.

16 Q. Okay.

17 A. But if somebody came around and gave us a big check, you
18 know -- I'm not saying -- nothing is forever so --

19 Q. Okay. So you would consider licensing your technology if
20 people pay you enough for it?

21 A. We would have to make a business decision.

22 Q. And what would that business decision be based on?

23 A. If it was strategic, if it was extremely profitable, et
24 cetera.

25 Q. For example, if you thought that it gave you a strong

1 technical -- technological advantage over a competitor, would
2 you license that to a competitor?

3 A. I'm not following you. Would we license our technology to
4 a competitor so they could compete with us?

5 Q. Yes, sir. Would that make sense to you to do that?

6 A. It doesn't sound to me that it would make sense.

7 Q. I mean, you're obviously a bright man and the COO of a
8 corporation. Why wouldn't it make sense to you to license
9 that technology to a direct competitor?

10 A. Well, it depends on how much we viewed them as a direct
11 competitor. So if --

12 Q. Let's say they are a direct competitor.

13 A. There would be potential, if we were trying to, for
14 example, propose a new standard where we wanted this to be an
15 industry standard in which case everybody would benefit more
16 by having an open system.

17 So in that case, even having competitors might be an
18 advantage would be one example I could think of where you
19 would want to do it. If it's a proprietary thing that would
20 allow a competitor that would only be interested in this
21 competitor, that would then compete, unless we got much more
22 money from the competitor for the license fee than we would
23 get by selling the product, that would be the trade-off.

24 Q. And that would be the trade-off?

25 A. Right.

09/05/2001 Chaparral Trial - Day 2

1 Q. Would it be fair to say that Crossroads is a major
2 competitor?

3 A. Yes.

4 Q. And I've received a note that I think I've gotten an
5 answer for, but just to make sure that I have. You've told us
6 who you believe the major competitors of Chaparral are, they
7 were Pathlight, Crossroads and ATTO, correct?

8 A. Correct, and then -- you know, there are additional --
9 there are a lot of -- there are other competitors. You asked
10 me who I considered the major competitors?

11 Q. Yes, sir."

12 MR. BERNSTEIN: Your Honor, we're going to continue on
13 with plaintiff's designations for Volume 2 of Mr. Gluck's
14 deposition from the same date, November 29th, 2000.

15 Q. "Earlier in your testimony in the prior deposition, you
16 said that Chaparral competed with Crossroads in some custom
17 board opportunities.

18 A. Yes, sir..

19 Q. Mr. Gluck I've marked as Exhibit 46 United States Patent
20 5941972. Do you recognize that as the --

21 A. Yes, sir.

22 Q. -- Crossroads patent?

23 A. Yes, sir, I do.

24 Q. The patent at issue in this case?

25 A. Yes, sir, I do.

09/05/2001 Chaparral Trial - Day 2

1 Q. When was the first time you saw that patent?

2 A. It's -- I'm going to give you a range. It's sometime in
3 February. I'm going to say February 9th or 10th, or the
4 second week of February, or something like that.

5 Q. How did you come across it?

6 A. I got a call from one of our investment bankers because we
7 were in registration, and -- who said to me that he had read a
8 statement on the wire by Brian Smith, the CEO of Crossroads,
9 that they were going to be very aggressive in their patent
10 portfolio, if you will.

11 And at the same time, one of our engineers in LA saw
12 the same wire and sent me up an e-mail, pointing me to the web
13 site where I could pull this patent off. So I then pulled the
14 patent off the web site and read the patent. But then,
15 somebody else in our company grabbed the official -- Jerry
16 Walker got the official patent. He contacted Dave Zinger --
17 he contacted a patent attorney and got the official patent.

18 Q. Which engineer in Los Angeles notified you about the
19 patent?

20 A. I believe George -- it was either George Kalwitz or Phil
21 -- either George or Phil.

22 Q. Phil who?

23 A. Phil Colline.

24 Q. Okay. When you pulled the document off the web site, did
25 you read it?

09/05/2001 Chaparral Trial - Day 2

1 A. Yes, I did.

2 Q. Did you mark it up?

3 A. I highlighted it.

4 Q. Did you write anything on it?

5 A. No, I didn't write anything, just highlighted it.

6 Q. Did you read it that day, the day you were told about it?

7 A. Yes.

8 Q. How much time did you spend reading it?

9 A. I read it through. I don't know, about a half hour, an
10 hour.

11 Q. Okay. Looking at the original message from Mr. Selinger,
12 the subject is Overpass status.

13 A. Overpass was -- well, go ahead. I'm sorry.

14 Q. What does Overpass refer to?

15 A. Overpass was the code name we gave to the patent.

16 Q. Why did you give the Crossroads patent a code name?

17 A. We just thought it would -- we needed to have these kind
18 of issues confidential with -- client-attorney privilege.
19 confidential.

20 Q. Who gave it the name?

21 A. I don't know if it was Jerry or Gary. I don't know.

22 Q. In your response to Nigel Squibb, you also say that you
23 and Pathlight are cooperating, and any Fibre Channel-to-SCSI
24 device would infringe this patent, the 972 patent, if it were
25 valid, correct?

09/05/2001 Chaparral Trial - Day 2

1 A. That's correct.

2 Q. What you're meaning here is that if the 972 patent is
3 valid, Chaparral storage routers along with Pathlight's --

4 A. RAID controller, right.

5 Q. Would be infringing?

6 A. Correct.

7 Q. Mr. Gluck, you refer to a two-page opinion of counsel that
8 was referenced in Chaparral's S-1 filing?

9 A. Correct.

10 Q. And that opinion of counsel relating to the 972 patent was
11 received in the April -- in the April time frame, correct?
12 Time frame from which attorney?

13 A. From Dave Zinger.

14 Q. At which firm?

15 A. Sheridan Ross.

16 Q. Did Chaparral decide to continue making and selling its
17 routers based on that two-page opinion of counsel?

18 A. Yes, because -- his opinion clarified my original
19 misconception that I mentioned to you, thinking it was Fibre
20 Channel-to-SCSI. His opinion clarified that it was really
21 access controls and that we were not infringing. So none of
22 the products that we were shipping were infringing.

23 So it didn't matter whether the patent was valid or
24 not; we were not infringing. But if the patent would be so
25 broad to cover us, then it would be invalid.

09/05/2001 Chaparral Trial - Day 2

- 1 Q. Did -- I'm sorry. Go ahead.
- 2 A. As I had originally, you know, thought.
- 3 Q. Was there anything else that Chaparral relied on in its
4 decision to continue making and selling its routers?
- 5 A. We all believed internally, after discussions with Mr.
6 Zinger and everybody else, that now that we had understood the
7 patent that we absolutely were not infringing any of our
8 products. So it was opinion of counsel and our own, you know,
9 belief, as well.
- 10 Q. Since that opinion of counsel in early April, did you
11 receive any other written opinion of counsel's?
- 12 A. We've now had one just recently.
- 13 Q. The November 20 opinion?
- 14 A. Correct. I'm not sure of the date, but it's this month,
15 we received a big, thick opinion from Dave Zinger.
- 16 Q. Okay. Just --
- 17 A. Which have been provided to you -- at least to you guys, I
18 think. We waived our privilege or whatever on that.
- 19 Q. Right. We have that and I'll show it to you. But between
20 the April opinion and the opinion that was provided late this
21 month, did Chaparral receive any other written opinions of
22 counsel?
- 23 A. Not that I'm aware of.
- 24 Q. Mr. Gluck, Exhibit 50 is a collection of fax transmittal
25 forms --

1 A. Uh-huh.

2 Q. -- to a variety of different people?

3 A. Uh-huh.

4 Q. If you take a look at these fax transmittal forms, I think
5 that you'll agree with me that this is your effort to send the
6 patent out to a variety of different people at getting their
7 help to finding prior art, correct?

8 A. Correct.

9 Q. So it's fair to say that Chaparral launched an extensive
10 effort to find prior art in an effort to invalidate the 972
11 patent, correct?

12 A. I don't know, you know, what the metaphor extensive would
13 be, but we certainly were looking for prior art to invalidate
14 the patent.

15 Q. Sure. You were darn serious about finding prior art?

16 A. Sure.

17 Q. And you would want Mr. Walker and others who were
18 responsible to work as hard as they possibly could to find
19 invalidating prior art, correct?

20 A. Correct.

21 Q. And to the best of your knowledge, that effort was
22 undertaken, correct?

23 A. Correct.

24 Q. It's correct, however, that the decision by Chaparral to
25 continue making and selling routers was made back in April,

09/05/2001 Chaparral Trial - Day 2

1 when the two-page opinion letter was received?

2 A. That's correct, uh-huh, that's correct.

3 Q. So when you're talking about independent suppliers,
4 Crossroads was the only major intelligent router competition?

5 A. They were the first -- what I would call independent.

6 Q. Okay. If you look at Exhibit 63, sir, could you go a
7 couple of pages into that and you'll see the -- right there,
8 the business plan reference.

9 A. All right.

10 Q. Do you recognize this document, sir?

11 MR. BAHLER: Do I have that? Oh, that's what this is.

12 A. Oh, okay. This was our original business plan document
13 when Chaparral was first trying to raise some money.

14 Q. Did you participate in the drafting of this document?

15 A. Yes.

16 Q. Did you write this document?

17 A. Probably the majority of it.

18 Q. Could you turn to page 14, please?

19 A. Uh-huh.

20 Q. Do you see the reference to router competition?

21 A. Uh-huh.

22 Q. Do you see the statement, the only major current
23 intelligent router competitor is Crossroads Systems?

24 A. Again, I would qualify that as an independent. I should
25 have said independent, but people that may cap the products

1 that are not competitors.

2 Q. Right.

3 A. So that's as we've discussed.

4 Q. That's a true statement with that qualification?

5 A. Correct.

6 Q. Let me make sure that we're clear, then. You agree that

7 Crossroads did a good job at developing the router market?

8 A. The independent router market, correct.

9 Q. Okay. And you also agree that when Chaparral came on the

10 market, it took advantage of the work that Crossroads had done

11 in developing the market, correct?

12 A. Correct.

13 Q. Since Chaparral came on the market, it has tracked

14 Crossroads as a competitor, correct?

15 A. Correct.

16 Q. Chaparral has paid close attention to Crossroads'

17 technical progress, correct?

18 A. Correct.

19 Q. You paid close attention to whatever progress Crossroads

20 is making with potential customers, correct?

21 A. Correct.

22 Q. You paid close attention to Crossroads' IPO, correct?

23 A. Correct.

24 Q. You paid close attention to Crossroads' pricing to the

25 extent you can learn it?

09/05/2001 Chaparral Trial - Day 2

1 A. Correct.

2 Q. It's fair to say that Chaparral, from the time it entered
3 this market to and through the present time, has kept track of
4 Crossroads' development?

5 A. Yes, sir.

6 Q. And at the time Chaparral entered this market, Crossroads
7 was ahead of Chaparral in the market in terms of a customer
8 base, correct?

9 A. That's correct.

10 Q. Crossroads was ahead of Chaparral in terms of developing
11 the market, correct?

12 A. Correct.

13 Q. Okay. At the time Chaparral was formed, Adaptec kept a
14 percentage of the company?

15 A. 19.9 percent.

16 Q. That was negotiated percentage?

17 A. Yes.

18 Q. Okay."

19 MR. BERNSTEIN: Your Honor, that concludes the
20 plaintiff's designations for Mr. Gluck. And now we have the
21 defendant's designations for Volume I of Mr. Gluck's
22 deposition.

23 Q. "You may be the wrong person to ask this, but is there
24 anything that you are aware of in Chaparral's technology that
25 you think makes it superior to Crossroads' technology with

09/05/2001 Chaparral Trial - Day 2

1 respect to the routers? For example, when you go out to sell
2 a product, you are able to say, not only do you have to worry
3 about price, but our products are superior?

4 A. Yes.

5 MR. BAHLER: Objection. Vague.

6 Q. Do you understand my question?

7 A. We have higher performance.

8 Q. Okay. What do you mean by higher performance?

9 A. We have higher performance in terms of the amount of data
10 that the router can transfer in a certain amount of time. And
11 there's two --

12 Q. Okay. Are there any other objective differences that you
13 could cite that you believe would make Chaparral a better
14 product?

15 A. I think it would be difficult to list all the features of
16 a product and do a comparison, but there are many other
17 features to a product.

18 Q. What would the most primary one be to you that we haven't
19 talked about?

20 A. The software management capability.

21 Q. And you believe that's superior in the Chaparral product?

22 A. We have in-band and out-of-band management.

23 Q. And Crossroads doesn't?

24 A. Not to my knowledge.

25 Q. And is Chaparral paying a royalty for those licenses?

09/05/2001 Chaparral Trial - Day 2

- 1 A. They were royalty-free with the exception of RAID code.
- 2 Q. Okay. Do you know how much --
- 3 A. \$25 per RAID code license.
- 4 Q. With respect to the RAID products, what percentage of the
- 5 cost of RAID product does the \$25 represent?
- 6 A. Again, it would depend on the -- which platform, which
- 7 product. Our products range in price.
- 8 Q. The RAID products?
- 9 A. The RAID products range in price from \$1500 to as high as
- 10 \$3,000.
- 11 Q. Well, for example, you went through a host of examples
- 12 earlier why you thought Chaparral products were superior in
- 13 one form or another to Crossroads' products.
- 14 A. Okay.
- 15 Q. And, for example, you talked -- I don't remember exactly
- 16 the technological side of what it was, but you said there was
- 17 something in the new product that would allow Chaparral to
- 18 interface with -- I think it was the 168 --
- 19 A. 160 megabytes per second SCSI.
- 20 Q. Okay. That's technology that Chaparral has, correct?
- 21 A. Yes.
- 22 Q. And by way of example --
- 23 A. Okay.
- 24 Q. -- you'd either have to get a lot more money from the
- 25 competitor or you would not want the competitor to have that

1 technology, correct?

2 A. Again, that's speculative -- I mean, it's speculation.
3 We're not doing it today. We haven't licensed our technology
4 today, so --

5 Q. Yes, sir.

6 A. -- we have additional competitors who could become major,
7 such as Gadzooks, who's acquired a company called Smart SAN.
8 There are companies that have developed their own router
9 technology that could choose to sell it to other people. I'm
10 thinking specifically Spectralogics has developed their own
11 router that currently they use with their own product, but
12 they, I believe, are now thinking or have proposed to sell
13 that on the open market.

14 There is other companies like Spectralogics that have
15 developed their own router products such as Sequent, which has
16 been acquired by IBM, or Compaq that could, again, choose to
17 sell that into the open market as a competitor. So my answer
18 was who is today."

19 MR. BERNSTEIN: And, your Honor, we're continuing on
20 with defendant's designations for Mr. Gluck's deposition,
21 Volume 2.

22 Q. "What was your first impression of this patent?

23 A. My first impression was it was -- I don't want to use the
24 word I used before. It was a totally invalid patent because
25 when I read it -- when I read it first, I read it as trying to

1 patent any Fibre Channel-to-SCSI device, which I said can't --
2 you can't do this. There's all kinds of prior art out there
3 that would totally invalidate this patent.

4 Q. Aside from thinking it was invalid, given the way you read
5 it, you understood that if it were valid, Chaparral's router
6 products would fall within the scope of the patent, correct?

7 A. Every product -- not only our products but every -- you
8 know, all kinds of other companies' products would fall under
9 the scope, correct, which is why I believe it would be -- it
10 could not possibly be enforced.

11 Q. Okay. So you formed two first impressions: One, it was
12 invalid?

13 A. Correct.

14 Q. What was your basis for believing it was not a valid
15 patent?

16 A. The opinion from our -- Dave Zinger came back, as well,
17 thinking that we were not infringing.

18 Q. Do you believe that Chaparral has a duty to avoid
19 infringing U.S. patents?

20 A. Sure.

21 Q. Did you take any steps to avoid infringing this patent?

22 A. Could you clarify that? You mean once we knew of the
23 patent, you mean?

24 Q. Yes.

25 A. Well, we don't believe we are infringing.

09/05/2001 Chaparral Trial - Day 2

1 Q. Okay. My question to you is: Has Chaparral taken any
2 steps to avoid infringing the '972 patent?

3 MR. BAHLER: Objection. Asked and answered.

4 A. We don't believe we are infringing, so we don't need to
5 take any steps because our products are not infringing.

6 Q. So --

7 A. So we got legal counsel that clarified that my initial
8 interpretation wasn't the right one; that it really had to do
9 with access controls, and we are not infringing on the patent.

10 Q. If you look at the response e-mail from Mr. Walker, it
11 talks about Dave Zinger starting to develop -- I'm sorry, it's
12 this paragraph.

13 A. You should pursue? No.

14 Q. Jerry Walker wrote --.

15 A. He will start to develop a limited opinion letter as the
16 why we believe the patent is invalid.

17 Q. Yeah. Let me back up a second.

18 A. Okay.

19 Q. Do you see that Mr. Walker states that, Dave Zinger may
20 start to develop a limited opinion letter?

21 A. Right.

22 Q. Do you know if that limited opinion letter was ever
23 written?

24 A. We did get an opinion letter that we referenced in our
25 S-1, a two-page letter that said that he believes that we were

1 not infringing and that if the patent was to be so broad that
2 it would be invalid.

3 Q. Did you have a conversation with Mr. Squibb prior to him
4 sending you this e-mail?

5 A. Yes, I did.

6 Q. And what did you two discuss?

7 A. I told him that I was soliciting potential prior art
8 because -- and I thought that they might have some, as well,
9 that would help invalidate this claim, because from our -- if
10 you look at my -- says, we are thinking of filing a
11 counterclaim on the basis of a fraudulent patent. In other
12 words, they did not disclose known prior art and, you know, in
13 my words, duped the Patent Office.

14 This was because when our patent attorney pulled the
15 wrapper, he learned that there was not a single interrogatory
16 or question by the Patent Office on this patent. It went
17 through, which I'm understanding only happens not very often.

18 Q. The patent attorney told you that?

19 A. Yes, he did. He said, maybe, I think, in his words, less
20 than one out of 20 times, something like that.

21 Q. Okay.

22 A. And I speculated. We speculated that perhaps the reason
23 that this happened is that Crossroads came up with new tech
24 term knowledge, i.e., storage router, and if a patent clerk is
25 doing a word search, you wouldn't find storage router in the

1 storage literature; you'd find bridge adapter, and so on. And
2 so it could go through without a question.

3 And I believe my comment to Nigel was my understanding
4 of patents was that they're supposed to reward creative
5 invention as opposed to creative writing.

6 Q. When you had your conversation whether Mr. Rahmani, did
7 you express that same thought?

8 A. My first conversation was with him is, A, were -- had he
9 seen the patent. His answer, yes. B, what was their
10 position. He said that they -- they already had prior art and
11 had a patent consult opinion of prior art. Then, I asked him
12 his opinion on Fibre SCSI, and he agreed with my opinion that
13 we were to be valid, any Fibre-to-SCSI product, you know,
14 would be infringing, and therefore, their prior art, along
15 with other prior art, could be used to an validate the patent.

16 Q. Did Mr. Zinger advise Chaparral that his two-page opinion
17 of counsel was sufficient to allow Chaparral to continue
18 making and selling its routers?

19 A. I didn't talk to Mr. Zinger, but I believe so. I mean, I
20 certainly was conveyed that from Jerry Walker and others.

21 Q. Did you read that opinion of counsel?

22 A. I read the two-page opinion of counsel, yes.

23 Q. Did Mr. Walker read it?

24 A. Yes, he did.

25 Q. And to your understanding, we don't have that opinion here

1 with us today. To your understanding, did that opinion of
2 counsel, provided in early April, about capture all of the
3 bases for Chaparral's belief that it did not infringe or the
4 patent was invalid?

5 A. I don't know what you mean, capture all the bases.

6 Q. To your mind, when you read the two-page opinion of
7 counsel, did you think that it was complete?

8 A. Yes, and I'll paraphrase because, you know, I think it
9 said something like, we think that the -- or the opinion of
10 counsel, whatever, is that -- actually, I shouldn't try to --
11 you'll get the letter, you'll see what it said. But based
12 upon -- in my mind, it conveyed both that we were clearly not
13 infringing, and if the patent were to be interpreted because
14 this was prior to any Markman hearing or anything, so if the
15 patent were to be interpreted, you know, much more broadly
16 than we believed, then the patent would be invalid.

17 So I think it's -- the wording was something to that
18 effect.

19 Q. So you think the two-page opinion was complete, correct?

20 A. Yes.

21 Q. And to your understanding, did Mr. Walker think the
22 two-page opinion was complete?

23 A. Yes, correct.

24 Q. Has anybody who is now an employee of Chaparral ever told
25 you that they were at the '96 Comdex and saw the Crossroads

09/05/2001 Chaparral Trial - Day 2

1 display?

2 A. I'm not sure if the Adap -- I may have mentioned to you
3 this product was conceived and invented by Adaptec, and so --

4 Q. Which product?

5 A. The router product. I think I mentioned that in my
6 original briefing.

7 Q. The Chaparral router?

8 A. The Chaparral router. And so, I believed that Adaptec
9 people had said that they had visited Crossroads, but I don't
10 have the specific -- but you asked me if I've heard that from
11 anybody, so my recollection would be that there were people
12 from Adaptec that had visited the Crossroads.

13 Q. To this point, Chaparral had not heard from Crossroads
14 that --

15 A. This was, remember, I told you about -- you asked when we
16 first heard about the patent, I mentioned, like, February 9th
17 or something. So all that triggered when I got the call from
18 the investment banker and our engineer saying, here's this
19 Crossroads patent and the notice from that Crossroads is going
20 to be more aggressive, and that's when we immediately got
21 Jerry to go find a patent attorney. So that's what this is --
22 was all started out.

23 Q. Crossroads was already in the router market before
24 Chaparral got in the market, correct?

25 A. Well, before Chaparral but Adaptec had been developing the

1 product.

2 Q. I meant '98. I'm sorry. Let me ask the question again.

3 Isn't it true that as of 1998, Crossroads was the only major
4 intelligent router competition?

5 A. What date in '98?

6 Q. Let's just say by the end of '98.

7 A. By the end of '98, as I say, other companies had their own
8 -- Sequent was shipping. My recollection is that Sequent was
9 shipping its own Fibre Channel-to-SCSI. As I say, everybody
10 called them bridge adapters, Fibre Channel-to-SCSI bridge
11 adapters, they developed by themselves. The Unisys had an
12 internally developed program they worked on. Spectralogics
13 had one that they were shipping in '98, to my recollection.

14 So Crossroads as an independent supplier of routers
15 other people, yes.

16 Q. Do you see further on down this business plan states, they
17 first began shipping their products approximately one year
18 ago?

19 A. Correct.

20 Q. And it goes on to state, while Crossroads has done a good
21 job educating the market and seeding the market with
22 evaluation units, they suffered from the early Fibre Channel
23 interoperability issues and lack of industry infrastructure?

24 A. Uh-huh.

25 Q. That statement's a true statement, right?

09/05/2001 Chaparral Trial - Day 2

1 A. Correct.

2 Q. That's important in your business to understand exactly
3 what the competitors are doing?

4 A. It's very typical. We have ATTO, we have Pathlight.
5 Everybody in our business, we have their product, we buy their
6 product. It's very customary in the business.

7 Q. Is it at all surprising to you that a company that was in
8 the market earlier than your company and had developed the
9 market earlier than your company has obtained patents relating
10 to the technology in this market?

11 A. I'm very surprised that they got that patent approved.

12 Q. That's not my question. Is it at all surprising that a
13 company that was in the market earlier than you and developed
14 the market earlier than you has obtained patents relating to
15 the technology in that market?

16 A. I don't agree with the premise. Adaptec has spent \$30
17 million on the product starting in 1996, before Crossroads was
18 a company, had their own patents, their own technology, the
19 400,000 gate array ASIC. So I don't agree with the premise
20 that Crossroads was first or other companies were there with
21 captive products. Yes, Crossroads made an independent router,
22 but I don't agree with your premise.

23 Q. Did Adaptec make a Fibre Channel-to-SCSI router?

24 A. Bridge adapter, router it's now called, but bridge
25 adapter.

1 Q. A Fibre Channel-to-SCSI bridge adapter?

2 A. Yes, sir. That's the part of the technology license that
3 we -- that's how Chaparral got started out is primarily a
4 marketing company, marketing and sales to take the Adaptec
5 technology and focus it in on this market. And sometimes the
6 first to the market, if you will, is the independent isn't the
7 ultimate leader. I would offer Upancore and Brocade as
8 examples.

9 Q. What do you mean by focus it in?

10 A. Adaptec was primarily -- felt a bigger market was the RAID
11 market. And so, they wanted a company to focus their sales,
12 marketing, future development efforts on their router, the
13 Fibre Channel-to-SCSI tape bridge adapter marketplace, which
14 we now call the router marketplace.

15 And so, they funded Chaparral in exchange for 19.9
16 percent interest. And the three of us -- and shortly became
17 eight of us -- started Chaparral with the exclusive license --
18 exclusive license for the Adaptec technology that they had
19 spent \$30 million in three years developing well before
20 Crossroads was a company, and we were taking that product and
21 focusing it exclusively on the Fibre Channel-SCSI bridge
22 adapter marketplace.

23 And Adaptec was continuing to focus on the RAID
24 marketplace. And then, six months later, Adaptec decided to
25 get out of the Fibre Channel-to-SCSI RAID business, and we

09/05/2001 Chaparral Trial - Day 2

1 spent the next three months and bought that business from
2 Adaptec. So now we have RAID and routers.

3 And the reason that our product is so much higher
4 performance than Crossroads' is because Adaptec spent
5 substantially more money and a longer period of time
6 developing the product, and we were able to leverage that
7 platform.

8 Q. And that was part of negotiations involving a number of
9 different issues including what Chaparral would pay Adaptec
10 for certain licenses, correct?

11 A. No. This was -- this is different than the license
12 agreement that I talked about, the technology transfer. The
13 original Chaparral was formed not paying any money to Adaptec.
14 But in exchange for giving them 19.9 percent of the company,
15 Adaptec funded the initial \$200,000 of the company capital,
16 give us the exclusive license to take this bridge -- Fibre
17 Channel-SCSI bridge adapter and go market it and, effectively,
18 transfer that technology to Chaparral in exchange for the 19.9
19 percent.

20 Q. And the \$25 a unit --

21 A. That was a later -- so then -- I'm sorry to preempt your
22 question.

23 Q. That's all right. That was my question. The \$25 a unit
24 fee --

25 A. That was not involved at all. So that was -- that was

09/05/2001 Chaparral Trial - Day 2

1 negotiation number one with Adaptec in January '98.
2 Negotiation number two with Adaptec, which is a very thick,
3 you know, technology transfer and multiple agreement, was when
4 Adaptec decided to get out of the Fibre Channel-to-SCSI RAID
5 business, and we decided to negotiate to take over that
6 business.

7 So that's when we negotiated a very extensive
8 technology transfer of all the technology, including making
9 offers to 20 of their employees and Adaptec putting, you know,
10 half a million in escrow to help us do that. And the \$25 RAID
11 license code was part of that negotiation, which was started
12 in July of '98 and concluded on November 25th of '98."

13 MR. BERNSTEIN: Your Honor, that concludes the
14 videotaped deposition testimony of Mr. Gluck.

15 THE COURT: All right.

16 MR. ALCOCK: Your Honor, we would call as an adverse
17 witness Mr. Walker.

18 (Witness was sworn.)

19 THE COURT: Tell us your full name and spell your
20 last, please.

21 THE WITNESS: My name is Jerry Lee Walker,
22 W-A-L-K-E-R.

23 JERRY L. WALKER, called by the Plaintiff, duly sworn.
24
25

1 DIRECT EXAMINATION

2 BY MR. ALLCOCK:

3 Q. Good afternoon, Mr. Walker.

4 A. Good afternoon.

5 Q. What is your present job?

6 A. I am currently retired.

7 Q. And you worked for Chaparral from when to when, sir?

8 A. From January of 1998 until the end of July of this year.

9 Q. And you were the Executive Vice-president of Engineering
10 during that entire time period?

11 A. Actually, my title was Executive Vice-president of
12 Operations.

13 Q. Of operations. And you were responsible for all the
14 engineers?

15 A. Yes, I was responsible for engineering, manufacturing,
16 product and customer support.

17 Q. Okay. I'm going to hand you a book of documents that
18 we'll use. Actually, two books. I've given them to counsel.
19 Now, I want to direct your attention, first, to Exhibit 132,
20 which is the first in the first book. Do you recognize
21 Exhibit 132?

22 A. Yes, sir.

23 Q. What is it?

24 A. It is a business plan.

25 Q. And is it the first business plan of the company?

09/05/2001 Chaparral Trial - Day 2

1 A. I don't know if it is the first business plan of the
2 company.

3 Q. Could you take a look at page 14 of the business plan and
4 the portion that says "router competition." Do you see that?

5 A. Yes, sir.

6 Q. And it starts out by talking about the only major current
7 intelligent router competitor is Crossroads Systems. Do you
8 see that?

9 A. Yes, sir.

10 Q. Is that -- was that an accurate statement at the time this
11 report was made?

12 A. Mr. Gluck wrote this report most of the time, and it -- I
13 believe my understanding at the time, that would be an
14 accurate statement.

15 Q. Okay. And it goes on to say, Chaparral Technologies now
16 has both the advantage of leapfrogging the market development
17 work done by Crossroads, and the significant advantage of a
18 cheaper, faster, better product through its strategic
19 relationship with Adaptec.

20 Do you understand what the advantage of leapfrogging
21 the market development means there, sir?

22 A. Well, I believe what Mr. Gluck had in mind in making that
23 statement is Adaptec was a billion-dollar company with a lot
24 of technology and a road map for several generations of
25 products that they were developing that Chaparral with its

09/05/2001 Chaparral Trial - Day 2

1 relationship with Adaptec would have the ability to capitalize
2 on the technology that Adaptec was developing.

3 And because Adaptec was in the business of storage and
4 integrated circuits for high-speed connectivity and in
5 developing their RAID products, which by definition are
6 high-performance products, the technology available to
7 Chaparral would be able to use the advantages and produce, as
8 Mr. Gluck said, a cheaper, faster, better product because of
9 this relationship.

10 Q. And what did it mean by leapfrogging the market
11 development work done by Crossroads? Were they the leaders in
12 developing the storage router market at that time?

13 A. Yes, they were.

14 Q. Okay. Let me turn your attention to Exhibit 56 in the
15 book. That's a memorandum, dated February 7, 2000, from Don
16 Matthews to you and then, to a number of other people. Do you
17 see that?

18 A. Yes, sir.

19 THE COURT: What is the number again, counsel?

20 MR. ALLCOCK: I'm sorry, your Honor, it's Exhibit 56.

21 THE COURT: All right.

22 Q. (BY MR. ALLCOCK) And down in the bottom portion of the
23 document is a discussion of LUN zoning. Do you see that?

24 A. Yes, sir.

25 Q. And it says it's scheduled for V3.1. That's a software

09/05/2001 Chaparral Trial - Day 2

1 release; is that right?

2 A. Correct.

3 Q. And this LUN zoning had the ability to control the access
4 of certain hosts to certain subsets of storage devices; is
5 that right?

6 A. That's right.

7 Q. And what this was a memo discussing, the date of this memo
8 is February 7, 2000; is that right?

9 A. Yes, sir.

10 Q. And so, the folks at Chaparral, the engineering folks, had
11 been developing this LUN zoning access control capability for
12 a little while by now?

13 A. For a little while. I believe it had actually started
14 architecture toward the end of 1999 with the actual work
15 beginning in the first quarter of 2000.

16 Q. Very good. And if you look at the next Exhibit, this is
17 Exhibit 12. This is a presentation of February 18, 2000 to
18 EMC. Do you see that?

19 A. Yes, sir.

20 Q. And EMC is a fairly large company?

21 A. Yes, they are.

22 Q. And you were presenting your company, Chaparral was
23 presenting to EMC in an effort to get them to buy your Fibre
24 Channel-to-SCSI routers?

25 A. This presentation I gave myself to EMC as an executive of

09/05/2001 Chaparral Trial - Day 2

1 the company, giving them an overview of Chaparral and what we
2 were doing, and familiarizing them with our efforts and trying
3 to understand what EMC's needs might be.

4 Q. Okay. And I notice if you go into the document and there
5 are numbers on it, CNS and then, it follows, the number I'm
6 interested in is 033597, there's a reference there to this LUN
7 zoning access control that we were talking about earlier. Do
8 you see that?

9 A. Yes, sir.

10 Q. And this is talking about this LUN zoning access control
11 being available in 2Q 2000?

12 A. That was our planned introduction time.

13 Q. Okay. So that would have been somewhere between April and
14 June of 2000?

15 A. Correct.

16 Q. And the diagram here shows three hosts; is that right?

17 A. Yes, sir.

18 Q. And it shows a number of those SCSI storage devices there
19 on the bottom?

20 A. Yes, sir, they are.

21 Q. And the notion of this LUN zoning is that those devices
22 can be configured to be accessed so that one of the hosts can
23 have access to one or more of the storage devices, and others
24 of the hosts will be precluded from accessing one or more of
25 the storage devices?

09/05/2001 Chaparral Trial - Day 2

1 A. Yes, sir.

2 Q. Now, I notice that a couple of pages before this -- oh,
3 I'm sorry. Before I leave that, these Chaparral Fibre
4 Channel-to-SCSI routers, what was the router you were
5 marketing at that time, sir? Was it is 1310?

6 A. The 1310 at that time, I believe, was the only router we
7 had.

8 Q. Okay. Now, back a couple of pages is -- and for the
9 record, your Honor, it's CNS 033594 -- is a different page
10 that talks about a different function, a reserve release
11 function. Do you see that?

12 A. Yes, sir.

13 Q. And that shows one SCSI device on one side of the router.
14 Do you see that?

15 A. Yes, sir.

16 Q. And a single host on the other side of the router?

17 A. Yes, sir.

18 Q. Now, I want to focus now on Exhibit 24 just for a moment.
19 I think you'll find it a little further down in your book.

20 A. Yes, sir, I've got it.

21 Q. And let me call up the first page of that. Exhibit 24 is
22 what, sir?

23 A. A presentation.

24 Q. And this is also a presentation that you made yourself?

25 A. Yes, it is.

09/05/2001 Chaparral Trial - Day 2

1 Q. And if you look, the date is April 18th of the year 2000?

2 A. Correct.

3 Q. And if you'll look at page CNS 0045933, there's also that
4 LUN zoning/masking slide that we saw earlier; is that right?

5 A. Yes.

6 Q. So would it be fair to say that you were developing this
7 LUN zoning access control feature at the end of 1999 and early
8 2000, and you were presenting it to customers in the early
9 part of the year 2000; is that right?

10 A. Yes.

11 Q. Now, if you would look at Exhibit 36 -- I'm sorry, it's
12 Exhibit 35. Could you tell us what Exhibit 35 is?

13 A. Yes, it's a Form S-1 which is a registration that's filed
14 when a company is considering doing an initial public
15 offering.

16 Q. And it's a pretty -- you have it in front of you there?

17 A. I do, sir.

18 Q. And you've -- I bet you, you spent a fair amount of time
19 on this document?

20 A. Yes, sir, I have.

21 Q. You are pretty careful when you make statements to the
22 public in these kinds of filings, aren't you?

23 A. Yes, you are.

24 Q. And if you could look at page 007564, there's a discussion
25 at the top. I think if you look at the page before the

09/05/2001 Chaparral Trial - Day 2

1 heading is embedded software, and the discussion is that, in
2 addition, we have developed embedded software permits to our
3 customers to prevent access to selected storage devices on a
4 server-by-server basis. This feature provides greater data
5 security by restricting access to shared data on the SAN only
6 to authorized users.

7 We expect to offer this as an optional feature for our
8 intelligent storage routers in the first half of 2000. Do you
9 see that?

10 A. Yes, sir.

11 Q. And that's consistent with the other marketing material
12 that we saw earlier?

13 A. Yes, it is.

14 Q. And the access control feature that is referenced here is,
15 in fact, that LUN zoning feature we were looking at?

16 A. Yes, it is.

17 Q. Now, in the midst of this time period, this February,
18 March, April time period, you first heard about the Crossroads
19 972 patent; is that right?

20 A. Yes.

21 Q. And did Mr. Gluck tell you about that?

22 A. I believe Mr. Gluck was the first to let me know about it.

23 Q. Okay. And that was in the early part of February?

24 A. I was thinking the middle part of February, but it's
25 definitely February sometime.

09/05/2001 Chaparral Trial - Day 2

- 1 Q. Okay. If you could take a look at Exhibit 39, can you
2 tell us what Exhibit 39 is?
- 3 A. It appears to be copies of pages from one of my notebooks.
- 4 Q. Okay. And engineers kind of have a practice of keeping a
5 notebook, don't they?
- 6 A. Thirty years of doing it, yes, sir.
- 7 Q. Right. So even when you get up in management, you can't
8 lose the habit?
- 9 A. That's correct.
- 10 Q. And so, what this is is not every day, but very frequently
11 in chronological order, you kept notes of various things that
12 you did?
- 13 A. That's correct.
- 14 Q. Now, if you would turn, please, to Exhibit -- I mean, to
15 page 040783 of Exhibit 39, and I want to ask you about the
16 entries on the bottom half of that page. Do you see those?
- 17 A. 040783?
- 18 Q. I think that's right. Let me see if I gave you the wrong
19 number. 040783. I apologize.
- 20 A. Yes, that's what I have, yes.
- 21 Q. Okay. It says 2-14-00, 2-14, 2000 on the top?
- 22 A. Correct.
- 23 Q. And there are a number of references on the lower portion
24 of that page to the Crossroads patent, is that right?
- 25 A. Yes.

09/05/2001 Chaparral Trial - Day 2

1 Q. What are those references about?

2 A. Once we became aware of the patent -- clearly, patents are
3 difficult to interpret, so what we did was what I think is a
4 prudent thing to do: We sought to find people who might be
5 able to help us understand what the patent was, whether or not
6 there was any prior art surrounding it, or whatever. So this
7 was -- we began the process of discovery, if you will, and
8 learning regarding the Crossroads patent.

9 Q. Very good.

10 A. For use for people I thought who might be able to help us
11 with that.

12 Q. And was at least one of your purposes in calling these
13 folks trying to find prior art that may impact the validity of
14 the Crossroads patent?

15 A. Well, certainly. Certainly is. People explore this, it
16 would be very difficult not to be also considering whether or
17 not there's prior art. So yes.

18 Q. Okay. And so Joel Dunning, he's at -- was he at HP at
19 that time?

20 A. He was at that time at a company called Converge Net in
21 California.

22 Q. Okay. And then, the next one down, it says Spectralogics.

23 A. Yes.

24 Q. And the next one -- oh, then, it says Pathlight
25 Consortium. Is that what it says?

1 A. Actually, what it says, it lists one, two, three, four
2 companies dash Consortium.

3 Q. I see. And so, were you thinking about contacting all
4 those four folks?

5 A. These were companies that had router products. And so,
6 the idea there that probably should have been a question mark
7 after consortium, basically contact these companies, are they
8 aware of the patent, you know, would they be interested in
9 possibly some kind of consortium.

10 Q. And you did contact Pathlight?

11 A. I did not personally. I believe Mr. Gluck did.

12 Q. Very good. And then, Bob Selinger, we'll get back to him
13 in a minute. And then, down on the bottom, John Heartly. Who
14 is he contacted with?

15 A. John Hartline.

16 Q. Oh, sorry.

17 A. John Hartline was an Adaptec employee who ran the
18 Longmont-based group for Adaptec that was developing the RAID
19 technology that Adaptec -- that Chaparral ultimately acquired
20 from Adaptec.

21 Q. Okay.

22 A. And he also was involved with Adaptec's efforts in
23 understanding whether or not the RAID technology could also be
24 applied to the router technology.

25 Q. And was that the focus of your call to him in this

09/05/2001 Chaparral Trial - Day 2

1 instance?

2 A. Yes.

3 Q. Okay. Very good. If you could turn to Exhibit 13, I said
4 that we'd get back to Mr. Selinger. This is an agreement you
5 had with Mr. Selinger; is that right?

6 A. That's correct.

7 Q. And what he was going to do was, as we've heard earlier,
8 this overpass investigation, that was his idea to come up with
9 that name?

10 A. It was Mr. Selinger's idea to call it Overpass. Engineers
11 also have a tendency to want to code name everything.

12 Q. Right. And so, this was what his tasks were going to be
13 including to contact Crossroads anonymously to understand
14 their intentions. Now, this was before there was any
15 litigation between Crossroads and Chaparral; is that right?

16 A. That's correct.

17 Q. Whose idea was that?

18 A. That was Mr. Selinger's idea. Mr. Selinger believed that
19 he may have known Mr. Smith from IBM days.

20 Q. Okay.

21 A. That was his idea, not mine. As far as I'm concerned, he
22 could have contacted Mr. Smith, representing Chaparral. I
23 know Mr. Smith was certainly not going to tell anyone calling
24 them out of the blue something that he didn't want to tell
25 them.

09/05/2001 Chaparral Trial - Day 2

1 Q. Okay. And so, Mr. Selinger created a report; is that
2 right?

3 A. Yes.

4 Q. And if you'd look at Exhibit 15, that's a copy of his
5 report to you and Mr. Gluck?

6 A. Yes.

7 Q. And it starts out by don't shoot the messenger. Did you
8 get the indication that this wasn't going to be the best news
9 you've heard when you read that?

10 A. Well, that's usually what one believes, but for the life
11 of me, even reading it today, I'm still not certain what Mr.
12 Selinger had in mind when he made that statement.

13 Q. Okay. Very good. And if you turn to the last -- the
14 document is four pages, single-spaced; is that right?

15 A. Yes, it is.

16 Q. And the bottom-line recommendation is on the last page
17 where Mr. Selinger says, figure out a way to settle. And
18 then, his plan has three parts to it: Portfolio, Catalyst and
19 terms. Do you see that?

20 A. I see that.

21 Q. And so, what his bottom-line recommendation to you was to
22 attempt to take a license with Crossroads; is that right? Is
23 that how you understood the term settle?

24 A. I think what Mr. Selinger was trying to say is if you get
25 into some kind of patent dispute, it could be very expensive

1 and time-consuming and distracting to both companies. And I
2 think he was trying to say the more civil way to do this is if
3 you think you could work out some kind of arrangement with
4 Crossroads, that's something that maybe you should consider.
5 That's how I interpreted what he meant.

6 Q. And he thought that the first step that you needed to do
7 was assemble a patent portfolio. Do you see that?

8 A. Yes, I do.

9 Q. And the reason that he suggested you do that first is
10 because he thought it unlikely that Crossroads, a competitor
11 of yours, would be willing to grant you a license; is that
12 right?

13 A. I would think he would think that. I think most people
14 would think that.

15 Q. So if you'd just look back and -- I don't want to spend a
16 lot of time on this, but the first thing that the report deals
17 with is a search for prior art. Do you see that?

18 A. Yes, I do.

19 Q. And it points out if you search the on-line patent library
20 provided by IBM?

21 A. Yes.

22 Q. That's a patent library that is searchable by computer?

23 A. Yes, it is. It's an internet-based, at least at that time
24 -- I believe they've sold it to someone else. At that time,
25 it was an internet-based patent search engine, if you will,

09/05/2001 Chaparral Trial - Day 2

1 that allowed you to search for patents using either the patent
2 number, or company name, or an inventor name. And that's what
3 he used in searching for prior art.

4 Q. And then, he says he did a more general search that turned
5 up this Unisys patent. Do you see that?

6 A. I see that.

7 Q. And then, he talks about this Sun SPARC storage prior art.
8 Do you see that?

9 A. Yes.

10 Q. And that's the subject of a fairly lengthy discussion
11 later on in the memo; is that right?

12 A. Yes, correct.

13 Q. This is that Sun SPARC work station is something that you
14 all focused on here at the beginning in February of the year
15 2000?

16 A. I believe that the most useful thing out of our consulting
17 arrangement with Mr. Selinger was a discovery of the Sun SPARC
18 storage and RAID.

19 Q. Okay. Now, if you could turn back to Exhibit 39. Oh, by
20 the way, I don't know if I have it written down. What's the
21 date of this report, sir?

22 A. The one we've been dealing with, the 15th? My copy's a
23 little blurred. It looks like February 29th, if I'm reading
24 that right.

25 Q. Okay.

09/05/2001 Chaparral Trial - Day 2

1 THE COURT: Is this a good place to stop?

2 MR. ALLCOCK: It is.

3 THE COURT: Members of the jury, I'm going to give you
4 your afternoon break. Stretch, use the facilities, go outside
5 if you'd like. Take about 15 minutes. Be ready to come back
6 in 15 minutes. Remember my instructions.

7 (Recess.)

8 THE COURT: All right. Anything before we bring in
9 the jury? All right.

10 (Jury present.)

11 THE COURT: Mr. Walker, you're still under oath.

12 THE WITNESS: Yes, sir.

13 MR. ALLCOCK: Thank you, your Honor. I was just going
14 to start orienting ourselves.

15 Q. (BY MR. ALLCOCK) Exhibit 15, the Selinger report that we
16 were talking about is February 29, 2000; is that right?

17 A. That's correct.

18 Q. And in there is the results of his prior art searching for
19 about the last couple of weeks before that; is that right?
20 He'd been on the job for a couple of weeks?

21 A. I don't remember exactly when we routinely -- it's here
22 somewhere, but I wouldn't doubt that's about right.

23 Q. All right. Now, let's take a look back to Exhibit 39 and
24 040786, and I'll put it up on the screen to save you time.

25 This is a note of 3-1, 2000. March 1st, 2000 on a

1 conversation or a meeting you had with Mr. Zinger and Mr.

2 Selinger?

3 A. Yes.

4 Q. And Zinger is the patent attorney that you used in this
5 regard?

6 A. That's correct.

7 Q. And what he told you, or at least what your impression
8 was, is if you were aware of the patent and don't have an
9 opinion but damages could be increased or, you say here,
10 trebled; is that right?

11 A. Again, once we learned about the patent, what we were
12 doing is trying to learn everything we could about the whole
13 process, the patent process and what the law says, et cetera,
14 et cetera, and we were getting advice from Mr. Zinger, and
15 this happened to be one of the things that Mr. Zinger informed
16 us of.

17 Q. So what you were intending to start out to do here on
18 March 1st, if not before, to get a written opinion from Mr.
19 Zinger that you were in this clear; is that right?

20 A. I believe what this was saying is Mr. Zinger educated us
21 that a written opinion or an opinion is something that's very
22 desirable and necessary regarding patents.

23 Q. Okay. So one of your goals after this date was to get a
24 written opinion from Mr. Zinger?

25 A. Yes.

1 Q. And the next note says let's get prior art. Do you see
2 that?

3 A. Yes.

4 Q. And it says, Dave will look at prior art. Do you see
5 that?

6 A. Yes.

7 Q. Now, you had already gotten a bunch of prior art from Mr.
8 Selinger in the -- in his initial report. You're now looking
9 for more prior art?

10 A. Well, it's not a poignant time. We haven't stopped
11 anything here. This is still the process of discovery and
12 learning.

13 Q. So you hadn't satisfied yourself that the prior art you
14 had invalidated the patent. You needed to go get more prior
15 art?

16 A. No, we hadn't come to any conclusion regarding the prior
17 art, yet. That's not something that we could do. That's
18 something that we would need Mr. Zinger to do.

19 Q. Fair enough. So now, if you turn to Exhibit 19, I believe
20 that that's an e-mail string with the first e-mail being on
21 the bottom from, again, Mr. Selinger to you, dated March 14th
22 of the year 2000. Do you see that?

23 A. Yes.

24 Q. And here, he is reporting to you on his further work on
25 prior art that he'd undertaken after the February 28th date;

1 is that right?

2 A. Yes.

3 Q. And he talks about a couple of different categories of
4 prior art, and in the first category, he notes this Methode
5 patent. Do you see that?

6 A. Yes, I do.

7 Q. That's another piece of prior art that he had uncovered?
8 Is that right?

9 A. If I recall correctly it was easy to uncover because it
10 was a reference patent in the 972 patent, if I recall. I
11 can't --

12 Q. Okay. Whatever. And then, also, on the next page, he
13 talks about Giga Labs. Do you see that on the next page?

14 A. I'm looking.

15 Q. I'm sorry. I meant to say EMC?

16 A. Yes.

17 Q. And STK, what is STK?

18 A. Storage Technology Corporation is what it stands for.

19 Q. And he put those in the second category of prior art that
20 he was looking at at that time?

21 A. Yes.

22 Q. All right. Now, you had a conversation with the lawyer,
23 Mr. Zinger, around about this time, and on that same day,
24 March 14th, you wrote an e-mail to Bob Selinger. Do you see
25 that? That's kind of in the middle of the string?

09/05/2001 Chaparral Trial - Day 2

1 A. Yes, I'm trying to see what the date is of that where it
2 says the date I wrote that.

3 Q. Well, I think if you look at the top, it's from Bob
4 Selinger back to you that's dated March 14th. So I think all
5 three of these e-mails occurred on one day with the first one
6 at 12:00 in the afternoon and the last one at 6:10 p.m?

7 A. Okay.

8 Q. Is that right? Does that look right to you?

9 A. I don't know for sure.

10 Q. Well, on the top, the bottom e-mail is at 12:10. Do you
11 see that?

12 A. Yes.

13 Q. And then, the top one from Selinger back to you is at
14 6:10. Do you see that?

15 A. Right.

16 Q. And that's responding to yours?

17 A. Okay.

18 Q. And in spite of all the prior art searching you'd done to
19 date, through March 14th of 2000, you were telling Bob
20 Selinger that he needed to pursue documented evidence that
21 access control, a well-known and was practiced prior to 12-31,
22 1986 -- 1996 so that Zinger can start to develop a limited
23 opinion letter which indicates why he believes the Overpass
24 patent is invalid. Do you see that?

25 A. Yes.

09/05/2001 Chaparral Trial - Day 2

1 Q. And this Sun product that they came up with initially, you
2 told them don't spend any more time on that?

3 A. That was what Mr. Zinger asked me to tell Mr. Selinger to
4 do.

5 Q. Very good. And then, Bob Selinger wrote back to you and
6 says that he's going to put looking for prior art on access
7 controls first thing after wrapping up this strategy review?

8 A. (Moving head up and down.)

9 Q. Is that right?

10 A. Yes.

11 Q. So is it fair to say that in the middle of March, you were
12 still looking for prior art on access controls?

13 A. Yes, it is.

14 Q. Okay. Now, shortly after this, the litigation was filed,
15 is that right, in late March?

16 A. Late March.

17 Q. Right. Then, in early April, Mr. Gluck started to try to
18 find some prior art through his contacts; is that right?

19 A. I believe Mr. Gluck did contact several people.

20 Q. Okay. So, for example, looking at Exhibit 22, this is an
21 e-mail to -- from Mr. Gluck to a Dave Trachy at Storage?

22 A. Dave Trachy.

23 Q. This was an effort for him to get prior art from there?

24 A. No. Mr. Trachy was an employee at Storage Technology
25 Corporation, a company that Chaparral was attempting to do

09/05/2001 Chaparral Trial - Day 2

1 business with, and Mr. Trachy was asking us about the
2 Crossroads patent.

3 Q. Oh, I see.

4 A. And what our views were of that.

5 Q. Okay. So --

6 A. He was not seeking prior art, to my knowledge, from Mr.
7 Trachy.

8 Q. If you look at Exhibit 37, that's a response e-mail from a
9 person named Nigel Squibb to Mr. Gluck and earlier in the --
10 and lower in the e-mail string, it talks about a request to
11 find prior art; is that right?

12 A. Yes.

13 Q. And who is Mr. Squibb with?

14 A. Mr. Squibb was with a company based in England. I believe
15 it was called Sam UK or Sam limited, something like that.

16 Q. Okay. And if you look at the next exhibit, which is
17 Exhibit 50, it's faxes from Mr. Gluck, mostly, and one from
18 you to Mr. Lippitt, Mr. Stallmo, Mr. Clayton, Mr. Clark, Mr.
19 Penn, Mr. Englebrecht, all copies of the 972 patent; is that
20 right?

21 A. I don't -- I haven't found Exhibit 50 yet.

22 Q. Exhibit 38.

23 A. Oh, 38.

24 Q. I apologize if I said 50.

25 A. Okay. Yes.

1 Q. And so, Mr. Gluck intensified the search for prior art
2 here in the early part of April and in May of 2000; is that
3 right?

4 A. That's correct. I wouldn't necessarily use the word
5 intensify. We were still in the learning and discovery
6 process.

7 Q. Okay. Now, Mr. Zinger was to prepare this limited opinion
8 letter as we saw on that March 14th memo; is that right?

9 A. That's correct.

10 Q. Now, if you look at Exhibit 39, at page 408, one and two,
11 this is a conversation you had with Mr. Zinger; is that right?
12 It notes on that conversation?

13 A. Yes.

14 Q. And it talks about a noninfringement opinion. So this
15 isn't about the limited opinion that the patents could be
16 invalid; this is a noninfringement opinion and this is your
17 products don't infringe?

18 A. That's what it appears to be, yes.

19 Q. Okay. And what you were doing is you were providing him
20 with alternatives on this access control feature. You were
21 giving him a flow diagram of the product with access controls
22 and a flow diagram of the product without access controls; is
23 that right?

24 A. That's what it says. I don't recall what those diagrams
25 were, but that is what it says.

1 Q. And you were giving him flowcharts with mapping and
2 address, but I think you'll agree with me, that should be
3 access -- and mapping with no access controls. Do you see
4 that?

5 A. I see that.

6 Q. And so, what Mr. Zinger was doing here in -- and I think
7 if you look at the page before, it's dated April 27, 2000,
8 page 40811.

9 A. Okay.

10 Q. So here, around about April 27 of 2000, Mr. Zinger is
11 being put in the position to evaluate infringement of a
12 product of yours with access controls and without access
13 controls; is that right?

14 A. I can't remember what these diagrams were, what access
15 control was in these particular diagrams. I don't remember
16 what that was.

17 Q. Okay. You earlier used the term LUN zoning
18 interchangeably with access controls. At about this time in
19 April, you had developed the access control LUN zoning
20 feature, but had not yet put it in the product; is that right?

21 A. That's correct.

22 Q. Okay. So would it be reasonable for us to assume that
23 these flow diagrams of access controls -- are those with LUN
24 zoning?

25 A. I don't know that for a fact. It could be.

09/05/2001 Chaparral Trial - Day 2

1 Q. Okay. If you used the words "access controls"
2 interchangeably with LUN zoning then as you do today, that's
3 what it would refer to?

4 A. Well, let me just say the words "access control" when I
5 used them was a word of convenience. I'm not necessarily
6 implying that the words access controls or what is stated in
7 the patent or anything like that. I was not qualified to do
8 that. Access control were -- was words, convenient words that
9 we tended to all use.

10 Q. Fine. Let me ask a question this way: At this time, in
11 April 28th of -- April 27th of 2000, the LUN zoning was an
12 access control that you were working on at Chaparral?

13 A. LUN zoning was a feature that we were working on at
14 Chaparral.

15 Q. That provided access controls?

16 A. Whether or not it provides access controls, I would say,
17 is subject to interpretation.

18 Q. Fair enough. So then, the next thing that happens is if
19 you look at Exhibit 107, I think that's in the second book.

20 A. No. It's in the first book.

21 Q. Exhibit 107 is an e-mail to a number of people from Al
22 Permut. He worked for you, didn't he?

23 A. He worked for the vice-president of engineering that
24 worked for me, yes.

25 Q. And this is a memo, dated May 8th of 2000, indicating that

09/05/2001 Chaparral Trial - Day 2

1 you were pulling the LUN zoning out of the planned release of
2 that software.

3 A. That's correct.

4 Q. And the date of that is what?

5 A. May 8th.

6 Q. And the reason that Chaparral pulled LUN zoning from the
7 product is because of a concern about infringement of the
8 Crossroads 972 patent?

9 A. There were a couple of reasons that we made the decision
10 to not introduce the feature of our product. First of all,
11 this decision was made within a matter of just a few weeks of
12 the lawsuit being initiated by Crossroads and Chaparral. We
13 still did not understand all aspects of the patent and our
14 products and what might or might not infringe, or even things
15 that we might be considering doing with our product.

16 And so, that was a major aspect of it. The second
17 aspect of it, also carrying an awful lot of weight in the
18 decision, was that the feature had received very little
19 interest from our customers. My sales force was not driving
20 me to get this feature in our product in the presentations I
21 had done with customers. Very lukewarm interest in this kind
22 of feature.

23 So, here we are, a few weeks after the lawsuit is
24 instigated and Crossroads to Chaparral, about to introduce
25 this feature being the engineer that I am and conservative and

09/05/2001 Chaparral Trial - Day 2

1 not knowing, yet, everything that I felt we needed to know, I
2 made the decision it would be prudent to back burner this
3 feature and not introduce it in our product at that time.

4 Q. And one of the reasons you didn't was a concern about
5 infringing the Crossroads 972 patent?

6 A. Concern from the standpoint of we did not yet know.

7 Q. Okay. And is it just coincidence that this decision was
8 made a few days after providing Mr. Zinger flowcharts of the
9 product with access control or without access control, or was
10 Mr. Zinger involved in this discussion?

11 A. We had several discussions from the time we learned of the
12 patent all the way up to this date. It was a continuum of
13 discussions and trying to put all this stuff together. So
14 there were lots of things that went into us making that
15 decision. The two main ones were the ones I just said.

16 Q. And part of your decision of pulling this feature was an
17 actual written opinion you got from counsel; isn't that
18 correct, sir?

19 A. We had gotten an opinion from counsel, yes.

20 Q. And that contributed to your pulling this feature, this
21 LUN zoning feature from the product here in May of 2000?

22 A. It was one of the factors that we considered in making
23 this decision, certainly.

24 Q. Now, if you turn to Exhibit 27, that is an opinion from
25 Mr. Zinger, a draft opinion, dated June 14th of the year 2000;

09/05/2001 Chaparral Trial - Day 2

1 is that right?

2 A. Yes.

3 Q. And I notice that the words say that it is the presently
4 marketed products of Chaparral do not infringe either
5 literally or under the doctrine of equivalents. Do you see
6 that?

7 A. Yes, I do.

8 Q. Now, at that point, on June 14th of the year 2000, the
9 presently marketed products did not include this LUN zoning
10 access control feature; is that right?

11 A. That's --

12 Q. Because you pulled it out a few days earlier?

13 A. That's correct.

14 Q. So this opinion really had nothing to do with the LUN
15 zoning access control feature?

16 A. This opinion did not.

17 Q. Now, the LUN zoning feature as part of, I believe you said
18 in your deposition, a standing order from you stayed out of
19 the product through the entire year of 2000; is that right?

20 A. That's correct.

21 Q. So if anybody wanted to engineer one and to put this
22 feature back in through the entire period of 2000, they would
23 have had to go to you, and you had a standing order to keep it
24 out?

25 A. That's correct. What I decided to do when we made the

09/05/2001 Chaparral Trial - Day 2

1 decision not to introduce it in the May time frame of 2000 to
2 back burner it and reconsider it when we were introducing a
3 new generation of products that were under development at that
4 time.

5 Q. Okay. Now, if you'll turn to Exhibit 32, which is in the
6 second book, that is the final Zinger opinion, dated November
7 20 of the year 2000; is that right?

8 A. That's correct.

9 Q. And as of this date, the products you were marketing did
10 not have the LUN zoning access control feature?

11 A. That's true.

12 Q. And so, this opinion has nothing to do with products that
13 contain that feature?

14 A. Does not.

15 Q. Now, in the first opinion, the exhibit, for the record,
16 your Honor, 27, there is no reference to the patent being
17 invalid; is that right? He doesn't give you an opinion on
18 invalidity in the June 14th opinion, does he?

19 A. No, he didn't.

20 Q. So although you had been searching for prior art from
21 early February, at least as of the middle of June, Mr. Zinger
22 did not give you an opinion that the patent's invalid; is that
23 right?

24 A. No, that's not correct. But if you look at the draft, the
25 second opinion, and you look at the final opinion in November,

1 it's obvious to me that the draft was just what it said. It's
2 a draft. It was incomplete. You can start up right from the
3 words that end in the draft and go straight into the words on
4 invalidity in his final opinion.

5 So it's my belief that the June 14th opinion is
6 labeled draft. I believe it was not complete at that time
7 would be my guess.

8 Q. Right. And it wasn't complete because there isn't a word
9 in there anywhere about the 972 patent being invalid, not a
10 word; is that right?

11 A. There is nothing about invalidity in the complete draft,
12 that's true.

13 Q. Okay. And then, in this November document, there is a
14 section on invalidity. It starts on page 23. Do you see
15 that, the invalidity analysis?

16 A. Yes.

17 Q. And he, after nine months of looking for prior art and
18 after almost eight months of Mr. Zinger analyzing this
19 information, he relies on one reference and one reference
20 only; is that right?

21 A. Yes.

22 Q. He relies on the Sun reference; is that right?

23 A. That's right.

24 Q. Now, we've heard all about this Adaptec prior art. You
25 worked at Adaptec?

09/05/2001 Chaparral Trial - Day 2

1 A. No, I never worked from Adaptec.

2 Q. Mr. Gluck worked at Adaptec?

3 A. No, Mr. Gluck didn't work at Adaptec.

4 Q. Did a number of people come over to Chaparral from
5 Adaptec?

6 A. Yes, there were.

7 Q. And you were well aware what they did?

8 A. Yes.

9 Q. And there's not a word in that Zinger letter about Adaptec
10 invalidating the patent?

11 A. There is not.

12 Q. Now, although you had -- Chaparral had taken the LUN
13 zoning feature out of the product for the entire year of 2000,
14 you continued to present it as a feature to customers -- I'm
15 showing you Exhibit 104 -- didn't you?

16 A. I'd like to, I think, correct one thing you said. We did
17 not take it out of the product. It was never in the product.

18 Q. Okay. You pulled it before it got in?

19 A. We took it out of developmental software. It never was in
20 the product, and I think that's very important.

21 Q. Okay. But regardless of whether you took it out or you --
22 or it never got in, you didn't take it out of the
23 presentations that you were making to customers?

24 A. That's correct.

25 Q. Here's a presentation made to Dell on May 24th that looks

09/05/2001 Chaparral Trial - Day 2

1 just like the earlier ones that we looked at; is that right?

2 A. That's true.

3 MR. BAHLER: Which exhibit number, counsel?

4 MR. ALLCOCK: I thought I said it earlier. It's
5 Exhibit 104.

6 Q. (BY MR. ALLCOCK) And you were deposed on December 8th of
7 the year 2000; is that right?

8 A. Approximately, yes.

9 Q. Right. And at that time, the engineers were still under
10 the standing order that this wouldn't go back in the product;
11 is that right?

12 A. Without my approval, right.

13 Q. Okay. Could you look at Exhibit 118. It's a press
14 release, dated November 8 of the year 2000. Do you see that?

15 A. Yes.

16 Q. And it talks about this A8526 product?

17 A. Yes.

18 Q. Now, in your deposition in December, you didn't suggest to
19 anybody that there was plans afoot for this LUN zoning to be
20 put back in the product, did you?

21 A. I don't recall. I don't know whether I was asked that
22 specific question.

23 Q. And you were telling the industry, or Chaparral was,
24 without a letter from a lawyer specific to LUN zoning, that
25 you were going to introduce these features that are highly

09/05/2001 Chaparral Trial - Day 2

1 sought after in this A8526 product; is that right?

2 A. That is correct.

3 Q. Were you aware of this press release when your deposition
4 was taken?

5 A. Yes.

6 Q. You did revisit the issue of putting this LUN zoning in
7 the product; is that right?

8 A. Right. What I said is when we chose not to introduce it
9 and back burner it that we would reconsider it at the time
10 this new generation of products came out, and I directed the
11 engineering staff to make sure that the feature was able to be
12 introduced in the new generation of products, and we made the
13 decision to introduce it.

14 Q. Okay. If you'll look at Exhibit 30, there was some --
15 dated October 6, 2000?

16 A. Yes.

17 Q. This is a marketing requirements document?

18 A. That's correct.

19 Q. And this is some information from the marketing people
20 about features that they consider important?

21 A. Yes.

22 Q. And a level A feature, these folks will tell you, is an
23 essential feature; is that right?

24 A. That's how it's labeled, yes.

25 Q. And so, here in October of 1986 -- I mean, October of

1 2000, I keep saying that -- they are talking about access
2 controls LUN zoning being a essential feature; is that right?

3 A. Yes.

4 Q. The Zinger final opinion was November 20?

5 A. Yes.

6 Q. Just a moment, your Honor. In connection with that Zinger
7 letter, I want you to turn back to Exhibit 19, which is the
8 e-mail --

9 A. Is that book one?

10 Q. -- that you wrote. Exhibit 19.

11 A. Okay.

12 Q. And this was after you'd already uncovered that Sun
13 product that Mr. Zinger finally ended up relying upon some
14 nine months later; is that right?

15 A. Right.

16 Q. And so, this pursuit of better prior art covering access
17 controls, the best you ended up with was the Sun thing that
18 you started with?

19 A. In terms of what Mr. Zinger cited, that's correct.

20 Q. Well, Mr. Zinger is a competent attorney, isn't he?

21 A. Yes, he is.

22 Q. And he is going to cite the best prior art that he can
23 find?

24 A. Yes.

25 Q. Now, the products that now have LUN zoning, the LUN zoning

09/05/2001 Chaparral Trial - Day 2

1 access control feature, were introduced in January, February
2 and March of the year 2001?

3 A. That's correct.

4 Q. And you have not obtained an opinion from Mr. Zinger on
5 whether or not those products infringe?

6 A. What the logic behind introducing the LUN zoning
7 feature --

8 Q. Excuse me, Mr. Walker.

9 A. Yes. All right.

10 Q. If you could answer that question.

11 A. Okay. Would you ask it again, please?

12 Q. Yes. You have not obtained a written opinion from Mr.
13 Zinger on those products that you're now introducing and
14 selling that contain the LUN zoning access control feature?

15 A. No, we have not.

16 Q. I have no further questions at this time, your Honor.

17 CROSS-EXAMINATION

18 BY MR. BAHLER:

19 Q. Mr. Walker, in response to that last question from Mr.
20 Allcock, you started to give an explanation and were
21 interrupted. Let me just give the question again. You
22 said --

23 THE COURT: Counsel, both of you -- I know the hour's
24 late -- are going to ask questions. Mr. Allcock asked a
25 question susceptible to a "Yes" or "No" answer, and the

1 witness started to give another answer. Now, let's don't have
2 any sidebar remarks. If you've got a question and want to
3 give an explanation, then ask him appropriately. You know how
4 to ask questions.

5 MR. BAHLER: Thank you, your Honor.

6 Q. (BY MR. BAHLER) Mr. Walker, you were going to offer an
7 explanation as to why LUN zoning was introduced in 2001. What
8 is that explanation?

9 A. At the time we were sued by Crossroads, we had no feature
10 called LUN zoning in our products. It's our belief that
11 Crossroads must have investigated what our products were, and
12 when they filed a lawsuit, they generally believed that we
13 infringed their patent.

14 We had no such thing in our product called LUN zoning.
15 And we got an opinion from Mr. Zinger that our products did
16 not infringe the patent, and so, we continued to ship our
17 product. Because we were still in the learning process, I
18 made the decision to be conservative and not introduce the LUN
19 zoning feature back in the May time frame, but back burner it,
20 see where the lawsuit was, learn more about it, and reconsider
21 it at the time the next generation of products was introduced.

22 When it came time to make the decision on the next
23 generation of products, the lawsuit was still in effect, we
24 had no LUN zoning in our products that whole time, and we also
25 had, we believed, a strong case regarding invalidity of the

09/05/2001 Chaparral Trial - Day 2

1 Crossroads patent. And we decided that we're already sued, we
2 don't have the feature, we're going to add the feature. We'll
3 still be in the same situation.

4 Crossroads sued us, we believe -- they believe we were
5 infringing the patent. So by adding, yet, another feature to
6 it, we didn't see that that put us in any different situation
7 than we already were in with Crossroads.

8 Q. All right, sir. Let me put up this marketing requirements
9 document. This is Exhibit 30 in your notebook, sir.

10 A. Yes.

11 Q. And Mr. Allcock pointed you to this prioritization scheme
12 that's over here on the left, and it says priority A and
13 that's considered essential?

14 A. Yes.

15 Q. What does essential mean within the context of this
16 marketing requirements document, Mr. Walker?

17 A. Well, a marketing requirements document, at least at
18 Chaparral, is something that's jointly created between the
19 marketing department and the engineering department, and
20 essential are the A marking is intended to say that at a
21 particular point in time, designated by the A400, the A410,
22 those are software releases.

23 It was the view that those features needed to be
24 available at the time of introduction of those software
25 levels. And the A designation that it is essential that it be

09/05/2001 Chaparral Trial - Day 2

1 in there. Remember, I had directed engineering to continue
2 the development of the LUN zoning feature so that should we
3 decide to put it in the next generation of products, it would
4 be engineered and ready to go.

5 So a lot of the essential that you see there is my
6 direction to the company, as well.

7 Q. Now, does essential on that marketing requirements
8 document imply that it was essential in order to sell a
9 product in the marketplace?

10 A. No. We had never done a market survey or study as to the
11 value of LUN zoning feature. If you look at the same
12 document, there's probably a dozen other features that are
13 scheduled to be introduced.

14 Q. Now, in fact, Mr. Walker, what was your experience with
15 respect to the customer visits that you were making regarding
16 LUN zoning?

17 A. My own personal experience in making customer
18 presentations is that very lukewarm reception to it. If you
19 remember the presentation material that was presented earlier,
20 those tended to be 30 to 60 pages thick. It has one page that
21 describes how LUN zoning works.

22 Typically, what would happen is I would give that part
23 of the presentation and elicit no comments. So my own
24 personal experience was very little interest in the feature.

25 Q. All right, sir. Let me refer you to Plaintiff's Exhibit

09/05/2001 Chaparral Trial - Day 2

1 107, which Mr. Walker -- or, I'm sorry, Mr. Allcock talked to
2 you about.

3 And if you'd look down here, section that says, please
4 note we will also need to pull out the more full-featured LUN
5 zoning from the planned 4.1 -- that says release there, right,
6 sir?

7 A. Yes, that's a release. There was not a feature in the
8 product. He was going to pull it out of the developmental
9 software that engineering was designing within Chaparral.

10 Q. Had LUN zoning been a feature that had been in any
11 products at any time during the year 2000?

12 A. No --

13 Q. At Chaparral?

14 A. -- it was not.

15 Q. Let me refer you to Exhibit 12, which is this page from
16 the presentation you were giving to EMC. First of all, this
17 was dated -- this is Exhibit 12. This was a presentation that
18 you made February 18th, 2000, right, sir?

19 A. That's correct.

20 Q. Okay. And it says, first of all, the title is not LUN
21 zoning/access control, it's LUN masking/zoning, right?

22 A. True.

23 Q. What does that mean?

24 A. Well, LUN masking was another feature that was being
25 developed along with LUN zoning. It operated in a slightly

09/05/2001 Chaparral Trial - Day 2

1 different fashion. Our definition when we called a feature
2 LUN masking meant that a storage device could either be seen
3 by all the hosts on the Fibre Channel side of the router or
4 not seen by all of the hosts. So it was an all-or-one thing.

5 You could either read and write to that device, or
6 send commands to it. All the hosts could or none of the hosts
7 could. It was an all-or-none thing. It was a feature
8 different than the LUN zoning.

9 Q. Okay. Is it your understanding that Crossroads is
10 contending that LUN masking infringes the 972 patent?

11 A. I have never heard any words to that effect, no.

12 Q. Okay. Now, on this page, there's something called --
13 there's a reference to, says LUN masking/zoning is configured
14 to be a CAPI using host WWNs. What is that about?

15 A. Well, WWNs stands for worldwide names. One of the, I
16 think, valuable features of the Fibre Channel technology is it
17 was specified such that each device in the world -- and there
18 might be millions of them -- will be given a unique identifier
19 that they call worldwide names so that you could always
20 distinguish a particular device from another device.

21 What the words mean here is that the router in
22 implementing and configuring one masking and zoning would use
23 the worldwide names of the computers attached to the Fibre
24 Channel side.

25 Q. Mr. Walker, what is CAPI?

09/05/2001 Chaparral Trial - Day 2

1 A. CAPI stands for configuration application programming
2 interface. But what that is is an interface, actually
3 multiple interfaces into the Chaparral products that allow
4 computers to be able to perform various functions including
5 configuration in setting up a LUN masking and zoning.

6 So it's designed in our product, specified interface
7 that we make available to our customers so that they can write
8 applications or other software to make our product do various
9 things.

10 Q. Mr. Walker, is CAPI a secret?

11 A. Not at all. CAPI is something that we actually greatly
12 encourage our customers to use, and the reason we do is one of
13 the weaknesses that Chaparral's products have always had is we
14 have never developed the application software that can reside
15 in a host computer and control and manage our product. Some
16 of our competitors have done that. And so, one of our
17 weaknesses is we haven't had the resources to develop that
18 software to manage our product.

19 So we encourage our customers to use CAPI, which is a
20 well-specified, defined interface, to allow them to write
21 applications to control, configure our product and add value
22 to the ultimate solution that they then sell to the end user.

23 Q. How do customers go about getting this CAPI?

24 A. They ask for it.

25 Q. Is that all?

09/05/2001 Chaparral Trial - Day 2

1 A. Any customer, the typical way it works is any customer
2 working with one of our salesmen or account managers,
3 typically, they worked with us, also, and we understand what
4 their requirements and needs are, and when we learn that they
5 want to add this kind of value by developing this software to
6 add value to their solutions, we freely provide them the CAPI
7 specification and the help they need to allow them to do that.

8 Q. All right, sir. Mr. Walker, you found out about the 972
9 patent in February of 2000, right?

10 A. That's correct.

11 Q. And you contacted Mr. Zinger, right?

12 A. Yes, immediately thereafter.

13 Q. Why did you pick him?

14 A. Mr. Zinger had been selected by Chaparral prior to us
15 learning of the Crossroads patent to do what they call
16 prosecute our own patents, which means when we have patentable
17 ideas, Mr. Zinger would work on them and file patent
18 applications for us.

19 So he was quite familiar with our products, had also
20 done patent work with other data storage companies and so was
21 very capable and competent in doing these kinds of things.

22 Q. And how long had the relationship existed with between
23 Chaparral and Mr. Zinger before he got sued?

24 A. I don't remember the exact amount of time. It probably
25 was six to nine months would be my guess. I'm not sure.

09/05/2001 Chaparral Trial - Day 2

1 Q. Six to nine months, surely Chaparral had selected Mr.
2 Zinger to do patent application work for it, right?

3 A. Yes.

4 Q. Do you know how that selection was done?

5 A. I made the selection personally based on recommendations
6 that I got from various people. I interviewed Mr. Zinger as
7 well as other potential IP attorneys.

8 Q. All right, sir. Now, in your notebook and I'm holding in
9 my hand are Mr. Zinger's opinions which are Defendant's
10 Exhibit 179, 180 and 181. Are these the -- all the written
11 opinions that you got from Mr. Zinger?

12 A. Those are the written opinions.

13 Q. Did you get any other opinions from Mr. Zinger?

14 A. We got many opinions from Mr. Zinger in terms of a
15 dialogue and discussions we were having with him.

16 Q. All right, sir. Now, based upon the written and oral
17 opinions that you got from Mr. Zinger, is it your belief today
18 that Chaparral products with LUN zoning infringe the 972
19 patent?

20 A. No.

21 Q. Is it your belief today that the 972 patent is valid?

22 A. No.

23 Q. Mr. Walker, after all you've been through in this case,
24 and if you find out about the 972 patent today -- let's say we
25 can erase all the way back to the beginning of February 2000,

09/05/2001 Chaparral Trial - Day 2

1 you find out about that 972 patent today, would you do
2 anything different?

3 A. No.

4 Q. Pass the witness.

5 MR. ALLCOCK: No further question.

6 THE COURT: You may step down, sir.

7 THE COURT: Members of the jury, I don't like the way
8 the sky looks, so I'm going to let y'all slip off and beat the
9 downtown traffic. I think the rains are supposed to calm down
10 during the night, and I think tomorrow is supposed to be a lot
11 better. But I do check with the weather, and I guess it's the
12 same thing all the time.

13 We've got flash floods and warnings and all that. So
14 be careful going home, but I'm going to recess a little early
15 today so you could get home. But I would like to start at
16 8:30 in the morning. Anybody have any problems with that?
17 All right. Please remember the instructions and be careful
18 going home.

19 (Jury not present.)

20 THE COURT: Actually, counsel, we're supposed to also
21 receive very heavy thunderstorms, but I figured most of you
22 can get your own way.

23 When you get cleaned up, I'd like to see counsel in
24 chambers. Recess till 8:30.

25 (Proceedings adjourned.)

**CROSSROADS VS. PATHLIGHT
PLAINTIFF'S REVISED TRIAL EXHIBIT LIST**

| TRIAL EX. NO. | DEPO EX. NO. | BATES RANGE | DATE | DESCRIPTION | OBJECTIONS | OFFERED | ADMITTED |
|---------------|---|---|-------------|--|--------------------|---------|-----------------|
| P-1 | N/A for certified; uncert. Is Exh. 2. To Hodges Expert Report | N/A | 8/24/99 | U. S. Patent No. 5,941,972 to Hoese (certified copy) | | | Admitted 6/6/01 |
| P-2 | N/A | N/A | Pre-8/24/99 | File Wrapper for U. S. Patent No. 5,941,972 (certified copy) | | | |
| P-3 | N/A | N/A | 4/27/01 | Declaration of Geoff Hoese in Support of Crossroads' Opposition to Pathlight's Motion for Summary Judgment | Hearsay; relevance | | |
| P-4 | Hoese Exhibit 2 | CRDS 40807 - CRDS 40823 | 6/19/96 | PowerPoint Presentation: Verrazano FC-SCSI Bridge Product Overview | | | |
| P-5 | Hoese Exhibit 3 | CRDS 40925 - CRDS 40958 (mixed pages) | 9/10/96 | Confidential Document: Verrazano Software Development | | | |

249

Gray Cary/SDV\447270.1
103671-160174

| TRIAL EX. NO. | DEPO EX. NO. | BATES RANGE | DATE | DESCRIPTION | OBJECTIONS | OFFERED | ADMITTED |
|---------------|--------------------|----------------------------------|---------|---|-----------------------|---------|--------------------|
| P-6 | Hoese Exh. 4 | CRDS 39727 - CRDS 39758 | 1/22/97 | Verrazano System Structure | | | |
| P-7 | Hodges Exh. 5 | CRDS 40510 - CRDS 40512 | 5/28/97 | Fax from Geoff Hoese to Anthony Peterman enclosing Conception of Invention | Hearsay; relevance | | Admitted 6/6/01 |
| P-8 | Rahmani Exh. 37 | PTI 007775 - PTI 007780 | 3/30/99 | ITL Access Control Design Specification | | | |
| P-9 | Rahmani Exh. 38 | PTI 008287 - PTI 008291 | 4/19/99 | ITL Access Control - Requirement Specification Version 1.03 | | | |
| P-10 | Rahmani Exh. 39 | PTI 007771 - PTI 007774 | 9/7/99 | ITL Access Control (IAC) Requirement Specification | | | |
| P-11 | Rahmani Exhibit 43 | PTI 064685 - PTI 064689 | 9/7/99 | Email from Said Rahmani to Peter Passeretti dated 9/7/99 with attachments | | | |
| P-12 | Rahmani Exhibit 50 | PTI 064243 - PTI 064288 | 3/21/99 | Powerpoint Presentation: SAN Solutions: Overall Comparison of Three SAN Solutions | | | |
| P-13 | Rahmani Exhibit 54 | PTI 126760 - PTI 126773 | 2/28/00 | Powerpoint Presentation: Pathlight Enterprise SAN Demonstration | | | |
| P-14 | Rahmani Exh. 55 | PTI 007854 - PTI 007899 | 1998 | SAN Gateway Remote Management and Configuration Guide Version 1.11 | | | |

| TRIAL EX. NO. | DEPO EX. NO. | BATES RANGE | DATE | DESCRIPTION | OBJECTIONS | OFFERED | ADMITTED |
|---------------|------------------------|----------------------------|----------------|---|------------------------|---------|-----------------|
| P-15 | Rahmani Exh. 62 | PTI 065368 - PTI 065479 | 1999 | IBM Publication: Installation and User's Guide 2108 Model G07 | | | |
| P-16 | Rahmani Exhibit 64 | PTI 064329 - PTI 064330 | 3/6/99 | Powerpoint Presentation: Storage Area Networking IP Protection | | | |
| P-17 | Rahmani Exh. 76 | N/A | 1999 | Pathlight SAN Gateway Service Guide Version 2.02 | | | |
| P-18 | Rahmani Exh. 78 | N/A | 1999 | Pathlight SAN Router Installation and User's Guide Version 2.00 | | | |
| P-19 | Rahmani Exh. 79 | PTI 165062 - PTI 165243 | 2000 | Pathlight SAN Router Installation & User's Guide | | | |
| P-20 | Rahmani Exh. 80 | PTI 164348 - PTI 164531 | 1999 | Pathlight SAN Gateway Installation and User's Guide Version 2.02 | | | |
| P-21 | Rahmani/Keiler Exh. 85 | PTI 165032 - PTI 165243 | 2000 | Pathlight SAN Router Installation and User's Guide Version 2.04 | | | |
| P-22 | Rahmani Exh. 88 | PTI 167074 - PTI 167293 | 8/00 | SAN Gateway Installation and User's Guide Version 2.04, August 2000 | | 6/7/01 | Admitted 6/7/01 |
| P-23 | Rahmani Exh. 89 | PTI 165032 - PTI 165243 | 8/00 | SAN Router Installation and User's Guide Version 2.04, September 2000 | | 6/7/01 | Admitted 6/7/01 |
| P-24 | Flamm Exh. 6 (partial) | N/A | Printed 2/2/01 | CD ROM of the Pathlight Web Site | Hearsay; relevance/403 | 6/7/01 | Admitted 6/7/01 |

| TRIAL EX. NO. | DEPO EX. NO. | BATES RANGE | DATE | DESCRIPTION | OBJECTIONS | OFFERED | ADMITTED |
|---------------|---------------|----------------------------------|---------|--|---------------------------|---------|----------|
| P-25 | Regan Exh. 2 | CRDS 63593 - CRDS 63594 | Undated | Product Gross Margin chart | | | |
| P-26 | Regan Exh. 3 | CRDS 63595 - CRDS 63597 | Undated | Product ASP chart | | | |
| P-27 | Regan Exh. 4 | CRDS 63598 - CRDS 63600 | Undated | Product Cost chart | | | |
| P-28 | Regan Exh. 5 | N/A | Undated | Crossroads Systems vs. Pathlight Technology Sales Information from 11/1/99 through 1/31/01 | | | |
| P-29 | Regan Exh. 6 | CRDS 51873 - CRDS 51977 | 7/00 | Crossroads Systems, Inc. Financial Reporting Package, July 2000 (Fiscal Q3, '00) | | | |
| P-30 | Regan Exh. 7 | PTI 048416 | 8/99 | OEM Price List (August 1999) | | | |
| P-31 | Regan Exh. 8 | CRDS 63590 - CRDS 63592 | 3/30/01 | Crossroads Systems, Inc. Hewlett-Packard - Total Historical Revenue & Units | | | |
| P-32 | Hood Exh. 109 | PTI 169581 - PTI 169646 | 1/01 | Amendment and Plan of Merger among ADIC, Ptech Acquisition, Inc. and Pathlight | Hearsay; relevance/403 | | |

| TRIAL EX. NO. | DEPO EX. NO. | BATES RANGE | DATE | DESCRIPTION | OBJECTIONS | OFFERED | ADMITTED |
|---------------|---------------|----------------------------|-----------------------|---|---------------|----------|-------------------|
| P-33 | Hood Exh. 110 | PTI 170791 - PTI 170970 | 2/14/01 | Securities and Exchange Commission Form S-4 filed by Advanced Digital Information Corporation | Relevance/403 | | |
| P-34 | Hood Exh. 111 | PTI 170971 - PTI 171039 | 1/30/01 | Securities and Exchange Commission For 8-K pertaining to ADIC | Relevance/403 | | |
| P-35 | Hood Exh. 114 | PTI 169664 - PTI 169748 | Undated | Database of VPS License Key Activation for IBM SAN Gateway's manufacturing | | | |
| P-36 | Hood Exh. 115 | PTI 169647 - PTI 169655 | 2/15/01 | New database listing of customers and software features activated by license key | | | |
| P-37 | Hood Exh. 116 | PTI 169656 - PTI 169663 | 12/8/99 - 12/13/00 | Database used to track issuing of license keys for software options for customers | | | |
| P-38 | Hood Exh. 119 | PTI 169749 - PTI 169883 | 2/5/01 | Pathlight Sales, Order and Backlog Reports | | | |
| P-39 | Smith Exh. 4 | CRDS 52581 - CRDS 52641 | 4/26/97 | OEM License and Purchase Agreement Between Crossroads and Hewlett-Packard | | 06/06/01 | Admitted 06/06/01 |
| P-40 | Smith Exh. 6 | CRDS 02273 - CRDS 02290 | 4/15/98 | Hewlett-Packard SSD and Crossroads CP4200 License Agreement | | 06/06/01 | Admitted 06/06/01 |

| TRIAL EX. NO. | DEPO EX. NO. | BATES RANGE | DATE | DESCRIPTION | OBJECTIONS | OFFERED | ADMITTED |
|---------------|--------------------------------|----------------------------|----------|---|------------|----------|-------------------|
| P-41 | Smith Exh. 7 | CRDS 29603 - CRDS 29646 | 9/22/98 | Purchase and License Agreement Between Hewlett-Packard and Crossroads | | 06/06/01 | Admitted 06/06/01 |
| P-42 | Flamm Exh. 5 (Livolsi Exh. 16) | CRDS 39764 - CRDS 39788 | 2/7/00 | SWOT Analysis | Hearsay | | |
| P-43 | Flamm Exh. 7 | N/A | 4/20/00 | Memo from Randy Hood to Jan White re VPS client software license | | | |
| P-44 | Flamm Exh. 8 | N/A | Undated | Handwritten calculation | | | |
| P-45 | N/A | PTI 82750 - PTI 82871 | 4/21/98 | IBM's Request for Proposal to Pathlight | | | |
| P-46 | N/A | PTI 173350 - PTI 173369 | 3/12/01 | Summary - Sales, Orders and Backlog Report | | | |
| P-47 | N/A | PTI 047912 - PTI 047913 | 9/29/99 | Email from James Watson to IBM | | | |
| P-48 | N/A | PTI 047939 - PTI 047950 | 9/29/99 | Fax from James Watson to Randy Hood enclosing documents pertaining to IBM and VPS | | | |
| P-49 | N/A | PTI 047865 - PTI 047867 | 11/24/99 | Fax from Randy Hood to Hank Watson enclosing VPS quotation to IBM | | 6/6/01 | Admitted 6/7/01 |
| P-50 | N/A | PTI 048566 - PTI 048569 | Undated | Vicom White Paper: Comparing Crossroads, Pathlight, and SLIC | Hearsay | | |

| TRIAL EX. NO. | DEPO EX. NO. | BATES RANGE | DATE | DESCRIPTION | OBJECTIONS | OFFERED | ADMITTED |
|---------------|-----------------------|----------------------------------|----------|--|------------|----------|----------------------|
| P-51 | N/A | PTI 048393 - PTI 048398 | Undated | Pathlight Marketing Document (discusses VPS) | | | |
| P-52 | N/A | CRDS 22345 - CRDS 22346 | 2000 | Charts pertaining to Competition | Hearsay | | |
| P-53 | N/A | CRDS 39765 - CRDS 39773 | 2/7/00 | Competitive Snapshots | Hearsay | | |
| P-54 | N/A | CRDS 63620 - CRDS 63623 | 6/23/00 | Amendment to Licensing Agreement By and Between Hewlett-Packard and Crossroads Systems, Inc. | | 06/06/01 | Admitted 06/06/01 |
| P-55 | N/A | PTI 183455 - PTI 183558 | | Documents produced by Pathlight on 5/15/01 | | | |
| P-56 | Rahmani Exh. 65 | PTI 165498 - PTI 165425 | 10/23/00 | Billing statement from Salzman & Levy | | | |
| P-57 | Rahmani Exh. 66 | PTI 165706 | 12/23/99 | 12/23/99 Handwritten notes | | | |
| P-58 | Rahmani Exhibit 67 | PTI 165428 - PTI 165429 | Undated | Document entitled "Response to Crossroads '972 Patent" | | | |
| P-59 | Rahmani Exh. 68 | PTI 165658 - PTI 165659 | 2/25/00 | 2/25/00 Email from Rahmani to Mark DeWilde re Crossroads Opinion Documentation | | | |

| TRIAL EX. NO. | DEPO EX. NO. | BATES RANGE | DATE | DESCRIPTION | OBJECTIONS | OFFERED | ADMITTED |
|---------------|---------------------|----------------------------|----------|--|------------|---------|-----------------|
| P-60 | Rahmani Exh. 69 | PTI 165663 - PTI 165665 | 2/24/00 | Document entitled "Crossroads Patent Opinion Documentation, Thursday, February 24, 2000", with handwritten notes | | | |
| P-61 | Rahmani Exh. 70 | PTI 165660 - PTI 165662 | 2/26/00 | Document entitled "Crossroads Patent Opinion Documentation, Thursday, February 24, 2000" | | | |
| P-62 | Rahmani Exh. 71 | PTI 165684 | 3/31/00 | 2/26/00 Email from Rahmani to Mark DeWilde and Salzman & Levy re patent issues | | | |
| P-63 | Rahmani Exh. 74 | PTI 165685 | 4/6/00 | Email from Greg Prestas to Mark DeWilde and Salzman & Levy re Storage Router definition | | | |
| P-64 | Rahmani Exh. 95 | PTI 167772 - PTI 167774 | 2/24/00 | Crossroads Patent Opinion Documentation dated 2/24/00 | | | |
| P-65 | Rahmani Exh. 100 | PTI 167669 | 2/28/00 | 2/28/00 Email from Mark DeWilde to Frank Hopkins | | | |
| P-66 | Rahmani Exh. 101 | PTI 167770 | 2/25/00 | 2/25/00 Email from Said Rahmani to Mark DeWilde | | | |
| P-67 | Rahmani Exh. 102 | PTI 167776 | 4/4/00 | 4/4/00 Email from Said Rahmani to Mark DeWilde and Greg Prestas | | | |
| P-68 | Rahmani Exhibit 104 | PTI 167809 | 11/15/99 | Email from Mark DeWilde to Patents | | 6/7/01 | Admitted 6/7/01 |
| P-69 | Rahmani Exhibit 105 | PTI 167810 | 11/18/99 | Email from Said Rahmani to Patents | | 6/7/01 | Admitted 6/7/01 |

| TRIAL EX. NO. | DEPO EX. NO. | BATES RANGE | DATE | DESCRIPTION | OBJECTIONS | OFFERED | ADMITTED |
|---------------|--------------------------------|-------------------------------|----------|---|------------|---------|-----------------|
| P-70 | Levy/ Rahmani Exhibit 81 | PTI 165433 - PTI 165614 | 4/10/00 | Opinion letter of Mark Levy, Esq. | | 6/7/01 | Admitted 6/7/01 |
| P-71 | N/A | PTI 167665 - PTI 167666 | 2/25/00 | Email from Mark DeWilde to Said Rahmani re Crossroads Opinion Documentation | | | |
| P-72 | N/A | PTI 167811 | 11/19/99 | Email from Mark DeWilde to Patents | | | |
| P-73 | N/A | PTI 167812 | 11/19/99 | Email from Mark DeWilde to Patents | | | |
| P-74 | N/A | PTI 167813 - PTI 167858 | 2/24/00 | Email from Mark DeWilde to Mark Levy with attachments | | | |
| P-75 | N/A | PTI 167667 - PTI 167668 | 2/25/00 | Email from Said Rahmani to Mark DeWilde | | 6/7/01 | Admitted 6/7/01 |
| P-76 | N/A | PTI 167775 | 4/6/00 | Email from Prestas to Patents | | | |
| P-77 | N/A | N/A | 7/26/00 | Pathlight's Original Answers to Crossroads' First Set of Interrogatories (1 - 5) | | | |
| P-78 | N/A | N/A | 1/4/01 | Pathlight's Original Answers to Crossroads' Second Set of Interrogatories (6) | | | |
| P-79 | N/A | N/A | 3/9/01 | Pathlight's Original Answers to Crossroads' Third Set of Interrogatories (7 - 13) | | | |
| P-80 | N/A | N/A | 3/9/01 | Pathlight's Answers to Crossroads' Request for Admissions (1 - 20) | | | |

| TRIAL EX. NO. | DEPO EX. NO. | BATES RANGE | DATE | DESCRIPTION | OBJECTIONS | OFFERED | ADMITTED |
|---------------|--------------|-------------|---------|--|--------------------|---------|----------|
| P-81 | N/A | N/A | 5/8/01 | Pathlight's Supplemental Answers to Crossroads' Interrogatory Nos. 1 - 7 and 9 | | | |
| P-82 | N/A | N/A | 5/8/01 | Crossroads' Supplemental Answers to Pathlight's Interrogatory Nos. 2 - 10 | | | |
| P-83 | N/A | N/A | 4/6/01 | Pathlight Technology, Inc.'s Motion for Summary Judgment of Invalidity and Brief in Support Thereof, with attached exhibits | Hearsay; relevance | | |
| P-84 | N/A | N/A | 4/27/01 | Crossroads' Opposition to Pathlight's Motion for Summary Judgment of Invalidity and Brief in Support Thereof, with exhibits | Hearsay; relevance | | |
| P-85 | N/A | N/A | 5/8/01 | Defendant Pathlight Technology Inc.'s Reply to Crossroads' Opposition to Pathlight's Motion for Summary Judgment of Invalidity | Hearsay; relevance | | |
| P-86 | N/A | N/A | 5/14/01 | Order Denying Pathlight's Motion for Summary Judgment | Hearsay; relevance | | |
| P-87 | N/A | N/A | 6/19/00 | Crossroads' Preliminary Statement | Hearsay; relevance | | |
| P-88 | N/A | N/A | 6/19/00 | Pathlight's Preliminary Statement | Hearsay; relevance | | |
| P-89 | N/A | N/A | 7/11/00 | Crossroads' Markman Brief | Hearsay; relevance | | |

| TRIAL EX. NO. | DEPO EX. NO. | BATES RANGE | DATE | DESCRIPTION | OBJECTIONS | OFFERED | ADMITTED |
|---------------|--|-------------|---------|--|---|---------|----------|
| P-90 | N/A | N/A | 7/11/00 | Pathlight's Markman Brief | Hearsay; relevance | | |
| P-91 | Hodges Exh. 3; also Exh. 4 to Hodges Expert Report | N/A | 7/27/00 | Markman Order | Hearsay; relevance (Agree to introduction of actual claim construction) | | |
| P-92 | Hodges Exh. 1 | N/A | 3/12/01 | Expert Report of Paul Hodges, Ph.D., with attached exhibits 1 - 20 (includes screenshots) (exhibits are listed separately) | Agreement b/w parties to not introduce; hearsay | | |
| P-93 | Hodges Exh. 4 | N/A | 3/26/01 | Rebuttal Report of Paul Hodges, Ph.D. | Agreement b/w parties to not introduce; hearsay | | |
| P-94 | Regan Exh. 1 | N/A | 3/13/01 | Expert Report of D. Paul Regan, CPA, CFE, including all exhibits thereto and documents cited therein | Agreement b/w parties to not introduce; hearsay | | |
| P-95 | Kuffner Exh. 1 | N/A | 3/12/01 | Expert Report of Kenneth E. Kuffner, including all exhibits attached thereto and documents cited therein | Agreement b/w parties to not introduce; hearsay | | |
| P-96 | Kuffner Exh. 2 | N/A | 3/26/01 | Supplemental Report of Kenneth E. Kuffner | Agreement b/w parties to not introduce; hearsay | | |

| TRIAL EX. NO. | DEPO EX. NO. | BATES RANGE | DATE | DESCRIPTION | OBJECTIONS | OFFERED | ADMITTED |
|---------------|-----------------|-------------------------|---------|---|---|---------|----------|
| P-97 | Stephens Exh. 1 | N/A | 3/13/01 | Expert Report of Gary R. Stephens, including all documents cited therein | Agreement b/w parties to not introduce; hearsay | | |
| P-98 | Stephens Exh. 2 | N/A | 3/26/01 | Rebuttal Report of Gary R. Stephens, including all documents cited therein | Agreement b/w parties to not introduce; hearsay | | |
| P-99 | Berg Exh. 3 | N/A | 3/13/01 | Expert Report of Brian Berg, with exhibits 1 - 7 and including all documents therein | Agreement b/w parties to not introduce; hearsay | | |
| P-100 | Flamm Exh. 1 | N/A | 3/26/01 | Expert Report of Kenneth Flamm, including all documents cited therein and with exhibits 1 - 9 | Agreement b/w parties to not introduce; hearsay | | |
| P-101 | N/A | N/A | 4/9/01 | Pathlight's 35 U.S.C. § 282 Notice | Relevance | | |
| P-102 | N/A | N/A | 5/14/01 | Pathlight's Supplemental 35 U.S.C. § 282 Notice | Relevance | | |
| P-103 | Hodges Exh. 6 | N/A | 6/16/98 | U. S. Patent No. 5,768,623 to Judd | | | |
| P-104 | Smith Exh. 24 | CRDS 08556 - CRDS 08557 | 7/12/96 | Letter from Clarion to Brian Smith | | | |

| TRIAL EX. NO. | DEPO EX. NO. | BATES RANGE | DATE | DESCRIPTION | OBJECTIONS | OFFERED | ADMITTED |
|---------------|--------------------------------|-------------------------|-------------|---|--|---------|----------|
| P-105 | Smith Exh. 25 | CRDS 08558 - CRDS 08555 | 7/22/96 | Fax enclosing Data General/Clarion Purchase Order | | | |
| P-106 | N/A | CRDS 13635 - CRDS 13653 | 1996 - 1997 | Group of Clarion Emails | | | |
| P-107 | Exh. 1 to Hodges Expert Report | N/A | Undated | Curriculum Vitae of Dr. Hodges | Agreement that will only object if not allowed to jointly introduce CV for Stephens; hearsay | | |
| P-108 | Exh. 5 to Hodges Expert Report | N/A | | Photographs of Pathlight SAN Router | | | |
| P-109 | Exh. 6 to Hodges Expert Report | N/A | | Photographs of SAN Gateway (IBM Version) | | | |
| P-110 | Exh. 7 to Hodges Expert Report | N/A | | Screen Shots from Left Gateway (Test 1, SAN Gateway, IBM version) LeftG01 through LeftG41 | Demonstrative o.k.; hearsay if introduced | | |
| P-111 | Exh. 8 to Hodges Expert Report | N/A | | Screen shots from Right computer (Test 1, SAN Gateway, IBM version) RightG01 through RightG21 | Demonstrative o.k.; hearsay if introduced | | |

| TRIAL EX. NO. | DEPO EX. NO. | BATES RANGE | DATE | DESCRIPTION | OBJECTIONS | OFFERED | ADMITTED |
|---------------|---------------------------------|-------------|------|---|---|---------|----------|
| P-112 | Exh. 9 to Hodges Expert Report | N/A | | Screen Shots from Left computer (Test 2, SAN Gateway, IBM version) LeftG42 through LeftG53 | Demonstrative o.k.; hearsay if introduced | | |
| P-113 | Exh. 10 to Hodges Expert Report | N/A | | Screen shots from Right computer (Test 2, SAN Gateway, IBM version) RightG22 through RightG33 | Demonstrative o.k.; hearsay if introduced | | |
| P-114 | Exh. 11 to Hodges Expert Report | N/A | | Screen Shots from Left computer (Test 3, SAN Gateway, IBM version) LeftG54 through LeftG60 | Demonstrative o.k.; hearsay if introduced | | |
| P-115 | Exh. 12 to Hodges Expert Report | N/A | | Screen shots from Right computer (Test 3, SAN Gateway, IBM version) RightG34 through RightG40 | Demonstrative o.k.; hearsay if introduced | | |
| P-116 | Exh. 13 to Hodges Expert Report | N/A | | Screen Shots from Left computer (Test 4, SAN Router) SANLeft01 through SANLeft30 | Demonstrative o.k.; hearsay if introduced | | |
| P-117 | Exh. 14 to Hodges Expert Report | N/A | | Screen shots from Right computer (Test 4, SAN Router) SANRight01 through SANRight15 | Demonstrative o.k.; hearsay if introduced | | |

| TRIAL EX. NO. | DEPO EX. NO. | BATES RANGE | DATE | DESCRIPTION | OBJECTIONS | OFFERED | ADMITTED |
|---------------|---------------------------------|-------------|------|--|---|---------|----------|
| P-118 | Exh. 15 to Hodges Expert Report | N/A | | Hyperterminal screen shots relating to a reboot of SAN Gateway (IBM Version) | Demonstrative o.k.; hearsay if introduced | | |
| P-119 | Exh. 16 to Hodges Expert Report | N/A | | Hyperterminal screen shots relating to VPS of SAN Gateway (IBM Version) | Demonstrative o.k.; hearsay if introduced | | |
| P-120 | Exh. 17 to Hodges Expert Report | N/A | | Hyperterminal screen shots relating to rescanning the SCSI bus of SAN Gateway (IBM Version) | Demonstrative o.k.; hearsay if introduced | | |
| P-121 | Exh. 18 to Hodges Expert Report | N/A | | Performance Tests/ Data of SAN Gateway (IBM version) | Demonstrative o.k.; hearsay if introduced | | |
| P-122 | Exh. 19 to Hodges Expert Report | N/A | | SYM53C876/876E Data Pages | | | |
| P-123 | Exh. 20 to Hodges Expert Report | N/A | | ISP2100, 2200 Data Pages | | | |
| P-124 | N/A | N/A | | Pathlight's SAN Gateway, including all hardware and software necessary to make it functional | | | |

| TRIAL EX. NO. | DEPO EX. NO. | BATES RANGE | DATE | DESCRIPTION | OBJECTIONS | OFFERED | ADMITTED |
|---------------|-----------------|----------------------------|---------|--|------------|---------|----------|
| P-125 | N/A | N/A | | Pathlight's SAN Router, including all hardware and software necessary to make it functional | | | |
| P-126 | N/A | N/A | | IBM's Storage Area Network Data Gateway, including all hardware and software necessary to make it functional | | | |
| P-127 | N/A | N/A | | Crossroads CP 4100 Product, including all hardware and software necessary to make it functional | | | |
| P-128 | N/A | N/A | | Crossroads CP 4400 Product, including all hardware and software necessary to make it functional | | | |
| P-129 | Rahmani Exh. 42 | PTI 039169 - PTI 039176 | Undated | Document Entitled "Introduction" | | | |
| P-130 | Hood Exh. 30 | PTI 048906 - PTI 048921 | 5/12/00 | Manufacturing Services Agreement between Pathlight and XeTel | | | |
| P-131 | Rahmani Exh. 40 | PTI 154501 - PTI 154516 | 1998 | SAN Gateway Firmware Overview, Major Components | Hearsay | | |
| P-132 | Rahmani Exh. 47 | PTI 155471 - PTI 155546 | 5/31/00 | IBM SAN Gateway Installation Cookbook (5/31/00 Draft Document) | | | |

| TRIAL EX. NO. | DEPO EX. NO. | BATES RANGE | DATE | DESCRIPTION | OBJECTIONS | OFFERED | ADMITTED |
|---------------|-----------------|-------------------------|----------|--|------------------------|---------|-----------------|
| P-133 | Rahmani Exh. 48 | PTI 149751 - PTI 149833 | 1999 | IBM Publication: IBM 2108 Model G07 San Data Gateway | | | |
| P-134 | Rahmani Exh. 75 | N/A | 1999 | Pathlight SAN Gateway Service Guide Version 2.01 | | | |
| P-135 | Walker Exh. 136 | CNS 173589 - CNS 173621 | 11/20/00 | Opinion Letter of David Zinger, Esq. | Hearsay; relevance | | |
| P-136 | N/A | CRDS 64417 - CRDS 64430 | 5/18/01 | Pages Printed from ADIC Web Site | Hearsay; relevance/403 | 6/7/01 | Admitted 6/7/01 |
| P-137 | Rahmani Exh. 72 | PTI 165641 - PTI 165657 | 3/31/00 | 3/31/00 Letter from Alan Albright to Gary Allison enclosing Crossroads complaint against Chaparral | | | |
| P-138 | N/A | CRDS 64431 | 5/21/01 | ADIC Press Release | Hearsay; relevance/403 | | |
| P-139 | Arroyo Exh. 3 | N/A | Undated | Printout of Arroyo's floppy drive disc drive directory | | | |
| P-140 | Arroyo Exh. 4 | CRDS 63362 - CRDS 63363 | Undated | Notes written by witness into computer file | | | |
| P-141 | Arroyo Exh. 5 | CRDS 63301 - CRDS 63331 | 1996 | Bridge.c code, copyright 1995, revised 1996 | | | Admitted 6/6/01 |

| TRIAL EX. NO. | DEPO EX. NO. | BATES RANGE | DATE | DESCRIPTION | OBJECTIONS | OFFERED | ADMITTED |
|---------------|-------------------------|---|---------|--|------------|---------|-----------------|
| P-142 | Arroyo Exh. 6 | CRDS 63334 - CRDS 63440 | 1996 | Bridge.c code, copyright 1995, revised 1996 | | | |
| P-143 | Arroyo Exh. 7 | CRDS 63498 - CRDS 63574 | 1996 | Bridge.c code, copyright 1995, revised 1996 | | | |
| P-144 | Arroyo Exh. 8 | CRDS 63441 - CRDS 63497 | 3/19/97 | Bridge.c code, further revised, 3/19/97 | | | |
| P-145 | Arroyo Exh. 9 | CRDS 63127.9729 G.1 - CRDS 63127.9729 G.107 | 9/18/97 | Bridge.c code, further revised, 9/18/97 | | | Admitted 6/6/01 |
| P-146 | N/A | PTI 49674 - PTI 49675 | Undated | PowerPoint Presentation entitled "Competition" | | | |
| P-147 | N/A | PTI 57537 - PTI 57599 | 5/12/00 | Competitive Analysis PowerPoint Presentation | | | |
| P-148 | Dunning Exh. 13 | HP 335 - HP 486 | 1997 | Hewlett-Packard Service and User Manual for Fibre Channel SCSI Multiplexer | | | |
| P-149 | Hood (2/22/01) Exh. 120 | PTI 169884 -PTI 170012 | 2000 | Pathlight Invoices (to customers purchasing Pathlight products) | | | |
| P-150 | Hood (9/7/00) Exh. 5 | PTI 056770 -PTI 056771 | 5/00 | Pathlight's OEM Price List (May 2000) | | | |

| TRIAL EX. NO. | DEPO EX. NO. | BATES RANGE | DATE | DESCRIPTION | OBJECTIONS | OFFERED | ADMITTED |
|---------------|-------------------------|-------------------------|---------|---|---------------------------------------|---------|-----------------|
| P-151 | Hood (12/12/00) Exh. 8 | PTI 049712 - PTI 049733 | 4/18/00 | 4/25/00 Email from James Watson to Terry Kelleher and Hank Watson re Quote for IBM on LVD | | 6/7/01 | Admitted 6/7/01 |
| P-152 | Hood (2/22/01) Exh. 113 | N/A | Undated | Untitled list of shareholders | Relevance | 6/7/01 | Admitted 6/7/01 |
| P-153 | N/A | N/A | 2/2/01 | Color Printout of CD ROM of the Pathlight Website | Relevance & Prej for ADIC. references | | |
| P-154 | N/A | PTI 165524 - PTI 165544 | 4/10/00 | Opinion Letter from Mark Levy, Esq. To Pathlight (clean copy) | | | |
| P-155 | N/A | PTI 124129 | 9/9/99 | Email from Said Rahmani to "Coreteam" | | | |
| P-156 | N/A | PTI 124120 | 9/2/99 | Email from Jeffrey Goldner to Said Rahmani re "Problems That Must Be Fixed or Verified" | | | |
| P-157 | N/A | PTI 093551 | 10/5/99 | Letter from Randy Hood to Richard Lamperd re Existing SAN Gateway upgrade quotation | | | |
| P-158 | N/A | PTI 165618 - PTI 165619 | 4/6/00 | Letter from Mark DeWilde to Mark and David re Crossroads' claims | | | |
| P-159 | Engelbrecht Exh. 2 | LSI 01421 - LSI 1658 | 1997 | Symbios Logic Software Interface Specification Series 3 SCSI RAID Controller Software Release 02.xx | | | |

| TRIAL EX. NO. | DEPO EX. NO. | BATES RANGE | DATE | DESCRIPTION | OBJECTIONS | OFFERED | ADMITTED |
|---------------|---------------------------------|-------------------------|---------|--|--------------------------------------|---------|----------|
| P-160 | Engelbrecht Exh. 9 | LSI 01853 - LSI 02040 | 9/96 | RAID Manager 5 With RDAC 5 For UNIX V.4 User's Guide | | | |
| P-161 | Exh. 3 to Hodges' Expert Report | N/A | N/A | Data CD Containing Snapshot of Pathlight Website | Relevance & Prej for ADIC references | | |
| P-162 | Sims Exh. 4 | CRDS 28244 - CRDS 28400 | 7/14/99 | PowerPoint Presentation: Organizational Meeting | | | |
| P-163 | LiVolsi Exh. 9 | CRDS 42968 - CRDS 43033 | 11/3/98 | Crossroads Presentation to Dell Computer | | | |
| P-164 | N/A | N/A | 4/14/00 | Plaintiff Crossroad Systems, (Texas), Inc.'s Original Complaint | Relevance; hearsay | | |
| P-165 | N/A | N/A | 9/15/00 | Plaintiff Crossroad Systems, (Texas), Inc.'s First Amended Complaint | Relevance; hearsay | | |
| P-166 | N/A | PTI 048829 | 5/4/00 | Letter from Randy Hood to Jan white re VPS client software license | | | |
| P-167 | N/A | PTI 049813 - PTI 049828 | 4/14/00 | Pathlight Statement Package, March 2000, Fiscal Year 2000 | | | |
| P-168 | N/A | PTI 049798 - PTI 049812 | 5/16/00 | Pathlight Statement Package, April 2000, Fiscal Year 2000 | | | |
| P-169 | N/A | N/A | 5/25/01 | CD ROM of the Crossroads Web Site | Hearsay | | |

| TRIAL EX. NO. | DEPO EX. NO. | BATES RANGE | DATE | DESCRIPTION | OBJECTIONS | OFFERED | ADMITTED |
|---------------|---|-------------|---------|--|--|---------|----------|
| P-170 | N/A | N/A | 5/25/01 | Supplemental Expert Report of D. Paul Regan, CPA, CFE, including revised Exhibit C | Not entered per agreement b/w parties; hearsay | | |
| P-171 | Graphic from Expert Report of Paul Hodges | N/A | 3/13/01 | Table 2: Pathlight Product Configuration(s) | Demonstrative o.k.; hearsay if evidence | | |
| P-172 | Graphic from Expert Report of Paul Hodges | N/A | 3/13/01 | Table 3: Equipment Used For Testing Pathlight Products | Demonstrative o.k.; hearsay if evidence | | |
| P-173 | Graphic from Expert Report of Paul Hodges | N/A | 3/13/01 | Table 4: Drive Identities | Demonstrative o.k.; hearsay if evidence | | |
| P-174 | Graphic from Expert Report of Paul Hodges | N/A | 3/13/01 | Table 5A: Test 1 | Demonstrative o.k.; hearsay if evidence | | |
| P-175 | Graphic from Expert Report of Paul Hodges | N/A | 3/13/01 | Table 5B: Test 1 (continued) | Demonstrative o.k.; hearsay if evidence | | |
| P-176 | Graphic from Expert Report of Paul Hodges | N/A | 3/13/01 | Table 6: Information and Menus Available/Test Setup | Demonstrative o.k.; hearsay if evidence | | |
| P-177 | Graphic from Expert Report of Paul Hodges | N/A | 3/13/01 | Table 7: Channel Zoning Drive Identities | Demonstrative o.k.; hearsay if evidence | | |

| TRIAL EX. NO. | DEPO EX. NO. | BATES RANGE | DATE | DESCRIPTION | OBJECTIONS | OFFERED | ADMITTED |
|---------------|---|-------------|---------|--|---|---------|----------|
| P-178 | Graphic from Expert Report of Paul Hodges | N/A | 3/13/01 | Table 8: Channel Zoning | Demonstrative o.k.; hearsay if evidence | | |
| P-179 | Graphic from Expert Report of Paul Hodges | N/A | 3/13/01 | Table 9: Local/Global Storage | Demonstrative o.k.; hearsay if evidence | | |
| P-180 | Graphic from Expert Report of Paul Hodges | N/A | 3/13/01 | Table 10A: SAN Router Drive Identities | Demonstrative o.k.; hearsay if evidence | | |
| P-181 | Graphic from Expert Report of Paul Hodges | N/A | 3/13/01 | Table 10B: Screen Shots From SAN Router | Demonstrative o.k.; hearsay if evidence | | |
| P-182 | Graphic from Expert Report of Paul Hodges | N/A | 3/13/01 | Screen Shot 1: Host Viewing SCSI Storage Devices ("LeftG12") | Demonstrative o.k.; hearsay if evidence | | |
| P-183 | Graphic from Expert Report of Paul Hodges | N/A | 3/13/01 | Graphs 1 - 4 | Demonstrative o.k.; hearsay if evidence | | |
| P-184 | Graphic from Expert Report of Paul Hodges | N/A | 3/13/01 | Figure 1: Block Diagram of SAN Gateway | Demonstrative o.k.; hearsay if evidence | | |

| TRIAL EX. NO. | DEPO EX. NO. | BATES RANGE | DATE | DESCRIPTION | OBJECTIONS | OFFERED | ADMITTED |
|---------------|---|-------------|---------|---|---|---------|----------|
| P-185 | Graphic from Expert Report of Paul Hodges | N/A | 3/13/01 | Screen Shot 2: Maintaining The Configuration of the Map (LeftG36) | Demonstrative o.k.; hearsay if evidence | | |
| P-186 | Graphic from Expert Report of Paul Hodges | N/A | 3/13/01 | Figure 3: Pathlight Web Site Excerpt Regarding Access Controls | Demonstrative o.k.; hearsay if evidence | | |
| P-187 | Graphic from Expert Report of Paul Hodges | N/A | 3/13/01 | Figure 4: VPS Access Controls (Annotated) | Demonstrative o.k.; hearsay if evidence | | |
| P-188 | Graphic from Expert Report of Paul Hodges | N/A | 3/13/01 | Computer code commands chart | Demonstrative o.k.; hearsay if evidence | | |
| P-189 | Graphic from Expert Report of Paul Hodges | N/A | 3/13/01 | Table 11: Claim Chart for Claims 2 – 14 | Demonstrative o.k.; hearsay if evidence | | |
| P-190 | Graphic from Expert Report of Paul Hodges | N/A | 3/13/01 | Figure 5: Channel Zoning | Demonstrative o.k.; hearsay if evidence | | |
| P-191 | Graphic from Expert Report of Paul Hodges | N/A | 3/13/01 | Screen Shot 3: Access Controls Via Channel Zoning (LeftG45) | Hearsay | | |

| TRIAL EX. NO. | DEPO EX. NO. | BATES RANGE | DATE | DESCRIPTION | OBJECTIONS | OFFERED | ADMITTED |
|---------------|---|-------------|----------|---|------------|---------|----------|
| P-192 | Graphic from Expert Report of Paul Hodges | N/A | 3/13/01 | Table 12: Conception Chart | | | |
| P-193 | N/A | N/A | N/A | SCSI Cable | | | |
| P-194 | N/A | N/A | N/A | Fibre Channel Cable | | | |
| P-195 | N/A | N/A | N/A | SCSI Disk Drives | | | |
| P-196 | N/A | N/A | 6/30/00 | Crossroads' First Notice of 30(b)(6) Deposition to Pathlight | Relevance | | |
| P-197 | N/A | N/A | 7/13/00 | Crossroads' Second Notice of 30(b)(6) Deposition to Pathlight | Relevance | | |
| P-198 | N/A | N/A | 10/26/00 | Crossroads' Third Notice of 30(b)(6) Deposition to Pathlight | Relevance | | |
| P-199 | N/A | N/A | 11/22/00 | Crossroads' Fourth Notice of 30(b)(6) Deposition to Pathlight | Relevance | | |
| P-200 | N/A | N/A | | Crossroads' Fifth Notice of 30(b)(6) Deposition to Pathlight | Relevance | | |
| P-201 | N/A | N/A | 2/9/01 | Crossroads' Sixth Notice of 30(b)(6) Deposition to Pathlight | Relevance | | |
| P-202 | N/A | N/A | 11/24/00 | Pathlight's First Request for Admissions (Nos. 1-19) | Relevance | | |
| P-203 | N/A | N/A | 1/5/01 | Crossroads' Responses to Pathlight's First Request for Admissions (Nos. 1-19) | | | |

| TRIAL EX. NO. | DEPO EX. NO. | BATES RANGE | DATE | DESCRIPTION | OBJECTIONS | OFFERED | ADMITTED |
|---------------|--------------|-------------|----------|---|------------|---------|----------|
| P-204 | N/A | N/A | 2/2/01 | Pathlight's Second Request for Admissions (Nos. 20-30) | Relevance | | |
| P-205 | N/A | N/A | 3/9/01 | Crossroads' Responses to Pathlight's Second Request for Admissions (Nos. 20-30) | | | |
| P-206 | N/A | N/A | 2/2/01 | Crossroads' Requests for Admissions to Pathlight (Set One) | Relevance | | |
| P-207 | N/A | N/A | 3/9/01 | Pathlight's Answers to Crossroads' Request for Admissions (Set One) | | | |
| P-208 | N/A | N/A | 4/17/00 | Crossroads' First Request for Production of Documents to Pathlight | Relevance | | |
| P-209 | N/A | N/A | 6/16/00 | Pathlight's Answers to Crossroads' First Request for Production of Documents | | | |
| P-210 | N/A | N/A | 9/18/00 | Crossroads' Second Request for Production of Documents to Pathlight | Relevance | | |
| P-211 | N/A | N/A | 10/26/00 | Pathlight's Answers to Crossroads' Second Request for Production of Documents | | | |
| P-212 | N/A | N/A | 2/2/01 | Crossroads' Third Request for Production of Documents to Pathlight | Relevance | | |
| P-213 | N/A | N/A | 3/9/01 | Pathlight's Answers to Crossroads' Third Request for Production of Documents | | | |
| P-214 | N/A | N/A | 6/26/00 | Crossroads' First Set of Interrogatories to Pathlight | Relevance | | |

| TRIAL EX. NO. | DEPO EX. NO. | BATES RANGE | DATE | DESCRIPTION | OBJECTIONS | OFFERED | ADMITTED |
|---------------|--------------|-------------|----------|---|------------|---------|----------|
| P-215 | N/A | N/A | 7/26/00 | Pathlight's Original Answers to Crossroads' First Set of Interrogatories | | | |
| P-216 | N/A | N/A | 11/22/00 | Crossroads' Second Set of Interrogatories to Pathlight | Relevance | | |
| P-217 | N/A | N/A | 1/4/01 | Pathlight's Original Answers to Crossroads' Second Set of Interrogatories | Relevance | | |
| P-218 | N/A | N/A | 2/2/01 | Crossroads' Third Set of Interrogatories to Pathlight | Relevance | | |
| P-219 | N/A | N/A | 3/9/01 | Pathlight's Original Answers to Crossroads' Third Set of Interrogatories | Relevance | | |
| P-220 | N/A | N/A | 6/20/00 | Pathlight's First Set of Interrogatories (Nos. 1-6) to Crossroads | Relevance | | |
| P-221 | N/A | N/A | 6/26/00 | Crossroads' Responses to Pathlight's First Set of Interrogatories (Nos. 1-6) | | | |
| P-222 | N/A | N/A | 11/24/00 | Pathlight's Second Set of Interrogatories (No. 7) to Crossroads | Relevance | | |
| P-223 | N/A | N/A | 1/5/01 | Crossroads' Responses to Pathlight's Second Set of Interrogatories (No. 7) | | | |
| P-224 | N/A | N/A | 3/9/01 | Crossroads' Supplemental Responses to Pathlight's Second Set of Interrogatories (No. 7) | | | |

| TRIAL EX. NO. | DEPO EX. NO. | BATES RANGE | DATE | DESCRIPTION | OBJECTIONS | OFFERED | ADMITTED |
|---------------|---|-------------------------------|---------|--|----------------------|---------|-----------------|
| P-225 | N/A | N/A | 2/2/01 | Pathlight's Third Set of Interrogatories (Nos. 8-16) to Crossroads | Relevance | | |
| P-226 | N/A | N/A | 3/9/01 | Crossroads' Responses to Pathlight's Third Set of Interrogatories (Nos. 8-16) | | | |
| P-227 | Hood Exh. 4 | PTI 054705 - PTI 055418 | 2000 | Pathlight's Financial Statement Package for Fiscal Year 2000 | | 6/7/01 | Admitted 6/7/01 |
| P-228 | N/A | N/A | 5/9/01 | Crossroads' Supplemental Responses to Chaparral's First Set of Interrogatories (Interrogatory No. 3) | | | |
| P-229 | Lavan Exh. 24 (Pltf. Exh. 214) | CNS 0045256 | | 5/16/00 Memo to Michael Gluck, et al., from Morris (Pltf. Exh. 214) | Relevance; prejudice | | |
| P-230 | Lavan Exh. 26 (Pltf. Exh. 216) | N/A | | User's Guide, G6322/G7324 (Pltf. Exh. 216) | Relevance; prejudice | | |
| P-231 | Levy Exh. 122 (portion of Court Exh. C) | PTI 173554 | 2/8/01 | Letter from Mark Levy to Mark DeWilde | | 6/7/01 | Admitted 6/7/01 |
| P-232 | Levy Exh. 123 (Court Exh. B) | PTI 171664 - PTI 171714 | 10/4/00 | Letter from Mark Levy to Mark DeWilde enclosing patent application documents | | 6/7/01 | Admitted 6/7/01 |
| P-233 | Levy Exh. 124 (portion of Court Exh. C) | PTI 173555 - PTI 173605 | 10/4/00 | Letter from Mark Levy to Mark DeWilde enclosing patent application documents | | | |

| TRIAL EX. NO. | DEPO EX. NO. | BATES RANGE | DATE | DESCRIPTION | OBJECTIONS | OFFERED | ADMITTED |
|---------------|---|----------------------------|---------------------|--|------------|---------|----------|
| P-234 | Levy Exh. 125 (portion of Court Exh. C) | PTI 173606 | 8/22/00 | Letter from David Banner to Mark DeWilde | | | |
| P-235 | N/A | PTI 183704 - PTI 183742 | 4/7/00 - 10/4/00 | Patent documents produced by Pathlight on 6/7/01 | | | |
| P-236 | N/A | N/A | | Chaparral's Original Responses to Crossroads' Second Set of Interrogatories (6/14) | | | |

09/04/2001 Chaparral Trial - Day 1

1 UNITED STATES DISTRICT COURT WESTERN DISTRICT OF TEXA
2 WESTERN DIVISION
3 CROSSROADS SYSTEMS,) Docket No. A 00-CA-217 SS (TEXAS), INC., A TE
4 CORPORATION)
5 vs.) Austin, Texas)
6 CHAPARRAL NETWORK) STORAGE, INC., A)
7 DELAWARE CORPORATION) September 4, 2001
8 TRANSCRIPT OF TRIAL ON THE MERITS
9 BEFORE THE HONORABLE SAM SPARKS Volume 1 of 6

10

11 APPEARANCES:

12 For the Plaintiff: Mr. Alan D. Albright
13 Mr. John Allcock
14 Mr. John Giust
15 401 B Street, Suite 1700
16
17 For the Defendant: Mr. David D. Bahler
18 Mr. Stephen D. Dellett
19 Fulbright & Jaworksi
20 Austin, Texas 78701
21 Court Reporter: Lily Iva Reznik, RPR, CRR
22 200 W. 8th Street
23 (512)916-5564

24

25 Proceedings recorded by mechanical stenography, transcript produced by c

09/04/2001 Chaparral Trial - Day 1

1
2
3
4
5
6
7
8
9
10
11
12
13
14
15
16
17
18
19
20
21
22
23
24
25

I N D E X

Page

| | |
|--------------------------------|-----|
| Jury Voir Dire | 11 |
| Plaintiff's Opening Statements | 58 |
| Defendant's Opening Statements | 87 |
| Proceedings Adjourned | 172 |

Direct Cross Redirect RecrossWitnesses:

| | | | | |
|-------------|-----|-----|--|--|
| Brian Smith | 110 | 127 | | |
|-------------|-----|-----|--|--|

09/04/2001 Chaparral Trial - Day 1

| | E X H I B I T S | | |
|----|--------------------------------------|---------|----------|
| | | Offered | Admitted |
| 1 | | | |
| 2 | | | |
| 3 | Plaintiff's | | |
| 4 | #1-2, 4-6, 8-9, 12-20, 22-30, 32-33, | 84 | 85 |
| 5 | 35-40, 41-42, 44-49, 50-62, 65-68, | 84 | 85 |
| 6 | 75-101, 104-113, 118-125, 127-137, | 84 | 85 |
| 7 | 139-144, 182, 200-202, 214-254, | 84 | 85 |
| 8 | 256-261, 278 | 84 | 85 |
| 9 | | | |
| 10 | Defendant's | | |
| 11 | #1-30 | 85 | 85 |
| 12 | #31 | 157 | 157 |
| 13 | #34-59, 62, 74, 78-79, 84, 99, | 85 | 85 |
| 14 | 104, 107-109, 111-122, 126-129, | 85 | 85 |
| 15 | 131, 133-168, 170-172, 174, | 85 | 85 |
| 16 | 179-181, 188, 190-232, 238-246, | 85 | 85 |
| 17 | 249, 253-271 | 85 | 85 |
| 18 | | | |
| 19 | | | |
| 20 | | | |
| 21 | | | |
| 22 | | | |
| 23 | | | |
| 24 | | | |
| 25 | | | |

09/04/2001 Chaparral Trial - Day 1

1 THE COURT: Call 00-CA-217, Crossroads Systems, Inc.
2 vs. Chaparral Network Storage, Inc. Anybody want to make an
3 announcement or you just want to sit there and look kind of
4 stupid?

5 MR. ALLCOCK: Morning, your Honor. John Allcock here
6 again, representing Crossroads.

7 THE COURT: All right.

8 MR. BAHLER: Dave Bahler, your Honor, representing
9 Chaparral.

10 THE COURT: All right, gentlemen. Are you ready to go
11 to trial?

12 MR. ALLCOCK: We are, your Honor.

13 MR. BAHLER: Yes, your Honor.

14 THE COURT: All right. Have you had time to review
15 the preliminary instructions I intend to read to the jury
16 after the jury is selected but this morning, before I recess
17 them, before you tear up my courtroom?

18 MR. BAHLER: Your Honor, we have. I have just a few
19 comments.

20 THE COURT: Be glad to hear them.

21 MR. BAHLER: Yes, of course. Page 2, the first full
22 paragraph, one, two, three, four, five, the sixth line. The
23 end of that line, it says, claimed invention that were
24 publicly known or I would add there, that were offered for
25 sale, comma, or publicly known or.

09/04/2001 Chaparral Trial - Day 1

1 THE COURT: That's fair. Publicly known or offered
2 for sale or used?

3 MR. BAHLER: Or used in a publicly accessible way,
4 yes.

5 THE COURT: All right.

6 MR. BAHLER: Second one, the next page, the third full
7 paragraph, fourth line. We are not pursuing enablement
8 anymore, so you can delete that they were not enabled.

9 THE COURT: Done.

10 MR. BAHLER: The line before that, it says that they
11 were anticipated by a prior art, semicolon, that they were,
12 quote, due to obviousness issues, should say that they were
13 invalid due to obviousness.

14 THE COURT: Well, I've already said that once in the
15 first part of the sentence. That's a series of things that
16 would make it invalid. That's why they invented a semicolon.

17 MR. BAHLER: Or that they were due to obviousness.
18 All right. That sounds fine. I guess that's misread.

19 The back of the line just below that, the last part
20 says, and they were enforceable due to inequitable conduct.
21 That should say, and they were unenforceable due to
22 inequitable conduct.

23 THE COURT: You're right on that one.

24 MR. BAHLER: The next, page four, the fourth line, it
25 says, if you decide that the claims had been infringed that

09/04/2001 Chaparral Trial - Day 1

1 they are not invalid and/or unenforceable, I think that should
2 -- we should add that there. We've got a double negative,
3 though.

4 THE COURT: That's because of the burden of proof.

5 MR. BAHLER: All right.

6 THE COURT: I don't think the jury will catch that.

7 MR. BAHLER: Yeah, I know. This is -- I'm sorry.

8 THE COURT: That's all right.

9 MR. BAHLER: I notice at the tail end of this you say,
10 now I believe you are ready for opening statements, but then,
11 on page 4, in the middle you say that this case will begin
12 this afternoon at 1:30.

13 THE COURT: No. I don't want to keep y'all on edge --

14 MR. BAHLER: Oh.

15 THE COURT: -- so you don't know when your opening
16 statements will be.

17 MR. BAHLER: I mean, 1:30 sounds doable, but it kind
18 of depends on what happens today.

19 THE COURT: I understand. It will be doable.

20 MR. BAHLER: Okay.

21 THE COURT: All right. Plaintiff.

22 MR. ALBRIGHT: Your Honor, if I followed what Mr.
23 Bahler was saying when he and you agreed to modify those
24 sections, offer for sale -- the offer for sale will be more --
25 there's a year grace period, so we offered for sale more than

09/04/2001 Chaparral Trial - Day 1

1 a year prior to the filing of the patent.

2 MR. BAHLER: Fine.

3 MR. ALBRIGHT: And, your Honor, that's all the
4 plaintiff has.

5 THE COURT: Year before the application?

6 MR. ALBRIGHT: Yes, sir, before the filing.

7 THE COURT: Okay. All right. I, frankly, don't know
8 if this will help or not, but I have been involved out at
9 Berkeley, only place in the world that hasn't changed since
10 1955, '56, and the people on the panels I was speaking, they
11 seem to know more than I did and they get these instructions,
12 they believe it helps. So we'll give our whirl.

13 What did you decide about statements during the trial?

14 MR. BAHLER: Your Honor, I considered that, and I
15 think I'd like to save that for the next trial.

16 THE COURT: All right. We'll play it straight down
17 the middle. All right. Anything else from the plaintiff?

18 MR. ALBRIGHT: Your Honor, one minor housekeeping
19 matter. It's my understanding that the defendant intends to,
20 not till this coming weekend, add some additional
21 demonstrative exhibits that they are going to present in the
22 case next week, and we believe that we should have those
23 demonstrative exhibits by sometime this week so that we can
24 adequately prepare.

25 We have provided all of our demonstrative exhibits for

1 the entire trial already as of this date.

2 MR. BAHLER: Your Honor, we are striving to get all
3 our demonstratives to them. They have an almost complete
4 supplement. We have some supplementation. We'll get them to
5 them by the end of this week.

6 THE COURT: See, all you had to do was ask him.

7 MR. BAHLER: We already told him.

8 THE COURT: See. That's what communication is. All
9 right. Anything else from the plaintiff? Anything from the
10 defendant?

11 MR. BAHLER: Your Honor, I have one issue. Alan, I'm
12 sorry. I should have brought this up. This deals with this
13 label issue. We plan to bring that label up during opening
14 statements. They've objected to the exhibits. This is
15 subject to their motion in limine.

16 THE COURT: I've overruled the motion in limine.

17 MR. BAHLER: Okay.

18 THE COURT: Have y'all gotten an order? I did exactly
19 what I told you I was going to do last week.

20 MR. ALBRIGHT: Your Honor, I don't know that we've
21 seen an order.

22 MR. BAHLER: I don't think we've seen an order.

23 MR. ALBRIGHT: We have not seen an order.

24 MR. BAHLER: So I don't know what to say.

25 THE COURT: I entered summary judgment orders Friday.

09/04/2001 Chaparral Trial - Day 1

1 MR. ALBRIGHT: And we --

2 THE COURT: Margaret, I know --

3 MR. ALBRIGHT: -- we misunderstood the Court's order
4 to be overruling our motion in limine with respect to that
5 issue. The only issue I think the Court left open that we
6 have not seen was with respect to the settlement from the last
7 case.

8 THE COURT: I have sustained that motion.

9 MR. ALBRIGHT: But you sustained the motion in limine?

10 THE COURT: Yes. Before you mention anything about a
11 settlement, you will approach the bench and tell me what and
12 why, and then, we'll make that decision. As in all my orders
13 on motion in limine, there is that little zinger at the bottom
14 that says this is not an order on admissibility. So the new
15 rules don't apply to me.

16 You have to make your objections as a real lawyer.
17 The only possible way that that could come in is on some sort
18 of notice theory. And I thought about that this afternoon --
19 in the second half of the ball game, because it wasn't much of
20 a ball game. I couldn't figure out any notice theory that I
21 would bring up or that I would allow a settlement and come in,
22 but my mind's open on it. You just don't mention it until you
23 approach the bench.

24 MR. ALBRIGHT: Yes, sir. Thank you, sir.

25 MR. BAHLER: That's it.

09/04/2001 Chaparral Trial - Day 1

1 THE COURT: I'll get you an order in just a second.

2 All right. Gentlemen, I will be just introducing, I
3 assume, Mr. Allcock and Mr. Bahler. You will introduce all
4 the rest.

5 MR. ALLCOCK: Yes, your Honor.

6 THE COURT: All right. If you'll have your witness
7 list available. That's the only work you'll get to do during
8 the voir dire. Counsel, after selection of the jury, too, I'm
9 just going to give them the converted verdict form that we
10 used in the last trial just like I said.

11 We may -- I may change my mind and use a verdict form
12 similar to the one requested by the plaintiff or the defendant
13 that has all of the claims down, but that looked a little more
14 complex. And I'm telling them that the verdict form may look
15 like this. So anybody has any objection, I'll be glad to hear
16 it now. I'll just show them the objections. I started to
17 even give them the definitions, but I think we're going to
18 give them about all they can digest right now.

19 But, anyway, the verdict form that I handed to you
20 last week is the verdict form I intend to give a copy to each
21 juror. Anybody have any objection?

22 MR. BAHLER: Your Honor, we had discussed in chambers
23 about modifying that verdict form to include this modified
24 product, original modified product.

25 THE COURT: All right. And I may do that at the end.

09/04/2001 Chaparral Trial - Day 1

1 MR. BAHLER: All right.

2 THE COURT: As a matter of fact, I think we'll
3 probably have to do that at the end if the evidence comes out.

4 MR. BAHLER: Okay.

5 THE COURT: This is just to give them an idea so
6 they'll have an idea.

7 MR. BAHLER: Your Honor, do you happen to have another
8 copy of that verdict form?

9 THE COURT: Oh, I'm sure we can get one for you. All
10 right, counsel. Just stand at ease until we have the panel
11 ready, I guess. Do you want to pre-admit any exhibits?

12 MR. ALBRIGHT: Your Honor, if you give us -- we'll
13 talk about that at lunch, and I think that we'd offer
14 pre-admitted exhibits.

15 MR. BAHLER: Not anything nobody's objected to.

16 MR. ALBRIGHT: That would be fine us with.

17 MR. BAHLER: We've cooperated with a bunch of
18 objections. And I think everything that's not objected to, we
19 could let in.

20 THE COURT: Get the numbers for the record, and then,
21 we'll do that and that will save some time.

22 MR. ALBRIGHT: Great. Thank you, your Honor.

23 (Jury venire present.)

24 JURY VOIR DIRE.

25 THE COURT: Hello, members of the jury panel. You'll

09/04/2001 Chaparral Trial - Day 1

1 be glad it's not raining, but they've got a 70 percent chance
2 now. Nobody's seen any rain since Thursday, Friday, some of
3 you last week.

4 How many of you were surprised to get our invitation?
5 Well, the service in federal court for jury has gone pretty
6 much along the congressional lines, so we have 16 counties in
7 the Austin Division. Many of you from as far as Brenham and
8 Junction in either side can be coming in.

9 It's not as bad as our Pecos Division. You can drive,
10 actually, 240 miles one way to the courthouse and back, and
11 because of the accommodations in Pecos and the fact that many
12 of those folks are ranchers, they drive every day, 480 miles a
13 day to serve the jury. So those of you who came in thought it
14 was a long route, be glad it's not Pecos.

15 We'll use our best organization during the time that
16 you're here to make sure that we don't waste your time. We
17 don't want you to waste your time because you are expensive.
18 Y'all cost the taxpayers probably \$4,500 today. So we try to
19 keep you down if you just listen to the instructions and call
20 on Fridays.

21 We have six federal judges here in Austin that try
22 cases, and we will need you when we're trying cases, but we
23 like to cut your numbers down when, all of a sudden, on
24 Friday, lawyers settle cases or cases go away. So when you
25 come, we can use your time efficiently.

09/04/2001 Chaparral Trial - Day 1

1 How many people have never been on jury service
2 before? Well, I'll tell you how things are going to go. In
3 just a minute, we're going to call 15 names, they'll be
4 selected from a computer. Show them our computer. Every one
5 of you has a name tag in there. Those of you who win at bingo
6 will be called first, generally.

7 But just because your name is not called, don't think
8 that you won't get on the jury panel because from time to
9 time, we will have to call another name. All of you have been
10 qualified to be jurors in the United States District Court,
11 but we have to determine whether you're qualified to be a
12 juror on this particular case.

13 I always use the example my father was an athlete at
14 the University of Texas. I went through school at the
15 University on scholarship. My four sons went there. And if I
16 were called to officiate at an A & M/Texas game, I think that
17 I probably would be better off yelling at the referees than
18 being one, so I would have to decline.

19 Some of you may have had life experiences that would
20 allow you to be the best jurors in one case but not a good
21 juror on another case. Another example that crops up
22 frequently is in the criminal field where a lot of people
23 think that marihuana ought to be legalized, but it is a
24 federal, federal felony, punishable by a penitentiary
25 sentence, to possess marihuana. And so, those folks sometimes

09/04/2001 Chaparral Trial - Day 1

1 don't want to serve on the jury.

2 But we've got a civil case today. The only problem
3 about the civil case is it's going to last two weeks. In
4 federal court, many of the times that our cases can last
5 months, but this is a two-week case. It's not as bad as it
6 sounds because any jury in a two-week case, you only work
7 Monday through Thursday so that you have one full day each
8 week to catch up and do the things that you need to do.

9 And since Monday was a holiday, this jury will work
10 Tuesday, Wednesday, Thursday, Monday, Tuesday, Wednesday of
11 next week. You'll be through next week. There won't be any
12 problem about your being through next week. But it will go
13 into next week.

14 And it's going to be an interesting case. It's a
15 patents case. Those of you who are selected, I think, will
16 find it very educational and enjoyable. Got good lawyers and
17 it will be progressed as we go. In federal court, unlike the
18 state court, the lawyers, each party has a time. Each side
19 has ten hours to present their evidence.

20 At the end of those ten hours apiece, the evidence is
21 over, doesn't make any difference where they are, although
22 they'll be through. They're used to that. And so, we know
23 exactly when the case will end and your deliberations will
24 begin.

25 Each of you are under oath. We have the

09/04/2001 Chaparral Trial - Day 1

1 questionnaires that you filled out. The lawyers have copies
2 of it, so a lot of information they have. I'll have some
3 questions to make sure you're qualified as a juror. If there
4 are any questions that you want to answer only in private, you
5 have that right. Just say, "I'd like to approach the bench."
6 I don't know when they called this big desk the bench. I've
7 heard a lot of stories, some of which I can't share with you.

8 But you could come up and answer the question over
9 here. The only problem is it's not really private. You can
10 see we're going to have twelve lawyers surrounding you, but
11 you can come up if you need to. None of the questions will be
12 asked in any way, shape or form to embarrass you, but simply
13 to make sure that the lawyers have sufficient information to
14 select from your number seven people to hear this case.

15 All right. So listen up. Now, when your name is
16 called, Mr. Mace, the gentleman over here, who runs the
17 courtroom, will show you where to sit. And then, if you have
18 to respond to any questions, it would be most helpful if you
19 would state your name each time and your number.

20 If you don't know your number, just let us know.
21 Melissa will give it to you. And that way, the Court Reporter
22 will identify each response that you make with your
23 appropriate name and number. That's what the lawyers are
24 having to use right now, forms with each of you on the number.
25 So if you'll do that, it would be helpful.

09/04/2001 Chaparral Trial - Day 1

1 Call the names of the panel.

2 MS. HAJDA: Juror No. 39, Carol Spreen.

3 THE COURT: There is no trophy for being first.

4 MS. HAJDA: No. 4, Joan Morgan, No. 80, Kristen
5 Wierzowiecki, No. 55, Sheila Lankford, No. 70, Robert Hyman,
6 No. 82, Jody Peterson, No. 74, Rob Steele, No. 26, Naomi
7 Jenkins, No. 51, Douglas Duncan, No. 68, Mae Lebeau, No. 36,
8 Jerome Gooch, No. 43, Laura Bost, No. 48, Karen Dillender, No.
9 93, Dennis Case, and No. 57, Alexander Barrientes.

10 THE COURT: Now, all of those of you whose name
11 Melissa screwed up, raise your right hand. Two. She's
12 getting better. Over the years, she's getting better.

13 This case, as I indicated, will last today, tomorrow
14 and Thursday and probably Monday, Tuesday and Wednesday, maybe
15 Thursday, depends on the deliberation. It will not go further
16 than Friday of next week. Now, it may go into Friday, but I
17 don't have a crystal -- well, I do. A fella gave me a crystal
18 ball, and I look at it and everything's upside down. I can't
19 ever tell anything about it one way or the other. But you'll
20 be through in two weeks.

21 Now, is there anything, for whatever reason, valid
22 reason, medical, somebody has a medical appointment or
23 children, or parents, or that type of thing that you just
24 wouldn't be able to serve those two weeks? All right. We'll
25 start with you, ma'am. If you tell me your name.

09/04/2001 Chaparral Trial - Day 1

1 THE JUROR: Sheila Lankford. I'm Juror No. 55. I
2 just had cancer surgery. I'm sole caretaker of my mother,
3 who's 84, and my father --

4 THE COURT: I'm going to excuse you. All you had to
5 do was make that telephone call that -- she's not near as mean
6 as she looks -- and we would have been able to save you some
7 time. So I'll excuse you and you may have a seat back over
8 there, please, ma'am.

9 THE JUROR: Thank you. Yes, ma'am.

10 THE JUROR: I'm Kristen Wierzowiecki, No. 80, I
11 believe. I actually start school on Monday, and I am a single
12 mom.

13 THE COURT: Okay. What school -- do your children
14 start school or you start school?

15 THE JUROR: No. I start school.

16 THE COURT: What school is that?

17 THE JUROR: It's in Round Rock, cosmetology school.

18 THE COURT: Okay. All right. I'll excuse you.

19 THE JUROR: Okay.

20 THE COURT: I saw another hand. Yes, ma'am.

21 THE JUROR: Naomi Jenkins.

22 THE COURT: Don't think I'm easy.

23 THE JUROR: Juror No. 26. I am the care provider for
24 my father who has a doctor's appointment on Friday. If this
25 isn't on Friday, then that won't matter. I also have three

09/04/2001 Chaparral Trial - Day 1

1 small children that I will have to put in daycare to cooperate
2 with the jury duty. Two weeks is quite a lengthy time to --
3 for that expense.

4 THE COURT: So you live in Round Rock?

5 THE JUROR: Yes, I do.

6 THE COURT: Child care people love to cooperate with
7 me --

8 THE JUROR: Okay.

9 THE COURT: -- because we tell them, you know, we love
10 to cooperate with you because you're down here serving your
11 country --

12 THE JUROR: Okay.

13 THE COURT: -- and they don't like it, they could come
14 down here, too. And they generally just love to cooperate.
15 So I didn't think there's going to be a problem. Friday,
16 you'll be able to take your dad to the doctor.

17 THE JUROR: Thank you.

18 THE COURT: All right. Yes, ma'am. Did you have your
19 hand up?

20 THE JUROR: I'm Mae Lebeau. I'm juror No. 68. I
21 would love to serve, but right now, I'm caretaker of my
22 mother. My father just passed, and I'm sole provider and
23 caretaker of my mother who's ill.

24 THE COURT: All right. I will excuse you, Ms. Lebeau.
25 Give it a shot.

09/04/2001 Chaparral Trial - Day 1

1 THE JUROR: I'm Carol Spreen, Juror No. 39. And I
2 have a medical problem that sometimes I get an attack. I had
3 a bone transplant in my neck, and I was on 500 milligrams of a
4 pain reliever last week. I don't know.

5 THE COURT: You know, I think we'll just let you rest
6 up a little bit, and call Melissa and when you're feeling a
7 little bit better, we'll use you on another jury.

8 THE JUROR: I think so.

9 THE COURT: Thank you.

10 THE COURT: Yes, ma'am. Yes, sir.

11 THE JUROR: No. 57, Alex Barrientes. I'm a teaching
12 assistant at elementary school in the Special Ed division.
13 It's a very one-on-one-based program.

14 THE COURT: What school?

15 THE JUROR: Anderson Mill Elementary in Round Rock
16 District.

17 THE COURT: And on your Special Ed, have you already
18 been assigned kids?

19 THE JUROR: Yes. School started a couple of weeks
20 ago.

21 THE COURT: I'm not jumping on you, but this is the
22 kind of thing. If y'all have something like this, you've got
23 Special Ed kids that are dependent upon you or medical
24 problem, all you have to do is -- you know, Melissa, that's
25 all she does, just work with the jury panels. It's all she

09/04/2001 Chaparral Trial - Day 1

1 does because we've got lots of juries. You're just one panel.

2 We're dealing with two to four panels every week.

3 And so, we work as hard as we can to not inconvenience
4 you. But we'll put you down. We'll let you be excused. You
5 may sit and you may serve in the summer.

6 THE JUROR: Thank you.

7 THE COURT: Put him down for the summer. All right.
8 We didn't do too hot. I want a little bit better draw.

9 MS. HAJDA: We're just going to start with seat No. 1,
10 yes. No. 34, Carolyn Schneider, replacing No. 39, Carol
11 Spreen.

12 THE COURT: Ms. Sneider, are you all right for these
13 two weeks?

14 THE JUROR: Yes, sir. I promise.

15 THE COURT: All right. Ray of sunshine on a dark day.
16 Getting darker.

17 MS. HAJDA: No. 14, Roger Chapa, replacing No. 80,
18 Kristen Wierzowiecki.

19 THE COURT: Mr. Chapa, are you all right for those two
20 weeks?

21 THE JUROR: Yes.

22 THE COURT: Thank you, sir.

23 MS. HAJDA: Juror No. 17, Vince Jackson, replacing No.
24 55, Sheila Lankford.

25 THE COURT: Mr. Jackson, how about you for the next

09/04/2001 Chaparral Trial - Day 1

1 two weeks?

2 THE JUROR: I've got diabetes and I've got asthma, and
3 I have these attacks, like, if I stay too long. So I'd like
4 to be excused, if I could.

5 THE JUROR: Are you under medication for both?

6 THE JUROR: Yes, sir.

7 THE COURT: All right. You may have a seat. Now, I
8 know that 18 percent of you have diabetes. So I just want you
9 to know that. All right. Call the next name.

10 MS. HAJDA: No. 78, Hayes Saxon, replacing No. 17,
11 Vince Jackson.

12 THE COURT: Mr. Saxon, how about you, sir?

13 THE JUROR: Other than I'm a graduate of Texas A & M
14 University, I don't --

15 THE COURT: Well, Mr. Jackson, I have two
16 daughters-in-law that share that distinction, one son-in-law,
17 and they sure have produced a lot of good grand-babies. So
18 we'll let you serve. I jumped on the weatherman being wrong
19 one day, and one of Austin's leading weatherperson's father
20 was there, and he didn't much care for that either.

21 MS. HAJDA: Juror No. 45, Cheryl Hunter, replacing No.
22 68, Mae Lebeau.

23 THE COURT: Ms. Hunter, are you all right for those
24 two weeks?

25 THE JUROR: Well, I do the payroll for our company.

09/04/2001 Chaparral Trial - Day 1

1 If they can go without a paycheck for two weeks.

2 THE COURT: They'll just understand how important you
3 are.

4 MS. HAJDA: No. 29, Jonathan Jones, replacing No. 57,
5 Alexander Barrientes.

6 THE COURT: Mr. Jones, are you all right for the time?

7 THE JUROR: Yes, sir.

8 THE COURT: All right. Thank you. Those of you
9 haven't been called, stay on the edge of your seat and listen
10 to the questions. If any of you have to be called, I will
11 really ask you if what information you need to bring to the
12 lawyers' attention rather than answer every single question.
13 So listen to the questions and formulate how you would answer
14 them.

15 Y'all are now the panelists. How quickly you become
16 and get titles in federal court. This is a lawsuit that is a
17 patents lawsuit, what we call an alleged patent infringement
18 lawsuit. It's filed by Crossroads Systems, Incorporated, and
19 it's -- one of its lawyers is Mr. John Allcock.

20 Mr. Allcock, if you will stand and introduce the folks
21 at your table, please, sir.

22 MR. ALLCOCK: Thank you, your Honor. My name is John
23 Allcock. I'm privileged to represent Crossroads here today.
24 Let me introduce you, first, to the lawyer team that you'll be
25 seeing in the course of the trial. To my left is Alan

09/04/2001 Chaparral Trial - Day 1

1 Albright, and that's Matt Bernstein to his left, and to my
2 right is John Giust.

3 Now, let me introduce you to the two Crossroads
4 representatives. First, Brian Smith is the chairman of the
5 board and the CEO of the company. And Patty Prince is the
6 general counsel at the company. Thank you, your Honor.

7 THE COURT: Anybody on the panel know any of the
8 lawyers? They're associated with the law firm of Gray, Cary,
9 Ware & Freidenrich. Anybody happen to know anybody from that
10 law firm? Anybody have any dealings with ownership interest
11 or business relations of any kind with Crossroads Systems,
12 Incorporated?

13 All right. The defendant in this case is Chaparral
14 Network Storage, Incorporated, and Mr. David Bahler is one of
15 their lawyers and he'll introduce their team.

16 MR. BAHLER: Thank you, your Honor. My name is Dave
17 Bahler. I'm with Fulbright & Jaworski here in Austin. To my
18 right is Steve Dellett, also a lawyer with Fulbright. Behind
19 me are Michael Barrett and Marc Garrett, also the lawyers with
20 Fulbright. And my client representative is Mr. Jerry Walker,
21 one of the founders of Chaparral Network Storage.

22 THE COURT: Anybody know anybody of these lawyers or
23 anybody that's associated with the law firm of Fulbright &
24 Jaworski? Anybody have any business dealings, relations with
25 the Chaparral Network Storage, Incorporated, or any ownership

1 interest or have any business dealings at all?

2 Now, I want to tell you just a little bit about the
3 lawsuit. There's a lot of paper involved, probably the
4 pleadings -- I can't reach as high as the pleadings are. I
5 just brought a portion of them in here in case I need them.
6 So what I say is not evidence, but this is going to tell you
7 just a little bit about what the lawsuit might be about so
8 that it -- the questions might be more important and you might
9 understand the questions that you're going to be asked.

10 The plaintiff, Crossroads Systems, is a developer, a
11 manufacturer of what is known as storage router and storage
12 solutions, and it holds the United States patent entitled
13 storage router and method for providing virtual local storage.

14 The defendant, Chaparral Network Storage, manufactures
15 and sells storage area network products for use in computer
16 networks. Crossroads alleges that Chaparral's products
17 infringe the claims of its patent and seeks compensatory
18 damages for this alleged infringement.

19 Crossroads also alleges that the infringement was what
20 is known in the law as a willful infringement. Chaparral
21 denies that its products infringe the patent, but also alleges
22 that the patent is not valid because: One, Crossroads was not
23 the first to invent the patented router; two, that the
24 description of the router in the patent application is
25 unclear.

09/04/2001 Chaparral Trial - Day 1

1 So the patent is what is known in the law as
2 indefinite, and the patent is not enforceable because it's
3 alleged that Crossroads failed to disclose material
4 information at the Patents Office during the patent
5 application process. And Chaparral contends that it owes no
6 damages whatsoever.

7 So that's basically what this lawsuit is about. It's
8 an alleged infringement as you will learn shortly, those of
9 you selected to be a juror, that after a patent is issued,
10 there is a presumption of validity of the patent, but a jury
11 will determine whether the patent is valid or enforceable.

12 So now, is there anybody on the panel who knows of or
13 ever heard of a storage router? Okay. I've got one. Name
14 and number.

15 THE JUROR: 29, Jonathan Jones.

16 THE COURT: Okay. And do you use one?

17 THE JUROR: No.

18 THE COURT: Okay. Did you learn it in crossword
19 puzzles or something?

20 THE JUROR: No. I work at Dell Computers.

21 THE COURT: So you know what a router is?

22 THE JUROR: Yes.

23 THE JUROR: Naomi Jenkins, Juror No. 26. I work for
24 Advanced Micro Devices. Also, I've heard about it through
25 professional deals.

09/04/2001 Chaparral Trial - Day 1

1 THE COURT: Do you use one?

2 THE JUROR: Personally no, but I'm sure our company
3 uses many.

4 THE COURT: Yes, sir.

5 THE JUROR: Hayes Saxon, Juror No. 78. We do have a
6 storage area network at our location.

7 THE COURT: All right. Do you use it yourself?

8 THE JUROR: No, I do not.

9 THE COURT: All right. And you mine as well give a
10 plug for the employer.

11 THE JUROR: I'm sorry. Electronic Data Systems, EDS.

12 THE COURT: Okay. Anybody else know what a storage
13 router is?

14 All right. Let's start off with some basic, just
15 hands-up questions. How many of you use a computer in your
16 work? Now, lawyers are slow, so keep them up for just a
17 minute. I tell you what's better. Put your hands down. How
18 many of you don't? Okay. Those three. How many of you have
19 and use a computer at home? All right. How many don't? All
20 right.

21 All right. We've already gotten at least three that
22 work in the computer industry. Let's see how many others work
23 in the computer industry. How many in the front row work in
24 any way, shape or form in the computer industry all the way to
25 selling computers at wherever they sell them?

09/04/2001 Chaparral Trial - Day 1

1 All right. We've got both of you and your names. Why
2 don't you tell us what you do. Name and number again, sir.
3 Yes, sir. And that's a good idea. See, he's got good sight.
4 And y'all think I can see you but you're wrong. I do my best
5 faking. I know there are people out there because Mr. Mace is
6 standing between you and me, but help me out.

7 THE JUROR: My name is Hayes Saxon, Juror 78. I'm an
8 advanced system administrator with EDS. I do network
9 engineering and, also, web design.

10 THE COURT: All right. Thank you.

11 THE JUROR: Naomi Jenkins, Juror No. 26. I work for a
12 engineering group called Advanced Process Control. We work
13 with automating the manufacturing process.

14 THE COURT: Thank you. Second row. Anybody in the
15 engine -- in the computer industry? Yes, sir.

16 THE JUROR: Jonathan Jones, Juror 29. I work in the
17 finance group within Dell, and I work in the planning and
18 budgeting.

19 THE COURT: All right. Thank you. Anyone on the
20 panel own a patent? Okay. You're going to get to say your
21 name and number.

22 THE JUROR: Naomi Jenkins, No. 26. I have a patent
23 for an analysis process for Advanced Process Control.

24 THE COURT: All right. Thank you. Anybody else on
25 the panel? Anybody else applied for a patent? Well, my third

09/04/2001 Chaparral Trial - Day 1

1 son writes music, and I don't know that you're ever going to
2 hear it. I hope that you might, but he applies and gets
3 copyrights.

4 Anybody on the panel own a copyright? Yes, sir.

5 THE JUROR: Robert Hyman, Juror No. 77, and I have
6 music copyrights.

7 THE COURT: What do you have copyrights on?

8 THE JUROR: About 35 songs.

9 THE COURT: Songs? Good. I hope we get to hear
10 yours. Anybody else on the copyright that you've applied for
11 a copyright? All right. Anybody on the panel, other than
12 this lady here, invented anything that you have utilized?

13 How many of you are familiar with the process of
14 getting a patent? Yes, ma'am. Tell me your name and number.

15 THE JUROR: Joan Morgan, Juror No. 4. My husband
16 invented a patent.

17 THE COURT: Okay. What did he attempt to patent?

18 THE JUROR: For a tool.

19 THE COURT: Okay. And did he get one?

20 THE JUROR: No.

21 THE COURT: Okay. But you're familiar with how he
22 went about it?

23 THE JUROR: Yes, sir.

24 THE COURT: All right. Anybody else familiar with the
25 process? Anybody ever heard of a company called Pathlight

09/04/2001 Chaparral Trial - Day 1

1 Technology? Anybody ever heard of a company called ADIC?

2 Okay. That's all right. Name and number.

3 THE JUROR: Hayes Saxon, Juror No. 78.

4 THE COURT: Okay. And what is -- have you ever had
5 any relationship in any way with ADIC?

6 THE JUROR: Yes, sir. In a previous position, I
7 actually purchased one of their tape stored libraries, and we
8 currently use their products at our location here.

9 THE COURT: All right. Never worked for them?

10 THE JUROR: Never worked for them.

11 THE COURT: All right. Anybody else? All right. How
12 many of you have any formal or practical accounting experience
13 where you do accounting work? Yes, sir.

14 THE JUROR: Jonathan Jones, Juror 29. I work in the
15 budgeting side of the company.

16 THE COURT: All right. You do payrolls?

17 THE JUROR: Yes, sir.

18 THE COURT: I count that as accounting sometimes when
19 I -- back in the days when I worked.

20 THE JUROR: Only part I do are the journal entries.
21 My name is Cheryl Hunter, Juror No. 45.

22 THE COURT: All right. Anybody? Yes, ma'am.

23 THE JUROR: Caroline Schneider, No. 34. I'm also a
24 bookkeeper, accounting for 15 years.

25 THE COURT: All right. Thank you. Anybody else?

09/04/2001 Chaparral Trial - Day 1

1 Accounting experience.

2 THE JUROR: Joan Morgan, No. 4. I did accounting --
3 not accounting, bookkeeping in the old days.

4 THE COURT: Okay. And in the old days, who did you do
5 it for?

6 THE JUROR: K-Mart.

7 THE COURT: Okay. Thank you. Anybody else? All
8 right. How many of you have college degrees, just raise your
9 hand and keep them up. All right. And how many of you have
10 high school degrees? Keep them up. I believe I've covered
11 this, but let me ask you this again. How many of you have
12 developed or helped developed a computer program? Any kind of
13 program?

14 All right. I know three of you are going to answer
15 that. You've got your hands up. Anybody else? All right.
16 How many of you believe that you're experienced and
17 knowledgeable in computer security? Okay. Name and number
18 again. That's all right. You can keep your seat.

19 THE JUROR: Hayes Saxon, Juror No. 78.

20 THE COURT: I don't want to wear you out. Anybody
21 ever been associated with a firm called Infinity Comm Stor?
22 Anybody ever know anybody that worked for the United States
23 Patents Office? How many of you have now or in the past
24 operated your own business? All right. Again, we'll get
25 names and numbers, please.

09/04/2001 Chaparral Trial - Day 1

1 THE JUROR: Carolyn Schneider, 34. I had my own
2 jewelry business.

3 THE COURT: Okay. Thank you, ma'am.

4 THE JUROR: Hayes Saxon, Juror No. 78. I ran a
5 painting business when I was in college.

6 THE COURT: Okay.

7 THE JUROR: Robert --

8 THE COURT: When you say painting business, outside
9 painting?

10 THE JUROR: Primarily interior of apartments.

11 THE COURT: Okay.

12 THE JUROR: Robert Hyman, Juror 70. I had a roofing
13 company.

14 THE COURT: All right.

15 THE JUROR: Rob Steele, 74. I own a construction
16 company.

17 THE COURT: Yes, ma'am.

18 THE JUROR: Cheryl Hunter, Juror No. 45. I was in
19 business with my husband, Hunter Gourmet Salsas.

20 THE COURT: Okay. Anybody else? Each of the parties
21 here are corporations. A corporation is a legal entity in the
22 law, just like a person is, just like a partnership is, just
23 like an association is, and under the Constitution, they're
24 entitled to equal treatment under the law. One corporation is
25 a Texas corporation. It is a Colorado corporation.

09/04/2001 Chaparral Trial - Day 1

1 Of course, corporations are owned by people, so
2 they're really people, they're not a legal entity. Is there
3 anybody on the panel who would not be able, for any reason, to
4 treat either one of these corporations equally, starting out?

5 Now. Mr. Allcock, if you'd read the list of the
6 witnesses. I've asked the lawyers to have an inclusive list
7 of witnesses, that is, people that may be called. A lot of
8 these people will not be called. Don't be alarmed by the
9 length, but if you hear a name that you think you might know,
10 if you'll raise your hand, he'll stop, and we'll ask you about
11 them.

12 MR. ALLCOCK: Thank you, your Honor. Brian Smith,
13 John Middleton, Brian Bianchi, Geoff Hoese, Jeff Russell,
14 Keith Arroyo, Paul Hodges, Ken Kuffner, Paul Regan, David
15 Zinger, Robert Selinger, Michael Gluck, Russ Bleakely. And
16 although not called a witness that you'll hear mentioned, not
17 infrequently, is Dale Quisenberry.

18 THE COURT: Yes, sir.

19 THE JUROR: John Middleton live in Austin?

20 MR. ALLCOCK: He does.

21 THE JUROR: I possibly know him.

22 THE COURT: Now, let's don't take -- I run this show.

23 THE JUROR: Okay. I'm sorry.

24 THE COURT: It's all right. You're doing all right.

25 But I need your name and number.

09/04/2001 Chaparral Trial - Day 1

1 THE JUROR: I'm sorry, Rob Steele, Juror No. 74.

2 THE COURT: This gentleman that you may know, is it a
3 business relationship in any way?

4 THE JUROR: No, sir.

5 THE COURT: The fact that he may be a witness, would
6 you be able to evaluate his testimony as you would any other
7 that you don't know?

8 THE JUROR: Yes.

9 THE COURT: So it's not a witness like your brother
10 come in and you wouldn't listen to him at all or something?

11 THE JUROR: No.

12 THE COURT: All right. Anybody else know any of those
13 folks? All right. Mr. Bahler, if you'd read the list of your
14 witnesses, please.

15 MR. BAHLER: Ian Davies, Kenneth Flamm, George
16 Kalwitz, Stan Manzanares, Gary Stephens, Jerry Walker, Barbara
17 Bardach, William Hulsey, Bill Hulsey, Paul LiVolsi, Rick
18 Luttrall, Theodore -- Ted Neman, Brad Painter, Alan Permut,
19 Robert Sims and Neil Wanamaker.

20 THE COURT: Anybody think you may know any of those
21 folks? How many of you know what a SCSI is?

22 THE JUROR: SCSI? SCSI cable?

23 THE COURT: S-C-S-I. Yes, you just gave it away. Two
24 of you. Okay. Those of you in the first row, how many of you
25 have filed a lawsuit, had a lawsuit filed against you, or your

09/04/2001 Chaparral Trial - Day 1

1 company, or employer where you were involved or been a witness
2 either in a courtroom or in what we call a deposition? How
3 many of you had that experience, litigation experience? Okay.
4 We'll start with you, ma'am.

5 THE JUROR: Schneider, No. 34. I work for a physician
6 which we had a medical lawsuit against one of our physicians,
7 and I had to participate in a deposition.

8 THE COURT: About how long ago?

9 THE JUROR: Probably ten years ago.

10 THE COURT: All right. Thank you, ma'am. Yes, sir.

11 THE JUROR: Robert Hyman, Juror 70. I was working for
12 a manufacturing company and I had an injury, and it was an
13 injury lawsuit.

14 THE COURT: And did you participate as a witness?

15 THE JUROR: Yes, I did.

16 THE COURT: About how long ago?

17 THE JUROR: Five years ago.

18 THE JUROR: Rob Steele, No. 74. I've had several
19 safety-related lawsuits against our company. They've never
20 gone to trial.

21 THE COURT: Have you been deposed?

22 THE JUROR: Yes.

23 THE COURT: And when is the last time?

24 THE JUROR: About three years ago.

25 THE COURT: All right.

09/04/2001 Chaparral Trial - Day 1

1 THE JUROR: I had to give a deposition once about a
2 criminal assault case.

3 THE COURT: Okay. About how long ago?

4 THE JUROR: Naomi Jenkins, Juror No. 26. Twelve
5 years.

6 THE COURT: All right. Anybody in the second row have
7 any litigation experience? Yes, ma'am.

8 THE JUROR: Karen Dillender, Juror No. 48. About 20
9 years ago, it was a real estate. I owned some property and
10 they were going to foreclose on it, but it was taken care of.

11 THE COURT: Did you have to be a witness anywhere?

12 THE JUROR: No. But I had to give a --

13 THE COURT: Deposition?

14 THE JUROR: Yes.

15 THE COURT: Anybody else? All right. Those of you
16 who had that experience, was it so good or so bad that you
17 cannot just make it go away? Don't let it influence you at
18 all. If you can't make the pledge that it will not influence
19 you, raise your hand.

20 How many of you have been on juries before on the
21 front row? Yes, sir.

22 THE JUROR: Rob Steele, No. 74. I served in San
23 Marcos several times.

24 THE COURT: Okay.

25 THE JUROR: Hays County.

09/04/2001 Chaparral Trial - Day 1

1 THE COURT: Civil or criminal or both?

2 THE JUROR: Both.

3 THE COURT: And have you reached a verdict in those
4 cases?

5 THE JUROR: Yes, sir, we did.

6 THE COURT: Okay. Anybody else on the front row? How
7 about the second row? Anybody, yes, ma'am.

8 THE JUROR: Cheryl Hunter, Juror No. 45. San Marcos,
9 civil and we reached a verdict.

10 THE COURT: All right. Thank you. Anybody else on
11 the back row? All right. The two of you, was that experience
12 so great or so bad that it would influence you in this case?

13 THE JUROR: No.

14 THE JUROR: I'm here.

15 THE COURT: The answer is "Yes" or "No."

16 THE JUROR: No.

17 THE JUROR: No, it would not affect me.

18 THE COURT: All right. How many of you have had that
19 incredible experience of going to law school? How many of you
20 have now or in the past worked for a law firm or lawyers?
21 Anybody married to or have children who are lawyers?

22 One of the important questions that I ask in a case
23 like this is how many of you will under your oath state that
24 you will follow the Court's instructions at the end of the
25 case? Now, I've never had everyone leap up and say, "I won't

09/04/2001 Chaparral Trial - Day 1

1 follow them." But it's very important because you, as a
2 juror, will be the exclusive judges of the facts; that is,
3 you'll make the facts in this lawsuit. You'll determine from
4 the evidence what actually happened and the factual issues.

5 But you'll be obligated to follow the instructions on
6 the law which you'll have orally and you'll have in writing
7 when you make your determination to the facts. And you're not
8 at liberty to think, well, the law ought to be something else.
9 You'll be under an obligation to follow the legal instructions
10 where you think they're right, wrong or indifferent.

11 Now, is there anybody who can't make that commitment
12 and that is to follow the legal instructions? Because we all
13 will rely on the fact that the jury will.

14 How many of you, if any, knew anybody else on the
15 panel before you came here today? Anybody know any of the
16 federal court staff that works here or at the Thornberry
17 Center? All right. I'll have the lawyers up here, please.

18 (At the Bench, on the record.)

19 THE COURT: Do you have any additional questions?

20 MR. ALBRIGHT: We do, your Honor. One juror, No. 82,
21 Jody Peterson.

22 THE COURT: You have to speak a little louder.

23 MR. ALBRIGHT: Juror No. 82, Jody Peterson.

24 THE COURT: Okay.

25 MR. ALBRIGHT: I guess in the form under employment

09/04/2001 Chaparral Trial - Day 1

1 and as prior employment in a -- if he could just give us a
2 hint.

3 THE COURT: Who is it?

4 MR. ALBRIGHT: No. 82. I believe that's 82, Peterson.

5 MR. ALLCOCK: See No. 6, your Honor.

6 THE COURT: Is it a man?

7 MR. ALBRIGHT: Yeah.

8 THE COURT: It's a man. Okay.

9 MR. ALBRIGHT: He hasn't answered anything to
10 anything. The other is Mr. 74, Rob Steele. He said he knew
11 Mr. Middleton, and I think we need to know how he knows John
12 Middleton.

13 MR. BAHLER: That applies to my question.

14 THE COURT: Y'all just stay right here. Mr. Peterson.

15 THE JUROR: Yes.

16 THE COURT: What type of work do you do, sir?

17 THE JUROR: I'm a stay-at-home dad.

18 THE COURT: I have a son that does that.

19 THE JUROR: Yeah.

20 THE COURT: And those kids are some of the best
21 grandkids. What is the last work you did?

22 THE JUROR: Maintenance engineering.

23 THE COURT: All right.

24 THE JUROR: Commercial.

25 THE COURT: Are you married?

09/04/2001 Chaparral Trial - Day 1

1 THE JUROR: Widowed.

2 THE COURT: And where do you live?

3 THE JUROR: Near Lexington.

4 THE COURT: Okay. And, Mr. Steel, I need to know how
5 you know Mr. Middleton.

6 THE JUROR: If it's the same person.

7 THE COURT: If it is. I don't know if it is.

8 THE JUROR: He is a cousin.

9 THE COURT: A what?

10 THE JUROR: He's related to me. He would be a cousin
11 -- second cousin.

12 THE COURT: Now, there are cousins and cousins. Let
13 me ask you this and see if I can get out of this hole. Tell
14 me the frequency that you might run into him.

15 THE JUROR: I see him once every ten years.

16 THE COURT: Okay. Well, you got me out of the hole.
17 Any other questions?

18 MR. ALLCOCK: No.

19 THE COURT: All right. Members of the jury, for those
20 of you out there, as well as here, that have that terrible
21 habit of smoking, just like junior high school, you go out the
22 front door. Don't let the -- Mr. Mace doesn't smoke, but the
23 Security Officers will race you to the door.

24 Those of you in the box, talk about everything you
25 want except this case. Don't talk about this case. Those of

09/04/2001 Chaparral Trial - Day 1

1 you out here, it's America; you can talk about anything as
2 long as you don't let these folks hear you. So talk about
3 anything but the case.

4 And y'all be back and sit anywhere you want, but I
5 want you to be back and be in the same seat that you are now.
6 And I'm going to give a 20-minute recess. Twenty minutes.

7 (Jury not present.)

8 THE COURT: If the plaintiff will state your
9 peremptories in the record, please.

10 MR. ALBRIGHT: Yes, sir. Mr. Hayes Saxon, No. 78.

11 THE COURT: Poor guy got doubled, probably.

12 MR. ALBRIGHT: Ms. Naomi Jenkins, No. 26. Mr.
13 Jonathan Jones, No. 29.

14 THE COURT: Just don't want anybody that understands
15 this case. Go ahead.

16 MR. ALBRIGHT: And Mr. Rob Steele, No. 79, I believe.

17 THE COURT: Any objection, exceptions, or Batson
18 challenges to any of the peremptories of the plaintiff?

19 MR. BAHLER: No, your Honor.

20 THE COURT: I'll have the defendant read their
21 challenges in the record.

22 MR. BAHLER: No. 26, Jenkins, No. 48, Dillender, No.
23 -- I'm sorry, No. 43, Bost, and No. 14, Chapa.

24 THE COURT: Any exceptions, objections, or Batson
25 challenges on any of the defendant's peremptories?

09/04/2001 Chaparral Trial - Day 1

1 MR. ALBRIGHT: No, your Honor.

2 THE COURT: The Court finds no basis for a Batson
3 challenge. The Clerk will read the jury selected.

4 THE CLERK: Juror No. 34, Carolyn Schneider, Juror No.
5 4, Joan Morgan, Juror No. 70, Robert Hyman, Juror No. 82, Jody
6 Peterson, Juror No. 51, Douglas Duncan, Juror No. 45, Cheryl
7 Hunter and Juror No. 36, Jereme Gooch.

8 THE COURT: The jury acceptable to the plaintiff?

9 MR. ALBRIGHT: Yes, sir.

10 THE COURT: Acceptable to the defense?

11 MR. BAHLER: Yes, your Honor.

12 THE COURT: All right. Let's go select them.

13 (Jury present.)

14 THE COURT: Members of the jury panel, the Clerk is
15 going to read the names of those persons who have been
16 selected. If your name is read, if you'll simply stand at
17 your chair, please.

18 THE CLERK: Juror No. 34, Carolyn Schneider, Juror No.
19 4, Joan Morgan, Juror No. 70, Robert Hyman, Juror No. 82, Jody
20 Peterson, Juror No. 51, Douglas Duncan, Juror No. 45, Cheryl
21 Hunter, and Juror No. 36, Jereme Gooch.

22 THE COURT: All right. Ladies and gentlemen, I'm
23 going to put you in the custody of Mr. Mace, who's going to
24 show you where the jury room is. And then, everybody else
25 that desires to is going to be able to be released. And then,

09/04/2001 Chaparral Trial - Day 1

1 we'll bring you back in and we'll start the hearing. So those
2 of you selected, please go with Mr. Mace, he'll show you the
3 jury room and the way to come in and out of that jury room.

4 (Jury exited.)

5 THE COURT: Ladies and gentlemen of the jury panel,
6 that's the only case I have because I'm trying it for two
7 weeks, so I can't give you another opportunity today, but I
8 will give you another opportunity, I hope, to serve as a jury.

9 It is, of course, to me the most important
10 responsibility that each of you have because since 1963, I've
11 been trying cases, and I've been fortunate to go throughout
12 the world. And we have the best system of justice because
13 people are the ones who run our system.

14 When I came here in 1991, I got half this docket, 960
15 plus cases, civil and three and a half years of behind
16 criminal. Judge Nowlin took the other half. He had had the
17 entire docket until then. And through jury panel after jury
18 panel after jury panel, we are now trying cases ten months,
19 eleven months after the lawsuit has been filed, and we're
20 current on our criminal docket. And the reason only that we
21 can do that is you folks come in for jury service.

22 So we appreciate it and which -- there's not anything
23 wrong than having a trial hanging over your head whether you
24 -- no matter what side you're on, and so when you come in, I
25 appreciate it. The jury service used to be six months in

09/04/2001 Chaparral Trial - Day 1

1 federal court. When you were tied up, you were tied up for
2 six months.

3 And every first Monday of every month, you would come
4 in, and we'd select juries for that month. We cut it back to
5 two months. So I don't know if you'll be back or not, because
6 we have a lot of numbers, probably you will be back. Remember
7 that it's not that much out of your life to fulfill that
8 responsibility.

9 Those of you who have been on juries know how
10 difficult it is at the end of the evidence to make those
11 decisions that affect people's lives. It's so much better for
12 each of you who have your everyday walk of life to come in and
13 make those decisions than it is for judges to do it. We see
14 the same thing time and time and time again.

15 So I'm going to release you today. Be careful going
16 back to your homes. I appreciate your coming in. And when
17 you get that call and come in, if you have a problem, call
18 Melissa. Now, if it's just trying to get out of jury verdict,
19 I can -- I mean jury duty, I can smell that a mile away, and
20 I'll tell her no, you tell them to come in. But if you've got
21 some problem, she'll work it out with you where we want you at
22 your most convenient spot because it's a lot cheaper for the
23 taxpayer to do it.

24 Y'all may be excused with the thanks of the Court.

25 (Jury venire exited.)

09/04/2001 Chaparral Trial - Day 1

1 THE COURT: Counsel, in addition to the preliminary
2 instructions I intend to give the jury, I am also going to
3 allow them to take notes during this trial. Any objections
4 I'll hear them now.

5 MR. ALBRIGHT: Not from us, your Honor.

6 MR. BAHLER: No objection, your Honor.

7 THE COURT: All right. Counsel, does either side or
8 both wish to invoke the Rule?

9 MR. ALBRIGHT: We do, your Honor.

10 MR. BAHLER: Yes, your Honor

11 (Jury present.)

12 THE COURT: Members of the jury, I open court every
13 day and every day after the noon hour with three questions.
14 Those questions are very important and I -- it requires an
15 oral answer to each of you from each of you, and, of course,
16 you remain under oath.

17 But the questions are: Has anybody attempted to talk
18 to you about this case? Have you talked to anybody about the
19 case? Have you learned anything at all about the case outside
20 the presence of one another and this courtroom?

21 The reason these questions are very important is that
22 the seven of you are to hear the evidence at the same time and
23 only the evidence that you hear together. And you'll have all
24 of the exhibits with you when I ask you the questions to
25 resolve at the end of the presentation of the evidence.

09/04/2001 Chaparral Trial - Day 1

1 But when you go home, your family members or your
2 friends are going to ask, you know, what kind of case is it,
3 what did they do, that type of thing, and if you talk to them
4 about that, they may say something that might influence you
5 but the other six did not hear, and that's the reason we ask
6 you not to talk about the case to anybody.

7 That includes yourselves. The law does not want the
8 jurors to talk during the trial about themselves, about the
9 case until they've heard all of the evidence, and at that
10 time, then only when all seven of you are within hearing
11 distance are you to discuss the case because the whole theory
12 of our jurisprudence is that the jurors hear the case at the
13 same time and decide the case at the same time so that there
14 are no individual influences that are involved.

15 So let's practice. Has anybody attempted to talk to
16 you about this case? Now, a shake of the head won't do it.
17 She cannot get a shake in that machine. Now, she tried but
18 she can't. Yes or no?

19 THE JURORS: No.

20 THE COURT: Have you talked to anybody about this
21 case?

22 THE JURORS: No.

23 THE COURT: And have you learned anything at all about
24 the case outside the presence of each other and this court
25 room?

09/04/2001 Chaparral Trial - Day 1

1 THE JURORS: No?

2 THE COURT: All right. If you'll stand, please, and
3 be sworn as the jury.

4 THE CLERK: Each of you raise your right hand, please.
5 Do you and each of you solemnly swear or affirm that in the
6 case of Crossroads Systems, Inc. vs. Chaparral Network
7 Storage, Inc. that you will a true verdict render according to
8 the law as it may be given to you in charge by the Court and
9 to the evidence as submitted to you under the rulings of the
10 Court, so help you God?

11 (Affirmative responses given.)

12 THE COURT: Let the record reflect that each juror had
13 a negative answer to the first three questions and affirmative
14 answer to the oath.

15 Now, members of the jury, this case is a dispute
16 relating to a United States patent. Patents are issued by the
17 United States Patent and Trademark Office, which will be
18 referred to as the PTO, for the protection of an invention.

19 The purpose of a patent is to promote the progress of
20 science and technology. A valid United States patent gives
21 the inventor or the patent holder the right for a period of
22 time to keep others from making, using, offering to sell, or
23 selling the patented invention within the United States or for
24 importing it into the United States without the patent
25 holder's permission.

1 A violation of the patent holder's rights is called an
2 infringement. A patent also gives the patent holder the right
3 to keep others from contributing to an infringement by someone
4 else and from actively inducing others to infringement.

5 The patent holder may seek to enforce a patent against
6 persons believing to be infringers by filing a lawsuit in
7 federal court. To obtain a patent, a person must file an
8 application with the PTO. The PTO is an agency of the federal
9 government and as technically educated examiners who review
10 the applications for patents.

11 The application includes what is called a
12 specification which must contain a written description of the
13 claimed invention, telling what the invention is, how it
14 works, how to make it and how to use it so others skilled in
15 the field will know how to make or use it.

16 The specification must also contain a description of
17 what the inventor believed at the time of the filing to be the
18 best way of making or using the invention. The specification
19 concludes with one or more numbered sentences, and these are
20 what are called patent claims. The patent of the claims is to
21 specify what the applicant considers the invention so it could
22 be understood by anyone in the ordinary skill in the field.

23 When the patent is eventually issued by the PTO, the
24 claims define the boundaries of the claimed invention and give
25 notice to the public of those boundaries. After the applicant

1 files the application, the PTO patent examiner will review the
2 patent application to determine whether the claims are
3 patentable and whether the specification adequately describes
4 the invention claimed.

5 In examining a patent application, the patent examiner
6 makes a search of the PTO records for what is referred to as
7 prior art. Prior art is defined by law. And I will give you,
8 at a later time, specific instructions as to what constitutes
9 prior art.

10 However, in general, prior art includes things which
11 existed before the claimed invention that were publicly known
12 or offered for sale for more than a year before the
13 application, or used in a publicly accessible way in this
14 country, or that were patented or described in a publication
15 in any country.

16 The examiner considers, among other things, whether
17 each claim defines an invention that is new, useful and not
18 obvious in view of the prior art. Prior art considered by the
19 examiner is listed on the patent and is often referred to as
20 cited references. After the prior art search and examination
21 of the application, the patent examiner then advises the
22 applicant in writing what the examiner has found and whether
23 any claim is being allowed.

24 This writing for the patent examiner is called an
25 office action. And often, the first office action by the

1 examiner rejects the claims. The applicant then responds to
2 this and sometimes changes the claims or submits new claims.
3 The process may go back and forth between the patent examiner
4 and the applicant for some time until the examiner is
5 satisfied that the application and claims meet the
6 requirements for patentability.

7 The papers generated during this time of communicating
8 back and forth between the patent examiner and the applicant
9 is what is called a prosecution history. And all of this
10 material is kept secret by the -- between the applicant and
11 the PTO until the patent is issued. At the time of issuance,
12 the patent becomes available to the public.

13 The fact that the PTO issues a patent, however, does
14 not necessarily mean that any invention claimed in the patent
15 is, in fact, deserving of patent protection. A person accused
16 of infringement has the right to argue in federal court that a
17 claimed invention in a patent application does not meet the
18 requirements for patentability, and therefore, the issued
19 patent claim is invalid.

20 In this case, the plaintiff, Crossroads Systems
21 Incorporated, has been issued and is the holder of a United
22 States patent 5941972. It will be referred to as the 972
23 patent. This patent relates to what is entitled storage
24 router and method for providing virtual local storage.

25 The plaintiff, Crossroads Systems, alleges that

09/04/2001 Chaparral Trial - Day 1

1 Chaparral Network Storage has infringed this patent through
2 what is known as literal infringement as well as infringement
3 under the doctrine of equivalents. The plaintiff, Crossroads
4 Systems, additionally alleges that the defendant, Chaparral
5 Network Storage, induced others by -- regarding claims under
6 this patent and that it -- excuse me, induced infringement by
7 others regarding the claims under the patent and that it
8 contributorily infringed claims under the patent.

9 The plaintiff, Crossroads Storage, also alleges that
10 the infringement was willful and entitles it to compensatory
11 damages for these infringements. The defendant, Chaparral
12 Network Storage, denies that its products infringe the patent
13 in any way.

14 The defendant, Chaparral Network Storage, further
15 contends that the claims of the 972 patent are not valid as
16 they were anticipated by prior art, that they were due to
17 obviousness, that they were indefinite, and that they're
18 unenforceable due to inequitable conduct during the
19 application of the patent.

20 I will, of course, give you further instructions when
21 I have heard the evidence and will give you specific
22 definitions and descriptions of these terms. I'm giving you a
23 copy of what is referred to as a verdict form, which is a list
24 of questions that may be submitted to you for determination at
25 the end of the evidence.

09/04/2001 Chaparral Trial - Day 1

1 There may be modifications on these questions, but
2 basically, these are the questions that you may be asked, and
3 I'm giving a copy to each of you so that you can think about
4 these questions as you hear the evidence and listen to the
5 lawyers proceed in the trial.

6 Basically, your job will be to decide whether certain
7 claims of the 972 patent had been infringed and whether those
8 claims are valid. If you decide that the claims have been
9 infringed and that they are not invalid or unenforceable, the
10 plaintiff is entitled to compensatory damages established by
11 the evidence.

12 Now, the lawyers will be more specific in detail in
13 their opening statements, and I believe you will find this
14 case to be interesting and will fully understand the issues to
15 be determined by you at the end of the presentation of the
16 evidence in this case.

17 Don't feel lost as you proceed along. Wait and keep
18 an open mind. Don't make any decisions before you've heard
19 all of the evidence and have had the opportunity to discuss
20 that evidence with your fellow jurors.

21 Now, the case will begin at 1:30 this afternoon with
22 each side making an opening statement. The opening statement
23 is not evidence, but it should give you an outline to help you
24 understand what the evidence will be presented and the reasons
25 for that presentation.

09/04/2001 Chaparral Trial - Day 1

1 The plaintiff, who has the burden of proving
2 infringement and damages, will be allowed to call its
3 witnesses first. The plaintiff's counsel will then ask the
4 witnesses that they call their questions, then the defendant's
5 counsel has the right to ask questions. And then, the
6 plaintiff's counsel has the right to finish up with the
7 witness and ask questions.

8 And we'll proceed all the way through all of the
9 witnesses that the plaintiff will call, and then, the process
10 turns around. The defendant will call the witnesses that the
11 defendant wants, and the defendant's lawyer will answer -- ask
12 the questions first and last.

13 When all of the evidence has been presented, it is my
14 responsibility to prepare the legal instructions for you. I
15 will then give a copy to the lawyers. I will read them to
16 you, as I'm required to do, but I also give them to you in
17 writing, and you'll have that in the deliberation room when it
18 is time to deliberate.

19 You will also have your total recall of the evidence.
20 We've known since the 1950s that a jury of five or more people
21 in a trial that lasts no more than two weeks retains 90
22 percent of everything that goes on in the courtroom, not just
23 the evidence but everything else that goes in.

24 So listen to the evidence. All of the exhibits, that
25 is, the documents admitted into evidence, you will have when

09/04/2001 Chaparral Trial - Day 1

1 you deliberate, and the lawyers will tell you at the end of
2 the case which ones they think are the most important that you
3 should review, if any, and you will make your determination
4 from the evidence.

5 Now, the evidence is going to come in three forms.
6 The evidence is going to come in the answers under oath by the
7 witnesses, not the questions, not what the lawyers say, but
8 the answers and the documents I admit into evidence. And
9 sometimes there's stipulations.

10 For example, the lawyers could stipulate today was
11 Tuesday and didn't have to bring anybody with a calendar. Or
12 they could stipulate that it rained a minute ago, and you
13 won't have to look out the window and see that it rained. It
14 would be a fact that's not in dispute, and they're going to
15 try to save you time by saying you can rely upon this fact
16 because we agree upon it.

17 Now, I'm going to allow you in this case, because of
18 the nature of the case, to take notes. So when you come back
19 at 1:30, Mr. Mace will give each one of you a notebook and you
20 take notes, but the notes are just for you. Take whatever
21 notes that you think are important, but remember, just like
22 when you're back in school, when you're writing something out,
23 you're forgetting to listen. So just take things that are
24 important.

25 And when you get back there to deliberate, remember

09/04/2001 Chaparral Trial - Day 1

1 that the notes are just for you to remind you of certain
2 things. You're not to share your notes with anybody. You're
3 not to become a witness by saying this is what my notes say.
4 It's just a personal reminder to you so that you can discuss
5 with your other jurors what your view of the evidence is.

6 Also remember that at the end of the case, Mr. Mace
7 takes the notebooks back. So don't write the Judge is fat or
8 something like that on them because we have to look at them
9 afterwards. Little pictures are fine, but as long as we don't
10 understand them, but remember that they become part of the
11 record.

12 Your job in this case will be to find the facts.
13 You'll see from the verdict form basically the type of
14 questions that are going to be asked. And in our system of
15 justice, the jury finds -- you have exclusive authority to
16 find the facts, whatever you find in the facts will stand up.

17 My job is to determine what evidence that you should
18 base it on. I may sustain an objection to evidence. The
19 lawyers are obligated to bring my attention by objection to
20 evidence that they think that you may not should see legally
21 or should rely on. If I sustain the objection, that means
22 that you probably won't hear the evidence. But don't try to
23 guess at what it was or think it's important.

24 If I overrule the objection, that means that you'll
25 hear the evidence, but, again, don't think it's more important

09/04/2001 Chaparral Trial - Day 1

1 than anything else because we've gone to school for three long
2 years and we've gotten lots of scar tissue in courtrooms
3 learning what the Rules of Evidence are.

4 Sometimes you'll hear evidence and I may turn to you
5 and I'll say, members of the jury, I'm going to instruct you,
6 you cannot rely upon that evidence in any way, shape or form.
7 I'm not telling you to forget it because I can't tell you to
8 erase what you've heard, but I'm telling you don't rely on
9 this evidence for any purpose when you're determining the
10 answers to the questions.

11 So, basically, that's how the case will go. Now, the
12 lawyers, before they make their opening statements, want to
13 set up the courtroom so that we can have some presentation
14 that will assist you in getting you in the case and get you to
15 understand the mechanism of this invention.

16 You're very fortunate because the lawyers are good.
17 And don't feel lost, you'll catch up pretty quickly, and
18 you'll find out what this case is about. I think you'll find
19 it very interesting.

20 Remember the instructions now. I'm going to release
21 you until 1:25. For those of you who are not familiar with
22 downtown, there's some restaurants right down the street here.
23 For those of you who, like myself, don't need lunch or don't
24 want lunch, just walk in right over here, even though it looks
25 like it has stopped raining.

09/04/2001 Chaparral Trial - Day 1

1 Those of you who have not seen the Capitol that has
2 been redone, it is fantastic. I recommend that you do that.
3 Be but be back at 1:25. Mr. Mace will show you where to be
4 here. And we'll try to start promptly at 1:30.

5 (Jury not present.)

6 THE COURT: You've got two hours.

7 MR. ALBRIGHT: Sir, may I raise one issue for
8 housekeeping purposes?

9 THE COURT: Sure.

10 MR. ALBRIGHT: What we are planning to do -- and we've
11 given notice to Fulbright about -- is after opening arguments,
12 which would just ballparking take about an hour and a half
13 total, we've got three witnesses lined up to go, which we
14 think will take the remainder of the afternoon.

15 Ballparking, we'll go through about 4:30. Is that
16 sufficient for you because we are going to start with more
17 technical witnesses in the morning, and we believe it won't
18 have an impact on when the plaintiff's case is going to get
19 over with, anyway.

20 But I just wanted to make sure after three witnesses,
21 you didn't want -- you weren't going to look up and say, "I'd
22 like another one." But that's what we are planning on doing
23 today, if that's all right with you.

24 THE COURT: Well, you know, I've been at this job
25 almost ten years. I've never said I want another one, I'd

09/04/2001 Chaparral Trial - Day 1

1 like another one. But the answer in this meek little
2 argument, we will go a full day today. But we'll see. I
3 don't want to give them too much, but on the other hand, this
4 is Tuesday and we'll just see how. I don't anticipate
5 quitting at 4:30.

6 MR. ALBRIGHT: Thank you, your Honor.

7 (Lunch recess.)

8 THE COURT: All right, counsel. Ready for the jury?

9 MR. ALLCOCK: We are, your Honor.

10 MR. BAHLER: Yes, your Honor.

11 THE COURT: As I indicated to you earlier, the Rule
12 has been invoked, so it will be up to counsel to identify the
13 witnesses and make sure the witnesses do not violate the rules
14 subject to disqualification of their testimony. Bring the
15 jury in.

16 (Jury present.)

17 THE COURT: Members of the jury, during the lunch
18 break, did anyone attempt to talk to you about this case?

19 THE JURORS: No, sir.

20 THE COURT: Did you talk to anybody about the case?

21 THE JURORS: No.

22 THE COURT: And did you learn anything at all about
23 the case outside the presence of each other and this
24 courtroom?

25 THE JURORS: No, sir.

09/04/2001 Chaparral Trial - Day 1

1 THE COURT: All right. Show negative responses to all
2 questions by all jurors. Mr. Allcock, you have the lectern.

3 MR. ALCOCK: Thank you, your Honor.

4 MR. BAHLER: Your Honor, may I move around to see
5 better?

6 THE COURT: You may anywhere that you desire.

7 MR. BAHLER: Thank you, your Honor.

8 MR. ALCOCK: May it please the Court, counsel.

9 PLAINTIFF'S OPENING STATEMENT

10 Ladies and gentlemen of the jury, as I said, I'm
11 privileged to represent Crossroads in this case. I'd like to
12 say that every case can be summarized in just a few words, and
13 this case is no different. This is a case about invention and
14 infringement, about inventors and infringers.

15 I represent Crossroads. They are the inventors in
16 this case. The defendant, Chaparral, are the infringers.
17 Crossroads got a patent from the United States Patent and
18 Trademark Office in August of 1999. The defendants,
19 upper-level management, found out about that patent just a few
20 months later, in February of the year 2000.

21 And they were immediately very concerned about their
22 patent, about that patent. They knew immediately that all
23 their products were at great risk of infringing that patent,
24 so they hired an expert, a technical consultant, very capable
25 gentleman, who's now their chief technical officer, and he

09/04/2001 Chaparral Trial - Day 1

1 wrote a report.

2 And that report about the Crossroads patent told them
3 one thing and one thing only, figure out a way to sell, and
4 that was before there was even litigation. So they did some
5 further investigation, they hired a patent lawyer, and they
6 tried hard to find a way around the Crossroads patent and they
7 couldn't.

8 So in May of the year 2000, they pulled from the
9 product the patented feature. They took it out so as to
10 attempt to avoid infringement. There were two problems. For
11 the rest of the year 2000, although they had the feature eye
12 of the product, they didn't tell anyone, not their customers,
13 not anyone, that they had pulled this feature because of a
14 potential infringement problem.

15 In fact, they did the opposite. And, second of all,
16 as the year wore on, they realized that this patented feature
17 was essential, in their own words, that trying to sell their
18 product without it was like trying to sell a black and white
19 TV set. So at the beginning part of the year 2001, without
20 going back to their patent lawyer, without going back to their
21 expert, they introduced the infringing feature back into the
22 product.

23 So there aren't very many sales of the products.
24 They've only been selling them for a few months. And so, this
25 case isn't primarily about damages, although we will ask for

1 reasonable compensation. This case is primarily about a
2 determination that the product that they're selling infringes
3 and a determination that the conduct of which I've just
4 summarized is not acceptable conduct here in Austin.

5 So that's a brief summary of the case. I am now going
6 to spend, actually, a fair amount of time going over generally
7 what you're going to see in the case. I do that because I
8 think it's helpful for the jury to have an overview of the
9 case as the evidence comes in. And so, while it might take a
10 little bit of time to go through this, I think in the long
11 run, it will save time because as the witnesses' testimony
12 comes in, you'll have a proper context for that testimony.

13 So I'm going to talk about four topics here today,
14 first, just a little bit about the parties, second, about
15 Crossroads and Crossroads' patented invention, and I'm going
16 to spend a little bit of time on that subject. I'm going to
17 show you some graphics, and I think you'll understand the
18 invention after I show you those.

19 Then, Chaparral's use, the defendant's use of the
20 patented invention and the story that I just told, how they
21 took it out and then, put it back in. And then, very briefly,
22 I'm going to talk about damages, reasonable compensation. So
23 those are the topics.

24 Let me start out with Crossroads. Crossroads is an
25 amazing company. In 1994, two gentlemen, Brian Smith, who

1 you'll hear from, and Dale Quisenberry, who you'll hear about,
2 just the two of them, started a little company. It was a
3 consulting company to begin with. And then, they realized
4 that they could build a product and sell a product, a product
5 that really wasn't fully commercialized before.

6 And that's what they did. They came up with a product
7 called a storage router, and they, ladies and gentlemen, made
8 the market. There wasn't really a market for these products
9 back then. They also hired two brilliant engineers that
10 you'll hear from tomorrow, Geoff Hoese and Jeff Russell.
11 They're the inventors of the patent at issue.

12 Now, I will describe the invention here to you in some
13 detail, in a few moments, but right now, I want to bring you
14 forward. And these four words, if five years from now, ten
15 years from now, anyone asks you about what your jury service
16 was about here in this Austin federal court, you'll be able to
17 answer them with just these four words.

18 Access controls, that's easy to understand in broader
19 term. LUN zoning, that's the more technical term and perhaps
20 a more limited term. Those features are a key part of what
21 Geoff Hoese and Jeff Russell's invention is all about, and
22 those features are the ones that Chaparral has used in their
23 product and infringed.

24 So I'm going to explain to you, in some detail, about
25 what those features are and how they work in these router

09/04/2001 Chaparral Trial - Day 1

1 products that we're talking about, but let me give you some
2 background, first. For some people, problems are bad things;
3 for other people, problems are opportunities.

4 And for Crossroads and Geoff Hoese and Jeff Russell,
5 problems were opportunities. This was the state of the
6 computer networking world when Crossroads came up with its
7 invention. It's a picture that you're all very familiar with.
8 You have computers that are connected to each other, and one
9 of these fancy things is called a network so that they can
10 communicate with each other.

11 But increasingly in the modern world, you need more
12 memory than those computers have in their own systems, and you
13 want to store that memory some distance away from the main
14 building, for example, and so you can have remote storage.
15 That's just memory that the computers use to find files, like,
16 for example, it could be the personnel department's records or
17 the tax department's records, but they -- sometimes it's
18 convenient and more frequently than ever, it's convenient, for
19 those things to be some distance away.

20 And the problem becomes that you need to find a way
21 for the computers to communicate with these remote storage
22 devices. Now, before the Crossroads invention, this picture
23 that I've showed you is the common picture, it's the common
24 way things were done. And when Brian Smith and Dale
25 Quisenberry started the company, this stuff called Fibre

09/04/2001 Chaparral Trial - Day 1

1 Channel was just starting to become a big deal. It's a real
2 big deal now.

3 But it was just starting to become in common use in
4 1994, and it was so because information can move really fast
5 on this Fibre Channel. On the other side of the picture,
6 there's something called SCSI. The Court mentioned it earlier
7 using the more common term for it, SCSI. And that's a very
8 old way for devices to communicate with each other.

9 And you'll be explained in more detail as the trial
10 goes on, but for now, all you need to understand is this Fibre
11 Channel speaks one language; let's call it English. This SCSI
12 speaks a different language; let's call it Greek. And so, the
13 English computers cannot communicate with the Greek storage
14 devices without a translator.

15 And so, before Crossroads came up with its router
16 products, the common way of communicating was something called
17 a network server. You've heard about those, and anyone that
18 has used computers has communicated through those. And when
19 you have an occasional -- you run into this maddening problem,
20 the server slows things down.

21 The one thing we know about the modern computing era
22 is there is a need, a need for speed, and increasingly, we are
23 unhappy when the computers don't work as fast as we want them
24 to work. And these network servers before the Crossroads
25 routers became part of the landscape had this problem.

1 So Crossroads came up with an alternative, something
2 called a storage router. It solved this speed problem. It
3 allowed the computers that spoke this language to communicate
4 with the remote devices that spoke the other language. Now,
5 routers were not completely new. They had been in existence
6 before.

7 But Crossroads was the first company to really put
8 these things on the landscape. And, as I said earlier, they
9 kind of made a market. And they were able to do this and, in
10 fact, introduced a product in 1997, but it was a fairly
11 bare-bone product. It was kind of like a Chevrolet, not a
12 luxury sedan.

13 It didn't have all the features that it could have
14 had. After all, it was kind of starting the market, and so,
15 it did not use this access control LUN zoning invention of the
16 patent. Crossroads did fairly well selling products without
17 the inventive feature for a number of years, and in fact, it
18 just introduced recently products using the patented feature.

19 So the product that Crossroads initially introduced
20 what was not the invention but Hoese and Russell, way back in
21 1997, they came up with something that was far ahead of their
22 time and that's the invention. So the early Crossroads
23 products didn't succeed because they were fancy; they
24 succeeded because they were first.

25 So now, let me tell you what the invention is.

1 Security is important in the modern world. So you've got a
2 couple of computers on this side of the router, and on the
3 other side of the router, you've got the personnel
4 department's information. That's in remote storage A. In
5 remote storage B, you've got the tax department's information.
6 And in storage C, you've got the company web site.

7 You would like it to be that computer A, which is in
8 the personnel department, can only get to the personnel
9 records. They can't get to the tax records, but they can also
10 get to the company web site.

11 So, in other words, their access to the remote storage
12 is restricted to only the information that they have a right
13 to see. And computer B is the tax department's records. They
14 similarly can't get into your personnel file. They can get
15 into the company's tax records. And because the company web
16 site is a general interest to everybody, they can get into
17 there.

18 So A is limited to A's storage location. B is limited
19 to B's storage location. And there's a storage location that
20 either of them can access freely. No one, no one before Geoff
21 Hoese and Jeff Russell had thought of a storage router with
22 access controls. The defendants will try to prove that
23 someone else came up with this concept first.

24 You'll look at that evidence and you'll conclude that
25 Geoff Hoese and Jeff Russell were the first people to think of

1 the idea of combining a storage router with access controls.
2 The Patent Office thought so. On December 31, 1997,
3 Crossroads filed for a patent on this invention. It was
4 granted August 24th of 1999.

5 And the Court has said a few words to you about
6 patents, but let me amplify on what you've been told. If you
7 look over the last decade, you'll see a lot of inventions, and
8 I think most of us would think the world is better for them,
9 at least the federal government thought so or our founding
10 fathers did.

11 The right to grant patents is found in the United
12 States Constitution. And the way it works is if you think
13 you've invented something new, you can prepare a patent
14 application and send it to the Patent and Trademark Office;
15 it's in Washington, D.C. There, they have technically trained
16 examiners, people who will examine the patent and look to see
17 if anyone had done it before.

18 And if they conclude that no one had done what you
19 claim to have invented before, they will grant you a patent,
20 and the patent is sort of like a deed on your property, except
21 for it's a form of intellectual property. It gives you a
22 right to own that property and gives you the right to keep
23 other people from using that property.

24 So if they fall within the scope of the patent, then
25 they're trespassing on your property, and you have the right

1 to stop them from doing so, and you have the right to be paid
2 reasonable compensation for their trespass.

3 But the Patent Office doesn't have the patent police.
4 No one enforces patents for patent owners. They have to do it
5 themselves, and the way that we do it in this country is what
6 we're doing here: We come into court in front of a jury, like
7 yourself, and present our case to enforce our patent rights,
8 and that's why we're here.

9 One more thing about patents. You're going to hear a
10 lot about claims, and some of the discussion I'm going to get
11 to in a minute involves that. Here's a fancy invention, a
12 screwdriver, and remember I told you a patent is -- at the end
13 has claims. There are a list of elements that define what you
14 own, like a deed.

15 So here's a claim covering this invention, a tool
16 comprising a handle, a shaft and a tip for engaging a threaded
17 fastener. So if somebody thought of a screwdriver first,
18 applied to the Patent Office, no one had done it before, this
19 would be the kind of a claim that the Patent Office might
20 allow.

21 And so, if someone uses a tool that has a handle, a
22 shaft and a tip for engaging a threaded fastener -- patent
23 lawyers never talk in complete English, they need to use some
24 funny words sometimes -- then you would infringe that patent.
25 And if you took one of the elements off, you wouldn't.

1 So in other words, if I took the handle off and just
2 had a bare steel shaft with no handle, that wouldn't infringe
3 this patent claim. May not be very useful, but it wouldn't
4 infringe. Now, the reason I mention that to you is because in
5 a few minutes, we're going to see how Chaparral took the
6 handle off to try to avoid the patent, and then, put the
7 handle back on.

8 This will be my final point for those of you that are
9 keeping track of where we are in the presentation. I've
10 already told you most of what I've got to tell you about the
11 parties. I'm going to have a little more to say about that
12 with respect to Chaparral here in a moment.

13 And I have now told you most of what I'm going to tell
14 you about the patented invention. This is the last slide that
15 I wanted to go over with you. This is figure 3 of the patent.
16 It's the figure that you see on the cover of the patent. If
17 you pick the patent up and you looked at the front page, this
18 is what you'd see.

19 And with the exception of we've added some color and
20 added, you know, some computer monitors and other things to
21 make it look a little bit more realistic. But it's a lot like
22 the picture that you saw a few moments ago, and what this
23 shows you is a storage router with access controls.

24 On your left-hand side of the picture, you've got five
25 different work stations or computers. In the middle, you've

1 got the storage router. This channel is a Fibre Channel
2 connecting all the computers so the information can go really
3 quickly. On the other side, we've got three storage devices,
4 two kind of little ones, and one really big one, and that --
5 they're all connected by a SCSI bus. Bus is just a fancy word
6 for wire.

7 And so you can see work station A is limited to this
8 part of the storage device. Work station B is limited to that
9 part of the storage device, and so on for C and D. E is
10 lucky, it has its own little storage device all to itself.
11 And up at the top, you've got a global data that every work
12 station or computer can access.

13 So it's a little more detailed than the drawing that I
14 showed you earlier, but it basically describes what the
15 invention is. Now, I mentioned to you earlier, Crossroads
16 didn't include this in their earlier products, and it only
17 came in in the later products, and the reason that's so is
18 because they were first to market. They were kind of building
19 the market. They could sell products that didn't have
20 necessarily the latest advanced features and still do pretty
21 well.

22 Not so with Chaparral. Chaparral is a Colorado
23 company. Unlike Crossroads, they were late to the market.
24 They started in 1998 and they first started products in 1999.
25 Starting in late 1999 and early 2000, they talked about

1 internally putting access controls into their product. They
2 had two kinds of products that are kind of related to each
3 other: One's a storage router, and another thing is something
4 called a RAID controller.

5 The difference between them isn't really important for
6 this case, but you'll be explained what the differences are
7 when technical testimony comes in. But they had some of these
8 products and they were internally looking at adding access
9 controls -- or their technical internal term for it was LUN
10 zoning -- to their products.

11 And they were doing this because they saw the need for
12 this advanced feature in order to sell their products, and so,
13 they pitched LUN zoning to all the big companies. They went
14 to EMC. And this slide is actually a slide from a
15 presentation to EMC. That's their slide. And they went to
16 Dell and IBM. The Dell and IBM slides are almost identical to
17 this.

18 And you can see, you have host one, host two, host
19 three. Those are the computers. You have remote storage down
20 here. That's comparable to the little storage devices I
21 showed you a few moments ago. And here it says SCSI, S-C-S-I
22 devices can be configured to be accessed or masked from
23 multiple hosts. That is, you can have access controls from
24 multiple hosts as I showed you on figure 3 of the patent just
25 a few moments ago.

09/04/2001 Chaparral Trial - Day 1

1 And they are calling it LUN masking and zoning and
2 they are telling people, and they said this in a statement
3 they filed with the Securities and Exchange Commission in the
4 beginning part of the year 2000 that this feature was going to
5 be available in the second quarter, that is, April, May, June
6 of the year 2000.

7 They ran into a stumbling block. In February of 2000,
8 the then president of the defendant, Chaparral, came across
9 the Crossroads patent. One of the investment bankers for the
10 company gave it to him. It prompted a flurry of activity. He
11 immediately sent it around to all of the upper-level
12 management at the company. He immediately recognized that
13 their products were at risk, at serious risk for infringing
14 the Crossroads patent.

15 So the first thing he did -- or one of the first
16 things after they had this internal discussion is they sent
17 the patent on to an expert in the industry, a guy named
18 Selinger. He's now the chief technical officer of Chaparral
19 although back then, he was a consultant. Maybe you'll hear
20 from him in this case. You certainly will by deposition.
21 We're going to read his deposition to you. Maybe they'll
22 bring him live, I don't know.

23 And they wanted this Selinger to do a investigation
24 and analysis of this Crossroads patent. And they gave it a
25 code name because they knew that later on, people would look

1 at what was written down. They called it overpass. Another
2 reason is they wanted the consultant to call Brian Smith and
3 talk to him, but they didn't want him to tell him who he was
4 working for when he made that call and that's what happened.

5 And after a couple of weeks, this expert consultant
6 came back with his report on the 972 patent. It's about a
7 three- or four-page, single-spaced document. You'll see it,
8 it will be in evidence. And it was written to the company
9 president and the executive vice-president of engineering, Mr.
10 Walker.

11 Here's my overpass report. Don't shoot the messenger.
12 So from the cover of it, you know that this was not good news
13 for Chaparral. After it goes on for a number of pages, he
14 comes up with a final recommendation, figure out a way to
15 settle. Now what's remarkable is there was no lawsuit when
16 this was written.

17 This was an analysis done by Chaparral before this
18 lawsuit was filed, so the investigation went further. They
19 went and hired a patent lawyer, and what I'm showing you is a
20 March 1 notebook entry of Mr. Walker's concerning a meeting
21 between Dave Zinger, he's the patent lawyer that they went to
22 see, Bob Selinger, that's the expert that wrote the "figure
23 out a way to settle" memo that I showed you a moment ago.

24 And there are a few interesting, indeed, remarkable
25 things about this. The first is they realized that they

1 desperately need a letter, opinion from this patent lawyer.
2 It says here, we are aware of patent, we don't have an
3 opinion, damages are trebled.

4 Now, I'm not sure that's quite right, but clearly,
5 they were very concerned and very interested in getting a
6 letter from this patent lawyer, giving them a clearance to
7 sell at least some of their products. Then, it goes on:
8 Don't want to back burner the patent. Let's get prior art.
9 Dave will look at prior art. And then, it lists a number of
10 types of prior art.

11 So what's that all about? Well, as the Court told you
12 earlier, one of the ways that you can invalidate a patent is
13 trying to find prior art, trying to find publications or
14 patents or products that show that somebody else did what you
15 invented first. And then, that can invalidate the patent.

16 So they wanted to see if they could find prior art to
17 invalidate the Crossroads patent so they could go on and sell
18 their products with the access control LUN zoning feature. So
19 they went at it with a vengeance. Here's a March 14th memo.
20 Bob, I spoke with Dave Zinger. Bob is Bob Selinger and this
21 is a memo from Mr. Walker -- without having him see your
22 e-mail, Dave indicates that we should do two things.

23 You should pursue documented evidence that access
24 control, in quotes, it means the same thing as LUN zoning --
25 is well-known and was practiced prior to 12-31-96. And he

09/04/2001 Chaparral Trial - Day 1

1 will start to develop a, quote, limited opinion letter, which
2 indicates why we believe the overpass patent is invalid. He
3 needs to access control info as part of it.

4 No one had done a router with access controls before.
5 So even though they had been searching for a month and a half
6 by now, they hadn't found anything, and they needed to find
7 something in order to get this letter that they needed to sell
8 their products.

9 The search intensified in April of 2000 because this
10 lawsuit was filed at the end of March 2000. So the search
11 intensified and went on through April of 2000. And you will
12 see in evidence notes from Mr. Walker calling all kinds of
13 companies, trying to find prior art to invalidate this patent.

14 You'll see faxes from the company president, Mr.
15 Gluck, to all kinds of people, sending him the patent, trying
16 to find prior art to invalidate it. You'll see e-mails from
17 the president of the company to a number of people, trying to
18 find prior art to invalidate the patent.

19 What happened? In early May, they pulled LUN zoning
20 out of their product. Please note the memo of May 8th, 2000
21 to quite a number of people in the company, copied to quite a
22 number of people. And there were other documents that are
23 like this that say hold the LUN zoning feature.

24 Please note, we will also need to pull out the more
25 full-featured LUN zoning from the planned 4.1 release. So

1 they were telling their customers in February and March and
2 they were telling the SEC C in March that they were going to
3 have LUN zoning in their products.

4 They found out about the patent, they did analysis
5 including hiring a patent lawyer, and they had to pull it out.
6 Now, when Mr. Walker was asked questions in his deposition
7 about why it was taken out, do you know why it was decided to
8 pull the feature? That's the LUN zoning feature -- out of
9 that firmware? It was decided based on interpretation of
10 Crossroads' patent and opinion of our legal counsel. You say
11 opinion of legal counsel. Are you referring to an opinion
12 that's been reduced to writing? Yes.

13 So they got their written opinion that they wanted,
14 but in order to get it, they had to pull LUN zoning out of
15 their product. They pulled it out of their products in May,
16 middle of May. They got a draft of the opinion just a couple
17 of weeks later. Here's the letter, June 14th.

18 Based on this, it is our judgment that the presently
19 marketed products -- very carefully worded letter, presently
20 marketed products. They pulled the LUN zoning feature out
21 just a couple of weeks before this letter was written -- of
22 Chaparral including its data routers do not infringe the
23 claims of the 972 patent.

24 Let's see why they don't infringe. Here's page 28 of
25 this draft letter and comparing the claim language with the

1 Chaparral router, it is determined that the Chaparral router
2 does not include this feature. Let's see what feature they're
3 talking about.

4 Specifically, the Chaparral router does not, according
5 to the interpretation of this claim language, provide any
6 restriction regarding which SCSI storage devices can be
7 accessed by particular FC -- that's Fibre Channel devices. No
8 such control or feature is maintained in the Chaparral router.

9 So they didn't have an access control feature in the
10 presently marketed devices. They pulled it a couple of weeks
11 earlier because of a concern about the patent. And within a
12 couple of weeks after pulling that feature, they get the
13 letter that they need that justifies their continuing to sell
14 the product, and they continued to sell the product throughout
15 the year 2000.

16 And this draft letter of June 2000 turned into a final
17 letter in November of 2000. And you'll hear testimony that
18 throughout that entire time period, they did not include LUN
19 zoning or access controls of any type in their products. So
20 you may be wondering why are we here if they looked at the
21 patent, realized that they had a problem, and took the feature
22 out. Why are we troubling you with this case?

23 Two reasons. First, they never told anybody that they
24 pulled it out. They never told anybody that the feature
25 wasn't going to be available because of this problem with the

09/04/2001 Chaparral Trial - Day 1

1 Crossroads patent. And secondly, in the course of that year,
2 they figured something out. In the words of one of their own
3 internal marketing documents that you'll see in a minute, it
4 was essential to selling the product. In the words of one of
5 their former engineers who we deposed, selling the product
6 without access controls was like selling a black and white
7 television.

8 And so, it was a commercial necessity for them to put
9 it back in. Here's a presentation made to Dell Computer on
10 May 24th of 2000. Remember, they pulled the access controls
11 in early May of 2000 and that draft letter was in early June
12 of 2000.

13 What were they telling Dell Computer? Nothing
14 different. They're talking about LUN masking and zoning.
15 They're talking about the devices can be configured to be
16 accessed or masked from multiple hosts. And this all is
17 talking about Chaparral, Fibre Channel-to-SCSI routers.

18 Here's a press release, November 8 of 2000. This is
19 talking about one of their RAID controllers. The A8526 has
20 the features that are highly sought after in SAN environments.
21 SAN environments are the storage area network. It involves
22 the computers and the remote storage.

23 LUN zoning and array partitioning provide a cost
24 effective solution for sharing disk arrays. This is November
25 8th of 2000. They throughout the year 2000, even though they

09/04/2001 Chaparral Trial - Day 1

1 pulled it and it isn't in their product, are still trying to
2 appear to the outside world like it's still in there.

3 And as I told you, they realized in the course of that
4 time it needed to be. Here's a former Chaparral engineer.
5 You'll hear his deposition read to you. He's not available to
6 be here live. Yes, as I think, yes, you need certain features
7 as the technology evolves. If you don't have them, then
8 you've got a black and white television and nobody wants it.

9 So the routers, without the access control LUN zoning
10 feature, Chaparral found out were like trying to sell a black
11 and white television. You don't have to believe me. You can
12 see what the documents written at the time show. Here's a
13 marketing document. Internal Chaparral marketing document.
14 It was written in the fall of the year 2000.

15 Talks about LUN zoning. And if you have any question
16 about LUN zoning is and whether or not it is the same as
17 access control, the controller will maintain a list of host
18 systems -- that's computers, work stations -- that are either
19 allowed to access or prevented from accessing each partition.

20 So that's on one page of the document. Now, if you go
21 to the back, you see what the release priorities are. And
22 there's a number of categories. I think it's A through E, if
23 memory serves. And category A is essential and in case you
24 don't know what the essential means, the category is defined
25 as requirements that must be included in the product.

1 And if you look at the priority level as to the
2 products shown on this page and there are products on other
3 pages that you can see when you actually see the document,
4 they are category A products. They are products for which LUN
5 zoning or access controls is essential.

6 And they were. Here are the sales that are after
7 January of 2001, when they put the LUN zoning back in. You
8 can see the total shipments, you can see the date of the
9 document, you can see the total revenue, \$1,667,830 of revenue
10 after they put the LUN zoning access controls back in.

11 So let's recap and then, I'll move on to the last
12 topic. They discover the patent in February of 2000. They
13 hire an expert and a lawyer to analyze the patent and try to
14 find prior art. In May of 2000, they pulled LUN zoning out of
15 the product because of a concern with the patent.

16 They tell the public nothing throughout the year about
17 their pulling LUN zoning. They get two letters from a patent
18 lawyer, one in June, one in November, that don't address a
19 product with LUN zoning and say it's okay to sell a product
20 that doesn't have access controls.

21 And then, they put it back in in January of 2001.
22 Now, you've got to say what did they tell their lawyer, who
23 wrote these letters about this? Exhibit 136 is the November
24 opinion letter from Mr. Zinger. Mr. Zinger is the lawyer. So
25 the question here is: Does this November letter mention LUN

09/04/2001 Chaparral Trial - Day 1

1 zoning anywhere in it? That's the letter that says it's okay
2 to sell products that don't have access controls.

3 And the lawyer says no, my letter doesn't mention LUN
4 zoning anywhere. When, of course, why would it? They pulled
5 it out of their products in May and didn't put it in until
6 after he wrote this November letter. But it gets more
7 interesting. In fact, you said you didn't know of any
8 Chaparral products that use LUN zoning; is that right? That's
9 correct.

10 Now, the interesting thing about that answer is this
11 deposition was taken in July of 2001, after Chaparral had been
12 selling products with LUN zoning for the better part of seven
13 months. They apparently didn't tell their lawyer. Subsequent
14 to the time you prepared this opinion, have you become aware
15 of any Chaparral products that use LUN zoning? Answer, no.

16 Did you perform any analysis of LUN zoning to
17 determine whether that feature if incorporated into a
18 Chaparral product would be infringing? Answer, no. Now, I
19 don't think that's quite right. I think what we're going to
20 find out, if Mr. Zinger comes here to testify, is that before
21 he wrote that letter in June, he talked with the people at
22 Chaparral about access controls.

23 And he took a look. There's nothing written down or
24 very little written down. But he took a look at the product
25 with access controls and without access controls. And I'll

09/04/2001 Chaparral Trial - Day 1

1 leave it for you to conclude as to whether or not he thought
2 that it was okay for them to use access controls when it's
3 nowhere mentioned in his opinion letter.

4 They took the handle off for a while, realized they
5 couldn't sell it without a handle and then, put it back on.
6 We will prove to you that the product that they sell have all
7 the elements of the claims of the 972 patent. Now, the claims
8 of the 972 patent are a little more complicated than a
9 screwdriver.

10 But we will through technical testimony and some
11 graphics that we've prepared and some animations that we've
12 prepared, we'll explain to you the background that you need to
13 know to understand this slightly more complicated claim. And
14 we will present to you one of the best experts you could find
15 anywhere on this topic. He's a Ph.D. from Stanford.

16 He spent almost 30 years at IBM working in the very
17 area that this patent involves, storage area networks. He has
18 analyzed multiple pages of documents that describe the
19 defendant's product. He has tested. He set up a test setup
20 and he has tested the defendant's product, and he will explain
21 to you how it is that they have every element of these claims
22 including the element that requires implement access controls.

23 You may hear some testimony that there have been some
24 very recent, like, within the last week, changes to these
25 Chaparral products. I'm not so sure you'll hear the

09/04/2001 Chaparral Trial - Day 1

1 testimony, but it's possible that you'll hear that, and you'll
2 just have to make your judgment about why that activity is
3 occurring a week before opening statement in this case.

4 You also may hear that the LUN zoning that Chaparral
5 has isn't really access controls because it's like Swiss
6 cheese; you can find your way through it quite easily. That
7 isn't what they're telling their customers about their LUN
8 zoning and access controls.

9 So I've now completed three of four topics that I was
10 going to talk with you about. And the fourth one, as I
11 promised you, is going to be very short. And the reason it's
12 very short is because the time period that they've sold as
13 opposed to marketed products that are infringing is very
14 short.

15 Here's a summary of the sales of products, what we
16 believe is a reasonable royalty rate on those products, and
17 the total damages shown there is \$275,000. Crossroads is
18 entitled to reasonable compensation. As I said at the
19 beginning, that's not the primary purpose that we're here.

20 The primary purpose that we're here is to have a
21 determination that the products that the defendant is selling
22 infringe our patent and a determination that the patent is
23 valid and a determination that the conduct that the defendant
24 has engaged in should not be tolerated, that the conduct
25 evidences willful infringement of a patent.

09/04/2001 Chaparral Trial - Day 1

1 And it is conduct that they should be dissuaded from
2 engaging in and others should be dissuaded from engaging in so
3 that the patent won't be infringed after today. I thank you
4 very much for your attention, and I look forward to putting
5 this case on before you.

6 THE COURT: Members of the jury, I'm going to give you
7 ten minutes to stretch, use the facilities, and we will
8 continue.

9 (Jury not present.)

10 MR. ALBRIGHT: Your Honor, we have done what we said
11 earlier we're going to do with exhibits. If you want to take
12 two minutes now, we could take care of that, or I'll do it
13 whenever you care to.

14 THE COURT: Well, that's fine.

15 MR. ALBRIGHT: Your Honor, I would offer a list of
16 Plaintiff'S Third Amended Trial Exhibit List which has no
17 objections by the defendant.

18 THE COURT: Counsel, let's remember that this is a
19 courtroom and I'm presiding over.

20 MR. BAHLER: Thank you, your Honor.

21 THE COURT: All fights are scheduled for Friday. All
22 right. What exhibits?

23 MR. ALBRIGHT: Your Honor, we have actually printed
24 out -- I can submit or I can read them, whichever you --

25 THE COURT: Let's read the numbers and put them in the

09/04/2001 Chaparral Trial - Day 1

1 record, and then, you could submit however you want.

2 MR. ALBRIGHT: Yes, sir. Without objection,
3 Plaintiff's Exhibit 1, 2, 4, 5, 6, 8, 9, 12, 13 through 20, 22
4 through 28, 29, 30, 32, 33, 35 through 40.

5 THE COURT: 38, 32 --

6 MR. ALBRIGHT: I'm sorry, 32, 33, your Honor, 35
7 through 40, 41 and 42, 44 through 49, 50 through 56, 57
8 through 62, 65, 66 through 68, 71 through 74, 75 through 83,
9 84 through 94, 95 through 101, 104 through 113, 118 through
10 125, 127, 128 through 134, 135 through 137, 139 through 144,
11 Plaintiff's Exhibit 182, Plaintiff's Exhibit 200 through 202,
12 Plaintiff's Exhibit 214 through 221, Plaintiff's Exhibit 222
13 through 228, Plaintiff's Exhibit 229 through 236, Plaintiff's
14 Exhibit 237 through 244, Plaintiff's Exhibit 245 through 251,
15 Plaintiff's Exhibit 252 through 254, Plaintiff's 256 through
16 261, Plaintiff's Exhibit 278. And a formal list of that is
17 here, your Honor.

18 Defendant's Exhibits we have no objections by
19 plaintiff are Defendant's Exhibit --

20 MR. BAHLER: Mr. Albright, why don't you let me read
21 them. Might speed things up.

22 MR. ALBRIGHT: Be delighted.

23 MR. BAHLER: Your Honor, Defendant's Exhibits that
24 have been admitted without objection are Defendant's Exhibit 1
25 through 30; 34 through 59; 62, 74, 78, 79, 84, 99, 104, 107

09/04/2001 Chaparral Trial - Day 1

1 through 109, 111 --

2 THE COURT: Wait, 107 through what?

3 MR. BAHLER: 109. 111 through 122, 126 through 129,
4 131, 133 through 168, 170 through 172, 174, 179 through 181,
5 188, 190 through 232, 238 through 246, 249 --

6 THE COURT: 238.

7 MR. BAHLER: Through 246.

8 THE COURT: All right.

9 MR. BAHLER: 249 and 253 through 271.

10 THE COURT: Okay, counsel. Are you sure you have
11 enough exhibits?

12 MR. BAHLER: I think so, your Honor.

13 THE COURT: Those exhibits are admitted for the record
14 without objection.

15 MR. BAHLER: Your Honor, I have a point. The reason
16 Mr. Allcock and I were having a heated discussion was that we
17 never did see many of these slides before today, and I'm so
18 hesitant to hop up in front of the jury to just put Christmas
19 lights around it. But there was stuff in here, for example,
20 Zinger's testimony.

21 Mr. Zinger is going to be here on the stand. That
22 stuff is all hearsay. If we'd have been given an opportunity
23 to review those slides beforehand and object to them, we could
24 have done that. We weren't going -- we were not given that
25 opportunity.

09/04/2001 Chaparral Trial - Day 1

1 MR. ALLCOCK: Your Honor, everything I showed was
2 either a demonstrative exhibit that they've already had, or a
3 portion of an exhibit that was on the list that just was read
4 as being admitted exhibits.

5 MR. BAHLER: Your Honor --

6 THE COURT: But deposition testimony, it's fair game.
7 I usually relax the admissibility on opening statements with
8 regard to deposition testimony that counsel's aware of, but
9 they're entitled to know it's coming so that they can object
10 to it just as if the witness was in the chair.

11 And I'm not so sure of the hearsay -- usually is --
12 but sworn testimony can be admissible and it's discretionary.
13 But you're entitled to know about it beforehand. So if
14 there's any other susses, not SCSIs but susses, I don't want
15 anybody complaining about it.

16 MR. ALLCOCK: Very well, your Honor.

17 MR. BAHLER: Thank you, your Honor.

18 THE CLERK: When he was giving these names, you left
19 these numbers -- he included 39, but 39 is not listed on the
20 Plaintiff's Exhibits. It needs to be clear on the record.

21 THE COURT: He's got 35 and 40.

22 THE CLERK: Right. And 39 is supposed to be included,
23 apparently.

24 THE COURT: Okay. Did you try to slip 39 in there?

25 MR. ALBRIGHT: Don't --

09/04/2001 Chaparral Trial - Day 1

1 THE COURT: Is 39 objected to?

2 MR. BAHLER: No.

3 MR. DELLETT: It isn't.

4 THE COURT: It's two-to-one.

5 MR. BAHLER: It's withdrawn.

6 MR. ALBRIGHT: Was just pressing it.

7 THE COURT: All right. Ten minutes.

8 (Recess.)

9 THE COURT: Bring them in.

10 (Jury present.)

11 THE COURT: Mr. Bahler, you have the lectern, sir.

12 DEFENDANT'S OPENING STATEMENTS

13 MR. BAHLER: Thank you, your Honor. May it please the
14 Court, counsel.

15 Members of the jury, my name is Dave Bahler. As I
16 said, I work for Fulbright & Jaworski here in Austin, Texas,
17 and I'm proud to represent Chaparral in this case. This case
18 was filed in the end of March last year, March 2000. Judge
19 Sparks mentioned that his docket runs in ten months. Well,
20 this is a complicated case, and patent cases are a little bit
21 slower.

22 This one has come to trial not soon enough for
23 Chaparral. Chaparral has looked so forward to this day. When
24 this case was filed, it was a horrible disruption to their
25 business. They've lost sales, they've lost investments,

09/04/2001 Chaparral Trial - Day 1

1 they've lost their good name in the marketplace. And finally,
2 it can come to an end.

3 Ladies and gentlemen of the jury, Crossroads filed
4 this case simply because they can't compete in the
5 marketplace. They can't compete. They've lost money every
6 single quarter that they've been in business, and they are
7 running to the courthouse and trying to accomplish in the
8 courthouse what they fail to accomplish in the marketplace.

9 Now, Judge Sparks mentioned to you the order of
10 evidence. I'd just like to remind you again, if I may. The
11 way the rules are set up to apply to courts or trials like
12 this, the plaintiff always gets to go first. Crossroads gets
13 to go first. You just heard Mr. Allcock's opening statement.
14 I get to go second, which is what I'm doing now.

15 Then, when I sit down, they will present their
16 evidence first. So you will hear all of it. And the way the
17 Court has set up the schedule, it's likely that you won't hear
18 Chaparral's side of this case until sometime next week.
19 That's a big gap. We're going to get a three-day weekend
20 here, and that's a big gap between their side of the case and
21 Chaparral's side of the case.

22 And what I ask you to do, ladies and gentlemen, is to
23 wait to hear the entire story because I do assure you that
24 there are two sides to this story. At the end of this
25 evidence, three things will become clear. First, this patent

09/04/2001 Chaparral Trial - Day 1

1 never should have issued. This patent is old. This patent
2 has been tried in things that have come before and never
3 should have issued that patent, and I'll get into that in much
4 more detail in just a little bit.

5 Second, the patent is unenforceable which means it
6 cannot be enforced against anyone, against you, against me,
7 and, quite significant, it can't be enforced against
8 Chaparral. Why? Because Crossroads was less than honest when
9 they were dealing with the Patent Office when they were
10 getting this patent. That is -- and the consequences of that
11 act mean that the patent is unenforceable.

12 And lastly, the patent is does not infringe. Now, if
13 any one of these three things is proven to your satisfaction,
14 any one, Crossroads -- I'm sorry, Chaparral pays Crossroads
15 nothing, zero. Only one of those things needs to be necessary
16 for you to conclude that Chaparral owes Crossroads nothing.

17 But at the end of the day, the end of the evidence,
18 sometime next week, probably Tuesday with any luck, all three
19 will be shown to your satisfaction. Now, I don't want you to
20 think for a moment that since Chaparral is here in this
21 courthouse, that they have done anything wrong. This is
22 America, ladies and gentlemen, and anybody can file a lawsuit.
23 Anybody with a word processor and/or a typewriter and \$140
24 could walk into the Clerk's Office, which is right across the
25 court lobby here, and file a complaint.

09/04/2001 Chaparral Trial - Day 1

1 That's what Crossroads did here in this case. That's
2 all they have done. That's why Chaparral is here. Chaparral
3 did that, as I mentioned, because they've been losing money
4 hand over fist, and the only way they think they could make
5 money is from you, ladies and gentlemen. They want you to
6 give them money from Chaparral in this case.

7 None of us should be here. This is a day after Labor
8 Day. This thing really messed up my weekend, I'll really tell
9 you that. I know you have better things to do. I know
10 Chaparral has better things to do. I enjoy this stuff. I
11 would not rather be anywhere else in the world, frankly,
12 however, we shouldn't be here. Why? Because this case is
13 completely baseless.

14 This case should be fought in the marketplace, not in
15 this courthouse. Put these parties right back where they
16 belong, in the marketplace where they can fight fair and
17 square. Before I get started in a little bit more detail
18 about those three topics, I'd like to tell you a little bit
19 about Chaparral.

20 Chaparral is a company that's located in Boulder,
21 Colorado, and was started by three friends, one of whom is
22 Jerry Walker. I introduced you to Mr. Walker. He'll be
23 sitting with me at counsel table, and you'll be hearing from
24 him in this case. He was one of those founders.

25 The other two are a fella named Gary Allison, fella

1 named Michael Gluck. Those three guys got together and formed
2 Chaparral. Turned out that Mr. Allison had a contact at a
3 company called Adaptec. And Adaptec is a very big company,
4 much bigger than Crossroads, much bigger than Chaparral.
5 Chaparral's only 70 employees. And they, Adaptec, had been in
6 this area for quite some time, but they hadn't really been
7 making products that did this routing stuff.

8 What they had been making is chips that go into
9 computers that handle Fibre Channel, on the one hand, they
10 handle SCSI on the other hand. They were very good at doing
11 that. And Adaptec got the idea and this was 1996 when they
12 got this idea, 1996, that's a very important date.

13 This is long before Crossroads had thought of
14 anything. Adaptec thought of the idea of making a Fibre
15 Channel-to-SCSI router device and they built it. And they
16 started selling it, but then, they decided they didn't have
17 the expertise to really sell it right and what did they do?
18 Well, Mr. Allison got with his friend, the chairman and CEO of
19 Adaptec, and decided that these three guys, Mr. Gluck, Mr.
20 Allison and Mr. Walker, were to combine their almost 70 years
21 of experience in the storage industry and take this product
22 that Adaptec had developed but didn't quite know how to market
23 and Chaparral would take that over.

24 And they would market it and that's what happened.
25 Chaparral's product started with Adaptec. They didn't get one

09/04/2001 Chaparral Trial - Day 1

1 thing from Crossroads, not one, not one thing. This is a
2 patent case. I'd like to tell you just a little bit about the
3 patent process. The Judge gave you a little bit of a
4 background, but there's a few things that you really need to
5 know in order to appreciate this.

6 I know that one of y'all had a husband that applied
7 for a patent, so you might be more familiar than the others,
8 but nonetheless, patent application process is confidential.
9 When Crossroads filed their patent on December 31st, 1997,
10 December 31st, 1997, there were only -- from that point until
11 the patent issued in August 1999, there were only two people
12 in the world that knew about the existence of that thing.

13 Crossroads, actually, the company, bunch of people
14 within Crossroads knew about it and the patent examiner. The
15 rest of us, Chaparral included, didn't know. They had no
16 right to participate in that proceeding. They couldn't tell
17 the Patent Office what the Patent Office needed to know. What
18 they couldn't tell the Patent Office that what Crossroads was
19 trying to do had, in fact, been done before, for example, at
20 Adaptec, and we'll hear evidence of that.

21 Because it's confidential, because the relationship
22 between the patent -- the person applying for the patent and
23 the Patent Office is confidential, the law places a very heavy
24 burden on people applying for a patent. Why? Well, the
25 confidence is one, but just them and the Patent Office.

1 That's it.

2 Number two, the Patent Office has a lot of work to do.
3 There are over 100,000 patents filed in the United States
4 every year, and there is a brace of examiners that kind of
5 varies between 2,200 and 2,500 depending on the time, and
6 those examiners are charged with examining patent applications
7 on behalf of these people who file inventions.

8 Now, the Patent Office, contrary to some beliefs, is
9 not a marble pillar building, sitting on a hill in oak trees
10 shade in Washington, D.C., no way. The Patent Office, in
11 fact, is in rented space. It's not even a government-owned
12 building, it's not even in Washington, it's in Virginia. It's
13 right next to Washington Reagan Airport.

14 The Patent Office is not filled with scientists in
15 white jackets running around with beakers and microscopes and
16 meters, measuring people's inventions. No. The Patent Office
17 is filled with offices. That's what it is. It's an office
18 building, very large office building, and in those offices are
19 these patent examiners.

20 And what the patent examiners have to look at is not
21 beakers, or test tubes, or microscopes, or meters. It's
22 paper, lots and lots of paper. That's how examiners look at
23 things to determine whether or not something's patentable.

24 Do they look at products that are sold by people? No,
25 they don't look at that. They can't unless the patent

1 applicant tells them about it. And this, the evidence will
2 show, Crossroads did not do. Crossroads had very valuable
3 information that they withheld from the Patent Office they
4 didn't tell the Patent Office about.

5 And if they had, the evidence will show that this
6 patent never should have issued. It is, in fact, invalid.
7 Now, the law recognizes that the Patent Office is not perfect,
8 that it has a lot of work to do that it has to rely upon
9 people applying for patents to be completely honest with them.

10 And that's not a perfect system. It couldn't hardly
11 be. There's almost six million patents that have issued since
12 the beginning of time. But the law provides a safety net.
13 There are, in fact, two Patent Offices. There's one in
14 Washington, D.C., and there's one sitting right in front of
15 you, you, the members of this jury.

16 You have the right, in fact, a duty and the power to
17 look at these facts all by yourself, brand-new, and determine
18 whether or not this patent should have issued, whether or not
19 Crossroads committed inequitable conduct in front of the
20 Patent Office, whether this patent is a valid patent or not.
21 That's your right. That's your duty.

22 Now, I'd like to go into a little bit more detail on
23 those three topics starting with the invalidity. And that all
24 starts with a sticker that Crossroads put on their products.
25 It's a sticker that had the patent number, the patent number

1 from the patent in this case.

2 And many of you have seen patent numbers applied to
3 products. Sometimes you see them on cartons. Sometimes
4 they're molded into the metal of parts. I collect old
5 railroad lanterns, and that's one of the ways you can tell how
6 old they are is you look at the patent numbers. They're
7 stamped right into the metal, all of these old things, some
8 date back to the 1800s.

9 But the law doesn't permit -- well, the law permits
10 people to put patent numbers on products. It's kind of like
11 advertising. But they can't just do it because they want to
12 because the law prohibits falsely marking products with patent
13 numbers. Prohibits that. As a result, companies do
14 investigations before they put the patent numbers on their
15 products.

16 That's exactly what Crossroads did in this case.
17 Upper management of Crossroads conducted an investigation.
18 When was that done? That was done in late 1999. This was
19 before they sued Chaparral, before they were motivated by
20 litigation.

21 That after this patent issued, their first patent that
22 ever issued to that company, after it issued they did an
23 analysis, upper management did an analysis and determined that
24 the product that they were selling at the time, the 4100
25 product, included the invention of the 972 patent. Here's

1 that patent label right here. May I have the first slide,
2 please.

3 This is actually a drawing of the label. The label is
4 this part right here. And this is an engineering drawing.
5 And may I have the next slide, please. It applies to the
6 Crossroads 4100 and 4200 products. Those are storage routers.
7 May I have the next slide, please? And the label up in that
8 area included the word protected by U.S. Patent Number
9 5941972. This was applied to their products in January 2000.

10 They told the world that their product, the 972
11 patent, was embodied or included in both their 4100 and 4200
12 products. That's what they told the world. That's what they
13 told Chaparral, also. May I have the next slide, please.

14 So what we have here is we have Crossroads patent
15 issuing -- they filed their patent on December 31st, 1997.
16 Next slide, please. And after it issued, right about here in
17 August of 1999, beginning at about January 2000, Crossroads
18 labeled its product. Now, I've included this line here that
19 shows old. That's one year before the filing date of that
20 patent, and I'll explain that in just a little bit.

21 So this is what Crossroads told the world when they
22 put that patent number on their product. They told the world
23 that the 972 patent was included in their own 4100 -- the 4100
24 product, the product that they were selling at that time.

25 And then, what did they do next? Well, they took this

09/04/2001 Chaparral Trial - Day 1

1 patent, first patent that had ever issued to that company, and
2 they filed their first lawsuit and they filed it against
3 Chaparral. May I have the next slide, please. They filed
4 this lawsuit against Chaparral on March 31st, 2000. Now, this
5 is interesting.

6 I don't have the benefit of the slides that Mr.
7 Allcock used during his opening statement, but if you take a
8 look at those, first of all, the one he showed you showing
9 announcement of LUN zoning in the second quarter of 2000.
10 That shows infringement in his mind. That's what he wanted
11 you to believe. You know what? It's not infringement.

12 You're just telling people what you're planning to do
13 is not infringement. And by the way, also, what is the second
14 quarter of 2000? It starts April 1st, 2000 and ends when?
15 The end of June. When did they sue them? They sued them at
16 the end of March. LUN zoning was not in this product.

17 And filing a lawsuit is very, very serious. Companies
18 do not take this lightly. They have to do an investigation
19 before they do this because filing baseless lawsuits is like
20 putting a patent label on your product that's wrong. It's
21 against the law. There's serious sanction for that, and I
22 have no doubt that a careful company like Crossroads did that
23 investigation.

24 They investigated it and they concluded that the
25 Crossroads patent -- Crossroads -- that the Chaparral 1310

09/04/2001 Chaparral Trial - Day 1

1 product without LUN zoning infringed. That's important.
2 That's the second thing they told the public. They filed the
3 lawsuit. And the only way they could have done that is to
4 have concluded, had to have investigated and had to conclude
5 that the 1310 product infringed. They had to have done that.
6 That's required.

7 It's not their story today. You heard all this talk
8 about LUN zoning. They've changed their story. They're not
9 shooting at that 1310 anymore. And the evidence will show
10 that this patent label, they'll say that's a mistake. That's
11 what they're going to tell you, whoops, we made a mistake, we
12 accidentally marked our product with that patent number. We
13 made a mistake. It was no mistake.

14 Why did they change their story? Here's why. May I
15 have the next slide, please. It turns out that the access
16 control in the 4100 product and in the Chaparral 1310 product
17 in both of these products was something called the SCSI
18 reserve command. The SCSI reserve command. You'll hear a lot
19 of evidence about that.

20 SCSI is a language. It's not only a bus or a bunch of
21 wires that are included in the computer, dedicated primarily
22 to storage, it's kind of an industry standard. And in those
23 industry standards, there are specifications that tell you how
24 to communicate on that bus. One of these things is a command
25 called the SCSI reserve command.

09/04/2001 Chaparral Trial - Day 1

1 You'll hear a lot of evidence about that. The only --
2 the evidence will show that the only access control in the
3 4100 in the spring of 2000, actually, the only access control
4 that's ever existed in the 4100 is the SCSI reserve command.
5 The evidence would show that the access control that existed
6 in the 1310 was also the SCSI reserve command.

7 Now, about the fall of last year, as this case was
8 developing, the parties go through what's called discovery.
9 You have to tell each other what's going on. That's part of
10 the rules. Kind of unusual in the United States, but it's the
11 rules that we play with a lot in the United States in courts.

12 The parties have to tell the other side what's going
13 on. Well, about the fall of last year, Crossroads figured out
14 that Chaparral knew that the SCSI reserve command was old, and
15 that was what was being used in the 4100 and the 1310
16 products. So before they changed this story, they found this
17 out.

18 They found out that both the 4100 product, the product
19 that they had put their label on and the 1310 product, the
20 product that they had sued Chaparral on, that product was old.
21 And you know what? If the 972 patent is in the Crossroads
22 4100 which they told people that they labeled, if the 972
23 patent is in the 1310, SCSI reserve command and both of those
24 things are old, guess what, that means the 972 patent itself
25 is old. And if it's old, what? It's invalid. So they had to

1 change their story.

2 If they hadn't changed their story right out of their
3 own acts, they would have invalidated their own patent. So
4 now they say LUN zoning. That's what it is. That's what it
5 has been all along of the LUN zoning. Oh, the SCSI reserve
6 command, that never was access control. Dr. Hodges, their
7 Ph.D., is going to stand up here and tell you that to your
8 face. Don't believe it for a minute.

9 They were right when they put that patent label on
10 that product. That product was -- they had a right when they
11 concluded that the SCSI reserve command was their invention
12 and that's old and their patent is invalid. For your
13 information, the jury forms that you have, this deals with
14 Questions 7 and 8. The answer to those questions, ladies and
15 gentlemen, is a definite yes, patents in these claims are
16 invalid.

17 The second aspect that I would like to talk to you
18 about is unenforceability. And that, as I mentioned earlier,
19 is if Crossroads or if a patent applicant, in this case,
20 Crossroads, is not completely honest with the Patent Office
21 when dealing with the Patent Office and they don't tell the
22 Patent Office everything that they should tell them, then they
23 can't enforce the patent later.

24 That's the law. Why is that? Well, the secrecy is
25 one thing. Also, the patent is a very powerful and precious

09/04/2001 Chaparral Trial - Day 1

1 right. An issued U.S. patent permits a company like
2 Crossroads to drag anybody they want into federal court,
3 anybody. It's very, very powerful.

4 These cases are not cheap, ladies and gentlemen. This
5 case has been going on since March 31st, and there's been a
6 lot of money spent in defending Chaparral -- Chaparral
7 defending itself against these baseless charges. Very, very
8 powerful right.

9 So if you're not completely honest with the Patent
10 Office when you deal with the Patent Office while your patent
11 application is pending, the consequences are very severe,
12 justifiably so, and the consequences are unenforceability.
13 That means that Crossroads cannot enforce their patent against
14 Chaparral. They can't enforce it against you or me or
15 anybody. Simply unenforceable.

16 And that, once again, starts with the patent label.
17 May I have the next slide, please. Here's the patent label.
18 This is the label they apply to their 4100 product, all right?
19 And they told the public that it was covered by the 972
20 patent, patent in this case.

21 The 972 patent included the 4100 product or vice
22 versa, actually, is more accurate. The 4100 product included
23 the invention or was using the invention, the 972 patent. And
24 when they filed the application with the Patent Office in
25 December 31st, 1997, they were required to tell the Patent

09/04/2001 Chaparral Trial - Day 1

1 Office about things that they, themselves, had done more than
2 one year before.

3 Things like public uses of the invention, things like
4 offering the invention for sale. Did they do that? Did they
5 do those acts? Did they have activity before the end of 1996?
6 You bet. May I have the next slide, please.

7 Turns out that in November 1996, now, this is a month
8 before the so-called critical date, that December 31st, 1996,
9 more than one year before the filing date -- Crossroads took
10 the 4100 product, prototype of the 4100 product and took it to
11 a show in Las Vegas called Comdex, huge show, hundreds of
12 thousands of people go to this show.

13 And they had a technology demonstration, as I
14 mentioned, and they handed out this brochure right here saying
15 that CrossPoint 4100 Fibre Channel-to-SCSI router, and they
16 had there the same booth, the machine operating. That's a
17 public use, ladies and gentlemen, and it's something the
18 Patent Office should have known about.

19 Public use of their own invention. A public use of
20 their invention that they told after the patent issued, they
21 said it was included in the patent. They said that the
22 product included the invention in the patent, and yet, they'd
23 shown that product more than a year before they filed. Don't
24 you think that was important for the Patent Office to know?

25 I certainly do. And yet, not one word. Not one word

1 did they tell the Patent Office. They took a gamble. They
2 took a gamble when they filed their patent that the Patent
3 Office wouldn't find out about their own activity more than
4 one year before the filing date. They won. The Patent Office
5 didn't find out.

6 You know what? This stuff is nothing that the Patent
7 Office could have found. This is exactly the stuff that this
8 rule that I'm talking about applies to, exactly. Patent
9 Office looks at these papers, mounds of papers, Crossroads'
10 own product wouldn't have been in that stuff. That's
11 something that Crossroads knew about. That was unique
12 knowledge between the Crossroads and the Patent Office between
13 this unique relationship of trust and honesty.

14 Who knew that? Crossroads did. They didn't tell the
15 Patent Office examiner. They won that gamble. They got their
16 patent. They also took a gamble that they could hide it from
17 Chaparral and lost that gamble. And they also took a gamble
18 they could hide it from you, and they're going to lose that
19 one because you're going to find out about this.

20 They didn't tell the Patent Office critical
21 information, information that would have invalidated their
22 patent, clearly, and that means their patent is unenforceable.
23 We shouldn't be here and they know it. Jury questionnaire,
24 that's Question 11 for those of you keeping track. The
25 question should be answered a resounding yes.

09/04/2001 Chaparral Trial - Day 1

1 So we have the first two things. First, the patent is
2 invalid. Second, the patent is unenforceable. I'm about to
3 go to the noninfringement issue. Either one of those first
4 two, if proven to your satisfaction, ladies and gentlemen,
5 means that Chaparral owes Crossroads nothing. Even if it's
6 invalid, if you conclude that, or unenforceable, indeed, the
7 evidence will show both of those, but only one is necessary.

8 Moving on to the third one which is infringement. As
9 I mentioned, ladies and gentlemen, Chaparral got started using
10 technology from Adaptec. May I have the next slide, please.
11 Here's a drawing of what -- of what they got from Adaptec.
12 This is dated December 1996.

13 And Adaptec invented a Fibre Channel-to-SCSI, what
14 they call a bridge at that time. This is Fibre Channel
15 arbitrated loop over here, this is SCSI over here, and this is
16 a box, this is a storage router. And that's what -- that's
17 where Chaparral got it started, and they're still using
18 Adaptec today.

19 Chaparral took that technology from Adaptec and took
20 it further forward. You'll hear Mr. Walker talk about how
21 that technology was adapted and still exists today in
22 Chaparral's products, still exists today, still used today.
23 Technology that they got from Adaptec is still being used
24 today.

25 You'll hear from a fella named Ian Davies, software

09/04/2001 Chaparral Trial - Day 1

1 developer. Ian Davies is an interesting individual because he
2 got started at Adaptec. He worked on that Adaptec product
3 that I just had up there. He worked on it while at Adaptec
4 and when that product was transferred from Adaptec to
5 Chaparral, he continued working on it.

6 You'll hear from him. You'll hear from him how they
7 didn't use one screw, one bolt, one resistor, capacitor,
8 anything from Crossroads, not one thing. They got the stuff
9 that they are using from Adaptec. They got it from the
10 beginning and are using it today.

11 Now, Mr. Allcock mentioned that Chaparral found out
12 about this 972 patent in February of 2000. That's absolutely
13 true. They found out about it and what did they do? They did
14 exactly the right thing. They contacted their patent lawyer
15 almost immediately. That's exactly what the law requires you
16 to do. That's what they expect.

17 If you see a patent, you don't know what it means.
18 These guys are not lawyers, so they contact an expert. They
19 contacted Mr. Zinger, patent law expert. Mr. Zinger had been
20 working with them. His name's Dave Zinger. Been working with
21 him for many months as -- actually, it may be a year -- on
22 patenting Chaparral's own products.

23 He knew Chaparral's own products very well, so he
24 didn't have to get up to speed. It's a very logical choice.
25 Mr. Zinger not only had a law degree and knew patent law very

1 well but, also, he was an engineer. He has a technical
2 degree. He knew computers very well.

3 Mr. Zinger was a fine choice. And Mr. Zinger looked
4 at this 972 patent and concluded that it was invalid, never
5 should have issued, or, in the alternative, he concluded that
6 it was not infringed by the Chaparral products. And so,
7 ladies and gentlemen, if you find that, you won't be first.
8 Mr. Zinger had done that months before.

9 Now, as Mr. Allcock noted, Chaparral found out about
10 this patent without any word from Crossroads, not one word,
11 not a letter, not a phone call, not a, hey, why don't you look
12 at this patent, nothing. No personal conversation, nothing.
13 What did Crossroads do? First thing they did was to file
14 suit.

15 That's the first thing they did, shoot first and ask
16 questions later. That's Crossroads' attitude in this case.
17 Now, Mr. Allcock wrote some four words for you to remember,
18 ten years from now, access controls and LUN zoning. That's
19 the essence of the invention.

20 Patent says access controls, no doubt about that.
21 You're not going to hear one witness from this stand, and that
22 patent document does not include any mention of LUN zoning,
23 not one. The patent isn't about LUN zoning, it's about access
24 controls. In fact, you won't even hear mention of the word
25 zoning in that patent. It's just not there.

09/04/2001 Chaparral Trial - Day 1

1 And, in fact, the LUN zoning that occurred -- this
2 appears in Chaparral's most recent products -- is much more
3 like the SCSI reserve command, using the SCSI reserve
4 commands. Technology that they had, although relating all the
5 way back to the Adaptec day, much more like that than it is
6 the access controls that are contemplated by the 972 patent.

7 Much more like that. And this, ladies and gentlemen,
8 deals with Questions 1 through 4 and 6 on your form, those are
9 the infringement questions. Each of those questions should be
10 answered a resounding no. Chaparral doesn't infringe, they
11 never have and never will.

12 So we've got these three reasons. First, Chaparral
13 owes Crossroads nothing because the Crossroads patent never
14 should have issued. It's invalid. Second, Crossroads' patent
15 was not enforceable because Crossroads was less than honest
16 when dealing with Patent Office. And third, there is no
17 infringement of the Chaparral products, the 1310, before, now
18 or ever. There's no infringement.

19 Mr. Allcock says this case is not about money. Now,
20 whenever I hear that, this case is not about money, it's not
21 about money, it's always about money, every single time and
22 that's what this case is about. They want to convince you to
23 get Chaparral to pay them money. It's exactly what this case
24 is about.

25 They say it's all about access control. Well, in

1 fact, access control is a very small part of their invention.
2 Mr. Allcock made reference to the claims that are at the end
3 of the patent. He's right. They're like a deed to land.
4 They kind of describe, it's kind of archaic patent law
5 language exactly what's being claimed.

6 And let me have the next slide, please. Now, what
7 I've done here, I don't expect you to read this. What I've
8 done here is reproduce the last page of this patent. We're
9 going to go into much more detail on this. But what I've done
10 is I've gone into the claim. This includes all the claims, 1
11 through 14.

12 You can kind of make that out. I've gone through all
13 those claims, and I've highlighted the word access control.
14 That's how much it occurs. And yet, they're going to get a
15 witness on this stand who is supposed to be an expert in
16 economics that's going to ask you to pay them either 25
17 percent or 17 percent of the gross selling price of the
18 Chaparral product when this is how much of their invention is
19 really access control.

20 Looked at another way, the accused Chaparral products
21 have about 500,000 lines of code. That's the way programmers
22 like to measure things, the lines of code. They printed out
23 on a sheet of paper -- actually, they probably do it on the
24 screens, and they count the lines of code.

25 The product -- the accused products include about

1 500,000 lines of code. How much of that code is dedicated to
2 LUN zoning? This feature that they're shooting at that they
3 say is so incredibly valuable? Well, it turns out that it's
4 less than 5,000 lines. That's one percent. One percent of
5 our product.

6 This much of their invention, one percent of our
7 product includes the thing that they're shooting at. Yet,
8 they want -- they're going to try to convince you to pay them
9 either 25 percent or 17 percent of the gross selling price.
10 This outrage never stops.

11 So, ladies and gentlemen of the jury, we have these
12 three things. First, the patent is not valid, never should
13 have issued by the Patent Office. It's old. Crossroads is
14 trying to patent something that's old, and you're the first to
15 hear about it because the Patent Office didn't see it.

16 Second of all, the Patent Office didn't see it because
17 Crossroads didn't tell them about it, and that means the
18 patent is unenforceable. This patent never should have
19 issued, ever. And third, the patent doesn't infringe. If any
20 one of those -- at the end of the day, once again, this
21 evidence is not going to be completely in this case until
22 Tuesday next week, and if at that time you find any one of
23 those things true, then Chaparral pays Crossroads absolutely
24 nothing.

25 But, indeed, ladies and gentlemen, I feel confident

09/04/2001 Chaparral Trial - Day 1

1 that you will find each one of those true, all three of them.
2 I'd like to thank you in advance for your attention to this
3 case on behalf of Chaparral. I know Tuesday after Labor Day
4 is not the favorite thing to come to the courthouse sitting on
5 a jury.

6 And on behalf of Chaparral, I'd like to thank you for
7 coming here today, and what I ask is that you listen to all
8 the evidence and when all the evidence is in, you make a fair
9 judgment. That's all we can ask. Thank you.

10 THE COURT: You may call your first witness.

11 MR. ALBRIGHT: Your Honor, we're going to move the
12 screen.

13 THE COURT: If you're going to move the screen, I
14 suggest you move it.

15 MR. ALBRIGHT: Your Honor, we would call Brian Smith
16 to the stand, please, sir.

17 THE COURT: Come forward, be sworn, please.

18 (Witness was sworn.)

19 THE COURT: Take your seat, please. If you'll tell us
20 your full name, please, sir, and spell your last.

21 THE WITNESS: Brian Rutledge Smith, S-M-I-T-H.

22 BRIAN R. SMITH, called by the Plaintiff, duly sworn.

23 DIRECT EXAMINATION

24 BY MR. ALBRIGHT:

25 Q. Mr. Smith, would you introduce yourself to the ladies and

09/04/2001 Chaparral Trial - Day 1

1 gentlemen of the jury, please, sir?

2 A. Good afternoon. My name is Brian Smith. I am the
3 Chairman and CEO of Crossroads Systems.

4 Q. And would you briefly tell the jury what your educational
5 background is, starting with college?

6 A. Yes. I have an undergraduate degree in electrical
7 engineering from the University of Cincinnati, and I have a
8 graduate degree in electrical engineering from Purdue
9 University.

10 Q. When you graduated from Purdue, what did you do
11 professionally, sir?

12 A. I went to work for IBM.

13 Q. What time period would that be?

14 A. That was 1990.

15 Q. Okay. Moving ahead to 1992, 1993 time period, tell the
16 jury, if you would, please, sir, how it is that what is now
17 Crossroads began?

18 A. When I moved from New York to Austin to work for IBM and
19 after a while, we met a gentleman named Dale Quisenberry, who
20 we started to talk about -- I started to talk with about a
21 business opportunity, and we founded Crossroads together,
22 precursor to that in 1994.

23 Q. And what was the name of the precursor that you and Mr.
24 Quisenberry formed?

25 A. We called it Infinity Comm Stor.

09/04/2001 Chaparral Trial - Day 1

1 Q. And just very briefly, tell the jury what it is that you
2 all did in that time period.

3 A. We did consulting work. We used our expertise to provide
4 potential customers with answers to questions they may have or
5 develop different things for them, marketing, engineer
6 products, that kind of thing.

7 Q. Tell the jury, if you would, fast-forwarding to 1996 what
8 it was that made you decide to launch out and begin Crossroads
9 with Mr. Quisenberry?

10 A. Consulting was a very good business but it didn't scale
11 very well, so we looked to get back to our original roots
12 which was in delivering products. And so, we looked for a
13 product to develop.

14 Q. And what product was that?

15 A. We decided to invent the new world, new space called the
16 storage router world.

17 Q. And would you give the jury an idea during the '96-'97
18 time period what Brian Smith's role was with respect to
19 selling Fibre Channel and SCSI -- Fibre Channel routers to --

20 A. I spent a lot of time doing a number of things. First was
21 evangelizing, because Fibre Channel was a new standard, and
22 educating potential customers, as well as our partners, on the
23 merits of Fibre Channel. I also spent a great deal of time
24 with customers, looking for opportunities to potentially sell
25 products that we would eventually develop to them over time.

1 Q. And would you give the jury in the 1996-1997 time period
2 what kind of commitment in terms of hours in your personal
3 life, professional life you invested in Crossroads?

4 A. That was certainly an extraordinary amount, 80 plus hours
5 each week in flying around, meeting with investors, meeting
6 with potential customers and talking to partners.

7 Q. Your Honor, may I move to the table for just a second,
8 your Honor?

9 THE COURT: Pardon?

10 MR. ALBRIGHT: May I move to the table? We have a
11 couple of demonstratives I'd like to show Mr. Smith.

12 THE COURT: You don't need my permission to move
13 around in the courtroom.

14 Q. (BY MR. ALBRIGHT) Mr. Smith, just quickly, since these are
15 physical items we're going to be discussing, I just wanted to
16 give the jury an idea of what it is that we're talking about
17 when we're talking about it. Would you tell the jury what
18 this is I'm holding in my hands?

19 A. It's a SCSI cable.

20 Q. And that SCSI would be the S-C-S-I that we've seen and
21 heard so much about?

22 A. That's correct.

23 Q. Comparing this to this, tell the jury what this long
24 orange cord is.

25 A. That's a fiber-optic cable that can be used to connect

1 Fibre Channel devices together.

2 Q. Okay. And in terms of length comparing the Fibre Channel
3 to the SCSI spec, what happens with respect to the distance
4 that information can carry?

5 A. The SCSI spec allows us to go up to 25 meters but
6 typically only six meters in enterprise whereas Fibre Channel
7 allows us to extend up to ten kilometers.

8 Q. Okay. In terms of speed, is there any difference?

9 A. There are differences: The SCSI has a different set of
10 data rates, 20 megabytes a second, 40 megabytes a second, 80
11 megabytes a second. Fibre Channel started off at slower rates
12 than the 100 megabytes a second that currently use that and
13 has moved to 200 megabytes. And there's contemplation even
14 beyond that today, so it's even a lot faster.

15 Q. What would this be?

16 A. That is a disk drive, looks like a SCSI disk drive.

17 Q. Where does this go?

18 A. Typically in either a computer server or in an external
19 storage device.

20 Q. And this is what?

21 A. That is -- if you'll show me the back. That is a 4100.

22 Q. Okay. Who makes this?

23 A. Crossroads does.

24 Q. So this is the Crossroads 4100 router?

25 A. It is.

09/04/2001 Chaparral Trial - Day 1

1 Q. Okay. Mr. Allcock discussed a little bit about the
2 technology describing what it did. He described it as
3 basically translating Greek to English. Do you remember that
4 portion of the argument?

5 A. Yes.

6 Q. Would you give the jury just a brief understanding of what
7 Mr. Allcock was telling them?

8 A. Fibre Channel and SCSI speak different languages. One's a
9 networking language, the other one is a bus or point-to-point
10 language, and there needs to be a conversion between the two
11 so that devices on either end to speak to each one another.

12 Q. Thinking back to 1996, about how many folks were at
13 Crossroads during time period?

14 A. In the middle of '96, six or seven. About the end of the
15 year, about twelve.

16 Q. And was Brian Smith's role during that period of time to
17 be design products?

18 A. No.

19 Q. Or inventing stuff?

20 A. No.

21 Q. Getting patents?

22 A. No.

23 Q. Who did you rely on at Crossroads to perform that task?

24 A. My engineering team, the couple of gentlemen we had hired,
25 including Mr. Hoese and Mr. Russell.

09/04/2001 Chaparral Trial - Day 1

1 Q. Okay. And the jury's going to meet Mr. Hoese and they're
2 going to meet Mr. Russell. And would you tell the jury who
3 they are with respect to the 972 patent?

4 A. They are the inventors of the 972 patent.

5 Q. Okay. What was Brian Smith's direct involvement with the
6 972 patent?

7 A. None in terms of invention, just simply encouraging our
8 engineering team to patent things that they thought were
9 patentable.

10 Q. Did you have an involvement on the micro level of this
11 patent?

12 A. I did not.

13 Q. And fast-forwarding just for a second, is this the only
14 patent that Crossroads has obtained?

15 A. It is not.

16 Q. How many off the top of your head?

17 A. I believe currently we hold seven patents issued.

18 Q. And do you have any idea how many patents Crossroads has
19 applied for?

20 A. More than 30 additionally from that.

21 Q. So it would be fair to say intellectual property is pretty
22 important?

23 A. It's a key part of our company, yes.

24 Q. I want to also go back to Crossroads' investment in the
25 Crossroads industry. Could you give the jury an idea because

09/04/2001 Chaparral Trial - Day 1

1 we heard during the defense opening argument about, you know,
2 why you were bringing the lawsuit in terms of wanting damages
3 and your financial condition. Would you give the jury an idea
4 of how much money investors put in Crossroads?

5 A. To date, we have raised over \$100 million to fund and
6 develop the company and this product line as well as the
7 marketplace.

8 Q. Could you give the jury an idea of how much you've made in
9 revenues?

10 A. Somewhere in excess of \$75 million.

11 Q. And what has Crossroads done with that revenue of \$75
12 million?

13 A. We've taken the profits and redeployed them into the
14 company to continue to develop new products that we continue
15 to work on.

16 Q. There's going to be evidence in this case that will come
17 in the future that the reason that folks at Chaparral
18 discovered the 972 patent was indirectly the fact that you had
19 made certain statements in public about protecting your
20 intellectual property and this was back in early 2000.

21 A. Uh-huh.

22 Q. Would you tell the jury why you made those statements in
23 early 2000 about Crossroads' intention of protecting its
24 intellectual property?

25 A. Crossroads has always had the intent of protecting its

09/04/2001 Chaparral Trial - Day 1

1 intellectual property, even from days much earlier than 2000,
2 and we had made that a part of our public communication to
3 investors at different venues.

4 Q. Could you give the jury how much Crossroads invests in
5 terms of each patent disclosure?

6 A. Patent disclosure costs us around \$15,000 each today, but
7 we invest dramatically more than that in engineering time to
8 write it down and search for the implementation of it.

9 Q. So it's early 2000. You've made the statements that
10 you're going to protect Crossroads' intellectual property.
11 What did you do, as the CEO and Chairman of Crossroads, to put
12 that in effect?

13 A. All along, ask the engineering team to patent things that
14 were patentable, file for patent protection, and then, to work
15 through the process with the Patent and Trademark Office to
16 get them issued.

17 Q. Okay. And with respect to protecting, specifically, the
18 972 patent, what did you do?

19 A. Asked our then advising counsel to look into the patent
20 and see if there were infringers.

21 Q. Okay. And what was the result of that investigation to
22 the best of your knowledge?

23 A. We were told that there were infringement by Chaparral and
24 others.

25 Q. Okay: Now, Mr. Bahler spent a fair amount of time talking

09/04/2001 Chaparral Trial - Day 1

1 about the fact that Crossroads has marked some of its product
2 or all of its products since a certain date with a label that
3 has the 972 patent on it. You're aware that that's been done,
4 correct?

5 A. Yes.

6 Q. Did you have any responsibility as the CEO and Chairman of
7 Crossroads in terms of putting labels on the products?

8 A. I did not.

9 Q. Who would you have delegated the responsibility for making
10 the decision to apply a label to the routers to?

11 A. Be part of the process with our engineering team and
12 marketing team.

13 Q. Okay. Specifically in this case, do you know if it was
14 Mr. John Middleton who got the task of deciding whether or not
15 to put this label on the products?

16 A. I'm sure he would have been part of the process, yes.

17 Q. Okay. At the time Crossroads put this label on the
18 product, were you, Brian Smith, as the CEO and Chairman of
19 Crossroads Technology, telling the world that it believed that
20 SCSI reserve or some form of software was in the product
21 actually performed what is covered by the 972 patent?

22 A. I'm sorry, beginning of the question again.

23 Q. Did you make the decision that that was what was in it by
24 the decision --

25 A. It was not my decision.

1 Q. Okay. Would you -- and we're about to meet Mr. Middleton.

2 A. Uh-huh.

3 Q. Would you defer to Mr. Middleton in terms of explaining to
4 the jury under oath why it is that Crossroads did put the
5 label on the product?

6 A. Yes, I would.

7 Q. Okay. I want to go back to the '97 time period when the
8 972 patent was being invented. Are you with me during that
9 time period?

10 A. Uh-huh.

11 Q. Would you tell the jury who it was at Crossroads who was
12 working on that patent?

13 A. The patent would have been worked on by Geoff Hoese and
14 Jeff Russell.

15 Q. Okay. And, as I understand it, Mr. Hoese is a person
16 who's on the software side?

17 A. That's correct.

18 Q. And Mr. Russell is a person who is on the hardware side?

19 A. That's correct.

20 Q. In terms of what those words mean, if we look at the
21 router I showed you earlier, the box, for example, would be
22 the hardware, correct?

23 A. That's correct.

24 Q. So it's Mr. Hoese who's going to be best able to explain
25 what the access control feature is in the 972 patent?

09/04/2001 Chaparral Trial - Day 1

1 A. I believe so.

2 Q. With respect specifically to the 972 patent, who did you,
3 as the CEO and Chairman of Crossroads, rely on to get this
4 patent process completed?

5 A. Originally would have been with Geoff Hoese and he was
6 hired to be our director of software, and then, over time, he
7 and John Middleton together had that responsibility.

8 Q. And who would you have relied on to make certain that the
9 Patent Office got every bit of information that they needed to
10 make the right decision?

11 A. Would have been Geoff and Jeff.

12 Q. Okay. Geoff Hoese and Jeff Russell?

13 A. Yes, that would be.

14 Q. Okay. I want to go quickly -- actually, I think I'm going
15 to skip that.

16 Let's talk about the 4100. And Mr. Bahler showed the
17 jury a picture of -- I think it's the CrossPoint 4100 that was
18 from the 1996 Comdex. Do you remember that portion of the
19 argument?

20 A. Yes.

21 Q. Tell the jury what Comdex is.

22 A. Comdex is an annual trade show held in November in Las
23 Vegas where computer dealers and customers can come together
24 to learn about new products.

25 Q. Okay. And did Crossroads, in fact, show something that

1 was called the CrossPoint 4100 at Comdex?

2 A. We did not.

3 Q. Did you show something at the Comdex in 1996?

4 A. Yes.

5 Q. And what was it that you actually showed in 1996?

6 A. We showed the technology demonstration connecting one
7 server to one storage device through a hard-wired prototype.

8 Q. And just so I make sure I understand, would you tell the
9 jury what you mean through a hardware prototype?

10 A. Hard-wired.

11 Q. Hard-wired.

12 A. It is one way to connect from one server to one of the
13 storage device. Everything was prefixed before getting to the
14 show.

15 Q. So going back to our Greek and English example of this
16 translation, what would that thing in '96 have been able to
17 do?

18 A. Simply ask or convert how do I go to the rest room or
19 where is the rest room kind of analogy.

20 Q. Jury's heard a lot about access controls. Would this
21 thing that was shown in 1996 at Comdex, would it have enabled
22 to perform anything in the possible universe of words would
23 have been able to accomplish what is access control?

24 A. No, I don't believe so.

25 Q. I want to turn your attention, if you would, please, sir,

09/04/2001 Chaparral Trial - Day 1

1 to a company that's actually in the news today, Hewlett
2 Packard.

3 A. Uh-huh.

4 Q. Would you tell the jury what part Hewlett Packard played
5 in Crossroads' history?

6 A. Hewlett Packard was viewed and still is viewed as a
7 significant strategic customer and partner. They own a big
8 part of the marketplace that we sell to today from a
9 connectivity viewpoint, so we wanted them as a partner and a
10 customer so we began to discuss with them in the early time
11 frame how we could either work together or how they could buy
12 our products.

13 Q. I want to take you back to that time period again, and
14 there was a product that is known as a Mux.

15 A. Uh-huh.

16 Q. Are you familiar with that term?

17 A. Yes.

18 Q. In case the jury isn't, could you tell them what Mux
19 stands for?

20 A. Mux stands for multiplexer.

21 Q. Okay. In what role did the Mux play in the relationship
22 between Hewlett Packard and Crossroads in 1996?

23 A. HP had developed a project called multiplexer that they
24 had no additional resources to continue to develop and were
25 looking for a partner to take over that development.

1 Q. Okay. Now, down the road in this trial, I believe there's
2 a probability that the jury is going to be told that Hewlett
3 Packard can be considered to be competitive with Crossroads.
4 Would you give the jury an idea of what their position is
5 currently with respect to Crossroads in terms of being an
6 investor?

7 A. They're certainly an investor. They purchased \$3 million
8 worth of our securities in 1998. So they have been a great
9 partner even since before then, but from a financial point of
10 view, they invest in the company and they still hold that
11 position today.

12 Q. Where would Hewlett Packard rank in terms of first,
13 second, third, or whatever, as a customer of Crossroads?

14 A. Today, in our last reported public quarter, they were over
15 a ten percent customer, which is a significant part of our
16 business. In fact, substantially higher than ten percent.

17 Q. Could be closer to 20, maybe?

18 A. I think even above that.

19 Q. Okay. Would it be fair to say they're one of the top one
20 or two customers of Crossroads products?

21 A. They are today, yes.

22 Q. And products of y'all's, Hewlett Packard and Crossroads,
23 that are competitive with each other?

24 A. They're not.

25 Q. Can you imagine any scenario in which someone fairly

1 looking at your relationship with Hewlett Packard could
2 describe you all as being competitive, given their
3 relationship with you as an investor and a customer?

4 A. I cannot.

5 Q. Would it be fair to say, at some point, you picked Hewlett
6 Packard or they picked you perhaps as a strategic partner?

7 A. Absolutely, it would be fair to say they picked us because
8 of the abilities we had in the company, and they believed what
9 we were about.

10 Q. Compare and contrast, we just talked about Hewlett Packard
11 in relationship -- Chaparral's the defendant in this case.
12 Would it be fair to say that Crossroads and Chaparral are
13 competitors?

14 A. Yes.

15 Q. And why would you describe your products, the router
16 product that the jury can see right in front of them, as being
17 competitive with Chaparral products?

18 A. We compete in the market for the same set of customers.

19 Q. Okay. They also sell what's known as a RAID product,
20 correct?

21 A. Yes.

22 Q. And would you tell the jury what R-A-I-D, RAID stands for?

23 A. RAID stands for redundant array of inexpensive discs.

24 Q. Okay. If you were to have to enter negotiations with
25 Chaparral to license some of your intellectual property

09/04/2001 Chaparral Trial - Day 1

1 portfolio, would you consider them to be a competitor?

2 A. Yes.

3 Q. Mr. Smith, did you authorize this suit to obtain damages?

4 A. Yes.

5 Q. Okay. Did you do it to protect Crossroads' intellectual
6 property?

7 A. Yes.

8 Q. I'm going to finish up, Mr. Smith, with one quick area.
9 We heard that you've never made a profit, that dire economic
10 times abound, and that's the reason these seven people are
11 having to sit in this trial. Would you tell the jury what
12 Crossroads' current financial health is?

13 A. Sure. We're a very healthy company. We are no doubt. We
14 have over \$60 million in cash, and we have very good other
15 financial metrics that indicate we are a healthy company.

16 Q. For some time and let me ask it this way: In, say, 1988
17 and 1999, what was Crossroads' position in terms of share of
18 the market in the router industry?

19 A. We had significant part of that kind of growing market at
20 the time. Probably 80 plus percent.

21 Q. Is Crossroads still greater than 50 percent in the router
22 market?

23 A. We are today, yes.

24 Q. As part of that result of being the first to market?

25 A. Yes, definitely.

09/04/2001 Chaparral Trial - Day 1

1 Q. I pass the witness.

2 CROSS-EXAMINATION

3 BY MR. BAHLER:

4 Q. Mr. Smith, you brought up Comdex 1996, and I'd like to
5 cover that in little bit more detail. That show in 1996 was
6 November 1996, correct, sir?

7 A. Correct.

8 Q. That was in Las Vegas?

9 A. Yes.

10 Q. And there were -- I've heard reports that there were
11 200,000 people there. Does that sound aligned to you?

12 A. That sounds about right.

13 Q. And you mentioned this technology demonstration, right?

14 A. Uh-huh.

15 Q. And just so we're clear about this, what you had on the
16 table was kind of a mock-up of what you have here on the
17 table, the 4100, and you had wires coming out of it down to a
18 PC that was under the table, right?

19 A. That's correct.

20 Q. And in the PC, that's where all the translations from
21 Greek to English were going on, right?

22 A. Yes.

23 Q. And that's where all the Fibre Channel stuff is coming in,
24 right?

25 A. Yes.

09/04/2001 Chaparral Trial - Day 1

1 Q. That's where all the SCSI stuff was coming out the other
2 side, right?

3 A. Yes.

4 Q. It was all done in the PC, but there was hardware down
5 there, correct?

6 A. That's correct.

7 Q. And it was working?

8 A. It was.

9 Q. Okay. Now you mentioned the middle of 1996, there were
10 six or seven people working for Crossroads. The project which
11 ultimately became the Crossroads 4100 product was called the
12 Verrazano product inside, right?

13 A. Actually, Verrazano was an architectural description.

14 Q. Okay. Would you please take a look at what I have up on
15 the screen as Defendant's Exhibit 150. This is a presentation
16 that you prepared, right, sir?

17 A. I don't remember if I prepared it or not. It has my name
18 on it.

19 Q. At least your name's on it, right?

20 A. Uh-huh.

21 Q. Okay. And you prepared this in June 1996, right?

22 A. That's the date, yes.

23 Q. All right. And just so we're clear about this, this is
24 called -- this presentation is called Verrazano Fibre
25 Channel-to-SCSI bridge product overview, right?

09/04/2001 Chaparral Trial - Day 1

1 A. It is.

2 Q. So Verrazano was a product, right?

3 A. As I remember, Verrazano was a description of an
4 architecture that we used internally.

5 Q. Well, this doesn't say architectural overview, does it,
6 sir?

7 A. It does not.

8 Q. Okay. Please take a look at within that document, this is
9 page 12 of that document. And here is a presentation of the
10 Verrazano architecture, right, sir?

11 A. I believe so, yes.

12 Q. All right. And this was June 1996, right?

13 A. Yes.

14 Q. And, in fact, what was in the computer underneath the
15 table at Comdex 1996 looked just like this, right, sir?

16 A. I don't know that.

17 Q. Okay. Well, let me ask you this: The technology
18 demonstration at Comdex 1996 included a Tachyon Fibre Channel
19 controller, right, sir?

20 A. It did.

21 Q. And the technology demonstration at Comdex 1996 included a
22 SCSI controller, right, sir?

23 A. It did.

24 Q. Just like shown in the picture, right?

25 A. Uh-huh.

1 Q. And the Tachyon Fibre Channel controller was connected to
2 a Fibre Channel at Comdex 1996, right, sir?

3 A. Yes.

4 Q. And the SCSI controller was connected to a SCSI bus in
5 1996, right, sir?

6 A. It was.

7 Q. All right. And just so we're clear here, Tachyon,
8 T-A-C-H-Y-O-N, that's a chip made by Hewlett Packard, right?

9 A. That's correct.

10 Q. And that has certain things inside of it that permit
11 computers such as -- well, that permit computers to
12 communicate with Fibre Channel, right?

13 A. It permits devices behind it to communicate. I don't know
14 what they are specifically.

15 Q. Okay. And it has certain elements, right, the Tachyon,
16 right --

17 A. Yes.

18 Q. -- that are permitted to do that. One of the things is a
19 buffer memory inside there?

20 A. I believe so.

21 Q. And that's a first in, first out or so-called FIFO memory,
22 right?

23 A. I don't know that.

24 Q. Okay. And there is a DMA, or direct memory access engine,
25 in there, too, right?

1 A. I believe there is.

2 Q. Okay. And that transfers information from the FIFO memory
3 to the system memory, right? That's how it works?

4 A. I believe that's how it works.

5 Q. And also in there is a Fibre Channel protocol unit, right?

6 A. I don't recall what else is in there.

7 Q. Maybe Mr. Hoese can help us more on this, but the very
8 least, the technology demonstration at Comdex 1996 included a
9 Fibre Channel controller and it was, indeed, a Hewlett Packard
10 Tachyon Fibre Channel?

11 A. Yes.

12 Q. And it was working, right?

13 A. Yes.

14 Q. Now, the SCSI controller that was included in the
15 technology demonstration at Comdex 1996 was made by a company
16 called Symbios Logic, right, sir?

17 A. I believe so, yes.

18 Q. And they made chips that connected to Fibre Channel -- I'm
19 sorry, SCSI buses to computer buses, right?

20 A. Yes.

21 Q. And that's how -- that's what a SCSI controller basically
22 does, right?

23 A. I believe so.

24 Q. And inside this Symbios Logic SCSI controller chip, there
25 were things that permitted it to do its function, also, right,

1 sir?

2 A. Indeed.

3 Q. And had an internal buffer memory, right?

4 A. I believe so.

5 Q. Okay. And it also had one of these direct memory access
6 or DMA engines that transferred data from the internal -- from
7 the buffer inside of a SCSI controller into the computer
8 memory, right?

9 A. I believe so.

10 Q. Okay. And it also had a SCSI protocol unit, right?

11 A. That I'm not sure of.

12 Q. Okay. Mr. Hoese may be able to help us on that, right?

13 A. Uh-huh, yes.

14 Q. In any event, the Symbios Logic SCSI controller was
15 included in the technology demonstration at Comdex 1996,
16 right?

17 A. Yes.

18 Q. Okay. Now, the technology demonstration also included a
19 microprocessor, right?

20 A. Yes.

21 Q. And, in fact, included an Intel i960 microprocessor?

22 A. I believe so.

23 Q. Just like shown on this drawing from Exhibit 150, right?

24 A. I believe so.

25 Q. Okay. And the microprocessor that was in the technology

09/04/2001 Chaparral Trial - Day 1

1 demonstration at Comdex 1996, that kind of supervised the
2 operation of the entire router, correct?
3 A. Of the technology prototype, yes.
4 Q. By the way, sir, have you ever called that technology
5 prototype a prototype of the 4100?
6 A. I don't recall that.
7 Q. You don't recall that? All right, sir. Have you ever
8 told anybody that the technology demonstration at Comdex 1996
9 was a prototype of the 4100?
10 A. Again, I don't recall that.
11 Q. Okay. And, also, included in Comdex 1996 technology
12 demonstration was a system memory, right?
13 A. I believe so, but I'm not clear on that.
14 Q. Okay. And that technology demonstration operated to take
15 information from the Fibre Channel through the Tachyon Fibre
16 Channel stored in memory?
17 A. I don't know how the data flow actually worked.
18 Q. That was under control by the -- well, however it did it,
19 that was under control by the microprocessor, right?
20 A. Yes, I believe so.
21 Q. The technology demonstration had a system memory, didn't
22 it, sir?
23 A. Again, I don't know the --
24 Q. Mr. Hoese would know that?
25 A. Mr. Hoese would certainly know that.

09/04/2001 Chaparral Trial - Day 1

- 1 Q. Okay. And then, well, if you don't know, you don't know.
2 And at that technology -- and this was -- technology
3 demonstration was in a room that was sponsored by the Fibre
4 Channel arbitrated -- Fibre Channel loop community, right?
5 A. I believe so.
6 Q. FCLC, right?
7 A. Yes.
8 Q. There was a big room, right?
9 A. Big, couple of thousand square feet, I think.
10 Q. Right. And it was open to the public?
11 A. Yes.
12 Q. Right? And Crossroads was there and had a booth there,
13 right?
14 A. Yes.
15 Q. And in that booth was this technology demonstration
16 working away, correct?
17 A. That's correct.
18 Q. And also in that booth, you had handouts, right?
19 A. I believe we did, yes.
20 Q. Take a look at Defendant's 166. This is an example of a
21 handout that you had at Comdex 1996, correct, sir?
22 A. Yes, I believe so.
23 Q. All right. And this deals with the CrossPoint 4100
24 product, right?
25 A. Preliminary technical data, yes.

09/04/2001 Chaparral Trial - Day 1

1 Q. You had a technology demonstration running at Comdex 1996,
2 right?

3 A. Yes.

4 Q. As we discovered intensely?

5 A. Yes.

6 Q. And you were handing out this CrossPoint 4100 product
7 literature, right?

8 A. Correct.

9 Q. That technology demonstration was a prototype of the 4100
10 product, right, sir?

11 A. I don't believe so.

12 Q. Now, why were you at Comdex '96?

13 A. We were there to meet potential customers.

14 Q. Customers, right?

15 A. Yes, sir.

16 Q. You were interested in selling this thing, right?

17 A. We were interested in getting their feedback on what
18 products they would like to have.

19 Q. Okay. In fact, as a result of the Comdex 1996 show, you
20 actually sold some 4100 products, right?

21 A. What do you mean by as a result?

22 Q. Well, after the Comdex 1996 show, you actually sold 4100
23 products, right?

24 A. Certainly historically, yes.

25 Q. And you sold some of those before the end of 1996,

09/04/2001 Chaparral Trial - Day 1

1 correct?

2 A. No, that's not true.

3 Q. All right. Please take a look at Defendant's Exhibit 156.

4 Got that in front of the screen there. Can you read that,

5 sir?

6 A. Barely.

7 Q. Mr. Smith, I have a notebook to refer to what we're

8 talking about. I think a better copy of 156 is in there. Can

9 you see it? Is that a good copy, sir?

10 A. It's about the same quality.

11 Q. Okay. Let's take a look at the third page, okay? Now,

12 first of all -- I'm sorry, back up to the first page. This is

13 an e-mail that you wrote to a fella named Joe Boykin, right,

14 sir?

15 A. That's what it says, yes.

16 Q. And Joe Boykin was at Clariion, right?

17 A. That's what it says.

18 Q. Clariion was part of the visual equipment at the time?

19 A. No, I don't believe so.

20 Q. This relationship came later perhaps?

21 A. I don't know that Clariion and Digital were ever related.

22 Q. Okay. In any event, it was Clariion, right?

23 A. Yes.

24 Q. And you wrote this e-mail December 20th, 1996, right?

25 A. That's what it says, yes.

1 Q. Before the end of '96, right, sir?

2 A. That's correct.

3 Q. Okay. Now, this is actually an e-mail which shows -- it
4 shows -- actually, there's several e-mails stacked up here,
5 right, sir?

6 A. That's what it looks like, yes.

7 Q. And some of the e-mails, it's kind of interlinked between
8 e-mails he wrote to you and e-mails you wrote to him, right?

9 A. I believe so.

10 Q. And this part right here is something that was written by
11 Mr. Boykin, right where he says, first, we have already
12 provided you with a PO for four no-cost evaluation units to be
13 delivered in mid-December. That's what he told you, right?

14 A. Yes.

15 Q. And Crossroads had received the purchase order for these
16 evaluation units before this time, correct?

17 A. I believe so.

18 Q. All right. And then, but he doesn't want those anymore,
19 right, he wants the real thing, right?

20 A. He says here he wants the evaluation units.

21 Q. At the bottom of that page, he says on completion of a
22 successful evaluation, they intend to purchase 50 devices at a
23 price of \$1995, right?

24 A. Yes.

25 Q. They wanted to buy them from you, right?

09/04/2001 Chaparral Trial - Day 1

1 A. That was his intent.

2 Q. Okay. And he had delivery time. He wants ten in
3 February, another 15 in March or February, 15 in March and
4 then, another 15 -- another ten at the end of March, right?

5 A. Yes, that's what he says.

6 Q. That's a definite price for the product, right?

7 A. He certainly mentions that, yes.

8 Q. And definite delivery schedule for the product, right,
9 sir?

10 A. That's what he was requesting.

11 Q. Okay. Take a look at the last page of that exhibit. This
12 is kind of on the e-mail trail again. This is where he said,
13 this is -- kind of repeats that other e-mail: It is still my
14 intention to purchase units on completion of the evaluation.
15 And he talks about a PO for \$100,000, which is \$1995 for 50
16 units, right?

17 A. Yes.

18 Q. And that's the 50 units he was talking about earlier,
19 right?

20 A. I believe so.

21 Q. And those were for the 4100 product, right, sir?

22 A. I'm not sure of that. He's asking for betas of the 4100.

23 Q. Right. 4100 product, right, sir?

24 MR. ALBRIGHT: Your Honor, Mr. Bahler can you tell us
25 which exhibit number he's showing?

09/04/2001 Chaparral Trial - Day 1

1 MR. BAHLER: This is 156. Sorry. I thought I said
2 that.
3 A. The document says betas.
4 Q. (BY MR. BAHLER) Right. It shows the 4100 product, right?
5 A. That's what it says.
6 Q. And you say in the next paragraph that you would prefer
7 that they did their evaluation on beta units, right?
8 A. Where are you?
9 Q. The next paragraph. This is -- it's on the screen there,
10 sir. Here, I'll highlight it. We would prefer that you did
11 your evaluation with our beta units, right?
12 A. That's what it says, yes.
13 Q. And you said the prototype units, now, that's something
14 different from beta units, right?
15 A. Yes.
16 Q. But they still were -- they're 4100 prototype units,
17 right, sir?
18 A. I don't know that.
19 Q. They could be sent in January. That's what you told them,
20 right?
21 A. It's what it says, yes.
22 Q. And then, you said -- you told them that beta would be
23 better units than prototype units, right?
24 A. It says that we would prefer that they did their
25 evaluation with our beta units.

09/04/2001 Chaparral Trial - Day 1

1 Q. Okay. And then, at the last part of that paragraph, you
2 say -- you defer to the prototypes that you're going to be
3 offering to them. The prototypes have a slightly more
4 difficult method of field upgrade but nothing too painful.
5 These are the units that you saw at Comdex. That's what you
6 told Mr. Boykin, right?

7 A. That's what it says.

8 Q. And you're referring to the technology demonstration at
9 Comdex 1996, right there, right, sir?

10 A. I don't know that.

11 Q. Did you have any other prototype units at Comdex 1996?

12 A. I don't know what else we had there.

13 Q. So the only one that you can remember is the technology
14 demonstration that we just talked about, right, sir?

15 A. That was the technology prototype.

16 Q. And right here, you refer to the prototype at Comdex 1996
17 as being the prototype of the 4100 product, right, sir?

18 A. I don't know if they're the same. I can't tell that.

19 Q. Once again, you don't recall any other prototypes at 1996,
20 do you?

21 A. I don't.

22 Q. And lastly, you conclude in that paragraph -- and this is
23 you. You say, betas can be returned for the real thing so we
24 are allowing customers to evaluate betas for 60 days
25 evaluation PO, 60 days evaluation beta for class price of

09/04/2001 Chaparral Trial - Day 1

1 \$3300. You wanted him to pay you \$3300 for each of those beta
2 units, right, sir?

3 A. I don't believe so. I'm sure this was under an evaluation
4 for this order which we would have expected them back.

5 Q. They were evaluating them, though, weren't they? They
6 were expected to evaluate them, right?

7 A. We were certainly going to evaluate our product, yes.

8 Q. And if it was acceptable to them, they just keep them,
9 right?

10 A. We -- when we do evaluation purchase orders, we expect to
11 receive the units back because we cannot sell them.

12 Q. Doesn't say anywhere in this e-mail that you wanted them
13 back, does it?

14 A. No. It's customary knowledge in the industry that
15 evaluation purchase orders are to be evaluated and then
16 returned. In fact, the FCC won't even let us sell them
17 because they weren't -- they didn't have the clearance of the
18 FCC by then.

19 Q. Is the FCC approval required to sell evaluation units?

20 A. That was my understanding.

21 Q. You're still asking for \$3300 there, weren't you, sir?

22 A. Like I said, it's customary to put a price on evaluation
23 PO.

24 Q. Why didn't you just give it to them and say give it back?

25 A. We were just following industry standard practice.

09/04/2001 Chaparral Trial - Day 1

1 Q. And industry standard practice is to put a price and a
2 delivery time on evaluation units, right?

3 A. That's what we were doing, yes.

4 Q. And evaluation that's being done is by the customer, not
5 by Crossroads here, right?

6 A. That's right.

7 Q. And if it was acceptable to the customer, they could keep
8 it, right?

9 A. That's not what the arrangement was.

10 Q. Is there anywhere -- can you find anywhere on this e-mail
11 that says you've got to give it back regardless?

12 A. I'd have to go read it all.

13 Q. Well, I think I'll let your counsel bring that to your
14 attention.

15 MR. ALBRIGHT: Your Honor, I would ask for the sidebar
16 comments --

17 MR. BAHLER: I'll hold it down, your Honor, I'm sorry.

18 THE COURT: Not only hold it down, but stop it.

19 Q. (BY MR. BAHLER) Now, Mr. Smith, you talked about the
20 Hewlett Packard Mux, right, sir?

21 A. Yes.

22 Q. It's a -- that's short for multiplexor, right?

23 A. Yes.

24 Q. And that was you mentioned your relationship with Hewlett
25 Packard, right?

1 A. Yes.

2 Q. You not only were in the Fibre Channel loop community,
3 which is a prototype of the 4100, but you were also in the
4 technology suite with Hewlett Packard at Comdex 1996?

5 A. Yes.

6 Q. And that was for the purpose of promoting the Hewlett
7 Packard Mux, HP Mux, right, sir?

8 A. I don't remember the exact purpose.

9 Q. Okay. Well, that's what the first technology transfer
10 between Crossroads and Hewlett Packard was this Hewlett
11 Packard Mux, right, sir?

12 A. We were certainly talking about owning that product, yes.

13 Q. And that ultimately became known as the Crossroads
14 CrossPoint 4400 product, right, sir?

15 A. That's correct.

16 Q. Now, the Hewlett Packard Mux was connectable to multiple
17 Fibre Channel hosts, right?

18 A. As I understand it, at least two.

19 Q. Okay. And it had a Fibre Channel controller inside of it,
20 right?

21 A. Yes.

22 Q. And since it was a Hewlett Packard product, that was
23 Hewlett Packard Tachyon Fibre Channel, wasn't it, sir?

24 A. I know it was a HP Tachyon. I don't know if there was a
25 causal relationship.

09/04/2001 Chaparral Trial - Day 1

1 Q. All right. Fair enough. And inside the HP Mux was a
2 supervisor unit or a microprocessor, right?

3 A. Yes.

4 Q. And it was also an internal memory inside of that?

5 A. It was.

6 Q. System memory, and there was also a SCSI controller,
7 right?

8 A. Yes.

9 Q. And the Hewlett Packard Mux was a box that included all
10 that stuff that connected Fibre Channel hosts to SCSI storage
11 devices, right, sir?

12 A. Yes.

13 Q. And you established a -- well, let's see. Take a look at
14 Defendant's Exhibit 152. That's a letter from Ms. Barbara
15 Bardach, right?

16 A. Yes.

17 Q. And at the time, she was vice-president of business
18 development for Crossroads, right, sir?

19 A. Yes.

20 Q. And let's see here. You got a copy of that letter, right,
21 sir?

22 A. That's what it says.

23 Q. All right. The first sentence there, it says, on behalf
24 of Crossroads, I'd like to -- Brian and I -- that's you,
25 right?

09/04/2001 Chaparral Trial - Day 1

1 A. I believe so.

2 Q. Want to thank you and Joel -- that's Mr. Joel Dunning,
3 right?

4 A. Yes.

5 Q. For inviting us to represent Crossroads in your technology
6 suite at the Mirage Hotel during Comdex.

7 A. Yes.

8 Q. Right? So Crossroads was with Hewlett Packard in the
9 technology suite at the Comdex, right?

10 A. Yes.

11 Q. And, once again, that occurred beginning of November '96,
12 right?

13 A. Yes.

14 Q. Dated the end of November 1996, right?

15 A. It is.

16 Q. All right. Later on, you tell him or Ms. Bardach tells
17 him, as you know, we enjoyed an extremely successful week.
18 Our prospective customer -- there were prospective customers
19 in the technology suite, right, Mr. Smith?

20 A. Yes.

21 Q. Who visited us at Comdex are quite enthusiastic about the
22 Fibre Channel SCSI Mux Joel's group designed. That's the
23 Hewlett Packard Mux, right?

24 A. Yes.

25 Q. That's what ultimately became known as the Crossroads 4400

1 product, right, sir?

2 A. Yes.

3 Q. Now, eventually, Crossroads entered into what is known as
4 a reseller agreement with Hewlett Packard, right, sir?

5 A. I believe so.

6 Q. And reseller agreement means you would buy product from
7 Hewlett Packard and you agreed to sell it, right?

8 A. That was the intent.

9 Q. All right. Okay. And that's contrasted with OEM, which
10 means you change it a little bit. Reseller means you're going
11 to buy it and resell it with your label on it, right, sir?

12 A. I believe we originally contemplated the reseller
13 agreement to keep things moving.

14 Q. And so that the units that were going to be transferred
15 from Hewlett Packard to Crossroads, Crossroads was going to
16 pay for, right?

17 A. I don't recall the actual terms.

18 Q. Well, it didn't -- wasn't called a seller agreement, it
19 was called a reseller agreement, right?

20 A. That was the name, yes.

21 Q. And reseller means there's got to be a sale to began with,
22 right?

23 A. I assume so.

24 Q. That means that units that were coming from Hewlett
25 Packard to Crossroads were being sold to Crossroads so that

1 they could resell them to other people, right?

2 A. Again, I don't recall when we actually would have done
3 that, if we ever did.

4 Q. But it was called a reseller agreement, right?

5 A. Yes, absolutely.

6 Q. Please take a look at Defendant's Exhibit 153. Now, this
7 is a flyer that you had at that technology suite in Comdex
8 1996 with Hewlett Packard, right, sir?

9 A. That's correct.

10 Q. You handed this out to prospective customers, right?

11 A. I believe so.

12 Q. And this dealt with the CrossPoint 4400. Now, that was
13 the Crossroads version of the 4400 Hewlett Packard Mux, right,
14 or it was rather -- strike that. It was Crossroads' label
15 that they applied and called the Hewlett Packard Mux, right?

16 A. I don't know that HP applied that. I'm confused with the
17 question.

18 Q. Crossroads did.

19 A. Again, I don't recall what the marketing strategy was.

20 Q. But nonetheless, CrossPoint 4400 was Crossroads' version
21 of the HP Mux, right, sir?

22 A. Yes, that's what it says.

23 Q. And these were being handed out in November 1996 to
24 potential customers, right, these flyers, Exhibit 153, right?

25 A. Yes, again, I don't recall where but yes.

1 Q. Okay. Please take a look at Defendant's Exhibit 163.
2 Now, this is an e-mail from you, right?
3 A. Yes.
4 Q. And it's to Ms. Bardach, right?
5 A. Yes.
6 Q. And it talks about, also, Mr. Hoese's involved in this,
7 too, right?
8 A. Yes, that's his name.
9 Q. Okay. And the subject -- actually e-mailed. These are
10 cc's actually e-mailed to Joel, this is Joel Dunning, right?
11 A. It says to Barbara.
12 Q. Okay. Why is Joel's name on here?
13 A. I don't know that.
14 Q. Okay. All right. And in here, this is before -- in here
15 you say delivery of the first five Muxes shipped from HP due
16 to arrive 1-3-97, right, or earlier, right?
17 A. Yes, but this e-mail's only to Crossroads people.
18 Q. All right. Exactly. And you're telling them that the
19 delivery of the first five Muxes will be shipped from Hewlett
20 Packard today and they will arrive on January 3rd, '97, right?
21 A. That's what it says.
22 Q. All right. And today meant December 30th, '96, right?
23 A. Yeah, that's the e-mail.
24 Q. So Crossroads bought those HP Muxes from Hewlett Packard,
25 right?

09/04/2001 Chaparral Trial - Day 1

1 A. I don't know that we ever bought them.

2 Q. Okay. Well, once again, Crossroads was a reseller of
3 Hewlett Packard products, right?

4 A. But we would have had the same evaluation relationship
5 when we would have looked at the product first, so they never
6 bought these.

7 Q. In fact, Crossroads needed those five units because it had
8 already resold some to some people, right?

9 A. I don't know that.

10 Q. Take a look at Exhibit 158. Now, this is a letter to a
11 fella at EMC, right?

12 A. Yes, I believe so.

13 Q. Fella named Bob Rarich?

14 A. It's Tom, yes.

15 Q. Tom Rarich. And you were carbon-copied on the letter,
16 right, sir?

17 A. Yes.

18 Q. Okay. And you say -- this is from Barbara Bardach, again,
19 right, sir?

20 A. Yes.

21 Q. Happy holidays, Barbara Bardach, right, sir?

22 A. Yes.

23 Q. Okay. Ms. Bardach says to Tom, thanks for confirming
24 today that you will be ordering an evaluation unit for the
25 CrossPoint 4400 Fibre Channel-to-SCSI router, right?

09/04/2001 Chaparral Trial - Day 1

1 A. Yes.

2 Q. Now, this is December 19th, 1996, right, sir?

3 A. Yes.

4 Q. And so, you needed some products from Hewlett Packard to
5 sell this guy, right?

6 A. Again, it says in a 60-day evaluation for evaluation, so I
7 don't know that we needed to buy any.

8 Q. All right. Letter continues by saying, your no charge PO
9 should reflect the \$17,000 price. That's for the evaluation
10 unit, right, sir?

11 A. Yes.

12 Q. And should the evaluation not be returned to Crossroads,
13 right?

14 A. Those are the words, yes.

15 Q. So here's an offer of an evaluation unit that does not
16 require any returning of anything to Crossroads, right, sir?

17 A. I can't confirm that.

18 Q. Well, doesn't this say that if this evaluation unit met
19 with EMC's approval that they would pay you \$17,000, no
20 questions asked, right?

21 A. I don't read that here.

22 Q. All right. There's nothing there that requires them to
23 return anything, is there, sir?

24 A. Certainly those words are not here.

25 Q. The fact that details of the offer, sir, are the 4400,

09/04/2001 Chaparral Trial - Day 1

1 right? That's the subject, right?

2 A. That's the product ordered, yes.

3 Q. And evaluation is 60 days at no charge, right?

4 A. Yes, that's correct.

5 Q. And if the evaluation unit meets with their approval, they
6 pay you \$17,000, right?

7 A. Again, that's not the industry practice or practice we
8 employed which is to have them returned.

9 Q. But regardless of what the industry standard is, that's
10 what this letter says, right, sir?

11 A. It has an evaluation unit price on it.

12 Q. Now, Mr. Smith, there came a time when you visited a
13 company called Adaptec, right?

14 A. I believe so.

15 Q. And, in fact, you visited Adaptec in the spring of 1997,
16 just a little bit after all these discussions we've been
17 having?

18 A. I believe that's correct.

19 Q. Please take a look at Defendant's Exhibit 140. It's a
20 two-page document, and this is in your handwriting, right,
21 sir?

22 A. Yes, it is.

23 Q. And these are notes that you took regarding your visit to
24 Adaptec, right?

25 A. They appear to be.

09/04/2001 Chaparral Trial - Day 1

1 Q. And you looked at something called an Adaptec bridge,
2 right?

3 A. I believe so.

4 Q. All right. Something called an Adaptec bridge, right?
5 And you called it a 4200 look-alike, right?

6 A. Yes, that's the words -- those are the words.

7 Q. And the 4200 product is one of Crossroads' own products,
8 right?

9 A. It is.

10 Q. And it has -- 4200 product has a single Fibre Channel wire
11 connection and two SCSI connections --

12 A. It does..

13 Q. -- right? And that's contrasted with the 4100 which has
14 one of each, right?

15 A. That's correct.

16 Q. So you characterized this Adaptec bridge as the 4200
17 look-alike, yes?

18 A. Those are the words, yes.

19 Q. And you took a close look at it and you included all this
20 stuff, right?

21 A. I don't recall taking a close look at it physically,
22 but --

23 Q. Well, you concluded that it had an Emerald on the Fibre
24 Channel side?

25 A. Uh-huh.

1 Q. Actually, that's a SCSI controller?

2 A. I believe that's a Fibre Channel controller.

3 Q. You're absolutely right. That's a Fibre Channel
4 controller?

5 A. Yes.

6 Q. And it had an 895 dual channel controller that's a SCSI
7 channel?

8 A. That's correct.

9 Q. Microprocessor?

10 A. That's what it says.

11 Q. And it had a PCI bridge?

12 A. That's what it says, yes.

13 Q. It has two PCI buses?

14 A. That's what it says.

15 Q. And you looked at it close enough to realize it has all
16 that stuff including all the other elements, a RAID box, XOR
17 assist engine, right?

18 A. This may have been what they presented. I don't know.

19 Q. And then, they said they told you they had a
20 three-and-a-half-inch form factor sandwich design with a
21 baseboard that would have included a 586 plus memory and
22 plug-in interface card, right?

23 A. That's what's written, yes.

24 Q. Please take a look at Defendant's Exhibit 28. Actually,
25 the fourth page of Defendant's 28.

1 A. I don't have that --

2 Q. It's a block diagram.

3 A. I actually don't have that document.

4 Q. Do you have the Exhibit 61, sir?

5 A. I don't.

6 Q. Well, I'll get you a hard copy if you need it, but why
7 don't we just try to work from the screen, if we can, all
8 right?

9 A. Okay.

10 Q. Now, this block diagram on the right is called a Coronado
11 Lite Fibre Channel-to-SCSI bridge, right, sir?

12 A. Yes, that's the title.

13 MR. ALBRIGHT: Your Honor, I think Mr. Bahler ought to
14 move for admission of the exhibit.

15 MR. BAHLER: This is 28.

16 THE COURT: I'm sorry. I thought you said 61.

17 MR. BAHLER: No. 28's in, which is the same as 61.
18 61's not in. 28, page 4 is.

19 Q. (BY MR. BAHLER) And it's called a Coronado Lite Fibre
20 Channel, the SCSI bridge, and a nomenclature AEC 7312, right?

21 A. Yes.

22 Q. And this is actually dated December 6th, 1996, right, sir?

23 A. Yes.

24 Q. And that was before you visited Adaptec in February of
25 1997, right?

09/04/2001 Chaparral Trial - Day 1

1 A. Yes.

2 Q. And the thing you looked at was -- well, first of all,
3 were you looking at the AEC 7312 when you went to Adaptec?

4 A. I don't recall.

5 Q. Okay. Well, the -- well, whatever you looked at at
6 Adaptec had an Emerald on the Fibre Channel side?

7 A. That's what it says, yes.

8 Q. And Emerald on the Fibre Channel side, right?

9 A. Yes.

10 Q. And that's what this block diagram shows, right?

11 A. Yes.

12 Q. And it had an 895 dual channel SCSI on the SCSI side,
13 right?

14 A. Yes.

15 Q. Okay. That's what this had. That's what the block
16 diagram on Exhibit 28 has, right?

17 A. Those are the same numbers, yes. I'm not familiar with
18 what Excalibur is.

19 Q. Okay. And it had what the thing you looked at at Adaptec
20 had an AMD 586 processor, right?

21 A. Yes.

22 Q. And that's the same as in Exhibit 28, page 4, right?

23 A. It appears to be.

24 Q. Okay. And the thing you looked at at Adaptec was PCI
25 bridge chip, right?

09/04/2001 Chaparral Trial - Day 1

- 1 A. Yes.
- 2 Q. And that also appears in the block diagram of Exhibit 28,
3 page 4, right?
- 4 A. Appears to be, yes.
- 5 Q. And then, you had PCI buses, right?
- 6 A. Yes.
- 7 Q. The thing you saw at Adaptec in February '97, right?
- 8 A. Yes.
- 9 Q. And the block diagram on the right has PCI bus, right,
10 sir?
- 11 A. Yes.
- 12 Q. And the thing you saw at Adaptec in February of '97 had a
13 RAID XOR, assist engine, right?
- 14 A. The presentation has it, yes.
- 15 Q. And the block diagram has a RAID X or engine, right?
- 16 A. Appears to be, yes.
- 17 Q. And then, you mentioned that it had a
18 three-and-a-half-inch form factor. And although this says
19 three-and-a-quarter-inch form factor, did you actually measure
20 the thing you saw at Adaptec?
- 21 A. I don't recall that I saw anything physically other than
22 this presentation.
- 23 Q. Now, the block diagram on the right is a block diagram of
24 whatever you saw at Adaptec in February of 1997, right, sir?
- 25 A. Appears to be.

09/04/2001 Chaparral Trial - Day 1

1 Q. Did you ever see a product?

2 A. I don't believe I ever did.

3 Q. Well, let me see if I can jog your memory. I'll hand you
4 what's been marked as Defendant's Exhibit 31. Before I do
5 this, your Honor, I offer 31 into evidence.

6 MR. ALBRIGHT: No objection, your Honor.

7 THE COURT: All right. 31's admitted.

8 Q. (BY MR. BAHLER) Please take a look at Defendant's Exhibit
9 31, Mr. Smith. Now, that is a -- let's see here. That is a
10 three-and-a-half-inch form factor product, right, sir?

11 A. I would assume so without measuring it, yes.

12 Q. And it's a sandwich design, right?

13 A. Appears to be, yes.

14 Q. And the baseboard in the 586 and memory are on one of
15 those boards, right?

16 A. They appear to be.

17 Q. Okay. And the plug-in interface card with custom
18 connector, that's on one of the ends of those boards, right?

19 A. I would assume so.

20 Q. That's what you wrote down on your notes when you went to
21 Adaptec in February '97?

22 A. That's what I wrote down.

23 Q. Did you see that board when you went to Adaptec in
24 February 1997?

25 A. I don't recall ever seeing a board like this.

09/04/2001 Chaparral Trial - Day 1

1 Q. Possible, though, right?

2 A. I would guess so.

3 Q. Did you see any board?

4 A. I really don't recall that.

5 Q. All right. Now, Mr. Smith, you're no longer employed by
6 Crossroads today?

7 A. That's not true.

8 Q. Okay. Well, you're no longer the president, right?

9 A. I haven't been president for a long time.

10 Q. Okay. But there was a time when you were both President
11 and CEO and Chairman of the Board of Crossroads, right?

12 A. That's true.

13 Q. And when you had that position, you signed documents on
14 behalf of Crossroads all the time, right, sir?

15 A. That's true.

16 Q. Okay. And when you signed those documents, you made sure
17 that they were correct, right?

18 A. Certainly wanted them to be, yes.

19 Q. And if you didn't understand them, you had somebody
20 explain them to you, right?

21 A. Certainly.

22 Q. You never signed anything that you didn't completely
23 understand when you were signing on behalf of your company,
24 right?

25 A. I signed things that -- many things that required --

09/04/2001 Chaparral Trial - Day 1

1 Q. The question was, you never signed anything that you
2 didn't completely understand, did you, sir?

3 A. I'm not sure I completely understood everything, but
4 certainly had people who are -- that I trusted to work for me
5 to help me whether it was a document to sign or not.

6 Q. Please take a look at Defendant's Exhibit 9. There we go.
7 Okay. Now, that's Defendant's Exhibit 9, first of all, Mr.
8 Smith, turn to the second page.

9 A. I don't actually have 9.

10 Q. You don't have 9?

11 A. No.

12 Q. Well --

13 A. I'm sorry. I do.

14 Q. It's kind of in numerical order.

15 A. Actually, they aren't. That's okay. Go ahead.

16 Q. That's a paper you signed. Take a look at the second
17 page. I have it up on the screen here.

18 A. Yes.

19 Q. That's your signature, right?

20 A. Yes.

21 Q. You signed it in April 1998, right, sir?

22 A. Yes, that's the date.

23 Q. And that's a paper that was filed with the Patent Office,
24 right?

25 A. That appears to be.

09/04/2001 Chaparral Trial - Day 1

1 Q. And it was filed in the Patent Office in connection with
2 the 972 patent that's the patent at issue in this case, right,
3 sir?

4 A. It appears to be, yes.

5 Q. All right. Now, just above your signature, you made the
6 following declaration to the Patent Office: We acknowledge
7 the duty to disclose information which is material to the
8 examination of this application in accordance with Title 27,
9 Code of Federal Regulations, Section 156A, right?

10 A. That's what it says.

11 Q. And you understood that to be the -- you acknowledged that
12 you were going to comply with what's known as the duty of
13 disclosure, right, sir?

14 A. That's what it says here.

15 Q. All right. And you personally acknowledged that duty,
16 right, sir?

17 A. As it related to me, yes.

18 Q. Okay. And it was explained to you that you need to tell
19 the Patent Office everything that you know about when applying
20 for a patent, right?

21 A. I don't recall that.

22 Q. Okay. And was it explained to you that you need to
23 disclose things that aren't simply exactly like the invention
24 but things that are close? Was that explained to you, sir?

25 A. I don't recall that.

09/04/2001 Chaparral Trial - Day 1

1 Q. Okay. Well, Mr. Smith, even though you signed this paper,
2 personally acknowledging duty to disclose information to the
3 Patent Office, you never told the Patent Office about the
4 technology demonstration at Comdex in 1996, did you, sir?

5 A. I don't recall doing that.

6 Q. And you never told the Patent Office about the 4100
7 evaluation offers before the end of '96, did you, sir?

8 A. I don't recall that.

9 Q. And you never told anybody about the -- you never told the
10 Patent Office about the 4400 evaluation unit that you were
11 offering to EMC, did you?

12 A. I don't recall that either.

13 Q. And you didn't tell the Patent Office about the Adaptec
14 product that you saw in February '97 either, did you?

15 A. I don't recall that either.

16 Q. Mr. Smith, who made the decision within Crossroads to file
17 the lawsuit against Chaparral?

18 A. Would have been our senior executive team.

19 Q. Okay. That included yourself?

20 A. It would.

21 Q. And you concurred with that?

22 A. I did.

23 Q. And before you did that, you had an investigation done,
24 right?

25 A. We did.

09/04/2001 Chaparral Trial - Day 1

1 Q. And you concluded to your satisfaction that the Crossroads
2 1310 product infringed the 972 patent, right?

3 A. Which product was that?

4 Q. I'm sorry. The Chaparral 1310 product, you would -- this
5 team, including yourself, concluded that the Chaparral 1310
6 product infringed your patent, right?

7 A. That was, as I recall, the advice given us in the -- from
8 our counsel.

9 Q. Okay. Had you bought a 1310 product before that?

10 A. I don't recall.

11 Q. Had you tested one?

12 A. Again, I don't recall.

13 Q. Okay. Did the 1310 have access controls at that time?

14 A. I don't know.

15 Q. You don't know, and yet, you filed suit against Chaparral,
16 not even knowing if the 1310 had access control; is that what
17 you're telling us?

18 A. That's something I would rely on someone else to tell me.

19 Q. Okay. You didn't know personally?

20 A. I certainly couldn't make that evaluation. That's why I
21 hired others to help me.

22 Q. And you have no doubt that that evaluation was correct,
23 right?

24 A. I don't.

25 Q. And that somebody concluded that the 1310 had access

09/04/2001 Chaparral Trial - Day 1

1 controls, right?

2 A. Again, I would rely on the counsel that we hired to help
3 us.

4 Q. And this was a -- before you filed this lawsuit in March
5 of 2000, right?

6 A. I believe so.

7 Q. Pass the witness.

8 THE COURT: Mr. Albright.

9 MR. ALBRIGHT: Your Honor, we have a matter to take up
10 outside of the jury.

11 THE COURT: Members of the jury, I'll let you slip in
12 to use the facilities. Mr. Mace will tell you when it's
13 needed to come back.

14 (Jury not present.)

15 THE COURT: You need the witness up here?

16 MR. ALBRIGHT: No, sir.

17 THE COURT: You may step down.

18 MR. ALBRIGHT: Your Honor, may I approach and hand you
19 this exhibit?

20 THE COURT: You may.

21 MR. ALBRIGHT: Your Honor --

22 THE COURT: Defendant's 242.

23 MR. ALBRIGHT: Yes, sir. It was admitted. It's
24 obviously the defendant's exhibit. It was admitted without
25 objection by us today. If the Court would turn -- actually,

1 Mr. Bahler in his questions just brought into account an issue
2 that is part of page 1 of this, which is indirectly Crossroads
3 Systems names Sanders Chief Executive Officer by his questions
4 relating to what Mr. Smith's position was.

5 If you would turn to page 2 of this exhibit, which is
6 in evidence, if you would look at the first topic, Pathlight
7 Technology admits infringement and settles lawsuit with
8 Crossroads Systems. Your Honor, we would argue that the issue
9 of the Pathlight settlement has now been brought in by the
10 questions that Mr. Bahler asked as well as an exhibit that the
11 defendants offered and the Court admitted.

12 And, therefore, pursuant to your earlier order that we
13 approach the bench, I wanted to approach the bench and raise
14 this issue with the Court. We believe that the document is
15 relevant, also, based on the fact that Mr. Bahler made -- I
16 think, at least, twice arguments in his opening statement that
17 the lawsuit against Chaparral was frivolous, and I think it
18 would go to rebut that.

19 In addition, an argument that I would make with
20 respect just generally to the admissibility of the license
21 with respect to rebut their counterclaim of obviousness in one
22 of three that would be a secondary consideration, I wanted to
23 get basically all the arguments out up front.

24 Your Honor, this is now in evidence. It's something
25 that the jury has. And we believe we ought to be able to

1 discuss both the Pathlight Technology admission of
2 infringement as well as if you look down on -- under April
3 24th, 2001, there's an entry that says Chaparral Network
4 Storage drops lawsuit against Crossroads Systems.

5 We believe that that issue is now open for examination
6 of witnesses, as well, given that this is an exhibit that's in
7 evidence.

8 THE COURT: All right. Two grounds, one is the
9 exhibit. What questions or statements did you believe Mr.
10 Bahler has stated in the record before the jury would allow
11 the settlement in?

12 MR. ALBRIGHT: First, your Honor, that he discussed --
13 he argued during opening argument that this lawsuit was
14 frivolous.

15 THE COURT: Well, this lawsuit could be frivolous. I
16 don't see all the smoke Mr. Bahler has put in on all of this
17 stuff which is just smoke. It's not even good smoke, but I've
18 heard the evidence twice, so I know. I don't know what the
19 jury's smelling, but this lawsuit could be frivolous or the
20 other one may not have. You're talking about a different
21 product. That's not going get you on the horse. What's next?

22 MR. ALBRIGHT: Your Honor, it would be that Mr. Bahler
23 has raised the issue of Mr. Smith's position at Crossroads and
24 there --

25 THE COURT: So what? What is the problem? He's no --

09/04/2001 Chaparral Trial - Day 1

1 longer chief. You put him in as president and chief executive
2 officer. He was entitled to ask if he still is.

3 MR. ALBRIGHT: Your Honor, he is the chief executive
4 officer and chairman.

5 THE COURT: Okay. But he's not the president. I
6 don't know --

7 MR. ALBRIGHT: He never asked if he was president,
8 right.

9 THE COURT: I'm missing something. What is the
10 significance of this?

11 MR. ALBRIGHT: Your Honor, I just believe that since
12 there is information in evidence now that someone else is
13 going to become the CEO that we're -- we should be allowed to
14 put in evidence of with respect to anything that's in the
15 exhibits, been admitted into evidence.

16 THE COURT: Okay. So we're getting down. Any other
17 statements or questions by Mr. Bahler that would allow the
18 Pathlight lawsuit to come in?

19 MR. ALBRIGHT: No, sir.

20 THE COURT: All right. The Court finds no basis
21 whatsoever for any of the statements nor any of the questions
22 to let the settlement in. However, I'm going to hear Mr.
23 Bahler's argument on 242. It is in evidence.

24 MR. BAHLER: It is in evidence, your Honor. This is
25 three pages from Crossroads' web site which obviously was

1 overlooked, and this line item that's on the third page.

2 THE COURT: It's on the second page.

3 MR. BAHLER: Second page was inadvertently included in
4 this exhibit. It was a mistake, your Honor, plain and simple,
5 and I would move the Court to withdraw this exhibit at this
6 time. I know they have been unopposed, but I make one
7 observation. I cut them a break when it came to opening
8 statements. Those slides came in without me looking at them.

9 They don't permit me to withdraw this exhibit, then I
10 think they're being very unreasonable.

11 MR. BARRETT: Your Honor, may I say one thing? This
12 exhibit may have been admitted, but that was just an
13 inadvertent mistake. We made very clear to opposing counsel
14 that we didn't want any mention of the settlement in any web
15 pages, and we have objected to all the other web pages, and
16 this one was just a simple mistake.

17 By admitting this, we're not saying the settlement is
18 now in play. That was never the intention. That was simply a
19 mistake to put that on the agreed-to list. We made very clear
20 we didn't want any settlement on the web page which is that
21 stack of papers in there. And this somehow slipped in as a
22 mistake, and we didn't want to admit this.

23 THE COURT: Well, counsel, y'all have tried very hard
24 to pre-admit hundreds of exhibits. I can see where a exhibit
25 -- I'm going to allow 242 to be withdrawn. I would not have

09/04/2001 Chaparral Trial - Day 1

1 allowed, for the record, any questions to go into the exhibit
2 because of its admission in the event that I did not allow 242
3 to be withdrawn.

4 But it was there and would be in evidence, and the
5 lawyers would be free to at least read it to the jury. They
6 would not be able to enlarge upon it. That's for the record.
7 But I believe because we had pre-admitted hundreds of exhibits
8 in a short period of time that it would be most inequitable to
9 allow that exhibit to be in, and they are withdrawn with the
10 objection of plaintiff.

11 MR. ALBRIGHT: Your Honor. Would the ruling be the
12 same with respect to the issue of the withdrawal of the
13 lawsuit that Chaparral -- the information -- I understand the
14 Court's going to withdraw exhibit --

15 THE COURT: Is this the counterclaim that was filed in
16 this lawsuit?

17 MR. ALBRIGHT: Well, your Honor, it wasn't. Frankly,
18 it was not a counterclaim. Chaparral filed a state court
19 lawsuit against Crossroads in Colorado. The case was removed
20 in Colorado and motions for transfer were filed, and it was
21 filed -- it was brought to this court, although I don't
22 believe that it was ever consolidated in this court. It was
23 transferred to this court.

24 THE COURT: We're talking about the same one here.

25 MR. ALBRIGHT: Yes, sir. Chaparral dismissed that

09/04/2001 Chaparral Trial - Day 1

1 case with prejudice. Again, they have opened the door to the
2 admissibility of that issue by arguing our claim against them
3 is frivolous. I think it's fair for the jury to hear that
4 Chaparral filed the lawsuit against us, and not only did they
5 file the lawsuit against us that they dismissed it with
6 prejudice. Voluntarily dismissed it with prejudice.

7 THE COURT: And that lawsuit was one for --

8 MR. ALBRIGHT: I believe, at a minimum, it was for
9 defamation. Actually, I apologize, your Honor. Actually, it
10 was the thrust of the lawsuit was -- that the Chaparral
11 lawsuit against us was that this case was -- our case against
12 them was frivolous and had been done in order to injure
13 Chaparral and defame Chaparral.

14 And when push came to shove in terms of us requesting
15 depositions and discovery for Chaparral folks to learn about
16 the basis of that claim, Chaparral decided to file a motion to
17 dismiss with prejudice. And I believe that the plaintiff --
18 I'm sorry, Chaparral's opened the door with respect to that
19 issue by continuing to maintain to this jury that Crossroads'
20 claims are frivolous. It would go directly to that issue,
21 your Honor.

22 THE COURT: Well, certainly argumentative and subject
23 to objection as an opening statement, but none was made. So
24 we're here waiting for somebody to stand up. Nobody stood up.
25 At this point in time, I'm not going to permit it. It's not

1 to say that I may not if it gets any worse, I'll have to
2 review those pleadings myself to see what the circumstances
3 are. And I will do that before the meet of the morning.

4 MR. ALBRIGHT: And, finally, your Honor, just for
5 purposes of the record, if the Court would give a ruling with
6 respect to Crossroads' argument that going back to the
7 admissibility of the settlement which included a license,
8 Crossroads would argue that the license would be evidence to
9 rebut -- as a consideration to rebut Chaparral's argument of
10 obviousness.

11 And we believe there are a million cases on --

12 THE COURT: As far as the jury will know, Pathlight
13 may have had bad lawyers. I mean, there's just no relevance
14 of it as to what one party might do and those lawyers. I
15 don't mean that to be critical. I mean, it's just nothing
16 that is relevant that the jury can draw from.

17 I wondered about the admissibility on that, that my
18 ruling would still be before you get into that, you need to
19 advise counsel and myself of that. I didn't know if you were
20 going to use it in your damage presentation or not.

21 MR. ALBRIGHT: I believe that's where we would use it,
22 your Honor.

23 THE COURT: We'll cross that bridge when we have to.
24 No pun intended. All right. Bring the jury in. I'm going to
25 recess the jury and let them go home.

1 (Jury present.)

2 THE COURT: Members of the jury, it's come to my
3 attention that we've got at least two of you that have a lot
4 of miles to go. You're not used to driving to Austin and back
5 and forth, so I'm going to go ahead and recess early today so
6 that you can get home and try to make your plans.

7 I generally run the courtroom to 6:00, and the reason
8 for that is, as you will learn, even though I'm letting you
9 out at ten to 5:00, it's not a real nice thing to do because
10 you're not going to get home much earlier getting out at 5:00
11 than you would at 6:00.

12 I have one letter for one of you with regard to the
13 keeping the children, which I'm going to sign and give to
14 them. They always say, you know, no matter what, we're going
15 to do this. And I don't ever want to be involved between
16 parents and the people keeping their children, but I do get
17 involved in it occasionally, just to explain the necessity for
18 it.

19 So this letter will go to -- and if there's any
20 problem, I understand the husband picked up -- the father did
21 the things today. If there's any problem, let me know, and I
22 can be, believe it or not, diplomatic, as well as
23 non-diplomatic.

24 Now, all of you are going to go home this evening and
25 then, drive back tomorrow. Is 8:30 too early or -- tell me.

09/04/2001 Chaparral Trial - Day 1

1 Is 8:30 too early for anybody?

2 THE JUROR: 8:30 is better.

3 THE COURT: We'll try to start promptly at 8:30.

4 Please remember my instructions: Please don't talk to anybody
5 including your family. You can tell them that it's a patent
6 case and you caught the crazy judge who you don't know and
7 you've heard a lot of crazy things about him, and he told you
8 not to talk to anybody, so you better not talk to anybody.
9 And we'll see you in the morning at 8:30. And I've got this
10 letter, they're making a copy for the file, and we'll deliver
11 it.

12 Okay. Any questions from the jury? All right. All
13 stand as the jury recesses.

14 (Jury not present.)

15 THE COURT: Mr. Albright, here, I'm going to give you
16 this fine notebook that I -- just come on up here. Anything
17 further of the plaintiff?

18 MR. ALCOCK: Nothing further, your Honor.

19 THE COURT: Anything from the defendant this evening?

20 MR. BAHLER: No, your Honor.

21 THE COURT: All right. 8:30 in the morning, counsel.

22 (Proceedings adjourned.)
23
24
25