

- [54] **METHOD FOR DYNAMICALLY ALLOCATING DATA CHANNELS ON A TRUNKED COMMUNICATION SYSTEM**
- [75] Inventors: **Kenneth J. Zdunek, Schaumburg; Garry C. Hess, Hanover Park; Richard A. Comroe, Dundee, all of Ill.**
- [73] Assignee: **Motorola, Inc., Schaumburg, Ill.**
- [21] Appl. No.: **44,525**
- [22] Filed: **Apr. 30, 1987**
- [51] Int. Cl.⁴ **H04B 7/14; H04Q 11/00**
- [52] U.S. Cl. **340/825.030; 370/95.1; 455/34**
- [58] Field of Search **340/825.030, 825.01; 370/95, 17; 455/17, 33, 34, 54, 56, 62**

4,578,815	3/1986	Persinotti	455/33
4,593,389	6/1986	Wurzburg et al.	370/110.1
4,609,778	9/1986	Franklin et al.	379/243
4,679,187	7/1987	Irvin	370/17
4,698,805	10/1987	Sasuta et al.	455/17
4,707,832	11/1987	Glenn et al.	370/124

Primary Examiner—Donald J. Yusko
Assistant Examiner—Edwin C. Holloway, III
Attorney, Agent, or Firm—Wayne J. Egan; Thomas G. Berry

- [56] **References Cited**
- U.S. PATENT DOCUMENTS**
- 4,012,597 3/1977 Lynk, Jr. et al. 455/53
- 4,197,500 4/1980 Klein et al. 455/62
- 4,352,183 9/1982 Davis et al. 371/33
- 4,551,852 11/1985 Gravel et al. 455/33
- 4,553,262 11/1985 Coe 455/15
- 4,556,972 12/1985 Chan et al. 370/94
- 4,573,206 2/1986 Grauel et al. 455/33
- 4,574,163 3/1986 Zato 379/62

[57] **ABSTRACT**
 Disclosed is a method to dynamically allocate a number of data channels on a trunked radio system (100). The data activity is monitored during a predetermined time interval. If activity is above a predetermined maximum, an additional channel may be reserved for data use. Conversely, if data traffic is low, a data channel may be reallocated for voice message use. Moreover, should the amount of data traffic among the available data channels be unbalanced, the present method contemplates reassigning subscriber units (114 or 116) to the available data channels to balance the data traffic load, thereby providing superior access time and system performance.

14 Claims, 6 Drawing Sheets

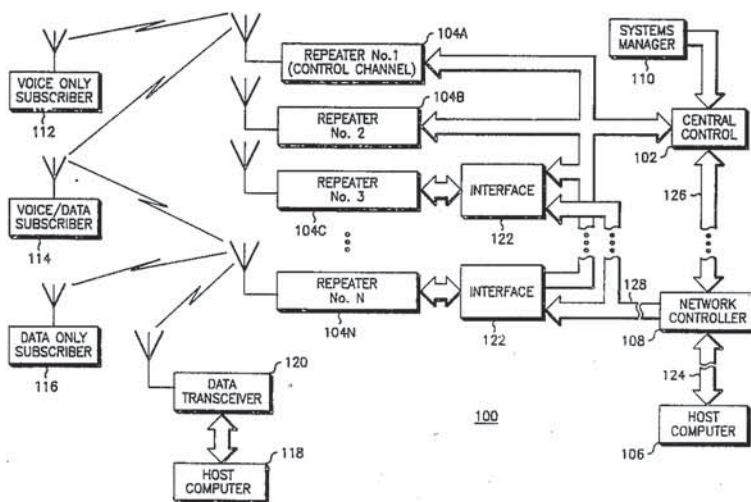

EXHIBIT
 EX. 1008

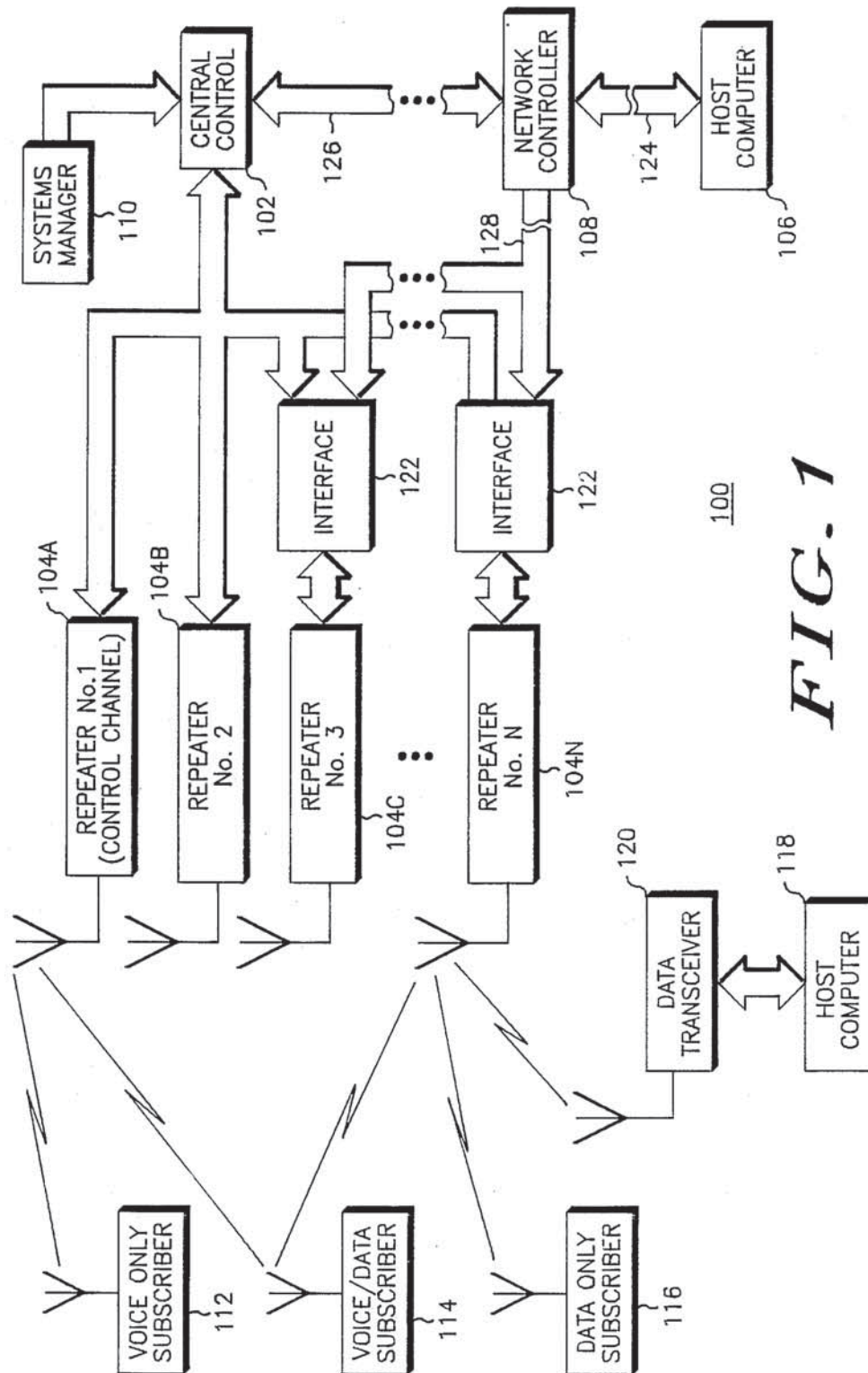

FIG. 1

FIG. 2

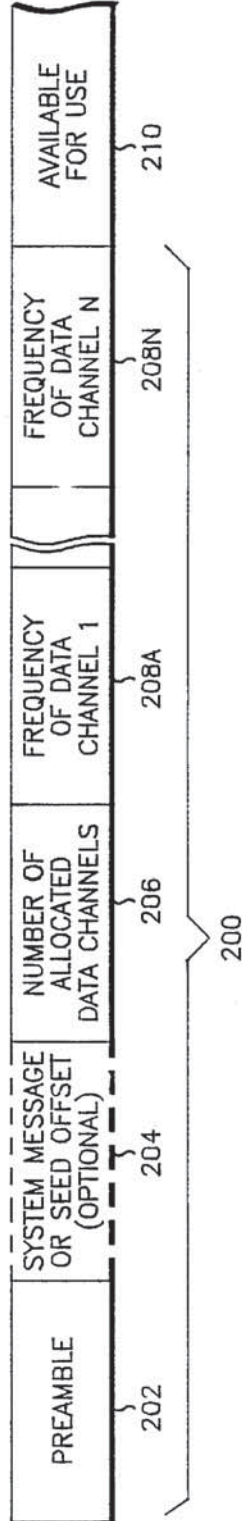
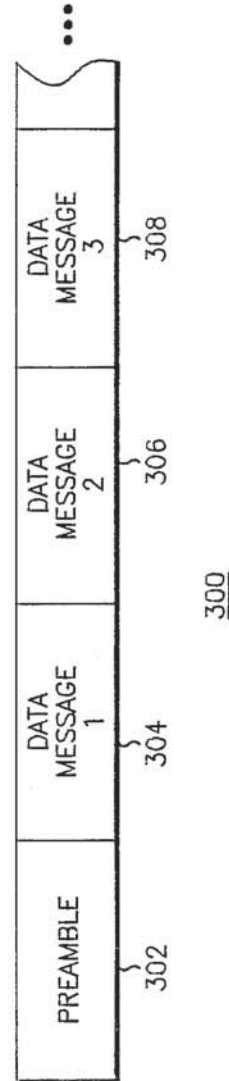
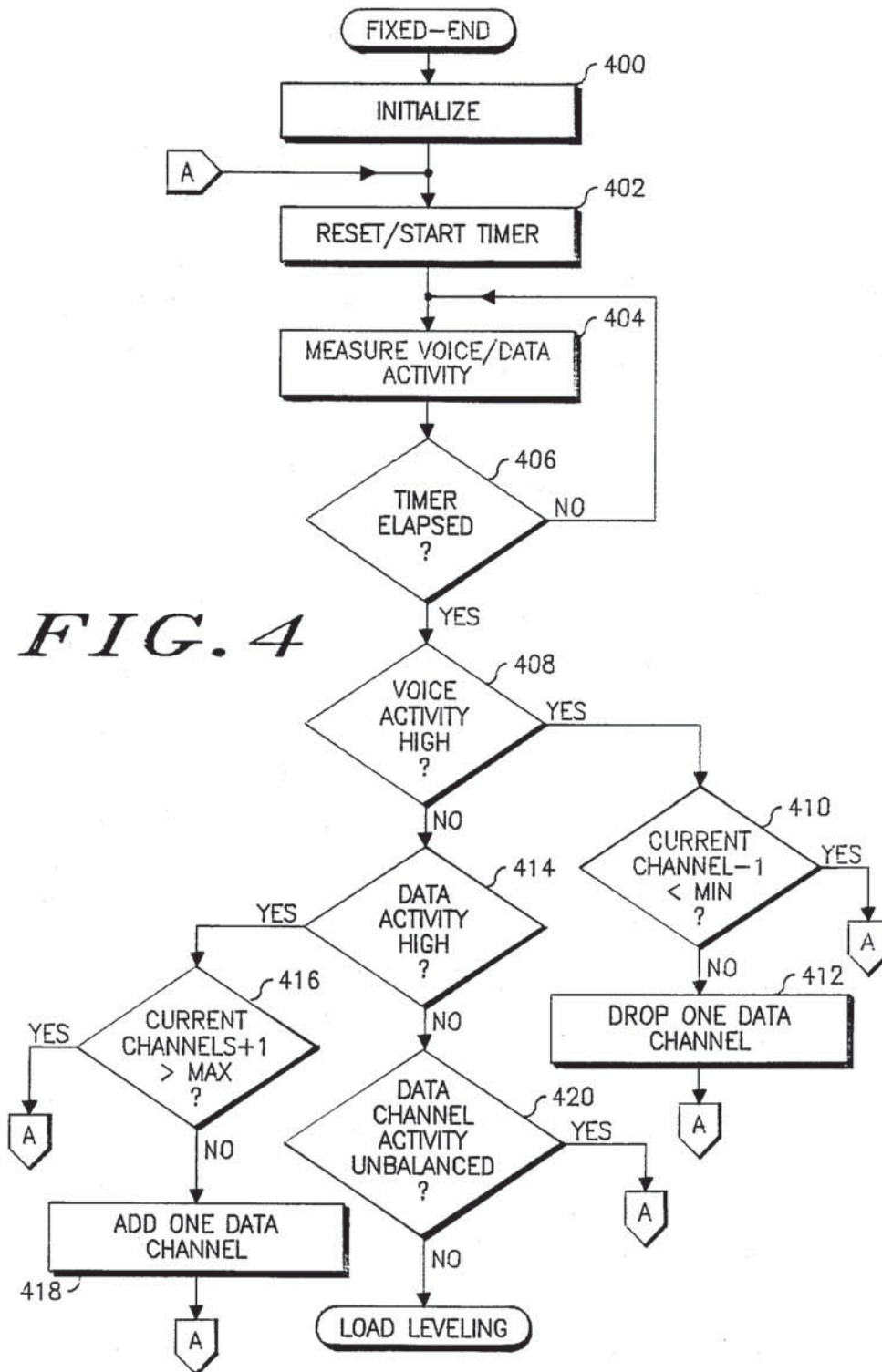

FIG. 3





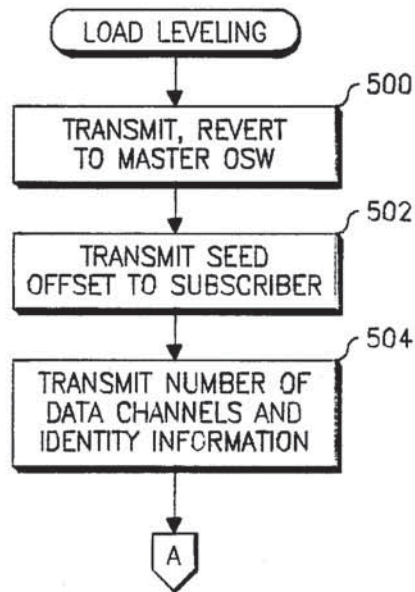
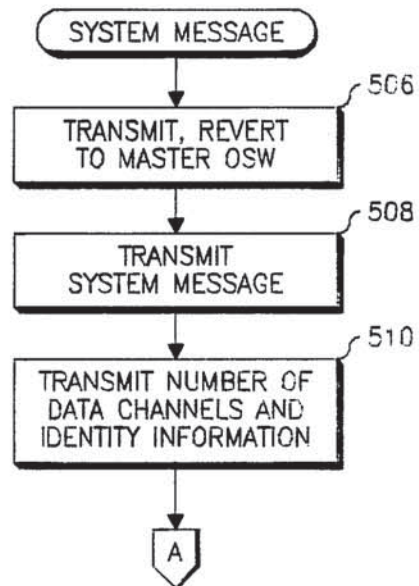

FIG. 5A

FIG. 5B



Explore Litigation Insights

Docket Alarm provides insights to develop a more informed litigation strategy and the peace of mind of knowing you're on top of things.

Real-Time Litigation Alerts



Keep your litigation team up-to-date with **real-time alerts** and advanced team management tools built for the enterprise, all while greatly reducing PACER spend.

Our comprehensive service means we can handle Federal, State, and Administrative courts across the country.

Advanced Docket Research



With over 230 million records, Docket Alarm's cloud-native docket research platform finds what other services can't. Coverage includes Federal, State, plus PTAB, TTAB, ITC and NLRB decisions, all in one place.

Identify arguments that have been successful in the past with full text, pinpoint searching. Link to case law cited within any court document via Fastcase.

Analytics At Your Fingertips



Learn what happened the last time a particular judge, opposing counsel or company faced cases similar to yours.

Advanced out-of-the-box PTAB and TTAB analytics are always at your fingertips.

API

Docket Alarm offers a powerful API (application programming interface) to developers that want to integrate case filings into their apps.

LAW FIRMS

Build custom dashboards for your attorneys and clients with live data direct from the court.

Automate many repetitive legal tasks like conflict checks, document management, and marketing.

FINANCIAL INSTITUTIONS

Litigation and bankruptcy checks for companies and debtors.

E-DISCOVERY AND LEGAL VENDORS

Sync your system to PACER to automate legal marketing.