



US005563883A

United States Patent [19]

[11] Patent Number: **5,563,883**

Cheng

[45] Date of Patent: **Oct. 8, 1996**

- [54] **DYNAMIC CHANNEL MANAGEMENT AND SIGNALLING METHOD AND APPARATUS**
- [76] Inventor: **Alexander L. Cheng**, 11 Sprindale Ave., White Plains, N.Y. 10604
- [21] Appl. No.: **276,534**
- [22] Filed: **Jul. 18, 1994**
- [51] Int. Cl.⁶ **H04H 1/04**
- [52] U.S. Cl. **370/73; 348/12; 370/85.7; 370/85.8; 455/4.2; 455/5.1**
- [58] **Field of Search** **348/6, 9, 12, 13; 455/3.1, 4.2, 5.1, 6.1, 34.1; 379/71, 73, 76, 80, 85.3, 85.7, 85.8, 95.1, 95.2**

[56] **References Cited**

U.S. PATENT DOCUMENTS

4,573,206	2/1986	Grael et al.	455/34.1
5,132,680	7/1992	Tezuka et al.	370/85.8
5,224,097	6/1993	Kaneshima	370/85.8
5,331,316	7/1994	Mestdagh	370/85.7
5,355,375	10/1994	Christensen	370/85.8
5,374,952	12/1994	Flohr	348/12
5,434,611	7/1995	Tamura	348/12

Primary Examiner—Benedict V. Safourek

[57] **ABSTRACT**

There is provided a dynamic and adaptable method and apparatus to support two-way multi-media communication

services on a multiple access communication system, which comprises a central controller, a shared transmission media and a plurality of remote terminals dispersed throughout the network. The central controller comprises switch and control apparatus and a pool of transmitters and receivers. The communication channels between the central controller and remote terminals are arranged for signalling data and traffic bearer channels in the forward and reverse directions. The number of signalling data channels is adjusted to satisfy the traffic requirements and for redundancy purposes. The forward and reverse signalling data channels are coupled in different mappings to support terminal grouping. Multiple access of the remote terminals for the upstream traffic are mitigated by separating remote terminals in groups via the channel allocation and the terminal assignment process. Communication between the central controller and the remote terminals follows a multiple access scheme controlled by the central controller via polling procedure on each of the forward signalling data channels independently. In case of collision, the central controller engages the remote terminals in a selective polling process to resolve the contention. The overlapping polling method of the controlled access scheme increases the utilization of the signalling channel and reduces the time required to gain access to the shared transmission media. By dynamically adjusting the load on signalling data channels, the signalling process is greatly improved for efficiency and redundancy against anomalies with the added benefit of improved flexibility and extensibility. The system is especially useful in a two-way CATV network.

20 Claims, 16 Drawing Sheets

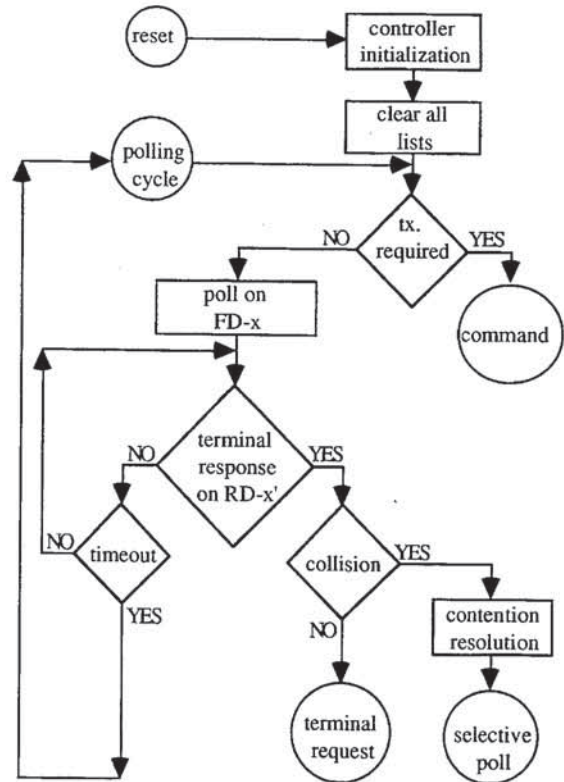

EXHIBIT
EX 1001

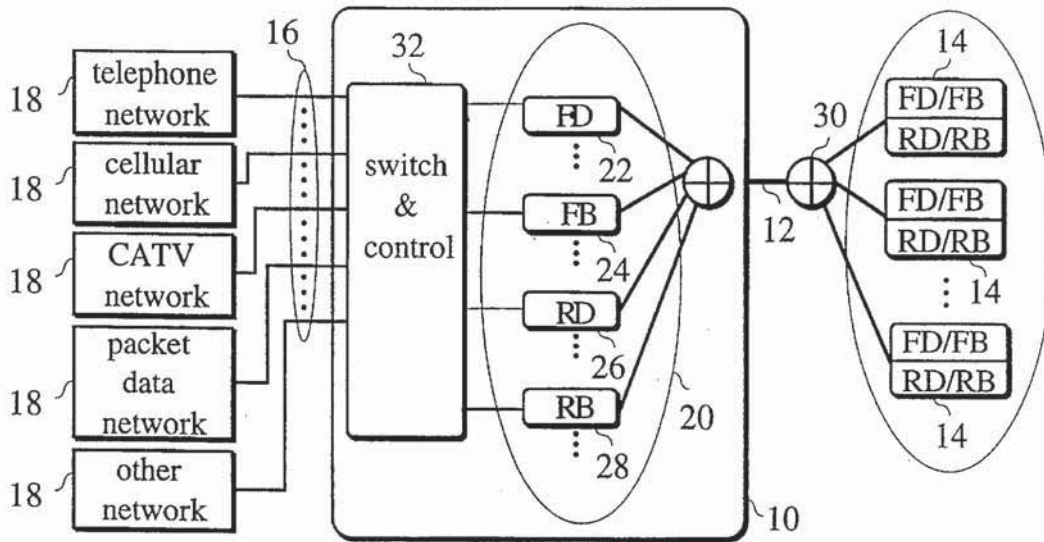

Figure 1

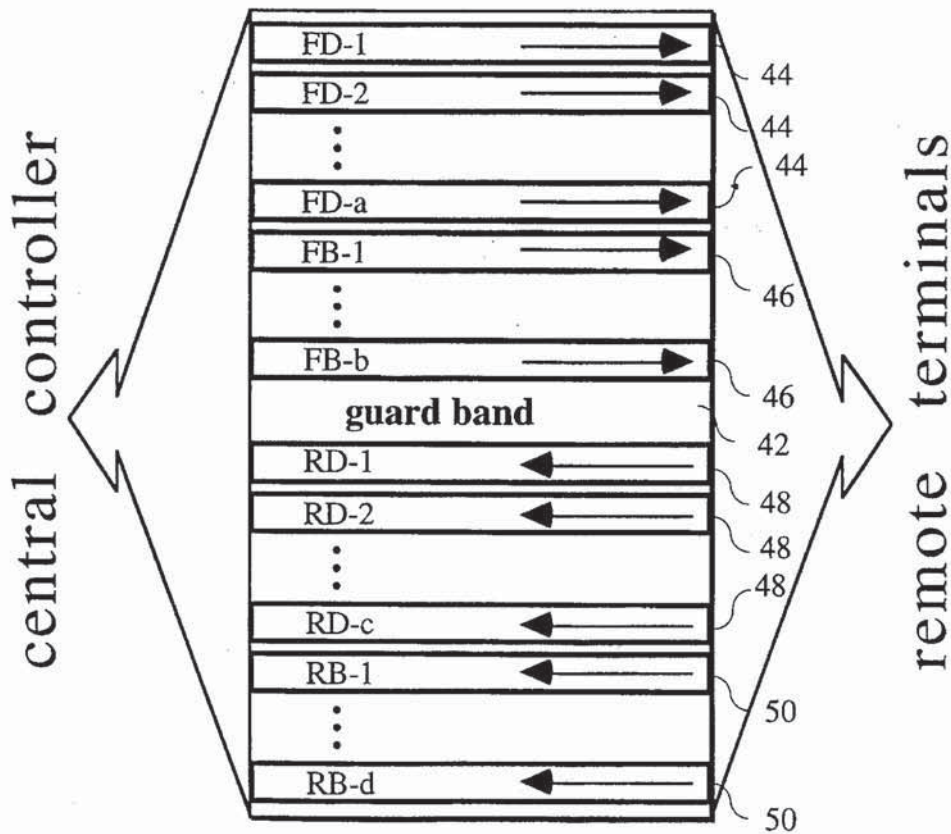

Figure 2

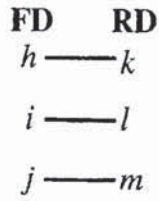

Figure 3a

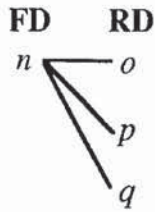

Figure 3b

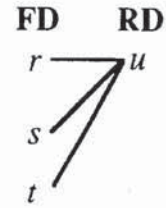

Figure 3c

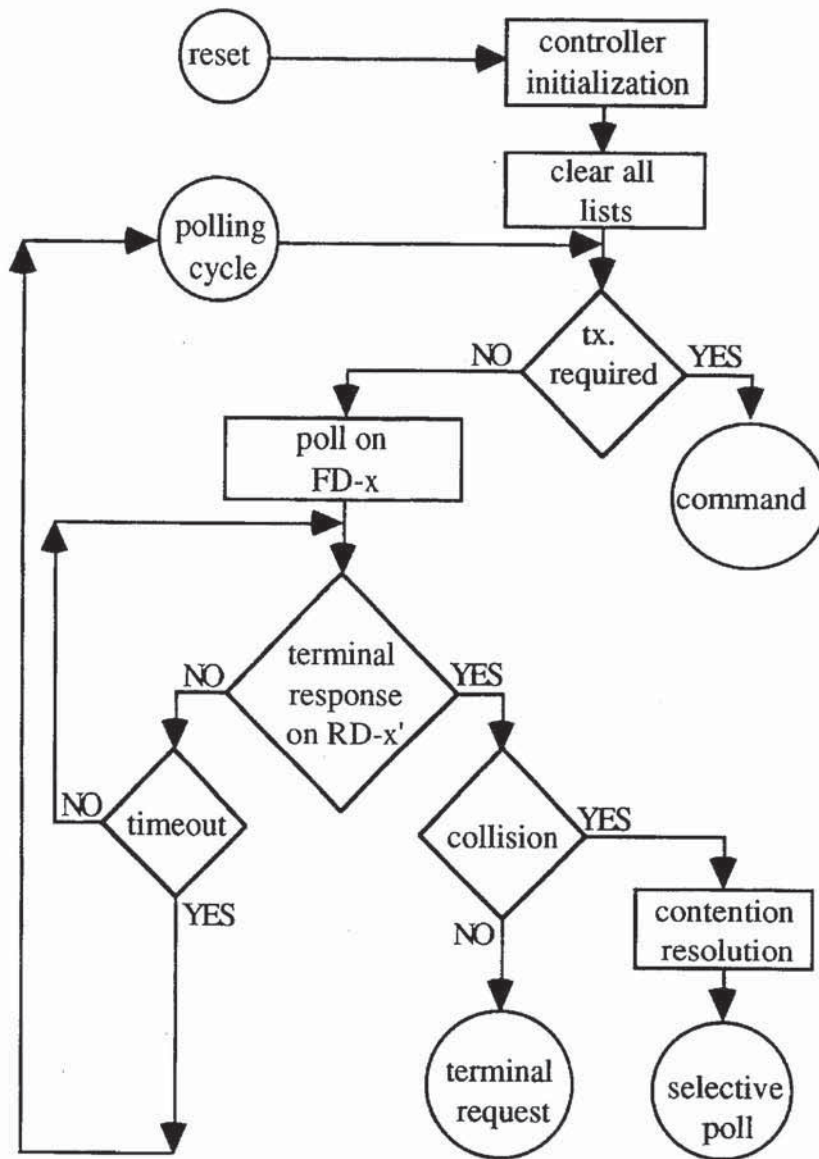

Figure 4

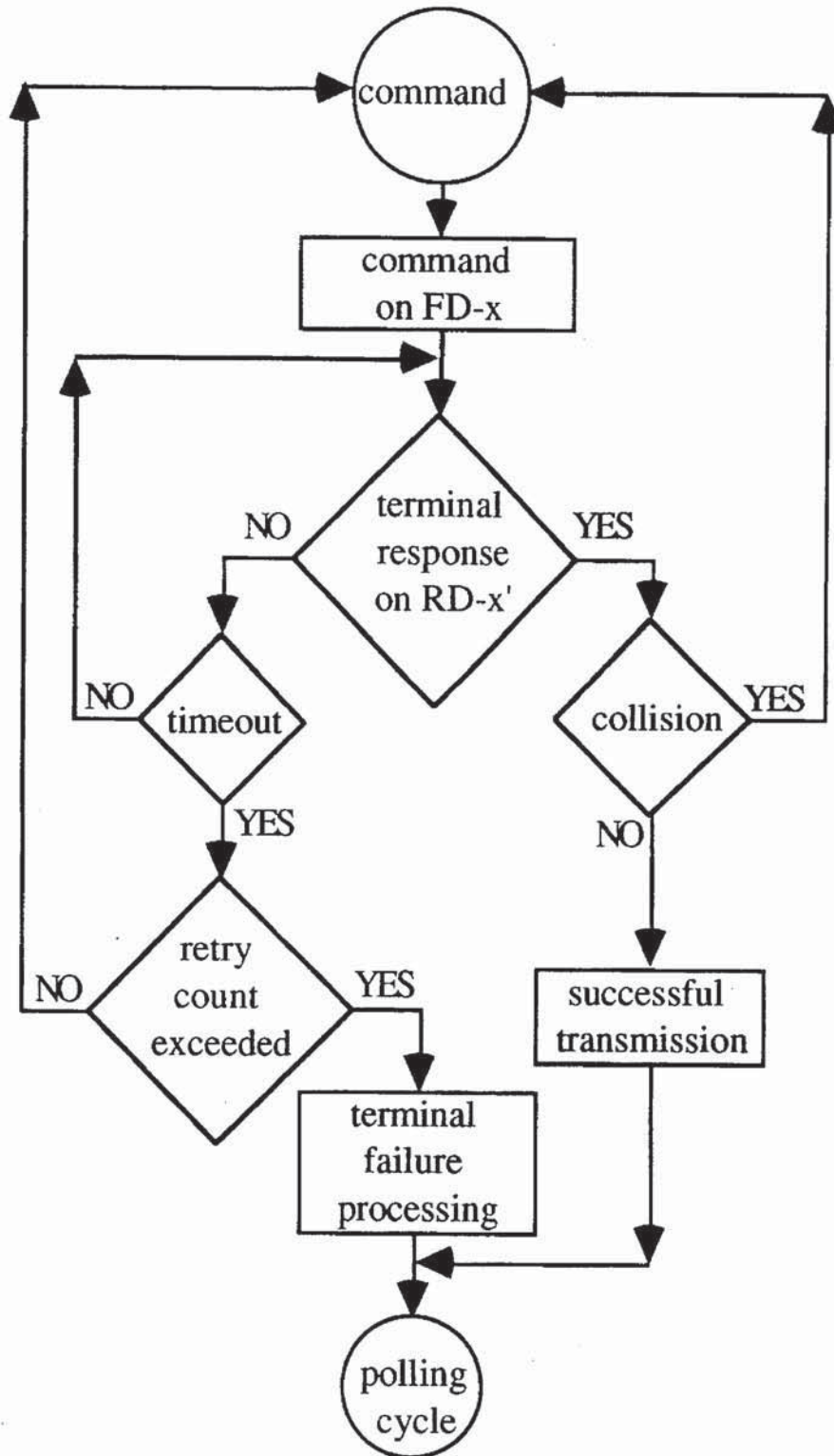

Figure 5

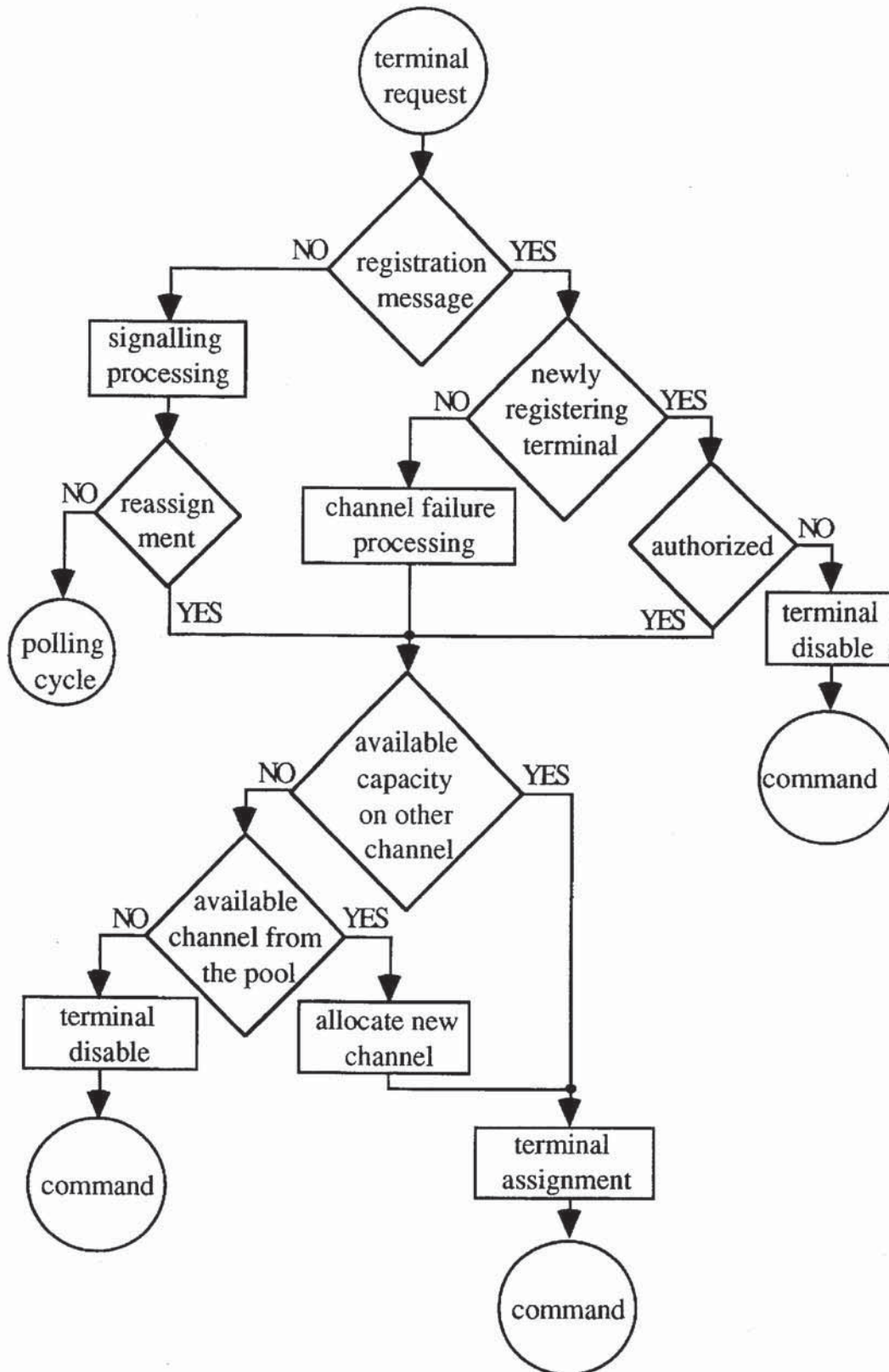

Figure 6

Explore Litigation Insights

Docket Alarm provides insights to develop a more informed litigation strategy and the peace of mind of knowing you're on top of things.

Real-Time Litigation Alerts



Keep your litigation team up-to-date with **real-time alerts** and advanced team management tools built for the enterprise, all while greatly reducing PACER spend.

Our comprehensive service means we can handle Federal, State, and Administrative courts across the country.

Advanced Docket Research



With over 230 million records, Docket Alarm's cloud-native docket research platform finds what other services can't. Coverage includes Federal, State, plus PTAB, TTAB, ITC and NLRB decisions, all in one place.

Identify arguments that have been successful in the past with full text, pinpoint searching. Link to case law cited within any court document via Fastcase.

Analytics At Your Fingertips



Learn what happened the last time a particular judge, opposing counsel or company faced cases similar to yours.

Advanced out-of-the-box PTAB and TTAB analytics are always at your fingertips.

API

Docket Alarm offers a powerful API (application programming interface) to developers that want to integrate case filings into their apps.

LAW FIRMS

Build custom dashboards for your attorneys and clients with live data direct from the court.

Automate many repetitive legal tasks like conflict checks, document management, and marketing.

FINANCIAL INSTITUTIONS

Litigation and bankruptcy checks for companies and debtors.

E-DISCOVERY AND LEGAL VENDORS

Sync your system to PACER to automate legal marketing.