

Sept. 21, 1954

H. POLLACK ET AL

2,689,598

CONVERTIBLE ARTICLE OF FURNITURE

Filed Oct. 26, 1951

2 Sheets-Sheet 1

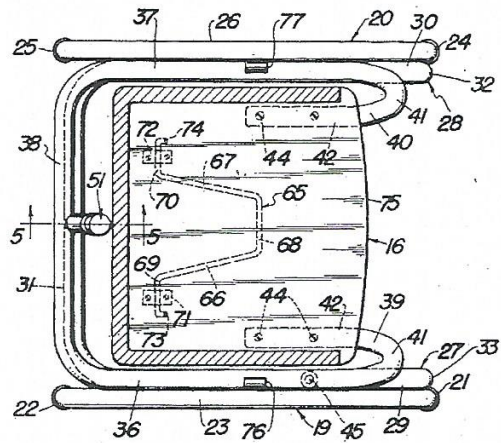

FIG. 2.

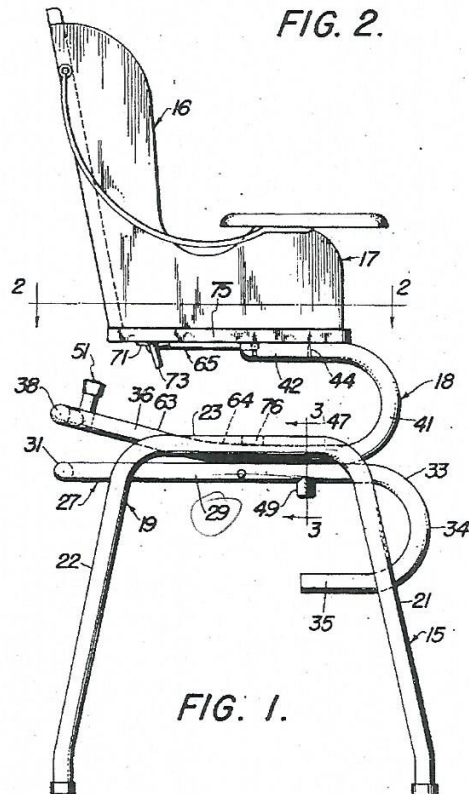

FIG. 1.

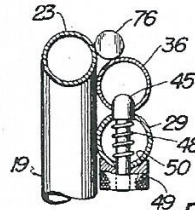

FIG. 3.

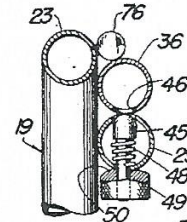

FIG. 4.

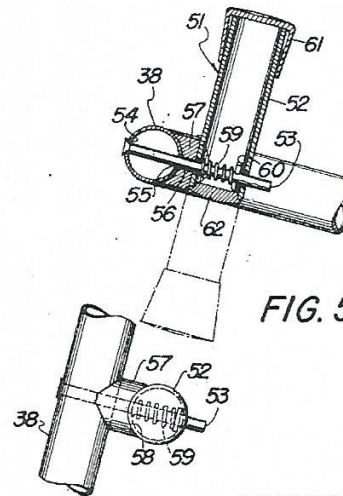

FIG. 5.

INVENTORS
 FIG. 6. HYMAN POLLACK
 DAVID BRAND
 BY *[Signature]*
 ATTORNEY

Ex. 1005 (774)