

INOvent delivery system

Operation and Maintenance Manual

CGA Variant



This Product will perform in conformity with the description thereof contained in this operating manual and accompanying labels and/or inserts, when assembled, operated, maintained, and repaired in accordance with the instructions provided. This Product must be checked periodically. A defective Product should not be used. Parts that are broken, missing, plain worn, distorted, or contaminated should be replaced immediately. Should repair or replacement become necessary, Datex-Ohmeda recommends that a telephonic or written request for service advice be made to the nearest Datex-Ohmeda Field Service Support center. This Product or any of its parts should not be repaired other than in accordance with written instructions provided by Datex-Ohmeda and by Datex-Ohmeda trained personnel. The Product must not be altered without the prior written approval of Datex-Ohmeda's Quality Assurance Department. The user of this Product shall have the sole responsibility for any malfunction which results from improper use, faulty maintenance, improper repair, damage, or alteration by anyone other than Datex-Ohmeda.

⚠ WARNING U.S. Federal and Canadian law restrict this device to sale by or on the order of a licensed medical practitioner. Outside the U.S.A. and Canada, check local laws for any restriction that may apply.

Inhaled Nitric Oxide mixtures must be handled and stored in compliance with federal, state and local regulations.

Datex-Ohmeda products have unit serial numbers with coded logic which indicates a product group code, the year of manufacture and a sequential unit number for identification.

AAA A 12345

└──────────┬──────────┘ This alpha character indicates the year of product manufacture and when the serial number was assigned; "B" = 1998, "C" = 1999, "D" = 2000, etc. "I" and "O" are not used.

Contents

1/Introduction	Definitions and Abbreviations	1-3
	Symbols used in this manual or on the system	1-4
2/General Information	Overview	2-2
	Configuration options	2-3
	Main component views	2-4
	Display and user controls	2-7
	Theory of operation	2-11
	NO Flow from the cylinder to the patient breathing circuit.	2-11
	Effect of inserting the INOvent into a breathing circuit.	2-14
3/Setup	NO delivery system connections	3-2
	Mounting	3-2
	System connections	3-3
	Electrical connections	3-8
	Setup menu	3-10
	Cylinder concentration	3-10
	Hourmeter display.	3-10
	To set the alarm loudness.	3-10
	To set the display brightness	3-11
4/Calibration	Calibration information	4-2
	NO, NO ₂ And O ₂ Sensor low range calibration (daily, room air)	4-3
	Procedure	4-3
	NO, NO ₂ And O ₂ Sensor high range calibration	4-5
	Procedure	4-5

5/Pre-Use Procedures	1. Initial connections and leak test	5-2
	2. System purge and performance test	5-3
	3. Manual NO delivery system purge and performance test	5-5
6/Operation	Before operation	6-2
	Connection to an ICU ventilator circuit	6-4
	Connection to a high frequency oscillatory ventilator circuit	6-8
	Connection to a circle anesthesia system	6-11
	Connection to a transport ventilator circuit	6-14
	Connection to bagging systems	6-16
	Operation	6-23
	Setting or changing the delivered NO concentration	6-23
	During operation	6-25
	Pausing NO flow	6-25
	Changing NO therapy cylinders and purging the regulator assembly	6-26
	Electronic delivery shutdown	6-28
	Monitoring the environment	6-29
7/Alarms	General alarm information	7-2
	High, medium and low priority alarms	7-2
	Alarm silencing	7-3
	Changing the alarm settings	7-4
	Alarm adjustment range	7-5
	Alarm adjustment procedure	7-5
	Clearing resolved alarm messages	7-7
	Alarm message table	7-9
8/Manual NO delivery system	Manual NO delivery system description	8-2
	Manual NO delivery system connections	8-3
	Manual NO delivery system operation	8-4
9/Troubleshooting	Troubleshooting procedure	9-2
	If the system fails to operate properly	9-2

Troubleshooting guide index	9-3
Troubleshooting guide	9-4
If the problem can't be corrected using the above suggestions.	9-13
If the INOvent delivery system must be returned for servicing	9-13

10/Maintenance

User maintenance schedule	10-2
INOvent delivery system cleaning.	10-4
Injector Module sterilizing and disinfecting	10-5
Autoclave sterilizing	10-5
High level disinfecting.	10-5
Patient Circuit Adapters & Sample Line	10-6
Monthly System Checkout	10-7
1. Initial connections leak tests	10-7
2. Purge and system alarms tests.	10-10
3. Calibration and monitoring alarms	10-12
4. INOvent delivery system performance	10-14
5. Manual NO delivery system purge and performance	10-15
Emptying the Fluid Trap Bottle	10-17
Replacing the Fluid Trap Filter Cartridge	10-18
Replacing the NO ₂ Sensor	10-19
Replacing the NO Sensor.	10-20
Replacing the O ₂ Sensor.	10-22
Cleaning or replacing the Cooling Fan Filter.	10-23
Fuse replacement and line voltage selection	10-24
Replacing the high pressure hose CGA626 connector tip	10-26

11/Parts and Accessories

Standard accessories	11-2
Optional accessories	11-2
Replaceable parts	11-3

12/Appendix A - Specifications

Functional	12-2
Ventilator compatibility	12-2

	Injector Module	12-3
	Manual NO delivery system	12-3
	NO delivery	12-4
	Maximum NO delivery	12-4
	Gas monitoring	12-5
	Calibration Gas cylinders	12-5
	Calibration Gas regulator	12-5
	NO Delivery shutdown.	12-5
	Physical	12-6
	Dimensions	12-6
	Environmental	12-7
	Electrical	12-8
13/Appendix B - Cylinder Information	Preparing the NO therapy gas cylinder for use	13-2
	Replacing the NO therapy gas cylinder	13-3
	NO therapy gas cylinder leak check	13-4
	Cylinder information	13-5
	Warnings	13-6
14/Appendix C - Pre- Use Procedures Card	14-1
15/Appendix D - Transport INOvent delivery system	Description	15-2
	Battery operation information	15-2
	Setup	15-4
	Regulator connection diagrams.	15-4
	Operation.	15-5
	Maintenance	15-6
	User maintenance schedule	15-6
	Replaceable parts and accessories	15-7
	Specifications	15-8
	Dimensions	15-8
	Electrical	15-8

**16/Appendix E -
Optional Mounting**

Cart mount16-2
Shelf or table mount16-4
 Optional Cylinder Mount Regulator and
 Hose assembly16-4

**17/Appendix F -
Alternate Cylinder
Concentrations**

In 'Section 3/Setup' of this manual17-2
 Cylinder concentration17-2
In 'Section 5/Pre-Use Procedures' of this manual17-3
 2. System purge and performance test. 17- 3
 3. Manual NO delivery system purge and
 performance test.17-3
In 'Section 10/Maintenance' of this manual17-4
 Monthly System Checkout17-4
 4. INOvent delivery system performance17-4

Warranty

.....W-1

Notes:

Introduction

⚠WARNING If an alarm occurs, safeguard the patient first before troubleshooting or repair procedures.

Use only pharmaceutical grade NO/N₂.

In this section

Definitions and Abbreviations	1-3
Symbols used in this manual or on the system	1-4

Important

Before using the INOvent delivery system, read through this manual and the related manuals provided. Read through the manuals for the ventilator, humidifier and any other accessory items used. Follow the manual instructions and obey Warnings and Cautions.

Know the proper setup and operation of the ventilator and the humidifier you are using.

Know the proper information provided in this Operation and Maintenance manual before operating the INOvent delivery system.

Keep this manual readily available to answer questions.

Read through each step or procedure to understand it before doing it.

All specifications in this manual are nominal.

Read the User Responsibility statement on the inside front cover of this manual; it describes what the user must do to maintain this product.

 **WARNING** The INOvent delivery system must only be used in accordance with the indications, usage, contraindications, warnings and precautions described in the nitric oxide drug package inserts and labeling. Drug package inserts and labeling are packaged with each drug cylinder. Refer to this material prior to use.

The use of devices which radiate high-intensity electrical fields may affect the operation of the delivery system. Do not drape the leads of these devices across the delivery system. Constant surveillance of all monitoring and life support equipment is mandatory whenever interfering devices are in operation on or near a patient.

Definitions and abbreviations

% v/v:	% volume/volume
Button:	A pushbutton control used to select a function.
Control wheel:	Rotary control used to change and confirm settings or actions.
Display:	The electronic information panel on the front of the delivery system.
HFOV:	High frequency oscillating ventilator.
Menu:	A list of available choices for an operation.
Menu area:	Area in the display where choice selections are shown.
Message area:	Area in the display where information is shown.
N ₂ :	Nitrogen.
NO:	Nitric oxide.
NO ₂ :	Nitrogen dioxide.
NO/N ₂ :	Nitric oxide (NO) and nitrogen (N ₂) gas mixture.
Numeric area:	Area in the display where values and settings are shown.
O ₂ :	Oxygen.
Pop-up box:	Menu or message which appears on the display.
Resolved alarm:	An alarm whose cause has been corrected.
Set NO:	The concentration of NO delivered by the system as set by the user.

















Symbols used in the manual or on the system













WARNINGS and **CAUTIONS** tell you about dangerous conditions that can occur if you do not obey all of the instructions in this manual.

Warnings tell you about a condition that can cause injury to the operator or the patient.

Cautions tell you about a condition that can cause damage to the equipment. Read and obey all warnings and cautions.

Other symbols replace words on the equipment or in this manual. These symbols include:

 On (power.)	 This way up.
 Off.	 Dangerous voltage.
 Standby.	 Input.
 Alternating current.	 Output.
 Protective earth ground.	REF Stock number.
 Earth ground.	SN Serial number.
 Alarm Silence.	 Sample gas outlet.
 Equipotential.	 O ₂ Sensor connector.
+ Plus, positive polarity.	 NO/O ₂ Manual delivery system.
- Minus, negative polarity.	 NO ₂ Sensor.

→	Movement in one direction.		NO Sensor.
134°C	Autoclavable.		O ₂ Sensor.
	Not autoclavable.		Product "Use by" information (indicating warranty expiration date as YYYY-MM).
	Type B equipment.		Replace fuse only as marked.
	Type BF equipment.		Indicates operating-on-battery.
	Warning and Caution symbol.		CE European Union Representative
	Attention, consult accompanying documents, IEC 601-1.		A system with this mark agrees with the European Council Directive (93/42/EEC) for Medical Devices when it is used as specified in the Operation and Maintenance Manual. The xxxx is the certification number of the Notified Body used by Datex-Ohmeda's Quality Systems.

Notes:

2/General Information

In this section

Overview	2-2
Configuration options	2-3
Main component views	2-4
Display and user controls	2-7
Theory of operation	2-11
NO Flow from the cylinder to the patient breathing circuit	2-11
Effect of inserting the INOvent into a breathing circuit	2-14

Overview

- The INOvent delivery system delivers nitric oxide therapy gas into the inspiratory limb of the patient breathing circuit in a way that provides a constant concentration of NO, as set by the user, to the patient throughout the inspired breath.
- The INOvent delivery system uses a specially designed Injector Module which enables the tracking of ventilator waveforms and the delivery of a synchronized and proportional dose of NO.
- The INOvent delivery system may be used with most ventilators.
- The INOvent delivery system provides continuous on-line integrated monitoring of delivered O₂, NO₂, and NO, and a comprehensive alarm system.
- The interactive control panel and display provide a simple-to-understand interface for operation of the INOvent delivery system.
- The battery system provides up to 30 minutes of uninterrupted nitric oxide delivery in the absence of an external power source.
- The INOvent delivery system provides an integrated Manual NO delivery system for administration of a fixed concentration of NO/O₂ therapy with a resuscitator bag.

Configuration Options

The INOvent delivery system is available in two configuration options:

- Shelf or table option and
- Mounted on a transport cart which holds two NO therapy gas cylinders.

The options let you choose the setup which meets the needs of the work environment.

Main component views

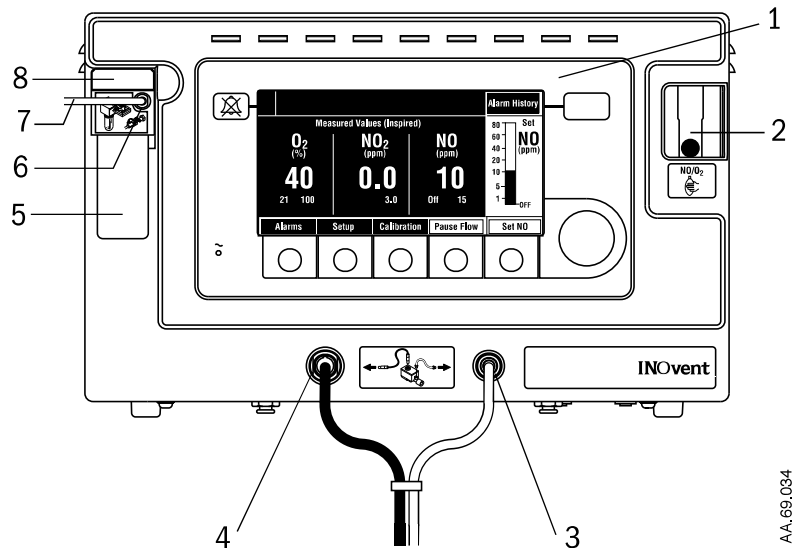

AA-69.034

1. Display and operating panel
2. Manual NO Delivery System Activity Indicator
3. NO/N₂ Injector Tube connector
4. Injector Module Electrical Cable connector
5. Fluid Trap Bottle
6. Inspiratory Gas Sample Line connector
7. Inspiratory Gas Sample Line
8. Fluid Trap Filter Cartridge

Figure 2-1 • INOvent delivery system, front view

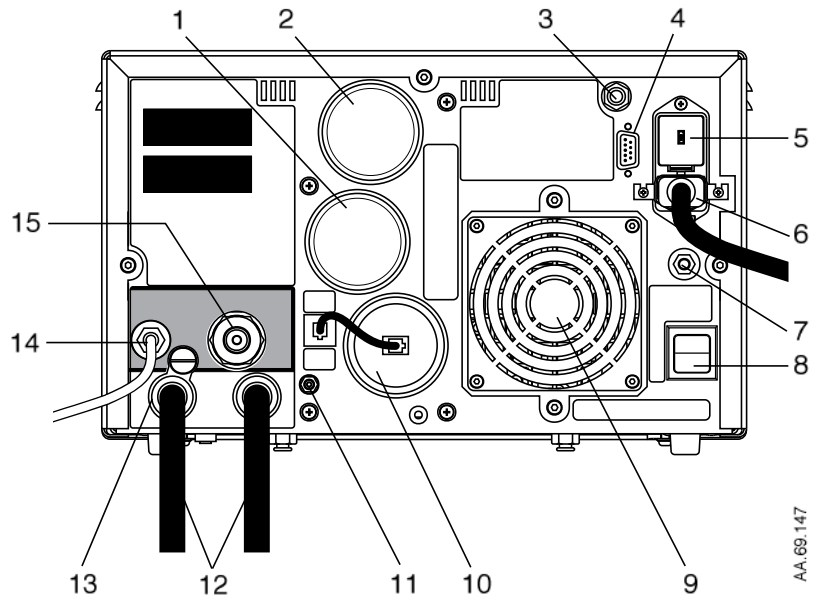

AA.69.147

1. NO Sensor
2. NO₂ Sensor
3. Nurse Call connector
4. Serial Port connector
5. Power Entry Module
6. Power Cord connector
7. External Ground connection point
8. ON/STANDBY switch
9. Cooling Fan and Filter
10. O₂ Sensor
11. Sample gas outlet
12. Regulator Low Pressure Hose with Quick Connector (2)
13. NO/N₂ Input Hose Connector (2)
14. Resuscitator Bag O₂ Tube connector
15. Connector to the O₂ Flowmeter

Figure 2-2 • INOvent delivery system, rear view

INOvent delivery system

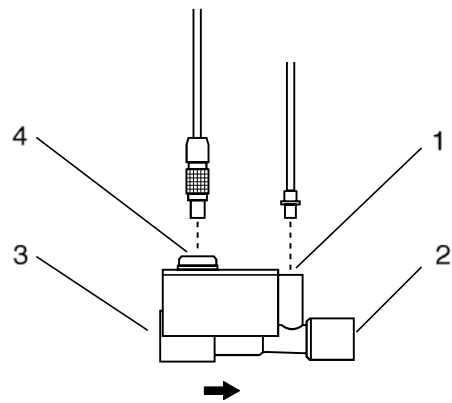

AA.69.266

1. NO/N₂ injector tube connection to the INOvent delivery system
2. Inspiratory limb breathing circuit connection; to humidifier
3. Inspiratory limb breathing circuit connection; from ventilator
4. Electrical cable connection to the INOvent delivery system

Figure 2-3 • Injector Module, side view

Display and user controls

The INOvent delivery system display and control panel has a control wheel, buttons, and an easy-to-view electroluminescent display. All the INOvent delivery system controls and monitoring are in one place which reduces the need for extensive visual scanning.

The buttons and control wheel on the INOvent delivery system control panel perform an assortment of functions and access various features.

The steps for performing any operation, or accessing any function, on the INOvent delivery system require the same interaction with the control panel, namely:

1. Select (press) a button associated with the desired function or operation,
2. Rotate the control wheel to select a menu item or value,
3. Confirm the selection by pressing either the control wheel or the function button.

The control panel display, buttons and control wheel are used to:

- Set the concentration of delivered NO,
- Adjust alarms,
- Pause NO delivery,
- Silence alarms,
- Review alarm history,
- Define setup options,
- Calibrate the monitors.

A single tone indicates:

- Your choice of an action with a button or the control wheel,
- An invalid action with a button or the control wheel or
- A message box appearance on the display.

In normal operation, a typical display presents these major sources of information:

- The Set NO value,
- The measured values of three inspired gases O₂, NO₂ and NO,
- Alarm information.

Menus guide you through the steps needed to deliver NO. Display and user controls are also discussed in the sections of this manual where system operations are explained.

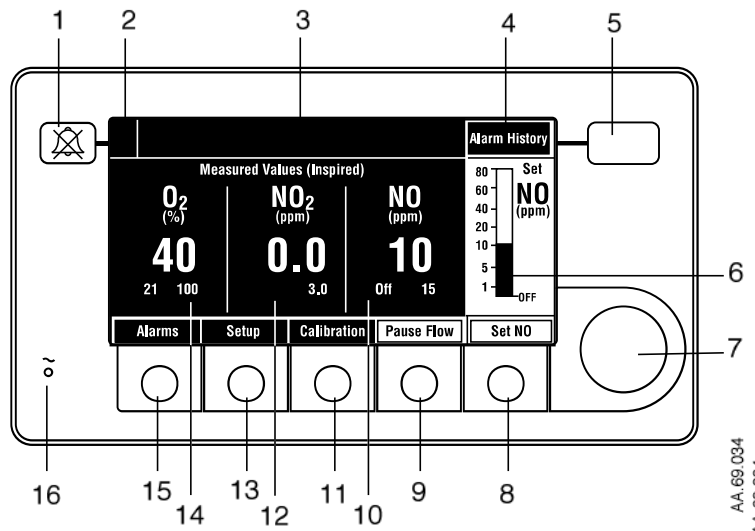

1. Alarm Silence button
2. Alarm Silenced Countdown Timer
3. Alarm message area
4. Alarm History indication area
5. Alarm History button
6. NO Bargraph
7. Control Wheel
8. Set NO button
9. Pause Flow button
10. Inspired NO Measured Value
11. Calibration button
12. Inspired NO₂ Measured Value
13. Setup button
14. Inspired O₂ Measured Value
15. Alarms button
16. Mains Power light

Figure 2-4 • User controls and indicators on the front

Following are brief descriptions of display and user controls shown in figure 2-4. See the other areas in the manual for more information.

1. Alarm Silence button

Pushing the Alarm Silence button silences an audible alarm and starts the alarm silence countdown timer in the upper left location of figure 2-4 (item 2). The counter shows the remaining silence time. A new alarm will sound even if the Alarm Silence function has previously been activated.

2. Alarm Silenced Countdown Timer

The Alarm Silenced Countdown Timer shows a silenced bell and the remaining silence time when the Alarm Silence button is pushed. The timer counts down from 120 seconds to zero for high and medium priority alarms.

- 3. Alarm message area** The highest priority most recent alarm message appears in the top part of this alarm message area first. On high priority alarms, the elapsed-time counter counts up. Alarm messages are also accompanied by audio signals. Refer to section 7/Alarms for additional information on alarms.
- 4. Alarm History indication area** This normally blank area displays “Alarm History” if there are resolved alarms. See section 7/Alarms for information on resolved alarms.
- 5. Alarm History button** Pushing the Alarm History button shows the Alarm History menu listing the resolved alarms. There is an option to clear the displayed resolved alarms.
- 6. NO Bargraph** The NO Bargraph shows the Set NO value in ppm.
- 7. Control Wheel** The Control Wheel’s function is defined by the information on the display. When a menu is displayed, turning the wheel in either direction selects a choice or adjusts device settings on the menu. Pressing the wheel then selects the current menu item or confirms the adjusted setting.
- 8. Set NO button** Pushing the Set NO button allows adjustment of the Set NO bargraph.
- 9. Pause Flow button** Pushing the Pause Flow button displays the “Pause Flow” message box but does not pause the NO flow. To pause NO flow, you must push the Pause Flow button a second time.
- 10. Inspired NO Measured Value** The measured value of inspired NO (in ppm) is displayed in large numbers. Low and high alarm settings for inspired NO appear below these numbers.
- 11. Calibration button** Pushing the Calibration button displays the menu for calibrating the high and low range of the sensors. Refer to section 4/Calibration for information on calibration.
- 12. Inspired NO₂ Measured Value** The measured value of inspired NO₂ in ppm is displayed in large numbers. The high alarm setting for inspired NO₂ appears below these numbers.
- 13. Setup button** Pushing the Setup button displays the Setup menu for setting the alarm volume and display brightness or returning to the normal display. See section 3/Setup and Calibration for additional information.

14. Inspired O₂ Measured Value

The inspired O₂ measured value in % is displayed in large numbers. The low and high alarm settings for inspired O₂ appear below these numbers.

15. Alarms button

Pushing the Alarms button displays the menu for setting the user-adjustable alarm limits. High limits can be set for O₂, NO₂ and NO. Low limits can be set for O₂ and NO. See section 7/Alarms for additional information on alarms.

16. Mains Power light

When the green Mains Power light is on, the system is connected to a functioning mains power outlet.

Theory of Operation

The INOvent delivery system delivers nitric oxide therapy gas into the inspiratory limb of the patient breathing circuit in a way that provides a constant concentration of NO to the patient throughout the inspired breath.

The INOvent delivery system uses a specially designed Injector Module which enables the tracking of ventilator waveforms and the delivery of a synchronized and proportional dose of NO.

NO Flow from the Cylinder to the Patient Breathing Circuit

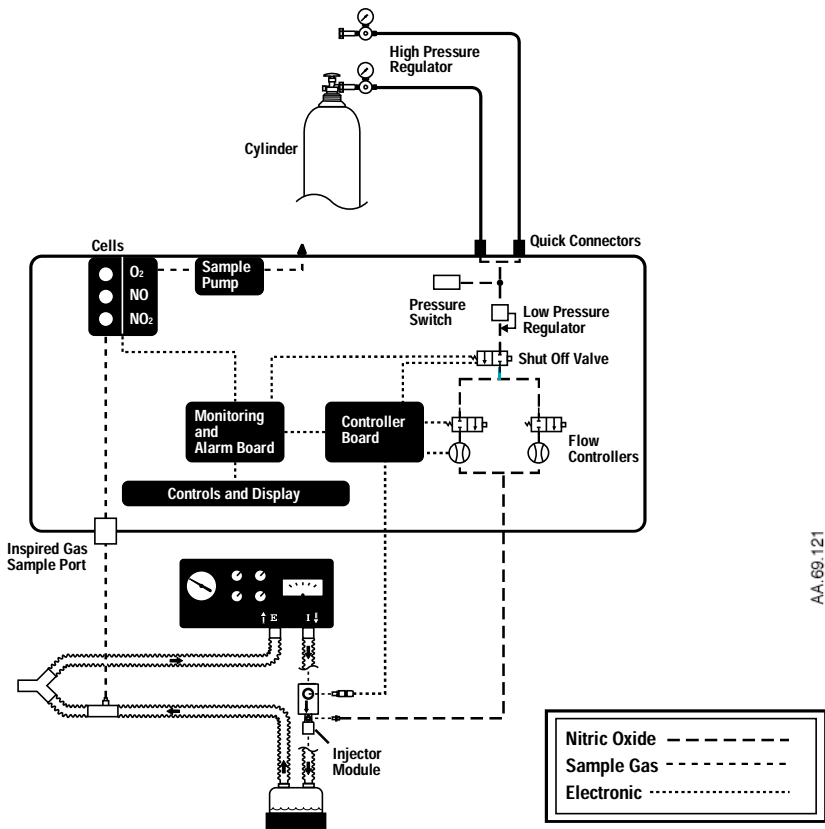

Figure 2-5 • NO Flow from the cylinder to the patient breathing circuit

See figure 2-5.

Nitric oxide therapy gas is stored as a gas mixture (Nitric Oxide [NO] and Nitrogen [N₂] balance gas) in an aluminum cylinder at a maximum pressure of 2200 psi. When the cylinder valve is opened, nitric oxide therapy gas is regulated down by a high pressure NO regulator.

INOvent delivery system

The regulator has a safety relief valve which opens if the regulator malfunctions. The regulator also has a supply pressure gauge which indicates the pressure in the cylinder.

Regulator and gauge location varies with the INOvent delivery system configuration option chosen. Each INOvent delivery system has two sets of regulators and gauges.

The nitric oxide therapy gas enters the INOvent delivery system through the NO/N₂ input hose connectors (quick-connects.) When the gas enters the INOvent delivery system, a pressure switch monitors if adequate pressure is available.

A low pressure regulator reduces the pressure to a nominal 26 psi. The output of this regulator supplies a shut-off valve where it waits for a delivery demand from the user.

When the shut-off valve is opened, NO flows through one of two flow controllers: a high flow or a low flow controller. The high and low flow controllers ensure accurate delivery of nitric oxide therapy gas over a wide range of ventilator flow rates and desired NO concentrations.

Nitric oxide therapy gas is introduced into the inspiratory limb of the breathing circuit through the INOvent Injector Module. The Injector Module must be between the ventilator and the humidifier chamber. Nitrogen dioxide (NO₂), an unwanted by-product of mixing NO and O₂, is reduced by injecting the nitric oxide therapy gas downstream of the ventilator.

The Injector Module uses an integrated respiratory flow sensor to measure ventilator flow rate in the breathing circuit inspiratory limb. This lets the INOvent delivery system track ventilator waveforms and inject a synchronized and proportional flow rate of NO. This supplies a constant concentration to the patient.

The INOvent delivery system “dual-channel” design ensures safe delivery of nitric oxide therapy gas. One channel has the delivery components: controller board, flow controllers, and injector module. The other channel has the monitoring components: monitor and alarm board, monitor sensors (NO, NO₂, and O₂ cells) and inspired-gas sample system.

The dual-channel approach to delivery and monitoring permits delivering NO independent of monitoring if the monitor malfunctions. The INOvent delivery system also has the safety features of an integrated system such as automatic shutdown if the NO monitored value becomes greater than 100 ppm.

When nitric oxide therapy gas delivery is required, the user selects the desired NO dose level in parts per million (ppm.)

The INOvent delivery system processes both the desired level for NO delivery as well as the instantaneous patient circuit flow from the INOvent Injector Module. Using this information, the INOvent delivery system injects the proportional amount of NO necessary to deliver a constant concentration throughout the breath.

The INOvent delivery system tracks ventilator waveforms and injects a synchronized, proportional, flow of NO into the inspiratory limb of the breathing circuit. This delivers a constant concentration of NO to the patient, independent of ventilator modes and flow rates as shown in figure 2-6.

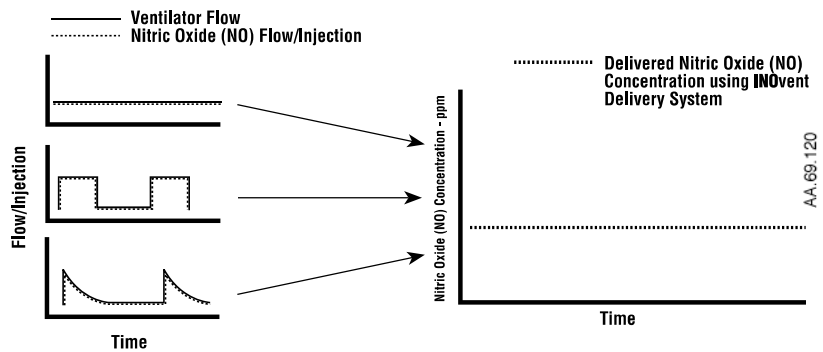

Figure 2-6 • INOvent delivery system injection method: a constant NO concentration

Effect of inserting the INOvent into a breathing circuit

There are two main effects of connecting and using the INOvent delivery system in a ventilator breathing circuit.

First, the INOvent delivery system adds gas to the breathing circuit in proportion to the NO setting. For example, at an 80 ppm NO setting (the maximum NO setting with a 800 ppm NO cylinder concentration), the INOvent delivery system adds 10% more gas to that delivered by the ventilator, 5% more for a 40 ppm setting, etc.

Second, the INOvent delivery system subtracts gas from the breathing circuit via the gas sampling system at a nominal flowrate of 230 mL/min.

These two effects of adding and subtracting gas from the ventilator breathing circuit have the following effects.

Oxygen Dilution

The INOvent delivery system adds gas to the breathing circuit in proportion to the NO setting as described above. The gas being added by the INOvent delivery system is a mixture of NO with the balance gas being Nitrogen (N_2 .) Thus, the oxygen concentration in the breathing circuit gas is reduced because of the NO/ N_2 injection.

This reduction is proportional to the NO setting. At an NO setting of 80 ppm with a cylinder concentration of 800 ppm NO, the added gas is 10%. Thus, the O_2 concentration is reduced by 10% of its original value. For example, if the original O_2 concentration was 50% v/v, then the value after injection, at the 80 ppm setting, is 45% v/v.

Volume Control Ventilation

When using volume control ventilation with the INOvent delivery system, the measured tidal volume delivered to the patient shows small changes depending on the NO setting being used. Some minor ventilator adjustments may be required to the volume setting to compensate for this addition and subtraction of gases.

For example, assume a respiratory rate of 20 bpm and a tidal volume of 500 mL. The reduction in tidal volume due to the sampling system is 230 / 20 bpm. This is approximately 10 mL per breath. The increase in tidal volume due to an NO setting of 80 ppm with a cylinder concentration of 800 ppm is 10% of 500 mL. This is 50 mL per breath. Thus, the total effect on the delivered tidal volume is between -10 mL to +40 mL for an NO set range between 0 to 80 ppm.

Pressure Control Ventilation

In pressure control ventilation there are no significant effects of the INOvent delivery system on the pressures in the breathing circuit and hence to the tidal volume being delivered to the patient. This is because the ventilator actively controls the pressure in the breathing circuit and makes adjustments to compensate for the effect of the INOvent delivery system.

However, if a ventilator has inspired tidal volume measurement which is monitored inside the ventilator, this measurement reflects the change in the ventilator gas flow necessary because of the effect of the INOvent delivery system.

For example, assuming a respiratory rate of 20 bpm and a tidal volume of 500 mL, the net effect on the inspired tidal volume is -40 mL to +10 mL for an NO set range of 0 to 80 ppm.

Trigger Sensitivity

The addition and subtraction of gases by the INOvent delivery system may effect the trigger sensitivity of the ventilator when using synchronize modes of ventilation.

In ventilators which have flow trigger modes where the trigger flow is set to less than 1 L/min, this may cause the ventilator to auto-trigger. The trigger sensitivity of the ventilator should be checked after connecting the INOvent delivery system.

High Frequency Oscillatory Ventilator

The effect of the INOvent delivery system on a High Frequency Oscillatory Ventilator (HFOV) is minor changes to the bias flow because of the gas sampling system and the addition of gas flow in proportion to the NO setting.

For example, with a bias flow of 10 L/min, the reduction in bias flow due to the sampling system is 0.23 L/min. The increase in bias flow due to an NO setting of 80 ppm with a cylinder concentration of 800 ppm is 10% of 10 L/min which is 1 L/min. Thus, the bias flow will vary between 9.77 and 10.77 for an NO set range between 0 to 80 ppm.

Circle Anesthesia Ventilator Systems

The effect of the INOvent delivery system on circle anesthesia ventilator systems which use volume control ventilation is to cause small changes in the tidal volume being delivered to the patient depending on the NO setting being used. Minor changes to the volume setting on the ventilator may be necessary to compensate for this addition and subtraction of gases.

For example, assume a respiratory rate of 10 bpm and a tidal volume of 500 mL.

The reduction in tidal volume caused by the sampling system is 230 / 10 bpm. This is approximately 20 mL per breath. The increase in tidal volume caused by an NO setting of 40 ppm with a cylinder concentration of 800 ppm is 10% of 500 mL. This is 50 mL per breath. Thus, the total effect on the delivered tidal volume is between -20 mL to +30 mL for an NO set range between 0 to 80 ppm.

Recirculation of gases in circle breathing systems should be avoided to ensure that the accumulated gases in the ventilator bellows are not introduced into the inspiratory limb of the breathing circuit. The gas in the ventilator bellows may contain undesirable levels of NO₂ and other reaction products that may not be removed by the absorbent when it contains appreciable moisture as might occur in typical use.

Recirculation of gases can be avoided by using fresh gas flowrates equal to a patient's minute volume. This can be explained as follows.

During the expiratory phase of the breathing cycle, the fresh gas from the common gas outlet enters the absorber and flows in the reverse direction displacing some of the expired gas that is present.

During the next inspiratory phase, the accumulated gas in the ventilator bellows displaces the fresh gas in the absorber, pushing it into the inspiratory limb where it mixes with the fresh gas from the common gas outlet and flows to the patient.

As long as the fresh gas flow is equal to or greater than the patient's minute volume, there is sufficient fresh gas in the absorber such that no accumulated gas from the ventilator bellows reaches the inspiratory limb of the breathing circuit and hence to the patient.

Maximum NO Delivery

The INOvent delivery system is limited to a maximum NO flow of 6.2 L/min. This means the maximum deliverable NO concentration will vary based on the ventilator flow rate.

Figure 2-7 illustrates the maximum deliverable NO concentration versus constant inspiratory flow rate (for an 800 ppm cylinder concentration). The graph depicts the decrease in maximum deliverable concentration by the INOvent delivery system as a function of constant inspiratory flow rate.

The INOvent delivery system will deliver a maximum concentration of 80 ppm (using 800 ppm cylinder concentration) up to an inspiratory flow rate of 55 L/min. As inspiratory ventilator flows increase, the maximum deliverable NO concentration decreases gradually until the inspiratory flow rate reaches 120 L/min. The maximum deliverable NO concentration at 120 L/min (using 800 ppm cylinder concentration) is 40 ppm. The NO flow rate for a constant inspiratory flow rate can be calculated from the following formula:

$$\frac{(\text{NO}_{\text{set}}) \times (\text{Fresh gas flow rate})}{(\text{Cylinder concentration}) - (\text{NO}_{\text{set}})}$$

When intermittent inspiratory flow rates are used, peak ventilator flows may be attained which exceed the INOvent flow rate specification of 120 L/min. Peak inspiratory flow rates are transient and extremely short in duration. As a result, the portion of the breath which is not matched by the INOvent delivery system is extremely small and virtually negligible with respect to the entire range of the breath.

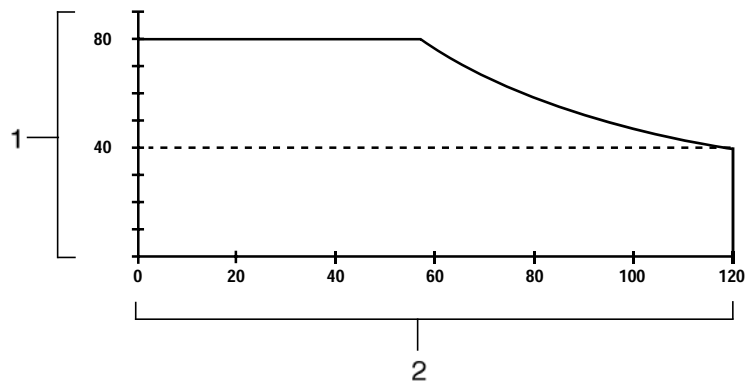

1. Maximum deliverable NO concentration (ppm)
2. Constant inspiratory flowrate (L/min)

Figure 2-7 • Maximum deliverable NO concentration vs. constant Inspiratory flow rate

Notes:

3/Setup

In this section This section provides connection information for the INOvent delivery system.

- INOvent delivery system connections 3-2
 - Mounting 3-2
 - System connections. 3-3
- Electrical connections 3-8
- Setup menu 3-10
 - Cylinder concentration. 3-10
 - Hourmeter display 3-10
 - To set the alarm loudness 3-10
 - To set the display brightness. 3-11

INOvent delivery system connections

See figures 2-1 or 2-2 if you need to identify additional parts.

Mounting

Refer to the following mounting instructions:

- when first using the system or
- when installing a replacement system.

Cart mounting

If the optional transport cart is used, the INOvent delivery system must be properly mounted and secured to the cart before making system connections. See figure 3-1.

1. Place the INOvent delivery system on the cart top shelf with the four mounting feet inserted into the four mounting slots.
 - Make sure the INOvent delivery system is pushed to the back and is against the shelf backstop.
2. Tighten the mounting screw at the back of the cart top shelf to attach the INOvent delivery system.

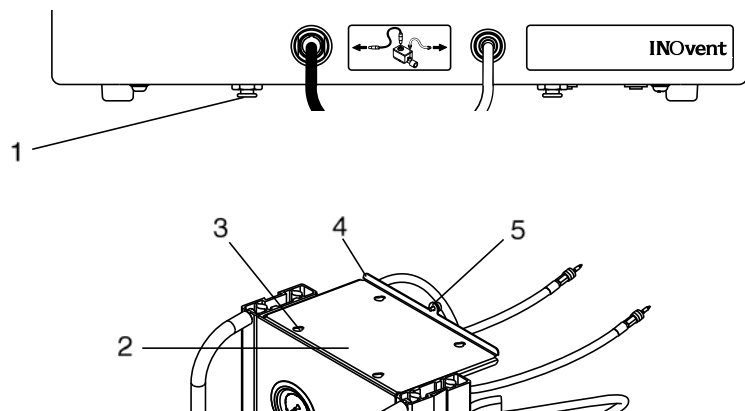

1. System mounting feet (4)
2. Cart top shelf
3. Mounting slots on cart top shelf (4)
4. Shelf backstop
5. Mounting screw

Figure 3-1 • Cart mounting

Shelf or table mounting

Place the INOvent delivery system on the shelf or table where it will be used.

- Allow safe and convenient routing for nitric oxide and therapy gas hoses.

System connections

1. Remove all protective caps from the connectors and ports on the INOvent delivery system.

See figure 3-2.

2. Connect the low pressure NO/N₂ hose from the regulator to the back of the INOvent delivery system by inserting until the red sleeve pops into place.

Important To remove this type of hose connector, pull the widest part of the connection away from the back of the system until the hose connection releases. You can then pull the hose connector out.

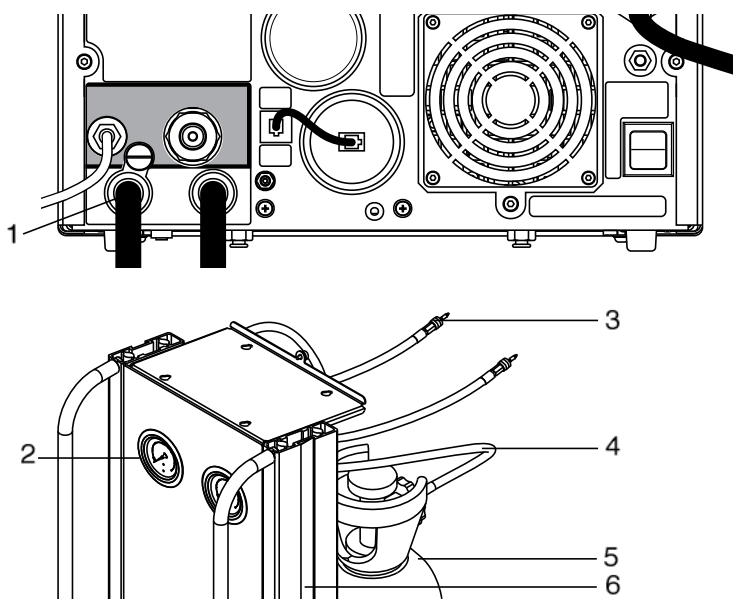

AA-69.147

AA-69.037

1. Regulated low pressure NO/N₂ hose connectors (2)
2. Cylinder gauge boot (2)
3. Regulator low pressure NO/N₂ hoses (2)
4. Regulator high pressure hoses (2)
5. Gas cylinder (2)
6. Dovetail rail (2)

Figure 3-2 • System connections

3. Check the therapy gas cylinders for the correct product identity labels and NO concentration. The NO concentration must match that shown in the Setup menu for Cylinder Concentration. For additional cylinder information see section 13/Appendix B - Cylinder Information.
4. If necessary, attach the cylinder gauge boots to the gauges on the front of the cart by pressing the boots into the gauge openings. Gauge boots are shown in figure 3-2.
5. If a cart is used, lock accessory supports into the dovetail rail before attaching accessories. Place heavier accessories near the base of the cart.
 - Make sure that any load is evenly distributed to help maximize stability when the system is moved.

⚠CAUTION Make sure the cart is stable after the accessories are attached.

6. Place the cart where it will be used and push down on the wheel locks with your foot to lock the casters. To unlock a caster, push down on the opposite end of the wheel lock.

⚠CAUTION Do not lean on, or lean anything against, the cart.

7. Connect and tighten the fittings on the high pressure hose from the regulator to the NO therapy gas supplies. Refer to figure 3-3.
 - a. Make sure the hose tip or seal is in place and not damaged when connecting to the cylinders.
 - b. Note: over-tightening a fitting can reduce the useful life of the tip.
 - Section 13/Appendix B - Cylinder Information has information on cylinders and leak checks.

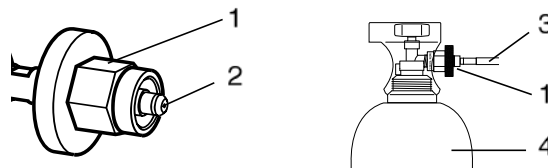

1. High pressure hose fitting (CGA type)
2. High pressure hose fitting tip
3. High pressure hose from the regulator
4. Therapy gas cylinder

Figure 3-3 • Cylinder connections

AA.69.132, AA.69.141

8. Make sure two NO gas cylinders, with more than 200 psi in each cylinder, are available.
9. Empty and clean the fluid trap bottle (figure 3-4) before each patient and whenever the trap is more than half full. See “Emptying the Fluid Trap” in section 6/Maintenance.
10. Connect the inspiratory gas sample line (figure 3-4) to the inspiratory gas sample line connector.

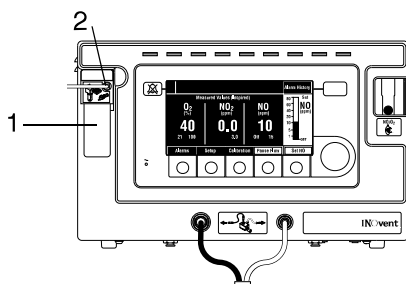

AA.69.094

1. Fluid trap bottle
2. Inspiratory gas sample line connector

Figure 3-4 • Fluid trap bottle and inspiratory gas sample line connector

11. Check that the three sensors (NO, NO₂ and O₂) are installed on the back of the INOvent delivery system. The O₂ sensor has a short cable which must be plugged into the sensor and into the back of the system. See section 9/Maintenance for sensor installation information.

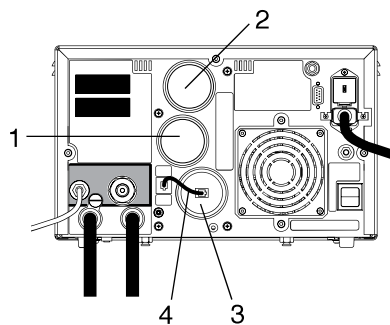

AA.69.147

1. NO sensor
2. NO₂ sensor
3. O₂ sensor
4. Short cable for O₂ sensor

Figure 3-5 • Sensor items

12. Connect either end of the Injector Module electrical cable to the Injector Module as shown in figure 3-6.

- Align the connector before pushing the connector firmly into place.
- A keyway is identified by a red dot on both the connector and the Injector Module.

13. Connect the NO/N₂ Injector Tube to the Injector Module. See figure 3-6.

Important To remove this type of electrical connector, the knurled sleeve on the connector must be pulled outward before removing the connector from the Injector Module or the front panel.

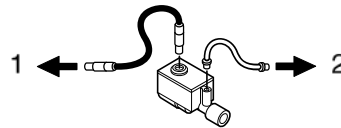

AA.69.024

1. Electrical cable to the delivery system
2. NO/N₂ Injector Tube to the delivery system

Figure 3-6 • Injector Module connections

14. Connect the other end of the Injector Module electrical cable to the front of the INOvent delivery system.

- A keyway is identified by a red dot on the connector and on the front panel.

15. Connect the other end of the NO/N₂ Injector Tube to the front of the INOvent delivery system.

16. Tie the NO/N₂ Injector Tube to the Injector Module electrical cable using hose clips as shown in figure 3-7.

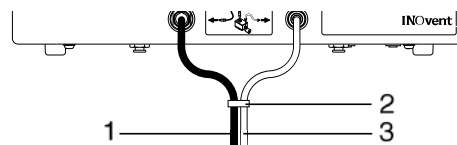

AA.69.034

1. Injector Module Electrical Cable
2. Hose Clip
3. NO/N₂ Injector Tube

Figure 3-7 • Hose clip connection

Note: The Injector Module is inserted later into the inspiratory limb to measure the ventilator flow rate and inject the therapy gas.

Figure 3-8 shows a typical system connection diagram.

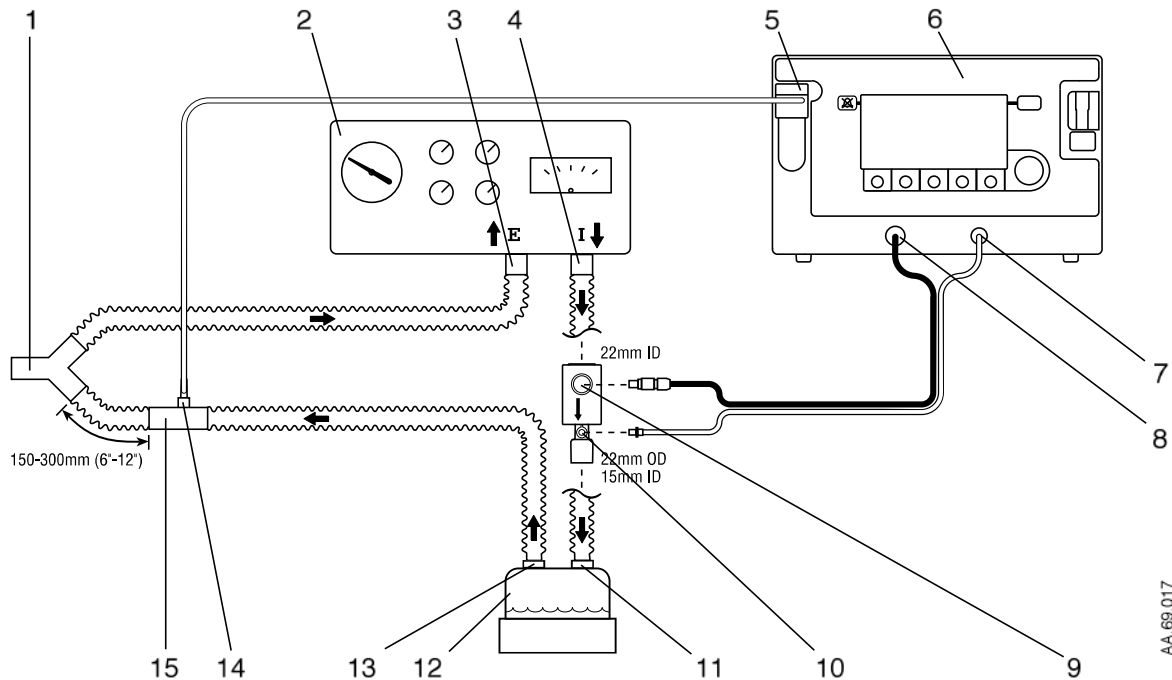

1. Patient wye
2. Ventilator
3. Ventilator Expiratory port
4. Ventilator Inspiratory port
5. Patient gas sample line input connection
6. INOvent delivery system
7. NO/N₂ Injector Tube front panel connection
8. Injector Module Cable front panel connection
9. Injector Module Electrical Cable connection
10. NO/N₂ Injector Tube connection
11. Humidifier inlet
12. Humidifier
13. Humidifier outlet
14. Patient Gas sample line connection
15. Sample Tee

Figure 3-8 • Typical system connection diagram (ICU ventilator)

Electrical connections

1. If you are using a nurse call system, refer to your nurse call system operation manual for the proper connection procedure. Connection is to the Nurse Call connector on the back of the INOvent delivery system.
 - See section 12/Appendix A - Specifications for Nurse Call connector information.

⚠CAUTION The correct AC line voltage for your local area must appear in the Power Entry Module window on the back.

2. Check that the correct AC line voltage appears in the Power Entry Module window on the back: 100V, 120V, 220V or 240V, whichever is appropriate for your local voltage.
 - If the voltage shown is not correct, see “Fuse Replacement and Line Voltage Selection” in section 10/Maintenance to set the voltage selection to the correct local voltage.

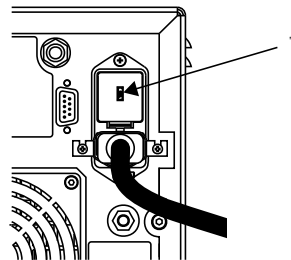

AA.66.267

1. Power Entry Module window

Figure 3-9 • Power Entry Module window

3. Connect the power cord to the INOvent delivery system (see figure 3-10) and tighten the power cord clamp screws using a #1 Phillips screwdriver.

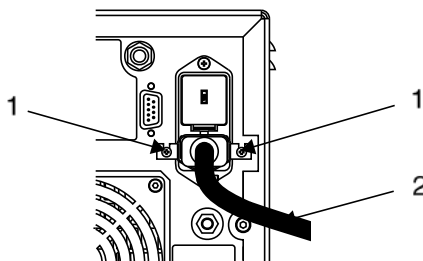

AA.66.267

1. Power cord clamp screws
2. Power cord

Figure 3-10 • Power cord and clamp

- 4. Connect the INOvent delivery system power cord to an emergency-power-backed hospital-grade outlet.
 - The front panel green Mains Power light must light to indicate that line voltage is present.
 - The power cord must always be connected to an electrical outlet to maintain a full battery charge.

- 5. Switch the ON/STANDBY control to ON. (The system may take a minute before operation.)
 - The Power-ON display (figure 3-11) appears during self-tests followed by a typical display as shown in figure 3-12.

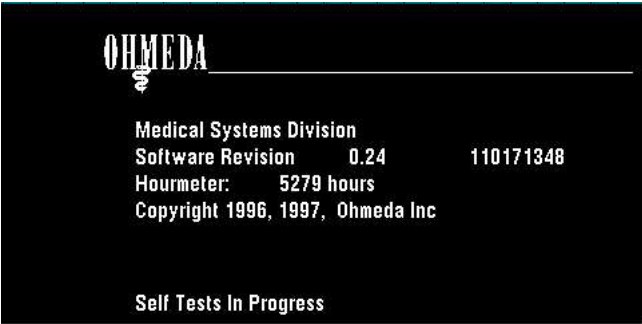

SCR_1.tif

Figure 3-11 • Power-ON display

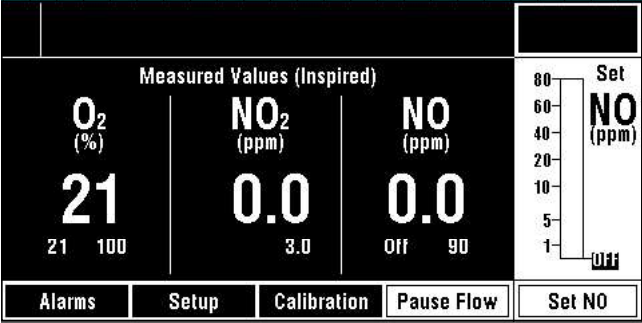

510k_2.tif

Figure 3-12 • Typical display

Setup menu

The Setup menu lets you change alarm volume and display brightness. You can view, but not change, the software revision, NO cylinder concentration configuration and hourmeter.

Push the Setup button to see the Setup menu (shown in figure 3-13).

Cylinder concentration

The INOvent delivery system is factory-set for an 800 ppm cylinder concentration. This set concentration is indicated in the Setup menu. Alternate cylinder concentrations may be available by a special request to Datex-Ohmeda. See 17/Appendix F.

When connecting an NO cylinder to the INOvent delivery system, always check to see it is the same concentration for which the system is configured as appears in the setup menu.

Hourmeter display

The Power-ON display (figure 3-11) and the Setup menu (figure 3-13) provide an hourmeter indication which can be used for maintenance and service purposes. The hourmeter counts the hours when the ON/STANDBY switch is in the ON position.

To set the alarm loudness

1. Push the Setup button to see the Setup menu.
2. Turn the control wheel to highlight the Alarm Loudness value (shown in figure 3-13.)

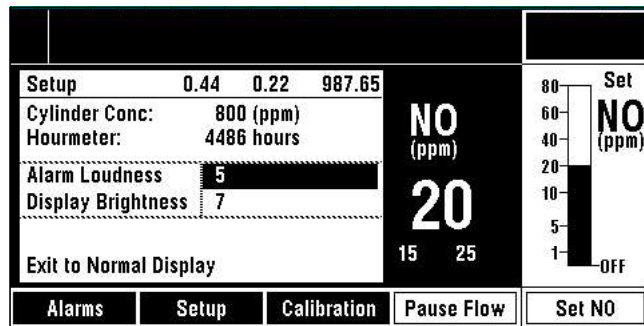

510k_9.tif

Figure 3-13 • Setup menu - Alarm Loudness level highlighted

3. Push the control wheel to confirm the Alarm Loudness level selection. Figure 3-14 shows the same level in a selection box after pushing the control wheel.

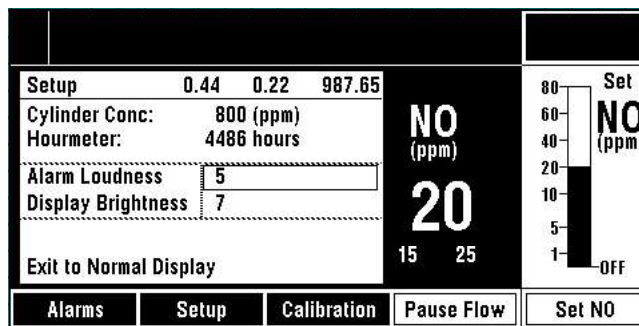

510k_10.tif

Figure 3-14 • Select menu - Alarm Loudness level selected for adjustment

4. Turn the control wheel to indicate the loudness level you want. Choices range from 1 (softest) to 5 (loudest.)
5. Push the control wheel to confirm your selection.
6. If you are finished with the Setup menu, turn the control wheel to select Exit to Normal Display.
 - If you want to set the display brightness, continue with step 2 of "To set the display brightness."
7. Push the control wheel to exit.

To set the display brightness

1. Push the Setup button.
2. Turn the control wheel to highlight the Display Brightness level on the Setup menu.
3. Push the control wheel to confirm the display brightness level for change.
4. Turn the control wheel to show the level you want. Choices range from 1 (darkest) to 10 (brightest.)
5. Push the control wheel to confirm your selection.
6. If you are finished with the Setup menu, turn the control wheel to select Exit to Normal Display. Push the control wheel to exit.

INOvent delivery system

Notes:

4/Calibration

In this section

This section describes how to calibrate the NO, NO₂ and O₂ sensors when calibration is needed. For example:

- after replacing a sensor,
- during Pre-Use Procedures,
- Monthly System Checkout or
- when messages ask you to do so (i.e., “Calibration Due”).

Calibration information4-2

NO, NO₂ and O₂ Sensor low range calibration
(daily, room air)4-3

 Procedure4-3

NO, NO₂ and O₂ Sensor high range calibration4-5

 Procedure4-5

Calibration information

⚠CAUTION Calibrate only with the correct calibration gas.

Make sure that the calibration gas expiration date is still valid.

Calibrate the sensors in the environment in which they will be used: for example, in the ICU.

NO therapy can be administered during the sensor calibration process but inspired gases are not monitored and gas monitoring alarms are disabled.

The ventilator settings must not be changed during sensor calibration or an alarm condition may occur.

You calibrate the low ranges of the three sensors at the same time using room air.

The high ranges must be calibrated using their respective NO and NO₂ calibration gases and O₂ using a medical grade 100% O₂ from a wall or cylinder source.

The calibration process can be stopped at anytime by pushing the control wheel to cancel an operation or to exit to a normal display. Also, calibration can be stopped by selecting another control button (for example, Pause Flow.)

If calibrations fail, see the 9/Troubleshooting section in this manual.

NO, NO₂ and O₂ Sensor low range calibration (daily, room air)

Procedure Use the Calibration menus to calibrate the low range of the three gas sensors (NO, NO₂ and O₂) at the same time using room air; the calibration may take up to five minutes.

NO, NO₂ and O₂ room air levels are displayed during low range calibration and trend toward 0 ppm, 0 ppm and 21% respectively.

1. From a normal display with the INOvent delivery system operating, push the Calibration button to reach the first Calibration menu. It shows the Low Range (room air) "NO, NO₂ and O₂" option highlighted (figure 4-1).

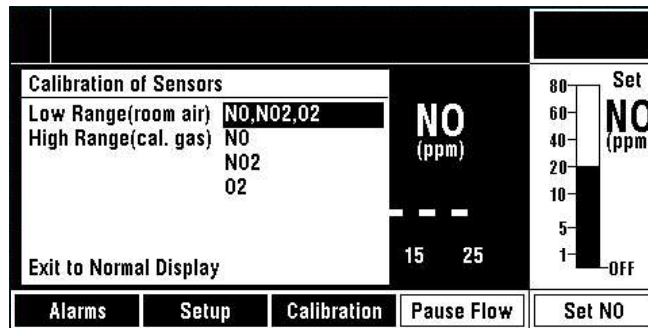

510k_11

Figure 4-1 • Calibration menu - low range sensor calibration option highlighted

2. Push the control wheel to start the low range calibration. All three sensors calibrate automatically at the same time. The display in figure 4-2 appears during the calibration. Calibration may take a few minutes.
 - The sample line does not have to be disconnected to do this step. The system draws in room air from within the system enclosure through an NO/NO₂ scrubber.

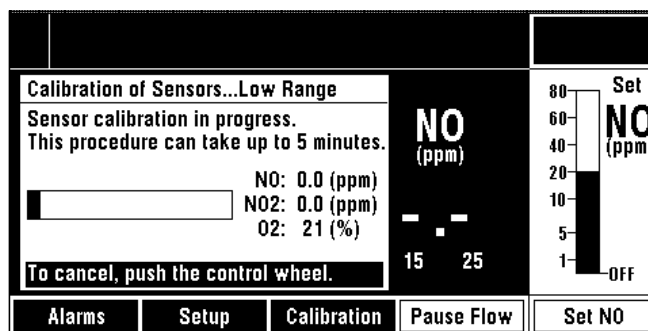

scr_12

Figure 4-2 • Calibration menu - low range sensor calibration in progress

3. When the calibration is successful, the display in figure 4-3 appears.
 - If calibration is unsuccessful for any of the sensors, an appropriate message as in figure 4-4 is displayed. In this case follow the instructions on the display.
 - You may turn the control wheel to “Exit to Normal Display” or continue on to “High range calibration (calibration gas.)”

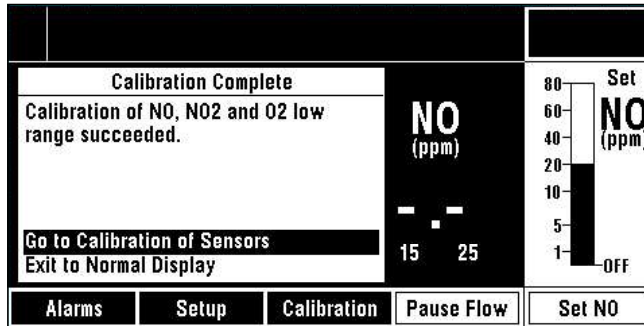

510k_13

Figure 4-3 • Calibration menu - low range calibration completed

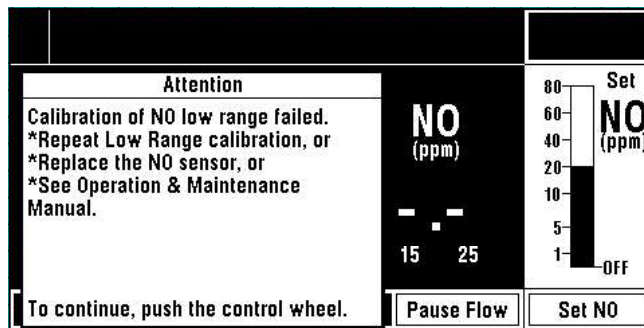

510k_14

Figure 4-4 • Calibration menu - NO low range calibration failed

4. To continue on to “High range calibration (calibration gas),” turn the control wheel to select “Go to Calibration of Sensors.”
5. Push the control wheel to accept “Go to Calibration of Sensors” and continue with the following steps.

NO, NO₂ and O₂ Sensor high range calibration

⚠CAUTION Never connect the sample line directly to a high pressure source. This could damage the sampling system.

Use the Calibration menus to calibrate the high range of the NO, NO₂ and O₂ sensors.

Procedures for high range calibration of the three sensors are essentially the same as for the low range, but a different calibration gas is used for each sensor. Calibration must be done individually:

- NO and NO₂ each with their respective NO and NO₂ calibration gases,
- O₂ with a medical grade 100% O₂ from a wall or cylinder source.

Note: Contact the drug supplier for NO and NO₂ calibration gases.

Procedure

1. To calibrate the NO or NO₂ sensor high range: connect the calibration gas for the sensor you are calibrating as shown in figure 4-5. When calibrating NO, connect NO calibration gas; when calibrating NO₂, connect NO₂ calibration gas. Then, go to step 3.

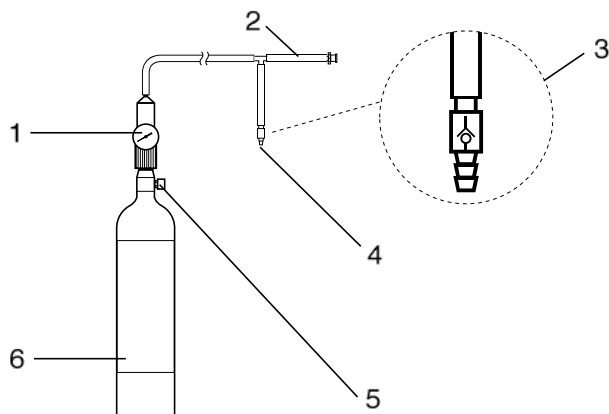

1. Calibration gas cylinder pressure gauge
2. Sample Line
3. One-way valve
4. Vent to atmosphere or scavenge - Do not occlude
5. Cylinder ON/OFF control
6. NO or NO₂ calibration gas cylinder

Figure 4-5 • Connection diagram for NO and NO₂ high range calibration

- To calibrate the O₂ sensor high range, connect the O₂ calibration gas as shown in figure 4-6. Then, go to step 3.

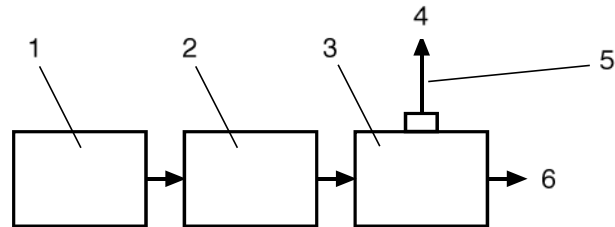

AA_69.260

- 100% O₂
- Flowmeter
- Sample Tee
- O₂ to the Sample System
- INOvent delivery system Sample Line
- To the atmosphere

Figure 4-6 • Connection diagram for O₂ high range calibration

- On the Calibration menu) turn the control wheel to highlight the NO, NO₂ or O₂ selection of “High Range (cal. gas).” Example shown in figure 4-7.

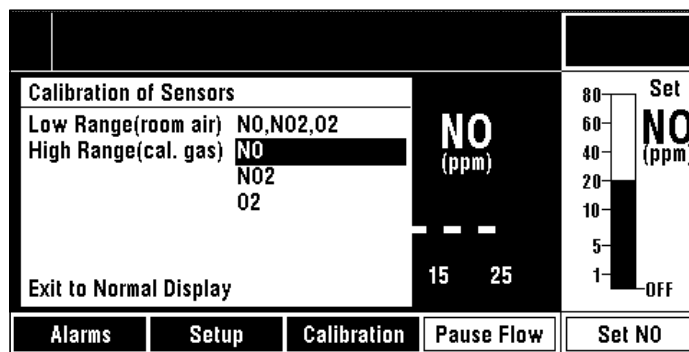

scr_11b

Figure 4-7 • Calibration menu - high range NO sensor calibration option highlighted

- Make sure that the calibration gas cylinder ON/OFF control is turned OFF.
- Attach the system sample line to the calibration gas source.
- Turn the calibration gas source ON.

7. Push the control wheel to start the high range calibration of the selected sensor. A display similar to figure 4-8 appears.
8. Follow the instructions given on the display. These instructions are shown here:
 - 1. Flow NO [NO₂ or 100% O₂] calibration gas into the sample line.
 - 2. Wait for “Measured NO, NO₂ or 100% O₂” to stabilize.
 (Note: The “Measured” value is the monitored value of the calibration gas during sampling. This value updates continuously during the calibration process. After the “Measured” value has stabilized, push the control wheel.)
 - 3. Set “Calibration XX” to cal. gas value.
 (Select “Calibration XX.” Then, turn the control wheel to set the value to that marked on the calibration gas cylinder label [or 100% for O₂.] Figure 4-8 shows the “Calibration NO” value set to match a calibration gas cylinder label value of 45 ppm.) Then, push the control wheel to enter. “In Progress...” will be shown on the Calibration NO line as in figure 4-9.

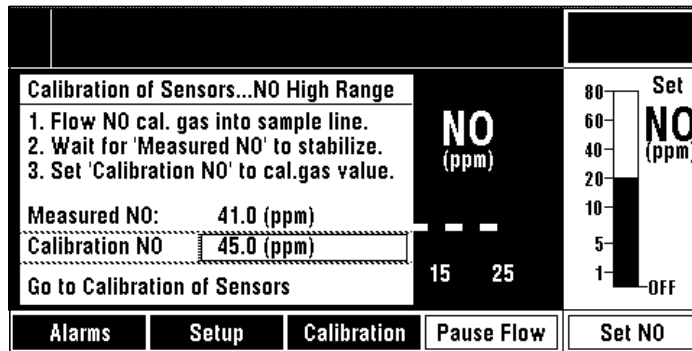

510k_15

Figure 4-8 • High range calibration menu example - Calibration NO adjusted to 45 ppm

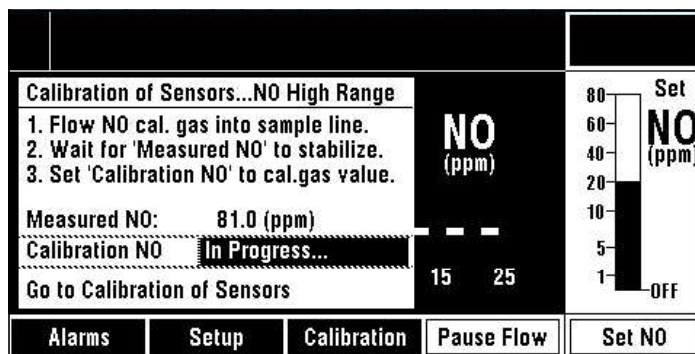

510k_16

Figure 4-9 • High range calibration menu example - Calibration NO “In Progress” highlighted

9. If the high range calibration fails, follow the instructions given on the display (shown in figure 4-10).

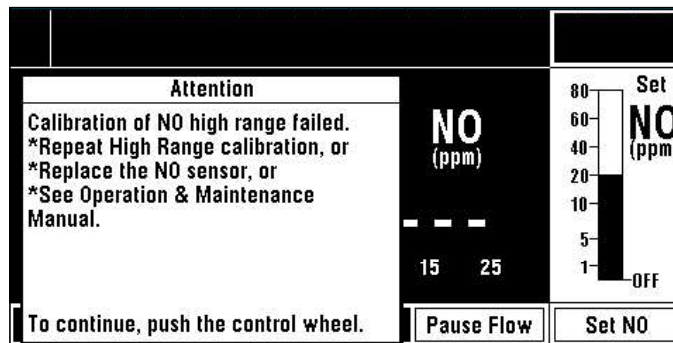

510k_17

Figure 4-10 • High range calibration menu example - NO high range calibration failed

10. When the current sensor calibration is finished, select “Go to Calibration of Sensors” and push the control wheel.
 11. When the “Calibration of Sensors” display appears, select the next sensor for calibration.
- If you are finished with all three sensor calibrations:
12. Select “Exit to Normal Display” and push the control wheel.
 13. Turn the calibration gas cylinder ON/OFF control to OFF.
 14. Reconnect the sample line to the breathing circuit.

5/Pre-Use Procedures

Important The Pre-Use Procedures consist of three tests which must be done before delivering NO therapy to a patient:

- 1. Initial connections and leak test.
- 2. System purge and performance test.
- 3. Manual NO delivery system purge and performance test.

These Pre-Use Procedures are for 800 ppm concentration configurations only.

In this section

- 1. Initial connections and leak test 5-2
- 2. System purge and performance test 5-3
- 3. Manual NO delivery system purge and performance test . . 5-5

1. Initial connections and leak test

1. If necessary, connect the INOvent delivery system as described in section 3/Setup.
2. Check the cables and hoses for signs of wear or damage and replace as needed.
3. Turn the INOvent delivery system ON and confirm that the buzzer and the speaker sound. Wait for the start-up routine to finish. (The Power-ON display appears during self-tests followed by a normal display.)
4. Confirm from your records that a Monthly System Checkout has been done in the last month. If it hasn't, do a Monthly System Checkout. See section 10/Maintenance.
5. Do a system high pressure leak test.
 - a. With the INOvent delivery system ON, turn each cylinder valve ON then OFF. Check for adequate cylinder pressures. Wait for 30 seconds and check for pressure decrease.
 - b. If there is any decrease, make sure that the auxiliary oxygen flowmeter to the Manual NO System is not turned on and check for leaks around the hose connections using soapy water.
 - c. Check for leaks at the NO cylinder valve outlet connection using soapy water.

Note: The pressure drop leak test will not detect leaks at the cylinder valve outlet connection because of the check valve in the regulator hose. See 13/ Appendix B - Cylinder Information if you suspect a leak.

2. System purge and performance test

⚠ WARNING Make sure a purge has been completed within five minutes before the start of NO therapy. If not, repeat the performance test as described here, making sure the NO₂ is less than the value listed for the cylinder concentration being used.

1. Connect the Injector Module to an O₂ auxiliary flowmeter using O₂ tubing, a 4.5 mm to 15 mm adapter and a breathing circuit adapter to condition the flow before the Injector Module. See figure 5-1.
2. Connect a sample tee to the outlet of the injector module with 300 mm of 22 mm hose to ensure gas mixing prior to gas sampling (see figure 5-1.) Attach a sampling line from the sample tee to the sample connector on the front panel.

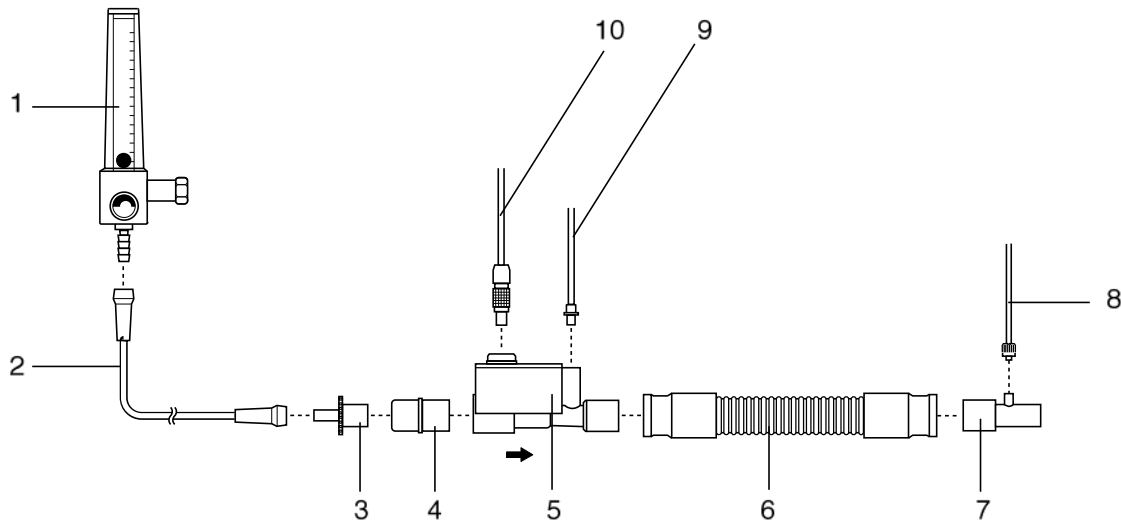

AA.69.032

- 1 O₂ Flowmeter
- 2 O₂ Tubing
- 3 15M x 4.5 mm Adapter
- 4 22M / 15F x 22M / 15F Adapter
- 5 Injector Module
- 6 300 mm of 22 mm hose
- 7 Sample Tee
- 8 Inspiratory Gas Sample Line
- 9 NO/N₂ Injector Tube
- 10 Injector Module Electrical Cable

Figure 5-1 • Circuit connections for purge and performance test

INOvent delivery system

3. Do a low range calibration of the NO, NO₂ and O₂ monitors. (See section 4/Calibration.)
4. Make sure both NO cylinders are turned off after being turned on.
5. Set the oxygen flow to 15 L/min and the Set NO concentration to its maximum setting.
6. Make sure both cylinder high pressure gauges go to zero to purge both high pressure circuits.
7. Check that the NO₂ value is higher than 0.2 ppm to verify that the NO₂ monitor is functional and
8. Make sure these two alarms occur:
 - Low NO/N₂ Pressure”
 - Delivery Failure”(This may take a few minutes depending on the cylinder pressures at the start of the test.)
9. When the alarms have occurred, turn on the NO cylinder with which you intend to start therapy. Leave the other cylinder turned off.
10. Set the O₂ flow on the auxiliary flowmeter to 15 L/min and the Set NO to 40 ppm.
 - a. Wait for 3 minutes or until the monitor readings are stable.
 - b. Make sure that the O₂, NO₂ and NO readings are within the acceptable ranges given below.Note: These acceptable readings include the errors of the NO delivery system and the NO therapy gas.

	O ₂ %v/v (±3 %v/v)	NO ₂ ppm (max)	NO ppm (min/max)
Set NO = 40 ppm:	95	1.5	32/48

11. Do the monitor high range calibrations if required.

3. Manual NO delivery system purge and performance test

⚠WARNING The Manual NO delivery system must be set up and available at all times. The Manual NO delivery system must be configured as shown in figure 8-2.

Do not connect an O₂ supply, wall or cylinder, directly to the O₂ inlet on the rear of the INOvent delivery system.

⚠CAUTION Supplemental O₂ should only be turned on and used when the manual delivery system is in use.

1. Connect the Manual NO delivery system as described in section 3/ Setup.
2. Disconnect the resuscitator bag. Connect the 22 mm / 15 mm sample tee (with the sample line connected) to the oxygen tubing using a 15M x 4.5 mm adapter. See figure 5-2.

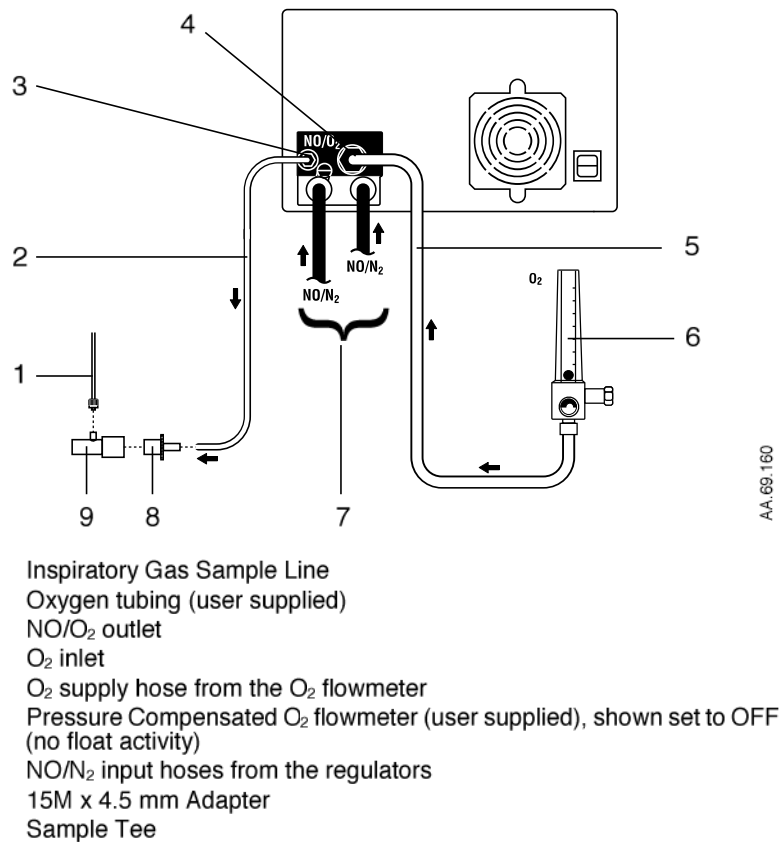

Figure 5-2 • Sample tee connection to the Manual NO delivery system

INOvent delivery system

3. Flow 15 L/min of O₂ from the auxiliary O₂ flowmeter into the Manual delivery system and make sure the float moves to the middle of the NO Flow Indicator Window.
4. Wait for the gas to flow through the oxygen tubing. Make sure that the NO reading is 20 ± 8 ppm and the NO₂ reading is less than 1.0 ppm. If the NO₂ reading is greater than 1.0, continue flowing gas until the limit is reached.

Note: These acceptable readings include the errors of the NO delivery system and the NO therapy gas.

5. Reduce the O₂ flow to 1 L/min and make sure that the float drops to the bottom of the NO Flow Indicator.
6. Set the O₂ flow to zero and disconnect the sample tee and 15M x 4.5 mm adapter from the oxygen tubing.
7. Reconnect the resuscitator bag to the oxygen tubing.

- End of the Pre-Use Procedures -

6/Operation

⚠WARNING Use only “Latex-Free” breathing circuits and ventilators when using the INOvent delivery system.

The use of devices which radiate high-intensity electrical fields may affect the operation of the delivery system. Do not drape the leads of these devices across the delivery system. Constant surveillance of all monitoring and life support equipment is mandatory whenever interfering devices are in operation on or near a patient.

Make sure a purge has been completed within five minutes before the start of NO therapy. If not, repeat the performance test as described in section 5/Pre-Use Procedures making sure the NO₂ is less than the value listed for the cylinder concentration being used.

Set the INOvent delivery system alarm thresholds for the current patient conditions to monitor any inadvertent changes in treatment. For alarm information, see section 7/Alarms.

Be certain all cables and hoses are positioned to help prevent damaging or occluding them.

Patient disconnect and high pressure alarms are required for the ventilator.

⚠CAUTION Use distilled water in the humidifier to prevent the formation of bases or acids.

In this section This section 6 provides information for connecting and operating the INOvent delivery system in patient breathing circuits

Before operation	6-2
Connection to an ICU ventilator circuit	6-4
Connection to a high frequency oscillatory ventilator circuit	6-8
Connection to a circle anesthesia system	6-11
Connection to a transport ventilator circuit	6-14
Connection to bagging systems.	6-16
Operation	6-23
Setting or changing the delivered NO concentration	6-23
During operation	6-25
Pausing NO flow	6-25
Changing NO therapy cylinders and purging the regulator assembly	6-26
Electronic delivery shutdown	6-28
Monitoring the environment	6-29

Before operation

6-2

1. Before operating the INOvent delivery system in the ventilator patient breathing circuit, make sure the Pre-Use Procedures of section 5 have been completed. The procedures include:
 - Initial connections and leak test.
 - System purge and performance test.
 - Manual NO delivery purge and performance test.
2. Make sure the NO therapy gas cylinder pressure gauge shows an adequate cylinder supply pressure. The cylinder must be replaced when its pressure is less than 200 psig.

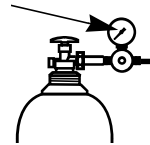

AA.69.121

- To change the cylinder, see “Changing the NO therapy cylinder and purging the regulator assembly” at the end of this section.
3. Setup the ventilator. See the ventilator manual for its setup and operation.
 4. Do a breathing circuit test as described in the ventilator’s operation manual.
 5. Empty and clean the fluid trap. See section 10/Maintenance for the procedure.

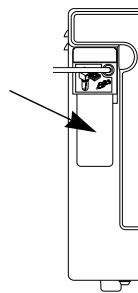

AA.69.034

Connect the INOvent delivery system to the patient circuit. Use one of the following the connection diagrams for the patient breathing circuit you are using and follow the steps shown.

Connection diagrams in this section include the following:

ICU ventilator circuit:

Figure 6-1 System connection diagram, ICU ventilator circuit

Figure 6-2 • Adult circuit connection diagram

Figure 6-3 • Neonatal circuit connection diagram

Figure 6-4 • Pediatric circuit connection diagram

6-3

Connection to a high frequency oscillatory ventilator circuit:

Figure 6-5 System connection diagram, high frequency oscillatory ventilator circuit

Connection to a circle anesthesia system:

Figure 6-6 System connection diagram, anesthesia system with ventilator

Connection to a transport ventilator circuit:

Figure 6-7 System connection diagram for a transport ventilator circuit

Connection to bagging systems:

Figure 6-8 • System connection diagram for a hyper-inflation bag

Figure 6-9 • System connection diagram for a self-filling resuscitator bag

Figure 6-10 • System connection diagram for a spontaneous breathing circuit

Connection to an ICU ventilator circuit

⚠WARNING The INOvent delivery system subtracts gas from the breathing circuit via the gas sampling system; this can effect the sensitivity of a flow triggered synchronized breath mode of some ventilators. The trigger sensitivity of the ventilator should be checked after connecting the INOvent delivery system to the breathing circuit

The humidifier chamber volume should not be more than 480 mL to help prevent elevated NO₂ values.

⚠CAUTION Note the airflow direction arrow on the Injector Module: flow out of the ventilator must be through the Injector Module in the direction of the arrow on the module.

The Injector Module should only be used in the dry part of the breathing circuit to make sure flow measurement is correct.

To condition ventilator flow and make sure flow measurements are accurate, connect the Injector Module to the humidifier chamber; then, connect to the ventilator inspiratory port using breathing circuit tubing. This can also be done by placing a breathing circuit filter between the Injector Module and the ventilator.

To avoid medications interfering with the gas monitoring system, administer surfactants or other medications only on the patient side of the sample tee.

Procedure:

- When connecting breathing tubing, make sure it is long enough for any required equipment movement.
- Make sure that the system is not wheeled over tubing connected to a patient or to the equipment.

Refer to the connection diagrams in figures 6-1 through 6-4 for the following steps.

1. Connect a breathing hose from the ventilator inspiratory port to the Injector Module **input** end using the appropriate adapters.
2. Connect a breathing hose or adapter from the **output** end of the Injector Module to the humidifier inlet port.
3. Connect a breathing hose from the humidifier outlet port to a sample tee.

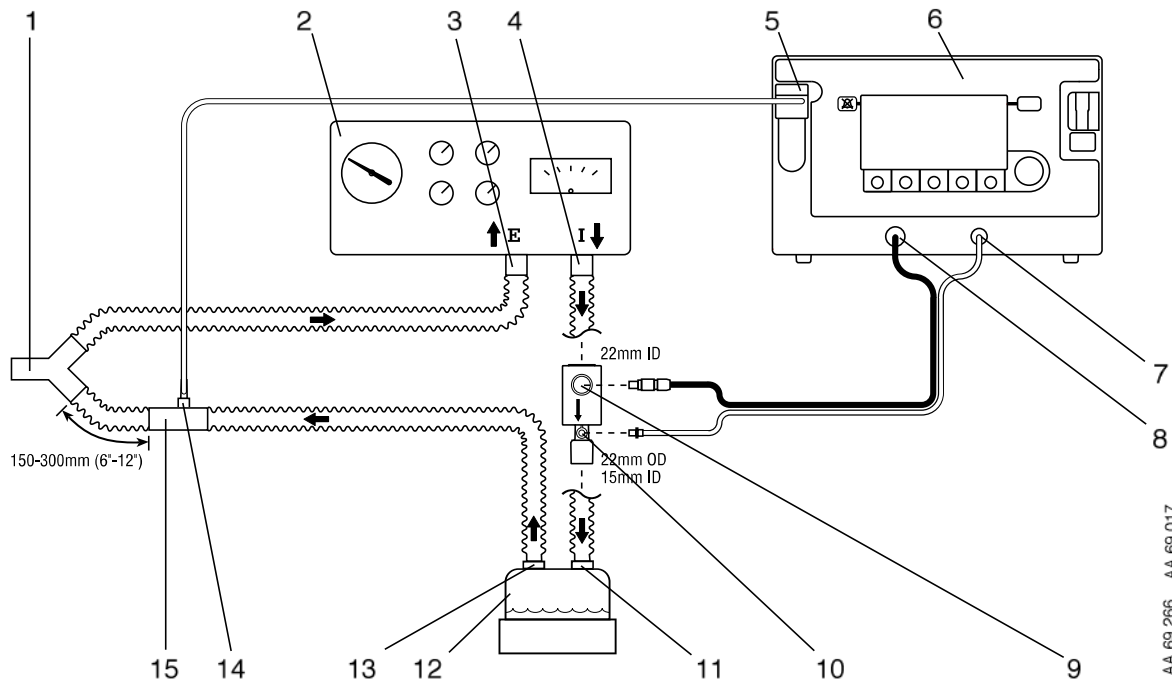

6-5

Note: The above connection diagram is also printed on the left side of the INOvent delivery system.

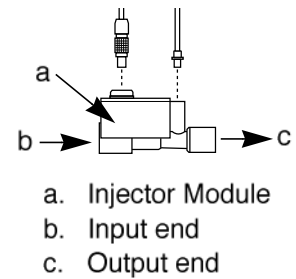

- 1. Patient wye
- 2. Ventilator
- 3. Ventilator Expiratory port
- 4. Ventilator Inspiratory port
- 5. Patient Gas sample line input connection
- 6. INOvent delivery system
- 7. NO/N₂ Injector Tube front panel connection
- 8. Injector Module Electrical Cable front panel connection
- 9. Injector Module Electrical Cable connection
- 10. Injector Module NO/N₂ Injector Tube connection
- 11. Humidifier inlet
- 12. Humidifier
- 13. Humidifier outlet
- 14. Patient Gas sample line connection
- 15. Sample Tee

Figure 6-1 • System connection diagram, ICU ventilator

4. Connect a breathing hose from the sample tee to the patient wye.

Important This breathing hose between the sample tee and the patient wye should be between 6 and 12 inches (150 to 300 mm) long: greater than 6 inches to minimize the sampling of mixed inspired/expired concentrations, less than 12 inches to help ensure correct patient NO₂ measurement.

5. Connect the gas sample line from the “Sample Inlet” port on the front of the fluid trap to the sample tee. Make sure the sample port at the T-piece is pointing upward to help avoid fluid accumulation in the sample line.
6. Connect a breathing hose from the ventilator expiratory port to the expiratory limb of the patient wye.
7. The trigger sensitivity of the ventilator should be checked after connecting the INOvent delivery system to the breathing circuit.
8. Proceed to “Operation” - “Setting the delivered NO concentration.”

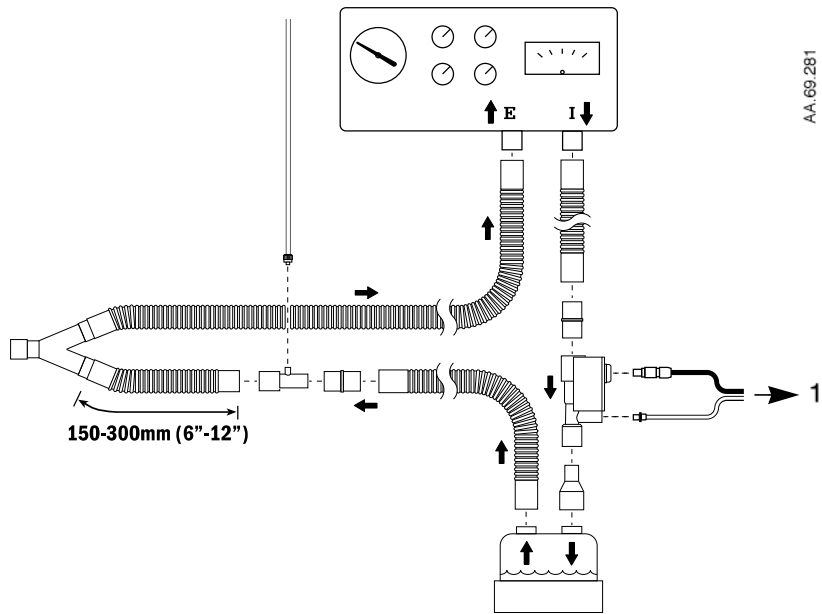

AA 69.281

1. To INOvent delivery system

Figure 6-2 • Adult circuit connection diagram

AA.69.280

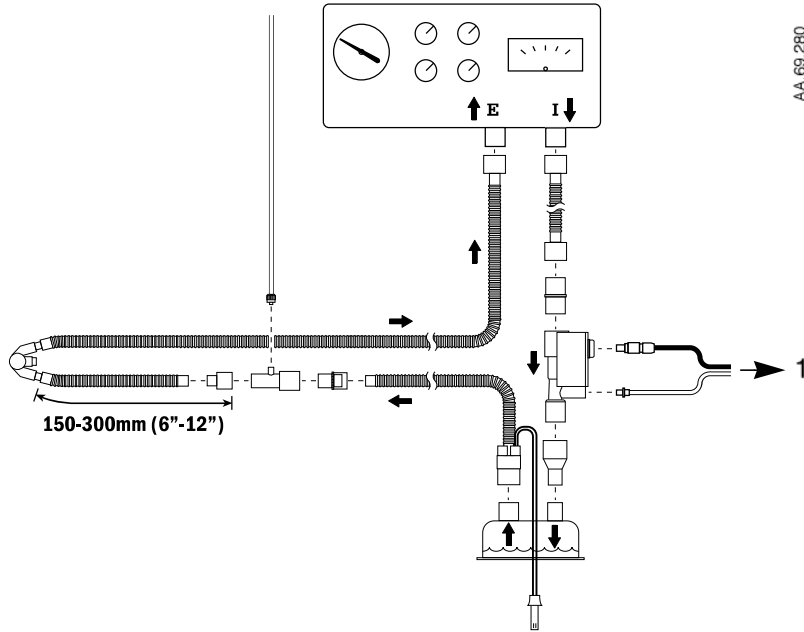

1. To INOvent delivery system

Figure 6-3 • Neonatal circuit connection diagram

AA.69.282

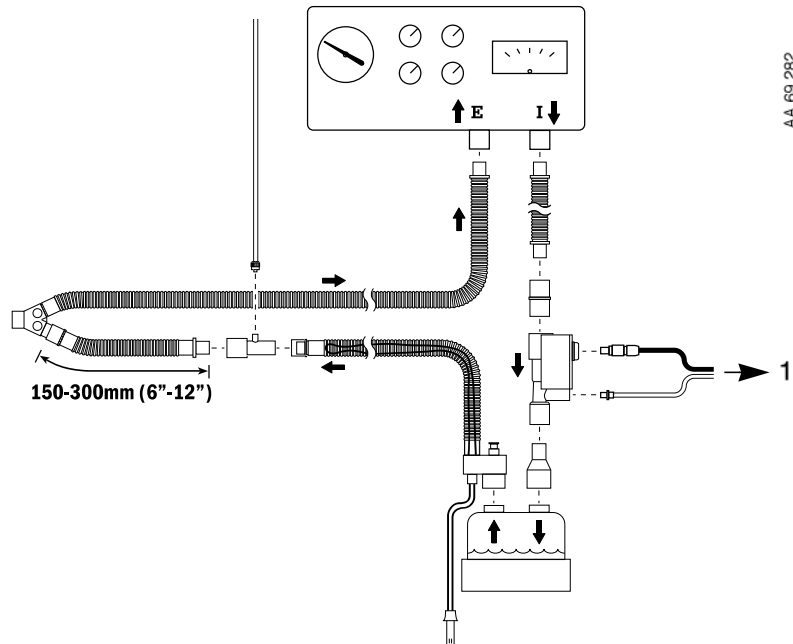

1. To INOvent delivery system

Figure 6-4 • Pediatric circuit connection diagram

Connection to a high frequency oscillatory ventilator circuit

⚠WARNING Omission of the one-way valve may result in high NO delivery.

Note the airflow direction arrow on the one-way valve. The flow out of the Injector Module must be through the one-way valve in the direction of the arrow on the valve.

⚠CAUTION Note the airflow direction arrow on the Injector Module; the flow out of the ventilator must be through the Injector Module in the direction of the arrow on the module.

The Injector Module should only be used in the dry part of the breathing circuit to make sure flow measurement is correct.

To avoid medications interfering with the gas monitoring system, administer surfactants or other medications only on the patient side of the sample tee.

- When connecting breathing tubing, make sure it is long enough for any required equipment movement.
- Make sure that the system is not wheeled over tubing connected to a patient or to the equipment.

Procedure:

Refer to the connection diagram in figure 6-5 for the following steps.

1. Connect tubing from the ventilator outlet to the INOvent delivery system Injector Module input end using the appropriate adapters
2. Connect the output end of the Injector Module to the input end of a one-way valve.

Important: Note the airflow direction arrow on the one-way valve. The flow out of the Injector Module must be through the one-way valve in the direction of the arrow on the valve.

3. Connect the output end of the one-way valve to the humidifier inlet port.
4. Connect tubing from the humidifier outlet port to the bias flow tube on the high frequency oscillating ventilator.

- Connect the gas sample line from the "Sample Inlet" port on the front of the INOvent delivery system fluid trap to a sampling tee on the Flexible Breathing Circuit of the high frequency oscillating ventilator.

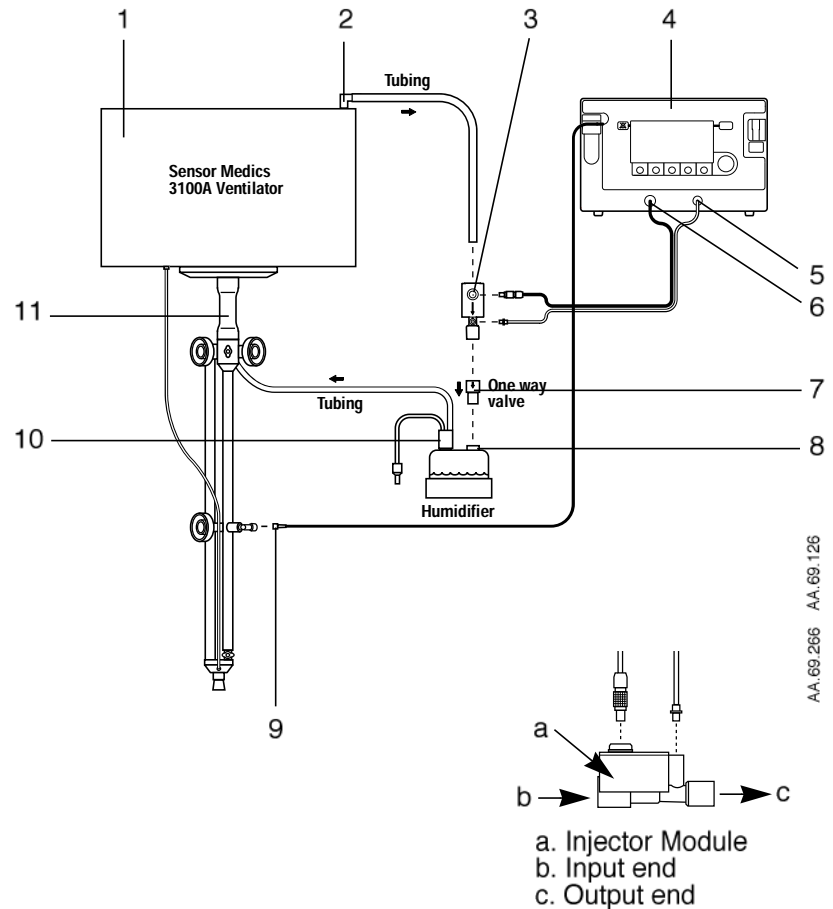

- High Frequency Oscillatory Ventilator
- Ventilator outlet
- Injector Module
- INOvent delivery system
- NO/N₂ Injector Tube connection
- Injector Module Electrical Cable connection
- One-way valve
- Humidifier inlet
- Patient gas sample line connection
- Humidifier outlet
- Bias Flow Tube

Figure 6-5 • System connection diagram, high frequency oscillatory ventilator

Notes:

6-10

Connection to a circle anesthesia system

⚠WARNING Avoid recirculation of gases. Undesired recirculation of gases will occur if fresh gas flows are less than the patient minute volume and may result in:

- Higher NO₂ levels due to the limited ability of the carbon dioxide absorbent to remove NO₂.
- Higher NO concentrations than those set due to NO re-circulated through the absorber.
- Reduction in O₂ concentration because nitrogen is the balance gas for nitric oxide and will be present in the re-circulated gases.

Use only Sodasorb in combination with Isoflurane or Desflurane. Other anesthetic agents and CO₂ absorbents have not been evaluated for reactive by-products.

⚠CAUTION Note the airflow direction arrow on the Injector Module: the flow out of the absorber must be through the Injector Module in the direction of the arrow on the module.

N₂O will also affect the Set NO versus the measured NO value. For a 50% N₂O, 50% O₂ composition, the measured NO value will be approximately 7% indicated less than the same Set NO value at 100% O₂. For example, at a Set NO value of 20 ppm, measured NO will be approximately 18 ppm.

Similarly, the effect of 2%v/v Isoflurane will result in a high measured NO value of approximately 3% indicated for the same Set NO value at 100% O₂.

Sudden changes in anesthetic agent concentration may cause brief transient changes in the measured NO and NO₂ values.

Procedure:

- When connecting breathing tubing, make sure it is long enough for any required equipment movement.
- Make sure that the system is not wheeled over tubing connected to a patient or to the equipment.

Refer to the System connection diagram in figure 6-6 for the following steps.

1. Connect the Injector Module's **input** end to the absorber port which connects to the inspiratory limb of the breathing circuit.

Note: For OR ventilator systems with inspiratory flow measurement at the inspiratory port of the absorber, place the Injector Module upstream of the inspiratory flow sensor.

2. Connect an inspiratory breathing hose from the **output** end of the Injector Module to a sample tee.
3. Connect an inspiratory breathing hose from the output end of the Injector Module to a sample tee.
4. Connect an inspiratory limb breathing hose from the sample tee to the patient wye:

Important This breathing hose between the sample tee and the patient Y should be between 6 and 12 inches (150 to 300 mm) long: greater than 6 inches to minimize the sampling of mixed inspired/expired concentrations and less than 12 inches to help ensure correct patient NO₂ measurement.

5. Connect the gas sample line from the "Sample Inlet" port on the front of the fluid trap to the sample tee. Make sure the sample port at the T-piece is pointing upward to help avoid fluid accumulation in the sample line.
6. Connect a breathing hose from the patient wye the absorber port which connects to the expiratory limb of the breathing circuit.

Note: With a circle anesthesia breathing circuit, the INOvent delivery system will perform as specified in the technical specifications with fresh gas flow rates equal to or more than the patient minute ventilation.

7. Proceed to "Operation" - "Setting the delivered NO concentration."

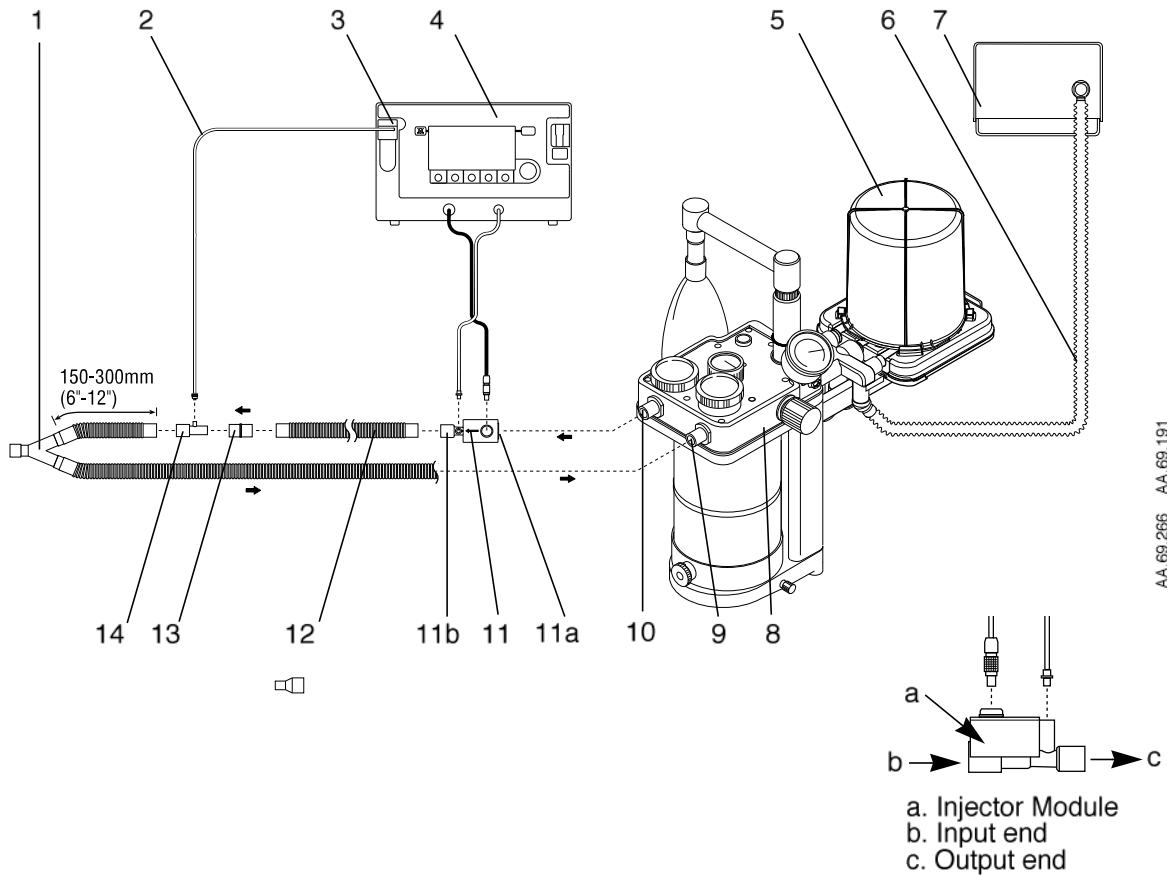

6-13

AA.69.266 AA.69.191

- 1 Patient wye
- 2 Patient Gas sample line
- 3 Patient Gas sample line connection ("Sample Inlet" port)
- 4 INOvent delivery system
- 5 Bellows assembly
- 6 Ventilator drive gas
- 7 Ventilator (rear view)
- 8 Absorber
- 9 Absorber expiratory port
- 10 Absorber Inspiratory port
- 11 Injector Module
 - a. Injector Module input end
 - b. Injector Module output end
- 12 Hose
- 13 22M / 15F x 22M / 15F Adapter
- 14 Sample Tee

Figure 6-6 • System connection diagram, anesthesia system with ventilator

Connection to a transport ventilator circuit

⚠ WARNING If the INOvent delivery system is to be mounted in a transportation vehicle, it must be equipped with four (4) vibration isolation devices positioned near the feet of the device. See Appendix A for validated vibration isolators.

6-14

Connection to a BIO-MED MVP-10 or an Infrasonics Infant Star 100 ventilator is shown in figure 6-7.

When operating on the battery, keeping the display brightness and the audio alarm loudness to the minimum needed will help prolong battery charge life.

Display brightness and alarm loudness can be changed if desired by pushing the Setup key to display the Setup menu.

Note: The display brightness automatically dims to the lowest setting (1) when running on battery.

If a humidifier is not being used in the breathing circuit, a “Dry Sample Gas” alarm may occur. This alarm occurs if the sample gas has less than 15% relative humidity.

The design of the gas sampling system allows its use without humidification under certain conditions.

- When the ambient humidity is greater than approximately 45% RH, the sample gas is humidified as it flows through the INOvent delivery system and probably will not display the alarm message.
- Short term use of the INOvent delivery system with the “Dry Sample Gas” alarm present should not affect the O₂, NO and NO₂ sensors.

Long-term use with the alarm present can reduce the life of all the sensors and may result in slightly lower NO readings.

After connection as shown in the figure for the configuration you are using, proceed to “Setting the delivered NO concentration.”

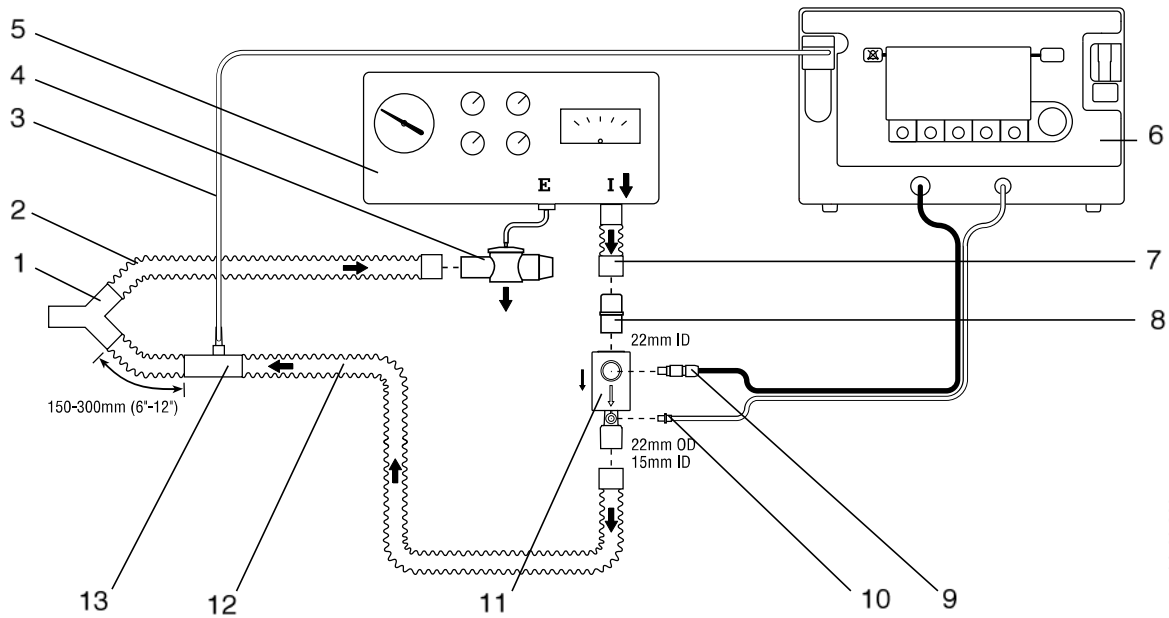

6-15

AA-69.266 AA-69.167

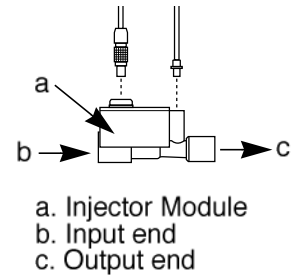

- 1 Patient wye
- 2 Expiratory Breathing Circuit Hose
- 3 Patient Gas sample line
- 4 Ventilator Expiratory Valve
- 5 Ventilator
- 6 INOvent delivery system
- 7 Ventilator Inspiratory port
- 8 22M / 15F x 22M / 15F Adapter
- 9 Injector Module Electrical Cable
- 10 NO/N₂ Injector Tube
- 11 Injector Module
- 12 Inspiratory Breathing Circuit Hose
- 13 Sample Tee

Figure 6-7 • System connection diagram for a transport ventilator circuit

Connection to bagging systems

The INOvent delivery system can be used with self-inflating and hyper-inflation manual resuscitator bagging systems and with spontaneous breathing circuits.

6-16 **⚠WARNING** **The hyperinflation bag will, under some conditions, contain NO₂ in excess of 1 ppm. Use of large tidal volume breaths may expose the patients to the NO₂ present in the bag, for part of the breath. In general, if the inspiratory flow rate induced by the manual ventilation does not exceed the fresh gas flow rate, the patient should not be exposed to the concentrations of NO₂ present in the hyperinflation bag.**

Adult and infant hyperinflation bags generate more NO₂ when used at lower minute ventilation. If use of the bag is interrupted (for example to adjust the tracheal tube), before resuming ventilation of the patient the user should squeeze the bag several times to empty residual gas from the bag.

Because of the potential for inhalation of excessive concentrations of NO₂, and the difficulty in monitoring the peak inhaled NO₂ concentrations, ventilation with a hyperinflation bag or self-inflating bag is intended only for short term use.

The Datex-Ohmeda monitors within the INOvent will not detect generation of NO₂ within the hyperinflation bag or self-inflating bag devices, and the alarms for excessive NO₂ cannot warn of NO₂ produced within the manual bag system.

To minimize the delivered concentration of NO₂, the following steps should be taken for use with the manual resuscitator bags:

- a. Concentrations of greater than 20 ppm NO should not be used due to excessive NO₂ generation.**
- b. Use the smallest bag adequate to deliver the desired tidal volume.**
- c. Inspiratory tubing lengths greater than 72 inches should not be used.**
- d. Use the highest fresh gas flow rated (up to 15 L/min) that is practical.**
- e. Use the lowest practical inspired oxygen concentration.**
- f. After starting fresh gas flow, squeeze the bag several times to empty residual gas in the bag prior to using the system to ventilate a patient.**

Testing has only been conducted using specific hyperinflation and self-inflating bag systems. See Appendix A for validated manual resuscitator breathing systems.

Procedure:

⚠CAUTION New O₂ tubing must be used each time for optimal fit on 4.5 mm adapter.

If a humidifier is not being used in the breathing circuit, a “Dry Sample Gas” alarm may occur.

6-17

This alarm occurs if the sample gas has less than 15% relative humidity. The design of the gas sampling system allows its use without humidification under certain conditions.

- When the ambient humidity is greater than approximately 45% RH, the sample gas is humidified as it flows through the INOvent delivery system and probably will not display the alarm message.
- Short term use of the INOvent delivery system with the “Dry Sample Gas” alarm present should not affect the O₂, NO and NO₂ sensors. Long-term use with the alarm present can reduce the life of all the sensors and may result in slightly lower NO readings.

Note the values shown in Tables 6-1 and 6-2.

Bagging system connections are shown in:

- Figure 6-8 for a hyper-inflation bag,
- Figure 6-9 for a self-filling resuscitator bag,
- Figure 6-10 for a spontaneous breathing circuit.

⚠ WARNING The values of NO₂ in the following table are the values expected in the tracheal tube under the specific test conditions. Use of lower fresh gas flows than shown in the tabulated information will increase the concentration of NO₂ in the inhaled gas.

Table 6-1 • Neonatal Hyperinflation Manual Resuscitator Breathing Circuit Table

The following table shows the maximum measured NO₂ values in the inspiratory limb and at the rear of the breathing bag after five minutes of bagging. Carrier gas = 100% oxygen, I:E = 1:2.

6-18

Set NO(ppm)	NO ₂ measured at tracheal tube (ppm)	NO ₂ measured in bag (ppm)	Vt(mL)	Rate (bpm)	Flow Rate (L/min)
10	0.4	0.2	150	20	8
10	0.1	0.1	150	40	15
10	0.1	0.1	50	80	8
10	0.1	0.1	50	40	15
20	0.4	0.2	150	20	8
20	0.1	0.4	150	40	15
20	0.1	0.4	50	20	8
20	0.1	0.3	50	40	15
⚠ WARNING Concentrations greater than 20 ppm NO should not be used because of excessive NO₂ generation.					
40	0.3	1.3	50	20	8
40	0.2	1.4	50	40	15
40	0.6	0.3	150	20	8
40	0.2	1.5	150	40	15
80	0.8	5.2	50	20	8
80	0.8	4.1	50	40	15
80	1.0	3.6	150	20	8
80	0.8	5.4	150	40	15

⚠ WARNING The values of NO₂ in the following table are the values expected in the tracheal tube under the specific test conditions. Use of lower fresh gas flows than shown in the tabulated information will increase the concentration of NO₂ in the inhaled gas.

**Table 6-2 • Adult
Hyperinflation Manual
Resuscitator Breathing Circuit
Table**

The following table shows the maximum measured NO₂ values in the inspiratory limb and at the rear of the breathing bag after five minutes of bagging. Carrier gas = 100% oxygen, I:E = 1:2.

6-19

Set NO(ppm)	NO ₂ measured at tracheal tube (ppm)	NO ₂ measured in bag (ppm)	Vt(mL)	Rate (bpm)	Flow Rate (L/min)
10	0.2	0.2	700	20	5
10	0.0	0.1	500	40	15
10	0.0	0.1	300	20	5
10	0.0	0.1	200	40	15
20	0.5	0.6	700	20	5
20	0.1	0.4	500	40	15
20	0.1	0.4	300	20	5
20	0.1	0.4	200	40	15
⚠ WARNING Concentrations greater than 20 ppm NO should not be used because of excessive NO₂ generation.					
40	0.3	2.1	300	20	5
40	0.4	2.3	200	30	15
40	0.9	1.9	700	20	5
40	0.4	2.4	500	30	15
80	1.2	9.0	300	20	5
80	1.4	9.0	200	30	15
80	2.8	8.8	700	20	5
80	1.5	9.1	500	30	15

INOvent delivery system

6-20

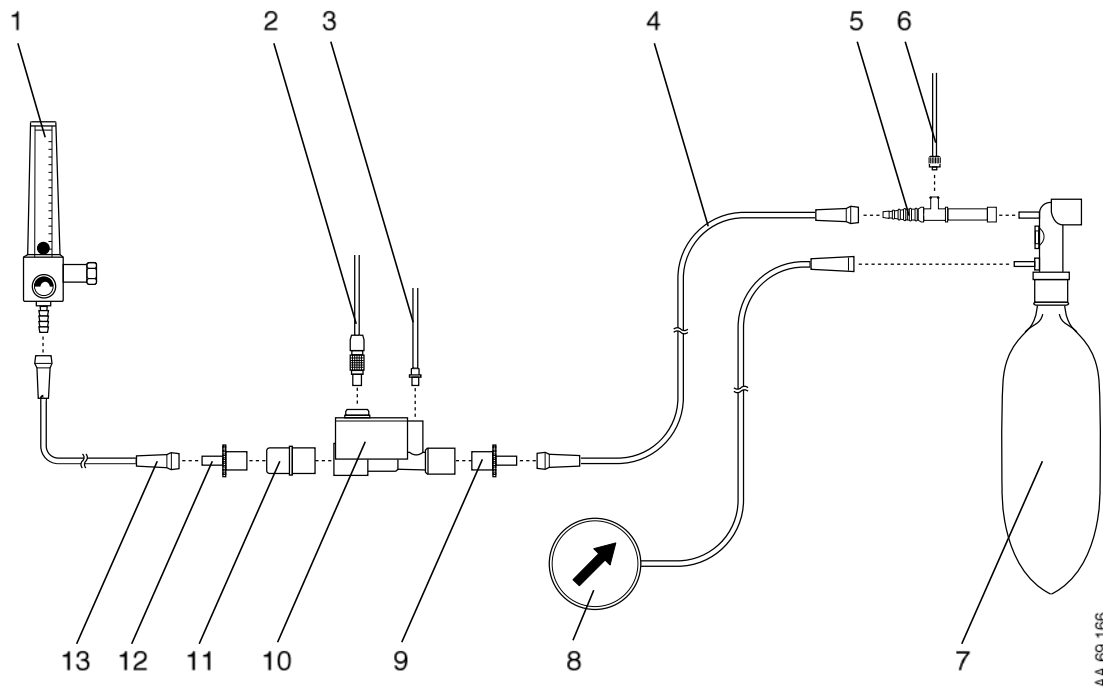

AA.69.166

- 1 O₂ Flowmeter
- 2 Injector Module Electrical Cable
- 3 NO/N₂ Injector Tube
- 4 O₂ Tubing
- 5 O₂ Tubing Sample Tee
- 6 Patient Gas sample line
- 7 Hyper-Inflation Bag
- 8 Pressure Gauge
- 9 15M x 4.5 mm Adapter for the output end of the Injector Module
- 10 Injector Module
- 11 22M / 15F x 22M / 15F Adapter for the input end of the Injector Module
- 12 15M x 4.5 mm Adapter
- 13 O₂ Tubing

Figure 6-8 • System connection diagram for a hyper-inflation bag

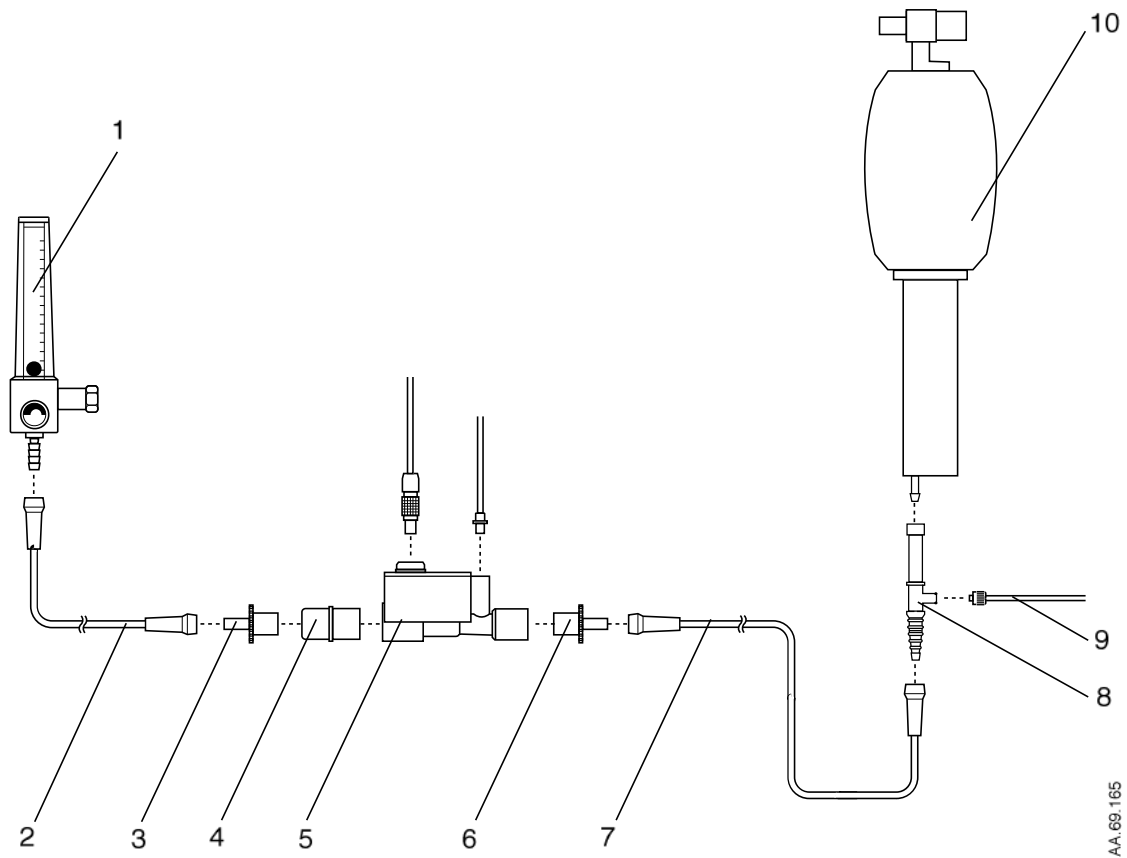

- 1 O₂ Flowmeter
- 2 O₂ Tubing
- 3 15M x 4.5 mm Adapter
- 4 22M / 15F x 22M / 15F Adapter for the input end of the Injector Module
- 5 Injector Module
- 6 15M x 4.5 mm Adapter for the output end of the Injector Module
- 7 O₂ Tubing
- 8 O₂ Tubing Sample Tee
- 9 Patient Gas sample line
- 10 Resuscitator bag with O₂ reservoir
- 11 NO/N₂ Injector Tube
- 12 Injector Module Electrical Cable

Figure 6-9 • System connection diagram for a self-filling resuscitator bag

INOvent delivery system

6-22

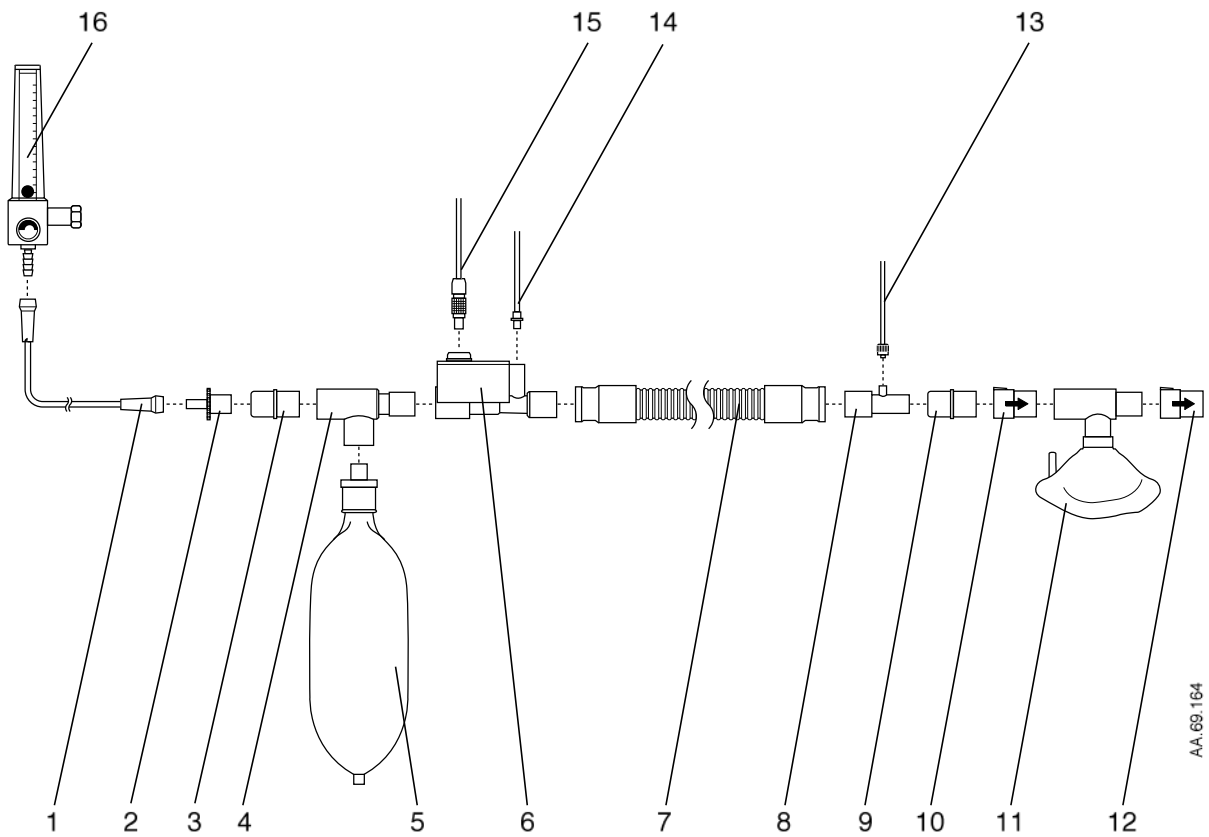

AA.69.164

- 1 O₂ Tubing
- 2 15M x 4.5 mm Adapter
- 3 22M / 15F x 22M / 15F Adapter
- 4 Breathing Circuit Tee
- 5 Breathing Circuit Bag
- 6 Injector Module
- 7 Breathing Circuit Hose
- 8 Sample Tee
- 9 22M / 15F x 22M / 15F Adapter
- 10 One-way valve
- 11 Sealed Face Mask
- 12 One-way valve
- 13 Patient Gas Sample Line
- 14 NO/N₂ Injector Tube
- 15 Injector Module Electrical Cable
- 16 O₂ Flowmeter

Figure 6-10 • System connection diagram for a spontaneous breathing circuit

Operation

Setting or changing the delivered NO concentration

After connecting the INOvent delivery system to the patient circuit, turn the INOvent delivery system ON.

- Turning the system on delivers nitric oxide concentration when there is flow in the patient circuit.
- Figure 6-11 shows a normal state display with the Set NO bargraph at off after the startup tests are completed.

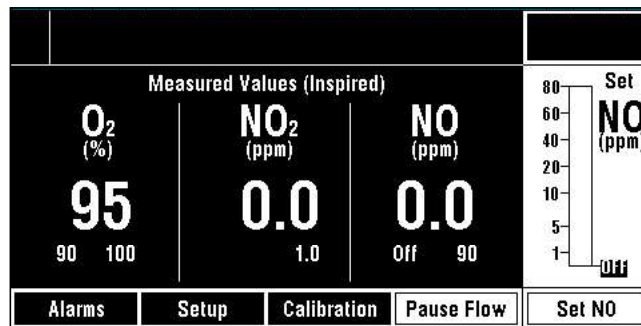

6-23

510k_3.tif

Figure 6-11 • Set NO display - Set NO is 0.0 ppm (OFF)

To set or change the NO concentration delivered:

1. Push the Set NO button.
 - The bargraph border now flashes
 - The bargraph top now becomes a moveable double line indicating the current concentration setting.
2. Turn the control wheel clockwise to increase the NO concentration or counterclockwise to decrease the concentration. Figure 6-12 shows the concentration line set at 20 ppm.

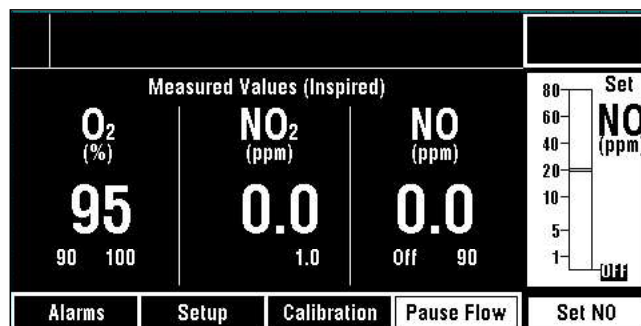

510k_4.tif

Figure 6-12 • Set NO display - NO setpoint is a double line

3. Push either the Set NO button or the control wheel to confirm the newly-entered concentration.
 - If you don't push the button or the wheel within five seconds, a reminder message, shown in figure 6-13, appears to prompt you to do so. A highlight box around the display flashes.
 - If you don't respond to the message within 15 seconds, the system defaults to its previous NO setting.

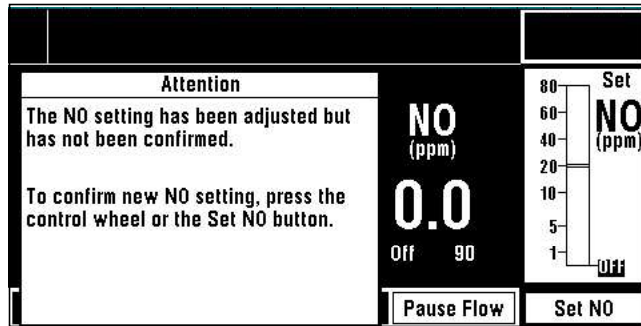

510k_5.tif

Figure 6-13 • Set NO display - confirm new NO setpoint reminder message

- Figure 6-14 shows the NO concentration set to 20 ppm after the Set NO button or the control wheel is pressed. The system is now set to deliver the new concentration.

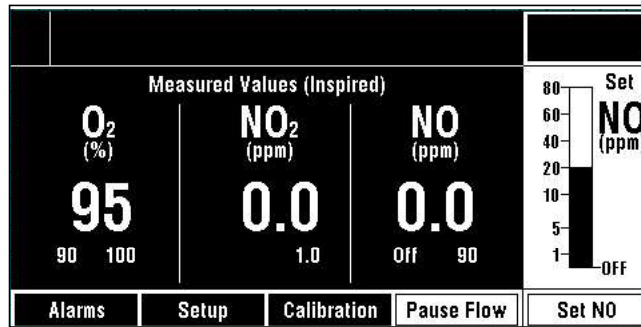

510k_6.tif

Figure 6-14 • Set NO display - normal state, NO bargraph showing 20 ppm setting

4. After the monitored values have stabilized, you can set or change the user-adjustable alarms. (See section 7/Alarms for changing the alarm settings.)

Note: NO delivery dilutes the therapy gas O₂ concentration up to 10% depending upon the Set NO concentration.

The system is now ready for use. The new NO concentration is delivered when there is flow in the patient circuit.

During operation

Pausing NO flow

⚠WARNING Do not pause flow more than two times consecutively to avoid elevated NO₂ values when NO delivery is resumed.

The Low NO alarm is disabled while NO flow is paused.

6-25

Nitric oxide flow can be paused for two-minute periods.

To pause nitric oxide flow during operation:

1. Press the Pause Flow button to display the Pause Flow confirmation message box shown in figure 6-15.

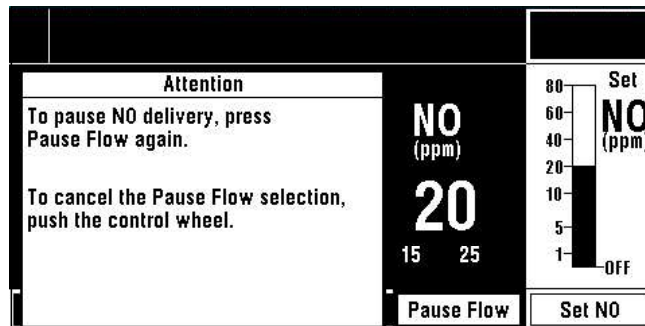

510k_18.tif

Figure 6-15 • Pause Flow confirmation message box

2. Then:

- Press the Pause Flow button a second time to pause the nitric oxide flow. The FLOW PAUSED message box appears with a two-minute countdown timer as shown in figure 6-16.

or:

- Press the Control Wheel to remove the Pause Flow confirmation message box. The Pause Flow confirmation message box disappears after 15 seconds if no action is taken.

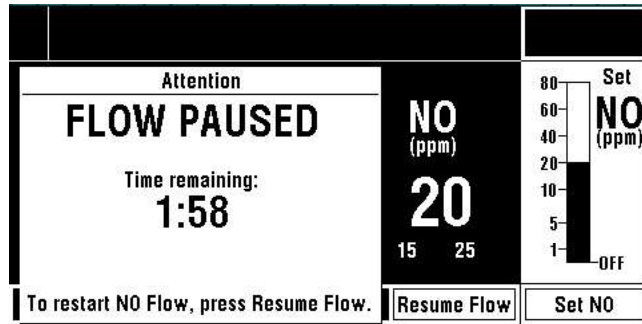

510k_19.tif

Figure 6-16 • FLOW PAUSED message box

Once nitric oxide flow is paused, it will resume:

- if the Resume Flow button is pressed or
- after two minutes have passed.

When the nitric oxide flow is resumed, the FLOW PAUSED message is removed.

Changing the NO therapy cylinder and purging the regulator assembly

⚠ WARNING You **MUST** purge the regulator assembly **IMMEDIATELY BEFORE** using a new NO cylinder to make sure the patient continues to receive the correct NO concentration and does not receive greater than 3.0 ppm of NO₂.

Important Replace an NO therapy gas cylinder when its pressure is less than 200 psig.

The regulator assembly **must** be purged immediately before using a new NO therapy gas cylinder. A small purge manifold allows you to purge the regulator assembly. The manifold is located either between the regulators on the transport cart or attached to the wall mount regulator inlet fitting.

To purge the regulator assembly immediately before using a new NO therapy gas cylinder do the following.

1. Determine which regulator assembly is not being used and requires purging. The cylinder valve should be closed on this regulator assembly that is not being used.

- On this regulator assembly that requires purging, disconnect the low pressure hose quick-connect fitting from the NO/N₂ input on the rear of the INOvent delivery system (shown in figure 6-17.)

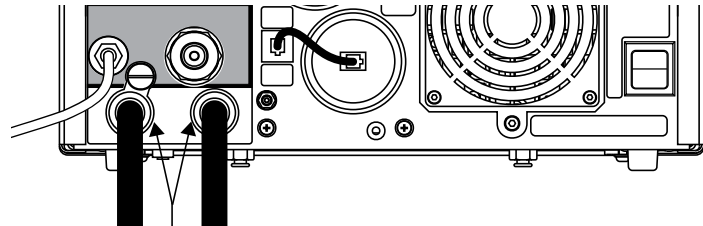

AA.69.147

6-27

Figure 6-17 • Low pressure hose quick-connect fittings

- Open the cylinder valve on the new NO therapy gas cylinder.
- Close the cylinder valve on the new NO therapy gas cylinder.
- Check for leaks at the cylinder valve outlet connection of the new therapy cylinder using soapy water (see 13/Appendix B.)
- Insert the low pressure hose quick-connect fitting into the purge manifold. See figure 6-18.

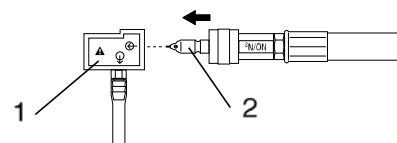

AA.69.152

- Purge manifold
- Low Pressure Hose Quick-Connect Fitting

Figure 6-18 • Inserting the low pressure hose quick-connect fitting into the purge manifold

- Firmly push and hold the quick-connect fitting in place while the pressure drops to zero on the regulator gauge.
- After the pressure drops to zero (approximately 15 seconds), reconnect the low pressure hose quick-connect fitting to the NO/N₂ input on the rear of the INOvent delivery system.

To use the new cylinder:

1. Open the cylinder valve on the new cylinder.
2. Close the cylinder valve on the empty cylinder and label appropriately.
3. Replace the empty NO therapy gas cylinder (see 13/Appendix B.) Leave the replacement cylinder valve turned off until needed. The purge procedure will be performed on this cylinder immediately before its use.

Electronic delivery shutdown

If the electronic NO delivery fails:

- A loud buzzer operates and
- The system stops NO delivery to the patient and
- Displays a message similar to the one in figure 6-19.

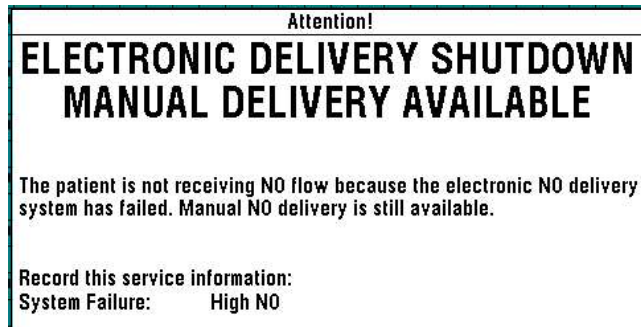

Figure 6-19 • System shutdown display

1. Record the service information as requested on the display.
2. Turn the system to STANDBY.
3. Use the Manual NO delivery system which can still be used. If you need to know how to use the manual system, see "Manual NO Delivery System operation" in section 8/Manual NO delivery system."

Monitoring the environment

You can use the system monitor to measure the environmental levels of NO and NO₂. You will need a Luer fitting cap for the patient line sample tee.

1. Disconnect the sample line connector from the sample tee.

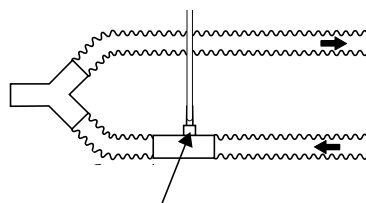

6-29

AA.66.017

Figure 6-20 • Sample line connector at the sample tee

2. Cap the Luer fitting on the sample tee to prevent gas loss from the patient circuit.

⚠WARNING After removing the sample line connector, cap the Luer fitting on the sample tee to prevent gas loss from the patient circuit.

3. With the sample system turned on, sample the room air with the sample line and read the NO and NO₂ readings. If an alarm occurs, press the Alarm Silence button to turn it off.
4. After environmental monitoring, remove the Luer fitting cap on the sample tee and reconnect the sample line.

Notes:

6-30

7/Alarms

In this section

- General alarm information 7-2
 - High, medium and low priority alarms 7-2
 - Alarm silencing 7-3
 - Changing the alarm settings 7-4
 - Alarm adjustment ranges 7-5
 - Alarm adjustment procedure 7-5
 - Clearing resolved alarm messages 7-7
 - Alarm message table 7-9

General alarm information

Note: Refer to the your ventilator manual for information on the Apnea, High Pressure and High Pressure Relief alarms.

An Alarm message table is provided at the end of this section.

All alarms have tones and visible messages. You'll see and hear an alarm when:

- the measured value of a gas exceeds the high or low limits shown in the measured value display area,
- a device alarm condition occurs, such as an expended monitor cell.

A secondary alarm circuit activates when the main alarm circuit fails, providing a continuous, non-silenceable buzzing tone. In this case the system must be turned off.

High, medium and low priority alarms

Alarms have priorities of high, medium and low. Higher priority alarm messages are displayed in the upper left alarm message area first.

See figure 7-1. The most recent high priority alarm message (for example "High NO") is shown in the top left part of the alarm message area. High priority alarm messages are shown on a **light** background.

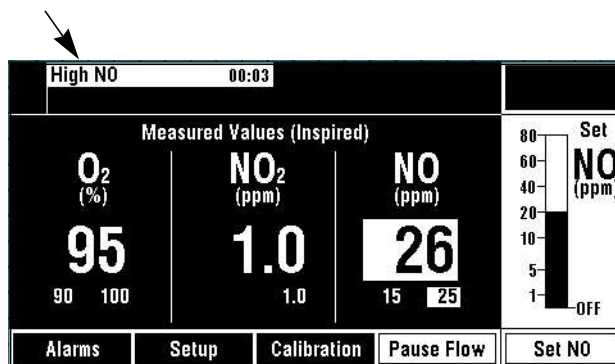

510k_20

Figure 7-1 • High priority alarm message shown in most recent alarm location (upper left)

The most recent medium priority alarm message (for example "High O₂" in figure 7-2) appears in **normal** video in the top right or the top left part of the alarm message area.

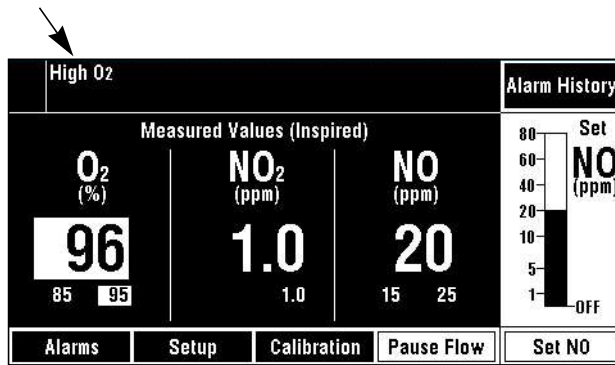

510K_21'

7-3

Figure 7-2 • Medium priority alarm message shown in most recent alarm location (upper left)

The most recent low priority alarm message (for example “Sample Line/Filter Block” in figure 7-3) appears in **normal** video in the bottom right part of the alarm message area.

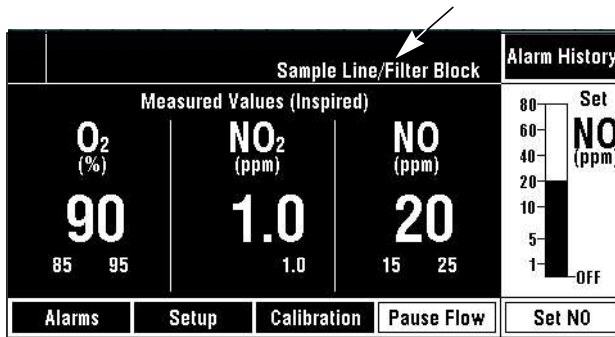

510K_22

Figure 7-3 • Low priority alarm message shown in low priority alarm location

Alarm silencing

Push the Alarm Silence button to silence high and medium priority alarms for 120 seconds. Most low priority alarms are permanently silenced.

Alarm messages, however, remain visible during the alarm silence period as long as the alarm cause is active.

Note: Tone loudness is set through the Setup button menu.

The following table provides alarm tone information.

Alarm Priority	Tone Frequency	Tone Description	Comment
High:	400 Hz	5-pulse group	Repeats after 10 seconds if not silenced.
Medium:	400 Hz	3-pulse group	Repeats after 25 seconds if not silenced.
Low:	400 Hz	1 pulse	Repeats after 40 seconds if not silenced.

7-4

Figure 7-4 shows that a High NO alarm message has been silenced. Note the alarm silenced symbol in the top left location indicating a silenced alarm. An alarm silenced countdown timer has counted down from 120 seconds and now indicates 114 seconds remaining of the silence period.

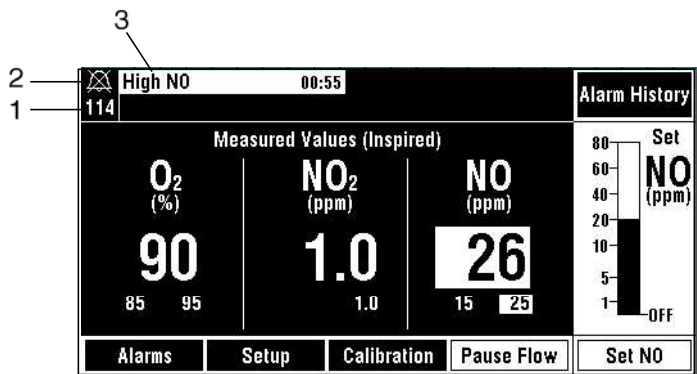

510k_23

1. Countdown timer
2. Alarm silenced symbol
3. High nitric oxide alarm message

Figure 7-4 • Silenced alarm and countdown timer example (upper left of the display)

Changing the alarm settings

Each alarm setting is displayed below its respective measured gas value. See figure 7-5.



510k_23

1. Measured gas value
2. Low alarm limit
3. High alarm limit

Figure 7-5 • Alarm setting displays

When an alarm occurs for a measured gas concentration, the measured value and the alarm limit setting are displayed on a light background. (See figure 7-6.)

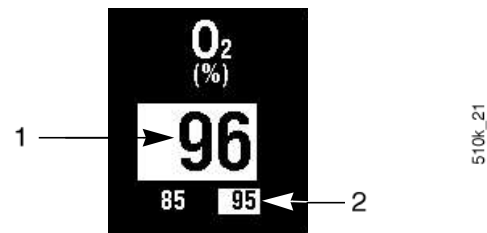

1. Measured gas alarming
2. Alarm limit exceeded

Figure 7-6 • Alarm active display

Alarm adjustment ranges

Alarms	Adjustment	Step value	Default	Detection range	Priority
High NO (ppm)	1 to 100 *	1	90 *	NO > high limit	High
Low NO (ppm) (Can be OFF)	OFF, 0.1 to 9.9*	0.1	Off	NO < low limit	High
	10 to 100*	1.0			
High NO ₂ (ppm)	0 to 5	0.1	3	NO ₂ > high limit	High
High O ₂ (% v/v) (Can be OFF)	21 to 100	1	100 %	O ₂ > high limit	Medium
Low O ₂ (% v/v)	18 to 100	1 %	21 %	O ₂ < low limit	High

* Values shown are for maximum Set NO range of 80 ppm. For other maximum Set NO ranges, the high adjustment range and the default value is 1.5 X maximum NO Set.

Alarm adjustment procedure

A user-adjustable low limit alarm cannot be set above the high limit setting.

1. With the monitor ON and after the monitored values have stabilized, push the Alarms button to show the Alarms menu.

This menu lets you:

- Set a high limit for measured values of the three gases (O₂, NO₂ and NO.)
- Set a low limit for the measured values of NO and O₂.
- Exit to the normal display.

2. Turn the control wheel to highlight the alarm setpoint to be changed. In figure 7-7, the Low NO alarm setting is highlighted.

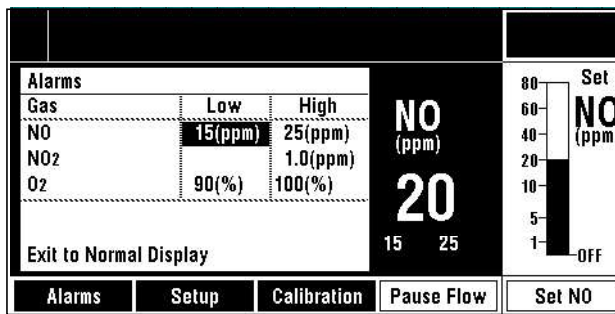

510k_7.tif

Figure 7-7 • Alarms menu - low NO alarm setting highlighted

3. Push the control wheel to select the highlighted alarm setpoint for change; in figure 7-8 the Low NO setpoint is shown in a selection box.

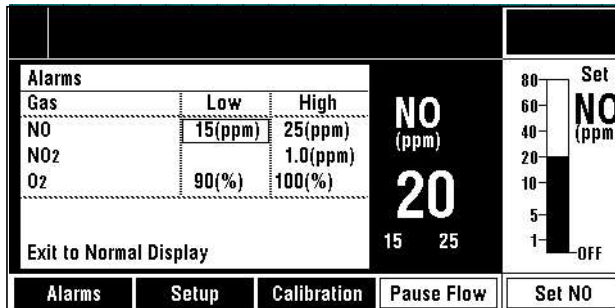

510k_8.tif

Figure 7-8 • Alarms menu - low NO alarm setting selected for adjustment

4. Turn the control wheel until the value you wanted is displayed in the selection box.
5. Push the control wheel to confirm your selection. The alarm limit is displayed below its respective measured gas value when the normal display is shown. See figure 7-9.

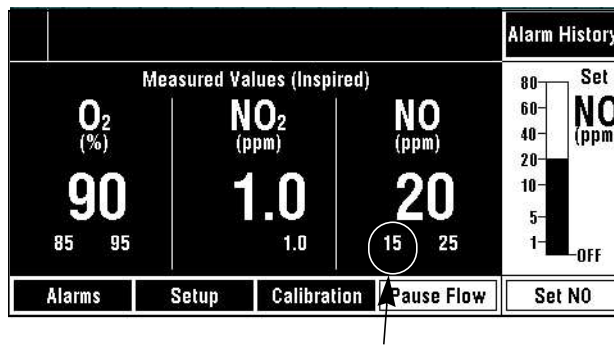

510K_22

Figure 7-9 • New nitric alarm limit set

7-7

- If you are finished with the Alarms menu, turn the control wheel to select Exit to Normal Display. To adjust another value, continue using the above procedure. Push the control wheel to exit when you are finished.

Clearing resolved alarm messages

An “Alarm History” indication in the top right location of the display indicates there are resolved alarms that can be reviewed and cleared.

Alarm History

A resolved alarm is an alarm that occurred but is no longer true: that is, the alarm message came and went. A history of up to the last ten resolved alarm messages is stored for analysis or troubleshooting.

Push the Alarm History button to see the Alarm History menu. The messages are displayed in chronological order, starting with the most recent resolved alarm.

Note: The alarm history list is cleared if the INOvent delivery system is turned OFF and then ON.

To clear alarm messages on the resolved alarm history list:

- Push the Alarm History button to see the Alarm History menu.
 - Figure 7-10 shows page 1 of the menu when there are more than five alarm messages.
 - Figure 7-11 shows page 2 of the menu used when there are more than five alarm messages.

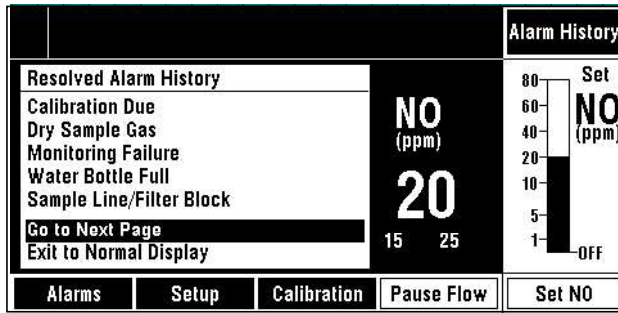

510k_24.tif

Figure 7-10 • Resolved Alarm History menu - six or more resolved alarms, page 1

7-8

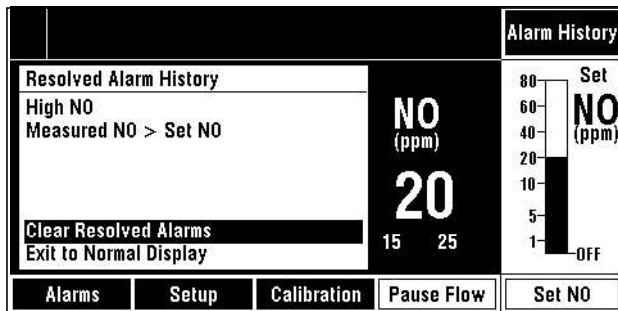

510k_25.tif

Figure 7-11 • Resolved Alarm History menu - 6 or more resolved alarms, page 2

2. Turn the control wheel to highlight the message or action wanted.
3. Push the control wheel to complete the action you want or go to the next page. Figure 7-12 shows the menu with all alarm messages removed.
4. When finished, turn the control wheel to “Exit to Normal Display.” Push the wheel to exit.

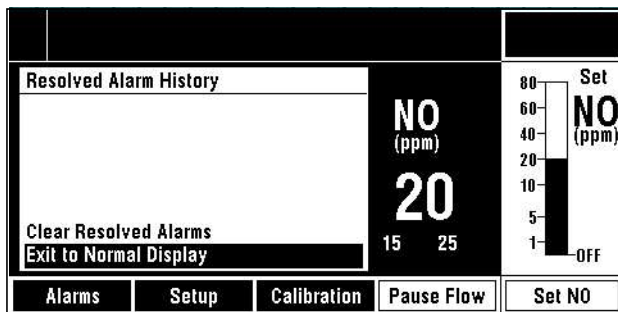

510k_26.tif

Figure 7-12 • Resolved Alarm History menu - resolved alarms cleared

A list of alarm messages starts on the next page.

Alarm message table

⚠WARNING The INOvent delivery system should not be connected to the patient during troubleshooting or service activities.

When an alarm occurs, check the patient condition and then check the equipment.

Use the table below for information on conditions. The last column references numbers in the Troubleshooting Guide table of section 9/ Troubleshooting.

7-9

Alarm	Priority	Conditions	See Troubleshooting Guide number:
Battery Inoperable	Low	Displayed when running on mains power and battery not functioning.	13
Low Battery	High	Displayed when running on battery and charge is low.	14
Low Battery Charge	Low	Displayed only when running on mains power and battery charge is low.	15
Running on Battery	Low	Displayed only when running on battery.	16
Set NO Error	Low	System detects a Set NO communication error.	7
Water Bottle Full	Low	System detects full water bottle.	18
Sample Line/ Filter Block	Low	System failed to clear blockage after 3 purge routines.	17
Dry Sample Gas	Low	Sample gas < 15% relative humidity.	11
Wet Sample Gas	Low	Sample gas > 95% relative humidity.	35
Calibration Due	Low	Loss of calibration data.	25
Failed NO Cell	Low	System detects absence or failure of an NO cell.	26
Failed NO ₂ Cell	Low	System detects absence or failure of an NO ₂ cell.	27
Failed O ₂ Cell	Low	System detects absence or failure of an O ₂ cell.	28
Weak NO Cell	Low	Weak NO cell detected during calibration.	29
Weak NO ₂ Cell	Low	Weak NO ₂ cell detected during calibration.	30
Weak O ₂ Cell	Low	Weak O ₂ cell detected during calibration.	31
High NO	High	Measured NO value > User set limit; default: 1.5 x Bargraphmax*, but not greater than 90 ppm.	2

INOvent delivery system

High NO Flow	High	During calibration, NO flow changed and NO concentration may exceed 100 ppm or O ₂ dilution > 20%.	23
High NO ₂	High	Measured NO ₂ value > User set limit; default: 3.0 ppm.	12
High O ₂	Medium	Measured O ₂ value > User set limit; default: 100 %.	22
Low NO	High	Measured NO value < User set limit; default: Off.	1, 3
Low NO/N ₂ Pressure	High	NO therapy gas supply pressure < 32 psig.	4
Low O ₂	High	Measured O ₂ value < User set limit; default: 21 %.	21
Decreased NO Flow	Low	NO flow < 60% of NO flow when calibration was initiated.	8
Increased NO Flow	Low	NO flow > 160% of NO flow when calibration was initiated.	9
Measured NO < Set NO	Low	NO _{meas} < 50% of NO _{set} and NO _{meas} < NO _{set} - NO _{offset} .**	1, 5
Measured NO > Set NO	Low	NO _{meas} > 150% of NO _{set} and NO _{meas} > NO _{set} + NO _{offset} .**	1, 6
Injector Module Fail	High	System cannot detect a working Injector Module.	34
Delivery Failure	High	Calculated NO flow is outside acceptable range or leak rate was unacceptable at Power-ON.	10
Monitoring Failure	Low	Monitor fails to communicate correctly or reports a fault.	17
System Failure	Shutdown	NO _{meas} > 2 x Bargraphmax or 100 ppm or other system failure. *	24
Service Advisory	Low	System detects a condition which needs service.	33

* Bargraphmax = Maximum value settable on the Set NO Bargraph.

** NOoffset = 5 ppm when Set NO range = 0 - 20
7 ppm when Set NO range = 0 - 40
10 ppm when Set NO range = 0 - 80.

- End of Alarm message table -

8/Manual NO delivery system

In this section	Manual NO delivery system description	8-2
	Manual NO delivery system connections	8-3
	Manual NO delivery system operation	8-4

Manual NO delivery system description

The Manual NO delivery system permits continued NO delivery if the ventilator or the main INOvent delivery system fails. The manual system is completely pneumatic and is not linked to the primary delivery system.

The Manual NO delivery system is used with a pressure compensated (PC) O₂ flowmeter (user supplied) and a manual resuscitator bag (user supplied) to deliver a 20 ppm concentration of NO to the patient with an O₂ flowrate of 15 L/min and an 800 ppm NO cylinder.

The pressure compensated O₂ flowmeter provides the ON/OFF function and is used to set the O₂ flow at 15 L/min. A shutoff valve in the delivery system prevents NO flow if there is insufficient O₂ flow.

When the manual NO delivery system is operating correctly, the float in the NO Flow Indicator Window will be in the position shown in figure 8-1.

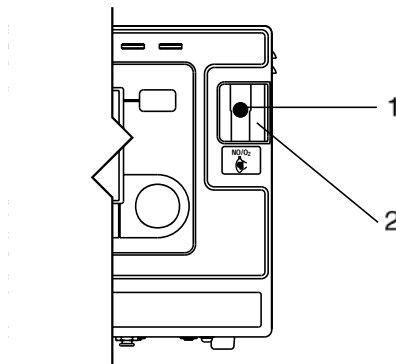

1. Float
2. NO Flow Indicator Window

Figure 8-1 • Manual NO delivery system: NO Flow Indicator Window and Float

69.023

Manual NO delivery system connections

- ⚠ WARNING** The Manual NO delivery system must be set up and available at all times. The Manual NO delivery system must be configured as shown in figure 8-2.
- Do not connect an O₂ supply, wall or cylinder, directly to the O₂ inlet on the rear of the INOvent delivery system.
- ⚠ CAUTION** Supplemental O₂ should only be turned on and used when the manual delivery system is in use.

Refer to the connection diagram in figure 8-2 when making the Manual NO delivery system connections. This diagram is also printed on the right side of the INOvent delivery system.

1. Connect O₂ tubing (user-supplied) to the manual resuscitator bag with O₂ reservoir (user-supplied) and to the NO/O₂ output connector on the back of the INOvent delivery system.
2. Connect a Pressure Compensated (PC) O₂ flowmeter (user supplied) to an O₂ supply (wall or cylinder.) The flowmeter must have a male O₂ DISS outlet.
3. Connect the O₂ hose supplied with the INOvent delivery system to the flowmeter outlet and to the back of the INOvent delivery system at the O₂ inlet connector.

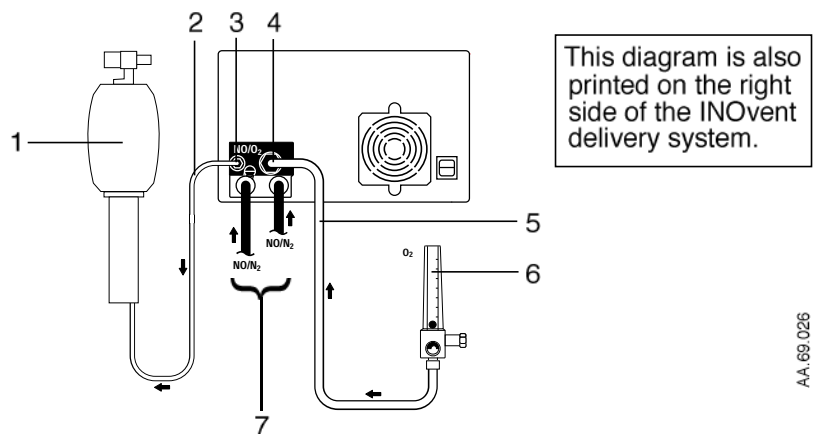

- 1 Resuscitator bag with O₂ reservoir (user supplied)
- 2 Oxygen tubing (user supplied)
- 3 NO/O₂ outlet
- 4 O₂ inlet
- 5 O₂ supply hose from the O₂ flowmeter
- 6 Pressure Compensated O₂ flowmeter (user supplied), shown set to OFF (no float activity)
- 7 NO/N₂ input hoses from the regulators

Figure 8-2 • Manual NO delivery system connection diagram

Manual NO delivery system operation

⚠CAUTION Supplemental O₂ should only be turned on when the manual delivery system is in use.

1. If not already done, the Manual NO delivery system should be setup as described in “Manual NO delivery system Connections” above. A system connection diagram is also printed on the side of the INOvent delivery system.

2. To start the Manual NO delivery system, set the O₂ flowmeter to 15 L/min. This starts the Manual NO delivery system.

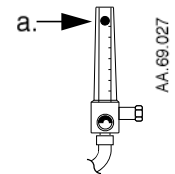

a. Flowmeter

3. Check for movement of the float in the NO Flow Indicator on the right front side of the INOvent delivery system. This float movement indicates NO flow. A shut-off valve prevents NO flow if there is insufficient oxygen.

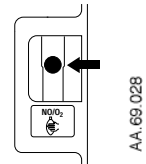

4. Squeeze the resuscitator bag three to five times to purge the system before connecting the resuscitator bag to the patient.

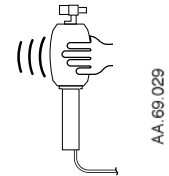

5. Use your regular procedure to connect the resuscitator bag to the patient.

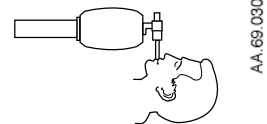

6. To stop the manual NO delivery, turn the O₂ flowmeter to OFF.

9/Troubleshooting

In this section	Troubleshooting procedure	9-2
	If the system fails to operate properly	9-2
	Troubleshooting guide index	9-3
	Troubleshooting guide	9-4
	If the problem can't be corrected using the above suggestions	9-13
	If the INOvent delivery system must be returned for servicing	9-13

Troubleshooting procedure

⚠ WARNING The INOvent delivery system should not be connected to the patient during troubleshooting or service activities.

If the system fails to operate properly

1. Check the patient condition and take appropriate action.
2. Verify that the system is set up as detailed in section 3/Setup.
3. See section 7/Alarms. It provides:
 - Alarm information,
 - An “Alarm message table” with numbered references the **Troubleshooting guide** provided here below.
4. After checking the Alarm message table in section 7/Alarms, find a symptom/alarm in the following **Troubleshooting guide** which best describes the problem.
5. Follow the recommended action in the **Troubleshooting guide** to correct the problem. Replacing a component or making an adjustment as suggested by the Guide may fix a problem.

Troubleshooting guide index

Symptom / Alarms in the Troubleshooting Guide listed alphabetically	See Guide Number:
Battery Inoperable.	13.
Calibration Due.	25.
Decreased NO Flow.	8.
Delivery Failure.	10.
Dry Sample Gas.	11.
Failed NO Cell.	26.
Failed NO ₂ Cell.	27.
Failed O ₂ Cell.	28.
High NO alarm.	2.
High NO Flow.	23.
High NO ₂ .	12.
High O ₂ .	22.
Increased NO Flow.	9.
Injector Module Fail.	34.
Low Battery Charge.	15.
Low Battery.	14.
Low NO.	3.
Low NO/N ₂ Pressure.	4.
Low O ₂ .	21.
Low range calibration and high range calibration cannot bring the NO monitor, the NO ₂ monitor or the O ₂ monitor to indicate gas calibration.	19.
Measured NO < Set NO.	5.
Measured NO > Set NO.	6.
Monitored NO reading is outside of the specified range of the setting.	1.
Monitoring Failure.	32.
NO or NO ₂ monitors read greater than 25 and 5 ppm respectively for ambient atmosphere monitoring.	20.
Running on Battery.	16.
Sample Line/Filter Block or Monitoring Failure.	17.
Service Advisory.	33.
Set NO Error.	7.
System Shutdown.	24.
Water Bottle Full.	18.
Weak NO Cell.	29.
Weak NO ₂ Cell.	30.
Weak O ₂ Cell.	31.
Wet Sample Gas.	35.

Troubleshooting guide

Symptom/Alarm	Possible Cause	Recommended Action
1. Monitored NO reading is outside of the specified range of the setting.	a. An incorrect NO/N ₂ gas cylinder was used.	Make sure the cylinder NO gas concentration is the same concentration as in the Setup menu.
	b. The NO calibration drifted or the monitor failed.	Re-calibrate the NO monitor.
	c. Degraded calibration gas was used.	Replace the calibration gas and recalibrate the monitor.
	d. The Injector Module may have failed.	Replace the Injector Module.
	e. The INOvent delivery system may have failed.	Replace the delivery system and contact Datex-Ohmeda Technical Support.
	f. System purge not done being before use.	Do a system purge before use.
	g. Sample system leaks.	Check sample system components for proper connection: Sample Tee, Patient Gas Sample Line; Fluid Trap Bottle; Fluid Trap Filter Cartridge.
	h. Injector Module may be placed incorrectly in the circuit.	Refer to section 6/Operation for the proper location of the Injector Module.
	i. Leaking breathing circuit between the Injector Module and the ventilator can cause over-delivery of NO due to reverse flow when using PEEP.	Repair the leak in the breathing circuit.
2. High NO alarm.	Note: A newly installed NO sensor will give high readings until fully conditioned and calibrated.	
	The High NO alarm setting may be inappropriately set.	Make sure the High NO alarm is set greater than the Set NO value. See Troubleshooting Guide #1 Possible Causes and Recommended Actions.

Symptom/Alarm	Possible Cause	Recommended Action
3. Low NO.	The Low NO alarm setting may be inappropriately set.	Make sure the Low NO alarm is set less than the Set NO value. See Troubleshooting Guide #1 Possible Causes and Recommended Actions.
4. Low NO/N ₂ Pressure.	a. The NO cylinder supply may be low.	Make sure the NO cylinder is turned on. If the high pressure cylinder gauge (0-3000 psi range) reads less than 200 psi, change the cylinder immediately.
	b. The supply line may be leaking or not connected.	If the cylinder gauge reads OK, listen for a hissing sound to detect supply line leakage. Make sure the quick-connect low pressure hoses are connected correctly to the back of the INOvent delivery system. Tighten the regulator connection to the NO cylinder and turn on the cylinder. Select the alternate NO supply and regulator. Disconnect the leaking regulated pressure hose from the back of the INOvent delivery system.
	c. The INOvent delivery system may have failed.	Replace the delivery system and contact Datex-Ohmeda Technical Support.
5. Measured NO < Set NO.		See Troubleshooting Guide #1.
6. Measured NO > Set NO.		See Troubleshooting Guide #1.
7. Set NO Error.	System communication problem.	Call Datex-Ohmeda Service.
8. Decreased NO Flow.	Ventilator flow changed.	Discontinue sensor calibration. Make sure that no changes were made to the ventilator settings during sensor calibration. Resume sensor calibration.
		Discontinue sensor calibration. Make sure that no changes were made to the ventilator settings during sensor calibration. Resume sensor calibration.
9. Increased NO Flow.	Ventilator flow changed.	Discontinue sensor calibration. Make sure that no changes were made to the ventilator settings during sensor calibration. Resume sensor calibration.

INOvent delivery system

Symptom/Alarm	Possible Cause	Recommended Action
10. Delivery Failure.	a. The ventilator flow rate is outside of specifications. Set NO is outside of specifications based on the flow rate.	<p>Make sure the INOvent delivery system is connected to the patient breathing circuit and that the ventilator gas flow is between 4 to 120 Lpm with the appropriate NO setting.</p> <p>Make sure the NO/N₂ supply is correctly connected. See Troubleshooting Guide #4.</p>
	b. The INOvent delivery system may have failed.	Replace the delivery system and contact Datex-Ohmeda Technical Support.
	c. If the message occurs during Power-ON, it is probably the system failing a leak test.	Call Datex-Ohmeda Service.
11. Dry Sample Gas.	Low humidity in the breathing circuit.	<p>Increase humidity if possible.</p> <p>Long-term use of the INOvent delivery system with this alarm present can reduce the life of the NO and NO₂ sensors.</p>
12. High NO ₂ .	a. Sample line occlusion.	Confirm whether or not the High NO ₂ alarm occurs concurrently with a sample line failure alarm.
	In this case, this alarm may occur with a Sample Line/Filter Block alarm	If so, this alarm will clear within 10 seconds after the sample line fault is remedied.
	b. Ventilator flow stoppage.	<p>After ventilation stoppage, allow the ventilator gas to wash NO and NO₂ from the breathing circuit before connecting to the patient.</p> <p>Continue the NO delivery after the problem has been corrected.</p>
	c. The NO ₂ alarm limit may be set too low.	Make sure the NO ₂ alarm limit is appropriate for the Set NO.
	d. The NO ₂ calibration may have drifted or the monitor may have failed.	Re-calibrate the NO ₂ monitor.
	e. Degraded calibration gas was used.	Replace the calibration gas and recalibrate the monitor.
	f. The INOvent delivery system may have failed.	Replace the delivery system and contact Datex-Ohmeda Technical Support.
g. The ventilator setting may be incorrect.	Check the ventilator's minute volume setting.	

Symptom/Alarm	Possible Cause	Recommended Action
	h. The patient circuit setup may be incorrect.	Make sure the patient circuit hoses and lengths are correct. See "Connecting the system to the patient circuit" in section 6/Operation.
	i. The therapy gas cylinder may not have the correct concentration.	Make sure the therapy gas cylinder label shows the proper concentration and date.
	j. The wrong calibration gas may have been used.	Make sure calibration gas with the correct date and concentration was used. Re-calibrate the NO ₂ monitor if necessary.
	k. System purge not done being before use.	Do a system purge before use.
13. Battery Inoperable.	Prolonged use of battery.	<ol style="list-style-type: none"> 1. Switch the ON/STANDBY control to STANDBY. 2. Connect the power cord to a power outlet and verify that the Mains Power light is on. 3. Wait at least 12 hours. If the symptom still occurs, contact your Datex-Ohmeda Service Representative.
14. Low Battery.	Battery is running low.	Connect to AC mains power source immediately.
15. Low Battery Charge.	System was operated on the battery.	Leave connected to AC power source. If message does not disappear after charging for sufficient period of time, contact your Datex-Ohmeda Service Representative.
16. Running on Battery.	a. The mains power may have failed or the power cord may have been inadvertently disconnected.	<p>Make sure the electrical power from the wall outlet is functioning and that the INOvent delivery system power cord is connected to an emergency-power-backed electrical wall outlet.</p> <p>Make sure the power cord is fully inserted into the Power Entry Module and that the power cord clamp is tightened.</p>

INOvent delivery system

Symptom/Alarm	Possible Cause	Recommended Action
	b. The voltage selector may be set wrong or the fuse may be defective.	<p>Check for the correct voltage indication on the Power Entry Module.</p> <p>Switch the INOvent delivery system to STANDBY and disconnect the power cord from the power source. Make sure the fuse in the Power Entry Module has not opened. Replace it if necessary. If the fuse fails again, replace the delivery system and contact Datex-Ohmeda Technical Support.</p> <p>Continue NO delivery after the problem has been corrected.</p>
	c. The INOvent delivery system may have failed.	Replace the delivery system and contact Datex-Ohmeda Technical Support.
17. Sample Line/Filter Block or Monitoring Failure.	a. The sample line may be blocked.	Make sure the sample inlet line and outlet port are not obstructed.
	b. The fluid trap filter cartridge may be blocked.	<p>Change the sample line if needed.</p> <p>Replace the fluid trap filter cartridge if needed.</p> <p>Continue NO delivery after the problem has been corrected.</p> <p>Don't be concerned if the high NO₂ alarm is activated because of the oxidation of the NO and O₂ trapped in the sample system. The high NO₂ alarm will clear within 10 seconds after the blocked sample line is cleared.</p>
	c. Leakage around the sensors.	Make sure the sensors are correctly seated with O-rings.
	d. The sample pump may have failed.	Listen for the motor sound from the sample pump. If the sound has stopped, the sample pump has failed.
	e. The INOvent delivery system may have failed.	Replace the delivery system and contact Datex-Ohmeda Technical Support.
18. Water Bottle Full.	The fluid trap bottle on the front of the INOvent delivery system is full.	Empty the bottle. Also empty the bottle before each patient and whenever the bottle is more than half full.

Symptom/Alarm	Possible Cause	Recommended Action
19. Low range calibration and high range calibration cannot bring the NO monitor, the NO ₂ monitor or the O ₂ monitor to indicate gas calibration.	a. There is a leak around the sensors.	Make sure the sensors are correctly seated with O-rings and the sensor covers are fully closed.
	b. The wrong calibration gas was used to calibrate the monitor.	Make sure the correct calibration gas is used.
	c. Bad calibration gas was used.	Replace the calibration gas and recalibrate the monitor.
	d. The monitor sensor may have failed.	Change the NO, NO ₂ or O ₂ sensor.
20. NO or NO ₂ monitors read greater than 25 and 5 ppm respectively for ambient atmosphere monitoring.	a. The NO supply line may be leaking.	Use the free end of the sample line to "sniff" for leakage of NO along the supply line. Do a leak test. See section 5/Pre-Use Procedures. Turn off the NO cylinder and make sure the regulator seal is in place. Tighten the regulator to the NO cylinder as necessary and turn the cylinder on.
	b. The calibration may have drifted or the monitor may have failed.	Make sure the monitor is correctly calibrated.
	c. Bad calibration gas was used.	Replace the calibration gas and recalibrate the monitor.
	d. The NO gas cylinder may be leaking.	If a high reading persists, turn off the NO cylinder and monitor the ambient gas concentrations. If a high monitor reading persists, move the NO gas cylinder to a well ventilated area away from people. Refer to the instructions on the handling of gas cylinders.
21. Low O ₂ .	a. The O ₂ supply may be disconnected or turned off.	Make sure the ventilator O ₂ supply is operating. Continue the NO delivery after the problem has been corrected.

INOvent delivery system

Symptom/Alarm	Possible Cause	Recommended Action
	b. The O ₂ concentration setting at the ventilator was reduced.	Make sure the O ₂ setting at the ventilator is correct. Continue the NO delivery after the problem has been corrected.
	c. The O ₂ alarm setting may be inappropriate.	The INOvent delivery system can dilute the O ₂ concentration set at the blender by up to 10%. Make sure the low O ₂ alarm setting is 10% lower than the allowable tolerance of the O ₂ blender setting and the O ₂ monitor reading. Continue NO delivery after the problem has been corrected.
	d. The monitor or calibration may have failed.	Re-calibrate the O ₂ monitor. Continue NO delivery after the problem has been corrected.
	e. The O ₂ sensor may not be properly seated.	Make sure the O ₂ sensor is properly seated. Check the O ₂ sensor o-ring seal.
	f. The Injector Module may have failed.	Replace the Injector Module.
	g. The O ₂ sensor electrical cable may be disconnected or have failed.	Reconnect or replace the O ₂ sensor electrical cable.
	h. The O ₂ sensor may be spent.	Change the O ₂ sensor if the monitor fails to calibrate. Continue NO delivery after the problem has been corrected.
	i. The INOvent delivery system may have failed.	Replace the delivery system and contact Datex-Ohmeda Technical Support.
22. High O ₂ .	a. The O ₂ concentration setting at the gas blender was increased.	Make sure the O ₂ setting is correct at the O ₂ /Air blender. Continue NO delivery after the problem has been corrected.

Symptom/Alarm	Possible Cause	Recommended Action
	b. The O ₂ alarm setting may be inappropriate.	<p>The INOvent delivery system can dilute the O₂ concentration set at the blender by up to 10%.</p> <p>Make sure the High O₂ alarm is set above the sum of the allowable tolerance of the O₂ blender setting, the NO dilution effect and the O₂ monitor reading.</p> <p>Continue the NO therapy gas after the problem has been corrected.</p>
	c. The calibration may have drifted or the monitor may have failed.	<p>Re-calibrate the O₂ monitor.</p> <p>Change the O₂ sensor if the monitor fails to calibrate.</p> <p>Continue NO delivery after the problem has been corrected.</p>
23.High NO Flow.	During calibration, ventilator flow changed.	<p>Discontinue sensor calibration. Make sure that no changes were made to the ventilator settings during sensor calibration.</p> <p>Resume sensor calibration.</p>
24.System Shutdown.	a. System shutdown caused by a high NO reading after a new NO sensor installed.	<p>Turn the system to STANDBY then ON to reset it. Do the Pre-Use Procedures and continue the NO delivery.</p> <p>Calibrate the NO sensor.</p> <p>Do the Pre-Use Procedures and continue the NO delivery.</p>
	b. System shutdown caused by a transient effect.	<p>Turn the system to STANDBY then ON to reset it. Do the Pre-Use Procedures and continue the NO delivery.</p>
	c. The INOvent delivery system may have failed.	<p>Replace the delivery system and contact Datex-Ohmeda Technical Support.</p>
25.Calibration Due.	Loss of calibration data.	<p>Perform low and high sensor calibrations.</p>
26.Failed NO Cell.	NO cell absent or failed.	<p>Verify the cell is seated in its mating part.</p> <p>Replace NO cell.</p>
27.Failed NO ₂ Cell.	NO ₂ cell absent or failed.	<p>Verify the cell is seated in its mating part.</p> <p>Replace NO₂ cell.</p>

INOvent delivery system

Symptom/Alarm	Possible Cause	Recommended Action
28. Failed O ₂ Cell.	a. The O ₂ sensor electrical cable may be disconnected or have failed.	Reconnect or replace the O ₂ sensor electrical cable.
	b. O ₂ cell absent or failed.	Replace O ₂ cell.
29. Weak NO Cell.	NO cell spent.	Replace NO cell as soon as possible.
30. Weak NO ₂ Cell.	NO ₂ cell spent.	Replace NO ₂ cell as soon as possible.
31. Weak O ₂ Cell.	O ₂ cell spent.	Replace O ₂ cell as soon as possible.
32. Monitoring Failure.	Monitor fails to communicate correctly or reports a fault.	Contact your Datex-Ohmeda Service Representative.
33. Service Advisory.	System detects a condition which needs service.	Contact your Datex-Ohmeda Service Representative.
34. Injector Module Fail.	a. The Injector Module electrical cable may be disconnected.	Reconnect the electrical cable and restart the INOvent delivery system.
	b. The Injector Module may have failed.	Replace the Injector Module.
	c. The electrical cable may have failed.	Replace the electrical cable and restart the INOvent delivery system.
35. Wet Sample Gas.	Fluid Trap Filter Cartridge may be damaged.	Replace the Fluid Trap Filter Cartridge.

* Bargraph_{max} = Maximum value settable on the Set NO Bargraph.

** NO_{offset} = 5 ppm when Set NO range = 0 - 207 ppm when Set NO range = 0 - 4010 ppm when Set NO range = 0 - 80.

- End of the Troubleshooting Guide -

**If the problem can't
be corrected using
the above
information**

Contact Datex-Ohmeda Technical Support at the number listed on the back cover of this manual if the problem can't be corrected using the above suggestions.

**If the INOvent
delivery system must
be returned for
servicing**

1. Disconnect the items indicated in figure 9-1 from the front and back of the unit.

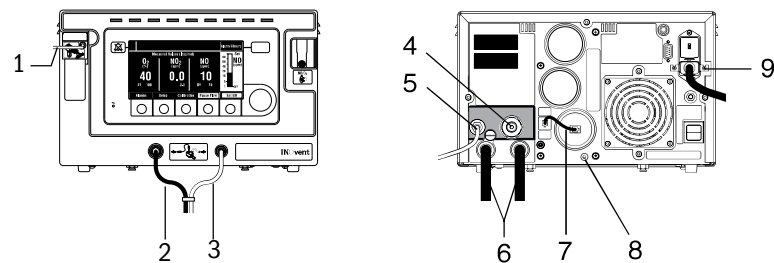

1. Inspiratory Gas Sample Line.
2. Injector Module Electrical Cable.
3. NO/N₂ Injector Tube.
4. Tubing to the pressure compensated O₂ Flowmeter.
5. Resuscitator Bag O₂ tubing.
6. NO/N₂ Input Hoses (2).
7. O₂ Sensor Electrical Cable.
8. Slotted locking screw (loosen if installed on a cart).
9. Loosen and remove the Power Cord.

Figure 9-1 • INOvent delivery system, front view

2. Pack the INOvent delivery system and the accessories as requested by the Datex-Ohmeda authorized representative.
 - Use the original or service loaner packaging materials to protect the system during transit back to Datex-Ohmeda.
3. Make sure the outside of the box is labeled:
"FRAGILE, HANDLE WITH CARE."
4. Send the unit to the attention:
"Care of (name of Datex-Ohmeda-authorized representative)."

Notes:

10/Maintenance

In this section

User maintenance schedule	10-2
INOvent delivery system cleaning	10-4
Injector Module sterilizing and disinfecting	10-5
Autoclave sterilizing	10-5
High level disinfecting	10-5
Patient Circuit Adapters & Sample Line.	10-6
Monthly System Checkout	10-7
1. Initial connections leak tests	10-7
2. Purge and system alarms tests	10-10
3. Calibration and monitoring alarms	10-12
4. INOvent delivery system performance.	10-14
5. Manual NO delivery system purge and performance	10-15
Emptying the Fluid Trap Bottle.	10-17
Replacing the Fluid Trap Filter Cartridge.	10-18
Replacing the NO ₂ Sensor	10-19
Replacing the NO Sensor	10-20
Replacing the O ₂ Sensor	10-22
Cleaning or replacing the Cooling Fan Filter	10-23
Fuse replacement and line voltage selection.	10-24
Replacing the high pressure hose CGA626 connector tip. .	10-26

User maintenance schedule

⚠CAUTION To help prevent fire, use only lubricants approved for O₂ equipment, such as KRYTOX. Don't use lubricants which contain oil or grease: they burn or explode in high O₂ concentrations. All covers used on the system must be made from antistatic materials. Static electricity can cause fires.

Refer to the applicable ventilator and humidifier manuals for instructions on their use.

Frequency	Maintenance
Daily	<ol style="list-style-type: none"> 1. Check the supply cylinder pressure: a cylinder with less than 200 psig should be replaced. 2. Check the NO reading against the NO setting. Calibrate as needed. 3. Do the low range calibration of NO, NO₂ and O₂. See section 4/Calibration. 4. Clean the external surfaces. 5. Make sure the connectors, hoses and cables are satisfactory.
Start of each patient	Do the Pre-Use Procedures.
During use	<ol style="list-style-type: none"> 1. Check the supply cylinder pressure: a cylinder with less than 200 psig should be replaced. 2. Check the NO reading against the NO setting. Calibrate as needed. 3. Empty the fluid trap as needed.
Between each patient	<ol style="list-style-type: none"> 1. Sterilize the reusable components. 2. Replace the single patient use items. 3. Make sure that the delivery system power cord is always plugged into an emergency-power-backed electrical outlet.
Weekly	Check the cooling fan intake at the back to be sure there is no air blockage. Replace or clean the cooling fan filter if it is contaminated with dirt or dust. See section 10/Maintenance.
Monthly	Do the "Monthly System Checkout" described later in this section.

Frequency	Maintenance
Annually	<p>Use this procedure to check the battery:</p> <ol style="list-style-type: none"> 1. Plug the INOvent delivery system power cord into a functioning, grounded electrical outlet. 2. Make sure that the ON/STANDBY switch is in the STANDBY position and the green power indicator on the front panel is ON. 3. Make sure that the system is connected to the electrical outlet for at least ten hours to charge the battery. 4. After at least ten hours, disconnect the power cord from the electrical outlet. 5. With the ON/STANDBY at ON make sure the system operates from the battery for at least 20 minutes. 6. Repeat steps 1 through 3 to recharge the battery before doing the Pre-Use Procedures. 7. Connect the system to the electrical outlet for at least ten hours to have at least a twenty minute battery-operation time available when next using the system on a patient.

INOvent delivery system cleaning

⚠CAUTION Make sure that the unit is completely dry before using it.

Use the cleaning solution sparingly and apply only with a cloth wetted with the solution.

Don't let liquid get into the enclosure.

Don't saturate the INOvent delivery system. Excessive solution may flow into the system and damage internal components.

Don't use organic, halogenated, or petroleum based solvents, anesthetic agents, glass cleaners, acetone, or other harsh cleaning agents.

Don't use abrasive cleaning agents (such as steel wool, silver polish or cleaner.)

Don't touch, push or rub the display panel with abrasive cleaning compounds, brushes, rough surface materials or anything which can scratch the panel. Don't use organic solvents to clean the display panel.

Don't attempt to clean internal parts of the Injector Module other than by autoclaving or high level disinfecting.

Item	Cleaning Procedure
External surfaces	<ul style="list-style-type: none">• Disconnect the power before cleaning.• The delivery system enclosure exterior can be cleaned using a damp soft cloth. If necessary, a mild detergent may be used to remove stains. Use a moist cloth and a neutral detergent.• Clean the outer surface of the INOvent delivery system with a soft cloth dampened in a mild soap and water solution or isopropyl alcohol (70%.)• The delivery system is not autoclavable: don't autoclave it.
Display panel	Use a cotton swab saturated with 70% isopropyl alcohol and gently wipe the panel.

⚠CAUTION Don't autoclave or gas sterilize the INOvent delivery system.
Don't clean with the power connected.

Injector Module sterilizing and disinfecting

⚠CAUTION Don't sterilize or disinfect with the power connected.

Autoclave sterilizing

1. Disconnect the electrical cable and the injector tube from the Injector Module before autoclaving.
 - The module can withstand 134 °C for up to three minutes at 27 psi.
 - If you have questions about a sterilizing agent, refer to the agent manufacturer's data. Read the sterilization equipment user manual.

2. After sterilization, examine the parts. Parts which are broken, visually worn, distorted or discolored should be replaced immediately.

High level disinfecting

1. Fill a container with ethyl alcohol (70% by volume.)

2. Totally submerge the Injector Module in the alcohol for at least 30 minutes.

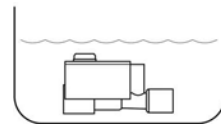

AA69347

3. To remove contamination if lint or fibers were noticed wrapped around the hot wire sensor in the module, gently agitate the module to splash the alcohol through the module openings.

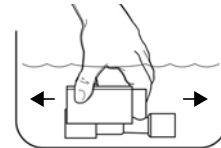

AA69348

⚠CAUTION Do not try to physically remove the fibers from the extremely delicate sensor.

Do not insert anything into the module throat to remove contamination or to dry.

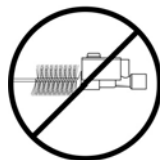

AA69351 AA69352

4. If rinsing is required, **use distilled water only.**
5. When removing the module from the liquid, dump the excess alcohol from the module's
 - electrical connector,
 - injector port and
 - inside flowmeter.

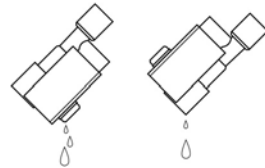

AA69349

6. Allow any liquid to evaporate completely before using the module.
 - Using low air pressure to dry the module or remove lint fiber is acceptable.

Important: If lint or fibers remain wrapped around the hot wire sensor in the module after drying, do not use the module: remove it from service.

Patient Circuit Adapters & Sample Line

These are single-patient use items. Do not sterilize them.

Monthly System Checkout

Important This system checkout **must** be done monthly. It calibrates the monitoring system, validates the delivery systems for accuracy and verifies that the alarm system operates correctly.

This monthly system checkout consists of:

1. Initial connections and leak tests.
2. Purge and system alarms tests.
3. Calibration and monitoring alarms.
4. INOvent delivery system performance.
5. Manual NO delivery system purge and performance.

Following are the five Monthly Systems Checkout procedure descriptions.

1. Initial connections and leak tests

1. Check that the INOvent delivery system is connected as described in section 3/Setup. The Injector Module does not have to be connected to a ventilator.
2. Check the cables and hoses for signs of wear or damage and replace as needed.
3. Turn the INOvent delivery system to ON and make sure the buzzer and the speaker sound. Wait for the start-up routine to finish.
4. Do a system high pressure leak test:
 - a. With the INOvent delivery system ON, turn each cylinder valve ON then OFF.
 - b. Check for adequate cylinder pressures.
 - c. Wait for 30 seconds and check for pressure decrease.

INOvent delivery system

- d. If there is any decrease,
 - Make sure that the auxiliary oxygen flowmeter to the Manual NO System is not turned on and
 - Check for leaks around the hose connections using soapy water.
- e. Check for leaks at the NO cylinder valve outlet connection with soapy water.

Note: the pressure drop leak test will not detect leaks at the cylinder valve outlet connection because of the check valve in the regulator hose.

5. Do a low pressure system leak test. This test checks for leaks in the low pressure circuit of both:
 - the main INOvent delivery system and
 - the Manual NO delivery system.
 - a. Refer to figure 10-1. Disconnect the oxygen tubing from the resuscitator bag.
 - b. Connect the oxygen tubing to the Injector Module using a 4.5 mm to 15 mm adapter.
 - c. Connect a squeeze bulb tester to the Injector Module output port.
 - d. Squeeze the bulb several times. The bulb must stay collapsed for 30 seconds.
 - e. Remove the squeeze bulb from the Injector Module outlet.

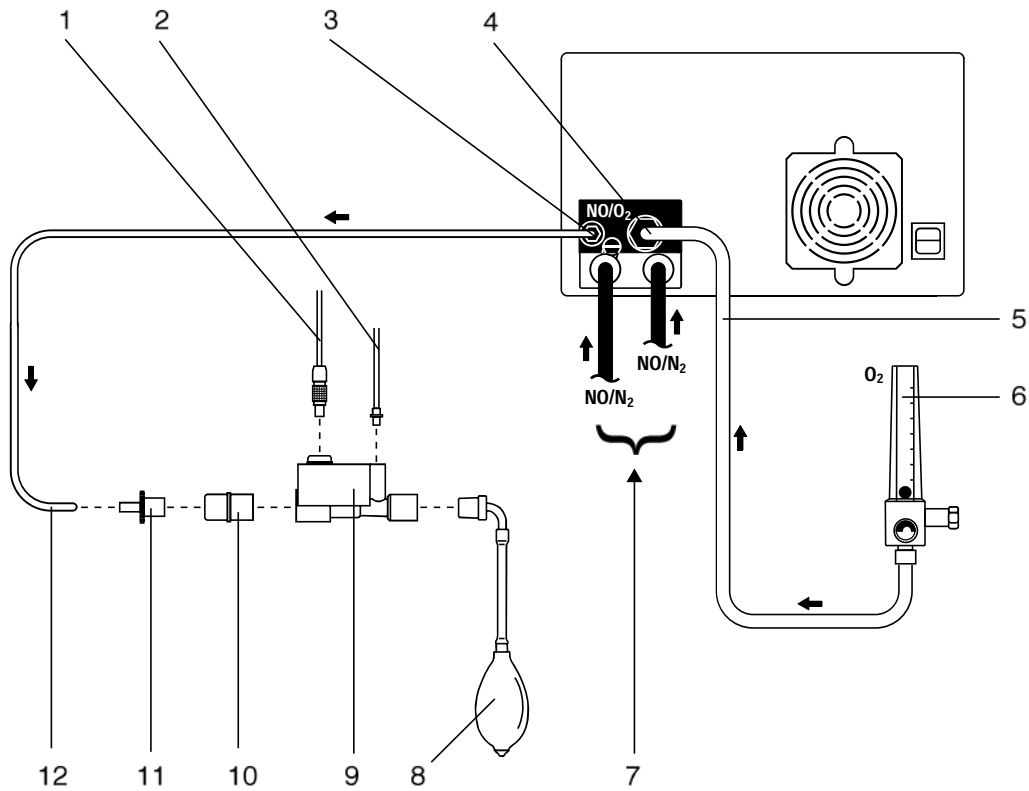

AA.69.144

- 1 Injector Module Electrical Cable
- 2 NO/N₂ Injector Tube
- 3 NO/O₂ outlet
- 4 O₂ Inlet
- 5 O₂ supply hose from the O₂ flowmeter
- 6 Pressure Compensated O₂ flowmeter
- 7 NO/N₂ input hoses from regulators
- 8 Squeeze Bulb tester
- 9 Injector Module
- 10 22M / 15F x 22M / 15F Adapter
- 11 15M x 4.5 mm Adapter
- 12 O₂ Tubing

Figure 10-1 • Low pressure system leak test connection diagram

2. Purge and system alarms tests

These tests purge the NO regulators, the high pressure hoses, the INOvent injector tube and the Manual NO delivery system of NO₂ or air which may have gotten into the system. They also test the main system alarms.

1. Refer to figure 10-2. Connect the sample tee to the outlet of the Injector Module with 300 mm of 22 mm hose to ensure gas mixing before gas sampling.
2. Attach a sampling line from the sample tee to the sample connector on the front panel,
3. Attach the O₂ flowmeter to the Injector Module inlet.

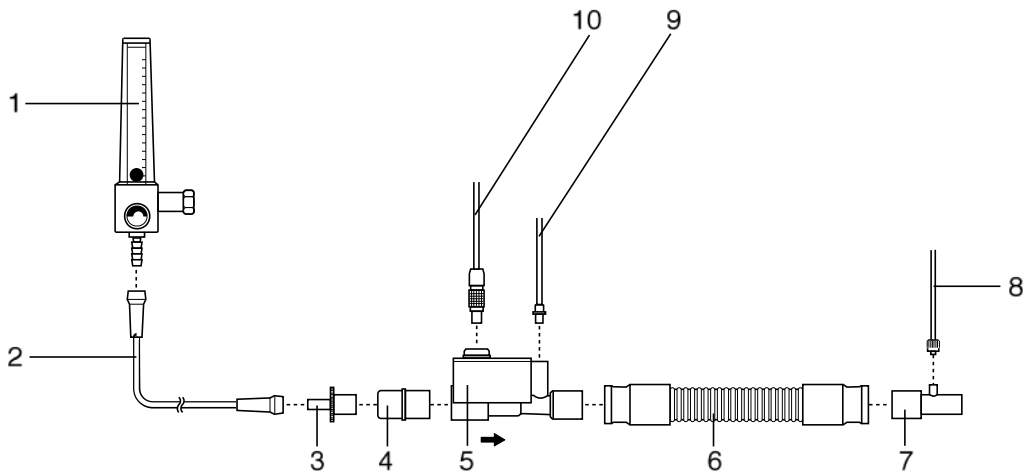

LA.69.032

- 1 O₂ Flowmeter
- 2 O₂ Tubing
- 3 15M x 4.5 mm Adapter
- 4 22M / 15F x 22M / 15F Adapter
- 5 Injector Module
- 6 300 mm of 22 mm hose
- 7 Sample Tee
- 8 Inspiratory Gas Sample Line
- 9 NO/N₂ Injector Tube
- 10 Injector Module Electrical Cable

Figure 10-2 • Circuit connections for purge and performance test

4. Make sure both NO cylinders are turned off.
5. Set the oxygen flow to 15 L/min.

6. Set the Set NO concentration to its maximum setting.
7. Make sure both cylinder pressure gauges go to zero to purge both high pressure circuits.
8. Check that the NO₂ value is higher than 0.2 ppm to verify that the NO₂ monitor is functional.
9. Make sure the following alarms occur. (This may take a few minutes depending on the cylinder pressures at the start of the test.)

“Low NO/N₂ Pressure” “Delivery Failure”
10. When the alarms have occurred, turn on the NO cylinder with which you intend to start therapy and leave the other cylinder turned off.
11. Set the O₂ flow rate to 5 L/min.
12. Set the Set NO to 5 ppm.
13. Disconnect the injector tube from the INOvent front panel outlet connector
14. Disconnect the sample line from the sample tee.
15. Hold the sample line close to the outlet in order to sample the gas coming from the injector tube connector on the INOvent front panel.
16. As the monitored NO value rises, make sure the following alarms occur.

“High NO” “System Shutdown”
17. Turn the system to STANDBY (o) and then ON (o) to reset the system.
18. Reconnect the injection tube to the front panel of the INOvent delivery system.
19. Reconnect the sample line to the sample tee on the Injector Module.

3. Calibration and monitoring alarms

1. Start with the connections as they are at the end of "Purge and system alarms tests" above.
2. Set the flow on the O₂ auxiliary flowmeter to 5 L/min.
3. Do an O₂ sensor high range calibration. (See section 4/Calibration.)
4. Leaving the sample line connected, exit the calibration window and go to the Alarms menu and note its present value.
5. Set the "High O₂" alarm to 95 %v/v. Make sure that the "High O₂" alarm occurs.
6. Return the "High O₂" alarm setting to its previous value.
7. Do a low range calibration of the NO, NO₂ and the O₂ sensors. (See section 4/Calibration.)
8. Do an NO sensor high range calibration. (See section 4/Calibration.)
9. Leaving the sample line connected to the NO calibration gas cylinder, exit the calibration window.
10. Go to the Alarms menu and note its present value.
11. Set the "High NO" alarm below the calibration gas value. Make sure that the "High NO" and "Low O₂" alarms occur.
12. Return the "High NO" alarm setting to its previous value.
13. Do an NO₂ sensor high range calibration. (See section 4/Calibration.)
14. Leaving the sample line connected to the NO₂ calibration gas cylinder, exit the calibration window and make sure that the "High NO₂" alarm occurs.
15. Reconnect the sample line to the sample tee on the Injector Module.

16. On the Alarms menu, note its present value.
17. Set the Low NO alarm limit to 5 ppm and confirm that the Low NO alarm occurs.
18. Return the Low NO alarm limit setting to its previous value.

1

4. INOvent delivery system performance

1. Start with the connections as they are at the end of “Calibration and monitoring alarms” above.
2. Set the O₂ flow on the auxiliary flowmeter to 15 L/min.
3. Set the Set NO to 10 ppm.
4. Make sure that the NO reading is within the acceptable range of 2 to 18 ppm.
5. Increase the Set NO concentration to 40 ppm.
6. Make sure that the NO reading is within the acceptable range of 32 to 48 ppm.
7. Make sure that the NO₂ reading is less than 1.5 ppm.

5. Manual NO delivery system purge and performance

⚠ WARNING The Manual NO delivery system must be set up and available at all times.

⚠ CAUTION Supplemental O₂ should only be turned on and used when the manual delivery system is in use.

Refer to figure 10-3 for these connections.

1. Connect O₂ tubing (user-supplied) to the NO/O₂ output connector on the back of the INOvent delivery system.
2. Connect a 22 mm / 15 mm sample tee (with the gas sample line connected) to the oxygen tubing using a 15M x 4.5 mm adapter.

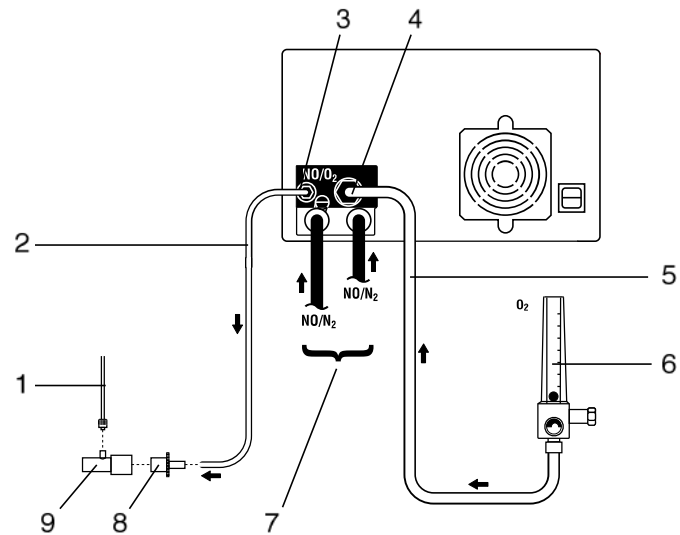

- 1 Inspiratory Gas Sample Line
- 2 Oxygen tubing (user supplied)
- 3 NO/O₂ outlet
- 4 O₂ inlet
- 5 O₂ supply hose from the O₂ flowmeter
- 6 Pressure Compensated O₂ flowmeter (user supplied), shown set to OFF (no float activity)
- 7 NO/N₂ input hoses from the regulators
- 8 15M x 4.5 mm Adapter
- 9 Sample Tee

Figure 10-3 • Sample tee connection to the Manual NO delivery system

INOvent delivery system

3. Connect a Pressure Compensated (PC) O₂ flowmeter (user supplied) to an O₂ supply (wall or cylinder.) The flowmeter must have a male O₂ DISS outlet.
4. Connect the O₂ hose supplied with the INOvent delivery system to the flowmeter outlet and to the O₂ inlet connector on the back of the INOvent delivery system.
5. Flow 15 L/min of O₂ from the auxiliary O₂ flowmeter into the Manual delivery system and make sure the float moves to the middle of the NO Flow Indicator Window.
6. Wait for the gas to flow through the oxygen tubing.
 - a. Make sure that the NO reading is 20 ± 8 ppm and the NO₂ reading is less than 1.0 ppm.
 - b. If the NO₂ reading is greater than 1.0 ppm, continue flowing gas until the limit is reached.
7. Reduce the O₂ flow to 1 L/min and make sure that the float drops to the bottom of the NO Flow Indicator.
8. Set the O₂ flow to zero.
9. Disconnect the sample tee and 15M x 4.5 mm adapter from the oxygen tubing.
10. Reconnect the resuscitator bag to the oxygen tubing.

- End of the Monthly System Checkout -

Emptying the Fluid Trap Bottle

⚠WARNING When handling any component of the patient circuit that comes in contact with the patient's exhalant gas or fluids, wear safety eyeglasses, gloves, mask and gown.

The fluid trap on the front of the system (see figure 10-4) collects fluids separated from the patient sample.

You must empty and clean the fluid trap before each patient or whenever the trap is more than half full. Allowing it to fill and overflow during a case may cause system errors. A water-bottle-full message will remind you to remove the trap bottle for emptying if it gets full.

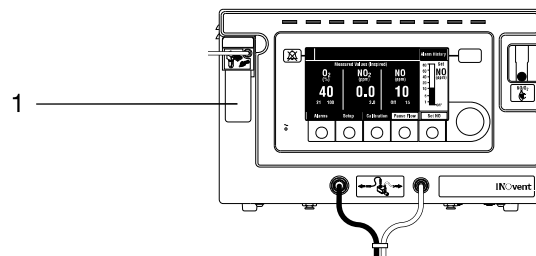

AA-69.034

1. Fluid Trap Bottle

Figure 10-4 • Fluid Trap Bottle location

To empty the Fluid Trap bottle

1. Remove the bottle by pulling it straight down.
2. Empty the contents into a patient wastes receptacle.
3. Clean the bottle.
4. The sealing O-rings must be lubricated if needed only with Vac Kote or KRYTOX (lubricants specified safe for use in an oxygen enriched environment).
5. Replace the bottle by pushing it up into position.
6. Check for leaks by:
 - a. Running the system,
 - b. Occluding the sample line and
 - c. Noting that the monitor purges within 5 seconds.

Replacing the Fluid Trap Filter Cartridge

⚠ WARNING When handling any component of the patient circuit that comes in contact with the patient's exhalant gas or fluids, wear safety eyeglasses, gloves, mask and gown.

If there is a "Sample Line/Filter Block or Monitoring Failure" message, the fluid trap filter cartridge may have to be replaced.

The disposable fluid trap filter cartridge on top of the Sample Inlet on the front of the system (see figure 10-5) protects the system sensor from moisture and other contaminants.

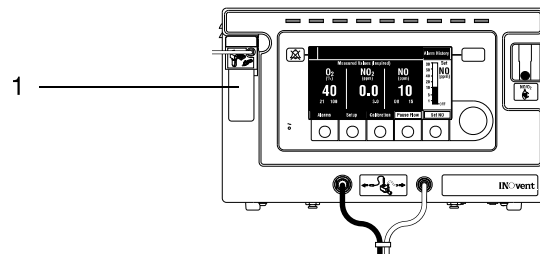

1. Fluid Trap Filter Cartridge

Figure 10-5 • Fluid Trap Filter Cartridge location

To replace the Fluid Trap Filter Cartridge

1. Grasp the cartridge on both sides and gently pull it forward, away from its pins on the front panel.
2. Discard a used cartridge in a receptacle designated for patient wastes.
3. To replace the cartridge, just line it up with the pins and push it into place until it seats properly.
 - A replacement cartridge stock number is shown in section 11/ Parts and Accessories.
4. Check for leaks by:
 - a. Running the system,
 - b. Occluding the sample line and
 - c. Noting that the monitor purges within 5 seconds.

Replacing the NO₂ Sensor

⚠WARNING Handle and dispose of sensors according to your biohazard policies. Do not incinerate.

The NO₂ sensor is located on the back of the INOvent delivery system (see figure 10-6.)

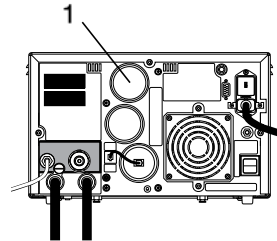

1. NO₂ Sensor

Figure 10-6 • NO₂ sensor location

To replace the NO₂ sensor

1. Remove the NO₂ sensor cover by turning it counterclockwise and pulling it out.
2. Grasp the NO₂ sensor on both sides and gently pull it from its socket.
3. To install the replacement sensor:
 - a. Remove its shorting jumper,
 - b. Align its pins with the socket,
 - c. Press it into place.
 - A replacement sensor stock number is shown in section 11/Parts and Accessories.
4. To replace the NO₂ sensor cover, make sure the sensor cover O-ring is present. Insert the cover and turn it clockwise to tighten.
5. Calibrate the NO₂ sensor (see section 4/Calibration) before returning the system to use.

Replacing the NO Sensor

⚠ WARNING If you change an NO sensor while delivering NO to a patient, install the NO sensor only when the NO High Range Calibration menu is displayed, otherwise the system will shut down.

Handle and dispose of sensors according to your biohazard policies. Do not incinerate.

The NO sensor is on the back of the INOvent delivery system (see figure 10-7.)

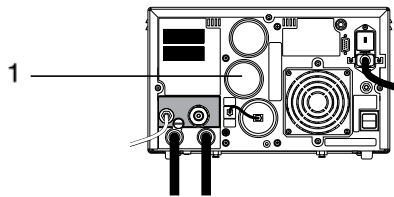

1. NO Sensor

Figure 10-7 • NO sensor location

If you change the NO sensor while delivering NO to a patient, install the sensor only when the NO High Range Calibration menu is displayed, otherwise the system will shut down.

If you're replacing the sensor with the system in STANDBY or not connected to wall power, follow steps 3 through 7.

To replace the NO sensor

1. Press Calibration to reach the Calibration menu.
2. On the Calibration menu turn the control wheel to highlight the NO selection of "High Range (cal. gas)" (example shown in figure 10-8.)

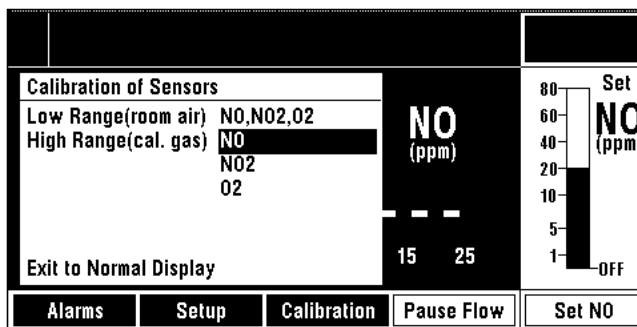
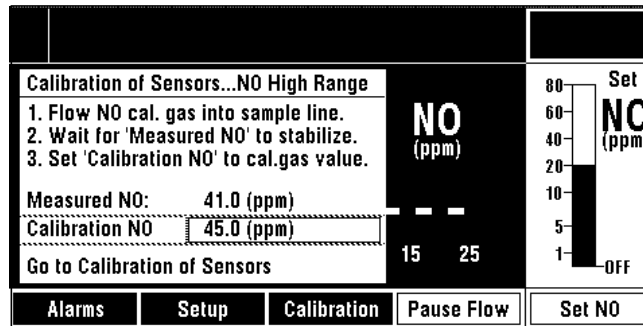

Figure 10-8 • Calibration menu - high range NO sensor calibration option highlighted

- Push the control wheel to display the NO high range calibration menu. A display similar to figure 10-9 appears.



510k_15.tif

1

Figure 10-9 • High range calibration menu example - Calibration NO adjusted to 45 ppm

- Remove the NO sensor cover by turning it counterclockwise and pulling it out.
- Grasp the NO sensor on both sides and gently pull it from its socket.
- To install the replacement sensor, align its pins with the socket and press it into place.
 - A replacement sensor stock number is shown in section 11/Parts and Accessories.
- To replace the NO sensor cover, make sure the sensor cover O-ring is present. Insert the cover and turn it clockwise to tighten.
- Follow the instructions on the NO High Range calibration menu to calibrate the sensor before returning the system to use.

Note: A newly installed NO sensor needs up to 45 minutes for conditioning before a calibration will stabilize. Otherwise, very high NO readings will result, causing a system shutdown.

Replacing the O₂ Sensor

⚠ WARNING Handle and dispose of sensors according to your biohazard policies. Do not incinerate.

⚠ CAUTION Don't lose the O₂ sensor o-ring.

The O₂ sensor is located on the back of the INOvent delivery system (see figure 10-10.)

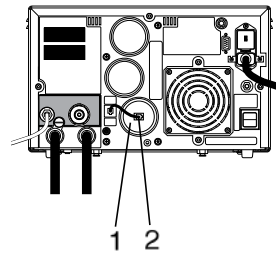

AA.69.147

1. O₂ Sensor
2. O₂ Sensor Cable Connector

Figure 10-10 • O₂ sensor location

To replace the O₂ sensor

1. Squeeze the O₂ Sensor Cable connector and pull it out from the center of the O₂ sensor.
2. Hold the O₂ sensor on both sides, turn it counterclockwise and gently pull it out.
3. To install the replacement O₂ sensor, place it into the socket and turn it firmly into place.
 - A replacement sensor stock number is shown in section 11/Parts and Accessories.
4. Replace the cable connector.
5. Calibrate the O₂ sensor before returning the system to use.

Note: A newly installed O₂ sensor needs up to 45 minutes for conditioning before a calibration will stabilize. Otherwise, very high O₂ readings will result, causing a system shutdown.

Cleaning or replacing the Cooling Fan Filter

⚠CAUTION Don't cover or block the cooling fan.

The cooling fan at the back of the delivery system (see figure 10-11) provides air circulation to help protect the heat-sensitive electronic components. Check the cooling fan intake on a weekly basis to be sure there is no blockage.

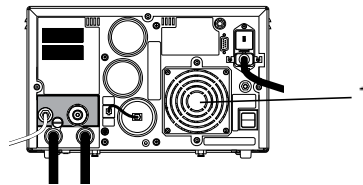

1. Cooling Fan Filter and intake

Figure 10-11 • Cooling fan intake and filter holder location

To clean or replace the fan filter

1. Push the ON/STANDBY control to STANDBY and remove the power cord from the power source.
2. Remove the flexible plastic fan filter holder by gently bending it out on one side.
3. Remove the exposed filter from the fan guard.
4. Vacuum or wash the filter in a solution of soap and water.
5. Thoroughly dry the filter. If the filter is worn or difficult to clean, replace it with a new filter.
6. Clean or vacuum the fan grill area and the filter holder to remove any accumulated lint and dust.
7. Install the filter and push the plastic fan filter holder into place.
8. Connect mains power to the system.
9. Check that the fan is not obstructed, is operating properly and is pulling air into the system enclosure.

Fuse replacement and line voltage selection

⚠ WARNING For continued protection against hazard, replace the fuses only with the correct fuse type and rating.

The power entry module on the back of the system (see figure 10-12) contains a voltage selector cartridge and two power input fuses.

The voltage selector cartridge (marked with various voltages) inside the module allows matching the system input voltage requirements to the available local line voltage. When this cartridge is correctly installed, the local line voltage shows in the module window and no adjustment is needed.

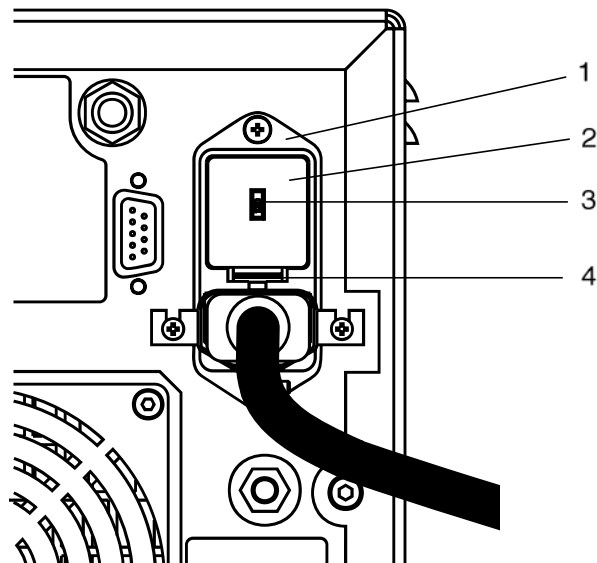

AA.09.267

1. Power Entry Module
2. Power Entry Module Cover
3. Power Entry Module Window
4. Power Entry Module Cover Latch

Figure 10-12 • Power Entry Module

To replace a fuse or change the line voltage selection

1. Turn the INOvent delivery system to STANDBY and remove the power cord from the power source.
2. Note the voltage indication in the power input module window. This marking should match the voltage available at the wall power receptacle.

3. Use a small, straight-blade screwdriver to gently pry up on the power input module cover latch and pull the cover out. The cover is also a fuseholder and the fuses come out with the cover.
 - Don't disturb the voltage selection cartridge. If it slips out of position, replace it so that the marked voltage noted in step 2 will face outward be displayed through the cover window when it is closed.
4. If you are replacing the fuse(s), remove the old fuse(s) and replace with the correct similarly rated fuse. (See the Fuse Kit in section 11/ Parts and Accessories or the fuse values in section 12/Appendix A - Specifications.)
5. If you are changing the voltage selection, gently pull the voltage selection cartridge out and reinsert it with the correct local line voltage indication facing outward.
6. Making sure the fuses are straight in the module cover, insert it back into the power input module. It must snap into place when pushed in.
7. Verify that the voltage indication in the module window is same as the voltage available at the wall power receptacle.
8. Replace the power cord and test the delivery system for proper operation.

1

Replacing the high pressure hose CGA626 connector tip

The high pressure hose CGA626 connector has a replaceable tip. See figure 10-13.

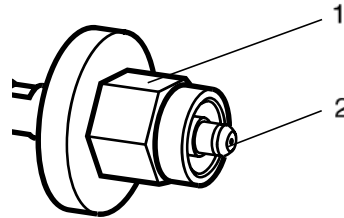

1. High pressure hose CGA626 connector
2. High pressure hose connector tip

Figure 10-13 • Power Entry Module

If the tip is worn or damaged, it should be replaced to make sure there is a proper seal at the therapy gas cylinder connection.

To replace the CGA626 connector tip

1. Disconnect both high pressure hoses from the therapy gas cylinders.
2. Remove the connector tip by pulling on the tip while turning it counterclockwise.
3. Thoroughly clean out the connector threads.
4. Squeeze the four flexible prongs on the replacement tip by squeezing two prongs at a time using only your fingers. This will help start the new tip into the threads.
5. Turn the replacement tip into the connector threads.
6. When the replacement tip is fully in, it should turn freely. You should not be able to remove it by just turning it counterclockwise.

11/Parts and Accessories

In this section	Standard accessories	11-2
	Optional accessories	11-2
	Replaceable parts	11-3

Standard accessories

Item	Stock number
Adapter, 22M / 15F x 22M / 15F	1605-3134-000
Adapter, 15M x 4.5 mm ID	1605-3138-000
Adapter, 22F x 15M	1605-3137-000
Adapter, 22M / 15F x 15M with gas sampling tee	1605-3133-000
Adapter, one-way valve, 22F x 22M	1605-3139-000
Cable, Injector Module	1605-3057-000
Cartridge, Water Separator, package of 25	6050-0001-772
Clip, cable management	1605-3128-000
Hose, O ₂ , DISS to DISS	1605-3129-000
Injector Module (two supplied)	1605-3038-000
Sample Line, standard, package of 10	78010
Sensor, NO	6050-0004-318
Sensor, NO ₂	6050-0004-319
Sensor, O ₂	6050-0004-110
Squeeze bulb leak tester	0309-1319-800
Tubing assembly, NO injector, package of 10	1605-3044-000

Optional accessories

Item	Stock number
INOvent delivery system Cart, CGA 626	1605-8002-000
Cabinet, Cart storage, kit	1605-8017-000
Dual Hook (use with Post)	1605-3083-000
Flowmeter Kit, pressure-compensated O ₂ with dovetail adapter	1010-8017-000
O-Ring Kit, External, includes: (2) Water Separator Bottle O-Rings, (1) cell cap O-Ring, (1) O ₂ cell O-Ring	6050-0004-911
Post, 1 inch diameter, dovetail mount	0216-6819-800
Purge Manifold kit, Nitric Oxide	1605-8012-000
Regulator, INOvent transport, CGA 626	1605-8011-000
Regulator, Wall Mount CGA 626	1605-8005-000
Sample tee, O ₂ tubing, pkg. of 10	1605-3171-000

Replaceable parts

Item	Stock number
Cord, Power, NEMA 5-15P w/IEC320 Connector	1605-3047-000
Filter, Fan	0208-2734-300
Fuse, Power Entry Module, 5 mm x 20 mm, T2.0A/L250V	1503-3073-000
Pad, rubber, cylinder support, for optional Cart	1605-3000-000
Paint, touch-up, Arctic White	1001-3363-000
Strap, cylinder	1605-3003-000
Tip, CGA626, PCTFE Nitric Oxide	1605-3149-000
Water Separator Bottle	6050-0000-847

Notes:

12/Appendix A - Specifications

Note: All specifications in this manual are nominal.

In this section

Functional	12-2
Ventilator compatibility	12-2
Adult Ventilators	12-2
Anesthesia Ventilators	12-2
Neonatal Ventilators	12-2
High Frequency Oscillatory Ventilators	12-3
Transport Ventilators	12-3
Manual Resuscitator Breathing Systems	12-3
Injector Module	12-3
Manual NO delivery system	12-3
NO delivery	12-4
Maximum NO delivery	12-4
Gas monitoring	12-5
Calibration Gas cylinders	12-5
Calibration Gas regulator	12-5
NO delivery shutdown	12-5
Physical	12-6
Dimensions	12-6
Environmental	12-7
Electrical	12-8

Functional

Ventilator compatibility

⚠ WARNING Patient disconnect and high pressure alarms are required for the ventilator.

The INOvent delivery system is compatible with most types of ventilators by connecting into the inspired limb of a patient's breathing circuit. The system measures the gas flow in the breathing circuit and then injects NO/N₂ gas to produce the selected NO concentration in ppm.

The INOvent delivery system has been validated against the following ventilators.

Adult Ventilators

Bear 1000
Dräger Evita 2
Dräger Evita 4
Puritan Bennett 7200
Siemens Servo 300
Siemens Servo 900C

Anesthesia Ventilators

Datex-Ohmeda 7800
Datex-Ohmeda 7900
Datex-Ohmeda Aestiva Ventilator
North American Dräger Narcomed A-VE

Neonatal Ventilators

Bear 750vs (Cub)
Bear BP2001 (Cub)
Bird VIP
Dräger Babylog 8000
Infrasonics Infant Star (not HFV mode)
Infrasonics Infant Star 500
Newport Wave
Sechrist IV-100B

High Frequency Oscillatory Ventilators

SensorMedics 3100A

Transport Ventilators

BIO-MED MVP-10
Infrasonics Infant Star 100

Manual Resuscitator Breathing Systems

Hudson RCI Hyperinflation 1L Adult #5404
Hudson RCI Hyperinflation .5L Neonatal #5403
Nellcor-Puritan Bennett Self-inflating 1.76L Adult #655005
Nellcor-Puritan Bennett Self-inflating .52L Infant #616416

	Measure	Neonatal	Adult
Inspiratory flow rate:	L/min	4 - 55	4 - 120
Max. oxygen dilution:	%v/v	10	5
Respiratory rate:	bpm	6 - 60	6 - 60
Airway peak pressure:	cm H2O	0 - 70	0 - 70
PEEP:	cm H2O	0 - 20	0 - 20

Injector Module

Conical connectors:	Inlet, 22 mm female.Outlet, 22 mm male and 15 mm female.
Cleaning and sterilizing:	See "Cleaning" and "Sterilizing" in section 10/Maintenance.
Maximum pressure drop:	1.5 cm H2O at 60 L/min.

Manual NO delivery system

Compatible with pressure-compensated flowmeters capable of adjustment to 15 L/min flow.

Manual NO delivery NO₂ and NO acceptable reading range:

	NO Cylinder Concentration ppm:	800	100
Manual NO delivery ppm:		20	2.5
Tolerance:		±8	±1
Max NO ₂ reading:		1.0	0.5

Note: These acceptable readings include the errors of the NO delivery system and the NO therapy gas.

NO delivery

Direct setting of NO (in ppm) with constant concentration throughout the breath.

System warm-up:	1 minute to operation; 5 minutes to stability.
NO delivery:	Only when there is gas flow in the breathing circuit.
NO injection:	Into the inspiratory limb of the breathing circuit.
NO concentration:	Delivered independent of ventilation changes.
NO delivery pause:	120 seconds.
Set NO range:	0 - 80 ppm.
Set NO resolution:	0.1 to 1 ppm depending on the NO range.
Accuracy:	±10% of full scale at 20 °C.
NO inlet pressure:	40 - 90 psig (276 - 621 kPa)
Breathing circuit gas composition:	Air / O ₂ mixtures.

Maximum NO delivery

	NO Cylinder Concentration:	
	800	100
Ventilator flow @ 4-55 L/min:	80 ppm	10 ppm
Ventilator flow @ 4-120 L/min:	40 ppm	5 ppm

NO/N₂ cylinder concentration accuracy: ± 5 %.

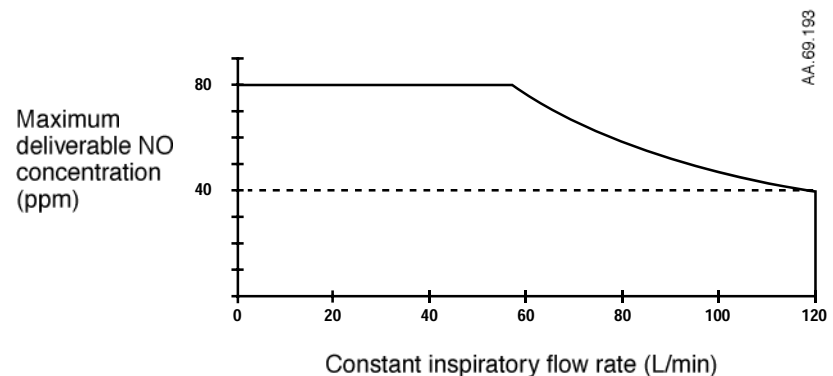

Figure 12-1 • Maximum deliverable NO concentration vs Constant inspiratory flow rate

Gas monitoring

Gas	Range	Resolution
Nitric Oxide:	0 - 10 ppm	0.1
	10 - 100 ppm	1
Nitrogen dioxide:	0 - 15 ppm	0.1
Oxygen:	18 - 100 %v/v	1

Accuracy: ± 3 % full scale at 20 °C

Calibration: Daily zero; monthly span.

Rise Time: 30 seconds (10 - 90 %)

Sample flow: 230 mL/min

Note: The monitoring accuracy has been verified only with mixtures of O₂, NO₂, NO, N₂ and water vapor.

Calibration Gas cylinders

		Accuracy
NO Calibration Gas:	40-80 ppm NO	± 4 %
NO ₂ Calibration Gas:	10-15 ppm NO ₂	± 10 %

Calibration Gas regulator

Flow rate to Sample Tee: 400-700 mL/min

Pressure at Sample Tee: < 70 cm H₂O above ambient

NO delivery shutdown

The delivery system stops Nitric Oxide flow under the following conditions.

- NO delivery is greater than 100 ppm.
- Oxygen dilution is greater than 20%v/v.
- NO delivered is greater than two times the maximum NO setting.
- NO delivery system failure.

Physical

Dimensions

Maximum	Delivery system only	Delivery system on optional Cart*
Weight:	18 kg / 39.6 lbs	52 kg / 114.4 lbs
Width and depth:	350 mm W x 400 mm D / 13.8 in x 15.7 in	510 x 600 mm / 20.1 in x 23.6 in
Height:	215 mm / 8.5 in	1410 mm / 55.5 in

*Excluding cylinders

Environmental

	Operating:	Storage:
Temperature:	10 to 40 °C	-15 to +50 °C
Humidity:	20 to 95% RH non-condensing	10 to 95% RH non-condensing
Ambient pressure:	600 to 800 mm Hg	87 to 800 mm Hg

1

Electrical

Input voltage:	• 100-120/220-240 VAC at 50/60 Hz.
Input power:	• 109 VA max.
Input fuse:	• 5 mm x 20 mm, T2.0A/L250V.
Classification:	• ⚡ Class I, Type B.
Standards:	• ETL Certified to meet UL 2601-1 and CSA C22.2 No. 601.1 for medical electrical equipment.
RS 232:	<p>⚠ CAUTION RS 232 cables must be shielded.</p> <ul style="list-style-type: none"> • 9 pin female DSUB connector. • Pin 2 receive; pin 3 transmit; pin 5 ground (isolated.) • 9600 baud, no parity, one stop bit. • One line of data, once per minute, terminated by a carriage return. • Line of data includes: <ul style="list-style-type: none"> a. Time since power ON (hours:minutes); b. O₂ (data and alarm status); c. NO₂ (data and alarm status); d. NO (data and alarm status); e. Set NO (data and pause status); f. Additional alarms status.
Battery backup:	<ul style="list-style-type: none"> • A sealed lead acid battery provides power backup to operate the system for up to 30 minutes when fully charged. • Connect the system to an electrical outlet for at least ten hours to charge the battery. • Dispose of used batteries according to local regulations.
Nurse Call:	<p>⚠ CAUTION Nurse Call cables must be shielded.</p> <ul style="list-style-type: none"> • Refer to the hospital nurse call system operation manual for the proper connection procedure. • Relay isolated. • 1/4 inch stereo phone jack. • Configuration: On high priority alarm or power failure, switch closure between tip and sleeve (open between ring and sleeve.)

13/Appendix B - Cylinder Information

⚠WARNING Use only pharmaceutical grade NO/N₂.

In this section	Preparing the NO therapy gas cylinder for use	13-2
	Replacing the NO therapy gas cylinder	13-3
	NO therapy gas cylinder leak check	13-4
	Cylinder information.	13-5
	Warnings.	13-6

Preparing the NO therapy gas cylinder for use

Only individuals familiar with compressed gases and NO mixtures should handle them.

Store gas cylinders in well-ventilated areas designed to accommodate NO mixtures. The storage area ventilation system must prevent nitric oxide accumulations above the threshold limit value of 25 ppm.

1. Check the cylinder labels for the correct NO concentration.
2. Check the cylinder for external damage such as dents, cuts, gouges, corrosion, bent or broken valve components and a loose neck ring.

Replacing the NO therapy gas cylinder

Replace an NO therapy gas cylinder when its pressure is less than 200 psig.

Refer NO cylinder replacement to the properly qualified individual. Only individuals familiar with compressed gas cylinders and NO mixtures should handle them.

Make sure the replacement cylinder has the correct product identity and component concentration before using it.

To replace the NO therapy gas cylinder:

1. Firmly close the depleted cylinder's valve.
2. Slowly remove the regulator connection from the depleted cylinder.
3. Securely replace the outlet cap if one was attached on the depleted cylinder.
4. Mark the depleted cylinder "EMPTY" and move it to the empty cylinder storage cart and secure it.
5. Check the replacement cylinder for the correct product identity and component concentration. Remove the replacement cylinder from the storage cart.
6. Put the replacement cylinder on the transport cart's cylinder mounting location and secure it with the straps provided or secure it to a wall.
7. Remove the valve outlet cap from the cylinder if one is attached.
8. Securely attach the cylinder pressure regulator or high pressure hose to the new cylinder; make sure the correct seal is present. Keep this cylinder valve closed until necessary for use.

NO therapy gas cylinder leak check

This cylinder gas leak check may be used when an NO therapy gas cylinder is installed into a system and when a leak is suspected.

1. Apply soapy water to the cylinder valve regulator connection, valve joints and safety relief device. Figure 13-1 shows possible cylinder gas leak locations.
2. If bubbles form, there is a leak. A leak detected at the cylinder valve regulator connection may be tightened as long as the valve has not been opened.
 - If a leak is detected which cannot be corrected by tightening the valve regulator connection, the second cylinder should be immediately attached and the second cylinder valve regulator connection checked for leaks.
 - If an NO mixture is leaking at any point other than at the valve-regulator connection, contact your cylinder administrator immediately.

If there are no leaks, the cylinder is ready for use.

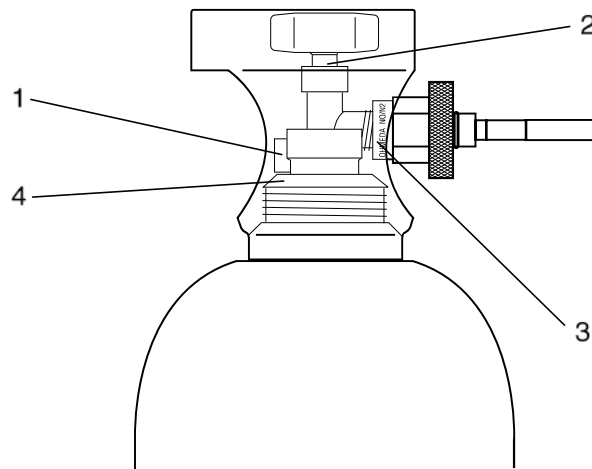

AA.69.141

1. Safety relief device
2. Bonnet nut
3. Cylinder valve regulator connection
4. Neck

Figure 13-1 • Possible cylinder gas leak locations

Cylinder information

Always:

- Check the product label for the correct product.
- Use a properly designed cart to move a cylinder.
- Properly secure a cylinder when moving it.
- Apply a proper pressure regulating device to the cylinder before using it.
- Check the cylinder pressure before each work shift.
- Apply the valve outlet cap and valve protection cap to a cylinder when it is not connected.

Warnings

⚠WARNING:

Always secure a cylinder when not using it.

Never lift a cylinder by its valve or valve protective cap or by using a chain, sling or magnet.

Never drop a cylinder.

Never use a hammer, pry or wedge to loosen a valve or protection cap. The valve and protection cap should operate by hand.

Never let oil, grease or other combustible come in contact with a cylinder or valve.

Never remove or deface cylinder labeling or markings.

Never modify equipment without first contacting Datex-Ohmeda.

Never use an adapter to connect a cylinder to the System.

Never use equipment not designed to use NO mixtures.

Never attempt to repair a leak on a cylinder valve or its safety relief device.

Never operate equipment that is leaking.

Never ship a leaking cylinder.

Never store cylinders:

- **where damage can result from the elements, such as standing water or temperatures over 125 °F.**
- **where they can contact artificially low temperatures.**
- **where they can contact corrosive substances.**
- **where they can be cut or abraded by an object.**
- **next to a walkway, elevator or platform edge.**
- **unless they are properly secured.**

14/Appendix C - Pre-Use Procedures Card

The Pre-Use Procedures card is printed separately and must be kept with the INOvent delivery system.

14

INOvent delivery system

Notes:

15/Appendix D - Transport INOvent delivery system

In this section

Description	15-2
Battery operation information.....	15-2
Setup	15-4
Regulator connection diagrams.....	15-4
Operation	15-5
Maintenance	15-6
User maintenance schedule	15-6
Replaceable parts and accessories.....	15-7
Specifications.....	15-8
Dimensions	15-8
Electrical	15-8

Description

The INOvent transport delivery system is similar to the standard INOvent delivery system. It has some additional features which enhance its use in a transport role.

- A longer life battery for transporting patients.
- A battery icon and life indicator which indicates how much battery charge remains.
- Design changes to provide greater immunity to electromagnetic fields which may be present in transport vehicles.

Battery operation information

The battery charge indicator is a bargraph icon shown in figure 15-1. The illuminated portion of the bargraph shows the relative charge left on the battery.

The illuminated portion decreases to the left as battery power is used up. When it reaches the point shown in figure 15-2,

- A Low Battery alarm sounds,
- A Low Battery message is displayed (see figure 15-3),
- The time elapsed since the sounding of the alarm is displayed to the right of the Low Battery message (see figure 15-3),

⚠Caution When first running on battery, the battery charge indicator reads high for one to two minutes: this is the time it takes for the voltage to stabilize when going from mains power to battery power.

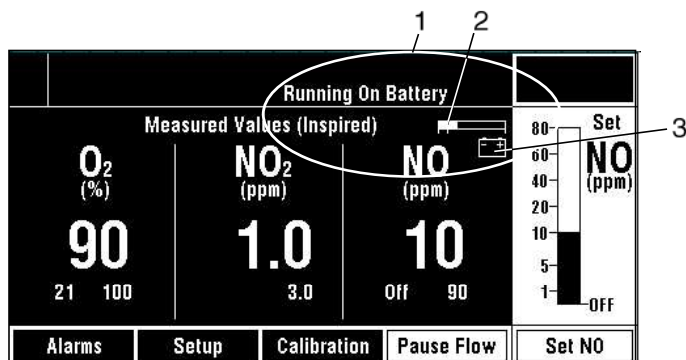

1. Battery information area
2. Battery charge level indicator
3. "Operating-on-battery" indicator

Figure 15-1 • Running on Battery icon and battery information

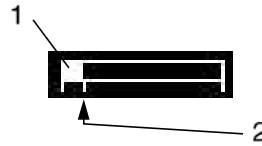

510k_32.tif

1. Length of illuminated portion indicates battery charge remaining (length decreases to the left)
2. Low battery alarm sounds when illuminated portion reaches this point

Figure 15-2 • Battery charge remaining bargraph

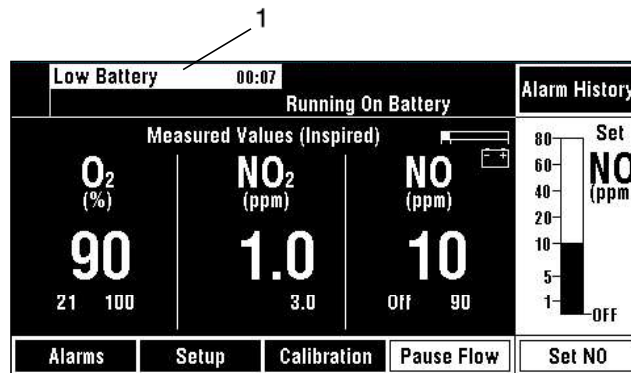

510k_32.tif

1. Message showing time elapsed since a low battery alarm

Figure 15-3 • Message showing time elapsed since a low battery alarm

Setup

INOvent delivery system setup is the same as in section 3/Setup of this manual with one addition.

The Sensor Cover is attached to the chassis at the rear of the delivery system. It covers the three sensors (NO, NO₂ and O₂) and provides additional high intensity electrical field screening for the sensors. The cover is shown in figure 15-4.

⚠Caution If the sensor cover is not installed, the monitored values may be affected by high intensity electrical fields which can be found in transport vehicles. Figure 15-5 shows cover removal and replacement.

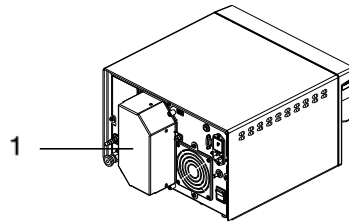

AA.69.174

1. Sensor cover

Figure 15-4 • Sensor cover location

Regulator connection diagrams

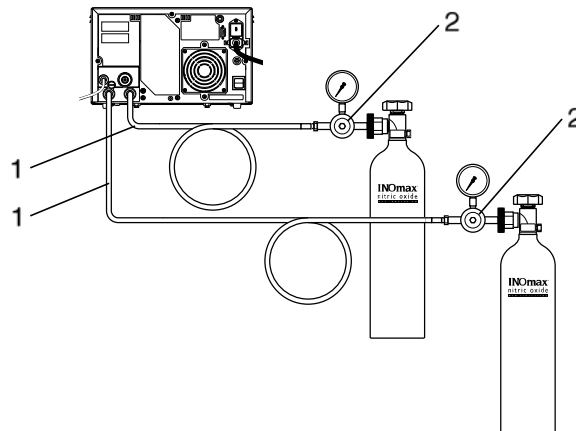

AA.69.195

- 1. 4650 mm / 15 ft. hose
- 2. Regulator assembly CGA 626 , stock number 1605-8005-000

Figure 15-5 • Configuration using regulator assembly CGA 626, stock number 1605-8005-000

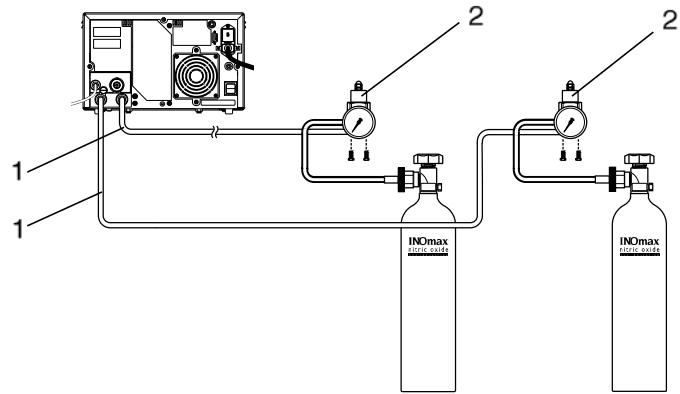

AA. 69.196

- 1. 1220 mm / 4 ft. hose
- 2. Regulator assembly CGA 626 , stock number 1605-8011-000

Figure 15-6 • Configuration using transport regulator assembly CGA 626, stock number 1605-8011-000

Operation

See section 6/Operation of this manual for details.

Maintenance

User maintenance schedule

Maintenance for the Transport INOvent delivery system is the same as in section 10/Maintenance of this manual with the addition of the annual battery check as outlined below.

Annually: Use this procedure to check the battery:

1. Plug the delivery system power cord into a functioning, grounded electrical outlet.
2. Make sure that ON/STANDBY switch is in the STANDBY position and the green power indicator on the front is ON.
3. Make sure that the system is connected to the electrical outlet for at least 20 hours to charge the battery.
4. After at least 20 hours, disconnect the power cord from the electrical outlet.
5. With the ON/STANDBY switch in the ON position, make sure the system operates from the battery for at least 90 minutes.
6. Repeat steps 1 and 3 to recharge the battery before doing the Pre-Use Procedures and using the system. The ON/STANDBY switch does not have to be in the ON position to charge the battery.

Notes: Connect the system to the electrical outlet for at least 20 hours following a complete discharge to have at least a 90 minute battery operation time available when next using the system.

When not using the system, keep it connected to the electrical outlet with the ON/STANDBY switch in the STANDBY position to maintain the battery in a fully charged condition.

Replaceable Parts and Accessories

Part	Stock number
Sensor cover	1605-8013-000
Regulator, INOvent transport, CGA 626	1605-8011-000
Vibration Isolator	
• Barry Control T-44-AB-10 (4 required)	—

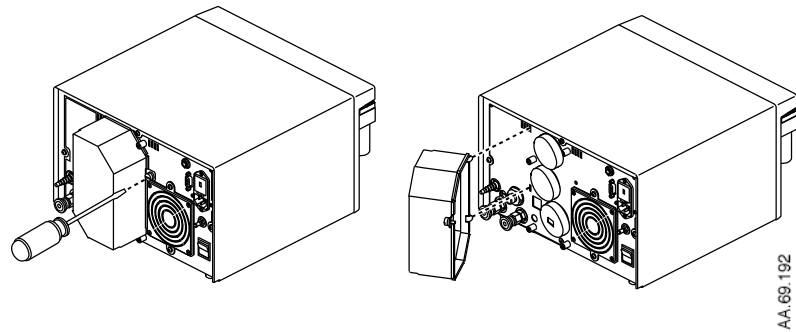

Figure 15-7 • Sensor cover removal and replacement

Specifications

Note: All specifications in this manual are nominal.

Specifications for the transport model are similar to the cart- or table-mounted models with the exceptions listed here.

Dimensions

Maximum	Delivery system only	Delivery system on optional Cart
Weight:	21 kg / 46.2 lbs	55 kg / 121 lbs
Width and depth:	350 mm W x 430 mm D / 13.8 in x 15.8 in	510 x 600 mm / 20.1 in x 23.6 in
Height:	215 mm / 8.5 in	1410 mm / 55.5 in

Electrical

Input voltage:	100-120 / 220-240 Vac at 50/60 Hz. 120 Vac at 400 Hz.
Input power:	60 VA nom.; 109 VA max.
Standards:	IEC 801-3 Electrical Field Radiated Immunity test, amplitude 20 V/m.
Battery backup:	A sealed lead acid battery provides power backup to operate the system for up to 3 hours when fully charged. Connect the system to an electrical outlet for at least 20 hours to charge the battery. Dispose of used batteries according to local regulations.

⚠Caution **RS 232 and Nurse Call cables should not be used during transport to reduce susceptibility to high intensity electrical fields.**

16/Appendix E - Optional Mounting

16

In this section

Cart mount	16-2
Shelf or table mount	16-4
Optional Cylinder Mount Regulator and Hose assembly	16-4

Cart mount

The optional INOvent delivery system Cart, shown in figures 16-1 and 16-2, provides a stable base for the INOvent delivery system or the Transport INOvent delivery system.

The cart holds two NO cylinders and the associated regulators. In this configuration, the INOvent delivery system or the Transport INOvent delivery system can move with the patient throughout the hospital providing uninterrupted nitric oxide therapy.

Complete setup connections for the INOvent delivery system to the cart are in “INOvent delivery system connections” of section 3/Setup in this manual.

Note: The INOvent delivery system Cart is not available in some markets because of cylinder size restrictions.

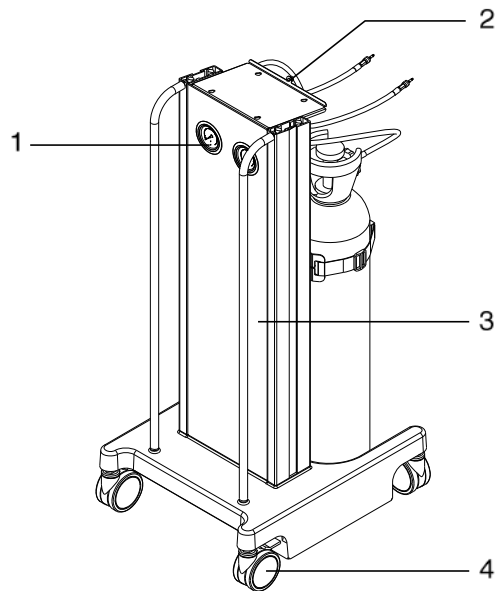

AA-69.037

1. High pressure gauge (2)
2. Delivery system locking screw
3. Cart assembly
4. Caster (4)

Figure 16-1 • Optional INOvent delivery system Cart, front view

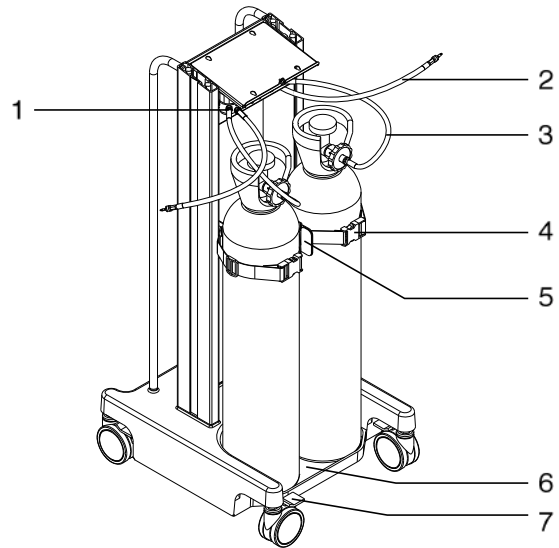

AA.69.039

1. NO Therapy Gas Regulator
2. Regulator Low Pressure hose with Quick Connector (2)
3. Regulator High Pressure hose (2)
4. Cylinder Mounting Strap (2)
5. Cylinder Holding Bracket
6. Cylinder Well
7. Caster Lock Lever

Figure 16-2 • Optional INOvent delivery system Cart, rear view

Shelf or table mount

In this configuration, the INOvent delivery system is placed on a shelf, table or bench. This may be desirable where floor space is limited and there is little need for moving the INOvent delivery system within the hospital.

Using the shelf/table mount option, space in the workplace will have to be dedicated for securely mounting the two cylinders of NO and their associated regulators. Some modifications to shelves, cabinetry, and/or countertops may be needed to allow for safe and convenient routing of NO hoses.

Optional Cylinder Mount Regulator and Hose assembly

Figure 16-3 shows the optional cylinder mount regulator assembly for using a wall-mounted NO cylinder without a cart.

The cylinder valve connector attaches to the therapy gas cylinder. The hose quick-connector attaches to the rear of the INOvent delivery system.

The optional cylinder mount regulator assembly may also be used with the Transport INOvent delivery system in configurations intended for medical transport.

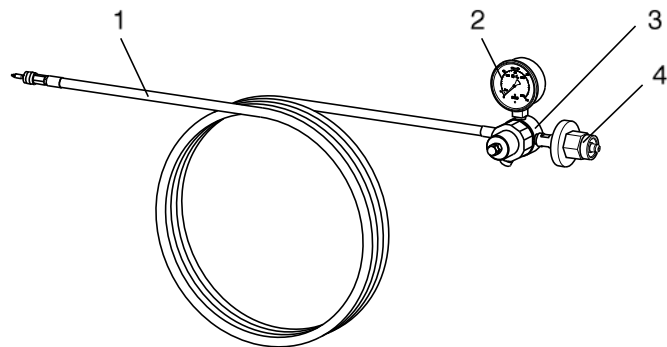

AA.69.132

1. Hose with quick-connector
2. Pressure Gauge
3. Primary Regulator
4. Cylinder valve connector

Figure 16-3 • Regulator assembly for using wall-mounted cylinders

17/Appendix F - Alternate Cylinder Concentrations

In this section This section describes specific tasks. Use it as a step-by-step guide or a training tool.

The INOvent delivery system is factory-set for delivering 0 to 80 ppm nitric oxide with a cylinder concentration of 800 ppm. The main body of this manual describes the operation of the INOvent delivery system with the 800 ppm cylinder concentration.

The INOvent delivery system may be configured for alternate cylinder concentrations by special request to Datex-Ohmeda.

This appendix describes the concentrations available and the differences in the sections of this manual which result from the different cylinder NO concentrations.

- In Section 3/Setup of this manual 17-2
 - Cylinder concentration 17-2
- In Section 5/Pre-Use Procedures of this manual 17-3
 - 2. System purge and performance test 17-3
 - 3. Manual NO delivery system purge and performance test 17-3
- In Section 10/Maintenance of this manual 17-4
 - Monthly System Checkout 17-4
 - 4. INOvent delivery system performance 17-4

In 'Section 3/Setup' of this manual

Cylinder concentration

Push the Setup button to see the Setup menu. A Setup menu example is shown in figure 17-1.

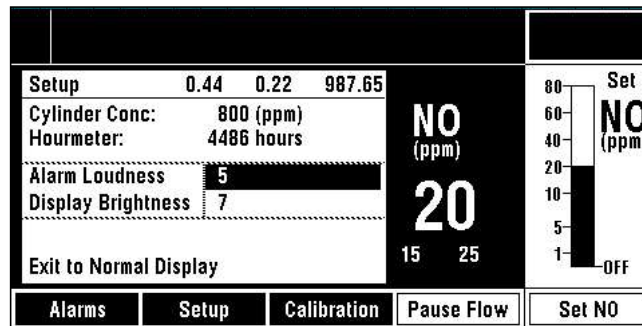

510k_9.tif

Figure 17-1 • Typical Setup menu

The INOvent delivery system can be set by a Datex-Ohmeda representative for use with the cylinder concentrations of NO as shown in Table 17-1. This set concentration is indicated in the Setup menu.

Table 17-1: Cylinder Concentrations and Set NO Range Table

NO Cylinder Concentration (ppm):	800	100
Set NO Range (ppm):	0-80	0-10

When connecting a nitric oxide cylinder to the INOvent delivery system, always check to see that it is the same concentration for which the system is configured as appears in the Setup menu.

In 'Section 5/Pre-Use Procedures' of this manual

2. System purge and performance test

10. Set the O₂ flow on the auxiliary flowmeter to 15 L/min and the Set NO to the value given in table 17-2 based on the cylinder concentration being used.
 - a. Wait for 3 minutes or until the monitor readings are stable
 - b. Make sure that the O₂, NO₂ and NO readings are within the acceptable ranges given in table 17-2.

Table 17-2: INOvent delivery system O₂, NO₂ and NO acceptable readings

NO Cylinder Concentration ppm:	800	100
Set NO ppm:	40	5
O ₂ %v/v (±3 %v/v):	95	95
NO ₂ ppm max:	1.5	0.5
NO ppm (min/max):	32/48	4/6

Note: These acceptable readings include the errors of the NO delivery system and the NO therapy gas.

3. Manual NO delivery system purge and performance test

3. Flow 15 L/min of O₂ from the auxiliary O₂ flowmeter into the Manual delivery system and make sure the float moves to the middle of the NO Flow Indicator Window.
4. Wait for the gas to flow through the oxygen tubing. Make sure that the NO and NO₂ readings are within the acceptable ranges given in table 17-3. If the NO₂ reading is greater than the value listed in the table, continue flowing gas until the limit is reached.

Table 17-3: Manual NO delivery NO₂ and NO acceptable readings

NO Cylinder Concentration ppm:	800	100
Manual NO delivery ppm:	20	2.5
Tolerance:	±8	±1
Max NO ₂ reading:	1.0	0.5

Note: These acceptable readings include the errors of the NO delivery system and the NO therapy gas.

In 'Section 10/Maintenance' of this manual

Monthly System Checkout

4. INOvent delivery system performance

1. Start with the connections as they are at the end of "Calibration and monitoring alarms" above.
2. Set the O₂ flow on the auxiliary flowmeter to 15 L/min and the Set NO to the low Set NO value in the following table. Make sure that the NO reading, based upon cylinder concentration, is within the acceptable range given in the "Low Set NO" row of table 17-4.

Table 17-4: INOvent delivery system O₂, NO₂ and NO acceptable reading range

NO Cylinder Concentration ppm:	800	100
High Set NO ppm:	40	5
Measured NO ppm (min/max):	32/48	4/6
Low Set NO:	10	1
Measured NO:	2/18	0.5/1.5

Note: This table includes the errors of the NO delivery system and the NO therapy gas.

3. Increase the Set NO concentration to High Set NO value.
4. Make sure that the NO reading, based upon cylinder concentration, is within the acceptable range given in the "High Set NO" row of the above table.
5. Make sure that the NO₂ reading is less than 1.5 ppm.

This Product is sold by Datex-Ohmeda under the warranties set forth in the following paragraphs. Such warranties are extended only with respect to the purchase of this Product directly from Datex-Ohmeda or Datex-Ohmeda's Authorized Dealers as new merchandise and are extended to the Buyer thereof, other than for the purpose of resale.

For a period of twelve (12) months from the date of original delivery to Buyer or to Buyer's order, but in no event for a period of more than two years from the date of original delivery by Datex-Ohmeda to a Datex-Ohmeda Authorized Dealer, this Product, other than its expendable parts, is warranted against functional defects in materials and workmanship and to conform to the description of the Product contained in this operation manual and accompanying labels and/or inserts, provided that the same is properly operated under the conditions of normal use, that regular periodic maintenance and service is performed and that replacements and repairs are made in accordance with the instructions provided. This same warranty is made for a period of thirty (30) days with respect to expendable parts, one hundred eighty (180) days with respect to NO and NO₂ sensors and one (1) year for the O₂ sensor. The foregoing warranties shall not apply if the Product has been repaired other than by Datex-Ohmeda or in accordance with written instructions provided by Datex-Ohmeda, or altered by anyone other than Datex-Ohmeda, or if the Product has been subject to abuse, misuse, negligence, or accident.

19-1

Datex-Ohmeda's sole and exclusive obligation and Buyer's sole and exclusive remedy under the above warranties is limited to repairing or replacing, free of charge, at Datex-Ohmeda's option, a Product, which is telephonically reported to the nearest Datex-Ohmeda Field Service Support Center and which, if so advised by Datex-Ohmeda, is thereafter returned with a statement of the observed deficiency, not later than seven (7) days after the expiration date of the applicable warranty, to the Datex-Ohmeda Service and Distribution Center during normal business hours, transportation charges prepaid, and which, upon Datex-Ohmeda's examination, is found not to conform with above warranties. Datex-Ohmeda *shall not be otherwise liable for any damages including but not limited to incidental damages, consequential damages, or special damages.*

There are no express or implied warranties which extend beyond the warranties hereinabove set forth. Datex-Ohmeda makes no warranty of merchantability or fitness for a particular purpose with respect to the product or parts thereof.

INOvent delivery system
Operational and Maintenance Manual,
English
1605 0014 000
02 00 C 01 21 03
Printed in USA
©Datex-Ohmeda, Inc.
All rights reserved

