

[54] RESPIRATING GAS SUPPLY METHOD AND APPARATUS THEREFOR

[75] Inventors: Gerald Durkan, Altoona, Pa.; Leonard M. Sieracki, Columbia, Md.

[73] Assignee: Kircaldie, Randall and McNab, Wethersfield, Conn. ; as trustee

[21] Appl. No.: 446,542

[22] Filed: Dec. 3, 1982

[51] Int. Cl.<sup>3</sup> ..... A61M 16/00

[52] U.S. Cl. .... 128/200.14; 128/203.12; 128/204.23; 128/204.24; 128/204.26; 128/207.18

[58] Field of Search ..... 128/202.22, 203.12, 128/204.21, 204.22, 204.23, 204.24, 204.25, 204.26, 204.28, 205.13, 205.17, 205.24, 716, 725, 200.14, 207.18; 137/834, 841

[56] References Cited

U.S. PATENT DOCUMENTS

3,097,638	7/1963	Streimer .	
3,357,428	12/1967	Carlson .	
3,611,178	10/1971	McConnell	128/204.23
3,820,539	6/1974	Olliver .	
3,863,630	2/1975	Cavallo .	
3,976,064	8/1976	Wood et al.	128/204.28
4,121,579	10/1978	Bird	128/204.25
4,141,354	2/1979	Ismach .	
4,141,356	2/1979	Smargiassi	128/204.23
4,186,737	2/1980	Valenta et al.	

4,197,843	4/1980	Bird .	
4,206,754	6/1980	Cox et al. .	
4,215,681	8/1980	Zalkin et al. .	
4,241,732	12/1980	Berindtsson	128/204.24
4,289,126	9/1981	Seireg et al. .	
4,393,869	7/1983	Boyarsky et al.	128/204.23

Primary Examiner—Henry J. Recla  
Attorney, Agent, or Firm—Griffin, Branigan & Butler

[57] ABSTRACT

In various embodiments of a respirating gas supply method and apparatus a control circuit (32) responsive to a sensor (28) operates valve means (26) to supply pulses of respirating gas through a single hose cannula (48) to an in vivo respiratory system when negative pressure indicative of inspiration is sensed by the sensor (28). The control circuit (32) operates the valve (26) to communicate the in vivo respiratory system with a supply of gas (20) only if the negative pressure sensed by the sensor (28) does not occur within a predetermined yet selectively variable required minimum delay interval between successive pulsed applications of gas to the in vivo respiratory system. The pulse of gas applied to the in vivo respiratory system can be spiked pulses or square pulses. Humidifiers, nebulizers, and sources of a second gas are provided in accordance with various embodiments. Apnea event detection is also provided.

11 Claims, 14 Drawing Figures

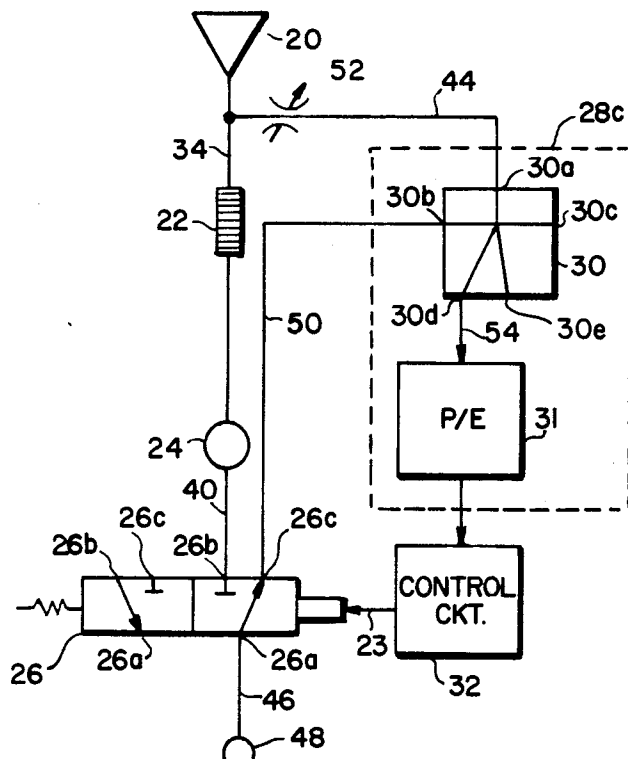

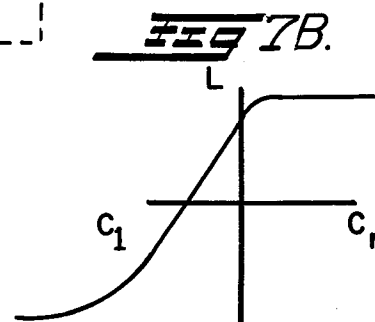
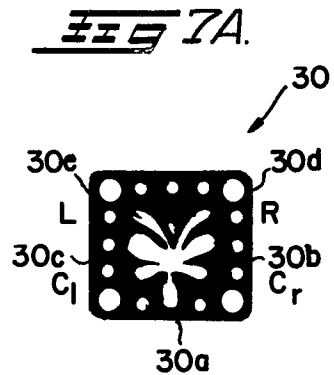
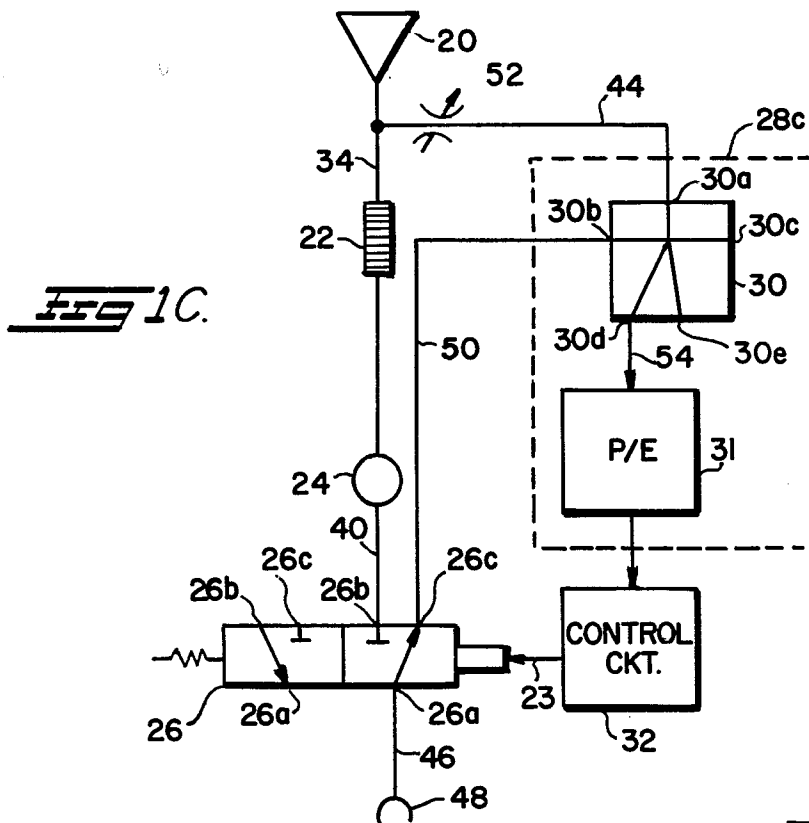
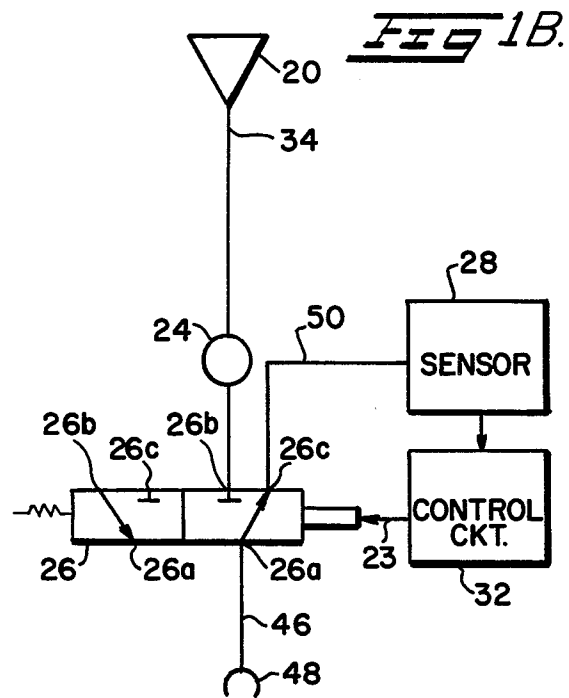
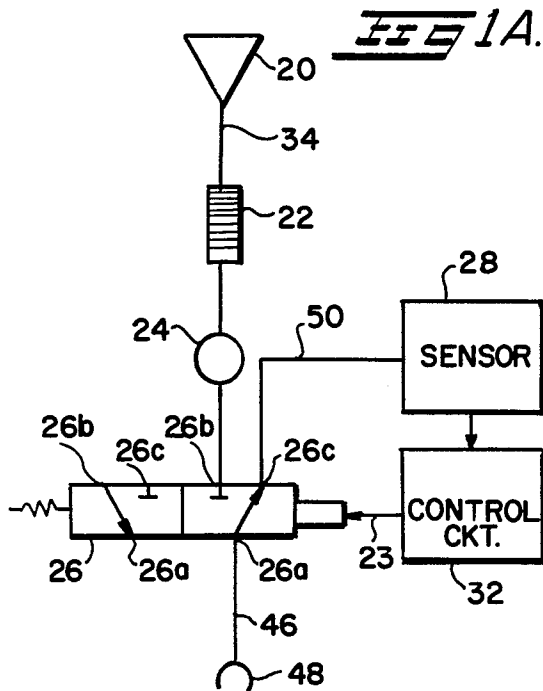

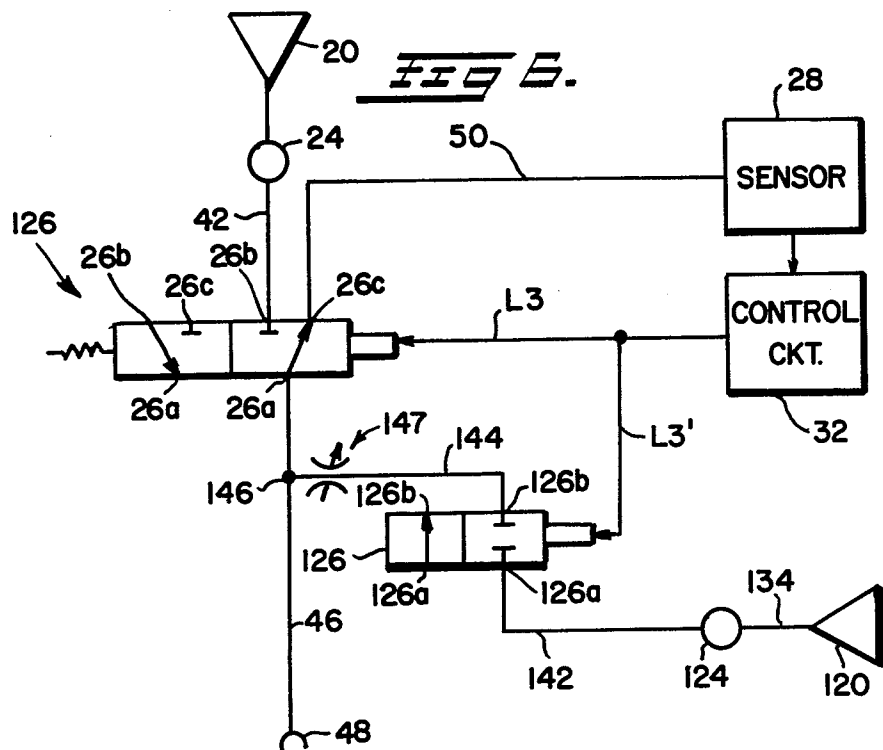
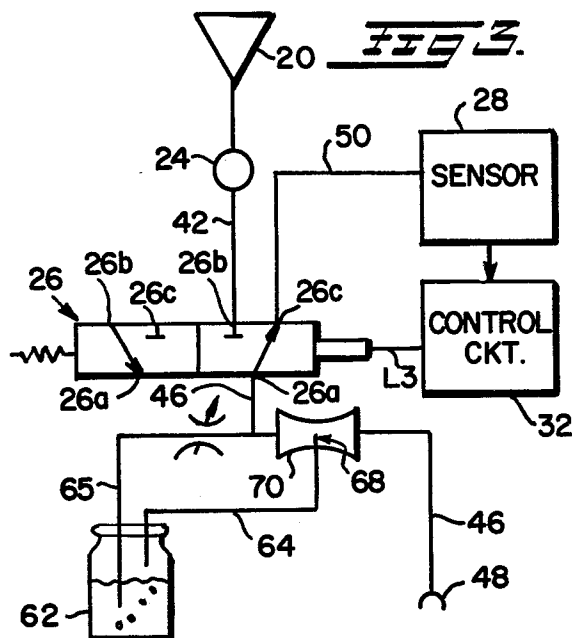
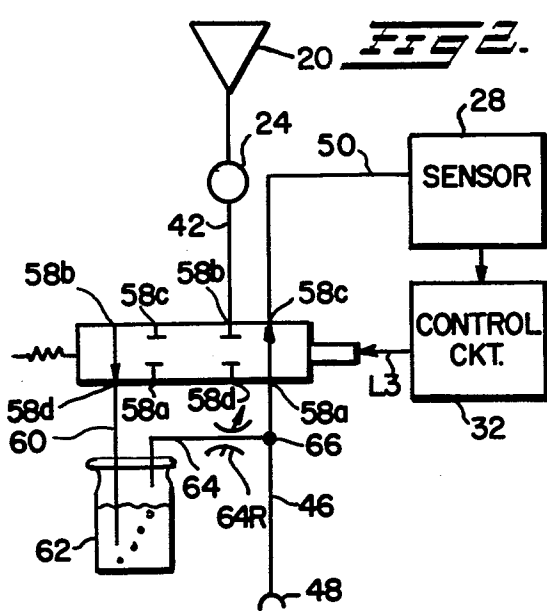

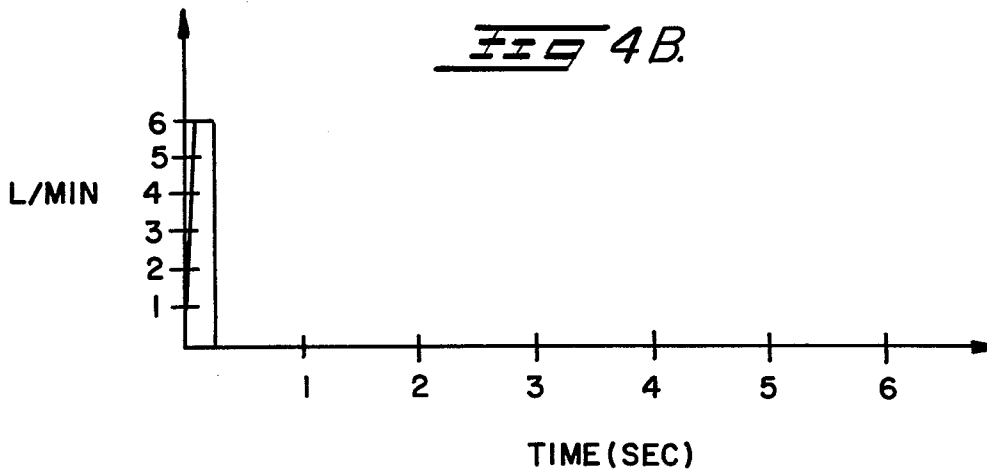
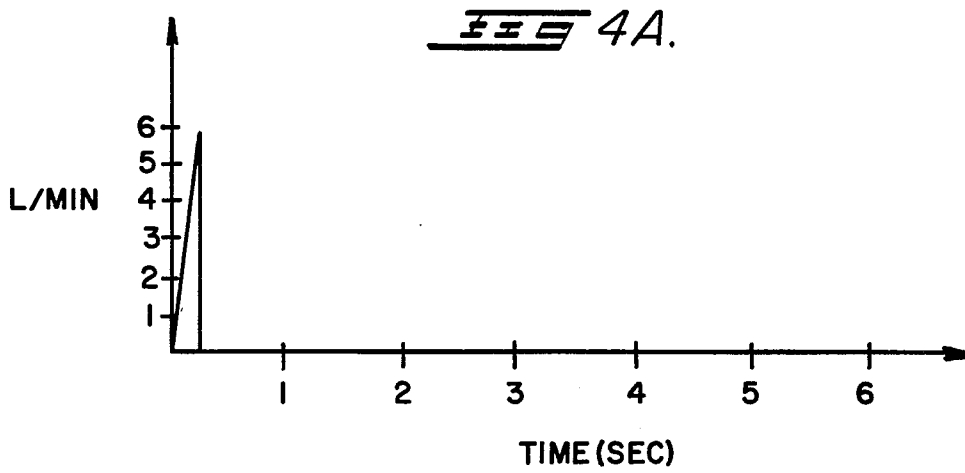

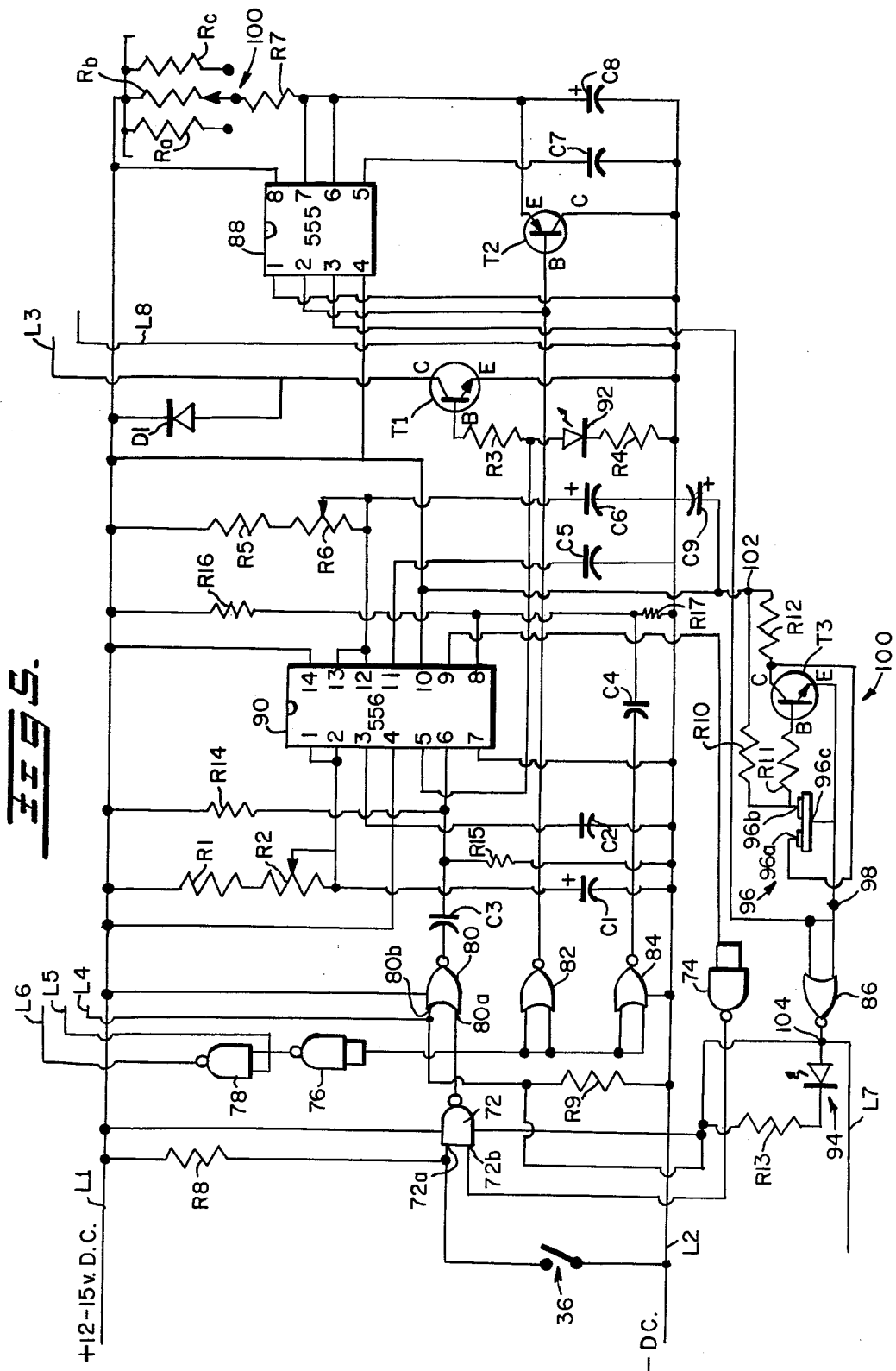

**FFS.**

# Explore Litigation Insights

Docket Alarm provides insights to develop a more informed litigation strategy and the peace of mind of knowing you're on top of things.

## Real-Time Litigation Alerts



Keep your litigation team up-to-date with **real-time alerts** and advanced team management tools built for the enterprise, all while greatly reducing PACER spend.

Our comprehensive service means we can handle Federal, State, and Administrative courts across the country.

## Advanced Docket Research



With over 230 million records, Docket Alarm's cloud-native docket research platform finds what other services can't. Coverage includes Federal, State, plus PTAB, TTAB, ITC and NLRB decisions, all in one place.

Identify arguments that have been successful in the past with full text, pinpoint searching. Link to case law cited within any court document via Fastcase.

## Analytics At Your Fingertips



Learn what happened the last time a particular judge, opposing counsel or company faced cases similar to yours.

Advanced out-of-the-box PTAB and TTAB analytics are always at your fingertips.

## API

Docket Alarm offers a powerful API (application programming interface) to developers that want to integrate case filings into their apps.

## LAW FIRMS

Build custom dashboards for your attorneys and clients with live data direct from the court.

Automate many repetitive legal tasks like conflict checks, document management, and marketing.

## FINANCIAL INSTITUTIONS

Litigation and bankruptcy checks for companies and debtors.

## E-DISCOVERY AND LEGAL VENDORS

Sync your system to PACER to automate legal marketing.