

McDermott Will & Emery

Boston Brussels Chicago Düsseldorf Houston London Los Angeles Miami Milan
Munich New York Orange County Paris Rome Silicon Valley Washington, D.C.

Strategic alliance with MWE China Law Offices (Shanghai)

Toby H. Kusmer, P.C.
Attorney at Law
tkusmer@mwe.com
+1 617 535 4065

January 3, 2012

CERTIFICATE OF ELECTRONIC TRANSMISSION

I hereby certify that this correspondence is being electronically transmitted to the United States Patent and Trademark Office on January 3, 2012

/Jessica Brown/
Jessica Brown

Commissioner for Patents
Mail Stop PATENT APPLICATION
P.O. Box 1450
Alexandria, VA 22313-1450

Re: U.S. Continuation Patent Application
Attorney Docket No. 77580-155(VRNK-1CP3CNFT5)
SYSTEM AND METHOD EMPLOYING AN AGILE NETWORK PROTOCOL
FOR SECURE COMMUNICATIONS USING SECURE DOMAIN NAMES

Subject: Transmitting Patent Application for Track I Prioritized Examination

Dear Sir/Madam:

We enclose for filing the patent application for Track I Prioritized Examination of:

Inventors: Victor Larson (Fairfax, VA); Robert Dunham Short III (Leesburg, VA);
Edmond Colby Munger (Crownsville, MD); Michael Williamson (South
Riding, VA)

Assignee: VIRNETX, INC.

For: SYSTEM AND METHOD EMPLOYING AN AGILE NETWORK
PROTOCOL FOR SECURE COMMUNICATIONS USING SECURE
DOMAIN NAMES

This patent application is a continuation of U.S. Application No. 13/049,552, filed March 16, 2011, which is a continuation of U.S. Application No. 11/840,560, filed August 17, 2007, now U.S. Patent No. 7,921,211, issued April 5, 2011, which is a continuation of U.S. Application No. 10/714,849, filed November 18, 2003, now U.S. Patent No. 7,418,504, issued August 26, 2008, which is a continuation of U.S. Application No. 09/558,210, filed April 26, 2000, now abandoned, which is a continuation-in-part of U.S. Application No. 09/504,783, filed on February 15, 2000, now U.S. Patent No. 6,502,135, issued December 31, 2002, which is a continuation-in-part of U.S. Application No. 09/429,643, filed October 29, 1999, now U.S. Patent No. 7,010,604, issued March 07, 2006, which derives from U.S. Provisional Application Nos. 60/106,261, filed October 30, 1998, and 60/137,704, filed June 7, 1999, and includes:

- Certification and Request for Prioritized Examination (Track I)

U.S. practice conducted through McDermott Will & Emery LLP.

28 State Street Boston Massachusetts 02109-1775 Telephone: +1 617 535 4000 Facsimile: +1 617 535 3800 www.mwe.com

DM_US 31253087-1.077580.0155

Petitioner Apple Inc. - Exhibit 1051, p. 1

- Ninety-three (93) pages of specification, claims, and abstract;
- Forty (40) sheets of drawings (Figs. 1-37);
- Application Data Sheet (6 pages);
- Declaration and Petition from parent application no. 10/714,849, signed by the inventors (6 pages)
- Power of Attorney and Statement under 37 CFR 3.73(b) from parent application no. 11/840,560, signed by the assignee

The filing fee has been calculated as shown below:

	NO. OF CLAIMS		EXTRA CLAIMS	Large Entity RATE	AMOUNT
Total Claims	30	-20	10	\$60	\$600.00
Independent Claims	2	-3	0	\$250	\$0.00
Multiple Dependent Claim(s)					\$0.00
Basic Filing Fee					\$380.00
Search Fee					\$620.00
Examination Fee					\$250.00
Utility Application Size Fee for 50 additional sheets that exceed 100 sheets 133 sheets * .75 = 100					\$00.00
Publication Fee					\$300.00
Prioritized Examination Fee (Track I) under 37 C.F.R. 1.17(c)					\$4800.00
Processing Fee 37 C.F.R. 1.17(i)					\$130.00
Total of Above Calculations					\$7080.00
Total Fee Due					\$7080.00

- Please charge my Deposit Account No. 501133 in the amount of **\$7080.00**. Please reference attorney docket no. 77580-155(VRNK-1CP3CNFT5).
- The Commissioner is hereby authorized to charge payment of the following fees associated with this communication or credit any overpayment to Deposit Account No. 501133.
 - Any additional filing fees required under 37 CFR 1.16.
- The Commissioner is hereby authorized to charge payment of the following fees during the pendency of this application or credit any overpayment to Deposit Account No. 501133.
 - Any patent application processing fees under 37 CFR 1.17.
 - Any filing fees under 37 CFR 1.16 for presentation of extra claims.

Commissioner for Patents

January 3, 2012

Page 3

Please return the Official Filing Receipt to the undersigned.

Respectfully submitted,
McDERMOTT WILL & EMERY LLP
CUSTOMER NUMBER 23630

/Toby H. Kusmer/

Toby H. Kusmer, P.C., Reg. No. 26,418

600 13th Street, N.W.
Washington, DC 20005-3096
Telephone: (617) 535-4000
Facsimile: (617) 535-3800
Date: January 3, 2012

McDermott Will & Emery

Boston Brussels Chicago Düsseldorf Houston London Los Angeles Miami Milan
Munich New York Orange County Paris Rome Silicon Valley Washington, D.C.

Strategic alliance with MWE China Law Offices (Shanghai)

Toby H. Kusmer, P.C.
Attorney at Law
tkusmer@mwe.com
+1 617 535 4065

January 3, 2012

CERTIFICATE OF ELECTRONIC TRANSMISSION

I hereby certify that this correspondence is being electronically transmitted to the United States Patent and Trademark Office on January 3, 2012

/Jessica Brown/
Jessica Brown

Commissioner for Patents
Mail Stop PATENT APPLICATION
P.O. Box 1450
Alexandria, VA 22313-1450

Re: U.S. Continuation Patent Application
Attorney Docket No. 77580-155(VRNK-1CP3CNFT5)
SYSTEM AND METHOD EMPLOYING AN AGILE NETWORK PROTOCOL
FOR SECURE COMMUNICATIONS USING SECURE DOMAIN NAMES

Subject: Transmitting Patent Application for Track I Prioritized Examination

Dear Sir/Madam:

We enclose for filing the patent application for Track I Prioritized Examination of:

Inventors: Victor Larson (Fairfax, VA); Robert Dunham Short III (Leesburg, VA);
Edmond Colby Munger (Crownsville, MD); Michael Williamson (South
Riding, VA)

Assignee: VIRNETX, INC.

For: SYSTEM AND METHOD EMPLOYING AN AGILE NETWORK
PROTOCOL FOR SECURE COMMUNICATIONS USING SECURE
DOMAIN NAMES

This patent application is a continuation of U.S. Application No. 13/049,552, filed March 16, 2011, which is a continuation of U.S. Application No. 11/840,560, filed August 17, 2007, now U.S. Patent No. 7,921,211, issued April 5, 2011, which is a continuation of U.S. Application No. 10/714,849, filed November 18, 2003, now U.S. Patent No. 7,418,504, issued August 26, 2008, which is a continuation of U.S. Application No. 09/558,210, filed April 26, 2000, now abandoned, which is a continuation-in-part of U.S. Application No. 09/504,783, filed on February 15, 2000, now U.S. Patent No. 6,502,135, issued December 31, 2002, which is a continuation-in-part of U.S. Application No. 09/429,643, filed October 29, 1999, now U.S. Patent No. 7,010,604, issued March 07, 2006, which derives from U.S. Provisional Application Nos. 60/106,261, filed October 30, 1998, and 60/137,704, filed June 7, 1999, and includes:

- Certification and Request for Prioritized Examination (Track I)

U.S. practice conducted through McDermott Will & Emery LLP.

28 State Street Boston Massachusetts 02109-1775 Telephone: +1 617 535 4000 Facsimile: +1 617 535 3800 www.mwe.com

DM_US 31253087-1.077580.0155

- Ninety-three (93) pages of specification, claims, and abstract;
- Forty (40) sheets of drawings (Figs. 1-37);
- Application Data Sheet (6 pages);
- Declaration and Petition from parent application no. 10/714,849, signed by the inventors (6 pages)
- Power of Attorney and Statement under 37 CFR 3.73(b) from parent application no. 11/840,560, signed by the assignee

The filing fee has been calculated as shown below:

	NO. OF CLAIMS		EXTRA CLAIMS	Large Entity RATE	AMOUNT
Total Claims	30	-20	10	\$60	\$600.00
Independent Claims	2	-3	0	\$250	\$0.00
Multiple Dependent Claim(s)					\$0.00
Basic Filing Fee					\$380.00
Search Fee					\$620.00
Examination Fee					\$250.00
Utility Application Size Fee for 50 additional sheets that exceed 100 sheets 133 sheets * .75 = 100					\$00.00
Publication Fee					\$300.00
Prioritized Examination Fee (Track I) under 37 C.F.R. 1.17(c)					\$4800.00
Processing Fee 37 C.F.R. 1.17(i)					\$130.00
Total of Above Calculations					\$7080.00
Total Fee Due					\$7080.00

- Please charge my Deposit Account No. 501133 in the amount of **\$7080.00**. Please reference attorney docket no. 77580-155(VR NK-1CP3CNFT5).
- The Commissioner is hereby authorized to charge payment of the following fees associated with this communication or credit any overpayment to Deposit Account No. 501133.
 - Any additional filing fees required under 37 CFR 1.16.
- The Commissioner is hereby authorized to charge payment of the following fees during the pendency of this application or credit any overpayment to Deposit Account No. 501133.
 - Any patent application processing fees under 37 CFR 1.17.
 - Any filing fees under 37 CFR 1.16 for presentation of extra claims.

Commissioner for Patents
January 3, 2012
Page 3

Please return the Official Filing Receipt to the undersigned.

Respectfully submitted,
McDERMOTT WILL & EMERY LLP
CUSTOMER NUMBER 23630

/Toby H. Kusmer/

Toby H. Kusmer, P.C., Reg. No. 26,418

600 13th Street, N.W.
Washington, DC 20005-3096
Telephone: (617) 535-4000
Facsimile: (617) 535-3800
Date: January 3, 2012

**CERTIFICATION AND REQUEST
 FOR PRIORITIZED EXAMINATION (TRACK I)** (Page 1 of 1)

First Named Inventor:	LARSON, Victor	Nonprovisional Application Number (if known):	
Title of Invention:	SYSTEM AND METHOD EMPLOYING AN AGILE NETWORK PROTOCOL FOR SECURE COMMUNICATIONS USING SECURE DOMAIN NAMES		

APPLICANT HEREBY CERTIFIES THE FOLLOWING AND REQUESTS PRIORITIZED EXAMINATION (TRACK I) FOR THE ABOVE-IDENTIFIED APPLICATION.

1. (a) The application is an original nonprovisional utility application filed under 35 U.S.C. 111(a). This certification and request is being filed with the utility application via EFS-Web.

OR

(b) The application is an original nonprovisional plant application filed under 35 U.S.C. 111(a). This certification and request is being filed with the plant application in paper. (Note: Plant applications cannot be filed via EFS-Web.)

Note: The following are excluded from the Track I program: design applications, provisional applications, national stage applications, PCT international applications, reissue applications, and reexamination proceedings.

- The following fees (in amounts consistent with the current fee schedule available at <http://www.uspto.gov/about/offices/cfo/finance/fees.jsp>) are filed with the application: (1) basic filing fee; (2) search fee; (3) examination fee; (4) any required excess claims fees; (5) any required application size fee; (6) publication fee; (7) processing fee (Track I) set forth in 37 CFR 1.17(i); and (8) prioritized examination fee (Track I) set forth in 37 CFR 1.17(c).
- An executed oath or declaration under 37 CFR 1.63 is filed with the application.
- The application contains or is amended to contain no more than four independent claims and no more than thirty total claims, and no multiple dependent claims.

Signature /Toby H. Kusmer/	Date 2012-01-03
Name (Print/Typed) Toby H. Kusmer, P.C.	Practitioner Registration Number 26,418

Note: Signatures of all the inventors or assignees of record of the entire interest or their representative(s) are required in accordance with 37 CFR 1.33 and 11.18. Please see 37 CFR 1.4(d) for the form of the signature. If necessary, submit multiple forms for more than one signature, see below*.

*Total of 1 forms are submitted.

Privacy Act Statement

The **Privacy Act of 1974 (P.L. 93-579)** requires that you be given certain information in connection with your submission of the attached form related to a patent application or patent. Accordingly, pursuant to the requirements of the Act, please be advised that: (1) the general authority for the collection of this information is 35 U.S.C. 2(b)(2); (2) furnishing of the information solicited is voluntary; and (3) the principal purpose for which the information is used by the U.S. Patent and Trademark Office is to process and/or examine your submission related to a patent application or patent. If you do not furnish the requested information, the U.S. Patent and Trademark Office may not be able to process and/or examine your submission, which may result in termination of proceedings or abandonment of the application or expiration of the patent.

The information provided by you in this form will be subject to the following routine uses:

1. The information on this form will be treated confidentially to the extent allowed under the Freedom of Information Act (5 U.S.C. 552) and the Privacy Act (5 U.S.C. 552a). Records from this system of records may be disclosed to the Department of Justice to determine whether disclosure of these records is required by the Freedom of Information Act.
2. A record from this system of records may be disclosed, as a routine use, in the course of presenting evidence to a court, magistrate, or administrative tribunal, including disclosures to opposing counsel in the course of settlement negotiations.
3. A record in this system of records may be disclosed, as a routine use, to a Member of Congress submitting a request involving an individual, to whom the record pertains, when the individual has requested assistance from the Member with respect to the subject matter of the record.
4. A record in this system of records may be disclosed, as a routine use, to a contractor of the Agency having need for the information in order to perform a contract. Recipients of information shall be required to comply with the requirements of the Privacy Act of 1974, as amended, pursuant to 5 U.S.C. 552a(m).
5. A record related to an International Application filed under the Patent Cooperation Treaty in this system of records may be disclosed, as a routine use, to the International Bureau of the World Intellectual Property Organization, pursuant to the Patent Cooperation Treaty.
6. A record in this system of records may be disclosed, as a routine use, to another federal agency for purposes of National Security review (35 U.S.C. 181) and for review pursuant to the Atomic Energy Act (42 U.S.C. 218(c)).
7. A record from this system of records may be disclosed, as a routine use, to the Administrator, General Services, or his/her designee, during an inspection of records conducted by GSA as part of that agency's responsibility to recommend improvements in records management practices and programs, under authority of 44 U.S.C. 2904 and 2906. Such disclosure shall be made in accordance with the GSA regulations governing inspection of records for this purpose, and any other relevant (*i.e.*, GSA or Commerce) directive. Such disclosure shall not be used to make determinations about individuals.
8. A record from this system of records may be disclosed, as a routine use, to the public after either publication of the application pursuant to 35 U.S.C. 122(b) or issuance of a patent pursuant to 35 U.S.C. 151. Further, a record may be disclosed, subject to the limitations of 37 CFR 1.14, as a routine use, to the public if the record was filed in an application which became abandoned or in which the proceedings were terminated and which application is referenced by either a published application, an application open to public inspection or an issued patent.
9. A record from this system of records may be disclosed, as a routine use, to a Federal, State, or local law enforcement agency, if the USPTO becomes aware of a violation or potential violation of law or regulation.

**SYSTEM AND METHOD EMPLOYING AN AGILE NETWORK PROTOCOL FOR
SECURE COMMUNICATIONS USING SECURE DOMAIN NAMES**

CROSS-REFERENCE TO RELATED APPLICATIONS

[0001] This application claims priority from and is a continuation of a co-pending U.S. Application No. 13/049,552, filed March 16, 2011, which is a continuation of U.S. Application No. 11/840,560, filed August 17, 2007, now U.S. Patent No. 7,921,211, which is a continuation of U.S. Application No. 10/714,849, filed November 18, 2003, now U.S. Patent No. 7,418,504, which is a continuation of U.S. Application No. 09/558,210, filed April 26, 2000, now abandoned, which is a continuation-in-part of U.S. Application No. 09/504,783, filed on February 15, 2000, now U.S. Patent No. 6,502,135, issued December 31, 2002, which claims priority from and is a continuation-in-part patent application of previously-filed U.S. Application No. 09/429,643, filed on October 29, 1999, now U.S. Patent No. 7,010,604, issued March 07, 2006. The subject matter of U.S. application serial number 09/429,643, which is bodily incorporated herein, derives from provisional U.S. Application Nos. 60/106,261 (filed October 30, 1998) and 60/137,704 (filed June 7, 1999). The present application is also related to U.S. application serial number 09/558,209, filed April 26, 2000, now abandoned, and which is incorporated by reference herein. Each of the above-mentioned applications is incorporated herein by reference in its entirety as though fully set forth herein.

BACKGROUND OF THE INVENTION

[0002] A tremendous variety of methods have been proposed and implemented to provide security and anonymity for communications over the Internet. The variety stems, in part, from the different needs of different Internet users. A basic heuristic framework to aid in discussing these different security techniques is illustrated in FIG. 1. Two terminals, an originating terminal 100 and a destination terminal 110 are in communication over the Internet. It is desired for the communications to be secure, that is, immune to eavesdropping. For example, terminal 100 may transmit secret information to terminal 110 over the Internet 107. Also, it may be desired to prevent an eavesdropper from discovering that terminal 100 is in communication with terminal 110. For example, if terminal 100 is a user and terminal 110 hosts a web site, terminal 100's user may not want anyone in the intervening networks to know what

web sites he is “visiting.” Anonymity would thus be an issue, for example, for companies that want to keep their market research interests private and thus would prefer to prevent outsiders from knowing which websites or other Internet resources they are “visiting.” These two security issues may be called data security and anonymity, respectively.

[0003] Data security is usually tackled using some form of data encryption. An encryption key 48 is known at both the originating and terminating terminals 100 and 110. The keys may be private and public at the originating and destination terminals 100 and 110, respectively or they may be symmetrical keys (the same key is used by both parties to encrypt and decrypt). Many encryption methods are known and usable in this context.

[0004] To hide traffic from a local administrator or ISP, a user can employ a local proxy server in communicating over an encrypted channel with an outside proxy such that the local administrator or ISP only sees the encrypted traffic. Proxy servers prevent destination servers from determining the identities of the originating clients. This system employs an intermediate server interposed between client and destination server. The destination server sees only the Internet Protocol (IP) address of the proxy server and not the originating client. The target server only sees the address of the outside proxy. This scheme relies on a trusted outside proxy server. Also, proxy schemes are vulnerable to traffic analysis methods of determining identities of transmitters and receivers. Another important limitation of proxy servers is that the server knows the identities of both calling and called parties. In many instances, an originating terminal, such as terminal A, would prefer to keep its identity concealed from the proxy, for example, if the proxy server is provided by an Internet service provider (ISP).

[0005] To defeat traffic analysis, a scheme called Chaum’s mixes employs a proxy server that transmits and receives fixed length messages, including dummy messages. Multiple originating terminals are connected through a mix (a server) to multiple target servers. It is difficult to tell which of the originating terminals are communicating to which of the connected target servers, and the dummy messages confuse eavesdroppers’ efforts to detect communicating pairs by analyzing traffic. A drawback is that there is a risk that the mix server could be compromised. One way to deal with this risk is to spread the trust among multiple mixes. If one mix is compromised, the identities of the originating and target terminals may remain concealed.

This strategy requires a number of alternative mixes so that the intermediate servers interposed between the originating and target terminals are not determinable except by compromising more than one mix. The strategy wraps the message with multiple layers of encrypted addresses. The first mix in a sequence can decrypt only the outer layer of the message to reveal the next destination mix in sequence. The second mix can decrypt the message to reveal the next mix and so on. The target server receives the message and, optionally, a multi-layer encrypted payload containing return information to send data back in the same fashion. The only way to defeat such a mix scheme is to collude among mixes. If the packets are all fixed-length and intermixed with dummy packets, there is no way to do any kind of traffic analysis.

[0006] Still another anonymity technique, called ‘crowds,’ protects the identity of the originating terminal from the intermediate proxies by providing that originating terminals belong to groups of proxies called crowds. The crowd proxies are interposed between originating and target terminals. Each proxy through which the message is sent is randomly chosen by an upstream proxy. Each intermediate proxy can send the message either to another randomly chosen proxy in the “crowd” or to the destination. Thus, even crowd members cannot determine if a preceding proxy is the originator of the message or if it was simply passed from another proxy.

[0007] ZKS (Zero-Knowledge Systems) Anonymous IP Protocol allows users to select up to any of five different pseudonyms, while desktop software encrypts outgoing traffic and wraps it in User Datagram Protocol (UDP) packets. The first server in a 2+-hop system gets the UDP packets, strips off one layer of encryption to add another, then sends the traffic to the next server, which strips off yet another layer of encryption and adds a new one. The user is permitted to control the number of hops. At the final server, traffic is decrypted with an untraceable IP address. The technique is called onion-routing. This method can be defeated using traffic analysis. For a simple example, bursts of packets from a user during low-duty periods can reveal the identities of sender and receiver.

[0008] Firewalls attempt to protect LANs from unauthorized access and hostile exploitation or damage to computers connected to the LAN. Firewalls provide a server through which all access to the LAN must pass. Firewalls are centralized systems that require

administrative overhead to maintain. They can be compromised by virtual-machine applications (“applets”). They instill a false sense of security that leads to security breaches for example by users sending sensitive information to servers outside the firewall or encouraging use of modems to sidestep the firewall security. Firewalls are not useful for distributed systems such as business travelers, extranets, small teams, etc.

SUMMARY OF THE INVENTION

[0009] A secure mechanism for communicating over the internet, including a protocol referred to as the Tunneled Agile Routing Protocol (TARP), uses a unique two-layer encryption format and special TARP routers. TARP routers are similar in function to regular IP routers. Each TARP router has one or more IP addresses and uses normal IP protocol to send IP packet messages (“packets” or “datagrams”). The IP packets exchanged between TARP terminals via TARP routers are actually encrypted packets whose true destination address is concealed except to TARP routers and servers. The normal or “clear” or “outside” IP header attached to TARP IP packets contains only the address of a next hop router or destination server. That is, instead of indicating a final destination in the destination field of the IP header, the TARP packet’s IP header always points to a next-hop in a series of TARP router hops, or to the final destination. This means there is no overt indication from an intercepted TARP packet of the true destination of the TARP packet since the destination could always be next-hop TARP router as well as the final destination.

[0010] Each TARP packet’s true destination is concealed behind a layer of encryption generated using a link key. The link key is the encryption key used for encrypted communication between the hops intervening between an originating TARP terminal and a destination TARP terminal. Each TARP router can remove the outer layer of encryption to reveal the destination router for each TARP packet. To identify the link key needed to decrypt the outer layer of encryption of a TARP packet, a receiving TARP or routing terminal may identify the transmitting terminal by the sender/receiver IP numbers in the cleartext IP header.

[0011] Once the outer layer of encryption is removed, the TARP router determines the final destination. Each TARP packet 140 undergoes a minimum number of hops to help foil

traffic analysis. The hops may be chosen at random or by a fixed value. As a result, each TARP packet may make random trips among a number of geographically disparate routers before reaching its destination. Each trip is highly likely to be different for each packet composing a given message because each trip is independently randomly determined. This feature is called *agile routing*. The fact that different packets take different routes provides distinct advantages by making it difficult for an interloper to obtain all the packets forming an entire multi-packet message. The associated advantages have to do with the inner layer of encryption discussed below. Agile routing is combined with another feature that furthers this purpose; a feature that ensures that any message is broken into multiple packets.

[0012] The IP address of a TARP router can be changed, a feature called *IP agility*. Each TARP router, independently or under direction from another TARP terminal or router, can change its IP address. A separate, unchangeable identifier or address is also defined. This address, called the TARP address, is known only to TARP routers and terminals and may be correlated at any time by a TARP router or a TARP terminal using a Lookup Table (LUT). When a TARP router or terminal changes its IP address, it updates the other TARP routers and terminals which in turn update their respective LUTs.

[0013] The message payload is hidden behind an inner layer of encryption in the TARP packet that can only be unlocked using a session key. The session key is not available to any of the intervening TARP routers. The session key is used to decrypt the payloads of the TARP packets permitting the data stream to be reconstructed.

[0014] Communication may be made private using link and session keys, which in turn may be shared and used according to any desired method. For example, public/private keys or symmetric keys may be used.

[0015] To transmit a data stream, a TARP originating terminal constructs a series of TARP packets from a series of IP packets generated by a network (IP) layer process. (Note that the terms “network layer,” “data link layer,” “application layer,” etc. used in this specification correspond to the Open Systems Interconnection (OSI) network terminology.) The payloads of these packets are assembled into a block and chain-block encrypted using the session key. This

assumes, of course, that all the IP packets are destined for the same TARP terminal. The block is then interleaved and the interleaved encrypted block is broken into a series of payloads, one for each TARP packet to be generated. Special TARP headers IP_T are then added to each payload using the IP headers from the data stream packets. The TARP headers can be identical to normal IP headers or customized in some way. They should contain a formula or data for deinterleaving the data at the destination TARP terminal, a time-to-live (TTL) parameter to indicate the number of hops still to be executed, a data type identifier which indicates whether the payload contains, for example, TCP or UDP data, the sender's TARP address, the destination TARP address, and an indicator as to whether the packet contains real or decoy data or a formula for filtering out decoy data if decoy data is spread in some way through the TARP payload data.

[0016] Note that although chain-block encryption is discussed here with reference to the session key, any encryption method may be used. Preferably, as in chain block encryption, a method should be used that makes unauthorized decryption difficult without an entire result of the encryption process. Thus, by separating the encrypted block among multiple packets and making it difficult for an interloper to obtain access to all of such packets, the contents of the communications are provided an extra layer of security.

[0017] Decoy or dummy data can be added to a stream to help foil traffic analysis by reducing the peak-to-average network load. It may be desirable to provide the TARP process with an ability to respond to the time of day or other criteria to generate more decoy data during low traffic periods so that communication bursts at one point in the Internet cannot be tied to communication bursts at another point to reveal the communicating endpoints.

[0018] Dummy data also helps to break the data into a larger number of inconspicuously-sized packets permitting the interleave window size to be increased while maintaining a reasonable size for each packet. (The packet size can be a single standard size or selected from a fixed range of sizes.) One primary reason for desiring for each message to be broken into multiple packets is apparent if a chain block encryption scheme is used to form the first encryption layer prior to interleaving. A single block encryption may be applied to a portion, or entirety, of a message, and that portion or entirety then interleaved into a number of separate

packets. Considering the agile IP routing of the packets, and the attendant difficulty of reconstructing an entire sequence of packets to form a single block-encrypted message element, decoy packets can significantly increase the difficulty of reconstructing an entire data stream.

[0019] The above scheme may be implemented entirely by processes operating between the data link layer and the network layer of each server or terminal participating in the TARP system. Because the encryption system described above is insertable between the data link and network layers, the processes involved in supporting the encrypted communication may be completely transparent to processes at the IP (network) layer and above. The TARP processes may also be completely transparent to the data link layer processes as well. Thus, no operations at or above the Network layer, or at or below the data link layer, are affected by the insertion of the TARP stack. This provides additional security to all processes at or above the network layer, since the difficulty of unauthorized penetration of the network layer (by, for example, a hacker) is increased substantially. Even newly developed servers running at the session layer leave all processes below the session layer vulnerable to attack. Note that in this architecture, security is distributed. That is, notebook computers used by executives on the road, for example, can communicate over the Internet without any compromise in security.

[0020] IP address changes made by TARP terminals and routers can be done at regular intervals, at random intervals, or upon detection of “attacks.” The variation of IP addresses hinders traffic analysis that might reveal which computers are communicating, and also provides a degree of immunity from attack. The level of immunity from attack is roughly proportional to the rate at which the IP address of the host is changing.

[0021] As mentioned, IP addresses may be changed in response to attacks. An attack may be revealed, for example, by a regular series of messages indicating that a router is being probed in some way. Upon detection of an attack, the TARP layer process may respond to this event by changing its IP address. In addition, it may create a subprocess that maintains the original IP address and continues interacting with the attacker in some manner.

[0022] Decoy packets may be generated by each TARP terminal on some basis determined by an algorithm. For example, the algorithm may be a random one which calls for the

generation of a packet on a random basis when the terminal is idle. Alternatively, the algorithm may be responsive to time of day or detection of low traffic to generate more decoy packets during low traffic times. Note that packets are preferably generated in groups, rather than one by one, the groups being sized to simulate real messages. In addition, so that decoy packets may be inserted in normal TARP message streams, the background loop may have a latch that makes it more likely to insert decoy packets when a message stream is being received. Alternatively, if a large number of decoy packets is received along with regular TARP packets, the algorithm may increase the rate of dropping of decoy packets rather than forwarding them. The result of dropping and generating decoy packets in this way is to make the apparent incoming message size different from the apparent outgoing message size to help foil traffic analysis.

[0023] In various other embodiments of the invention, a scalable version of the system may be constructed in which a plurality of IP addresses are preassigned to each pair of communicating nodes in the network. Each pair of nodes agrees upon an algorithm for “hopping” between IP addresses (both sending and receiving), such that an eavesdropper sees apparently continuously random IP address pairs (source and destination) for packets transmitted between the pair. Overlapping or “reusable” IP addresses may be allocated to different users on the same subnet, since each node merely verifies that a particular packet includes a valid source/destination pair from the agreed-upon algorithm. Source/destination pairs are preferably not reused between any two nodes during any given end-to-end session, though limited IP block sizes or lengthy sessions might require it.

[0024] Further improvements described in this continuation-in-part application include: (1) a load balancer that distributes packets across different transmission paths according to transmission path quality; (2) a DNS proxy server that transparently creates a virtual private network in response to a domain name inquiry; (3) a large-to-small link bandwidth management feature that prevents denial-of service attacks at system chokepoints; (4) a traffic limiter that regulates incoming packets by limiting the rate at which a transmitter can be synchronized with a receiver; and (5) a signaling synchronizer that allows a large number of nodes to communicate with a central node by partitioning the communication function between two separate entities.

[0025] The present invention provides key technologies for implementing a secure virtual Internet by using a new agile network protocol that is built on top of the existing Internet protocol (IP). The secure virtual Internet works over the existing Internet infrastructure, and interfaces with client applications the same way as the existing Internet. The key technologies provided by the present invention that support the secure virtual Internet include a “one-click” and “no-click” technique to become part of the secure virtual Internet, a secure domain name service (SDNS) for the secure virtual Internet, and a new approach for interfacing specific client applications onto the secure virtual Internet. According to the invention, the secure domain name service interfaces with existing applications, in addition to providing a way to register and serve domain names and addresses.

[0026] According to one aspect of the present invention, a user can conveniently establish a VPN using a “one-click” or a “no-click” technique without being required to enter user identification information, a password and/or an encryption key for establishing a VPN. The advantages of the present invention are provided by a method for establishing a secure communication link between a first computer and a second computer over a computer network, such as the Internet. In one embodiment, a secure communication mode is enabled at a first computer without a user entering any cryptographic information for establishing the secure communication mode of communication, preferably by merely selecting an icon displayed on the first computer. Alternatively, the secure communication mode of communication can be enabled by entering a command into the first computer. Then, a secure communication link is established between the first computer and a second computer over a computer network based on the enabled secure communication mode of communication. According to the invention, it is determined whether a secure communication software module is stored on the first computer in response to the step of enabling the secure communication mode of communication. A predetermined computer network address is then accessed for loading the secure communication software module when the software module is not stored on the first computer. Subsequently, the proxy software module is stored in the first computer. The secure communication link is a virtual private network communication link over the computer network. Preferably, the virtual private network can be based on inserting into each data packet one or more data values that vary according to a pseudo-random sequence. Alternatively, the virtual private network can be based

on a computer network address hopping regime that is used to pseudorandomly change computer network addresses or other data values in packets transmitted between the first computer and the second computer, such that the second computer compares the data values in each data packet transmitted between the first computer and the second computer to a moving window of valid values. Yet another alternative provides that the virtual private network can be based on a comparison between a discriminator field in each data packet to a table of valid discriminator fields maintained for the first computer.

[0027] According to another aspect of the invention, a command is entered to define a setup parameter associated with the secure communication link mode of communication. Consequently, the secure communication mode is automatically established when a communication link is established over the computer network.

[0028] The present invention also provides a computer system having a communication link to a computer network, and a display showing a hyperlink for establishing a virtual private network through the computer network. When the hyperlink for establishing the virtual private network is selected, a virtual private network is established over the computer network. A non-standard top-level domain name is then sent over the virtual private network communication to a predetermined computer network address, such as a computer network address for a secure domain name service (SDNS).

[0029] The present invention provides a domain name service that provides secure computer network addresses for secure, non-standard top-level domain names. The advantages of the present invention are provided by a secure domain name service for a computer network that includes a portal connected to a computer network, such as the Internet, and a domain name database connected to the computer network through the portal. According to the invention, the portal authenticates a query for a secure computer network address, and the domain name database stores secure computer network addresses for the computer network. Each secure computer network address is based on a non-standard top-level domain name, such as .scom, .sorg, .snet, .snet, .sedu, .smil and .sint.

[0030] The present invention provides a way to encapsulate existing application network traffic at the application layer of a client computer so that the client application can securely communicate with a server protected by an agile network protocol. The advantages of the present invention are provided by a method for communicating using a private communication link between a client computer and a server computer over a computer network, such as the Internet. According to the invention, an information packet is sent from the client computer to the server computer over the computer network. The information packet contains data that is inserted into the payload portion of the packet at the application layer of the client computer and is used for forming a virtual private connection between the client computer and the server computer. The modified information packet can be sent through a firewall before being sent over the computer network to the server computer and by working on top of existing protocols (i.e., UDP, ICMP and TCP), the present invention more easily penetrates the firewall. The information packet is received at a kernel layer of an operating system on the server side. It is then determined at the kernel layer of the operating system on the host computer whether the information packet contains the data that is used for forming the virtual private connection. The server side replies by sending an information packet to the client computer that has been modified at the kernel layer to containing virtual private connection information in the payload portion of the reply information packet. Preferably, the information packet from the client computer and the reply information packet from the server side are each a UDP protocol information packet. Alternative, both information packets could be a TCP/IP protocol information packet, or an ICMP protocol information packet.

BRIEF DESCRIPTION OF THE DRAWINGS

[0031] FIG. 1 is an illustration of secure communications over the Internet according to a prior art embodiment.

[0032] FIG. 2 is an illustration of secure communications over the Internet according to an embodiment of the invention.

[0033] FIG. 3a is an illustration of a process of forming a tunneled IP packet according to an embodiment of the invention.

[0034] FIG. 3b is an illustration of a process of forming a tunneled IP packet according to another embodiment of the invention.

[0035] FIG. 4 is an illustration of an OSI layer location of processes that may be used to implement the invention.

[0036] FIG. 5 is a flow chart illustrating a process for routing a tunneled packet according to an embodiment of the invention.

[0037] FIG. 6 is a flow chart illustrating a process for forming a tunneled packet according to an embodiment of the invention.

[0038] FIG. 7 is a flow chart illustrating a process for receiving a tunneled packet according to an embodiment of the invention.

[0039] FIG. 8 shows how a secure session is established and synchronized between a client and a TARP router.

[0040] FIG. 9 shows an IP address hopping scheme between a client computer and TARP router using transmit and receive tables in each computer.

[0041] FIG. 10 shows physical link redundancy among three Internet Service Providers (ISPs) and a client computer.

[0042] FIG. 11 shows how multiple IP packets can be embedded into a single “frame” such as an Ethernet frame, and further shows the use of a discriminator field to camouflage true packet recipients.

[0043] FIG. 12A shows a system that employs hopped hardware addresses, hopped IP addresses, and hopped discriminator fields.

[0044] FIG. 12B shows several different approaches for hopping hardware addresses, IP addresses, and discriminator fields in combination.

[0045] FIG. 13 shows a technique for automatically re-establishing synchronization between sender and receiver through the use of a partially public sync value.

[0046] FIG. 14 shows a “checkpoint” scheme for regaining synchronization between a sender and recipient.

[0047] FIG. 15 shows further details of the checkpoint scheme of FIG. 14.

[0048] FIG. 16 shows how two addresses can be decomposed into a plurality of segments for comparison with presence vectors.

[0049] FIG. 17 shows a storage array for a receiver’s active addresses.

[0050] FIG. 18 shows the receiver’s storage array after receiving a sync request.

[0051] FIG. 19 shows the receiver’s storage array after new addresses have been generated.

[0052] FIG. 20 shows a system employing distributed transmission paths.

[0053] FIG. 21 shows a plurality of link transmission tables that can be used to route packets in the system of FIG. 20.

[0054] FIG. 22A shows a flowchart for adjusting weight value distributions associated with a plurality of transmission links.

[0055] FIG. 22B shows a flowchart for setting a weight value to zero if a transmitter turns off.

[0056] FIG. 23 shows a system employing distributed transmission paths with adjusted weight value distributions for each path.

[0057] FIG. 24 shows an example using the system of FIG. 23.

[0058] FIG. 25 shows a conventional domain-name look-up service.

[0059] FIG. 26 shows a system employing a DNS proxy server with transparent VPN creation.

[0060] FIG. 27 shows steps that can be carried out to implement transparent VPN creation based on a DNS look-up function.

[0061] FIG. 28 shows a system including a link guard function that prevents packet overloading on a low-bandwidth link LOW BW.

[0062] FIG. 29 shows one embodiment of a system employing the principles of FIG. 28.

[0063] FIG. 30 shows a system that regulates packet transmission rates by throttling the rate at which synchronizations are performed.

[0064] FIG. 31 shows a signaling server 3101 and a transport server 3102 used to establish a VPN with a client computer.

[0065] FIG. 32 shows message flows relating to synchronization protocols of FIG. 31.

[0066] FIG. 33 shows a system block diagram of a computer network in which the “one-click” secure communication link of the present invention is suitable for use.

[0067] FIG. 34 shows a flow diagram for installing and establishing a “one-click” secure communication link over a computer network according to the present invention.

[0068] FIG. 35 shows a flow diagram for registering a secure domain name according to the present invention.

[0069] FIG. 36 shows a system block diagram of a computer network in which a private connection according to the present invention can be configured to more easily traverse a firewall between two computer networks.

[0070] FIG. 37 shows a flow diagram for establishing a virtual private connection that is encapsulated using an existing network protocol.

DETAILED DESCRIPTION OF THE INVENTION

[0071] Referring to FIG. 2, a secure mechanism for communicating over the internet employs a number of special routers or servers, called TARP routers 122-127 that are similar to regular IP routers 128-132 in that each has one or more IP addresses and uses normal IP protocol to send normal-looking IP packet messages, called TARP packets 140. TARP packets 140 are identical to normal IP packet messages that are routed by regular IP routers 128-132 because each TARP packet 140 contains a destination address as in a normal IP packet. However, instead of indicating a final destination in the destination field of the IP header, the TARP packet's 140 IP header always points to a next-hop in a series of TARP router hops, or the final destination, TARP terminal 110. Because the header of the TARP packet contains only the next-hop destination, there is no overt indication from an intercepted TARP packet of the true destination of the TARP packet 140 since the destination could always be the next-hop TARP router as well as the final destination, TARP terminal 110.

[0072] Each TARP packet's true destination is concealed behind an outer layer of encryption generated using a link key 146. The link key 146 is the encryption key used for encrypted communication between the end points (TARP terminals or TARP routers) of a single link in the chain of hops connecting the originating TARP terminal 100 and the destination TARP terminal 110. Each TARP router 122-127, using the link key 146 it uses to communicate with the previous hop in a chain, can use the link key to reveal the true destination of a TARP packet. To identify the link key needed to decrypt the outer layer of encryption of a TARP packet, a receiving TARP or routing terminal may identify the transmitting terminal (which may indicate the link key used) by the sender field of the clear IP header. Alternatively, this identity may be hidden behind another layer of encryption in available bits in the clear IP header. Each TARP router, upon receiving a TARP message, determines if the message is a TARP message by using authentication data in the TARP packet. This could be recorded in available bytes in the TARP packet's IP header. Alternatively, TARP packets could be authenticated by attempting to

decrypt using the link key 146 and determining if the results are as expected. The former may have computational advantages because it does not involve a decryption process.

[0073] Once the outer layer of decryption is completed by a TARP router 122-127, the TARP router determines the final destination. The system is preferably designed to cause each TARP packet 140 to undergo a minimum number of hops to help foil traffic analysis. The time to live counter in the IP header of the TARP message may be used to indicate a number of TARP router hops yet to be completed. Each TARP router then would decrement the counter and determine from that whether it should forward the TARP packet 140 to another TARP router 122-127 or to the destination TARP terminal 110. If the time to live counter is zero or below zero after decrementing, for an example of usage, the TARP router receiving the TARP packet 140 may forward the TARP packet 140 to the destination TARP terminal 110. If the time to live counter is above zero after decrementing, for an example of usage, the TARP router receiving the TARP packet 140 may forward the TARP packet 140 to a TARP router 122-127 that the current TARP terminal chooses at random. As a result, each TARP packet 140 is routed through some minimum number of hops of TARP routers 122-127 which are chosen at random.

[0074] Thus, each TARP packet, irrespective of the traditional factors determining traffic in the Internet, makes random trips among a number of geographically disparate routers before reaching its destination and each trip is highly likely to be different for each packet composing a given message because each trip is independently randomly determined as described above. This feature is called *agile routing*. For reasons that will become clear shortly, the fact that different packets take different routes provides distinct advantages by making it difficult for an interloper to obtain all the packets forming an entire multi-packet message. Agile routing is combined with another feature that furthers this purpose, a feature that ensures that any message is broken into multiple packets.

[0075] A TARP router receives a TARP packet when an IP address used by the TARP router coincides with the IP address in the TARP packet's IP header IPc. The IP address of a TARP router, however, may not remain constant. To avoid and manage attacks, each TARP router, independently or under direction from another TARP terminal or router, may change its IP address. A separate, unchangeable identifier or address is also defined. This address, called

the TARP address, is known only to TARP routers and terminals and may be correlated at any time by a TARP router or a TARP terminal using a Lookup Table (LUT). When a TARP router or terminal changes its IP address, it updates the other TARP routers and terminals which in turn update their respective LUTs. In reality, whenever a TARP router looks up the address of a destination in the encrypted header, it must convert a TARP address to a real IP address using its LUT.

[0076] While every TARP router receiving a TARP packet has the ability to determine the packet's final destination, the message payload is embedded behind an inner layer of encryption in the TARP packet that can only be unlocked using a session key. The session key is not available to any of the TARP routers 122-127 intervening between the originating 100 and destination 110 TARP terminals. The session key is used to decrypt the payloads of the TARP packets 140 permitting an entire message to be reconstructed.

[0077] In one embodiment, communication may be made private using link and session keys, which in turn may be shared and used according any desired method. For example, a public key or symmetric keys may be communicated between link or session endpoints using a public key method. Any of a variety of other mechanisms for securing data to ensure that only authorized computers can have access to the private information in the TARP packets 140 may be used as desired.

[0078] Referring to FIG. 3a, to construct a series of TARP packets, a data stream 300 of IP packets 207a, 207b, 207c, etc., such series of packets being formed by a network (IP) layer process, is broken into a series of small sized segments. In the present example, equal-sized segments 1-9 are defined and used to construct a set of interleaved data packets A, B, and C. Here it is assumed that the number of interleaved packets A, B, and C formed is three and that the number of IP packets 207a-207c used to form the three interleaved packets A, B, and C is exactly three. Of course, the number of IP packets spread over a group of interleaved packets may be any convenient number as may be the number of interleaved packets over which the incoming data stream is spread. The latter, the number of interleaved packets over which the data stream is spread, is called the *interleave window*.

[0079] To create a packet, the transmitting software interleaves the normal IP packets 207a *et. seq.*, to form a new set of interleaved payload data 320. This payload data 320 is then encrypted using a session key to form a set of session-key-encrypted payload data 330, each of which, A, B, and C, will form the payload of a TARP packet. Using the IP header data, from the original packets 207a-207c, new TARP headers IPT are formed. The TARP headers IPT can be identical to normal IP headers or customized in some way. In a preferred embodiment, the TARP headers IPT are IP headers with added data providing the following information required for routing and reconstruction of messages, some of which data is ordinarily, or capable of being, contained in normal IP headers:

1. A window sequence number — an identifier that indicates where the packet belongs in the original message sequence.

2. An interleave sequence number — an identifier that indicates the interleaving sequence used to form the packet so that the packet can be deinterleaved along with other packets in the interleave window.

3. A time-to-live (TTL) datum — indicates the number of TARP-router-hops to be executed before the packet reaches its destination. Note that the TTL parameter may provide a datum to be used in a probabilistic formula for determining whether to route the packet to the destination or to another hop.

4. Data type identifier — indicates whether the payload contains, for example, TCP or UDP data.

5. Sender's address — indicates the sender's address in the TARP network.

6. Destination address — indicates the destination terminal's address in the TARP network.

7. Decoy/Real — an indicator of whether the packet contains real message data or dummy decoy data or a combination.

[0080] Obviously, the packets going into a single interleave window must include only packets with a common destination. Thus, it is assumed in the depicted example that the IP headers of IP packets 207a-207c all contain the same destination address or at least will be received by the same terminal so that they can be deinterleaved. Note that dummy or decoy data or packets can be added to form a larger interleave window than would otherwise be required by the size of a given message. Decoy or dummy data can be added to a stream to help foil traffic analysis by leveling the load on the network. Thus, it may be desirable to provide the TARP process with an ability to respond to the time of day or other criteria to generate more decoy data during low traffic periods so that communication bursts at one point in the Internet cannot be tied to communication bursts at another point to reveal the communicating endpoints.

[0081] Dummy data also helps to break the data into a larger number of inconspicuously-sized packets permitting the interleave window size to be increased while maintaining a reasonable size for each packet. (The packet size can be a single standard size or selected from a fixed range of sizes.) One primary reason for desiring for each message to be broken into multiple packets is apparent if a chain block encryption scheme is used to form the first encryption layer prior to interleaving. A single block encryption may be applied to a portion, or the entirety, of a message, and that portion or entirety then interleaved into a number of separate packets.

[0082] Referring to FIG. 3b, in an alternative mode of TARP packet construction, a series of IP packets are accumulated to make up a predefined interleave window. The payloads of the packets are used to construct a single block 520 for chain block encryption using the session key. The payloads used to form the block are presumed to be destined for the same terminal. The block size may coincide with the interleave window as depicted in the example embodiment of FIG. 3b. After encryption, the encrypted block is broken into separate payloads and segments which are interleaved as in the embodiment of Fig 3a. The resulting interleaved packets A, B, and C, are then packaged as TARP packets with TARP headers as in the Example of FIG. 3a. The remaining process is as shown in, and discussed with reference to, FIG. 3a.

[0083] Once the TARP packets 340 are formed, each entire TARP packet 340, including the TARP header IPT, is encrypted using the link key for communication with the

first-hop-TARP router. The first hop TARP router is randomly chosen. A final unencrypted IP header IP_C is added to each encrypted TARP packet 340 to form a normal IP packet 360 that can be transmitted to a TARP router. Note that the process of constructing the TARP packet 360 does not have to be done in stages as described. The above description is just a useful heuristic for describing the final product, namely, the TARP packet.

[0084] Note that, TARP header IP_T could be a completely custom header configuration with no similarity to a normal IP header except that it contain the information identified above. This is so since this header is interpreted by only TARP routers.

[0085] The above scheme may be implemented entirely by processes operating between the data link layer and the network layer of each server or terminal participating in the TARP system. Referring to FIG. 4, a TARP transceiver 405 can be an originating terminal 100, a destination terminal 110, or a TARP router 122-127. In each TARP Transceiver 405, a transmitting process is generated to receive normal packets from the Network (IP) layer and generate TARP packets for communication over the network. A receiving process is generated to receive normal IP packets containing TARP packets and generate from these normal IP packets which are “passed up” to the Network (IP) layer. Note that where the TARP Transceiver 405 is a router, the received TARP packets 140 are not processed into a stream of IP packets 415 because they need only be authenticated as proper TARP packets and then passed to another TARP router or a TARP destination terminal 110. The intervening process, a “TARP Layer” 420, could be combined with either the data link layer 430 or the Network layer 410. In either case, it would intervene between the data link layer 430 so that the process would receive regular IP packets containing embedded TARP packets and “hand up” a series of reassembled IP packets to the Network layer 410. As an example of combining the TARP layer 420 with the data link layer 430, a program may augment the normal processes running a communications card, for example, an Ethernet card. Alternatively, the TARP layer processes may form part of a dynamically loadable module that is loaded and executed to support communications between the network and data link layers.

[0086] Because the encryption system described above can be inserted between the data link and network layers, the processes involved in supporting the encrypted communication may be completely transparent to processes at the IP (network) layer and above. The TARP processes may also be completely transparent to the data link layer processes as well. Thus, no operations at or above the network layer, or at or below the data link layer, are affected by the insertion of the TARP stack. This provides additional security to all processes at or above the network layer, since the difficulty of unauthorized penetration of the network layer (by, for example, a hacker) is increased substantially. Even newly developed servers running at the session layer leave all processes below the session layer vulnerable to attack. Note that in this architecture, security is distributed. That is, notebook computers used by executives on the road, for example, can communicate over the Internet without any compromise in security.

[0087] Note that IP address changes made by TARP terminals and routers can be done at regular intervals, at random intervals, or upon detection of “attacks.” The variation of IP addresses hinders traffic analysis that might reveal which computers are communicating, and also provides a degree of immunity from attack. The level of immunity from attack is roughly proportional to the rate at which the IP address of the host is changing.

[0088] As mentioned, IP addresses may be changed in response to attacks. An attack may be revealed, for example, by a regular series of messages indicates that a router is being probed in some way. Upon detection of an attack, the TARP layer process may respond to this event by changing its IP address. To accomplish this, the TARP process will construct a TARP-formatted message, in the style of Internet Control Message Protocol (ICMP) datagrams as an example; this message will contain the machine’s TARP address, its previous IP address, and its new IP address. The TARP layer will transmit this packet to at least one known TARP router; then upon receipt and validation of the message, the TARP router will update its LUT with the new IP address for the stated TARP address. The TARP router will then format a similar message, and broadcast it to the other TARP routers so that they may update their LUTs. Since the total number of TARP routers on any given subnet is expected to be relatively small, this process of updating the LUTs should be relatively fast. It may not, however, work as well when there is a relatively large number of TARP routers and/or a relatively large number of clients;

this has motivated a refinement of this architecture to provide scalability; this refinement has led to a second embodiment, which is discussed below.

[0089] Upon detection of an attack, the TARP process may also create a subprocess that maintains the original IP address and continues interacting with the attacker. The latter may provide an opportunity to trace the attacker or study the attacker's methods (called "fishbowling" drawing upon the analogy of a small fish in a fish bowl that "thinks" it is in the ocean but is actually under captive observation). A history of the communication between the attacker and the abandoned (fishbowed) IP address can be recorded or transmitted for human analysis or further synthesized for purposes of responding in some way.

[0090] As mentioned above, decoy or dummy data or packets can be added to outgoing data streams by TARP terminals or routers. In addition to making it convenient to spread data over a larger number of separate packets, such decoy packets can also help to level the load on inactive portions of the Internet to help foil traffic analysis efforts.

[0091] Decoy packets may be generated by each TARP terminal 100, 110 or each router 122-127 on some basis determined by an algorithm. For example, the algorithm may be a random one which calls for the generation of a packet on a random basis when the terminal is idle. Alternatively, the algorithm may be responsive to time of day or detection of low traffic to generate more decoy packets during low traffic times. Note that packets are preferably generated in groups, rather than one by one, the groups being sized to simulate real messages. In addition, so that decoy packets may be inserted in normal TARP message streams, the background loop may have a latch that makes it more likely to insert decoy packets when a message stream is being received. That is, when a series of messages are received, the decoy packet generation rate may be increased. Alternatively, if a large number of decoy packets is received along with regular TARP packets, the algorithm may increase the rate of dropping of decoy packets rather than forwarding them. The result of dropping and generating decoy packets in this way is to make the apparent incoming message size different from the apparent outgoing message size to help foil traffic analysis. The rate of reception of packets, decoy or otherwise, may be indicated to the decoy packet dropping and generating processes through perishable decoy and regular packet counters. (A perishable counter is one that resets or decrements its value in response to

time so that it contains a high value when it is incremented in rapid succession and a small value when incremented either slowly or a small number of times in rapid succession.) Note that destination TARP terminal 110 may generate decoy packets equal in number and size to those TARP packets received to make it appear it is merely routing packets and is therefore not the destination terminal.

[0092] Referring to FIG. 5, the following particular steps may be employed in the above- described method for routing TARP packets.

- S0. A background loop operation is performed which applies an algorithm which determines the generation of decoy IP packets. The loop is interrupted when an encrypted TARP packet is received.
- S2. The TARP packet may be probed in some way to authenticate the packet before attempting to decrypt it using the link key. That is, the router may determine that the packet is an authentic TARP packet by performing a selected operation on some data included with the clear IP header attached to the encrypted TARP packet contained in the payload. This makes it possible to avoid performing decryption on packets that are not authentic TARP packets.
- S3. The TARP packet is decrypted to expose the destination TARP address and an indication of whether the packet is a decoy packet or part of a real message.
- S4. If the packet is a decoy packet, the perishable decoy counter is incremented.
- S5. Based on the decoy generation/dropping algorithm and the perishable decoy counter value, if the packet is a decoy packet, the router may choose to throw it away. If the received packet is a decoy packet and it is determined that it should be thrown away (S6), control returns to step S0.
- S7. The TTL parameter of the TARP header is decremented and it is determined if the TTL parameter is greater than zero.

- S8. If the TTL parameter is greater than zero, a TARP address is randomly chosen from a list of TARP addresses maintained by the router and the link key and IP address corresponding to that TARP address memorized for use in creating a new IP packet containing the TARP packet.
- S9. If the TTL parameter is zero or less, the link key and IP address corresponding to the TARP address of the destination are memorized for use in creating the new IP packet containing the TARP packet.
- S 10. The TARP packet is encrypted using the memorized link key.
- S 11. An IP header is added to the packet that contains the stored IP address, the encrypted TARP packet wrapped with an IP header, and the completed packet transmitted to the next hop or destination.

[0093] Referring to FIG. 6, the following particular steps may be employed in the above- described method for generating TARP packets.

- S20. A background loop operation applies an algorithm that determines the generation of decoy IP packets. The loop is interrupted when a data stream containing IP packets is received for transmission.
- S21. The received IP packets are grouped into a set consisting of messages with a constant IP destination address. The set is further broken down to coincide with a maximum size of an interleave window. The set is encrypted, and interleaved into a set of payloads destined to become TARP packets.
- S22. The TARP address corresponding to the IP address is determined from a lookup table and stored to generate the TARP header. An initial TTL count is generated and stored in the header. The TTL count may be random with minimum and maximum values or it may be fixed or determined by some other parameter.
- S23. The window sequence numbers and interleave sequence numbers are recorded in the TARP headers of each packet.

- S24. One TARP router address is randomly chosen for each TARP packet and the IP address corresponding to it stored for use in the clear IP header. The link key corresponding to this router is identified and used to encrypt TARP packets containing interleaved and encrypted data and TARP headers.
- S25. A clear IP header with the first hop router's real IP address is generated and added to each of the encrypted TARP packets and the resulting packets.

[0094] Referring to FIG. 7, the following particular steps may be employed in the above- described method for receiving TARP packets.

- S40. A background loop operation is performed which applies an algorithm which determines the generation of decoy IP packets. The loop is interrupted when an encrypted TARP packet is received.
- S42. The TARP packet may be probed to authenticate the packet before attempting to decrypt it using the link key.
- S43. The TARP packet is decrypted with the appropriate link key to expose the destination TARP address and an indication of whether the packet is a decoy packet or part of a real message.
- S44. If the packet is a decoy packet, the perishable decoy counter is incremented.
- S45. Based on the decoy generation/dropping algorithm and the perishable decoy counter value, if the packet is a decoy packet, the receiver may choose to throw it away.
- S46. The TARP packets are cached until all packets forming an interleave window are received.
- S47. Once all packets of an interleave window are received, the packets are deinterleaved.
- S48. The packets block of combined packets defining the interleave window is then decrypted using the session key.

- S49. The decrypted block is then divided using the window sequence data and the IP_T headers are converted into normal IP_C headers. The window sequence numbers are integrated in the IP_C headers.
- S50. The packets are then handed up to the IP layer processes.

1. SCALABILITY ENHANCEMENTS

[0095] The IP agility feature described above relies on the ability to transmit IP address changes to all TARP routers. The embodiments including this feature will be referred to as “boutique” embodiments due to potential limitations in scaling these features up for a large network, such as the Internet. (The “boutique” embodiments would, however, be robust for use in smaller networks, such as small virtual private networks, for example). One problem with the boutique embodiments is that if IP address changes are to occur frequently, the message traffic required to update all routers sufficiently quickly creates a serious burden on the Internet when the TARP router and/or client population gets large. The bandwidth burden added to the networks, for example in ICMP packets, that would be used to update all the TARP routers could overwhelm the Internet for a large scale implementation that approached the scale of the Internet. In other words, the boutique system’s scalability is limited.

[0096] A system can be constructed which trades some of the features of the above embodiments to provide the benefits of IP agility without the additional messaging burden. This is accomplished by IP address-hopping according to shared algorithms that govern IP addresses used between links participating in communications sessions between nodes such as TARP nodes. (Note that the IP hopping technique is also applicable to the boutique embodiment.) The IP agility feature discussed with respect to the boutique system can be modified so that it becomes decentralized under this scalable regime and governed by the above-described shared algorithm. Other features of the boutique system may be combined with this new type of IP-agility.

[0097] The new embodiment has the advantage of providing IP agility governed by a local algorithm and set of IP addresses exchanged by each communicating pair of nodes. This

local governance is session-independent in that it may govern communications between a pair of nodes, irrespective of the session or end points being transferred between the directly communicating pair of nodes.

[0098] In the scalable embodiments, blocks of IP addresses are allocated to each node in the network. (This scalability will increase in the future, when Internet Protocol addresses are increased to 128-bit fields, vastly increasing the number of distinctly addressable nodes). Each node can thus use any of the IP addresses assigned to that node to communicate with other nodes in the network. Indeed, each pair of communicating nodes can use a plurality of source IP addresses and destination IP addresses for communicating with each other.

[0099] Each communicating pair of nodes in a chain participating in any session stores two blocks of IP addresses, called netblocks, and an algorithm and randomization seed for selecting, from each netblock, the next pair of source/destination IP addresses that will be used to transmit the next message. In other words, the algorithm governs the sequential selection of IP-address pairs, one sender and one receiver IP address, from each netblock. The combination of algorithm, seed, and netblock (IP address block) will be called a “hopblock.” A router issues separate transmit and receive hopblocks to its clients. The send address and the receive address of the IP header of each outgoing packet sent by the client are filled with the send and receive IP addresses generated by the algorithm. The algorithm is “clocked” (indexed) by a counter so that each time a pair is used, the algorithm turns out a new transmit pair for the next packet to be sent.

[00100] The router’s receive hopblock is identical to the client’s transmit hopblock. The router uses the receive hopblock to predict what the send and receive IP address pair for the next expected packet from that client will be. Since packets can be received out of order, it is not possible for the router to predict with certainty what IP address pair will be on the next sequential packet. To account for this problem, the router generates a range of predictions encompassing the number of possible transmitted packet send/receive addresses, of which the next packet received could leap ahead. Thus, if there is a vanishingly small probability that a given packet will arrive at the router ahead of 5 packets transmitted by the client before the given packet, then the router can generate a series of 6 send/receive IP address pairs (or “hop window”) to compare with the next received packet. When a packet is received, it is marked in the hop

window as such, so that a second packet with the same IP address pair will be discarded. If an out-of-sequence packet does not arrive within a predetermined timeout period, it can be requested for retransmission or simply discarded from the receive table, depending upon the protocol in use for that communications session, or possibly by convention.

[00101] When the router receives the client's packet, it compares the send and receive IP addresses of the packet with the next N predicted send and receive IP address pairs and rejects the packet if it is not a member of this set. Received packets that do not have the predicted source/destination IP addresses falling with the window are rejected, thus thwarting possible hackers. (With the number of possible combinations, even a fairly large window would be hard to fall into at random.) If it is a member of this set, the router accepts the packet and processes it further. This link-based IP-hopping strategy, referred to as "IHOP," is a network element that stands on its own and is not necessarily accompanied by elements of the boutique system described above. If the routing agility feature described in connection with the boutique embodiment is combined with this link-based IP-hopping strategy, the router's next step would be to decrypt the TARP header to determine the destination TARP router for the packet and determine what should be the next hop for the packet. The TARP router would then forward the packet to a random TARP router or the destination TARP router with which the source TARP router has a link-based IP hopping communication established.

[00102] Figure 8 shows how a client computer 801 and a TARP router 811 can establish a secure session. When client 801 seeks to establish an IHOP session with TARP router 811, the client 801 sends "secure synchronization" request ("SSYN") packet 821 to the TARP router 811. This SYN packet 821 contains the client's 801 authentication token, and may be sent to the router 811 in an encrypted format. The source and destination IP numbers on the packet 821 are the client's 801 current fixed IP address, and a "known" fixed IP address for the router 811. (For security purposes, it may be desirable to reject any packets from outside of the local network that are destined for the router's known fixed IP address.) Upon receipt and validation of the client's 801 SSYN packet 821, the router 811 responds by sending an encrypted "secure synchronization acknowledgment" ("SSYN ACK") 822 to the client 801. This SSYN ACK 822 will contain the transmit and receive hopblocks that the client 801 will use when communicating

with the TARP router 811. The client 801 will acknowledge the TARP router's 811 response packet 822 by generating an encrypted SSYN ACK ACK packet 823 which will be sent from the client's 801 fixed IP address and to the TARP router's 811 known fixed IP address. The client 801 will simultaneously generate a SSYN ACK ACK packet; this SSYN ACK packet, referred to as the Secure Session Initiation (SSI) packet 824, will be sent with the first {sender, receiver} IP pair in the client's transmit table 921 (FIG. 9), as specified in the transmit hopblock provided by the TARP router 811 in the SSYN ACK packet 822. The TARP router 811 will respond to the SSI packet 824 with an SSI ACK packet 825, which will be sent with the first {sender, receiver} IP pair in the TARP router's transmit table 923. Once these packets have been successfully exchanged, the secure communications session is established, and all further secure communications between the client 801 and the TARP router 811 will be conducted via this secure session, as long as synchronization is maintained. If synchronization is lost, then the client 801 and TARP router 802 may re-establish the secure session by the procedure outlined in Figure 8 and described above.

[00103] While the secure session is active, both the client 901 and TARP router 911 (FIG. 9) will maintain their respective transmit tables 921, 923 and receive tables 922, 924, as provided by the TARP router during session synchronization 822. It is important that the sequence of IP pairs in the client's transmit table 921 be identical to those in the TARP router's receive table 924; similarly, the sequence of IP pairs in the client's receive table 922 must be identical to those in the router's transmit table 923. This is required for the session synchronization to be maintained. The client 901 need maintain only one transmit table 921 and one receive table 922 during the course of the secure session. Each sequential packet sent by the client 901 will employ the next {send, receive} IP address pair in the transmit table, regardless of TCP or UDP session. The TARP router 911 will expect each packet arriving from the client 901 to bear the next IP address pair shown in its receive table.

[00104] Since packets can arrive out of order, however, the router 911 can maintain a "look ahead" buffer in its receive table, and will mark previously-received IP pairs as invalid for future packets; any future packet containing an IP pair that is in the look-ahead buffer but is marked as previously received will be discarded. Communications from the TARP router 911 to

the client 901 are maintained in an identical manner; in particular, the router 911 will select the next IP address pair from its transmit table 923 when constructing a packet to send to the client 901, and the client 901 will maintain a look-ahead buffer of expected IP pairs on packets that it is receiving. Each TARP router will maintain separate pairs of transmit and receive tables for each client that is currently engaged in a secure session with or through that TARP router.

[00105] While clients receive their hopblocks from the first server linking them to the Internet, routers exchange hopblocks. When a router establishes a link-based IP-hopping communication regime with another router, each router of the pair exchanges its transmit hopblock. The transmit hopblock of each router becomes the receive hopblock of the other router. The communication between routers is governed as described by the example of a client sending a packet to the first router.

[00106] While the above strategy works fine in the IP milieu, many local networks that are connected to the Internet are Ethernet systems. In Ethernet, the IP addresses of the destination devices must be translated into hardware addresses, and vice versa, using known processes (“address resolution protocol,” and “reverse address resolution protocol”). However, if the link-based IP-hopping strategy is employed, the correlation process would become explosive and burdensome. An alternative to the link-based IP hopping strategy may be employed within an Ethernet network. The solution is to provide that the node linking the Internet to the Ethernet (call it the border node) use the link-based IP-hopping communication regime to communicate with nodes outside the Ethernet LAN. Within the Ethernet LAN, each TARP node would have a single IP address which would be addressed in the conventional way. Instead of comparing the {sender, receiver} IP address pairs to authenticate a packet, the intra-LAN TARP node would use one of the IP header extension fields to do so. Thus, the border node uses an algorithm shared by the intra-LAN TARP node to generate a symbol that is stored in the free field in the IP header, and the intra-LAN TARP node generates a range of symbols based on its prediction of the next expected packet to be received from that particular source IP address. The packet is rejected if it does not fall into the set of predicted symbols (for example, numerical values) or is accepted if it does. Communications from the intra-LAN TARP node to the border node are accomplished in the same manner, though the algorithm will necessarily be different for security

reasons. Thus, each of the communicating nodes will generate transmit and receive tables in a similar manner to that of Figure 9; the intra-LAN TARP nodes transmit table will be identical to the border node's receive table, and the intra-LAN TARP node's receive table will be identical to the border node's transmit table.

[00107] The algorithm used for IP address-hopping can be any desired algorithm. For example, the algorithm can be a given pseudo-random number generator that generates numbers of the range covering the allowed IP addresses with a given seed. Alternatively, the session participants can assume a certain type of algorithm and specify simply a parameter for applying the algorithm. For example the assumed algorithm could be a particular pseudo-random number generator and the session participants could simply exchange seed values.

[00108] Note that there is no permanent physical distinction between the originating and destination terminal nodes. Either device at either end point can initiate a synchronization of the pair. Note also that the authentication/synchronization-request (and acknowledgment) and hopblock-exchange may all be served by a single message so that separate message exchanges may not be required.

[00109] As another extension to the stated architecture, multiple physical paths can be used by a client, in order to provide link redundancy and further thwart attempts at denial of service and traffic monitoring. As shown in Figure 10, for example, client 1001 can establish three simultaneous sessions with each of three TARP routers provided by different ISPs 1011, 1012, 1013. As an example, the client 1001 can use three different telephone lines 1021, 1022, 1023 to connect to the ISPs, or two telephone lines and a cable modem, etc. In this scheme, transmitted packets will be sent in a random fashion among the different physical paths. This architecture provides a high degree of communications redundancy, with improved immunity from denial-of- service attacks and traffic monitoring.

2. FURTHER EXTENSIONS

[00110] The following describes various extensions to the techniques, systems, and methods described above. As described above, the security of communications occurring between computers in a computer network (such as the Internet, an Ethernet, or others) can be

enhanced by using seemingly random source and destination Internet Protocol (IP) addresses for data packets transmitted over the network. This feature prevents eavesdroppers from determining which computers in the network are communicating with each other while permitting the two communicating computers to easily recognize whether a given received data packet is legitimate or not. In one embodiment of the above-described systems, an IP header extension field is used to authenticate incoming packets on an Ethernet.

[00111] Various extensions to the previously described techniques described herein include: (1) use of hopped hardware or “MAC” addresses in broadcast type network; (2) a self synchronization technique that permits a computer to automatically regain synchronization with a sender; (3) synchronization algorithms that allow transmitting and receiving computers to quickly re-establish synchronization in the event of lost packets or other events; and (4) a fast-packet rejection mechanism for rejecting invalid packets. Any or all of these extensions can be combined with the features described above in any of various ways.

A. Hardware Address Hopping

[00112] Internet protocol-based communications techniques on a LAN—or across any dedicated physical medium—typically embed the IP packets within lower-level packets, often referred to as “frames.” As shown in FIG. 11, for example, a first Ethernet frame 1150 comprises a frame header 1101 and two embedded IP packets IP1 and IP2, while a second Ethernet frame 1160 comprises a different frame header 1104 and a single IP packet IP3. Each frame header generally includes a source hardware address 1101 A and a destination hardware address 1101 B; other well-known fields in frame headers are omitted from FIG. 11 for clarity. Two hardware nodes communicating over a physical communication channel insert appropriate source and destination hardware addresses to indicate which nodes on the channel or network should receive the frame.

[00113] It may be possible for a nefarious listener to acquire information about the contents of a frame and/or its communicants by examining frames on a local network rather than (or in addition to) the IP packets themselves. This is especially true in broadcast media, such as Ethernet, where it is necessary to insert into the frame header the hardware address of the

machine that generated the frame and the hardware address of the machine to which frame is being sent. All nodes on the network can potentially “see” all packets transmitted across the network. This can be a problem for secure communications, especially in cases where the communicants do not want for any third party to be able to identify who is engaging in the information exchange. One way to address this problem is to push the address-hopping scheme down to the hardware layer. In accordance with various embodiments of the invention, hardware addresses are “hopped” in a manner similar to that used to change IP addresses, such that a listener cannot determine which hardware node generated a particular message nor which node is the intended recipient.

[00114] FIG. 12A shows a system in which Media Access Control (“MAC”) hardware addresses are “hopped” in order to increase security over a network such as an Ethernet. While the description refers to the exemplary case of an Ethernet environment, the inventive principles are equally applicable to other types of communications media. In the Ethernet case, the MAC address of the sender and receiver are inserted into the Ethernet frame and can be observed by anyone on the LAN who is within the broadcast range for that frame. For secure communications, it becomes desirable to generate frames with MAC addresses that are not attributable to any specific sender or receiver.

[00115] As shown in FIG. 12A, two computer nodes 1201 and 1202 communicate over a communication channel such as an Ethernet. Each node executes one or more application programs 1203 and 1218 that communicate by transmitting packets through communication software 1204 and 1217, respectively. Examples of application programs include video conferencing, e-mail, word processing programs, telephony, and the like. Communication software 1204 and 1217 can comprise, for example, an OSI layered architecture or “stack” that standardizes various services provided at different levels of functionality.

[00116] The lowest levels of communication software 1204 and 1217 communicate with hardware components 1206 and 1214 respectively, each of which can include one or more registers 1207 and 1215 that allow the hardware to be reconfigured or controlled in accordance with various communication protocols. The hardware components (an Ethernet network interface card, for example) communicate with each other over the communication medium. Each

hardware component is typically pre-assigned a fixed hardware address or MAC number that identifies the hardware component to other nodes on the network. One or more interface drivers control the operation of each card and can, for example, be configured to accept or reject packets from certain hardware addresses. As will be described in more detail below, various embodiments of the inventive principles provide for “hopping” different addresses using one or more algorithms and one or more moving windows that track a range of valid addresses to validate received packets. Packets transmitted according to one or more of the inventive principles will be generally referred to as “secure” packets or “secure communications” to differentiate them from ordinary data packets that are transmitted in the clear using ordinary, machine-correlated addresses.

[00117] One straightforward method of generating non-attributable MAC addresses is an extension of the IP hopping scheme. In this scenario, two machines on the same LAN that desire to communicate in a secure fashion exchange random-number generators and seeds, and create sequences of quasi-random MAC addresses for synchronized hopping. The implementation and synchronization issues are then similar to that of IP hopping.

[00118] This approach, however, runs the risk of using MAC addresses that are currently active on the LAN—which, in turn, could interrupt communications for those machines. Since an Ethernet MAC address is at present 48 bits in length, the chance of randomly misusing an active MAC address is actually quite small. However, if that figure is multiplied by a large number of nodes (as would be found on an extensive LAN), by a large number of frames (as might be the case with packet voice or streaming video), and by a large number of concurrent Virtual Private Networks (VPNs), then the chance that a non-secure machine’s MAC address could be used in an address-hopped frame can become non-trivial. In short, any scheme that runs even a small risk of interrupting communications for other machines on the LAN is bound to receive resistance from prospective system administrators. Nevertheless, it is technically feasible, and can be implemented without risk on a LAN on which there is a small number of machines, or if all of the machines on the LAN are engaging in MAC-hopped communications.

[00119] Synchronized MAC address hopping may incur some overhead in the course of session establishment, especially if there are multiple sessions or multiple nodes involved in

the communications. A simpler method of randomizing MAC addresses is to allow each node to receive and process every incident frame on the network. Typically, each network interface driver will check the destination MAC address in the header of every incident frame to see if it matches that machine's MAC address; if there is no match, then the frame is discarded. In one embodiment, however, these checks can be disabled, and every incident packet is passed to the TARP stack for processing. This will be referred to as "promiscuous" mode, since every incident frame is processed. Promiscuous mode allows the sender to use completely random, unsynchronized MAC addresses, since the destination machine is guaranteed to process the frame. The decision as to whether the packet was truly intended for that machine is handled by the TARP stack, which checks the source and destination IP addresses for a match in its IP synchronization tables. If no match is found, the packet is discarded; if there is a match, the packet is unwrapped, the inner header is evaluated, and if the inner header indicates that the packet is destined for that machine then the packet is forwarded to the IP stack—otherwise it is discarded.

[00120] One disadvantage of purely-random MAC address hopping is its impact on processing overhead; that is, since every incident frame must be processed, the machine's CPU is engaged considerably more often than if the network interface driver is discriminating and rejecting packets unilaterally. A compromise approach is to select either a single fixed MAC address or a small number of MAC addresses (e.g., one for each virtual private network on an Ethernet) to use for MAC-hopped communications, regardless of the actual recipient for which the message is intended. In this mode, the network interface driver can check each incident frame against one (or a few) pre-established MAC addresses, thereby freeing the CPU from the task of physical-layer packet discrimination. This scheme does not betray any useful information to an interloper on the LAN; in particular, every secure packet can already be identified by a unique packet type in the outer header. However, since all machines engaged in secure communications would either be using the same MAC address, or be selecting from a small pool of predetermined MAC addresses, the association between a specific machine and a specific MAC address is effectively broken.

[00121] In this scheme, the CPU will be engaged more often than it would be in non-secure communications (or in synchronized MAC address hopping), since the network interface driver cannot always unilaterally discriminate between secure packets that are destined for that machine, and secure packets from other VPNs. However, the non-secure traffic is easily eliminated at the network interface, thereby reducing the amount of processing required of the CPU. There are boundary conditions where these statements would not hold, of course—e.g., if all of the traffic on the LAN is secure traffic, then the CPU would be engaged to the same degree as it is in the purely-random address hopping case; alternatively, if each VPN on the LAN uses a different MAC address, then the network interface can perfectly discriminate secure frames destined for the local machine from those constituting other VPNs. These are engineering tradeoffs that might be best handled by providing administrative options for the users when installing the software and/or establishing VPNs.

[00122] Even in this scenario, however, there still remains a slight risk of selecting MAC addresses that are being used by one or more nodes on the LAN. One solution to this problem is to formally assign one address or a range of addresses for use in MAC-hopped communications. This is typically done via an assigned numbers registration authority; e.g., in the case of Ethernet, MAC address ranges are assigned to vendors by the Institute of Electrical and Electronics Engineers (IEEE). A formally-assigned range of addresses would ensure that secure frames do not conflict with any properly-configured and properly-functioning machines on the LAN.

[00123] Reference will now be made to FIGS. 12A and 12B in order to describe the many combinations and features that follow the inventive principles. As explained above, two computer nodes 1201 and 1202 are assumed to be communicating over a network or communication medium such as an Ethernet. A communication protocol in each node (1204 and 1217, respectively) contains a modified element 1205 and 1216 that performs certain functions that deviate from the standard communication protocols. In particular, computer node 1201 implements a first “hop” algorithm 1208X that selects seemingly random source and destination IP addresses (and, in one embodiment, seemingly random IP header discriminator fields) in order to transmit each packet to the other computer node. For example, node 1201 maintains a transmit

table 1208 containing triplets of source (S), destination (D), and discriminator fields (DS) that are inserted into outgoing IP packet headers. The table is generated through the use of an appropriate algorithm (e.g., a random number generator that is seeded with an appropriate seed) that is known to the recipient node 1202. As each new IP packet is formed, the next sequential entry out of the sender's transmit table 1208 is used to populate the IP source, IP destination, and IP header extension field (e.g., discriminator field). It will be appreciated that the transmit table need not be created in advance but could instead be created on-the-fly by executing the algorithm when each packet is formed.

[00124] At the receiving node 1202, the same IP hop algorithm 1222X is maintained and used to generate a receive table 1222 that lists valid triplets of source IP address, destination IP address, and discriminator field. This is shown by virtue of the first five entries of transmit table 1208 matching the second five entries of receive table 1222. (The tables may be slightly offset at any particular time due to lost packets, misordered packets, or transmission delays). Additionally, node 1202 maintains a receive window W3 that represents a list of valid IP source, IP destination, and discriminator fields that will be accepted when received as part of an incoming IP packet. As packets are received, window W3 slides down the list of valid entries, such that the possible valid entries change over time. Two packets that arrive out of order but are nevertheless matched to entries within window W3 will be accepted; those falling outside of window W3 will be rejected as invalid. The length of window W3 can be adjusted as necessary to reflect network delays or other factors.

[00125] Node 1202 maintains a similar transmit table 1221 for creating IP packets and frames destined for node 1201 using a potentially different hopping algorithm 1221 X, and node 1201 maintains a matching receive table 1209 using the same algorithm 1209X. As node 1202 transmits packets to node 1201 using seemingly random IP source, IP destination, and/or discriminator fields, node 1201 matches the incoming packet values to those falling within window WI maintained in its receive table. In effect, transmit table 1208 of node 1201 is synchronized (i.e., entries are selected in the same order) to receive table 1222 of receiving node 1202. Similarly, transmit table 1221 of node 1202 is synchronized to receive table 1209 of node 1201. It will be appreciated that although a common algorithm is shown for the source,

destination and discriminator fields in FIG. 12A (using, e.g., a different seed for each of the three fields), an entirely different algorithm could in fact be used to establish values for each of these fields. It will also be appreciated that one or two of the fields can be “hopped” rather than all three as illustrated.

[00126] In accordance with another aspect of the invention, hardware or “MAC” addresses are hopped instead of or in addition to IP addresses and/or the discriminator field in order to improve security in a local area or broadcast-type network. To that end, node 1201 further maintains a transmit table 1210 using a transmit algorithm 1210X to generate source and destination hardware addresses that are inserted into frame headers (e.g., fields 1101A and 1101 B in FIG. 11) that are synchronized to a corresponding receive table 1224 at node 1202. Similarly, node 1202 maintains a different transmit table 1223 containing source and destination hardware addresses that is synchronized with a corresponding receive table 1211 at node 1201. In this manner, outgoing hardware frames appear to be originating from and going to completely random nodes on the network, even though each recipient can determine whether a given packet is intended for it or not. It will be appreciated that the hardware hopping feature can be implemented at a different level in the communications protocol than the IP hopping feature (e.g., in a card driver or in a hardware card itself to improve performance).

[00127] FIG. 12B shows three different embodiments or modes that can be employed using the aforementioned principles. In a first mode referred to as “promiscuous” mode, a common hardware address (e.g., a fixed address for source and another for destination) or else a completely random hardware address is used by all nodes on the network, such that a particular packet cannot be attributed to any one node. Each node must initially accept all packets containing the common (or random) hardware address and inspect the IP addresses or discriminator field to determine whether the packet is intended for that node. In this regard, either the IP addresses or the discriminator field or both can be varied in accordance with an algorithm as described above. As explained previously, this may increase each node’s overhead since additional processing is involved to determine whether a given packet has valid source and destination hardware addresses.

[00128] In a second mode referred to as “promiscuous per VPN” mode, a small set of fixed hardware addresses are used, with a fixed source/destination hardware address used for all nodes communicating over a virtual private network. For example, if there are six nodes on an Ethernet, and the network is to be split up into two private virtual networks such that nodes on one VPN can communicate with only the other two nodes on its own VPN, then two sets of hardware addresses could be used: one set for the first VPN and a second set for the second VPN. This would reduce the amount of overhead involved in checking for valid frames since only packets arriving from the designated VPN would need to be checked. IP addresses and one or more discriminator fields could still be hopped as before for secure communication within the VPN. Of course, this solution compromises the anonymity of the VPNs (i.e., an outsider can easily tell what traffic belongs in which VPN, though he cannot correlate it to a specific machine/person). It also requires the use of a discriminator field to mitigate the vulnerability to certain types of DoS attacks, (For example, without the discriminator field, an attacker on the LAN could stream frames containing the MAC addresses being used by the VPN; rejecting those frames could lead to excessive processing overhead. The discriminator field would provide a low-overhead means of rejecting the false packets.)

[00129] In a third mode referred to as “hardware hopping” mode, hardware addresses are varied as illustrated in FIG. 12A, such that hardware source and destination addresses are changed constantly in order to provide non-attributable addressing. Variations on these embodiments are of course possible, and the invention is not intended to be limited in any respect by these illustrative examples.

B. Extending the Address Space

[00130] Address hopping provides security and privacy. However, the level of protection is limited by the number of addresses in the blocks being hopped. A hopblock denotes a field or fields modulated on a packet-wise basis for the purpose of providing a VPN. For instance, if two nodes communicate with IP address hopping using hopblocks of 4 addresses (2 bits) each, there would be 16 possible address-pair combinations. A window of size 16 would result in most address pairs being accepted as valid most of the time. This limitation can be overcome by using a discriminator field in addition to or instead of the hopped address fields.

The discriminator field would be hopped in exactly the same fashion as the address fields and it would be used to determine whether a packet should be processed by a receiver.

[00131] Suppose that two clients, each using four-bit hopblocks, would like the same level of protection afforded to clients communicating via IP hopping between two A blocks (24 address bits eligible for hopping). A discriminator field of 20 bits, used in conjunction with the 4 address bits eligible for hopping in the IP address field, provides this level of protection. A 24-bit discriminator field would provide a similar level of protection if the address fields were not hopped or ignored. Using a discriminator field offers the following advantages: (1) an arbitrarily high level of protection can be provided, and (2) address hopping is unnecessary to provide protection. This may be important in environments where address hopping would cause routing problems.

C. Synchronization Techniques

[00132] It is generally assumed that once a sending node and receiving node have exchanged algorithms and seeds (or similar information sufficient to generate quasi-random source and destination tables), subsequent communication between the two nodes will proceed smoothly. Realistically, however, two nodes may lose synchronization due to network delays or outages, or other problems. Consequently, it is desirable to provide means for re-establishing synchronization between nodes in a network that have lost synchronization.

[00133] One possible technique is to require that each node provide an acknowledgment upon successful receipt of each packet and, if no acknowledgment is received within a certain period of time, to re-send the unacknowledged packet. This approach, however, drives up overhead costs and may be prohibitive in high-throughput environments such as streaming video or audio, for example.

[00134] A different approach is to employ an automatic synchronizing technique that will be referred to herein as “self-synchronization.” In this approach, synchronization information is embedded into each packet, thereby enabling the receiver to re-synchronize itself upon receipt of a single packet if it determines that it has lost synchronization with the sender. (If communications are already in progress, and the receiver determines that it is still in sync with

the sender, then there is no need to re-synchronize.) A receiver could detect that it was out of synchronization by, for example, employing a “dead-man” timer that expires after a certain period of time, wherein the timer is reset with each valid packet. A time stamp could be hashed into the public sync field (see below) to preclude packet-retry attacks.

[00135] In one embodiment, a “sync field” is added to the header of each packet sent out by the sender. This sync field could appear in the clear or as part of an encrypted portion of the packet. Assuming that a sender and receiver have selected a random-number generator (RNG) and seed value, this combination of RNG and seed can be used to generate a random-number sequence (RNS). The RNS is then used to generate a sequence of source/destination IP pairs (and, if desired, discriminator fields and hardware source and destination addresses), as described above. It is not necessary, however, to generate the entire sequence (or the first N-1 values) in order to generate the Nth random number in the sequence; if the sequence index N is known, the random value corresponding to that index can be directly generated (see below). Different RNGs (and seeds) with different fundamental periods could be used to generate the source and destination IP sequences, but the basic concepts would still apply. For the sake of simplicity, the following discussion will assume that IP source and destination address pairs (only) are hopped using a single RNG sequencing mechanism.

[00136] In accordance with a “self-synchronization” feature, a sync field in each packet header provides an index (i.e., a sequence number) into the RNS that is being used to generate IP pairs. Plugging this index into the RNG that is being used to generate the RNS yields a specific random number value, which in turn yields a specific IP pair. That is, an IP pair can be generated directly from knowledge of the RNG, seed, and index number; it is not necessary, in this scheme, to generate the entire sequence of random numbers that precede the sequence value associated with the index number provided.

[00137] Since the communicants have presumably previously exchanged RNGs and seeds, the only new information that must be provided in order to generate an IP pair is the sequence number. If this number is provided by the sender in the packet header, then the receiver need only plug this number into the RNG in order to generate an IP pair — and thus verify that the IP pair appearing in the header of the packet is valid. In this scheme, if the sender and

receiver lose synchronization, the receiver can immediately re-synchronize upon receipt of a single packet by simply comparing the IP pair in the packet header to the IP pair generated from the index number. Thus, synchronized communications can be resumed upon receipt of a single packet, making this scheme ideal for multicast communications. Taken to the extreme, it could obviate the need for synchronization tables entirely; that is, the sender and receiver could simply rely on the index number in the sync field to validate the IP pair on each packet, and thereby eliminate the tables entirely.

[00138] The aforementioned scheme may have some inherent security issues associated with it — namely, the placement of the sync field. If the field is placed in the outer header, then an interloper could observe the values of the field and their relationship to the IP stream. This could potentially compromise the algorithm that is being used to generate the IP-address sequence, which would compromise the security of the communications. If, however, the value is placed in the inner header, then the sender must decrypt the inner header before it can extract the sync value and validate the IP pair; this opens up the receiver to certain types of denial-of-service (DoS) attacks, such as packet replay. That is, if the receiver must decrypt a packet before it can validate the IP pair, then it could potentially be forced to expend a significant amount of processing on decryption if an attacker simply retransmits previously valid packets. Other attack methodologies are possible in this scenario.

[00139] A possible compromise between algorithm security and processing speed is to split up the sync value between an inner (encrypted) and outer (unencrypted) header. That is, if the sync value is sufficiently long, it could potentially be split into a rapidly-changing part that can be viewed in the clear, and a fixed (or very slowly changing) part that must be protected. The part that can be viewed in the clear will be called the “public sync” portion and the part that must be protected will be called the “private sync” portion.

[00140] Both the public sync and private sync portions are needed to generate the complete sync value. The private portion, however, can be selected such that it is fixed or will change only occasionally. Thus, the private sync value can be stored by the recipient, thereby obviating the need to decrypt the header in order to retrieve it. If the sender and receiver have previously agreed upon the frequency with which the private part of the sync will change, then

the receiver can selectively decrypt a single header in order to extract the new private sync if the communications gap that has led to lost synchronization has exceeded the lifetime of the previous private sync. This should not represent a burdensome amount of decryption, and thus should not open up the receiver to denial-of-service attack simply based on the need to occasionally decrypt a single header.

[00141] One implementation of this is to use a hashing function with a one-to-one mapping to generate the private and public sync portions from the sync value. This implementation is shown in FIG. 13, where (for example) a first ISP 1302 is the sender and a second ISP 1303 is the receiver. (Other alternatives are possible from FIG. 13.) A transmitted packet comprises a public or “outer” header 1305 that is not encrypted, and a private or “inner” header 1306 that is encrypted using for example a link key. Outer header 1305 includes a public sync portion while inner header 1306 contains the private sync portion. A receiving node decrypts the inner header using a decryption function 1307 in order to extract the private sync portion. This step is necessary only if the lifetime of the currently buffered private sync has expired. (If the currently-buffered private sync is still valid, then it is simply extracted from memory and “added” (which could be an inverse hash) to the public sync, as shown in step 1308.) The public and decrypted private sync portions are combined in function 1308 in order to generate the combined sync 1309. The combined sync (1309) is then fed into the RNG (1310) and compared to the IP address pair (1311) to validate or reject the packet.

[00142] An important consideration in this architecture is the concept of “future” and “past” where the public sync values are concerned. Though the sync values, themselves, should be random to prevent spoofing attacks, it may be important that the receiver be able to quickly identify a sync value that has already been sent — even if the packet containing that sync value was never actually received by the receiver. One solution is to hash a time stamp or sequence number into the public sync portion, which could be quickly extracted, checked, and discarded, thereby validating the public sync portion itself.

[00143] In one embodiment, packets can be checked by comparing the source/destination IP pair generated by the sync field with the pair appearing in the packet header. If (1) they match, (2) the time stamp is valid, and (3) the dead-man timer has expired,

then re-synchronization occurs; otherwise, the packet is rejected. If enough processing power is available, the dead-man timer and synchronization tables can be avoided altogether, and the receiver would simply resynchronize (e.g., validate) on every packet.

[00144] The foregoing scheme may require large-integer (e.g., 160-bit) math, which may affect its implementation. Without such large-integer registers, processing throughput would be affected, thus potentially affecting security from a denial-of-service standpoint. Nevertheless, as large integer math processing features become more prevalent, the costs of implementing such a feature will be reduced.

D. Other Synchronization Schemes

[00145] As explained above, if W or more consecutive packets are lost between a transmitter and receiver in a VPN (where W is the window size), the receiver's window will not have been updated and the transmitter will be transmitting packets not in the receiver's window. The sender and receiver will not recover synchronization until perhaps the random pairs in the window are repeated by chance. Therefore, there is a need to keep a transmitter and receiver in synchronization whenever possible and to re-establish synchronization whenever it is lost.

[00146] A "checkpoint" scheme can be used to regain synchronization between a sender and a receiver that have fallen out of synchronization. In this scheme, a checkpoint message comprising a random IP address pair is used for communicating synchronization information. In one embodiment, two messages are used to communicate synchronization information between a sender and a recipient:

1. SYNC_REQ is a message used by the sender to indicate that it wants to synchronize; and
2. SYNC_ACK is a message used by the receiver to inform the transmitter that it has been synchronized.

[00147] According to one variation of this approach, both the transmitter and receiver maintain three checkpoints (see FIG. 14):

1. In the transmitter, ckpt_o (“checkpoint old”) is the IP pair that was used to re-send the last SYNC_REQ packet to the receiver. In the receiver, ckpt_o (“checkpoint old”) is the IP pair that receives repeated SYNC_REQ packets from the transmitter.
2. In the transmitter, ckpt_n (“checkpoint new”) is the IP pair that will be used to send the next SYNC_REQ packet to the receiver. In the receiver, ckpt_n (“checkpoint new”) is the IP pair that receives a new SYNC_REQ packet from the transmitter and which causes the receiver’s window to be re-aligned, ckpt_o set to ckpt_n, a new ckpt_n to be generated and a new ckpt_r to be generated.
3. In the transmitter, ckpt_r is the IP pair that will be used to send the next SYNC_ACK packet to the receiver. In the receiver, ckpt_r is the IP pair that receives a new SYNC_ACK packet from the transmitter and which causes a new ckpt_n to be generated. Since SYNC_ACK is transmitted from the receiver ISP to the sender ISP, the transmitter ckpt_r refers to the ckpt_r of the receiver and the receiver ckpt_r refers to the ckpt_r of the transmitter (see FIG. 14).

When a transmitter initiates synchronization, the IP pair it will use to transmit the next data packet is set to a predetermined value and when a receiver first receives a SYNC_REQ, the receiver window is updated to be centered on the transmitter’s next IP pair. This is the primary mechanism for checkpoint synchronization.

[00148] Synchronization can be initiated by a packet counter (e.g., after every N packets transmitted, initiate a synchronization) or by a timer (every S seconds, initiate a synchronization) or a combination of both. See FIG. 15. From the transmitter’s perspective, this technique operates as follows: (1) Each transmitter periodically transmits a “sync request” message to the receiver to make sure that it is in sync. (2) If the receiver is still in sync, it sends back a “sync ack” message. (If this works, no further action is necessary). (3) If no “sync ack” has been received within a period of time, the transmitter retransmits the sync request again. If the transmitter reaches the next checkpoint without receiving a “sync ack” response, then synchronization is broken, and the transmitter should stop transmitting. The transmitter will

continue to send sync_reqs until it receives a sync_ack, at which point transmission is reestablished.

[00149] From the receiver's perspective, the scheme operates as follows: (1) when it receives a "sync request" request from the transmitter, it advances its window to the next checkpoint position (even skipping pairs if necessary), and sends a "sync ack" message to the transmitter. If sync was never lost, then the "jump ahead" really just advances to the next available pair of addresses in the table (i.e., normal advancement).

[00150] If an interloper intercepts the "sync request" messages and tries to interfere with communication by sending new ones, it will be ignored if the synchronization has been established or it will actually help to re-establish synchronization.

[00151] A window is realigned whenever a re-synchronization occurs. This realignment entails updating the receiver's window to straddle the address pairs used by the packet transmitted immediately after the transmission of the SYNC_REQ packet. Normally, the transmitter and receiver are in synchronization with one another. However, when network events occur, the receiver's window may have to be advanced by many steps during resynchronization. In this case, it is desirable to move the window ahead without having to step through the intervening random numbers sequentially. (This feature is also desirable for the auto-sync approach discussed above).

E. Random Number Generator with a Jump-Ahead capability

[00152] An attractive method for generating randomly hopped addresses is to use identical random number generators in the transmitter and receiver and advance them as packets are transmitted and received. There are many random number generation algorithms that could be used. Each one has strengths and weaknesses for address hopping applications.

[00153] Linear congruential random number generators (LCRs) are fast, simple and well characterized random number generators that can be made to jump ahead n steps efficiently. An LCR generates random numbers $X_1, X_2, X_3 \dots X_k$ starting with seed X_0 using a recurrence

$$X_i = (a X_{i-1} + b) \bmod c, \quad (1)$$

where a , b and c define a particular LCR. Another expression for X_i ,

$$X_i = ((a^i(X_0 + b) - b) / (a - 1)) \bmod c \quad (2)$$

enables the jump-ahead capability. The factor a^i can grow very large even for modest i if left unfettered. Therefore some special properties of the modulo operation can be used to control the size and processing time required to compute (2). (2) can be rewritten as:

$$X_i = (a^i(X_0(a-1) + b) - b) / (a-1) \bmod c. \quad (3)$$

It can be shown that:

$$\begin{aligned} & (a^i(X_0(a-1) + b) - b) / (a-1) \bmod c = \\ & ((a^i \bmod ((a-1)c)(X_0(a-1) + b) - b) / (a-1)) \bmod c \end{aligned} \quad (4).$$

[00154] $(X_0(a-1) + b)$ can be stored as $(X_0(a-1) + b) \bmod c$, b as $b \bmod c$ and compute $a^i \bmod ((a-1)c)$ (this requires $O(\log(i))$ steps).

[00155] A practical implementation of this algorithm would jump a fixed distance, n , between synchronizations; this is tantamount to synchronizing every n packets. The window would commence n IP pairs from the start of the previous window. Using X_j^w , the random number at the j^{th} checkpoint, as X_0 and n as i , a node can store $a^n \bmod ((a-1)c)$ once per LCR and set

$$\mathbf{[00156]} \quad X_{j+1}^w = X_{n(j+1)} = ((a^n \bmod ((a-1)c) (X_j^w (a-1) + b) - b) / (a-1)) \bmod c, \quad (5)$$

to generate the random number for the $j+1^{\text{th}}$ synchronization. Using this construction, a node could jump ahead an arbitrary (but fixed) distance between synchronizations in a constant amount of time (independent of n).

[00157] Pseudo-random number generators, in general, and LCRs, in particular, will eventually repeat their cycles. This repetition may present vulnerability in the IP hopping

scheme. An adversary would simply have to wait for a repeat to predict future sequences. One way of coping with this vulnerability is to create a random number generator with a known long cycle. A random sequence can be replaced by a new random number generator before it repeats. LCRs can be constructed with known long cycles. This is not currently true of many random number generators.

[00158] Random number generators can be cryptographically insecure. An adversary can derive the RNG parameters by examining the output or part of the output. This is true of LCGs. This vulnerability can be mitigated by incorporating an encryptor, designed to scramble the output as part of the random number generator. The random number generator prevents an adversary from mounting an attack—e.g., a known plaintext attack—against the encryptor.

F. Random Number Generator Example

[00159] Consider a RNG where $a=31, b=4$ and $c=15$. For this case equation (1) becomes:

$$X_i = (31 X_{i-1} + 4) \text{ mod } 15. \quad (6)$$

If one sets $X_0=1$, equation (6) will produce the sequence 1, 5, 9, 13, 2, 6, 10, 14, 3, 7, 11, 0, 4, 8, 12. This sequence will repeat indefinitely. For a jump ahead of 3 numbers in this sequence $a^n = 31^3 = 29791$, $c*(a-1) = 15*30 = 450$ and $a^n \text{ mod } ((a-1)c) = 31^3 \text{ mod } (15*30) = 29791 \text{ mod } (450) = 91$. Equation (5) becomes:

$$((91 (X_i 30 + 4) - 4) / 30) \text{ mod } 15 \quad (7).$$

Table 1 shows the jump ahead calculations from (7) . The calculations start at 5 and jump ahead 3.

TABLE 1

I	X_i	$(X_i \cdot 30 + 4)$	$91(X_i \cdot 30 + 4) - 4$	$((91(X_i \cdot 30 + 4) - 4) / 30)$	X_{i+3}
1	5	154	14010	467	2
4	2	64	5820	194	14
7	14	424	38580	1286	11
10	11	334	30390	1013	8
13	8	244	22200	740	5

G. Fast Packet Filter

[00160] Address hopping VPNs must rapidly determine whether a packet has a valid header and thus requires further processing, or has an invalid header (a hostile packet) and should be immediately rejected. Such rapid determinations will be referred to as “fast packet filtering.” This capability protects the VPN from attacks by an adversary who streams hostile packets at the receiver at a high rate of speed in the hope of saturating the receiver’s processor (a so-called “denial of service” attack). Fast packet filtering is an important feature for implementing VPNs on shared media such as Ethernet.

[00161] Assuming that all participants in a VPN share an unassigned “A” block of addresses, one possibility is to use an experimental “A” block that will never be assigned to any machine that is not address hopping on the shared medium. “A” blocks have a 24 bits of address that can be hopped as opposed to the 8 bits in “C” blocks. In this case a hopblock will be the “A” block. The use of the experimental “A” block is a likely option on an Ethernet because:

1. The addresses have no validity outside of the Ethernet and will not be routed out to a valid outside destination by a gateway.
2. There are 2^{24} (~16 million) addresses that can be hopped within each “A” block. This yields >280 trillion possible address pairs making it very unlikely that an adversary would guess a valid address. It also provides acceptably low probability of collision

between separate VPNs (all VPNs on a shared medium independently generate random address pairs from the same “A” block).

3. The packets will not be received by someone on the Ethernet who is not on a VPN (unless the machine is in promiscuous mode) minimizing impact on non-VPN computers.

[00162] The Ethernet example will be used to describe one implementation of fast packet filtering. The ideal algorithm would quickly examine a packet header, determine whether the packet is hostile, and reject any hostile packets or determine which active IP pair the packet header matches. The problem is a classical associative memory problem. A variety of techniques have been developed to solve this problem (hashing, B—trees etc). Each of these approaches has its strengths and weaknesses. For instance, hash tables can be made to operate quite fast in a statistical sense, but can occasionally degenerate into a much slower algorithm. This slowness can persist for a period of time. Since there is a need to discard hostile packets quickly at all times, hashing would be unacceptable.

H. Presence Vector Algorithm

[00163] A presence vector is a bit vector of length 2^n that can be indexed by n -bit numbers (each ranging from 0 to $2^n - 1$). One can indicate the presence of k n -bit numbers (not necessarily unique), by setting the bits in the presence vector indexed by each number to 1. Otherwise, the bits in the presence vector are 0. An n -bit number, x , is one of the k numbers if and only if the x^{th} bit of the presence vector is 1. A fast packet filter can be implemented by indexing the presence vector and looking for a 1, which will be referred to as the “test.”

[00164] For example, suppose one wanted to represent the number 135 using a presence vector. The 135th bit of the vector would be set. Consequently, one could very quickly determine whether an address of 135 was valid by checking only one bit: the 135th bit. The presence vectors could be created in advance corresponding to the table entries for the IP addresses. In effect, the incoming addresses can be used as indices into a long vector, making comparisons very fast. As each RNG generates a new address, the presence vector is updated to

reflect the information. As the window moves, the presence vector is updated to zero out addresses that are no longer valid.

[00165] There is a trade-off between efficiency of the test and the amount of memory required for storing the presence vector(s). For instance, if one were to use the 48 bits of hopping addresses as an index, the presence vector would have to be 35 terabytes. Clearly, this is too large for practical purposes. Instead, the 48 bits can be divided into several smaller fields. For instance, one could subdivide the 48 bits into four 12-bit fields (see FIG. 16). This reduces the storage requirement to 2048 bytes at the expense of occasionally having to process a hostile packet. In effect, instead of one long presence vector, the decomposed address portions must match all four shorter presence vectors before further processing is allowed. (If the first part of the address portion doesn't match the first presence vector, there is no need to check the remaining three presence vectors).

[00166] A presence vector will have a 1 in the y^{th} bit if and only if one or more addresses with a corresponding field of y are active. An address is active only if each presence vector indexed by the appropriate sub-field of the address is 1.

[00167] Consider a window of 32 active addresses and 3 checkpoints. A hostile packet will be rejected by the indexing of one presence vector more than 99% of the time. A hostile packet will be rejected by the indexing of all 4 presence vectors more than 99.9999995% of the time. On average, hostile packets will be rejected in less than 1.02 presence vector index operations.

[00168] The small percentage of hostile packets that pass the fast packet filter will be rejected when matching pairs are not found in the active window or are active checkpoints. Hostile packets that serendipitously match a header will be rejected when the VPN software attempts to decrypt the header. However, these cases will be extremely rare. There are many other ways this method can be configured to arbitrate the space/speed tradeoffs.

I. Further Synchronization Enhancements

[00169] A slightly modified form of the synchronization techniques described above can be employed. The basic principles of the previously described checkpoint synchronization scheme remain unchanged. The actions resulting from the reception of the checkpoints are, however, slightly different. In this variation, the receiver will maintain between OoO (“Out of Order”) and $2 \times \text{WINDOW_SIZE} + \text{OoO}$ active addresses ($1 \leq \text{OoO} \leq \text{WINDOW_SIZE}$ and $\text{WINDOW_SIZE} \geq 1$). OoO and WINDOW_SIZE are engineerable parameters, where OoO is the minimum number of addresses needed to accommodate lost packets due to events in the network or out of order arrivals and WINDOW_SIZE is the number of packets transmitted before a SYNC_REQ is issued. FIG. 17 depicts a storage array for a receiver’s active addresses.

[00170] The receiver starts with the first $2 \times \text{WINDOW_SIZE}$ addresses loaded and active (ready to receive data). As packets are received, the corresponding entries are marked as “used” and are no longer eligible to receive packets. The transmitter maintains a packet counter, initially set to 0, containing the number of data packets transmitted since the last *initial* transmission of a SYNC_REQ for which SYNC_ACK has been received. When the transmitter packet counter equals WINDOW_SIZE, the transmitter generates a SYNC_REQ and does its initial transmission. When the receiver receives a SYNC_REQ corresponding to its current CKPT_N, it generates the next WINDOW_SIZE addresses and starts loading them in order starting at the first location after the last active address wrapping around to the beginning of the array after the end of the array has been reached. The receiver’s array might look like FIG. 18 when a SYNC_REQ has been received. In this case a couple of packets have been either lost or will be received out of order when the SYNC_REQ is received.

[00171] FIG. 19 shows the receiver’s array after the new addresses have been generated. If the transmitter does not receive a SYNC_ACK, it will re-issue the SYNC_REQ at regular intervals. When the transmitter receives a SYNC_ACK, the packet counter is decremented by WINDOW_SIZE. If the packet counter reaches $2 \times \text{WINDOW_SIZE} - \text{OoO}$ then the transmitter ceases sending data packets until the appropriate SYNC_ACK is finally received. The transmitter then resumes sending data packets. Future behavior is essentially a repetition of this initial cycle. The advantages of this approach are:

1. There is no need for an efficient jump ahead in the random number generator,
2. No packet is ever transmitted that does not have a corresponding entry in the receiver side
3. No timer based re-synchronization is necessary. This is a consequence of 2.
4. The receiver will always have the ability to accept data messages transmitted within OoO messages of the most recently transmitted message.

J. Distributed Transmission Path Variant

[00172] Another embodiment incorporating various inventive principles is shown in FIG. 20. In this embodiment, a message transmission system includes a first computer 2001 in communication with a second computer 2002 through a network 2011 of intermediary computers. In one variant of this embodiment, the network includes two edge routers 2003 and 2004 each of which is linked to a plurality of Internet Service Providers (ISPs) 2005 through 2010. Each ISP is coupled to a plurality of other ISPs in an arrangement as shown in FIG. 20, which is a representative configuration only and is not intended to be limiting. Each connection between ISPs is labeled in FIG. 20 to indicate a specific physical transmission path (e.g., AD is a physical path that links ISP A (element 2005) to ISP D (element 2008)). Packets arriving at each edge router are selectively transmitted to one of the ISPs to which the router is attached on the basis of a randomly or quasi-randomly selected basis.

[00173] As shown in FIG. 21, computer 2001 or edge router 2003 incorporates a plurality of link transmission tables 2100 that identify, for each potential transmission path through the network, valid sets of IP addresses that can be used to transmit the packet. For example, AD table 2101 contains a plurality of IP source/destination pairs that are randomly or quasi-randomly generated. When a packet is to be transmitted from first computer 2001 to second computer 2002, one of the link tables is randomly (or quasi-randomly) selected, and the next valid source/destination address pair from that table is used to transmit the packet through the network. If path AD is randomly selected, for example, the next source/destination IP address pair (which is pre-determined to transmit between ISP A (element 2005) and ISP B (element

2008)) is used to transmit the packet. If one of the transmission paths becomes degraded or inoperative, that link table can be set to a “down” condition as shown in table 2105, thus preventing addresses from being selected from that table. Other transmission paths would be unaffected by this broken link.

3. CONTINUATION-IN-PART IMPROVEMENTS

[00174] The following describes various improvements and features that can be applied to the embodiments described above. The improvements include: (1) a load balancer that distributes packets across different transmission paths according to transmission path quality; (2) a DNS proxy server that transparently creates a virtual private network in response to a domain name inquiry; (3) a large-to-small link bandwidth management feature that prevents denial-of-service attacks at system chokepoints; (4) a traffic limiter that regulates incoming packets by limiting the rate at which a transmitter can be synchronized with a receiver; and (5) a signaling synchronizer that allows a large number of nodes to communicate with a central node by partitioning the communication function between two separate entities. Each is discussed separately below.

A. Load Balancer

[00175] Various embodiments described above include a system in which a transmitting node and a receiving node are coupled through a plurality of transmission paths, and wherein successive packets are distributed quasi-randomly over the plurality of paths. See, for example, FIGS. 20 and 21 and accompanying description. The improvement extends this basic concept to encompass distributing packets across different paths in such a manner that the loads on the paths are generally balanced according to transmission link quality.

[00176] In one embodiment, a system includes a transmitting node and a receiving node that are linked via a plurality of transmission paths having potentially varying transmission quality. Successive packets are transmitted over the paths based on a weight value distribution function for each path. The rate that packets will be transmitted over a given path can be different for each path. The relative “health” of each transmission path is monitored in order to identify paths that have become degraded. In one embodiment, the health of each path is

monitored in the transmitter by comparing the number of packets transmitted to the number of packet acknowledgements received. Each transmission path may comprise a physically separate path (e.g., via dial-up phone line, computer network, router, bridge, or the like), or may comprise logically separate paths contained within a broadband communication medium (e.g., separate channels in an FDM, TDM, CDMA, or other type of modulated or unmodulated transmission link).

[00177] When the transmission quality of a path falls below a predetermined threshold and there are other paths that can transmit packets, the transmitter changes the weight value used for that path, making it less likely that a given packet will be transmitted over that path. The weight will preferably be set no lower than a minimum value that keeps nominal traffic on the path. The weights of the other available paths are altered to compensate for the change in the affected path. When the quality of a path degrades to where the transmitter is turned off by the synchronization function (i.e., no packets are arriving at the destination), the weight is set to zero. If all transmitters are turned off, no packets are sent.

[00178] Conventional TCP/IP protocols include a “throttling” feature that reduces the transmission rate of packets when it is determined that delays or errors are occurring in transmission. In this respect, timers are sometimes used to determine whether packets have been received. These conventional techniques for limiting transmission of packets, however, do not involve multiple transmission paths between two nodes wherein transmission across a particular path relative to the others is changed based on link quality.

[00179] According to certain embodiments, in order to damp oscillations that might otherwise occur if weight distributions are changed drastically (e.g., according to a step function), a linear or an exponential decay formula can be applied to gradually decrease the weight value over time that a degrading path will be used. Similarly, if the health of a degraded path improves, the weight value for that path is gradually increased.

[00180] Transmission link health can be evaluated by comparing the number of packets that are acknowledged within the transmission window (see embodiments discussed above) to the number of packets transmitted within that window and by the state of the

transmitter (i.e., on or off). In other words, rather than accumulating general transmission statistics over time for a path, one specific implementation uses the “windowing” concepts described above to evaluate transmission path health.

[00181] The same scheme can be used to shift virtual circuit paths from an “unhealthy” path to a “healthy” one, and to select a path for a new virtual circuit.

[00182] FIG. 22A shows a flowchart for adjusting weight values associated with a plurality of transmission links. It is assumed that software executing in one or more computer nodes executes the steps shown in FIG. 22A. It is also assumed that the software can be stored on a computer-readable medium such as a magnetic or optical disk for execution by a computer.

[00183] Beginning in step 2201, the transmission quality of a given transmission path is measured. As described above, this measurement can be based on a comparison between the number of packets transmitted over a particular link to the number of packet acknowledgements received over the link (e.g., per unit time, or in absolute terms). Alternatively, the quality can be evaluated by comparing the number of packets that are acknowledged within the transmission window to the number of packets that were transmitted within that window. In yet another variation, the number of missed synchronization messages can be used to indicate link quality. Many other variations are of course possible.

[00184] In step 2202, a check is made to determine whether more than one transmitter (e.g., transmission path) is turned on. If not, the process is terminated and resumes at step 2201.

[00185] In step 2203, the link quality is compared to a given threshold (e.g., 50%, or any arbitrary number). If the quality falls below the threshold, then in step 2207 a check is made to determine whether the weight is above a minimum level (e.g., 1%). If not, then in step 2209 the weight is set to the minimum level and processing resumes at step 2201. If the weight is above the minimum level, then in step 2208 the weight is gradually decreased for the path, then in step 2206 the weights for the remaining paths are adjusted accordingly to compensate (e.g., they are increased).

[00186] If in step 2203 the quality of the path was greater than or equal to the threshold, then in step 2204 a check is made to determine whether the weight is less than a steady-state value for that path. If so, then in step 2205 the weight is increased toward the steady-state value, and in step 2206 the weights for the remaining paths are adjusted accordingly to compensate (e.g., they are decreased). If in step 2204 the weight is not less than the steady-state value, then processing resumes at step 2201 without adjusting the weights.

[00187] The weights can be adjusted incrementally according to various functions, preferably by changing the value gradually. In one embodiment, a linearly decreasing function is used to adjust the weights; according to another embodiment, an exponential decay function is used. Gradually changing the weights helps to damp oscillators that might otherwise occur if the probabilities were abruptly.

[00188] Although not explicitly shown in FIG. 22A the process can be performed only periodically (e.g., according to a time schedule), or it can be continuously run, such as in a background mode of operation. In one embodiment, the combined weights of all potential paths should add up to unity (e.g., when the weighting for one path is decreased, the corresponding weights that the other paths will be selected will increase).

[00189] Adjustments to weight values for other paths can be prorated. For example, a decrease of 10% in weight value for one path could result in an evenly distributed increase in the weights for the remaining paths. Alternatively, weightings could be adjusted according to a weighted formula as desired (e.g., favoring healthy paths over less healthy paths). In yet another variation, the difference in weight value can be amortized over the remaining links in a manner that is proportional to their traffic weighting.

[00190] FIG. 22B shows steps that can be executed to shut down transmission links where a transmitter turns off. In step 2210, a transmitter shut-down event occurs. In step 2211, a test is made to determine whether at least one transmitter is still turned on. If not, then in step 2215 all packets are dropped until a transmitter turns on. If in step 2211 at least one transmitter is turned on, then in step 2212 the weight for the path is set to zero, and the weights for the remaining paths are adjusted accordingly.

[00191] FIG. 23 shows a computer node 2301 employing various principles of the above-described embodiments. It is assumed that two computer nodes of the type shown in FIG. 23 communicate over a plurality of separate physical transmission paths. As shown in FIG. 23, four transmission paths X1 through X4 are defined for communicating between the two nodes. Each node includes a packet transmitter 2302 that operates in accordance with a transmit table 2308 as described above. (The packet transmitter could also operate without using the IP-hopping features described above, but the following description assumes that some form of hopping is employed in conjunction with the path selection mechanism.). The computer node also includes a packet receiver 2303 that operates in accordance with a receive table 2309, including a moving window W that moves as valid packets are received. Invalid packets having source and destination addresses that do not fall within window W are rejected.

[00192] As each packet is readied for transmission, source and destination IP addresses (or other discriminator values) are selected from transmit table 2308 according to any of the various algorithms described above, and packets containing these source/destination address pairs, which correspond to the node to which the four transmission paths are linked, are generated to a transmission path switch 2307. Switch 2307, which can comprise a software function, selects from one of the available transmission paths according to a weight distribution table 2306. For example, if the weight for path X1 is 0.2, then every fifth packet will be transmitted on path X1. A similar regime holds true for the other paths as shown. Initially, each link's weight value can be set such that it is proportional to its bandwidth, which will be referred to as its "steady-state" value.

[00193] Packet receiver 2303 generates an output to a link quality measurement function 2304 that operates as described above to determine the quality of each transmission path. (The input to packet receiver 2303 for receiving incoming packets is omitted for clarity). Link quality measurement function 2304 compares the link quality to a threshold for each transmission link and, if necessary, generates an output to weight adjustment function 2305. If a weight adjustment is required, then the weights in table 2306 are adjusted accordingly, preferably according to a gradual (e.g., linearly or exponentially declining) function. In one

embodiment, the weight values for all available paths are initially set to the same value, and only when paths degrade in quality are the weights changed to reflect differences.

[00194] Link quality measurement function 2304 can be made to operate as part of a synchronizer function as described above. That is, if resynchronization occurs and the receiver detects that synchronization has been lost (e.g., resulting in the synchronization window W being advanced out of sequence), that fact can be used to drive link quality measurement function 2304. According to one embodiment, load balancing is performed using information garnered during the normal synchronization, augmented slightly to communicate link health from the receiver to the transmitter. The receiver maintains a count, $MESS_R(W)$, of the messages received in synchronization window W . When it receives a synchronization request ($SYNC_REQ$) corresponding to the end of window W , the receiver includes counter $MESS_R$ in the resulting synchronization acknowledgement ($SYNC_ACK$) sent back to the transmitter. This allows the transmitter to compare messages sent to messages received in order to assess the health of the link.

[00195] If synchronization is completely lost, weight adjustment function 2305 decreases the weight value on the affected path to zero. When synchronization is regained, the weight value for the affected path is gradually increased to its original value. Alternatively, link quality can be measured by evaluating the length of time required for the receiver to acknowledge a synchronization request. In one embodiment, separate transmit and receive tables are used for each transmission path.

[00196] When the transmitter receives a $SYNC_ACK$, the $MESS_R$ is compared with the number of messages transmitted in a window ($MESS_T$). When the transmitter receives a $SYNC_ACK$, the traffic probabilities will be examined and adjusted if necessary. $MESS_R$ is compared with the number of messages transmitted in a window ($MESS_T$). There are two possibilities:

1. If $MESS_R$ is less than a threshold value, $THRESH$, then the link will be deemed to be unhealthy. If the transmitter was turned off, the transmitter is turned on and the weight P for that link will be set to a minimum value MIN . This will keep a trickle of traffic on the link for

monitoring purposes until it recovers. If the transmitter was turned on, the weight P for that link will be set to:

$$P' = \alpha \times \text{MIN} + (1 - \alpha) \times P \quad (1)$$

Equation 1 will exponentially damp the traffic weight value to MIN during sustained periods of degraded service.

2. If MESS_R for a link is greater than or equal to THRESH, the link will be deemed healthy. If the weight P for that link is greater than or equal to the steady state value S for that link, then P is left unaltered. If the weight P for that link is less than THRESH then P will be set to:

$$P' = \beta \times S + (1 - \beta) \times P \quad (2)$$

where β is a parameter such that $0 \leq \beta \leq 1$ that determines the damping rate of P.

[00197] Equation 2 will increase the traffic weight to S during sustained periods of acceptable service in a damped exponential fashion.

[00198] A detailed example will now be provided with reference to FIG. 24. As shown in FIG. 24, a first computer 2401 communicates with a second computer 2402 through two routers 2403 and 2404. Each router is coupled to the other router through three transmission links. As described above, these may be physically diverse links or logical links (including virtual private networks).

[00199] Suppose that a first link L1 can sustain a transmission bandwidth of 100 Mb/s and has a window size of 32; link L2 can sustain 75 Mb/s and has a window size of 24; and link L3 can sustain 25 Mb/s and has a window size of 8. The combined links can thus sustain 200Mb/s. The steady state traffic weights are 0.5 for link L1; 0.375 for link L2, and 0.125 for link L3. MIN=1Mb/s, THRESH =0.8 MESS_T for each link, $\alpha=.75$ and $\beta=.5$. These traffic weights will remain stable until a link stops for synchronization or reports a number of packets received less than its THRESH. Consider the following sequence of events:

1. Link L1 receives a SYNC_ACK containing a MESS_R of 24, indicating that only 75% of the MESS_T (32) messages transmitted in the last window were successfully received. Link L1 would be below THRESH (0.8). Consequently, link L1's traffic weight value would be reduced to 0.12825, while link L2's traffic weight value would be increased to 0.65812 and link L3's traffic weight value would be increased to 0.217938.

2. Link L2 and L3 remained healthy and link L1 stopped to synchronize. Then link L1's traffic weight value would be set to 0, link L2's traffic weight value would be set to 0.75, and link L3's traffic weight value would be set to 0.25.

3. Link L1 finally received a SYNC_ACK containing a MESS_R of 0 indicating that none of the MESS_T (32) messages transmitted in the last window were successfully received. Link L1 would be below THRESH. Link L1's traffic weight value would be increased to .005, link L2's traffic weight value would be decreased to 0.74625, and link L3's traffic weight value would be decreased to 0.24875.

4. Link L1 received a SYNC_ACK containing a MESS_R of 32 indicating that 100% of the MESS_T (32) messages transmitted in the last window were successfully received. Link L1 would be above THRESH. Link L1's traffic weight value would be increased to 0.2525, while link L2's traffic weight value would be decreased to 0.560625 and link L3's traffic weight value would be decreased to .186875.

5. Link L1 received a SYNC_ACK containing a MESS_R of 32 indicating that 100% of the MESS_T (32) messages transmitted in the last window were successfully received. Link L1 would be above THRESH. Link L1's traffic weight value would be increased to 0.37625; link L2's traffic weight value would be decreased to 0.4678125, and link L3's traffic weight value would be decreased to 0.1559375.

6. Link L1 remains healthy and the traffic probabilities approach their steady state traffic probabilities.

B. Use of a DNS Proxy to Transparently Create Virtual Private Networks

[00200] A second improvement concerns the automatic creation of a virtual private network (VPN) in response to a domain-name server look-up function.

[00201] Conventional Domain Name Servers (DNSs) provide a look-up function that returns the IP address of a requested computer or host. For example, when a computer user types in the web name “Yahoo.com,” the user’s web browser transmits a request to a DNS, which converts the name into a four-part IP address that is returned to the user’s browser and then used by the browser to contact the destination web site.

[00202] This conventional scheme is shown in FIG. 25. A user’s computer 2501 includes a client application 2504 (for example, a web browser) and an IP protocol stack 2505. When the user enters the name of a destination host, a request DNS REQ is made (through IP protocol stack 2505) to a DNS 2502 to look up the IP address associated with the name. The DNS returns the IP address DNS RESP to client application 2504, which is then able to use the IP address to communicate with the host 2503 through separate transactions such as PAGE REQ and PAGE RESP.

[00203] In the conventional architecture shown in FIG. 25, nefarious listeners on the Internet could intercept the DNS REQ and DNS RESP packets and thus learn what IP addresses the user was contacting. For example, if a user wanted to set up a secure communication path with a web site having the name “Target.com,” when the user’s browser contacted a DNS to find the IP address for that web site, the true IP address of that web site would be revealed over the Internet as part of the DNS inquiry. This would hamper anonymous communications on the Internet.

[00204] One conventional scheme that provides secure virtual private networks over the Internet provides the DNS server with the public keys of the machines that the DNS server has the addresses for. This allows hosts to retrieve automatically the public keys of a host that the host is to communicate with so that the host can set up a VPN without having the user enter the public key of the destination host. One implementation of this standard is presently being developed as part of the FreeS/WAN project(RFC 2535).

[00205] The conventional scheme suffers from certain drawbacks. For example, any user can perform a DNS request. Moreover, DNS requests resolve to the same value for all users.

[00206] According to certain aspects of the invention, a specialized DNS server traps DNS requests and, if the request is from a special type of user (e.g., one for which secure communication services are defined), the server does not return the true IP address of the target node, but instead automatically sets up a virtual private network between the target node and the user. The VPN is preferably implemented using the IP address “hopping” features of the basic invention described above, such that the true identity of the two nodes cannot be determined even if packets during the communication are intercepted. For DNS requests that are determined to not require secure services (e.g., an unregistered user), the DNS server transparently “passes through” the request to provide a normal look-up function and return the IP address of the target web server, provided that the requesting host has permissions to resolve unsecured sites. Different users who make an identical DNS request could be provided with different results.

[00207] FIG. 26 shows a system employing various principles summarized above. A user’s computer 2601 includes a conventional client (e.g., a web browser) 2605 and an IP protocol stack 2606 that preferably operates in accordance with an IP hopping function 2607 as outlined above. A modified DNS server 2602 includes a conventional DNS server function 2609 and a DNS proxy 2610. A gatekeeper server 2603 is interposed between the modified DNS server and a secure target site 2704. An “unsecure” target site 2611 is also accessible via conventional IP protocols.

[00208] According to one embodiment, DNS proxy 2610 intercepts all DNS lookup functions from client 2605 and determines whether access to a secure site has been requested. If access to a secure site has been requested (as determined, for example, by a domain name extension, or by reference to an internal table of such sites), DNS proxy 2610 determines whether the user has sufficient security privileges to access the site. If so, DNS proxy 2610 transmits a message to gatekeeper 2603 requesting that a virtual private network be created between user computer 2601 and secure target site 2604. In one embodiment, gatekeeper 2603 creates “hopblocks” to be used by computer 2601 and secure target site 2604 for secure communication. Then, gatekeeper 2603 communicates these to user computer 2601. Thereafter,

DNS proxy 2610 returns to user computer 2601 the resolved address passed to it by the gatekeeper (this address could be different from the actual target computer) 2604, preferably using a secure administrative VPN. The address that is returned need not be the actual address of the destination computer.

[00209] Had the user requested lookup of a non-secure web site such as site 2611, DNS proxy would merely pass through to conventional DNS server 2609 the look-up request, which would be handled in a conventional manner, returning the IP address of non-secure web site 2611. If the user had requested lookup of a secure web site but lacked credentials to create such a connection, DNS proxy 2610 would return a “host unknown” error to the user. In this manner, different users requesting access to the same DNS name could be provided with different look-up results.

[00210] Gatekeeper 2603 can be implemented on a separate computer (as shown in FIG. 26) or as a function within modified DNS server 2602. In general, it is anticipated that gatekeeper 2703 facilitates the allocation and exchange of information needed to communicate securely, such as using “hopped” IP addresses. Secure hosts such as site 2604 are assumed to be equipped with a secure communication function such as an IP hopping function 2608.

[00211] It will be appreciated that the functions of DNS proxy 2610 and DNS server 2609 can be combined into a single server for convenience. Moreover, although element 2602 is shown as combining the functions of two servers, the two servers can be made to operate independently.

[00212] FIG. 27 shows steps that can be executed by DNS proxy server 2610 to handle requests for DNS look-up for secure hosts. In step 2701, a DNS look-up request is received for a target host. In step 2702, a check is made to determine whether access to a secure host was requested. If not, then in step 2703 the DNS request is passed to conventional DNS server 2609, which looks up the IP address of the target site and returns it to the user’s application for further processing.

[00213] In step 2702, if access to a secure host was requested, then in step 2704 a further check is made to determine whether the user is authorized to connect to the secure host. Such a check can be made with reference to an internally stored list of authorized IP addresses, or can be made by communicating with gatekeeper 2603 (e.g., over an “administrative” VPN that is secure). It will be appreciated that different levels of security can also be provided for different categories of hosts. For example, some sites may be designated as having a certain security level, and the security level of the user requesting access must match that security level. The user’s security level can also be determined by transmitting a request message back to the user’s computer requiring that it prove that it has sufficient privileges.

[00214] If the user is not authorized to access the secure site, then a “host unknown” message is returned (step 2705). If the user has sufficient security privileges, then in step 2706 a secure VPN is established between the user’s computer and the secure target site. As described above, this is preferably done by allocating a hopping regime that will be carried out between the user’s computer and the secure target site, and is preferably performed transparently to the user (i.e., the user need not be involved in creating the secure link). As described in various embodiments of this application, any of various fields can be “hopped” (e.g., IP source/destination addresses; a field in the header; etc.) in order to communicate securely.

[00215] Some or all of the security functions can be embedded in gatekeeper 2603, such that it handles all requests to connect to secure sites. In this embodiment, DNS proxy 2610 communicates with gatekeeper 2603 to determine (preferably over a secure administrative VPN) whether the user has access to a particular web site. Various scenarios for implementing these features are described by way of example below:

[00216] Scenario #1: Client has permission to access target computer, and gatekeeper has a rule to make a VPN for the client. In this scenario, the client’s DNS request would be received by the DNS proxy server 2610, which would forward the request to gatekeeper 2603. The gatekeeper would establish a VPN between the client and the requested target. The gatekeeper would provide the address of the destination to the DNS proxy, which would then return the resolved name as a result. The resolved address can be transmitted back to the client in a secure administrative VPN.

[00217] Scenario #2: Client does not have permission to access target computer. In this scenario, the client's DNS request would be received by the DNS proxy server 2610, which would forward the request to gatekeeper 2603. The gatekeeper would reject the request, informing DNS proxy server 2610 that it was unable to find the target computer. The DNS proxy 2610 would then return a "host unknown" error message to the client.

[00218] Scenario #3: Client has permission to connect using a normal non-VPN link, and the gatekeeper does not have a rule to set up a VPN for the client to the target site. In this scenario, the client's DNS request is received by DNS proxy server 2610, which would check its rules and determine that no VPN is needed. Gatekeeper 2603 would then inform the DNS proxy server to forward the request to conventional DNS server 2609, which would resolve the request and return the result to the DNS proxy server and then back to the client.

[00219] Scenario #4: Client does not have permission to establish a normal/non-VPN link, and the gatekeeper does not have a rule to make a VPN for the client to the target site. In this scenario, the DNS proxy server would receive the client's DNS request and forward it to gatekeeper 2603. Gatekeeper 2603 would determine that no special VPN was needed, but that the client is not authorized to communicate with non-VPN members. The gatekeeper would reject the request, causing DNS proxy server 2610 to return an error message to the client.

C. Large Link to Small Link Bandwidth Management

[00220] One feature of the basic architecture is the ability to prevent so-called "denial of service" attacks that can occur if a computer hacker floods a known Internet node with packets, thus preventing the node from communicating with other nodes. Because IP addresses or other fields are "hopped" and packets arriving with invalid addresses are quickly discarded, Internet nodes are protected against flooding targeted at a single IP address.

[00221] In a system in which a computer is coupled through a link having a limited bandwidth (e.g., an edge router) to a node that can support a much higher-bandwidth link (e.g., an Internet Service Provider), a potential weakness could be exploited by a determined hacker. Referring to FIG. 28, suppose that a first host computer 2801 is communicating with a second host computer 2804 using the IP address hopping principles described above. The first host

computer is coupled through an edge router 2802 to an Internet Service Provider (ISP) 2803 through a low bandwidth link (LOW BW), and is in turn coupled to second host computer 2804 through parts of the Internet through a high bandwidth link (HIGH BW). In this architecture, the ISP is able to support a high bandwidth to the internet, but a much lower bandwidth to the edge router 2802.

[00222] Suppose that a computer hacker is able to transmit a large quantity of dummy packets addressed to first host computer 2801 across high bandwidth link HIGH BW. Normally, host computer 2801 would be able to quickly reject the packets since they would not fall within the acceptance window permitted by the IP address hopping scheme. However, because the packets must travel across low bandwidth link LOW BW, the packets overwhelm the lower bandwidth link before they are received by host computer 2801. Consequently, the link to host computer 2801 is effectively flooded before the packets can be discarded.

[00223] According to one inventive improvement, a “link guard” function 2805 is inserted into the high-bandwidth node (e.g., ISP 2803) that quickly discards packets destined for a low- bandwidth target node if they are not valid packets. Each packet destined for a low-bandwidth node is cryptographically authenticated to determine whether it belongs to a VPN. If it is not a valid VPN packet, the packet is discarded at the high-bandwidth node. If the packet is authenticated as belonging to a VPN, the packet is passed with high preference. If the packet is a valid non-VPN packet, it is passed with a lower quality of service (e.g., lower priority).

[00224] In one embodiment, the ISP distinguishes between VPN and non-VPN packets using the protocol of the packet. In the case of IPSEC [rfc 2401], the packets have IP protocols 420 and 421. In the case of the TARP VPN, the packets will have an IP protocol that is not yet defined. The ISP’s link guard, 2805, maintains a table of valid VPNs which it uses to validate whether VPN packets are cryptographically valid. According to one embodiment, packets that do not fall within any hop windows used by nodes on the low-bandwidth link are rejected, or are sent with a lower quality of service. One approach for doing this is to provide a copy of the IP hopping tables used by the low-bandwidth nodes to the high-bandwidth node, such that both the high-bandwidth and low-bandwidth nodes track hopped packets (e.g., the high-bandwidth node moves its hopping window as valid packets are received). In such a

scenario, the high-bandwidth node discards packets that do not fall within the hopping window before they are transmitted over the low-bandwidth link. Thus, for example, ISP 2903 maintains a copy 2910 of the receive table used by host computer 2901. Incoming packets that do not fall within this receive table are discarded. According to a different embodiment, link guard 2805 validates each VPN packet using a keyed hashed message authentication code (HMAC) [rfc 2104].

[00225] According to another embodiment, separate VPNs (using, for example, hopblocks) can be established for communicating between the low-bandwidth node and the high-bandwidth node (i.e., packets arriving at the high-bandwidth node are converted into different packets before being transmitted to the low-bandwidth node).

[00226] As shown in FIG. 29, for example, suppose that a first host computer 2900 is communicating with a second host computer 2902 over the Internet, and the path includes a high bandwidth link HIGH BW to an ISP 2901 and a low bandwidth link LOW BW through an edge router 2904. In accordance with the basic architecture described above, first host computer 2900 and second host computer 2902 would exchange hopblocks (or a hopblock algorithm) and would be able to create matching transmit and receive tables 2905, 2906, 2912 and 2913. Then in accordance with the basic architecture, the two computers would transmit packets having seemingly random IP source and destination addresses, and each would move a corresponding hopping window in its receive table as valid packets were received.

[00227] Suppose that a nefarious computer hacker 2903 was able to deduce that packets having a certain range of IP addresses (e.g., addresses 100 to 200 for the sake of simplicity) are being transmitted to ISP 2901, and that these packets are being forwarded over a low-bandwidth link. Hacker computer 2903 could thus “flood” packets having addresses falling into the range 100 to 200, expecting that they would be forwarded along low bandwidth link LOW BW, thus causing the low bandwidth link to become overwhelmed. The fast packet reject mechanism in first host computer 3000 would be of little use in rejecting these packets, since the low bandwidth link was effectively jammed before the packets could be rejected. In accordance with one aspect of the improvement, however, VPN link guard 2911 would prevent the attack from impacting the performance of VPN traffic because the packets would either be rejected as

invalid VPN packets or given a lower quality of service than VPN traffic over the lower bandwidth link. A denial-of-service flood attack could, however, still disrupt non-VPN traffic.

[00228] According to one embodiment of the improvement, ISP 2901 maintains a separate VPN with first host computer 2900, and thus translates packets arriving at the ISP into packets having a different IP header before they are transmitted to host computer 2900. The cryptographic keys used to authenticate VPN packets at the link guard 2911 and the cryptographic keys used to encrypt and decrypt the VPN packets at host 2902 and host 2901 can be different, so that link guard 2911 does not have access to the private host data; it only has the capability to authenticate those packets.

[00229] According to yet a third embodiment, the low-bandwidth node can transmit a special message to the high-bandwidth node instructing it to shut down all transmissions on a particular IP address, such that only hopped packets will pass through to the low-bandwidth node. This embodiment would prevent a hacker from flooding packets using a single IP address. According to yet a fourth embodiment, the high-bandwidth node can be configured to discard packets transmitted to the low-bandwidth node if the transmission rate exceeds a certain predetermined threshold for any given IP address; this would allow hopped packets to go through. In this respect, link guard 2911 can be used to detect that the rate of packets on a given IP address are exceeding a threshold rate; further packets addressed to that same IP address would be dropped or transmitted at a lower priority (e.g., delayed).

D. Traffic Limiter

[00230] In a system in which multiple nodes are communicating using “hopping” technology, a treasonous insider could internally flood the system with packets. In order to prevent this possibility, one inventive improvement involves setting up “contracts” between nodes in the system, such that a receiver can impose a bandwidth limitation on each packet sender. One technique for doing this is to delay acceptance of a checkpoint synchronization request from a sender until a certain time period (e.g., one minute) has elapsed. Each receiver can effectively control the rate at which its hopping window moves by delaying “SYNC_ACK” responses to “SYNC_REQ” messages.

[00231] A simple modification to the checkpoint synchronizer will serve to protect a receiver from accidental or deliberate overload from an internally treasonous client. This modification is based on the observation that a receiver will not update its tables until a SYNC_REQ is received on hopped address CKPT_N. It is a simple matter of deferring the generation of a new CKPT_N until an appropriate interval after previous checkpoints.

[00232] Suppose a receiver wished to restrict reception from a transmitter to 100 packets a second, and that checkpoint synchronization messages were triggered every 50 packets, A compliant transmitter would not issue new SYNC_REQ messages more often than every 0.5 seconds. The receiver could delay a non-compliant transmitter from synchronizing by delaying the issuance of CKPT_N for 0.5 second after the last SYNC_REQ was accepted.

[00233] In general, if M receivers need to restrict N transmitters issuing new SYNC_REQ messages after every W messages to sending R messages a second in aggregate, each receiver could defer issuing a new CKPT_N until $M \times N \times W / R$ seconds have elapsed since the last SYNC_REQ has been received and accepted. If the transmitter exceeds this rate between a pair of checkpoints, it will issue the new checkpoint before the receiver is ready to receive it, and the SYNC_REQ will be discarded by the receiver. After this, the transmitter will re-issue the SYNC_REQ every T1 seconds until it receives a SYNC_ACK. The receiver will eventually update CKPT_N and the SYNC_REQ will be acknowledged. If the transmission rate greatly exceeds the allowed rate, the transmitter will stop until it is compliant. If the transmitter exceeds the allowed rate by a little, it will eventually stop after several rounds of delayed synchronization until it is in compliance. Hacking the transmitter's code to not shut off only permits the transmitter to lose the acceptance window. In this case it can recover the window and proceed only after it is compliant again.

[00234] Two practical issues should be considered when implementing the above scheme:

1. The receiver rate should be slightly higher than the permitted rate in order to allow for statistical fluctuations in traffic arrival times and non-uniform load balancing.

2. Since a transmitter will rightfully continue to transmit for a period after a SYNC_REQ is transmitted, the algorithm above can artificially reduce the transmitter's bandwidth. If events prevent a compliant transmitter from synchronizing for a period (e.g. the network dropping a SYNC_REQ or a SYNC_ACK) a SYNC_REQ will be accepted later than expected. After this, the transmitter will transmit fewer than expected messages before encountering the next checkpoint. The new checkpoint will not have been activated and the transmitter will have to retransmit the SYNC_REQ. This will appear to the receiver as if the transmitter is not compliant. Therefore, the next checkpoint will be accepted late from the transmitter's perspective. This has the effect of reducing the transmitter's allowed packet rate until the transmitter transmits at a packet rate below the agreed upon rate for a period of time.

[00235] To guard against this, the receiver should keep track of the times that the last C SYNC_REQs were received and accepted and use the minimum of $MxNxW/R$ seconds after the last SYNC_REQ has been received and accepted, $2xMxNxW/R$ seconds after next to the last SYNC_REQ has been received and accepted, $CxMxNxW/R$ seconds after $(C-1)^{th}$ to the last SYNC_REQ has been received, as the time to activate CKPT_N. This prevents the receiver from inappropriately limiting the transmitter's packet rate if at least one out of the last C SYNC_REQs was processed on the first attempt.

[00236] FIG. 30 shows a system employing the above-described principles. In FIG. 30, two computers 3000 and 3001 are assumed to be communicating over a network N in accordance with the "hopping" principles described above (e.g., hopped IP addresses, discriminator values, etc.). For the sake of simplicity, computer 3000 will be referred to as the receiving computer and computer 3001 will be referred to as the transmitting computer, although full duplex operation is of course contemplated. Moreover, although only a single transmitter is shown, multiple transmitters can transmit to receiver 3000.

[00237] As described above, receiving computer 3000 maintains a receive table 3002 including a window W that defines valid IP address pairs that will be accepted when appearing in incoming data packets. Transmitting computer 3001 maintains a transmit table 3003 from which the next IP address pairs will be selected when transmitting a packet to receiving computer 3000. (For the sake of illustration, window W is also illustrated with reference to transmit table 3003).

As transmitting computer moves through its table, it will eventually generate a SYNC_REQ message as illustrated in function 3010. This is a request to receiver 3000 to synchronize the receive table 3002, from which transmitter 3001 expects a response in the form of a CKPT_N (included as part of a SYNC_ACK message). If transmitting computer 3001 transmits more messages than its allotment, it will prematurely generate the SYNC_REQ message. (If it has been altered to remove the SYNC_REQ message generation altogether, it will fall out of synchronization since receiver 3000 will quickly reject packets that fall outside of window W, and the extra packets generated by transmitter 3001 will be discarded).

[00238] In accordance with the improvements described above, receiving computer 3000 performs certain steps when a SYNC_REQ message is received, as illustrated in FIG. 30. In step 3004, receiving computer 3000 receives the SYNC_REQ message. In step 3005, a check is made to determine whether the request is a duplicate. If so, it is discarded in step 3006. In step 3007, a check is made to determine whether the SYNC_REQ received from transmitter 3001 was received at a rate that exceeds the allowable rate R (i.e., the period between the time of the last SYNC_REQ message). The value R can be a constant, or it can be made to fluctuate as desired. If the rate exceeds R, then in step 3008 the next activation of the next CKPT_N hopping table entry is delayed by W/R seconds after the last SYNC_REQ has been accepted.

[00239] Otherwise, if the rate has not been exceeded, then in step 3109 the next CKPT_N value is calculated and inserted into the receiver's hopping table prior to the next SYNC_REQ from the transmitter 3101. Transmitter 3101 then processes the SYNC_REQ in the normal manner.

E. Signaling Synchronizer

[00240] In a system in which a large number of users communicate with a central node using secure hopping technology, a large amount of memory must be set aside for hopping tables and their supporting data structures. For example, if one million subscribers to a web site occasionally communicate with the web site, the site must maintain one million hopping tables, thus using up valuable computer resources, even though only a small percentage of the users may actually be using the system at any one time. A desirable solution would be a system that permits

a certain maximum number of simultaneous links to be maintained, but which would “recognize” millions of registered users at any one time. In other words, out of a population of a million registered users, a few thousand at a time could simultaneously communicate with a central server, without requiring that the server maintain one million hopping tables of appreciable size.

[00241] One solution is to partition the central node into two nodes: a signaling server that performs session initiation for user log-on and log-off (and requires only minimally sized tables), and a transport server that contains larger hopping tables for the users. The signaling server listens for the millions of known users and performs a fast-packet reject of other (bogus) packets. When a packet is received from a known user, the signaling server activates a virtual private link (VPL) between the user and the transport server, where hopping tables are allocated and maintained. When the user logs onto the signaling server, the user’s computer is provided with hop tables for communicating with the transport server, thus activating the VPL. The VPLs can be torn down when they become inactive for a time period, or they can be torn down upon user log-out. Communication with the signaling server to allow user log-on and log-off can be accomplished using a specialized version of the checkpoint scheme described above.

[00242] FIG. 31 shows a system employing certain of the above-described principles. In FIG. 31, a signaling server 3101 and a transport server 3102 communicate over a link. Signaling server 3101 contains a large number of small tables 3106 and 3107 that contain enough information to authenticate a communication request with one or more clients 3103 and 3104. As described in more detail below, these small tables may advantageously be constructed as a special case of the synchronizing checkpoint tables described previously. Transport server 3102, which is preferably a separate computer in communication with signaling server 3101, contains a smaller number of larger hopping tables 3108, 3109, and 3110 that can be allocated to create a VPN with one of the client computers.

[00243] According to one embodiment, a client that has previously registered with the system (e.g., via a system administration function, a user registration procedure, or some other method) transmits a request for information from a computer (e.g., a web site). In one variation, the request is made using a “hopped” packet, such that signaling server 3101 will quickly reject invalid packets from unauthorized computers such as hacker computer 3105. An

“administrative” VPN can be established between all of the clients and the signaling server in order to ensure that a hacker cannot flood signaling server 3101 with bogus packets. Details of this scheme are provided below.

[00244] Signaling server 3101 receives the request 3111 and uses it to determine that client 3103 is a validly registered user. Next, signaling server 3101 issues a request to transport server 3102 to allocate a hopping table (or hopping algorithm or other regime) for the purpose of creating a VPN with client 3103. The allocated hopping parameters are returned to signaling server 3101 (path 3113), which then supplies the hopping parameters to client 3103 via path 3114, preferably in encrypted form.

[00245] Thereafter, client 3103 communicates with transport server 3102 using the normal hopping techniques described above. It will be appreciated that although signaling server 3101 and transport server 3102 are illustrated as being two separate computers, they could of course be combined into a single computer and their functions performed on the single computer. Alternatively, it is possible to partition the functions shown in FIG. 31 differently from as shown without departing from the inventive principles.

[00246] One advantage of the above-described architecture is that signaling server 3101 need only maintain a small amount of information on a large number of potential users, yet it retains the capability of quickly rejecting packets from unauthorized users such as hacker computer 3105. Larger data tables needed to perform the hopping and synchronization functions are instead maintained in a transport server 3102, and a smaller number of these tables are needed since they are only allocated for “active” links. After a VPN has become inactive for a certain time period (e.g., one hour), the VPN can be automatically torn down by transport server 3102 or signaling server 3101.

[00247] A more detailed description will now be provided regarding how a special case of the checkpoint synchronization feature can be used to implement the signaling scheme described above.

[00248] The signaling synchronizer may be required to support many (millions) of standing, low bandwidth connections. It therefore should minimize per-VPL memory usage while providing the security offered by hopping technology. In order to reduce memory usage in the signaling server, the data hopping tables can be completely eliminated and data can be carried as part of the SYNC_REQ message. The table used by the server side (receiver) and client side (transmitter) is shown schematically as element 3106 in FIG. 31.

[00249] The meaning and behaviors of CKPT_N, CKPT_O and CKPT_R remain the same from the previous description, except that CKPT_N can receive a combined data and SYNC_REQ message or a SYNC_REQ message without the data.

[00250] The protocol is a straightforward extension of the earlier synchronizer. Assume that a client transmitter is on and the tables are synchronized. The initial tables can be generated “out of band.” For example, a client can log into a web server to establish an account over the Internet. The client will receive keys etc encrypted over the Internet. Meanwhile, the server will set up the signaling VPN on the signaling server.

[00251] Assuming that a client application wishes to send a packet to the server on the client’s standing signaling VPL:

1. The client sends the message marked as a data message on the inner header using the transmitter’s CKPT_N address. It turns the transmitter off and starts a timer T1 noting CKPT_O. Messages can be one of three types: DATA, SYNC_REQ and SYNC_ACK. In the normal algorithm, some potential problems can be prevented by identifying each message type as part of the encrypted inner header field. In this algorithm, it is important to distinguish a data packet and a SYNC_REQ in the signaling synchronizer since the data and the SYNC_REQ come in on the same address.

2. When the server receives a data message on its CKPT_N, it verifies the message and passes it up the stack. The message can be verified by checking message type and other information (i.e., user credentials) contained in the inner header. It replaces its CKPT_O with CKPT_N and generates the next CKPT_N. It updates its transmitter side CKPT_R to

correspond to the client's receiver side CKPT_R and transmits a SYNC_ACK containing CKPT_O in its payload.

3. When the client side receiver receives a SYNC_ACK on its CKPT_R with a payload matching its transmitter side CKPT_O and the transmitter is off, the transmitter is turned on and the receiver side CKPT_R is updated. If the SYNC_ACK's payload does not match the transmitter side CKPT_O or the transmitter is on, the SYNC_ACK is simply discarded.

4. T1 expires: If the transmitter is off and the client's transmitter side CKPT_O matches the CKPT_O associated with the timer, it starts timer T1 noting CKPT_O again, and a SYNC_REQ is sent using the transmitter's CKPT_O address. Otherwise, no action is taken.

5. When the server receives a SYNC_REQ on its CKPT_N, it replaces its CKPT_O with CKPT_N and generates the next CKPT_N. It updates its transmitter side CKPT_R to correspond to the client's receiver side CKPT_R and transmits a SYNC_ACK containing CKPT_O in its payload.

6. When the server receives a SYNC_REQ on its CKPT_O, it updates its transmitter side CKPT_R to correspond to the client's receiver side CKPT_R and transmits a SYNC_ACK containing CKPT_O in its payload.

[00252] FIG. 32 shows message flows to highlight the protocol. Reading from top to bottom, the client sends data to the server using its transmitter side CKPT_N. The client side transmitter is turned off and a retry timer is turned off. The transmitter will not transmit messages as long as the transmitter is turned off. The client side transmitter then loads CKPT_N into CKPT_O and updates CKPT_N. This message is successfully received and is passed up the stack. It also synchronizes the receiver i.e., the server loads CKPT_N into CKPT_O and generates a new CKPT_N, it generates a new CKPT_R in the server side transmitter and transmits a SYNC_ACK containing the server side receiver's CKPT_O to the server. The SYNC_ACK is successfully received at the client. The client side receiver's CKPT_R is

updated, the transmitter is turned on and the retry timer is killed. The client side transmitter is ready to transmit a new data message.

[00253] Next, the client sends data to the server using its transmitter side CKPT_N. The client side transmitter is turned off and a retry timer is turned off. The transmitter will not transmit messages as long as the transmitter is turned off. The client side transmitter then loads CKPT_N into CKPT_O and updates CKPT_N. This message is lost. The client side timer expires and as a result a SYNC_REQ is transmitted on the client side transmitter's CKPT_O (this will keep happening until the SYNC_ACK has been received at the client). The SYNC_REQ is successfully received at the server. It synchronizes the receiver i.e., the server loads CKPT_N into CKPT_O and generates a new CKPT_N, it generates an new CKPT_R in the server side transmitter and transmits a SYNC_ACK containing the server side receiver's CKPT_O the server. The SYNC_ACK is successfully received at the client. The client side receiver's CKPT_R is updated, the transmitter is turned off and the retry timer is killed. The client side transmitter is ready to transmit a new data message.

[00254] There are numerous other scenarios that follow this flow. For example, the SYNC_ACK could be lost. The transmitter would continue to re-send the SYNC_REQ until the receiver synchronizes and responds.

[00255] The above-described procedures allow a client to be authenticated at signaling server 3201 while maintaining the ability of signaling server 3201 to quickly reject invalid packets, such as might be generated by hacker computer 3205. In various embodiments, the signaling synchronizer is really a derivative of the synchronizer. It provides the same protection as the hopping protocol, and it does so for a large number of low bandwidth connections.

F. One-Click Secure On-line Communications and Secure Domain Name Service

[00256] The present invention provides a technique for establishing a secure communication link between a first computer and a second computer over a computer network. Preferably, a user enables a secure communication link using a single click of a mouse, or a corresponding minimal input from another input device, such as a keystroke entered on a keyboard or a click entered through a trackball. Alternatively, the secure link is automatically

established as a default setting at boot-up of the computer (i.e., no click). FIG. 33 shows a system block diagram 3300 of a computer network in which the one-click secure communication method of the present invention is suitable. In FIG. 33, a computer terminal or client computer 3301, such as a personal computer (PC), is connected to a computer network 3302, such as the Internet, through an ISP 3303. Alternatively, computer 3301 can be connected to computer network 3302 through an edge router. Computer 3301 includes an input device, such as a keyboard and/or mouse, and a display device, such as a monitor. Computer 3301 can communicate conventionally with another computer 3304 connected to computer network 3302 over a communication link 3305 using a browser 3306 that is installed and operates on computer 3301 in a well-known manner.

[00257] Computer 3304 can be, for example, a server computer that is used for conducting e-commerce. In the situation when computer network 3302 is the Internet, computer 3304 typically will have a standard top-level domain name such as .com, .net, .org, .edu, .mil or .gov.

[00258] FIG. 34 shows a flow diagram 3400 for installing and establishing a “one-click” secure communication link over a computer network according to the present invention. At step 3401, computer 3301 is connected to server computer 3304 over a non-VPN communication link 3305. Web browser 3306 displays a web page associated with server 3304 in a well-known manner. According to one variation of the invention, the display of computer 3301 contains a hyperlink, or an icon representing a hyperlink, for selecting a virtual private network (VPN) communication link (“go secure” hyperlink) through computer network 3302 between terminal 3301 and server 3304. Preferably, the “go secure” hyperlink is displayed as part of the web page downloaded from server computer 3304, thereby indicating that the entity providing server 3304 also provides VPN capability.

[00259] By displaying the “go secure” hyperlink, a user at computer 3301 is informed that the current communication link between computer 3301 and server computer 3304 is a non-secure, non-VPN communication link. At step 3402, it is determined whether a user of computer 3301 has selected the “go secure” hyperlink. If not, processing resumes using a non-secure (conventional) communication method (not shown). If, at step 3402, it is determined that the user

has selected the “go secure” hyperlink, flow continues to step 3403 where an object associated with the hyperlink determines whether a VPN communication software module has already been installed on computer 3301. Alternatively, a user can enter a command into computer 3301 to “go secure.”

[00260] If, at step 3403, the object determines that the software module has been installed, flow continues to step 3407. If, at step 3403, the object determines that the software module has not been installed, flow continues to step 3404 where a non-VPN communication link 3307 is launched between computer 3301 and a website 3308 over computer network 3302 in a well-known manner. Website 3308 is accessible by all computer terminals connected to computer network 3302 through a non-VPN communication link. Once connected to website 3308, a software module for establishing a secure communication link over computer network 3302 can be downloaded and installed. Flow continues to step 3405 where, after computer 3301 connects to website 3308, the software module for establishing a communication link is downloaded and installed in a well-known manner on computer terminal 3301 as software module 3309. At step 3405, a user can optionally select parameters for the software module, such as enabling a secure communication link mode of communication for all communication links over computer network 3302. At step 3406, the communication link between computer 3301 and website 3308 is then terminated in a well-known manner.

[00261] By clicking on the “go secure” hyperlink, a user at computer 3301 has enabled a secure communication mode of communication between computer 3301 and server computer 3304. According to one variation of the invention, the user is not required to do anything more than merely click the “go secure” hyperlink. The user does not need to enter any user identification information, passwords or encryption keys for establishing a secure communication link. All procedures required for establishing a secure communication link between computer 3301 and server computer 3304 are performed transparently to a user at computer 3301.

[00262] At step 3407, a secure VPN communications mode of operation has been enabled and software module 3309 begins to establish a VPN communication link. In one embodiment, software module 3309 automatically replaces the top-level domain name for server

3304 within browser 3406 with a secure top-level domain name for server computer 3304. For example, if the top-level domain name for server 3304 is .com, software module 3309 replaces the .com top-level domain name with a .scom top-level domain name, where the “s” stands for secure. Alternatively, software module 3409 can replace the top-level domain name of server 3304 with any other non-standard top-level domain name.

[00263] Because the secure top-level domain name is a non-standard domain name, a query to a standard domain name service (DNS) will return a message indicating that the universal resource locator (URL) is unknown. According to the invention, software module 3409 contains the URL for querying a secure domain name service (SDNS) for obtaining the URL for a secure top-level domain name. In this regard, software module 3309 accesses a secure portal 3310 that interfaces a secure network 3311 to computer network 3302. Secure network 3311 includes an internal router 3312, a secure domain name service (SDNS) 3313, a VPN gatekeeper 3314 and a secure proxy 3315. The secure network can include other network services, such as e-mail 3316, a plurality of chatrooms (of which only one chatroom 3317 is shown), and a standard domain name service (STD DNS) 3318. Of course, secure network 3311 can include other resources and services that are not shown in FIG. 33.

[00264] When software module 3309 replaces the standard top-level domain name for server 3304 with the secure top-level domain name, software module 3309 sends a query to SDNS 3313 at step 3408 through secure portal 3310 preferably using an administrative VPN communication link 3319. In this configuration, secure portal 3310 can only be accessed using a VPN communication link. Preferably, such a VPN communication link can be based on a technique of inserting a source and destination IP address pair into each data packet that is selected according to a pseudo-random sequence; an IP address hopping regime that pseudorandomly changes IP addresses in packets transmitted between a client computer and a secure target computer; periodically changing at least one field in a series of data packets according to a known sequence; an Internet Protocol (IP) address in a header of each data packet that is compared to a table of valid IP addresses maintained in a table in the second computer; and/or a comparison of the IP address in the header of each data packet to a moving window of valid IP addresses, and rejecting data packets having IP addresses that do not fall within the

moving window. Other types of VPNs can alternatively be used. Secure portal 3310 authenticates the query from software module 3309 based on the particular information hopping technique used for VPN communication link 3319.

[00265] SDNS 3313 contains a cross-reference database of secure domain names and corresponding secure network addresses. That is, for each secure domain name, SDNS 3313 stores a computer network address corresponding to the secure domain name. An entity can register a secure domain name in SDNS 3313 so that a user who desires a secure communication link to the website of the entity can automatically obtain the secure computer network address for the secure website. Moreover, an entity can register several secure domain names, with each respective secure domain name representing a different priority level of access in a hierarchy of access levels to a secure website. For example, a securities trading website can provide users secure access so that a denial of service attack on the website will be ineffectual with respect to users subscribing to the secure website service. Different levels of subscription can be arranged based on, for example, an escalating fee, so that a user can select a desired level of guarantee for connecting to the secure securities trading website. When a user queries SDNS 3313 for the secure computer network address for the securities trading website, SDNS 3313 determines the particular secure computer network address based on the user's identity and the user's subscription level.

[00266] At step 3409, SDNS 3313 accesses VPN gatekeeper 3314 for establishing a VPN communication link between software module 3309 and secure server 3320. Server 3320 can only be accessed through a VPN communication link. VPN gatekeeper 3314 provisions computer 3301 and secure web server computer 3320, or a secure edge router for server computer 3320, thereby creating the VPN. Secure server computer 3320 can be a separate server computer from server computer 3304, or can be the same server computer having both non-VPN and VPN communication link capability, such as shown by server computer 3322. Returning to FIG. 34, in step 3410, SDNS 3313 returns a secure URL to software module 3309 for the .com server address for a secure server 3320 corresponding to server 3304.

[00267] Alternatively, SDNS 3313 can be accessed through secure portal 3310 "in the clear", that is, without using an administrative VPN communication link. In this situation, secure

portal 3310 preferably authenticates the query using any well-known technique, such as a cryptographic technique, before allowing the query to proceed to SDNS 3319. Because the initial communication link in this situation is not a VPN communication link, the reply to the query can be “in the clear.” The querying computer can use the clear reply for establishing a VPN link to the desired domain name. Alternatively, the query to SDNS 3313 can be in the clear, and SDNS 3313 and gatekeeper 3314 can operate to establish a VPN communication link to the querying computer for sending the reply.

[00268] At step 3411, software module 3309 accesses secure server 3320 through VPN communication link 3321 based on the VPN resources allocated by VPN gatekeeper 3314. At step 3412, web browser 3306 displays a secure icon indicating that the current communication link to server 3320 is a secure VPN communication link. Further communication between computers 3301 and 3320 occurs via the VPN, e.g., using a “hopping” regime as discussed above. When VPN link 3321 is terminated at step 3413, flow continues to step 3414 where software module 3309 automatically replaces the secure top-level domain name with the corresponding non-secure top-level domain name for server 3304. Browser 3306 accesses a standard DNS 3325 for obtaining the non-secure URL for server 3304. Browser 3306 then connects to server 3304 in a well-known manner. At step 3415, browser 3306 displays the “go secure” hyperlink or icon for selecting a VPN communication link between terminal 3301 and server 3304. By again displaying the “go secure” hyperlink, a user is informed that the current communication link is a non-secure, non-VPN communication link.

[00269] When software module 3309 is being installed or when the user is off-line, the user can optionally specify that all communication links established over computer network 3302 are secure communication links. Thus, anytime that a communication link is established, the link is a VPN link. Consequently, software module 3309 transparently accesses SDNS 3313 for obtaining the URL for a selected secure website. In other words, in one embodiment, the user need not “click” on the secure option each time secure communication is to be effected.

[00270] Additionally, a user at computer 3301 can optionally select a secure communication link through proxy computer 3315. Accordingly, computer 3301 can establish a VPN communication link 3323 with secure server computer 3320 through proxy computer 3315.

Alternatively, computer 3301 can establish a non-VPN communication link 3324 to a non-secure website, such as non-secure server computer 3304.

[00271] FIG. 35 shows a flow diagram 3500 for registering a secure domain name according to the present invention. At step 3501, a requester accesses website 3308 and logs into a secure domain name registry service that is available through website 3308. At step 3502, the requestor completes an online registration form for registering a secure domain name having a top-level domain name, such as .com, .net, .org, .edu, .mil or .gov. Of course, other secure top-level domain names can also be used. Preferably, the requestor must have previously registered a non-secure domain name corresponding to the equivalent secure domain name that is being requested. For example, a requester attempting to register secure domain name “website.scom” must have previously registered the corresponding non-secure domain name “website.com”.

[00272] At step 3503, the secure domain name registry service at website 3308 queries a non-secure domain name server database, such as standard DNS 3322, using, for example, a whois query, for determining ownership information relating to the non-secure domain name corresponding to the requested secure domain name. At step 3504, the secure domain name registry service at website 3308 receives a reply from standard DNS 3322 and at step 3505 determines whether there is conflicting ownership information for the corresponding non-secure domain name. If there is no conflicting ownership information, flow continues to step 3507, otherwise flow continues to step 3506 where the requestor is informed of the conflicting ownership information. Flow returns to step 3502.

[00273] When there is no conflicting ownership information at step 3505, the secure domain name registry service (website 3308) informs the requestor that there is no conflicting ownership information and prompts the requestor to verify the information entered into the online form and select an approved form of payment. After confirmation of the entered information and appropriate payment information, flow continues to step 3508 where the newly registered secure domain name sent to SDNS 3313 over communication link 3326.

[00274] If, at step 3505, the requested secure domain name does not have a corresponding equivalent non-secure domain name, the present invention informs the requestor

of the situation and prompts the requestor for acquiring the corresponding equivalent non-secure domain name for an increased fee. By accepting the offer, the present invention automatically registers the corresponding equivalent non-secure domain name with standard DNS 3325 in a well-known manner. Flow then continues to step 3508.

G. Tunneling Secure Address Hopping Protocol Through
Existing Protocol Using Web Proxy

[00275] The present invention also provides a technique for implementing the field hopping schemes described above in an application program on the client side of a firewall between two computer networks, and in the network stack on the server side of the firewall. The present invention uses a new secure connectionless protocol that provides good denial of service rejection capabilities by layering the new protocol on top of an existing IP protocol, such as the ICMP, UDP or TCP protocols. Thus, this aspect of the present invention does not require changes in the Internet infrastructure.

[00276] According to the invention, communications are protected by a client-side proxy application program that accepts unencrypted, unprotected communication packets from a local browser application. The client-side proxy application program tunnels the unencrypted, unprotected communication packets through a new protocol, thereby protecting the communications from a denial of service at the server side. Of course, the unencrypted, unprotected communication packets can be encrypted prior to tunneling.

[00277] The client-side proxy application program is not an operating system extension and does not involve any modifications to the operating system network stack and drivers. Consequently, the client is easier to install, remove and support in comparison to a VPN. Moreover, the client-side proxy application can be allowed through a corporate firewall using a much smaller “hole” in the firewall and is less of a security risk in comparison to allowing a protocol layer VPN through a corporate firewall.

[00278] The server-side implementation of the present invention authenticates valid field-hopped packets as valid or invalid very early in the server packet processing, similar to a standard virtual private network, for greatly minimizing the impact of a denial of service attempt

in comparison to normal TCP/IP and HTTP communications, thereby protecting the server from invalid communications.

[00279] FIG. 36 shows a system block diagram of a computer network 3600 in which a virtual private connection according to the present invention can be configured to more easily traverse a firewall between two computer networks. FIG. 37 shows a flow diagram 3700 for establishing a virtual private connection that is encapsulated using an existing network protocol.

[00280] In FIG. 36 a local area network (LAN) 3601 is connected to another computer network 3602, such as the Internet, through a firewall arrangement 3603. Firewall arrangement operates in a well-known manner to interface LAN 3601 to computer network 3602 and to protect LAN 3601 from attacks initiated outside of LAN 3601.

[00281] A client computer 3604 is connected to LAN 3601 in a well-known manner. Client computer 3604 includes an operating system 3605 and a web browser 3606. Operating system 3605 provides kernel mode functions for operating client computer 3604. Browser 3606 is an application program for accessing computer network resources connected to LAN 3601 and computer network 3602 in a well-known manner. According to the present invention, a proxy application 3607 is also stored on client computer 3604 and operates at an application layer in conjunction with browser 3606. Proxy application 3607 operates at the application layer within client computer 3604 and when enabled, modifies unprotected, unencrypted message packets generated by browser 3606 by inserting data into the message packets that are used for forming a virtual private connection between client computer 3604 and a server computer connected to LAN 3601 or computer network 3602. According to the invention, a virtual private connection does not provide the same level of security to the client computer as a virtual private network. A virtual private connection can be conveniently authenticated so that, for example, a denial of service attack can be rapidly rejected, thereby providing different levels of service that can be subscribed to by a user.

[00282] Proxy application 3607 is conveniently installed and uninstalled by a user because proxy application 3607 operates at the application layer within client computer 3604. On installation, proxy application 3607 preferably configures browser 3606 to use proxy application

for all web communications. That is, the payload portion of all message packets is modified with the data for forming a virtual private connection between client computer 3604 and a server computer. Preferably, the data for forming the virtual private connection contains field-hopping data, such as described above in connection with VPNs. Also, the modified message packets preferably conform to the UDP protocol. Alternatively, the modified message packets can conform to the TCP/IP protocol or the ICMP protocol. Alternatively, proxy application 3606 can be selected and enabled through, for example, an option provided by browser 3606. Additionally, proxy application 3607 can be enabled so that only the payload portion of specially designated message packets is modified with the data for forming a virtual private connection between client computer 3604 and a designated host computer. Specially designated message packets can be, for example, selected predetermined domain names.

[00283] Referring to FIG. 37, at step 3701, unprotected and unencrypted message packets are generated by browser 3606. At step 3702, proxy application 3607 modifies the payload portion of all message packets by tunneling the data for forming a virtual private connection between client computer 3604 and a destination server computer into the payload portion. At step, 3703, the modified message packets are sent from client computer 3604 to, for example, website (server computer) 3608 over computer network 3602.

[00284] Website 3608 includes a VPN guard portion 3609, a server proxy portion 3610 and a web server portion 3611. VPN guard portion 3609 is embedded within the kernel layer of the operating system of website 3608 so that large bandwidth attacks on website 3608 are rapidly rejected. When client computer 3604 initiates an authenticated connection to website 3608, VPN guard portion 3609 is keyed with the hopping sequence contained in the message packets from client computer 3604, thereby performing a strong authentication of the client packet streams entering website 3608 at step 3704. VPN guard portion 3609 can be configured for providing different levels of authentication and, hence, quality of service, depending upon a subscribed level of service. That is, VPN guard portion 3609 can be configured to let all message packets through until a denial of service attack is detected, in which case VPN guard portion 3609 would allow only client packet streams conforming to a keyed hopping sequence, such as that of the present invention.

[00285] Server proxy portion 3610 also operates at the kernel layer within website 3608 and catches incoming message packets from client computer 3604 at the VPN level. At step 3705, server proxy portion 3610 authenticates the message packets at the kernel level within host computer 3604 using the destination IP address, UDP ports and discriminator fields. The authenticated message packets are then forwarded to the authenticated message packets to web server portion 3611 as normal TCP web transactions.

[00286] At step 3705, web server portion 3611 responds to message packets received from client computer 3604 in accordance with the particular nature of the message packets by generating reply message packets. For example, when a client computer requests a webpage, web server portion 3611 generates message packets corresponding to the requested webpage. At step 3706, the reply message packets pass through server proxy portion 3610, which inserts data into the payload portion of the message packets that are used for forming the virtual private connection between host computer 3608 and client computer 3604 over computer network 3602. Preferably, the data for forming the virtual private connection is contains field-hopping data, such as described above in connection with VPNs. Server proxy portion 3610 operates at the kernel layer within host computer 3608 to insert the virtual private connection data into the payload portion of the reply message packets. Preferably, the modified message packets sent by host computer 3608 to client computer 3604 conform to the UDP protocol. Alternatively, the modified message packets can conform to the TCP/IP protocol or the ICMP protocol.

[00287] At step 3707, the modified packets are sent from host computer 3608 over computer network 3602 and pass through firewall 3603. Once through firewall 3603, the modified packets are directed to client computer 3604 over LAN 3601 and are received at step 3708 by proxy application 3607 at the application layer within client computer 3604. Proxy application 3607 operates to rapidly evaluate the modified message packets for determining whether the received packets should be accepted or dropped. If the virtual private connection data inserted into the received information packets conforms to expected virtual private connection data, then the received packets are accepted. Otherwise, the received packets are dropped.

[00288] While the present invention has been described in connection with the illustrated embodiments, it will be appreciated and understood that modifications may be made without departing from the true spirit and scope of the invention.

CLAIMS

What is claimed is:

1. A client device comprising:
 - (a) memory configured and arranged to facilitate a connection of the client device with a target device over a secure communication link created based on (i) an address request generated by the client device, and (ii) a determination as a result of the address request that the target device is a device with which a secure communication link can be established when the requested address is identified in an address lookup;
 - (b) an application program configured and arranged so as to allow participation in audio/video communications with the target device over the secure communication link once the secure communication link is established; and
 - (c) a signal processing configuration arranged to execute the application program.
2. The client device of claim 1, wherein the client device is a computer.
3. The client device of claim 1, wherein the client device is a phone.
4. The client device of claim 3, wherein the establishment of the secure communication link is based on a determination being made by a server that the target device is a device with which a secure communication link can be established when the address request corresponds to a target device identified in the address lookup.
5. The client device of claim 4, wherein the address lookup is a network address lookup.
6. The client device of claim 3, wherein the secure communication link is a virtual private network link.
7. The client device of claim 3, wherein the address request includes a secure domain name.

8. The client device of claim 3, wherein the address request includes a domain name, and the establishment of the secure communication link is based on the determination being made by a proxy module that the target device is a device with which a secure communication link can be established when the secure domain name corresponds to a target device identified in a DNS lookup table.

9. The client device of claim 3, wherein the secure communication link is a broadband connection.

10. The client device of claim 3, wherein the secure communication link is a modulated transmission link.

11. The client device of claim 3, where the secure communication link supports at least one of the following: FTM, TDM and CDMA.

12. The client device of claim 3, wherein the secure communication link supports TCP/IP protocols

13. The client device of claim 3, wherein the target device is a server.

14. The client device of claim 3, wherein the target device is a computer.

15. The client device of claim 3, wherein the target device is a phone.

16. A method executed by a client device for communicating with a target device, the method comprising:

(a) facilitating a connection with the target device over a secure communication link created based on (i) an address request generated by the client device, and (ii) a determination as a result of the address request that the target device is a device with which a secure communication link can be established when the requested address is identified in an address lookup; and

(b) allowing participation in audio/video communications with the target device over the secure communication link once the secure communication link is established.

17. The method of claim 16, wherein the client device is a computer.
18. The method of claim 16, wherein the client device is a phone.
19. The method of claim 16, wherein the address lookup is a network address lookup.
20. The method of claim 16, wherein the establishment of the secure communication link is based on a determination being made by a server that the target device is a device with which a secure communication link can be established when the address request corresponds to a target device identified in the address lookup.
21. The method of claim 16, wherein the secure communication link is a virtual private network link.
22. The method of claim 16, wherein the address request includes a secure domain name.
23. The method of claim 16, wherein the secure communication link is a broadband connection.
24. The method of claim 16, wherein the secure communication link is an unmodulated transmission link.
25. The method of claim 16, wherein the secure communication link is a modulated transmission link.
26. The method of claim 16, where the secure communication link supports at least one of the following: FTM, TDM and CDMA.
27. The method of claim 16, wherein the secure communication link supports TCP/IP protocols
28. The method of claim 16, wherein the target device is a server.
29. The method of claim 16, wherein the target device is a computer.

30. The method of claim 16, wherein the target device is a phone.

ABSTRACT

A client device comprises: (a) a memory, (b) an application program, and (c) a signal processing configuration. The memory is configured and arranged to facilitate a connection of the client device with a target device over a secure communication link created based on (i) an address request generated by the client device, and (ii) a determination as a result of the address request that the target device is a device with which a secure communication link can be established when the requested address is identified in an address lookup. The application program is configured and arranged so as to allow participation in audio/video communications with the target device over the secure communication link once the secure communication link is established. The signal processing configuration is arranged to execute the application program.

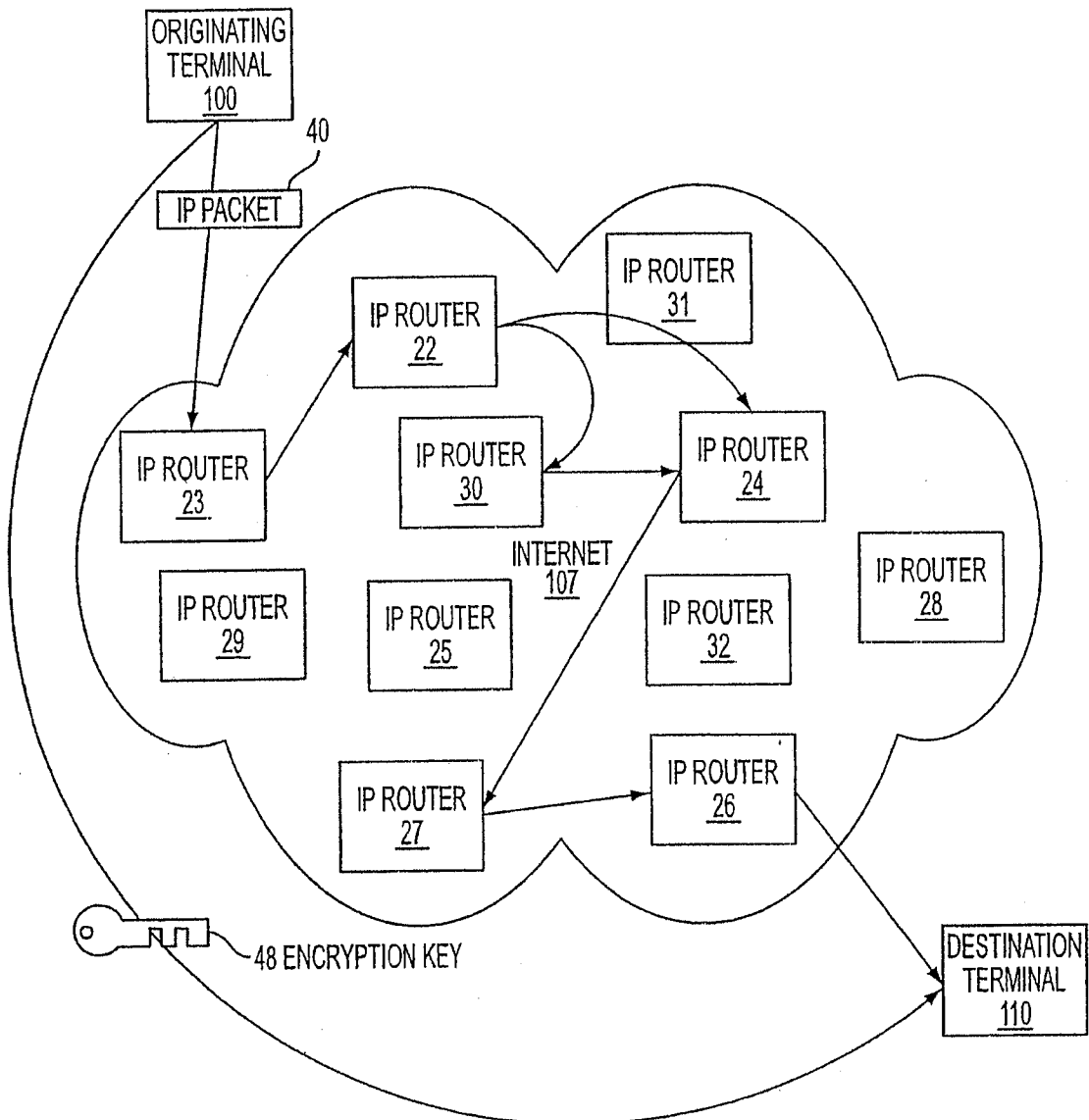

FIG. 1

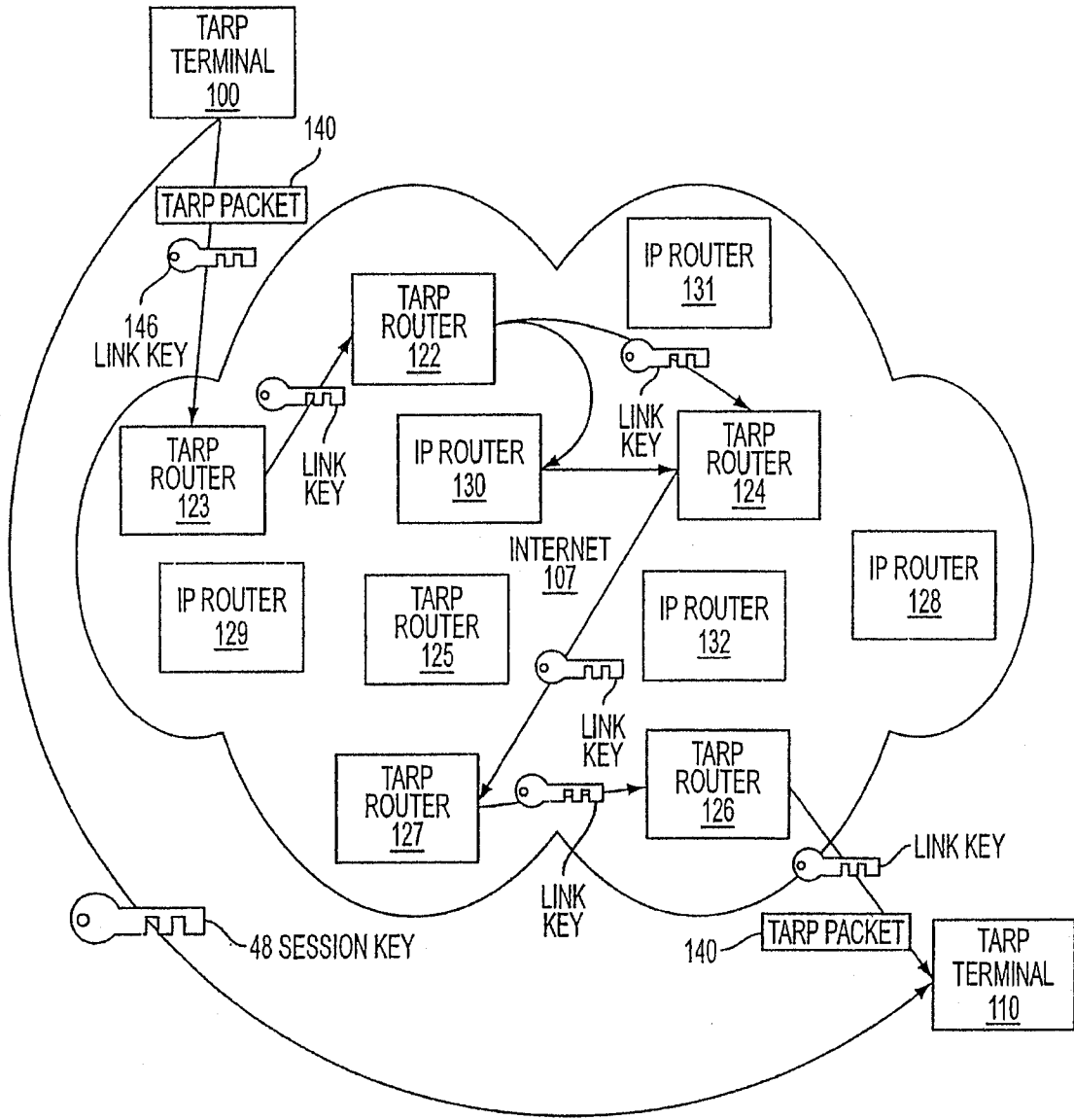

FIG. 2

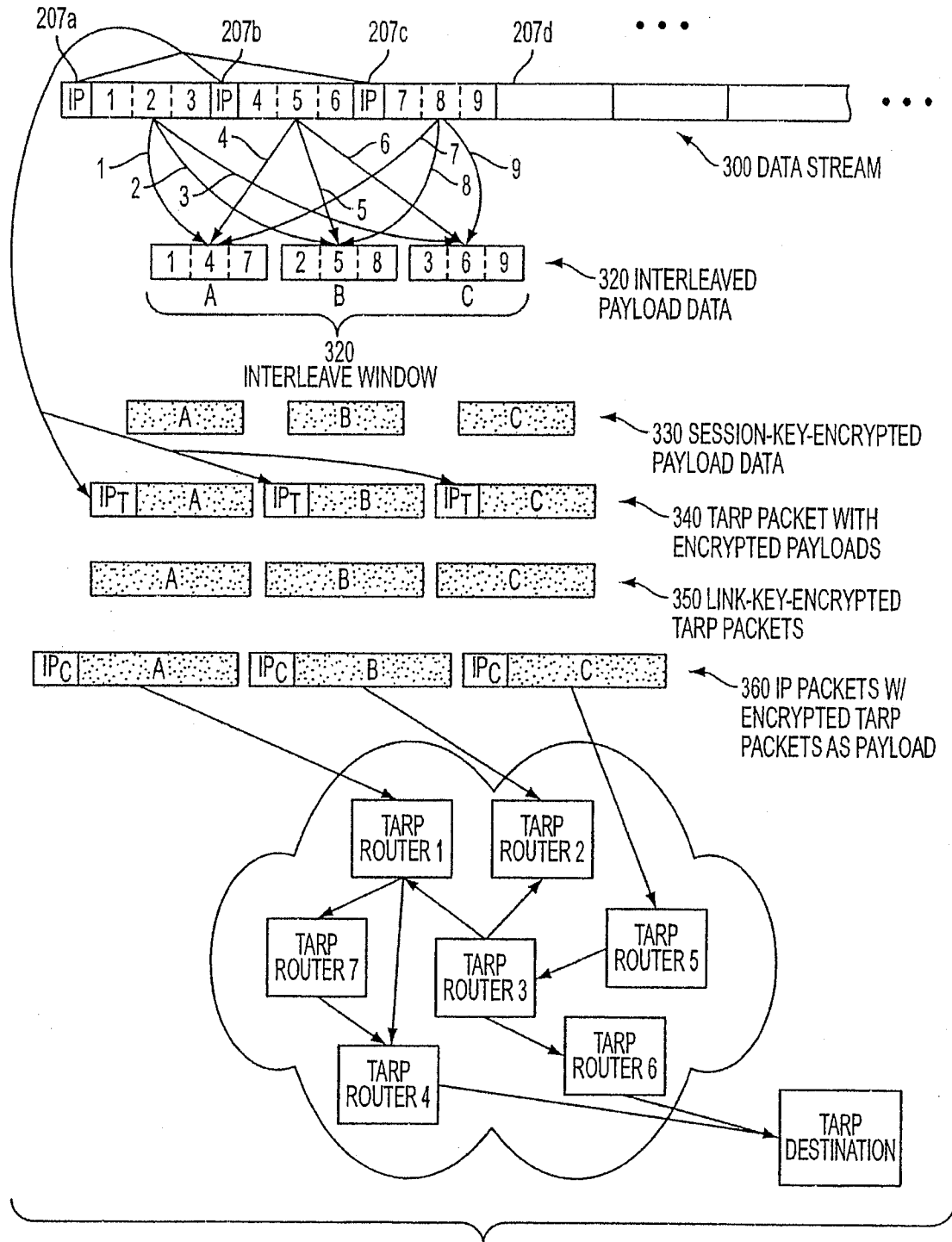

FIG. 3A

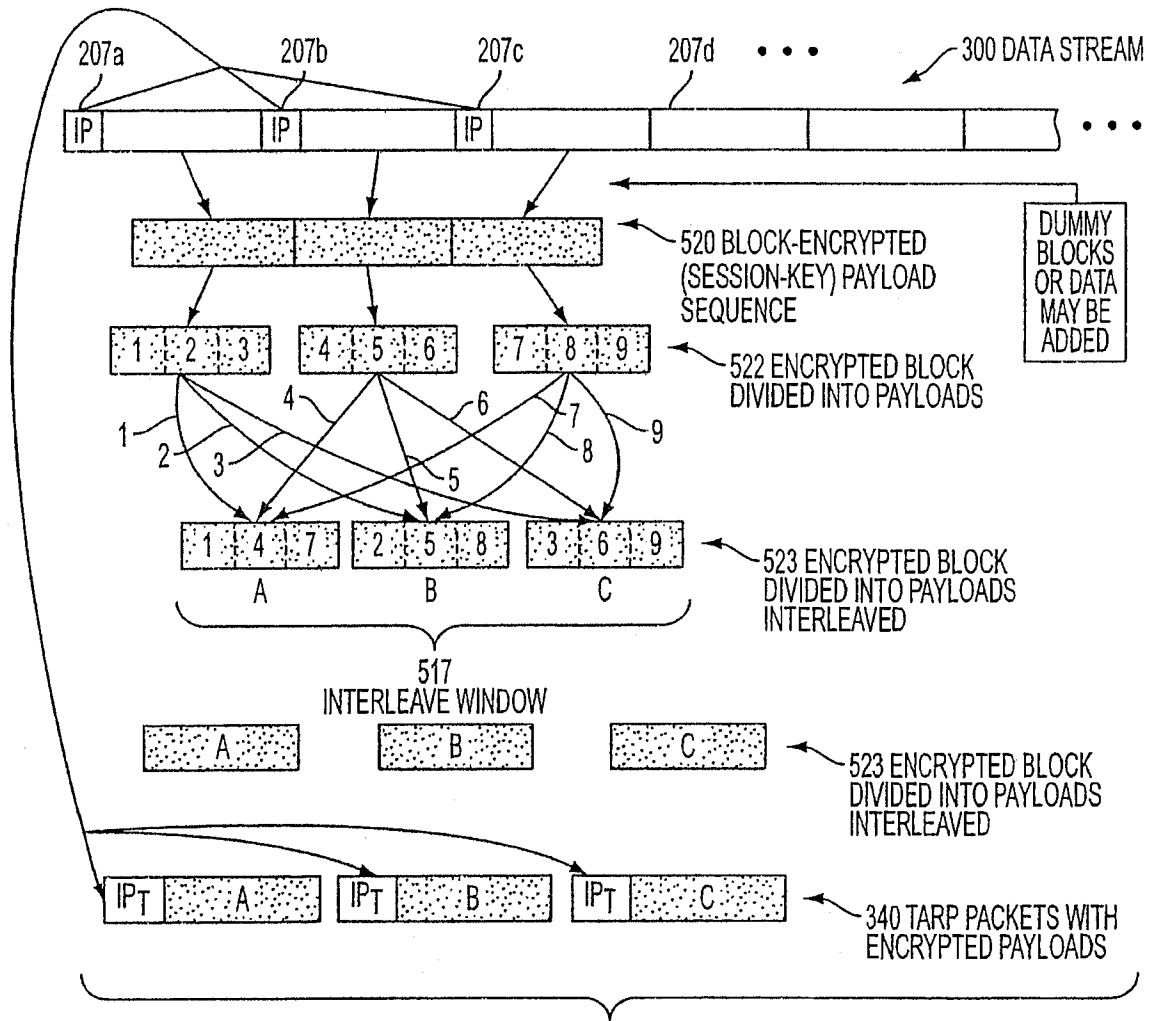

FIG. 3B

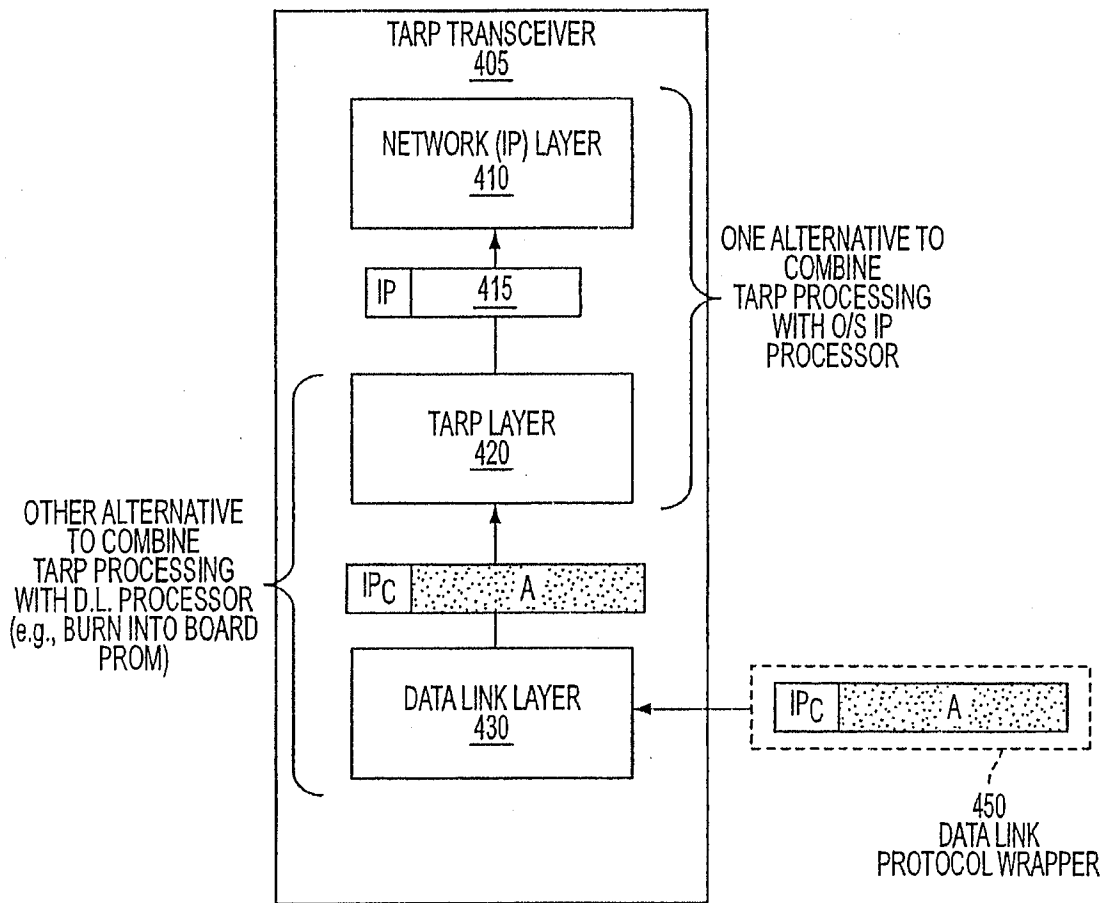

FIG. 4

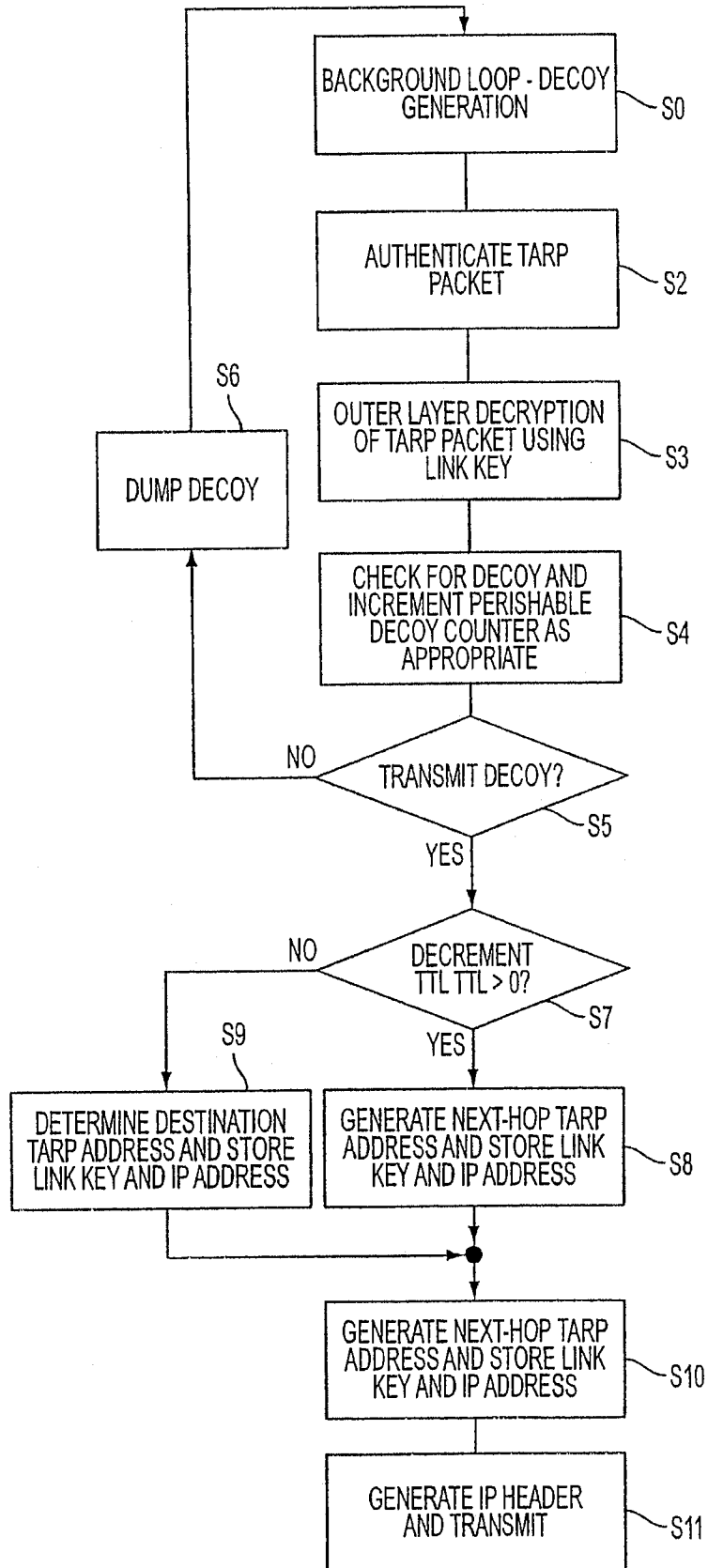

FIG. 5

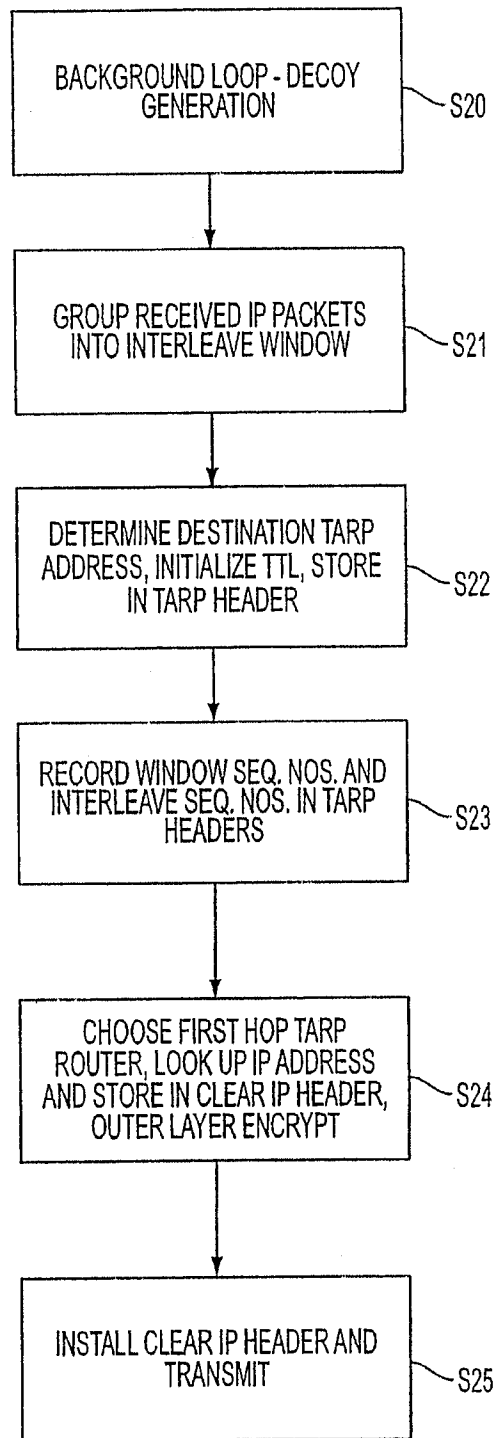

FIG. 6

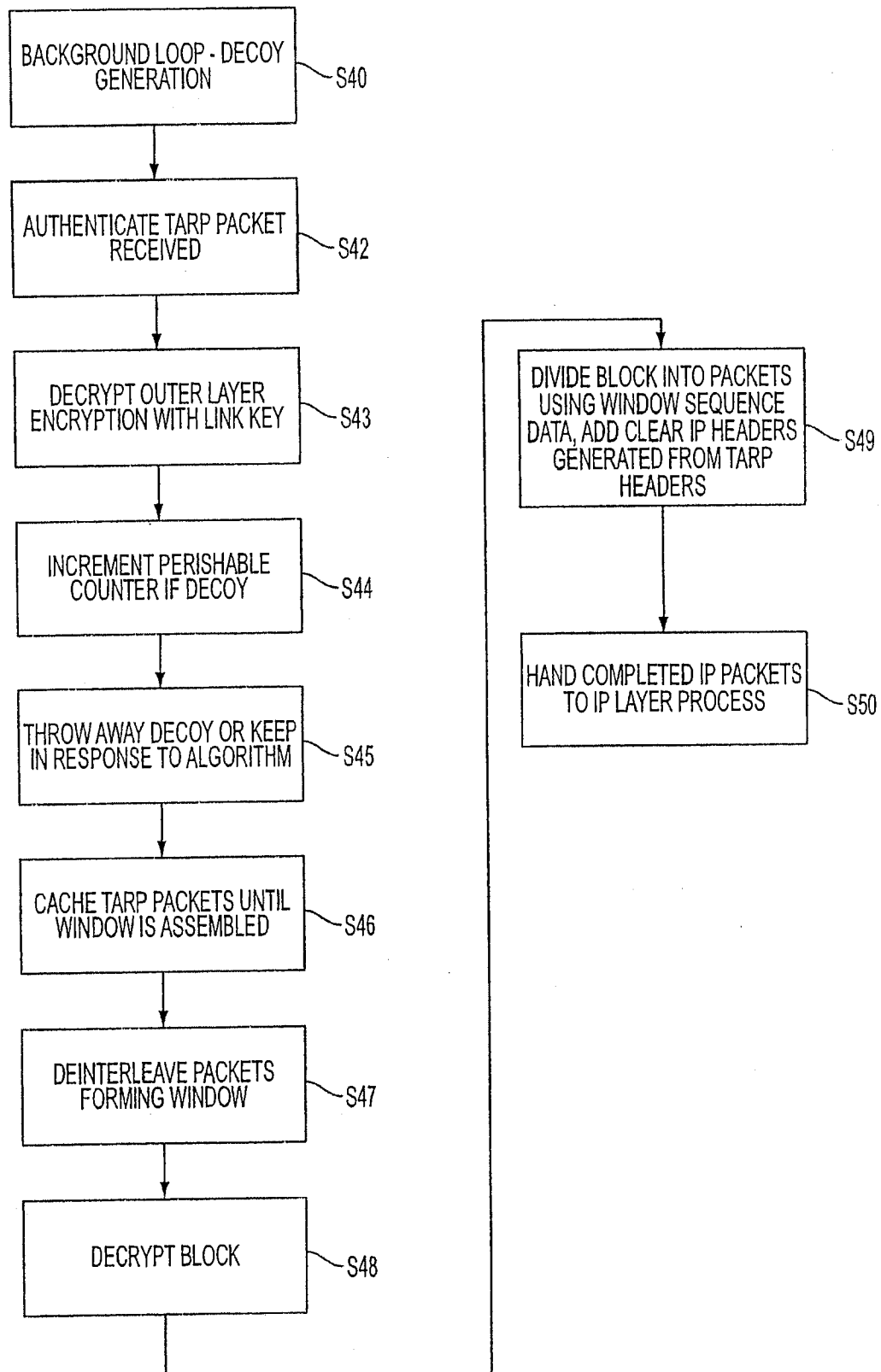

FIG. 7

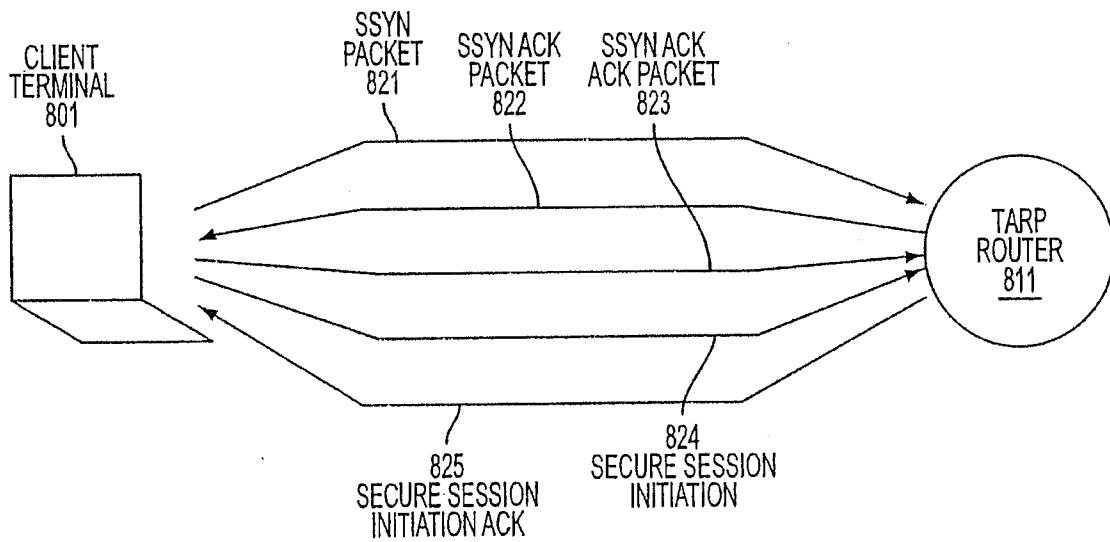

FIG. 8

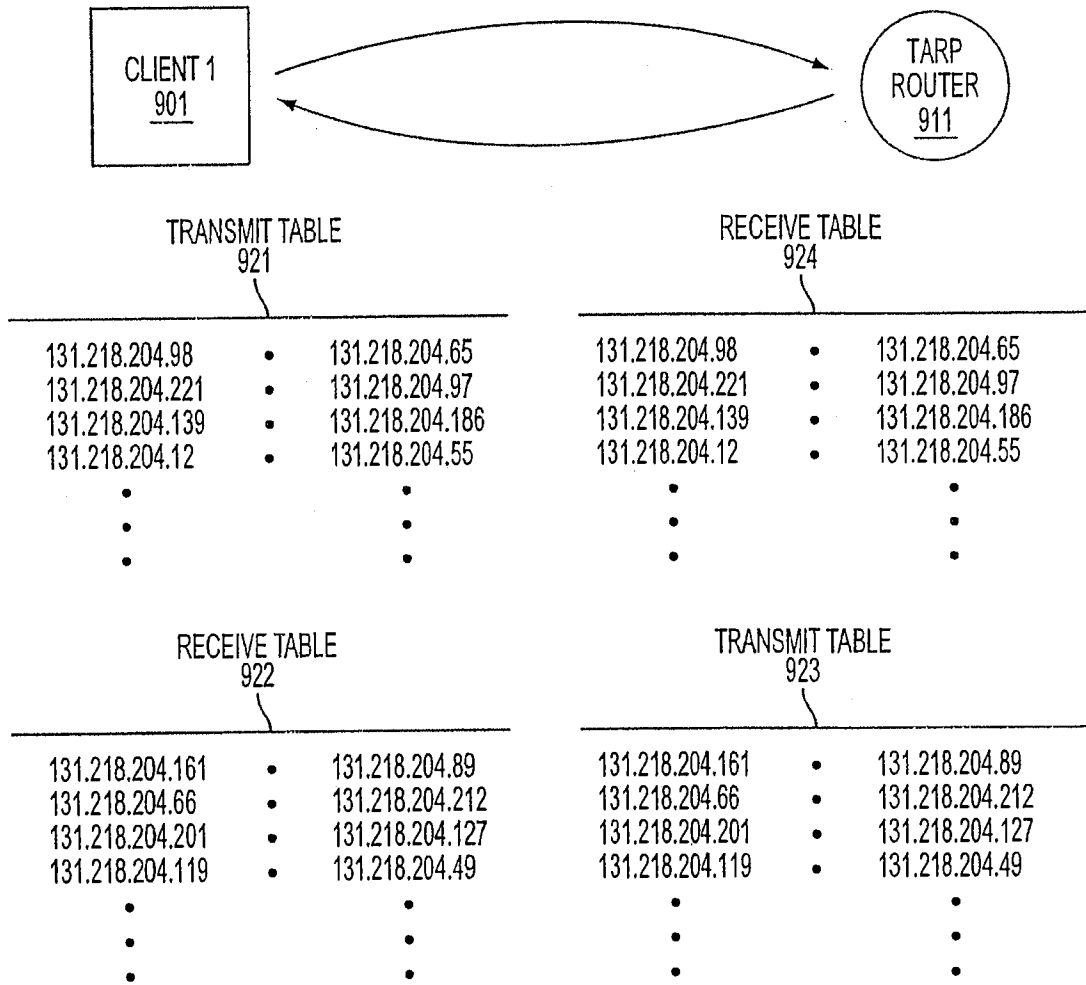

FIG. 9

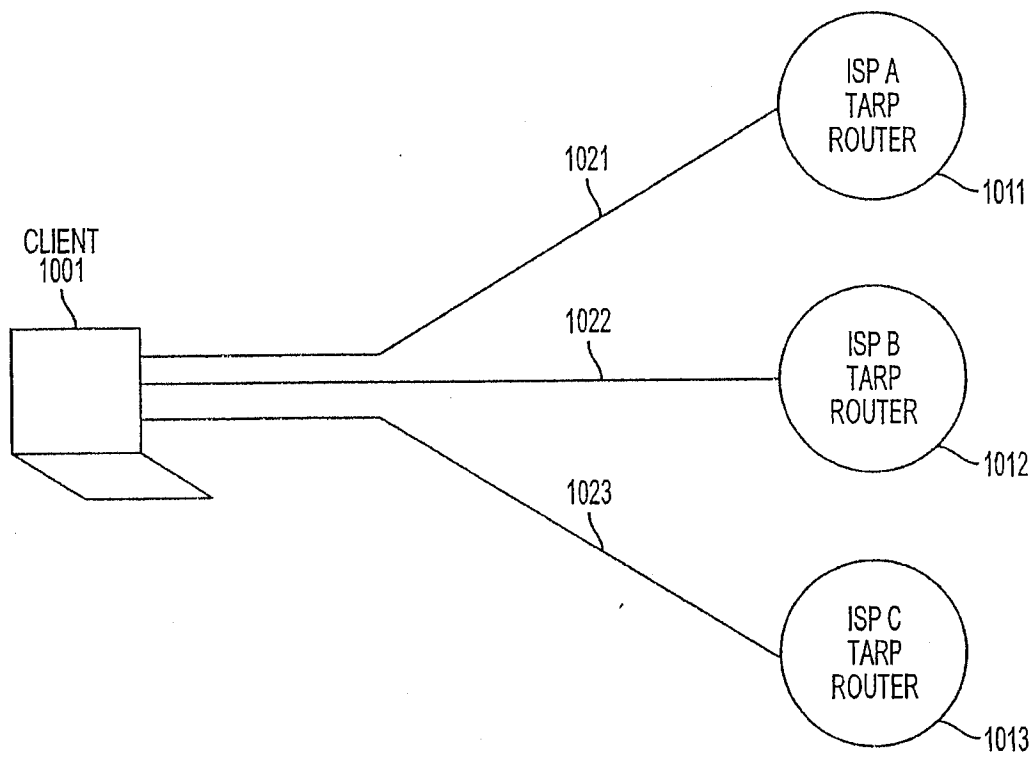

FIG. 10

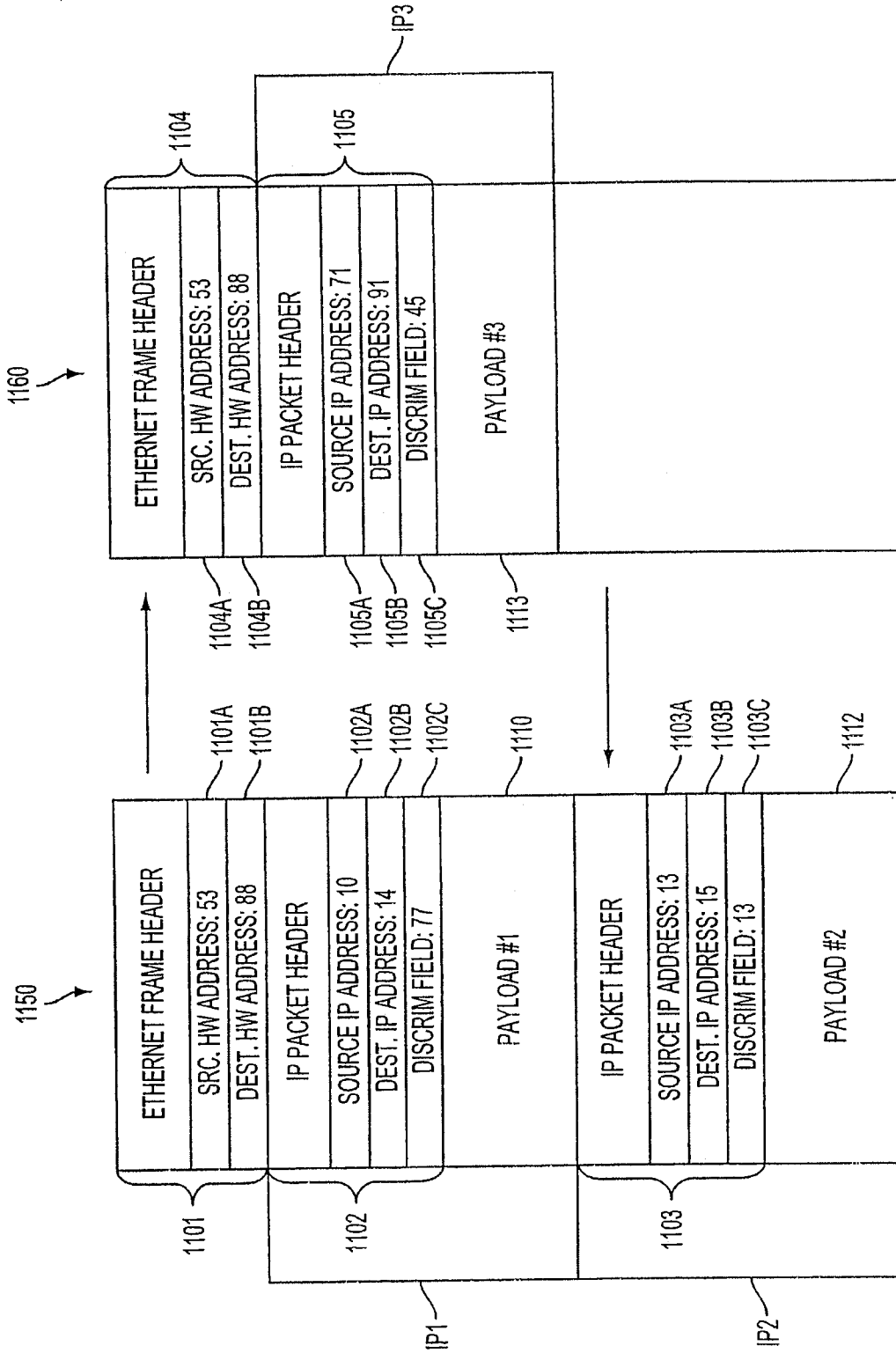

FIG. 11

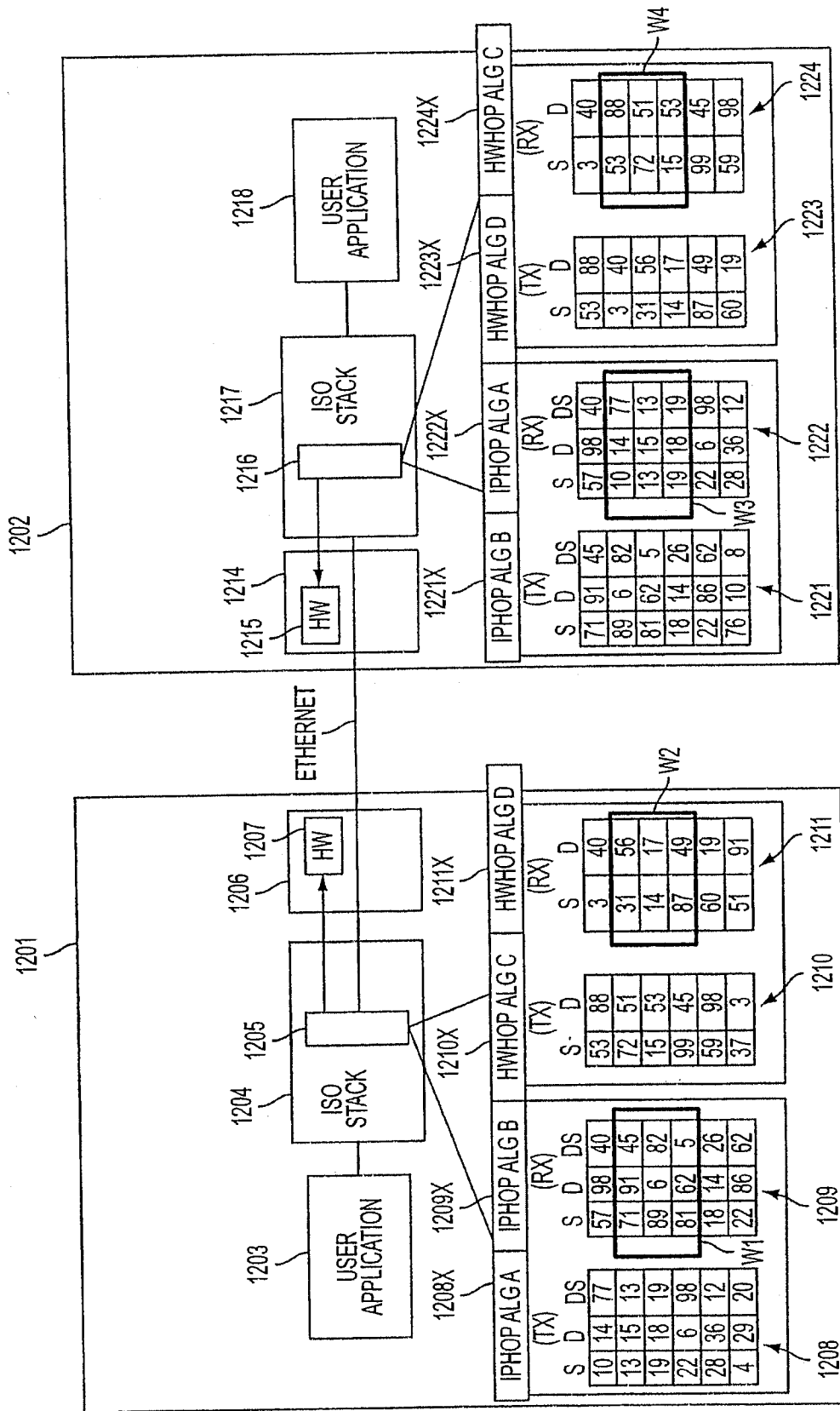

FIG. 12A

MODE OR EMBODIMENT	HARDWARE ADDRESSES	IP ADDRESSES	DISCRIMINATOR FIELD VALUES
1. PROMISCUOUS	SAME FOR ALL NODES OR COMPLETELY RANDOM	CAN BE VARIED IN SYNC	CAN BE VARIED IN SYNC
2. PROMISCUOUS PER VPN	FIXED FOR EACH VPN	CAN BE VARIED IN SYNC	CAN BE VARIED IN SYNC
3. HARDWARE HOPPING	CAN BE VARIED IN SYNC	CAN BE VARIED IN SYNC	CAN BE VARIED IN SYNC

FIG. 12B

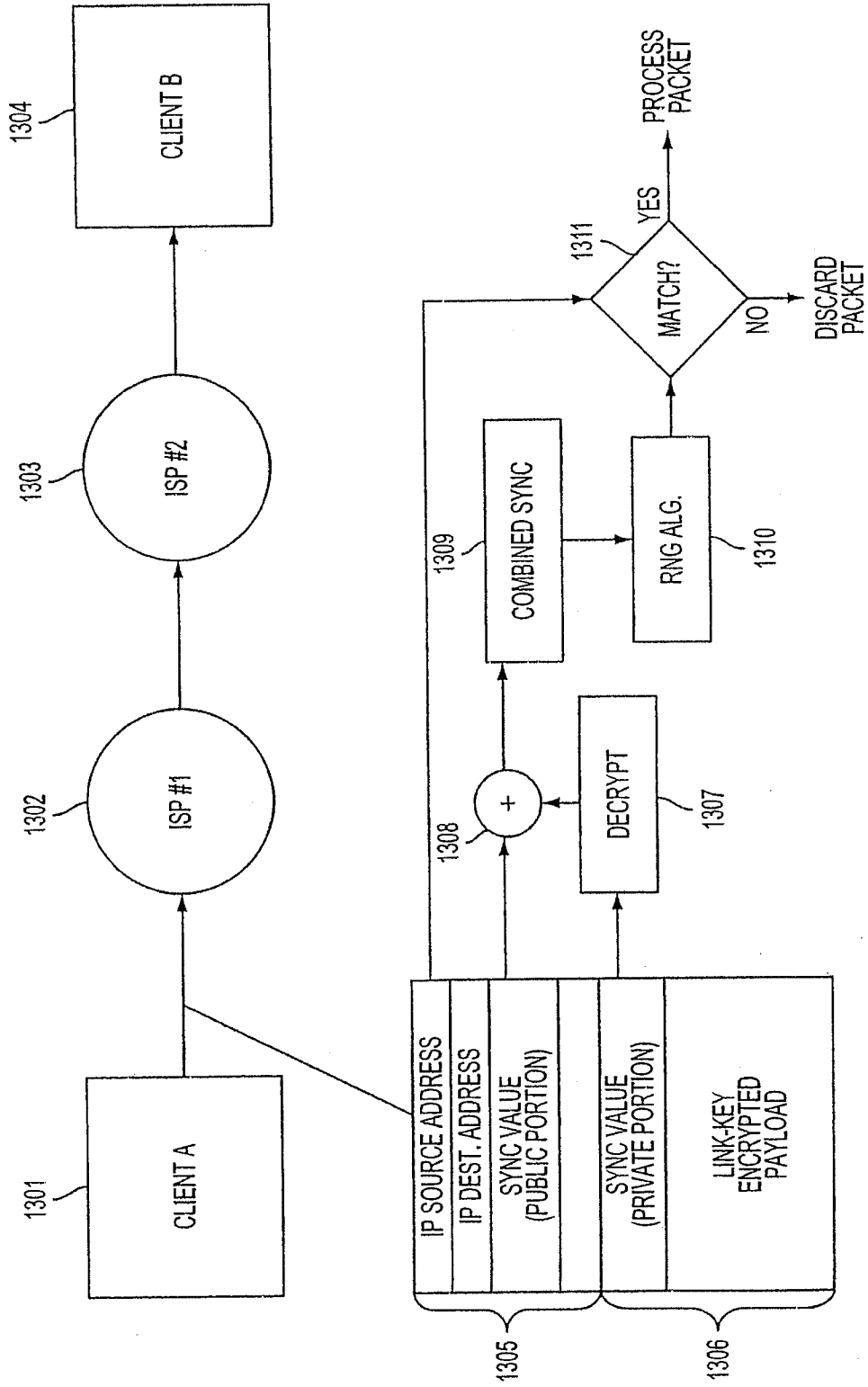

FIG. 13

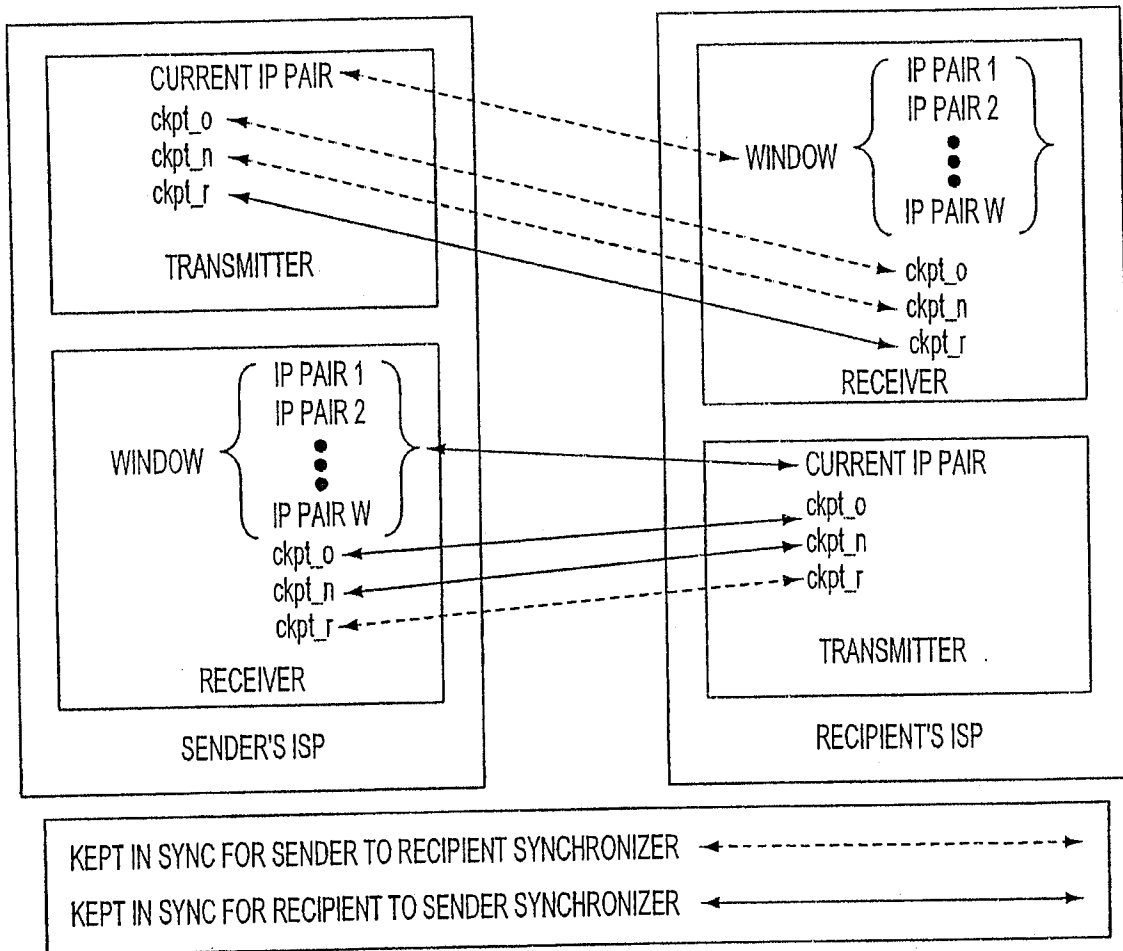

FIG. 14

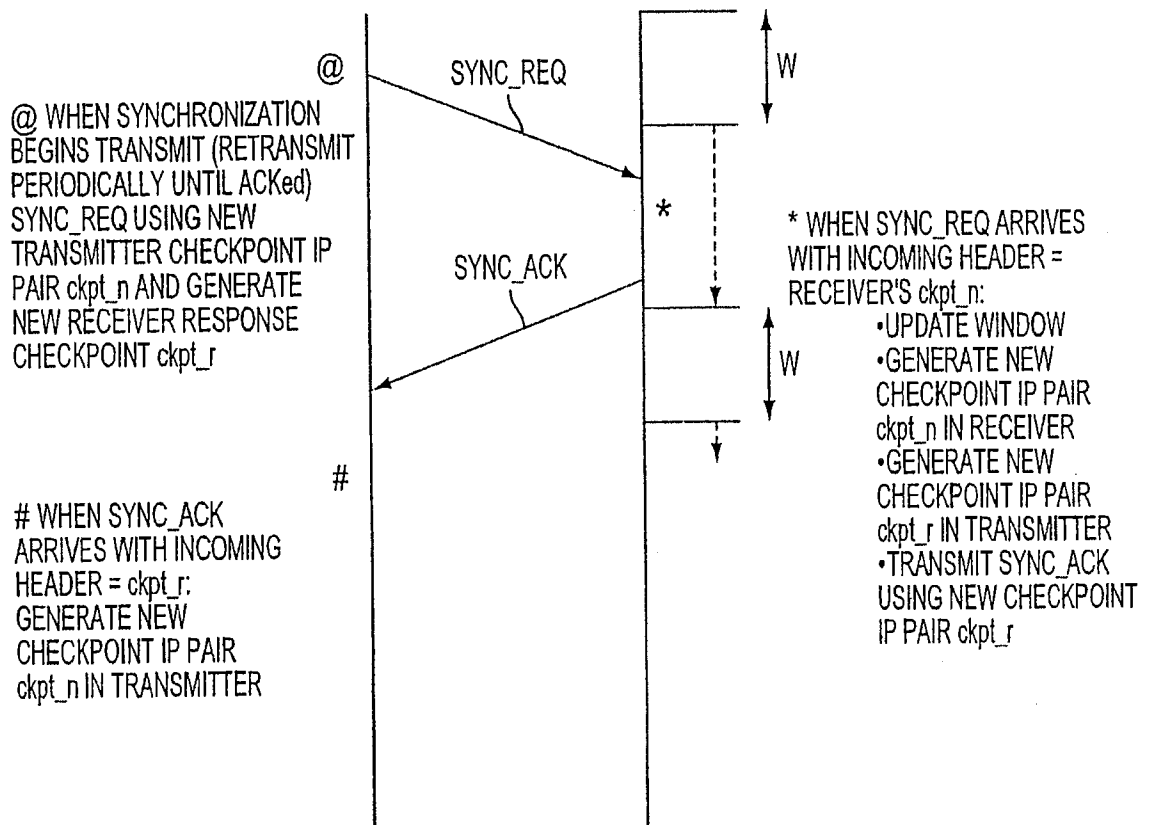

FIG. 15

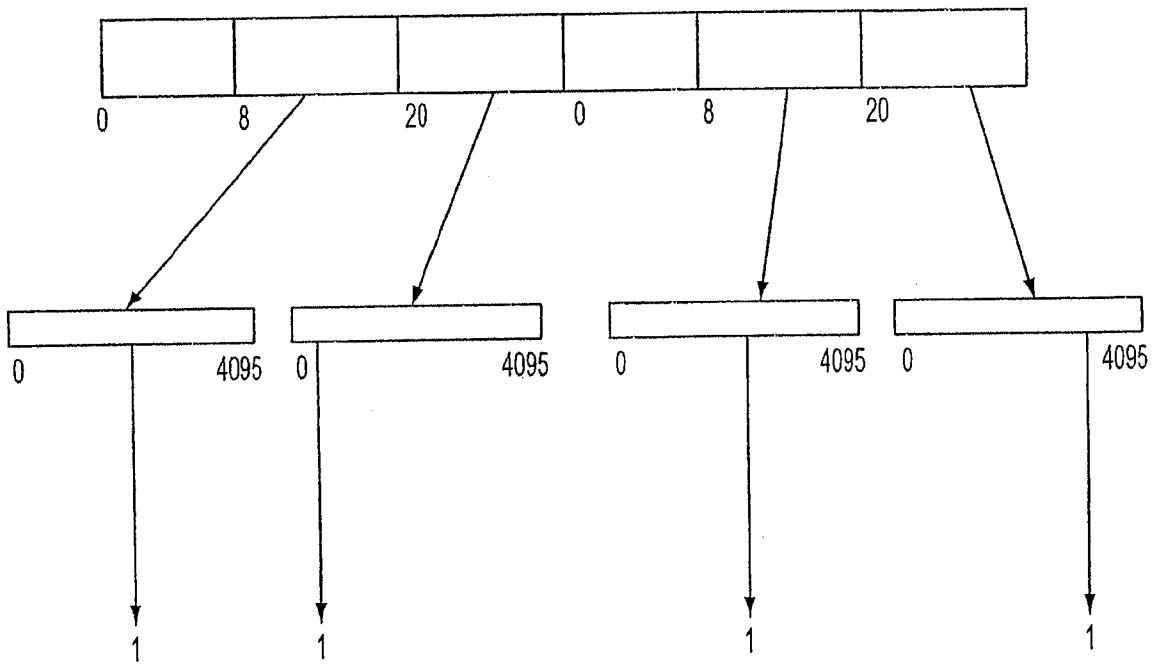

FIG. 16

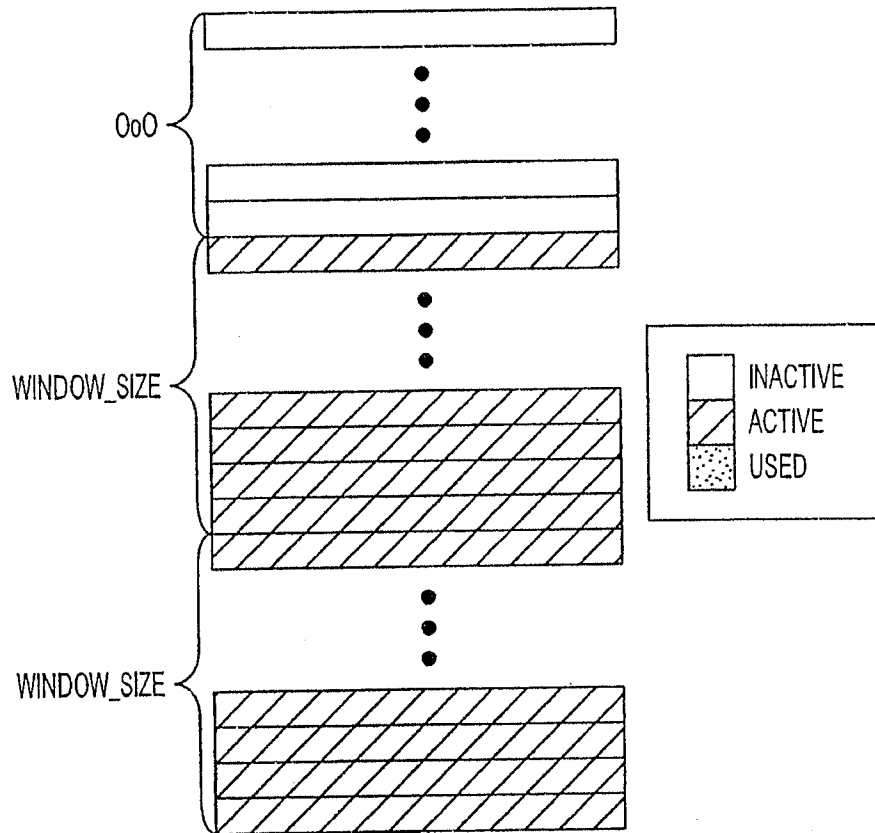

FIG. 17

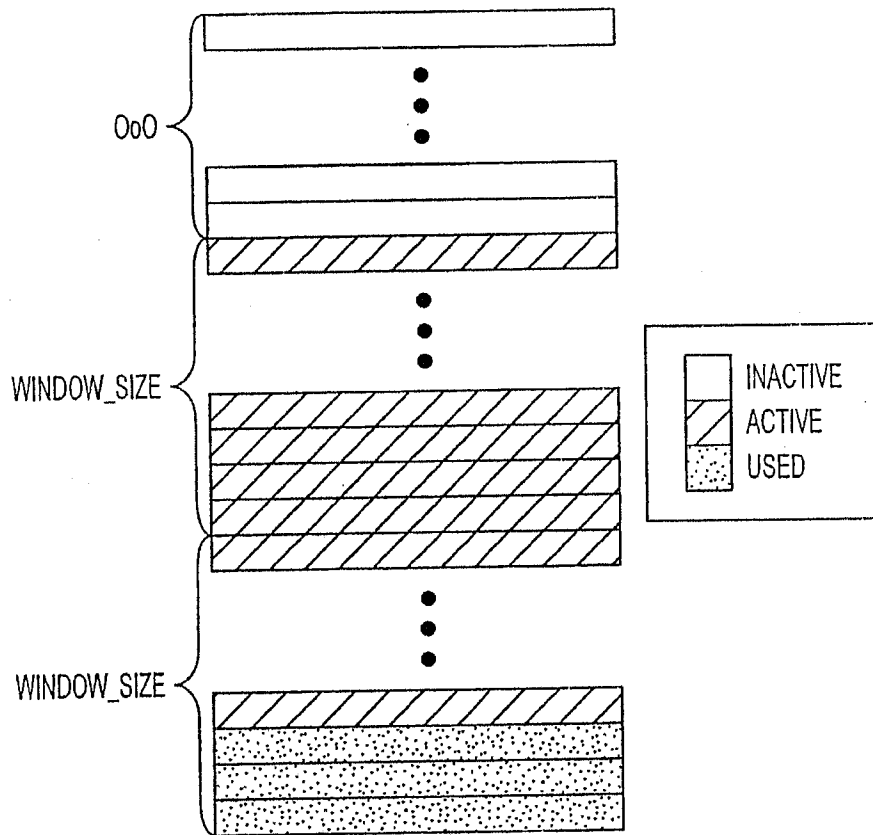

FIG. 18

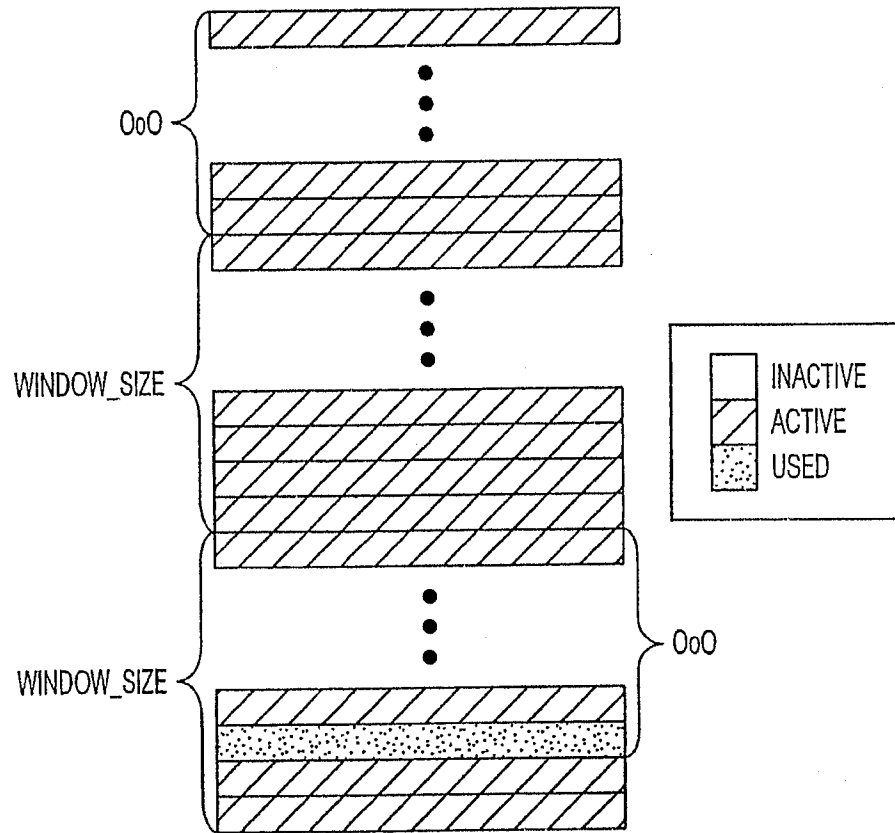

FIG. 19

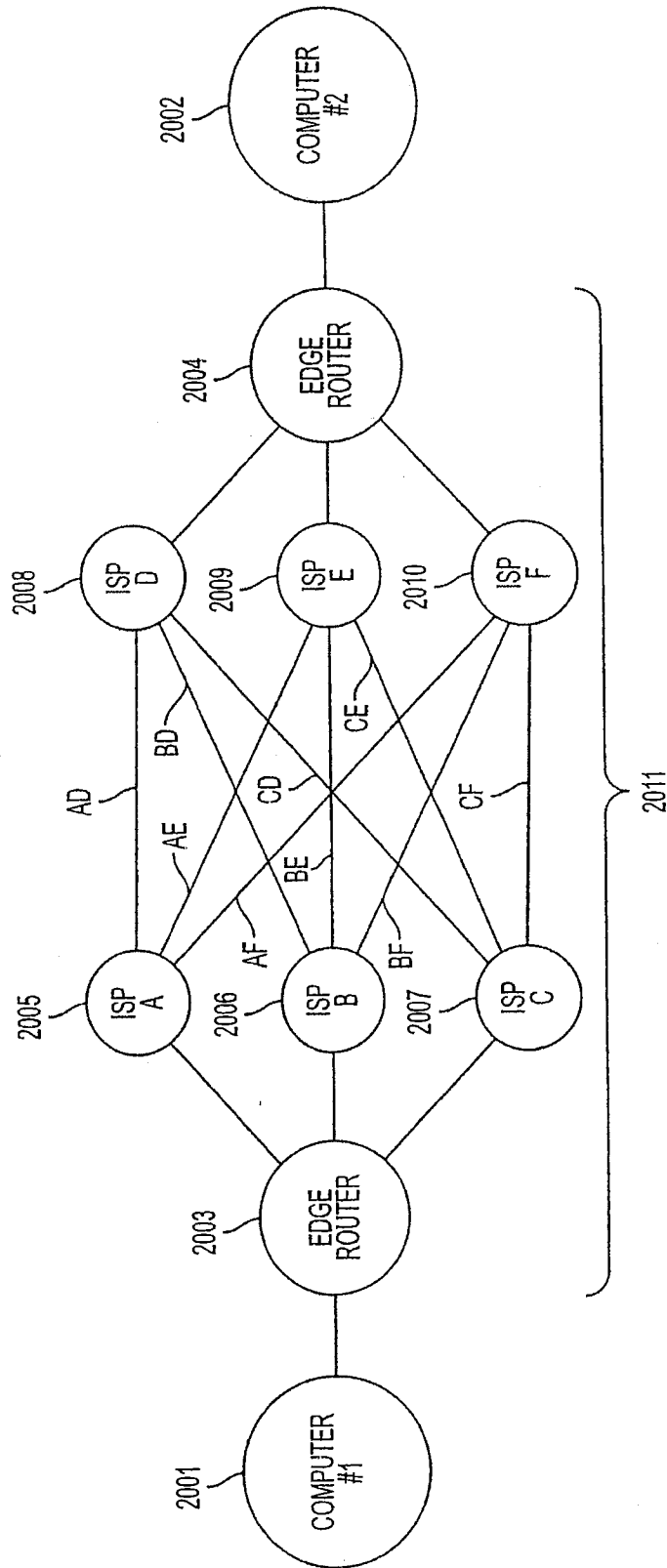

FIG. 20

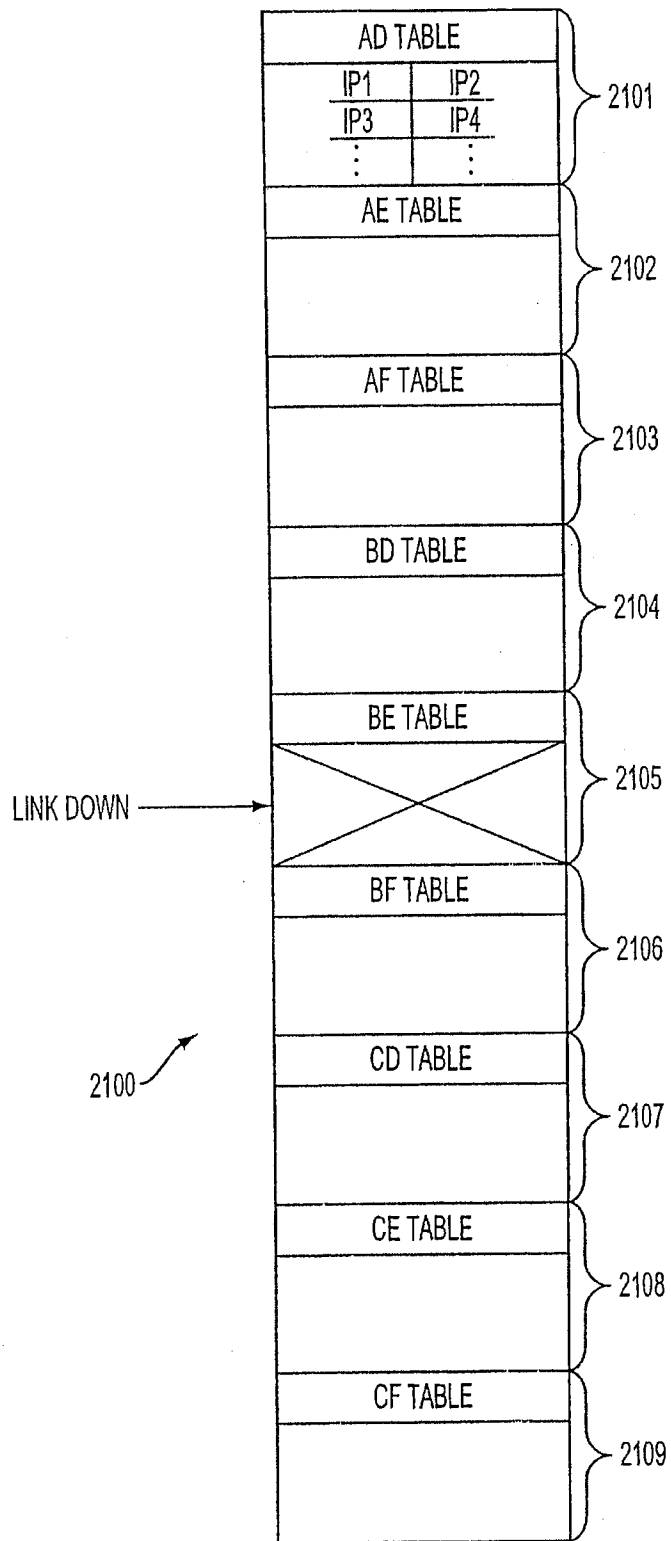

FIG. 21

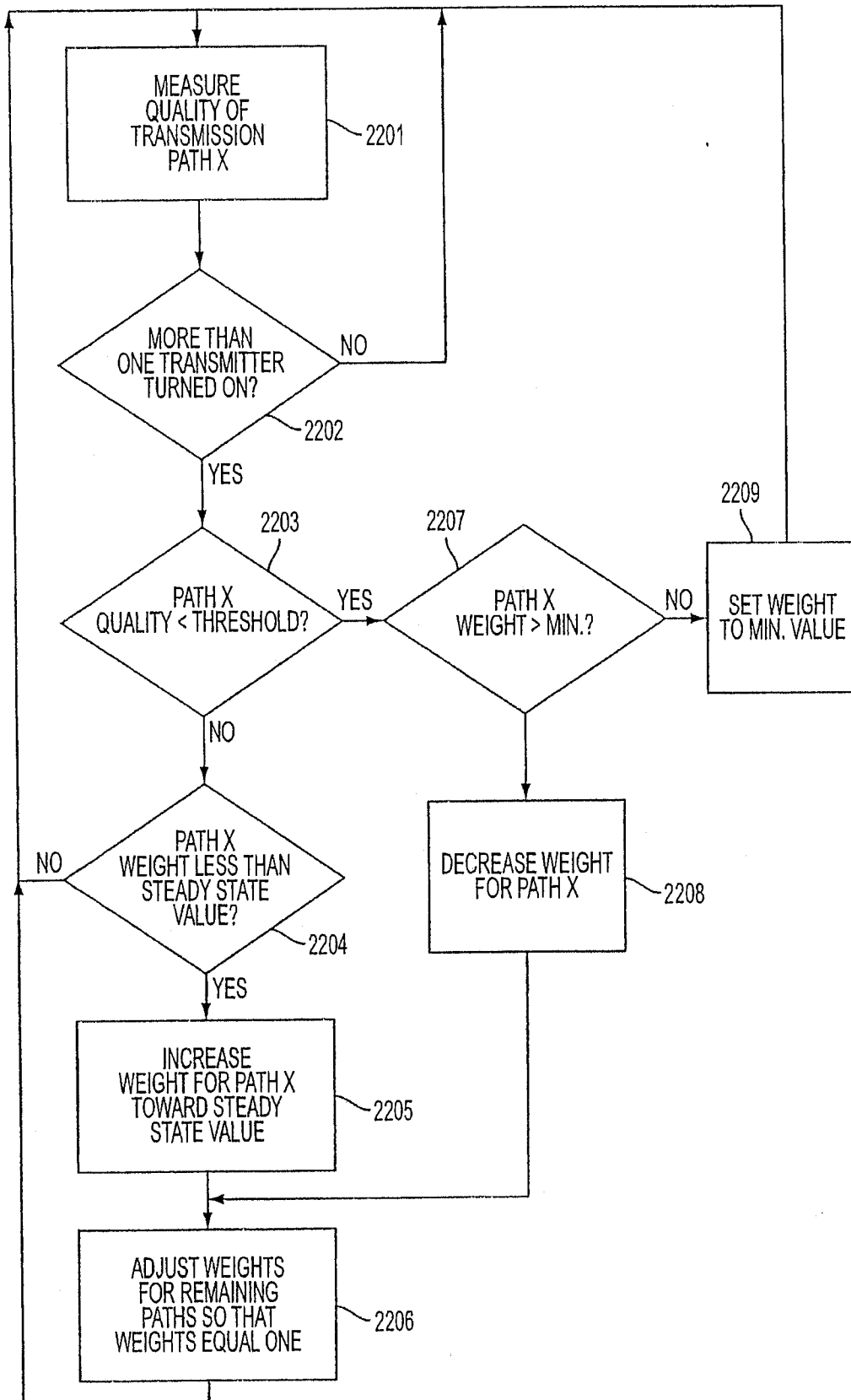

FIG. 22A

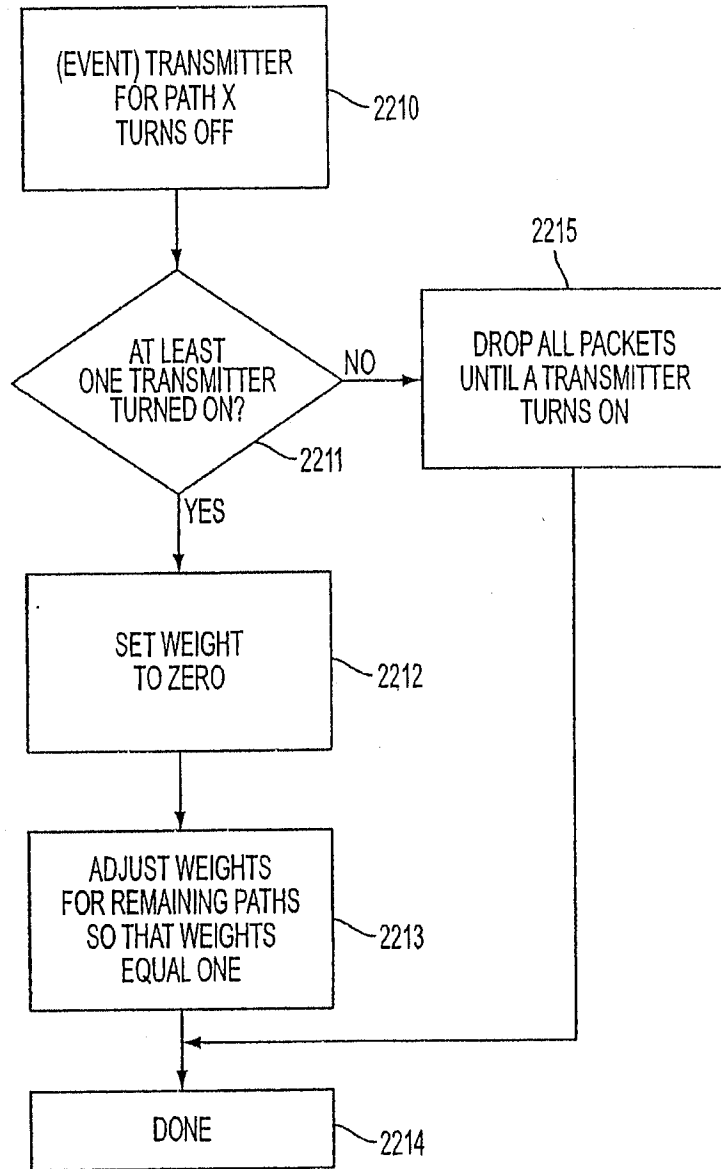

FIG. 22B

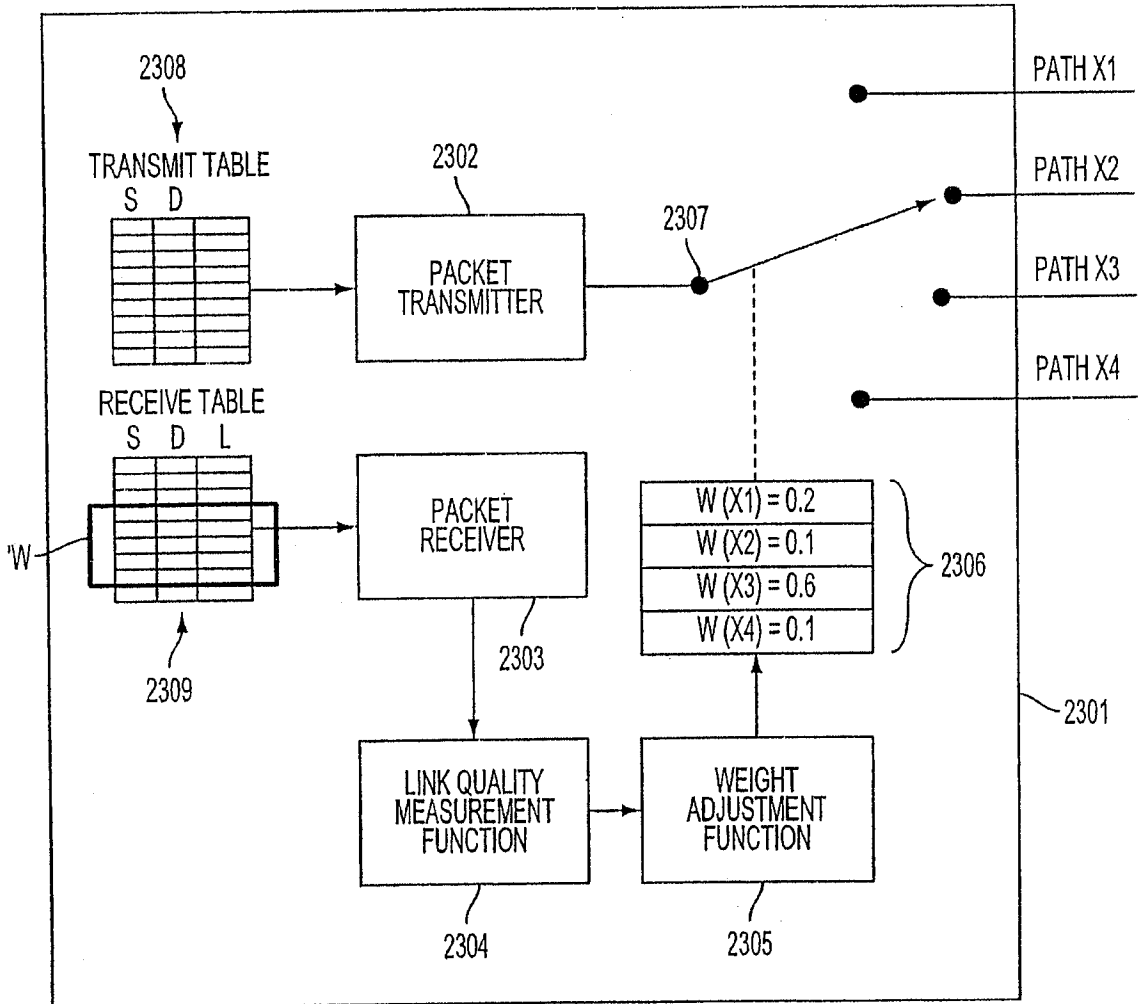

FIG. 23

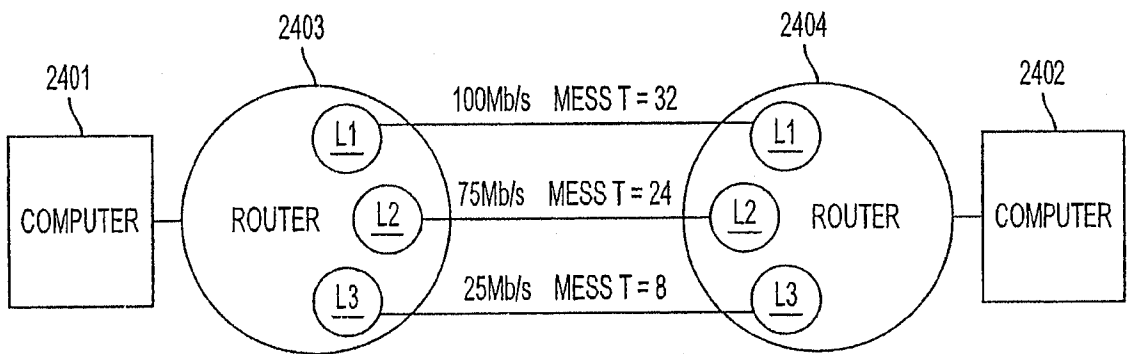

FIG. 24

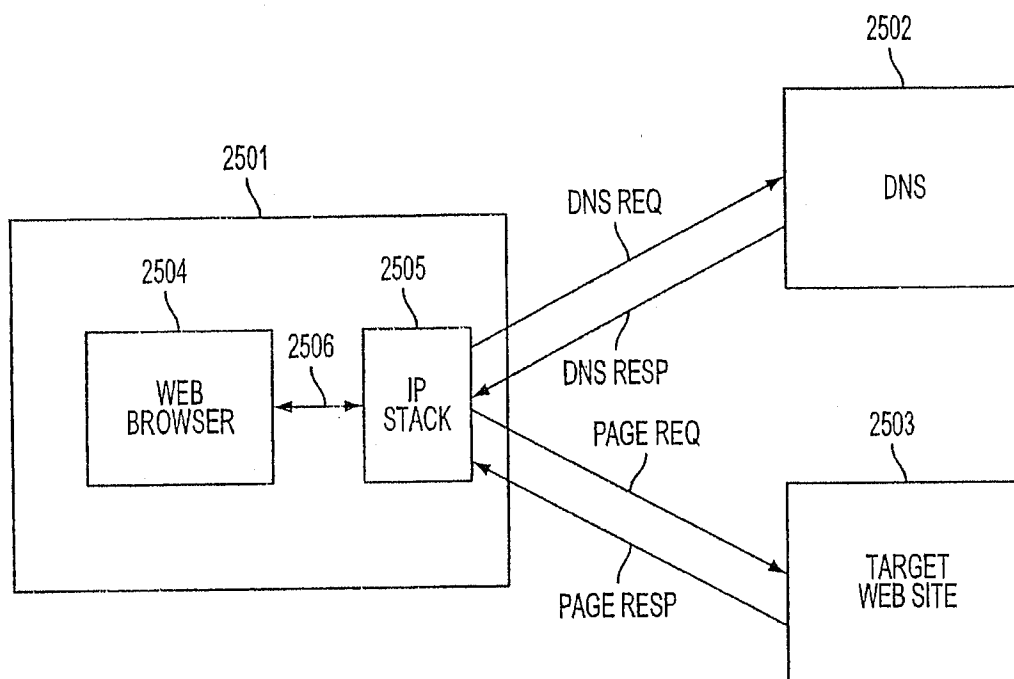

FIG. 25
(PRIOR ART)

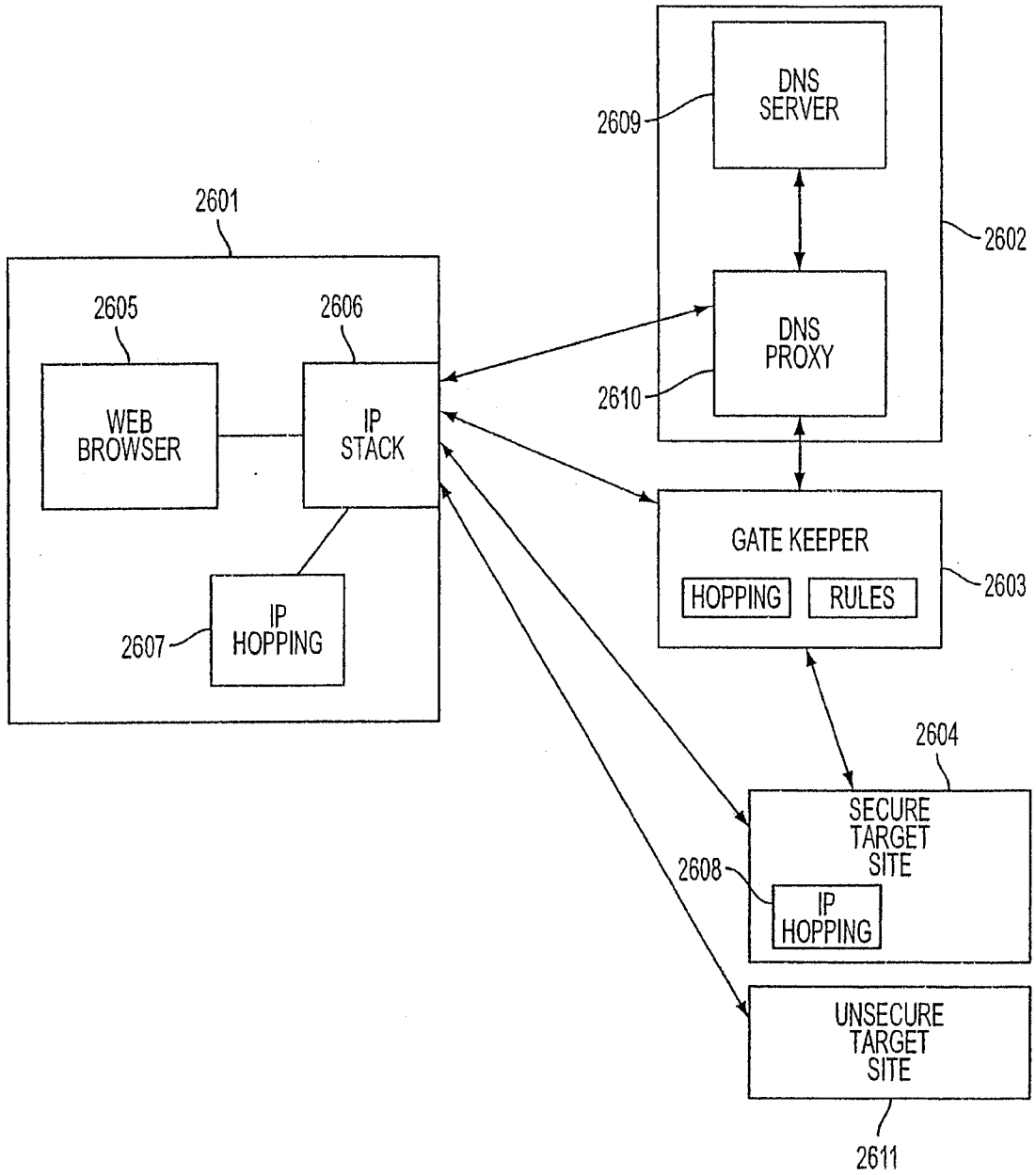

FIG. 26

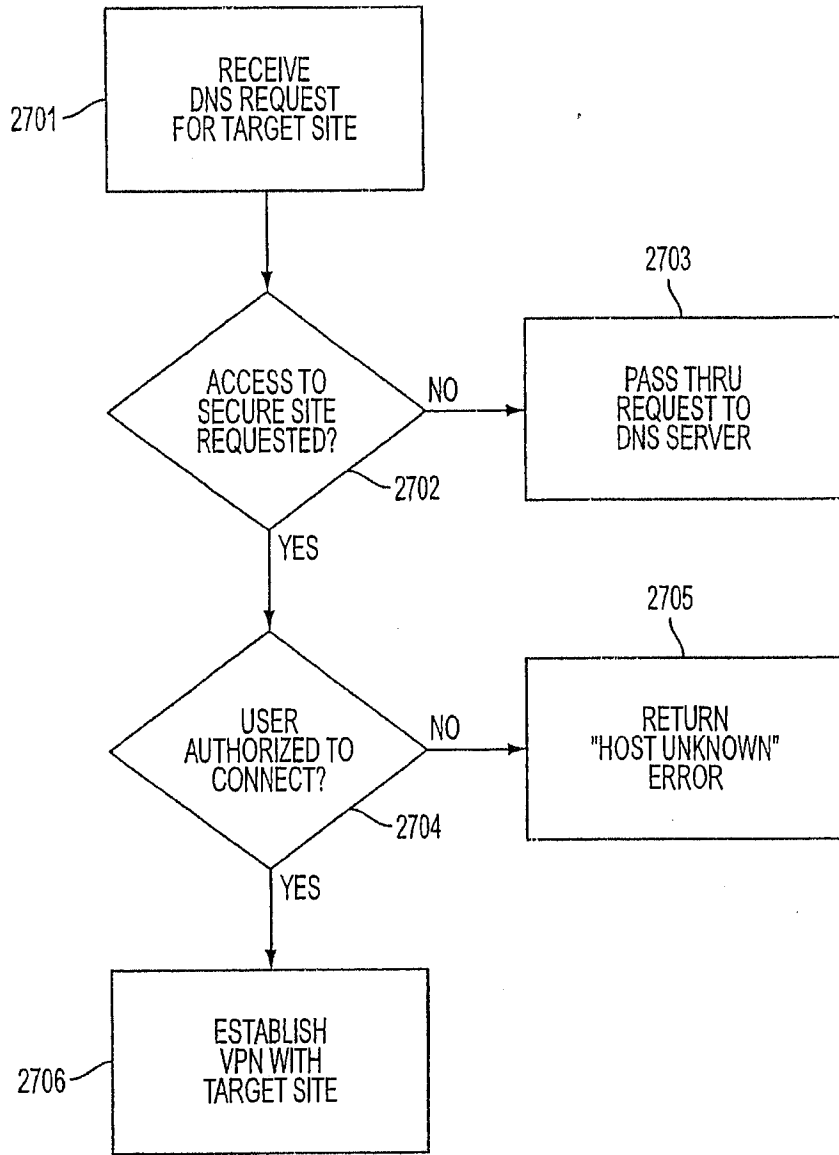

FIG. 27

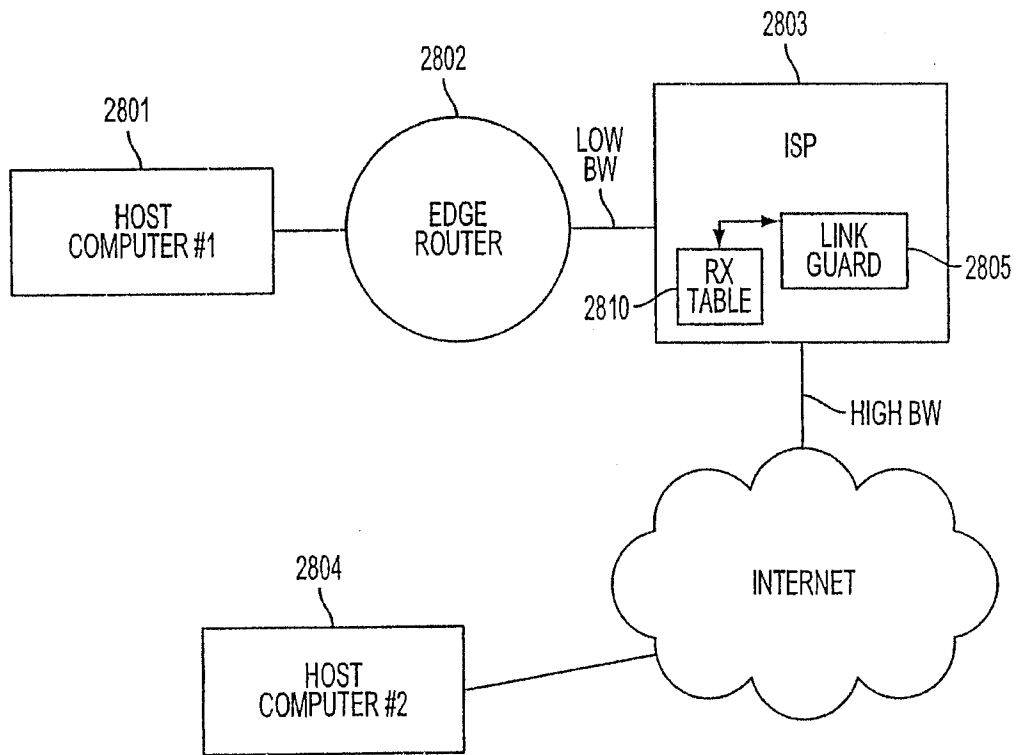

FIG. 28

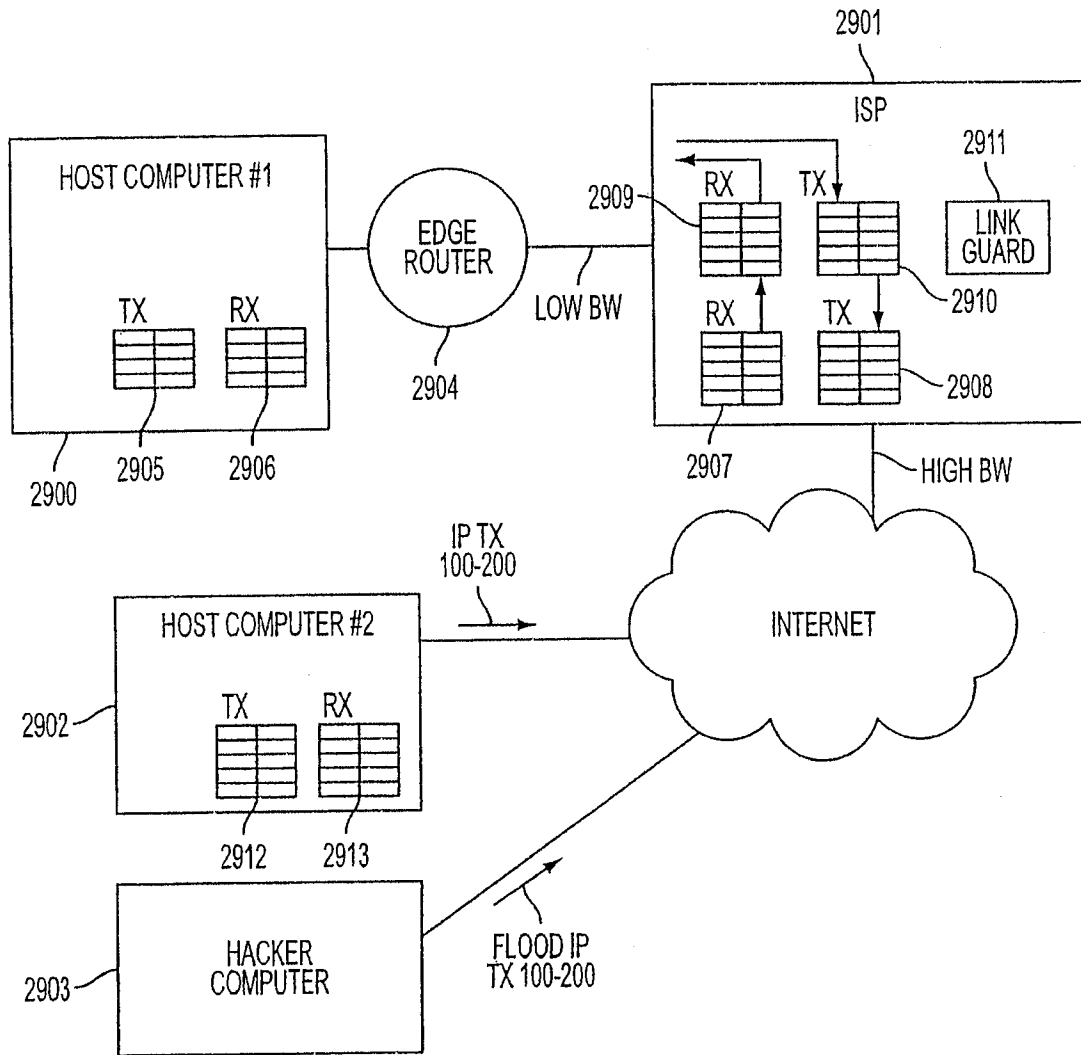

FIG. 29

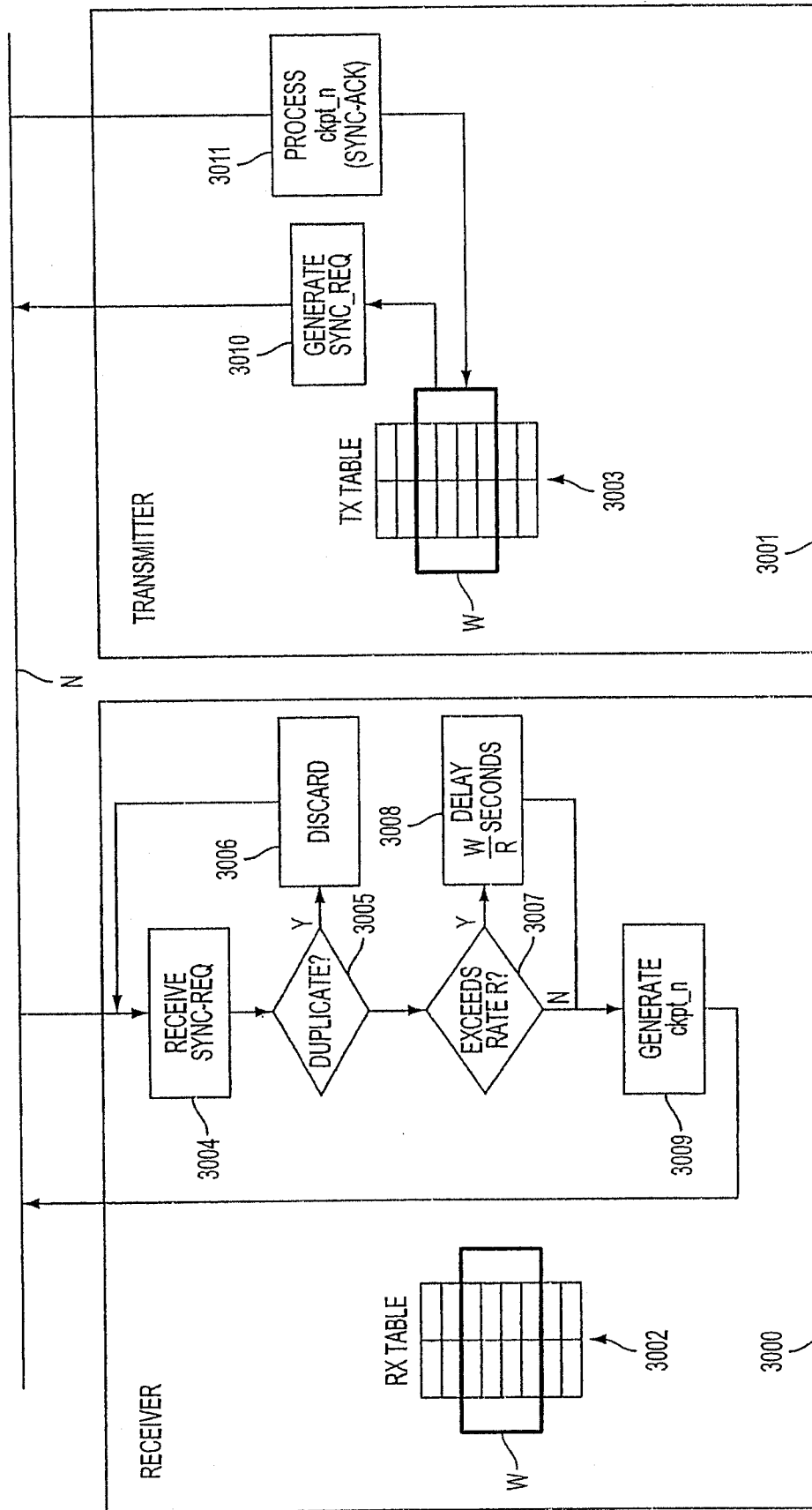

FIG. 30

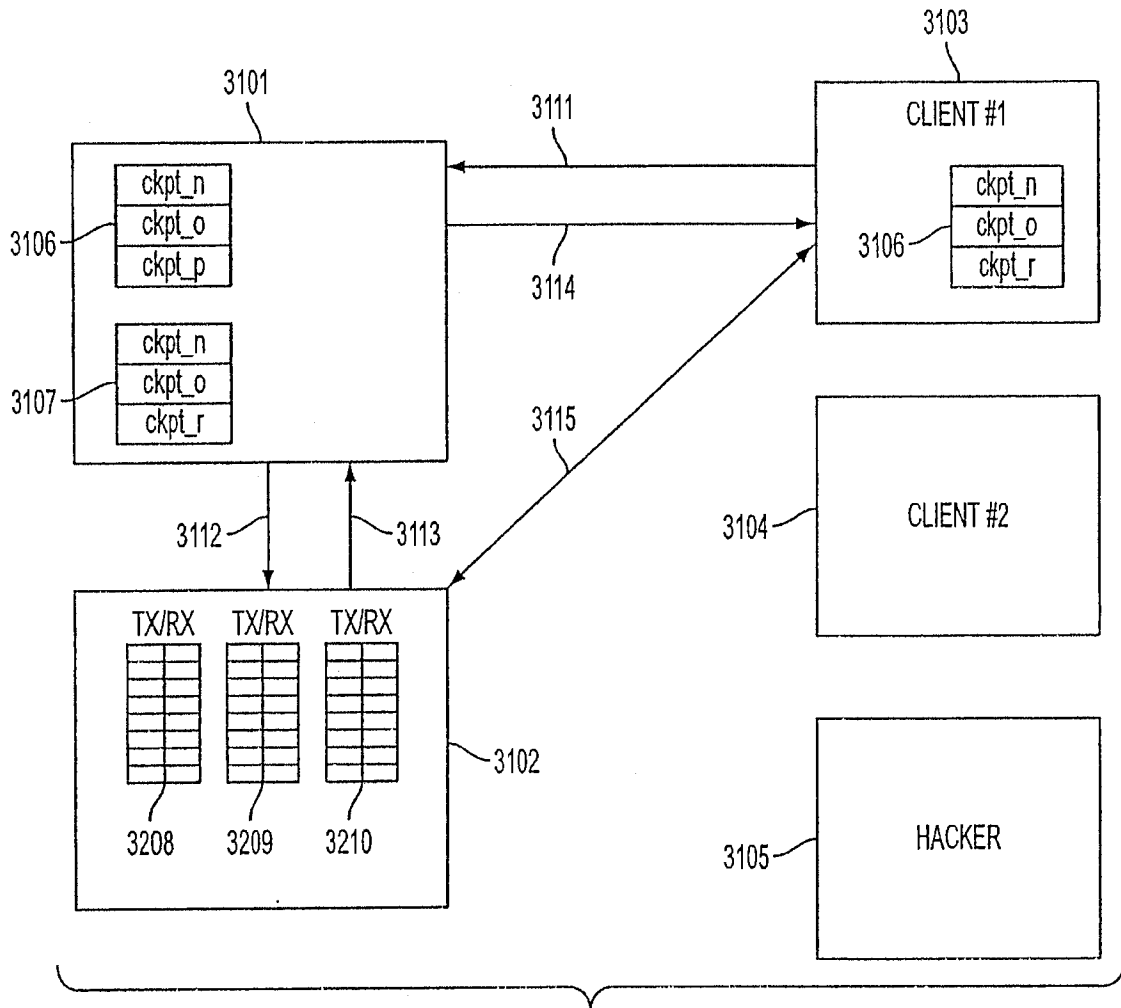

FIG. 31

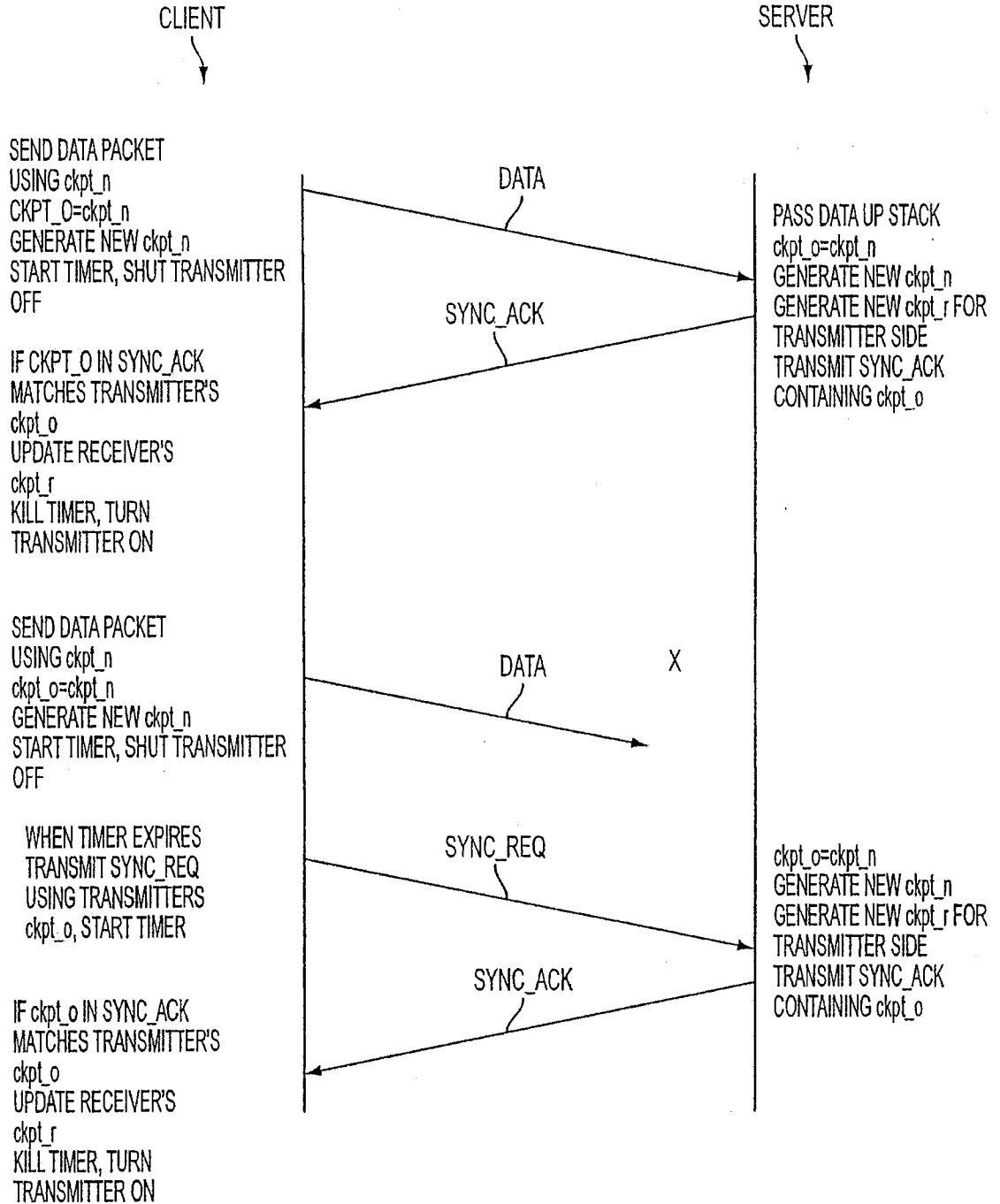

FIG. 32

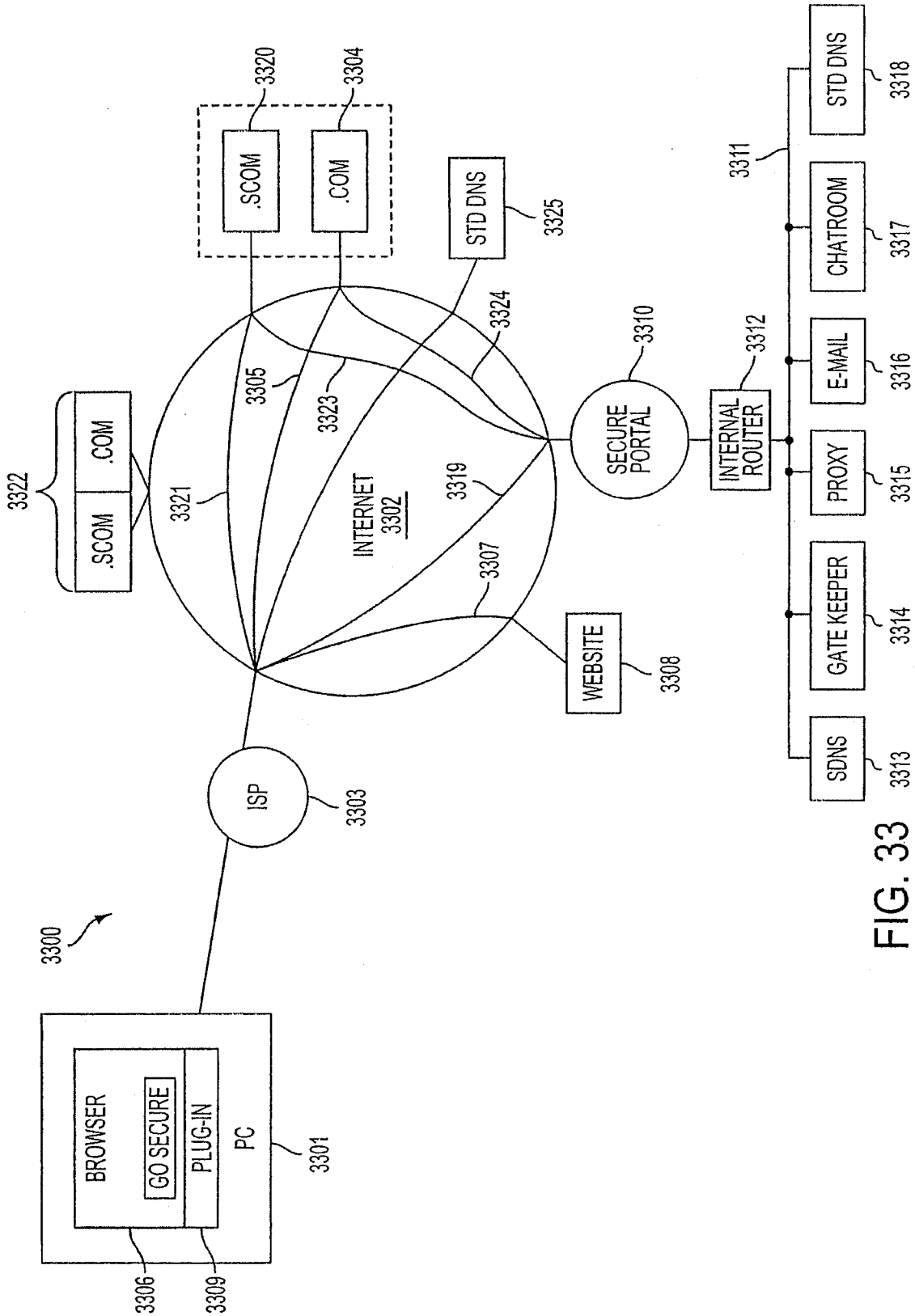

FIG. 33

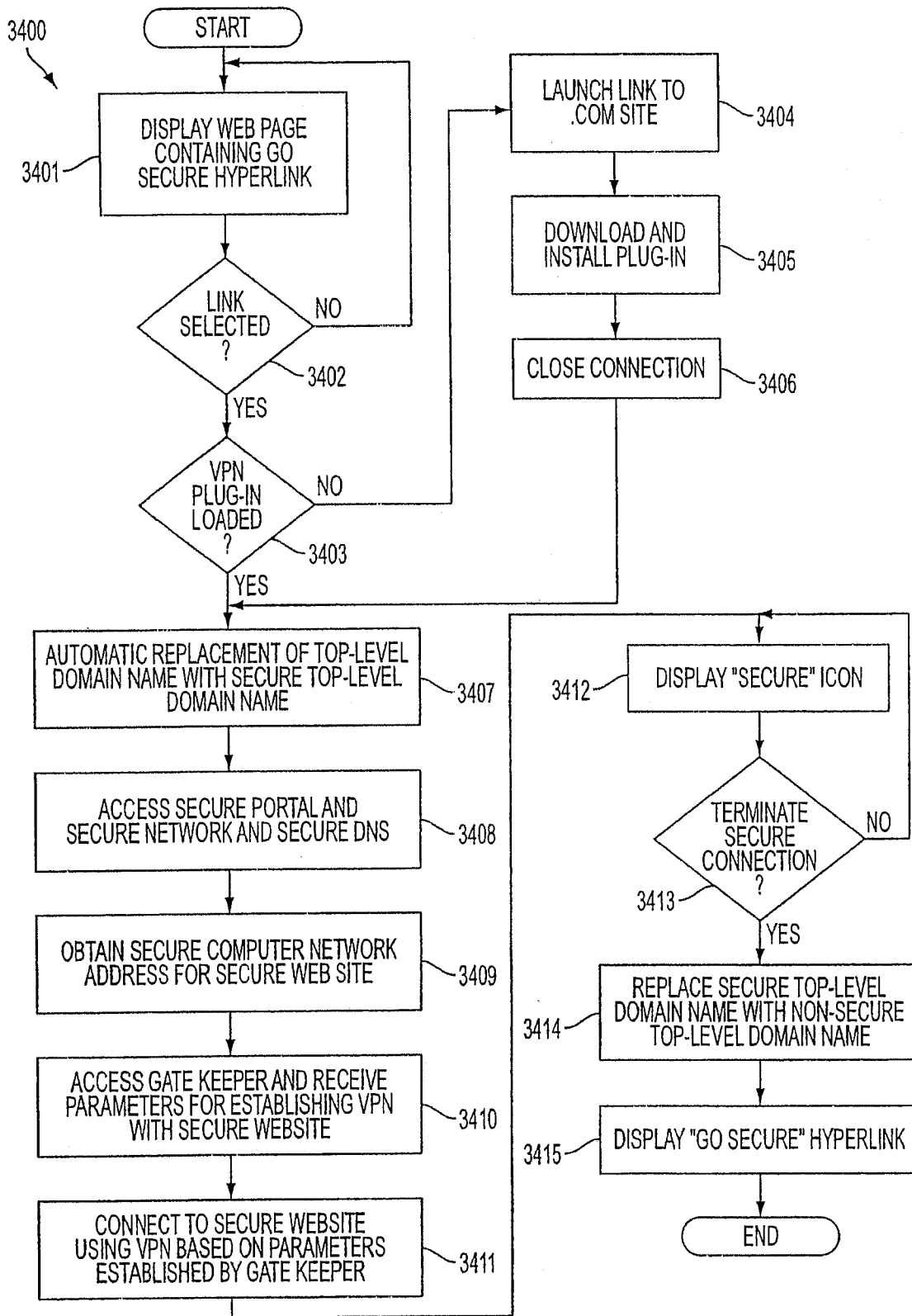

FIG. 34

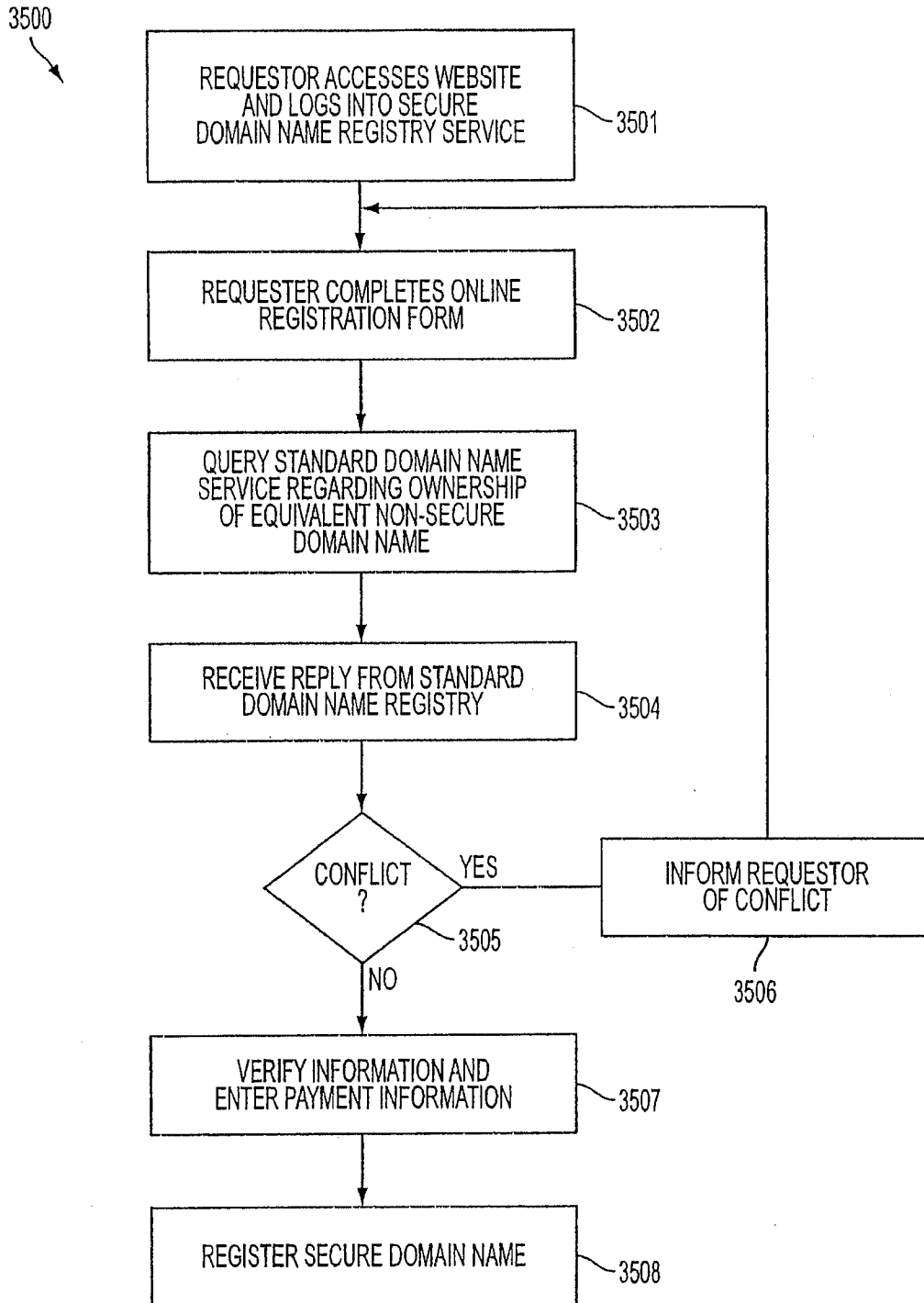

FIG. 35

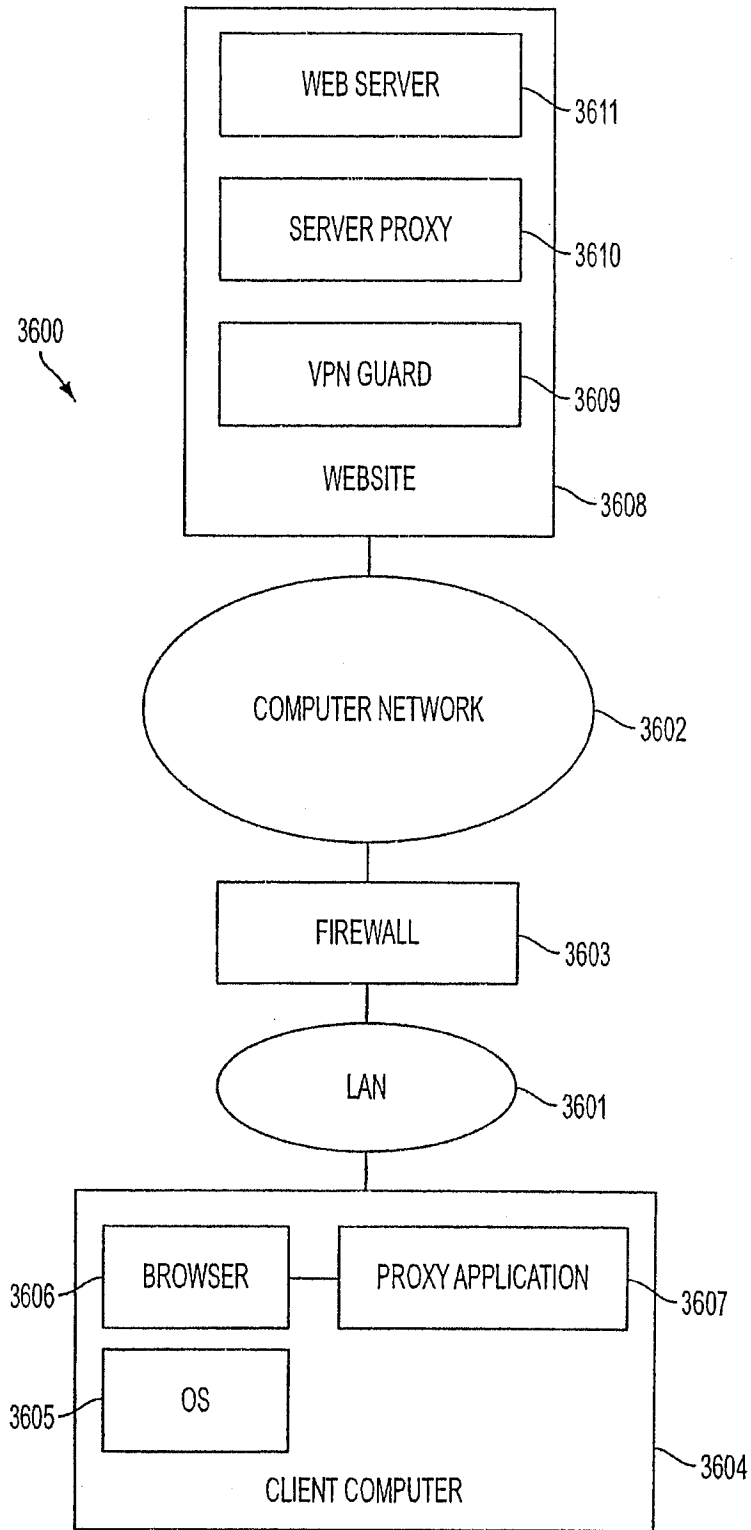

FIG. 36

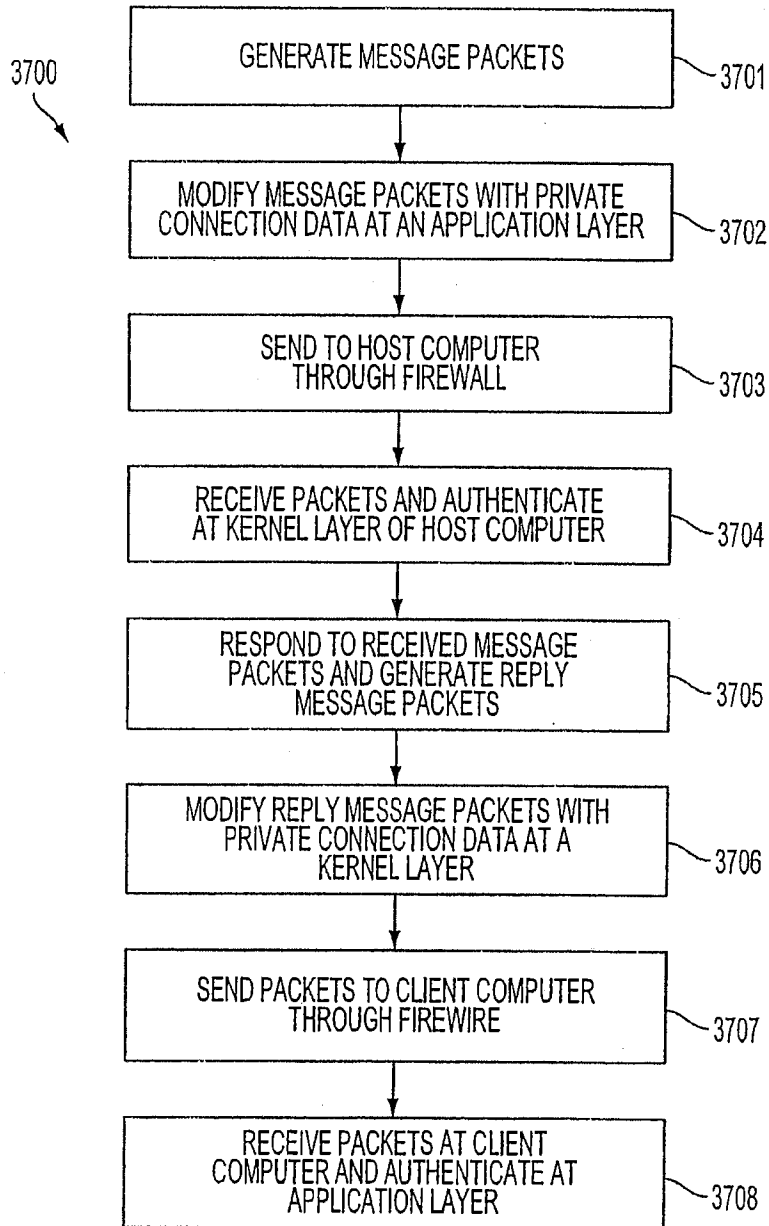

FIG. 37

JOINT DECLARATION FOR PATENT APPLICATION

As the below named inventors, we hereby declare that:

Our residence, post office address and citizenship are as stated below next to our names;

We believe we are the original, first and joint inventors of the subject matter which is claimed and for which a patent is sought on the invention entitled AN AGILE NETWORK PROTOCOL FOR SECURE COMMUNICATIONS USING SECURE DOMAIN NAMES, the specification of which

- is attached hereto.
- was filed on _____ as Application Serial Number _____ and was amended on _____ (if applicable).
- was filed under the Patent Cooperation Treaty (PCT) and accorded International Application No. _____, filed _____, and amended on _____ (if any).

We hereby state that we have reviewed and understand the contents of the above-identified specification, including the claims, as amended by any amendment referred to above.

We hereby acknowledge the duty to disclose information which is material to patentability in accordance with Title 37, Code of Federal Regulations, §1.56(a).

Prior Foreign Application(s)

We hereby claim foreign priority benefits under Title 35, United States Code, §119 of any foreign application(s) for patent or inventor's certificate listed below and have also identified below any foreign application(s) for patent or inventor's certificate having a filing date before that of the application on which priority is claimed:

Country	Application No.	Date of Filing (day month year)	Date of Issue (day month year)	Priority Claimed Under 35 U.S.C. §119

Prior United States Provisional Application(s)

We hereby claim priority benefits under Title 35, United States Code, §119(e)(1) of any U.S. provisional application listed below:

U.S. Provisional Application No.	Date of Filing (day month year)	Priority Claimed Under 35 U.S.C. §119(e)(1)
60/106,261	30 October 1998	Yes
60/137,704	7 June 1999	Yes

Prior United States Application(s)

We hereby claim the benefit under Title 35, United States Code, §120 of any United States application(s) listed below and, insofar as the subject matter of each of the claims of this application is not disclosed in the prior United States application in the manner provided by the first paragraph of Title 35, United States Code, §112, we acknowledge the duty to disclose material information as defined in Title 37, Code of Federal Regulations, §1.56(a) which occurred between the filing date of the prior application and the national or PCT international filing date of this application:

Application Serial No.	Date of Filing (Day, Month, Year)	Status — Patented, Pending, Abandoned
09/558,210	26 April 2000	Pending
09/504,783	15 February 2000	Patented
09/429,643	29 October 1999	Pending

Power of Attorney

And we hereby appoint, both jointly and severally, as our attorneys with full power of substitution and revocation, to prosecute this application and to transact all business in the Patent and Trademark Office connected herewith the practitioners at:

Customer Number: 22907 (WDC)

Please address all correspondence and telephone communications to the address and telephone number for this Customer Number.

We hereby declare that all statements made herein of our own knowledge are true and that all statements made on information and belief are believed to be true; and further that these statements were made with the knowledge that willful false statements and the like so made are punishable by fine or imprisonment, or both, under Section 1001 of Title 18 of the United States Code and that such willful false statements may jeopardize the validity of the application or any patent issuing thereon.

Signature *Victor Larson* Date 11/10/2003
 Full Name of First Inventor Larson Victor
 Family Name First Given Name Second Given Name
 Residence Fairfax, Virginia Citizenship USA
 Post Office Address 12026 Lisa Marie Court, Fairfax, Virginia 22033

Signature _____ Date _____
 Full Name of Second Inventor Short III Robert Dunham
 Family Name First Given Name Second Given Name
 Residence Leesburg, Virginia Citizenship USA
 Post Office Address 38710 Goose Creek Lane, Leesburg, Virginia 20175

Signature _____ Date _____
 Full Name of Third Inventor Munger Edmund Colby
 Family Name First Given Name Second Given Name
 Residence Crownsville, Maryland Citizenship USA
 Post Office Address 1101 Opaca Court, Crownsville, Maryland 21032

Signature *Michael Williamson* Date Nov 10 2003
 Full Name of Fourth Inventor Williamson Michael
 Family Name First Given Name Second Given Name
 Residence South Riding, Virginia Citizenship USA
 Post Office Address 26203 Ocala Circle, South Riding, Virginia 20152

JOINT DECLARATION FOR PATENT APPLICATION

As the below named inventors, we hereby declare that:

Our residence, post office address and citizenship are as stated below next to our names;

We believe we are the original, first and joint inventors of the subject matter which is claimed and for which a patent is sought on the invention entitled AN AGILE NETWORK PROTOCOL FOR SECURE COMMUNICATIONS USING SECURE DOMAIN NAMES, the specification of which

- is attached hereto.
- was filed on _____ as Application Serial Number _____ and was amended on _____ (if applicable).
- was filed under the Patent Cooperation Treaty (PCT) and accorded International Application No. _____, filed _____, and amended on _____ (if any).

We hereby state that we have reviewed and understand the contents of the above-identified specification, including the claims, as amended by any amendment referred to above.

We hereby acknowledge the duty to disclose information which is material to patentability in accordance with Title 37, Code of Federal Regulations, §1.56(a).

Prior Foreign Application(s)

We hereby claim foreign priority benefits under Title 35, United States Code, §119 of any foreign application(s) for patent or inventor's certificate listed below and have also identified below any foreign application(s) for patent or inventor's certificate having a filing date before that of the application on which priority is claimed:

Country	App. Filing No.	Date of Filing (day-month-year)	Date of Issue (day-month-year)	Priority Claimed Under 35 U.S.C. §119

Prior United States Provisional Application(s)

We hereby claim priority benefits under Title 35, United States Code, §119(e)(1) of any U.S. provisional application listed below:

U.S. Provisional Application No.	Date of Filing (day-month-year)	Priority Claimed Under 35 U.S.C. §119(e)(1)
60/106,261	30 October 1998	Yes
60/137,704	7 June 1999	Yes

Prior United States Application(s)

We hereby claim the benefit under Title 35, United States Code, §120 of any United States application(s) listed below and, insofar as the subject matter of each of the claims of this application is not disclosed in the prior United States application in the manner provided by the first paragraph of Title 35, United States Code, §112, we acknowledge the duty to disclose material information as defined in Title 37, Code of Federal Regulations, §1.56(a) which occurred between the filing date of the prior application and the national or PCT international filing date of this application:

Application Serial No.	Date of Filing (Day, Month, Year)	Status — Patented, Pending, Abandoned
09/558,210	26 April 2000	Pending
09/504,783	15 February 2000	Patented
09/429,643	29 October 1999	Pending

Power of Attorney

And we hereby appoint, both jointly and severally, as our attorneys with full power of substitution and revocation, to prosecute this application and to transact all business in the Patent and Trademark Office connected herewith the practitioners at:

Customer Number: 22907 (WDC)

Please address all correspondence and telephone communications to the address and telephone number for this Customer Number.

We hereby declare that all statements made herein of our own knowledge are true and that all statements made on information and belief are believed to be true; and further that these statements were made with the knowledge that willful false statements and the like so made are punishable by fine or imprisonment, or both, under Section 1001 of Title 18 of the United States Code and that such willful false statements may jeopardize the validity of the application or any patent issuing thereon.

Signature _____ Date _____
 Full Name of First Inventor Larson Victor
 Family Name First Given Name Second Given Name
 Residence Fairfax, Virginia Citizenship USA
 Post Office Address 12026 Lisa Marie Court, Fairfax, Virginia 22033

Signature Robert J. Short III Date 11/7/03
 Full Name of Second Inventor Short, III Robert Dunham
 Family Name First Given Name Second Given Name
 Residence Leesburg, Virginia Citizenship USA
 Post Office Address 38710 Goose Creek Lane, Leesburg, Virginia 20175

Signature _____ Date _____
 Full Name of Third Inventor Munger Edmund Colby
 Family Name First Given Name Second Given Name
 Residence Crownsville, Maryland Citizenship USA
 Post Office Address 1101 Opaca Court, Crownsville, Maryland 21032

Signature _____ Date _____
 Full Name of Fourth Inventor Williamson Michael
 Family Name First Given Name Second Given Name
 Residence South Riding, Virginia Citizenship USA
 Post Office Address 26203 Ocala Circle, South Riding, Virginia 20152

JOINT DECLARATION FOR PATENT APPLICATION

As the below named inventors, we hereby declare that:

Our residence, post office address and citizenship are as stated below next to our names;

We believe we are the original, first and joint inventors of the subject matter which is claimed and for which a patent is sought on the invention entitled AN AGILE NETWORK PROTOCOL FOR SECURE COMMUNICATIONS USING SECURE DOMAIN NAMES, the specification of which

- is attached hereto.
- was filed on _____ as Application Serial Number _____ and was amended on _____ (if applicable).
- was filed under the Patent Cooperation Treaty (PCT) and accorded International Application No. _____, filed _____, and amended on _____ (if any).

We hereby state that we have reviewed and understand the contents of the above-identified specification, including the claims, as amended by any amendment referred to above.

We hereby acknowledge the duty to disclose information which is material to patentability in accordance with Title 37, Code of Federal Regulations, §1.56(a).

Prior Foreign Application(s)

We hereby claim foreign priority benefits under Title 35, United States Code, §119 of any foreign application(s) for patent or inventor's certificate listed below and have also identified below any foreign application(s) for patent or inventor's certificate having a filing date before that of the application on which priority is claimed:

Country	Application No.	Date of Filing (day month year)	Date of Issue (day month year)	Priority Claimed Under 35 U.S.C. §119

Prior United States Provisional Application(s)

We hereby claim priority benefits under Title 35, United States Code, §119(e)(1) of any U.S. provisional application listed below:

U.S. Provisional Application No.	Date of Filing (day month year)	Priority Claimed Under 35 U.S.C. §119(e)(1)
60/106,261	30 October 1998	Yes
60/137,704	7 June 1999	Yes

Prior United States Application(s)

We hereby claim the benefit under Title 35, United States Code, §120 of any United States application(s) listed below and, insofar as the subject matter of each of the claims of this application is not disclosed in the prior United States application in the manner provided by the first paragraph of Title 35, United States Code, §112, we acknowledge the duty to disclose material information as defined in Title 37, Code of Federal Regulations, §1.56(a) which occurred between the filing date of the prior application and the national or PCT international filing date of this application:

Application Serial No.	Date of Filing (Day, Month, Year)	Status — Patented, Pending, Abandoned
09/558,210	26 April 2000	Pending
09/504,783	15 February 2000	Patented
09/429,643	29 October 1999	Pending

Power of Attorney

And we hereby appoint, both jointly and severally, as our attorneys with full power of substitution and revocation, to prosecute this application and to transact all business in the Patent and Trademark Office connected herewith the practitioners at:

Customer Number: 22907 (WDC)

Please address all correspondence and telephone communications to the address and telephone number for this Customer Number.

We hereby declare that all statements made herein of our own knowledge are true and that all statements made on information and belief are believed to be true; and further that these statements were made with the knowledge that willful false statements and the like so made are punishable by fine or imprisonment, or both, under Section 1001 of Title 18 of the United States Code and that such willful false statements may jeopardize the validity of the application or any patent issuing thereon.

Signature _____ Date _____
 Full Name of First Inventor Larson Victor
 Family Name First Given Name Second Given Name
 Residence Fairfax, Virginia Citizenship USA
 Post Office Address 12026 Lisa Marie Court, Fairfax, Virginia 22033

Signature _____ Date _____
 Full Name of Second Inventor Short, III Robert Dunham
 Family Name First Given Name Second Given Name
 Residence Leesburg, Virginia Citizenship USA
 Post Office Address 38710 Goose Creek Lane, Leesburg, Virginia 20175

Signature *Edmund Colby Mungel* Date 11 November 2007
 Full Name of Third Inventor Mungel Edmund Colby
 Family Name First Given Name Second Given Name
 Residence Crownsville, Maryland Citizenship USA
 Post Office Address 1101 Opaca Court, Crownsville, Maryland 21032

Signature _____ Date _____
 Full Name of Fourth Inventor Williamson Michael
 Family Name First Given Name Second Given Name
 Residence South Riding, Virginia Citizenship USA
 Post Office Address 26203 Ocala Circle, South Riding, Virginia 20152

Under the Paperwork Reduction Act of 1995, no persons are required to respond to a collection of information unless it contains a valid OMB control number.

Application Data Sheet 37 CFR 1.76		Attorney Docket Number	77580-155(VRNK-1CP3CNFT5)
		Application Number	
Title of Invention	SYSTEM AND METHOD EMPLOYING AN AGILE NETWORK PROTOCOL FOR SECURE COMMUNICATIONS USING SECURE DOMAIN NAMES		
The application data sheet is part of the provisional or nonprovisional application for which it is being submitted. The following form contains the bibliographic data arranged in a format specified by the United States Patent and Trademark Office as outlined in 37 CFR 1.76. This document may be completed electronically and submitted to the Office in electronic format using the Electronic Filing System (EFS) or the document may be printed and included in a paper filed application.			

Secrecy Order 37 CFR 5.2

- Portions or all of the application associated with this Application Data Sheet may fall under a Secrecy Order pursuant to 37 CFR 5.2 (Paper filers only. Applications that fall under Secrecy Order may not be filed electronically.)

Applicant Information:

Applicant 1					Remove
Applicant Authority <input checked="" type="radio"/> Inventor		<input type="radio"/> Legal Representative under 35 U.S.C. 117		<input type="radio"/> Party of Interest under 35 U.S.C. 118	
Prefix	Given Name	Middle Name	Family Name	Suffix	
	Victor		Larson		
Residence Information (Select One) <input checked="" type="radio"/> US Residency <input type="radio"/> Non US Residency <input type="radio"/> Active US Military Service					
City	Fairfax	State/Province	VA	Country of Residenceⁱ	US
Citizenship under 37 CFR 1.41(b)ⁱ		US			
Mailing Address of Applicant:					
Address 1		12026 Lisa Marie Court			
Address 2					
City	Fairfax	State/Province	VA		
Postal Code	22033	Countryⁱ	US		
Applicant 2					Remove
Applicant Authority <input checked="" type="radio"/> Inventor		<input type="radio"/> Legal Representative under 35 U.S.C. 117		<input type="radio"/> Party of Interest under 35 U.S.C. 118	
Prefix	Given Name	Middle Name	Family Name	Suffix	
	Robert	Dunham	Short	III	
Residence Information (Select One) <input checked="" type="radio"/> US Residency <input type="radio"/> Non US Residency <input type="radio"/> Active US Military Service					
City	Leesburg	State/Province	VA	Country of Residenceⁱ	US
Citizenship under 37 CFR 1.41(b)ⁱ		US			
Mailing Address of Applicant:					
Address 1		38710 Goose Creek Lane			
Address 2					
City	Leesburg	State/Province	VA		
Postal Code	20175	Countryⁱ	US		
Applicant 3					Remove
Applicant Authority <input checked="" type="radio"/> Inventor		<input type="radio"/> Legal Representative under 35 U.S.C. 117		<input type="radio"/> Party of Interest under 35 U.S.C. 118	
Prefix	Given Name	Middle Name	Family Name	Suffix	
	Edmond	Colby	Munger		
Residence Information (Select One) <input checked="" type="radio"/> US Residency <input type="radio"/> Non US Residency <input type="radio"/> Active US Military Service					
City	Crownsville	State/Province	MD	Country of Residenceⁱ	US

Application Data Sheet 37 CFR 1.76	Attorney Docket Number	77580-155(VRNK-1CP3CNFT5)
	Application Number	
Title of Invention	SYSTEM AND METHOD EMPLOYING AN AGILE NETWORK PROTOCOL FOR SECURE COMMUNICATIONS USING SECURE DOMAIN NAMES	

Citizenship under 37 CFR 1.41(b) i	US		
Mailing Address of Applicant:			
Address 1	1101 Opaca Court		
Address 2			
City	Crownsville	State/Province	MD
Postal Code	21032	Country ⁱ	US
Applicant 4	<input type="button" value="Remove"/>		
Applicant Authority	<input checked="" type="radio"/> Inventor	<input type="radio"/> Legal Representative under 35 U.S.C. 117	<input type="radio"/> Party of Interest under 35 U.S.C. 118
Prefix	Given Name	Middle Name	Family Name
	Michael		Williamson
Residence Information (Select One) <input checked="" type="radio"/> US Residency <input type="radio"/> Non US Residency <input type="radio"/> Active US Military Service			
City	South Riding	State/Province	VA
		Country of Residence ⁱ	US
Citizenship under 37 CFR 1.41(b) i	US		
Mailing Address of Applicant:			
Address 1	26203 Ocala Circle		
Address 2			
City	South Riding	State/Province	VA
Postal Code	20152	Country ⁱ	US
All Inventors Must Be Listed - Additional Inventor Information blocks may be generated within this form by selecting the Add button.			<input type="button" value="Add"/>

Correspondence Information:

Enter either Customer Number or complete the Correspondence Information section below. For further information see 37 CFR 1.33(a).			
<input type="checkbox"/> An Address is being provided for the correspondence Information of this application.			
Customer Number	23630		
Email Address	mweipdocket@mwe.com	<input type="button" value="Add Email"/>	<input type="button" value="Remove Email"/>

Application Information:

Title of the Invention	SYSTEM AND METHOD EMPLOYING AN AGILE NETWORK PROTOCOL FOR SECURE COMMUNICATIONS USING SECURE DOMAIN NAMES		
Attorney Docket Number	77580-155(VRNK-1CP3CNFT5)	Small Entity Status Claimed	<input type="checkbox"/>
Application Type	Nonprovisional		
Subject Matter	Utility		
Suggested Class (if any)	707	Sub Class (if any)	770
Suggested Technology Center (if any)	2100		
Total Number of Drawing Sheets (if any)	40	Suggested Figure for Publication (if any)	

Application Data Sheet 37 CFR 1.76	Attorney Docket Number	77580-155(VR NK-1CP3CNFT5)
	Application Number	
Title of Invention	SYSTEM AND METHOD EMPLOYING AN AGILE NETWORK PROTOCOL FOR SECURE COMMUNICATIONS USING SECURE DOMAIN NAMES	

Publication Information:

<input type="checkbox"/>	Request Early Publication (Fee required at time of Request 37 CFR 1.219)
<input type="checkbox"/>	Request Not to Publish. I hereby request that the attached application not be published under 35 U.S. C. 122(b) and certify that the invention disclosed in the attached application has not and will not be the subject of an application filed in another country, or under a multilateral international agreement, that requires publication at eighteen months after filing.

Representative Information:

Representative information should be provided for all practitioners having a power of attorney in the application. Providing this information in the Application Data Sheet does not constitute a power of attorney in the application (see 37 CFR 1.32). Enter either Customer Number or complete the Representative Name section below. If both sections are completed the Customer Number will be used for the Representative Information during processing.			
Please Select One:	<input checked="" type="radio"/> Customer Number	<input type="radio"/> US Patent Practitioner	<input type="radio"/> Limited Recognition (37 CFR 11.9)
Customer Number	23630		

Domestic Benefit/National Stage Information:

This section allows for the applicant to either claim benefit under 35 U.S.C. 119(e), 120, 121, or 365(c) or indicate National Stage entry from a PCT application. Providing this information in the application data sheet constitutes the specific reference required by 35 U.S.C. 119(e) or 120, and 37 CFR 1.78(a)(2) or CFR 1.78(a)(4), and need not otherwise be made part of the specification.					
Prior Application Status	Pending		Remove		
Application Number	Continuity Type	Prior Application Number	Filing Date (YYYY-MM-DD)		
	Continuation of	13/049552	2011-03-16		
Prior Application Status	Patented		Remove		
Application Number	Continuity Type	Prior Application Number	Filing Date (YYYY-MM-DD)	Patent Number	Issue Date (YYYY-MM-DD)
13/049552	Continuation of	11/840560	2007-08-17	7921211	2011-04-05
Prior Application Status	Patented		Remove		
Application Number	Continuity Type	Prior Application Number	Filing Date (YYYY-MM-DD)	Patent Number	Issue Date (YYYY-MM-DD)
11/840560	Continuation of	10/714849	2003-11-18	7418504	2008-08-26
Prior Application Status	Abandoned		Remove		
Application Number	Continuity Type	Prior Application Number	Filing Date (YYYY-MM-DD)		
10/714849	Continuation of	09/558210	2000-04-26		
Prior Application Status	Patented		Remove		
Application Number	Continuity Type	Prior Application Number	Filing Date (YYYY-MM-DD)	Patent Number	Issue Date (YYYY-MM-DD)
09/558210	Continuation in part of	09/504783	2000-02-15	6502135	2002-12-31
Prior Application Status	Patented		Remove		

Under the Paperwork Reduction Act of 1995, no persons are required to respond to a collection of information unless it contains a valid OMB control number.

Application Data Sheet 37 CFR 1.76	Attorney Docket Number	77580-155(VRNK-1CP3CNFT5)
	Application Number	
Title of Invention	SYSTEM AND METHOD EMPLOYING AN AGILE NETWORK PROTOCOL FOR SECURE COMMUNICATIONS USING SECURE DOMAIN NAMES	

Application Number	Continuity Type	Prior Application Number	Filing Date (YYYY-MM-DD)	Patent Number	Issue Date (YYYY-MM-DD)
09/504783	Continuation in part of	09/429643	1999-10-29	7010604	2006-03-07
Prior Application Status	Expired		<input type="button" value="Remove"/>		
Application Number	Continuity Type	Prior Application Number	Filing Date (YYYY-MM-DD)		
09/429643	non provisional of	60/106261	1998-10-30		
Prior Application Status	Expired		<input type="button" value="Remove"/>		
Application Number	Continuity Type	Prior Application Number	Filing Date (YYYY-MM-DD)		
09/429643	non provisional of	60/137704	1999-06-07		
Additional Domestic Benefit/National Stage Data may be generated within this form by selecting the Add button.					<input type="button" value="Add"/>

Foreign Priority Information:

This section allows for the applicant to claim benefit of foreign priority and to identify any prior foreign application for which priority is not claimed. Providing this information in the application data sheet constitutes the claim for priority as required by 35 U.S.C. 119(b) and 37 CFR 1.55(a).

Application Number	Country ⁱ	Parent Filing Date (YYYY-MM-DD)	Priority Claimed
			<input type="button" value="Remove"/>
			<input checked="" type="radio"/> Yes <input type="radio"/> No
Additional Foreign Priority Data may be generated within this form by selecting the Add button.			

Assignee Information:

Providing this information in the application data sheet does not substitute for compliance with any requirement of part 3 of Title 37 of the CFR to have an assignment recorded in the Office.

Assignee 1	<input type="button" value="Remove"/>
If the Assignee is an Organization check here. <input checked="" type="checkbox"/>	
Organization Name	VIRNETX, INC.
Mailing Address Information:	
Address 1	5615 Scotts Valley Drive, Suite 110
Address 2	
City	Scotts Valley
State/Province	CA
Country ⁱ	US
Postal Code	95066
Phone Number	--
Fax Number	--
Email Address	--
Additional Assignee Data may be generated within this form by selecting the Add button.	

Signature:

A signature of the applicant or representative is required in accordance with 37 CFR 1.33 and 10.18. Please see 37 CFR 1.4(d) for the form of the signature.

Under the Paperwork Reduction Act of 1995, no persons are required to respond to a collection of information unless it contains a valid OMB control number.

Application Data Sheet 37 CFR 1.76		Attorney Docket Number	77580-155(VRNK-1CP3CNFT5)		
		Application Number			
Title of Invention	SYSTEM AND METHOD EMPLOYING AN AGILE NETWORK PROTOCOL FOR SECURE COMMUNICATIONS USING SECURE DOMAIN NAMES				
Signature	/Toby H. Kusmer/			Date (YYYY-MM-DD)	2012-01-03
First Name	Toby H.	Last Name	Kusmer, P.C.	Registration Number	26418

This collection of information is required by 37 CFR 1.76. The information is required to obtain or retain a benefit by the public which is to file (and by the USPTO to process) an application. Confidentiality is governed by 35 U.S.C. 122 and 37 CFR 1.14. This collection is estimated to take 23 minutes to complete, including gathering, preparing, and submitting the completed application data sheet form to the USPTO. Time will vary depending upon the individual case. Any comments on the amount of time you require to complete this form and/or suggestions for reducing this burden, should be sent to the Chief Information Officer, U.S. Patent and Trademark Office, U.S. Department of Commerce, P.O. Box 1450, Alexandria, VA 22313-1450. DO NOT SEND FEES OR COMPLETED FORMS TO THIS ADDRESS. **SEND TO: Commissioner for Patents, P.O. Box 1450, Alexandria, VA 22313-1450.**

Privacy Act Statement

The Privacy Act of 1974 (P.L. 93-579) requires that you be given certain information in connection with your submission of the attached form related to a patent application or patent. Accordingly, pursuant to the requirements of the Act, please be advised that: (1) the general authority for the collection of this information is 35 U.S.C. 2(b)(2); (2) furnishing of the information solicited is voluntary; and (3) the principal purpose for which the information is used by the U.S. Patent and Trademark Office is to process and/or examine your submission related to a patent application or patent. If you do not furnish the requested information, the U.S. Patent and Trademark Office may not be able to process and/or examine your submission, which may result in termination of proceedings or abandonment of the application or expiration of the patent.

The information provided by you in this form will be subject to the following routine uses:

1. The information on this form will be treated confidentially to the extent allowed under the Freedom of Information Act (5 U.S.C. 552) and the Privacy Act (5 U.S.C. 552a). Records from this system of records may be disclosed to the Department of Justice to determine whether the Freedom of Information Act requires disclosure of these records.
2. A record from this system of records may be disclosed, as a routine use, in the course of presenting evidence to a court, magistrate, or administrative tribunal, including disclosures to opposing counsel in the course of settlement negotiations.
3. A record in this system of records may be disclosed, as a routine use, to a Member of Congress submitting a request involving an individual, to whom the record pertains, when the individual has requested assistance from the Member with respect to the subject matter of the record.
4. A record in this system of records may be disclosed, as a routine use, to a contractor of the Agency having need for the information in order to perform a contract. Recipients of information shall be required to comply with the requirements of the Privacy Act of 1974, as amended, pursuant to 5 U.S.C. 552a(m).
5. A record related to an International Application filed under the Patent Cooperation Treaty in this system of records may be disclosed, as a routine use, to the International Bureau of the World Intellectual Property Organization, pursuant to the Patent Cooperation Treaty.
6. A record in this system of records may be disclosed, as a routine use, to another federal agency for purposes of National Security review (35 U.S.C. 181) and for review pursuant to the Atomic Energy Act (42 U.S.C. 218(c)).
7. A record from this system of records may be disclosed, as a routine use, to the Administrator, General Services, or his/her designee, during an inspection of records conducted by GSA as part of that agency's responsibility to recommend improvements in records management practices and programs, under authority of 44 U.S.C. 2904 and 2906. Such disclosure shall be made in accordance with the GSA regulations governing inspection of records for this purpose, and any other relevant (i.e., GSA or Commerce) directive. Such disclosure shall not be used to make determinations about individuals.
8. A record from this system of records may be disclosed, as a routine use, to the public after either publication of the application pursuant to 35 U.S.C. 122(b) or issuance of a patent pursuant to 35 U.S.C. 151. Further, a record may be disclosed, subject to the limitations of 37 CFR 1.14, as a routine use, to the public if the record was filed in an application which became abandoned or in which the proceedings were terminated and which application is referenced by either a published application, an application open to public inspections or an issued patent.
9. A record from this system of records may be disclosed, as a routine use, to a Federal, State, or local law enforcement agency, if the USPTO becomes aware of a violation or potential violation of law or regulation.

Under the Paperwork Reduction Act of 1995, no persons are required to respond to a collection of information unless it displays a valid OMB control number.

POWER OF ATTORNEY TO PROSECUTE APPLICATIONS BEFORE THE USPTO

I hereby revoke all previous powers of attorney given in the application identified in the attached statement under 37 CFR 3.73(b).

I hereby appoint:

Practitioners associated with the Customer

23,630

OR

Practitioner(s) named below (if more than ten practitioners are to be named, then a customer number must be used):

Name	Registration Number	Name	Registration Number

as attorney(s) or agent(s) to represent the undersigned before the United States Patent and Trademark Office (USPTO) in connection with any and all patent applications assigned only to the undersigned according to the USPTO assignment records or assignment documents attached to this form in accordance with 37 CFR 3.73(b).

Please change the correspondence address for the application identified in the attached statement under 37 CFR 3.73(b) to:

The address associated with Customer

23,630

OR

<input checked="" type="checkbox"/> Firm or Individual Name	McDermott Will & Emery LLP		
Address	28 State Street		
City	Boston	State	MA Zip 02109
Country	U.S.A.		
Telephone	(617) 535-4065	Email	tkusmer@mwe.com

Assignee Name and Address:
VIRNETX, INC.
5615 SCOTTS VALLEY DRIVE, SUITE 110
SCOTTS VALLEY, CALIFORNIA 95066

A copy of this form, together with a statement under 37 CFR 3.73(b) (Form PTO/SB/96 or equivalent) is required to be filed in each application in which this form is used. The statement under 37 CFR 3.73(b) may be completed by one of the practitioners appointed in this form if the appointed practitioner is authorized to act on behalf of the assignee, and must identify the application in which this Power of Attorney is to be filed.

SIGNATURE of Assignee of Record

The individual whose signature and title is supplied below is authorized to act on behalf of the assignee

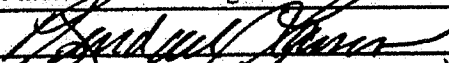
Signature		Date	10/19/07
Name	Randall Carson	Telephone	831.608.5698
Title	President		

This collection of information is required by 37 CFR 1.31, 1.32 and 1.33. The information is required to obtain or retain a benefit by the public which is to file (and by the USPTO to process) an application. Confidentiality is governed by 35 U.S.C. 122 and 37 CFR 1.11 and 1.14. This collection is estimated to take 3 minutes to complete, including gathering, preparing, and submitting the completed application form to the USPTO. Time will vary depending upon the individual case. Any comments on the amount of time you require to complete this form and/or suggestions for reducing this burden, should be sent to the Chief Information Officer, U.S. Patent and Trademark Office, U.S. Department of Commerce, P.O. Box 1450, Alexandria, VA 22313-1450. DO NOT SEND FEES OR COMPLETED FORMS TO THIS ADDRESS. SEND TO: Commissioner for Patents, P.O. Box 1450, Alexandria, VA 22313-1450

STATEMENT UNDER 37 CFR 3.73(b)

Applicant/Patent Owner: VIRNETX, INC.

Application No./Patent No.: 11/840,560

Filed/Issue Date: AUGUST 17, 2007

Entitled: **AN AGILE NETWORK PROTOCOL FOR SECURE COMMUNICATIONS USING
SECURE DOMAIN NAMES**

VIRNETX, INC

, a CORPORATION

(Name of Assignee)

(Type of Assignee, e.g., corporation, partnership, university, government agency, etc.)

states that it is:

- 1. the assignee of the entire right, title, and interest; or
- 2. an assignee of less than the entire right, title and interest
(The extent (by percentage) of its ownership interest is _____ %)

in the patent application/patent identified above by virtue of either:

A. An assignment from the inventor(s) of the patent application/patent identified above. The assignment was recorded in the United States Patent and Trademark Office at Reel _____, Frame _____, or for which a copy thereof is attached.

OR

B. A chain of title from the inventor(s), of the patent application/patent identified above, to the current assignee as follows:

1. From: Victor Larson, et al. To: Science Applications International Corporation
The document was recorded in the United States Patent and Trademark Office at
Reel 019722, Frame 0321, or for which a copy thereof is attached.

2. From: Science Applications International Corporation To: VirnetX, Inc.
The document was recorded in the United States Patent and Trademark Office at
Reel 019722, Frame 0525, or for which a copy thereof is attached.

3. From: N/A To: _____
The document was recorded in the United States Patent and Trademark Office at
Reel _____, Frame _____, or for which a copy thereof is attached.

Additional documents in the chain of title are listed on a supplemental sheet.

As required by 37 CFR 3.73(b)(1)(i), the documentary evidence of the chain of title from the original owner to the assignee was, or concurrently is being, submitted for recordation pursuant to 37 CFR 3.11.

[NOTE: A separate copy (i.e., a true copy of the original assignment document(s)) must be submitted to Assignment Division in accordance with 37 CFR Part 3, to record the assignment in the records of the USPTO. See MPEP 302.08]

The undersigned (whose file is supplied below) is authorized to act on behalf of the assignee.

Kendall Carson
Signature

16/19/07
Date

Kendall Carson
Printed or Typed Name

831.608.5698
Telephone number

President
Title

This collection of information is required by 37 CFR 3.73(b). The information is required to obtain or retain a benefit by the public which is to file (and by the USPTO to process) an application. Confidentiality is governed by 35 U.S.C. 122 and 37 CFR 1.11 and 1.14. This collection is estimated to take 12 minutes to complete, including gathering, preparing, and submitting the completed application form to the USPTO. Time will vary depending upon the individual case. Any comments on the amount of time you require to complete this form and/or suggestions for reducing this burden, should be sent to the Chief Information Officer, U.S. Patent and Trademark Office, U.S. Department of Commerce, P.O. Box 1450, Alexandria, VA 22313-1450. DO NOT SEND FEES OR COMPLETED FORMS TO THIS ADDRESS SEND TO: Commissioner for Patents, P.O. Box 1450, Alexandria, VA 22313-1450.

Electronic Patent Application Fee Transmittal

Application Number:	
Filing Date:	
Title of Invention:	SYSTEM AND METHOD EMPLOYING AN AGILE NETWORK PROTOCOL FOR SECURE COMMUNICATIONS USING SECURE DOMAIN NAMES
First Named Inventor/Applicant Name:	Victor Larson
Filer:	Toby H. Kusmer./Jessica Brown
Attorney Docket Number:	77580-155(VR NK-1CP3CNFT5)

Filed as Large Entity

Track I Prioritized Examination - Nonprovisional Application under 35 USC 111(a) Filing Fees

Description	Fee Code	Quantity	Amount	Sub-Total in USD(\$)
Basic Filing:				
Utility application filing	1011	1	380	380
Utility Search Fee	1111	1	620	620
Utility Examination Fee	1311	1	250	250
Request for Prioritized Examination	1817	1	4800	4800

Pages:

Claims:

Claims in excess of 20	1202	10	60	600
------------------------	------	----	----	-----

Miscellaneous-Filing:

Description	Fee Code	Quantity	Amount	Sub-Total in USD(\$)
Publ. Fee- early, voluntary, or normal	1504	1	300	300
Processing Fee, except for Provis. apps	1808	1	130	130
Petition:				
Patent-Appeals-and-Interference:				
Post-Allowance-and-Post-Issuance:				
Extension-of-Time:				
Miscellaneous:				
Total in USD (\$)				7080

Electronic Acknowledgement Receipt

EFS ID:	11750923
Application Number:	13342795
International Application Number:	
Confirmation Number:	4180
Title of Invention:	SYSTEM AND METHOD EMPLOYING AN AGILE NETWORK PROTOCOL FOR SECURE COMMUNICATIONS USING SECURE DOMAIN NAMES
First Named Inventor/Applicant Name:	Victor Larson
Customer Number:	23630
Filer:	Toby H. Kusmer./Jessica Brown
Filer Authorized By:	Toby H. Kusmer.
Attorney Docket Number:	77580-155(VRNK-1CP3CNFT5)
Receipt Date:	03-JAN-2012
Filing Date:	
Time Stamp:	18:26:28
Application Type:	Utility under 35 USC 111(a)

Payment information:

Submitted with Payment	yes
Payment Type	Deposit Account
Payment was successfully received in RAM	\$7080
RAM confirmation Number	7002
Deposit Account	501133
Authorized User	

The Director of the USPTO is hereby authorized to charge indicated fees and credit any overpayment as follows:

Charge any Additional Fees required under 37 C.F.R. Section 1.16 (National application filing, search, and examination fees)

Charge any Additional Fees required under 37 C.F.R. Section 1.17 (Patent application and reexamination processing fees)

File Listing:					
Document Number	Document Description	File Name	File Size(Bytes)/ Message Digest	Multi Part /.zip	Pages (if appl.)
1	Transmittal of New Application	155Transmittal.pdf	94568 61307c3a751d59bb34fd9bcc81568499cae97e81	no	3
Warnings:					
Information:					
2	TrackOne Request	155PrioritizedExamApp.pdf	134471 d4e38e52cd04d41102b1727416e00b19b4996f32	no	2
Warnings:					
Information:					
3		155Specification.pdf	411676 2b2e233befac36be0f0c9a08a36abe9e485e2af3	yes	93
	Multipart Description/PDF files in .zip description				
	Document Description		Start	End	
	Specification		1	88	
	Claims		89	92	
	Abstract		93	93	
Warnings:					
Information:					
4	Drawings-only black and white line drawings	155Figures.pdf	549449 2419b3a118e466c2173663ed94012ba0f35701de	no	40
Warnings:					
Information:					
5	Oath or Declaration filed	155Declaration.pdf	333919 9f7a6c1a2de1091148101fdb24c5829a566b46b	no	6
Warnings:					
Information:					
6	Application Data Sheet	155ADS.pdf	1032767 2f2a4fad674f5b23eaa30d527866f4129309194b	no	6
Warnings:					
Information:					
7	Power of Attorney	155POA.pdf	234761 c7583bc27431f4c6fdafc35141f1d731c3dad50	no	2

Warnings:					
Information:					
8	Fee Worksheet (SB06)	fee-info.pdf	42157	no	2
			ce656d5b9b665f7d3335fc8c53b8aadae89b8046		
Warnings:					
Information:					
Total Files Size (in bytes):				2833768	
<p>This Acknowledgement Receipt evidences receipt on the noted date by the USPTO of the indicated documents, characterized by the applicant, and including page counts, where applicable. It serves as evidence of receipt similar to a Post Card, as described in MPEP 503.</p> <p><u>New Applications Under 35 U.S.C. 111</u> If a new application is being filed and the application includes the necessary components for a filing date (see 37 CFR 1.53(b)-(d) and MPEP 506), a Filing Receipt (37 CFR 1.54) will be issued in due course and the date shown on this Acknowledgement Receipt will establish the filing date of the application.</p> <p><u>National Stage of an International Application under 35 U.S.C. 371</u> If a timely submission to enter the national stage of an international application is compliant with the conditions of 35 U.S.C. 371 and other applicable requirements a Form PCT/DO/EO/903 indicating acceptance of the application as a national stage submission under 35 U.S.C. 371 will be issued in addition to the Filing Receipt, in due course.</p> <p><u>New International Application Filed with the USPTO as a Receiving Office</u> If a new international application is being filed and the international application includes the necessary components for an international filing date (see PCT Article 11 and MPEP 1810), a Notification of the International Application Number and of the International Filing Date (Form PCT/RO/105) will be issued in due course, subject to prescriptions concerning national security, and the date shown on this Acknowledgement Receipt will establish the international filing date of the application.</p>					



UNITED STATES PATENT AND TRADEMARK OFFICE

UNITED STATES DEPARTMENT OF COMMERCE
United States Patent and Trademark Office
Address: COMMISSIONER FOR PATENTS
P.O. Box 1450
Alexandria, Virginia 22313-1450
www.uspto.gov

Table with 7 columns: APPLICATION NUMBER, FILING or 371(c) DATE, GRP ART UNIT, FIL FEE REC'D, ATTY. DOCKET NO, TOT CLAIMS, IND CLAIMS. Row 1: 13/342,795, 01/03/2012, 2447, 2150, 77580-155(VR NK-1CP3CNFT5), 30, 2

CONFIRMATION NO. 4180

23630
McDermott Will & Emery
600 13th Street, NW
Washington, DC 20005-3096

FILING RECEIPT



Date Mailed: 01/20/2012

Receipt is acknowledged of this non-provisional patent application. The application will be taken up for examination in due course. Applicant will be notified as to the results of the examination. Any correspondence concerning the application must include the following identification information: the U.S. APPLICATION NUMBER, FILING DATE, NAME OF APPLICANT, and TITLE OF INVENTION. Fees transmitted by check or draft are subject to collection. Please verify the accuracy of the data presented on this receipt. If an error is noted on this Filing Receipt, please submit a written request for a Filing Receipt Correction. Please provide a copy of this Filing Receipt with the changes noted thereon. If you received a "Notice to File Missing Parts" for this application, please submit any corrections to this Filing Receipt with your reply to the Notice. When the USPTO processes the reply to the Notice, the USPTO will generate another Filing Receipt incorporating the requested corrections

Applicant(s)

Victor Larson, Fairfax, VA;
Robert Dunham Short III, Leesburg, VA;
Edmond Colby Munger, Crownsville, MD;
Michael Williamson, South Riding, VA;

Assignment For Published Patent Application

VIRNETX, INC., Scotts Valley, CA

Power of Attorney: The patent practitioners associated with Customer Number 23630

Domestic Priority data as claimed by applicant

This application is a CON of 13/049,552 03/16/2011
which is a CON of 11/840,560 08/17/2007 PAT 7921211
which is a CON of 10/714,849 11/18/2003 PAT 7418504
which is a CON of 09/558,210 04/26/2000 ABN
which is a CIP of 09/504,783 02/15/2000 PAT 6502135
which is a CIP of 09/429,643 10/29/1999 PAT 7010604
which claims benefit of 60/106,261 10/30/1998
and claims benefit of 60/137,704 06/07/1999

Foreign Applications (You may be eligible to benefit from the Patent Prosecution Highway program at the USPTO. Please see http://www.uspto.gov for more information.)

If Required, Foreign Filing License Granted: 01/18/2012

The country code and number of your priority application, to be used for filing abroad under the Paris Convention, is US 13/342,795

Projected Publication Date: 04/26/2012

Non-Publication Request: No

Early Publication Request: No

Title

SYSTEM AND METHOD EMPLOYING AN AGILE NETWORK PROTOCOL FOR SECURE COMMUNICATIONS USING SECURE DOMAIN NAMES

Preliminary Class

709

PROTECTING YOUR INVENTION OUTSIDE THE UNITED STATES

Since the rights granted by a U.S. patent extend only throughout the territory of the United States and have no effect in a foreign country, an inventor who wishes patent protection in another country must apply for a patent in a specific country or in regional patent offices. Applicants may wish to consider the filing of an international application under the Patent Cooperation Treaty (PCT). An international (PCT) application generally has the same effect as a regular national patent application in each PCT-member country. The PCT process **simplifies** the filing of patent applications on the same invention in member countries, but **does not result** in a grant of "an international patent" and does not eliminate the need of applicants to file additional documents and fees in countries where patent protection is desired.

Almost every country has its own patent law, and a person desiring a patent in a particular country must make an application for patent in that country in accordance with its particular laws. Since the laws of many countries differ in various respects from the patent law of the United States, applicants are advised to seek guidance from specific foreign countries to ensure that patent rights are not lost prematurely.

Applicants also are advised that in the case of inventions made in the United States, the Director of the USPTO must issue a license before applicants can apply for a patent in a foreign country. The filing of a U.S. patent application serves as a request for a foreign filing license. The application's filing receipt contains further information and guidance as to the status of applicant's license for foreign filing.

Applicants may wish to consult the USPTO booklet, "General Information Concerning Patents" (specifically, the section entitled "Treaties and Foreign Patents") for more information on timeframes and deadlines for filing foreign patent applications. The guide is available either by contacting the USPTO Contact Center at 800-786-9199, or it can be viewed on the USPTO website at <http://www.uspto.gov/web/offices/pac/doc/general/index.html>.

For information on preventing theft of your intellectual property (patents, trademarks and copyrights), you may wish to consult the U.S. Government website, <http://www.stopfakes.gov>. Part of a Department of Commerce initiative, this website includes self-help "toolkits" giving innovators guidance on how to protect intellectual property in specific countries such as China, Korea and Mexico. For questions regarding patent enforcement issues, applicants may call the U.S. Government hotline at 1-866-999-HALT (1-866-999-4158).

LICENSE FOR FOREIGN FILING UNDER
Title 35, United States Code, Section 184
Title 37, Code of Federal Regulations, 5.11 & 5.15

GRANTED

The applicant has been granted a license under 35 U.S.C. 184, if the phrase "IF REQUIRED, FOREIGN FILING LICENSE GRANTED" followed by a date appears on this form. Such licenses are issued in all applications where the conditions for issuance of a license have been met, regardless of whether or not a license may be required as set forth in 37 CFR 5.15. The scope and limitations of this license are set forth in 37 CFR 5.15(a) unless an earlier license has been issued under 37 CFR 5.15(b). The license is subject to revocation upon written notification. The date indicated is the effective date of the license, unless an earlier license of similar scope has been granted under 37 CFR 5.13 or 5.14.

This license is to be retained by the licensee and may be used at any time on or after the effective date thereof unless it is revoked. This license is automatically transferred to any related applications(s) filed under 37 CFR 1.53(d). This license is not retroactive.

The grant of a license does not in any way lessen the responsibility of a licensee for the security of the subject matter as imposed by any Government contract or the provisions of existing laws relating to espionage and the national security or the export of technical data. Licensees should apprise themselves of current regulations especially with respect to certain countries, of other agencies, particularly the Office of Defense Trade Controls, Department of State (with respect to Arms, Munitions and Implements of War (22 CFR 121-128)); the Bureau of Industry and Security, Department of Commerce (15 CFR parts 730-774); the Office of Foreign Assets Control, Department of Treasury (31 CFR Parts 500+) and the Department of Energy.

NOT GRANTED

No license under 35 U.S.C. 184 has been granted at this time, if the phrase "IF REQUIRED, FOREIGN FILING LICENSE GRANTED" DOES NOT appear on this form. Applicant may still petition for a license under 37 CFR 5.12, if a license is desired before the expiration of 6 months from the filing date of the application. If 6 months has lapsed from the filing date of this application and the licensee has not received any indication of a secrecy order under 35 U.S.C. 181, the licensee may foreign file the application pursuant to 37 CFR 5.15(b).

SelectUSA

The United States represents the largest, most dynamic marketplace in the world and is an unparalleled location for business investment, innovation and commercialization of new technologies. The USA offers tremendous resources and advantages for those who invest and manufacture goods here. Through SelectUSA, our nation works to encourage, facilitate, and accelerate business investment. To learn more about why the USA is the best country in the world to develop technology, manufacture products, and grow your business, visit SelectUSA.gov.

PATENT APPLICATION FEE DETERMINATION RECORD
Substitute for Form PTO-875

Application or Docket Number
13/342,795

APPLICATION AS FILED - PART I

	(Column 1)	(Column 2)
FOR	NUMBER FILED	NUMBER EXTRA
BASIC FEE (37 CFR 1.16(a), (b), or (c))	N/A	N/A
SEARCH FEE (37 CFR 1.16(k), (l), or (m))	N/A	N/A
EXAMINATION FEE (37 CFR 1.16(o), (p), or (q))	N/A	N/A
TOTAL CLAIMS (37 CFR 1.16(j))	30	minus 20 = * 10
INDEPENDENT CLAIMS (37 CFR 1.16(h))	2	minus 3 = *
APPLICATION SIZE FEE (37 CFR 1.16(s))	If the specification and drawings exceed 100 sheets of paper, the application size fee due is \$310 (\$155 for small entity) for each additional 50 sheets or fraction thereof. See 35 U.S.C. 41(a)(1)(G) and 37 CFR 1.16(s).	
MULTIPLE DEPENDENT CLAIM PRESENT (37 CFR 1.16(j))		

SMALL ENTITY	
RATE(\$)	FEE(\$)
N/A	
N/A	
N/A	
TOTAL	

OTHER THAN SMALL ENTITY	
RATE(\$)	FEE(\$)
N/A	380
N/A	620
N/A	250
x 60 =	600
x 250 =	0.00
	0.00
TOTAL	1850

* If the difference in column 1 is less than zero, enter "0" in column 2.

APPLICATION AS AMENDED - PART II

	(Column 1)	(Column 2)	(Column 3)	
AMENDMENT A	CLAIMS REMAINING AFTER AMENDMENT	HIGHEST NUMBER PREVIOUSLY PAID FOR	PRESENT EXTRA	
	Total (37 CFR 1.16(i))	*	Minus **	=
	Independent (37 CFR 1.16(h))	*	Minus ***	=
	Application Size Fee (37 CFR 1.16(s))			
	FIRST PRESENTATION OF MULTIPLE DEPENDENT CLAIM (37 CFR 1.16(j))			

SMALL ENTITY	
RATE(\$)	ADDITIONAL FEE(\$)
x =	
x =	
TOTAL ADD'L FEE	

OTHER THAN SMALL ENTITY	
RATE(\$)	ADDITIONAL FEE(\$)
x =	
x =	
TOTAL ADD'L FEE	

	(Column 1)	(Column 2)	(Column 3)	
AMENDMENT B	CLAIMS REMAINING AFTER AMENDMENT	HIGHEST NUMBER PREVIOUSLY PAID FOR	PRESENT EXTRA	
	Total (37 CFR 1.16(i))	*	Minus **	=
	Independent (37 CFR 1.16(h))	*	Minus ***	=
	Application Size Fee (37 CFR 1.16(s))			
	FIRST PRESENTATION OF MULTIPLE DEPENDENT CLAIM (37 CFR 1.16(j))			

SMALL ENTITY	
RATE(\$)	ADDITIONAL FEE(\$)
x =	
x =	
TOTAL ADD'L FEE	

OTHER THAN SMALL ENTITY	
RATE(\$)	ADDITIONAL FEE(\$)
x =	
x =	
TOTAL ADD'L FEE	

* If the entry in column 1 is less than the entry in column 2, write "0" in column 3.
 ** If the "Highest Number Previously Paid For" IN THIS SPACE is less than 20, enter "20".
 *** If the "Highest Number Previously Paid For" IN THIS SPACE is less than 3, enter "3".
 The "Highest Number Previously Paid For" (Total or Independent) is the highest found in the appropriate box in column 1.



UNITED STATES PATENT AND TRADEMARK OFFICE

UNITED STATES DEPARTMENT OF COMMERCE
United States Patent and Trademark Office
Address: COMMISSIONER FOR PATENTS
P.O. Box 1450
Alexandria, Virginia 22313-1450
www.uspto.gov

APPLICATION NUMBER	FILING OR 371(C) DATE	FIRST NAMED APPLICANT	ATTY. DOCKET NO./TITLE
13/342,795	01/03/2012	Victor Larson	77580-155(VRNK-1CP3CNFT5)

23630
McDermott Will & Emery
600 13th Street, NW
Washington, DC 20005-3096

CONFIRMATION NO. 4180
POA ACCEPTANCE LETTER



Date Mailed: 01/20/2012

NOTICE OF ACCEPTANCE OF POWER OF ATTORNEY

This is in response to the Power of Attorney filed 01/03/2012.

The Power of Attorney in this application is accepted. Correspondence in this application will be mailed to the above address as provided by 37 CFR 1.33.

/btsebhatu/

Office of Data Management, Application Assistance Unit (571) 272-4000, or (571) 272-4200, or 1-888-786-0101



UNITED STATES PATENT AND TRADEMARK OFFICE

UNITED STATES DEPARTMENT OF COMMERCE
United States Patent and Trademark Office
Address: COMMISSIONER FOR PATENTS
P.O. Box 1450
Alexandria, Virginia 22313-1450
www.uspto.gov

APPLICATION NO.	FILING DATE	FIRST NAMED INVENTOR	ATTORNEY DOCKET NO.	CONFIRMATION NO.
13/342,795	01/03/2012	Victor Larson	77580-155(VR NK-1CP3CNFT5)	4180

23630 7590 02/01/2012
McDermott Will & Emery
600 13th Street, NW
Washington, DC 20005-3096

EXAMINER

ART UNIT	PAPER NUMBER
----------	--------------

2165

NOTIFICATION DATE	DELIVERY MODE
-------------------	---------------

02/01/2012

ELECTRONIC

Please find below and/or attached an Office communication concerning this application or proceeding.

The time period for reply, if any, is set in the attached communication.

Notice of the Office communication was sent electronically on above-indicated "Notification Date" to the following e-mail address(es):

mweipdocket@mwe.com

**Decision Granting Request for
Prioritized Examination
(Track I or After RCE)**

Application No.: 13342795

1. THE REQUEST FILED 1/03/2012 IS **GRANTED**.

The above-identified application has met the requirements for prioritized examination

- A. for an original nonprovisional application (Track I).
- B. for an application undergoing continued examination (RCE).

2. **The above-identified application will undergo prioritized examination.** The application will be accorded special status throughout its entire course of prosecution until one of the following occurs:

- A. filing a **petition for extension of time** to extend the time period for filing a reply;
- B. filing an **amendment to amend the application to contain more than four independent claims, more than thirty total claims**, or a multiple dependent claim;
- C. filing a **request for continued examination**;
- D. filing a notice of appeal;
- E. filing a request for suspension of action;
- F. mailing of a notice of allowance;
- G. mailing of a final Office action;
- H. completion of examination as defined in 37 CFR 41.102; or
- I. abandonment of the application.

Telephone inquiries with regard to this decision should be directed to Mano Padmanabhan at 571-272-4210. In his/her absence, calls may be directed to Kakali Chaki, 571-272-3719.

/Mano Padmanabhan/

Supervisory Patent Examiner, AU2188



UNITED STATES PATENT AND TRADEMARK OFFICE

UNITED STATES DEPARTMENT OF COMMERCE
United States Patent and Trademark Office
Address: COMMISSIONER FOR PATENTS
P.O. Box 1450
Alexandria, Virginia 22313-1450
www.uspto.gov

Table with 5 columns: APPLICATION NO., FILING DATE, FIRST NAMED INVENTOR, ATTORNEY DOCKET NO., CONFIRMATION NO.
13/342,795 01/03/2012 Victor Larson 77580-155(VRNK-1CP3CNFT5) 4180

23630 7590 03/01/2012
McDermott Will & Emery
600 13th Street, NW
Washington, DC 20005-3096

EXAMINER

LIM, KRISNA

ART UNIT PAPER NUMBER

2453

NOTIFICATION DATE DELIVERY MODE

03/01/2012

ELECTRONIC

Please find below and/or attached an Office communication concerning this application or proceeding.

The time period for reply, if any, is set in the attached communication.

Notice of the Office communication was sent electronically on above-indicated "Notification Date" to the following e-mail address(es):

mweipdocket@mwe.com

Office Action Summary	Application No. 13/342,795	Applicant(s) LARSON ET AL.	
	Examiner KRISNA LIM	Art Unit 2453	

-- The MAILING DATE of this communication appears on the cover sheet with the correspondence address --

Period for Reply

A SHORTENED STATUTORY PERIOD FOR REPLY IS SET TO EXPIRE 3 MONTH(S) OR THIRTY (30) DAYS, WHICHEVER IS LONGER, FROM THE MAILING DATE OF THIS COMMUNICATION.

- Extensions of time may be available under the provisions of 37 CFR 1.136(a). In no event, however, may a reply be timely filed after SIX (6) MONTHS from the mailing date of this communication.
- If NO period for reply is specified above, the maximum statutory period will apply and will expire SIX (6) MONTHS from the mailing date of this communication.
- Failure to reply within the set or extended period for reply will, by statute, cause the application to become ABANDONED (35 U.S.C. § 133). Any reply received by the Office later than three months after the mailing date of this communication, even if timely filed, may reduce any earned patent term adjustment. See 37 CFR 1.704(b).

Status

- 1) Responsive to communication(s) filed on 03 January 2012.
- 2a) This action is **FINAL**.
- 2b) This action is non-final.
- 3) An election was made by the applicant in response to a restriction requirement set forth during the interview on _____; the restriction requirement and election have been incorporated into this action.
- 4) Since this application is in condition for allowance except for formal matters, prosecution as to the merits is closed in accordance with the practice under *Ex parte Quayle*, 1935 C.D. 11, 453 O.G. 213.

Disposition of Claims

- 5) Claim(s) 1-30 is/are pending in the application.
- 5a) Of the above claim(s) _____ is/are withdrawn from consideration.
- 6) Claim(s) _____ is/are allowed.
- 7) Claim(s) 1-30 is/are rejected.
- 8) Claim(s) _____ is/are objected to.
- 9) Claim(s) _____ are subject to restriction and/or election requirement.

Application Papers

- 10) The specification is objected to by the Examiner.
- 11) The drawing(s) filed on _____ is/are: a) accepted or b) objected to by the Examiner.
Applicant may not request that any objection to the drawing(s) be held in abeyance. See 37 CFR 1.85(a).
Replacement drawing sheet(s) including the correction is required if the drawing(s) is objected to. See 37 CFR 1.121(d).
- 12) The oath or declaration is objected to by the Examiner. Note the attached Office Action or form PTO-152.

Priority under 35 U.S.C. § 119

- 13) Acknowledgment is made of a claim for foreign priority under 35 U.S.C. § 119(a)-(d) or (f).
a) All b) Some * c) None of:
 - 1. Certified copies of the priority documents have been received.
 - 2. Certified copies of the priority documents have been received in Application No. _____.
 - 3. Copies of the certified copies of the priority documents have been received in this National Stage application from the International Bureau (PCT Rule 17.2(a)).

* See the attached detailed Office action for a list of the certified copies not received.

Attachment(s)

- 1) Notice of References Cited (PTO-892)
- 2) Notice of Draftperson's Patent Drawing Review (PTO-948)
- 3) Information Disclosure Statement(s) (PTO/SB/08)
Paper No(s)/Mail Date _____.
- 4) Interview Summary (PTO-413)
Paper No(s)/Mail Date _____.
- 5) Notice of Informal Patent Application
- 6) Other: _____.

Art Unit: 2453

1. Claims 1-28 are presented for examination.'

The applicant's oath/declaration has been reviewed by the examiner and is found to conform to the requirements prescribed in 37 C.F.R. 1.63.

2. The nonstatutory double patenting rejection is based on a judicially created doctrine grounded in public policy (a policy reflected in the statute) so as to prevent the unjustified or improper timewise extension of the "right to exclude" granted by a patent and to prevent possible harassment by multiple assignees. A nonstatutory obviousness-type double patenting rejection is appropriate where the conflicting claims are not identical, but at least one examined application claim is not patentably distinct from the reference claim(s) because the examined application claim is either anticipated by, or would have been obvious over, the reference claim(s). See, e.g., *In re Berg*, 140 F.3d 1428, 46 USPQ2d 1226 (Fed. Cir. 1998); *In re Goodman*, 11 F.3d 1046, 29 USPQ2d 2010 (Fed. Cir. 1993); *In re Longi*, 759 F.2d 887, 225 USPQ 645 (Fed. Cir. 1985); *In re Van Ornum*, 686 F.2d 937, 214 USPQ 761 (CCPA 1982); *In re Vogel*, 422 F.2d 438, 164 USPQ 619 (CCPA 1970); and *In re Thorington*, 418 F.2d 528, 163 USPQ 644 (CCPA 1969).

A timely filed terminal disclaimer in compliance with 37 CFR 1.321(c) or 1.321(d) may be used to overcome an actual or provisional rejection based on a nonstatutory double patenting ground provided the conflicting application or patent either is shown to be commonly owned with this application, or claims an invention made as a result of activities undertaken within the scope of a joint research agreement.

Effective January 1, 1994, a registered attorney or agent of record may sign a terminal disclaimer. A terminal disclaimer signed by the assignee must fully comply with 37 CFR 3.73(b).

3. Claims 1-30 are rejected on the ground of nonstatutory obviousness-type double patenting as being unpatentable over claims 1-17 of U.S. Patent No. 6,502,135.

Although the conflicting claims are not identical, they are not patentably distinct from

Art Unit: 2453

each other because they are directed to a network device (a domain name service system) configured to be connected to a secure communication network using the received look up network address of a second network device based on an identifier associated with the second network device and the information for a network address. The difference is a variation and clarification of the claim languages. For example, the current application clearly cites a signal processing to execute the application program for a secure communications service. It would have been obvious to one of ordinary skilled in the art at the time the invention was made to recognize that such using of the processor for executing the application program is well known in the art and it is not patentably distinguishable.

4. Claims 1-30 are rejected on the ground of nonstatutory obviousness-type double patenting as being unpatentable over claims 1, 3-7, 13-16 and 33-40 of U.S. Patent No. 7,188,180. Although the conflicting claims are not identical, they are not patentably distinct from each other because they are directed to a network device (a domain name service system) configured to be connected to a secure communication network using the received look up network address of a second network device based on an identifier associated with the second network device and the information for a virtual network address. The difference is a variation and clarification of the claim languages. For example, the current application clearly cites a signal processing to execute the application program for a secure communications service. It would have been obvious to one of ordinary skilled in the art at the time the invention was made to recognize that such using of the processor for executing the application program is well known in the art and it is not patentably distinguishable.

5. Claims 1-30 are rejected on the ground of nonstatutory obviousness-type double patenting as being unpatentable over claims 1, 8, 9, 12, 13, 14, 16, 17, and 23-33 of U.S. Patent No. 7,418,504. Although the conflicting claims are not identical, they are not patentably distinct from each other because they are directed to a network device (a

Art Unit: 2453

domain name service system) configured to be connected to a secure communication network using the received look up network address of a second network device based on an identifier associated with the second network device and the information for a network address. The difference is a variation and clarification of the claim languages. For example, the current application clearly cites a signal processing to execute the application program for a secure communications service. It would have been obvious to one of ordinary skilled in the art at the time the invention was made to recognize that such using of the processor for executing the application program is well known in the art and it is not patentably distinguishable.

6. Claims 1-30 are rejected on the ground of nonstatutory obviousness-type double patenting as being unpatentable over claims 1, 8-11 and 14-35 of U.S. Patent No. 7,921,211. Although the conflicting claims are not identical, they are not patentably distinct from each other because they are directed to a network device (a domain name service system) configured to be connected to a secure communication network using the received look up network address of a second network device based on an identifier associated with the second network device and the information for a virtual network address. The difference is a variation and clarification of the claim languages. For example, the current application clearly cites a signal processing to execute the application program for a secure communications service. It would have been obvious to one of ordinary skilled in the art at the time the invention was made to recognize that such using of the processor for executing the application program is well known in the art and it is not patentably distinguishable.

7. Claims 1-30 are rejected on the ground of nonstatutory obviousness-type double patenting as being unpatentable over claims 1-8, 10-13 and 17-18 of U.S. Patent No. 7,987,274. Although the conflicting claims are not identical, they are not patentably distinct from each other because they are directed to a network device (a domain name service system) configured to be connected to a secure communication network using

Art Unit: 2453

the received look up network address of a second network device based on an identifier associated with the second network device and the information for a virtual network address. The difference is a variation and clarification of the claim languages. For example, the current application clearly cites a signal processing to execute the application program for a secure communications service. It would have been obvious to one of ordinary skilled in the art at the time the invention was made to recognize that such using of the processor for executing the application program is well known in the art and it is not patentably distinguishable.

8. Claims 1-30 are rejected on the ground of nonstatutory obviousness-type double patenting as being unpatentable over claims 1-6, 8-9, and 14-22 of U.S. Patent No. 8,051,181. Although the conflicting claims are not identical, they are not patentably distinct from each other because they are directed to a network device (a domain name service system) configured to be connected to a secure communication network using the received look up network address of a second network device based on an identifier associated with the second network device and the information for a virtual network address. The difference is a variation and clarification of the claim languages. For example, the current application clearly cites a signal processing to execute the application program for a secure communications service. It would have been obvious to one of ordinary skilled in the art at the time the invention was made to recognize that such using of the processor for executing the application program is well known in the art and it is not patentably distinguishable.

9. Claims 1-30 are provisionally rejected on the ground of nonstatutory obviousness-type double patenting as being unpatentable over claims 14-20 and 26-39 of copending Application No. 13/080,680. Although the conflicting claims are not identical, they are not patentably distinct from each other because they are directed to a network device (a domain name service system) configured to be connected to a secure communication network using the received look up network address of a second

Art Unit: 2453

network device based on an identifier associated with the second network device and the information for a virtual network address. The difference is a variation and clarification of the claim languages. For example, the current application clearly cites a signal processing to execute the application program for a secure communications service. It would have been obvious to one of ordinary skilled in the art at the time the invention was made to recognize that such using of the processor for executing the application program is well known in the art and it is not patentably distinguishable.

This is a provisional obviousness-type double patenting rejection because the conflicting claims have not in fact been patented.

10. Claims 1-30 are provisionally rejected on the ground of nonstatutory obviousness-type double patenting as being unpatentable over claims 1-11 and 16-26 of copending Application No. 13/336,790. Although the conflicting claims are not identical, they are not patentably distinct from each other because they are directed to a network device comprising: a storage device storing an application program for a secure communication service; and at least one processor configured to execute the application program for the secure communications service so as to enable the network device to: a) send a request to look up; b) receive an indication; c) connect to the second network device ..., and d) communicate ... via ... communication link. The difference is a variation and clarification of the claim languages. For example, the current application clearly cites that communicate with the second network device using the secure communication link while the copending application 13/336,790 does use the virtual private network communication link. Such variation and clarification are cited in the dependent claims and thus they are obvious and they are not patentably distinguishable.

This is a provisional obviousness-type double patenting rejection because the conflicting claims have not in fact been patented.

Art Unit: 2453

11. Claims 1-30 are provisionally rejected on the ground of nonstatutory obviousness-type double patenting as being unpatentable over claims 1-11, 14-25 and 28 of copending Application No. 13/337,757. Although the conflicting claims are not identical, they are not patentably distinct from each other because they are directed to a network device comprising: a storage device storing an application program for a secure communication service; and at least one processor configured to execute the application program for the secure communications service so as to enable the network device to: a) send a request to look up; b) receive an indication; c) connect to the second network device ..., and d) communicate ... via ... communication link. The difference is a variation and clarification of the claim languages. For example, the current application clearly cites that communicate with the second network device using the secure communication link while the copending application does use the virtual private network communication link. Such variation and clarification are cited in the dependent claims and thus they are obvious and they are not patentably distinguishable.

This is a provisional obviousness-type double patenting rejection because the conflicting claims have not in fact been patented.

12. Claims 1-30 are provisionally rejected on the ground of nonstatutory obviousness-type double patenting as being unpatentable over claims 1-10 and 15-24 copending Application No. 13/339,257. Although the conflicting claims are not identical, they are not patentably distinct from each other because the difference is a variation and written style of the claim languages. For example, the current application clearly cites a signal processing to execute the application program for a secure communications service. It would have been obvious to one of ordinary skilled in the art at the time the invention was made to recognize that such using of the processor for executing the application program is well known in the art and it is not patentably distinguishable.

Art Unit: 2453

This is a provisional obviousness-type double patenting rejection because the conflicting claims have not in fact been patented.

13. Claims 1-30 are provisionally rejected on the ground of nonstatutory obviousness-type double patenting as being unpatentable over claims 1-30 of copending Application No. 13/336,958. Although the conflicting claims are not identical, they are not patentably distinct from each other because they are directed to a network device using a communication link to communication among network devices based a determination or indication. For example, the current application is based on a determination while the copending application is based on the indication. Another example, the current application clearly cites that communicate with the second network device (target device) using the secure communication link while the copending application uses the encrypted communication channels. Such variation and clarification are cited in the dependent claims and thus they are obvious and they are not patentably distinguishable.

This is a provisional obviousness-type double patenting rejection because the conflicting claims have not in fact been patented.

14. Claims 1-30 are provisionally rejected on the ground of nonstatutory obviousness-type double patenting as being unpatentable over claims 1-30 of copending Application No. 13/343,465. Although the conflicting claims are not identical, they are not patentably distinct from each other because they are directed to a network device using a communication link to communication among network devices based a determination or indication. For example, the current application clearly cites that communicate with the second network device (target device) using the secure communication link while the copending application uses the encrypted communication

Art Unit: 2453

channels. Such variation and clarification are cited in the dependent claims and thus they are obvious and they are not patentably distinguishable.

This is a provisional obviousness-type double patenting rejection because the conflicting claims have not in fact been patented.

15. The following is a quotation of 35 U.S.C. 103(a) which forms the basis for all obviousness rejections set forth in this Office action:

(a) A patent may not be obtained through the invention is not identically disclosed or described as set forth in section 102 of this title, if the differences between the subject matter sought to be patented and the prior art are such that the subject matter as a whole would have been obvious at the time the invention was made to a person having ordinary skill in the art to which said subject matter pertains. Patentability shall not be negated by the manner in which the invention was made.

The factual inquiries set forth in *Graham v. John Deere Co.*, 383 U.S. 1, 148 USPQ 459 (1966), that are applied for establishing a background for determining obviousness under 35 U.S.C. 103(a) are summarized as follows:

1. Determining the scope and contents of the prior art.
2. Ascertaining the differences between the prior art and the claims at issue.
3. Resolving the level of ordinary skill in the pertinent art.
4. Considering objective evidence present in the application indicating obviousness or nonobviousness.

16. Claims 1-30 are rejected under 35 U.S.C. § 103(a) as being unpatentable over VPN Overview and Aventail connect v3.1/v2.6 administrator's Guide References (hereafter VPN Overview and/or Aventail). Applicants submitted these papers in the parent application.

17. Aventail disclosed the invention substantially as claimed. Taking claims 1, 4-8, and 16 as exemplary claims, the reference disclose a network device, comprising features of:

Art Unit: 2453

send a request to look up a network address of a second network device based on an identifier associated with the second network device (e.g., Window TCP/IP network application use WinSock to gain access to networks or the Internet ... and the application executes a DNS ... and requests a connection ..., see page 8 of Aventail);

connect to the second network device, using the received network address of the second network device and communicate with the second network device using the secure communications service via the network communication link (e.g., Aventail, Page 77- Depending on the security policy and the Aventail ExtraNet Server configuration, Aventail Connect will automatically proxy their allowed application traffic into the private network. In this situation, Aventail Connect will forward traffic destined for the private internal network to the Aventail ExtraNet Server. Then, based on the security policy, the Aventail ExtraNet Server will proxy mobile user traffic into the private network but only to those resources allowed")

18. As mention above, Aventail disclosed both DNS request and VPN establish, Aventail did not explicitly detail the VPN. Such detail VPN (e.g., see Figs. 1-3 and 9, pages 6, 9, 11-12, 15, 22-28, etc.) is clearly taught by VPN Overview. Thus, it would have been obvious to one of ordinary skilled in the art to combine the teaching of Aventail with the well-known VPN (e.g., VPN Overview) so that the system with the feature of enhanced security, effectively monitoring and directing network traffic would be archived as suggested by Aventail (e.g., see page 1).

19. As to claims 2, 3, 9-15, 17-18 and 23-30, those features are well known the art at the time the invention was m, 3ade.

20. The prior art made of record and not relied upon is considered pertinent to applicant's disclosure.

The references are cited in the Form PTO-892 for the applicant's review.

A shortened statutory period for response to this action is set to expire 3 (three)

Art Unit: 2453

months and 0 (zero) days from the mail date of this letter.

Extensions of time may be available under the provisions of 37 CFR 1.136(a). In no event, however, may a reply be timely filed after SIX (6) MONTHS from the mailing date of this communication.

If NO period for reply is specified above, the maximum statutory period will apply and will expire SIX (6) MONTHS from the mailing date of this communication.

Failure to reply within the set or extended period for reply will, by statute, cause the application to become ABANDONED (35 U.S.C. § 133).

Any reply received by the Office later than three months after the mailing date of this communication, even if timely filed, may reduce any earned patent term adjustment. See 37 CFR 1.704(b).

Any inquiry concerning this communication or earlier communications from the examiner should be directed to Krisna Lim whose telephone number is 571-272-3956. The examiner can normally be reached on Tuesday to Friday from 7:10 AM to 5:40 PM.

If attempts to reach the examiner by telephone are unsuccessful, the examiner's supervisor, Krista Zele, can be reached on 571-272-7288. The fax phone number for the organization where this application or proceeding is assigned is 571-273-8300.

Information regarding the status of an application may be obtained from the Patent Application Information Retrieval (PAIR) system. Status information for published applications may be obtained from either Private PAIR or Public PAIR. Status information for unpublished applications is available through Private PAIR only. For more information about the PAIR system, see <http://pair-direct.uspto.gov>. Should you have questions on access to the Private PAIR system, contact the Electronic Business Center (EBC) at 866-217-9197 (toll-free).

KI

February 26, 2012

Application/Control Number: 13/342,795

Page 12

Art Unit: 2453

/Krisna Lim/

Primary Examiner Art Unit 2453

Notice of References Cited	Application/Control No. 13/342,795	Applicant(s)/Patent Under Reexamination LARSON ET AL.	
	Examiner KRISNA LIM	Art Unit 2453	Page 1 of 1

U.S. PATENT DOCUMENTS

*	Document Number Country Code-Number-Kind Code	Date MM-YYYY	Name	Classification
*	A	US-2009/0199258	Deng et al.	725/142
*	B	US-2009/0193513	Agarwal et al.	726/15
*	C	US-2009/0193498	Agarwal et al.	726/1
*	D	US-2008/0144625	Wu et al.	370/392
*	E	US-7,852,861	Wu et al.	370/401
*	F	US-7,584,500	Dillon et al.	726/3
*	G	US-6,813,777	Weinberger et al.	725/76
*	H	US-2005/0108517	Dillon et al.	713/150
	I	US-		
	J	US-		
	K	US-		
	L	US-		
	M	US-		

FOREIGN PATENT DOCUMENTS

*	Document Number Country Code-Number-Kind Code	Date MM-YYYY	Country	Name	Classification
	N				
	O				
	P				
	Q				
	R				
	S				
	T				

NON-PATENT DOCUMENTS

*	Document Number Country Code-Number-Kind Code	Date MM-YYYY	Country	Name	Classification
	Include as applicable: Author, Title Date, Publisher, Edition or Volume, Pertinent Pages)				
	U				
	V				
	W				
	X				

*A copy of this reference is not being furnished with this Office action. (See MPEP § 707.05(a).)
Dates in MM-YYYY format are publication dates. Classifications may be US or foreign.



UNITED STATES PATENT AND TRADEMARK OFFICE

UNITED STATES DEPARTMENT OF COMMERCE
 United States Patent and Trademark Office
 Address: COMMISSIONER FOR PATENTS
 P.O. Box 1450
 Alexandria, Virginia 22313-1450
 www.uspto.gov

BIB DATA SHEET

CONFIRMATION NO. 4180

SERIAL NUMBER 13/342,795	FILING or 371(c) DATE 01/03/2012 RULE	CLASS 709	GROUP ART UNIT 2453 77580-155(VR NK-1CP3CN FT5)	ATTORNEY DOCKET NO.	
APPLICANTS Victor Larson, Fairfax, VA; Robert Dunham Short III, Leesburg, VA; Edmond Colby Munger, Crownsville, MD; Michael Williamson, South Riding, VA;					
** CONTINUING DATA ***** This application is a CON of 13/049,552 03/16/2011 which is a CON of 11/840,560 08/17/2007 PAT 7,921,211 which is a CON of 10/714,849 11/18/2003 PAT 7,418,504 which is a CON of 09/558,210 04/26/2000 ABN which is a CIP of 09/504,783 02/15/2000 PAT 6,502,135 which is a CIP of 09/429,643 10/29/1999 PAT 7,010,604 which claims benefit of 60/106,261 10/30/1998 and claims benefit of 60/137,704 06/07/1999					
** FOREIGN APPLICATIONS *****					
** IF REQUIRED, FOREIGN FILING LICENSE GRANTED ** 01/18/2012					
Foreign Priority claimed <input type="checkbox"/> Yes <input checked="" type="checkbox"/> No 35 USC 119(a-d) conditions met <input type="checkbox"/> Yes <input checked="" type="checkbox"/> No Verified and Acknowledged /KRISNA LIM/ Examiner's Signature	<input type="checkbox"/> Met after Allowance Initials	STATE OR COUNTRY VA	SHEETS DRAWINGS 40	TOTAL CLAIMS 30	INDEPENDENT CLAIMS 2
ADDRESS McDermott Will & Emery 600 13th Street, NW Washington, DC 20005-3096 UNITED STATES					
TITLE SYSTEM AND METHOD EMPLOYING AN AGILE NETWORK PROTOCOL FOR SECURE COMMUNICATIONS USING SECURE DOMAIN NAMES					
FILING FEE RECEIVED 2150	FEES: Authority has been given in Paper No. _____ to charge/credit DEPOSIT ACCOUNT No. _____ for following:		<input type="checkbox"/> All Fees <input type="checkbox"/> 1.16 Fees (Filing) <input type="checkbox"/> 1.17 Fees (Processing Ext. of time) <input type="checkbox"/> 1.18 Fees (Issue) <input type="checkbox"/> Other _____ <input type="checkbox"/> Credit		

EAST Search History

EAST Search History (Prior Art)

Ref #	Hits	Search Query	DBs	Default Operator	Plurals	Time Stamp
L1	63	((VICTOR) near2 (LARSON)).INV.	US-PGPUB; USPAT; USOCR	OR	OFF	2012/02/23 09:27
L2	193	((ROBERT) near2 (SHORT)).INV.	US-PGPUB; USPAT; USOCR	OR	OFF	2012/02/23 09:28
L3	0	((EDMOND) near2 (MUNGER)).INV.	US-PGPUB; USPAT; USOCR	OR	OFF	2012/02/23 09:28
L4	0	((EDMOND) near2 (MUNGER)).INV.	US-PGPUB; USPAT; USOCR	OR	OFF	2012/02/23 09:29
L5	96	((MICHAEL) near2 (WILLIAMSON)).INV.	US-PGPUB; USPAT; USOCR	OR	OFF	2012/02/23 09:29
L6	108552	(secure same communication)	US-PGPUB; USPAT; USOCR; FPRS; EPO; JPO; DERWENT; IBM_TDB	OR	OFF	2012/02/23 09:39
L7	1343	(request same network same address same lookup)	US-PGPUB; USPAT; USOCR; FPRS; EPO; JPO; DERWENT; IBM_TDB	OR	OFF	2012/02/23 09:40
L8	132	l6 and l7	US-PGPUB; USPAT; USOCR; FPRS; EPO; JPO; DERWENT; IBM_TDB	OR	OFF	2012/02/23 09:40
L9	73	l8 and (VPN or (virtual same private same network))	US-PGPUB; USPAT; USOCR; FPRS; EPO; JPO; DERWENT; IBM_TDB	OR	OFF	2012/02/23 09:40
L10	46	l9 and (domain same name)	US-PGPUB; USPAT; USOCR; FPRS; EPO; JPO; DERWENT; IBM_TDB	OR	OFF	2012/02/23 09:42

2/23/2012 9:58:40 AM

Index of Claims 	Application/Control No. 13342795	Applicant(s)/Patent Under Reexamination LARSON ET AL.
	Examiner KRISNA LIM	Art Unit 2453

✓	Rejected
=	Allowed

-	Cancelled
÷	Restricted

N	Non-Elected
I	Interference

A	Appeal
O	Objected

Claims renumbered in the same order as presented by applicant
 CPA
 T.D.
 R.1.47

CLAIM		DATE							
Final	Original	02/26/2012							
	1	✓							
	2	✓							
	3	✓							
	4	✓							
	5	✓							
	6	✓							
	7	✓							
	8	✓							
	9	✓							
	10	✓							
	11	✓							
	12	✓							
	13	✓							
	14	✓							
	15	✓							
	16	✓							
	17	✓							
	18	✓							
	19	✓							
	20	✓							
	21	✓							
	22	✓							
	23	✓							
	24	✓							
	25	✓							
	26	✓							
	27	✓							
	28	✓							
	29	✓							
	30	✓							

Search Notes 	Application/Control No. 13342795	Applicant(s)/Patent Under Reexamination LARSON ET AL.
	Examiner KRISNA LIM	Art Unit 2453

SEARCHED			
Class	Subclass	Date	Examiner
709	223-227	02/23/2012	kl

SEARCH NOTES		
Search Notes	Date	Examiner
EAST, Inventors	02/23/2012	kl

INTERFERENCE SEARCH			
Class	Subclass	Date	Examiner

--	--

03-09-12

JFW

PTO/SB/21 (07-09)

Approved for use through 07/31/2012. OMB 0651-0031
 U.S. Patent and Trademark Office; U.S. DEPARTMENT OF COMMERCE

Under the Paperwork Reduction Act of 1995, no persons are required to respond to a collection of information unless it displays a valid OMB control number.

	Application Number	13/342,795
	Filing Date	01-03-2012
	First Named Inventor	Victor Larson
	Art Unit	2453
	Examiner Name	Krisna Lim
	Attorney Docket Number	77580-155(VRNK-1CP3CNFT5)
Total Number of Pages in This Submission		52

ENCLOSURES (Check all that apply)		
<input checked="" type="checkbox"/> Fee Transmittal Form	<input type="checkbox"/> Drawing(s)	<input type="checkbox"/> After Allowance Communication to TC
<input checked="" type="checkbox"/> Fee Attached	<input type="checkbox"/> Licensing-related Papers	<input type="checkbox"/> Appeal Communication to Board of Appeals and Interferences
<input type="checkbox"/> Amendment/Reply	<input type="checkbox"/> Petition	<input type="checkbox"/> Appeal Communication to TC (Appeal Notice, Brief, Reply Brief)
<input type="checkbox"/> After Final	<input type="checkbox"/> Petition to Convert to a Provisional Application	<input type="checkbox"/> Proprietary Information
<input type="checkbox"/> Affidavits/declaration(s)	<input type="checkbox"/> Power of Attorney, Revocation	<input type="checkbox"/> Status Letter
<input type="checkbox"/> Extension of Time Request	<input type="checkbox"/> Change of Correspondence Address	<input checked="" type="checkbox"/> Other Enclosure(s) (please identify below):
<input type="checkbox"/> Express Abandonment Request	<input type="checkbox"/> Terminal Disclaimer	
<input checked="" type="checkbox"/> Information Disclosure Statement	<input type="checkbox"/> Request for Refund	
<input type="checkbox"/> Certified Copy of Priority Document(s)	<input type="checkbox"/> CD, Number of CD(s) _____	
<input type="checkbox"/> Reply to Missing Parts/Incomplete Application	<input type="checkbox"/> Landscape Table on CD	
<input type="checkbox"/> Reply to Missing Parts under 37 CFR 1.52 or 1.53	Remarks 16 Boxes of Non Patent Literature documents which include; copies of references not previously submitted in a priority application (C8, C19, C21, C24; D257, D258, D261, D263, D264, D266, D292-D111P).	

SIGNATURE OF APPLICANT, ATTORNEY, OR AGENT

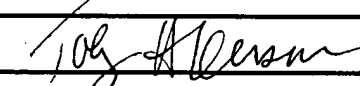
Firm Name	McDermott, Will and Emery		
Signature			
Printed name	Toby H. Kusmer		
Date	March 7, 2012	Reg. No.	26,418

CERTIFICATE OF TRANSMISSION/MAILING

I hereby certify that this correspondence is being facsimile transmitted to the USPTO or deposited with the United States Postal Service with sufficient postage as first class mail in an envelope addressed to: Commissioner for Patents, P.O. Box 1450, Alexandria, VA 22313-1450 on the date shown below:

Signature			
Typed or printed name		Date	

This collection of information is required by 37 CFR 1.5. The information is required to obtain or retain a benefit by the public which is to file (and by the USPTO to process) an application. Confidentiality is governed by 35 U.S.C. 122 and 37 CFR 1.11 and 1.14. This collection is estimated to 2 hours to complete, including gathering, preparing, and submitting the completed application form to the USPTO. Time will vary depending upon the individual case. Any comments on the amount of time you require to complete this form and/or suggestions for reducing this burden, should be sent to the Chief Information Officer, U.S. Patent and Trademark Office, U.S. Department of Commerce, P.O. Box 1450, Alexandria, VA 22313-1450. DO NOT SEND FEES OR COMPLETED FORMS TO THIS ADDRESS. SEND TO: Commissioner for Patents, P.O. Box 1450, Alexandria, VA 22313-1450.

If you need assistance in completing the form, call 1-800-PTO-9199 and select option 2.



Under the Paperwork Reduction Act of 1995 no persons are required to respond to a collection of information unless it displays a valid OMB control number.

FEE TRANSMITTAL

Complete if Known

Application Number	13/342,795
Filing Date	01-03-2012
First Named Inventor	Victor Larson
Examiner Name	Krisna Lim
Art Unit	2453
Attorney Docket No.	77580-155(VRNN-1CP3CNFT5)

Applicant claims small entity status. See 37 CFR 1.27

TOTAL AMOUNT OF PAYMENT (\$) 180.00

METHOD OF PAYMENT (check all that apply)

Check Credit Card Money Order None Other (please identify): _____

Deposit Account Deposit Account Number: 501133 Deposit Account Name: McDermott, Will and Emery

For the above-identified deposit account, the Director is hereby authorized to: (check all that apply)

Charge fee(s) indicated below Charge fee(s) indicated below, except for the filing fee

Charge any additional fee(s) or underpayments of fee(s) under 37 CFR 1.16 and 1.17 Credit any overpayments

WARNING: Information on this form may become public. Credit card information should not be included on this form. Provide credit card information and authorization on PTO-2038.

FEE CALCULATION

1. BASIC FILING, SEARCH, AND EXAMINATION FEES

Application Type	FILING FEES		SEARCH FEES		EXAMINATION FEES		Fees Paid (\$)
	Fee (\$)	Small Entity Fee (\$)	Fee (\$)	Small Entity Fee (\$)	Fee (\$)	Small Entity Fee (\$)	
Utility	380	190	620	310	250	125	_____
Design	250	125	120	60	160	80	_____
Plant	250	125	380	190	200	100	_____
Reissue	380	190	620	310	750	375	_____
Provisional	250	125	0	0	0	0	_____

2. EXCESS CLAIM FEES

Fee Description	Fee (\$)	Small Entity Fee (\$)
Each claim over 20 (including Reissues)	60	30
Each independent claim over 3 (including Reissues)	250	125
Multiple dependent claims	450	225

Total Claims	Extra Claims	Fee (\$)	Fee Paid (\$)	Multiple Dependent Claims	Fee (\$)	Fee Paid (\$)
_____ - 20 or HP = _____	x _____	= _____	_____	_____	_____	_____

HP = highest number of total claims paid for, if greater than 20.

Indep. Claims	Extra Claims	Fee (\$)	Fee Paid (\$)
_____ - 3 or HP = _____	x _____	= _____	_____

HP = highest number of independent claims paid for, if greater than 3.

3. APPLICATION SIZE FEE

If the specification and drawings exceed 100 sheets of paper (excluding electronically filed sequence or computer listings under 37 CFR 1.52(e)), the application size fee due is \$310 (\$155 for small entity) for each additional 50 sheets or fraction thereof. See 35 U.S.C. 41(a)(1)(G) and 37 CFR 1.16(s).

Total Sheets	Extra Sheets	Number of each additional 50 or fraction thereof	Fee (\$)	Fee Paid (\$)
_____ - 100 = _____	/ 50 = _____	(round up to a whole number) x _____	= _____	_____

4. OTHER FEE(S)

Description	Fee (\$)	Fees Paid (\$)
Non-English Specification,	\$130 fee (no small entity discount)	_____
Other (e.g., late filing surcharge):	Information Disclosure Statement Filing Fee of \$180.00	\$180.00

SUBMITTED BY

Signature		Registration No. (Attorney/Agent) 26,418	Telephone 617-535-4000
Name (Print/Type)	Toby H. Kusner		Date March 7, 2012

This collection of information is required by 37 CFR 1.136. The information is required to obtain or retain a benefit by the public which is to file (and by the USPTO to process) an application. Confidentiality is governed by 35 U.S.C. 122 and 37 CFR 1.14. This collection is estimated to take 30 minutes to complete, including gathering, preparing, and submitting the completed application form to the USPTO. Time will vary depending upon the individual case. Any comments on the amount of time you require to complete this form and/or suggestions for reducing this burden, should be sent to the Chief Information Officer, U.S. Patent and Trademark Office, U.S. Department of Commerce, P.O. Box 1450, Alexandria, VA 22313-1450. DO NOT SEND FEES OR COMPLETED FORMS TO THIS ADDRESS. SEND TO: Commissioner for Patents, P.O. Box 1450, Alexandria, VA 22313-1450.

If you need assistance in completing the form, call 1-800-PTO-9199 and select option 2.

Subst. for form 1449/PTO	Complete if Known	
	Application Number	13/342,795
INFORMATION DISCLOSURE STATEMENT BY APPLICANT <i>(Use as many sheets as necessary)</i>	Filing Date	01-03-2012
	First Named Inventor	Victor Larson
	Art Unit	2453
	Examiner Name	Krisna Lim
	Docket Number	77580-155(VRNL-1CP3CNFT5)

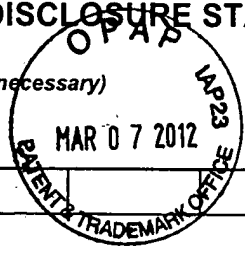

CERTIFICATION STATEMENT

Under 37 C.F.R. 1.98(d), copies of all patent, publication, pending U.S. application or other information that was previously submitted to, or cited by the USPTO in an earlier application are not required. Applicant will provide copies of the previously submitted references at the Examiner's request. **Enclosed are copies of references not previously submitted in a priority application (C8, C19, C21, C24; D257, D258, D261, D263, D264, D266, D292-D1111).**

The present application 13/342,795 claims priority from and is a continuation of a co-pending **U.S. Application No. 13/049,552, filed March 16, 2011, which is a continuation of U.S. Application No. 11/840,560, filed August 17, 2007, now U.S. Patent No. 7,921,211, which is a continuation of U.S. Application No. 10/714,849, filed November 18, 2003, now U.S. Patent No. 7,418,504, which is a continuation of U.S. Application No. 09/558,210, filed April 26, 2000, now abandoned, which is a continuation-in-part of U.S. Application No. 09/504,783, filed on February 15, 2000, now U.S. Patent No. 6,502,135, issued December 31, 2002,**

Please See 37 CFR 1.97 and 1.98 to make the appropriate selection(s)

- Information Disclosure Statement is being filed with the filing of the application or before the receipt of a first office action.
- That each item of information contained in the information disclosure statement was first cited in any communication from a foreign patent office in a counterpart foreign application not more than three months prior to the filing of the information disclosure statement; or
- That no item of information contained in the information disclosure statement was cited in a communication from a foreign patent office in a counterpart foreign application, and, to the knowledge of the person signing the certification after making reasonable inquiry, no item of information contained in the information disclosure statement was known to any individual designated in § 1.56(c) more than three months prior to the filing of the information disclosure statement.
- The Commissioner is hereby authorized to charge the fee pursuant to 37 CFR 1.17(P) in the amount of \$180.00, or further fees which may be due, to Deposit Account 50-1133.
- Information Disclosure Statement is being filed with the Request for Continued Examination. The Commissioner is hereby authorized to charge the fee pursuant to 37 CFR 1.17(P) in the amount of \$810.00, or further fees which may be due, to Deposit Account 50-1133.

SIGNATURE

A signature of the applicant or representative is required in accordance with CFR 1.33, 10.18. Please see CFR 1.4(d) for the form of the signature.

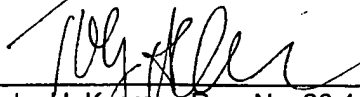
 Toby H. Kusmer, Reg. No.:26,418
 McDermott Will & Emery LLP
 28 State Street
 Boston, MA 02109
 Tel. (617) 535-4000
 Fax (617) 535-3800

Date: 3/7/12

03-09-12

JFW

PTO/SB/21 (07-09)

Approved for use through 07/31/2012. OMB 0651-0031
 U.S. Patent and Trademark Office; U.S. DEPARTMENT OF COMMERCE

Under the Paperwork Reduction Act of 1995, no persons are required to respond to a collection of information unless it displays a valid OMB control number.

 <p>Do not use for all correspondence after initial filing</p>	Application Number	13/342,795
	Filing Date	01-03-2012
	First Named Inventor	Victor Larson
	Art Unit	2453
	Examiner Name	Krisna Lim
	Attorney Docket Number	77580-155(VRnk-1CP3CNFT5)
Total Number of Pages in This Submission	52	

ENCLOSURES (Check all that apply)				
<input checked="" type="checkbox"/> Fee Transmittal Form	<input type="checkbox"/> Drawing(s)	<input type="checkbox"/> After Allowance Communication to TC		
<input checked="" type="checkbox"/> Fee Attached	<input type="checkbox"/> Licensing-related Papers	<input type="checkbox"/> Appeal Communication to Board of Appeals and Interferences		
<input type="checkbox"/> Amendment/Reply	<input type="checkbox"/> Petition	<input type="checkbox"/> Appeal Communication to TC (Appeal Notice, Brief, Reply Brief)		
<input type="checkbox"/> After Final	<input type="checkbox"/> Petition to Convert to a Provisional Application	<input type="checkbox"/> Proprietary Information		
<input type="checkbox"/> Affidavits/declaration(s)	<input type="checkbox"/> Power of Attorney, Revocation	<input type="checkbox"/> Status Letter		
<input type="checkbox"/> Extension of Time Request	<input type="checkbox"/> Change of Correspondence Address	<input checked="" type="checkbox"/> Other Enclosure(s) (please identify below):		
<input type="checkbox"/> Express Abandonment Request	<input type="checkbox"/> Terminal Disclaimer			
<input checked="" type="checkbox"/> Information Disclosure Statement	<input type="checkbox"/> Request for Refund			
<input type="checkbox"/> Certified Copy of Priority Document(s)	<input type="checkbox"/> CD, Number of CD(s) _____			
<input type="checkbox"/> Reply to Missing Parts/ Incomplete Application	<input type="checkbox"/> Landscape Table on CD			
<input type="checkbox"/> Reply to Missing Parts under 37 CFR 1.52 or 1.53				
<table border="1"> <tr> <th>Remarks</th> </tr> <tr> <td>16 Boxes of Non Patent Literature documents which include; copies of references not previously submitted in a priority application (C8, C19, C21, C24; D257, D258, D261, D263, D264, D266, D292-D1111P).</td> </tr> </table>			Remarks	16 Boxes of Non Patent Literature documents which include; copies of references not previously submitted in a priority application (C8, C19, C21, C24; D257, D258, D261, D263, D264, D266, D292-D1111P).
Remarks				
16 Boxes of Non Patent Literature documents which include; copies of references not previously submitted in a priority application (C8, C19, C21, C24; D257, D258, D261, D263, D264, D266, D292-D1111P).				

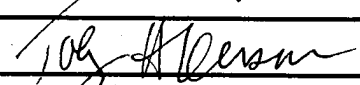
SIGNATURE OF APPLICANT, ATTORNEY, OR AGENT			
Firm Name	McDermott, Will and Emery		
Signature			
Printed name	Toby H. Kusmer		
Date	March 7, 2012	Reg. No.	26,418

CERTIFICATE OF TRANSMISSION/MAILING		
I hereby certify that this correspondence is being facsimile transmitted to the USPTO or deposited with the United States Postal Service with sufficient postage as first class mail in an envelope addressed to: Commissioner for Patents, P.O. Box 1450, Alexandria, VA 22313-1450 on the date shown below:		
Signature		
Typed or printed name		Date

This collection of information is required by 37 CFR 1.5. The information is required to obtain or retain a benefit by the public which is to file (and by the USPTO to process) an application. Confidentiality is governed by 35 U.S.C. 122 and 37 CFR 1.11 and 1.14. This collection is estimated to 2 hours to complete, including gathering, preparing, and submitting the completed application form to the USPTO. Time will vary depending upon the individual case. Any comments on the amount of time you require to complete this form and/or suggestions for reducing this burden, should be sent to the Chief Information Officer, U.S. Patent and Trademark Office, U.S. Department of Commerce, P.O. Box 1450, Alexandria, VA 22313-1450. DO NOT SEND FEES OR COMPLETED FORMS TO THIS ADDRESS. SEND TO: Commiissioner for Patents, P.O. Box 1450, Alexandria, VA 22313-1450.

If you need assistance in completing the form, call 1-800-PTO-9199 and select option 2.

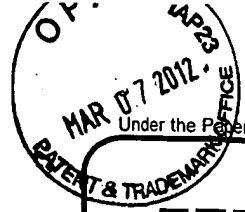

Under the Paperwork Reduction Act of 1995 no persons are required to respond to a collection of information unless it displays a valid OMB control number.

FEE TRANSMITTAL

Complete if Known

Application Number	13/342,795
Filing Date	01-03-2012
First Named Inventor	Victor Larson
Examiner Name	Krisna Lim
Art Unit	2453
Attorney Docket No.	77580-155(VR NK-1CP3CNFT5)

Applicant claims small entity status. See 37 CFR 1.27

TOTAL AMOUNT OF PAYMENT (\$) 180.00

METHOD OF PAYMENT (check all that apply)

Check Credit Card Money Order None Other (please identify): _____

Deposit Account Deposit Account Number: 501133 Deposit Account Name: McDermott, Will and Emery

For the above-identified deposit account, the Director is hereby authorized to: (check all that apply)

Charge fee(s) indicated below Charge fee(s) indicated below, except for the filing fee

Charge any additional fee(s) or underpayments of fee(s) under 37 CFR 1.16 and 1.17 Credit any overpayments

WARNING: Information on this form may become public. Credit card information should not be included on this form. Provide credit card information and authorization on PTO-2038.

FEE CALCULATION

1. BASIC FILING, SEARCH, AND EXAMINATION FEES

Application Type	FILING FEES		SEARCH FEES		EXAMINATION FEES		Fees Paid (\$)
	Fee (\$)	Small Entity Fee (\$)	Fee (\$)	Small Entity Fee (\$)	Fee (\$)	Small Entity Fee (\$)	
Utility	380	190	620	310	250	125	_____
Design	250	125	120	60	160	80	_____
Plant	250	125	380	190	200	100	_____
Reissue	380	190	620	310	750	375	_____
Provisional	250	125	0	0	0	0	_____

2. EXCESS CLAIM FEES

Fee Description	Fee (\$)	Small Entity Fee (\$)
Each claim over 20 (including Reissues)	60	30
Each independent claim over 3 (including Reissues)	250	125
Multiple dependent claims	450	225

Total Claims	Extra Claims	Fee (\$)	Fee Paid (\$)	Multiple Dependent Claims	Fee (\$)	Fee Paid (\$)
_____ - 20 or HP = _____	x _____	= _____	_____	_____	_____	_____

HP = highest number of total claims paid for, if greater than 20.

Indep. Claims	Extra Claims	Fee (\$)	Fee Paid (\$)
_____ - 3 or HP = _____	x _____	= _____	_____

HP = highest number of independent claims paid for, if greater than 3.

3. APPLICATION SIZE FEE

If the specification and drawings exceed 100 sheets of paper (excluding electronically filed sequence or computer listings under 37 CFR 1.52(e)), the application size fee due is \$310 (\$155 for small entity) for each additional 50 sheets or fraction thereof. See 35 U.S.C. 41(a)(1)(G) and 37 CFR 1.16(s).

Total Sheets	Extra Sheets	Number of each additional 50 or fraction thereof	Fee (\$)	Fee Paid (\$)
_____ - 100 = _____	/ 50 = _____	(round up to a whole number) x _____	= _____	_____

4. OTHER FEE(S)

Description	Amount	Fees Paid (\$)
Non-English Specification,	\$130 fee (no small entity discount)	_____
Other (e.g., late filing surcharge): Information Disclosure Statement Filing Fee of \$180.00		\$180.00

SUBMITTED BY

Signature		Registration No. (Attorney/Agent) 26,418	Telephone 617-535-4000
Name (Print/Type)	Toby H. Kusner		Date March 7, 2012

This collection of information is required by 37 CFR 1.136. The information is required to obtain or retain a benefit by the public which is to file (and by the USPTO to process) an application. Confidentiality is governed by 35 U.S.C. 122 and 37 CFR 1.14. This collection is estimated to take 30 minutes to complete, including gathering, preparing, and submitting the completed application form to the USPTO. Time will vary depending upon the individual case. Any comments on the amount of time you require to complete this form and/or suggestions for reducing this burden, should be sent to the Chief Information Officer, U.S. Patent and Trademark Office, U.S. Department of Commerce, P.O. Box 1450, Alexandria, VA 22313-1450. DO NOT SEND FEES OR COMPLETED FORMS TO THIS ADDRESS. SEND TO: Commissioner for Patents, P.O. Box 1450, Alexandria, VA 22313-1450.

If you need assistance in completing the form, call 1-800-PTO-9199 and select option 2.

Subst. for form 1449/PTO INFORMATION DISCLOSURE STATEMENT BY APPLICANT <i>(Use as many sheets as necessary)</i>	Complete if Known	
	Application Number	13/342,795
	Filing Date	01-03-2012
	First Named Inventor	Victor Larson
	Art Unit	2453
	Examiner Name	Krisna Lim
	Docket Number	77580-155(VR NK-1CP3CNFT5)

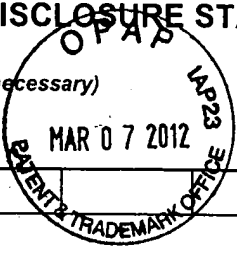

CERTIFICATION STATEMENT

Under 37 C.F.R. 1.98(d), copies of all patent, publication, pending U.S. application or other information that was previously submitted to, or cited by the USPTO in an earlier application are not required. Applicant will provide copies of the previously submitted references at the Examiner's request. **Enclosed are copies of references not previously submitted in a priority application (C8, C19, C21, C24; D257, D258, D261, D263, D264, D266, D292-D1111).**

The present application 13/342,795 claims priority from and is a continuation of a co-pending **U.S. Application No. 13/049,552, filed March 16, 2011, which is a continuation of U.S. Application No. 11/840,560, filed August 17, 2007, now U.S. Patent No. 7,921,211, which is a continuation of U.S. Application No. 10/714,849, filed November 18, 2003, now U.S. Patent No. 7,418,504, which is a continuation of U.S. Application No. 09/558,210, filed April 26, 2000, now abandoned, which is a continuation-in-part of U.S. Application No. 09/504,783, filed on February 15, 2000, now U.S. Patent No. 6,502,135, issued December 31, 2002,**

Please See 37 CFR 1.97 and 1.98 to make the appropriate selection(s)

- Information Disclosure Statement is being filed with the filing of the application or before the receipt of a first office action.
- That each item of information contained in the information disclosure statement was first cited in any communication from a foreign patent office in a counterpart foreign application not more than three months prior to the filing of the information disclosure statement; or
- That no item of information contained in the information disclosure statement was cited in a communication from a foreign patent office in a counterpart foreign application, and, to the knowledge of the person signing the certification after making reasonable inquiry, no item of information contained in the information disclosure statement was known to any individual designated in § 1.56(c) more than three months prior to the filing of the information disclosure statement.
- The Commissioner is hereby authorized to charge the fee pursuant to 37 CFR 1.17(P) in the amount of \$180.00, or further fees which may be due, to Deposit Account 50-1133.
- Information Disclosure Statement is being filed with the Request for Continued Examination. The Commissioner is hereby authorized to charge the fee pursuant to 37 CFR 1.17(P) in the amount of \$810.00, or further fees which may be due, to Deposit Account 50-1133.

SIGNATURE

A signature of the applicant or representative is required in accordance with CFR 1.33, 10.18. Please see CFR 1.4(d) for the form of the signature.

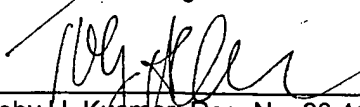
 Toby H. Kusmer, Reg. No.:26,418
 McDermott Will & Emery LLP
 28 State Street
 Boston, MA 02109
 Tel. (617) 535-4000
 Fax (617) 535-3800

Date: 3/7/12

03-09-12

TFW

Approved for use through 07/31/2012. OMB 0651-0031
 U.S. Patent and Trademark Office; U.S. DEPARTMENT OF COMMERCE

Under the Paperwork Reduction Act of 1995, no persons are required to respond to a collection of information unless it displays a valid OMB control number.

 <p>Do not use for all correspondence after initial filing)</p>	Application Number	13/342,795	
	Filing Date	01-03-2012	
	First Named Inventor	Victor Larson	
	Art Unit	2453	
	Examiner Name	Krisna Lim	
Total Number of Pages in This Submission	52	Attorney Docket Number	77580-155(VRNK-1CP3CNFT5)

ENCLOSURES (Check all that apply)		
<input checked="" type="checkbox"/> Fee Transmittal Form	<input type="checkbox"/> Drawing(s)	<input type="checkbox"/> After Allowance Communication to TC
<input checked="" type="checkbox"/> Fee Attached	<input type="checkbox"/> Licensing-related Papers	<input type="checkbox"/> Appeal Communication to Board of Appeals and Interferences
<input type="checkbox"/> Amendment/Reply	<input type="checkbox"/> Petition	<input type="checkbox"/> Appeal Communication to TC (Appeal Notice, Brief, Reply Brief)
<input type="checkbox"/> After Final	<input type="checkbox"/> Petition to Convert to a Provisional Application	<input type="checkbox"/> Proprietary Information
<input type="checkbox"/> Affidavits/declaration(s)	<input type="checkbox"/> Power of Attorney, Revocation	<input type="checkbox"/> Status Letter
<input type="checkbox"/> Extension of Time Request	<input type="checkbox"/> Change of Correspondence Address	<input checked="" type="checkbox"/> Other Enclosure(s) (please identify below):
<input type="checkbox"/> Express Abandonment Request	<input type="checkbox"/> Terminal Disclaimer	
<input checked="" type="checkbox"/> Information Disclosure Statement	<input type="checkbox"/> Request for Refund	
<input type="checkbox"/> Certified Copy of Priority Document(s)	<input type="checkbox"/> CD, Number of CD(s) _____	
<input type="checkbox"/> Reply to Missing Parts/ Incomplete Application	<input type="checkbox"/> Landscape Table on CD	
<input type="checkbox"/> Reply to Missing Parts under 37 CFR 1.52 or 1.53	Remarks 16 Boxes of Non Patent Literature documents which include; copies of references not previously submitted in a priority application (C8, C19, C21, C24; D257, D258, D261, D263, D264, D266, D292-D111f).	

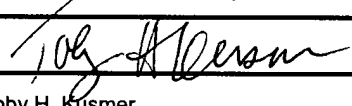
SIGNATURE OF APPLICANT, ATTORNEY, OR AGENT			
Firm Name	McDermott, Will and Emery		
Signature			
Printed name	Toby H. Kusmer		
Date	March 7, 2012	Reg. No.	26,418

CERTIFICATE OF TRANSMISSION/MAILING			
I hereby certify that this correspondence is being facsimile transmitted to the USPTO or deposited with the United States Postal Service with sufficient postage as first class mail in an envelope addressed to: Commissioner for Patents, P.O. Box 1450, Alexandria, VA 22313-1450 on the date shown below:			
Signature			
Typed or printed name		Date	

This collection of information is required by 37 CFR 1.5. The information is required to obtain or retain a benefit by the public which is to file (and by the USPTO to process) an application. Confidentiality is governed by 35 U.S.C. 122 and 37 CFR 1.11 and 1.14. This collection is estimated to 2 hours to complete, including gathering, preparing, and submitting the completed application form to the USPTO. Time will vary depending upon the individual case. Any comments on the amount of time you require to complete this form and/or suggestions for reducing this burden, should be sent to the Chief Information Officer, U.S. Patent and Trademark Office, U.S. Department of Commerce, P.O. Box 1450, Alexandria, VA 22313-1450. DO NOT SEND FEES OR COMPLETED FORMS TO THIS ADDRESS. SEND TO: Commissioner for Patents, P.O. Box 1450, Alexandria, VA 22313-1450.

If you need assistance in completing the form, call 1-800-PTO-9199 and select option 2.

Subst. for form 1449/PTO		Complete if Known	
INFORMATION DISCLOSURE STATEMENT BY APPLICANT <i>(Use as many sheets as necessary)</i>		Application Number	13/342,795
		Filing Date	01-03-2012
		First Named Inventor	Victor Larson
		Art Unit	2453
		Examiner Name	Krisna Lim
		Docket Number	77580-155(VRNL-1CP3CNFT5)

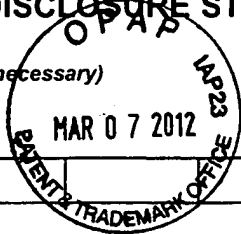

CERTIFICATION STATEMENT

Under 37 C.F.R. 1.98(d), copies of all patent, publication, pending U.S. application or other information that was previously submitted to, or cited by the USPTO in an earlier application are not required. Applicant will provide copies of the previously submitted references at the Examiner's request. **Enclosed are copies of references not previously submitted in a priority application (C8, C19, C21, C24; D257, D258, D261, D263, D264, D266, D292-D1111).**

The present application 13/342,795 claims priority from and is a continuation of a co-pending **U.S. Application No. 13/049,552, filed March 16, 2011, which is a continuation of U.S. Application No. 11/840,560, filed August 17, 2007, now U.S. Patent No. 7,921,211, which is a continuation of U.S. Application No. 10/714,849, filed November 18, 2003, now U.S. Patent No. 7,418,504, which is a continuation of U.S. Application No. 09/558,210, filed April 26, 2000, now abandoned, which is a continuation-in-part of U.S. Application No. 09/504,783, filed February 15, 2000, now U.S. Patent No. 6,502,135, issued December 31, 2002.**

Please See 37 CFR 1.97 and 1.98 to make the appropriate selection(s)

- Information Disclosure Statement is being filed with the filing of the application or before the receipt of a first office action.
- That each item of information contained in the information disclosure statement was first cited in any communication from a foreign patent office in a counterpart foreign application not more than three months prior to the filing of the information disclosure statement; or
- That no item of information contained in the information disclosure statement was cited in a communication from a foreign patent office in a counterpart foreign application, and, to the knowledge of the person signing the certification after making reasonable inquiry, no item of information contained in the information disclosure statement was known to any individual designated in § 1.56(c) more than three months prior to the filing of the information disclosure statement.
- The Commissioner is hereby authorized to charge the fee pursuant to 37 CFR 1.17(P) in the amount of \$180.00, or further fees which may be due, to Deposit Account 50-1133.
- Information Disclosure Statement is being filed with the Request for Continued Examination. The Commissioner is hereby authorized to charge the fee pursuant to 37 CFR 1.17(P) in the amount of \$810.00, or further fees which may be due, to Deposit Account 50-1133.

SIGNATURE

A signature of the applicant or representative is required in accordance with CFR 1.33, 10.18. Please see CFR 1.4(d) for the form of the signature.

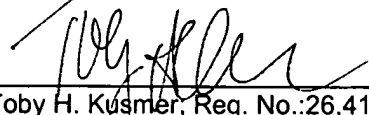
 Toby H. Kusmer, Reg. No.: 26,418
 McDermott Will & Emery LLP
 28 State Street
 Boston, MA 02109
 Tel. (617) 535-4000
 Fax (617) 535-3800

Date: 3/7/12

03/12/2012 HVUONG1 00000003 501133 13342795
 01 FC:1806 180.00 DA



Under the Paperwork Reduction Act of 1995 no persons are required to respond to a collection of information unless it displays a valid OMB control number

FEE TRANSMITTAL

Complete if Known

Application Number	13/342,795
Filing Date	01-03-2012
First Named Inventor	Victor Larson
Examiner Name	Krisna Lim
Art Unit	2453
Attorney Docket No.	77580-155(VR NK-1CP3CNFT5)

Applicant claims small entity status. See 37 CFR 1.27

TOTAL AMOUNT OF PAYMENT (\$) 180.00

METHOD OF PAYMENT (check all that apply)

Check Credit Card Money Order None Other (please identify): _____

Deposit Account Deposit Account Number: 501133 Deposit Account Name: McDermott, Will and Emery

For the above-identified deposit account, the Director is hereby authorized to: (check all that apply)

Charge fee(s) indicated below Charge fee(s) indicated below, except for the filing fee

Charge any additional fee(s) or underpayments of fee(s) under 37 CFR 1.16 and 1.17 Credit any overpayments

WARNING: Information on this form may become public. Credit card information should not be included on this form. Provide credit card information and authorization on PTO-2038.

FEE CALCULATION

1. BASIC FILING, SEARCH, AND EXAMINATION FEES

Application Type	FILING FEES		SEARCH FEES		EXAMINATION FEES		Fees Paid (\$)
	Fee (\$)	Small Entity Fee (\$)	Fee (\$)	Small Entity Fee (\$)	Fee (\$)	Small Entity Fee (\$)	
Utility	380	190	620	310	250	125	_____
Design	250	125	120	60	160	80	_____
Plant	250	125	380	190	200	100	_____
Reissue	380	190	620	310	750	375	_____
Provisional	250	125	0	0	0	0	_____

2. EXCESS CLAIM FEES

Fee Description	Fee (\$)	Small Entity Fee (\$)
Each claim over 20 (including Reissues)	60	30
Each independent claim over 3 (including Reissues)	250	125
Multiple dependent claims	450	225

Total Claims _____ **Extra Claims** _____ **Fee (\$)** _____ **Fee Paid (\$)** _____
 - 20 or HP = _____ x _____ = _____

HP = highest number of total claims paid for, if greater than 20.

Indep. Claims _____ **Extra Claims** _____ **Fee (\$)** _____ **Fee Paid (\$)** _____
 - 3 or HP = _____ x _____ = _____

HP = highest number of independent claims paid for, if greater than 3.

3. APPLICATION SIZE FEE

If the specification and drawings exceed 100 sheets of paper (excluding electronically filed sequence or computer listings under 37 CFR 1.52(e)), the application size fee due is \$310 (\$155 for small entity) for each additional 50 sheets or fraction thereof. See 35 U.S.C. 41(a)(1)(G) and 37 CFR 1.16(s).

Total Sheets	Extra Sheets	Number of each additional 50 or fraction thereof	Fee (\$)	Fee Paid (\$)
_____	_____	_____ / 50 = _____ (round up to a whole number)	_____ x _____ = _____	_____

4. OTHER FEE(S)

Non-English Specification, \$130 fee (no small entity discount) Fees Paid (\$)
 Other (e.g., late filing surcharge): Information Disclosure Statement Filing Fee of \$180.00 \$180.00

SUBMITTED BY

Signature		Registration No. (Attorney/Agent) 26,418	Telephone 617-535-4000
Name (Print/Type)	Toby H. Kusner		Date March 7, 2012

This collection of information is required by 37 CFR 1.136. The information is required to obtain or retain a benefit by the public which is to file (and by the USPTO to process) an application. Confidentiality is governed by 35 U.S.C. 122 and 37 CFR 1.14. This collection is estimated to take 30 minutes to complete, including gathering, preparing, and submitting the completed application form to the USPTO. Time will vary depending upon the individual case. Any comments on the amount of time you require to complete this form and/or suggestions for reducing this burden, should be sent to the Chief Information Officer, U.S. Patent and Trademark Office, U.S. Department of Commerce, P.O. Box 1450, Alexandria, VA 22313-1450. DO NOT SEND FEES OR COMPLETED FORMS TO THIS ADDRESS. SEND TO: Commissioner for Patents, P.O. Box 1450, Alexandria, VA 22313-1450.

If you need assistance in completing the form, call 1-800-PTO-9199 and select option 2.

**INFORMATION DISCLOSURE STATEMENT
BY APPLICANT**

(Use as many sheets as necessary)

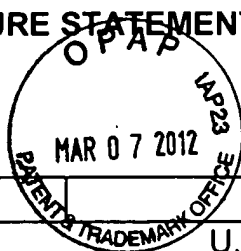
**Complete if Known**

Application Number	13/342,795
Filing Date	01-03-2012
First Named Inventor	Victor Larson
Art Unit	2453
Examiner Name	Krisna Lim
Docket Number	77580-155(VR NK-1CP3CNFT5)

U.S. PATENTS

EXAMINER'S INITIALS	CITE NO.	Patent Number	Publication Date	Name of Patentee or Applicant of Cited Document	Pages, Columns, Lines, Where Relevant Passages or Relevant Figures Appear
		Patent Number	Patent Date	Inventor	
	A1	09/399,753	09/22/1998	Graig Miller et al.	
	A2	2,895,502	07/21/1959	Roper et al.	
	A3	4,761,334	08/1988	Sagoi et al.	
	A4	4,885,778	12/5/1989	Weiss, Kenneth	
	A5	4,920,484	4/24/1990	Ranade	
	A6	4,933,846	06/12/1990	Humphrey et al.	
	A7	4,952,930	08/28/1990	Franaszek et al.	
	A8	4,988,990	01/29/1991	Warrior	
	A9	5,164,988	11/17/1992	Matyas	
	A10	5,204,961	04/20/1993	Barlow	
	A11	5,276,735	01/04/1994	Boebert et al	
	A12	5,303,302	04/12/1994	Burrows	
	A13	5,311,593	05/10/1994	Carmi	
	A14	5,329,521	07/12/1994	Walsh et al.	
	A15	5,341,426	08/23/1994	Barney et al.	
	A16	5,367,643	11/22/1994	Chang et al	
	A17	5,384,848	01/24/1995	Kikuchi	
	A18	5,511,122	04/23/1996	Atkinson	
	A19	5,548,646	08/20/1996	Aziz et al.	
	A20	5,559,883	09/24/1996	Williams	
	A21	5,561,669	10/01/1996	Lenney et al	
	A22	5,588,060	12/24/1996	Aziz	
	A23	5,590,285	12/31/1996	Krause et al.	
	A24	5,625,626	04/29/1997	Umekita	
	A25	5,629,984	05/13/1997	McManis	
	A26	5,654,695	08/05/1997	Olnowich et al	
	A27	5,682,480	10/28/1997	Nakagawa	
	A28	5,689,566	11/18/1997	Nguyen	
	A29	5,689,641	11/18/1997	Ludwig et al.	
	A30	5,740,375	04/14/1998	Dunne et al.	
	A31	5,757,925	05/1998	Faybishenko	
	A32	5,764,906	06/1998	Edelstein et al.	
	A33	5,771,239	06/23/1998	Moroney et al.	
	A34	5,774,660	6/30/1998	Brendel et al	
	A35	5,787,172	07/28/1998	Arnold	
	A36	5,790,548	08/04/1998	Sitaraman et al.	
	A37	5,796,942	08/18/1998	Esbensen	
	A38	5,805,801	09/08/1998	Holloway et al.	
	A39	5,805,803	09/08/1998	Birrell et al.	
	A40	5,822,434	10/13/1998	Caronni et al.	
	A41	5,842,040	11/24/1998	Hughes et al.	
	A42	5,845,091	12/01/1998	Dunne et al.	
	A43	5,864,666	01/1999	Shrader, Theodore Jack London	
	A44	5,867,650	02/02/1998	Osterman	
	A45	5,870,610	02/09/1999	Beyda et al.	
	A46	5,878,231	05/02/1999	Baehr et al	
	A47	5,892,903	04/06/1999	Klaus	
	A48	5,898,830	04/27/1999	Wesinger, Jr. et al.	
	A49	5,905,859	05/18/1999	Holloway et al.	
	A50	5,918,018	06/29/1999	Gooderum et al.	

**INFORMATION DISCLOSURE STATEMENT
BY APPLICANT***(Use as many sheets as necessary)***Complete if Known**

Application Number	13/342,795
Filing Date	01-03-2012
First Named Inventor	Victor Larson
Art Unit	2453
Examiner Name	Krisna Lim
Docket Number	77580-155(VR NK-1CP3CNFT5)

	A51		5,918,019	06/29/1999	Valencia
	A52		5,950,195	09/07/1999	Stockwell et al.
	A53		5,950,519	09/14/1999	Anatoli
	A54		5,960,204	09/28/1999	Yinger et al.
	A55		5,996,016	11/30/1999	Thalheimer et al.
	A56		6,006,259	12/21/1999	Adelman et al.
	A57		6,006,272	12/21/1999	Aravamudan et al
	A58		6,016,318	01/18/2000	Tomoike
	A59		6,016,512	01/18/2000	Huitema
	A60		6,041,342	03/21/2000	Yamaguchi
	A61		6,052,788	04/2000	Wesinger et al.
	A62		6,055,574	04/25/2000	Smorodinsky et al.
	A63		6,061,346	05/2000	Nordman, Mikael
	A64		6,061,736	05/09/2000	Rochberger et al
	A65		6,079,020	06/20/2000	Liu
	A66		6,081,900	06/2000	Subramaniam et al.
	A67		6,092,200	07/18/2000	Muniyappa et al.
	A68		6,101,182	08/2000	Sistanizadeh et al.
	A69		6,119,171	09/12/2000	Alkhatib
	A70		6,119,234	09/12/2000	Aziz et al.
	A71		6,147,976	11/14/2000	Shand et al.
	A72		6,157,957	12/05/2000	Berthaud
	A73		6,158,011	12/05/2000	Chen et al.
	A74		6,168,409	01/02/2001	Fare
	A75		6,173,399	01/09/2001	Gilbrech
	A76		6,175,867	01/16/2001	Taghadoss
	A77		6,178,409	01/23/2001	Weber et al.
	A78		6,178,505	01/23/2001	Schneider et al
	A79		6,179,102	01/30/2001	Weber, et al.
	A80		6,182,141	1/30/2001	Blum et al.
	A81		6,199,112	03/2001	Wilson, Stephen K.
	A82		6,202,081	03/2001	Naudus, Stanley T.
	A83		6,222,842	04/24/2001	Sasyan et al.
	A84		6,223,287	04/24/2001	Douglas et al.
	A85		6,226,748	05/01/2001	Bots et al.
	A86		6,226,751	05/01/2001	Arrow et al..
	A87		6,233,618	05/15/2001	Shannon
	A88		6,243,360	06/05/2001	Basilico
	A89		6,243,749	06/05/2001	Sitaraman et al.
	A90		6,243,754	06/05/2001	Guerin et al
	A91		6,246,670	06/12/2001	Karlsson et al.
	A92		6,256,671	07/03/2001	Strentzsch et al.
	A93		6,262,987	07/17/01	Mogul, Jeffrey C.
	A94		6,263,445	07/17/2001	Blumenau
	A95		6,269,099	07/31/2001	Borella et al.
	A96		6,286,047	09/04/2001	Ramanathan et al
	A97		6,298,341	10/02/01	Mann, et al.
	A98		6,301,223	10/9/2001	Hrastar et al
	A99		6,308,213	10/23/2001	Valencia
	A100		6,308,274	10/23/2001	Swift
	A101		6,311,207	10/30/2001	Mighdoll et al
	A102		6,314,463	11/2001	Abbott et al.
	A103		6,324,161	11/27/2001	Kirch
	A104		6,330,562	12/11/2001	Boden et al.
	A105		6,332,158	12/18/2001	Risley et al.
	A106		6,333,272	12/25/01	McMillin, et al.
	A107		6,338,082	01/08/02	Schneider, Eric

Complete if Known**INFORMATION DISCLOSURE STATEMENT
BY APPLICANT***(Use as many sheets as necessary)*

Application Number	13/342,795
Filing Date	01-03-2012
First Named Inventor	Victor Larson
Art Unit	2453
Examiner Name	Krisna Lim
Docket Number	77580-155(VR NK-1CP3CNFT5)

A108	6,353,614	03/05/2002	Borella et al.		
A109	6,425,003	07/23/2002	Herzog et al.		
A110	6,430,155	08/06/2002	Davie et al.		
A111	6,430,610	08/06/2002	Carter		
A112	6,487,598	11/26/2002	Valencia		
A113	6,496,867	12/17/2002	Beser et al.		
A114	6,502,135	12/2002	Munger et al.		
A115	6,505,232	01/07/2003	Mighdoll et al.		
A116	6,510,154	01/21/2003	Mayes et al.		
A117	6,549,516	04/15/2003	Albert et al.		
A118	6,557,037	04/2003	Provino, Joseph E.		
A119	6,560,634	05/06/2003	Broadhurst		
A120	6,571,296	05/27/2002	Dillon		
A121	6,571,338	05/27/2003	Shaio et al.		
A122	6,581,166	7/17/2003	Hirst et al.		
A123	6,606,708	08/12/2003	Devine et al.		
A124	6,615,357	9/2/2003	Boden et al.		
A125	6,618,761	09/09/2003	Munger et al.		
A126	6,671,702	12/30/2003	Kruglikov et al.		
A127	6,687,551	2/3/2004	Steindl		
A128	6,687,746	02/03/04	Shuster, et al.		
A129	6,701,437	03/02/2004	Hoke et al.		
A130	6,714,970	3/30/2004	Fiveash et al.		
A131	6,717,949	4/6/2004	Boden et al.		
A132	6,751,738	06/15/2004	Wesinger, Jr. et al..		
A133	6,752,166	06/22/04	Lull, et al.		
A134	6,757,740	06/29/04	Parekh, et al.		
A135	6,760,766	7/6/2004	Sahlqvist		
A136	6,813,777	11/2004	Weinberger et al.		
A137	6,826,616	11/30/2004	Larson et al.		
A138	6,839,759	1/4/2005	Larson et al.		
A139	6,937,597	08/30/2005	Rosenberg et al.		
A140	60/134,547	05/17/1999	Victory Sheymov		
A141	60/151,563	08/31/1999	Bryan Whittles		
A142	7,010,604	3/7/2006	Munger et al.		
A143	7,039,713	05/2006	Van Gunter et al.		
A144	7,072,964	07/04/2006	Whittle et al.		
A145	7,133,930	11/7/2006	Munger et al.		
A146	7,167,904	01/23/07	Devarajan, et al.		
A147	7,188,175	03/06/07	McKeeth, James A.		
A148	7,188,180	3/6/2007	Larson et al.		
A149	7,197,563	3/27/2007	Sheymov et al.		
A150	7,353,841	04/08/08	Kono, et al.		
A151	7,418,504	08/2008	Larson et al.		
A152	7,461,334	12/02/08	Lu, et al.		
A153	7,490,151	02/2009	Munger et al.		
A154	7,493,403	02/2009	Shull et al.		
A155	7,584,500	09/2009	Dillon et al.		
A156	7,764,231	07/27/2010	Karr et al.		
A157	7,852,861	12/2010	Wu et al.		
A158	7,921,211	04/2011	Larson et al.		
A159	7,933,990	04/2011	Munger et al.		
A160	8,051,181	11/2011	Larson et al.		

Subst. for form 1449/PTO				Complete if Known	
INFORMATION DISCLOSURE STATEMENT BY APPLICANT <i>(Use as many sheets as necessary)</i>				Application Number	13/342,795
				Filing Date	01-03-2012
				First Named Inventor	Victor Larson
				Art Unit	2453
				Examiner Name	Krisna Lim
				Docket Number	77580-155(VRNL-1CP3CNFT5)

U.S. PATENT APPLICATION PUBLICATIONS

EXAMINER'S INITIALS	CITE NO.	Patent Number	Publication Date	Name of Patentee or Applicant of Cited Document	Pages, Columns, Lines, Where Relevant Passages or Relevant Figures Appear
	B1	US2001/0049741	12/2001	Skene et al.	
	B2	US2002/0004898	1/10/02	Droge	
	B3	US2003/0196122	10/16/2003	Wesinger, Jr. et al.	
	B4	US2004/0199493	10/2004	Ruiz et al.	
	B5	US2004/0199520	10/2004	Ruiz et al.	
	B6	US2004/0199608	10/2004	Rechterman et al.	
	B7	US2004/0199620	10/2004	Ruiz et al.	
	B8	US2005/0055306	3/10/05	Miller et al.	
	B9	US2005/0108517	05/2005	Dillon et al.	
	B10	US2006/0059337	03/16/2006	Polyhonen et al.	
	B11	US2006/0123134	06/2006	Munger et al.	
	B12	US2007/0208869	09/2007	Adelman et al.	
	B13	US2007/0214284	09/2007	King et al.	
	B14	US2007/0266141	11/2007	Norton, Michael Anthony	
	B15	US2008/0005792	01/2008	*Larson et al.	
	B16	US2008/0144625	06/2008	Wu et al.	
	B17	US2008/0235507	09/2008	Ishikawa et al.	
	B18	US2009/0193498	07/2009	Agarwal et al.	
	B19	US2009/0193513	07/2009	Agarwal et al.	
	B20	US2009/0199258	08/2009	Deng et al.	
	B21	US2009/0199285	09/2009	Agarwal et al.	

FOREIGN PATENT DOCUMENTS

EXAMINER'S INITIALS	CITE NO.	Foreign Patent Document Country Code3 – Number 4 –Kind Code5 <i>(if known)</i>	Publication Date	Name of Patentee or Applicant of Cited Document	Pages, Columns, Lines Where Relevant Figures Appear	Translation	
						Yes	No
	C1	DE19924575	12/2/99	Provino et al.			
	C2	EP0814589	12/29/1997	AT&T Corp.			
	C3	EP0838930	4/29/1988	Digital Equipment Corporation			
	C4	EP0858189	8/12/98	Maciel et al.			
	C5	EP836306	4/15/1998	HEWLETT PACKARD CO			
	C6	GB2317792	04/01/1998	Secure Computing Corporation			
	C7	GB2334181	08/11/1999	NEC Technologies			
	C8	GB2340702	02/23/2000	Sun Microsystems Inc.			
	C9	JP04-363941	12/16/1992	Nippon Telegr & Teleph Corp			
	C10	JP09-018492	01/17/1997	Nippon Telegr & Teleph Corp			
	C11	JP10-070531	03/10/1998	Brother Ind Ltd.			
	C12	JP62-214744	9/21/1987	Hitachi Ltd.			
	C13	WO0070458	11/23/2000	Comsec Corporation			
	C14	WO0017775	3/30/00	Miller et al.			
	C15	WO01016766	03/08/2001	Science Applications International Corporation			
	C16	WO0150688	7/12/01	Kriens			
	C17	WO9827783	06/25/1998	Northern Telecom Limited			
	C18	WO9855930	12/10/98	Tang			

Subst. for form 1449/PTO				Complete if Known			
INFORMATION DISCLOSURE STATEMENT BY APPLICANT <i>(Use as many sheets as necessary)</i>				Application Number		13/342,795	
				Filing Date		01-03-2012	
				First Named Inventor		Victor Larson	
				Art Unit		2453	
				Examiner Name		Krisna Lim	
				Docket Number		77580-155(VRNL-1CP3CNFT5)	
	C19	WO9843396	10/01/1998	Northern Telecom Limited			
	C20	WO9859470	12/30/98	Kanter et al.			
	C21	WO9911019	03/04/1999	V One Corp			
	C22	WO9938081	7/29/99	Paulsen et al.			
	C23	WO9948303	9/23/99	Cox et al.			
	C24	WO01/61922	02/12/2001	Science Application International Corporation			

OTHER ART (Including Author, Title, Date, Pertinent Pages, Etc.)

EXAMINE R'S INITIALS	CITE NO.	Include name of the author (in CAPITAL LETTERS), title of the article (when appropriate), title of the item (book, magazine, journal, serial, symposium, catalog, etc.), date, page(s), volume-issue number(s), publisher, city and/or country where published.
	D1	Alan O. Frier et al., "The SSL Protocol Version 3.0", Nov. 18, 1996, printed from http://www.netscape.com/eng/ss13/draft302.txt on Feb. 4, 2002, 56 pages.
	D2	August Bequai, "Balancing Legal Concerns Over Crime and Security in Cyberspace", Computer & Security, vol. 17, No. 4, 1998, pp. 293-298.
	D3	D. B. Chapman et al., "Building Internet Firewalls", Nov. 1995, pp. 278-375.
	D4	D. Clark, "US Calls for Private Domain-Name System", Computer, IEEE Computer Society, Aug. 1, 1998, pp. 22-25.
	D5	Davila J et al, "Implementation of Virtual Private Networks at the Transport Layer", Information Security, Second International Work-shop, ISW'99. Proceedings (Lecture Springer-Verlag Berlin, Germany, [Online] 1999, pp. 85-102, XP002399276, ISBN 3-540-666
	D6	Dolev, Shlomi and Ostrovsky, Rafil, "Efficient Anonymous Multicast and Reception" (Extended Abstract), 16 pages.
	D7	Donald E. Eastlake, 3rd, "Domain Name System Security Extensions", INTERNET DRAFT, Apr. 1998, pp. 1-51.
	D8	F. Halsall, "Data Communications, Computer Networks and Open Systems", Chapter 4, Protocol Basics, 1996, pp. 198-203.
	D9	Glossary for the Linux FreeS/WAN project, printed from http://liberty.freeswan.org/freeswan_trees/freeswan-1.3/doc/glossary.html on Feb. 21, 2002, 25 pages.
	D10	J. Gilmore, "Swan: Securing the Internet against Wiretapping", printed from http://liberty.freeswan.org/freeswan_trees/freeswan-1.3/doc/rationale.html on Feb. 21, 2002, 4 pages.
	D11	James E. Bellaire, "New Statement of Rules-Naming Internet Domains", Internet Newsgroup, Jul. 30, 1995, 1 page.
	D12	Jim Jones et al., "Distributed Denial of Service Attacks: Defenses", Global Integrity Corporation, 2000, pp. 1-14.
	D13	Laurie Wells (LANCASTERBIBELMAIL MSN COM); "Subject: Security Icon" USENET Newsgroup, Oct. 19, 1998, XP002200606, 1 page.
	D14	Linux FreeS/WAN Index File, printed from http://liberty.freewan.org/freeswan_trees/freeswan-1.3/doc/ on Feb. 21, 2002, 3 Pages.
	D15	P. Srisuresh et al., "DNS extensions to Network address Translators (DNS_ALG)", Internet Draft, Jul. 1998, pp. 1-27.
	D16	Reiter, Michael K. and Rubin, Aviel D. (AT&T Labs-Research), "Crowds: Anonymity for Web Transactions", pp. 1-23.
	D17	RFC 2401 (dated Nov. 1998) Security Architecture for the Internet Protocol (RTP)
	D18	RFC 2543-SIP (dated March 1999): Session Initiation Protocol (SIP or SIPS)
	D19	Rich Winkel, "CAQ: Networking With Spooks: The NET & The Control Of Information", Internet Newsgroup, Jun. 21, 1997, 4 pages.
	D20	Rubin, Aviel D., Geer, Daniel, and Ranum, Marcus J. (Wiley Computer Publishing), "Web Security Sourcebook", pp. 82-94.
	D21	Search Report (dated Aug. 20, 2002), International Application No. PCT/US01/04340.
	D22	Search Report (dated Aug. 23, 2002), International Application No. PCT/US01/13260.
	D23	Search Report (dated Oct. 7, 2002), International Application No. PCT/US01/13261.

Subst. for form 1449/PTO INFORMATION DISCLOSURE STATEMENT BY APPLICANT <i>(Use as many sheets as necessary)</i>		Complete if Known	
		Application Number	13/342,795
		Filing Date	01-03-2012
		First Named Inventor	Victor Larson
		Art Unit	2453
		Examiner Name	Krisna Lim
		Docket Number	77580-155(VRNL-1CP3CNFT5)
D24	Search Report, IPER (dated Nov. 13, 2002), International Application No. PCT/US01/04340.		
D25	Search Report, IPER (dated Feb. 06, 2002), International Application No. PCT/US01/13261.		
D26	Search Report, IPER (dated Jan. 14, 2003), International Application No. PCT/US01/13260.		
D27	Shankar, A.U. "A verified sliding window protocol with variable flow control". Proceedings of ACM SIGCOMM conference on Communications architectures & protocols. pp. 84-91, ACM Press, NY, NY 1986.		
D28	Shree Murthy et al., "Congestion-Oriented Shortest Multi-path Routing", Proceedings of IEEE INFOCOM, 1996, pp. 1028-1036.		
D29	W. Stallings, "Cryptography And Network Security", 2nd, Edition, Chapter 13, IP Security, Jun. 8, 1998, pp. 399-440.		
D30	Microsoft Corporation's Fourth Amended Invalidity Contentions dated Jan. 5, 2009, VirnetX Inc. and Science Applications International Corp. v. Microsoft Corporation.		
D31	Appendix A of the Microsoft Corporation's Fourth Amended Invalidity Contentions dated Jan. 5, 2009.		
D32	Concordance Table For the References Cited in Tables on pages 6-15, 71-80 and 116-124 of the Microsoft Corporation's Fourth Amended Invalidity Contentions dated Jan. 5, 2009.		
D33	1. P. Mockapetris, "DNS Encoding of Network Names and Other Types," Network Working Group, RFC 1101 (April 1989) RFC1101, DNS SRV)		
D34	R. Atkinson, "An Internetwork Authentication Architecture," Naval Research Laboratory, Center for High Assurance Computing Systems (8/5/93). (Atkinson NRL, KX Records)		
D35	Henning Schulzrinne, <i>Personal Mobility For Multimedia Services In The Internet</i> , Proceedings of the Interactive Distributed Multimedia Systems and Services European Workshop at 143 (1996). (Schulzrinne 96)		
D36	Microsoft Corp., <i>Microsoft Virtual Private Networking: Using Point-to-Point Tunneling Protocol for Low-Cost, Secure, Remote Access Across the Internet</i> (1996) (printed from 1998 PDC DVD-ROM). (Point to Point, Microsoft Prior Art VPN Technology)		
D37	"Safe Surfing: How to Build a Secure World Wide Web Connection," IBM Technical Support Organization, (March 1996). (Safe Surfing, WEBSITE ART)		
D38	Goldschlag, et al., "Hiding Routing Information," Workshop on Information Hiding, Cambridge, UK (May 1996). (Goldschlag II, Onion Routing)		
D39	"IPSec Minutes From Montreal", IPSEC Working Group Meeting Notes, http://www.sandleman.ca/ipsec/1996/08/msg00018.html (June 1996). (IPSec Minutes, FreeS/WAN)		
D40	J. M. Galvin, "Public Key Distribution with Secure DNS," Proceedings of the Sixth USENIX UNIX Security Symposium, San Jose, California, July 1996. (Galvin, DNSSEC)		
D41	J. Gilmore, et al. "Re: Key Management, anyone? (DNS Keying)," IPsec Working Group Mailing List Archives (8/96). (Gilmore DNS, FreeS/WAN)		
D42	H. Orman, et al. "Re: 'Re: DNS? was Re: Key Management, anyone?' IETF IPsec Working Group Mailing List Archive (8/96-9/96). (Orman DNS, FreeS/WAN)		
D43	Arnt Gulbrandsen & Paul Vixie, <i>A DNS RR for specifying the location of services (DNS SRV)</i> , IETF RFC 2052 (October 1996). (RFC 2052, DNS SRV)		
D44	Freier, et al. "The SSL Protocol Version 3.0," Transport Layer Security Working Group (November 18, 1996). (SSL, UNDERLYING SECURITY TECHNOLOGY)		
D45	M. Handley, H. Schulzrinne, E. Schooler, Internet Engineering Task Force, Internet Draft, (12/02/1996). (RFC 2543 Internet Draft 1)		
D46	M.G. Reed, et al. "Proxies for Anonymous Routing," 12th Annual Computer Security Applications Conference, San Diego, CA, Dec. 9-13, 1996. (Reed, Onion Routing)		
D47	Kenneth F. Alden & Edward P. Wobber, <i>The AltaVista Tunnel: Using the Internet to Extend Corporate Networks</i> , Digital Technical Journal (1997) (Alden, AltaVista)		
D48	Automotive Industry Action Group, "ANX Release 1 Document Publication," AIAG (1997). (AIAG, ANX)		
D49	Automotive Industry Action Group, "ANX Release 1 Draft Document Publication," AIAG Publications (1997). (AIAG Release, ANX)		
D50	Aventail Corp. "Aventail VPN Data Sheet," available at http://www.archive.org/web/19970212013043/www.aventail.com/prod/vpndata.html (1997). (Data Sheet, Aventail)		
D51	Aventail Corp., "Directed VPN Vs. Tunnel," available at http://web.archive.org/web/19970620030312/www.aventail.com/educate/directvpn.html (1997). (Directed VPN, Aventail)		

Subst. for form 1449/PTO INFORMATION DISCLOSURE STATEMENT BY APPLICANT <i>(Use as many sheets as necessary)</i>		Complete if Known	
		Application Number	13/342,795
		Filing Date	01-03-2012
		First Named Inventor	Victor Larson
		Art Unit	2453
		Examiner Name	Krisna Lim
		Docket Number	77580-155(VRNC-1CP3CNFT5)
D52	Aventail Corp., "Managing Corporate Access to the Internet," Aventail AutoSOCKS White Paper available at http://web.archive.org/199706200300312/www.aventail.com/educate/whitepaper/ipmw.html (1997). (Corporate Access, Aventail)		
D53	Aventail Corp., "VPN Server V2.0 Administration Guide," (1997). (VPN, Aventail)		
D54	Goldschlag, et al. "Privacy on the Internet," Naval Research Laboratory, Center for High Assurance Computer Systems (1997). (Goldschlag I, Onion Routing)		
D55	Microsoft Corp., <i>Installing Configuring and Using PPTP with Microsoft Clients and Servers</i> (1997). (Using PPTP, Microsoft Prior Art VPN Technology)		
D56	Microsoft Corp., <i>IP Security for Microsoft Windows NT Server 5.0</i> (1997) (printed from 1998 PDC DVD-ROM). (IP Security, Microsoft Prior Art VPN Technology)		
D57	Microsoft Corp., <i>Microsoft Windows NT Active Directory: An Introduction to the Next Generation Directory Services</i> (1997) (printed from 1998 PDC DVD-ROM). (Directory, Microsoft Prior Art VPN Technology)		
D58	Microsoft Corp., <i>Routing and Remote Access Service for Windows NT Server New Opportunities Today and Looking Ahead</i> (1997) (printed from 1998 PDC DVD-ROM). Routing, Microsoft Prior Art VPN Technology)		
D59	Microsoft Corp., <i>Understanding Point-to-Point Tunneling Protocol PPTP</i> (1997) (printed from 1998 PDC DVD-ROM). (Understanding PPTP, Microsoft Prior Art VPN Technology)		
D60	J. Mark Smith et al., <i>Protecting a Private Network: The AltaVista Firewall</i> , Digital Technical Journal (1997). (Smith, AltaVista)		
D61	Naganand Doraswamy <i>Implementation of Virtual Private Networks (VPNs) with IP Security</i> , <draft-ietf-ipsec-vpn-00.txt> (March 12, 1997). (Doraswamy)		
D62	M. Handley, H. Schulzrinne, E. Schooler, Internet Engineering Task Force, Internet Draft, (03/27/1997). (RFC 2543 Internet Draft 2)		
D63	Aventail Corp., "Aventail and Cybersafe to Provide Secure Authentication For Internet and Intranet Communication," Press Release, April 3, 1997. (Secure Authentication, Aventail)		
D64	D. Wagner, et al. "Analysis of the SSL 3.0 Protocol," (April 15, 1997). (Analysis, UNDERLYING SECURITY TECHNOLOGIES)		
D65	Automotive Industry Action Group, "ANXO Certification Authority Service and Directory Service Definition for ANX Release 1," AIAG Telecommunications Project Team and Bellcore (May 9, 1997). (AIAG Definition, ANX)		
D66	Automotive Industry Action Group, "ANXO Certification Process and ANX Registration Process Definition for ANX Release 1," AIAG Telecommunications Project Team and Bellcore (May 9, 1997). (AIAG Certification, ANX)		
D67	Aventail Corp., "Aventail Announces the First VPN Solution to Assure Interoperability Across Emerging Security Protocols," June 2, 1997. (First VPN, Aventail)		
D68	Syverson, et al. "Private Web Browsing," Naval Research Laboratory, Center for High Assurance Computer Systems (June 2, 1997). (Syverson, Onion Routing)		
D69	Bellcore, "Metrics, Criteria, and Measurement Technique Requirements for ANX Release 1," AIAG Telecommunications Project Team and Bellcore (June 16, 1997). (AIAG Requirements, ANX)		
D70	M. Handley, H. Schulzrinne, E. Schooler, Internet Engineering Task Force, Internet Draft, (07/31/1997). (RFC 2543 Internet Draft 3)		
D71	R. Atkinson, "Key Exchange Delegation Record for the DNS," Network Working Group, RFC 2230 (November 1997). (RFC 2230, KX Records)		
D72	M. Handley, H. Schulzrinne, E. Schooler, Internet Engineering Task Force, Internet Draft, (11/11/1997). (RFC 2543 Internet Draft 4)		
D73	1998 Microsoft Professional Developers Conference DVD ("1998 PDC DVD-ROM") (including screenshots captured there from and produced as MSFTVX 00018827-00018832). (Conference, Microsoft Prior Art VPN Technology)		
D74	Microsoft Corp., <i>Virtual Private Networking An Overview</i> (1998) (printed from 1998 PDC DVD-ROM) (Overview, Microsoft Prior Art VPN Technology)		
D75	Microsoft Corp., <i>Windows NT 5.0 Beta Has Public Premiere at Seattle Mini-Camp Seminar attendees get first look at the performance and capabilities of Windows NT 5.0</i> (1998) (available at http://www.microsoft.com/presspass/features/1998/10-19nt5.mspxpfrue). (NT Beta, Microsoft Prior Art VPN Technology)		
D76	"What ports does SSL use" available at stason.org/TULARC/security/ssl-talk/3-4-What-ports-does-ssl-use.html (1998). (Ports, DNS SRV)		

Subst. for form 1449/PTO INFORMATION DISCLOSURE STATEMENT BY APPLICANT <i>(Use as many sheets as necessary)</i>		Complete if Known	
		Application Number	13/342,795
		Filing Date	01-03-2012
		First Named Inventor	Victor Larson
		Art Unit	2453
		Examiner Name	Krisna Lim
		Docket Number	77580-155(VR NK-1CP3CNFT5)
D77	Aventail Corp., "Aventail VPN V2.6 Includes Support for More Than Ten Authentication Methods Making Extranet VPN Development Secure and Simple," Press Release, January 19, 1998. (VPN V2.6, Aventail)		
D78	R. G. Moskowitz, "Network Address Translation Issues with IPsec," Internet Draft, Internet Engineering Task Force, February 6, 1998. (Moskowitz)		
D79	H. Schulzrinne, et al, "Internet Telephony Gateway Location," Proceedings of IEEE Infocom '98, The Conference on Computer Communications, Vol. 2 (March 29 – April 2, 1998). (Gateway, Schulzrinne)		
D80	C. Huitema, 45 al. "Simple Gateway Control Protocol," Version 1.0 (May 5, 1998). (SGCP)		
D81	DISA "Secret Internet Protocol Router Network," SIPRNET Program Management Office (D3113) DISN Networks, DISN Transmission Services (May 8, 1998). DISA, SIPRNET)		
D82	M. Handley, H. Schulzrinne, E. Schooler, Internet Engineering Task Force, Internet Draft, (05/14/1998). (RFC 2543 Internet Draft 5)		
D83	M. Handley, H. Schulzrinne, E. Schooler, Internet Engineering Task Force, Internet Draft, (06/17/1998). (RFC 2543 Internet Draft 6)		
D84	D. McDonald, et al. "PF_KEY Key Management API, Version 2," Network Working Group, RFC 2367 (July 1998). (RFC 2367)		
D85	M. Handley, H. Schulzrinne, E. Schooler, Internet Engineering Task Force, Internet Draft, (07/16/1998). (RFC 2543 Internet Draft 7)		
D86	M. Handley, H. Schulzrinne, E. Schooler, Internet Engineering Task Force, Internet Draft, (08/07/1998). (RFC 2543 Internet Draft 8)		
D87	Microsoft Corp., <i>Company Focuses on Quality and Customer Feedback</i> (August 18, 1998). (Focus, Microsoft Prior Art VPN Technology)		
D88	M. Handley, H. Schulzrinne, E. Schooler, Internet Engineering Task Force, Internet Draft, (09/18/1998). (RFC 2543 Internet Draft 9)		
D89	Atkinson, et al. "Security Architecture for the Internet Protocol," Network Working Group, RFC 2401 (November 1998). (RFC 2401, UNDERLYING SECURITY TECHNOLOGIES)		
D90	M. Handley, H. Schulzrinne, E. Schooler, Internet Engineering Task Force, Internet Draft, (11/12/1998). (RFC 2543 Internet Draft 10)		
D91	Donald Eastlake, <i>Domain Name System Security Extensions</i> , IETF DNS Security Working Group (December 1998). (DNSSEC-7)		
D92	M. Handley, H. Schulzrinne, E. Schooler, Internet Engineering Task Force, Internet Draft, (12/15/1998). (RFC 2543 Internet Draft 11)		
D93	Aventail Corp., "Aventail Connect 3.1/2.6 Administrator's Guide," (1999). (Aventail Administrator 3.1, Aventail)		
D94	Aventail Corp., "Aventail Connect 3.1/2.6 User's Guide," (1999). (Aventail User 3.1, Aventail)		
D95	Aventail Corp., "Aventail ExtraWeb Server v3.2 Administrator's Guide," (1999). (Aventail ExtraWeb 3.2, Aventail)		
D96	Kaufman et al, "Implementing IPsec," (Copyright 1999). (Implementing IPSEC, VPN REFERENCES)		
D97	Network Solutions, Inc. "Enabling SSL," NSI Registry (1999). (Enabling SSL, UNDERLYING SECURITY TECHNOLOGIES)		
D98	Check Point Software Technologies Ltd. (1999) (Check Point, Checkpoint FW)		
D99	Arnt Gulbrandsen & Paul Vixie, <i>A DNS RR for specifying the location of services (DNS SRV)</i> , <draft-ietf-dnsind-frc2052bis-02.txt> (January 1999). (Gulbrandsen 99, DNS SRV)		
D100	C. Scott, et al. <i>Virtual Private Networks</i> , O'Reilly and Associates, Inc., 2nd ed. (Jan. 1999). Scott VPNs)		
D101	M. Handley, H. Schulzrinne, E. Schooler, Internet Engineering Task Force, Internet Draft, (01/15/1999). (RFC 2543 Internet Draft 12)		
D102	Goldschlag, et al., "Onion Routing for Anonymous and Private Internet Connections," Naval Research Laboratory, Center for High Assurance Computer Systems (January 28, 1999). (Goldschlag III, Onion Routing)		
D103	H. Schulzrinne, "Internet Telephony: architecture and protocols – an IETF perspective," Computer Networks, Vol. 31, No. 3 (February 1999). (Telephony, Schulzrinne)		
D104	M. Handley, et al. "SIP: Session Initiation Protocol," Network Working Group, RFC 2543 and Internet Drafts (12/96-3/99). (Handley, RFC 2543)		
D105	FreeSWAN Project, <i>Linux FreeS/WAN Compatibility Guide</i> (March 4, 1999). (FreeSWAN Compatibility Guide, FreeSWAN)		

**INFORMATION DISCLOSURE STATEMENT
BY APPLICANT***(Use as many sheets as necessary)***Complete if Known**

Application Number	13/342,795
Filing Date	01-03-2012
First Named Inventor	Victor Larson
Art Unit	2453
Examiner Name	Krisna Lim
Docket Number	77580-155(VRNL-1CP3CNFT5)

D106	Telcordia Technologies, "ANX Release 1 Document Corrections," AIAG (May 11, 1999). (Telcordia, ANX)
D107	Ken Hornstein & Jeffrey Altman, <i>Distributing Kerberos KDC and Realm Information with DNS</i> <draft-eif-cat-krb-dns-locate-oo.txt> (June 21, 1999). (Hornstein, DNS SRV)
D108	Bhattacharya, et al., "An LDAP Schema for Configuration and Administration of IPsec Based Virtual Private Networks (VPNs)", IETF Internet Draft (October 1999). (Bhattacharya LDAP VPN)
D109	B. Patel, et al. "DHCP Configuration of IPSEC Tunnel Mode," IPSEC Working Group, Internet Draft 02 (10/15/1999). (Patel)
D110	Goncalves, et al. <i>Check Point FireWall-1 Administration Guide</i> , McGraw-Hill Companies (2000). (Goncalves, Checkpoint FW)
D111	"Building a Microsoft VPN: A Comprehensive Collection of Microsoft Resources," FirstVPN, (Jan 2000). (FirstVPN Microsoft)
D112	Gulbrandsen, Vixie, & Esibov, <i>A DNS RR for specifying the location of services (DNS SRV)</i> , IETF RFC 2782 (February 2000). (RFC 2782, DNS SRV)
D113	MITRE Organization, "Technical Description," Collaborative Operations in Joint Expeditionary Force Experiment (JEFX) 99 (February 2000). (MITRE, SIPRNET)
D114	H. Schulzrinne, et al. "Application-Layer Mobility Using SIP," <i>Mobile Computing and Communications Review</i> , Vol. 4, No. 3. pp. 47-57 (July 2000). (Application, SIP)
D115	Kindred et al, "Dynamic VPN Communities: Implementation and Experience," DARPA Information Survivability Conference and Exposition II (June 2001). (DARPA, VPN SYSTEMS)
D116	ANX 101: Basic ANX Service Outline. (Outline, ANX)
D117	ANX 201: Advanced ANX Service. (Advanced, ANX)
D118	Appendix A: Certificate Profile for ANX IPsec Certificates. (Appendix, ANX)
D119	Assured Digital Products. (Assured Digital)
D120	Aventail Corp., "Aventail AutoSOCKS the Client Key to Network Security," Aventail Corporation White Paper. (Network Security, Aventail)
D121	Cindy Moran, "DISN Data Networks: Secret Internet Protocol Router Network (SIPRNet)." (Moran, SIPRNET)
D122	Data Fellows F-Secure VPN+ (F-Secure VPN+)
D123	"Interim Operational Systems Doctrine for the Remote Access Security Program (RASP) Secret Dial-In Solution. (RASP, SIPRNET)
D124	<i>Onion Routing</i> , "Investigation of Route Selection Algorithms," available at http://www.onion-router.net/Archives/Route/index.html . (Route Selection, Onion Routing)
D125	Secure Computing, "Bullet-Proofing an Army Net," Washington Technology. (Secure, SIPRNET)
D126	SPARTA "Dynamic Virtual Private Network." (Sparta, VPN SYSTEMS)
D127	Standard Operation Procedure for Using the 1910 Secure Modems. (Standard, SIPRNET)
D128	Publicly available emails relating to FreeSWAN (MSFTVX00018833-MSFTVX00019206). (FreeSWAN emails, FreeSWAN)
D129	Kaufman et al., "Implementing IPsec," (Copyright 1999) (Implementing IPsec)
D130	Network Associates <i>Gauntlet Firewall For Unix User's Guide Version 5.0</i> (1999). (Gauntlet User's Guide - Unix, Firewall Products)
D131	Network Associates <i>Gauntlet Firewall For Windows NT Getting Started Guide Version 5.0</i> (1999) (Gauntlet Getting Started Guide - NT, Firewall Products)
D132	Network Associates <i>Gauntlet Firewall For Unix Getting Started Guide Version 5.0</i> (1999) (Gauntlet Unix Getting Started Guide, Firewall Products)
D133	Network Associates <i>Release Notes Gauntlet Firewall for Unix 5.0</i> (March 19, 1999) (Gauntlet Unix Release Notes, Firewall Products)
D134	Network Associates <i>Gauntlet Firewall For Windows NT Administrator's Guide Version 5.0</i> (1999) (Gauntlet NT Administrator's Guide, Firewall Products)
D135	Trusted Information Systems, Inc. <i>Gauntlet Internet Firewall Firewall-to-Firewall Encryption Guide Version 3.1</i> (1996) (Gauntlet Firewall-to-Firewall, Firewall Products)
D136	Network Associates <i>Gauntlet Firewall Global Virtual Private Network User's Guide for Windows NT Version 5.0</i> (1999) (Gauntlet NT GVPN, GVPN)
D137	Network Associates <i>Gauntlet Firewall For UNIX Global Virtual Private Network User's Guide Version 5.0</i> (1999) (Gauntlet Unix GVPN, GVPN)
D138	Dan Sterne <i>Dynamic Virtual Private Networks</i> (May 23, 2000) (Sterne DVPN, DVPN)
D139	Darrell Kindred <i>Dynamic Virtual Private Networks (DVPN)</i> (December 21, 1999) (Kindred DVPN, DVPN)

Subst. for form 1449/PTO INFORMATION DISCLOSURE STATEMENT BY APPLICANT <i>(Use as many sheets as necessary)</i>		Complete if Known	
		Application Number	13/342,795
		Filing Date	01-03-2012
		First Named Inventor	Victor Larson
		Art Unit	2453
		Examiner Name	Krisna Lim
		Docket Number	77580-155(VRNL-1CP3CNFT5)
D140	Dan Sterne <i>et al.</i> <i>TIS Dynamic Security Perimeter Research Project Demonstration</i> (March 9, 1998) (Dynamic Security Perimeter, DVPN)		
D141	Darrell Kindred <i>Dynamic Virtual Private Networks Capability Description</i> (January 5, 2000) (Kindred DVPN Capability, DVPN) 11		
D142	October 7, and 28 1997 email from Domenic J. Turchi Jr. (SPARTA00001712-1714, 1808-1811) (Turchi DVPN email, DVPN)		
D143	James Just & Dan Sterne <i>Security Quickstart Task Update</i> (February 5, 1997) (Security Quickstart, DVPN)		
D144	Virtual Private Network Demonstration dated March 21, 1998 (SPARTA00001844-54) (DVPN Demonstration, DVPN)		
D145	GTE Internetworking & BBN Technologies DARPA <i>Information Assurance Program Integrated Feasibilit Demonstration (IFD) 1.1 Plan</i> (March 10, 1998) (IFD 1.1, DVPN)		
D146	Microsoft Corp. Windows NT Server Product Documentation: Administration Guide - Connection Point Services, <i>available at</i> http://www.microsoft.com/technet/archive/winntas/proddocs/inetconctservice/cpsops.mspx (Connection Point Services) (Although undated, this reference refers to the operation of prior art versions of Microsoft Windows. Accordingly, upon information and belief, this reference is prior art to the patents-in-suit.)		
D147	Microsoft Corp. Windows NT Server Product Documentation: Administration Kit Guide - Connection Manager, <i>available at</i> http://www.microsoft.com/technet/archive/winntas/proddocs/inetconctservice/cmak.mspx (Connection Manager) (Although undated, this reference refers to the operation of prior art versions of Microsoft Windows such as Windows NT 4.0. Accordingly, upon information and belief, this reference is prior art to the patents-in-suit.)		
D148	Microsoft Corp. Autodial Heuristics, <i>available at</i> http://support.microsoft.com/kb/164249 (Autodial Heuristics) (Although undated, this reference refers to the operation of prior art versions of Microsoft Windows such as Windows NT 4.0. Accordingly, upon information and belief, this reference is prior art to the patents-in-suit.)		
D149	Microsoft Corp., Cariplo: Distributed Component Object Model, (1996) <i>available at</i> http://msdn2.microsoft.com/en-us/library/ms809332(printer).aspx (Cariplo I)		
D150	Marc Levy, COM Internet Services (Apr. 23, 1999), <i>available at</i> http://msdn2.microsoft.com/en-us/library/ms809302(printer).aspx (Levy)		
D151	Markus Horstmann and Mary Kirtland, DCOM Architecture (July 23, 1997), <i>available at</i> http://msdn2.microsoft.com/en-us/library/ms809311(printer).aspx (Horstmann)		
D152	Microsoft Corp., DCOM: A Business Overview (Apr. 1997), <i>available at</i> http://msdn2.microsoft.com/en-us/library/ms809320(printer).aspx (DCOM Business Overview I)		
D153	Microsoft Corp., DCOM Technical Overview (Nov. 1996), <i>available at</i> http://msdn2.microsoft.com/en-us/library/ms809340(printer).aspx (DCOM Technical Overview I)		
D154	Microsoft Corp., DCOM Architecture White Paper (1998) <i>available in</i> PDC DVD-ROM (DCOM Architecture)		
D155	Microsoft Corp, DCOM – The Distributed Component Object Model, A Business Overview White Paper (Microsoft 1997) <i>available in</i> PDC DVD-ROM (DCOM Business Overview II)		
D156	Microsoft Corp., DCOM - Cariplo Home Banking Over The Internet White Paper Microsoft 1996) <i>available in</i> PDC DVD-ROM (Cariplo II)		
D157	Microsoft Corp., DCOM Solutions in Action White Paper (Microsoft 1996) <i>available in</i> PDC DVD-ROM (DCOM Solutions in Action)		
D158	Microsoft Corp., DCOM Technical Overview White Paper (Microsoft 1996) <i>available 12 in</i> PDC DVD-ROM (DCOM Technical Overview II)		
D159	125. Scott Suhy & Glenn Wood, DNS and Microsoft Windows NT 4.0, (1996) <i>available at</i> http://msdn2.microsoft.com/en-us/library/ms810277(printer).aspx (Suhy)		
D160	126. Aaron Skonnard, <i>Essential Wininet</i> 313-423 (Addison Wesley Longman 1998) (Essential Wininet)		
D161	Microsoft Corp. Installing, Configuring, and Using PPTP with Microsoft Clients and Servers, (1998) <i>available at</i> http://msdn2.microsoft.com/enus/library/ms811078(printer).aspx (Using PPTP)		
D162	Microsoft Corp., Internet Connection Services for MS RAS, Standard Edition, http://www.microsoft.com/technet/archive/winntas/proddocs/inetconctservice/bcgstart.mspx (Internet Connection Services I)		

Subst. for form 1449/PTO INFORMATION DISCLOSURE STATEMENT BY APPLICANT <i>(Use as many sheets as necessary)</i>			Complete if Known	
			Application Number	13/342,795
			Filing Date	01-03-2012
			First Named Inventor	Victor Larson
			Art Unit	2453
			Examiner Name	Krisna Lim
			Docket Number	77580-155(VR NK-1CP3CNFT5)
D163	Microsoft Corp., Internet Connection Services for RAS, Commercial Edition, <i>available at</i> http://www.microsoft.com/technet/archive/winntas/proddocs/inetconctservice/bcgstrtc.mspx (Internet Connection Services II)			
D164	Microsoft Corp., Internet Explorer 5 Corporate Deployment Guide – Appendix B: Enabling Connections with the Connection Manager Administration Kit, <i>available at</i> http://www.microsoft.com/technet/prodtechnol/ie/deploy/deploy5/appendb.mspx (IE5 Corporate Development)			
D165	Mark Minasi, <i>Mastering Windows NT Server 4</i> 1359-1442 (6th ed., January 15, 1999) (Mastering Windows NT Server)			
D166	<i>Hands On, Self-Paced Training for Supporting Version 4.0</i> 371-473 (Microsoft Press 1998) (Hands On)			
D167	Microsoft Corp., MS Point-to-Point Tunneling Protocol (Windows NT 4.0), <i>available at</i> http://www.microsoft.com/technet/archive/winntas/maintain/featusability/pptpwp3.mspx (MS PPTP)			
D168	Kenneth Gregg, <i>et al.</i> , <i>Microsoft Windows NT Server Administrator's Bible</i> 173-206, 883-911, 974-1076 (IDG Books Worldwide 1999) (Gregg)			
D169	Microsoft Corp., Remote Access (Windows), <i>available at</i> http://msdn2.microsoft.com/enus/library/bb545687(VS.85.printer).aspx (Remote Access)			
D170	Microsoft Corp., Understanding PPTP (Windows NT 4.0), <i>available at</i> http://www.microsoft.com/technet/archive/winntas/plan/pptpudst.mspx (Understanding PPTP NT 4) (Although undated, this reference refers to the operation of prior art versions of Microsoft Windows such as Windows NT 4.0. Accordingly, upon information and belief, this reference is prior art to the patents-in-suit.)			
D171	Microsoft Corp., Windows NT 4.0: Virtual Private Networking, <i>available at</i> http://www.microsoft.com/technet/archive/winntas/deploy/confeat/vpntwk.mspx (NT4 VPN) (Although undated, this reference refers to the operation of prior art versions of Microsoft Windows such as Windows NT 4.0. Accordingly, upon information and belief, this reference is prior art to the patents-in-suit.)			
D172	Anthony Northrup, <i>NT Network Plumbing: Routers, Proxies, and Web Services</i> 299-399 (IDG Books Worldwide 1998) (Network Plumbing)			
D173	Microsoft Corp., Chapter 1 - Introduction to Windows NT Routing with Routing and Remote Access Service, <i>available at</i> http://www.microsoft.com/technet/archive/winntas/proddocs/rras40/rrasch01.mspx (Intro to RRAS) (Although undated, this reference refers to the operation of prior art versions of Microsoft Windows such as Windows NT 4.0. Accordingly, upon information and belief, this reference is prior art to the patents-in-suit.) 13			
D174	Microsoft Corp., Windows NT Server Product Documentation: Chapter 5 - Planning for Large-Scale Configurations, <i>available at</i> http://www.microsoft.com/technet/archive/winntas/proddocs/rras40/rrasch05.mspx (Large-Scale Configurations) (Although undated, this reference refers to the operation of prior art versions of Microsoft Windows such as Windows NT 4.0. Accordingly, upon information and belief, this reference is prior art to the patents-in-suit.)			
D175	F-Secure, <i>F-Secure NameSurfer</i> (May 1999) (from FSECURE 00000003) (NameSurfer 3)			
D176	F-Secure, <i>F-Secure VPN Administrator's Guide</i> (May 1999) (from FSECURE 00000003) (F-Secure VPN 3)			
D177	F-Secure, <i>F-Secure SSH User's & Administrator's Guide</i> (May 1999) (from FSECURE 00000003) (SSH Guide 3)			
D178	F-Secure, <i>F-Secure SSH2.0 for Windows NT and 95</i> (May 1999) (from FSECURE 00000003) (SSH 2.0 Guide 3)			
D179	F-Secure, <i>F-Secure VPN+ Administrator's Guide</i> (May 1999) (from FSECURE 00000003) (VPN+ Guide 3)			
D180	F-Secure, <i>F-Secure VPN+ 4.1</i> (1999) (from FSECURE 00000006) (VPN+ 4.1 Guide 6)			
D181	F-Secure, <i>F-Secure SSH</i> (1996) (from FSECURE 00000006) (F-Secure SSH 6)			
D182	F-Secure, <i>F-Secure SSH 2.0 for Windows NT and 95</i> (1998) (from FSECURE 00000006) (F-Secure SSH 2.0 Guide 6)			
D183	F-Secure, <i>F-Secure SSH User's & Administrator's Guide</i> (Sept. 1998) (from FSECURE 00000009) (SSH Guide 9)			
D184	F-Secure, <i>F-Secure SSH 2.0 for Windows NT and 95</i> (Sept. 1998) (from FSECURE 00000009) (F-Secure SSH 2.0 Guide 9)			

Subst. for form 1449/PTO		Complete if Known	
INFORMATION DISCLOSURE STATEMENT BY APPLICANT <i>(Use as many sheets as necessary)</i>		Application Number	13/342,795
		Filing Date	01-03-2012
		First Named Inventor	Victor Larson
		Art Unit	2453
		Examiner Name	Krisna Lim
		Docket Number	77580-155(VRNL-1CP3CNFT5)
D185	F-Secure, <i>F-Secure VPN+ (Sept. 1998) (from FSECURE 00000009) (VPN+ Guide 9)</i>		
D186	F-Secure, <i>F-Secure Management Tools, Administrator's Guide (1999) (from FSECURE 00000003) (F-Secure Management Tools)</i>		
D187	F-Secure, <i>F-Secure Desktop, User's Guide (1997) (from FSECURE 00000009) (FSecure Desktop User's Guide)</i>		
D188	SafeNet, Inc., <i>VPN Policy Manager (January 2000) (VPN Policy Manager)</i>		
D189	F-Secure, <i>F-Secure VPN+ for Windows NT 4.0 (1998) (from FSECURE 00000009) (FSecure VPN+)</i>		
D190	IRE, Inc., <i>SafeNet/Security Center Technical Reference Addendum (June 22, 1999) (Safenet Addendum)</i>		
D191	IRE, Inc., <i>System Description for VPN Policy Manager and SafeNet/SoftPK (March 30, 2000) (VPN Policy Manager System Description)</i>		
D192	IRE, Inc., <i>About SafeNet / VPN Policy Manager (1999) (About Safenet VPN Policy Manager)</i>		
D193	Trusted Information Systems, Inc., <i>Gauntlet Internet Firewall, Firewall Product Functional Summary July 22, 1996) (Gauntlet Functional Summary)</i>		
D194	Trusted Information Systems, Inc., <i>Running the Gauntlet Internet Firewall, An Administrator's Guide to Gauntlet Version 3.0 (May 31, 1995) (Running the Gauntlet Internet Firewall)</i>		
D195	Ted Harwood, <i>Windows NT Terminal Server and Citrix Metaframe (New Riders 1999) (Windows NT Harwood) 79</i>		
D196	Todd W. Mathers and Shawn P. Genoway, <i>Windows NT Thing Client Solutions: Implementing Terminal Server and Citrix MetaFrame (Macmillan Technical Publishing 1999) (Windows NT Mathers)</i>		
D197	Bernard Aboba et al., <i>Securing L2TP using IPSEC (February 2, 1999)</i>		
D198	156. <i>Finding Your Way Through the VPN Maze (1999) ("PGP")</i>		
D199	Linux FreeSWAN Overview (1999) (Linux FreeSWAN Overview)		
D200	TimeStep, <i>The Business Case for Secure VPNs (1998) ("TimeStep")</i>		
D201	WatchGuard Technologies, Inc., <i>WatchGuard LiveSecurity for MSS Powerpoint (Feb. 14 2000)</i>		
D202	WatchGuard Technologies, Inc., <i>MSS Version 2.5, Add-On for WatchGuard SOHO Release Notes (July 21, 2000)</i>		
D203	WatchGuard Technologies, Inc., <i>MSS Firewall Specifications (1999)</i>		
D204	WatchGuard Technologies, Inc., <i>Request for Information, Security Services (2000)</i>		
D205	WatchGuard Technologies, Inc., <i>Protecting the Internet Distributed Enterprise, White Paper (February 2000)</i>		
D206	Air Force Research Laboratory, <i>Statement of Work for Information Assurance System Architecture and Integration, PR No. N-8-6106 (Contract No. F30602-98-C-0012) (January 29, 1998)</i>		
D207	Technologies, Inc., <i>WatchGuard Firebox System Powerpoint (2000)</i>		
D208	GTE Internetworking & BBN Technologies DARPA <i>Information Assurance Program Integrated Feasibility Demonstration 1FD 1.2 Report, Rev. 1.0 (September 21, 1998)</i>		
D209	BBN Information Assurance Contract, <i>TIS Labs Monthly Status Report (March 16-April 30, 1998)</i>		
D210	DARPA, <i>Dynamic Virtual Private Network (VPN) Powerpoint</i>		
D211	GTE Internetworking, <i>Contractor's Program Progress Report (March 16-April 30, 1998)</i>		
D212	Darrell Kindred, <i>Dynamic Virtual Private Networks (DVPN) Countermeasure Characterization (January 30, 2001)</i>		
D213	<i>Virtual Private Networking Countermeasure Characterization (March 30, 2000)</i>		
D214	<i>Virtual Private Network Demonstration (March 21, 1998)</i>		
D215	Information Assurance/NAI Labs, <i>Dynamic Virtual Private Networks (VPNs) and Integrated Security Management (2000)</i>		
D216	Information Assurance/NAI Labs, <i>Create/Add DVPN Enclave (2000)</i>		
D217	NAI Labs, <i>IFE 3.1 Integration Demo (2000)</i>		
D218	Information Assurance, <i>Science Fair Agenda (2000)</i>		
D219	Darrell Kindred et al., <i>Proposed Threads for IFE 3.1 (January 13, 2000)</i>		
D220	<i>IFE 3.1 Technology Dependencies (2000)</i>		
D221	<i>IFE 3.1 Topology (February 9, 2000)</i>		
D222	Information Assurance, <i>Information Assurance Integration: IFE 3.1, Hypothesis & Thread Development January 10-11, 2000)</i>		
D223	Information Assurance/NAI Labs, <i>Dynamic Virtual Private Networks Presentation (2000)</i>		
D224	Information Assurance/NAI Labs, <i>Dynamic Virtual Private Networks Presentation v.2 (2000)</i>		

Subst. for form 1449/PTO INFORMATION DISCLOSURE STATEMENT BY APPLICANT <i>(Use as many sheets as necessary)</i>		Complete if Known	
		Application Number	13/342,795
		Filing Date	01-03-2012
		First Named Inventor	Victor Larson
		Art Unit	2453
		Examiner Name	Krisna Lim
		Docket Number	77580-155(VRNL-1CP3CNFT5)
D225	Information Assurance/NAI Labs, Dynamic Virtual Private Networks Presentation v.3 (2000)		
D226	T. Braun et al., <i>Virtual Private Network Architecture</i> , Charging and Accounting Technology for the Internet (August 1, 1999) (VPNA)		
D227	Network Associates Products - <i>PGP Total Network Security Suite, Dynamic Virtual Private Networks</i> (1999)		
D228	Microsoft Corporation, <i>Microsoft Proxy Server 2.0</i> (1997) (Proxy Server 2.0, Microsoft Prior Art VPN Technology)		
D229	David Johnson et. al., <i>A Guide To Microsoft Proxy Server 2.0</i> (1999) (Johnson, Microsoft Prior Art VPN Technology)		
D230	Microsoft Corporation, <i>Setting Server Parameters</i> (1997 (copied from Proxy Server 2.0 CD labeled MSFTVX00157288) (Setting Server Parameters, Microsoft Prior Art VPN Technology)		
D231	Kevin Schuler, <i>Microsoft Proxy Server 2</i> (1998) (Schuler, Microsoft Prior Art VPN Technology)		
D232	Erik Rozell et. al., <i>MCSE Proxy Server 2 Study Guide</i> (1998) (Rozell, Microsoft Prior 15 Art VPN Technology)		
D233	M. Shane Stigler & Mark A Linsenbardt, <i>IIS 4 and Proxy Server 2</i> (1999) (Stigler, Microsoft Prior Art VPN Technology)		
D234	David G. Schaer, <i>MCSE Test Success: Proxy Server 2</i> (1998) (Schaer, Microsoft Prior Art VPN Technology)		
D235	John Savill, <i>The Windows NT and Windows 2000 Answer Book</i> (1999) (Savill, Microsoft Prior Art VPN Technology)		
D236	Network Associates <i>Gauntlet Firewall Global Virtual Private Network User's Guide for Windows NT Version 5.0</i> (1999) (Gauntlet NT GVPN, GVPN)		
D237	Network Associates <i>Gauntlet Firewall For UNIX Global Virtual Private Network User's Guide Version 5.0</i> (1999) (Gauntlet Unix GVPN, GVPN)		
D238	File History for U.S. Application Serial No. 09/653,201, Applicant(s): Whittle Bryan, et al., Filing Date 08/31/2000.		
D239	<i>AutoSOCKS v2. 1</i> , Datasheet, http://web.archive.org/web/19970212013409/www.aventail.com/prod/autoskds.html		
D240	Ran Atkinson, <i>Use of DNS to Distribute Keys</i> , 7 Sept. 1993, http://ops.ietf.org/lists/namedroppers/namedroppers, 1 99x/msg00945.html		
D241	FirstVPN Enterprise Networks, Overview		
D242	Chapter 1: Introduction to Firewall Technology, Administration Guide; 12/19/07, http://www.books24x7.com/book/id_762/viewer_r.asp?bookid=762&chunked=41065062		
D243	The TLS Protocol Version 1.0; January 1999; page 65 of 71.		
D244	Elizabeth D. Zwicky, et al., <i>Building Internet Firewalls</i> , 2nd Ed.		
D245	<i>Virtual Private Networks - Assured Digital Incorporated - ADI 4500</i> ; http://web.archive.org/web/19990224050035/www.assured-digital.com/products/prodvpn/adia4500.htm		
D246	Accessware - The Third Wave in Network Security, Conclave from Internet Dynamics; http://web.archive.org/web/11980210013830/interdyn.com/Accessware.html		
D247	Extended System Press Release, Sept. 2, 1997; <i>Extended VPN Uses The Internet to Create Virtual Private Networks</i> , www.extendedsystems.com		
D248	Socks Version 5; Executive Summary; http://web.archive.org/web/199970620031945/www.aventail.com/educate/whitepaper/sockswp.html		
D249	Internet Dynamics First to Ship Integrated Security Solutions for Enterprise Intranets and Extranets; Sept. 15, 1997; http://web.archive.org/web/19980210014150/interdyn.com		
D250	Emails from various individuals to Linux IPsec re: DNS-LDAP Splicing		
D251	Fasbender, A., et al., Variable and Scalable Security: Protection of Location Information in Mobile IP, IEEE VTS, 46th, 1996, 5 pp.		
D252	David Kosiur, "Building and Managing Virtual Private Networks" (1998)		
D253	Request for Inter Partes Reexamination of Patent No. 6,502,135, dated Nov. 25, 2009.		
D254	Request for Inter Partes Reexamination of Patent No. 7,188,180, dated Nov. 25, 2009.		
D255	Yuan Dong Feng, "A novel scheme combining interleaving technique with cipher in Rayleigh fading channels," Proceedings of the International Conference on Communication technology, 2:S47-02-1-S47-02-4 (1998)		

Subst. for form 1449/PTO		Complete if Known	
INFORMATION DISCLOSURE STATEMENT BY APPLICANT <i>(Use as many sheets as necessary)</i>		Application Number	13/342,795
		Filing Date	01-03-2012
		First Named Inventor	Victor Larson
		Art Unit	2453
		Examiner Name	Krisna Lim
		Docket Number	77580-155(VRNL-1CP3CNFT5)
D256	Davies and Price, edited by Tadahiro Uezono, "Network Security", Japan, Nikkei McGraw-Hill, December 5, 1958, First Edition, first copy, p. 102-108		
D257	Davies et al., "An Introduction to Data Security in Teleprocessing and Electronic Funds Transfer," Security for Computer Networks, Second Edition, pp. 98-101 (1989)		
D258	Baumgartner et al, "Differentiated Services: A New Approach for Quality of Service in the Internet," International Conference on High Performance Networking, 255-273 (1998)		
D259	Chapman et al., "Domain Name System (DNS)," 278-296 (1995)		
D260	Davila et al., "Implementation of Virtual Private Networks at the Transport Layer," M. Mambo, Y. Zheng (Eds), Information Security (Second International) Workshop, ISW' 99. Lecture Notes in Computer Science (LNCS), Vol. 1729; 85-102 (1999)		
D261	De Raadt et al., "Cryptography in OpenBSD," 10 pages (1999)		
D262	Eastlake, "Domain Name System Security Extensions," Internet Citation, Retrieved from the Internet: URL:ftp://ftp.inet.no/pub/ietf/internet-drafts/draft-ietf-dnssec-secext2-05.txt (1998)		
D263	Gunter et al., "An Architecture for Managing QoS-Enabled VRNs Over the Internet," Proceedings 24th Conference on Local Computer Networks. LCN' 99 IEEE Comput. Soc Los Alamitos, CA, pages 122-131 (1999)		
D264	Shimizu, "Special Feature: Mastering the Internet with Windows 2000", Internet Magazine, 63:296-307 (2000)		
D265	Stallings, "Cryptography and Network Security," Principals and Practice, 2nd Edition, pages 399-440 (1999)		
D266	Takata, "U.S. Vendors Take Serious Action to Act Against Crackers – A Tracking Tool and a Highly Safe DNS Software are Released", Nikkei Communications, 257:87(1997)		
D267	Wells, Email (Lancasterb1be@mail.msn.com), Subject: "Security Icon," (1998)		
D268	Microsoft Corporation's Fifth Amended Invalidity Contentions dated September 18, 2009, VirnetX Inc. and Science Applications International Corp. v. Microsoft Corporation and invalidity claim charts for U.S. Patent Nos. 7,188,180 and 6,839,759		
D269	The IPSEC Protocol as described in Atkinson, et al., "Security Architecture for the Internet Protocol," Network Working Group, RFC 2401 (November 1998) ("RFC 2401"); http://web.archive.org/web/19991007070353/http://www.imib.med.tu-dresden.de/imib/Internet/Literatur/ipsec-docu_eng.html		
D270	S. Kent and R. Atkinson, "IP Authentication Header," RFC 2402 (November 1998); http://web.archive.org/web/19991007070353/http://www.imib.med.tu-dresden.de/imib/Internet/Literatur/ipsec-docu_eng.html		
D271	C. Madson and R. Glenn, "The Use of HMAC-MD5-96 within ESP and AH," RFC 2403 (November 1998); http://web.archive.org/web/19991007070353/http://www.imib.med.tu-dresden.de/imib/Internet/Literatur/ipsec-docu_eng.html		
D272	C. Madson and R. Glenn, "The Use HMAC-SHA-1-96 within ESP and AH," RFC 2404 (November 1998); http://web.archive.org/web/19991007070353/http://www.imib.med.tu-dresden.de/imib/Internet/Literatur/ipsec-docu_eng.html		
D273	C. Madson and N. Doraswamy, "The ESP DES-CBC Cipher Algorithm With Explicit IV", RFC 2405 (November 1998); http://web.archive.org/web/19991007070353/http://www.imib.med.tu-dresden.de/imib/Internet/Literatur/ipsec-docu_eng.html		

Subst. for form 1449/PTO INFORMATION DISCLOSURE STATEMENT BY APPLICANT <i>(Use as many sheets as necessary)</i>			Complete if Known	
			Application Number	13/342,795
			Filing Date	01-03-2012
			First Named Inventor	Victor Larson
			Art Unit	2453
			Examiner Name	Krisna Lim
			Docket Number	77580-155(VR NK-1CP3CNFT5)
D274	S. Kent and R. Atkinson, "IP Encapsulating Security Payload (ESP)," RFC 2406 (November 1998); http://web.archive.org/web/19991007070353/http://www.imib.med.tu-dresden.de/imib/Internet/Literatur/ipsec-docu_eng.html			
D275	Derrell Piper, "The Internet IP Security Domain of Interpretation for ISAKMP," RFC 2407 (November 1998); http://web.archive.org/web/19991007070353/http://www.imib.med.tu-dresden.de/imib/Internet/Literatur/ipsec-docu_eng.html			
D276	Douglas Maughan, et al, "Internet Security Association and Key Management Protocol (ISAKMP)," RFC 2408 (November 1998); http://web.archive.org/web/19991007070353/http://www.imib.med.tu-dresden.de/imib/Internet/Literatur/ipsec-docu_eng.html			
D277	D. Harkins and D. Carrell, "The Internet Key Exchange (IKE)," RFC 2409 (November 1998); http://web.archive.org/web/19991007070353/http://www.imib.med.tu-dresden.de/imib/Internet/Literatur/ipsec-docu_eng.html			
D278	R. Glenn and S. Kent, "The NULL Encryption Algorithm and Its Use With IPsec." RFC 2410 (November 1998); http://web.archive.org/web/19991007070353/http://www.imib.med.tu-dresden.de/imib/Internet/Literatur/ipsec-docu_eng.html			
D279	R. Thayer, et al., "IP Security Document Roadmap," RFC 2411 (November 1998); http://web.archive.org/web/19991007070353/http://www.imib.med.tu-dresden.de/imib/Internet/Literatur/ipsec-docu_eng.html			
D280	Hilarie K. Orman, "The OAKLEY Key Determination Protocol," RFC 2412 (November 1998) in combination with J.M. Galvin, "Public Key Distribution with Secure DNS," Proceedings of the Sixth USENIX UNIX Security Symposium, San Jose California (July 1996) ("Galvin")			
D281	DNS-related correspondence dated September 7, 1993 to September 20, 1993. (Pre KX, KX Records)			
D282	Aventail Corp., "AutoSOCKS v. 2.1 Datasheet," available at http://www.archive.org/web/19970212013409/www.aventail.com/prod/autosk2ds.html (1997). (AutoSOCKS, Aventail)			
D283	Aventail Corp., "Socks Version 5," Aventail Whitepaper, available at http://web.archive.org/web/19970620030312/www.aventail.com/educate/whitepaper/soc_kswp.html (1997). (Socks, Aventail)			
D284	Goncalves, et al. <i>Check Point FireWall -1 Administration Guide</i> , McGraw-Hill Companies (2000). (Goncalves, Checkpoint FW)			
D285	Assured Digital Products. (Assured Digital)			
D286	F-Secure, <i>F-Secure Evaluation Kit</i> (May 1999) (FSECURE 00000003) (Evaluation Kit 3)			
D287	F-Secure, <i>F-Secure Evaluation Kit</i> (Sept. 1998) (FSECURE 00000009) (Evaluation Kit 9)			
D288	IRE, Inc., <i>SafeNet/Soft-PK Version 4</i> (March 28, 2000) (Soft-PK Version 4)			
D289	IRE/SafeNet Inc., <i>VPN Technologies Overview</i> (March 28, 2000) (Safenet VPN Overview)			
D290	IRE, Inc., <i>SafeNet/VPN Policy Manager Quick Start Guide Version 1</i> (1999) (SafeNet VPN Policy Manager)			
D291	Information Assurance/NAI Labs, <i>Dynamic Virtual Private Networks Presentation v.3</i> (2000)			
D292	PCT International Search Report for related PCT Application No.: PCT/US01/13261, 8 pages .			
D293	PCT International Search Report for related PCT Application No.: PCT/US99/25323, 3 pages .			
D294	PCT International Search Report for related PCT Application No.: PCT/US99/25325, 3 pages .			
D295	Deposition Transcript for Gary Tomlinson dated February 27, 2009			
D296	Trial Transcript, VirnetX vs. Microsoft Corporation dated March 8, 2010, 8:45 AM			
D297	Trial Transcript, VirnetX vs. Microsoft Corporation dated March 8, 2010, 1:30 PM			
D298	Trial Transcript, VirnetX vs. Microsoft Corporation dated March 9, 2010, 9:00 AM			

Subst. for form 1449/PTO			Complete if Known	
INFORMATION DISCLOSURE STATEMENT BY APPLICANT <i>(Use as many sheets as necessary)</i>			Application Number	13/342,795
			Filing Date	01-03-2012
			First Named Inventor	Victor Larson
			Art Unit	2453
			Examiner Name	Krisna Lim
			Docket Number	77580-155(VRNL-1CP3CNFT5)
	D299	Trial Transcript, VirnetX vs. Microsoft Corporation dated March 9, 2010, 1:30 PM		
	D300	Trial Transcript, VirnetX vs. Microsoft Corporation dated March 10, 2010, 9:00 AM		
	D301	Trial Transcript, VirnetX vs. Microsoft Corporation dated March 10, 2010, 1:00 PM		
	D302	Trial Transcript, VirnetX vs. Microsoft Corporation dated March 11, 2010, 9:00 AM		
	D303	Trial Transcript, VirnetX vs. Microsoft Corporation dated March 11, 2010, 1:30 PM		
	D304	Trial Transcript, VirnetX vs. Microsoft Corporation dated March 12, 2010, 9:00 AM		
	D305	Trial Transcript, VirnetX vs. Microsoft Corporation dated March 12, 2010, 1:15 PM		
	D306	Trial Transcript, VirnetX vs. Microsoft Corporation dated March 15, 2010, 9:00 AM		
	D307	Trial Transcript, VirnetX vs. Microsoft Corporation dated March 15, 2010, 12:35 PM		
	D308	European Search Report dated January 24, 2011 from corresponding European Application Number 10011949.4		
	D309	European Search Report dated March 17, 2011 from corresponding European Application Number 10184502.2		
	D310	Hollenbeck et al., "Registry Registrar Protocol (RRP) Version 1.1.0; Internet Engineering Task Force, 34 pages (1999)		
	D311	Tannenbaum, "Computer Networks," pages 202-219 (1996)		
	D312	Defendants' Preliminary Joint Invalidation Contentions dated July 1, 2011		
	D313	Appendix B: DNS References to Defendants' Preliminary Joint Invalidation Contentions dated July 1, 2011		
	D314	Appendix A to Defendants' Preliminary Joint Invalidation Contentions dated July 1, 2011		
	D315	Exhibit 1, IETF RFC 2065: Domain Name System Security Extensions; Published January 1997 ¹ vs. Claims of the '211 Patent ²		
	D316	Exhibit 2, IETF RFC 2065: Domain Name System Security Extensions; Published January 1997 ¹ vs. Claims of the '504 Patent ²		
	D317	Exhibit 3, RFC 2543 ¹ vs. Claims of the '135 Patent ²		
	D318	Exhibit 4, RFC 2543 ¹ vs. Claims of the '211 Patent ²		
	D319	Exhibit 5, RFC 2543 ¹ vs. Claims of the '504 Patent ²		
	D320	Exhibit 6, SIP Draft v.2 ¹ vs. Claims of the '135 Patent ²		
	D321	Exhibit 7, SIP Draft v.2 ¹ vs. Claims of the '211 Patent ²		

Subst. for form 1449/PTO INFORMATION DISCLOSURE STATEMENT BY APPLICANT <i>(Use as many sheets as necessary)</i>			Complete if Known	
			Application Number	13/342,795
			Filing Date	01-03-2012
			First Named Inventor	Victor Larson
			Art Unit	2453
			Examiner Name	Krisna Lim
			Docket Number	77580-155(VR NK-1CP3CNFT5)
D322	Exhibit 8, SIP Draft v.2 ¹ vs. Claims of the '504 Patent ²			
D323	Exhibit 9, H.323 ¹ vs. Claims of the '135 Patent ²			
D324	Exhibit 10, H.323 ¹ vs. Claims of the '211 Patent ²			
D325	Exhibit 11, H.323 ¹ vs. Claims of the '504 Patent ²			
D326	Exhibit 12, SSL 3.0 ¹ vs. Claims of the '135 Patent ² .			
D327	Exhibit 13, SSL 3.0 ¹ vs. Claims of the '211 Patent ²			
D328	Exhibit 14, SSL 3.0 ¹ vs. Claims of the '504 Patent ²			
D329	Exhibit 15, RFC 2487 ¹ vs. Claims of the '135 Patent ²			
D330	Exhibit 16, RFC 2487 ¹ vs. Claims of the '211 Patent ²			
D331	Exhibit 17, RFC 2487 ¹ vs. Claims of the '504 Patent ²			
D332	Exhibit 18, RFC 2595 ¹ vs. Claims of the '135 Patent ²			
D333	Exhibit 19, RFC 2595 ¹ vs. Claims of the '211 Patent ²			
D334	Exhibit 20, RFC 2595 ¹ vs. Claims of the '504 Patent ²			
D335	Exhibit 21, iPass ¹ vs. Claims of the '135 Patent ²			
D336	Exhibit 22, iPASS ¹ vs. Claims of the '211 Patent ²			
D337	Exhibit 23, iPASS ¹ vs. Claims of the '504 Patent ²			
D338	Exhibit 24, "US '034" ¹ vs. Claims of the '135 Patent ²			
D339	Exhibit 25, US Patent No. 6,453,034 ("US '034") ¹ vs. Claims of the '211 Patent ²			
D340	Exhibit 26, US Patent No. 6,453,034 ("US '034") ¹ vs. Claims of the '504 Patent ²			
D341	Exhibit 27, US '287 ¹ vs. Claims of the '135 Patent ²			
D342	Exhibit 28, US '287 ¹ vs. Claims of the '211 Patent ²			
D343	Exhibit 29, US '287 ¹ vs. Claims of the '504 Patent ²			
D344	Exhibit 30, Overview of Access VPNs ¹ vs. Claims of the '135 Patent ²			
D345	Exhibit 31, Overview of Access VPNs ¹ vs. Claims of the '211 Patent ²			
D346	Exhibit 32, Overview of Access VPNs ¹ vs. Claims of the '504 Patent ²			
D347	Exhibit 34, RFC 1928 ¹ vs. Claims of the '135 Patent ²			

Subst. for form 1449/PTO INFORMATION DISCLOSURE STATEMENT BY APPLICANT <i>(Use as many sheets as necessary)</i>			Complete if Known	
			Application Number	13/342,795
			Filing Date	01-03-2012
			First Named Inventor	Victor Larson
			Art Unit	2453
			Examiner Name	Krisna Lim
			Docket Number	77580-155(VR NK-1CP3CNFT5)
D348	Exhibit 35, RFC 1928 ¹ vs. Claims of the '211 Patent ²			
D349	Exhibit 36, RFC 1928 ¹ vs. Claims of the '504 Patent ²			
D350	Exhibit 37, RFC 2661 ¹ vs. Claims of the '135 Patent ²			
D351	Exhibit 38, RFC 2661 ¹ vs. Claims of the '211 Patent ²			
D352	Exhibit 39, RFC 2661 ¹ vs. Claims of the '504 Patent ²			
D353	Exhibit 40, SecureConnect ¹ vs. Claims of the '135 Patent ²			
D354	Exhibit 41, SecureConnect ¹ vs. Claims of the '211 Patent ²			
D355	Exhibit 42, SecureConnect ¹ vs. Claims of the '504 Patent ²			
D356	Exhibit 43, SFS-HTTP ¹ vs. Claims of the '135 Patent ²			
D357	Exhibit 44, SFS-HTTP ¹ vs. Claims of the '211 Patent ²			
D358	Exhibit 45, SFS-HTTP ¹ vs. Claims of the '504 Patent ²			
D359	Exhibit 46, US '883 ¹ vs. Claims of the '135 Patent ²			
D360	Exhibit 47, US '883 ¹ vs. Claims of the '211 Patent ²			
D361	Exhibit 48, US '883 ¹ vs. Claims of the '504 Patent ²			
D362	Exhibit 49, US '132 ¹ vs. Claims of the '135 Patent ²			
D363	Exhibit 50, US '132 ¹ vs. Claims of the '211 Patent ²			
D364	Exhibit 51, US '132 ¹ vs. Claims of the '504 Patent ²			
D365	Exhibit 52, US '213 ¹ vs. Claims of the '135 Patent ²			
D366	Exhibit 53, US '213 ¹ vs. Claims of the '211 Patent ²			
D367	Exhibit 54, US '213 ¹ vs. Claims of the '504 Patent ²			
D368	Exhibit 55, B&M VPNs ¹ vs. Claims of the '135 Patent ²			
D369	Exhibit 56, B&M VPNs ¹ vs. Claims of the '211 Patent ²			
D370	Exhibit 57, B&M VPNs ¹ vs. Claims of the '504 Patent ²			
D371	Exhibit 58, BorderManager ¹ vs. Claims of the '135 Patent ²			
D372	Exhibit 59, BorderManager ¹ vs. Claims of the '211 Patent ²			
D373	Exhibit 60, BorderManager ¹ vs. Claims of the '504 Patent ²			

Subst. for form 1449/PTO INFORMATION DISCLOSURE STATEMENT BY APPLICANT <i>(Use as many sheets as necessary)</i>			Complete if Known	
			Application Number	13/342,795
			Filing Date	01-03-2012
			First Named Inventor	Victor Larson
			Art Unit	2453
			Examiner Name	Krisna Lim
			Docket Number	77580-155(VRNK-1CP3CNFT5)
D374	Exhibit 61, Prestige 128 Plus ¹ vs. Claims of the '135 Patent ²			
D375	Exhibit 62, Prestige 128 Plus ¹ vs. Claims of the '211 Patent ²			
D376	Exhibit 63, Prestige 128 Plus ¹ vs. Claims of the '504 Patent ²			
D377	Exhibit 64, RFC 2401 ¹ vs. Claims of the '135 Patent ²			
D378	Exhibit 65, RFC 2401 ¹ vs. Claims of the '211 Patent ²			
D379	Exhibit 66, RFC 2401 ¹ vs. Claims of the '504 Patent ²			
D380	Exhibit 67, RFC 2486 ¹ vs. Claims of the '135 Patent ²			
D381	Exhibit 68, RFC 2486 ¹ vs. Claims of the '211 Patent ²			
D382	Exhibit 69, RFC 2486 ¹ vs. Claims of the '504 Patent ²			
D383	Exhibit 70, Understanding IPsec ¹ vs. Claims of the '135 Patent ²			
D384	Exhibit 71, Understanding IPsec ¹ vs. Claims of the '211 Patent ²			
D385	Exhibit 72, Understanding IPsec ¹ vs. Claims of the '504 Patent ²			
D386	Exhibit 73, US '820 ¹ vs. Claims of the '135 Patent ²			
D387	Exhibit 74, US '820 ¹ vs. Claims of the '211 Patent ²			
D388	Exhibit 75, US '820 ¹ vs. Claims of the '504 Patent ²			
D389	Exhibit 76, US '019 ¹ vs. Claims of the '211 Patent ²			
D390	Exhibit 77, US '019 ¹ vs. Claims of the '504 Patent ²			
D391	Exhibit 78, US '049 ¹ vs. Claims of the '135 Patent ²			
D392	Exhibit 79, US '049 ¹ vs. Claims of the '211 Patent ²			
D393	Exhibit 80, US '049 ¹ vs. Claims of the '504 Patent ²			
D394	Exhibit 81, US '748 ¹ vs. Claims of the '135 Patent ²			
D395	Exhibit 82, US '261 ¹ vs. Claims of the '135 Patent ²			
D396	Exhibit 83, US '261 ¹ vs. Claims of the '211 Patent ²			
D397	Exhibit 84, US '261 ¹ vs. Claims of the '504 Patent ²			
D398	Exhibit 85, US '900 ¹ vs. Claims of the '135 Patent ²			
D399	Exhibit 86, US '900 ¹ vs. Claims of the '211 Patent ²			

Subst. for form 1449/PTO INFORMATION DISCLOSURE STATEMENT BY APPLICANT <i>(Use as many sheets as necessary)</i>			Complete if Known	
			Application Number	13/342,795
			Filing Date	01-03-2012
			First Named Inventor	Victor Larson
			Art Unit	2453
			Examiner Name	Krisna Lim
			Docket Number	77580-155(VR NK-1CP3CNFT5)
D400	Exhibit 87, US '900 ¹ vs. Claims of the '504 Patent ²			
D401	Exhibit 88, US '671 ¹ vs. Claims of the '135 Patent ²			
D402	Exhibit 89, US '671 ¹ vs. Claims of the '211 Patent ²			
D403	Exhibit 90, US '671 ¹ vs. Claims of the '504 Patent ²			
D404	Exhibit 91, JP '704 ¹ vs. Claims of the '135 Patent ²			
D405	Exhibit 92, JP '704 ¹ vs. Claims of the '211 Patent ²			
D406	Exhibit 93, JP '704 ¹ vs. Claims of the '504 Patent ²			
D407	Exhibit 94, GB '841 ¹ vs. Claims of the '135 Patent ²			
D408	Exhibit 95, GB '841 ¹ vs. Claims of the '211 Patent ²			
D409	Exhibit 96, GB '841 ¹ vs. Claims of the '504 Patent ²			
D410	Exhibit 97, US '318 ¹ vs. Claims of the '135 Patent ²			
D411	Exhibit 98, US '318 ¹ vs. Claims of the '211 Patent ²			
D412	Exhibit 99, US '318 ¹ vs. Claims of the '504 Patent ²			
D413	Exhibit 100, VPN/VLAN ¹ vs. Claims of the '135 Patent ²			
D414	Exhibit 101, Nikkei ¹ vs. Claims of the '135 Patent ²			
D415	Exhibit 102, NIKKEI ¹ vs. Claims of the '211 Patent ²			
D416	Exhibit 103, NIKKEI ¹ vs. Claims of the '504 Patent ²			
D417	Exhibit 104, Special Anthology ¹ vs. Claims of the '135 Patent ²			
D418	Exhibit 105, Omron ¹ vs. Claims of the '135 Patent ²			
D419	Exhibit 106, Gauntlet System ¹ vs. Claims of the '135 Patent ²			
D420	Exhibit 107, Gauntlet System ¹ vs. Claims of the '151 Patent ²			
D421	Exhibit 108, Gauntlet System ¹ vs. Claims of the '180 Patent ²			
D422	Exhibit 109, Gauntlet System ¹ vs. Claims of the '211 Patent ²			
D423	Exhibit 110, Gauntlet System ¹ vs. Claims of the '504 Patent ²			
D424	Exhibit 111, Gauntlet System ¹ vs. Claims of the '759 Patent ²			
D425	Exhibit 112, IntraPort System ¹ vs. Claims of the '135 Patent ²			

Subst. for form 1449/PTO			Complete if Known	
			Application Number	13/342,795
INFORMATION DISCLOSURE STATEMENT BY APPLICANT <i>(Use as many sheets as necessary)</i>			Filing Date	01-03-2012
			First Named Inventor	Victor Larson
			Art Unit	2453
			Examiner Name	Krisna Lim
			Docket Number	77580-155(VR NK-1CP3CNFT5)
D426	Exhibit 113, IntraPort System ¹ vs. Claims of the '151 Patent ²			
D427	Exhibit 114, IntraPort System ¹ vs. Claims of the '180 Patent ²			
D428	Exhibit 115, IntraPort System ¹ vs. Claims of the '211 Patent ²			
D429	Exhibit 116, IntraPort System ¹ vs. Claims of the '504 Patent ²			
D430	Exhibit 117, IntraPort System ¹ vs. Claims of the '759 Patent ²			
D431	Exhibit 118, Altiga VPN System ¹ vs. Claims of the '135 Patent ²			
D432	Exhibit 119, Altiga VPN System ¹ vs. Claims of the '151 Patent ²			
D433	Exhibit 120, Altiga VPN System ¹ vs. Claims of the '180 Patent ²			
D434	Exhibit 121, Altiga VPN System ¹ vs. Claims of the '211 Patent ²			
D435	Exhibit 122, Altiga VPN System ¹ vs. Claims of the '504 Patent ²			
D436	Exhibit 123, Altiga VPN System ¹ vs. Claims of the '759 Patent ²			
D437	Exhibit 124, Kiuchi ¹ vs. Claims of the '135 Patent ²			
D438	Exhibit 125, Kiuchi ¹ vs. Claims of the '151 Patent ²			
D439	Exhibit 126, Kiuchi ¹ vs. Claims of the '180 Patent ²			
D440	Exhibit 127, Kiuchi ¹ vs. Claims of the '211 Patent ²			
D441	Exhibit 128, Kiuchi ¹ vs. Claims of the '504 Patent ²			
D442	Exhibit 129, Kiuchi ¹ vs. Claims of the '759 Patent ²			
D443	Exhibit 130, Overview of Access VPNs and Tunneling Technologies ("Overview") ¹ vs. Claims of the '135 Patent ²			
D444	Exhibit 131, Overview of Access VPNs and Tunneling Technologies ("Overview") ¹ vs. Claims of the '151 Patent ²			
D445	Exhibit 132, Overview of Access VPNs and Tunneling Technologies ("Overview") ¹ vs. Claims of the '180 Patent ²			
D446	Exhibit 133, Overview of Access VPNs and Tunneling Technologies ("Overview") ¹ vs. Claims of the '211 Patent ²			
D447	Exhibit 134, Overview of Access VPNs and Tunneling Technologies ("Overview") ¹ vs. Claims of the '504 Patent ²			
D448	Exhibit 135, Overview ¹ vs. Claims of the '759 Patent ²			
D449	Exhibit 136, RFC 2401 ¹ vs. Claims of the '759 Patent ²			

Subst. for form 1449/PTO				Complete if Known	
INFORMATION DISCLOSURE STATEMENT BY APPLICANT <i>(Use as many sheets as necessary)</i>				Application Number	13/342,795
				Filing Date	01-03-2012
				First Named Inventor	Victor Larson
				Art Unit	2453
				Examiner Name	Krisna Lim
				Docket Number	77580-155(VRNK-1CP3CNFT5)
	D450	Exhibit 137, Schulzrinne ¹ vs. Claims of the '135 Patent ²			
	D451	Exhibit 138, Schulzrinne ¹ vs. Claims of the '151 Patent ²			
	D452	Exhibit 139, Schulzrinne ¹ vs. Claims of the '180 Patent ²			
	D453	Exhibit 140, Schulzrinne ¹ vs. Claims of the '211 Patent ²			
	D454	Exhibit 141, Schulzrinne ¹ vs. Claims of the '504 Patent ²			
	D455	Exhibit 142, Schulzrinne ¹ vs. Claims of the '759 Patent ²			
	D456	Exhibit 143, Solana ¹ vs. Claims of the '135 Patent ²			
	D457	Exhibit 144, Solana ¹ vs. Claims of the '151 Patent ²			
	D458	Exhibit 145, Solana ¹ vs. Claims of the '180 Patent ²			
	D459	Exhibit 146, Solana ¹ vs. Claims of the '211 Patent ²			
	D460	Exhibit 147, Solana ¹ vs. Claims of the '504 Patent ²			
	D461	Exhibit 148, Solana ¹ vs. Claims of the '759 Patent ²			
	D462	Exhibit 149, Atkinson ¹ vs. Claims of the '135 Patent ²			
	D463	Exhibit 150, Atkinson ¹ vs. Claims of the '151 Patent ²			
	D464	Exhibit 151, Atkinson ¹ vs. Claims of the '180 Patent ²			
	D465	Exhibit 152, Atkinson ¹ vs. Claims of the '211 Patent ²			
	D466	Exhibit 153, Atkinson ¹ vs. Claims of the '504 Patent ²			
	D467	Exhibit 154, Atkinson ¹ vs. Claims of the '759 Patent ²			
	D468	Exhibit 155, Marino ¹ vs. Claims of the '135 Patent ²			
	D469	Exhibit 156, Marino ¹ vs. Claims of the '151 Patent ²			
	D470	Exhibit 157, Marino ¹ vs. Claims of the '180 Patent ²			
	D471	Exhibit 158, Marino ¹ vs. Claims of the '211 Patent ²			
	D472	Exhibit 159, Marino ¹ vs. Claims of the '504 Patent ²			
	D473	Exhibit 160, Marino ¹ vs. Claims of the '759 Patent ²			
	D474	Exhibit 161, Aziz ('646) ¹ vs. Claims of the '759 Patent ²			
	D475	Exhibit 162, Wesinger ¹ vs. Claims of the '135 Patent ²			

Subst. for form 1449/PTO INFORMATION DISCLOSURE STATEMENT BY APPLICANT <i>(Use as many sheets as necessary)</i>			Complete if Known	
			Application Number	13/342,795
			Filing Date	01-03-2012
			First Named Inventor	Victor Larson
			Art Unit	2453
			Examiner Name	Krisna Lim
			Docket Number	77580-155(VR NK-1CP3CNFT5)
D476	Exhibit 163, Wesinger ¹ vs. Claims of the '151 Patent ²			
D477	Exhibit 164, Wesinger ¹ vs. Claims of the '180 Patent ²			
D478	Exhibit 165, Wesinger ¹ vs. Claims of the '211 Patent ²			
D479	Exhibit 166, Wesinger ¹ vs. Claims of the '504 Patent ²			
D480	Exhibit 167, Wesinger ¹ vs. Claims of the '759 Patent ²			
D481	Exhibit 168, Aziz ('234) ¹ vs. Claims of the '135 Patent ²			
D482	Exhibit 169, Aziz ('234) ¹ vs. Claims of the '151 Patent ²			
D483	Exhibit 170, Aziz ('234) ¹ vs. Claims of the '180 Patent ²			
D484	Exhibit 171, Aziz ('234) ¹ vs. Claims of the '211 Patent ²			
D485	Exhibit 172, Aziz ('234) ¹ vs. Claims of the '504 Patent ²			
D486	Exhibit 173, Aziz ('234) ¹ vs. Claims of the '759 Patent ²			
D487	Exhibit 174, Schneider ¹ vs. Claims of the '759 Patent ²			
D488	Exhibit 175, Valencia ¹ vs. Claims of the '135 Patent ²			
D489	Exhibit 176, Valencia ¹ vs. Claims of the '151 Patent ²			
D490	Exhibit 177, Valencia ¹ vs. Claims of the '180 Patent ²			
D491	Exhibit 178, Valencia ¹ vs. Claims of the '211 Patent ²			
D492	Exhibit 179, Valencia ¹ vs. Claims of the '504 Patent ²			
D493	Exhibit 180, RFC 2401 in Combination with U.S. Patent No. 6,496,867 ¹ vs. Claims of the '180 Patent ²			
D494	Exhibit 181, Davison ¹ vs. Claims of the '135 Patent ²			
D495	Exhibit 182, Davison ¹ vs. Claims of the '151 Patent ²			
D496	Exhibit 183, Davison ¹ vs. Claims of the '180 Patent ²			
D497	Exhibit 184, Davison ¹ vs. Claims of the '211 Patent ²			
D498	Exhibit 185, Davison ¹ vs. Claims of the '504 Patent ²			
D499	Exhibit 186, Davison ¹ vs. Claims of the '759 Patent ²			
D500	Exhibit 187, AutoSOCKS v2.1 ¹ vs. Claims of the '135 Patent ²			
D501	Exhibit 188, AutoSOCKS v2.1 ¹ vs. Claims of the '151 Patent ²			

Subst. for form 1449/PTO			Complete if Known	
INFORMATION DISCLOSURE STATEMENT BY APPLICANT <i>(Use as many sheets as necessary)</i>			Application Number	13/342,795
			Filing Date	01-03-2012
			First Named Inventor	Victor Larson
			Art Unit	2453
			Examiner Name	Krisna Lim
			Docket Number	77580-155(VR NK-1CP3CNFT5)
	D502	Exhibit 189, AutoSOCKS v2.1 Administrator's Guide ¹ vs. Claims of the '180 Patent ²		
	D503	Exhibit 190, AutoSOCKS ¹ vs. Claims of the '759 Patent ²		
	D504	Exhibit 191, Aventail Connect 3.01/2.51 ¹ vs. Claims of the '135 Patent ²		
	D505	Exhibit 192, Aventail Connect v3.01/2.51 ¹ vs. Claims of the '151 Patent ²		
	D506	Exhibit 193, Aventail Connect 3.01/2.51 ¹ vs. Claims of the '180 Patent ²		
	D507	Exhibit 194, Aventail Connect 3.01/2.51 ¹ vs. Claims of the '759 Patent ²		
	D508	Exhibit 195, Aventail Connect 3.1/2.6 Administrator's Guide ¹ vs. Claims of the '135 Patent ²		
	D509	Exhibit 196, Aventail Connect 3.1/2.6 Administrator's Guide ¹ vs. Claims of the '151 Patent ²		
	D510	Exhibit 197, Aventail Connect 3.1/2.6 ¹ vs. Claims of the '180 Patent ²		
	D511	Exhibit 198, Aventail Connect 3.1/2.6 ¹ vs. Claims of the '759 Patent ²		
	D512	Exhibit 199, BinGO! User's User's Guide/Extended Features Reference ¹ vs. Claims of the '151 Patent ²		
	D513	Exhibit 200, BinGO! User's User's Guide/Extended Features Reference ¹ vs. Claims of the '135 Patent ²		
	D514	Exhibit 201, BinGO! vs. Claims of the '180 Patent ²		
	D515	Exhibit 202, BinGO! vs. Claims of the '759 Patent ²		
	D516	Exhibit 203, Broadband Forum Technical Report TR-025 (Issue 1.0/5.0) ¹ vs. Claims of the '135 Patent ²		
	D517	Exhibit 204, Domain Name System (DNS) Security ¹ vs. Claims of the '211 Patent ²		
	D518	Exhibit 205, Domain Name System (DNS) Security ¹ vs. Claims of the '504 Patent ²		
	D519	Exhibit 206, RFC 2230, Key Exchange Delegation Record for the DNS ¹ vs. Claims of the '211 Patent ²		
	D520	Exhibit 207, RFC 2230, Key Exchange Delegation Record for the DNS ¹ vs. Claims of the '504 Patent ²		
	D521	Exhibit 208, RFC 2538, Storing Certificates in the Domain Name System (DNS) ¹ vs. Claims of the '211 Patent ²		
	D522	Exhibit 209, RFC 2538, Storing Certificates in the Domain Name System (DNS) ¹ vs. Claims of the '504 Patent ²		
	D523	Exhibit 210, IETF RFC 2065: Domain Name System Security Extensions; Published January 1997 ¹ vs. Claims of the '504 Patent ²		

Subst. for form 1449/PTO INFORMATION DISCLOSURE STATEMENT BY APPLICANT <i>(Use as many sheets as necessary)</i>			Complete if Known	
			Application Number	13/342,795
			Filing Date	01-03-2012
			First Named Inventor	Victor Larson
			Art Unit	2453
			Examiner Name	Krisna Lim
			Docket Number	77580-155(VR NK-1CP3CNFT5)
D524	Exhibit 211, IETF RFC 2065: Domain Name System Security Extensions; Published January 1997 ¹ vs. Claims of the '211 Patent ²			
D525	Exhibit 212, RFC 2486, RFC 2661, RFC 2401, and Internet-Draft, "Secure Remote Access with L2TP" ¹ vs. Claims of the '135 Patent ²			
D526	Exhibit 213, U.S. Patent No. 7,100,195 in Combination with RFC 2401 and U.S. Patent No. 6,496,867 ¹ vs. Claims of the '135 Patent ²			
D527	Exhibit 214, U.S. Patent No. 7,100,195 in Combination with RFC 2401 and U.S. Patent No. 6,496,867 ¹ vs. Claims of the '151 Patent ²			
D528	Exhibit 215, U.S. Patent No. 6,643,701 ¹ vs. Claims of the '135 Patent ²			
D529	Exhibit 216, U.S. Patent No. 6,643,701 ¹ vs. Claims of the '151 Patent ²			
D530	Exhibit 217, U.S. Patent No. 6,496,867 in Combination with RFC 2401 ¹ vs. Claims of the '151 Patent ²			
D531	Exhibit 218, U.S. Patent No. 6,496,867 in Combination with RFC 2401 ¹ vs. Claims of the '135 Patent ²			
D532	Exhibit 219, U.S. Patent No. 6,496,867 ¹ vs. Claims of the '211 Patent ²			
D533	Exhibit 220, U.S. Patent No. 6,496,867 ¹ vs. Claims of the '504 Patent ²			
D534	Exhibit 221, RFC 2486, RFC 2661, RFC 2401, and Internet-Draft, "Secure Remote Access with L2TP" ¹ vs. Claims of the '151 Patent ²			
D535	Exhibit 222, U.S. Patent No. 6,557,037 ¹ vs. Claims of the '211 Patent ²			
D536	Exhibit 223, U.S. Patent No. 6,557,037 ¹ vs. Claims of the '504 Patent ²			
D537	Exhibit 224, RFC 2230, Key Exchange Delegation Record for the DNS ¹ vs. Claims of the '135 Patent ²			
D538	Exhibit 225, RFC 2230, Key Exchange Delegation Record for the DNS ¹ vs. Claims of the '151 Patent ²			
D539	Exhibit Cisco-1, Cisco's Prior Art Systems ¹ vs. Claims of the '135 Patent			
D540	Exhibit Cisco-2, Cisco's Prior Art Systems ¹ vs. Claims of the '151 Patent			
D541	Exhibit Cisco-3, Cisco's Prior Art Systems ¹ vs. Claims of the '180 Patent			
D542	Exhibit Cisco-4, Cisco's Prior Art Systems ¹ vs. Claims of the '211 Patent			
D543	Exhibit Cisco-5, Cisco's Prior Art Systems ¹ vs. Claims of the '504 Patent			
D544	Exhibit Cisco-6, Cisco's Prior Art Systems ¹ vs. Claims of the '759 Patent			
D545	Exhibit Cisco-7, Cisco's Prior Art PIX System ¹ vs. Claims of the '759 Patent			

Subst. for form 1449/PTO INFORMATION DISCLOSURE STATEMENT BY APPLICANT <i>(Use as many sheets as necessary)</i>			Complete if Known	
			Application Number	13/342,795
			Filing Date	01-03-2012
			First Named Inventor	Victor Larson
			Art Unit	2453
			Examiner Name	Krisna Lim
			Docket Number	77580-155(VR NK-1CP3CNFT5)
D546	Exhibit A: Copy of U.S. Patent No. 6,502,135			
D547	Exhibit A: Copy of U.S. Patent No. 7,490,151			
D548	Exhibit B: Certificate of Service to Request For Inter Partes Reexamination Under 35 U.S.C. § 311 (Patent No. 6,502,135)			
D549	Exhibit B: Certificate of Service to Request For Inter Partes Reexamination Under 35 U.S.C. § 311 (Patent No. 7,490,151)			
D550	Exhibit B-1: File History of U.S. Patent 6,502,135			
D551	Exhibit B-2: Reexamination Record No. 95/001,269			
D552	Exhibit C1: Claim Chart – Aventail Connect v3.1 (Patent No. 6,502,135)			
D553	Exhibit C2: Claim Chart Aventail Connect V3.01 (Patent No. 6,502,135)			
D554	Exhibit C-1: Copy of U.S. Patent No. 7,010,604			
D555	Exhibit C2: Claim Chart Aventail Autosocks (Patent No. 7,490,151)			
D556	Exhibit C1: Claim Chart Aventail Connect v3.01 (Patent No. 7,490,151)			
D557	Exhibit C-2: Provisional Application 60/106,261			
D558	Exhibit C3: Claim Chart Aventail AutoSOCKS (Patent No. 6,502,135)			
D559	Exhibit C3: Claim Chart BinGO (Patent No. 7,490,151)			
D560	Exhibit C-3: Provisional Application 60/137,704			
D561	Exhibit C4: Claim Chart Wang (Patent No. 6,502,135)			
D562	Exhibit C4: Claim Chart Beser (Patent No. 7,490,151)			
D563	Exhibit C5: Claim Chart Beser (Patent No. 6,502,135)			
D564	Exhibit C5: Claim Chart Wang (Patent No. 7,490,151)			
D565	Exhibit C6: Claim Chart BinGO (Patent No. 6,502,135)			
D566	Exhibit D: Memorandum Opinion in <i>VirnetX v. Microsoft</i> .			
D567	Exhibit D-1: Takahiro Kiuchi and Shigekoto Kaihara, "C-HTTP – The Development of a Secure, Closed HPPT-Based Network on the Internet," Published in the Proceedings of SNDSS 1996.			
D568	Exhibit D-10: D.E. Denning and G.M. Sacco, "Time-stamps in Key Distribution Protocols," Communications of the ACM, Vol. 24, N.8, pp. 533-536. August 1981.			
D569	Exhibit D-11: C.I. Dalton and J.F. Griffin, "Applying Military Grade Security to the Internet," Proceedings of the 8th Joint European Networking Conference (JENC 8), (May 12-15 1997).			

Complete if Known**INFORMATION DISCLOSURE STATEMENT
BY APPLICANT***(Use as many sheets as necessary)*Application Number **13/342,795**Filing Date **01-03-2012**First Named Inventor **Victor Larson**Art Unit **2453**Examiner Name **Krisna Lim**Docket Number **77580-155(VRNL-1CP3CNFT5)**

	D570	Exhibit D-12: Steven M. Bellovin and Michael Merritt, "Encrypted Key Exchange: Password-Based protocols Secure against Dictionary Attacks," 1992 IEEE Symposium on Security and Privacy (1992).	
	D571	Exhibit D-2: Copy of U.S. Pat. No. 5,898,830	
	D572	Exhibit D-3: Eduardo Solana and Jürgen Harms, "Flexible Internet Secure Transactions Based on Collaborative Domains," Security Protocols Workshop 1997, pp. 37-51.	
	D573	Exhibit D-4: Copy of U.S. Pat. No. 6,119,234	
	D574	Exhibit D-5: Jeff Sedayao, "Mosaic Will Kill My Network!" - Studying Network Traffic Patterns of Mosaic Use," in Electron. Proc. 2nd World Wide Web Conf.'94: Mosaic and the Web, Chicago, IL, Oct. 1994.	
	D575	Exhibit D-6: M. Luby Juels and R. Ostrovsky, "Security of Blind Digital Signatures," Crypto '97, LNCS 1294, pages 150-164, Springer-Verlag, Berlin, 1997.	
	D576	Exhibit D-8: David M. Martin, "A Framework for Local Anonymity in the Internet," Technical Report. Boston University, Boston, MA, USA (Feb 21, 1998).	
	D577	Exhibit D-9: Copy of U.S. Pat. No. 7,764,231	
	D578	Exhibit E-1: Claim Charts Applying Kiuchi and Other References to Claims of the '135 Patent.	
	D579	Exhibit E1: Declaration of Chris Hopen (Patent No. 6,502,135)	
	D580	Exhibit E1: Declaration of Chris Hopen (Patent No. 7,490,151)	
	D581	Exhibit E-2: Claim Charts Applying Wesinger and Other References to Claims of the '135 Patent.	
	D582	Exhibit E2: Declaration of Michael Fratto (Patent No. 6,502,135)	
	D583	Exhibit E2: Declaration of Michael Fratto (Patent No. 7,490,151)	
	D584	Exhibit E-3: Claim Charts Applying Solana and Other References to Claims of the '135 Patent.	
	D585	Exhibit E3: Declaration of James Chester (Patent No. 6,502,135)	
	D586	Exhibit E3: Declaration of James Chester (Patent No. 7,490,151)	
	D587	Exhibit E-4: Claim Charts Applying Aziz and Other References to Claims of the '135 Patent.	
	D588	Exhibit X1: Aventail Connect Administrator's Guide v3.1/v2.6., PP 1-20 (1996-1999)	
	D589	Exhibit X10: Copy of U.S. Patent No. 4,885,778	
	D590	Exhibit X11: Copy of U.S. Patent No. 6,615,357	
	D591	Exhibit X2: Aventail Connect Administrator's Guide v3.01/v2.51., PP 1-116 (1996-1999)	
	D592	Exhibit X3: Aventail AutoSOCKS Administration & User's Guide v2.1., PP 1-70 (1996-1999)	
	D593	Exhibit X4: Reed et al., "Proxies for Anonymous Routine," 12th Annual Computer Security Applications Conference, San Diego, CA, December -9-13, pp 1-10 (1996).	

Subst. for form 1449/PTO INFORMATION DISCLOSURE STATEMENT BY APPLICANT <i>(Use as many sheets as necessary)</i>			Complete if Known	
			Application Number	13/342,795
			Filing Date	01-03-2012
			First Named Inventor	Victor Larson
			Art Unit	2453
			Examiner Name	Krisna Lim
			Docket Number	77580-155(VR NK-1CP3CNFT5)
D594	Exhibit X5: Wang, The Broadband Forum Technical Report, "TR-025 – Core Network Architecture Recommendations for Access to Legacy Data Networks over ADSL," Issue 1.0; pp. 1-24 , v1.0 (1999).			
D595	Exhibit X6: Copy of U.S. Patent No. 6,496,867			
D596	Exhibit X7: BinGO! User's Guide Incorporating by Reference BinGO! Extended Feature Reference.			
D597	Exhibit X7: Kent et al., "Security Architecture for the Internet Protocol, " Network Working Group Request for Comments (RFC) 2401, pp 1-70 (1998).			
D598	Exhibit X8: Copy of U.S. Patent No. 6,182,141			
D599	Exhibit X9: BinGO! User's Guide v1.6 (1999).			
D600	Exhibit Y1: Aventail Extranet Server 3.0 Administrator's Guide.			
D601	Exhibit Y10: Hanks, S., et al., RFC1701, "Generic Routing Encapsulation (GRE)," 1994, Is Accessible at http://www.ietf.org/rfc/rfc1701.txt .			
D602	Exhibit Y10: Socolofsky, T. et al., RFC 1180, "A TCP/IP Tutorial," January 1991.			
D603	Exhibit Y11: Simpson, W., editor, RFC 1661, "The Point-to-Point Protocol (PPP)," July 1994.			
D604	Exhibit Y11: Simpson, W., RFC1994, "PPP Challenge Handshake Authentication Protocol (CHAP)," 1996, http://www.ietf.org/rfc/rfc1994.txt .			
D605	Exhibit Y12: Meyer, G., RFC 1968, "The PPP Encryption Control Protocol (ECP)," June 1996.			
D606	Exhibit Y12: Perkins, D., RFC1171, "The Point-To-Point Protocol for the Transmission of Multi-Protocol Datagrams over Point-To-Point Links," 1990, Is Accessible at http://www.ietf.org/rfc/rfc1171.txt .			
D607	Exhibit Y13: Kummert, H., RFC 2420, "The PPP Triple-DES Encryption Protocol (3DESE)," September, 1998.			
D608	Exhibit Y14: Townsley, W.M., et al., RFC 2661, "Layer Two Tunneling Protocol 'L2TP'," August 1999.			
D609	Exhibit Y15: Pall, G.S., RFC 2118, "Microsoft Point-To-Point Encryption (MPPE) Protocol," March 1997.			
D610	Exhibit Y16: Gross, G., et al., RFC 2364, "PPP Over AAL5," July 1998.			
D611	Exhibit Y17: Srisuresh, P., RFC 2663, "IP Network Address Translator (NAT) Terminology and Considerations," August 1999.			
D612	Exhibit Y18: Heinanen, J., RFC 1483, "Multiprotocol Encapsulation over ATM Adaptation Layer 5," July 1993.			
D613	Exhibit Y2: Goldschlag et al., "Hiding Routing Information" (1996).			
D614	Exhibit Y3: Copy of U.S. Patent No. 5,950,519			
D615	Exhibit Y4: Ferguson, P. and Huston, G., "What Is a VPN", The Internet Protocol Journal, Vol 1., No. 1 (June 1998 ("Ferguson").			
D616	Exhibit Y5: Mockapetris, P., RFC 1034, "Domain Names – Concepts and Facilities," November 1987 ("RFC1034").			

Subst. for form 1449/PTO INFORMATION DISCLOSURE STATEMENT BY APPLICANT <i>(Use as many sheets as necessary)</i>			Complete if Known	
			Application Number	13/342,795
			Filing Date	01-03-2012
			First Named Inventor	Victor Larson
			Art Unit	2453
			Examiner Name	Krisna Lim
			Docket Number	77580-155(VR NK-1CP3CNFT5)
D617	Exhibit Y6: Mockapetris, P., RFC 1035, "Domain Names – Implementation and Specification," November 1987 ("RFC1035").			
D618	Exhibit Y8: Fielding, R., et al., RFC 2068, "Hypertext Transfer Protocol – HTTP/1.1," January 1997.			
D619	Exhibit Y8: Woodburn, R.A., et al., RFC1241, "A Scheme for an Internet Encapsulation Protocol: Version 1," 1991.			
D620	Exhibit Y9: Leech, M., et al., RFC 1928, "Socks Protocol Version 5," March 1996.			
D621	Exhibit Y9: Simpson, W., RFC1853, "IP in IP Tunneling," 1995, Is Accessible at http://www.ietf.org/rfc/rfc1583.txt .			
D622	Form PTO/SB/42, Listing Each Patent and Printed Publication Relied Upon to Provide a Substantial New Question of Patentability (Patent No. 6,502,135)			
D623	Form PTO/SB/42, Listing Each Patent and Printed Publication Relied Upon to Provide a Substantial New Question of Patentability (Patent No. 7,490,151)			
D624	Request for Inter Partes Reexamination (Patent No. 6,502,135)			
D625	Request for Inter Partes Reexamination Transmittal Form (PTO/SB/58) (Patent No. 6,502,135)			
D626	Request for Inter Partes Reexamination Transmittal Form (PTO/SB/58) (Patent No. 7,490,151)			
D627	Request for Inter Partes Reexamination Under 35 U.S.C. § 311 (Patent No. 6,502,135)			
D628	Request for Inter Partes Reexamination Under 35 U.S.C. § 311 (Patent No. 7,490,151)			
D629	Transmittal Letter (Patent No. 6,502,135)			
D630	Transmittal Letter (Patent No. 7,490,151)			
D631	Joint Claim Construction and Prehearing Statement			
D632	Exhibit A: Agreed Upon Terms; P.R. 4-3 Joint Claims Construction and Prehearing Statement			
D633	Exhibit B: Disputed Claim Terms; P.R. 4-3 Joint Claim Construction and Prehearing Statement			
D634	Exhibit C; VirnetX's Proposed Construction of Claim Terms and Supporting Evidence			
D635	Exhibit D; Defendants' Intrinsic and Extrinsic Support; P.R. 4-3 Joint Claim Construction and Prehearing Statement			
D636	File History of U.S. Patent 6,839,759			
D637	Exhibit B-4; VirnetX, Inc. v. Microsoft Corp., Case No. 6:07-cv-80, Microsoft's Motion for Partial Summary Judgment of Invalidity of U.S. Patent No. 6,839,759 (E.D. Tex. Dec. 18, 2009)			
D638	Exhibit D-2; Kent et al., "Security Architecture for the Internet Protocol," Internet Engineering Task Force, Internet Draft, (Feb. 1998)			
D639	Exhibit D-3; Aziz et al., U.S. Patent 5,548,646 to Aziz et al., "System for Signatureless Transmission and Reception of Data Packets Between Computer Networks," Filed Sept. 15, 1994 and issued Aug. 20, 1996			

Subst. for form 1449/PTO INFORMATION DISCLOSURE STATEMENT BY APPLICANT <i>(Use as many sheets as necessary)</i>			Complete if Known	
			Application Number	13/342,795
			Filing Date	01-03-2012
			First Named Inventor	Victor Larson
			Art Unit	2453
			Examiner Name	Krisna Lim
			Docket Number	77580-155(VRNL-1CP3CNFT5)
D640	Exhibit D-4; Yinger; U.S. Patent 5,960,204 to Yinger et al., "System and Method for Installing Applications on a Computer on an as needed basis, Filed on October 28, 1996 and Issued September 28, 1999			
D641	Exhibit D-8; Barlow; U.S. Patent 5,204,961 to Barlow, "Computer Network Operating with Multilevel Hierarchical Security with Selectable Common Trust Realms and Corresponding Security Protocols," Filed on June 25, 1990 and Issued April 20, 1993			
D642	Exhibit D-12; RFC 1122, Braden, "Requirements for Internet Hosts – Communication Layers," RFC 1122 (Oct. 1989)			
D643	Exhibit D-13; RFC 791; Information Sciences Institute, "Internet Protocol," DARPA Internet Program Specification RFC 791 (Sept. 1981)			
D644	Exhibit D-14; Caronni et al., "SKIP – Securing the Internet," 5th International Workshops on Enabling Technologies: Infrastructure for Collaborative Enterprises (WET ICE '96) (June 19-21, 1996)			
D645	Exhibit D-15; Maughan et al., "Internet Security Association and Key Management Protocol (ISAKMP)," IPSEC Work Group Draft (July 26, 1997)			
D646	Exhibit E-1; Claim Charts Applying Kiuchi as a Primary Reference to the '759 Patent.			
D647	Exhibit E-2; Claim Charts Applying Kent as a Primary Reference to the '759 Patent			
D648	Exhibit E-3; Claim Charts Applying Aziz as a Primary Reference to the '759 Patent			
D649	Exhibit E-4; Claim Charts Applying Kent in view of Caronni as a Primary Combination of References to the '759 Patent			
D650	Exhibit D-5; Edwards et al., "High Security Web Servers and Gateways," Computer Networks and ISDN System 29, pages 927-938 (Sept. 1997)			
D651	Exhibit D-10; Lee et al., "Hypertext Transfer Protocol – HTTP/1.0," RFC 1945 (May 1996)			
D652	Exhibit E-3; Claim Charts Applying Blum to Claims of the '151 Patent			
D653	Exhibit B-1, File History of U.S. Patent 7,490,151			
D654	Exhibit E-1, Claim Charts Applying Kiuchi, and Kiuchi and Martin to Claims of the '151 Patent			
D655	Exhibit E-2, Claim Charts Applying Wesinger, and Wesinger and Martin to Claims of the '151 Patent			
D656	Exhibit E-4, Claim Charts Applying Aziz and Edwards, and Aziz, Edwards, and Martin to Claims of the '151 Patent			
D657	Exhibit E-6, Claim Charts Applying Wesinger and Edwards, and Wesinger, Edwards, and Martin to Claims of the '151 Patent			
D658	VirnetX Inc., V. Mitel Networks Corp.; Defendants' Joint Invalidity Contentions			
D659	Exhibit 37, RFC 2661 ¹ vs. Claims of the '135 Patent ²			
D660	Exhibit 38, RFC 2661 ¹ vs. Claims of the '211 Patent ²			
D661	Exhibit 39, RFC 2661 ¹ vs. Claims of the '504 Patent ²			
D662	Exhibit 40, SecureConnect ¹ vs. Claims of the '135 Patent ²			

Subst. for form 1449/PTO INFORMATION DISCLOSURE STATEMENT BY APPLICANT <i>(Use as many sheets as necessary)</i>			Complete if Known	
			Application Number	13/342,795
			Filing Date	01-03-2012
			First Named Inventor	Victor Larson
			Art Unit	2453
			Examiner Name	Krisna Lim
			Docket Number	77580-155(VR NK-1CP3CNFT5)
D663	Exhibit 41, SecureConnect ¹ vs. Claims of the '211 Patent ²			
D664	Exhibit 42, SecureConnect ¹ vs. Claims of the '504 Patent ²			
D665	Exhibit 43, SFS-HTTP ¹ vs. Claims of the '135 Patent ²			
D666	Exhibit 44, SFS-HTTP ¹ vs. Claims of the '211 Patent ²			
D667	Exhibit 45, SFS-HTTP ¹ vs. Claims of the '504 Patent ²			
D668	Exhibit 46, US '883 ¹ vs. Claims of the '135 Patent ²			
D669	Exhibit 47, US '883 ¹ vs. Claims of the '211 Patent ²			
D670	Exhibit 48, US '883 ¹ vs. Claims of the '504 Patent ²			
D671	Exhibit 49, Chuah ¹ vs. Claims of the '135 Patent ²			
D672	Exhibit 50, Chuah ¹ vs. Claims of the '211 Patent ²			
D673	Exhibit 51, Chuah ¹ vs. Claims of the '504 Patent ²			
D674	Exhibit 52, U.S. '648 ¹ vs. Claims of the '135 Patent ²			
D675	Exhibit 53, U.S. '648 ¹ vs. Claims of the '211 Patent ²			
D676	Exhibit 57, B&M VPNs ¹ vs. Claims of the '504 Patent ²			
D677	Exhibit 58, BorderManager ¹ vs. Claims of the '135 Patent ²			
D678	Exhibit 59, BorderManager ¹ vs. Claims of the '211 Patent ²			
D679	Exhibit 60, BorderManager ¹ vs. Claims of the '504 Patent ²			
D680	Exhibit 61, Prestige 128 Plus ¹ vs. Claims of the '135 Patent ²			
D681	Exhibit 62, Prestige 128 Plus ¹ vs. Claims of the '211 Patent ²			
D682	Exhibit 63, Prestige 128 Plus ¹ vs. Claims of the '504 Patent ²			
D683	Exhibit 64, RFC 2401 ¹ vs. Claims of the '135 Patent ²			
D684	Exhibit 65, RFC 2401 ¹ vs. Claims of the '211 Patent ²			
D685	Exhibit 66, RFC 2401 ¹ vs. Claims of the '504 Patent ²			
D686	Exhibit 67, US '072 ¹ vs. Claims of the '135 Patent ²			
D687	Exhibit 68, RFC 2486 ¹ vs. Claims of the '211 Patent ²			
D688	Exhibit 69, RFC 2486 ¹ vs. Claims of the '504 Patent ²			

Subst. for form 1449/PTO INFORMATION DISCLOSURE STATEMENT BY APPLICANT <i>(Use as many sheets as necessary)</i>				Complete if Known	
				Application Number	13/342,795
				Filing Date	01-03-2012
				First Named Inventor	Victor Larson
				Art Unit	2453
				Examiner Name	Krisna Lim
				Docket Number	77580-155(VR NK-1CP3CNFT5)
D689	Exhibit 70 Understanding IPsec ¹ vs. Claims of the '135 Patent ²				
D690	Exhibit 71, Understanding IPsec ¹ vs. Claims of the '211 Patent ²				
D691	Exhibit 72, Understanding IPsec ¹ vs. Claims of the '504 Patent ²				
D692	Exhibit 73, US '820 ¹ vs. Claims of the '135 Patent ²				
D693	Exhibit 74, US '820 ¹ vs. Claims of the '211 Patent ²				
D694	Exhibit 75, US '820 ¹ vs. Claims of the '504 Patent ²				
D695	Exhibit 76, US '019 ¹ vs. Claims of the '211 Patent ²				
D696	Exhibit 77, US '019 ¹ vs. Claims of the '504 Patent ²				
D697	Exhibit 78, US '049 ¹ vs. Claims of the '135 Patent ²				
D698	Exhibit 79, US '049 ¹ vs. Claims of the '211 Patent ²				
D699	Exhibit 80, US '049 ¹ vs. Claims of the '504 Patent ²				
D700	Exhibit 81, US '748 ¹ vs. Claims of the '135 Patent ²				
D701	Exhibit 82, US '261 ¹ vs. Claims of the '135 Patent ²				
D702	Exhibit 83, US '261 ¹ vs. Claims of the '211 Patent ²				
D703	Exhibit 84, US '261 ¹ vs. Claims of the '504 Patent ²				
D704	Exhibit 85, US '900 ¹ vs. Claims of the '135 Patent ²				
D705	Exhibit 86, US '900 ¹ vs. Claims of the '211 Patent ²				
D706	Exhibit 87, US '900 ¹ vs. Claims of the '504 Patent ²				
D707	Exhibit 88, US '671 ¹ vs. Claims of the '135 Patent ²				
D708	Exhibit 89, US '671 ¹ vs. Claims of the '211 Patent ²				
D709	Exhibit 90, US '671 ¹ vs. Claims of the '504 Patent ²				
D710	Exhibit 91, JP '704 ¹ vs. Claims of the '135 Patent ²				
D711	Exhibit 92, JP '704 ¹ vs. Claims of the '211 Patent ²				
D712	Exhibit 93, JP '704 ¹ vs. Claims of the '504 Patent ²				
D713	Exhibit 94, GB '841 ¹ vs. Claims of the '135 Patent ²				
D714	Exhibit 95, GB '841 ¹ vs. Claims of the '211 Patent ²				

Subst. for form 1449/PTO				Complete if Known	
				Application Number	13/342,795
INFORMATION DISCLOSURE STATEMENT BY APPLICANT <i>(Use as many sheets as necessary)</i>				Filing Date	01-03-2012
				First Named Inventor	Victor Larson
				Art Unit	2453
				Examiner Name	Krisna Lim
				Docket Number	77580-155(VR NK-1CP3CNFT5)
D715	Exhibit 96, GB '841 ¹ vs. Claims of the '504 Patent ²				
D716	Exhibit 97, US '318 ¹ vs. Claims of the '135 Patent ²				
D717	Exhibit 98, US '318 ¹ vs. Claims of the '211 Patent ²				
D718	Exhibit 99, US '318 ¹ vs. Claims of the '504 Patent ²				
D719	Exhibit 100, VPN/VLAN ¹ vs. Claims of the '135 Patent ²				
D720	Exhibit 101, Nikkei ¹ vs. Claims of the '135 Patent ²				
D721	Exhibit 102, Nikkei ¹ vs. Claims of the '211 Patent ²				
D722	Exhibit 103, Nikkei ¹ vs. Claims of the '504 Patent ²				
D723	Exhibit 104, Special Anthology ¹ vs. Claims of the '135 Patent ²				
D724	Exhibit 106-A, Gauntlet System ¹ vs. Claims of the '135 Patent ²				
D725	Exhibit 109-A, Gauntlet System ¹ vs. Claims of the '211 Patent ²				
D726	Exhibit 110-A, Gauntlet System ¹ vs. Claims of the '504 Patent ²				
D727	Exhibit 112, IntraPort System ¹ vs. Claims of the '135 Patent ²				
D728	Exhibit 115, IntraPort System ¹ vs. Claims of the '211 Patent ²				
D729	Exhibit 116, IntraPort System ¹ vs. Claims of the '504 Patent ²				
D730	Exhibit 118, Altiga VPN System ¹ vs. Claims of the '135 Patent ²				
D731	Exhibit 121, Altiga VPN System ¹ vs. Claims of the '211 Patent ²				
D732	Exhibit 122, Altiga VPN System ¹ vs. Claims of the '504 Patent ²				
D733	Exhibit 124, Kiuchi ¹ vs. Claims of the '135 Patent ²				
D734	Exhibit 127, Kiuchi ¹ vs. Claims of the '211 Patent ²				
D735	Exhibit 128, Kiuchi ¹ vs. Claims of the '504 Patent ²				
D736	Exhibit 137, Schulzrinne ¹ vs. Claims of the '135 Patent ²				
D737	Exhibit 137, Schulzrinne ¹ vs. Claims of the '135 (Final) Patent ²				
D738	Exhibit 140, Schulzrinne ¹ vs. Claims of the '211 Patent ²				
D739	Exhibit 141, Schulzrinne ¹ vs. Claims of the '504 Patent ²				
D740	Exhibit 143, Solana ¹ vs. Claims of the '135 Patent ²				

Subst. for form 1449/PTO INFORMATION DISCLOSURE STATEMENT BY APPLICANT <i>(Use as many sheets as necessary)</i>				Complete if Known	
				Application Number	13/342,795
				Filing Date	01-03-2012
				First Named Inventor	Victor Larson
				Art Unit	2453
				Examiner Name	Krisna Lim
				Docket Number	77580-155(VR NK-1CP3CNFT5)
D741	Exhibit 146, Solana ¹ vs. Claims of the '211 Patent ²				
D742	Exhibit 147, Solana ¹ vs. Claims of the '504 Patent ²				
D743	Exhibit 155, Marino ¹ vs. Claims of the '135 Patent ²				
D744	Exhibit 158, Marino ¹ vs. Claims of the '211 Patent ²				
D745	Exhibit 159, Marino ¹ vs. Claims of the '504 Patent ²				
D746	Exhibit 168, Aziz ¹ vs. Claims of the '135 Patent ²				
D747	Exhibit 171, U.S. '234 ¹ vs. Claims of the '211 Patent ²				
D748	Exhibit 172, Aziz ¹ vs. Claims of the '504 Patent ²				
D749	Exhibit 175, Valencia ¹ vs. Claims of the '135 Patent ²				
D750	Exhibit 178, Valencia ¹ vs. Claims of the '211 Patent ²				
D751	Exhibit 179, Valencia ¹ vs. Claims of the '504 Patent ²				
D752	Exhibit 181, Davison ¹ vs. Claims of the '135 Patent ²				
D753	Exhibit 184, Davison ¹ vs. Claims of the '211 Patent ²				
D754	Exhibit 185, Davison ¹ vs. Claims of the '504 Patent ²				
D755	Exhibit 200, BinGO! User's Guide/Extended Features Reference ¹ vs. Claims of the '135 Patent ²				
D756	Exhibit 203, Broadband Forum Technical Report TR-025 (Issue 1.0/5.0) ¹ vs. Claims of the '135 Patent ²				
D757	Exhibit 206, RFC 2230, Key Exchange Delegation Record for the DNS ¹ vs. Claims of the '211 Patent ²				
D758	Exhibit 207, RFC 2230, Key Exchange Delegation Record for the DNS ¹ vs. Claims of the '504 Patent ²				
D759	Exhibit 208, RFC 2538, Storing Certificates in the Domain Name System (DNS) ¹ vs. Claims of the '211 Patent ²				
D760	Exhibit 209, RFC 2538, Storing Certificates in the Domain Name System (DNS) ¹ vs. Claims of the '504 Patent ²				
D761	Exhibit 212, RFC 2486, RFC 2661, RFC 2401 and Internet-Draft, "Secure Remote Access with L2TP" ¹ vs. Claims of the '135 Patent ²				
D762	Exhibit 218, U.S. Patent No. 6,496,867 in combination with RFC 2401 ¹ vs. Claims of the '135 Patent ²				
D763	Exhibit 219, U.S. Patent No. 6,496,867 ¹ vs. Claims of the '211 Patent ²				
D764	Exhibit 220, U.S. Patent No. 6,496,867 ¹ vs. Claims of the '504 Patent ²				
D765	Exhibit 222, U.S. Patent No. 6,557,037 ¹ vs. Claims of the '211 Patent ²				

Subst. for form 1449/PTO INFORMATION DISCLOSURE STATEMENT BY APPLICANT <i>(Use as many sheets as necessary)</i>			Complete if Known	
			Application Number	13/342,795
			Filing Date	01-03-2012
			First Named Inventor	Victor Larson
			Art Unit	2453
			Examiner Name	Krisna Lim
			Docket Number	77580-155(VR NK-1CP3CNFT5)
D766	Exhibit 223, U.S. Patent No. 6,557,037 ¹ vs. Claims of the '504 Patent ²			
D767	Exhibit 224, RFC 2230, Key Exchange Delegation Record for the DNS ¹ vs. Claims of the '135 Patent ²			
D768	Exhibit 228, U.S. 588 ¹ vs. Claims of the '211 Patent ² (Final)			
D769	Exhibit 229, U.S. 588 ¹ vs. Claims of the '504 Patent ² (Final)			
D770	Exhibit 230, Microsoft VPN ¹ vs. Claims of the '135 Patent ² (Final)			
D771	Exhibit 231, Microsoft VPN ¹ vs. Claims of the '211 Patent ² (Final)			
D772	Exhibit XX, Microsoft VPN ¹ vs. Claims of the '504 Patent ²			
D773	Exhibit Cisco-1, Cisco's Prior Art System ¹ vs. Claims of the '135 Patent ²			
D774	Exhibit Cisco-4, Cisco's Prior Art System ¹ vs. Claims of the '211 Patent ²			
D775	Exhibit Cisco-5, Cisco's Prior Art System ¹ vs. Claims of the '504 Patent ²			
D776	Exhibit 225, US '037 ¹ vs. Claims of the '135 Patent ²			
D777	Exhibit 226, ITU-T Standardization Activities ¹ vs. Claims of the '135 Patent ²			
D778	Exhibit 227, US '393 ¹ vs. Claims of the '135 Patent ²			
D779	Exhibit 233, The Miller Application ¹ vs. Claim 13 of the '135 Patent ²			
D780	Exhibit 234, Aventail Connect 3.1/2.6 Administrator's Guide ("Aventail Connect") ¹ vs. Claims of the '504 Patent ²			
D781	Exhibit 235, Microsoft VPN ¹ vs. Claims of the '504 Patent ²			
D782	Exhibit 1, IETF RFC 2065: Domain Name System Security Extensions; published January 1997 ¹ vs. Claims of the '211 Patent ²			
D783	Exhibit 2, IETF RFC 2065: Domain Name System Security Extensions; published January 1997 ¹ vs. Claims of the '504 Patent ²			
D784	Exhibit 3, RFC 2543 ¹ vs. Claims of the '135 Patent ²			
D785	Exhibit 4, RFC 2543 ¹ vs. Claims of the '211 Patent ²			
D786	Exhibit 5, RFC 2543 ¹ vs. Claims of the '504 Patent ²			
D787	Exhibit 6, SIP Draft v.2 ¹ vs. Claims of the '135 Patent ²			
D788	Exhibit 7, SIP Draft v.2 ¹ vs. Claims of the '211 Patent ²			
D789	Exhibit 8, SIP Draft v.2 ¹ vs. Claims of the '504 Patent ²			
D790	Exhibit 9, H.323 ¹ vs. Claims of the '135 Patent ²			

Subst. for form 1449/PTO			Complete if Known	
			Application Number	13/342,795
INFORMATION DISCLOSURE STATEMENT BY APPLICANT <i>(Use as many sheets as necessary)</i>			Filing Date	01-03-2012
			First Named Inventor	Victor Larson
			Art Unit	2453
			Examiner Name	Krisna Lim
			Docket Number	77580-155(VR NK-1CP3CNFT5)
D791	Exhibit 10, H.323 ¹ vs. Claims of the '211 Patent ²			
D792	Exhibit 11, H.323 ¹ vs. Claims of the '504 Patent ²			
D793	Exhibit 12, SSL 3.0 ¹ vs. Claims of the '135 Patent ²			
D794	Exhibit 13, SSL 3.0 ¹ vs. Claims of the '211 Patent ²			
D795	Exhibit 14, SSL 3.0 ¹ vs. Claims of the '504 Patent ²			
D796	Exhibit 15, RFC 2487 ¹ vs. Claims of the '135 Patent ²			
D797	Exhibit 16, RFC 2487 ¹ vs. Claims of the '211 Patent ²			
D798	Exhibit 17, RFC 2487 ¹ vs. Claims of the '504 Patent ²			
D799	Exhibit 18, RFC 2595 ¹ vs. Claims of the '135 Patent ²			
D800	Exhibit 21, iPass ¹ vs. Claims of the '135 Patent ²			
D801	Exhibit 22, iPass ¹ vs. Claims of the '211 Patent ²			
D802	Exhibit 23, iPass ¹ vs. Claims of the '504 Patent ²			
D803	Exhibit 24, U.S. Patent No. 6,453,034 ('034 Patent") vs. Claims of the 135 Patent ¹			
D804	Exhibit 25, U.S. Patent No. 6,453,034 ('034 Patent") vs. Claims of the 211 Patent ¹			
D805	Exhibit 26, U.S. Patent No. 6,453,034 ('034 Patent") vs. Claims of the 504 Patent ¹			
D806	Exhibit 27, U.S. Patent No. 6,223,287 ("287 Patent") vs. Claims of the 135 Patent ¹			
D807	Exhibit 28, U.S. Patent No. 6,223,287 ("287 Patent") vs. Claims of the 211 Patent ¹			
D808	Exhibit 29, U.S. Patent No. 6,223,287 ("287 Patent") vs. Claims of the 504 Patent ¹			
D809	Exhibit 35, RFC 1928 ¹ vs. Claims of the '211 Patent ²			
D810	Exhibit 36, RFC 1928 ¹ vs. Claims of the '504 Patent ²			
D811	Exhibit 106, Gauntlet System and Gauntlet References ¹ vs. Claims of the '135 Patent ²			
D812	Exhibit 109, Gauntlet System and Gauntlet References ¹ vs. Claims of the '211 Patent ²			
D813	Exhibit 110, Gauntlet System ¹ vs. Claims of the '504 Patent ²			
D814	Exhibit 130, Overview of Access VPNs and Tunneling Technologies ("Overview") ¹ vs. Claims of the '135 Patent ²			
D815	Exhibit 133, Overview of Access VPNs and Tunneling Technologies ("Overview") ¹ vs. Claims of the '211 Patent ²			

Subst. for form 1449/PTO INFORMATION DISCLOSURE STATEMENT BY APPLICANT <i>(Use as many sheets as necessary)</i>			Complete if Known	
			Application Number	13/342,795
			Filing Date	01-03-2012
			First Named Inventor	Victor Larson
			Art Unit	2453
			Examiner Name	Krisna Lim
			Docket Number	77580-155(VR NK-1CP3CNFT5)
D816	Exhibit 134, Overview of Access VPNs and Tunneling Technologies ("Overview") ¹ vs. Claims of the '504 Patent ²			
D817	Exhibit 149, Atkinson ¹ vs. Claims of the '135 Patent ²			
D818	Exhibit 152, Atkinson ¹ vs. Claims of the '211 Patent ²			
D819	Exhibit 153, Atkinson ¹ vs. Claims of the '504 Patent ²			
D820	Exhibit 162, Wesinger ¹ vs. Claims of the '135 Patent ²			
D821	Exhibit 165, Wesinger ¹ vs. Claims of the '211 Patent ²			
D822	Exhibit 166, Wesinger ¹ vs. Claims of the '504 Patent ²			
D823	Exhibit 187, AutoSOCKS v2.1 ¹ vs. Claims of the '135 Patent ²			
D824	Exhibit 191, Aventail Connect 3.01/2.51 ("Aventail Connect") ¹ vs. Claims of the '135 Patent ²			
D825	Exhibit 195, Aventail Connect 3.1/2.6 Administrator's Guide ("Aventail Connect") ¹ vs. Claims of the '135 Patent ²			
D826	Exhibit 204, Domain Name System (DNS) Security ¹ vs. Claims of the '211 Patent ²			
D827	Exhibit 205, Domain Name System (DNS) Security ¹ ("DNS Security") vs. Claims of the '504 Patent ²			
D828	Exhibit 210, Lendenmann ¹ vs. Claims of the '211 Patent ²			
D829	Exhibit 211, Lendenmann ¹ vs. Claims of the '504 Patent ²			
D830	Exhibit 213, U.S. Patent No. 7,100,195 in combination with RFC 2401 and U.S. Patent No. 6,496,867 ¹ vs. Claims of the '135 Patent ²			
D831	Exhibit 215, Aziz ¹ vs. Claims of the '135 Patent ²			
D832	Cisco '180, Efiling Acknowledgment			
D833	Exhibit A, U.S. Patent 7,188,180			
D834	Exhibit B1, File History of U.S. Patent 7,188,180			
D835	Exhibit B2, File History of U.S. Patent Application No. 09/588,209			
D836	Exhibit B3, File History of Reexamination Control No. 95/001,270, Reexamination of U.S. 7,188,180 requested by Microsoft Corp			
D837	Exhibit D1, "Lendenmann": Rolf Lendenman, Understanding OSF DCE 1.1 For AIX and OS/2, IBM International Technical Support Organization (Oct. 1995).			
D838	Exhibit D5, "Schneier": Bruce Schneier, Applied Cryptography (1996)			
D839	Exhibit D6, RFC 793; Information Sciences Institute, "Transmission Control Protocol," DARPA Internet Program Specification RFC 793 (Sept. 1981)			
D840	Exhibit D7, "Schimpf"; Brian C. Schimpf, "Securing Web Access with DCE," Presented at Network and Distributed System Security (Feb. 10-11, 1997)			

Subst. for form 1449/PTO			Complete if Known	
INFORMATION DISCLOSURE STATEMENT BY APPLICANT <i>(Use as many sheets as necessary)</i>			Application Number	13/342,795
			Filing Date	01-03-2012
			First Named Inventor	Victor Larson
			Art Unit	2453
			Examiner Name	Krisna Lim
			Docket Number	77580-155(VR NK-1CP3CNFT5)
D841	Exhibit D8, "Rosenberry"; Ward Rosenberry, David Kenney, and Gerry Fisher, Understanding DCE (1993)			
D842	Exhibit D9, Masys; Daniel R. Masys & Dixie B. Baker, "Protecting Clinical Data on Web Client Computers: The PCASSO Approach," Proceedings of the AMIA '98 Annual Symposium, Orlando, Florida (Nov. 7-11, 1998)			
D843	Exhibit E1, Claim Charts Applying Lendenmann as a Primary Reference to the '180 Patent.			
D844	Exhibit E2, Claim Charts Applying Kiuchi as a Primary Reference to the '180 Patent			
D845	Exhibit E3, Claim Charts Applying Solana as a Primary Reference to the '180 Patent			
D846	Exhibit E4, Claim Charts Applying Schimpf and Rosenberry as a Primary Reference to the '180 Patent			
D847	Request for Inter Partes Reexamination of Patent No. 7,188,180			
D848	Modified PTO Form 1449			
D849	Request for Inter Partes Reexamination Transmittal Form No. 7,188,180			
D850	Exhibit A; U.S. Patent 7,921,211 with Terminal Disclaimer			
D851	Exhibit B, Certificate of Service to Request For Inter Partes Reexamination Under 35 U.S.C. § 311 (Patent No. 7,921,211)			
D852	Exhibit C1, Claim Chart – USP 7,921,211 Relative to Solana, Alone and in Conjunction with RFC 920, Reed and Beser			
D853	Exhibit C2, Claim Chart – USP 7,921,211 Relative to Solana in view of RFC 2504 and Further in conjunction with RFC 920, Reed, and Beser			
D854	Exhibit C3, Claim Chart – USP 7,921,211 Relative to Provino, Alone and in Conjunction with RFC 920, Reed, and Beser)			
D855	Exhibit C4, Claim Chart – USP 7,921,211 Relative to Provino in view of RFC 2230 and Further in Conjunction with RFC 920, Reed and Beser			
D856	Exhibit C5, Claim Chart – USP 7,921,211 Relative to Provino in view of RFC 2504 and in Further Conjunction with RFC 920, Reed and Beser			
D857	Exhibit C6, Claim Chart – USP 7,921,211 Relative to Beser, Alone and in Conjunction with RFC 920, RFC 2401, and Reed			
D858	Exhibit C7, Claim Chart – USP 7,921,211 Relative to RFC 2230, Alone and in Conjunction with RFC 920, RFC 2401, Reed, and Beser			
D859	Exhibit C8, Claim Chart – USP 7,921,211 Relative to RFC 2538, Alone and in Conjunction with RFC 920, RFC 2401, Reed, Beser, and RFC 2065			
D860	Exhibit D1, Asserted Claim and Infringement Contentions by Plaintiff VirnetX, Inc. in <i>VirnetX, Inc. v. Cisco Systems, Inc., Apple Inc., Aastra Technologies Ltd, NEC Corporation, NEC Corporation of America and Aastra USA, Inc.</i> , Civ. Act 6:2010cv00417 (E.D. Tex)			
D861	Exhibit D2, Asserted Claims and Infringement Contentions by Plaintiff VirnetX, Inc. against Apple based on 7,921,211 Patent			
D862	Exhibit X1, Solana, E. et al. "Flexible Internet Secure Transactions Based on Collaborative Domains"			

Subst. for form 1449/PTO			Complete if Known	
INFORMATION DISCLOSURE STATEMENT BY APPLICANT <i>(Use as many sheets as necessary)</i>			Application Number	13/342,795
			Filing Date	01-03-2012
			First Named Inventor	Victor Larson
			Art Unit	2453
			Examiner Name	Krisna Lim
			Docket Number	77580-155(VRNL-1CP3CNFT5)
D863	Exhibit X2, U.S. Patent 6,557,037			
D864	Exhibit X4, Atkinson, R., IETF RFC 2230, "Key Exchange Delegation Record for the DNS" (November 1997)			
D865	Exhibit X6, Kent, et al., IETF RFC 2401, "Security Architecture for the Internet Protocol" (November 1998) Is Accessible at: http://www.ietf.org/rfc/rfc2401.txt			
D866	Exhibit X7, Eastlake, D. et al., IETF RFC 2065, "Domain Name System Security Extensions" (January 1997) Is Accessible at: http://www.ietf.org/rfc/rfc2065.txt			
D867	Exhibit X9, Guttman, E. et al., IETF RFC 2504, "Users' Security Handbook" (February 1999) Is Accessible At: http://www.ietf.org/rfc/rfc2504.txt			
D868	Exhibit Y3, Braden, R., RFC 1123, "Requirements for Internet Hosts – Application and Support," October 1989 ("RFC1123").			
D869	Exhibit Y4, Atkinson, R., RFC 1825, "Security Architecture for the Internet Protocol (August 1995) Is Accessible At: http://www.ietf.org/rfc/rfc1825.txt			
D870	Exhibit Y5, Housley, R. et al., RFC 2459, "Internet X.509 Public Key Infrastructure Certificate and CRL Profile" (January 1999) Is accessible At: http://www.ietf.org/rfc/rfc2459.txt			
D871	Exhibit A, U.S. Patent 7,418,504			
D872	Exhibit B, Certificate of Service to Request For Inter Partes Reexamination Under 35 U.S.C. § 311 (Patent No. 7,418,504)			
D873	Exhibit C1, Claim Chart – USP 7,418,504 Relative to Solana, Alone and in Conjunction with RFC 920, Reed, and Beser			
D874	Exhibit C2, Claim Chart – USP 7,418,504 Relative to Solana in view of RFC 2504 and Further in Conjunction with RFC 920, Reed, and Beser			
D875	Exhibit C3, Claim Chart – USP 7,418,504 Relative to Provino, Alone and in Conjunction with RFC 920, Reed, and Beser			
D876	Exhibit C4, Claim Chart – USP 7,418,504 Relative to Provino in View of RFC 2230 and Further in Conjunction with RFC 920, Reed and Beser			
D877	Exhibit C5, Claim Chart – USP 7,418,504 Relative to Provino in View of RFC 2504 and in Further Conjunction with RFC 920, Reed, and Beser			
D878	Exhibit C6, Claim Chart – USP 7,418,504 Relative to Beser, Alone and in Conjunction with RFC 920, RFC 2401, and Reed			
D879	Exhibit C7, Claim Chart – USP 7,418,504 Relative to RFC 2230, Alone and in Conjunction with RFC 920, RFC 2401, Reed, and Beser			
D880	Exhibit C8, Claim Chart – USP 7,418,504 Relative to RFC 2538, Alone and in Conjunction with RFC 920, RFC 2401, Reed, Beser, and RFC 2065			
D881	Exhibit D1, Asserted Claims and Infringement Contentions by Plaintiff VirnetX Inc. in <i>VirnetX, Inc. v. Cisco Systems, Inc., Applce, Inc, Aastra Technologies Ltd., NEC Corporation, NEC Corporation of America and Aastra USA, Inc.</i> , Civ. Act. 6:2010cv00417 (E.D. Tex)			
D882	Exhibit D2, Asserted Claims and Infringement Contentions by Plaintiff VirnetX Inc. against Apple Inc. Based on the 7,418,504			
D883	Exhibit X5, Eastlake, D., et al., IETF RFC 2538, "Storing Certificates in the Domain Name System (DNS)" (March 1999)			
D884	Exhibit X6, Kent, S. IETF RFC 2401, "Security Architecture for the Internet Protocol, (November1998) http://www.ietf.org/rfc/rfc2401.txt			

Subst. for form 1449/PTO			Complete if Known	
INFORMATION DISCLOSURE STATEMENT BY APPLICANT <i>(Use as many sheets as necessary)</i>			Application Number	13/342,795
			Filing Date	01-03-2012
			First Named Inventor	Victor Larson
			Art Unit	2453
			Examiner Name	Krisna Lim
			Docket Number	77580-155(VR NK-1CP3CNFT5)

	D885	Exhibit X8, Postel, J. et al., IETF RFC 920, "Domain Requirements" (October 1984) Is Accessible at http://www.ietf.org/rfc/rfc920.txt	
	D886	Exhibit X10, Reed, M. et al. "Proxies for Anonymous Routing," 12th Annual Computer Security Applications Conference, San Diego, CA, Dec. 9-13, 1996.	
	D887	Request for Inter Partes Reexamination Transmittal form	
	D888	Transmittal Letter	
	D889	Request for Inter Partes Reexamination Under 35 U.S.C. § 311	
	D890	Exhibit D-7, "Thomas": Brian Thomas, "Recipe for E-Commerce, IEEE Internet Computing, (Nov.-Dec. 1997)	
	D891	Exhibit D-9, "Kent II": Stephen Kent & Randall Atkinson, "IP Encapsulating Security Payload (ESP)," Internet Engineering Task Force, Internet Draft (Feb. 1998)	
	D892	Exhibit C1, Claim Chart – USP 7,921,211 Relative to Solana, Alone and in Conjunction with RFC 920, Reed and Beser (Came from Inval. Cisco dtd 11/18/11)	
	D893	Exhibit C2, Claim Chart – USP 7,921,211 Relative to Solana in View of RFC 2504 and Further in Conjunction with RFC 920, Reed, and Beser	
	D894	Exhibit C3, Claim Chart – USP 7,921,211 Relative to Provino, Alone and in Conjunction with RFC 920, Reed, and Beser	
	D895	Exhibit C4, Claim Chart – USP 7,921,211 Relative to Provino in View of RFC 2230 and Further in Conjunction with RFC 920, Reed and Beser	
	D896	Exhibit C5, Claim Chart – USP 7,921,211 Relative to Provino in View of RFC 2504 and in Further Conjunction with RFC 920, Reed and Beser	
	D897	Exhibit C6, Claim Chart – USP 7,921,211 Relative to Beser, Alone and in Conjunction with RFC 920, RFC 2401, and Reed	
	D898	Exhibit C7, Claim Chart – USP 7,921,211 Relative to RFC 2230, Alone and in Conjunction with RFC 920, Reed, and Beser	
	D899	Exhibit C8, Claim Chart – USP 7,921,211 Relative to RFC 2538, Alone and in Conjunction with RFC 920, RFC 2401, Reed, Beser, and RFC 2065	
	D900	211 Request for Inter Partes Reexamination	
	D901	Exhibit C1, Claim Chart – USP 7,418,504 Relative to Solana, Alone and in Conjunction with RFC 920, Reed and Beser	
	D902	Exhibit C2, Claim Chart – USP 7,418,504 Relative to Solana in View of RFC 2504 and Further in Conjunction with RFC 920, Reed, and Beser	
	D903	Exhibit C3, Claim Chart – USP 7,418,504 Relative to Provino, Alone and in Conjunction with RFC 920, Reed, and Beser	
	D904	Exhibit C5, Claim Chart – USP 7,418,504 Relative to Provino in View of RFC 2504 and in Further Conjunction with RFC 920, Reed and Beser	
	D905	Exhibit C6, USP 7,418,504 Relative to Beser, Alone and in Conjunction with RFC 920, RFC 2401, and Reed	
	D906	Exhibit C7, Claim Chart – USP 7,418,504 Relative to RFC 2230, Alone and in Conjunction with RFC 920, RFC 2401, Reed, and Beser	

Subst. for form 1449/PTO INFORMATION DISCLOSURE STATEMENT BY APPLICANT <i>(Use as many sheets as necessary)</i>			Complete if Known	
			Application Number	13/342,795
			Filing Date	01-03-2012
			First Named Inventor	Victor Larson
			Art Unit	2453
			Examiner Name	Krisna Lim
			Docket Number	77580-155(VR NK-1CP3CNFT5)
D907	Exhibit C8, Claim Chart – USP 7,418,504 Relative to RFC 2538, Alone and in Conjunction with RFC 920, RFC 2401, Reed, Beser, and RFC 2065			
D908	504 Request for Inter Partes Reexamination			
D909	Defendants' Supplemental Joint Invalidity Contentions			
D910	Exhibit 226, Securing Web Access with DCE ¹ vs. Claims of the '135 Patent ²			
D911	Exhibit 227, Securing Web Access with DCE ¹ vs. Claims of the '151 Patent ²			
D912	Exhibit 228, Understanding OSF DCE 1.1 for AIX and OS/2 ¹ vs. Claims of the '135 Patent ²			
D913	Exhibit 229, Understanding OSF DCE 1.1 for AIX and OS/2 ¹ vs. Claims of the '151 Patent ²			
D914	Exhibit 230, Understanding OSF DCE 1.1 for AIX and OS/2 ¹ vs. Claims of the '180 Patent ²			
D915	Exhibit 231, Understanding OSF DCE 1.1 for AIX and OS/2 ¹ vs. Claims of the '211 Patent ²			
D916	Exhibit 232, Understanding OSF DCE 1.1 for AIX and OS/2 ¹ vs. Claims of the '504 Patent ²			
D917	Exhibit 233, Understanding OSF DCE 1.1 for AIX and OS/2 ¹ vs. Claims of the '759 Patent ²			
D918	Exhibit 234, U.S. '648 ¹ vs. Claims of the '135 Patent			
D919	Exhibit 235, U.S. '648 ¹ vs. Claims of the '211 Patent			
D920	Exhibit 236, U.S. '648 ¹ vs. Claims of the '504 Patent ²			
D921	Exhibit 237, U.S. '648 ¹ vs. Claims of the '135 Patent ²			
D922	Exhibit 238, Gauntlet System ¹ vs. Claims of the '211 Patent ²			
D923	Exhibit 239, Gauntlet System ¹ vs. Claims of the '504 Patent ²			
D924	Exhibit 240, Gauntlet System ¹ vs. Claims of the '135 Patent ²			
D925	Exhibit 241, U.S. '588 ¹ vs. Claims of the '211 Patent ²			
D926	Exhibit 242, U.S. '588 ¹ vs. Claims of the '504 Patent ²			
D927	Exhibit 243, Microsoft VPN ¹ vs. Claims of the '135 Patent ²			
D928	Exhibit 244, Microsoft VPN ¹ vs. Claims of the '211 Patent ²			
D929	Exhibit 245, Microsoft VPN ¹ vs. Claims of the '504 Patent ²			
D930	Exhibit 246, ITU-T Standardization Activities ¹ vs. Claims of the '135 Patent ²			
D931	Exhibit 247, U.S. '393 ¹ vs. Claims of the '135 Patent ²			
D932	Exhibit 248, The Miller Application ¹ vs. Claim 13 of the '135 Patent ²			

**INFORMATION DISCLOSURE STATEMENT
BY APPLICANT***(Use as many sheets as necessary)*

Application Number	13/342,795
Filing Date	01-03-2012
First Named Inventor	Victor Larson
Art Unit	2453
Examiner Name	Krisna Lim
Docket Number	77580-155(VRNL-1CP3CNFT5)

D933	Exhibit 249, Gauntlet System ¹ vs. Claims of the '151 Patent ²			
D934	Exhibit 250, ITU-T Standardization Activities ¹ vs. Claims of the '151 Patent ²			
D935	Exhibit 251, U.S. Patent No. 5,940,393 ¹ vs. Claims of the '151 Patent ²			
D936	Exhibit 252, Microsoft VPN ¹ vs. Claims of the '151 Patent ²			
D937	Exhibit 253, U.S. Patent No.6,324,648 ¹ vs. Claims of the '151 Patent ²			
D938	Exhibit 254, U.S. Patent No.6,857,072 ¹ vs. Claims of the '151 Patent ²			
D939	Exhibit A, Aventail Press Release, May 2, 1997			
D940	Exhibit B, InfoWorld, "Aventail Delivers Highly Secure, Flexible VPN Solution," InfoWorld, page 64D, (1997)			
D941	Exhibit C, Aventail AutoSOCKS v2.1 Administrator's Guide			
D942	Exhibit D, Aventail Press Release, October 12, 1998			
D943	Exhibit G, Aventail Press Release, May 26, 1999			
D944	Exhibit H, Aventail Press Release, August 9, 1999			
D945	Exhibit J, "Aventail ExtraNet Center 3.1: Security with Solid Management, Network Computing, June 28, 1999			
D946	Petition in Opposition to Patent Owner's Petition to Vacate Inter Partes ReExamination Determination on Certain Prior Art			
D947	Request for Inter Partes Reexamination Under 35 U.S.C. § 311			
D948	Exhibit B, Certificate of Service to Request for Inter Partes Reexamination Under U.S.C. § 311			
D949	Exhibit C1, Claim Chart Aventail Connect v3.1			
D950	Exhibit C2, Claim Chart Aventail Connect v3.01			
D951	Exhibit C3, Claim Chart Aventail AutoSOCKS			
D952	Exhibit C4, Claim Chart Wang			
D953	Exhibit C5, Claim Chart Beser			
D954	Exhibit C6, Claim Chart BINGO			
D955	Exhibit X6, U.S. Patent 6,496,867			
D956	Exhibit X10, U.S. Patent 4,885,778			
D957	Exhibit X11, U.S. Patent 6,615,357			

Complete if Known**INFORMATION DISCLOSURE STATEMENT
BY APPLICANT***(Use as many sheets as necessary)*

Application Number	13/342,795
Filing Date	01-03-2012
First Named Inventor	Victor Larson
Art Unit	2453
Examiner Name	Krisna Lim
Docket Number	77580-155(VRKN-1CP3CNFT5)

D958	Exhibit Y3, U.S. Patent 5,950,519			
D959	Request for Inter Partes Reexamination Transmittal Form			
D960	Transmittal Letter			
D961	Exhibit D, v3.1 Administrator's Guide			
D962	Exhibit E-1, Claim Charts Applying Kiuchi to Various Claims of the '135 Patent			
D963	Exhibit E-2, Claim Charts Applying Wesinger to Various Claims of the '135 Patent			
D964	Exhibit E-3, Claim Charts Applying Solana to Various Claims of the '135 Patent			
D965	Exhibit E-4, Claim Charts Applying Aziz to Various Claims of the '135 Patent			
D966	Request for Inter Partes Reexamination Transmittal Form			
D967	Request for Inter Partes Reexamination			
D968	Request for Inter Partes Reexamination Transmittal Form 1449/PTO			
D969	Exhibit C1, Claim Chart Aventail Connect v3.01			
D970	Exhibit C2, Claim Chart Aventail AutoSOCKS			
D971	Exhibit C3, Claim Chart BINGO			
D972	Exhibit C4, Claim Chart Beser			
D973	Exhibit C5, Claim Chart Wang			
D974	Transmittal Letter			
D975	Request for Inter Partes Reexamination Under 35 U.S.C. § 311			
D976	Exhibit B, Certificate of Service to Request for Inter Partes Reexamination Under 35 U.S.C. § 311			
D977	Exhibit E-1, Claim Charts Applying Kiuchi, and Kiuchi and Martin to Claims of the '151 Patent			
D978	Exhibit E-2, Claim Charts Applying Wesinger, and Wesinger and Martin to Claims of the '151 Patent			
D979	Exhibit E-3, Claim Charts Applying Blum to Claims of the '151 Patent			
D980	Exhibit E-4, Claim Charts Applying Aziz and Edwards, and Aziz, Edwards, and Martin to Claims of the '151 Patent			
D981	Exhibit E-5, Claim Charts Applying Kiuchi and Edwards, and Kiuchi, Edwards, and Martin to Claims of the '151 Patent			
D982	Exhibit E-6, Claim Charts Applying Wesinger and Edwards, and Wesinger, Edwards, and Martin to Claims of the '151 Patent			

Subst. for form 1449/PTO			Complete if Known	
INFORMATION DISCLOSURE STATEMENT BY APPLICANT <i>(Use as many sheets as necessary)</i>			Application Number	13/342,795
			Filing Date	01-03-2012
			First Named Inventor	Victor Larson
			Art Unit	2453
			Examiner Name	Krisna Lim
			Docket Number	77580-155(VRKN-1CP3CNFT5)
D983	Exhibit A, U.S. Patent 6,839,759			
D984	Exhibit C-1, U.S. Patent 6,502,135			
D985	Exhibit E-1, Claim Charts Applying Kiuchi, as Primary Reference to the '759 Patent			
D986	Exhibit E-2, Claim Charts Applying Kent as a Primary Reference to the '759 Patent			
D987	Exhibit E-3, Claim Charts Applying Aziz as a Primary Reference to the '759 Patent			
D988	Exhibit E-4, Claim Charts Applying Kent in View of Caronni as a Primary Combination of References to the '759 Patent			
D989	Request for Inter Partes Reexamination Transmittal Form			
D990	Request for Inter Partes Reexamination			
D991	Request for Inter Partes Reexamination Transmittal(form 1449/PTO)			
D992	Certificate of Service to Request for Inter Partes Reexamination Under 35 U.S.C. § 311			
D993	Request for Inter Partes Reexamination			
D994	Request for Inter Partes Reexamination Transmittal Form			
D995	Request for Inter Partes Reexamination			
D996	Request for Inter Partes Reexamination Transmittal Form			
D997	Exhibit C1, Claim Chart – USP 7,921,211 Relative to Solana, Alone and in Conjunction with RFC 920, Reed and Beser			
D998	Exhibit C2, Claim Chart – USP 7,921,211 Relative to Solana in view of RFC 2504 and Further in conjunction with RFC 920, Reed, and Beser			
D999	Exhibit C3, Claim Chart – USP 7,921,211 Relative to Provino, Alone and in Conjunction with RFC 920, Reed, and Beser			
D1000	Exhibit C4, Claim Chart – USP 7,921,211 Relative to Provino in view of RFC 2230 and Further in Conjunction with RFC 920, Reed and Beser			
D1001	Exhibit C5, Claim Chart – USP 7,921,211 Relative to Provino in view of RFC 2504 and in Further Conjunction with RFC 920, Reed and Beser			
D1002	Exhibit C6, Claim Chart – USP 7,921,211 Relative to Beser, Alone and in Conjunction with RFC 920, RFC 2401, and Reed			
D1003	Exhibit C7, Claim Chart – USP 7,921,211 Relative to RFC 2230, Alone and in Conjunction with RFC 920, RFC 2401, Reed, and Beser			
D1004	Exhibit C8, Claim Chart – USP 7,921,211 Relative to RFC 2538, Alone and in Conjunction with RFC 920, RFC 2401, Reed, Beser, and RFC 2065			
D1005	Exhibit D1, Asserted Claim and Infringement Contentions by Plaintiff VirnetX, Inc. in <i>VirnetX, Inc. v. Cisco Systems, Inc., Apple Inc., Aastra Technologies Ltd, NEC Corporation, NEC Corporation of America and Aastra USA, Inc.</i> , Civ. Act 6:2010cv00417 (E.D. Tex)			
D1006	Exhibit D2, Asserted Claims and Infringement Contentions by Plaintiff VirnetX, Inc. against Apple based on 7,921,211 Patent			

Complete if Known**INFORMATION DISCLOSURE STATEMENT
BY APPLICANT***(Use as many sheets as necessary)*

Application Number	13/342,795
Filing Date	01-03-2012
First Named Inventor	Victor Larson
Art Unit	2453
Examiner Name	Krisna Lim
Docket Number	77580-155(VR NK-1CP3CNFT5)

D1007	Exhibit B1, File History of U.S. Patent 7,418,504			
D1008	Exhibit B2, File History of U.S. Patent Application No. 09/558,210			
D1009	Exhibit D-10, Gaspoz et al., "VPN on DCE: From Reference Configuration to Implementation," Bringing Telecommunication Services to the People – IS&N '95, Third International Conference on Intelligence in Broadband Services and Networks, October 1995 Proceedings, Lecture Notes in Computer Science, Vol. 998 (Springer, 1995)			
D1010	Exhibit D-11, Copy of U.S. Patent No. 6,269,099			
D1011	Exhibit D-11, Copy of U.S. Patent No. 6,560,634			
D1012	Exhibit D-13, Pallen, "The World Wide Web," British Medical Journal, Vol. 311 at 1554 (Dec. 1995)			
D1013	Exhibit D-14, Rivest et al., "A Method for Obtaining Digital Signatures and Public-Key Cryptosystems," Communications of the ACM, 21:120-126 (Feb. 1978)			
D1014	Exhibit D-15, Copy of U.S. Patent No. 4,952,930			
D1015	Exhibit D-17, Pfaffenberger, Netscape Navigator 3.0: Surfing the Web and Exploring the Internet, Academic Press (1996)			
D1016	Exhibit D-18, Gittler et al., "The DCE Security Service," Hewlett-Packard Journal, pages 41-48 (Dec. 1995)			
D1017	Exhibit D-6, Copy of U.S. Patent No. 5,689,641			
D1018	Exhibit D-9, Lawton, "New Top-Level Domains Promise Descriptive Names," Sunworld Online, 1996			
D1019	Exhibit E-1, Copy of Catalog Listing by IBM for RS/6000 Redbooks Collection which includes a Link to the <i>Lendenmann</i> reference. The link to the <i>Lendenmann</i> reference was archived at archive.org on December 7, 1998 and retrieved by the Wayback Machine			
D1020	Exhibit E-10, copy of an Archived Version of the Lawton reference archived at archive.org on February 19, 1999 and retrieved by the Wayback Machine			
D1021	Exhibit E-11, Abstracts of the Proceedings of the Symposium on Network and Distributed System Security, 1996, Archived at archive.org on April 10, 1997, and retrieved by the Wayback Machine			
D1022	Exhibit E-12, 1996 Symposium on Network and Distributed System Security, Website Archived by archive.org (Apr. 10, 1997), Retrieved by the Wayback Machine at http://web.archive.org/web/19970410114853/http://computer.org/cspress/catalog/proc9.htm .			
D1023	Exhibit E-13, Copy of Search Results for ISBN 0-12-553153-2 (Pfaffenberger) from www.isbnsearch.org			
D1024	Exhibit F-1, Claim Charts applying Lendenmann as a Primary Reference to the '504 Patent.			
D1025	Exhibit F-2, Claim Charts applying Aziz as a Primary Reference to the '504 Patent			
D1026	Exhibit F-3, Claim Charts applying Kiuchi and Pfaffenberger as Primary References to the '504 Patent			
D1027	Exhibit E-2, First Page of U.S. Patent No. 5,913,217 published June 15, 1999 and citing a portion of the Lendenmann reference as a prior art reference			
D1028	Exhibit E-3, Request for Comments 2026, "The Internet Standards Process – Revision 3," October 1996			

**INFORMATION DISCLOSURE STATEMENT
BY APPLICANT***(Use as many sheets as necessary)***Complete if Known**

Application Number	13/342,795
Filing Date	01-03-2012
First Named Inventor	Victor Larson
Art Unit	2453
Examiner Name	Krisna Lim
Docket Number	77580-155(VRNL-1CP3CNFT5)

	D1029	Exhibit E-4, First Page of U.S. 5,463,735, published October 31, 1995 and citing RFC 793 as a prior art Reference	
	D1030	Exhibit E-5, Copy of catalog listing from Boston University Digital Common Website, listing the Martin reference with an issue date of February 21, 1998	
	D1031	Exhibit E-6, Copy of Technical Reports Archive Listing from Boston University Computer Science Department which includes a link to the Martin paper. The link to the Martin paper was archived at archive.org on January 22, 1998 and Retrieved by the Wayback Machine	
	D1032	Exhibit E-7, Boston University Computer Science Department Technical Reports Instructions, available at: http://www.cs.bu.edu/techreports/INSTRUCTIONS	
	D1033	Exhibit E-8, U. Möller, "Implementation eines Anonymisierungsverfahrens für WWW-Zugriffe," Diplomarbeit, Universität Hamburg (July 16, 1999), citing to Martin at page 77.	
	D1034	Exhibit E-9, First page of U.S. 5,737,423, published April 7, 1998 and citing Schneier as Prior Art Reference	
	D1035	Request for Inter Partes ReExamination; U.S. Patent 7,418,504	
	D1036	Request for Inter Partes ReExamination Transmittal Form; U.S. Patent 7,418,504	
	D1037	Request for Inter Partes Reexamination Transmittal (Form 1449/PTO) 7,418,504	
	D1038	Exhibit C1, Claim Chart – USP 7,921,211 relative to Solana, alone and in conjunction with RFC 920, Reed and Beser	
	D1039	Exhibit C2, Claim Chart – USP 7,921,211 relative to Solana in view of RFC 2504 and further in conjunction with RFC 920, Reed, and Beser	
	D1040	Exhibit C3, Claim Chart – USP 7,921,211 relative to Provino, alone and in conjunction with RFC 920, Reed, and Beser	
	D1041	Exhibit C4, Claim Chart – USP 7,921,211 relative to Provino in view of RFC 2230 and further in conjunction with RFC 920, Reed and Beser	
	D1042	Exhibit C5, Claim Chart – USP 7,921,211 relative to Provino in view of RFC 2504 and in further conjunction with RFC 920, Reed and Beser	
	D1043	Exhibit C6, Claim Chart – USP 7,921,211 relative to Beser, Alone and in conjunction with RFC 920, RFC 2401, and Reed	
	D1044	Exhibit C7, Claim Chart – USP 7,921,211 relative to RFC 2230, alone and in conjunction with RFC 2401, Reed, and Beser	
	D1045	Exhibit C8, Claim Chart – USP 7,921,211 relative to RFC 2538, alone and in conjunction with RFC 920, RFC 2401, Reed, Beser, and RFC 2065	
	D1046	Request for Inter Partes Reexamination under 35 U.S.C. § 311	
	D1047	Exhibit C1, Claim Chart – USP 7,418,504 relative to Solana, alone and in conjunction with RFC 920, Reed and Beser	
	D1048	Exhibit C2, Claim Chart – USP 7,418,504 relative to Solana in view of RFC 2504 and further in conjunction with RFC 920, Reed, and Beser	
	D1049	Exhibit C3, Claim Chart – USP 7,418,504 relative to Provino, alone and in conjunction with RFC 920, Reed, and Beser	
	D1050	Exhibit C5, Claim Chart – USP 7,418,504 relative to Provino in view of RFC 2504 and in further conjunction with RFC 920, Reed and Beser	

**INFORMATION DISCLOSURE STATEMENT
BY APPLICANT***(Use as many sheets as necessary)***Complete if Known**

Application Number	13/342,795
Filing Date	01-03-2012
First Named Inventor	Victor Larson
Art Unit	2453
Examiner Name	Krisna Lim
Docket Number	77580-155(VR NK-1CP3CNFT5)

D1051	Exhibit C6, USP 7,418,504 relative to Beser, alone and in conjunction with RFC 920, RFC 2401, and Reed	
D1052	Exhibit C7, Claim Chart – USP 7,418,504 relative to RFC 2230, alone and in conjunction with RFC 920, RFC 2401, Reed, and Beser	
D1053	Exhibit C8, Claim Chart – USP 7,418,504 relative to RFC 2538, alone and in conjunction with RFC 920, RFC 2401, Reed, Beser, and RFC 2065	
D1054	Request for Inter Partes Reexamination under 35 U.S.C. § 311	
D1055	Exhibit 226, Securing Web Access with DCE ¹ vs. Claims of the '135 Patent ²	
D1056	Exhibit 227, Securing Web Access with DCE ¹ vs. Claims of the '151 Patent ²	
D1057	Exhibit 228, Understanding OSF DCE 1.1 for AIX and OS/2 ¹ vs. Claims of the '135 Patent ²	
D1058	Exhibit 229, Understanding OSF DCE 1.1 for AIX and OS/2 ¹ vs. Claims of the '151 Patent ²	
D1059	Exhibit 230, Understanding OSF DCE 1.1 for AIX and OS/2 ¹ vs. Claims of the '180 Patent ²	
D1060	Exhibit 231, Understanding OSF DCE 1.1 for AIX and OS/2 ¹ vs. Claims of the '211 Patent ²	
D1061	Exhibit 232, Understanding OSF DCE 1.1 for AIX and OS/2 ¹ vs. Claims of the '504 Patent ²	
D1062	Exhibit 233, Understanding OSF DCE 1.1 for AIX and OS/2 ¹ vs. Claims of the '759 Patent ²	
D1063	Exhibit 234, U.S. '648 ¹ vs. Claims of the '135 Patent ²	
D1064	Exhibit 235, U.S. '648 ¹ vs. Claims of the '211 Patent ²	
D1065	Exhibit 236, U.S. '648 ¹ vs. Claims of the '504 Patent ²	
D1066	Exhibit 237, U.S. '072 ¹ vs. Claims of the '135 Patent ²	
D1067	Exhibit 238, Gauntlet System ¹ vs. Claims of the '211 Patent ²	
D1068	Exhibit 239, Gauntlet System ¹ vs. Claims of the '504 Patent ²	
D1069	Exhibit 240, Gauntlet System ¹ vs. Claims of the '135 Patent ²	
D1070	Exhibit 241, U.S. '588 ¹ vs. Claims of the '211 Patent ²	
D1071	Exhibit 242, U.S. '588 ¹ vs. Claims of the '504 Patent ²	
D1072	Exhibit 243, Microsoft VPN ¹ vs. Claims of the '135 Patent ²	
D1073	Exhibit 244, Microsoft VPN ¹ vs. Claims of the '211 Patent ²	
D1074	Exhibit 245, Microsoft VPN ¹ vs. Claims of the '504 Patent ²	
D1075	Exhibit 246, ITU-T Standardization Activities ¹ vs. Claims of the '135 Patent ²	

Complete if Known**INFORMATION DISCLOSURE STATEMENT
BY APPLICANT***(Use as many sheets as necessary)*

Application Number	13/342,795
Filing Date	01-03-2012
First Named Inventor	Victor Larson
Art Unit	2453
Examiner Name	Krisna Lim
Docket Number	77580-155(VR NK-1CP3CNFT5)

D1076	Exhibit 247, U.S. '393 ¹ vs. Claims of the '135 Patent ²	
D1077	Exhibit 248, The Miller Application ¹ vs. Claim 13 of the '135 Patent ²	
D1078	Exhibit 249, Gauntlet System ¹ vs. Claims of the '151 Patent ²	
D1079	Exhibit 250, ITU-T Standardization Activities ¹ vs. Claims of the '151 Patent ²	
D1080	Exhibit 251, U.S. Patent No. 5,940,393 ¹ vs. Claims of the '151 Patent ²	
D1081	Exhibit 252, Microsoft VPN ¹ vs. Claims of the '151 Patent ²	
D1082	Exhibit 253, U.S. Patent No.6,324,648 ¹ vs. Claims of the '151 Patent ²	
D1083	Exhibit 254, U.S. Patent No.6,857,072 ¹ vs. Claims of the '151 Patent ²	
D1084	Petition in Opposition to Patent Owner's Petition to Vacate <i>Inter Partes</i> Reexamination	
D1085	Petition in Opposition to Patent Owner's Petition to Vacate <i>Inter Partes</i> Reexamination	
D1086	Petition in Opposition to Patent Owner's Petition to Vacate <i>Inter Partes</i> Reexamination	
D1087	Exhibit B1, File History of U.S. Patent 7,921,211	
D1088	Exhibit B2, File History of U.S. Patent Application No. 10/714,849	
D1089	Exhibit B4, <i>VirnetX, Inc. v. Microsoft Corp.</i> , Case No. 6:07-cv-80, Memorandum Opinion on Claim Construction (E.D. Tex. Jul. 30, 2009)	
D1090	Exhibit D15, U.S. Patent 4,952,930	
D1091	Exhibit F1, Claim Charts Applying Lendenmann as a Primary Reference to the '211 Patent	
D1092	Exhibit F2, Claim Charts Applying Aziz as a Primary Reference to the '211 Patent	
D1093	Exhibit F3, Claim Charts Applying Kiuchi and Pfaffenberger as Primary References to the '211 Patent	
D1094	Exhibit 2, Letter and attachment from Ramzi Khazen, Counsel for VirnetX, to Dmitry Kheyfits, Counsel for Cisco Systems (June 23, 2011)	
D1095	Exhibit P, Malkin, "Dial-In Virtual Private Networks Using Layer 3 Tunneling"	
D1096	Exhibit Q, Ortiz, "Virtual Private Networks: Leveraging the Internet"	
D1097	Exhibit R, Keromytix, "Creating Efficient Fail-Stop Cryptographic Protocols"	
D1098	Transcript of Markman Hearing Dated January 5, 2012	
D1099	Declaration of John P. J. Kelly, Ph.D	
D1100	Defendants' Responsive Claim Construction Brief; Exhibits A-P and 1-7	

Complete if Known**INFORMATION DISCLOSURE STATEMENT
BY APPLICANT***(Use as many sheets as necessary)*

Application Number	13/342,795
Filing Date	01-03-2012
First Named Inventor	Victor Larson
Art Unit	2453
Examiner Name	Krisna Lim
Docket Number	77580-155(VR NK-1CP3CNFT5)

D1101	Joint Claim Construction and Prehearing Statement Dated 11/08/11			
D1102	Exhibit A: Agreed Upon Terms Dated 11/08/11			
D1103	Exhibit B: Disputed Claim Terms Dated 11/08/11			
D1104	Exhibit C: VirnetX's Proposed Construction of Claim Terms and Supporting Evidence Dated 11/08/11			
D1105	Exhibit D: Defendant's Intrinsic and Extrinsic Support Dated 11/08/11			
D1106	Declaration of Austin Curry in Support of VirnetX Inc.'s Opening Claim Construction Brief			
D1107	Declaration of Mark T. Jones Opening Claims Construction Brief			
D1108	VirnetX Opening Claim Construction Brief			
D1109	VirnetX Reply Claim Construction Brief			
D1110	European Search Report from corresponding EP Application Number 11005789 (Our Ref.: 077580-0142)			
D1111	European Search Report from corresponding EP Application Number 11005792 (Our Ref.: 077580-0143)			

(12) UK Patent Application (19) GB (11) 2 340 702 (13) A

(43) Date of A Publication 23.02.2000

(21) Application No 9912200.4
(22) Date of Filing 25.05.1999
(30) Priority Data
(31) 09087823 (32) 29.05.1998 (33) US

(51) INT CL⁷
H04L 29/06 // H04L 9/00 12/22 12/46

(52) UK CL (Edition R)
H4P PPEB

(56) Documents Cited
EP 0887979 A2 EP 0825748 A2 WO 98/31124 A1

(71) Applicant(s)
Sun Microsystems Inc
(Incorporated in USA - Delaware)
901 San Antonio Road, MS Palo Alto-521,
California 94303, United States of America

(58) Field of Search
UK CL (Edition Q) H4P PPA PPEB PPEC PPG
INT CL⁶ H04L 12/22 12/48 12/66 29/06
ONLINE DATABASES: WPI, EPODOC, JAPIO

(72) Inventor(s)
Joseph E Provino

(74) Agent and/or Address for Service
D Young & Co
21 New Fetter Lane, LONDON, EC4A 1DA,
United Kingdom

(54) Abstract Title
Accessing a server in a virtual private network protected by a firewall

(57) A virtual private network 15 has a firewall 30, at least one server 31 and a nameserver 32 each having a network address (eg. an n-bit integer address). The server 31 also has a secondary address (eg. a human readable address) and the nameserver 32 provides an association between the secondary address and the network address. An authorised external device 12 establishes a secure tunnel between itself and the firewall for communication using encryption. When the external device requests connection to server 31 using the secondary address of server 31, the firewall provides external device 12 with the network address of the nameserver 32. The external device 12 transmits a request for resolution of the network address associated with the secondary address to the nameserver through the firewall. The nameserver then transmits the network address of the server 31 through the firewall to the external device using the secure tunnel. The external device can thereafter use the network address of server 31 in subsequent communications.

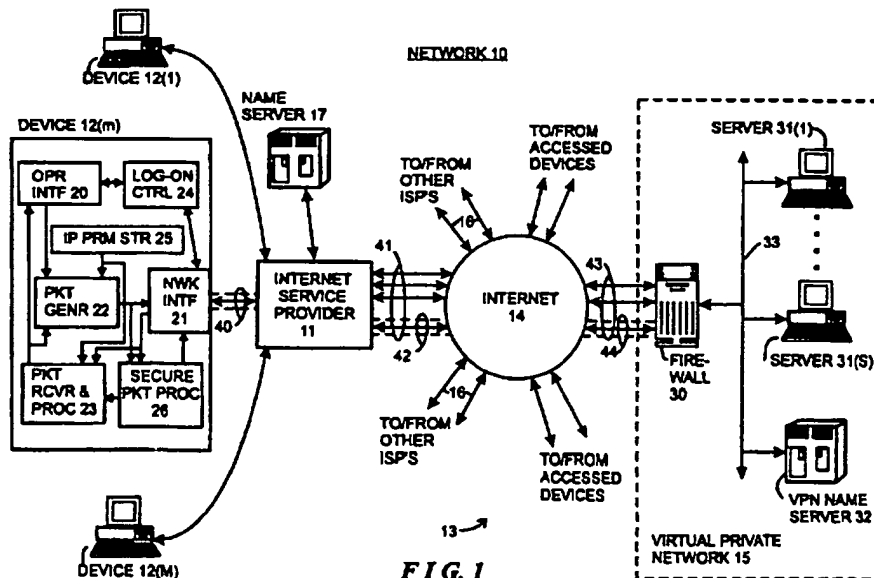
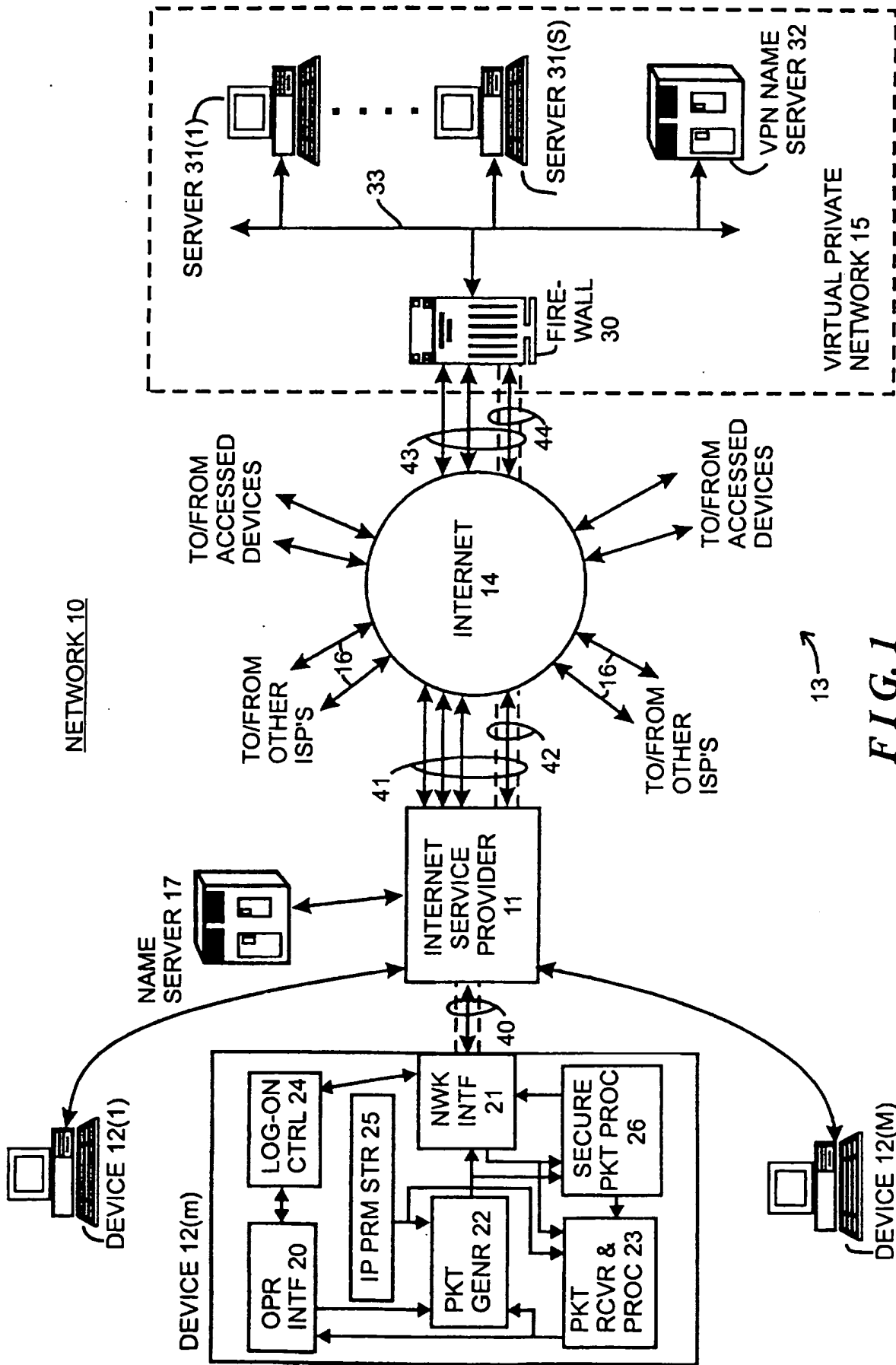

FIG. 1

GB 2 340 702

At least one drawing originally filed was Informal and the print reproduced here is taken from a later filed formal copy.

This print takes account of replacement documents submitted after the date of filing to enable the application to comply with the formal requirements of the Patents Rules 1995



FIELD OF THE INVENTION

The invention relates generally to the field of digital communications systems and methods, and more particularly to systems and methods for easing communications between devices connected to public networks such as the Internet and devices connected to private networks.

BACKGROUND OF THE INVENTION

Digital networks have been developed to facilitate the transfer of information, including data and programs, among digital computer systems and other digital devices. A variety of types of networks have been developed and implemented, including so-called "wide-area networks" (WAN's) and "local area networks" (LAN's), which transfer information using diverse information transfer methodologies. Generally, LAN's are implemented over relatively small geographical areas, such as within an individual office facility or the like, for transferring information within a particular office, company or similar type of organization. On the other hand, WAN's are generally implemented over relatively large geographical areas, and may be used to transfer information between LAN's as well as between devices that are not connected to LAN's. WAN's also include public networks, such as the Internet, which can carry information for a number of companies.

Several problems have arisen in connection with communication over a network, particularly a large public WAN such as the Internet. Generally, information is transferred over a network in message packets, which are transferred from one device, as a source device, to another device as a destination device, through one or more routers or switching nodes (generally, switching nodes) in the network. Each message packet includes a destination address which the switching nodes use to route the respective message packet to the appropriate destination device. Addresses over the Internet are in the form of an "n"-bit integer (where "n" may be thirty two or 128), which are difficult for a person to remember and enter when he or she wishes to enable a message packet to be transmitted. To relieve a user of the necessity of remembering and entering specific integer Internet

addresses, the Internet provides second addressing mechanism which is more easily utilized by human operators of the respective devices. In that addressing mechanism, Internet domains, such as LAN's, Internet service providers ("ISP's") and the like which are connected in the Internet, are identified by relatively human-readable names. To accommodate the use of human-readable names, nameservers, also referred to as DNS servers, are provided to resolve the human-readable names to the appropriate Internet addresses. When an operator at one device, wishing to transmit a message packet to another device, enters the other device's human-readable name, the device will initially contact a nameserver. Generally, the nameserver may be part of the ISP itself or it may be a particular device which is accessible through the ISP over the Internet; in any case, the ISP will identify the nameserver to be used to the device when the device logs in to the ISP. If, after being contacted by the device, the nameserver has or can obtain an integer Internet address for the human-readable domain name, it (that is, the nameserver) will provide the integer Internet address corresponding to the human-readable domain name to the operator's device. The device, in turn, can thereafter include the integer Internet address returned by the nameserver in the message packet and provide the message packet to the ISP for transmission over the Internet in a conventional manner. The Internet switching nodes use the integer Internet address to route the message packet to the intended destination device.

Other problems arise, in particular, in connection with the transfer of information over a public WAN such as the Internet. One problem is to ensure that information transferred over the WAN that the source device and the destination device wish to maintain confidential, in fact, remains confidential as against possible eavesdroppers which may intercept the information. To maintain confidentiality, various forms of encryption have been developed and are used to encrypt the information prior to transfer by the source device, and to decrypt the information after it has been received by the destination device. If it is desired that, for example, all information transferred between a particular source device and a particular destination device is maintained confidential, the devices can establish a "secure tunnel" therebetween, which essentially ensures that all information to be transferred by the source device to the destination device is encrypted (except for certain

protocol information, such as address information, which controls the flow of network packets through the network between the source and destination devices) prior to transfer, and that the encrypted information will be decrypted prior to utilization by the destination device. The source and destination devices may themselves perform the encryption and decryption, respectively, or the encryption and decryption may be performed by other devices prior to the message packets being transferred over the Internet.

A further problem that arises in particular in connection with companies, government agencies, and private organizations whose private networks, which may be LAN's, WAN's or any combination thereof, are connected to public WAN's such as the Internet, is to ensure that their private networks are secure against others whom the companies do not wish to have access thereto, or to regulate and control access by others whom the respective organizations may wish to have limited access. To accommodate that, the organizations typically connect their private networks to the public WAN's through a limited number of gateways sometimes referred to as "firewalls," through which all network traffic between the internal and public networks pass. Typically, network addresses of domains and devices in the private network "behind" the firewall are known to nameservers which are provided in the private network, but are not available to nameservers or other devices outside of the private network, making communication between a device outside of the private network and a device inside of the private network difficult.

SUMMARY OF THE INVENTION

Particular and preferred aspects of the invention are set out in the accompanying independent and dependent claims. Features of the dependent claims may be combined with those of the independent claims as appropriate and in combinations other than those explicitly set out in the claims.

The invention provides a new and improved system and method for easing communications between devices connected to public networks such as the Internet and devices connected to private networks by facilitating resolution of secondary addresses, such as the Internet's human-readable addresses, to network addresses by nameservers or the like connected to the private networks.

In brief summary, an embodiment of the invention provides a system comprising a virtual private network and an external device interconnected by a digital network. The virtual private network has a firewall, at least one internal device and a nameserver each having a network address. The internal device also has a secondary address, and the nameserver is configured to provide an association between the secondary address and the network address. The firewall, in response to a request from the external device to establish a connection therebetween, provides the external device with the network address of the nameserver. The external device, in response to a request from an operator or the like, including the internal device's secondary address, requesting access to the internal device, generates a network address request message for transmission over the connection to the firewall requesting resolution of the network address associated with the secondary address. The firewall provides the address resolution request to the nameserver, and the nameserver provides the network address associated with the secondary address to the firewall. The firewall, in turn, provides the network address in a network address response message for transmission over the connection to the external device. The external device can thereafter use the network address so provided in subsequent communications with the firewall intended for the internal device.

BRIEF DESCRIPTION OF THE DRAWINGS

Exemplary embodiments of the invention are described hereinafter, by way of example only, with reference to the accompanying drawings, in which:

FIG. 1 is a functional block diagram of a network constructed in accordance with the invention.

DETAILED DESCRIPTION OF AN ILLUSTRATIVE EMBODIMENT

FIG. 1 is a functional block diagram of a network 10 constructed in accordance with the invention. The network 10 as depicted in FIG. 1 includes an Internet service provider ("ISP") 11 which facilitates the transfer of message packets among one or more devices 12(1) through 12(M) (generally identified by reference numeral 12(m)) connected to ISP 11, and other devices, generally identified by reference numeral 13, over the Internet 14, thereby to facilitate the transfer of information in message packets among the devices 12(m) and 13. The ISP 11 connects to the Internet 14 over one or more logical connections or gateways or the like (generally referred to herein as "connections") generally identified by reference numeral 41. The ISP 11 may be a public ISP, in which case it connects to devices 12(m) which may be controlled by operators who are members of the general public to provide access by those operators to the Internet. Alternatively, ISP 11 may be a private ISP, in which case the devices 12(m) connected thereto are generally operated by, for example, employees of a particular company or governmental agency, members of a private organization or the like, to provide access by those employees or members to the Internet.

As is conventional, the Internet comprises a mesh of switching nodes (not separately shown) which interconnect ISP's 11 and devices 13 to facilitate the transfer of message packets thereamong. The message packets transferred over the Internet 14 conform to that defined by the so-called Internet protocol "IP" and include a header portion, a data portion, and may include an error detection and/or correction portion. The header portion includes information used to transfer the message packet through the Internet 14, including, for example, a destination address that identifies the device that is to receive the message packet as the destination device and a source address that identifies the device which generated the message packet. For each message packet, the destination and source addresses are each in the form of an integer that uniquely identifies the respective destination and source devices. The switching nodes comprising the Internet 14 use at least the destination address of each respective message packet to route it (that is, the respective message packet) to the destination device, if the destination device is connected to the Internet, or to an ISP 11 or other device connected to the Internet 14, which, in turn, will forward the message packet to the appropriate destination. The data portion of each message packet includes the data to be transferred

in the message packet, and the error detection and/or correction portion contains error detection and/or correction information which may be used to verify that the message packet was correctly transferred from the source to the destination device (in the case of error detection information), and correct selected types of errors if the message packet was not correctly transferred (in the case of error correction information).

The devices 12(m) connected to ISP 11 may comprise any of a number of types of devices which communicate over the Internet 14, including, for example, personal computers, computer workstations, and the like, with other devices 13. Each device 12(m) communicates with the ISP 11 to transfer message packets thereto for transfer over the Internet 14, or to receive message packets therefrom received by the ISP 11 over the Internet 14, using any convenient protocol such as the well-known point-to-point protocol ("PPP") if the device 12(m) is connected to the ISP 11 using a point-to-point link, any conventional multi-drop network protocol if the device 12(m) is connected to the ISP 11 over a multi-drop network such as the Ethernet, or the like. The devices 12(m) are generally constructed according to the conventional stored-program computer architecture, including, for example, a system unit, a video display unit and operator input devices such as a keyboard and mouse. A system unit generally includes processing, memory, mass storage devices such as disk and/or tape storage elements and other elements (not separately shown), including network and/or telephony interface devices for interfacing the respective device to the ISP 11. The processing devices process programs, including application programs, under control of an operating system, to generate processed data. The video display unit permits the device to display processed data and processing status to the user, and the operator input device enables the user to input data and control processing.

These elements of device 12(m), along with suitable programming, cooperate to provide device 12(m) with a number of functional elements including, for example, an operator interface 20, a network interface 21, a message packet generator 22, a message packet receiver and processor 23, an ISP log-on control 24, an Internet parameter store 25 and, in connection with the invention, a secure message packet processor 26. The operator interface 20 facilitates reception by the device

12(m) of input information from the operator input device(s) of device 12(m) and the display of output information to the operator on the video display device(s) of the device 12(m). The network interface 21 facilitates connection of the device 12(m) to the ISP 11 using the appropriate PPP or network protocol, to transmit message packets to the ISP 11 and receive message packets therefrom. The network interface 21 may facilitate connection to the ISP 11 over the public telephone network to allow for dial-up networking of the device 12(m) over the public telephone system. Alternatively or in addition, the network interface 21 may facilitate connection through the ISP 11 over, for example, a conventional LAN such as the Ethernet. The ISP log on control 24, in response to input provided by the operator interface 20 and/or in response to requests from programs (not shown) being processed by the device 12(m), communicates through the network interface 21 to facilitate the initialization ("log-on") of a communications session between the device 12(m) and the ISP 11, during which communications session the device 12(m) will be able to transfer information, in the form of, message packets with other devices over the Internet 14, as well as other devices 12(m') (m'≠m) connected to the ISP 11 or to other ISP's. During a log-on operation, the ISP log-on control 24 receives the Internet protocol ("IP") parameters which will be used in connection with message packet generation during the communications session.

During a communications session, the message packet generator 22, in response to input provided by the operator through the operator interface 20, and/or in response to requests from programs (not separately shown) being processed by the device 12(m), generates message packets for transmission through the network interface 21. The network interface 21 also receives message packets from the ISP 11 and provides them to message packet receiver and processor 23 for processing and provision to the operator interface 20 and/or other programs (not shown) being processed by the device 12(m). If the received message packets contain information, such as Web pages or the like, which is to be displayed to the operator, the information can be provided to the operator interface 20 to enable the information to be displayed on the device's video display unit. In addition or alternatively, the information may be provided to other programs (not shown) being processed by the device 12(m) for processing.

Generally, elements such as the operator interface 20, message packet generator 22, message packet receiver and processor 23, ISP log-on control 24 and Internet parameter store 25 may comprise elements of a conventional Internet browser, such as Mosaic, Netscape Navigator and Microsoft Internet Explorer.

In connection with the invention, as noted above the device 12(m) also includes a secure message packet processor 26. The secure message packet processor 26 facilitates the establishment and use of a "secure tunnel," which will be described below, between the device 12(m) and another device 12 (m') (m'≠m) or 13. Generally, in a secure tunnel, information in at least the data portion of message packets transferred between device 12(m) and a specific other device 12(m') (m'≠m) or 13 is maintained in secret by, for example, encrypting the data portion prior to transmission by the source device. Information in other portions of such message packets may also be maintained in secret, except for the information that is required to facilitate the transfer of the respective message packet between the devices, including, for example, at least the destination information, so as to allow the Internet's switching nodes and ISP's to identify the device that is to receive the message packet.

In addition to ISP 11, a number of other ISP's may connect to the Internet, as represented by arrows 16, facilitating communications between devices which are connected to those other ISP's with other devices over the Internet, which may include the devices 12(n) connected to ISP 11.

The devices 13 which devices 12(m) access and communicate with may also be any of a number of types of devices, including personal computers, computer workstations, and the like, and also including mini-and mainframe computers, mass storage systems, compute servers, local area networks ("LAN's") and wide area networks ("WAN's") including such devices and numerous other types of devices which may be connected directly or indirectly to the networks. In connection with the invention, at least one of the devices will include at least one private network, identified as virtual private network 15, which may be in the form of a LAN or WAN. The virtual private network 15 may comprise any of the devices 12(m') (m'≠m) (thereby connecting to the Internet 14

through an ISP) or 13 (thereby connecting directly to the Internet 14); in the illustrative embodiment described herein, the virtual private network 15 will be assumed to comprise a device 13. The virtual private network 15 itself includes a plurality of devices, identified herein as a firewall 30, a plurality of servers 31(1) through 31(S) (generally identified by reference numeral 31(s)) and a nameserver 32, all interconnected by a communication link 33. The firewall 30 and servers 31(s) may be similar to any of the various types of devices 12(m) and 13 described herein, and thus may include, for example, personal computers, computer workstations, and the like, and also including mini- and mainframe computers, mass storage systems, compute servers, local area networks ("LAN's") and wide area networks ("WAN's") including such devices and numerous other types of devices which may be connected directly or indirectly to the networks.

As noted above, the devices, including devices 12(m) and devices 13, communicate by transferring message packets over the Internet. The devices 12(m) and 13 can transfer information in a "peer-to-peer" manner, in a "client-server" manner, or both. Generally, in a "peer-to-peer" message packet transfer, a device merely transfers information in one or more message packets to another device. On the other hand, in a "client-server" manner, a device, operating as a client, can transfer a message packet to another device, operating as a server to for example, initiate service by the other device. A number of types of such services will be appreciated by those skilled in the art, including, for example, the retrieval of information from the other device, to enable the other device to perform processing operations, and the like. If the server is to provide information to the client, it (that is, the server) may generally be referred to as a storage server. On the other hand, if the server is to perform processing operations at the request of the client, it (that is, the server) may generally be referred to as a compute server. Other types of servers, for performing other types of services and operations at the request of clients, will be appreciated by those skilled in the art.

In a client/server arrangement, device 12(m) requiring service by, for example, a device 13, generates one or more request message packets requesting the required service, for transfer to the device 13. The request message packet includes the Internet address of the device 13 that is, as the destination device, to receive the message packet and perform the service. The device 12(m)

transfers the request message packet(s) to the ISP 11. The ISP 11, in turn, will transfer the message packet over the Internet to the device 13. If the device 13 is in the form of a WAN or LAN, the WAN or LAN will receive the message packet(s) and direct it (them) to a specific device connected therein which is to provide the requested service.

In any case, after the device 13 which is to provide the requested service receives the request message packet (s), it will process the request. If the device 12(m) which generated the request message packet(s), or its operator, has the required permissions to request the service from the device 13 which generated the request message packet, if the requested service is to initiate the transfer of information from the device 13 as a storage server to the device 12(m) as client, the device 13 will generate one or more response message packets including the requested information, and transmit the packet(s) over the Internet 14 to the ISP 11. The ISP 11, in turn, will transfer the message packet(s) to the device 12(m). On the other hand, if the requested service is to initiate processing by the device 13 as a compute server, the device 13 will perform the requested computation service(s). In addition, if the device 13 is to return processed data generated during the computations to the device 12(m) as client, the device 13 will generate one or more response message packet(s) including the processed data and transmit the packet(s) over the Internet 14 to the ISP 11. The ISP 11, in turn, will transfer the message packet(s) to the device 12(m). Corresponding operations may be performed by the devices 12(m) and 13, ISP 11 and Internet 14 in connection with other types of services which may be provided by the server devices 13.

As noted above, each message packet that is generated by devices 12(m) and 13 for transmission over the Internet 14 includes a destination address, which the switching nodes use to route the respective message packet to the appropriate destination device. Addresses over the Internet are in the form of an "n"-bit integer (where "n" currently may be thirty two or 128). To relieve, in particular, an operator of a device 12(m) of the necessity of remembering specific integer Internet addresses and providing them to the device 12(m) to initiate generation of a message packet for transmission over the Internet, the Internet provides a second addressing mechanism which is more easily utilized by human operators of the respective devices. In that addressing mechanism,

Internet domains, such as LAN's, Internet service providers ("ISP's") and the like which are connected in the Internet, are identified by relatively human-readable names. To accommodate human-readable domain names, ISP 11 is associated with a nameserver 17 (which may also be referred to as a DNS servers), which can resolve the human-readable domain names to provide the appropriate Internet address for the destination referred to in the respective human-readable name. Generally, the nameserver may be part of or connected directly to the ISP 11, as shown in FIG. 1, or it may be a particular device which is accessible through the ISP over the Internet. In any case, as noted above, when the device 12(m) logs on to the ISP 11 during a communications session, the ISP 11 will assign various Internet protocol ("IP") parameters which the device 12(m) is to use during the communications session, which will be stored in the Internet parameter store 25. These IP parameters include such information as

(a) an Internet address for the device 12(m) which will identify the device 12(m) during the communications session, and

(b) the identification of a nameserver 17 that the device 12(m) is to use during the communications session.

The device 12(m), when it generates message packets for transfer, will include its Internet address (item (a) above) as the source address. The device(s) 13 which receives the respective message packets can use the source address from message packets received from the device 12(m) in message packets which they (that is, device(s) 13) generate for transmission to the device 12(m), thereby to enable the Internet to route the message packets generated by the respective device 13 to the device 12(m). If the device 12(m) is to access the nameserver 17 over the Internet 14, the nameserver identification provided by the ISP 11 (item (b) above) will be in the form of an integer Internet address which will allow the device 12(m) to generate messages to the nameserver 17 requesting resolution of human-readable Internet addresses into integer Internet addresses. The ISP 11 may also assign other IP parameters to the device 12(m) when it logs on to the ISP 11, including, for example, the identification of a connection to the Internet 14 that is to be used for messages transmitted by the

device 12(m), particularly if the ISP 11 has multiple gateways. Generally, the device 12(m) will store the Internet parameters in the Internet parameter store 25 for use during the communications session.

When an operator operating device 12(m) wishes to enable the device 12(m) to transmit a message packet to a device 13, he or she provides the Internet address for the device 13 to the device 12(m), through the operator interface 20, and information, or the identification of information maintained by the device 12(m) that is to be transmitted in the message. The operator interface 20, in turn, will enable the packet generator 22 to the required packets for transmission through the ISP 11 over the Internet 11. If

(i) the operator has provided the integer Internet address, or

(ii) the operator has provided the human-readable Internet address, but the packet generator 22 already has the integer Internet address which corresponds to the human-readable Internet address provided by the operator,

the packet generator 22 may generate the packets directly upon being enabled by the operator interface 20, and provide them to the network interface 21 for transmission to the ISP 11.

However, if the operator has provided the human-readable Internet address for the device 13 to which the packets are to be transferred, and if the packet generator 22 does not already have the corresponding integer Internet address therefor, the packet generator 22 will enable the network address to be obtained from the nameserver 17 identified in the IP parameter store 25. In that operation, the packet generator 22 will initially contact nameserver 17 to attempt to obtain the appropriate integer Internet address from the nameserver 17. In these operations, the device 12(m) will generate appropriate message packets for transmission to the nameserver 17, using the nameserver's integer Internet address as provided by the ISP 11 when it (that is, the device 12(m)) logs on at the beginning of the communications session. In any case, if the nameserver 17 has or can obtain the integer Internet address for the human-readable name, it (that is, the nameserver 17) will

provide the integer Internet address to the device 12(m). The integer Internet address will be received by the packet generator 22 through the network interface 21 and packet receiver and processor 23. After the packet generator 22 receives the integer Internet address, it can generate the necessary message packets for transmission to the device 13 through the network interface 21 and ISP 11.

As noted above, one of the devices 13 connected to the Internet 14 is virtual private network 15, the virtual private network 15 including a firewall 30, a plurality of devices identified as servers 31(s), and a nameserver 32 interconnected by a communication link 33. The servers 31(s), firewall 30 and nameserver 32 can, as devices connected in a LAN or WAN, transfer information in the form of message packets thereamong. Since the firewall 30 is connected to the Internet 14 and can receive message packets thereover it has an Internet address. In addition, at least the servers 31(s) which can be accessed over the Internet also have respective Internet addresses, and in that connection the nameserver 32 serves to resolve human-readable Internet addresses for servers 31(s) internal to the virtual private network 15 to respective integer Internet addresses.

Generally, the virtual private network 15 is maintained by a company, governmental agency, organization or the like, which desires to allow the servers 31(s) to access other devices outside of the virtual private network 15 and transfer information thereto over the Internet 14, but which also desires to limit access to the servers 31(s) by devices 12(m) and other devices over the Internet 14 in a controlled manner. The firewall 30 serves to control access by devices external to the virtual private network 15 to servers 31(s) within the virtual private network 15. In that operation, the firewall 30 also connects to the Internet 14, receives message packets therefrom for transfer to a server 31(s). If the message packet indicates that the source of the message packet is requesting access to the particular server 31(s), and if the source is authorized to access the server 31(s), the firewall 30 will forward the message packet over the communication link 33 to the server 31(s). On the other hand if the source is not authorized to access the server 31(s), the firewall 30 will not forward the message packet to the server 31(s), and may, instead, transmit a response message packet to the source device indicating that the source was not authorized to access the server 31(s). The

firewall may be similar to other devices 31(s) in the virtual private network 15, with the addition of one or more connections to the Internet, which are generally identified by reference numeral 43.

Communications between devices external to the virtual private network 15, such as device 12(m), and a device, such as a server 31(s), inside the virtual private network 15, may be maintained over a secure tunnel between the firewall 30 and the external device as described above to maintain the information transferred therebetween secret while being transferred over the Internet 14 and through the ISP 11. A secure tunnel between device 12(m) and virtual private network 15 is represented in FIG. 1 by logical connections identified by reference numerals 40, 42, and 44; it will be appreciated that the logical connection 42 comprises one of the logical connections 41 between ISP 11 and Internet 14, and logical connection 44 comprises one of the logical connections 43 between the Internet 14 and the firewall 30.

Establishment of a secure tunnel can be initiated by device 12(m) external to the virtual private network 15. In that operation, the device 12(m), in response to a request from its operator, generates a message packet for transfer through the ISP 11 and Internet 14 to the firewall 30 requesting establishment of a secure tunnel between the device 12(m) and firewall 30. The message packet may be directed to a predetermined integer Internet address associated with the firewall 30 which is reserved for secure tunnel establishment requests, and which is known to and provided to the device 12(m) by the nameserver 17. If the device 12(m) is authorized to access a server 31(s) in the virtual private network 15, the client 12(m) and firewall 30 engage in a dialog, comprising one or more message packets transferred therebetween over the Internet 14. During the dialog, the firewall 30 may provide the device 12(m) with the identification of a decryption algorithm and associated decryption key which the device 12(m) is to use in decrypting the encrypted portions of message packets which the virtual private network transmits to the device 12(m). In addition, the firewall 30 may also provide the device 12(m) with the identification of an encryption algorithm and associated encryption key which the device 12(m) is to use in encrypting the portions of message packets which the device 12(m) transmits to the virtual private network 15 which are to be encrypted; alternatively, the device 12(m) can provide the identification of the encryption algorithm

and key that it (that is device 12(m)) will use to the firewall 30 during the dialog. The device 12(m) can store in its IP parameter store 25 information concerning the secure tunnel, including information associating the identification of the firewall 30 and the identifications of the encryption and decryption algorithms and associated keys for message packets to be transferred over the secure tunnel.

Thereafter, the device 12(m) and firewall 30 can transfer message packets over the secure tunnel. The device 12(m), in generating message packets for transfer over the secure tunnel, makes use of the secure packet processor 26 to encrypt the portions of the message packets which are to be encrypted prior to transmission by the network interface 21 to the ISP 11 for transfer over the Internet 14 to the firewall 30, and to decrypt the encrypted portions of the message packets received by the device 12(m) which are encrypted. In particular, after the packet generator 22 generates a message packet for transmission to the firewall 30 over the secure tunnel, it will provide the message packet to the secure packet processor 26. The secure packet processor 26, in turn, encrypts the portions of the message packet that are to be encrypted, using the encryption algorithm and key. After the firewall 30 receives a message packet from the device 12(m) over the secure tunnel, it will decrypt it and, if the intended recipient of the message packet is another device, such as a server 31(s), in the virtual private network 14, it (that is, the firewall 30) will transfer the message packet to that other device over the communication link 33.

For a message packet that is to be transferred by a device, such as a server 31(s), in the virtual private network 15 to the device 12(m) over the secure tunnel, the firewall 30 will receive such to the message packet over the communication link 33 and encrypt the message packet for transfer over the Internet 14 to the ISP 11. The ISP 11, in turn, forwards the message packet to the device 12(m), in particular to its network interface 21. The network interface 21 provides the message packet to the secure packet processor 26, which decrypts the encrypted portions of the message packet, using the decryption algorithm and key.

A problem arises in connection with accesses by a device, such as device 12(m), which is external to the virtual private network 15, and a device, such as a server 31(s), which is external to the firewall, namely, that nameserver 17 is not provided with integer Internet addresses for servers 31(s) and other devices which are in the virtual private network 15, except for integer Internet addresses associated with the firewall 30. Thus, the device 12(m), after the operator has entered the human-readable Internet address, will not be able to obtain the integer Internet address of the server 31(s) which is to be accessed from that nameserver 17.

To accommodate this problem, when the device 12(m) and firewall 30 cooperate to establish a secure tunnel therebetween, in addition to possibly providing the device 12(m) with the identifications of the encryption and decryption algorithms and keys which are to be used in connection with the message packets transferred over the secure tunnel, the firewall 30 also provides the device 12(m) with the identification of a nameserver, such as nameserver 32, in the virtual private network 15 which the device 12(m) can access to obtain the appropriate integer Internet addresses for the human-readable Internet addresses which may be provided by the operator of device 12(m). The identification of nameserver 32 is also stored in the IP parameter store 25, along with the identification of nameserver 17 which was provided by the ISP 11 when the device 12(m) logged on to the ISP 11 at the beginning of a communications session. Thus, when the device 12(m) is to transmit a message packet to a device, such as a server 31(s) in the virtual private network 14 using a human-readable Internet address provided by, for example, an operator, the device 12(m) will initially access the nameserver 17, as described above, to attempt to obtain the integer Internet address associated with the human-readable Internet address. Since nameserver 17 is outside of the virtual private network 15 and will not have the information requested by the device 12(m), it will send a response message packet so indicating. The device 12(m) will thereafter generate a request message packet for transmission to the nameserver 32 through the firewall 30 and over the secure tunnel. If the nameserver 32 has an integer Internet address associated with the human-readable Internet address in the request message packet provided by the device 12(m), it will provide the integer Internet address in a manner that is generally similar to that described above in connection

with nameserver 18, except that the integer Internet address will be provided by the nameserver 32 in a message packet directed to the firewall 30, and the firewall 30 will thereafter transmit the message packet over the secure tunnel to the device 12(m). In the message packet transmitted by the firewall 30, it will be appreciated that the integer Internet address in the message packet will be in the data portion of the message packet transferred over the secure tunnel and, accordingly, will be in encrypted form. The message packet will be processed by the device 12(m) in a manner similar to that described above in connection with other message packets received by it over the secure tunnel, that is, the message packet will be decrypted by the secure packet processor 26 prior to being provided to the packet receiver and processor 23 for processing. The integer Internet address for the server 31(s) can be cached in an access control list ("ACL") in the IP parameter store 25, along with the association of the human-readable Internet address thereto, an indication that the server 31(s) associated with that human-readable Internet address is to be accessed through the firewall 30 of the virtual private network 15, and the identifications of the encryption and decryption algorithms and keys to be used for encrypting and decrypting the appropriate portions of the message packets transmitted to server 31(s) and received from server 31(s).

It will be appreciated that, if the nameserver 32, in response to a message packet from the device 12(m) requesting the nameserver 32 to provide an integer Internet address for a human-readable Internet address provided by the device 12(m), if the nameserver 32 does not have an association between the human-readable Internet address and an integer Internet address, the nameserver 32 can provide a response message packet so indicating. If the device 12(m) has identification of other nameservers, such as may be associated with other virtual private networks (not shown), to which it (that is, device 12(m)) may have access, then the device 12(m) can attempt to access the other nameservers in a similar manner as described above. If the device 12(m) is unable to obtain an integer Internet address associated with the human-readable Internet address from any of the nameservers to which it has access, and which generally will be identified in its IP parameter store 25, it will generally be unable to access a device having the human-readable Internet address, and may so notify its operator or program which requested the access.

With this background, operations performed by the device 12(m) and virtual private network 15 in connection with the invention will be described in detail. Generally, operations proceed in two phases. In the first phase, the device 12(m) and virtual private network 15 cooperate to establish a secure tunnel through the Internet 14. In that first phase, the virtual private network 15, in particular the firewall 30 provide the identification of a nameserver 32, and may also provide the encryption and decryption algorithm and key information, as described above. In the second phase, after the secure tunnel has been established, the device 12(m) can use the information provided during the first phase in connection with generating and transferring message packets to one or more servers 31(s) in the virtual private network 15, in the process obtaining resolution human-readable Internet addresses to integer Internet addresses as necessary from the nameserver 32 that was identified by the firewall 30 during the first phase.

Thus, in the first (secure tunnel establishment) phase, the device 12(m) initially generates a message packet requesting establishment of a secure tunnel for transfer to the firewall 30. The message packet will include an integer Internet address for the firewall (which may have been provided by the device's operator or a program being processed by the device 12(m) or have been provided by a the nameserver 17 after a human-readable Internet address was provided by the operator or a program), and which, in particular, is to enable the firewall 30 to establish secure tunnels therewith. If the firewall 30 accepts the secure tunnel establishment request, and if the firewall 30 provides the encryption and decryption algorithms and keys as noted above, it (that is, the firewall) will generate a response message packet for transmission to the device 12(m) that identifies the encryption and decryption algorithms and keys; as noted above, this response message packet will not be encrypted. When the device 12(m) receives the response message, the identifications of the encryption and decryption algorithms and keys will be stored in the IP parameter store 25.

At some point later in the first phase, the firewall 30 will also generate a message packet for transmission to the device 12(m) that includes the integer Internet address of the nameserver 32. For this message packet, the portion of the message packet that contains the integer Internet address of

the nameserver 32 will be encrypted, using encryption algorithm and key that can be decrypted using the decryption algorithm and key provided in the response message packet described above. This message will generally have a structure

"<IIA(FW),IIA(DEV12(m))><SEC_TUN>
<ENCR<<IIA(FW),IIA(DEV_12(m))><DNS_ADRS:IIA(NS_32)>>>"

where

(i) "IIA(FW)" represents the source address, that is, integer Internet address of the firewall 30,

(ii) "IIA(DEV_12(m))" represents the destination address, that is, the integer Internet address of the device 12(m),

(iii) "DNS_ADRS:IIA(NS)" indicates that "IIA(NS_32)" represents the integer Internet address of the nameserver 32, the nameserver which the device 12(m) is authorized to use, and

(iv) "ENCR<...>" indicates that the information between brackets "<" and ">" is encrypted.

The initial portion of the message "<IIA(FW),IIA(DEV_12(m))>" forms at least part of the header portion of the message, and "<ENCR<<IIA(FW),IIA(DEV_12(m))><IIA(NS)>>>" represents at least part of the data portion of the message. The "<SEC_TUN>" represents an indicator in the header indicating that the message is being transferred over the secure tunnel, thereby indicating that the data portion of the message contains encrypted information.

After the device 12(m) receives the message from the firewall 30 as described above, since the message packet contains the <SEC_TUN> indicator, its network interface 21 will transfer the encrypted portion "<ENCR<<IIA(FW),IIA(DEV_12(m))><DNS_ADRS:IIA(NS_32)>>>" to the secure packet processor 26 for processing. The secure packet processor will decrypt the encrypted portion, determine that the portion "IIA(NS_32)" is the integer Internet address of a nameserver, in

particular nameserver 32, that the device 12(m) is authorized to use, and store that address in the IP parameter store 25, along with an indication that message packets thereto are to be transferred to the firewall 30 and that data in the message packets is to be encrypted using the encryption algorithm and key previously provided by the firewall 30. It will be appreciated that, since the integer Internet address of nameserver 32 is transferred from the firewall to the device 12(m) in encrypted form, it will be maintained in confidence even if the packet is intercepted by a third party.

Depending on the particular protocol used to establish the secure tunnel, the firewall 30 and device 12(m) may also exchange message packets containing other information than that described above.

As noted above, in the second phase, after the secure tunnel has been established, the device 12(m) can use the information provided during the first phase in connection with generating and transferring message packets to one or more of the servers 31(s) in the virtual private network 15. In those operations, if the operator of device 12(m), or a program being processed by device 12(m), wishes to have device 12(m) transmit a message packet to a server 31(s) in the virtual private network 15, if the operator, through the operator interface 20, or the program provides a human-readable Internet address, the device 12(m), in particular the packet generator 22, will initially determine whether the IP parameter store 25 has cached therein an integer Internet address that is associated with the human-readable Internet address. If not, the packet generator 22 will generate a request message packet for transfer to the nameserver 17 requesting it to provide the integer Internet address associated with the human-readable Internet address. If the nameserver 17 has an integer Internet address associated with the human-readable Internet address, it will provide the integer Internet address to the device 12(m). It will be appreciated that this may occur if the human-readable Internet address in the request message packet has been associated with a device 13 external to the virtual private network 15, as well as with a server 32(s) in the virtual private network 15. Thereafter, the device 12(m) can use the integer Internet address to generate message packets for transfer over the Internet as described above.

Assuming, on the other hand, that the nameserver 17 does not have a integer Internet address associated with the human-readable Internet address, it (that is, the nameserver 17) will provide a response message packet so indicating to the device 12(m). Thereafter, the packet generator 22 of device 12(m) will generate a request message packet for transmission to the next nameserver identified in its IP parameter store 25 requesting that nameserver to provide the integer Internet address associated with the human-readable Internet address. If that next nameserver is nameserver 32, the packet generator 22 will provide the message packet to the secure packet processor 26 for processing. The secure packet processor 26, in turn, will generate a request message packet for transfer over the secure tunnel to the firewall 30. This message will generally have a structure

```
"<IIA(DEV_12(m)),IIA(FW)><SEC_TUN>  
  
<ENCR<<IIA(DEV_12(m)),IIA(NS_32)><IIA_REQ>>>"
```

where

(i) "IIA(DEV_12(m))" represents the source address, that is, integer Internet address of the device 12(m)

(ii) "IIA(FW)" represents the destination address, that is, the integer Internet address of the firewall 30

(iii) "IIA(NS_32)" represents the address of the nameserver 32

(iii) "<<IIA(DEV_12(m)),IIA(NS_32)><IIA_REQ>>" represents the request message packet generated by the packet generator 22, where "<IIA(DEV_12(m)),IIA(NS_32)>" represents the header portion of the request message packet, and "<IIA_REQ>" represents the data portion of the request message packet,

(iv) "ENCR<....>" indicates that the information between brackets "<" and ">" is encrypted, and

(v) "<SEC_TUN>" represents an indicator in the header portion of the message packet generated by the secure packet generator 26 indicating that the message is being transferred over the secure tunnel, thereby indicating that the data portion of the message contains encrypted information.

When the firewall 30 receives the request message packet generated by the secure packet processor 26, it will decrypt the encrypted portion of the message packet to obtain <<IIA(DEV_12(m)),IIA(NS_32)>><IIA_REQ>>" represents the request message packet as generated by the packet generator 22. After obtaining the request message packet, the firewall 30 will transmit it over the communication link 33 to the nameserver 32. In that process, depending on the protocol for transmission of message packets over the communication link 33, the firewall 30 may need to modify the request message packet to conform to the protocol of communication link 33.

After the nameserver 32 receives the request message packet, it will process it to determine whether it has an integer Internet address associated with the human-readable Internet address provided in the request message packet. If the nameserver determines that it has such an integer Internet address, it will generate a response message packet including the integer Internet address for transmission to the firewall. Generally, the response message packet will have a structure:

<<IIA(NS_32),IIA(DEV_12(m))>><IIA_RESP>>

where

(i) "IIA(NS_32)" represents the source address, that is, integer Internet address of the nameserver 32,

(ii) "IIA(DEV_12(m))" represents the destination address, that is, integer Internet address of the device 12(m), and

(iii) "IIA_RESP" represents the integer Internet address associated with the human-readable Internet address.

After the firewall 30 receives the response message packet, since communications with device 12(m) are over the secure tunnel therebetween, it (that is, the firewall 30) will encrypt the response message packet received from the nameserver 32 and generate a message packet for transmission to the device 12(m) including the encrypted response message packet. Generally, the message packet generated by the firewall 30 has the structure:

```
"<IIA(FW),IIA(DEV12(m))><SEC_TUN>  
<ENCR<<IIA(NS_32),IIA(DEV_12(m))><IIA_RESP>>>"
```

where

(i) "IIA(FW)" represents the source address, that is, integer Internet address of the firewall 30,

(ii) "IIA(DEV_12(m))" represents the destination address, that is, the integer Internet address of the device 12(m),

(iii) "SEC_TUN" represents an indicator in the header portion of the message packet generated by the secure packet generator 26 indicating that the message is being transferred over the secure tunnel, thereby indicating that the data portion of the message contains encrypted information, and

(iv) "ENCR<...>" indicates that the information between brackets "<" and ">" (which constitutes the response message packet received from the nameserver 32) is encrypted.

In addition, depending on the protocol for transmission of message packets over the communication link 33, the firewall 30 may need to process and/or modify the message packet to conform to the protocol of Internet 14.

When the device 12(m) receives the message packet from the firewall 30, it (that is, the message packet) will be provided to the secure packet processor 26. The secure packet processor 26, in turn, will decrypt the encrypted portion of the message packet to obtain the integer Internet address associated with the human-readable Internet address, and load that information in the IP parameter store 25. Thereafter, the device can use that integer Internet address in generating message packets for transmission to the server 31(s) which is associated with the human-readable Internet address.

It will be appreciated that, if the nameserver 32 does not have an integer Internet address associated with the human-readable Internet address provided by the device 12(m) in the request message packet, it (that is, nameserver 32) can so indicate in the response message packet generated thereby. The firewall 30 will, in response to the response message packet provided by the nameserver 32, also generate a message packet for transmission to the device 12(m), the message packet including an encrypted portion comprising the response message packet generated by the nameserver 32. After the device 12(m) receives the message packet, the encrypted portion will be decrypted by the secure packet processor 26, which, in turn, will notify the packet generator 22 that the nameserver 32 does not have an integer Internet address associated with the human-readable Internet address. Thereafter, if the IP parameter store 25 contains the identification of another nameserver, the packet generator 22 of device 12(m) will generate a request message packet for transmission to the next nameserver identified in its IP parameter store 25 requesting that nameserver to provide the integer Internet address associated with the human-readable Internet address. On the other hand, if the IP parameter store 25 does not contain the identification of another nameserver, the packet generator 22 can notify the operator interface 20 or program that it is will be unable to generate a message packet for transmission to a device associated with the human-readable Internet address provided thereby.

An embodiment of the invention can provide a number of advantages. For example, it can provide a system for easing communications between devices connected to a public network such as the Internet 14, and devices connected to private networks such as virtual private network 15, by facilitating resolution

of human-readable addresses to network addresses by a nameservers connected to the private networks over a secure tunnel.

It will be appreciated that numerous modifications may be made to the arrangement described above in connection with FIG. 1. For example, although the network 10 has been described such that the identification of the encryption and decryption algorithms and keys are exchanged by the device 12(m) and firewall 30 during the dialog during which the secure tunnel is established, it will be appreciated that that information may be provided by the device 12(m) and firewall 30 separately from the establishment of a secure tunnel therebetween.

In addition, although an embodiment of the invention has been described in connection with the Internet, it will be appreciated that an embodiment of the invention can be used in connection with any network. Further, although an embodiment has been described in connection with a network which provides for human-readable network addresses, it will be appreciated that an embodiment can be used in connection with any network which provides for any form of secondary or informal network address arrangements.

It will be appreciated that a system in accordance with the invention can be constructed in whole or in part from special purpose hardware or a general purpose computer system, or any combination thereof, any portion of which may be controlled by a suitable program. Any program may in whole or in part comprise part of or be stored on the system in a conventional manner, or it may in whole or in part be provided in to the system over a network or other mechanism for transferring information in a conventional manner. Thus, such a computer program can form a product operable, when run on a computer, to provide the required functionality of an embodiment of the invention. The computer program product can be provided on a carrier medium, for example, a computer readable medium such as, for example, a memory, disc or other storage medium, or a transmission medium such as a telecommunications channel providing, for example, electrical, optical, wireless or other transmission. In addition, it will be appreciated that the system may be operated and/or otherwise controlled by means of information provided by an operator using operator input elements (not shown) which may be connected directly to the system or which may transfer the information to the system over a network or other mechanism for transferring information in a conventional manner.

The foregoing description has been limited to a specific embodiment of this invention. It will be apparent, however, that various variations and modifications may be made to the invention, with the attainment of some or all of the advantages of the invention.

CLAIMS

1. A system comprising a virtual private network and an external device which communicate over a digital network,

the virtual private network having a firewall, at least one internal device and a nameserver each having a network address, the internal device also having a secondary address, the nameserver being configured to provide an association between the secondary address and the network address,

the firewall, in response to a request from the external device to establish a connection therebetween, being configured to provide the external device with the network address of the nameserver, and

the external device, in response to a request requesting access to the internal device including the internal device's secondary address, being configured to generate a network address request message for transmission over the connection to the firewall requesting resolution of the network address associated with the secondary address, the firewall being configured to provide the address resolution request to the nameserver, the nameserver being configured to provide the network address associated with the secondary address, the firewall in turn being further configured to provide the network address in a network address response message for transmission over the connection to the external device.

2. A system according to claim 1, wherein the external device is further configured to use the network address provided in the network address response message in generating at least one message for transmission to the internal device.

3. A system according to claim 1 or claim 2, wherein the external device is configured to connect to the network through a network service provider.

4. A system according to claim 3, wherein the external device is configured to establish a communications session with the network service provider, the network service provider providing the external device with the identification of a further nameserver, the further nameserver being configured to provide an association between a secondary address and a network address for at least one device.

5. A system according to any preceding claim, wherein the external device is configured to maintain a list of nameservers which have been identified to said external device, the external device being configured to interrogate successive ones of the nameservers in the list in response to a request requesting access to another device, said request including a secondary address for said other device, until said external device receives a network address, in each interrogation the external device being configured to generate a said network address request message for transmission over the network for response by one of said nameservers in said list and to receive a network address response message therefrom.

6. A system according to any preceding claim, wherein the connection between the external device and the firewall is a secure tunnel, in which at least some portion of messages transferred between the external device and the firewall is encrypted.

7. A method of operating a system comprising a virtual private network and an external device interconnected by a digital network, the virtual private network having a firewall, at least one internal device and a nameserver each having a network address, the internal device also having a

secondary address, the nameserver being configured to provide an association between the secondary address and the network address, the method comprising the steps of:

- A. enabling the firewall, in response to a request from the external device to establish a connection therebetween, provide the external device with the network address of the nameserver; and
- B. enabling
 - (i) the external device, in response to a request requesting access to the internal device including the internal device's secondary address, to generate a network address request message for transmission over the connection to the firewall requesting resolution of the network address associated with the secondary address,
 - (ii) the firewall to provide the address resolution request to the nameserver,
 - (iii) the nameserver to provide the network address associated with the secondary address, and
 - (iv) the firewall to provide the network address in a network address response message for transmission over the connection to the external device.

8. A method according to claim 7, wherein the external device is further enabled to use the network address provided in the network address response message in generating at least one message for transmission to the internal device.

9. A method according to claim 7 or claim 8, wherein the external device is enabled to connect to the network through a network service provider.

10. A method according to claim 9, wherein the external device is enabled to establish a communications session with the network service provider, the network service provider being enabled to provide the external device with the identification of a further nameserver, the further nameserver being enabled to provide an association between a secondary address and a network address for at least one device.

11. A method according to any one of claims 7 to 10, wherein the external device is enabled to maintain a list of nameservers which have been identified to said external device, the external device being enabled to interrogate successive ones of the nameservers in the list in response to a request requesting access to another device, said request including a secondary address for said other device, until said external device receives a network address, in each interrogation the external device being enabled to generate a said network address request message for transmission over the network for response by one of said nameservers in said list and to receive a network address response message therefrom.

12. A method according to any one of claims 7 to 10, wherein the connection between the external device and the firewall is a secure tunnel, in which at least some portion of messages transferred between the external device and the firewall is encrypted.

13. A computer program product for use in connection with a virtual private network and an external device interconnected by a digital network, the virtual private network having a firewall, at least one internal device and a nameserver each having a network address, the internal device also having a secondary address, the nameserver being configured to provide an association between the secondary

address and the network address, the computer program product comprising :

- A. a nameserver identification code module configured to enable the firewall, in response to a request from the external device to establish a connection therebetween, to provide the external device with the network address of the nameserver,
- B. a network address request message generating code module for enabling the external device, in response to a request requesting access to the internal device including the internal device's secondary address, to generate a network address request message for transmission over the connection to the firewall requesting resolution of the network address associated with the secondary address,
- C. an address resolution request forwarding module for enabling the firewall to provide the address resolution request to the nameserver,
- D. a nameserver control module for enabling the nameserver to provide the network address associated with the secondary address, and
- E. a network address response message forwarding module for enabling the firewall to provide the network address in a network address response message for transmission over the connection to the external device.

14. A computer program product according to claim 13, further comprising a network address utilization module configured to enable the external device to use the network address provided in the network address response message in generating at least one message for transmission to the internal device.

15. A computer program product according to claim 13 or claim 14, further comprising a network service provider control module for enabling the external device to connect to the network through a network service provider.

16. A computer program product according to claim 15, wherein the network service provider control module includes a communications session establishment module for enabling the external device to a communications session with the network service provider and receive therefrom identification of a further nameserver.

17. A computer program product according to any one of claims 13 to 16, further including nameserver interrogation control module for enabling the external device to maintain a list of nameservers which have been identified to said external device, and to interrogate successive ones of the nameservers in the list in response to a request requesting access to another device, said request including a secondary address for said other device, until said external device receives a network address, in each interrogation the external device being enabled to generate a said network address request message for transmission over the network for response by one of said nameservers in said list and to receive a network address response message therefrom.

18. A computer program product according to any one of claims 13 to 16, wherein the connection between the external device and the firewall is a secure tunnel, in which at least some portion of messages transferred between the external device and the firewall is encrypted.

19. A computer program product according to any one of claims 13 to 18 on a carrier medium.
20. A computer program product according to claim 19, wherein the carrier medium is a computer readable medium.
21. A computer program product according to claim 19, wherein the carrier medium is a transmissions medium.
22. A system substantially as hereinbefore described with reference to the accompanying drawings.
23. A method substantially as hereinbefore described with reference to the accompanying drawings.
24. A computer program product substantially as hereinbefore described with reference to the accompanying drawings.



34

Application No: GB 9912200.4
Claims searched: All

Examiner: Gareth Griffiths
Date of search: 7 December 1999

**Patents Act 1977
Search Report under Section 17**

Databases searched:

UK Patent Office collections, including GB, EP, WO & US patent specifications, in:

UK CI (Ed.Q): H4P (PPA, PPEB, PPEC, PPG)

Int CI (Ed.6): H04L 12/22, 12/46, 12/66, 29/06

Other: Online Databases: WPI, EPODOC, JAPIO

Documents considered to be relevant:

Category	Identity of document and relevant passage	Relevant to claims
X, P	EP0887979 A2 (SUN MICROSYSTEMS) col.15 line 35 - col.17 line 24	1, 2, 5-8, 11-14, 17-21
A	EP0825748 A2 (AT&T) col.6 line 46 - col.11 line 40	
A, P	WO98/31124 A1 (HANSON) p.5 line 2 - p.6 line 25	

X	Document indicating lack of novelty or inventive step	A	Document indicating technological background and/or state of the art
Y	Document indicating lack of inventive step if combined with one or more other documents of same category.	P	Document published on or after the declared priority date but before the filing date of this invention.
&	Member of the same patent family	E	Patent document published on or after, but with priority date earlier than, the filing date of this application.

C19



PCT

WORLD INTELLECTUAL PROPERTY ORGANIZATION
International Bureau

INTERNATIONAL APPLICATION PUBLISHED UNDER THE PATENT COOPERATION TREATY (PCT)

<p>(51) International Patent Classification ⁶ : H04L 12/66, H04Q 11/04</p>	<p>A1</p>	<p>(11) International Publication Number: WO 98/43396 (43) International Publication Date: 1 October 1998 (01.10.98)</p>
<p>(21) International Application Number: PCT/CA98/00197 (22) International Filing Date: 11 March 1998 (11.03.98) (30) Priority Data: 08/821,145 20 March 1997 (20.03.97) US (71) Applicant: NORTHERN TELECOM LIMITED [CA/CA]; World Trade Center of Montreal, 8th floor, 380 St. Antoine Street West, Montreal, Quebec H2Y 3Y4 (CA). (72) Inventors: ALLAN, David, Ian; 852 Forest Street, Ottawa, Ontario K2B 5P9 (CA). CASEY, Liam, M.; 61 Aylmer Avenue, Ottawa, Ontario K1S 2X2 (CA). ROBERT, Andre, J.; 103 Sol Lane, R.R. #2, Woodlawn, Ontario K0A 3M0 (CA). (74) Agent: DIACONESCU, Aprilia, U.; Northern Telecom Lim- ited, Patent Dept., P.O. Box 3511, Station "C", Ottawa, On- tario K1Y 4H7 (CA).</p>	<p>(81) Designated States: AU, CA, JP, European patent (AT, BE, CH, DE, DK, ES, FI, FR, GB, GR, IE, IT, LU, MC, NL, PT, SE). Published With international search report.</p>	

(54) Title: A MECHANISM FOR MULTIPLEXING ATM AAL5 VIRTUAL CIRCUITS OVER ETHERNET

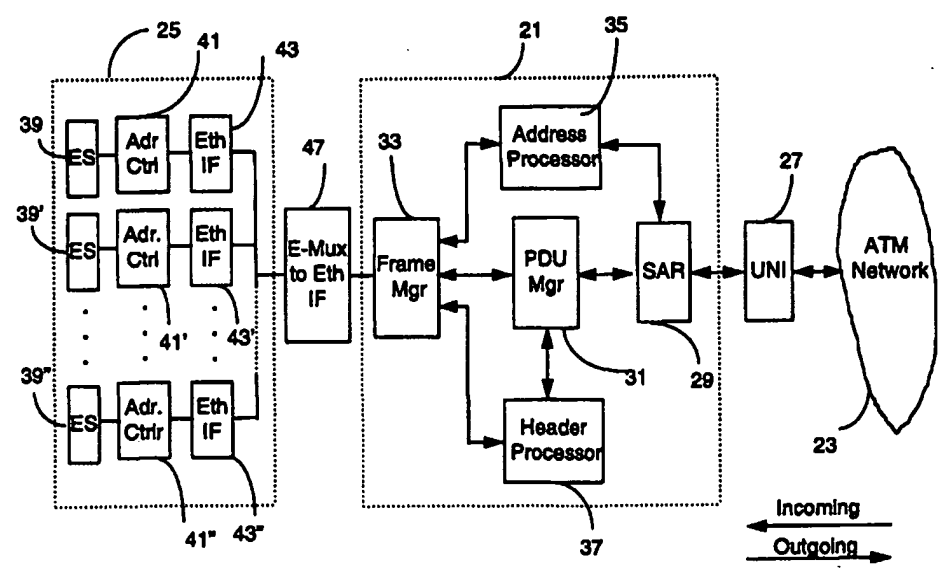

(57) Abstract

The invention provides for an E-Mux and a method for encapsulating/segmenting ATM cells into/from an Ethernet frame at the boundary between an ATM and an Ethernet network. An Ethernet end-station on the E-Mux is addressed using multiple MAC level identifiers, which are dynamically assigned according to the ATM virtual circuits which terminate on that end station, and have only transitory significance on the Ethernet. A unique ATM OUI identifies the frames carrying ATM-traffic.



INTERNATIONAL APPLICATION PUBLISHED UNDER THE PATENT COOPERATION TREATY (PCT)

<p>(51) International Patent Classification ⁶ : H04L 9/00</p>	<p>A1</p>	<p>(11) International Publication Number: WO 99/11019 (43) International Publication Date: 4 March 1999 (04.03.99)</p>
<p>(21) International Application Number: PCT/US98/17198 (22) International Filing Date: 24 August 1998 (24.08.98) (30) Priority Data: 08/917,341 26 August 1997 (26.08.97) US (71) Applicant: V-ONE CORPORATION [US/US]; Suite 300, 20250 Century Boulevard, Germantown, MD 20874 (US). (72) Inventors: CHEN, James, F.; 12648 Tavailah Road, Potomac, MD 20854 (US). WANG, Jieh-Shan; 10903 Silent Wood Place, N. Potomac, MD 20878 (US). BROOK, Christopher, T.; 7308 Pomander Lane, Chevy Chase, MD 20815 (US). GARVEY, Francis; 2908 S. Buchanan Street, Arlington, VA 22206 (US). (74) Agents: URCIA, Benjamin, E. et al.; Bacon & Thomas, PLLC, 4th floor, 625 Slaters Lane, Alexandria, VA 22314 (US).</p>		<p>(81) Designated States: AL, AM, AT, AU, AZ, BA, BB, BG, BR, BY, CA, CH, CN, CU, CZ, DE, DK, EE, ES, FI, GB, GE, GH, GM, HR, HU, ID, IL, IS, JP, KE, KG, KP, KR, KZ, LC, LK, LR, LS, LT, LU, LV, MD, MG, MK, MN, MW, MX, NO, NZ, PL, PT, RO, RU, SD, SE, SG, SI, SK, SL, TJ, TM, TR, TT, UA, UG, UZ, VN, YU, ZW, ARIPO patent (GH, GM, KE, LS, MW, SD, SZ, UG, ZW), Eurasian patent (AM, AZ, BY, KG, KZ, MD, RU, TJ, TM), European patent (AT, BE, CH, CY, DE, DK, ES, FI, FR, GB, GR, IE, IT, LU, MC, NL, PT, SE), OAPI patent (BF, BJ, CF, CG, CI, CM, GA, GN, GW, ML, MR, NE, SN, TD, TG).</p> <p>Published <i>With international search report.</i></p>

(54) Title: MULTI-ACCESS VIRTUAL PRIVATE NETWORK

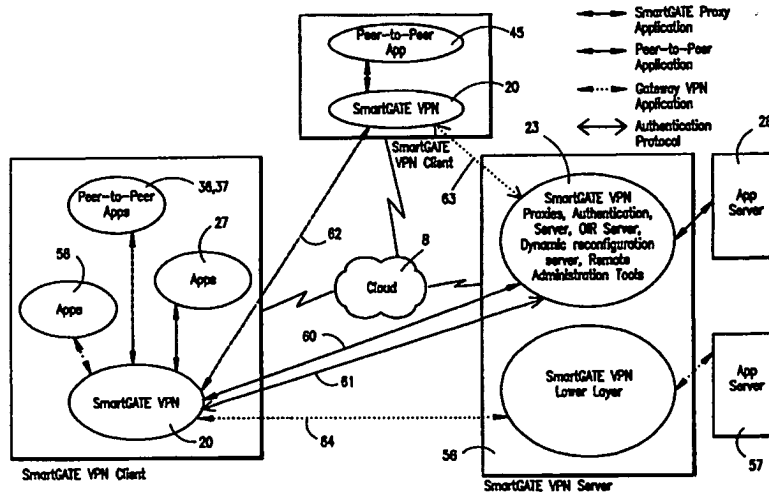

(57) Abstract

A virtual private network for communicating between a server and clients over an open network uses an applications level encryption and mutual authentication program (20) and at least one shim (50, 53) positioned above either the layers of a client computer to intercept function calls, communicate with the server and authenticate the parties to a communication and enable the parties to the communication to establish a common session key. Where the parties to the communication are peer-to-peer applications (36, 37, 45), the intercepted function calls, request for service, or data packets include the destination address of the peer application, which is supplied to the server so that the server can authenticate the peer and enable the peer to decrypt further direct peer-to-peer communications (62).

FOR THE PURPOSES OF INFORMATION ONLY

Codes used to identify States party to the PCT on the front pages of pamphlets publishing international applications under the PCT.

AL	Albania	ES	Spain	LS	Lesotho	SI	Slovenia
AM	Armenia	FI	Finland	LT	Lithuania	SK	Slovakia
AT	Austria	FR	France	LU	Luxembourg	SN	Senegal
AU	Australia	GA	Gabon	LV	Latvia	SZ	Swaziland
AZ	Azerbaijan	GB	United Kingdom	MC	Monaco	TD	Chad
BA	Bosnia and Herzegovina	GE	Georgia	MD	Republic of Moldova	TG	Togo
BB	Barbados	GH	Ghana	MG	Madagascar	TJ	Tajikistan
BE	Belgium	GN	Guinea	MK	The former Yugoslav Republic of Macedonia	TM	Turkmenistan
BF	Burkina Faso	GR	Greece			TR	Turkey
BG	Bulgaria	HU	Hungary	ML	Mali	TT	Trinidad and Tobago
BJ	Benin	IE	Ireland	MN	Mongolia	UA	Ukraine
BR	Brazil	IL	Israel	MR	Mauritania	UG	Uganda
BY	Belarus	IS	Iceland	MW	Malawi	US	United States of America
CA	Canada	IT	Italy	MX	Mexico	UZ	Uzbekistan
CF	Central African Republic	JP	Japan	NE	Niger	VN	Viet Nam
CG	Congo	KE	Kenya	NL	Netherlands	YU	Yugoslavia
CH	Switzerland	KG	Kyrgyzstan	NO	Norway	ZW	Zimbabwe
CI	Côte d'Ivoire	KP	Democratic People's Republic of Korea	NZ	New Zealand		
CM	Cameroon			PL	Poland		
CN	China	KR	Republic of Korea	PT	Portugal		
CU	Cuba	KZ	Kazakstan	RO	Romania		
CZ	Czech Republic	LC	Saint Lucia	RU	Russian Federation		
DE	Germany	LI	Liechtenstein	SD	Sudan		
DK	Denmark	LK	Sri Lanka	SE	Sweden		
EE	Estonia	LR	Liberia	SG	Singapore		

MULTI-ACCESS VIRTUAL PRIVATE NETWORK**BACKGROUND OF THE INVENTION****1. Field of the Invention**

5 This invention relates a system and method for allowing private communications over an open network, and in particular to a virtual private network which provides data encryption and mutual authentication services for both client/server and peer-to-peer applications at the applications, transport driver, and network driver levels.

10

2. Discussion of Related Art

 A virtual private network (VPN) is a system for securing communications between computers over an open network such as the Internet. By securing communications between the computers, the computers are linked together as if they were on a private local area network (LAN), effectively extending the reach of the network to remote sites without the infrastructure costs of constructing a private network. As a result, physically separate LANs

15

20

can work together as if they were a single LAN, remote computers can be temporarily connected to the LAN for communications with mobile workers or telecommuting, and electronic commerce can be carried out without the risks
5 inherent in using an open network.

In general, there are two approaches to virtual private networking, illustrated in Figs. 1A and 1B. The first is to use a dedicated server 1, which may also function as a gateway to a secured network 2, to provide
10 encryption and authentication services for establishment of secured links 3 between the server 1 and multiple clients 4-6 over the open network 7, represented in Fig. 1A as a cloud, while the second is to permit private communications links 8 to be established between any two computers or
15 computer systems 9-12 on network 7, as illustrated in Fig. 1B.

The advantages of a client/server arrangement such as the one shown in Fig. 1A are that the server can handle functions requiring the majority of the computing
20 resources, increasing the number of potential clients, and that management of the network, including key management is centralized. The disadvantage of a client/server network of this type is that peer-to-peer communications links between applications on the client computers cannot utilize
25 the security and management functions provided by the server, leaving such communications unprotected. On the

other hand, the advantage of the direct peer-to-peer approach illustrated in Fig. 1B is that it permits secured links to be established between any computers capable of carrying out the required security functions, with the disadvantages being the cost of configuring each computer to carry-out encryption, authentication, and key management functions, and the lack of central control.

In both the client/server and peer-to-peer approaches, a virtual private network can in theory be based either on applications level technology or can operate at a lower level. Generally, however, peer-to-peer "tunneling" arrangements require modification of the lower layers of a computer's communications architecture, while client/server arrangements can use the applications level approach because less modification of the clients is required, and thus the two approaches are in practice mutually exclusive. The present invention, on the other hand, seeks to provide a virtual private network which utilizes a client/server approach, including centralized control of encryption, authentication, and key management functions, while at the same time enabling secured peer-to-peer communications between applications, by utilizing the server to provide authentication and session key generation functions for both client to server communications and peer-to-peer communications, providing a virtual private network capable of serving both as an extended intranet or wide area network (WAN), and as a commercial mass marketing network,

with high level mutual authentication and encryption provided for all communications.

In order to completely integrate the two approaches and maximize the advantage of each approach, the invention maintains the applications level infrastructure of prior client server private networking arrangements, while adding shims to lower levels in order to accommodate a variety of peer-to-peer communications applications while utilizing the applications level infrastructure for authentication and session key generation purposes. This results in the synergistic effect that not only are existing peer-to-peer tunneling schemes and applications level client server security arrangements combined, but they are combined in a way which greatly reduces implementation costs

In order to understand the present invention, it is necessary to understand a few basic concepts about computer to computer communications, including the concepts of "layers" and communications protocols, and of mutual authentication and file encryption. Further information about layers and protocols can be found in numerous sources available on the Internet, a few of which are listed at the end of this section, while a detailed description of a mutual authentication and encryption system and method suitable for use in connection with the present invention can be found in U.S. Patent No. 5,602,918, which is incorporated herein by reference. In general, the basic

communications protocols and architecture used by the present invention, as well as authentication, encryption, and key management schemes, are already well-known, and can be implemented as a matter of routine programming once the basic nature of the invention is understood. The changes made by the present invention to the conventional client server virtual private network may be thought of as, essentially, the addition of means, most conveniently implemented as shims, which add a secured mutual authentication and session key generation channel between the server and all parties to a communication, at all levels at which a communication can be carried out.

Having explained the key differences between the present invention and existing systems, the basic concepts of layers and so forth will now be briefly explained by way of background. First, the concept of "layers," "tiers," and "levels," which essential to an understanding of the invention, simply refers to libraries or sets of software routines for carrying out a group of related functions, and which can conveniently be shared or called on by different programs at a higher level to facilitate programming, avoiding duplication and maximizing computer resources. For example, the Windows NT device driver architecture is made up of three basic layers, the first of which is the Network Driver Interface Specification (NDIS 3.0) layer, the second of which is called the Transport Driver Interface (TDI) layer, and the third being the file

systems. These layers are generically referred to as the network driver layer, the transport or transport driver layer, and the applications layer.

In the Windows NT architecture, the TDI layer formats
5 data received from the various file systems or applications
into packets or datagrams for transmission to a selected
destination over the open network, while the NDIS layer
controls the device drivers that send the data, packets, or
IP datagrams, for example by converting the stream of data
10 into a waveform suitable for transmission over a telephone
line or a twisted pair cable of the type known as an
Ethernet.

By providing layers in this manner, an applications
software programmer can design an application program to
15 supply data to the TDI layer without having to re-program
any of the specific functions carried out by that layer,
and all of the transmission, verification, and other
functions required to send a message will be taken care of
the TDI layer without further involvement by the
20 applications software. In a sense, each "layer" simply
accepts data from the higher layer and formats it by adding
a header or converting the data in a manner which is
content independent, with retrieval of the data simply
involving reverse conversion or stripping of the headers,
25 the receiving software receiving the data as if the
intervening layers did not exist.

In the case of Internet communications, the most commonly used set of software routines for the transport or TDI layer, which takes care of the data formatting and addressing, is the TCP/IP protocol, in which the transport control protocol (TCP) packages the data into datagrams and provides addressing, acknowledgements, and checksum functions, and the internet protocol (IP) further packages the TCP datagrams into packets by adding additional headers used in routing the packets to a destination address. Other transport protocols which can be included in the TDI layer include the user diagram protocol (UDP), the internet control message protocol (ICMP), and non-IP based protocols such as Netbeui or IPX.

Additional "protocols" are may be used at the applications level, although these protocols have nothing to do with the present invention except that they may be included in the applications programs served by the network. Common applications level protocols which utilize the TCP/IP protocol include hypertext transfer protocol (HTTP), simple mail transfer protocol (SMTP), and file transfer protocol (FTP), all of which operate at the layer above the transport layer.

Some applications are written to directly call upon the TCP functions. However, for most applications utilizing a graphical user interface conveniently rely on a set of software routines which are considered to operate

above the TDI layer, and are known as sockets. Sockets serve as an interface between the TCP set of functions, or stack, and various applications, by providing libraries of routines which facilitate TCP function calls, so that the application simply has to refer to the socket library in order to carry out the appropriate function calls. For Windows applications, a commonly used non-proprietary socket is the Windows socket, known as Winsock, although sockets exist for other operating systems or platforms, and alternative sockets are also available for Windows, including the Winsock 2 socket currently under development.

In order to implement a virtual private network, the encryption and authentication functions must be carried out at one of the above "levels," for example by modifying the network drivers to encrypt the IP datagrams, by inserting authentication headers into the TCP/IP stacks, or by writing applications to perform these functions using the existing drivers. If possible, it is generally desirable to minimize modification of the existing levels by adding a layer to perform the desired functions, calling upon the services of the layer below, while utilizing the same function calls so that the higher layer also does not need to be modified. Such a layer is commonly referred to as a "shim."

As indicated above, the preferred approach to implementing client/server virtual private networks is to

use an applications level security system to encrypt files to be transmitted, and to then utilize existing communications layers such as Winsock, or TCP/IP directly. This is the approach taken by the commercially available access control system known as SmartGATE™, developed by V-5 One Corp. of Germantown, Md., which provides both encryption and mutual authentication at the applications level utilizing a dedicated server known as an authentication server and authentication client software installed at the applications level on the client 10 computers. A description of the manner in which encryption and mutual authentication is carried out may be found in the above-cited U.S. Patent No. 5,602,918. While the principles of the invention are applicable to other client/server based virtual private networks, SmartGATE™ is 15 used as an example because it provides the most complete range of mutual authentication and encryption services currently available.

The present invention can be implemented using the existing SmartGATE™ system, but adds mutual authentication 20 and encryption services to lower layers by intercepting function calls or data packets and, during initialization of a communications link, establishing separate channels between the party initiating the communication and the authentication server, and between the authentication 25 server and the party which is to share in the communication, so as to mutually authenticate the parties

with respect to the server, and so as to establish a session key which can be used for further direct communications between the parties.

5 A number of protocols exist which can be used, in total or in part, to implement the mutual authentication and encryption services at the lower layers, using the same basic authentication and encryption scheme currently implemented by SmartGATE™ at the applications level. These include, by way of example, the SOCKS protocol, which
10 places a shim between the TDI or transport layer and the applications, and the commercially available program, known as SnareNet, which operates at the network driver level and can be directly utilized in connection with the present invention.

15 On the other hand, a network level implementation such as the SKIP protocol, which operates below the TDI layer to encrypt the datagrams, and which in its description explicitly precludes the generation of session keys (see the above cited U.S. Patent No. 5,602,918), is
20 fundamentally different in concept than the present invention. Similarly, alternative implementations such as Point-to-Point Tunneling Protocol (PPTP) which involve modifying the TCP/IP stack and/or hardware to provide encryption, as opposed to inserting shims, are not utilized
25 by the preferred embodiment of the present invention, although individual aspects of the protocol could perhaps

be used, and the present system could be added to computers also configured to accept PPTP communications.

The SmartGATE™ system uses public key and DES encryption to provide two-way authentication and 56-bit encrypted communications between a server equipped with the SmartGATE program and client computers equipped with a separate program. Currently, SmartGATE™ operates at the highest level, or applications level, by using shared secret keys to generate a session key for use in further communications between the authentication server or gateway and the client program. Since the session key depends on the secret keys at the gateway and client sides of the communication, mutual authentication is established during generation of the session key, which can then be used to encrypt further communications.

When installed on a client system, the SmartGATE™ client software reads a request for communications by an applications program, such as a browser program, and then proceeds to establish its own communications link with the destination server to determine if the server is an authentication server. If it is not, control of communications is relinquished, but if it is, then the security program and the server carry out a challenge/response routine in order to generate the session key, and all further communications are encrypted by the security program. Although this program is placed between

the Winsock layer and the applications, it does not function as a shim, however, because it only affects communications directed to the authentication server.

Having briefly summarized the concepts used by the present invention, including the concepts of layers, protocols, and shims, and having described a specific applications level security program which is to be modified according to the present invention by adding shims in a way which enables secured authentication and session key generation channels to be set up from the lower layers, it should now be possible to understand the nature of the invention, and in particular how it integrates the two approaches to virtual private networking in a way which greatly expands the concept and yet can easily be implemented. More details will be given below, but as a final observation in this background portion of the patent specification, it should be noted that while the overall concept of the invention is in a sense very simple, it is fundamentally at odds with present approaches. For example, the literature is replete with references to conflicts between VPN standards and implementations, as exemplified by the title of an article from LAN Times On-Line, 9/96, (<http://www.wcmh.com/>), which reads *Clash Over VPN Supremacy*. Even a cursory search of the available literature indicates that the amount of information and choices available to those wishing to set up a virtual private network is overwhelming. One can choose between

Netscape Communications Secure Socket Layer, Open Market Inc.'s Secure HTTP, Microsoft's PPTP, among others. However, all of these approaches operate at a single level, and force a choice between establishing a network of the type shown in Fig. 1A and a network of the type shown in Fig. 1B. Only the present invention offer the advantages of both approaches, without the inflexibility of client/server arrangements or the costs of more distributed architectures.

For further information on the various competing VPN protocols and systems, see also *The Development of Network Security Technologies*, Internet Smartsec, 2/97 (<http://www.smartsec.se>), which compares SmartGATE™ to other application level security systems, including PPTP, SSL, and S-HTTP; *Point-To-Point Tunneling Protocol (PPTP) Frequently Asked Questions*, Microsoft Corp., date unknown, (<http://www.microsoft.com>), *Simple Key-Management for Internet Protocols (SKIP)*, Aziz et al., date unknown, (<http://skip.incog.com>), and *SOCKS Protocol Version 5, RFC 1928*, Leech et al., 3/96 (<http://andrew2.andrew.cmu.edu>) (this document describes a protocol involving a TDI shim). For more general information on security problems, Internet protocols, and sockets, see *Introduction to the Internet Protocols*, Charles L. Hedrick, Rutgers University, 1987 (<http://oac3.hsc.uth.tmc.edu>); *Windows Sockets - Where Necessity is the Mother of Reinvention*, Stardust

Technologies, Inc., 1996, (<http://www.stardust.com>), and *Secure Internet Connections*, LAN Times, 6/17/96 (Ibid).

SUMMARY OF THE INVENTION

5 It is accordingly a principal objective of the invention to provide a client/server virtual private network which is capable not only of carrying out authenticated secure communications over an open network between an authentication server and clients, but also authenticated secure peer-to-peer communications.

10 It is also an objective the invention to provide a virtual private network that provides data encryption and mutual authentication for both client/server and peer-to-peer communications for different-types of applications, using both the applications level and lower levels of a
15 communications hierarchy.

It is a further objective of the invention to provide a client/server virtual private network which can provide both client/server and peer-to-peer encryption and authentication services for any application sharing a
20 specified socket or sockets, whether or not the application is recognized by the encryption and authentication program.

It is a still further objective of the invention to provide a client/server virtual private network which can

provide encryption and authentication services at the applications level, transport driver interface level, and network interface level, without the need for modifying either the communication driver or network driver, or any sockets utilizing the communications driver interface.

It is yet another objective of the invention to provide a virtual private network which provides encryption and authentication services for peer-to-peer communications while maintaining centralized control of key distribution and management functions.

Finally, it is also an objective of the invention to provide a virtual private network which provides encryption and authentication services for peer-to-peer communications and in which registration is carried out by a central gateway server.

These objectives of the invention are accomplished by providing a virtual private network for communicating between a server and clients over an open network and in which the clients are equipped with an applications level encryption and mutual authentication program which includes at least one shim positioned above either the socket, transport driver interface, or network interface layers of a client computers communications hierarchy, and which intercepts function calls or data packets in order to authenticate the parties to the communication by

establishing secured channels between the server and the parties to the communication, prior to establishment of the secured communications link between the parties, in order to carry out mutual authentication and session key generation functions.

More particularly, according to the principles of a preferred embodiment of the invention, client communications software is provided which, at the socket or transport driver interface levels, intercepts function calls to the socket or transport driver and directs calls to the authentication server in order to perform encryption and authentication routines, and at the network driver interface, performs encryption and authentication functions by intercepting the datagrams or data portions of the packets transmitted by the transport driver interface based on communications between the authentication server and the client. According to this aspect of the invention, a system of providing authentication and encryption services for the purpose of establishing a virtual private network includes a plurality of shims arranged to operate at different protocol levels in order to establish a common secure communications link to an authentication server.

In one especially preferred embodiment of the invention, the client software includes a Winsock shim arranged to intercept function calls to the Winsock library on a client machine and redirect initial communications

through the authentication client software to the authentication server, so that any function calls to the Winsock library of programs are intercepted by the shim and carried out by the applications level security program. In this embodiment, the client authentication software substitutes its own function calls for the original function calls in order to establish a secured communications link to the authentication server over which such functions as mutual authentication between the client and server, indirect authentication of peer applications by the now trusted server, session key generation, are carried out, as well as ancillary functions such as on-line registration (OLR), utilizing the unmodified original Winsock library and TCP/IP communications stacks.

By inserting a shim at the Winsock level, an applications level client/server based security program such as SmartGATE™ can be used to provide secure communications for any application which utilizes the Winsock library. In addition, by including analogous shims at other levels, the invention can be used to secure virtually any communications application, including those which by-pass the TDI layer and communicate directly with the network driver level.

Instead of the current array of mutually exclusive alternative methods and systems of establishing secured communications over an open network, the invention thus

provides a single integrated method and system capable of carrying out both client/server communications and peer-to-peer communications between a wide variety of communications applications regardless of whether the applications use a socket or even commonly accepted internet protocols, with complete mutual authentication and encryption of data files at all levels and between all parties to the network.

It will be appreciated that the term "virtual private network" is not to be taken as limiting, and that the principles of the invention can be applied to any remote access schemes which utilize the Internet or other relatively insecure networks to provide access for remote users, corporate intranets, and electronic commerce.

BRIEF DESCRIPTION OF THE DRAWINGS

Fig. 1A is a schematic diagram of a client/server virtual private network.

Fig. 1B is a schematic diagram of an alternative virtual private network based on peer-to-peer communications.

Fig. 2 is a functional block diagram showing the operation of an applications level security program in a conventional communications network hierarchy.

Fig. 3 is a functional block diagram showing the communications network hierarchy of Fig. 1, modified to provide a second layer of service in accordance with the principles of a preferred embodiment of the invention.

5 Fig. 4 is a functional block diagram showing the communications network hierarchy of Fig. 2, modified to provide a third layer of service in accordance with the principles of the preferred embodiment.

10 Fig. 5 is a functional block diagram showing the communication network hierarchy of Fig. 3, modified to provide a fourth layer of service in accordance with the principles of the preferred embodiment.

15 Fig. 6 is a schematic diagram of a virtual private network utilizing the principles of the preferred embodiment of the invention.

Fig. 7 is a flowchart illustrating a method of implementing the system of the preferred embodiment.

DETAILED DESCRIPTION OF THE PREFERRED EMBODIMENTS

20 Fig. 2 illustrates the operation of a client authentication program which is utilized in the present invention. An example of such a program is the SmartGATE™ program discussed briefly above, although other

applications level security programs, whether or not token based, could be modified in a manner similar to that discussed in the following description. The illustrated hierarchy is the Windows NT architecture, although versions of SmartGATE™ exist for other architectures, and the invention could easily be adapted for use with any version of SmartGATE™, including UNIX and MacIntosh versions, as well as for use with applications level security programs designed for communications architectures other than those supported by SmartGATE™. Conversely, it is intended that the present invention can be used with authentication and encryption schemes other than that used by SmartGATE™ and disclosed in U.S. Patent No. 5,602,918. For purposes of convenience, therefore, the software represented by SmartGATE™ is simply referred to as client authentication software.

In addition, it noted that the client computer architectures illustrated in Figs. 3-6, which are modified versions of the architecture of Fig. 2, is to be used with an overall network layout such as the one illustrated in Fig. 6, which includes an authentication server that may be a SmartGATE™ server, or another server depending on the client authentication software. The invention is not merely the addition of shims to the client software, but involves the manner in which the shims are used in the establishment of the authentications and key generation links to the server.

Turning to Fig. 2, which provides background for the description of the invention illustrated in Figs. 3-6, the client authentication software 20 is situated above the boundary of the transport or TDI layer 21 and is designed to utilize a socket 22, such as Winsock, to carry out communications with the authentication server 23 shown in Fig. 6 by means of a transport protocol such as TCP/IP, UDP, or the like, which in turn supply datagrams or packets to a hardware driver layer 24, such as NDIS 3.0, of a network or modem connection 25.

In operation, the client authentication software 20 intercepts interconnect calls 26 from client authentication software supported applications 27 and, if the calls are directed to the authentication server 23, or to a server 28 situated on a secured network whose access is controlled by the authentication server, establishes a secured communications link to the server by executing appropriate function calls 29 to the socket library, which in turn transmits function calls 30 to the TDI layer, causing the TDI layer to form datagrams or packets 31. Datagrams or packets 31 are then formatted over packaged for transmission by the hardware drivers 24 and sent to the communications network in the form of Ethernet packets or analog signals 32 containing the original datagrams from the TDI layer. Once the secured communications link has been established, client authentication software 20 encrypts all further data communications 34 from

applications 27, which are indicated by dashed lines,
before handing them off to the next lower layer in the form
of encrypted files 35. The dashed lines are shown in Fig.
2 as extending only to the TDI layer 21, because the
5 datagrams formed by the TDI layer are indistinguishable as
to content, but it is to be understood that datagrams or
packets 31 carry both the communications used to establish
the secure channel, and the encrypted files subsequently
sent therethrough.

10 Finally, in the case of SmartGATE™, the
authentication client software utilizes either a smart card
or secured file to supply the secret keys used during
authentication to generate a session key for encryption of
further communications, and also to carry out certain other
15 encryption and authentication functions, although it is of
course within the scope of the invention to use key
distribution and authentication methods which do not rely
on smartcards or tokens, and the tokens are not involved in
any of the basic communications functions of the client
20 authentication software 20.

In addition to the applications 27 which communicate
with the server via the authentication/encryption software
20, a typical system will have a number of additional
software applications 36 and 37 capable of carrying out
25 communications over the open network, but which the
authentication client software is not configured to handle,

and which are not specifically adapted or intended to carry out communications with the authentication server. These are referred to herein as peer-to-peer applications, and can include applications which use the same sockets as the authentication client software, applications which directly
5 call upon a transport driver interface stack, whether using the same protocol as the authentication client software or another protocol, all of which are intended to be represented by the TDI layer, and applications which are
10 written to call directly upon the hardware drivers. These peer-to-peer applications may have their own encryption and authentication capabilities, but cannot utilize the services of the authentication server or client software, and therefore the function calls made by the applications
15 and the files transmitted are indicated by separate reference numerals 40-43.

It will be appreciated by those skilled in the art that lower layer application programs which generate packets in forms other than those represented by the TDI
20 layer are also possible, and should be considered within the scope of the invention, but at present virtually all open network applications use at least one of the TDI protocols, and thus while these programs may interact directly with the network driver layer, and require a
25 network driver layer shim, as will be discussed below, are illustrated for purposes of convenience as part of the TDI layer applications.

Turning now to a preferred embodiment of the invention, the arrangement shown in Fig. 3 modifies the arrangement of Fig. 2 by adding a socket shim 50 between the socket 22 utilized by the authentication client software 20, the peer-to-peer applications 36 which also
5 utilize the socket 20, and the authentication client software itself. The shim 50 operates by hooking or intercepting call initiation function calls 40 made to the socket and, in response thereto, having the authentication client software initiate communications with the
10 authentication server 23, shown in Fig. 6, in order to carry out the authentication protocol, as will be discussed in more detail below. Shim 50 also causes files 41 intended for the TDI layer to be diverted to the authentication software for encryption based on the session
15 keys generated during the initial communications with the authentication server, and transmission as encrypted files 51 addressed to the peer application, also shown in Fig. 6, which could also be an application on the application
20 server 28.

Since the basic authentication client software is designed to send all communications directly to the authentication server, while the peer-to-peer applications are designed only to communicate with "peers" 45 and not
25 with the authentication server, the principal function of shim 50 is to arrange for the destination of address of the communication to be supplied to both the authentication

client software and to authentication server, even though
the peer application assumes that it is communicating only
with the peer application. This function permits session
key encrypted communications to be forwarded directly to
5 the peer application, as illustrated in Fig. 6, while the
latter function provides the authentication server with the
client address so that the authentication server can
establish a secured and authenticated link with the peer
application, via authentication client software on the peer
10 computer, and transmit the session key to the peer
application or at least enable the peer application to
recreate the session so that it can decrypt the encrypted
files received directly from the client application.

Thus, while it is appreciated that the use of socket
15 shims is well-known, as mentioned above, the socket shim
shown in Fig. 2 has the unique function of enabling direct
peer-to-peer communications with mediation by the
authentication server, permitting the highest level of
authentication service and collateral functions. In
20 addition, because of the mediation by the key server, the
peer applications do not need to have a shared secret key,
allowing centralized key management, with only the
authentication server having access to all of the client's
secret keys.

25 Figs. 4 shows the variation of the client
authentication software 20 in which a TDI shim 52 similar

in function to the socket shim 50 is provided above the TDI layer. Like the socket shim, implementation of the TDI shim essentially simply involves diverting certain information to the client software in order to establish a communications link with the authentication server, and subsequently perform encryption to obtain encrypted files for transmission directly through the TDI layer in the usual manner. As with the socket shim, TDI shims are not new and can be implemented in known manner, by intercepting TDI service requests, but with the difference from prior TDI shims that the TDI shim works with the authentication software and authentication server to authenticate communications and generate a session key.

Finally, as shown in Fig. 5, a further layer of authentication and encryption may be added by adding a network driver shim 55, either to the arrangement shown in Fig. 3 without the TDI shim, in combination with the TDI shim shown in Fig. 4, or in combination with the TDI shim of Fig. 4 but not the socket shim, to provide for authentication of communications at the network driver layer. At this layer, the shim 55 intercepts IP packets from applications, but instead of referring back to the applications level routine, checks the destination address (which can be in TCP format, UDP format, and so forth), establishes a session key by communications with the authentication server, converts the session key into a format which can be used to encrypt the IP packet, and

sends the IP packet towards the destination, all by carrying out the necessary operations at the network driver level, in a manner similar to that utilized by the above-mentioned SnareNet software program, but with the difference that the authenticating communications link and key generation is carried out by packets addressed to a corresponding layer 56 of the authentication server, which may be further connected to an applications server 57.

It will be noted that since the IP packets are not distinguishable by content, the network driver layer shim could be used as an additional level of security, rather than as an alternative to applications level encryption, with the encrypted files generated by software 20 being further encrypted by shim 55 before transmission to the authentication server or associated gateway.

The overall system utilizing the authentication client software illustrated in Figs. 3-5 is schematically illustrated in Fig. 6. The principal components of the overall system are the client computers containing software of the type illustrated in Figs. 2-5, including client authentication software 20 and shims 50, 53, and/or 55, and applications with communications capabilities (represented by applications 27, 36, 37, and 56 on one client, and application 45 on the other). For purposes of illustration, the client of Figs. 6 is thus depicted as including applications for communicating at the highest

levels, such as the SmartGATE™ proxy application, applications for communicating at the network driver level with corresponding applications connected to the lower layer of the authentication server, and peer-to-peer applications with no capability of communicating with SmartGATE™, but which use sockets or TDI protocols recognized by the shims.

In the case of the SmartGATE™ proxy application, communications are established in the same manner as in the currently available version of the SmartGATE™ authentication client software, and as described in U.S. Patent No. 5,602,918, the communications link being indicated by arrows 60 and 61, with arrow 60 representing the client/server response channel used to authenticate the parties and generate the session key.

In the case of a peer-to-peer application, in which the clients wish to communicate over a direct link 62, the invention provides for the function calls establishing the communications to be intercepted and the initialization procedure routed through channel 61 to the authentication server 23. Server 23 then opens a secured channel 63 to the authentication client software 20 associated with peer application 45 by performing the same mutual authentication procedure performed for the purpose of establishing channel 63, and once the channel is established with its own session key, transmits information using the channel 63

session key which allows the client to recreate the channel
60 session key for use in decrypting communications sent
over channel 62. Alternatively, after establishing channel
63, the channel 60 session key could be used to transmit
5 back to the original sending party information necessary to
recreate the channel 63 session key. In either case, the
authentication server is thus used to establish a fully
authenticated "tunnel" between the peer applications
without the need to modify any of the sockets, TDI
10 protocols, or hardware drivers on either of the client
computers. While the transmitting peer application has no
way of directly authenticating the receiving peer, only a
receiving peer authenticated by the authentication server
will be able to generate the necessary session keys, and
15 thus each of the parties to the communication is
effectively authenticated.

For the lower layer application 56, a similar protocol
may be employed, in which the attempted communication
between lower layer applications is intercepted, and the
20 communications link to the authentication server is used to
generate a session key, which is then used to encrypt the
packets or datagrams being sent. In this case, the
destination must be the lower layer of the authentication
server, and thus the communications link is indicated by a
25 separate channel 67.

Finally, the procedures associated with the network illustrated in Fig. 6 are summarized in the flowchart of Fig. 7. For communications directly with the applications level portion of the server 23, steps 100-103 are used, while for peer-to-peer communications, steps 104-109 are used, and for network driver level communications, steps 110-114 are used.

In particular, step 100 by which the applications level authentication program 20 illustrated in Figs. 3-5 receives a call initiation request, either directly from a supported applications program 27 or from a programs 36 and 37 via one of the shims 50 and 53, step 101 is step by which the program 20 addresses the authentication server, step 102 is the step by which the client and server are mutually authenticated and the session keys generated using, for example, the procedure described in U.S. Patent No. 5,602,918, and step 103 is the step by which program 20 encrypts further communications received directly or via shims 50 and 53 from the applications programs 27, 36, and 37.

For peer-to-peer communications, step 105, which is part of step 100, is the step by which the peer address is supplied to program 20, steps 106 and 107 are identical to steps 101 and 102, step 108 is the step by which communications channel 63 shown in Figure 6 is established, step 109 is the step by which the destination computer

authenticated by the server is enabled to decrypt communications received over channel 62, and step 110 is the step by which program 20 encrypts the communications. It will of course be appreciated that these steps represent
5 only a summary of the steps involved in carrying out the present invention, and that further steps will be apparent to those skilled in the art based on the above description of the apparatus and software portions of the preferred embodiment of the invention.

10 Having thus described various preferred embodiments of the invention, those skilled in the art will appreciate that variations and modifications of the preferred embodiment may be made without departing from the scope of the invention. It is accordingly intended that the
15 invention not be limited by the above description or accompanying drawings, but that it be defined solely in accordance with the appended claims.

I claim:

1. Apparatus for carrying out communications over a multi-tier virtual private network, said network including a server and a plurality of client computers, the server and client computers each including means for transmitting data to and receiving data from an open network, comprising:

means for intercepting function calls and requests for service sent by an applications program on one of said client computers to a lower level set of communications drivers; and

means for causing an applications level authentication and encryption program in said one of said client computers to communicate with the server, generate said session key, and encrypt files sent by the applications program before transmittal over said open network.

2. Apparatus as claimed in claim 1, further comprising means for intercepting files packaged by a transport driver interface layer to form packets and encrypting the packets using a session key generated during communications with a lower layer of the server.

3. A method as claimed in claim 1, further comprising means for intercepting a destination address during initialization of communications between said one of said

client computers and a second of said client computers on said virtual private network;

means for causing said applications level authentication and encryption program to communicate with the server to carry out functions a.) and b.);

means for transmitting said destination address to said server;

means for causing said server to carry-out functions a.) and b.) with respect to the second of said two client computers;

means for enabling said second of said two client computers to recreate the session key;

means for causing said authentication software to encrypt files to be sent to the destination address using the session key; and

means for transmitting the encrypted files directly to the destination address.

4. Apparatus as claimed in claim 3, wherein said means for intercepting the destination address is carried out by a shim positioned between a peer-to-peer applications program and a layer of a communications driver architecture of said one of the two client computers.

5. A multi-tier virtual private network, comprising:

a server and a plurality of client computers, the server and client computers each including means for

transmitting data to and receiving data from an open network,

wherein said means for transmitting data to and receiving data from the open network includes, in any client computer initiating communications with the server:

applications level encryption and authentication software arranged to communicate with the server in order to: a.) mutually authenticate the server and the client computer initiating communications with the server and b.) generate a session key for use by the client computer initiating communications to encrypt files;

at least one lower level set of communications drivers;

and a shim arranged to intercept function calls and requests for service sent by an applications program to the lower level set of communications drivers in order to cause the applications level authentication and encryption program to communicate with the server, generate said session key, and encrypt files sent by the applications program before transmittal over said open network.

6. A multi-tier virtual private network as claimed in claim 5, wherein said lower level set of communications drivers includes a network driver layer, a transport driver

interface layer arranged to package applications files as packets capable of being routed over the open network and supply the packets to the network driver layer for transmission to the open network, and an applications socket for facilitating service requests by said applications program to the transport driver interface layer, and wherein said shim is a socket shim positioned between the applications program and the socket to intercept function calls to the socket in order to cause the applications level authentication and encryption program to communicate with the server, generate said session key, and encrypt files sent by the applications program before the files are packaged by the transport driver interface layer.

7. A multi-tier virtual private network as claimed in claim 6, wherein said applications program is a peer-to-peer communications program, and wherein a peer application destination address, included in said function calls to the socket, is diverted by the socket shim and wherein a destination address including said intercepted function calls is supplied to the server during communications with the server, causing the service to establish a communications link with a peer application, mutually authenticate the peer application, and enable the peer application to reconstruct the session key in order to receive encrypted files sent by the peer-to-peer communications program over the open network.

8. A multi-tier virtual private network as claimed in claim 6, further including a transport driver interface shim positioned between the transport driver interface layer and a second applications program, for intercepting requests from the second applications program for service by the transport driver interface layer in order to cause the applications level authentication and encryption program to communicate with the server, generate said session key, and encrypt files sent by the applications program before the files are packaged by the transport driver interface layer.

9. A multi-tier virtual private network as claimed in claim 8, further comprising a network driver layer shim positioned between the network driver layer and the transport driver interface layer and arranged to intercept files packaged by the transport driver interface layer and encrypt the files using a session key generated during communications with a lower layer of the server.

10. A multi-tier virtual private network as claimed in claim 5, wherein said lower level set of communications drivers includes a network driver layer, and a transport driver interface layer arranged to package applications files as packets capable of being routed over the open network and supply the packets to the network driver layer for transmission to the open network, and wherein said shim is a transport driver interface layer shim positioned

between the applications program and the transport driver interface layer to intercept service requests by the applications program to the transport driver interface layer in order to cause the applications level authentication and encryption program to communicate with the server, generate said session key, and encrypt files sent by the applications program before the files are packaged by the transport driver interface layer.

11. A multi-tier virtual private network as claimed in claim 10, wherein said applications program is a peer-to-peer communications program, and wherein a peer application destination address, included in said intercepted requests for service, is diverted by the transport driver interface layer shim and supplied to the server during communications with the server, causing the service to establish a communications link with a peer application, mutually authenticate the peer application, and enable the peer application to reconstruct the session key in order to receive encrypted files sent by the peer-to-peer communications program over the open network.

12. A multi-tier virtual private network as claimed in claim 10, further comprising a network driver layer shim positioned between the network driver layer and the transport driver interface layer and arranged to intercept files packaged by the transport driver interface layer and

encrypt the files using a session key generated during communications with a lower layer of the server.

13. A multi-tier virtual private network, comprising:

a server and a plurality of client computers, the server and client computers each including means for transmitting data to and receiving data from an open network,

wherein said means for transmitting data to and receiving data from the open network includes, in any client computer initiating communications with the server:

applications level encryption and authentication software arranged to communicate with the server in order to: a.) mutually authenticate the server and the client computer initiating communications with the server and b.) generate a session key for use by the client computer initiating communications to encrypt files; and

at least one lower level set of communications drivers,

wherein said lower level set of communications drivers includes a network driver layer, a transport driver interface layer arranged to package applications files as packets capable of being routed over the open network and supply the packets to the network driver layer for transmission to the open network, and a

network driver layer shim positioned between the transport driver interface layer and the network driver layer and arranged to intercept files packaged by the transport driver interface layer and encrypt the files using a session key generated during communications with a lower layer of the server.

14. A multi-tier virtual private network, comprising:
a server and a plurality of client computers, the server and client computers each including means for transmitting data to and receiving data from an open network,

wherein said means for transmitting data to and receiving data from the open network includes, in any client computer initiating communications with the server:

applications level encryption and authentication software arranged to communicate with the server in order to: a.) mutually authenticate the server and the client computer initiating communications with the server and b.) generate a session key for use by the client computer initiating communications to encrypt files; and

further comprising means for securing peer-to-peer communications between applications on two of said client computers, said peer-to-peer communications securing means comprising:

means for intercepting a destination address during initialization of communications by a first of said two client computers;

means for causing said authentication software to communicate with the server to carry out functions a.) and b.);

means for transmitting said destination address to said server;

means for causing said server to carry-out functions a.) and b.) with respect to the second of said two client computers;

means for enabling said second of said two client computers to recreate the session key;

means for causing said authentication software to encrypt files to be sent to the destination address using the session key;

means for transmitting the encrypted files directly to the destination address.

15. A multi-tier virtual private network as claimed in claim 14, wherein said means for intercepting the destination address comprises a shim positioned between the peer-to-peer applications program and a layer of a communications driver architecture of said first of the two client computers.

16. A multi-tier virtual private network as claimed in claim 5, wherein said shim is positioned above a socket,

the socket being positioned above a transport driver layer of said communications driver architecture.

17. A multi-tier virtual private network as claimed in claim 5, wherein said shim is positioned above a transport driver layer of said communications driver architecture.

18. Computer software for installation on a client computer of a multi-tier virtual private network, said network including a server and a plurality of client computers, the server and client computers each including means for transmitting data to and receiving data from an open network,

wherein said computer software includes:

applications level encryption and authentication software arranged to communicate with the server in order to: a.) mutually authenticate the server and the client computer initiating communications with the server and b.) generate a session key for use by the client computer initiating communications to encrypt files;

and a shim arranged to intercept function calls and requests for service sent by an applications program to a lower level set of communications drivers in order to cause the applications level authentication and encryption program to communicate with the server, generate

said session key, and encrypt files sent by the applications program before transmittal over said open network.

19. Computer software as claimed in claim 18, wherein said lower level set of communications drivers includes a network driver layer, a transport driver interface layer arranged to package applications files as packets capable of being routed over the open network and supply the packets to the network driver layer for transmission to the open network, and an applications socket for facilitating service requests by said applications program to the transport driver interface layer, and wherein said shim is a socket shim positioned between the applications program and the socket to intercept function calls to the socket in order to cause the applications level authentication and encryption program to communicate with the server, generate said session key, and encrypt files sent by the applications program before the files are packaged by the transport driver interface layer.

20. Computer software as claimed in claim 19, wherein said applications program is a peer-to-peer communications program, and wherein a peer application destination address, included in said function calls to the socket, is diverted by the socket shim and wherein a destination address including said intercepted function calls is supplied to the server during communications with the

server, causing the service to establish a communications link with a peer application, mutually authenticate the peer application, and enable the peer application to reconstruct the session key in order to receive encrypted files sent by the peer-to-peer communications program over the open network.

21. Computer software as claimed in claim 19, further including a transport driver interface shim positioned between the transport driver interface layer and a second applications program, for intercepting requests from the second applications program for service by the transport driver interface layer in order to cause the applications level authentication and encryption program to communicate with the server, generate said session key, and encrypt files sent by the applications program before the files are packaged by the transport driver interface layer.

22. Computer software as claimed in claim 21, further comprising a network driver layer shim positioned between the network driver layer and the transport driver interface layer and arranged to intercept files packaged by the transport driver interface layer and encrypt the files using a session key generated during communications with a lower layer of the server.

23. Computer software as claimed in claim 18, wherein said lower level set of communications drivers includes a

network driver layer, and a transport driver interface layer arranged to package applications files as packets capable of being routed over the open network and supply the packets to the network driver layer for transmission to the open network, and wherein said shim is a transport driver interface layer shim positioned between the applications program and the transport driver interface layer to intercept service requests by the applications program to the transport driver interface layer in order to cause the applications level authentication and encryption program to communicate with the server, generate said session key, and encrypt files sent by the applications program before the files are packaged by the transport driver interface layer.

24. Computer software as claimed in claim 23, wherein said applications program is a peer-to-peer communications program, and wherein a peer application destination address, included in said intercepted requests for service, is diverted by the transport driver interface layer shim and supplied to the server during communications with the server, causing the service to establish a communications link with a peer application, mutually authenticate the peer application, and enable the peer application to reconstruct the session key in order to receive encrypted files sent by the peer-to-peer communications program over the open network.

25. Computer software as claimed in claim 23, further comprising a network driver layer shim positioned between the network driver layer and the transport driver interface layer and arranged to intercept files packaged by the transport driver interface layer and encrypt the files using a session key generated during communications with a lower layer of the server.

26. Computer software for installation on a client computer of a multi-tier virtual private network, said network including a server and a plurality of client computers, the server and client computers each including means for transmitting data to and receiving data from an open network,

wherein said computer software includes:

applications level encryption and authentication software arranged to communicate with the server in order to: a.) mutually authenticate the server and the client computer initiating communications with the server and b.) generate a session key for use by the client computer initiating communications to encrypt files; and

at least one lower level set of communications drivers,

wherein said lower level set of communications drivers includes a network driver layer, a transport driver interface layer

arranged to package applications files as packets capable of being routed over the open network and supply the packets to the network driver layer for transmission to the open network, and a network driver layer shim positioned between the transport driver interface layer and the network driver layer and arranged to intercept files packaged by the transport driver interface layer and encrypt the files using a session key generated during communications with a lower layer of the server.

27. Computer software for installation on a client computer of a multi-tier virtual private network, said network including a server and a plurality of client computers, the server and client computers each including means for transmitting data to and receiving data from an open network,

wherein said computer software includes:

applications level encryption and authentication software arranged to communicate with the server in order to: a.) mutually authenticate the server and the client computer initiating communications with the server and b.) generate a session key for use by the client computer initiating communications to encrypt files; and

further comprising means for securing peer-to-peer communications between applications on two of said client

computers, said peer-to-peer communications securing means comprising:

means for intercepting a destination address during initialization of communications by a first of said two client computers;

means for causing said authentication software to communicate with the server to carry out functions a.) and b.);

means for transmitting said destination address to said server;

means for causing said server to carry-out functions a.) and b.) with respect to the second of said two client computers;

means for enabling said second of said two client computers to recreate the session key;

means for causing said authentication software to encrypt files to be sent to the destination address using the session key;

means for transmitting the encrypted files directly to the destination address.

28. Computer software as claimed in claim 27, wherein said means for intercepting the destination address comprises a shim positioned between the peer-to-peer applications program and a layer of a communications driver architecture of said first of the two client computers.

29. Computer software as claimed in claim 27, wherein said shim is positioned above a socket, the socket being positioned above a transport driver layer of said communications driver architecture.

30. Computer software as claimed in claim 27, wherein said shim is positioned above a transport driver layer of said communications driver architecture.

31. A method of carrying out communications over a multi-tier virtual private network, said network including a server and a plurality of client computers, the server and client computers each including means for transmitting data to and receiving data from an open network, comprising the steps of:

intercepting function calls and requests for service sent by an applications program in one of said client computers to a lower level set of communications drivers;

causing an applications level authentication and encryption program said one of said client computers to communicate with the server, generate said session key, and encrypt files sent by the applications program before transmittal over said open network.

32. A method as claimed in claim 31, further comprising the step of intercepting files packaged by a transport driver interface layer to form packets and encrypting the

packets using a session key generated during communications with a lower layer of the server.

33. A method as claimed in claim 31, further comprising the step of intercepting a destination address during initialization of communications between said one of said client computers and a second of said client computers on said virtual private network;

causing said applications level authentication and encryption program to communicate with the server to carry out functions a.) and b.);

transmitting said destination address to said server;

causing said server to carry-out functions a.) and b.) with respect to the second of said two client computers;

enabling said second of said two client computers to recreate the session key;

causing said authentication software to encrypt files to be sent to the destination address using the session key; and

transmitting the encrypted files directly to the destination address.

34. A method as claimed in claim 33, wherein said step of intercepting the destination address is carried out by a shim positioned between a peer-to-peer applications program

and a layer of a communications driver architecture of said one of the two client computers.

Client/Server VPN

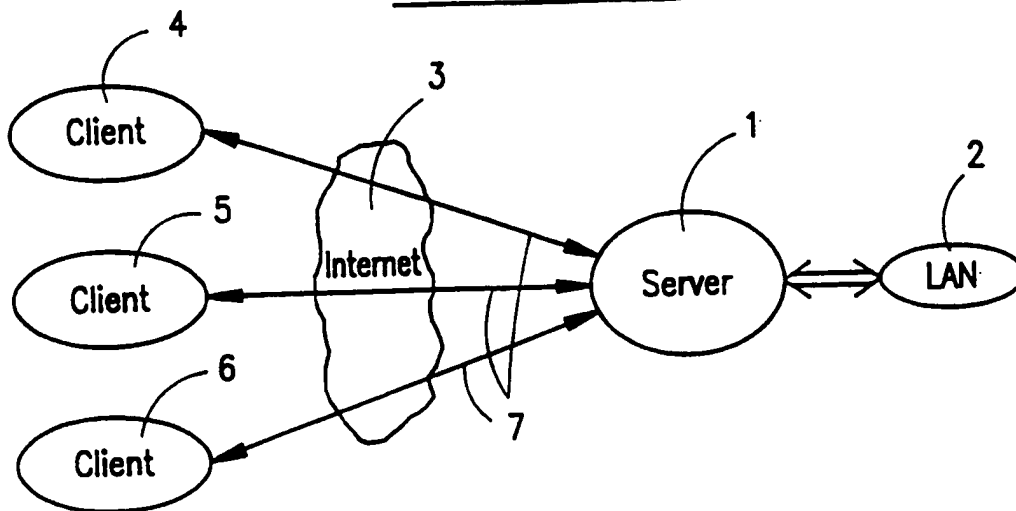

FIG. 1A
(PRIOR ART)

Peer-to-Peer Tunneling

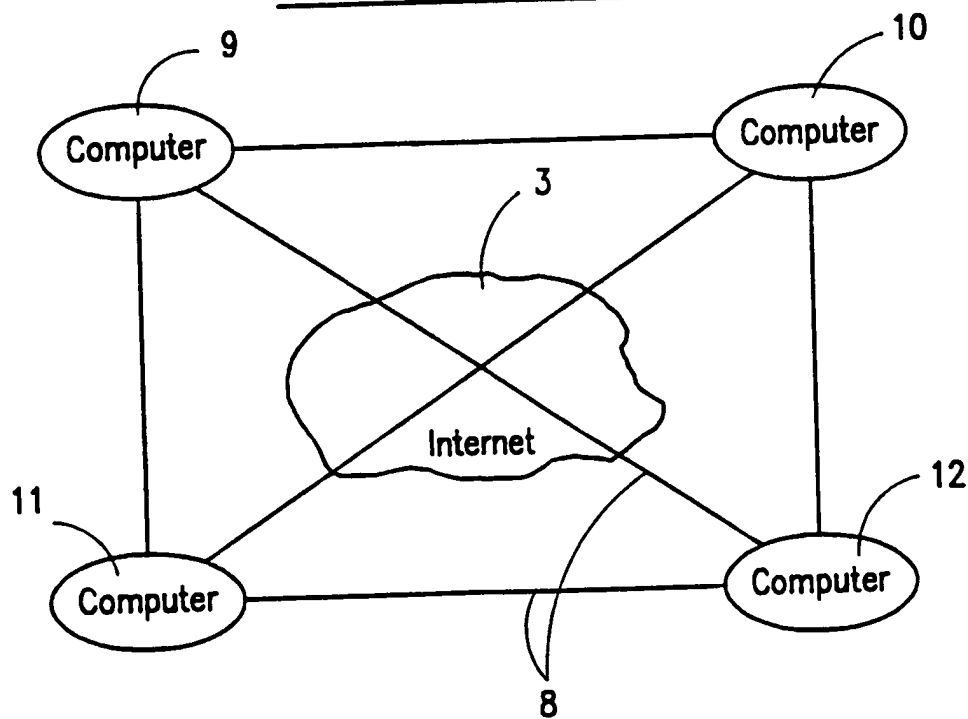

FIG. 1B
(PRIOR ART)

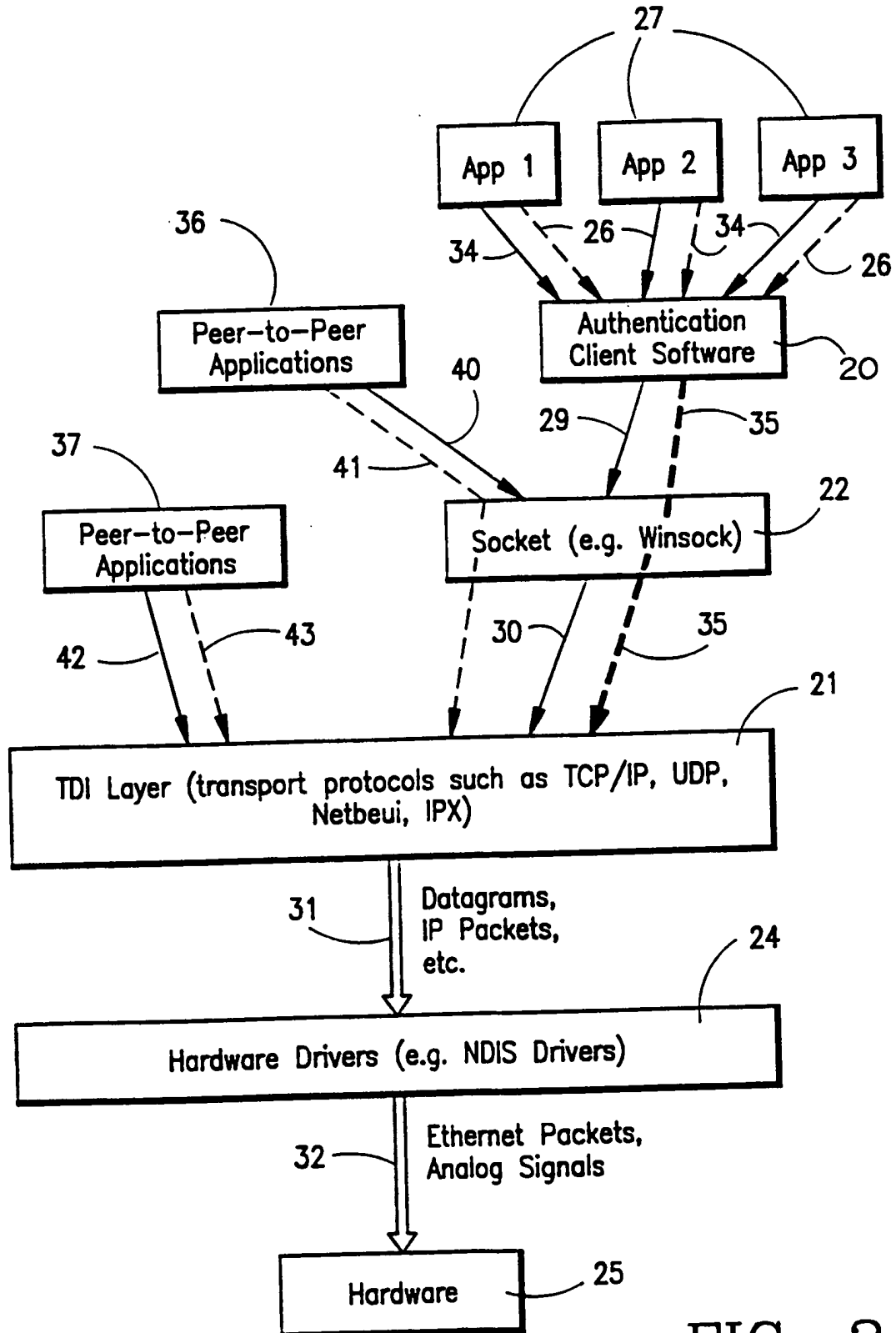

FIG. 2
(PRIOR ART)

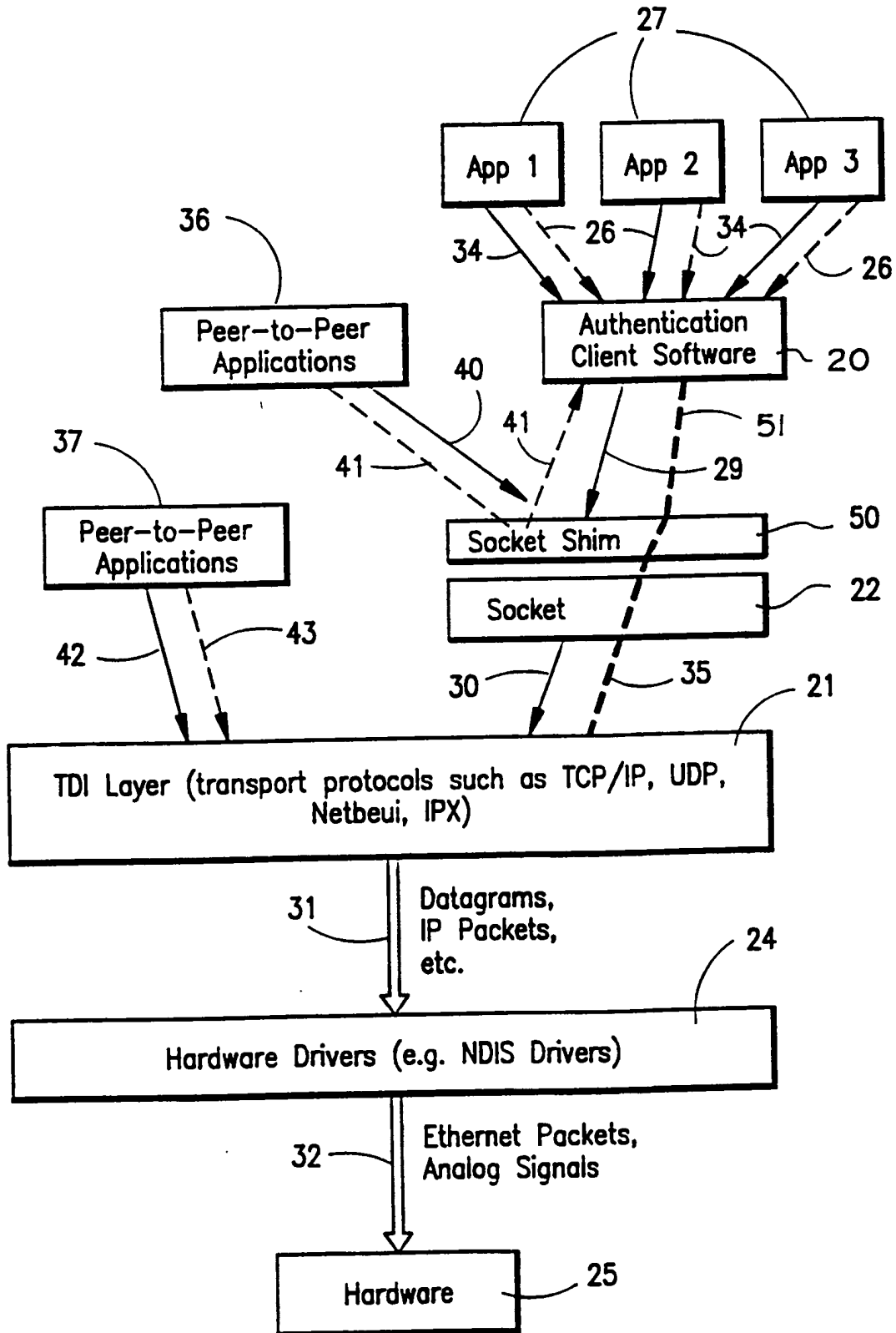

FIG. 3

4/7

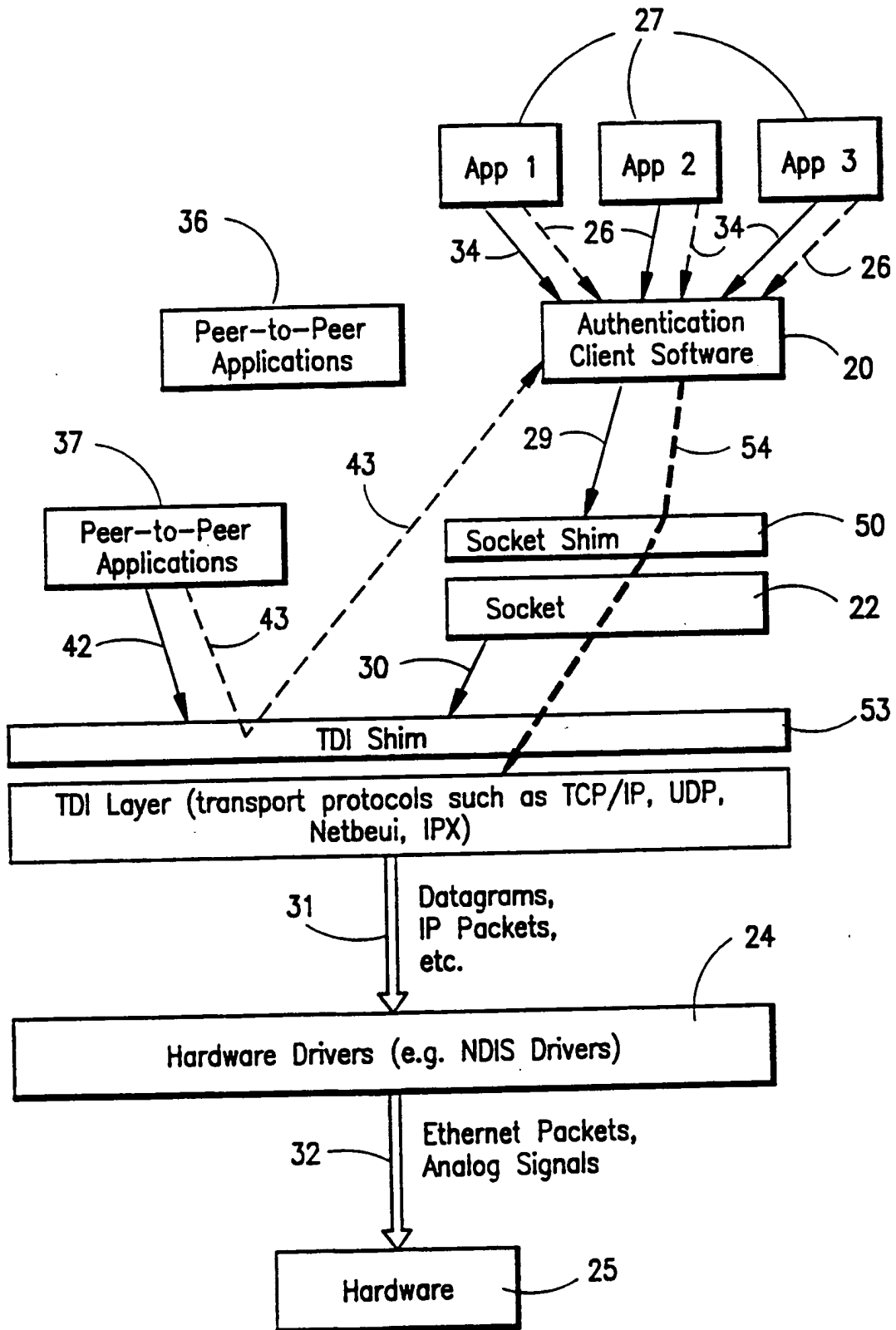

FIG. 4

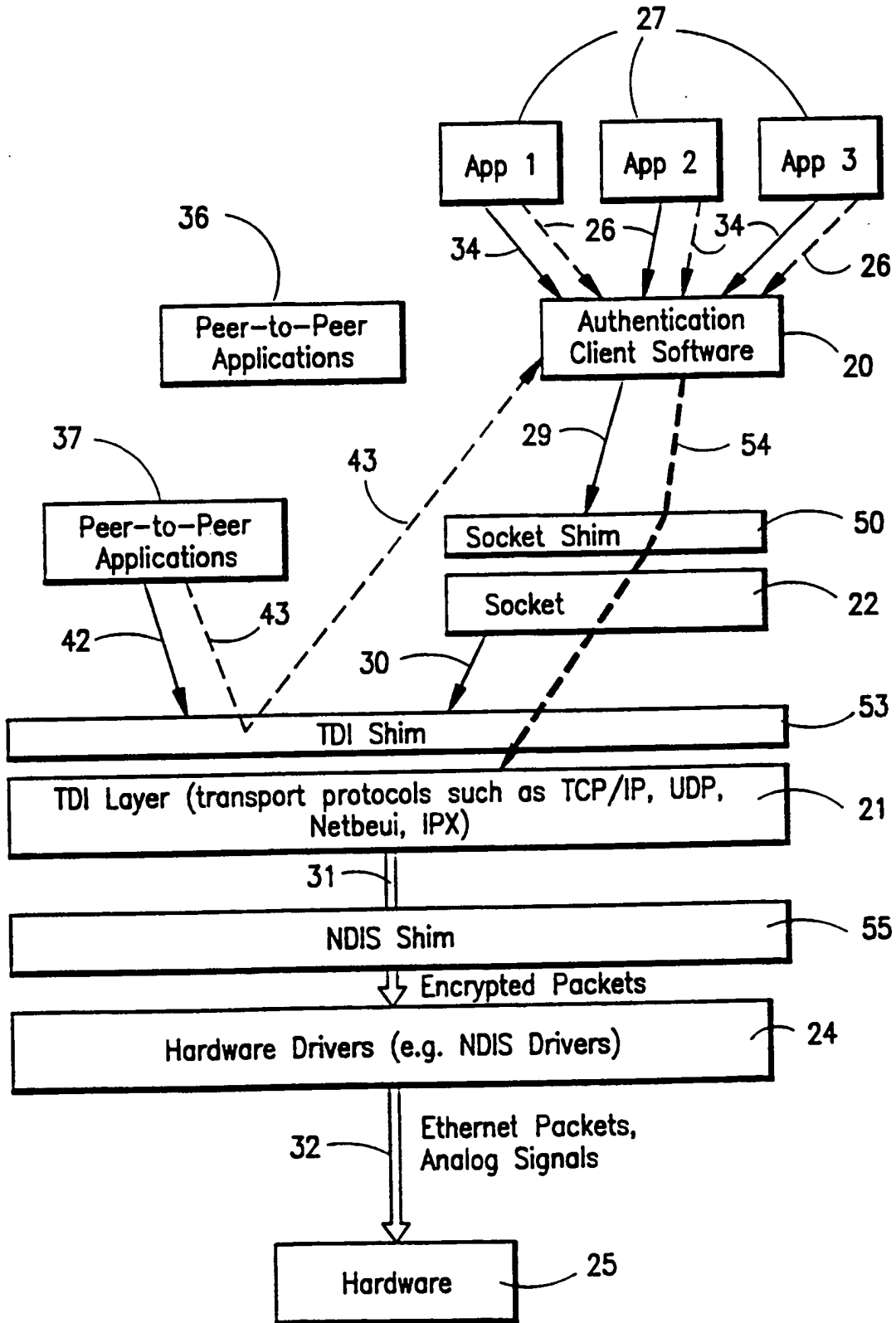

FIG. 5

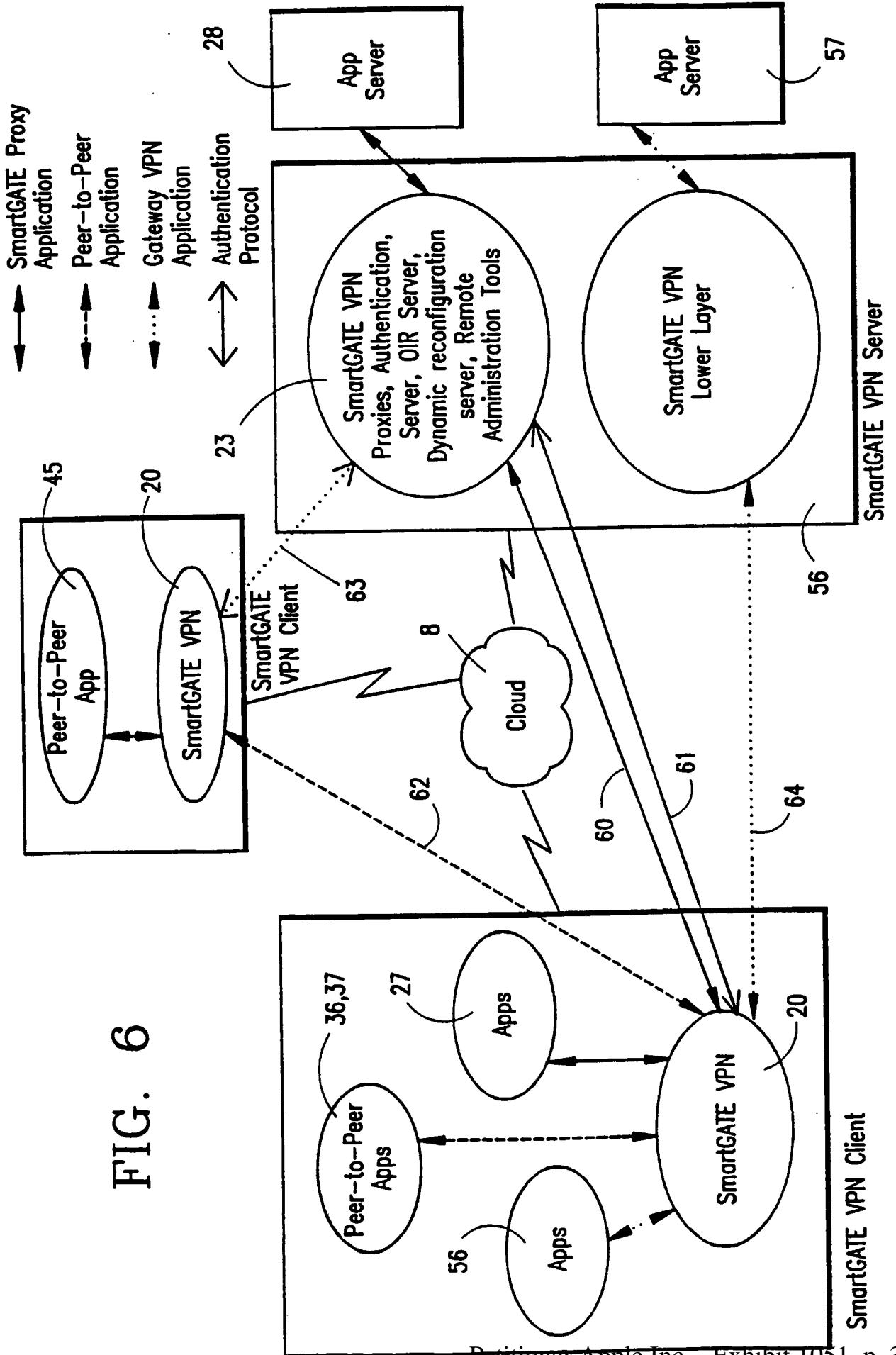

FIG. 6

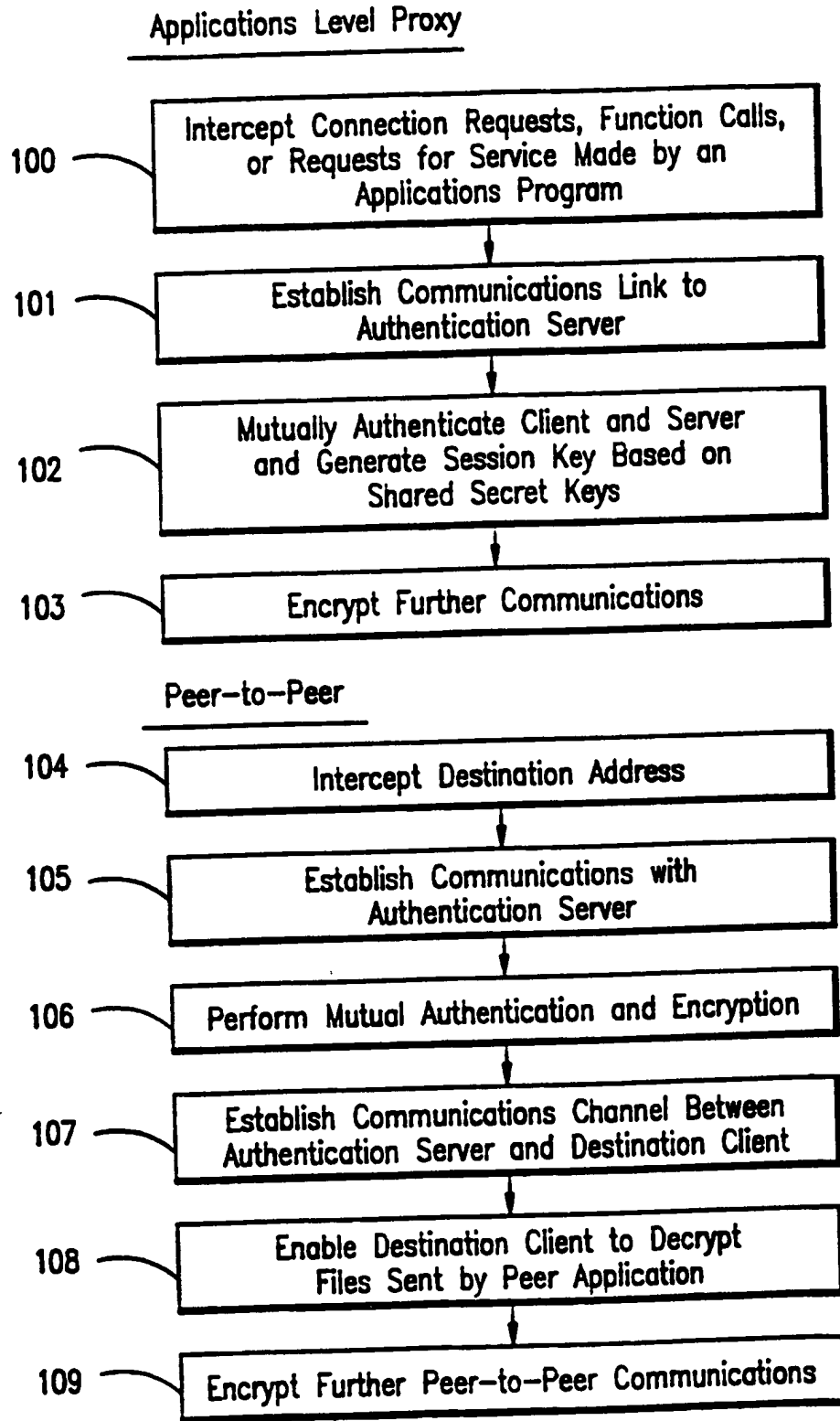

FIG. 7

INTERNATIONAL SEARCH REPORT

International application No.
PCT/US98/17198

A. CLASSIFICATION OF SUBJECT MATTER

IPC(6) :H04L 9/00
US CL :395/187.01

According to International Patent Classification (IPC) or to both national classification and IPC

B. FIELDS SEARCHED

Minimum documentation searched (classification system followed by classification symbols)

U.S. : 395/187.01, 186, 188.01; 200.17, 200.12; 380/49, 21, 25, 4

Documentation searched other than minimum documentation to the extent that such documents are included in the fields searched

Electronic data base consulted during the international search (name of data base and, where practicable, search terms used)

APS, STN, IEEE ProQuest
search terms: virtual private network, shims, DLLs, protocol layers, Winsock, sockets, encryption, authentication.

C. DOCUMENTS CONSIDERED TO BE RELEVANT

Category*	Citation of document, with indication, where appropriate, of the relevant passages	Relevant to claim No.
Y	US 5,657,390 A (ELGAMAL ET AL) 12 AUGUST 1997, FIGURES 1-8, COL. 3, LINES 20-55, COL. 5, LINE 15 TO COL. 8, LINE 32, COL. 11, LINE 1 TO COL. 16, LINE 49.	1, 5, 6, 16, 17, 18, 19, 23, 31
A	US 5,602,918 A (CHEN ET AL) 11 FEBRUARY 1997, SEE ENTIRE PATENT.	1-34
A	US 5,550,984 A (GELB) 27 AUGUST 1996, ABSTRACT, COL. 3, LINE 52 TO COL. 4, LINE 45, COL.6, LINES 27-55.	1-34
Y	HURWICZ, A VIRTUAL PRIVATE AFFAIR, BYTE MAGAZINE, JULY 1997, PAGES 79-87.	1, 5, 6, 16, 17, 18, 19, 23, 31

Further documents are listed in the continuation of Box C. See patent family annex.

* Special categories of cited documents:	*T* later document published after the international filing date or priority date and not in conflict with the application but cited to understand the principle or theory underlying the invention
A document defining the general state of the art which is not considered to be of particular relevance	*X* document of particular relevance; the claimed invention cannot be considered novel or cannot be considered to involve an inventive step when the document is taken alone
B earlier document published on or after the international filing date	*Y* document of particular relevance; the claimed invention cannot be considered to involve an inventive step when the document is combined with one or more other such documents, such combination being obvious to a person skilled in the art
L document which may throw doubts on priority claim(s) or which is cited to establish the publication date of another citation or other special reason (as specified)	*Z* document member of the same patent family
O document referring to an oral disclosure, use, exhibition or other means	
P document published prior to the international filing date but later than the priority date claimed	

Date of the actual completion of the international search

22 OCTOBER 1998

Date of mailing of the international search report

12 NOV 1998

Name and mailing address of the ISA/US
Commissioner of Patents and Trademarks
Box PCT
Washington, D.C. 20231

Facsimile No. (703) 305-3230

Authorized officer

JOSEPH PALYS

Telephone No. (703) 305-9600

**This Page is Inserted by IFW Indexing and Scanning
Operations and is not part of the Official Record**

BEST AVAILABLE IMAGES

Defective images within this document are accurate representations of the original documents submitted by the applicant.

Defects in the images include but are not limited to the items checked:

- BLACK BORDERS
- IMAGE CUT OFF AT TOP, BOTTOM OR SIDES
- FADED TEXT OR DRAWING
- BLURRED OR ILLEGIBLE TEXT OR DRAWING
- SKEWED/SLANTED IMAGES
- COLOR OR BLACK AND WHITE PHOTOGRAPHS
- GRAY SCALE DOCUMENTS
- LINES OR MARKS ON ORIGINAL DOCUMENT
- REFERENCE(S) OR EXHIBIT(S) SUBMITTED ARE POOR QUALITY
- OTHER:

IMAGES ARE BEST AVAILABLE COPY.

As rescanning these documents will not correct the image problems checked, please do not report these problems to the IFW Image Problem Mailbox.

C24

(12) INTERNATIONAL APPLICATION PUBLISHED UNDER THE PATENT COOPERATION TREATY (PCT)

(19) World Intellectual Property Organization
International Bureau



(43) International Publication Date
23 August 2001 (23.08.2001)

PCT

(10) International Publication Number
WO 01/61922 A2

- (51) International Patent Classification⁷: H04L 12/00 [US/US]; 12026 Lisa Marie Court, Fairfax, VA 22033 (US). WILLIAMSON, Michael [US/US]; 26203 Ocala Circle, South Riding, VA 20152 (US).
- (21) International Application Number: PCT/US01/04340
- (22) International Filing Date: 12 February 2001 (12.02.2001) (74) Agents: WRIGHT, Bradley, C. et al.; Banner & Witcoff, Ltd., 11th Floor, 1001 G Street, N.W., Washington, DC 20001-4597 (US).
- (25) Filing Language: English
- (26) Publication Language: English (81) Designated States (national): AE, AG, AL, AM, AT, AU, AZ, BA, BB, BG, BR, BY, BZ, CA, CH, CN, CR, CU, CZ, DE, DK, DM, DZ, EE, ES, FI, GB, GD, GE, GH, GM, HR, HU, ID, IL, IN, IS, JP, KE, KG, KP, KR, KZ, LC, LK, LR, LS, LT, LU, LV, MA, MD, MG, MK, MN, MW, MX, MZ, NO, NZ, PL, PT, RO, RU, SD, SE, SG, SI, SK, SL, TJ, TM, TR, TT, TZ, UA, UG, US, UZ, VN, YU, ZA, ZW.
- (30) Priority Data: 09/504,783 15 February 2000 (15.02.2000) US (84) Designated States (regional): ARIPO patent (GH, GM, KE, LS, MW, MZ, SD, SL, SZ, TZ, UG, ZW), Eurasian patent (AM, AZ, BY, KG, KZ, MD, RU, TJ, TM), European patent (AT, BE, CH, CY, DE, DK, ES, FI, FR, GB, GR, IE, IT, LU, MC, NL, PT, SE, TR), OAPI patent (BF, BJ, CF, CG, CI, CM, GA, GN, GW, ML, MR, NE, SN, TD, TG).
- (63) Related by continuation (CON) or continuation-in-part (CIP) to earlier application: US 09/504,783 (CON) Filed on 15 February 2000 (15.02.2000)
- (71) Applicant (for all designated States except US): SCIENCE APPLICATIONS INTERNATIONAL CORPORATION [US/US]; 10260 Campus Point Drive, San Diego, CA 92121 (US).
- (72) Inventors; and
- (75) Inventors/Applicants (for US only): MUNGER, Edmund, Colby [US/US]; 1101 Opaca Court, Crownsville, MD 21032 (US). SCHMIDT, Douglas, Charles [US/US]; 230 Oak Court, Severna Park, MD 21146 (US). SHORT, Robert, Dunham, III [US/US]; 38710 Goose Creek Lane, Leesburg, VA 20175 (US). LARSON, Victor

Published:
— without international search report and to be republished upon receipt of that report

For two-letter codes and other abbreviations, refer to the "Guidance Notes on Codes and Abbreviations" appearing at the beginning of each regular issue of the PCT Gazette.



WO 01/61922 A2

(54) Title: IMPROVEMENTS TO AN AGILE NETWORK PROTOCOL FOR SECURE COMMUNICATIONS WITH ASSURED SYSTEM AVAILABILITY

(57) Abstract: A plurality of computer nodes communicate using seemingly random Internet Protocol source and destination addresses. Data packets matching criteria defined by a moving window of valid addresses are accepted for further processing, while those that do not meet the criteria are quickly rejected. Improvements to the basic design include (1) a load balancer that distributes packets across different transmission paths according to transmission path quality; (2) a DNS proxy server that transparently creates a virtual private network in response to a domain name inquiry; (3) a large-to-small link bandwidth management feature that prevents denial-of-service attacks at system chokepoints; (4) a traffic limiter that regulates incoming packets by limiting the rate at which a transmitter can be synchronized with a receiver; and (5) a signaling synchronizer that allows a large number of nodes to communicate with a central node by partitioning the communication function between two separate entities.

**IMPROVEMENTS TO AN AGILE NETWORK PROTOCOL
FOR SECURE COMMUNICATIONS
WITH ASSURED SYSTEM AVAILABILITY**

5

CROSS-REFERENCE TO RELATED APPLICATION

This application claims priority from and is a continuation-in-part of previously filed U.S. application serial number 09/429,643, filed on October 29, 1999. The subject matter of that application, which is bodily incorporated herein, derives from provisional U.S. application numbers 60/106,261 (filed October 30, 1998) and 60/137,704 (filed June 7, 1999).

10

BACKGROUND OF THE INVENTION

A tremendous variety of methods have been proposed and implemented to provide security and anonymity for communications over the Internet. The variety stems, in part, from the different needs of different Internet users. A basic heuristic framework to aid in discussing these different security techniques is illustrated in FIG. 1. Two terminals, an originating terminal 100 and a destination terminal 110 are in communication over the Internet. It is desired for the communications to be secure, that is, immune to eavesdropping. For example, terminal 100 may transmit secret information to terminal 110 over the Internet 107. Also, it may be desired to prevent an eavesdropper from discovering that terminal 100 is in communication with terminal 110. For example, if terminal 100 is a user and terminal 110 hosts a web site, terminal 100's user may not want anyone in the intervening networks to know what web sites he is "visiting." Anonymity would thus be an issue, for example, for companies that want to keep their market research interests private and thus would prefer to prevent outsiders from knowing which web-sites or other Internet resources they are "visiting." These two security issues may be called data security and anonymity, respectively.

15

20

25

30

Data security is usually tackled using some form of data encryption. An encryption key 48 is known at both the originating and terminating terminals 100 and 110. The keys may be private and public at the originating and destination terminals 100 and 110, respectively or they may be symmetrical keys (the same key is used by

both parties to encrypt and decrypt). Many encryption methods are known and usable in this context.

To hide traffic from a local administrator or ISP, a user can employ a local proxy server in communicating over an encrypted channel with an outside proxy such that the local administrator or ISP only sees the encrypted traffic. Proxy servers prevent destination servers from determining the identities of the originating clients. This system employs an intermediate server interposed between client and destination server. The destination server sees only the Internet Protocol (IP) address of the proxy server and not the originating client. The target server only sees the address of the outside proxy. This scheme relies on a trusted outside proxy server. Also, proxy schemes are vulnerable to traffic analysis methods of determining identities of transmitters and receivers. Another important limitation of proxy servers is that the server knows the identities of both calling and called parties. In many instances, an originating terminal, such as terminal A, would prefer to keep its identity concealed from the proxy, for example, if the proxy server is provided by an Internet service provider (ISP).

To defeat traffic analysis, a scheme called Chaum's mixes employs a proxy server that transmits and receives fixed length messages, including dummy messages. Multiple originating terminals are connected through a mix (a server) to multiple target servers. It is difficult to tell which of the originating terminals are communicating to which of the connected target servers, and the dummy messages confuse eavesdroppers' efforts to detect communicating pairs by analyzing traffic. A drawback is that there is a risk that the mix server could be compromised. One way to deal with this risk is to spread the trust among multiple mixes. If one mix is compromised, the identities of the originating and target terminals may remain concealed. This strategy requires a number of alternative mixes so that the intermediate servers interposed between the originating and target terminals are not determinable except by compromising more than one mix. The strategy wraps the message with multiple layers of encrypted addresses. The first mix in a sequence can decrypt only the outer layer of the message to reveal the next destination mix in

sequence. The second mix can decrypt the message to reveal the next mix and so on. The target server receives the message and, optionally, a multi-layer encrypted payload containing return information to send data back in the same fashion. The only way to defeat such a mix scheme is to collude among mixes. If the packets are all
5 fixed-length and intermixed with dummy packets, there is no way to do any kind of traffic analysis.

Still another anonymity technique, called 'crowds,' protects the identity of the originating terminal from the intermediate proxies by providing that originating terminals belong to groups of proxies called crowds. The crowd proxies are
10 interposed between originating and target terminals. Each proxy through which the message is sent is randomly chosen by an upstream proxy. Each intermediate proxy can send the message either to another randomly chosen proxy in the "crowd" or to the destination. Thus, even crowd members cannot determine if a preceding proxy is the originator of the message or if it was simply passed from another proxy.

15 ZKS (Zero-Knowledge Systems) Anonymous IP Protocol allows users to select up to any of five different pseudonyms, while desktop software encrypts outgoing traffic and wraps it in User Datagram Protocol (UDP) packets. The first server in a 2+-hop system gets the UDP packets, strips off one layer of encryption to add another, then sends the traffic to the next server, which strips off yet another layer
20 of encryption and adds a new one. The user is permitted to control the number of hops. At the final server, traffic is decrypted with an untraceable IP address. The technique is called onion-routing. This method can be defeated using traffic analysis. For a simple example, bursts of packets from a user during low-duty periods can reveal the identities of sender and receiver.

25 Firewalls attempt to protect LANs from unauthorized access and hostile exploitation or damage to computers connected to the LAN. Firewalls provide a server through which all access to the LAN must pass. Firewalls are centralized systems that require administrative overhead to maintain. They can be compromised by virtual-machine applications ("applets"). They instill a false sense of security that
30 leads to security breaches for example by users sending sensitive information to

servers outside the firewall or encouraging use of modems to sidestep the firewall security. Firewalls are not useful for distributed systems such as business travelers, extranets, small teams, etc.

SUMMARY OF THE INVENTION

5 A secure mechanism for communicating over the internet, including a protocol referred to as the Tunneled Agile Routing Protocol (TARP), uses a unique two-layer encryption format and special TARP routers. TARP routers are similar in function to regular IP routers. Each TARP router has one or more IP addresses and uses normal IP protocol to send IP packet messages (“packets” or “datagrams”). The IP packets
10 exchanged between TARP terminals via TARP routers are actually encrypted packets whose true destination address is concealed except to TARP routers and servers. The normal or “clear” or “outside” IP header attached to TARP IP packets contains only the address of a next hop router or destination server. That is, instead of indicating a final destination in the destination field of the IP header, the TARP packet’s IP header
15 always points to a next-hop in a series of TARP router hops, or to the final destination. This means there is no overt indication from an intercepted TARP packet of the true destination of the TARP packet since the destination could always be next-hop TARP router as well as the final destination.

 Each TARP packet’s true destination is concealed behind a layer of encryption
20 generated using a link key. The link key is the encryption key used for encrypted communication between the hops intervening between an originating TARP terminal and a destination TARP terminal. Each TARP router can remove the outer layer of encryption to reveal the destination router for each TARP packet. To identify the link key needed to decrypt the outer layer of encryption of a TARP packet, a receiving
25 TARP or routing terminal may identify the transmitting terminal by the sender/receiver IP numbers in the cleartext IP header.

 Once the outer layer of encryption is removed, the TARP router determines the final destination. Each TARP packet 140 undergoes a minimum number of hops to help foil traffic analysis. The hops may be chosen at random or by a fixed value. As a
30 result, each TARP packet may make random trips among a number of geographically

disparate routers before reaching its destination. Each trip is highly likely to be different for each packet composing a given message because each trip is independently randomly determined. This feature is called *agile routing*. The fact that different packets take different routes provides distinct advantages by making it difficult for an interloper to obtain all the packets forming an entire multi-packet message. The associated advantages have to do with the inner layer of encryption discussed below. Agile routing is combined with another feature that furthers this purpose; a feature that ensures that any message is broken into multiple packets.

The IP address of a TARP router can be changed, a feature called *IP agility*. Each TARP router, independently or under direction from another TARP terminal or router, can change its IP address. A separate, unchangeable identifier or address is also defined. This address, called the TARP address, is known only to TARP routers and terminals and may be correlated at any time by a TARP router or a TARP terminal using a Lookup Table (LUT). When a TARP router or terminal changes its IP address, it updates the other TARP routers and terminals which in turn update their respective LUTs.

The message payload is hidden behind an inner layer of encryption in the TARP packet that can only be unlocked using a session key. The session key is not available to any of the intervening TARP routers. The session key is used to decrypt the payloads of the TARP packets permitting the data stream to be reconstructed.

Communication may be made private using link and session keys, which in turn may be shared and used according to any desired method. For example, public/private keys or symmetric keys may be used.

To transmit a data stream, a TARP originating terminal constructs a series of TARP packets from a series of IP packets generated by a network (IP) layer process. (Note that the terms "network layer," "data link layer," "application layer," etc. used in this specification correspond to the Open Systems Interconnection (OSI) network terminology.) The payloads of these packets are assembled into a block and chain-block encrypted using the session key. This assumes, of course, that all the IP packets are destined for the same TARP terminal. The block is then interleaved and the

interleaved encrypted block is broken into a series of payloads, one for each TARP packet to be generated. Special TARP headers IP_T are then added to each payload using the IP headers from the data stream packets. The TARP headers can be identical to normal IP headers or customized in some way. They should contain a formula or data for deinterleaving the data at the destination TARP terminal, a time-to-live (TTL) parameter to indicate the number of hops still to be executed, a data type identifier which indicates whether the payload contains, for example, TCP or UDP data, the sender's TARP address, the destination TARP address, and an indicator as to whether the packet contains real or decoy data or a formula for filtering out decoy data if decoy data is spread in some way through the TARP payload data.

Note that although chain-block encryption is discussed here with reference to the session key, any encryption method may be used. Preferably, as in chain block encryption, a method should be used that makes unauthorized decryption difficult without an entire result of the encryption process. Thus, by separating the encrypted block among multiple packets and making it difficult for an interloper to obtain access to all of such packets, the contents of the communications are provided an extra layer of security.

Decoy or dummy data can be added to a stream to help foil traffic analysis by reducing the peak-to-average network load. It may be desirable to provide the TARP process with an ability to respond to the time of day or other criteria to generate more decoy data during low traffic periods so that communication bursts at one point in the Internet cannot be tied to communication bursts at another point to reveal the communicating endpoints.

Dummy data also helps to break the data into a larger number of inconspicuously-sized packets permitting the interleave window size to be increased while maintaining a reasonable size for each packet. (The packet size can be a single standard size or selected from a fixed range of sizes.) One primary reason for desiring for each message to be broken into multiple packets is apparent if a chain block encryption scheme is used to form the first encryption layer prior to interleaving. A single block encryption may be applied to portion, or entirety, of a message, and that

portion or entirety then interleaved into a number of separate packets. Considering the agile IP routing of the packets, and the attendant difficulty of reconstructing an entire sequence of packets to form a single block-encrypted message element, decoy packets can significantly increase the difficulty of reconstructing an entire data stream.

5 The above scheme may be implemented entirely by processes operating between the data link layer and the network layer of each server or terminal participating in the TARP system. Because the encryption system described above is insertable between the data link and network layers, the processes involved in supporting the encrypted communication may be completely transparent to processes
10 at the IP (network) layer and above. The TARP processes may also be completely transparent to the data link layer processes as well. Thus, no operations at or above the Network layer, or at or below the data link layer, are affected by the insertion of the TARP stack. This provides additional security to all processes at or above the network layer, since the difficulty of unauthorized penetration of the network layer
15 (by, for example, a hacker) is increased substantially. Even newly developed servers running at the session layer leave all processes below the session layer vulnerable to attack. Note that in this architecture, security is distributed. That is, notebook computers used by executives on the road, for example, can communicate over the Internet without any compromise in security.

20 IP address changes made by TARP terminals and routers can be done at regular intervals, at random intervals, or upon detection of "attacks." The variation of IP addresses hinders traffic analysis that might reveal which computers are communicating, and also provides a degree of immunity from attack. The level of immunity from attack is roughly proportional to the rate at which the IP address of the
25 host is changing.

As mentioned, IP addresses may be changed in response to attacks. An attack may be revealed, for example, by a regular series of messages indicating that a router is being probed in some way. Upon detection of an attack, the TARP layer process may respond to this event by changing its IP address. In addition, it may create a

subprocess that maintains the original IP address and continues interacting with the attacker in some manner.

Decoy packets may be generated by each TARP terminal on some basis determined by an algorithm. For example, the algorithm may be a random one which
 5 calls for the generation of a packet on a random basis when the terminal is idle. Alternatively, the algorithm may be responsive to time of day or detection of low traffic to generate more decoy packets during low traffic times. Note that packets are preferably generated in groups, rather than one by one, the groups being sized to simulate real messages. In addition, so that decoy packets may be inserted in normal
 10 TARP message streams, the background loop may have a latch that makes it more likely to insert decoy packets when a message stream is being received. Alternatively, if a large number of decoy packets is received along with regular TARP packets, the algorithm may increase the rate of dropping of decoy packets rather than forwarding them. The result of dropping and generating decoy packets in this way is to make the
 15 apparent incoming message size different from the apparent outgoing message size to help foil traffic analysis.

In various other embodiments of the invention, a scalable version of the system may be constructed in which a plurality of IP addresses are preassigned to each pair of communicating nodes in the network. Each pair of nodes agrees upon an
 20 algorithm for "hopping" between IP addresses (both sending and receiving), such that an eavesdropper sees apparently continuously random IP address pairs (source and destination) for packets transmitted between the pair. Overlapping or "reusable" IP addresses may be allocated to different users on the same subnet, since each node merely verifies that a particular packet includes a valid source/destination pair from
 25 the agreed-upon algorithm. Source/destination pairs are preferably not reused between any two nodes during any given end-to-end session, though limited IP block sizes or lengthy sessions might require it.

Further improvements described in this continuation-in-part application include: (1) a load balancer that distributes packets across different transmission paths
 30 according to transmission path quality; (2) a DNS proxy server that transparently

creates a virtual private network in response to a domain name inquiry; (3) a large-to-small link bandwidth management feature that prevents denial-of-service attacks at system chokepoints; (4) a traffic limiter that regulates incoming packets by limiting the rate at which a transmitter can be synchronized with a receiver; and (5) a signaling synchronizer that allows a large number of nodes to communicate with a central node
5 by partitioning the communication function between two separate entities

BRIEF DESCRIPTION OF THE DRAWINGS

FIG. 1 is an illustration of secure communications over the Internet according to a prior art embodiment.

10 FIG. 2 is an illustration of secure communications over the Internet according to an embodiment of the invention.

FIG. 3a is an illustration of a process of forming a tunneled IP packet according to an embodiment of the invention.

15 FIG. 3b is an illustration of a process of forming a tunneled IP packet according to another embodiment of the invention.

FIG. 4 is an illustration of an OSI layer location of processes that may be used to implement the invention.

FIG. 5 is a flow chart illustrating a process for routing a tunneled packet according to an embodiment of the invention.

20 FIG. 6 is a flow chart illustrating a process for forming a tunneled packet according to an embodiment of the invention.

FIG. 7 is a flow chart illustrating a process for receiving a tunneled packet according to an embodiment of the invention.

25 FIG. 8 shows how a secure session is established and synchronized between a client and a TARP router.

FIG. 9 shows an IP address hopping scheme between a client computer and TARP router using transmit and receive tables in each computer.

FIG. 10 shows physical link redundancy among three Internet Service Providers (ISPs) and a client computer.

FIG. 11 shows how multiple IP packets can be embedded into a single “frame” such as an Ethernet frame, and further shows the use of a discriminator field to camouflage true packet recipients.

5 FIG. 12A shows a system that employs hopped hardware addresses, hopped IP addresses, and hopped discriminator fields.

FIG. 12B shows several different approaches for hopping hardware addresses, IP addresses, and discriminator fields in combination.

FIG. 13 shows a technique for automatically re-establishing synchronization between sender and receiver through the use of a partially public sync value.

10 FIG. 14 shows a “checkpoint” scheme for regaining synchronization between a sender and recipient.

FIG. 15 shows further details of the checkpoint scheme of FIG. 14.

FIG. 16 shows how two addresses can be decomposed into a plurality of segments for comparison with presence vectors.

15 FIG. 17 shows a storage array for a receiver’s active addresses.

FIG. 18 shows the receiver’s storage array after receiving a sync request.

FIG. 19 shows the receiver’s storage array after new addresses have been generated.

FIG. 20 shows a system employing distributed transmission paths.

20 FIG. 21 shows a plurality of link transmission tables that can be used to route packets in the system of FIG. 20.

FIG. 22A shows a flowchart for adjusting weight value distributions associated with a plurality of transmission links.

25 FIG. 22B shows a flowchart for setting a weight value to zero if a transmitter turns off.

FIG. 23 shows a system employing distributed transmission paths with adjusted weight value distributions for each path.

FIG. 24 shows an example using the system of FIG. 23.

FIG. 25 shows a conventional domain-name look-up service.

FIG. 26 shows a system employing a DNS proxy server with transparent VPN creation.

FIG. 27 shows steps that can be carried out to implement transparent VPN creation based on a DNS look-up function.

5 FIG. 28 shows a system including a link guard function that prevents packet overloading on a low-bandwidth link LOW BW.

FIG. 29 shows one embodiment of a system employing the principles of FIG. 28.

10 FIG. 30 shows a system that regulates packet transmission rates by throttling the rate at which synchronizations are performed.

FIG. 31 shows a signaling server 3101 and a transport server 3102 used to establish a VPN with a client computer.

FIG. 32 shows message flows relating to synchronization protocols of FIG. 31.

DETAILED DESCRIPTION OF THE INVENTION

15 Referring to FIG. 2, a secure mechanism for communicating over the internet employs a number of special routers or servers, called TARP routers 122-127 that are similar to regular IP routers 128-132 in that each has one or more IP addresses and uses normal IP protocol to send normal-looking IP packet messages, called TARP packets 140. TARP packets 140 are identical to normal IP packet messages that are
20 routed by regular IP routers 128-132 because each TARP packet 140 contains a destination address as in a normal IP packet. However, instead of indicating a final destination in the destination field of the IP header, the TARP packet's 140 IP header always points to a next-hop in a series of TARP router hops, or the final destination, TARP terminal 110. Because the header of the TARP packet contains only the next-
25 hop destination, there is no overt indication from an intercepted TARP packet of the true destination of the TARP packet 140 since the destination could always be the next-hop TARP router as well as the final destination, TARP terminal 110.

Each TARP packet's true destination is concealed behind an outer layer of encryption generated using a link key 146. The link key 146 is the encryption key
30 used for encrypted communication between the end points (TARP terminals or TARP

routers) of a single link in the chain of hops connecting the originating TARP terminal 100 and the destination TARP terminal 110. Each TARP router 122-127, using the link key 146 it uses to communicate with the previous hop in a chain, can use the link key to reveal the true destination of a TARP packet. To identify the link key needed to decrypt the outer layer of encryption of a TARP packet, a receiving TARP or routing terminal may identify the transmitting terminal (which may indicate the link key used) by the sender field of the clear IP header. Alternatively, this identity may be hidden behind another layer of encryption in available bits in the clear IP header. Each TARP router, upon receiving a TARP message, determines if the message is a TARP message by using authentication data in the TARP packet. This could be recorded in available bytes in the TARP packet's IP header. Alternatively, TARP packets could be authenticated by attempting to decrypt using the link key 146 and determining if the results are as expected. The former may have computational advantages because it does not involve a decryption process.

Once the outer layer of decryption is completed by a TARP router 122-127, the TARP router determines the final destination. The system is preferably designed to cause each TARP packet 140 to undergo a minimum number of hops to help foil traffic analysis. The time to live counter in the IP header of the TARP message may be used to indicate a number of TARP router hops yet to be completed. Each TARP router then would decrement the counter and determine from that whether it should forward the TARP packet 140 to another TARP router 122-127 or to the destination TARP terminal 110. If the time to live counter is zero or below zero after decrementing, for an example of usage, the TARP router receiving the TARP packet 140 may forward the TARP packet 140 to the destination TARP terminal 110. If the time to live counter is above zero after decrementing, for an example of usage, the TARP router receiving the TARP packet 140 may forward the TARP packet 140 to a TARP router 122-127 that the current TARP terminal chooses at random. As a result, each TARP packet 140 is routed through some minimum number of hops of TARP routers 122-127 which are chosen at random.

Thus, each TARP packet, irrespective of the traditional factors determining traffic in the Internet, makes random trips among a number of geographically disparate routers before reaching its destination and each trip is highly likely to be different for each packet composing a given message because each trip is independently randomly determined as described above. This feature is called *agile routing*. For reasons that will become clear shortly, the fact that different packets take different routes provides distinct advantages by making it difficult for an interloper to obtain all the packets forming an entire multi-packet message. Agile routing is combined with another feature that furthers this purpose, a feature that ensures that any message is broken into multiple packets.

A TARP router receives a TARP packet when an IP address used by the TARP router coincides with the IP address in the TARP packet's IP header IP_C. The IP address of a TARP router, however, may not remain constant. To avoid and manage attacks, each TARP router, independently or under direction from another TARP terminal or router, may change its IP address. A separate, unchangeable identifier or address is also defined. This address, called the TARP address, is known only to TARP routers and terminals and may be correlated at any time by a TARP router or a TARP terminal using a Lookup Table (LUT). When a TARP router or terminal changes its IP address, it updates the other TARP routers and terminals which in turn update their respective LUTs. In reality, whenever a TARP router looks up the address of a destination in the encrypted header, it must convert a TARP address to a real IP address using its LUT.

While every TARP router receiving a TARP packet has the ability to determine the packet's final destination, the message payload is embedded behind an inner layer of encryption in the TARP packet that can only be unlocked using a session key. The session key is not available to any of the TARP routers 122-127 intervening between the originating 100 and destination 110 TARP terminals. The session key is used to decrypt the payloads of the TARP packets 140 permitting an entire message to be reconstructed.

In one embodiment, communication may be made private using link and session keys, which in turn may be shared and used according any desired method. For example, a public key or symmetric keys may be communicated between link or session endpoints using a public key method. Any of a variety of other mechanisms
 5 for securing data to ensure that only authorized computers can have access to the private information in the TARP packets 140 may be used as desired.

Referring to FIG. 3a, to construct a series of TARP packets, a data stream 300 of IP packets 207a, 207b, 207c, etc., such series of packets being formed by a network (IP) layer process, is broken into a series of small sized segments. In the present
 10 example, equal-sized segments 1-9 are defined and used to construct a set of interleaved data packets A, B, and C. Here it is assumed that the number of interleaved packets A, B, and C formed is three and that the number of IP packets 207a-207c used to form the three interleaved packets A, B, and C is exactly three. Of course, the number of IP packets spread over a group of interleaved packets may be
 15 any convenient number as may be the number of interleaved packets over which the incoming data stream is spread. The latter, the number of interleaved packets over which the data stream is spread, is called the *interleave window*.

To create a packet, the transmitting software interleaves the normal IP packets 207a *et. seq.* to form a new set of interleaved payload data 320. This payload data 320
 20 is then encrypted using a session key to form a set of session-key-encrypted payload data 330, each of which, A, B, and C, will form the payload of a TARP packet. Using the IP header data, from the original packets 207a-207c, new TARP headers IP_T are formed. The TARP headers IP_T can be identical to normal IP headers or customized in some way. In a preferred embodiment, the TARP headers IP_T are IP headers with
 25 added data providing the following information required for routing and reconstruction of messages, some of which data is ordinarily, or capable of being, contained in normal IP headers:

1. A window sequence number – an identifier that indicates where the packet belongs in the original message sequence.

2. An interleave sequence number – an identifier that indicates the interleaving sequence used to form the packet so that the packet can be deinterleaved along with other packets in the interleave window.
3. A time-to-live (TTL) datum – indicates the number of TARP-router-hops to be executed before the packet reaches its destination. Note that the TTL parameter may provide a datum to be used in a probabilistic formula for determining whether to route the packet to the destination or to another hop.
4. Data type identifier – indicates whether the payload contains, for example, TCP or UDP data.
5. Sender's address – indicates the sender's address in the TARP network.
6. Destination address – indicates the destination terminal's address in the TARP network.
7. Decoy/Real – an indicator of whether the packet contains real message data or dummy decoy data or a combination.

Obviously, the packets going into a single interleave window must include only packets with a common destination. Thus, it is assumed in the depicted example that the IP headers of IP packets 207a-207c all contain the same destination address or at least will be received by the same terminal so that they can be deinterleaved. Note that dummy or decoy data or packets can be added to form a larger interleave window than would otherwise be required by the size of a given message. Decoy or dummy data can be added to a stream to help foil traffic analysis by leveling the load on the network. Thus, it may be desirable to provide the TARP process with an ability to respond to the time of day or other criteria to generate more decoy data during low traffic periods so that communication bursts at one point in the Internet cannot be tied to communication bursts at another point to reveal the communicating endpoints.

Dummy data also helps to break the data into a larger number of inconspicuously-sized packets permitting the interleave window size to be increased while maintaining a reasonable size for each packet. (The packet size can be a single

standard size or selected from a fixed range of sizes.) One primary reason for desiring for each message to be broken into multiple packets is apparent if a chain block encryption scheme is used to form the first encryption layer prior to interleaving. A single block encryption may be applied to a portion, or the entirety, of a message, and that portion or entirety then interleaved into a number of separate packets.

Referring to FIG. 3b, in an alternative mode of TARP packet construction, a series of IP packets are accumulated to make up a predefined interleave window. The payloads of the packets are used to construct a single block 520 for chain block encryption using the session key. The payloads used to form the block are presumed to be destined for the same terminal. The block size may coincide with the interleave window as depicted in the example embodiment of FIG. 3b. After encryption, the encrypted block is broken into separate payloads and segments which are interleaved as in the embodiment of Fig 3a. The resulting interleaved packets A, B, and C, are then packaged as TARP packets with TARP headers as in the Example of FIG. 3a. The remaining process is as shown in, and discussed with reference to, FIG. 3a.

Once the TARP packets 340 are formed, each entire TARP packet 340, including the TARP header IP_T , is encrypted using the link key for communication with the first-hop-TARP router. The first hop TARP router is randomly chosen. A final unencrypted IP header IP_C is added to each encrypted TARP packet 340 to form a normal IP packet 360 that can be transmitted to a TARP router. Note that the process of constructing the TARP packet 360 does not have to be done in stages as described. The above description is just a useful heuristic for describing the final product, namely, the TARP packet.

Note that, TARP header IP_T could be a completely custom header configuration with no similarity to a normal IP header except that it contain the information identified above. This is so since this header is interpreted by only TARP routers.

The above scheme may be implemented entirely by processes operating between the data link layer and the network layer of each server or terminal participating in the TARP system. Referring to FIG. 4, a TARP transceiver 405 can be

an originating terminal 100, a destination terminal 110, or a TARP router 122-127. In each TARP Transceiver 405, a transmitting process is generated to receive normal packets from the Network (IP) layer and generate TARP packets for communication over the network. A receiving process is generated to receive normal IP packets
5 containing TARP packets and generate from these normal IP packets which are “passed up” to the Network (IP) layer. Note that where the TARP Transceiver 405 is a router, the received TARP packets 140 are not processed into a stream of IP packets 415 because they need only be authenticated as proper TARP packets and then passed to another TARP router or a TARP destination terminal 110. The intervening process,
10 a “TARP Layer” 420, could be combined with either the data link layer 430 or the Network layer 410. In either case, it would intervene between the data link layer 430 so that the process would receive regular IP packets containing embedded TARP packets and “hand up” a series of reassembled IP packets to the Network layer 410. As an example of combining the TARP layer 420 with the data link layer 430, a
15 program may augment the normal processes running a communications card, for example, an Ethernet card. Alternatively, the TARP layer processes may form part of a dynamically loadable module that is loaded and executed to support communications between the network and data link layers.

Because the encryption system described above can be inserted between the
20 data link and network layers, the processes involved in supporting the encrypted communication may be completely transparent to processes at the IP (network) layer and above. The TARP processes may also be completely transparent to the data link layer processes as well. Thus, no operations at or above the network layer, or at or below the data link layer, are affected by the insertion of the TARP stack. This
25 provides additional security to all processes at or above the network layer, since the difficulty of unauthorized penetration of the network layer (by, for example, a hacker) is increased substantially. Even newly developed servers running at the session layer leave all processes below the session layer vulnerable to attack. Note that in this architecture, security is distributed. That is, notebook computers used by executives

on the road, for example, can communicate over the Internet without any compromise in security.

Note that IP address changes made by TARP terminals and routers can be done at regular intervals, at random intervals, or upon detection of “attacks.” The variation of IP addresses hinders traffic analysis that might reveal which computers
5 are communicating, and also provides a degree of immunity from attack. The level of immunity from attack is roughly proportional to the rate at which the IP address of the host is changing.

As mentioned, IP addresses may be changed in response to attacks. An attack
10 may be revealed, for example, by a regular series of messages indicates that a router is being probed in some way. Upon detection of an attack, the TARP layer process may respond to this event by changing its IP address. To accomplish this, the TARP process will construct a TARP-formatted message, in the style of Internet Control Message Protocol (ICMP) datagrams as an example; this message will contain the machine’s TARP address, its previous IP address, and its new IP address. The TARP
15 layer will transmit this packet to at least one known TARP router; then upon receipt and validation of the message, the TARP router will update its LUT with the new IP address for the stated TARP address. The TARP router will then format a similar message, and broadcast it to the other TARP routers so that they may update their
20 LUTs. Since the total number of TARP routers on any given subnet is expected to be relatively small, this process of updating the LUTs should be relatively fast. It may not, however, work as well when there is a relatively large number of TARP routers and/or a relatively large number of clients; this has motivated a refinement of this architecture to provide scalability; this refinement has led to a second embodiment,
25 which is discussed below.

Upon detection of an attack, the TARP process may also create a subprocess that maintains the original IP address and continues interacting with the attacker. The latter may provide an opportunity to trace the attacker or study the attacker’s methods (called “fishbowling” drawing upon the analogy of a small fish in a fish bowl that
30 “thinks” it is in the ocean but is actually under captive observation). A history of the

communication between the attacker and the abandoned (fishbowed) IP address can be recorded or transmitted for human analysis or further synthesized for purposes of responding in some way.

5 As mentioned above, decoy or dummy data or packets can be added to outgoing data streams by TARP terminals or routers. In addition to making it convenient to spread data over a larger number of separate packets, such decoy packets can also help to level the load on inactive portions of the Internet to help foil traffic analysis efforts.

10 Decoy packets may be generated by each TARP terminal 100, 110 or each router 122-127 on some basis determined by an algorithm. For example, the algorithm may be a random one which calls for the generation of a packet on a random basis when the terminal is idle. Alternatively, the algorithm may be responsive to time of day or detection of low traffic to generate more decoy packets during low traffic times. Note that packets are preferably generated in groups, rather than one by one,
15 the groups being sized to simulate real messages. In addition, so that decoy packets may be inserted in normal TARP message streams, the background loop may have a latch that makes it more likely to insert decoy packets when a message stream is being received. That is, when a series of messages are received, the decoy packet generation rate may be increased. Alternatively, if a large number of decoy packets is received
20 along with regular TARP packets, the algorithm may increase the rate of dropping of decoy packets rather than forwarding them. The result of dropping and generating decoy packets in this way is to make the apparent incoming message size different from the apparent outgoing message size to help foil traffic analysis. The rate of reception of packets, decoy or otherwise, may be indicated to the decoy packet
25 dropping and generating processes through perishable decoy and regular packet counters. (A perishable counter is one that resets or decrements its value in response to time so that it contains a high value when it is incremented in rapid succession and a small value when incremented either slowly or a small number of times in rapid succession.) Note that destination TARP terminal 110 may generate decoy packets

equal in number and size to those TARP packets received to make it appear it is merely routing packets and is therefore not the destination terminal.

Referring to FIG. 5, the following particular steps may be employed in the above-described method for routing TARP packets.

- 5
- S0. A background loop operation is performed which applies an algorithm which determines the generation of decoy IP packets. The loop is interrupted when an encrypted TARP packet is received.
 - S2. The TARP packet may be probed in some way to authenticate the packet
10 before attempting to decrypt it using the link key. That is, the router may determine that the packet is an authentic TARP packet by performing a selected operation on some data included with the clear IP header attached to the encrypted TARP packet contained in the payload. This makes it possible to avoid performing decryption on packets that are not authentic TARP packets.
 - 15 • S3. The TARP packet is decrypted to expose the destination TARP address and an indication of whether the packet is a decoy packet or part of a real message.
 - S4. If the packet is a decoy packet, the perishable decoy counter is incremented.
 - S5. Based on the decoy generation/dropping algorithm and the perishable decoy counter value, if the packet is a decoy packet, the router may choose to throw it
20 away. If the received packet is a decoy packet and it is determined that it should be thrown away (S6), control returns to step S0.
 - S7. The TTL parameter of the TARP header is decremented and it is determined if the TTL parameter is greater than zero.
 - S8. If the TTL parameter is greater than zero, a TARP address is randomly chosen
25 from a list of TARP addresses maintained by the router and the link key and IP address corresponding to that TARP address memorized for use in creating a new IP packet containing the TARP packet.
 - S9. If the TTL parameter is zero or less, the link key and IP address corresponding
30 to the TARP address of the destination are memorized for use in creating the new IP packet containing the TARP packet.

- S10. The TARP packet is encrypted using the memorized link key.
- S11. An IP header is added to the packet that contains the stored IP address, the encrypted TARP packet wrapped with an IP header, and the completed packet transmitted to the next hop or destination.

5

Referring to FIG. 6, the following particular steps may be employed in the above-described method for generating TARP packets.

- 10 • S20. A background loop operation applies an algorithm that determines the generation of decoy IP packets. The loop is interrupted when a data stream containing IP packets is received for transmission.
- S21. The received IP packets are grouped into a set consisting of messages with a constant IP destination address. The set is further broken down to coincide with a maximum size of an interleave window. The set is encrypted, and interleaved into
15 a set of payloads destined to become TARP packets.
- S22. The TARP address corresponding to the IP address is determined from a lookup table and stored to generate the TARP header. An initial TTL count is generated and stored in the header. The TTL count may be random with minimum and maximum values or it may be fixed or determined by some other parameter.
- 20 • S23. The window sequence numbers and interleave sequence numbers are recorded in the TARP headers of each packet.
- S24. One TARP router address is randomly chosen for each TARP packet and the IP address corresponding to it stored for use in the clear IP header. The link key corresponding to this router is identified and used to encrypt TARP packets containing interleaved and encrypted data and TARP headers.
25
- S25. A clear IP header with the first hop router's real IP address is generated and added to each of the encrypted TARP packets and the resulting packets.

30 Referring to FIG. 7, the following particular steps may be employed in the above-described method for receiving TARP packets.

- S40. A background loop operation is performed which applies an algorithm which determines the generation of decoy IP packets. The loop is interrupted when an encrypted TARP packet is received.
- 5 • S42. The TARP packet may be probed to authenticate the packet before attempting to decrypt it using the link key.
- S43. The TARP packet is decrypted with the appropriate link key to expose the destination TARP address and an indication of whether the packet is a decoy packet or part of a real message.
- 10 • S44. If the packet is a decoy packet, the perishable decoy counter is incremented.
- S45. Based on the decoy generation/dropping algorithm and the perishable decoy counter value, if the packet is a decoy packet, the receiver may choose to throw it away.
- S46. The TARP packets are cached until all packets forming an interleave window
15 are received.
- S47. Once all packets of an interleave window are received, the packets are deinterleaved.
- S48. The packets block of combined packets defining the interleave window is then decrypted using the session key.
- 20 • S49. The decrypted block is then divided using the window sequence data and the IP_T headers are converted into normal IP_C headers. The window sequence numbers are integrated in the IP_C headers.
- S50. The packets are then handed up to the IP layer processes.

1. SCALABILITY ENHANCEMENTS

25 The IP agility feature described above relies on the ability to transmit IP address changes to all TARP routers. The embodiments including this feature will be referred to as “boutique” embodiments due to potential limitations in scaling these features up for a large network, such as the Internet. (The “boutique” embodiments would, however, be robust for use in smaller networks, such as small virtual private
30 networks, for example). One problem with the boutique embodiments is that if IP

address changes are to occur frequently, the message traffic required to update all routers sufficiently quickly creates a serious burden on the Internet when the TARP router and/or client population gets large. The bandwidth burden added to the networks, for example in ICMP packets, that would be used to update all the TARP routers could overwhelm the Internet for a large scale implementation that approached the scale of the Internet. In other words, the boutique system's scalability is limited.

A system can be constructed which trades some of the features of the above embodiments to provide the benefits of IP agility without the additional messaging burden. This is accomplished by IP address-hopping according to shared algorithms that govern IP addresses used between links participating in communications sessions between nodes such as TARP nodes. (Note that the IP hopping technique is also applicable to the boutique embodiment.) The IP agility feature discussed with respect to the boutique system can be modified so that it becomes decentralized under this scalable regime and governed by the above-described shared algorithm. Other features of the boutique system may be combined with this new type of IP-agility.

The new embodiment has the advantage of providing IP agility governed by a local algorithm and set of IP addresses exchanged by each communicating pair of nodes. This local governance is session-independent in that it may govern communications between a pair of nodes, irrespective of the session or end points being transferred between the directly communicating pair of nodes.

In the scalable embodiments, blocks of IP addresses are allocated to each node in the network. (This scalability will increase in the future, when Internet Protocol addresses are increased to 128-bit fields, vastly increasing the number of distinctly addressable nodes). Each node can thus use any of the IP addresses assigned to that node to communicate with other nodes in the network. Indeed, each pair of communicating nodes can use a plurality of source IP addresses and destination IP addresses for communicating with each other.

Each communicating pair of nodes in a chain participating in any session stores two blocks of IP addresses, called netblocks, and an algorithm and randomization seed for selecting, from each netblock, the next pair of

source/destination IP addresses that will be used to transmit the next message. In other words, the algorithm governs the sequential selection of IP-address pairs, one sender and one receiver IP address, from each netblock. The combination of algorithm, seed, and netblock (IP address block) will be called a "hopblock." A router issues separate transmit and receive hopblocks to its clients. The send address and the receive address of the IP header of each outgoing packet sent by the client are filled with the send and receive IP addresses generated by the algorithm. The algorithm is "clocked" (indexed) by a counter so that each time a pair is used, the algorithm turns out a new transmit pair for the next packet to be sent.

10 The router's receive hopblock is identical to the client's transmit hopblock. The router uses the receive hopblock to predict what the send and receive IP address pair for the next expected packet from that client will be. Since packets can be received out of order, it is not possible for the router to predict with certainty what IP address pair will be on the next sequential packet. To account for this problem, the router generates a range of predictions encompassing the number of possible transmitted packet send/receive addresses, of which the next packet received could leap ahead. Thus, if there is a vanishingly small probability that a given packet will arrive at the router ahead of 5 packets transmitted by the client before the given packet, then the router can generate a series of 6 send/receive IP address pairs (or "hop window") to compare with the next received packet. When a packet is received, it is marked in the hop window as such, so that a second packet with the same IP address pair will be discarded. If an out-of-sequence packet does not arrive within a predetermined timeout period, it can be requested for retransmission or simply discarded from the receive table, depending upon the protocol in use for that communications session, or possibly by convention.

When the router receives the client's packet, it compares the send and receive IP addresses of the packet with the next N predicted send and receive IP address pairs and rejects the packet if it is not a member of this set. Received packets that do not have the predicted source/destination IP addresses falling within the window are rejected, thus thwarting possible hackers. (With the number of possible combinations,

even a fairly large window would be hard to fall into at random.) If it is a member of this set, the router accepts the packet and processes it further. This link-based IP-hopping strategy, referred to as "IHOP," is a network element that stands on its own and is not necessarily accompanied by elements of the boutique system described above. If the routing agility feature described in connection with the boutique embodiment is combined with this link-based IP-hopping strategy, the router's next step would be to decrypt the TARP header to determine the destination TARP router for the packet and determine what should be the next hop for the packet. The TARP router would then forward the packet to a random TARP router or the destination TARP router with which the source TARP router has a link-based IP hopping communication established.

Figure 8 shows how a client computer 801 and a TARP router 811 can establish a secure session. When client 801 seeks to establish an IHOP session with TARP router 811, the client 801 sends "secure synchronization" request ("SSYN") packet 821 to the TARP router 811. This SYN packet 821 contains the client's 801 authentication token, and may be sent to the router 811 in an encrypted format. The source and destination IP numbers on the packet 821 are the client's 801 current fixed IP address, and a "known" fixed IP address for the router 811. (For security purposes, it may be desirable to reject any packets from outside of the local network that are destined for the router's known fixed IP address.) Upon receipt and validation of the client's 801 SSYN packet 821, the router 811 responds by sending an encrypted "secure synchronization acknowledgment" ("SSYN ACK") 822 to the client 801. This SSYN ACK 822 will contain the transmit and receive hopblocks that the client 801 will use when communicating with the TARP router 811. The client 801 will acknowledge the TARP router's 811 response packet 822 by generating an encrypted SSYN ACK ACK packet 823 which will be sent from the client's 801 fixed IP address and to the TARP router's 811 known fixed IP address. The client 801 will simultaneously generate a SSYN ACK ACK packet; this SSYN ACK packet, referred to as the Secure Session Initiation (SSI) packet 824, will be sent with the first {sender, receiver} IP pair in the client's transmit table 921 (FIG. 9), as specified in the

transmit hopblock provided by the TARP router 811 in the SSYN ACK packet 822. The TARP router 811 will respond to the SSI packet 824 with an SSI ACK packet 825, which will be sent with the first {sender, receiver} IP pair in the TARP router's transmit table 923. Once these packets have been successfully exchanged, the secure
5 communications session is established, and all further secure communications between the client 801 and the TARP router 811 will be conducted via this secure session, as long as synchronization is maintained. If synchronization is lost, then the client 801 and TARP router 802 may re-establish the secure session by the procedure outlined in Figure 8 and described above.

10 While the secure session is active, both the client 901 and TARP router 911 (FIG. 9) will maintain their respective transmit tables 921, 923 and receive tables 922, 924, as provided by the TARP router during session synchronization 822. It is important that the sequence of IP pairs in the client's transmit table 921 be identical to those in the TARP router's receive table 924; similarly, the sequence of IP pairs in the
15 client's receive table 922 must be identical to those in the router's transmit table 923. This is required for the session synchronization to be maintained. The client 901 need maintain only one transmit table 921 and one receive table 922 during the course of the secure session. Each sequential packet sent by the client 901 will employ the next {send, receive} IP address pair in the transmit table, regardless of TCP or UDP
20 session. The TARP router 911 will expect each packet arriving from the client 901 to bear the next IP address pair shown in its receive table.

Since packets can arrive out of order, however, the router 911 can maintain a "look ahead" buffer in its receive table, and will mark previously-received IP pairs as invalid for future packets; any future packet containing an IP pair that is in the look-
25 ahead buffer but is marked as previously received will be discarded. Communications from the TARP router 911 to the client 901 are maintained in an identical manner; in particular, the router 911 will select the next IP address pair from its transmit table 923 when constructing a packet to send to the client 901, and the client 901 will maintain a look-ahead buffer of expected IP pairs on packets that it is receiving. Each

TARP router will maintain separate pairs of transmit and receive tables for each client that is currently engaged in a secure session with or through that TARP router.

While clients receive their hopblocks from the first server linking them to the Internet, routers exchange hopblocks. When a router establishes a link-based IP-hopping communication regime with another router, each router of the pair exchanges its transmit hopblock. The transmit hopblock of each router becomes the receive hopblock of the other router. The communication between routers is governed as described by the example of a client sending a packet to the first router.

While the above strategy works fine in the IP milieu, many local networks that are connected to the Internet are Ethernet systems. In Ethernet, the IP addresses of the destination devices must be translated into hardware addresses, and vice versa, using known processes (“address resolution protocol,” and “reverse address resolution protocol”). However, if the link-based IP-hopping strategy is employed, the correlation process would become explosive and burdensome. An alternative to the link-based IP hopping strategy may be employed within an Ethernet network. The solution is to provide that the node linking the Internet to the Ethernet (call it the border node) use the link-based IP-hopping communication regime to communicate with nodes outside the Ethernet LAN. Within the Ethernet LAN, each TARP node would have a single IP address which would be addressed in the conventional way. Instead of comparing the {sender, receiver} IP address pairs to authenticate a packet, the intra-LAN TARP node would use one of the IP header extension fields to do so. Thus, the border node uses an algorithm shared by the intra-LAN TARP node to generate a symbol that is stored in the free field in the IP header, and the intra-LAN TARP node generates a range of symbols based on its prediction of the next expected packet to be received from that particular source IP address. The packet is rejected if it does not fall into the set of predicted symbols (for example, numerical values) or is accepted if it does. Communications from the intra-LAN TARP node to the border node are accomplished in the same manner, though the algorithm will necessarily be different for security reasons. Thus, each of the communicating nodes will generate transmit and receive tables in a similar manner to that of Figure 9; the intra-LAN

TARP nodes transmit table will be identical to the border node's receive table, and the intra-LAN TARP node's receive table will be identical to the border node's transmit table.

5 The algorithm used for IP address-hopping can be any desired algorithm. For example, the algorithm can be a given pseudo-random number generator that generates numbers of the range covering the allowed IP addresses with a given seed. Alternatively, the session participants can assume a certain type of algorithm and specify simply a parameter for applying the algorithm. For example the assumed algorithm could be a particular pseudo-random number generator and the session
10 participants could simply exchange seed values.

Note that there is no permanent physical distinction between the originating and destination terminal nodes. Either device at either end point can initiate a synchronization of the pair. Note also that the authentication/synchronization-request (and acknowledgment) and hopblock-exchange may all be served by a single message
15 so that separate message exchanges may not be required.

As another extension to the stated architecture, multiple physical paths can be used by a client, in order to provide link redundancy and further thwart attempts at denial of service and traffic monitoring. As shown in Figure 10, for example, client 1001 can establish three simultaneous sessions with each of three TARP routers
20 provided by different ISPs 1011, 1012, 1013. As an example, the client 1001 can use three different telephone lines 1021, 1022, 1023 to connect to the ISPs, or two telephone lines and a cable modem, etc. In this scheme, transmitted packets will be sent in a random fashion among the different physical paths. This architecture provides a high degree of communications redundancy, with improved immunity
25 from denial-of-service attacks and traffic monitoring.

2. FURTHER EXTENSIONS

The following describes various extensions to the techniques, systems, and methods described above. As described above, the security of communications occurring between computers in a computer network (such as the Internet, an
30 Ethernet, or others) can be enhanced by using seemingly random source and

destination Internet Protocol (IP) addresses for data packets transmitted over the network. This feature prevents eavesdroppers from determining which computers in the network are communicating with each other while permitting the two communicating computers to easily recognize whether a given received data packet is legitimate or not. In one embodiment of the above-described systems, an IP header extension field is used to authenticate incoming packets on an Ethernet.

Various extensions to the previously described techniques described herein include: (1) use of hopped hardware or "MAC" addresses in broadcast type network; (2) a self-synchronization technique that permits a computer to automatically regain synchronization with a sender; (3) synchronization algorithms that allow transmitting and receiving computers to quickly re-establish synchronization in the event of lost packets or other events; and (4) a fast-packet rejection mechanism for rejecting invalid packets. Any or all of these extensions can be combined with the features described above in any of various ways.

A. Hardware Address Hopping

Internet protocol-based communications techniques on a LAN—or across any dedicated physical medium—typically embed the IP packets within lower-level packets, often referred to as "frames." As shown in FIG. 11, for example, a first Ethernet frame 1150 comprises a frame header 1101 and two embedded IP packets IP1 and IP2, while a second Ethernet frame 1160 comprises a different frame header 1104 and a single IP packet IP3. Each frame header generally includes a source hardware address 1101A and a destination hardware address 1101B; other well-known fields in frame headers are omitted from FIG. 11 for clarity. Two hardware nodes communicating over a physical communication channel insert appropriate source and destination hardware addresses to indicate which nodes on the channel or network should receive the frame.

It may be possible for a nefarious listener to acquire information about the contents of a frame and/or its communicants by examining frames on a local network rather than (or in addition to) the IP packets themselves. This is especially true in broadcast media, such as Ethernet, where it is necessary to insert into the frame

header the hardware address of the machine that generated the frame and the hardware address of the machine to which frame is being sent. All nodes on the network can potentially “see” all packets transmitted across the network. This can be a problem for secure communications, especially in cases where the communicants do not want for any third party to be able to identify who is engaging in the information exchange. One way to address this problem is to push the address-hopping scheme down to the hardware layer. In accordance with various embodiments of the invention, hardware addresses are “hopped” in a manner similar to that used to change IP addresses, such that a listener cannot determine which hardware node generated a particular message nor which node is the intended recipient.

FIG. 12A shows a system in which Media Access Control (“MAC”) hardware addresses are “hopped” in order to increase security over a network such as an Ethernet. While the description refers to the exemplary case of an Ethernet environment, the inventive principles are equally applicable to other types of communications media. In the Ethernet case, the MAC address of the sender and receiver are inserted into the Ethernet frame and can be observed by anyone on the LAN who is within the broadcast range for that frame. For secure communications, it becomes desirable to generate frames with MAC addresses that are not attributable to any specific sender or receiver.

As shown in FIG. 12A, two computer nodes 1201 and 1202 communicate over a communication channel such as an Ethernet. Each node executes one or more application programs 1203 and 1218 that communicate by transmitting packets through communication software 1204 and 1217, respectively. Examples of application programs include video conferencing, e-mail, word processing programs, telephony, and the like. Communication software 1204 and 1217 can comprise, for example, an OSI layered architecture or “stack” that standardizes various services provided at different levels of functionality.

The lowest levels of communication software 1204 and 1217 communicate with hardware components 1206 and 1214 respectively, each of which can include one or more registers 1207 and 1215 that allow the hardware to be reconfigured or

controlled in accordance with various communication protocols. The hardware components (an Ethernet network interface card, for example) communicate with each other over the communication medium. Each hardware component is typically pre-assigned a fixed hardware address or MAC number that identifies the hardware component to other nodes on the network. One or more interface drivers control the operation of each card and can, for example, be configured to accept or reject packets from certain hardware addresses. As will be described in more detail below, various embodiments of the inventive principles provide for “hopping” different addresses using one or more algorithms and one or more moving windows that track a range of valid addresses to validate received packets. Packets transmitted according to one or more of the inventive principles will be generally referred to as “secure” packets or “secure communications” to differentiate them from ordinary data packets that are transmitted in the clear using ordinary, machine-correlated addresses.

One straightforward method of generating non-attributable MAC addresses is an extension of the IP hopping scheme. In this scenario, two machines on the same LAN that desire to communicate in a secure fashion exchange random-number generators and seeds, and create sequences of quasi-random MAC addresses for synchronized hopping. The implementation and synchronization issues are then similar to that of IP hopping.

This approach, however, runs the risk of using MAC addresses that are currently active on the LAN—which, in turn, could interrupt communications for those machines. Since an Ethernet MAC address is at present 48 bits in length, the chance of randomly misusing an active MAC address is actually quite small. However, if that figure is multiplied by a large number of nodes (as would be found on an extensive LAN), by a large number of frames (as might be the case with packet voice or streaming video), and by a large number of concurrent Virtual Private Networks (VPNs), then the chance that a non-secure machine’s MAC address could be used in an address-hopped frame can become non-trivial. In short, any scheme that runs even a small risk of interrupting communications for other machines on the LAN is bound to receive resistance from prospective system administrators. Nevertheless, it

is technically feasible, and can be implemented without risk on a LAN on which there is a small number of machines, or if all of the machines on the LAN are engaging in MAC-hopped communications.

Synchronized MAC address hopping may incur some overhead in the course of session establishment, especially if there are multiple sessions or multiple nodes involved in the communications. A simpler method of randomizing MAC addresses is to allow each node to receive and process *every* incident frame on the network. Typically, each network interface driver will check the destination MAC address in the header of every incident frame to see if it matches that machine's MAC address; if there is no match, then the frame is discarded. In one embodiment, however, these checks can be disabled, and every incident packet is passed to the TARP stack for processing. This will be referred to as "promiscuous" mode, since every incident frame is processed. Promiscuous mode allows the sender to use completely random, unsynchronized MAC addresses, since the destination machine is guaranteed to process the frame. The decision as to whether the packet was truly intended for that machine is handled by the TARP stack, which checks the source and destination IP addresses for a match in its IP synchronization tables. If no match is found, the packet is discarded; if there is a match, the packet is unwrapped, the inner header is evaluated, and if the inner header indicates that the packet is destined for that machine then the packet is forwarded to the IP stack—otherwise it is discarded.

One disadvantage of purely-random MAC address hopping is its impact on processing overhead; that is, since every incident frame must be processed, the machine's CPU is engaged considerably more often than if the network interface driver is discriminating and rejecting packets unilaterally. A compromise approach is to select either a single fixed MAC address or a small number of MAC addresses (e.g., one for each virtual private network on an Ethernet) to use for MAC-hopped communications, regardless of the actual recipient for which the message is intended. In this mode, the network interface driver can check each incident frame against one (or a few) pre-established MAC addresses, thereby freeing the CPU from the task of physical-layer packet discrimination. This scheme does not betray any useful

information to an interloper on the LAN; in particular, every secure packet can already be identified by a unique packet type in the outer header. However, since all machines engaged in secure communications would either be using the same MAC address, or be selecting from a small pool of predetermined MAC addresses, the association between a specific machine and a specific MAC address is effectively broken.

In this scheme, the CPU will be engaged more often than it would be in non-secure communications (or in synchronized MAC address hopping), since the network interface driver cannot always unilaterally discriminate between secure packets that are destined for that machine, and secure packets from other VPNs. However, the non-secure traffic is easily eliminated at the network interface, thereby reducing the amount of processing required of the CPU. There are boundary conditions where these statements would not hold, of course—e.g., if *all* of the traffic on the LAN is secure traffic, then the CPU would be engaged to the same degree as it is in the purely-random address hopping case; alternatively, if each VPN on the LAN uses a different MAC address, then the network interface can perfectly discriminate secure frames destined for the local machine from those constituting other VPNs. These are engineering tradeoffs that might be best handled by providing administrative options for the users when installing the software and/or establishing VPNs.

Even in this scenario, however, there still remains a slight risk of selecting MAC addresses that are being used by one or more nodes on the LAN. One solution to this problem is to formally assign one address or a range of addresses for use in MAC-hopped communications. This is typically done via an assigned numbers registration authority; e.g., in the case of Ethernet, MAC address ranges are assigned to vendors by the Institute of Electrical and Electronics Engineers (IEEE). A formally-assigned range of addresses would ensure that secure frames do not conflict with any properly-configured and properly-functioning machines on the LAN.

Reference will now be made to FIGS. 12A and 12B in order to describe the many combinations and features that follow the inventive principles. As explained

above, two computer nodes 1201 and 1202 are assumed to be communicating over a network or communication medium such as an Ethernet. A communication protocol in each node (1204 and 1217, respectively) contains a modified element 1205 and 1216 that performs certain functions that deviate from the standard communication protocols. In particular, computer node 1201 implements a first “hop” algorithm 1208X that selects seemingly random source and destination IP addresses (and, in one embodiment, seemingly random IP header discriminator fields) in order to transmit each packet to the other computer node. For example, node 1201 maintains a transmit table 1208 containing triplets of source (S), destination (D), and discriminator fields (DS) that are inserted into outgoing IP packet headers. The table is generated through the use of an appropriate algorithm (e.g., a random number generator that is seeded with an appropriate seed) that is known to the recipient node 1202. As each new IP packet is formed, the next sequential entry out of the sender’s transmit table 1208 is used to populate the IP source, IP destination, and IP header extension field (e.g., discriminator field). It will be appreciated that the transmit table need not be created in advance but could instead be created on-the-fly by executing the algorithm when each packet is formed.

At the receiving node 1202, the same IP hop algorithm 1222X is maintained and used to generate a receive table 1222 that lists valid triplets of source IP address, destination IP address, and discriminator field. This is shown by virtue of the first five entries of transmit table 1208 matching the second five entries of receive table 1222. (The tables may be slightly offset at any particular time due to lost packets, misordered packets, or transmission delays). Additionally, node 1202 maintains a receive window W3 that represents a list of valid IP source, IP destination, and discriminator fields that will be accepted when received as part of an incoming IP packet. As packets are received, window W3 slides down the list of valid entries, such that the possible valid entries change over time. Two packets that arrive out of order but are nevertheless matched to entries within window W3 will be accepted; those falling outside of window W3 will be rejected as invalid. The length of window W3 can be adjusted as necessary to reflect network delays or other factors.

Node 1202 maintains a similar transmit table 1221 for creating IP packets and frames destined for node 1201 using a potentially different hopping algorithm 1221X, and node 1201 maintains a matching receive table 1209 using the same algorithm 1209X. As node 1202 transmits packets to node 1201 using seemingly random IP
5 source, IP destination, and/or discriminator fields, node 1201 matches the incoming packet values to those falling within window W1 maintained in its receive table. In effect, transmit table 1208 of node 1201 is synchronized (i.e., entries are selected in the same order) to receive table 1222 of receiving node 1202. Similarly, transmit table 1221 of node 1202 is synchronized to receive table 1209 of node 1201. It will
10 be appreciated that although a common algorithm is shown for the source, destination and discriminator fields in FIG. 12A (using, e.g., a different seed for each of the three fields), an entirely different algorithm could in fact be used to establish values for each of these fields. It will also be appreciated that one or two of the fields can be “hopped” rather than all three as illustrated.

15 In accordance with another aspect of the invention, hardware or “MAC” addresses are hopped instead of or in addition to IP addresses and/or the discriminator field in order to improve security in a local area or broadcast-type network. To that end, node 1201 further maintains a transmit table 1210 using a transmit algorithm 1210X to generate source and destination hardware addresses that are inserted into
20 frame headers (e.g., fields 1101A and 1101B in FIG. 11) that are synchronized to a corresponding receive table 1224 at node 1202. Similarly, node 1202 maintains a different transmit table 1223 containing source and destination hardware addresses that is synchronized with a corresponding receive table 1211 at node 1201. In this manner, outgoing hardware frames appear to be originating from and going to
25 completely random nodes on the network, even though each recipient can determine whether a given packet is intended for it or not. It will be appreciated that the hardware hopping feature can be implemented at a different level in the communications protocol than the IP hopping feature (e.g., in a card driver or in a hardware card itself to improve performance).

FIG. 12B shows three different embodiments or modes that can be employed using the aforementioned principles. In a first mode referred to as “promiscuous” mode, a common hardware address (e.g., a fixed address for source and another for destination) or else a completely random hardware address is used by all nodes on the network, such that a particular packet cannot be attributed to any one node. Each node must initially accept all packets containing the common (or random) hardware address and inspect the IP addresses or discriminator field to determine whether the packet is intended for that node. In this regard, either the IP addresses or the discriminator field or both can be varied in accordance with an algorithm as described above. As explained previously, this may increase each node’s overhead since additional processing is involved to determine whether a given packet has valid source and destination hardware addresses.

In a second mode referred to as “promiscuous per VPN” mode, a small set of fixed hardware addresses are used, with a fixed source/destination hardware address used for all nodes communicating over a virtual private network. For example, if there are six nodes on an Ethernet, and the network is to be split up into two private virtual networks such that nodes on one VPN can communicate with only the other two nodes on its own VPN, then two sets of hardware addresses could be used: one set for the first VPN and a second set for the second VPN. This would reduce the amount of overhead involved in checking for valid frames since only packets arriving from the designated VPN would need to be checked. IP addresses and one or more discriminator fields could still be hopped as before for secure communication within the VPN. Of course, this solution compromises the anonymity of the VPNs (i.e., an outsider can easily tell what traffic belongs in which VPN, though he cannot correlate it to a specific machine/person). It also requires the use of a discriminator field to mitigate the vulnerability to certain types of DoS attacks. (For example, without the discriminator field, an attacker on the LAN could stream frames containing the MAC addresses being used by the VPN; rejecting those frames could lead to excessive processing overhead. The discriminator field would provide a low-overhead means of rejecting the false packets.)

In a third mode referred to as “hardware hopping” mode, hardware addresses are varied as illustrated in FIG. 12A, such that hardware source and destination addresses are changed constantly in order to provide non-attributable addressing. Variations on these embodiments are of course possible, and the invention is not intended to be limited in any respect by these illustrative examples.

B. Extending the Address Space

Address hopping provides security and privacy. However, the level of protection is limited by the number of addresses in the blocks being hopped. A hopblock denotes a field or fields modulated on a packet-wise basis for the purpose of providing a VPN. For instance, if two nodes communicate with IP address hopping using hopblocks of 4 addresses (2 bits) each, there would be 16 possible address-pair combinations. A window of size 16 would result in most address pairs being accepted as valid most of the time. This limitation can be overcome by using a discriminator field in addition to or instead of the hopped address fields. The discriminator field would be hopped in exactly the same fashion as the address fields and it would be used to determine whether a packet should be processed by a receiver.

Suppose that two clients, each using four-bit hopblocks, would like the same level of protection afforded to clients communicating via IP hopping between two A blocks (24 address bits eligible for hopping). A discriminator field of 20 bits, used in conjunction with the 4 address bits eligible for hopping in the IP address field, provides this level of protection. A 24-bit discriminator field would provide a similar level of protection if the address fields were not hopped or ignored. Using a discriminator field offers the following advantages: (1) an arbitrarily high level of protection can be provided, and (2) address hopping is unnecessary to provide protection. This may be important in environments where address hopping would cause routing problems.

C. Synchronization Techniques

It is generally assumed that once a sending node and receiving node have exchanged algorithms and seeds (or similar information sufficient to generate quasi-random source and destination tables), subsequent communication between the two nodes will proceed smoothly. Realistically, however, two nodes may lose synchronization due to network delays or outages, or other problems. Consequently, it is desirable to provide means for re-establishing synchronization between nodes in a network that have lost synchronization.

One possible technique is to require that each node provide an acknowledgment upon successful receipt of each packet and, if no acknowledgment is received within a certain period of time, to re-send the unacknowledged packet. This approach, however, drives up overhead costs and may be prohibitive in high-throughput environments such as streaming video or audio, for example.

A different approach is to employ an automatic synchronizing technique that will be referred to herein as “self-synchronization.” In this approach, synchronization information is embedded into each packet, thereby enabling the receiver to re-synchronize itself upon receipt of a single packet if it determines that it has lost synchronization with the sender. (If communications are already in progress, and the receiver determines that it is still in sync with the sender, then there is no need to re-synchronize.) A receiver could detect that it was out of synchronization by, for example, employing a “dead-man” timer that expires after a certain period of time, wherein the timer is reset with each valid packet. A time stamp could be hashed into the public sync field (see below) to preclude packet-retry attacks.

In one embodiment, a “sync field” is added to the header of each packet sent out by the sender. This sync field could appear in the clear or as part of an encrypted portion of the packet. Assuming that a sender and receiver have selected a random-number generator (RNG) and seed value, this combination of RNG and seed can be used to generate a random-number sequence (RNS). The RNS is then used to generate a sequence of source/destination IP pairs (and, if desired, discriminator fields and hardware source and destination addresses), as described above. It is not necessary,

however, to generate the entire sequence (or the first N-1 values) in order to generate the Nth random number in the sequence; if the sequence index N is known, the random value corresponding to that index can be directly generated (see below). Different RNGs (and seeds) with different fundamental periods could be used to generate the source and destination IP sequences, but the basic concepts would still apply. For the sake of simplicity, the following discussion will assume that IP source and destination address pairs (only) are hopped using a single RNG sequencing mechanism.

In accordance with a “self-synchronization” feature, a sync field in each packet header provides an index (i.e., a sequence number) into the RNS that is being used to generate IP pairs. Plugging this index into the RNG that is being used to generate the RNS yields a specific random number value, which in turn yields a specific IP pair. That is, an IP pair can be generated directly from knowledge of the RNG, seed, and index number; it is not necessary, in this scheme, to generate the entire sequence of random numbers that precede the sequence value associated with the index number provided.

Since the communicants have presumably previously exchanged RNGs and seeds, the only new information that must be provided in order to generate an IP pair is the sequence number. If this number is provided by the sender in the packet header, then the receiver need only plug this number into the RNG in order to generate an IP pair – and thus verify that the IP pair appearing in the header of the packet is valid. In this scheme, if the sender and receiver lose synchronization, the receiver can immediately re-synchronize upon receipt of a single packet by simply comparing the IP pair in the packet header to the IP pair generated from the index number. Thus, synchronized communications can be resumed upon receipt of a single packet, making this scheme ideal for multicast communications. Taken to the extreme, it could obviate the need for synchronization tables entirely; that is, the sender and receiver could simply rely on the index number in the sync field to validate the IP pair on each packet, and thereby eliminate the tables entirely.

The aforementioned scheme may have some inherent security issues associated with it — namely, the placement of the sync field. If the field is placed in the outer header, then an interloper could observe the values of the field and their relationship to the IP stream. This could potentially compromise the algorithm that is being used to generate the IP-address sequence, which would compromise the security of the communications. If, however, the value is placed in the inner header, then the sender must decrypt the inner header before it can extract the sync value and validate the IP pair; this opens up the receiver to certain types of denial-of-service (DoS) attacks, such as packet replay. That is, if the receiver must decrypt a packet before it can validate the IP pair, then it could potentially be forced to expend a significant amount of processing on decryption if an attacker simply retransmits previously valid packets. Other attack methodologies are possible in this scenario.

A possible compromise between algorithm security and processing speed is to split up the sync value between an inner (encrypted) and outer (unencrypted) header. That is, if the sync value is sufficiently long, it could potentially be split into a rapidly-changing part that can be viewed in the clear, and a fixed (or very slowly changing) part that must be protected. The part that can be viewed in the clear will be called the “public sync” portion and the part that must be protected will be called the “private sync” portion.

Both the public sync and private sync portions are needed to generate the complete sync value. The private portion, however, can be selected such that it is fixed or will change only occasionally. Thus, the private sync value can be stored by the recipient, thereby obviating the need to decrypt the header in order to retrieve it. If the sender and receiver have previously agreed upon the frequency with which the private part of the sync will change, then the receiver can selectively decrypt a single header in order to extract the new private sync if the communications gap that has led to lost synchronization has exceeded the lifetime of the previous private sync. This should not represent a burdensome amount of decryption, and thus should not open up the receiver to denial-of-service attack simply based on the need to occasionally decrypt a single header.

One implementation of this is to use a hashing function with a one-to-one mapping to generate the private and public sync portions from the sync value. This implementation is shown in FIG. 13, where (for example) a first ISP 1302 is the sender and a second ISP 1303 is the receiver. (Other alternatives are possible from FIG. 13.) A transmitted packet comprises a public or “outer” header 1305 that is not encrypted, and a private or “inner” header 1306 that is encrypted using for example a link key. Outer header 1305 includes a public sync portion while inner header 1306 contains the private sync portion. A receiving node decrypts the inner header using a decryption function 1307 in order to extract the private sync portion. This step is necessary only if the lifetime of the currently buffered private sync has expired. (If the currently-buffered private sync is still valid, then it is simply extracted from memory and “added” (which could be an inverse hash) to the public sync, as shown in step 1308.) The public and decrypted private sync portions are combined in function 1308 in order to generate the combined sync 1309. The combined sync (1309) is then fed into the RNG (1310) and compared to the IP address pair (1311) to validate or reject the packet.

An important consideration in this architecture is the concept of “future” and “past” where the public sync values are concerned. Though the sync values, themselves, should be random to prevent spoofing attacks, it may be important that the receiver be able to quickly identify a sync value that has already been sent — even if the packet containing that sync value was never actually received by the receiver. One solution is to hash a time stamp or sequence number into the public sync portion, which could be quickly extracted, checked, and discarded, thereby validating the public sync portion itself.

In one embodiment, packets can be checked by comparing the source/destination IP pair generated by the sync field with the pair appearing in the packet header. If (1) they match, (2) the time stamp is valid, and (3) the dead-man timer has expired, then re-synchronization occurs; otherwise, the packet is rejected. If enough processing power is available, the dead-man timer and synchronization tables

can be avoided altogether, and the receiver would simply resynchronize (e.g., validate) on every packet.

The foregoing scheme may require large-integer (e.g., 160-bit) math, which may affect its implementation. Without such large-integer registers, processing throughput would be affected, thus potentially affecting security from a denial-of-service standpoint. Nevertheless, as large-integer math processing features become more prevalent, the costs of implementing such a feature will be reduced.

D. Other Synchronization Schemes

As explained above, if W or more consecutive packets are lost between a transmitter and receiver in a VPN (where W is the window size), the receiver's window will not have been updated and the transmitter will be transmitting packets not in the receiver's window. The sender and receiver will not recover synchronization until perhaps the random pairs in the window are repeated by chance. Therefore, there is a need to keep a transmitter and receiver in synchronization whenever possible and to re-establish synchronization whenever it is lost.

A "checkpoint" scheme can be used to regain synchronization between a sender and a receiver that have fallen out of synchronization. In this scheme, a checkpoint message comprising a random IP address pair is used for communicating synchronization information. In one embodiment, two messages are used to communicate synchronization information between a sender and a recipient:

1. SYNC_REQ is a message used by the sender to indicate that it wants to synchronize; and
2. SYNC_ACK is a message used by the receiver to inform the transmitter that it has been synchronized.

According to one variation of this approach, both the transmitter and receiver maintain three checkpoints (see FIG. 14):

1. In the transmitter, ckpt_o ("checkpoint old") is the IP pair that was used to re-send the last SYNC_REQ packet to the receiver. In the receiver, ckpt_o ("checkpoint old") is the IP pair that receives repeated SYNC_REQ packets from the transmitter.

2. In the transmitter, ckpt_n (“checkpoint new”) is the IP pair that will be used to send the next SYNC_REQ packet to the receiver. In the receiver, ckpt_n (“checkpoint new”) is the IP pair that receives a new SYNC_REQ packet from the transmitter and which causes the receiver’s window to be re-aligned, ckpt_o set to ckpt_n, a new ckpt_n to be generated and a new ckpt_r to be generated.
3. In the transmitter, ckpt_r is the IP pair that will be used to send the next SYNC_ACK packet to the receiver. In the receiver, ckpt_r is the IP pair that receives a new SYNC_ACK packet from the transmitter and which causes a new ckpt_n to be generated. Since SYNC_ACK is transmitted from the receiver ISP to the sender ISP, the transmitter ckpt_r refers to the ckpt_r of the receiver and the receiver ckpt_r refers to the ckpt_r of the transmitter (see FIG. 14).

When a transmitter initiates synchronization, the IP pair it will use to transmit the next data packet is set to a predetermined value and when a receiver first receives a SYNC_REQ, the receiver window is updated to be centered on the transmitter’s next IP pair. This is the primary mechanism for checkpoint synchronization.

Synchronization can be initiated by a packet counter (e.g., after every N packets transmitted, initiate a synchronization) or by a timer (every S seconds, initiate a synchronization) or a combination of both. See FIG. 15. From the transmitter’s perspective, this technique operates as follows: (1) Each transmitter periodically transmits a “sync request” message to the receiver to make sure that it is in sync. (2) If the receiver is still in sync, it sends back a “sync ack” message. (If this works, no further action is necessary). (3) If no “sync ack” has been received within a period of time, the transmitter retransmits the sync request again. If the transmitter reaches the next checkpoint without receiving a “sync ack” response, then synchronization is broken, and the transmitter should stop transmitting. The transmitter will continue to send sync_reqs until it receives a sync_ack, at which point transmission is reestablished.

From the receiver's perspective, the scheme operates as follows: (1) when it receives a "sync request" request from the transmitter, it advances its window to the next checkpoint position (even skipping pairs if necessary), and sends a "sync ack" message to the transmitter. If sync was never lost, then the "jump ahead" really just
 5 advances to the next available pair of addresses in the table (i.e., normal advancement).

If an interloper intercepts the "sync request" messages and tries to interfere with communication by sending new ones, it will be ignored if the synchronization has been established or it it will actually help to re-establish synchronization.

10 A window is realigned whenever a re-synchronization occurs. This realignment entails updating the receiver's window to straddle the address pairs used by the packet transmitted immediately after the transmission of the SYNC_REQ packet. Normally, the transmitter and receiver are in synchronization with one another. However, when network events occur, the receiver's window may have to be
 15 advanced by many steps during resynchronization. In this case, it is desirable to move the window ahead without having to step through the intervening random numbers sequentially. (This feature is also desirable for the auto-sync approach discussed above).

E. Random Number Generator with a Jump-Ahead capability

20 An attractive method for generating randomly hopped addresses is to use identical random number generators in the transmitter and receiver and advance them as packets are transmitted and received. There are many random number generation algorithms that could be used. Each one has strengths and weaknesses for address hopping applications.

25 Linear congruential random number generators (LCRs) are fast, simple and well characterized random number generators that can be made to jump ahead *n* steps efficiently. An LCR generates random numbers $X_1, X_2, X_3 \dots X_k$ starting with seed X_0 using a recurrence

$$X_i = (a X_{i-1} + b) \text{ mod } c, \quad (1)$$

30 where *a*, *b* and *c* define a particular LCR. Another expression for X_i ,

$$X_i = ((a^i(X_0 + b) - b) / (a - 1)) \bmod c \quad (2)$$

enables the jump-ahead capability. The factor a^i can grow very large even for modest i if left unfettered. Therefore some special properties of the modulo operation can be used to control the size and processing time required to compute (2). (2) can be
 5 rewritten as:

$$X_i = (a^i (X_0(a-1) + b) - b) / (a-1) \bmod c. \quad (3)$$

It can be shown that:

$$(a^i (X_0(a-1) + b) - b) / (a-1) \bmod c = ((a^i \bmod ((a-1)c) (X_0(a-1) + b) - b) / (a-1)) \bmod c \quad (4).$$

10 $(X_0(a-1) + b)$ can be stored as $(X_0(a-1) + b) \bmod c$, b as $b \bmod c$ and compute $a^i \bmod ((a-1)c)$ (this requires $O(\log(i))$ steps).

A practical implementation of this algorithm would jump a fixed distance, n , between synchronizations; this is tantamount to synchronizing every n packets. The window would commence n IP pairs from the start of the previous window. Using
 15 X_j^w , the random number at the j^{th} checkpoint, as X_0 and n as i , a node can store $a^n \bmod ((a-1)c)$ once per LCR and set

$$X_{j+1}^w = X_{n(j+1)} = ((a^n \bmod ((a-1)c) (X_j^w (a-1) + b) - b) / (a-1)) \bmod c, \quad (5)$$

to generate the random number for the $j+1^{\text{th}}$ synchronization. Using this construction, a node could jump ahead an arbitrary (but fixed) distance between synchronizations in
 20 a constant amount of time (independent of n).

Pseudo-random number generators, in general, and LCRs, in particular, will eventually repeat their cycles. This repetition may present vulnerability in the IP hopping scheme. An adversary would simply have to wait for a repeat to predict future sequences. One way of coping with this vulnerability is to create a random
 25 number generator with a known long cycle. A random sequence can be replaced by a new random number generator before it repeats. LCRs can be constructed with known long cycles. This is not currently true of many random number generators.

Random number generators can be cryptographically insecure. An adversary can derive the RNG parameters by examining the output or part of the output. This is
 30 true of LCGs. This vulnerability can be mitigated by incorporating an encryptor,

designed to scramble the output as part of the random number generator. The random number generator prevents an adversary from mounting an attack—e.g., a known plaintext attack—against the cryptor.

F. Random Number Generator Example

5 Consider a RNG where $a=31, b=4$ and $c=15$. For this case equation (1) becomes:

$$X_i = (31 X_{i-1} + 4) \text{ mod } 15. \quad (6)$$

If one sets $X_0=1$, equation (6) will produce the sequence 1, 5, 9, 13, 2, 6, 10, 14, 3, 7, 11, 0, 4, 8, 12. This sequence will repeat indefinitely. For a jump ahead of 3 numbers in this sequence $a^n = 31^3 = 29791$, $c \cdot (a-1) = 15 \cdot 30 = 450$ and $a^n \text{ mod } ((a-1)c) = 31^3 \text{ mod } (15 \cdot 30) = 29791 \text{ mod } (450) = 91$. Equation (5) becomes:

$$((91 (X_i \cdot 30 + 4) - 4) / 30) \text{ mod } 15 \quad (7).$$

Table 1 shows the jump ahead calculations from (7). The calculations start at 5 and jump ahead 3.

15

TABLE 1

1	X_i	$(X_i \cdot 30 + 4)$	$91 (X_i \cdot 30 + 4) - 4$	$((91 (X_i \cdot 30 + 4) - 4) / 30)$	X_{i+3}
1	5	154	14010	467	2
4	2	64	5820	194	14
7	14	424	38580	1286	11
10	11	334	30390	1013	8
13	8	244	22200	740	5

G. Fast Packet Filter

Address hopping VPNs must rapidly determine whether a packet has a valid header and thus requires further processing, or has an invalid header (a hostile packet) and should be immediately rejected. Such rapid determinations will be referred to as “fast packet filtering.” This capability protects the VPN from attacks by an adversary who streams hostile packets at the receiver at a high rate of speed in the hope of saturating the receiver’s processor (a so-called “denial of service” attack). Fast packet

filtering is an important feature for implementing VPNs on shared media such as Ethernet.

Assuming that all participants in a VPN share an unassigned "A" block of addresses, one possibility is to use an experimental "A" block that will never be assigned to any machine that is not address hopping on the shared medium. "A" blocks have a 24 bits of address that can be hopped as opposed to the 8 bits in "C" blocks. In this case a hopblock will be the "A" block. The use of the experimental "A" block is a likely option on an Ethernet because:

1. The addresses have no validity outside of the Ethernet and will not be routed out to a valid outside destination by a gateway.
2. There are 2^{24} (~16 million) addresses that can be hopped within each "A" block. This yields >280 trillion possible address pairs making it very unlikely that an adversary would guess a valid address. It also provides acceptably low probability of collision between separate VPNs (all VPNs on a shared medium independently generate random address pairs from the same "A" block).
3. The packets will not be received by someone on the Ethernet who is not on a VPN (unless the machine is in promiscuous mode) minimizing impact on non-VPN computers.

The Ethernet example will be used to describe one implementation of fast packet filtering. The ideal algorithm would quickly examine a packet header, determine whether the packet is hostile, and reject any hostile packets or determine which active IP pair the packet header matches. The problem is a classical associative memory problem. A variety of techniques have been developed to solve this problem (hashing, B-trees etc). Each of these approaches has its strengths and weaknesses. For instance, hash tables can be made to operate quite fast in a statistical sense, but can occasionally degenerate into a much slower algorithm. This slowness can persist for a period of time. Since there is a need to discard hostile packets quickly at all times, hashing would be unacceptable.

H. Presence Vector Algorithm

A presence vector is a bit vector of length 2^n that can be indexed by n -bit numbers (each ranging from 0 to 2^n-1). One can indicate the presence of k n -bit numbers (not necessarily unique), by setting the bits in the presence vector indexed by each number to 1. Otherwise, the bits in the presence vector are 0. An n -bit number, x , is one of the k numbers if and only if the x^{th} bit of the presence vector is 1. A fast packet filter can be implemented by indexing the presence vector and looking for a 1, which will be referred to as the "test."

For example, suppose one wanted to represent the number 135 using a presence vector. The 135^{th} bit of the vector would be set. Consequently, one could very quickly determine whether an address of 135 was valid by checking only one bit: the 135^{th} bit. The presence vectors could be created in advance corresponding to the table entries for the IP addresses. In effect, the incoming addresses can be used as indices into a long vector, making comparisons very fast. As each RNG generates a new address, the presence vector is updated to reflect the information. As the window moves, the presence vector is updated to zero out addresses that are no longer valid.

There is a trade-off between efficiency of the test and the amount of memory required for storing the presence vector(s). For instance, if one were to use the 48 bits of hopping addresses as an index, the presence vector would have to be 35 terabytes. Clearly, this is too large for practical purposes. Instead, the 48 bits can be divided into several smaller fields. For instance, one could subdivide the 48 bits into four 12-bit fields (see FIG. 16). This reduces the storage requirement to 2048 bytes at the expense of occasionally having to process a hostile packet. In effect, instead of one long presence vector, the decomposed address portions must match all four shorter presence vectors before further processing is allowed. (If the first part of the address portion doesn't match the first presence vector, there is no need to check the remaining three presence vectors).

A presence vector will have a 1 in the y^{th} bit if and only if one or more addresses with a corresponding field of y are active. An address is active only if each presence vector indexed by the appropriate sub-field of the address is 1.

Consider a window of 32 active addresses and 3 checkpoints. A hostile packet will be rejected by the indexing of one presence vector more than 99% of the time. A hostile packet will be rejected by the indexing of all 4 presence vectors more than 99.9999995% of the time. On average, hostile packets will be rejected in less than 5 1.02 presence vector index operations.

The small percentage of hostile packets that pass the fast packet filter will be rejected when matching pairs are not found in the active window or are active checkpoints. Hostile packets that serendipitously match a header will be rejected when the VPN software attempts to decrypt the header. However, these cases will be 10 extremely rare. There are many other ways this method can be configured to arbitrate the space/speed tradeoffs.

I. Further Synchronization Enhancements

A slightly modified form of the synchronization techniques described above can be employed. The basic principles of the previously described checkpoint 15 synchronization scheme remain unchanged. The actions resulting from the reception of the checkpoints are, however, slightly different. In this variation, the receiver will maintain between OoO (“Out of Order”) and $2 \times \text{WINDOW_SIZE} + \text{OoO}$ active addresses ($1 \leq \text{OoO} \leq \text{WINDOW_SIZE}$ and $\text{WINDOW_SIZE} \geq 1$). OoO and WINDOW_SIZE are engineerable parameters, where OoO is the minimum number of 20 addresses needed to accommodate lost packets due to events in the network or out of order arrivals and WINDOW_SIZE is the number of packets transmitted before a SYNC_REQ is issued. FIG. 17 depicts a storage array for a receiver’s active addresses.

The receiver starts with the first $2 \times \text{WINDOW_SIZE}$ addresses loaded and 25 active (ready to receive data). As packets are received, the corresponding entries are marked as “used” and are no longer eligible to receive packets. The transmitter maintains a packet counter, initially set to 0, containing the number of data packets transmitted since the last *initial* transmission of a SYNC_REQ for which SYNC_ACK has been received. When the transmitter packet counter equals 30 WINDOW_SIZE, the transmitter generates a SYNC_REQ and does its initial

transmission. When the receiver receives a SYNC_REQ corresponding to its current CKPT_N, it generates the next WINDOW_SIZE addresses and starts loading them in order starting at the first location after the last active address wrapping around to the beginning of the array after the end of the array has been reached. The receiver's array
5 might look like FIG. 18 when a SYNC_REQ has been received. In this case a couple of packets have been either lost or will be received out of order when the SYNC_REQ is received.

FIG. 19 shows the receiver's array after the new addresses have been generated. If the transmitter does not receive a SYNC_ACK, it will re-issue the
10 SYNC_REQ at regular intervals. When the transmitter receives a SYNC_ACK, the packet counter is decremented by WINDOW_SIZE. If the packet counter reaches $2 \times \text{WINDOW_SIZE} - \text{OoO}$ then the transmitter ceases sending data packets until the appropriate SYNC_ACK is finally received. The transmitter then resumes sending data packets. Future behavior is essentially a repetition of this initial cycle. The
15 advantages of this approach are:

1. There is no need for an efficient jump ahead in the random number generator,
2. No packet is ever transmitted that does not have a corresponding entry in the receiver side
3. No timer based re-synchronization is necessary. This is a consequence of 2.
- 20 4. The receiver will always have the ability to accept data messages transmitted within OoO messages of the most recently transmitted message.

J. Distributed Transmission Path Variant

Another embodiment incorporating various inventive principles is shown in FIG. 20. In this embodiment, a message transmission system includes a first
25 computer 2001 in communication with a second computer 2002 through a network 2011 of intermediary computers. In one variant of this embodiment, the network includes two edge routers 2003 and 2004 each of which is linked to a plurality of Internet Service Providers (ISPs) 2005 through 2010. Each ISP is coupled to a plurality of other ISPs in an arrangement as shown in FIG. 20, which is a
30 representative configuration only and is not intended to be limiting. Each connection

between ISPs is labeled in FIG. 20 to indicate a specific physical transmission path (e.g., AD is a physical path that links ISP A (element 2005) to ISP D (element 2008)). Packets arriving at each edge router are selectively transmitted to one of the ISPs to which the router is attached on the basis of a randomly or quasi-randomly selected
5 basis.

As shown in FIG. 21, computer 2001 or edge router 2003 incorporates a plurality of link transmission tables 2100 that identify, for each potential transmission path through the network, valid sets of IP addresses that can be used to transmit the packet. For example, AD table 2101 contains a plurality of IP source/destination
10 pairs that are randomly or quasi-randomly generated. When a packet is to be transmitted from first computer 2001 to second computer 2002, one of the link tables is randomly (or quasi-randomly) selected, and the next valid source/destination address pair from that table is used to transmit the packet through the network. If path AD is randomly selected, for example, the next source/destination IP address pair
15 (which is pre-determined to transmit between ISP A (element 2005) and ISP B (element 2008)) is used to transmit the packet. If one of the transmission paths becomes degraded or inoperative, that link table can be set to a "down" condition as shown in table 2105, thus preventing addresses from being selected from that table. Other transmission paths would be unaffected by this broken link.

20

3. CONTINUATION-IN-PART IMPROVEMENTS

The following describes various improvements and features that can be applied to the embodiments described above. The improvements include: (1) a load balancer that distributes packets across different transmission paths according to
25 transmission path quality; (2) a DNS proxy server that transparently creates a virtual private network in response to a domain name inquiry; (3) a large-to-small link bandwidth management feature that prevents denial-of-service attacks at system chokepoints; (4) a traffic limiter that regulates incoming packets by limiting the rate at which a transmitter can be synchronized with a receiver; and (5) a signaling
30 synchronizer that allows a large number of nodes to communicate with a central node

by partitioning the communication function between two separate entities. Each is discussed separately below.

A. Load Balancer

5 Various embodiments described above include a system in which a transmitting node and a receiving node are coupled through a plurality of transmission paths, and wherein successive packets are distributed quasi-randomly over the plurality of paths. See, for example, FIGS. 20 and 21 and accompanying description. The improvement extends this basic concept to encompass distributing packets across different paths in such a manner that the loads on the paths are generally balanced
10 according to transmission link quality.

In one embodiment, a system includes a transmitting node and a receiving node that are linked via a plurality of transmission paths having potentially varying transmission quality. Successive packets are transmitted over the paths based on a weight value distribution function for each path. The rate that packets will be
15 transmitted over a given path can be different for each path. The relative "health" of each transmission path is monitored in order to identify paths that have become degraded. In one embodiment, the health of each path is monitored in the transmitter by comparing the number of packets transmitted to the number of packet acknowledgements received. Each transmission path may comprise a physically
20 separate path (e.g., via dial-up phone line, computer network, router, bridge, or the like), or may comprise logically separate paths contained within a broadband communication medium (e.g., separate channels in an FDM, TDM, CDMA, or other type of modulated or unmodulated transmission link).

When the transmission quality of a path falls below a predetermined threshold
25 and there are other paths that can transmit packets, the transmitter changes the weight value used for that path, making it less likely that a given packet will be transmitted over that path. The weight will preferably be set no lower than a minimum value that keeps nominal traffic on the path. The weights of the other available paths are altered to compensate for the change in the affected path. When the quality of a path degrades
30 to where the transmitter is turned off by the synchronization function (i.e., no packets

are arriving at the destination), the weight is set to zero. If all transmitters are turned off, no packets are sent.

Conventional TCP/IP protocols include a “throttling” feature that reduces the transmission rate of packets when it is determined that delays or errors are occurring in transmission. In this respect, timers are sometimes used to determine whether packets have been received. These conventional techniques for limiting transmission of packets, however, do not involve multiple transmission paths between two nodes wherein transmission across a particular path relative to the others is changed based on link quality.

According to certain embodiments, in order to damp oscillations that might otherwise occur if weight distributions are changed drastically (e.g., according to a step function), a linear or an exponential decay formula can be applied to gradually decrease the weight value over time that a degrading path will be used. Similarly, if the health of a degraded path improves, the weight value for that path is gradually increased.

Transmission link health can be evaluated by comparing the number of packets that are acknowledged within the transmission window (see embodiments discussed above) to the number of packets transmitted within that window and by the state of the transmitter (i.e., on or off). In other words, rather than accumulating general transmission statistics over time for a path, one specific implementation uses the “windowing” concepts described above to evaluate transmission path health.

The same scheme can be used to shift virtual circuit paths from an “unhealthy” path to a “healthy” one, and to select a path for a new virtual circuit.

FIG. 22A shows a flowchart for adjusting weight values associated with a plurality of transmission links. It is assumed that software executing in one or more computer nodes executes the steps shown in FIG. 22A. It is also assumed that the software can be stored on a computer-readable medium such as a magnetic or optical disk for execution by a computer.

Beginning in step 2201, the transmission quality of a given transmission path is measured. As described above, this measurement can be based on a comparison

between the number of packets transmitted over a particular link to the number of packet acknowledgements received over the link (e.g., per unit time, or in absolute terms). Alternatively, the quality can be evaluated by comparing the number of packets that are acknowledged within the transmission window to the number of
5 packets that were transmitted within that window. In yet another variation, the number of missed synchronization messages can be used to indicate link quality. Many other variations are of course possible.

In step 2202, a check is made to determine whether more than one transmitter (e.g., transmission path) is turned on. If not, the process is terminated and resumes at
10 step 2201.

In step 2203, the link quality is compared to a given threshold (e.g., 50%, or any arbitrary number). If the quality falls below the threshold, then in step 2207 a check is made to determine whether the weight is above a minimum level (e.g., 1%). If not, then in step 2209 the weight is set to the minimum level and processing
15 resumes at step 2201. If the weight is above the minimum level, then in step 2208 the weight is gradually decreased for the path, then in step 2206 the weights for the remaining paths are adjusted accordingly to compensate (e.g., they are increased).

If in step 2203 the quality of the path was greater than or equal to the threshold, then in step 2204 a check is made to determine whether the weight is less
20 than a steady-state value for that path. If so, then in step 2205 the weight is increased toward the steady-state value, and in step 2206 the weights for the remaining paths are adjusted accordingly to compensate (e.g., they are decreased). If in step 2204 the weight is not less than the steady-state value, then processing resumes at step 2201 without adjusting the weights.

25 The weights can be adjusted incrementally according to various functions, preferably by changing the value gradually. In one embodiment, a linearly decreasing function is used to adjust the weights; according to another embodiment, an exponential decay function is used. Gradually changing the weights helps to damp oscillators that might otherwise occur if the probabilities were abruptly.

Although not explicitly shown in FIG. 22A the process can be performed only periodically (e.g., according to a time schedule), or it can be continuously run, such as in a background mode of operation. In one embodiment, the combined weights of all potential paths should add up to unity (e.g., when the weighting for one path is
5 decreased, the corresponding weights that the other paths will be selected will increase).

Adjustments to weight values for other paths can be prorated. For example, a decrease of 10% in weight value for one path could result in an evenly distributed increase in the weights for the remaining paths. Alternatively, weightings could be
10 adjusted according to a weighted formula as desired (e.g., favoring healthy paths over less healthy paths). In yet another variation, the difference in weight value can be amortized over the remaining links in a manner that is proportional to their traffic weighting.

FIG. 22B shows steps that can be executed to shut down transmission links
15 where a transmitter turns off. In step 2210, a transmitter shut-down event occurs. In step 2211, a test is made to determine whether at least one transmitter is still turned on. If not, then in step 2215 all packets are dropped until a transmitter turns on. If in step 2211 at least one transmitter is turned on, then in step 2212 the weight for the path is set to zero, and the weights for the remaining paths are adjusted accordingly.

FIG. 23 shows a computer node 2301 employing various principles of the
20 above-described embodiments. It is assumed that two computer nodes of the type shown in FIG. 23 communicate over a plurality of separate physical transmission paths. As shown in FIG. 23, four transmission paths X1 through X4 are defined for communicating between the two nodes. Each node includes a packet transmitter 2302
25 that operates in accordance with a transmit table 2308 as described above. (The packet transmitter could also operate without using the IP-hopping features described above, but the following description assumes that some form of hopping is employed in conjunction with the path selection mechanism.). The computer node also includes a packet receiver 2303 that operates in accordance with a receive table 2309,
30 including a moving window W that moves as valid packets are received. Invalid

packets having source and destination addresses that do not fall within window W are rejected.

As each packet is readied for transmission, source and destination IP addresses (or other discriminator values) are selected from transmit table 2308 according to any
5 of the various algorithms described above, and packets containing these source/destination address pairs, which correspond to the node to which the four transmission paths are linked, are generated to a transmission path switch 2307. Switch 2307, which can comprise a software function, selects from one of the available transmission paths according to a weight distribution table 2306. For
10 example, if the weight for path X1 is 0.2, then every fifth packet will be transmitted on path X1. A similar regime holds true for the other paths as shown. Initially, each link's weight value can be set such that it is proportional to its bandwidth, which will be referred to as its "steady-state" value.

Packet receiver 2303 generates an output to a link quality measurement
15 function 2304 that operates as described above to determine the quality of each transmission path. (The input to packet receiver 2303 for receiving incoming packets is omitted for clarity). Link quality measurement function 2304 compares the link quality to a threshold for each transmission link and, if necessary, generates an output to weight adjustment function 2305. If a weight adjustment is required, then the
20 weights in table 2306 are adjusted accordingly, preferably according to a gradual (e.g., linearly or exponentially declining) function. In one embodiment, the weight values for all available paths are initially set to the same value, and only when paths degrade in quality are the weights changed to reflect differences.

Link quality measurement function 2304 can be made to operate as part of a
25 synchronizer function as described above. That is, if resynchronization occurs and the receiver detects that synchronization has been lost (e.g., resulting in the synchronization window W being advanced out of sequence), that fact can be used to drive link quality measurement function 2304. According to one embodiment, load balancing is performed using information garnered during the normal
30 synchronization, augmented slightly to communicate link health from the receiver to

the transmitter. The receiver maintains a count, MESS_R(W), of the messages received in synchronization window W. When it receives a synchronization request (SYNC_REQ) corresponding to the end of window W, the receiver includes counter MESS_R in the resulting synchronization acknowledgement (SYNC_ACK) sent back to the transmitter. This allows the transmitter to compare messages sent to messages received in order to assess the health of the link.

If synchronization is completely lost, weight adjustment function 2305 decreases the weight value on the affected path to zero. When synchronization is regained, the weight value for the affected path is gradually increased to its original value. Alternatively, link quality can be measured by evaluating the length of time required for the receiver to acknowledge a synchronization request. In one embodiment, separate transmit and receive tables are used for each transmission path.

When the transmitter receives a SYNC_ACK, the MESS_R is compared with the number of messages transmitted in a window (MESS_T). When the transmitter receives a SYNC_ACK, the traffic probabilities will be examined and adjusted if necessary. MESS_R is compared with the number of messages transmitted in a window (MESS_T). There are two possibilities:

1. If MESS_R is less than a threshold value, THRESH, then the link will be deemed to be unhealthy. If the transmitter was turned off, the transmitter is turned on and the weight P for that link will be set to a minimum value MIN. This will keep a trickle of traffic on the link for monitoring purposes until it recovers. If the transmitter was turned on, the weight P for that link will be set to:

$$P' = \alpha \times \text{MIN} + (1 - \alpha) \times P \quad (1)$$

Equation 1 will exponentially damp the traffic weight value to MIN during sustained periods of degraded service.

2. If MESS_R for a link is greater than or equal to THRESH, the link will be deemed healthy. If the weight P for that link is greater than or equal to the steady state value S for that link, then P is left unaltered. If the weight P for that link is less than THRESH then P will be set to:

$$P' = \beta \times S + (1 - \beta) \times P \quad (2)$$

where β is a parameter such that $0 \leq \beta \leq 1$ that determines the damping rate of P.

Equation 2 will increase the traffic weight to S during sustained periods of acceptable service in a damped exponential fashion.

A detailed example will now be provided with reference to FIG. 24. As shown in FIG. 24, a first computer 2401 communicates with a second computer 2402 through two routers 2403 and 2404. Each router is coupled to the other router through three transmission links. As described above, these may be physically diverse links or logical links (including virtual private networks).

Suppose that a first link L1 can sustain a transmission bandwidth of 100 Mb/s and has a window size of 32; link L2 can sustain 75 Mb/s and has a window size of 24; and link L3 can sustain 25 Mb/s and has a window size of 8. The combined links can thus sustain 200Mb/s. The steady state traffic weights are 0.5 for link L1; 0.375 for link L2, and 0.125 for link L3. MIN=1Mb/s, THRESH =0.8 MESS_T for each link, $\alpha=.75$ and $\beta=.5$. These traffic weights will remain stable until a link stops for synchronization or reports a number of packets received less than its THRESH. Consider the following sequence of events:

1. Link L1 receives a SYNC_ACK containing a MESS_R of 24, indicating that only 75% of the MESS_T (32) messages transmitted in the last window were successfully received. Link 1 would be below THRESH (0.8). Consequently, link L1's traffic weight value would be reduced to 0.12825, while link L2's traffic weight value would be increased to 0.65812 and link L3's traffic weight value would be increased to 0.217938.

2. Link L2 and L3 remained healthy and link L1 stopped to synchronize. Then link L1's traffic weight value would be set to 0, link L2's traffic weight value would be set to 0.75, and link L3's traffic weight value would be set to 0.25.

3. Link L1 finally received a SYNC_ACK containing a MESS_R of 0 indicating that none of the MESS_T (32) messages transmitted in the last window were successfully received. Link L1 would be below THRESH. Link L1's traffic weight value would be increased to .005, link L2's traffic weight value would be

decreased to 0.74625, and link L3's traffic weight value would be decreased to 0.24875.

4. Link L1 received a SYNC_ACK containing a MESS_R of 32 indicating that 100% of the MESS_T (32) messages transmitted in the last window were
5 successfully received. Link L1 would be above THRESH. Link L1's traffic weight value would be increased to 0.2525, while link L2's traffic weight value would be decreased to 0.560625 and link L3's traffic weight value would be decreased to .186875.

5. Link L1 received a SYNC_ACK containing a MESS_R of 32 indicating
10 that 100% of the MESS_T (32) messages transmitted in the last window were successfully received. Link L1 would be above THRESH. Link L1's traffic weight value would be increased to 0.37625; link L2's traffic weight value would be decreased to 0.4678125, and link L3's traffic weight value would be decreased to 0.1559375.

15 6. Link L1 remains healthy and the traffic probabilities approach their steady state traffic probabilities.

B. Use of a DNS Proxy to Transparently Create Virtual Private Networks

A second improvement concerns the automatic creation of a virtual private network (VPN) in response to a domain-name server look-up function.

20 Conventional Domain Name Servers (DNSs) provide a look-up function that returns the IP address of a requested computer or host. For example, when a computer user types in the web name "Yahoo.com," the user's web browser transmits a request to a DNS, which converts the name into a four-part IP address that is returned to the user's browser and then used by the browser to contact the destination
25 web site.

This conventional scheme is shown in FIG. 25. A user's computer 2501 includes a client application 2504 (for example, a web browser) and an IP protocol stack 2505. When the user enters the name of a destination host, a request DNS REQ is made (through IP protocol stack 2505) to a DNS 2502 to look up the IP address
30 associated with the name. The DNS returns the IP address DNS RESP to client

application 2504, which is then able to use the IP address to communicate with the host 2503 through separate transactions such as PAGE REQ and PAGE RESP.

In the conventional architecture shown in FIG. 25, nefarious listeners on the Internet could intercept the DNS REQ and DNS RESP packets and thus learn what IP addresses the user was contacting. For example, if a user wanted to set up a secure communication path with a web site having the name "Target.com," when the user's browser contacted a DNS to find the IP address for that web site, the true IP address of that web site would be revealed over the Internet as part of the DNS inquiry. This would hamper anonymous communications on the Internet.

One conventional scheme that provides secure virtual private networks over the Internet provides the DNS server with the public keys of the machines that the DNS server has the addresses for. This allows hosts to retrieve automatically the public keys of a host that the host is to communicate with so that the host can set up a VPN without having the user enter the public key of the destination host. One implementation of this standard is presently being developed as part of the FreeS/WAN project(RFC 2535).

The conventional scheme suffers from certain drawbacks. For example, any user can perform a DNS request. Moreover, DNS requests resolve to the same value for all users.

According to certain aspects of the invention, a specialized DNS server traps DNS requests and, if the request is from a special type of user (e.g., one for which secure communication services are defined), the server does not return the true IP address of the target node, but instead automatically sets up a virtual private network between the target node and the user. The VPN is preferably implemented using the IP address "hopping" features of the basic invention described above, such that the true identity of the two nodes cannot be determined even if packets during the communication are intercepted. For DNS requests that are determined to not require secure services (e.g., an unregistered user), the DNS server transparently "passes through" the request to provide a normal look-up function and return the IP address of the target web server, provided that the requesting host has permissions to resolve

unsecured sites. Different users who make an identical DNS request could be provided with different results.

FIG. 26 shows a system employing various principles summarized above. A user's computer 2601 includes a conventional client (e.g., a web browser) 2605 and an IP protocol stack 2606 that preferably operates in accordance with an IP hopping function 2607 as outlined above. A modified DNS server 2602 includes a conventional DNS server function 2609 and a DNS proxy 2610. A gatekeeper server 2603 is interposed between the modified DNS server and a secure target site 2704. An "unsecure" target site 2611 is also accessible via conventional IP protocols.

According to one embodiment, DNS proxy 2610 intercepts all DNS lookup functions from client 2605 and determines whether access to a secure site has been requested. If access to a secure site has been requested (as determined, for example, by a domain name extension, or by reference to an internal table of such sites), DNS proxy 2610 determines whether the user has sufficient security privileges to access the site. If so, DNS proxy 2610 transmits a message to gatekeeper 2603 requesting that a virtual private network be created between user computer 2601 and secure target site 2604. In one embodiment, gatekeeper 2603 creates "hopblocks" to be used by computer 2601 and secure target site 2604 for secure communication. Then, gatekeeper 2603 communicates these to user computer 2601. Thereafter, DNS proxy 2610 returns to user computer 2601 the resolved address passed to it by the gatekeeper (this address could be different from the actual target computer) 2604, preferably using a secure administrative VPN. The address that is returned need not be the actual address of the destination computer.

Had the user requested lookup of a non-secure web site such as site 2611, DNS proxy would merely pass through to conventional DNS server 2609 the look-up request, which would be handled in a conventional manner, returning the IP address of non-secure web site 2611. If the user had requested lookup of a secure web site but lacked credentials to create such a connection, DNS proxy 2610 would return a "host unknown" error to the user. In this manner, different users requesting access to the same DNS name could be provided with different look-up results.

Gatekeeper 2603 can be implemented on a separate computer (as shown in FIG. 26) or as a function within modified DNS server 2602. In general, it is anticipated that gatekeeper 2703 facilitates the allocation and exchange of information needed to communicate securely, such as using "hopped" IP addresses. Secure hosts
 5 such as site 2604 are assumed to be equipped with a secure communication function such as an IP hopping function 2608.

It will be appreciated that the functions of DNS proxy 2610 and DNS server 2609 can be combined into a single server for convenience. Moreover, although element 2602 is shown as combining the functions of two servers, the two servers can
 10 be made to operate independently.

FIG. 27 shows steps that can be executed by DNS proxy server 2610 to handle requests for DNS look-up for secure hosts. In step 2701, a DNS look-up request is received for a target host. In step 2702, a check is made to determine whether access to a secure host was requested. If not, then in step 2703 the DNS request is passed to
 15 conventional DNS server 2609, which looks up the IP address of the target site and returns it to the user's application for further processing.

In step 2702, if access to a secure host was requested, then in step 2704 a further check is made to determine whether the user is authorized to connect to the secure host. Such a check can be made with reference to an internally stored list of
 20 authorized IP addresses, or can be made by communicating with gatekeeper 2603 (e.g., over an "administrative" VPN that is secure). It will be appreciated that different levels of security can also be provided for different categories of hosts. For example, some sites may be designated as having a certain security level, and the security level of the user requesting access must match that security level. The user's
 25 security level can also be determined by transmitting a request message back to the user's computer requiring that it prove that it has sufficient privileges.

If the user is not authorized to access the secure site, then a "host unknown" message is returned (step 2705). If the user has sufficient security privileges, then in step 2706 a secure VPN is established between the user's computer and the secure
 30 target site. As described above, this is preferably done by allocating a hopping regime

that will be carried out between the user's computer and the secure target site, and is preferably performed transparently to the user (i.e., the user need not be involved in creating the secure link). As described in various embodiments of this application, any of various fields can be "hopped" (e.g., IP source/destination addresses; a field in the header; etc.) in order to communicate securely.

Some or all of the security functions can be embedded in gatekeeper 2603, such that it handles all requests to connect to secure sites. In this embodiment, DNS proxy 2610 communicates with gatekeeper 2603 to determine (preferably over a secure administrative VPN) whether the user has access to a particular web site.

Various scenarios for implementing these features are described by way of example below:

Scenario #1: Client has permission to access target computer, and gatekeeper has a rule to make a VPN for the client. In this scenario, the client's DNS request would be received by the DNS proxy server 2610, which would forward the request to gatekeeper 2603. The gatekeeper would establish a VPN between the client and the requested target. The gatekeeper would provide the address of the destination to the DNS proxy, which would then return the resolved name as a result. The resolved address can be transmitted back to the client in a secure administrative VPN.

Scenario #2: Client does not have permission to access target computer. In this scenario, the client's DNS request would be received by the DNS proxy server 2610, which would forward the request to gatekeeper 2603. The gatekeeper would reject the request, informing DNS proxy server 2610 that it was unable to find the target computer. The DNS proxy 2610 would then return a "host unknown" error message to the client.

Scenario #3: Client has permission to connect using a normal non-VPN link, and the gatekeeper does not have a rule to set up a VPN for the client to the target site. In this scenario, the client's DNS request is received by DNS proxy server 2610, which would check its rules and determine that no VPN is needed. Gatekeeper 2603 would then inform the DNS proxy server to forward the request to conventional DNS

server 2609, which would resolve the request and return the result to the DNS proxy server and then back to the client.

Scenario #4: Client does not have permission to establish a normal/non-VPN link, and the gatekeeper does not have a rule to make a VPN for the client to the target site. In this scenario, the DNS proxy server would receive the client's DNS request and forward it to gatekeeper 2603. Gatekeeper 2603 would determine that no special VPN was needed, but that the client is not authorized to communicate with non-VPN members. The gatekeeper would reject the request, causing DNS proxy server 2610 to return an error message to the client.

10 C. Large Link to Small Link Bandwidth Management

One feature of the basic architecture is the ability to prevent so-called "denial of service" attacks that can occur if a computer hacker floods a known Internet node with packets, thus preventing the node from communicating with other nodes. Because IP addresses or other fields are "hopped" and packets arriving with invalid addresses are quickly discarded, Internet nodes are protected against flooding targeted at a single IP address.

In a system in which a computer is coupled through a link having a limited bandwidth (e.g., an edge router) to a node that can support a much higher-bandwidth link (e.g., an Internet Service Provider), a potential weakness could be exploited by a determined hacker. Referring to FIG. 28, suppose that a first host computer 2801 is communicating with a second host computer 2804 using the IP address hopping principles described above. The first host computer is coupled through an edge router 2802 to an Internet Service Provider (ISP) 2803 through a low bandwidth link (LOW BW), and is in turn coupled to second host computer 2804 through parts of the Internet through a high bandwidth link (HIGH BW). In this architecture, the ISP is able to support a high bandwidth to the internet, but a much lower bandwidth to the edge router 2802.

Suppose that a computer hacker is able to transmit a large quantity of dummy packets addressed to first host computer 2801 across high bandwidth link HIGH BW. Normally, host computer 2801 would be able to quickly reject the packets since they

would not fall within the acceptance window permitted by the IP address hopping scheme. However, because the packets must travel across low bandwidth link LOW BW, the packets overwhelm the lower bandwidth link before they are received by host computer 2801. Consequently, the link to host computer 2801 is effectively
5 flooded before the packets can be discarded.

According to one inventive improvement, a “link guard” function 2805 is inserted into the high-bandwidth node (e.g., ISP 2803) that quickly discards packets destined for a low-bandwidth target node if they are not valid packets. Each packet destined for a low-bandwidth node is cryptographically authenticated to determine
10 whether it belongs to a VPN. If it is not a valid VPN packet, the packet is discarded at the high-bandwidth node. If the packet is authenticated as belonging to a VPN, the packet is passed with high preference. If the packet is a valid non-VPN packet, it is passed with a lower quality of service (e.g., lower priority).

In one embodiment, the ISP distinguishes between VPN and non-VPN packets
15 using the protocol of the packet. In the case of IPSEC [rfc 2401], the packets have IP protocols 420 and 421. In the case of the TARP VPN, the packets will have an IP protocol that is not yet defined. The ISP’s link guard, 2805, maintains a table of valid VPNs which it uses to validate whether VPN packets are cryptographically valid.

According to one embodiment, packets that do not fall within any hop
20 windows used by nodes on the low-bandwidth link are rejected, or are sent with a lower quality of service. One approach for doing this is to provide a copy of the IP hopping tables used by the low-bandwidth nodes to the high-bandwidth node, such that both the high-bandwidth and low-bandwidth nodes track hopped packets (e.g., the high-bandwidth node moves its hopping window as valid packets are received). In
25 such a scenario, the high-bandwidth node discards packets that do not fall within the hopping window before they are transmitted over the low-bandwidth link. Thus, for example, ISP 2903 maintains a copy 2910 of the receive table used by host computer 2901. Incoming packets that do not fall within this receive table are discarded. According to a different embodiment, link guard 2805 validates each VPN packet
30 using a keyed hashed message authentication code (HMAC) [rfc 2104]. According

to another embodiment, separate VPNs (using, for example, hopblocks) can be established for communicating between the low-bandwidth node and the high-bandwidth node (i.e., packets arriving at the high-bandwidth node are converted into different packets before being transmitted to the low-bandwidth node).

5 As shown in FIG. 29, for example, suppose that a first host computer 2900 is communicating with a second host computer 2902 over the Internet, and the path includes a high bandwidth link HIGH BW to an ISP 2901 and a low bandwidth link LOW BW through an edge router 2904. In accordance with the basic architecture described above, first host computer 2900 and second host computer 2902 would exchange hopblocks (or a hopblock algorithm) and would be able to create matching
10 transmit and receive tables 2905, 2906, 2912 and 2913. Then in accordance with the basic architecture, the two computers would transmit packets having seemingly random IP source and destination addresses, and each would move a corresponding hopping window in its receive table as valid packets were received.

15 Suppose that a nefarious computer hacker 2903 was able to deduce that packets having a certain range of IP addresses (e.g., addresses 100 to 200 for the sake of simplicity) are being transmitted to ISP 2901, and that these packets are being forwarded over a low-bandwidth link. Hacker computer 2903 could thus “flood” packets having addresses falling into the range 100 to 200, expecting that they would
20 be forwarded along low bandwidth link LOW BW, thus causing the low bandwidth link to become overwhelmed. The fast packet reject mechanism in first host computer 3000 would be of little use in rejecting these packets, since the low bandwidth link was effectively jammed before the packets could be rejected. In accordance with one aspect of the improvement, however, VPN link guard 2911 would prevent the attack
25 from impacting the performance of VPN traffic because the packets would either be rejected as invalid VPN packets or given a lower quality of service than VPN traffic over the lower bandwidth link. A denial-of-service flood attack could, however, still disrupt non-VPN traffic.

30 According to one embodiment of the improvement, ISP 2901 maintains a separate VPN with first host computer 2900, and thus translates packets arriving at the

ISP into packets having a different IP header before they are transmitted to host computer 2900. The cryptographic keys used to authenticate VPN packets at the link guard 2911 and the cryptographic keys used to encrypt and decrypt the VPN packets at host 2902 and host 2901 can be different, so that link guard 2911 does not have
5 access to the private host data; it only has the capability to authenticate those packets.

According to yet a third embodiment, the low-bandwidth node can transmit a special message to the high-bandwidth node instructing it to shut down all transmissions on a particular IP address, such that only hopped packets will pass through to the low-bandwidth node. This embodiment would prevent a hacker from
10 flooding packets using a single IP address. According to yet a fourth embodiment, the high-bandwidth node can be configured to discard packets transmitted to the low-bandwidth node if the transmission rate exceeds a certain predetermined threshold for any given IP address; this would allow hopped packets to go through. In this respect, link guard 2911 can be used to detect that the rate of packets on a given IP address are
15 exceeding a threshold rate; further packets addressed to that same IP address would be dropped or transmitted at a lower priority (e.g., delayed).

D. Traffic Limiter

In a system in which multiple nodes are communicating using “hopping” technology, a treasonous insider could internally flood the system with packets. In
20 order to prevent this possibility, one inventive improvement involves setting up “contracts” between nodes in the system, such that a receiver can impose a bandwidth limitation on each packet sender. One technique for doing this is to delay acceptance of a checkpoint synchronization request from a sender until a certain time period (e.g., one minute) has elapsed. Each receiver can effectively control the rate at which its
25 hopping window moves by delaying “SYNC ACK” responses to “SYNC_REQ” messages.

A simple modification to the checkpoint synchronizer will serve to protect a receiver from accidental or deliberate overload from an internally treasonous client. This modification is based on the observation that a receiver will not update its tables
30 until a SYNC_REQ is received on hopped address CKPT_N. It is a simple matter of

deferring the generation of a new CKPT_N until an appropriate interval after previous checkpoints.

Suppose a receiver wished to restrict reception from a transmitter to 100 packets a second, and that checkpoint synchronization messages were triggered every
5 50 packets. A compliant transmitter would not issue new SYNC_REQ messages more often than every 0.5 seconds. The receiver could delay a non-compliant transmitter from synchronizing by delaying the issuance of CKPT_N for 0.5 second after the last SYNC_REQ was accepted.

In general, if M receivers need to restrict N transmitters issuing new
10 SYNC_REQ messages after every W messages to sending R messages a second in aggregate, each receiver could defer issuing a new CKPT_N until $M \times N \times W / R$ seconds have elapsed since the last SYNC_REQ has been received and accepted. If the transmitter exceeds this rate between a pair of checkpoints, it will issue the new checkpoint before the receiver is ready to receive it, and the SYNC_REQ will be
15 discarded by the receiver. After this, the transmitter will re-issue the SYNC_REQ every T1 seconds until it receives a SYNC_ACK. The receiver will eventually update CKPT_N and the SYNC_REQ will be acknowledged. If the transmission rate greatly exceeds the allowed rate, the transmitter will stop until it is compliant. If the transmitter exceeds the allowed rate by a little, it will eventually stop after several
20 rounds of delayed synchronization until it is in compliance. Hacking the transmitter's code to not shut off only permits the transmitter to lose the acceptance window. In this case it can recover the window and proceed only after it is compliant again.

Two practical issues should be considered when implementing the above scheme:

25 1. The receiver rate should be slightly higher than the permitted rate in order to allow for statistical fluctuations in traffic arrival times and non-uniform load balancing.

2. Since a transmitter will rightfully continue to transmit for a period after a SYNC_REQ is transmitted, the algorithm above can artificially reduce the
30 transmitter's bandwidth. If events prevent a compliant transmitter from synchronizing

for a period (e.g. the network dropping a SYNC_REQ or a SYNC_ACK) a SYNC_REQ will be accepted later than expected. After this, the transmitter will transmit fewer than expected messages before encountering the next checkpoint. The new checkpoint will not have been activated and the transmitter will have to retransmit the SYNC_REQ. This will appear to the receiver as if the transmitter is not compliant. Therefore, the next checkpoint will be accepted late from the transmitter's perspective. This has the effect of reducing the transmitter's allowed packet rate until the transmitter transmits at a packet rate below the agreed upon rate for a period of time.

To guard against this, the receiver should keep track of the times that the last C SYNC_REQs were received and accepted and use the minimum of $MxNxW/R$ seconds after the last SYNC_REQ has been received and accepted, $2xMxNxW/R$ seconds after next to the last SYNC_REQ has been received and accepted, $CxMxNxW/R$ seconds after $(C-1)^{th}$ to the last SYNC_REQ has been received, as the time to activate CKPT_N. This prevents the receiver from inappropriately limiting the transmitter's packet rate if at least one out of the last C SYNC_REQs was processed on the first attempt.

FIG. 30 shows a system employing the above-described principles. In FIG. 30, two computers 3000 and 3001 are assumed to be communicating over a network N in accordance with the "hopping" principles described above (e.g., hopped IP addresses, discriminator values, etc.). For the sake of simplicity, computer 3000 will be referred to as the receiving computer and computer 3001 will be referred to as the transmitting computer, although full duplex operation is of course contemplated. Moreover, although only a single transmitter is shown, multiple transmitters can transmit to receiver 3000.

As described above, receiving computer 3000 maintains a receive table 3002 including a window W that defines valid IP address pairs that will be accepted when appearing in incoming data packets. Transmitting computer 3001 maintains a transmit table 3003 from which the next IP address pairs will be selected when transmitting a packet to receiving computer 3000. (For the sake of illustration,

window W is also illustrated with reference to transmit table 3003). As transmitting computer moves through its table, it will eventually generate a SYNC_REQ message as illustrated in function 3010. This is a request to receiver 3000 to synchronize the receive table 3002, from which transmitter 3001 expects a response in the form of a CKPT_N (included as part of a SYNC_ACK message). If transmitting computer 3001 transmits more messages than its allotment, it will prematurely generate the SYNC_REQ message. (If it has been altered to remove the SYNC_REQ message generation altogether, it will fall out of synchronization since receiver 3000 will quickly reject packets that fall outside of window W , and the extra packets generated by transmitter 3001 will be discarded).

In accordance with the improvements described above, receiving computer 3000 performs certain steps when a SYNC_REQ message is received, as illustrated in FIG. 30. In step 3004, receiving computer 3000 receives the SYNC_REQ message. In step 3005, a check is made to determine whether the request is a duplicate. If so, it is discarded in step 3006. In step 3007, a check is made to determine whether the SYNC_REQ received from transmitter 3001 was received at a rate that exceeds the allowable rate R (i.e., the period between the time of the last SYNC_REQ message). The value R can be a constant, or it can be made to fluctuate as desired. If the rate exceeds R , then in step 3008 the next activation of the next CKPT_N hopping table entry is delayed by W/R seconds after the last SYNC_REQ has been accepted.

Otherwise, if the rate has not been exceeded, then in step 3109 the next CKPT_N value is calculated and inserted into the receiver's hopping table prior to the next SYNC_REQ from the transmitter 3101. Transmitter 3101 then processes the SYNC_REQ in the normal manner.

25 **E. Signaling Synchronizer**

In a system in which a large number of users communicate with a central node using secure hopping technology, a large amount of memory must be set aside for hopping tables and their supporting data structures. For example, if one million subscribers to a web site occasionally communicate with the web site, the site must maintain one million hopping tables, thus using up valuable computer resources, even

though only a small percentage of the users may actually be using the system at any one time. A desirable solution would be a system that permits a certain maximum number of simultaneous links to be maintained, but which would "recognize" millions of registered users at any one time. In other words, out of a population of a million
5 registered users, a few thousand at a time could simultaneously communicate with a central server, without requiring that the server maintain one million hopping tables of appreciable size.

One solution is to partition the central node into two nodes: a signaling server that performs session initiation for user log-on and log-off (and requires only
10 minimally sized tables), and a transport server that contains larger hopping tables for the users. The signaling server listens for the millions of known users and performs a fast-packet reject of other (bogus) packets. When a packet is received from a known user, the signaling server activates a virtual private link (VPL) between the user and the transport server, where hopping tables are allocated and maintained. When the
15 user logs onto the signaling server, the user's computer is provided with hop tables for communicating with the transport server, thus activating the VPL. The VPLs can be torn down when they become inactive for a time period, or they can be torn down upon user log-out. Communication with the signaling server to allow user log-on and log-off can be accomplished using a specialized version of the checkpoint scheme
20 described above.

FIG. 31 shows a system employing certain of the above-described principles. In FIG. 31, a signaling server 3101 and a transport server 3102 communicate over a link. Signaling server 3101 contains a large number of small tables 3106 and 3107 that contain enough information to authenticate a communication request with one or
25 more clients 3103 and 3104. As described in more detail below, these small tables may advantageously be constructed as a special case of the synchronizing checkpoint tables described previously. Transport server 3102, which is preferably a separate computer in communication with signaling server 3101, contains a smaller number of larger hopping tables 3108, 3109, and 3110 that can be allocated to create a VPN with
30 one of the client computers.

According to one embodiment, a client that has previously registered with the system (e.g., via a system administration function, a user registration procedure, or some other method) transmits a request for information from a computer (e.g., a web site). In one variation, the request is made using a “hopped” packet, such that signaling server 3101 will quickly reject invalid packets from unauthorized computers such as hacker computer 3105. An “administrative” VPN can be established between all of the clients and the signaling server in order to ensure that a hacker cannot flood signaling server 3101 with bogus packets. Details of this scheme are provided below.

Signaling server 3101 receives the request 3111 and uses it to determine that client 3103 is a validly registered user. Next, signaling server 3101 issues a request to transport server 3102 to allocate a hopping table (or hopping algorithm or other regime) for the purpose of creating a VPN with client 3103. The allocated hopping parameters are returned to signaling server 3101 (path 3113), which then supplies the hopping parameters to client 3103 via path 3114, preferably in encrypted form.

Thereafter, client 3103 communicates with transport server 3102 using the normal hopping techniques described above. It will be appreciated that although signaling server 3101 and transport server 3102 are illustrated as being two separate computers, they could of course be combined into a single computer and their functions performed on the single computer. Alternatively, it is possible to partition the functions shown in FIG. 31 differently from as shown without departing from the inventive principles.

One advantage of the above-described architecture is that signaling server 3101 need only maintain a small amount of information on a large number of potential users, yet it retains the capability of quickly rejecting packets from unauthorized users such as hacker computer 3105. Larger data tables needed to perform the hopping and synchronization functions are instead maintained in a transport server 3102, and a smaller number of these tables are needed since they are only allocated for “active” links. After a VPN has become inactive for a certain time period (e.g., one hour), the VPN can be automatically torn down by transport server 3102 or signaling server 3101.

A more detailed description will now be provided regarding how a special case of the checkpoint synchronization feature can be used to implement the signaling scheme described above.

5 The signaling synchronizer may be required to support many (millions) of standing, low bandwidth connections. It therefore should minimize per-VPL memory usage while providing the security offered by hopping technology. In order to reduce memory usage in the signaling server, the data hopping tables can be completely eliminated and data can be carried as part of the SYNC_REQ message. The table used by the server side (receiver) and client side (transmitter) is shown schematically as
10 element 3106 in FIG. 31.

The meaning and behaviors of CKPT_N, CKPT_O and CKPT_R remain the same from the previous description, except that CKPT_N can receive a combined data and SYNC_REQ message or a SYNC_REQ message without the data.

The protocol is a straightforward extension of the earlier synchronizer.
15 Assume that a client transmitter is on and the tables are synchronized. The initial tables can be generated "out of band." For example, a client can log into a web server to establish an account over the Internet. The client will receive keys etc encrypted over the Internet. Meanwhile, the server will set up the signaling VPN on the signaling server.

20 Assuming that a client application wishes to send a packet to the server on the client's standing signaling VPL:

1. The client sends the message marked as a data message on the inner header using the transmitter's CKPT_N address. It turns the transmitter off and starts a timer T1 noting CKPT_O. Messages can be one of three types: DATA, SYNC_REQ and
25 SYNC_ACK. In the normal algorithm, some potential problems can be prevented by identifying each message type as part of the encrypted inner header field. In this algorithm, it is important to distinguish a data packet and a SYNC_REQ in the signaling synchronizer since the data and the SYNC_REQ come in on the same address.

2. When the server receives a data message on its CKPT_N, it verifies the message and passes it up the stack. The message can be verified by checking message type and other information (i.e user credentials) contained in the inner header It replaces its CKPT_O with CKPT_N and generates the next CKPT_N. It updates its transmitter side CKPT_R to correspond to the client's receiver side CKPT_R and transmits a SYNC_ACK containing CKPT_O in its payload.

3. When the client side receiver receives a SYNC_ACK on its CKPT_R with a payload matching its transmitter side CKPT_O and the transmitter is off, the transmitter is turned on and the receiver side CKPT_R is updated. If the SYNC_ACK's payload does not match the transmitter side CKPT_O or the transmitter is on, the SYNC_ACK is simply discarded.

4. T1 expires: If the transmitter is off and the client's transmitter side CKPT_O matches the CKPT_O associated with the timer, it starts timer T1 noting CKPT_O again, and a SYNC_REQ is sent using the transmitter's CKPT_O address. Otherwise, no action is taken.

5. When the server receives a SYNC_REQ on its CKPT_N, it replaces its CKPT_O with CKPT_N and generates the next CKPT_N. It updates its transmitter side CKPT_R to correspond to the client's receiver side CKPT_R and transmits a SYNC_ACK containing CKPT_O in its payload.

6. When the server receives a SYNC_REQ on its CKPT_O, it updates its transmitter side CKPT_R to correspond to the client's receiver side CKPT_R and transmits a SYNC_ACK containing CKPT_O in its payload.

FIG. 32 shows message flows to highlight the protocol. Reading from top to bottom, the client sends data to the server using its transmitter side CKPT_N. The client side transmitter is turned off and a retry timer is turned off. The transmitter will not transmit messages as long as the transmitter is turned off. The client side transmitter then loads CKPT_N into CKPT_O and updates CKPT_N. This message is successfully received and a passed up the stack. It also synchronizes the receiver i.e, the server loads CKPT_N into CKPT_O and generates a new CKPT_N, it generates a new CKPT_R in the server side transmitter and transmits a SYNC_ACK containing

the server side receiver's CKPT_O the server. The SYNC_ACK is successfully received at the client. The client side receiver's CKPT_R is updated, the transmitter is turned on and the retry timer is killed. The client side transmitter is ready to transmit a new data message.

5 Next, the client sends data to the server using its transmitter side CKPT_N. The client side transmitter is turned off and a retry timer is turned off. The transmitter will not transmit messages as long as the transmitter is turned off. The client side transmitter then loads CKPT_N into CKPT_O and updates CKPT_N. This message is lost. The client side timer expires and as a result a SYNC_REQ is transmitted on the
10 client side transmitter's CKPT_O (this will keep happening until the SYNC_ACK has been received at the client). The SYNC_REQ is successfully received at the server. It synchronizes the receiver i.e, the server loads CKPT_N into CKPT_O and generates a new CKPT_N, it generates a new CKPT_R in the server side transmitter and transmits a SYNC_ACK containing the server side receiver's CKPT_O the server.
15 The SYNC_ACK is successfully received at the client. The client side receiver's CKPT_R is updated, the transmitter is turned off and the retry timer is killed. The client side transmitter is ready to transmit a new data message.

There are numerous other scenarios that follow this flow. For example, the SYNC_ACK could be lost. The transmitter would continue to re-send the
20 SYNC_REQ until the receiver synchronizes and responds.

The above-described procedures allow a client to be authenticated at signaling server 3201 while maintaining the ability of signaling server 3201 to quickly reject invalid packets, such as might be generated by hacker computer 3205. In various embodiments, the signaling synchronizer is really a derivative of the synchronizer. It
25 provides the same protection as the hopping protocol, and it does so for a large number of low bandwidth connections.

CLAIMS

1. A method of transmitting data packets between a first computer and a second computer, wherein the first computer and the second computer are linked via a plurality of separate transmission paths, the method comprising the steps of:

5 (1) assigning a weight value to each of the plurality of transmission paths, wherein each respective weight value represents the relative number of packets that a respective transmission path will transmit;

(2) for each data packet that is to be transmitted from the first computer to the second computer, selecting one of the plurality of transmission paths on the basis of
10 each respective transmission path's assigned weight value;

(3) measuring the transmission quality for each of the plurality of transmission paths; and

(4) adjusting downwardly to a non-zero value the assigned weight value for a transmission path for which the transmission quality has declined.

15 2. The method of claim 1, wherein step (4) comprises the step of gradually decreasing over time the assigned weight value in relation to weight values assigned to the remaining transmission paths.

3. The method of claim 2, wherein step (4) comprises the step of gradually decreasing the assigned weight value according to an incrementally decreasing
20 function.

4. The method of claim 2, wherein step (4) comprises the step of gradually decreasing the assigned weight value according to an exponentially decaying function.

5. The method of claim 1, wherein step (3) comprises the step of determining
25 that one or more packets transmitted to the second computer was not acknowledged by the second computer.

6. The method of claim 1, wherein step (3) comprises the step of evaluating the contents of a synchronization packet that maintains synchronization with a moving window of valid values.

7. The method of claim 1, further comprising the step of inserting into each data packet a source and destination IP address pair that is selected according to a pseudo-random sequence.

5 8. The method of claim 1, wherein step (4) comprises the step of adjusting downwardly the assigned weight value for a transmission path only if the transmission quality has declined below a predetermined threshold.

9. The method of claim 1, further comprising the step of adjusting upwardly the assigned weight value that was adjusted in step (4) if it is later determined that the transmission quality has improved.

10 10. The method of claim 1, further comprising the step of adjusting upwardly the weight values of the remaining transmission links in an amount that compensates for the downwardly adjusted weight value.

11. The method of claim 10, wherein the step of adjusting upwardly comprises the step of equally distributing the amount that was downwardly adjusted
15 across the remaining transmission links.

12. The method of claim 1, further comprising the step of adjusting downwardly to zero the assigned weight value for any transmission link whose quality has degraded below a preset threshold.

13. The method of claim 1, wherein steps (2) through (4) are repeated
20 periodically.

14. A first computer that transmits data packets to a second computer over a plurality of separate transmission paths, wherein the first computer performs the steps of:

(1) assigning a weight value to each of the plurality of transmission paths,
25 wherein each respective weight value represents the relative number of packets that a respective transmission path will transmit;

(2) for each data packet that is to be transmitted to the second computer, selecting one of the plurality of transmission paths on the basis of each respective transmission path's assigned weight value;

(3) measuring the transmission quality for each of the plurality of transmission paths; and

(4) adjusting downwardly to a non-zero value the assigned weight value for a transmission path for which the transmission quality has declined.

5 15. The first computer of claim 14, wherein the first computer gradually decreases over time the assigned weight value in relation to weight values assigned to the remaining transmission paths.

10 16. The first computer of claim 15, wherein the first computer gradually decreases the assigned weight value according to an incrementally decreasing function.

17. The first computer of claim 15, wherein the first computer gradually decreases the assigned weight value according to an exponentially decaying function.

15 18. The first computer of claim 14, wherein the first computer measures the transmission quality by determining that one or more packets transmitted to the second computer was not acknowledged by the second computer.

19. The first computer of claim 14, wherein the first computer measures the transmission quality by evaluating the contents of a synchronization packet that maintains synchronization with a moving window of valid values.

20 20. The first computer of claim 14, wherein the first computer inserts into each data packet a source and destination IP address pair that is selected according to a pseudo-random sequence.

21. The first computer of claim 14, wherein the first computer adjusts downwardly the assigned weight value for any transmission path only if the transmission quality has declined below a predetermined threshold.

25 22. The first computer of claim 14, wherein the first computer adjusts upwardly the assigned weight value that was adjusted in step (4) if it is later determined that the transmission quality has improved.

30 23. The first computer of claim 14, wherein the first computer adjusts upwardly the weight values of the remaining transmission links in an amount that compensates for the downwardly adjusted weight value.

24. The first computer of claim 23, wherein the first computer upwardly adjusts probabilities across the remaining transmission links in an amount equal to the downwardly adjusted weight value.

5 25. The first computer of claim 14, wherein the first computer adjusts downwardly to zero the assigned weight value for any transmission link whose quality has degraded below a preset threshold.

26. The first computer of claim 14, wherein the first computer repeats steps (2) through (4) periodically.

10 27. A system comprising the first computer of claim 14 and a second computer constructed in accordance with the first computer of claim 14.

28. A method of transparently creating a virtual private network (VPN) between a client computer and a target computer, comprising the steps of:

15 (1) generating from the client computer a Domain Name Service (DNS) request that requests an IP address corresponding to a domain name associated with the target computer;

(2) determining whether the DNS request transmitted in step (1) is requesting access to a secure web site; and

20 (3) in response to determining that the DNS request in step (2) is requesting access to a secure target web site, automatically initiating the VPN between the client computer and the target computer.

29. The method of claim 28, wherein steps (2) and (3) are performed at a DNS server separate from the client computer.

30. The method of claim 28, further comprising the step of:

25 (4) in response to determining that the DNS request in step (2) is not requesting access to a secure target web site, resolving the IP address for the domain name and returning the IP address to the client computer.

30 31. The method of claim 28, wherein step (3) comprises the step of, prior to automatically initiating the VPN between the client computer and the target computer, determining whether the client computer is authorized to establish a VPN with the target computer and, if not so authorized, returning an error from the DNS request.

32. The method of claim 28, wherein step (3) comprises the step of, prior to automatically initiating the VPN between the client computer and the target computer, determining whether the client computer is authorized to resolve addresses of non secure target computers and, if not so authorized, returning an error from the DNS request.

33. The method of claim 28, wherein step (3) comprises the step of establishing the VPN by creating an IP address hopping scheme between the client computer and the target computer.

34. The method of claim 28, wherein step (3) comprises the step of using a gatekeeper computer that allocates VPN resources for communicating between the client computer and the target computer.

35. The method of claim 28, wherein step (2) is performed in a DNS proxy server that passes through the request to a DNS server if it is determined in step (3) that access is not being requested to a secure target web site.

36. The method of claim 32, wherein step (3) comprises the step of transmitting a message to the client computer to determine whether the client computer is authorized to establish the VPN target computer.

37. A system that transparently creates a virtual private network (VPN) between a client computer and a secure target computer, comprising:
a DNS proxy server that receives a request from the client computer to look up an IP address for a domain name, wherein the DNS proxy server returns the IP address for the requested domain name if it is determined that access to a non-secure web site has been requested, and wherein the DNS proxy server generates a request to create the VPN between the client computer and the secure target computer if it is determined that access to a secure web site has been requested; and

a gatekeeper computer that allocates resources for the VPN between the client computer and the secure web computer in response to the request by the DNS proxy server.

38. The system of claim 37, wherein the gatekeeper computer creates the VPN by establishing an IP address hopping regime that is used to pseudorandomly

change IP addresses in packets transmitted between the client computer and the secure target computer.

39. The system of claim 37, wherein the gatekeeper computer determines whether the client computer has sufficient security privileges to create the VPN and, if
 5 the client computer lacks sufficient security privileges, rejecting the request to create the VPN.

40. A method of preventing data packets received from a high bandwidth link from flooding a low bandwidth link, comprising the steps of:

(1) receiving data packets from the high bandwidth link that are ostensibly
 10 addressed to a computer residing on the low-bandwidth link;

(2) for each data packet, determining whether the data packet is validly addressed to the computer on the low-bandwidth link;

(3) in response to determining that the data packet is not validly addressed to the computer on the low-bandwidth link, rejecting the data packet; and

15 (4) in response to determining that the data packet is validly addressed to the computer on the low-bandwidth link, forwarding the data packet to the computer over the low-bandwidth link.

41. The method of claim 40, wherein step (3) comprises the step of comparing a value in a header of each data packet to a set of valid values maintained for the
 20 computer on the low-bandwidth link.

42. The method of claim 41, wherein step (3) comprises the step of comparing a value in a header of each data packet to a moving window of valid values.

43. The method of claim 42, wherein step (3) comprises the step of comparing the IP address in the header of each data packet to a moving window of valid IP
 25 addresses, wherein the moving window is also maintained by the computer on the low-bandwidth link.

44. The method of claim 40, wherein step (3) comprises the step of reducing a priority level of the packet in relation to other data packets, wherein the priority level determines whether a particular data packet will be transmitted before another data
 30 packet having a different priority level.

45. The method of claim 40, wherein step (3) comprises the step of performing a cryptographic check on each data packet to determine whether each data packet is validly addressed.

5 46. The method of claim 40, wherein step (3) comprises the step of receiving a message from the computer on the low-bandwidth link to stop accepting messages having a particular characteristic.

47. The method of claim 46, wherein step (3) comprises the step of receiving a message from the computer on the low-bandwidth link to stop accepting messages addressed to a particular IP address.

10 48. The method of claim 40, wherein step (3) comprises the step of determining that a packet transmission rate has been exceeded for a given packet parameter.

15 49. The method of claim 48, wherein step (3) comprises the step of determining that a packet transmission rate has been exceeded for a given IP destination address.

50. In a system having a low bandwidth data link, a first computer coupled to the low bandwidth data link, and a high bandwidth data link, an improvement comprising:

20 a second computer coupled between the low bandwidth data link and the high bandwidth data link, wherein the second computer receives data packets from the high bandwidth data link and, if they are addressed to the first computer, routes them to the first computer over the low bandwidth data link,

25 wherein the second computer prevents invalid data packets ostensibly addressed to the first computer from being transmitted over the low bandwidth data link.

51. The system of claim 50, wherein the second computer prevents invalid data packets from being transmitted over the low bandwidth data link by comparing a discriminator field in a header of each data packet to a table of valid discriminator fields maintained for the first computer.

52. The system of claim 50, wherein the second computer compares an Internet Protocol (IP) address in a header of each data packet to a table of valid IP addresses.

53. The system of claim 52, wherein the second computer compares the IP address in the header of each data packet to a moving window of valid IP addresses, wherein the moving window is also maintained by the first computer.

54. The system of claim 50, wherein the second computer reduces a priority level of a data packet in relation to other data packets, wherein the priority level determines whether a particular data packet will be transmitted before another data packet having a different priority level.

55. The system of claim 50, wherein the second computer performs a cryptographic check on each data packet to determine whether each data packet is validly addressed.

56. The system of claim 50, wherein the second computer receives a message from the first computer that causes the second computer to stop accepting messages having a particular characteristic.

57. The system of claim 56, wherein the second computer receiving a message from the first computer to stop accepting messages addressed to a particular IP address.

58. The system of claim 50, wherein the second computer rejects invalid packets by determining that a packet transmission rate has been exceeded for a given packet parameter.

59. The system of claim 58, wherein the second computer determines that a packet transmission rate has been exceeded for a given IP destination address.

60. In a system comprising a first computer that transmits data packets to a second computer over a network according to a scheme by which at least one field in a series of data packets is periodically changed according to a sequence known by the first and second computers, and wherein the second computer periodically receives a synchronization request from the first computer to maintain synchronization of the sequence between the first and second computers, a method comprising the steps of:

(1) receiving at the first computer the synchronization request from the second computer;

(2) determining whether the synchronization request was received in less than a predetermined interval;

5 (3) in response to determining that the synchronization request was received in less than the predetermined interval, ignoring the synchronization request; and

(4) in response to determining that the synchronization request was not received in less than the predetermined interval, providing the synchronization response to the first computer.

10 61. The method of claim 60, wherein step (3) comprises the step of delaying the acceptance of a SYNC_REQ for W/R seconds, where W is the number of data packets between synchronization requests according to an agreed schedule, and R is the agreed rate at which synchronization requests should be received according to the agreed schedule.

15 62. The method of claim 60, further comprising the step of determining whether the synchronization request is a duplicate of a previously received synchronization request and, if it is a duplicate, discarding it.

20 63. The method of claim 60, wherein step (4) comprises the step of providing a response that includes a new checkpoint for synchronizing a window in a hopping table.

25 64. A computer that receives data packets from a second computer over a network according to a scheme by which at least one field in a series of data packets is periodically changed according to a known sequence, wherein the second computer periodically transmits a synchronization request to maintain synchronization of the sequence, wherein the computer performs the steps of:

(1) receiving the synchronization request from the second computer;

(2) determining whether the synchronization request was received in less than a predetermined interval;

30 (3) in response to determining that the synchronization request was received in less than a predetermined interval ignoring the synchronization request; and

(4) in response to determining that the synchronization request was not received in less than a predetermined interval, providing the response to the first computer.

5 65. The computer of claim 64, wherein the computer delays the acceptance of a SYNC_REQ in step (3) for W/R seconds, where W is the number of data packets between synchronization requests according to an agreed schedule, and R is the agreed rate at which synchronization requests should be received according to the agreed schedule.

10 66. The computer of claim 64, wherein the computer further performs the step of determining whether the synchronization request is a duplicate of a previously received synchronization request and, if it is a duplicate, discarding it.

15 67. A method of establishing communication between one of a plurality of client computers and a central computer that maintains a plurality of authentication tables each corresponding to one of the client computers, the method comprising the steps of:

(1) in the central computer, receiving from one of the plurality of client computers a request to establish a connection;

(2) authenticating, with reference to one of the plurality of authentication tables, that the request received in step (1) is from an authorized client;

20 (3) responsive to a determination that the request is from an authorized client, allocating resources to establish a virtual private link between the client and a second computer; and

(4) communicating between the authorized client and the second computer using the virtual private link.

25 68. The method of claim 67, wherein step (4) comprises the step of communicating according to a scheme by which at least one field in a series of data packets is periodically changed according to a known sequence.

30 69. The method of claim 68, wherein step (4) comprises the step of comparing an Internet Protocol (IP) address in a header of each data packet to a table of valid IP addresses maintained in a table in the second computer.

70. The method of claim 69, wherein step (4) comprises the step of comparing the IP address in the header of each data packet to a moving window of valid IP addresses, and rejecting data packets having IP addresses that do not fall within the moving window.

5 71. The method of claim 67, wherein step (2) comprises the step of using a checkpoint data structure that maintains synchronization of a periodically changing parameter known by the central computer and the client computer to authenticate the client.

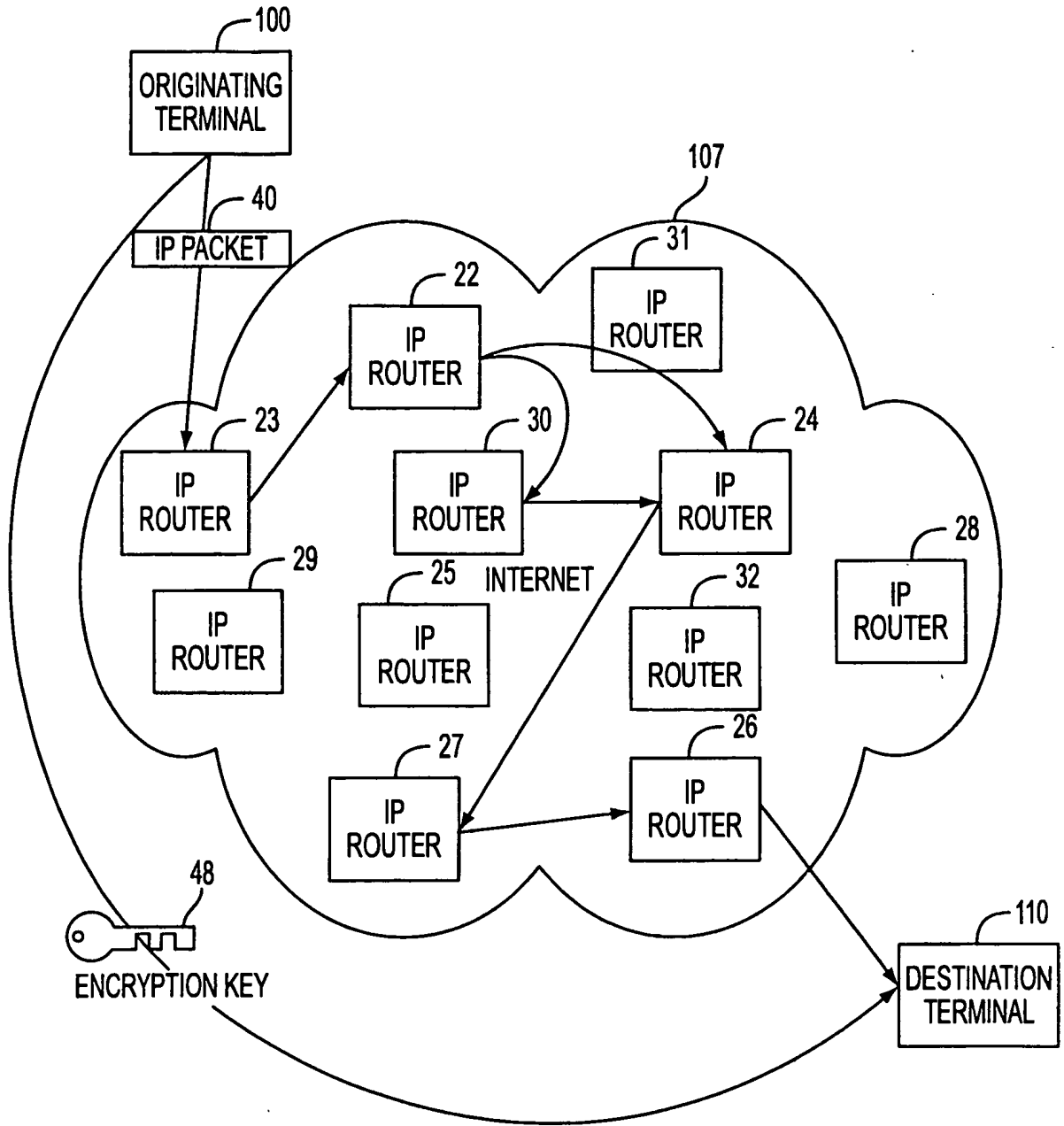

FIG. 1

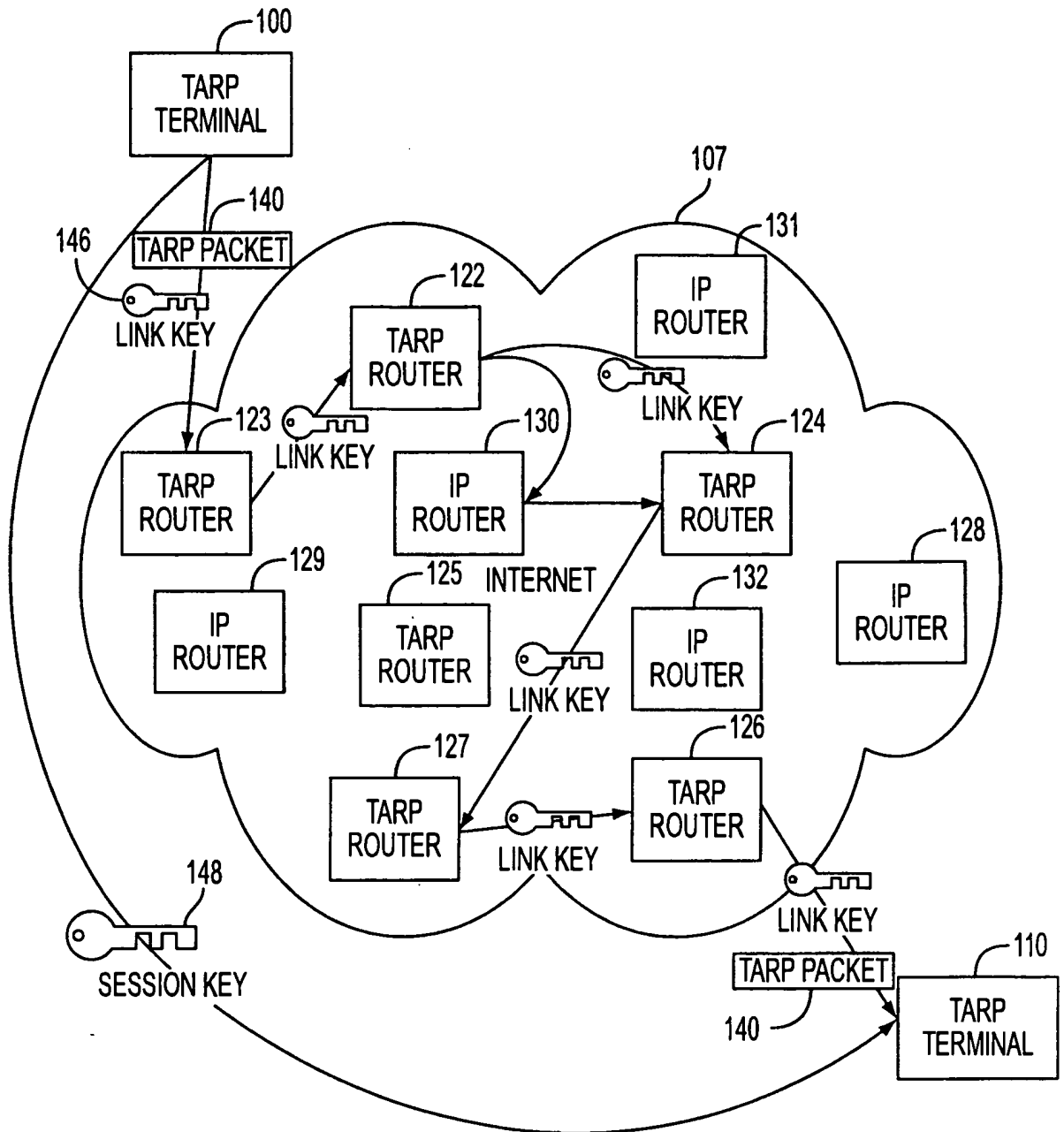

FIG. 2

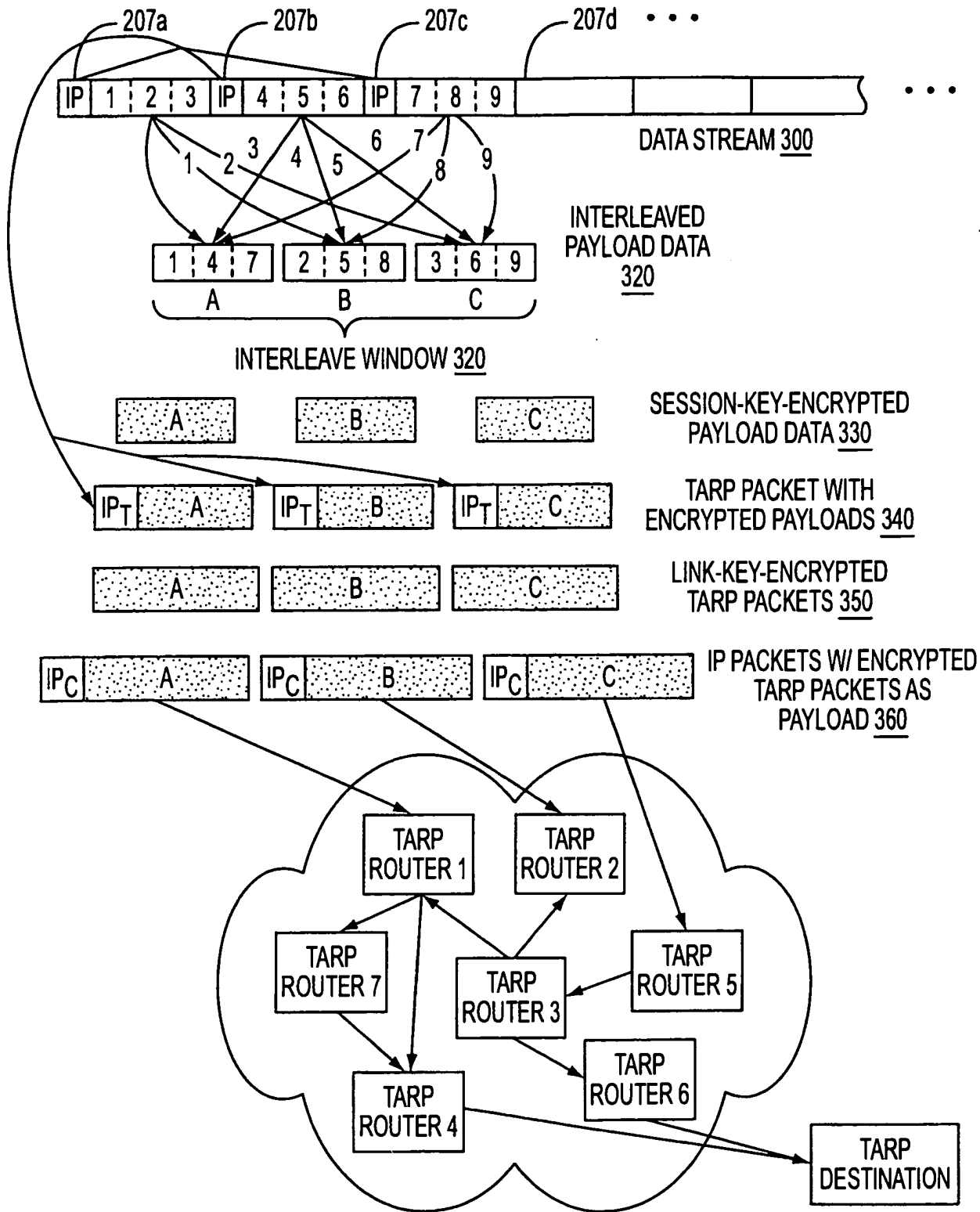

FIG. 3A

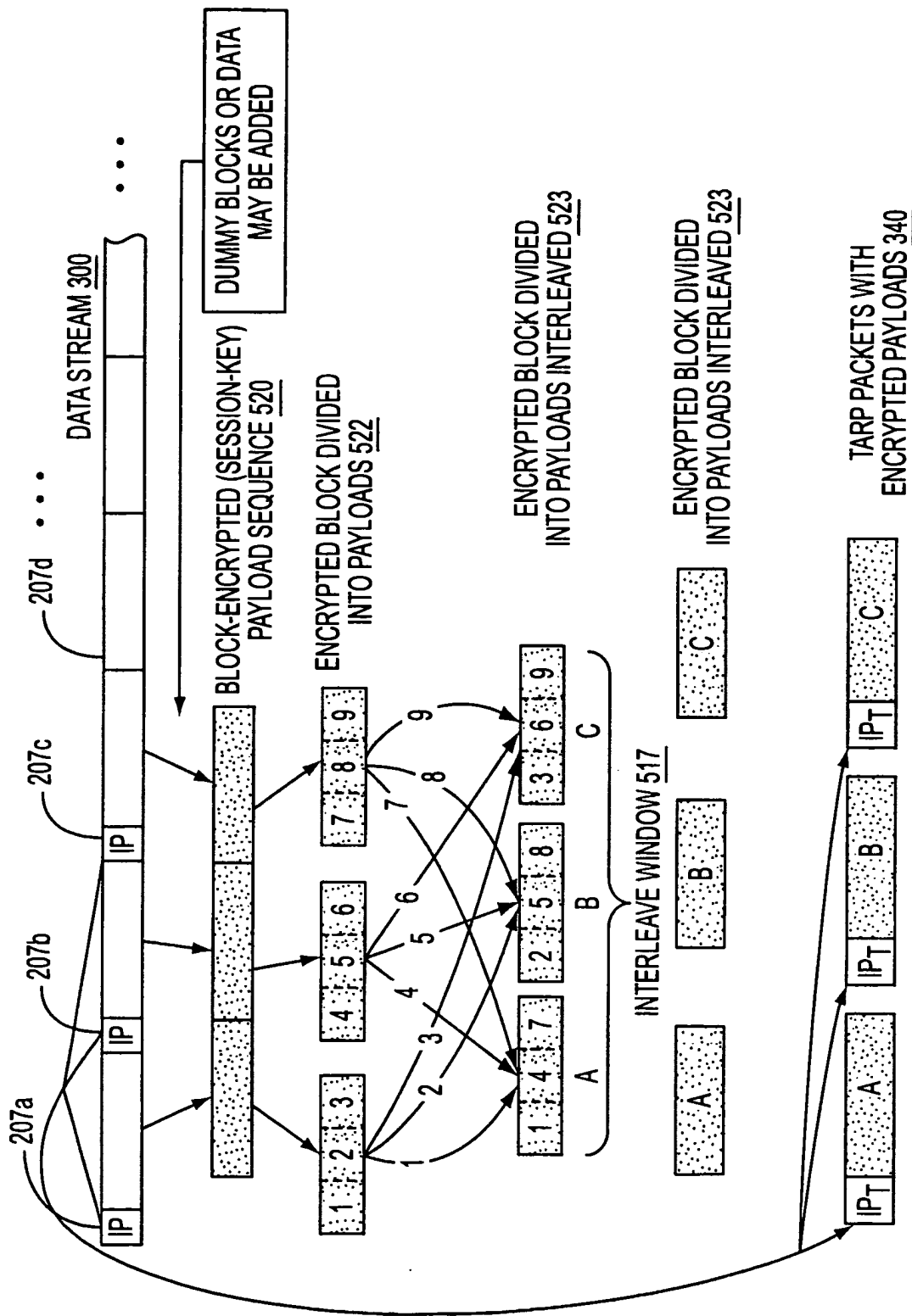

FIG. 3B

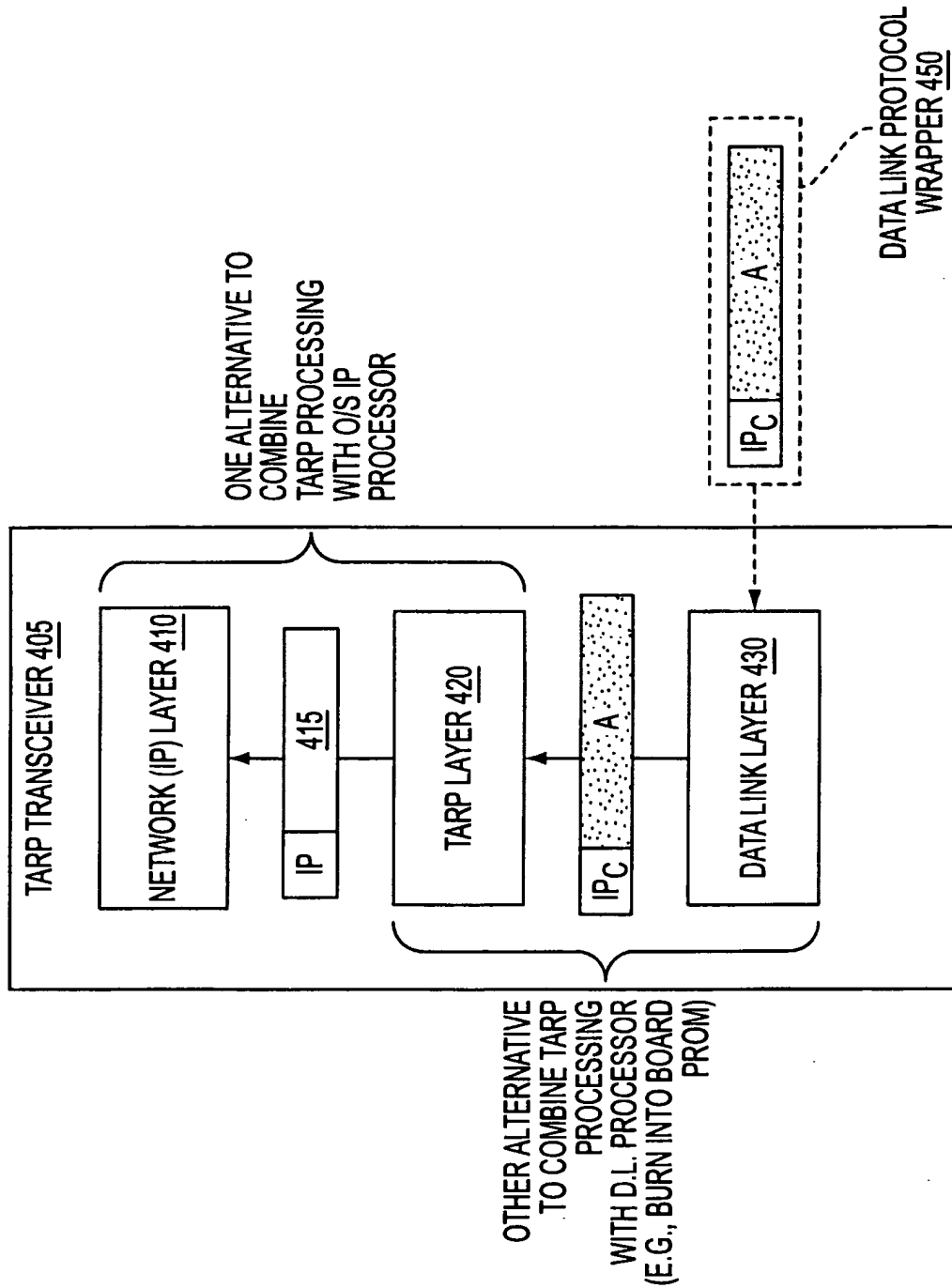

FIG. 4

6/35

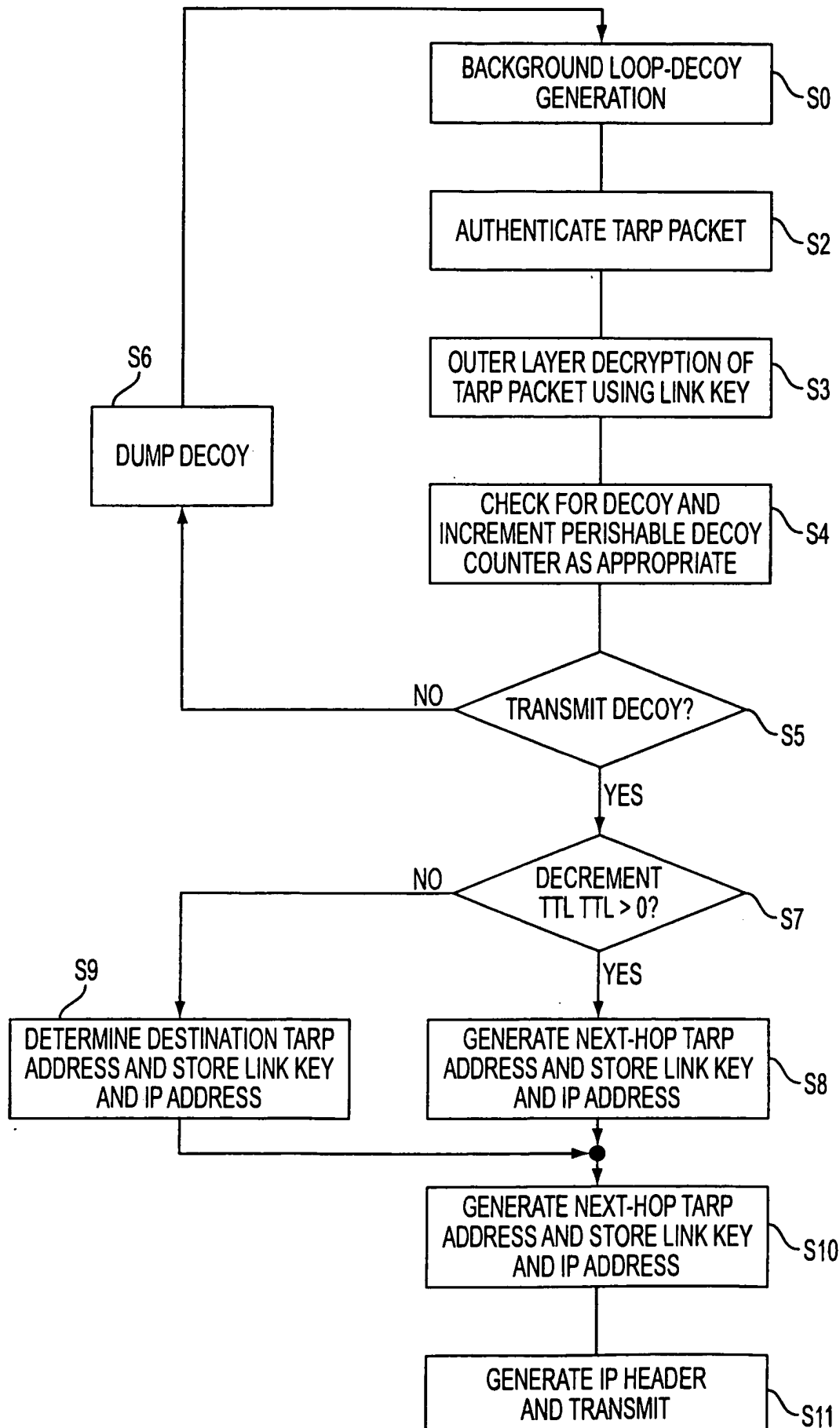

FIG. 5

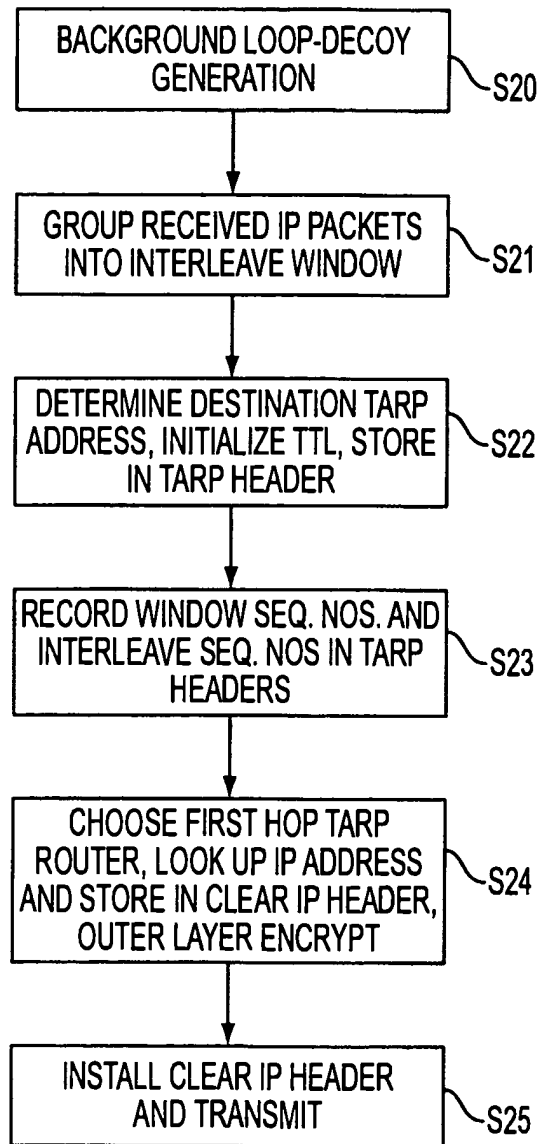

FIG. 6

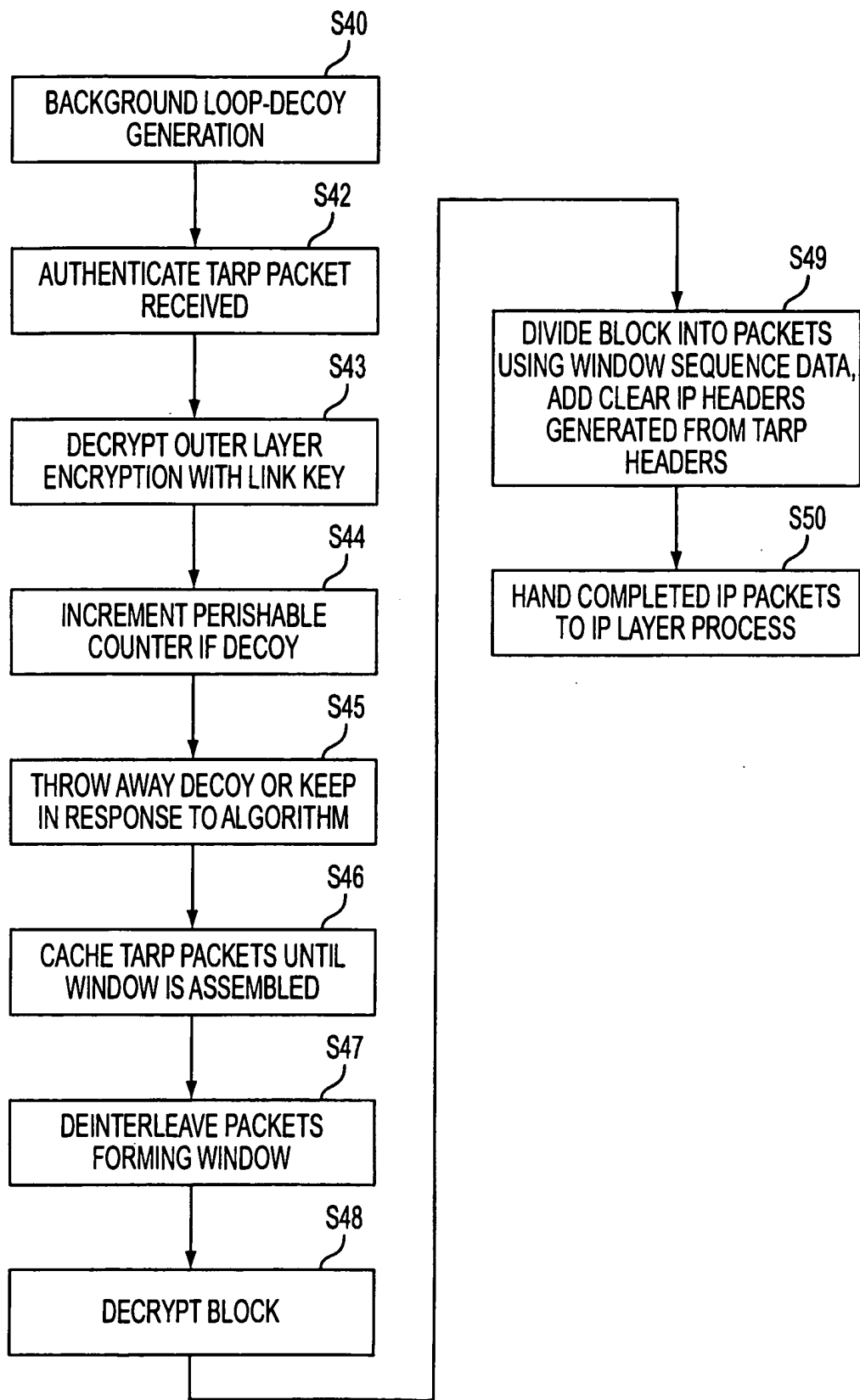

FIG. 7

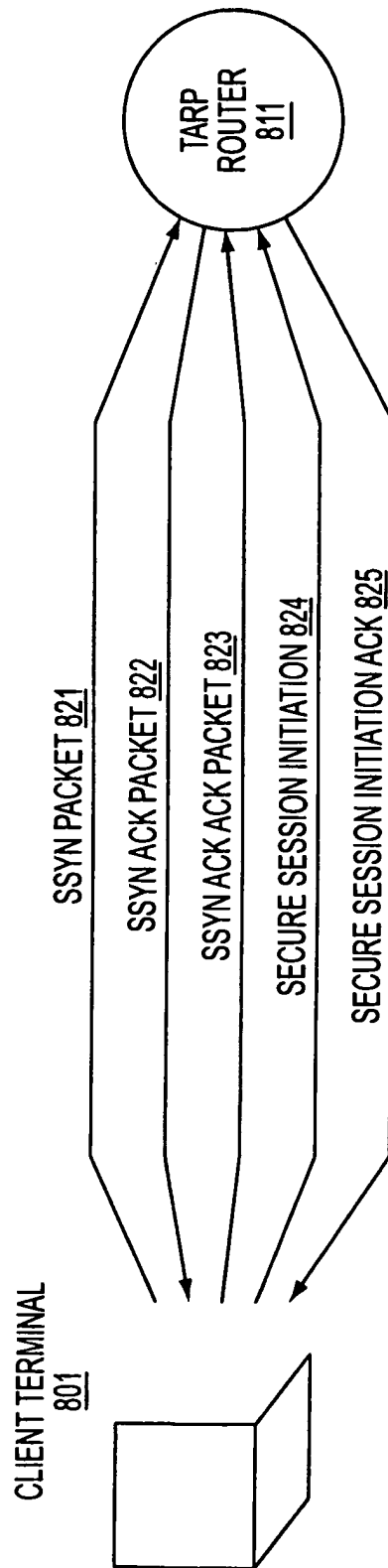
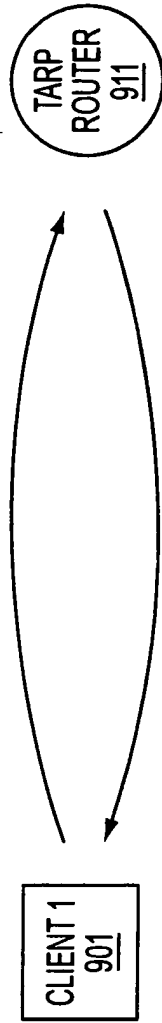

FIG. 8

10/35



TRANSMIT TABLE 921

131.218.204.98	,	131.218.204.65
131.218.204.221	,	131.218.204.97
131.218.204.139	,	131.218.204.186
131.218.204.12	,	131.218.204.55
.	,	.
.	,	.
.	,	.

RECEIVE TABLE 922

131.218.204.161	,	131.218.204.89
131.218.204.66	,	131.218.204.212
131.218.204.201	,	131.218.204.127
131.218.204.119	,	131.218.204.49
.	,	.
.	,	.
.	,	.

RECEIVE TABLE 924

131.218.204.98	,	131.218.204.65
131.218.204.221	,	131.218.204.97
131.218.204.139	,	131.218.204.186
131.218.204.12	,	131.218.204.55
.	,	.
.	,	.
.	,	.

TRANSMIT TABLE 923

131.218.204.161	,	131.218.204.89
131.218.204.66	,	131.218.204.212
131.218.204.201	,	131.218.204.127
131.218.204.119	,	131.218.204.49
.	,	.
.	,	.
.	,	.

FIG. 9

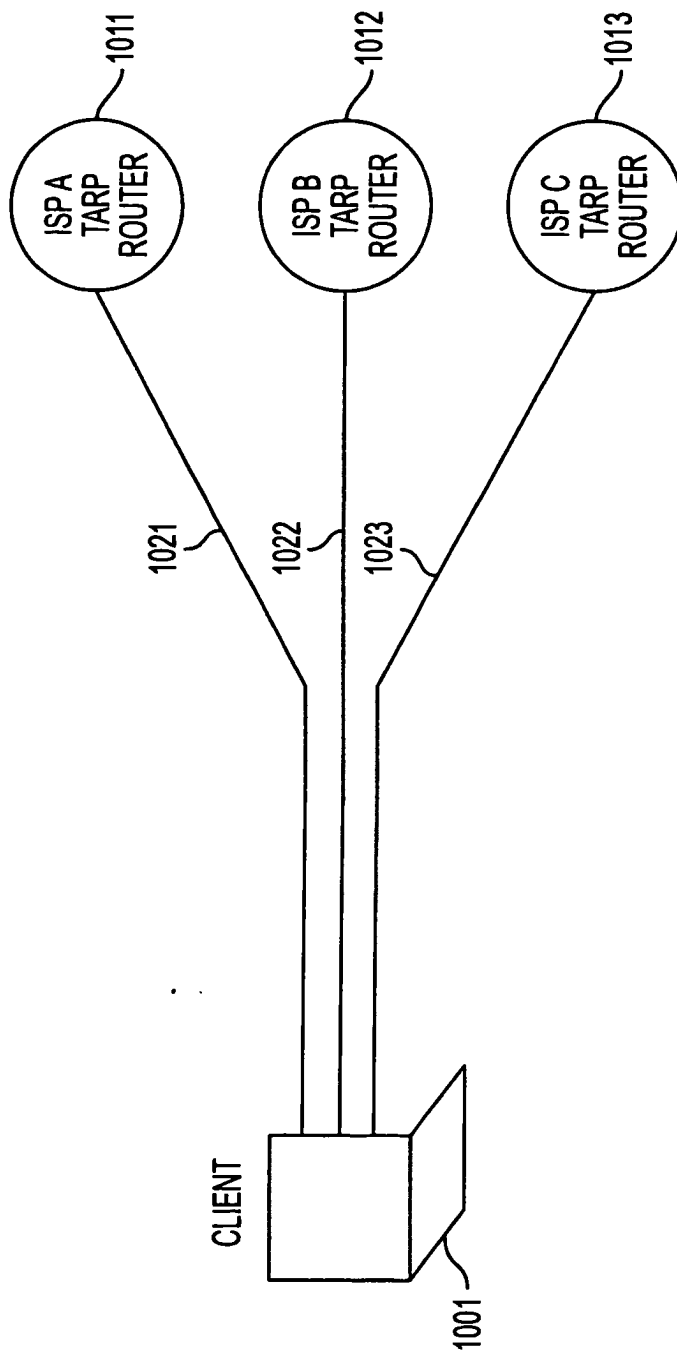

FIG. 10

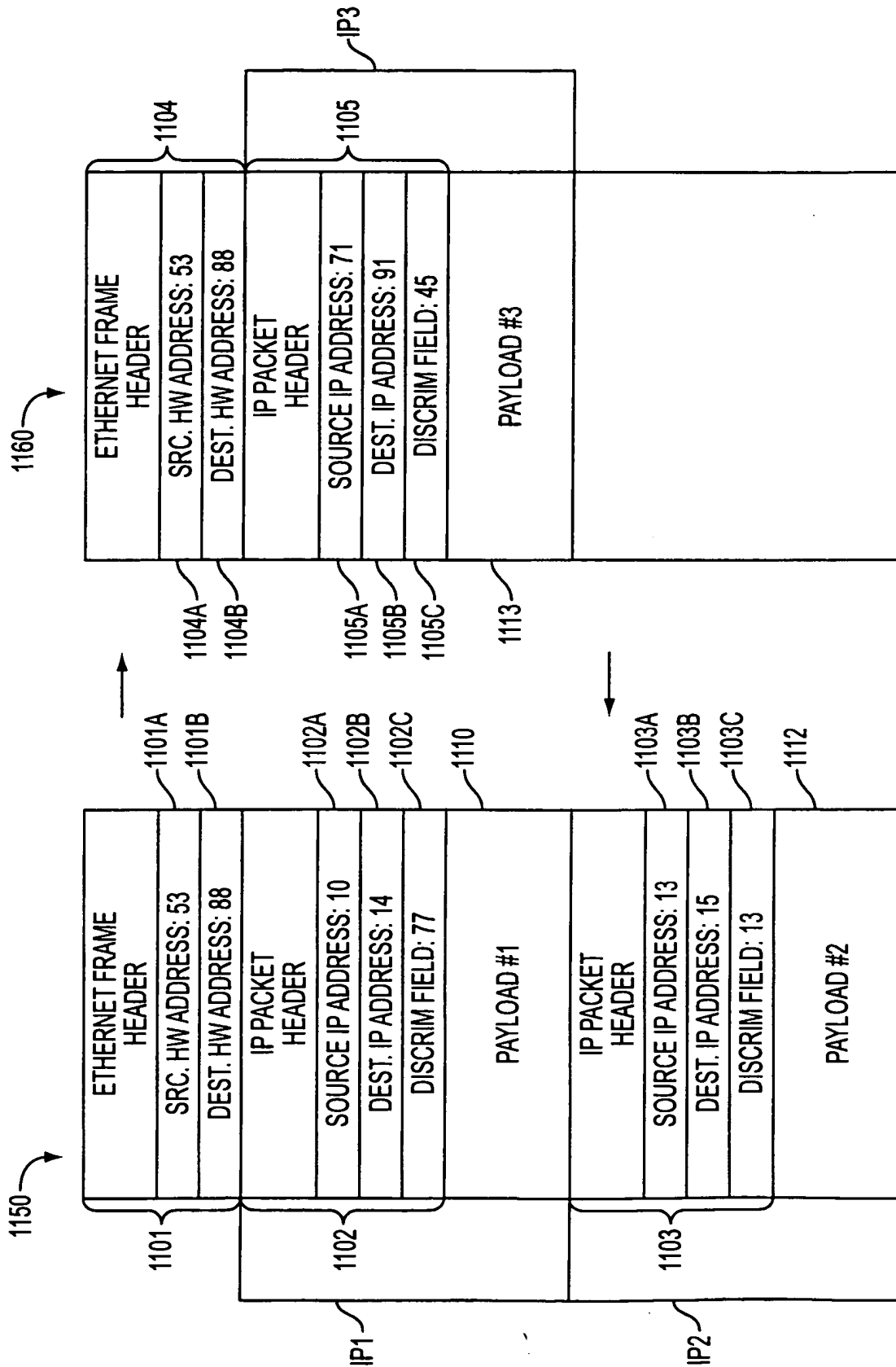

FIG. 11

13/35

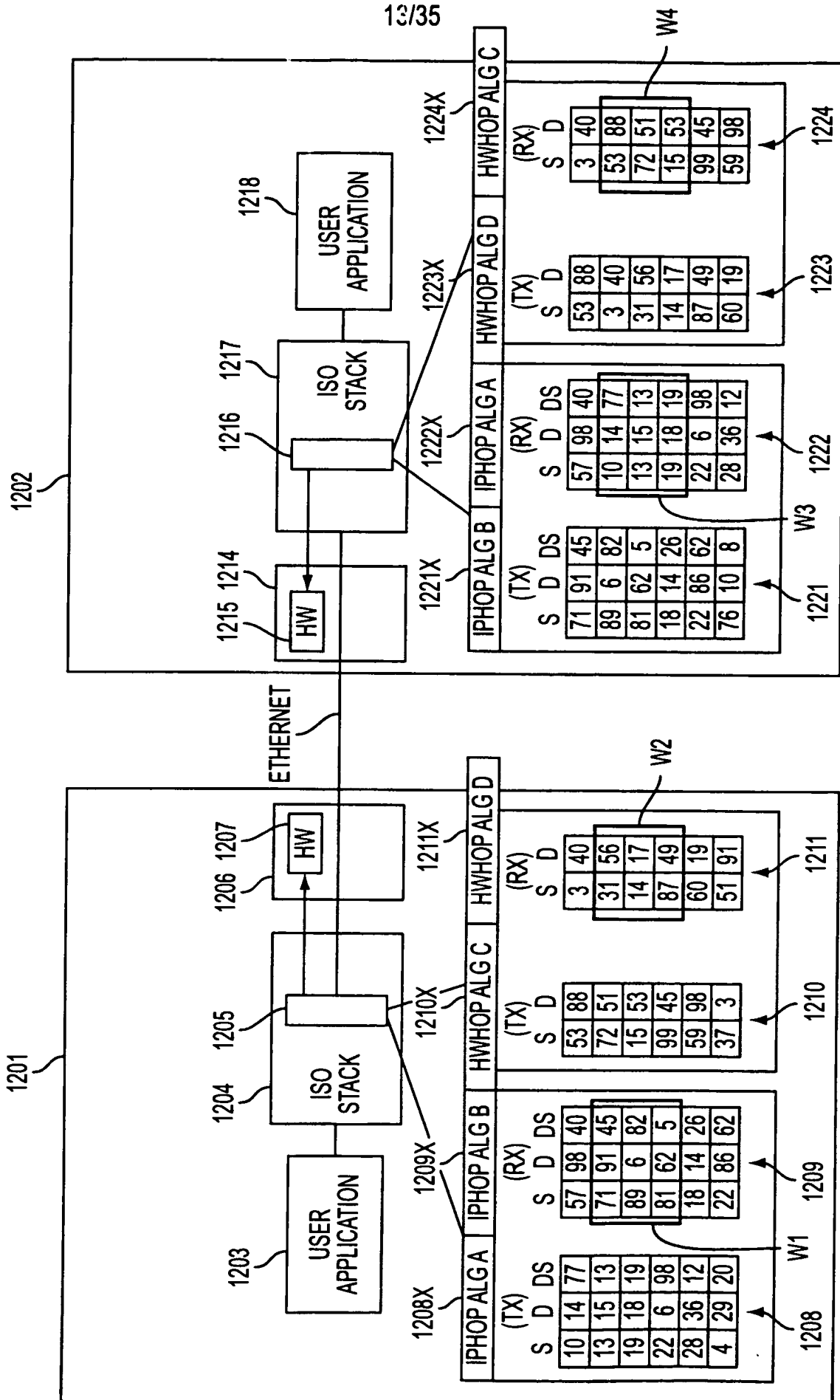

FIG. 12A

MODE OR EMBODIMENT	HARDWARE ADDRESSES	IP ADDRESSES	DISCRIMINATOR FIELD VALUES
1. PROMISCUOUS	SAME FOR ALL NODES OR COMPLETELY RANDOM	CAN BE VARIED IN SYNC	CAN BE VARIED IN SYNC
2. PROMISCUOUS PER VPN	FIXED FOR EACH VPN	CAN BE VARIED IN SYNC	CAN BE VARIED IN SYNC
3. HARDWARE HOPPING	CAN BE VARIED IN SYNC	CAN BE VARIED IN SYNC	CAN BE VARIED IN SYNC

FIG. 12B

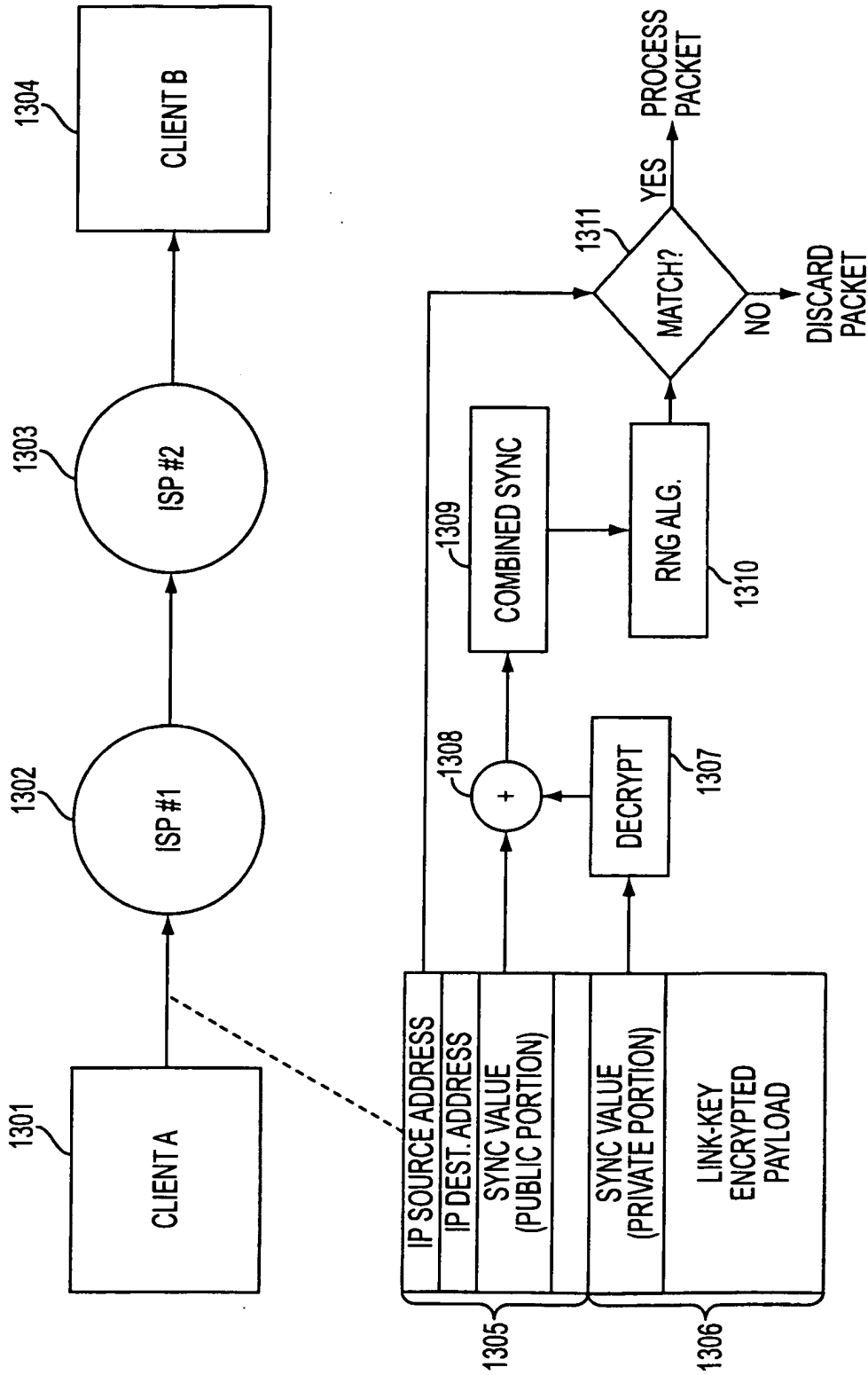

FIG. 13

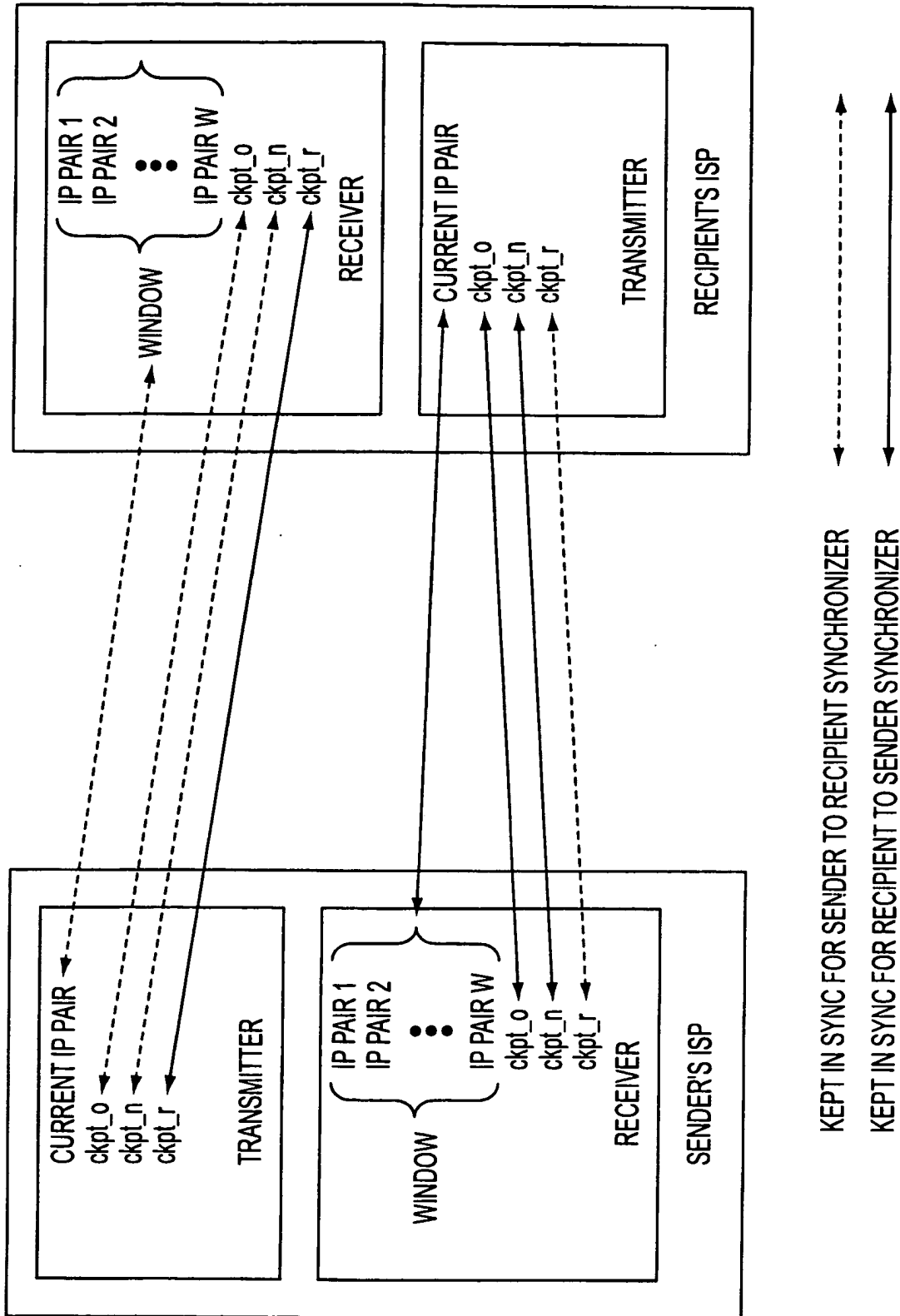

FIG. 14

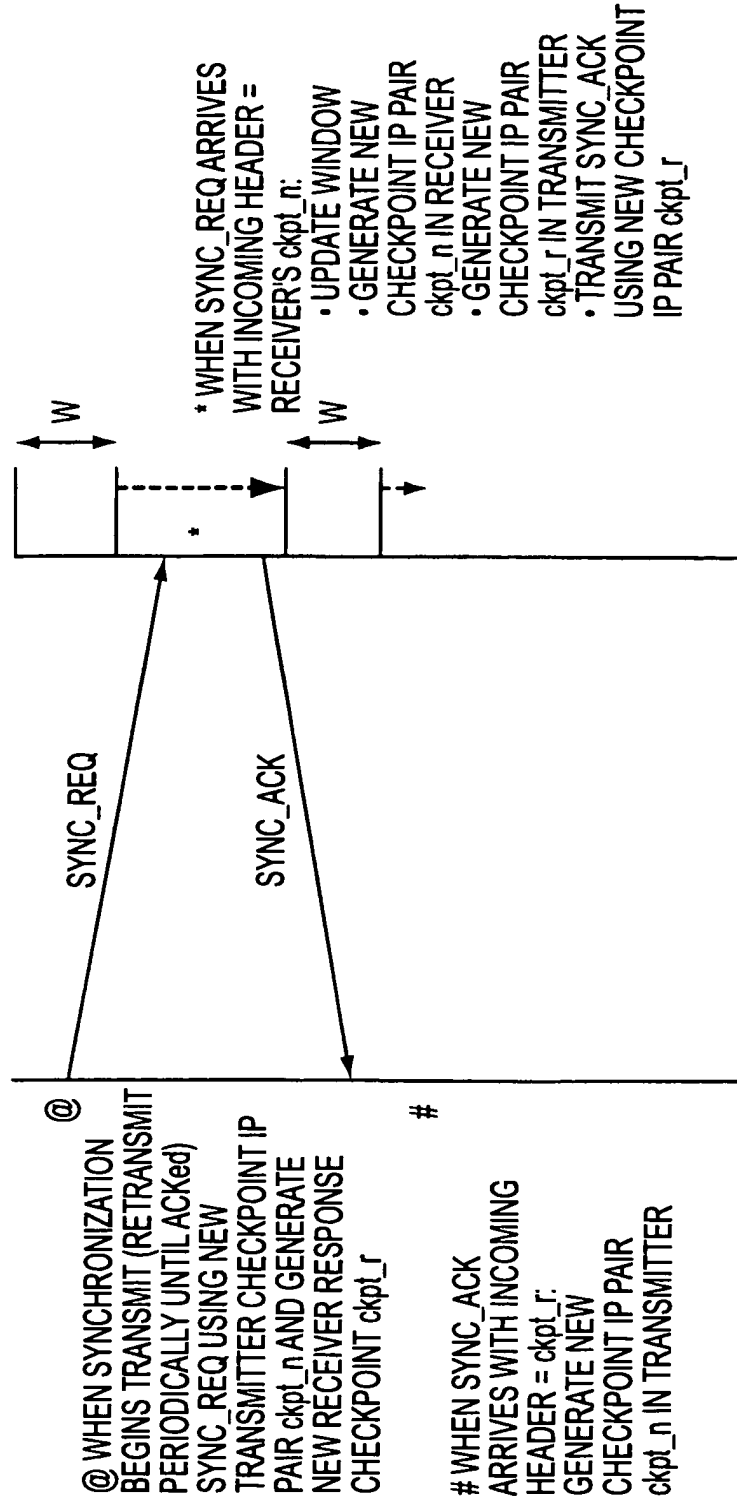

FIG. 15

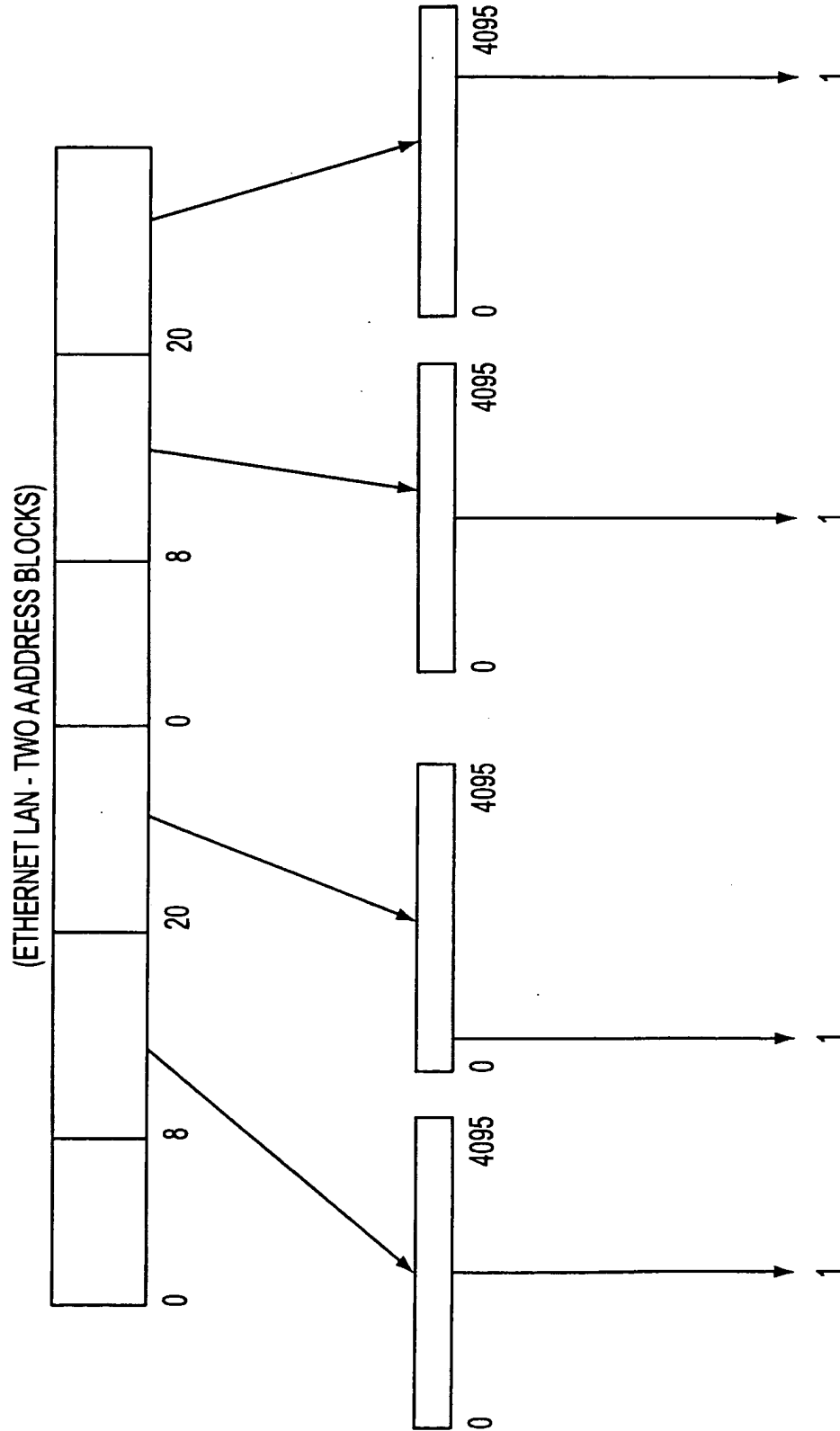

FIG. 16

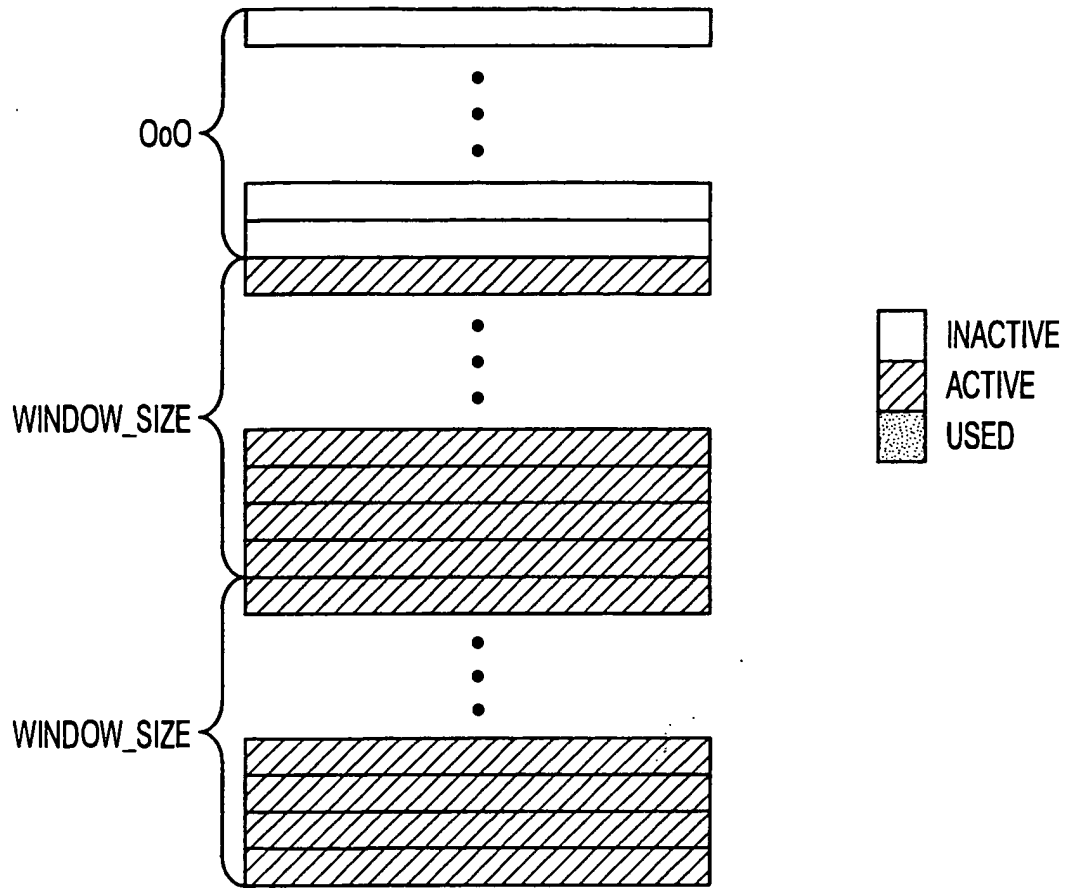

FIG. 17

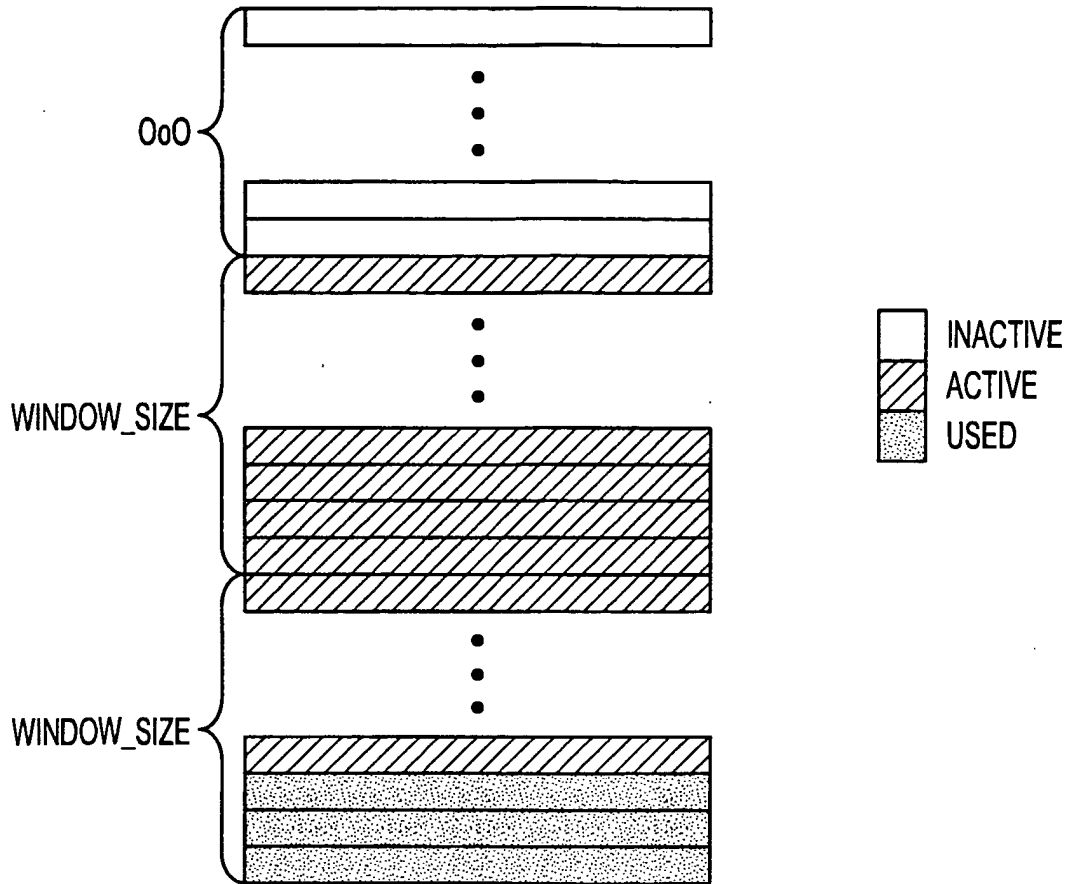

FIG. 18

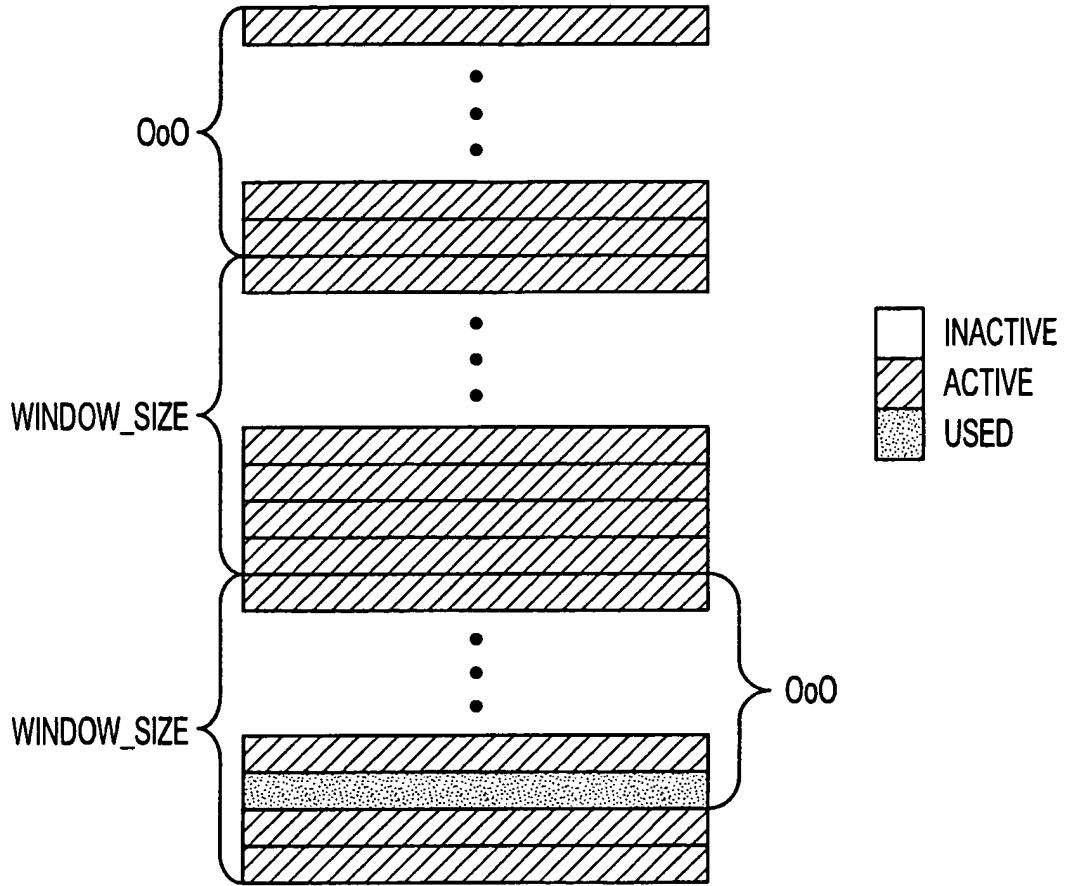

FIG. 19

22/35

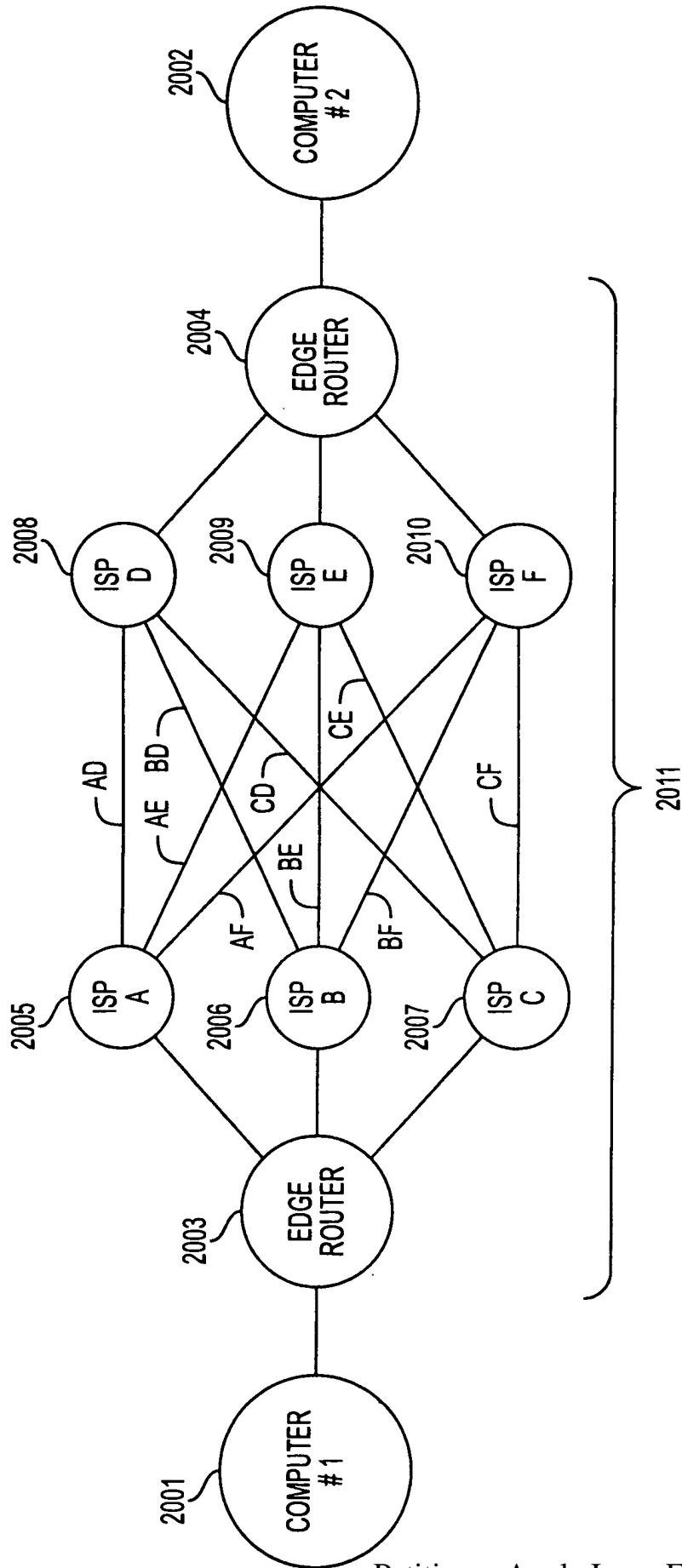

FIG. 20

23/35

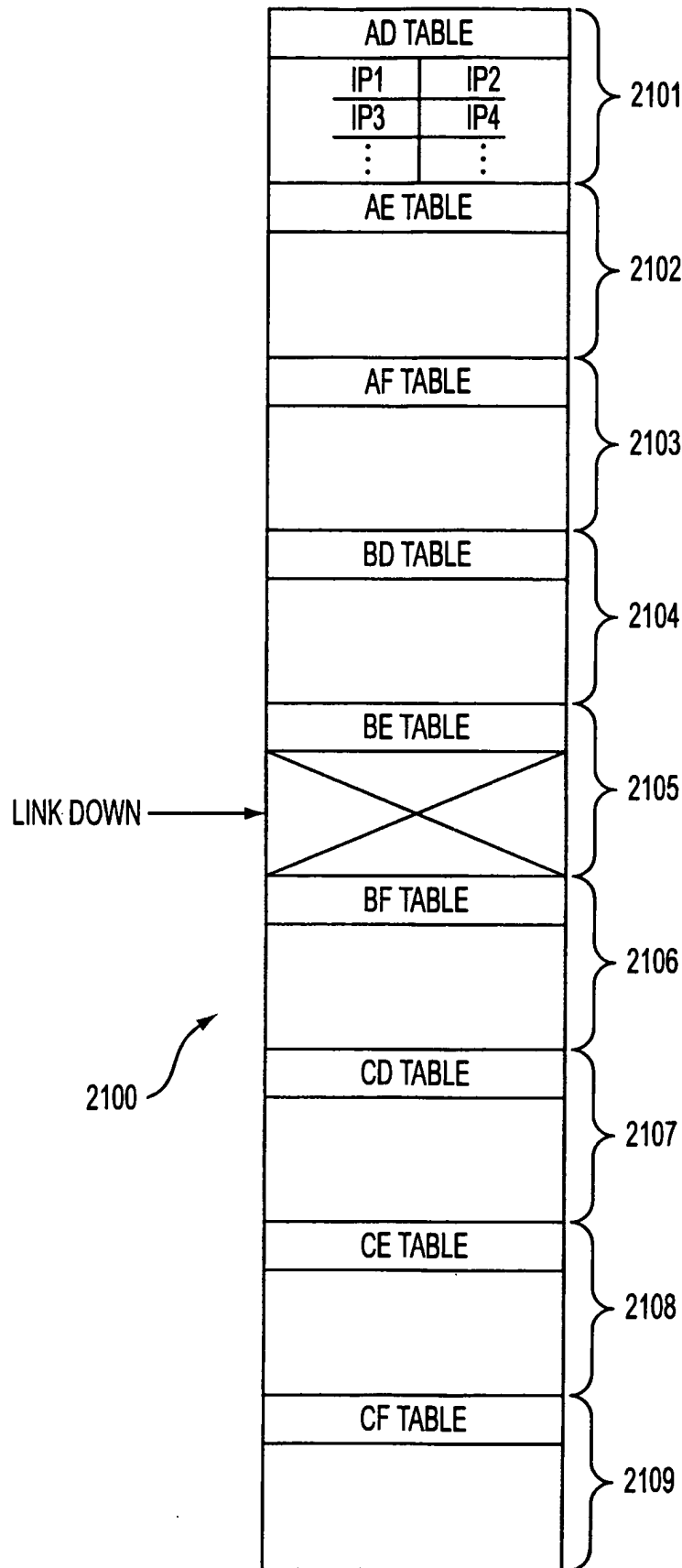

FIG. 21

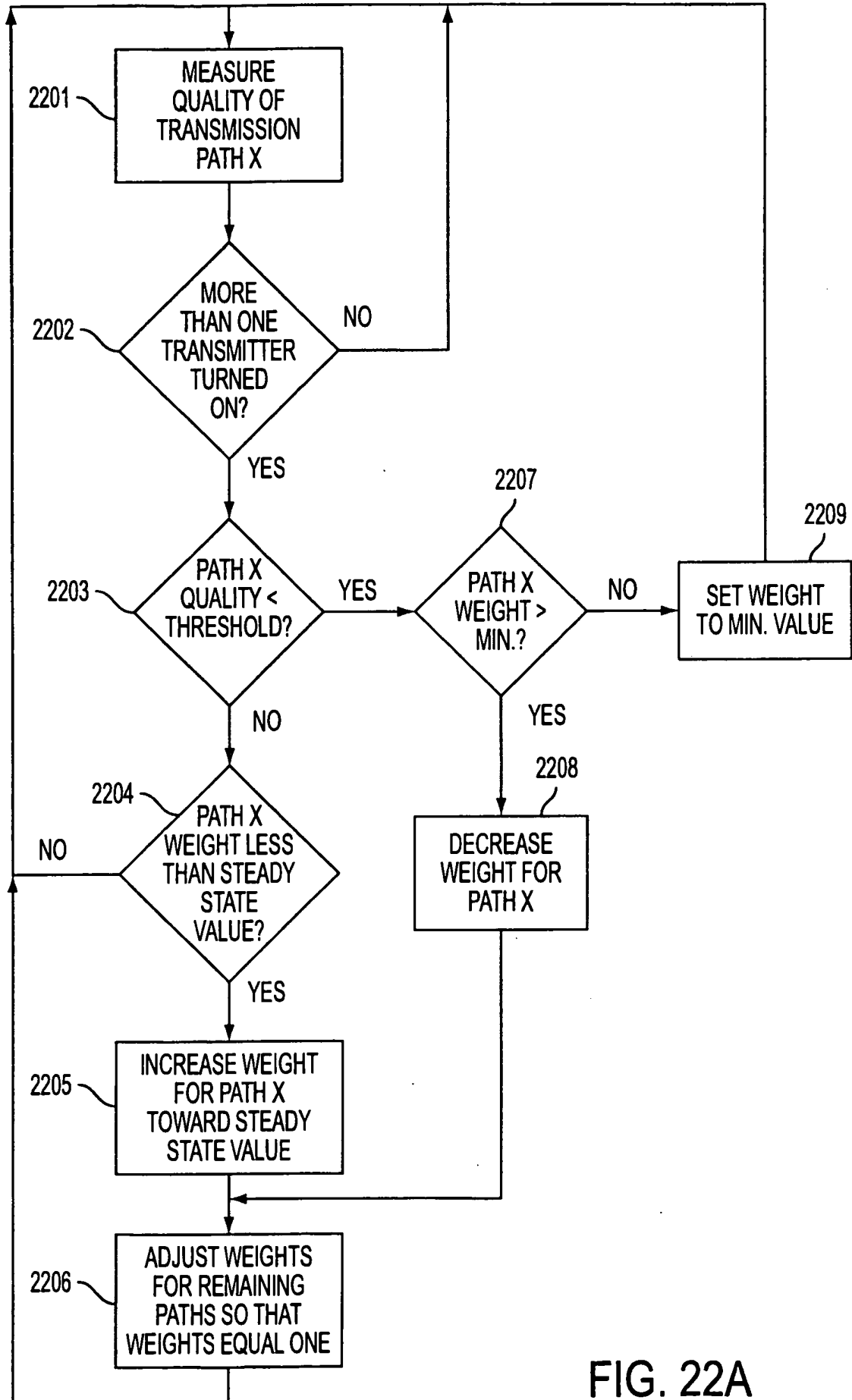

FIG. 22A

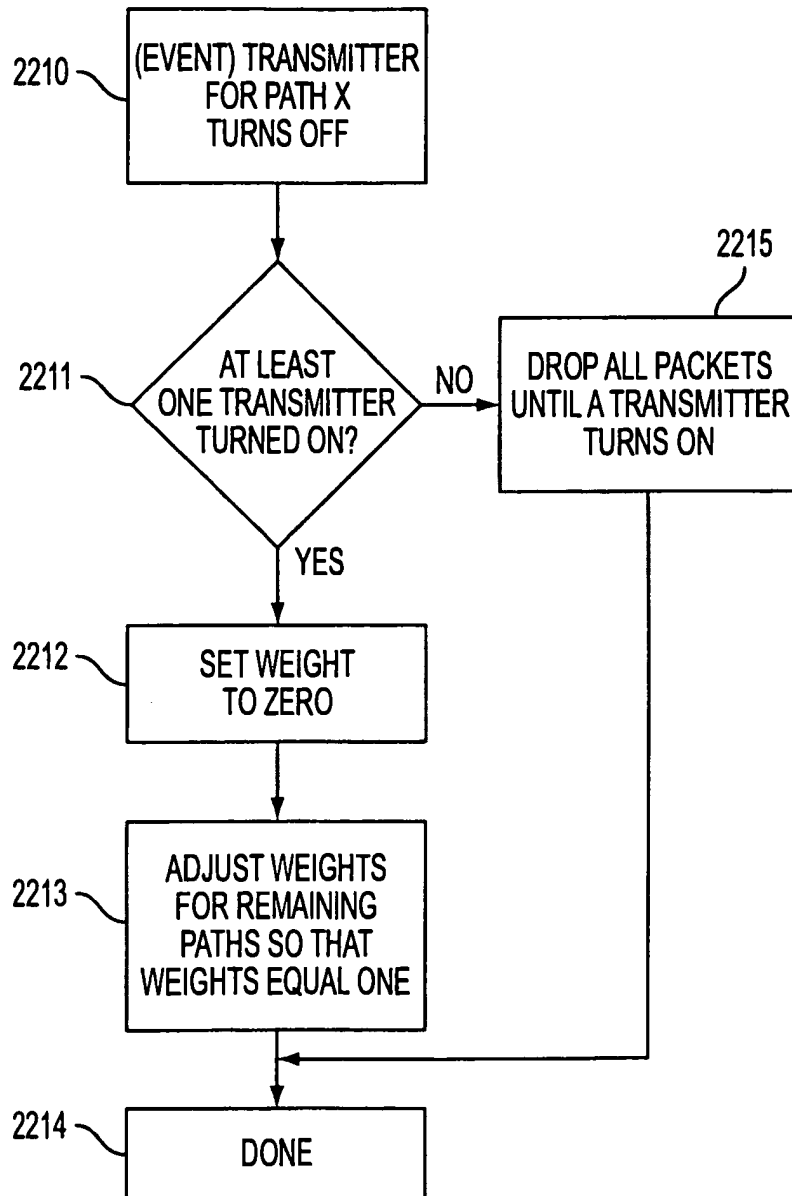

FIG. 22B

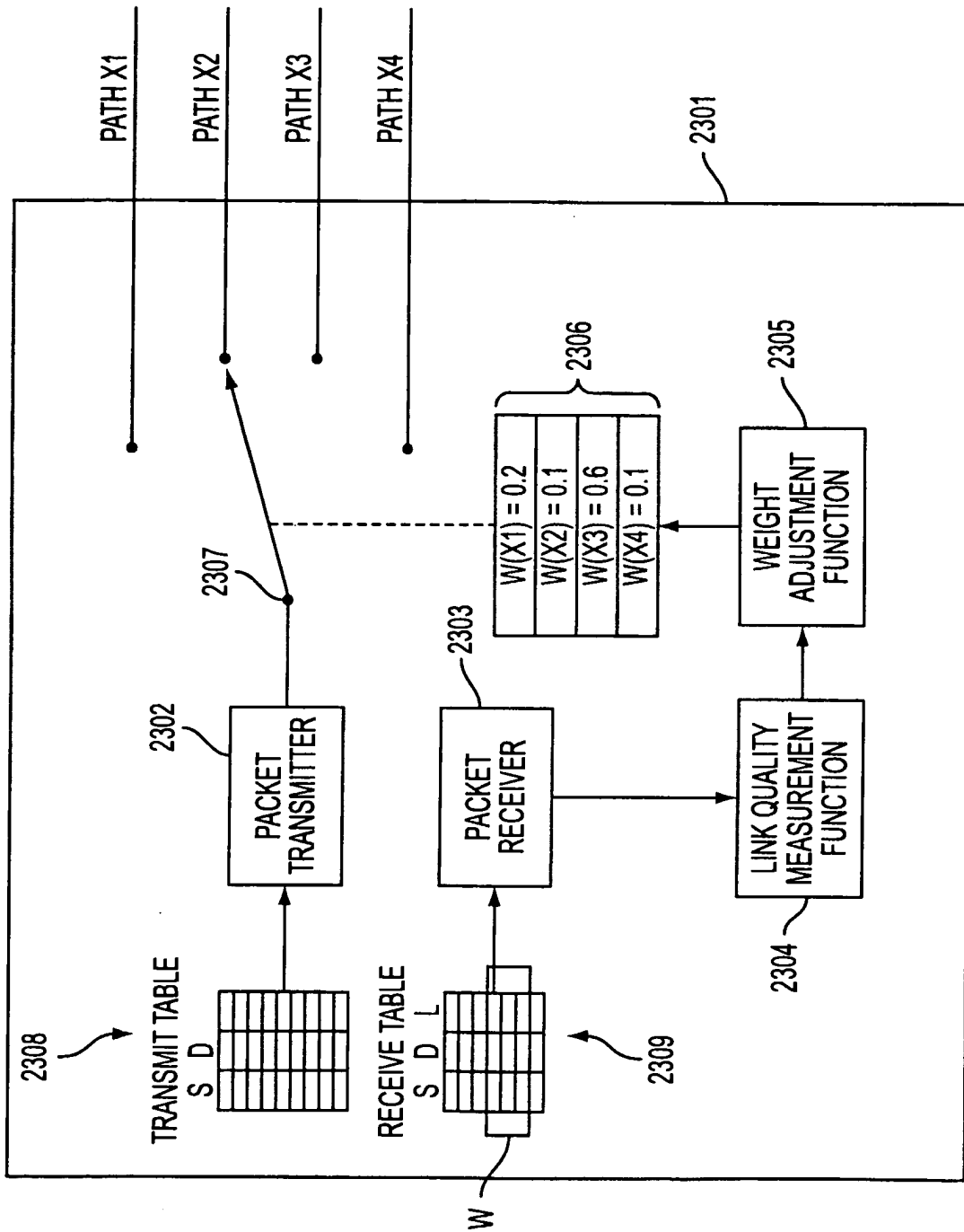

FIG. 23

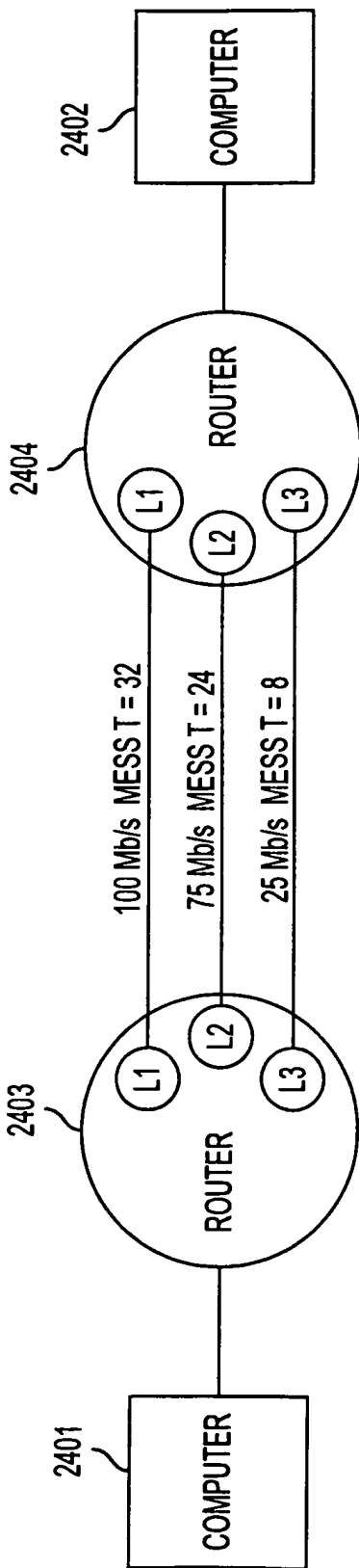

FIG. 24

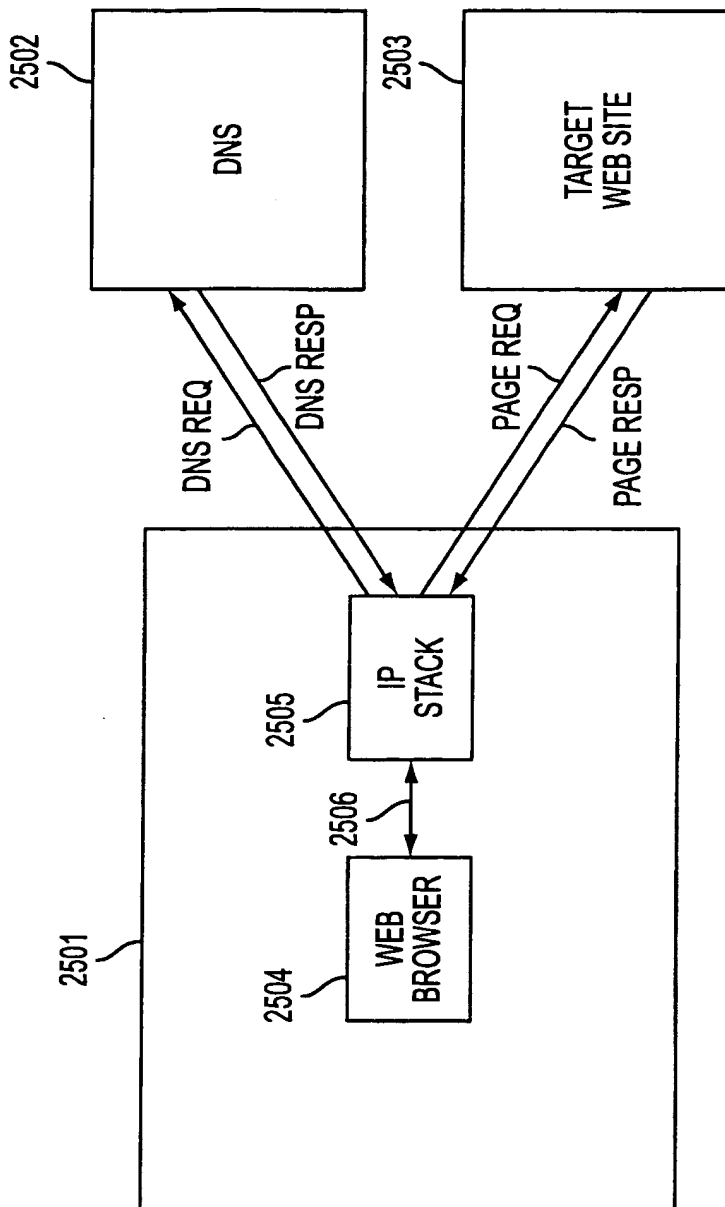

FIG. 25
(PRIOR ART)

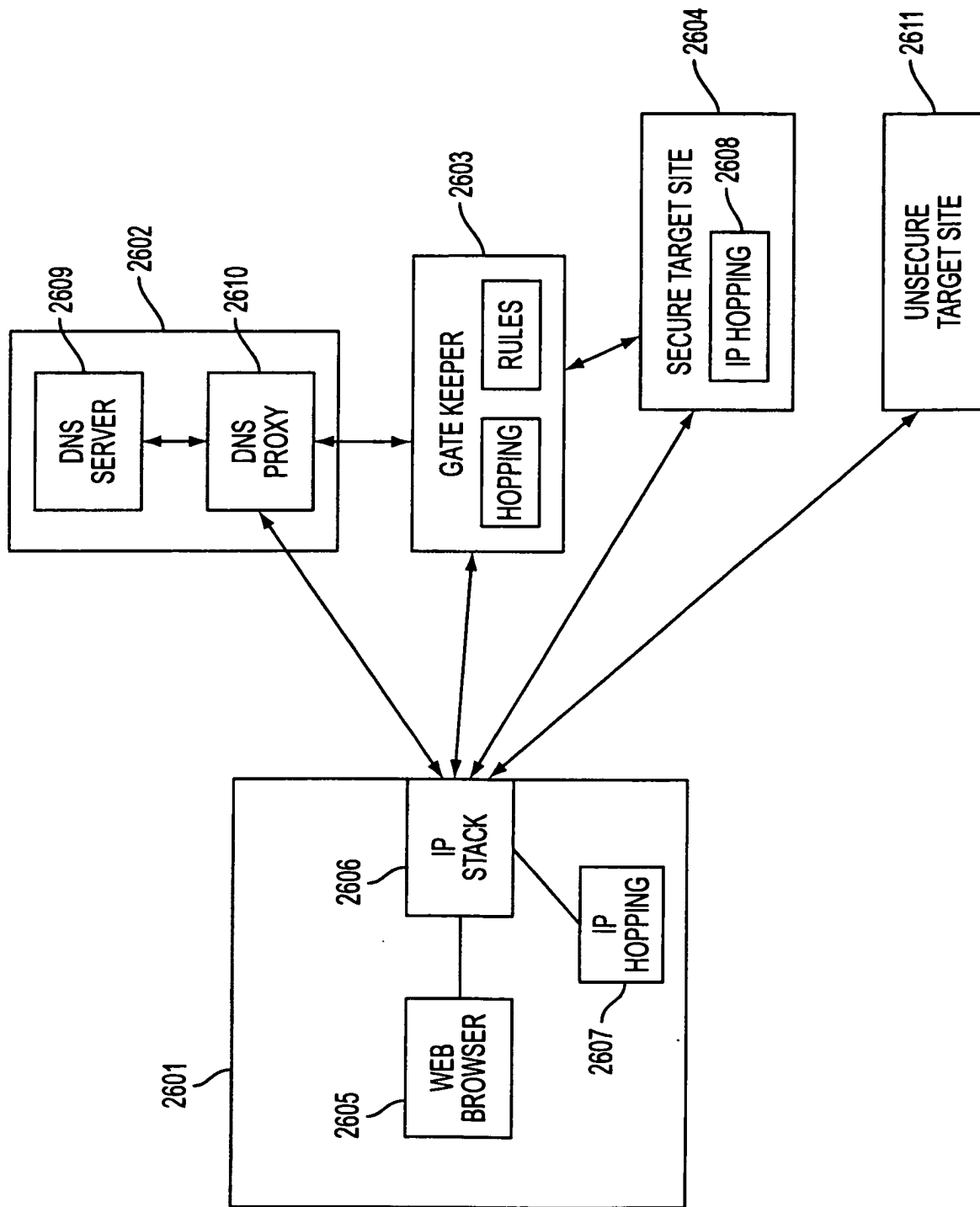

FIG. 26

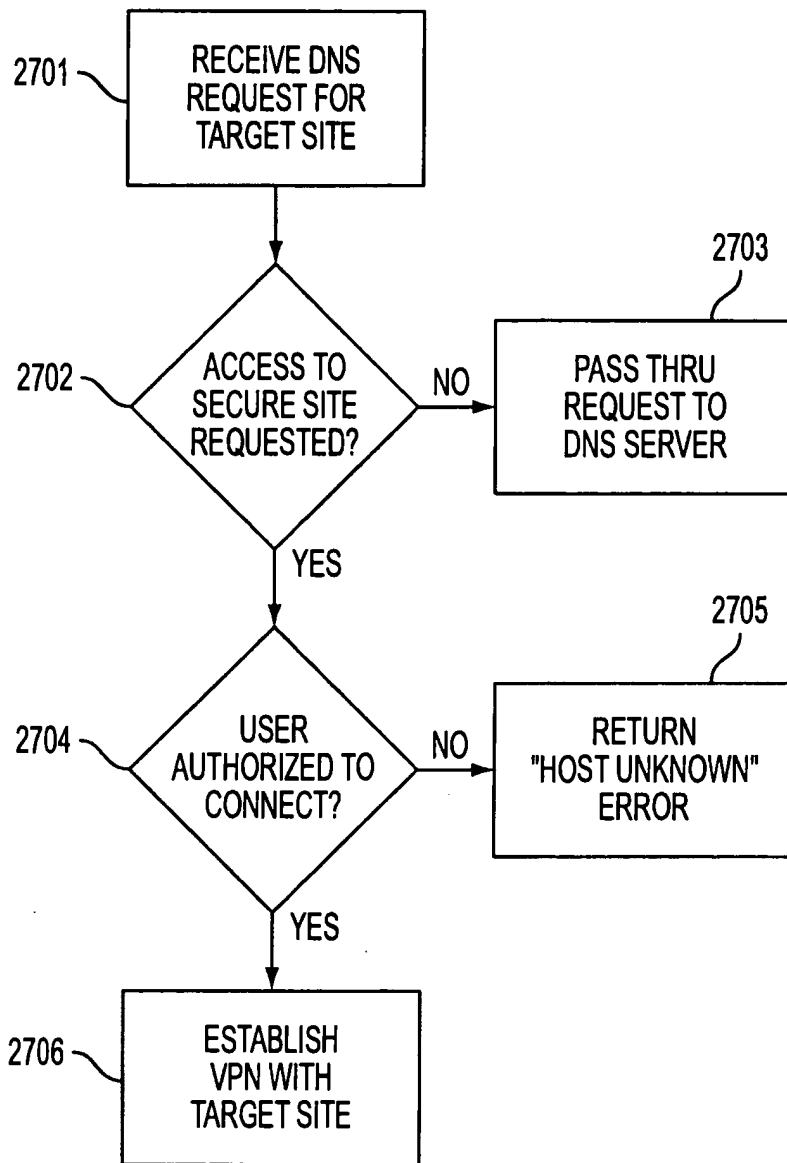

FIG. 27

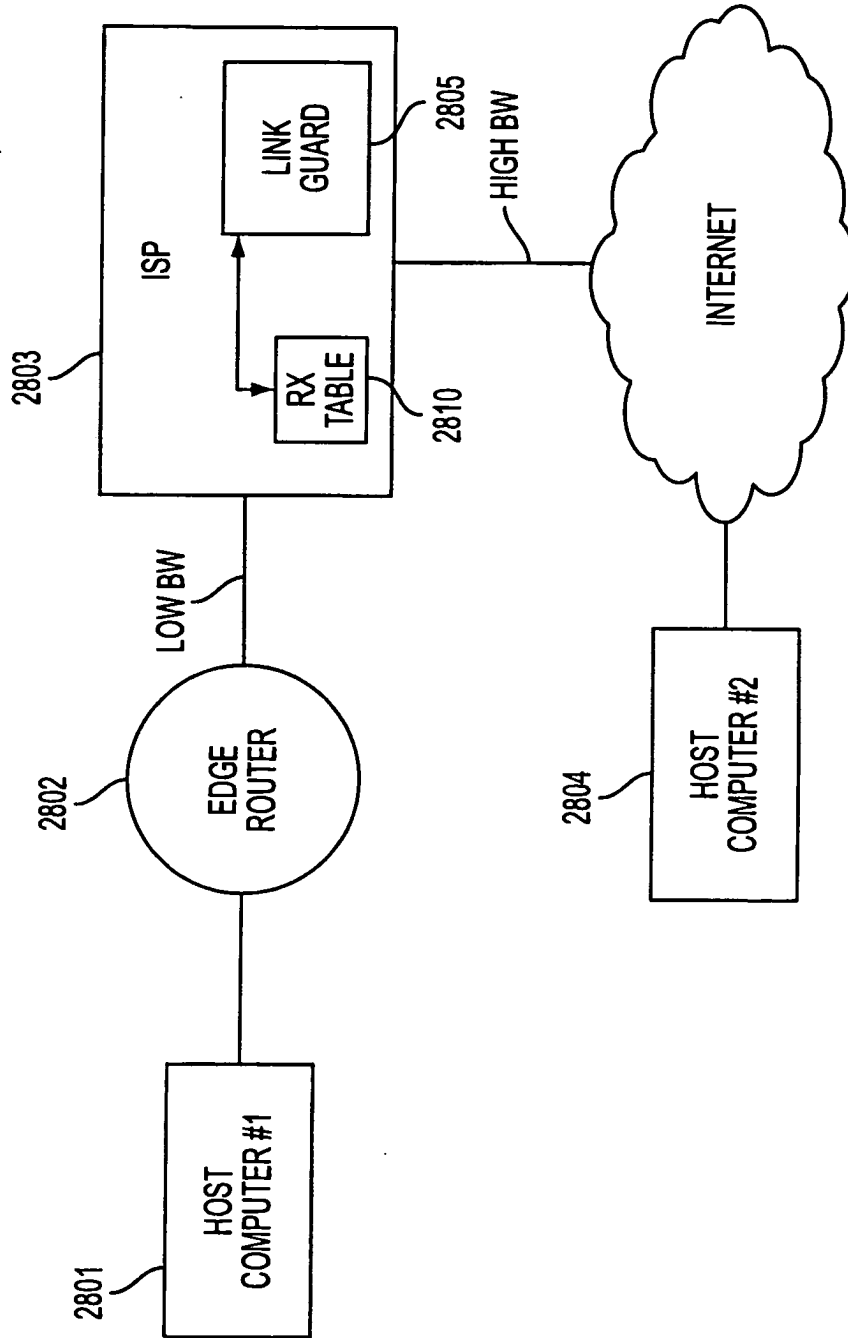

FIG. 28

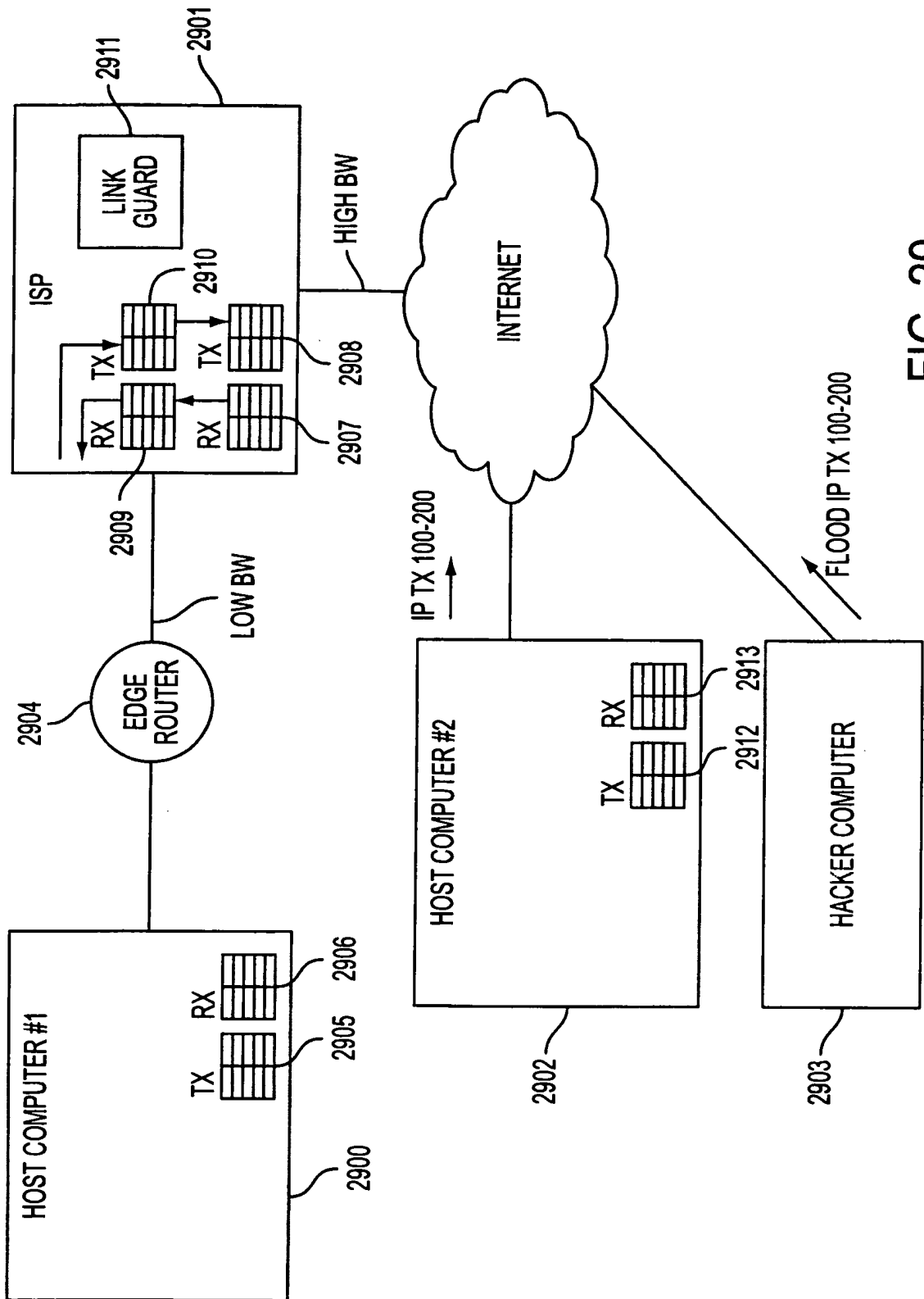

FIG. 29

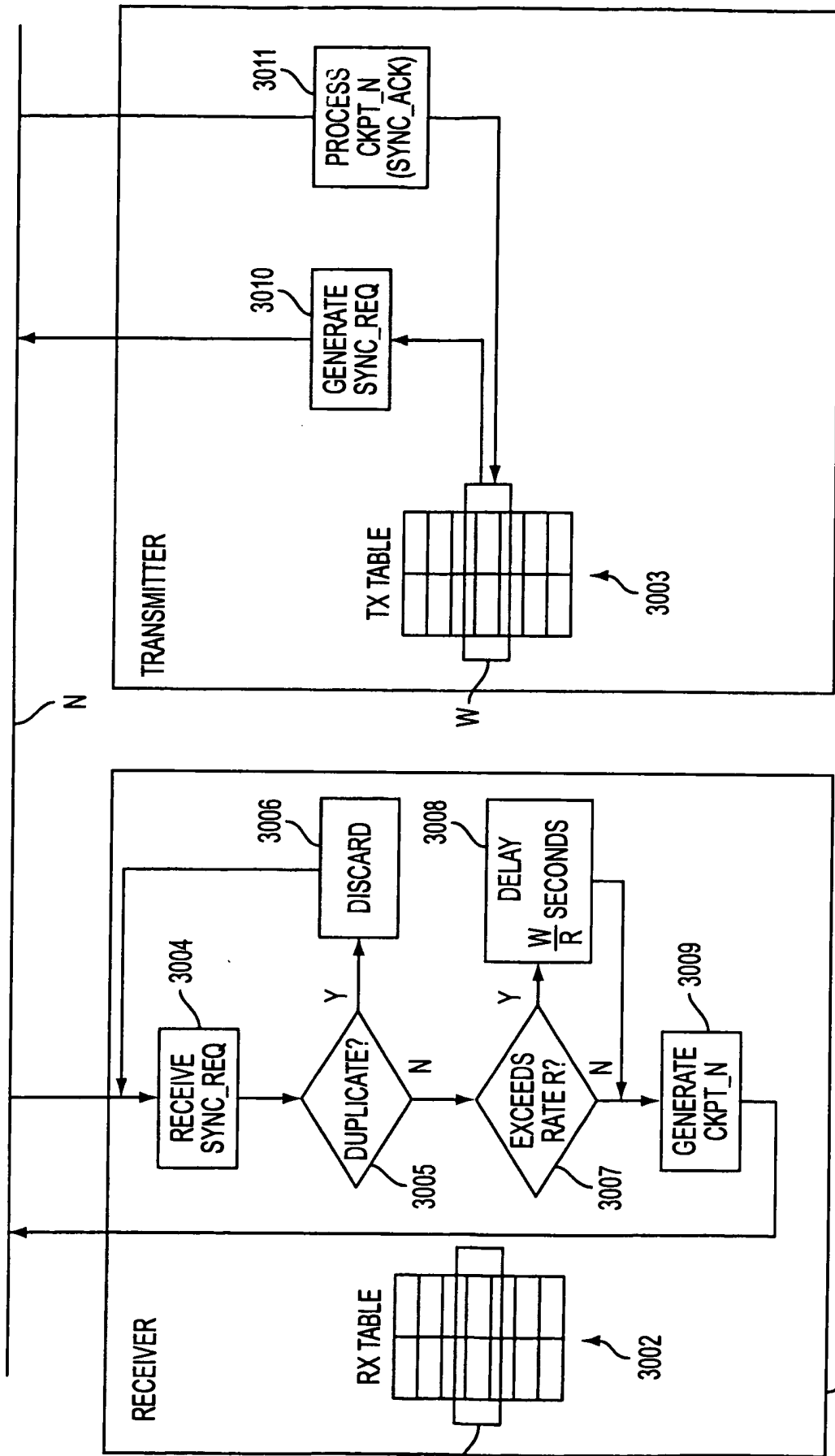

FIG. 30

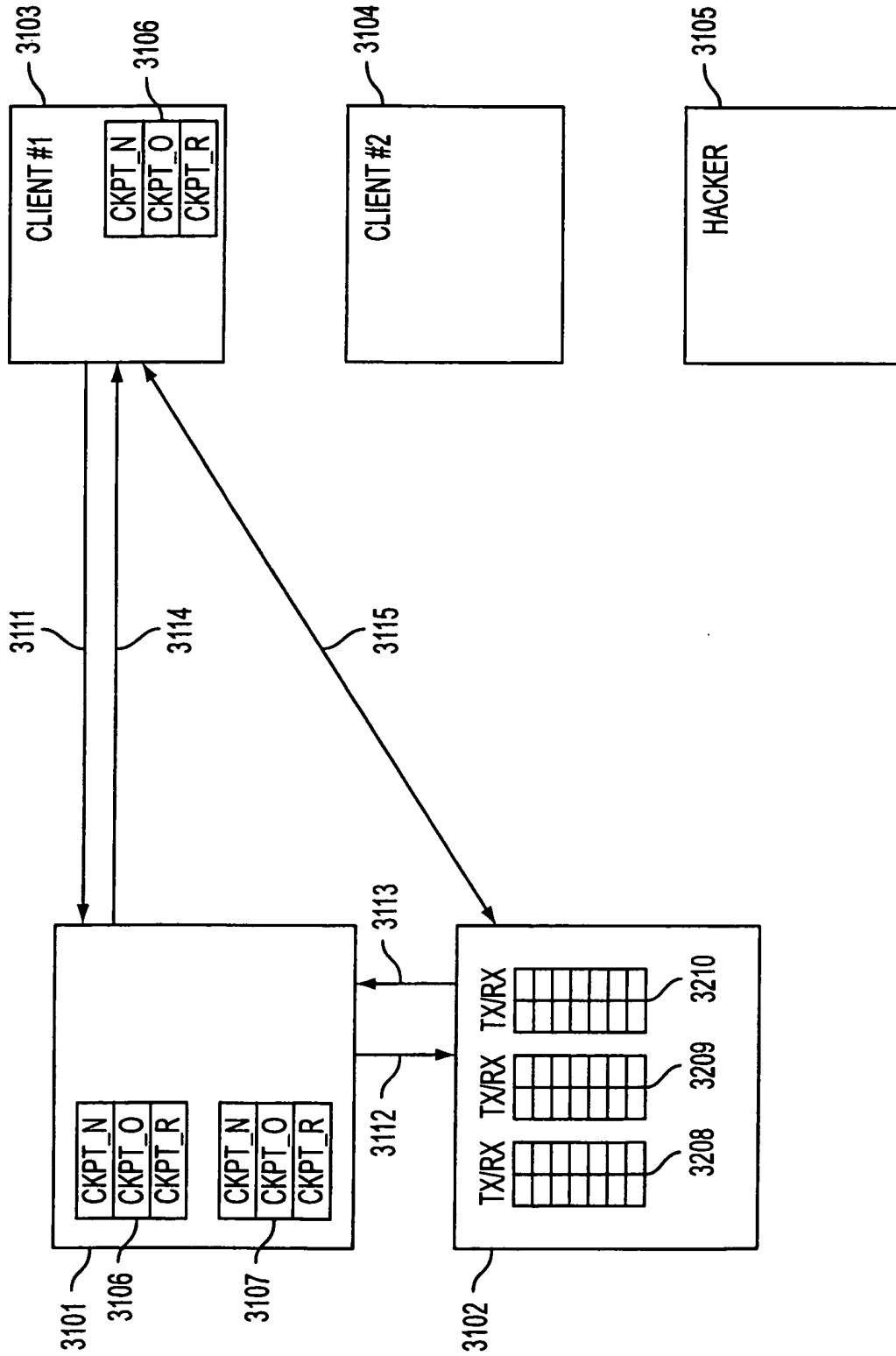

FIG. 31

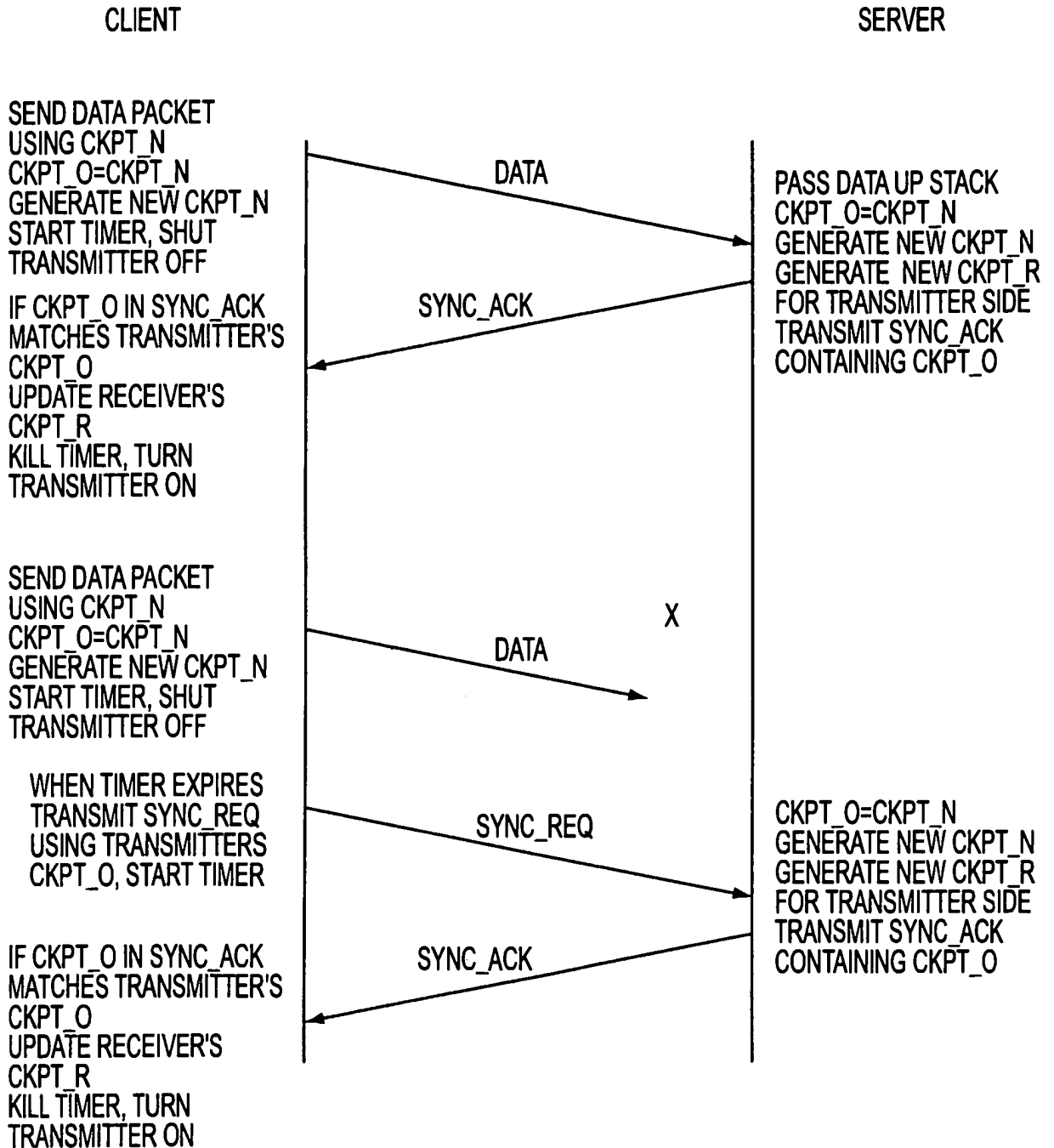

FIG. 32

(19) World Intellectual Property Organization
International Bureau



(43) International Publication Date
23 August 2001 (23.08.2001)

PCT

(10) International Publication Number
WO 01/061922 A3

- (51) International Patent Classification⁷: **H04L 12/56**, 29/06, 12/46
- (71) Applicant (for all designated States except US): **SCIENCE APPLICATIONS INTERNATIONAL CORPORATION** [US/US]; 10260 Campus Point Drive, San Diego, CA 92121 (US).
- (21) International Application Number: PCT/US01/04340
- (22) International Filing Date: 12 February 2001 (12.02.2001)
- (72) Inventors; and (75) Inventors/Applicants (for US only): **MUNGER, Edmund, Colby** [US/US]; 1101 Opaca Court, Crownsville, MD 21032 (US). **SCHMIDT, Douglas, Charles** [US/US]; 230 Oak Court, Severna Park, MD 21146 (US). **SHORT, Robert, Dunham, III** [US/US]; 38710 Goose Creek Lane, Leesburg, VA 20175 (US). **LARSON, Victor** [US/US]; 12026 Lisa Marie Court, Fairfax, VA 22033 (US). **WILLIAMSON, Michael** [US/US]; 26203 Ocala Circle, South Riding, VA 20152 (US).
- (25) Filing Language: English
- (26) Publication Language: English
- (30) Priority Data: 09/504,783 15 February 2000 (15.02.2000) US
- (63) Related by continuation (CON) or continuation-in-part (CIP) to earlier application: US 09/504,783 (CON) Filed on 15 February 2000 (15.02.2000)
- (74) Agents: **WRIGHT, Bradley, C. et al.**; Banner & Witcoff, Ltd., 11th Floor, 1001 G Street, N.W., Washington, DC 20001-4597 (US).

[Continued on next page]

(54) Title: AGILE NETWORK PROTOCOL FOR SECURE COMMUNICATIONS WITH ASSURED SYSTEM AVAILABILITY

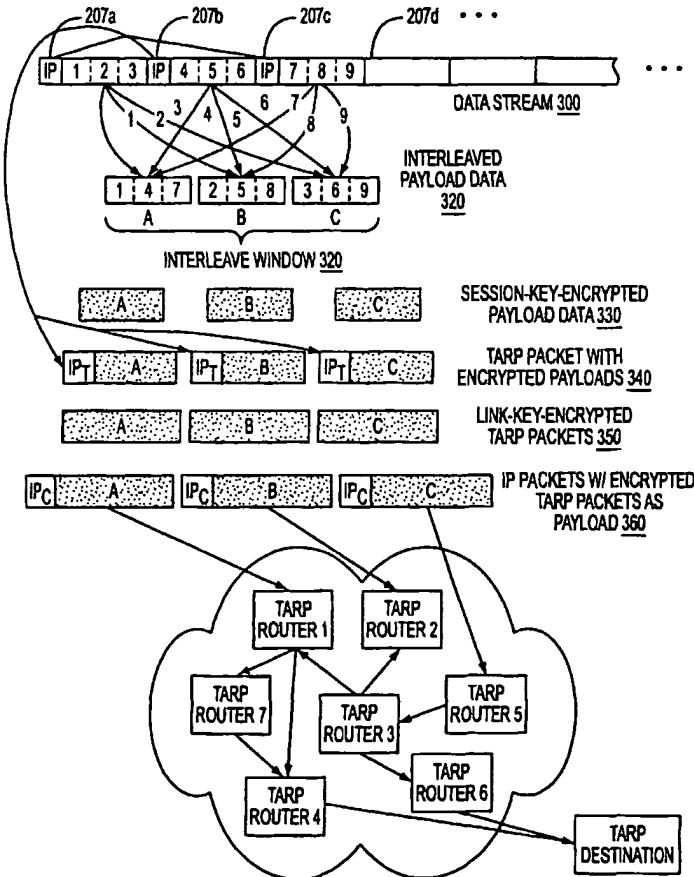

(57) Abstract: A plurality of computer nodes communicate using seemingly random Internet Protocol source and destination addresses. Data packets matching criteria defined by a moving window of valid addresses are accepted for further processing, while those that do not meet the criteria are quickly rejected. Improvements to the basic design include (1) a load balancer that distributes packets across different transmission paths according to transmission path quality; (2) a DNS proxy server that transparently creates a virtual private network in response to a domain name inquiry; (3) a large-to-small link bandwidth management feature that prevents denial-of-service attacks at system chokepoints; (4) a traffic limiter that regulates incoming packets by limiting the rate at which a transmitter can be synchronized with a receiver; and (5) a signaling synchronizer that allows a large number of nodes to communicate with a central node by partitioning the communication function between two separate entities.



WO 01/061922 A3



(81) Designated States (national): AE, AG, AL, AM, AT, AU, AZ, BA, BB, BG, BR, BY, BZ, CA, CH, CN, CR, CU, CZ, DE, DK, DM, DZ, EE, ES, FI, GB, GD, GE, GH, GM, HR, HU, ID, IL, IN, IS, JP, KE, KG, KP, KR, KZ, LC, LK, LR, LS, LT, LU, LV, MA, MD, MG, MK, MN, MW, MX, MZ, NO, NZ, PL, PT, RO, RU, SD, SE, SG, SI, SK, SL, TJ, TM, TR, TT, TZ, UA, UG, US, UZ, VN, YU, ZA, ZW.

(84) Designated States (regional): ARIPO patent (GH, GM, KE, LS, MW, MZ, SD, SL, SZ, TZ, UG, ZW), Eurasian patent (AM, AZ, BY, KG, KZ, MD, RU, TJ, TM), European patent (AT, BE, CH, CY, DE, DK, ES, FI, FR, GB, GR, IE,

IT, LU, MC, NL, PT, SE, TR), OAPI patent (BF, BJ, CF, CG, CI, CM, GA, GN, GW, ML, MR, NE, SN, TD, TG).

Published:

— with international search report

(88) Date of publication of the international search report:

6 March 2003

For two-letter codes and other abbreviations, refer to the "Guidance Notes on Codes and Abbreviations" appearing at the beginning of each regular issue of the PCT Gazette.

A. CLASSIFICATION OF SUBJECT MATTER
 IPC 7 H04L12/56 H04L29/06 H04L12/46

According to International Patent Classification (IPC) or to both national classification and IPC

B. FIELDS SEARCHED

Minimum documentation searched (classification system followed by classification symbols)
 IPC 7 H04L

Documentation searched other than minimum documentation to the extent that such documents are included in the fields searched

Electronic data base consulted during the international search (name of data base and, where practical, search terms used)

EPO-Internal, WPI Data, PAJ, INSPEC, COMPENDEX

C. DOCUMENTS CONSIDERED TO BE RELEVANT

Category *	Citation of document, with indication, where appropriate, of the relevant passages	Relevant to claim No.
A	EP 0 858 189 A (HITACHI LTD) 12 August 1998 (1998-08-12) column 6, line 35 -column 10, line 13 --- -/--	1-27

Further documents are listed in the continuation of box C.

Patent family members are listed in annex.

* Special categories of cited documents :

- *A* document defining the general state of the art which is not considered to be of particular relevance
- *E* earlier document but published on or after the international filing date
- *L* document which may throw doubts on priority claim(s) or which is cited to establish the publication date of another citation or other special reason (as specified)
- *O* document referring to an oral disclosure, use, exhibition or other means
- *P* document published prior to the international filing date but later than the priority date claimed

- *T* later document published after the international filing date or priority date and not in conflict with the application but cited to understand the principle or theory underlying the invention
- *X* document of particular relevance; the claimed invention cannot be considered novel or cannot be considered to involve an inventive step when the document is taken alone
- *Y* document of particular relevance; the claimed invention cannot be considered to involve an inventive step when the document is combined with one or more other such documents, such combination being obvious to a person skilled in the art.
- * & * document member of the same patent family

Date of the actual completion of the international search

6 August 2002

Date of mailing of the international search report

20. 08. 2002

Name and mailing address of the ISA

European Patent Office, P.B. 5818 Patentlaan 2
 NL - 2280 HV Rijswijk
 Tel. (+31-70) 340-2040, Tx. 31 651 epo nl,
 Fax: (+31-70) 340-3016

Authorized officer

Ströbeck, A.

C.(Continuation) DOCUMENTS CONSIDERED TO BE RELEVANT		
Category °	Citation of document, with indication, where appropriate, of the relevant passages	Relevant to claim No.
A	<p>MURTHY ET AL: "Congestion-oriented shortest multipath routing" PROCEEDINGS OF IEEE INFOCOM 1996. CONFERENCE ON COMPUTER COMMUNICATIONS. FIFTEENTH ANNUAL JOINT CONFERENCE OF THE IEEE COMPUTER AND COMMUNICATIONS SOCIETIES. NETWORKING THE NEXT GENERATION. SAN FRANCISCO, MAR. 24 - 28, 1996, PROCEEDINGS OF INFOCOM, L, vol. 2 CONF. 15, 24 March 1996 (1996-03-24), pages 1028-1036, XP010158171 ISBN: 0-8186-7293-5 abstract page 1028, left-hand column, line 38 -right-hand column, line 29</p>	1-27
E	<p>WO 01 50688 A (TELEFONAKTIEBOLAGET LM ERICSSON (PUBL)) 12 July 2001 (2001-07-12) page 11, line 18 -page 13, line 21</p>	28,29,34
A	<p>WO 98 59470 A (TELEFONAKTIEBOLAGET LM ERICSSON (PUBL)) 30 December 1998 (1998-12-30) page 4, line 5 -page 5, line 2</p>	28-39
X	<p>WO 99 48303 A (CISCO TECHNOLOGY, INC.) 23 September 1999 (1999-09-23) page 1, line 8 -page 2, line 5 page 5, line 33 -page 6, line 15 page 7, line 21 - line 33</p>	40,50
A		41-49, 51-59
A	<p>JONES JIM ET AL: "Distributed Denial of Service Attacks: Defenses" INTERNET ARTICLE, 'Online! 2000, XP002208785 Retrieved from the Internet: <URL:www.bal.org/pdf/DDOS-defense.pdf > 'retrieved on 2002-08-05! paragraph '0005!</p>	60-66
X	<p>WO 99 38081 A (ASCEND COMMUNICATIONS INC) 29 July 1999 (1999-07-29) page 9, line 13 -page 10, line 17 page 11, line 10 -page 12, line 2</p>	67
A		68-71

INTERNATIONAL SEARCH REPORT

INTERNATIONAL APPLICATION NO.
PCT/US 01/04340

Box I Observations where certain claims were found unsearchable (Continuation of item 1 of first sheet)

This International Search Report has not been established in respect of certain claims under Article 17(2)(a) for the following reasons:

1. Claims Nos.:
because they relate to subject matter not required to be searched by this Authority, namely:

2. Claims Nos.:
because they relate to parts of the International Application that do not comply with the prescribed requirements to such an extent that no meaningful International Search can be carried out, specifically:

3. Claims Nos.:
because they are dependent claims and are not drafted in accordance with the second and third sentences of Rule 6.4(a).

Box II Observations where unity of invention is lacking (Continuation of item 2 of first sheet)

This International Searching Authority found multiple inventions in this international application, as follows:

see additional sheet

1. As all required additional search fees were timely paid by the applicant, this International Search Report covers all searchable claims.
2. As all searchable claims could be searched without effort justifying an additional fee, this Authority did not invite payment of any additional fee.
3. As only some of the required additional search fees were timely paid by the applicant, this International Search Report covers only those claims for which fees were paid, specifically claims Nos.:
4. No required additional search fees were timely paid by the applicant. Consequently, this International Search Report is restricted to the invention first mentioned in the claims; it is covered by claims Nos.:

Remark on Protest

- The additional search fees were accompanied by the applicant's protest.
- No protest accompanied the payment of additional search fees.

FURTHER INFORMATION CONTINUED FROM PCT/ISA/ 210

This International Searching Authority found multiple (groups of) inventions in this international application, as follows:

1. Claims: 1-27

A system and a method to balance the load between communication paths with varying transmission quality.

2. Claims: 28-39

A system and a method to prevent someone from learning requested IP addresses by intercepting DNS requests.

3. Claims: 40-59

A method to prevent a denial-of-service attack from an unauthenticated user flooding dummy data packets on to a low bandwidth link.

4. Claims: 60-66

A method to prevent an authenticated user residing within a secure system from flooding it with dummy data packets.

5. Claims: 67-71

A method to allocate memory in a central computer communicating with a potentially large number of client computers.

Patent document cited in search report		Publication date	Patent family member(s)	Publication date
EP 0858189	A	12-08-1998	JP 10224400 A	21-08-1998
			EP 0858189 A2	12-08-1998
			US 6112248 A	29-08-2000
<hr/>				
WO 0150688	A	12-07-2001	SE 517217 C2	07-05-2002
			AU 2564501 A	16-07-2001
			WO 0150688 A1	12-07-2001
			SE 9904841 A	30-06-2001
			US 2001006523 A1	05-07-2001
<hr/>				
WO 9859470	A	30-12-1998	AU 8052398 A	04-01-1999
			SE 9702385 A	24-12-1998
			WO 9859470 A2	30-12-1998
<hr/>				
WO 9948303	A	23-09-1999	AU 3098299 A	11-10-1999
			WO 9948303 A2	23-09-1999
<hr/>				
WO 9938081	A	29-07-1999	US 6055575 A	25-04-2000
			AU 2562599 A	09-08-1999
			CA 2318267 A1	29-07-1999
			EP 1064602 A1	03-01-2001
			WO 9938081 A1	29-07-1999

**This Page is Inserted by IFW Indexing and Scanning
Operations and is not part of the Official Record**

BEST AVAILABLE IMAGES

Defective images within this document are accurate representations of the original documents submitted by the applicant.

Defects in the images include but are not limited to the items checked:

- BLACK BORDERS**
- IMAGE CUT OFF AT TOP, BOTTOM OR SIDES**
- FADED TEXT OR DRAWING**
- BLURRED OR ILLEGIBLE TEXT OR DRAWING**
- SKEWED/SLANTED IMAGES**
- COLOR OR BLACK AND WHITE PHOTOGRAPHS**
- GRAY SCALE DOCUMENTS**
- LINES OR MARKS ON ORIGINAL DOCUMENT**
- REFERENCE(S) OR EXHIBIT(S) SUBMITTED ARE POOR QUALITY**
- OTHER:**

IMAGES ARE BEST AVAILABLE COPY.

As rescanning these documents will not correct the image problems checked, please do not report these problems to the IFW Image Problem Mailbox.

Subst. for form 1449/PTO		Complete if Known	
INFORMATION DISCLOSURE STATEMENT BY APPLICANT <i>(Use as many sheets as necessary)</i>		Application Number	13/342,795
		Filing Date	01-03-2012
		First Named Inventor	Victor Larson
		Art Unit	2453
		Examiner Name	Krisna Lim
		Docket Number	77580-155(VRNK-1CP3CNFT5)

U.S. PATENTS

EXAMINER'S INITIALS	CITE NO.	Patent Number	Publication Date	Name of Patentee or Applicant of Cited Document	Pages, Columns, Lines, Where Relevant Passages or Relevant Figures Appear
	A161	6,131,121	10/10/2000	Mattaway et al.	
	A162	6,499,108	12/24/2002	Johnson	

U.S. PATENT APPLICATION PUBLICATIONS

EXAMINER'S INITIALS	CITE NO.	Patent Number	Publication Date	Name of Patentee or Applicant of Cited Document	Pages, Columns, Lines, Where Relevant Passages or Relevant Figures Appear

FOREIGN PATENT DOCUMENTS

EXAMINER'S INITIALS	CITE NO.	Foreign Patent Document Country Codes -Number & -Kind Codes (if known)	Publication Date	Name of Patentee or Applicant of Cited Document	Pages, Columns, Lines Where Relevant Figures Appear	Translation	
						Yes	No

OTHER ART (Including Author, Title, Date, Pertinent Pages, Etc.)

EXAMINER'S INITIALS	CITE NO.	Include name of the author (in CAPITAL LETTERS), title of the article (when appropriate), title of the item (book, magazine, journal, serial, symposium, catalog, etc.), date, page(s), volume-issue number(s), publisher, city and/or country where published.
	A1112	ITU-T Recommendation H.323, "Infrastructure of Audiovisual Services – Systems and Terminal Equipment for Audiovisual Services. Packet-Based Multimedia Communications System," International Telecommunications Union, pages 1-128, February 1998
	A1113	ITU-T Recommendation H.225.0, "Infrastructure of Audiovisual Services – Transmission Multiplexing and Synchronization. Call Signaling Protocols and Media Stream Packetization for Packet-Based Multimedia Communication systems," International Telecommunication Union, pages 1-155, February 1998
	A1114	ITU-T Recommendation H.235, "Infrastructure of Audiovisual Services – Systems Aspects. Security and Encryption for H-Series (H.323 and other H.245-based) Multimedia Terminals," International Telecommunication Union, pages 1-39, February 1998
	A1115	ITU-T Recommendation H.245, "Infrastructure of Audiovisual Services – Communication Procedures. Control Protocol for Multimedia Communication," International Telecommunication Union, pages 1-280, February 1998
	A1116	Request for Inter Partes Reexamination Under 35 U.S.C. § 311 (Patent No.8,051,181)
	A1117	Transmittal Letters (Patent No.8,051,181)
	A1118	Exhibit X5, Droms, R., RFC 2131, "Dynamic Host Configuration Protocol," 1987

EXAMINER

DATE CONSIDERED

*EXAMINER: Initial if reference considered, whether or not citation is in conformance with MPEP 609. Draw line through citation if not in conformance and not considered. Include copy of this form with next communication to applicant.

1 Applicant's unique citation designation number (optional). 2 Applicant is to place a check mark here if English language Translation is attached.

Subst. for form 1449/PTO				Complete if Known	
INFORMATION DISCLOSURE STATEMENT BY APPLICANT <i>(Use as many sheets as necessary)</i>				Application Number	13/342,795
				Filing Date	01-03-2012
				First Named Inventor	Victor Larson
				Art Unit	2453
				Examiner Name	Krisna Lim
				Docket Number	77580-155(VR NK-1CP3CNFT5)

CERTIFICATION STATEMENT

Please See 37 CFR 1.97 and 1.98 to make the appropriate selection(s)

- Information Disclosure Statement is being filed with the filing of the application or before the receipt of a first office action.
- That each item of information contained in the information disclosure statement was first cited in any communication from a foreign patent office in a counterpart foreign application not more than three months prior to the filing of the information disclosure statement; or
- That no item of information contained in the information disclosure statement was cited in a communication from a foreign patent office in a counterpart foreign application, and, to the knowledge of the person signing the certification after making reasonable inquiry, no item of information contained in the information disclosure statement was known to any individual designated in § 1.56(c) more than three months prior to the filing of the information disclosure statement.
- The Commissioner is hereby authorized to charge the fee pursuant to 37 CFR 1.17(P) in the amount of \$180.00, or further fees which may be due, to Deposit Account 50-1133.
- Information Disclosure Statement is being filed with the Request for Continued Examination. The Commissioner is hereby authorized to charge the fee pursuant to 37 CFR 1.17(P) in the amount of \$810.00, or further fees which may be due, to Deposit Account 50-1133.
- None

SIGNATURE

A signature of the applicant or representative is required in accordance with CFR 1.33, 10.18. Please see CFR 1.4(d) for the form of the signature.

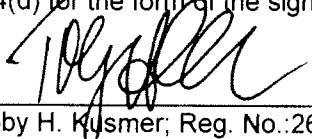
 Toby H. Kusmer; Reg. No.:26,418
 McDermott Will & Emery LLP
 28 State Street
 Boston, MA 02109
 Tel. (617) 535-4000
 Fax (617) 535-3800

Date: 4/24/12

Electronic Acknowledgement Receipt

EFS ID:	12625170
Application Number:	13342795
International Application Number:	
Confirmation Number:	4180
Title of Invention:	SYSTEM AND METHOD EMPLOYING AN AGILE NETWORK PROTOCOL FOR SECURE COMMUNICATIONS USING SECURE DOMAIN NAMES
First Named Inventor/Applicant Name:	Victor Larson
Customer Number:	23630
Filer:	Toby H. Kusmer./Kerrie Jones
Filer Authorized By:	Toby H. Kusmer.
Attorney Docket Number:	77580-155(VRNK-1CP3CNFT5)
Receipt Date:	25-APR-2012
Filing Date:	03-JAN-2012
Time Stamp:	13:09:05
Application Type:	Utility under 35 USC 111(a)

Payment information:

Submitted with Payment	no
------------------------	----

File Listing:

Document Number	Document Description	File Name	File Size(Bytes)/ Message Digest	Multi Part /.zip	Pages (if appl.)
1	Information Disclosure Statement (IDS) Form (SB08)	IDS.pdf	75770 <small>41aba6041289ad63753b7d54c3db99de0b0e4c20</small>	no	2

Warnings:

Information:

This is not an USPTO supplied IDS fillable form

The page size in the PDF is too large. The pages should be 8.5 x 11 or A4. If this PDF is submitted, the pages will be resized upon entry into the Image File Wrapper and may affect subsequent processing

2	Non Patent Literature	D1112.pdf	6631563	no	129
			906ff6daf56bfcc31393b154a52c600e04b0a378		

Warnings:

Information:

3	Non Patent Literature	D1113.pdf	8752435	no	156
			96293b2d311e620715c85cde849c7068873078e7		

Warnings:

Information:

4	Non Patent Literature	D1114.pdf	2184536	no	40
			2d5897e0d1e96ef708bd7248d1a4f52dab66814		

Warnings:

Information:

5	Non Patent Literature	D1115.pdf	13279514	no	281
			06c632218653419b404c6dd372a83acad284c62b		

Warnings:

Information:

6	Non Patent Literature	D1116.pdf	18717491	no	320
			82d8e4078df503f9f1b03f6fa1ab864a0d2ab00a		

Warnings:

Information:

7	Non Patent Literature	D1117.pdf	90402	no	3
			47ee405fbb7f1e62fd6e4793a276d820608be91d		

Warnings:

Information:

8	Non Patent Literature	D1118.pdf	2054150	no	40
			923ded65634628a0c2bb97275d15e8939e6101f1		

Warnings:

Information:

Total Files Size (in bytes):			51785861		
-------------------------------------	--	--	----------	--	--

This Acknowledgement Receipt evidences receipt on the noted date by the USPTO of the indicated documents, characterized by the applicant, and including page counts, where applicable. It serves as evidence of receipt similar to a Post Card, as described in MPEP 503.

New Applications Under 35 U.S.C. 111

If a new application is being filed and the application includes the necessary components for a filing date (see 37 CFR 1.53(b)-(d) and MPEP 506), a Filing Receipt (37 CFR 1.54) will be issued in due course and the date shown on this Acknowledgement Receipt will establish the filing date of the application.

National Stage of an International Application under 35 U.S.C. 371

If a timely submission to enter the national stage of an international application is compliant with the conditions of 35 U.S.C. 371 and other applicable requirements a Form PCT/DO/EO/903 indicating acceptance of the application as a national stage submission under 35 U.S.C. 371 will be issued in addition to the Filing Receipt, in due course.

New International Application Filed with the USPTO as a Receiving Office

If a new international application is being filed and the international application includes the necessary components for an international filing date (see PCT Article 11 and MPEP 1810), a Notification of the International Application Number and of the International Filing Date (Form PCT/RO/105) will be issued in due course, subject to prescriptions concerning national security, and the date shown on this Acknowledgement Receipt will establish the international filing date of the application.



UNITED STATES PATENT AND TRADEMARK OFFICE

UNITED STATES DEPARTMENT OF COMMERCE
United States Patent and Trademark Office
Address: COMMISSIONER FOR PATENTS
P.O. Box 1450
Alexandria, Virginia 22313-1450
www.uspto.gov

Table with 4 columns: APPLICATION NUMBER, FILING OR 371(C) DATE, FIRST NAMED APPLICANT, ATTY. DOCKET NO./TITLE. Row 1: 13/342,795, 01/03/2012, Victor Larson, 77580-155(VRNK-1CP3CNFT5)

23630
McDermott Will & Emery
600 13th Street, NW
Washington, DC 20005-3096

CONFIRMATION NO. 4180
PUBLICATION NOTICE



Title: SYSTEM AND METHOD EMPLOYING AN AGILE NETWORK PROTOCOL FOR SECURE COMMUNICATIONS USING SECURE DOMAIN NAMES

Publication No. US-2012-0102206-A1

Publication Date: 04/26/2012

NOTICE OF PUBLICATION OF APPLICATION

The above-identified application will be electronically published as a patent application publication pursuant to 37 CFR 1.211, et seq. The patent application publication number and publication date are set forth above.

The publication may be accessed through the USPTO's publically available Searchable Databases via the Internet at www.uspto.gov. The direct link to access the publication is currently http://www.uspto.gov/patft/.

The publication process established by the Office does not provide for mailing a copy of the publication to applicant. A copy of the publication may be obtained from the Office upon payment of the appropriate fee set forth in 37 CFR 1.19(a)(1). Orders for copies of patent application publications are handled by the USPTO's Office of Public Records. The Office of Public Records can be reached by telephone at (703) 308-9726 or (800) 972-6382, by facsimile at (703) 305-8759, by mail addressed to the United States Patent and Trademark Office, Office of Public Records, Alexandria, VA 22313-1450 or via the Internet.

In addition, information on the status of the application, including the mailing date of Office actions and the dates of receipt of correspondence filed in the Office, may also be accessed via the Internet through the Patent Electronic Business Center at www.uspto.gov using the public side of the Patent Application Information and Retrieval (PAIR) system. The direct link to access this status information is currently http://pair.uspto.gov/. Prior to publication, such status information is confidential and may only be obtained by applicant using the private side of PAIR.

Further assistance in electronically accessing the publication, or about PAIR, is available by calling the Patent Electronic Business Center at 1-866-217-9197.

Office of Data Management, Application Assistance Unit (571) 272-4000, or (571) 272-4200, or 1-888-786-0101

Subst. for form 1449/PTO				Complete if Known		
INFORMATION DISCLOSURE STATEMENT BY APPLICANT <i>(Use as many sheets as necessary)</i>				Application Number	13/342,795	
				Filing Date	01-03-2012	
				First Named Inventor	Victor Larson	
				Art Unit	2453	
				Examiner Name	Krisna Lim	
				Docket Number	77580-155(VRNK-1CP3CNFT5)	
U.S. PATENTS						
EXAMINER'S INITIALS	CITE NO.	Patent Number	Publication Date	Name of Patentee or Applicant of Cited Document	Pages, Columns, Lines, Where Relevant Passages or Relevant Figures Appear	
U.S. PATENT APPLICATION PUBLICATIONS						
EXAMINER'S INITIALS	CITE NO.	Patent Number	Publication Date	Name of Patentee or Applicant of Cited Document	Pages, Columns, Lines, Where Relevant Passages or Relevant Figures Appear	
FOREIGN PATENT DOCUMENTS						
EXAMINER'S INITIALS	CITE NO.	Foreign Patent Document Country Codes - Number - Kind Codes (if known)	Publication Date	Name of Patentee or Applicant of Cited Document	Pages, Columns, Lines Where Relevant Figures Appear	Translation Yes No
OTHER ART (Including Author, Title, Date, Pertinent Pages, Etc.)						
EXAMINER'S INITIALS	CITE NO.	Include name of the author (in CAPITAL LETTERS), title of the article (when appropriate), title of the item (book, magazine, journal, serial, symposium, catalog, etc.), date, page(s), volume-issue number(s), publisher, city and/or country where published.				
	A1119	Hopen Transcript dated April 11, 2012				
	A1120	VirnetX Claim Construction Opinion				
EXAMINER				DATE CONSIDERED		

*EXAMINER: Initial if reference considered, whether or not citation is in conformance with MPEP 609. Draw line through citation if not in conformance and not considered. Include copy of this form with next communication to applicant.

1 Applicant's unique citation designation number (optional). 2 Applicant is to place a check mark here if English language Translation is attached.

Subst. for form 1449/PTO				Complete if Known	
INFORMATION DISCLOSURE STATEMENT BY APPLICANT <i>(Use as many sheets as necessary)</i>				Application Number	13/342,795
				Filing Date	01-03-2012
				First Named Inventor	Victor Larson
				Art Unit	2453
				Examiner Name	Krisna Lim
				Docket Number	77580-155(VR NK-1CP3CNFT5)

CERTIFICATION STATEMENT

Please See 37 CFR 1.97 and 1.98 to make the appropriate selection(s)

- Information Disclosure Statement is being filed with the filing of the application or before the receipt of a first office action.
- That each item of information contained in the information disclosure statement was first cited in any communication from a foreign patent office in a counterpart foreign application not more than three months prior to the filing of the information disclosure statement; or
- That no item of information contained in the information disclosure statement was cited in a communication from a foreign patent office in a counterpart foreign application, and, to the knowledge of the person signing the certification after making reasonable inquiry, no item of information contained in the information disclosure statement was known to any individual designated in § 1.56(c) more than three months prior to the filing of the information disclosure statement.
- The Commissioner is hereby authorized to charge the fee pursuant to 37 CFR 1.17(P) in the amount of \$180.00, or further fees which may be due, to Deposit Account 50-1133.
- Information Disclosure Statement is being filed with the Request for Continued Examination. The Commissioner is hereby authorized to charge the fee pursuant to 37 CFR 1.17(P) in the amount of \$810.00, or further fees which may be due, to Deposit Account 50-1133.
- None

SIGNATURE

A signature of the applicant or representative is required in accordance with CFR 1.33, 10.18. Please see CFR 1.4(d) for the form of the signature.

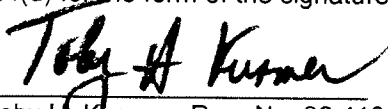

Toby H. Kusmer; Reg. No.:26,418
 McDermott Will & Emery LLP
 28 State Street
 Boston, MA 02109
 Tel. (617) 535-4000
 Fax (617) 535-3800

Date: *May 3, 2012*

Electronic Acknowledgement Receipt

EFS ID:	12699912
Application Number:	13342795
International Application Number:	
Confirmation Number:	4180
Title of Invention:	SYSTEM AND METHOD EMPLOYING AN AGILE NETWORK PROTOCOL FOR SECURE COMMUNICATIONS USING SECURE DOMAIN NAMES
First Named Inventor/Applicant Name:	Victor Larson
Customer Number:	23630
Filer:	Toby H. Kusmer./Kerrie Jones
Filer Authorized By:	Toby H. Kusmer.
Attorney Docket Number:	77580-155(VRNK-1CP3CNFT5)
Receipt Date:	03-MAY-2012
Filing Date:	03-JAN-2012
Time Stamp:	17:40:01
Application Type:	Utility under 35 USC 111(a)

Payment information:

Submitted with Payment	no
------------------------	----

File Listing:

Document Number	Document Description	File Name	File Size(Bytes)/ Message Digest	Multi Part /.zip	Pages (if appl.)
1	Information Disclosure Statement (IDS) Form (SB08)	IDS.pdf	62411 <small>a26c556867cc159918360e29250c1372755f8fba</small>	no	2

Warnings:

Information:

This is not an USPTO supplied IDS fillable form

The page size in the PDF is too large. The pages should be 8.5 x 11 or A4. If this PDF is submitted, the pages will be resized upon entry into the Image File Wrapper and may affect subsequent processing

2	Non Patent Literature	D1119.pdf	2878466	no	57
			8b71e4b3742f29ed35c56c766502d527a0d df2bb		

Warnings:

The page size in the PDF is too large. The pages should be 8.5 x 11 or A4. If this PDF is submitted, the pages will be resized upon entry into the Image File Wrapper and may affect subsequent processing

Information:

3	Non Patent Literature	D1120.pdf	533111	no	31
			a82b1ad1fb1fb3bddbe19efd0f1f957db8e5 4c55		

Warnings:

The page size in the PDF is too large. The pages should be 8.5 x 11 or A4. If this PDF is submitted, the pages will be resized upon entry into the Image File Wrapper and may affect subsequent processing

Information:

Total Files Size (in bytes):	3473988
-------------------------------------	---------

This Acknowledgement Receipt evidences receipt on the noted date by the USPTO of the indicated documents, characterized by the applicant, and including page counts, where applicable. It serves as evidence of receipt similar to a Post Card, as described in MPEP 503.

New Applications Under 35 U.S.C. 111

If a new application is being filed and the application includes the necessary components for a filing date (see 37 CFR 1.53(b)-(d) and MPEP 506), a Filing Receipt (37 CFR 1.54) will be issued in due course and the date shown on this Acknowledgement Receipt will establish the filing date of the application.

National Stage of an International Application under 35 U.S.C. 371

If a timely submission to enter the national stage of an international application is compliant with the conditions of 35 U.S.C. 371 and other applicable requirements a Form PCT/DO/EO/903 indicating acceptance of the application as a national stage submission under 35 U.S.C. 371 will be issued in addition to the Filing Receipt, in due course.

New International Application Filed with the USPTO as a Receiving Office

If a new international application is being filed and the international application includes the necessary components for an international filing date (see PCT Article 11 and MPEP 1810), a Notification of the International Application Number and of the International Filing Date (Form PCT/RO/105) will be issued in due course, subject to prescriptions concerning national security, and the date shown on this Acknowledgement Receipt will establish the international filing date of the application.

Subst. for form 1449/PTO				Complete if Known			
INFORMATION DISCLOSURE STATEMENT BY APPLICANT <i>(Use as many sheets as necessary)</i>				Application Number	13/342,795		
				Filing Date	01-03-2012		
				First Named Inventor	Victor Larson		
				Art Unit	2453		
				Examiner Name	Krisna Lim		
				Docket Number	77580-155(VR NK-1CP3CNFT5)		
U.S. PATENTS							
EXAMINER'S INITIALS	CITE NO.	Patent Number	Publication Date	Name of Patentee or Applicant of Cited Document	Pages, Columns, Lines, Where Relevant Passages or Relevant Figures Appear		
U.S. PATENT APPLICATION PUBLICATIONS							
EXAMINER'S INITIALS	CITE NO.	Patent Number	Publication Date	Name of Patentee or Applicant of Cited Document	Pages, Columns, Lines, Where Relevant Passages or Relevant Figures Appear		
FOREIGN PATENT DOCUMENTS							
EXAMINER'S INITIALS	CITE NO.	Foreign Patent Document Country Codes - Number - Kind Codes (if known)	Publication Date	Name of Patentee or Applicant of Cited Document	Pages, Columns, Lines Where Relevant Figures Appear	Translation	
						Yes	No
OTHER ART (Including Author, Title, Date, Pertinent Pages, Etc.)							
EXAMINER'S INITIALS	CITE NO.	Include name of the author (in CAPITAL LETTERS), title of the article (when appropriate), title of the item (book, magazine, journal, serial, symposium, catalog, etc.), date, page(s), volume-issue number(s), publisher, city and/or country where published.					
	A1121	Declaration of Angelos D. Keromytis, Ph.D.					
	A1122	Declaration of Dr. Robert Dunham Short III					
	A1123	Exhibit A-1, Verdict Form from VirnetX, Inc. v. Microsoft Corp., No. 6:07-CV-80 (E.D. Tex.)					
	A1124	Exhibit A-3, Declaration of Jason Nieh, Ph.D. (Control No. 95/001,269)					
	A1125	Exhibit A-4, Redacted Deposition of Chris Hopen from VirnetX, Inc. v. Cisco Systems, Inc., No. 6:07-CV 417 (E.D. Tex. April 11, 2012)					
	A1126	Exhibit B-1, Excerpt from Deposition of Defense FY 2000/2001 Biennial Budget Estimates, (Feb. 1999)					
	A1127	Exhibit B-2, Collection of Reports and Presentations on DARPA Projects					
	A1128	Exhibit B-3, Maryann Lawlor, Transient Partnerships Stretch Security Policy Management, Signal Magazine (Sept. 2001) http://www.afcea.org/signal/articles/anmviewer.asp?a=494&print=yes					
	A1129	Joel Snyder, Living in Your Own Private Idaho, Network World (January 28, 1998) http://www.networkworld.com/intranet/0126review.html .					
	A1130	Time Greene, CEO's Chew the VPN Fat, CNN.com (June 17, 1999), http://www.cnn.com/TECH/computing/9906/17/vpnfat.ent.idg/index.html?iref=allsearch					
EXAMINER				DATE CONSIDERED			

*EXAMINER: Initial if reference considered, whether or not citation is in conformance with MPEP 609. Draw line through citation if not in conformance and not considered. Include copy of this form with next communication to applicant.

1 Applicant's unique citation designation number (optional). 2 Applicant is to place a check mark here if English language Translation is attached.

Subst. for form 1449/PTO				Complete if Known	
INFORMATION DISCLOSURE STATEMENT BY APPLICANT <i>(Use as many sheets as necessary)</i>				Application Number	13/342,795
				Filing Date	01-03-2012
				First Named Inventor	Victor Larson
				Art Unit	2453
				Examiner Name	Krisna Lim
				Docket Number	77580-155(VRNK-1CP3CNFT5)

CERTIFICATION STATEMENT

Please See 37 CFR 1.97 and 1.98 to make the appropriate selection(s)

- Information Disclosure Statement is being filed with the filing of the application or before the receipt of a first office action.
- That each item of information contained in the information disclosure statement was first cited in any communication from a foreign patent office in a counterpart foreign application not more than three months prior to the filing of the information disclosure statement; or
- That no item of information contained in the information disclosure statement was cited in a communication from a foreign patent office in a counterpart foreign application, and, to the knowledge of the person signing the certification after making reasonable inquiry, no item of information contained in the information disclosure statement was known to any individual designated in § 1.56(c) more than three months prior to the filing of the information disclosure statement.
- The Commissioner is hereby authorized to charge the fee pursuant to 37 CFR 1.17(P) in the amount of \$180.00, or further fees which may be due, to Deposit Account 50-1133.
- Information Disclosure Statement is being filed with the Request for Continued Examination. The Commissioner is hereby authorized to charge the fee pursuant to 37 CFR 1.17(P) in the amount of \$810.00, or further fees which may be due, to Deposit Account 50-1133.
- None

SIGNATURE

A signature of the applicant or representative is required in accordance with CFR 1.33, 10.18. Please see CFR 1.4(d) for the form of the signature.

 Toby H. Kusmer, Reg. No.: 26,418
 McDermott Will & Emery LLP
 28 State Street
 Boston, MA 02109
 Tel. (617) 535-4000
 Fax (617) 535-3800

Date: 5/10/12

Electronic Acknowledgement Receipt

EFS ID:	12824184
Application Number:	13342795
International Application Number:	
Confirmation Number:	4180
Title of Invention:	SYSTEM AND METHOD EMPLOYING AN AGILE NETWORK PROTOCOL FOR SECURE COMMUNICATIONS USING SECURE DOMAIN NAMES
First Named Inventor/Applicant Name:	Victor Larson
Customer Number:	23630
Filer:	Toby H. Kusmer./Kerrie Jones
Filer Authorized By:	Toby H. Kusmer.
Attorney Docket Number:	77580-155(VRNK-1CP3CNFT5)
Receipt Date:	21-MAY-2012
Filing Date:	03-JAN-2012
Time Stamp:	14:37:07
Application Type:	Utility under 35 USC 111(a)

Payment information:

Submitted with Payment	no
------------------------	----

File Listing:

Document Number	Document Description	File Name	File Size(Bytes)/ Message Digest	Multi Part /.zip	Pages (if appl.)
1	Information Disclosure Statement (IDS) Form (SB08)	IDS.pdf	75809 <small>a0d5df3b2bf31ae48ef2a05060d02321fb2c8237</small>	no	2

Warnings:

Information:

This is not an USPTO supplied IDS fillable form					
The page size in the PDF is too large. The pages should be 8.5 x 11 or A4. If this PDF is submitted, the pages will be resized upon entry into the Image File Wrapper and may affect subsequent processing					
2	Non Patent Literature	D1121.pdf	4301486 cb320cd4e2284187bad62b1dcc5985f9a30fc2ae	no	98
Warnings:					
The page size in the PDF is too large. The pages should be 8.5 x 11 or A4. If this PDF is submitted, the pages will be resized upon entry into the Image File Wrapper and may affect subsequent processing					
Information:					
3	Non Patent Literature	D1122.pdf	235218 1ee5e74886cc86d9669ccefboe913ab95d7ab123	no	6
Warnings:					
The page size in the PDF is too large. The pages should be 8.5 x 11 or A4. If this PDF is submitted, the pages will be resized upon entry into the Image File Wrapper and may affect subsequent processing					
Information:					
4	Non Patent Literature	D1123.pdf	78623 8e809ede185d2847d6fe215a8f1b281e9df11a70	no	3
Warnings:					
The page size in the PDF is too large. The pages should be 8.5 x 11 or A4. If this PDF is submitted, the pages will be resized upon entry into the Image File Wrapper and may affect subsequent processing					
Information:					
5	Non Patent Literature	D1124.pdf	424402 929e7bf435c6276ef913af84eb6aa5e9f5014ebc	no	9
Warnings:					
The page size in the PDF is too large. The pages should be 8.5 x 11 or A4. If this PDF is submitted, the pages will be resized upon entry into the Image File Wrapper and may affect subsequent processing					
Information:					
6	Non Patent Literature	D1125.pdf	186247 4bf903af938028fc72f6cabcc8efb2f788bc6b6	no	5
Warnings:					
The page size in the PDF is too large. The pages should be 8.5 x 11 or A4. If this PDF is submitted, the pages will be resized upon entry into the Image File Wrapper and may affect subsequent processing					
Information:					
7	Non Patent Literature	D1126.pdf	987245 2f6bdc05cf88407b211635be0a65eaaad52878c	no	23
Warnings:					
The page size in the PDF is too large. The pages should be 8.5 x 11 or A4. If this PDF is submitted, the pages will be resized upon entry into the Image File Wrapper and may affect subsequent processing					
Information:					

8	Non Patent Literature	D1127.pdf	5974350 66f2a38a997c8dc339f848fb04a4ef68df80bfb4	no	95
Warnings:					
The page size in the PDF is too large. The pages should be 8.5 x 11 or A4. If this PDF is submitted, the pages will be resized upon entry into the Image File Wrapper and may affect subsequent processing					
Information:					
9	Non Patent Literature	D1128.pdf	351127 3f824e2ea0a2cf055600561add2b717e1ed56cd9	no	5
Warnings:					
The page size in the PDF is too large. The pages should be 8.5 x 11 or A4. If this PDF is submitted, the pages will be resized upon entry into the Image File Wrapper and may affect subsequent processing					
Information:					
10	Non Patent Literature	D1129.pdf	298881 e6ef10c93c51f5e3ca0af7ea9d2bd99cea9550fd	no	5
Warnings:					
The page size in the PDF is too large. The pages should be 8.5 x 11 or A4. If this PDF is submitted, the pages will be resized upon entry into the Image File Wrapper and may affect subsequent processing					
Information:					
11	Non Patent Literature	D1130.pdf	273615 9ba7c10abc4f5b09e617216e4bf1aa755b31931c	no	6
Warnings:					
The page size in the PDF is too large. The pages should be 8.5 x 11 or A4. If this PDF is submitted, the pages will be resized upon entry into the Image File Wrapper and may affect subsequent processing					
Information:					
Total Files Size (in bytes):				13187003	
<p>This Acknowledgement Receipt evidences receipt on the noted date by the USPTO of the indicated documents, characterized by the applicant, and including page counts, where applicable. It serves as evidence of receipt similar to a Post Card, as described in MPEP 503.</p> <p><u>New Applications Under 35 U.S.C. 111</u> If a new application is being filed and the application includes the necessary components for a filing date (see 37 CFR 1.53(b)-(d) and MPEP 506), a Filing Receipt (37 CFR 1.54) will be issued in due course and the date shown on this Acknowledgement Receipt will establish the filing date of the application.</p> <p><u>National Stage of an International Application under 35 U.S.C. 371</u> If a timely submission to enter the national stage of an international application is compliant with the conditions of 35 U.S.C. 371 and other applicable requirements a Form PCT/DO/EO/903 indicating acceptance of the application as a national stage submission under 35 U.S.C. 371 will be issued in addition to the Filing Receipt, in due course.</p> <p><u>New International Application Filed with the USPTO as a Receiving Office</u> If a new international application is being filed and the international application includes the necessary components for an international filing date (see PCT Article 11 and MPEP 1810), a Notification of the International Application Number and of the International Filing Date (Form PCT/RO/105) will be issued in due course, subject to prescriptions concerning national security, and the date shown on this Acknowledgement Receipt will establish the international filing date of the application.</p>					

IN THE UNITED STATES PATENT AND TRADEMARK OFFICE

In re Application of: Victor Larson <i>et al.</i>	:	
	:	
Serial No.: 13/342,795	:	Confirmation No. 4180
	:	
Filed: January 3, 2012	:	Group Art Unit: 2453
	:	
Customer Number: 23630	:	Examiner: Lim, Krisna

For: System and Method Employing an Agile Network Protocol for Secure Communications
Using Secure Domain Names

Mail Stop Amendment
Commissioner for Patents
P.O. Box 1450
Alexandria, VA 22313-1450

REPLY "A"

Sir:

This Reply is being filed in response to the Office Action mailed from the United States Patent and Trademark office on March 1, 2012.

Applicants appreciate Examiner's thorough examination of the subject application and request reconsideration and further examination in view of the following:

Claims begin on page 2 of this paper.

Remarks begin on page 5 of this paper.

Claims

The claims are being presented solely for the convenience of the Office. No claims are being added, amended, deleted, or canceled.

Claims Listing

1. (Original) A client device comprising:
 - (a) memory configured and arranged to facilitate a connection of the client device with a target device over a secure communication link created based on (i) an address request generated by the client device, and (ii) a determination as a result of the address request that the target device is a device with which a secure communication link can be established when the requested address is identified in an address lookup;
 - (b) an application program configured and arranged so as to allow participation in audio/video communications with the target device over the secure communication link once the secure communication link is established; and
 - (c) a signal processing configuration arranged to execute the application program.
2. (Original) The client device of claim 1, wherein the client device is a computer.
3. (Original) The client device of claim 1, wherein the client device is a phone.
4. (Original) The client device of claim 3, wherein the establishment of the secure communication link is based on a determination being made by a server that the target device is a device with which a secure communication link can be established when the address request corresponds to a target device identified in the address lookup.
5. (Original) The client device of claim 4, wherein the address lookup is a network address lookup.
6. (Original) The client device of claim 3, wherein the secure communication link is a virtual private network link.
7. (Original) The client device of claim 3, wherein the address request includes a secure domain name.
8. (Original) The client device of claim 3, wherein the address request includes a domain name, and the establishment of the secure communication link is based on the determination being

made by a proxy module that the target device is a device with which a secure communication link can be established when the secure domain name corresponds to a target device identified in a DNS lookup table.

9. (Original) The client device of claim 3, wherein the secure communication link is a broadband connection.
10. (Original) The client device of claim 3, wherein the secure communication link is a modulated transmission link.
11. (Original) The client device of claim 3, where the secure communication link supports at least one of the following: FTM, TDM and CDMA.
12. (Original) The client device of claim 3, wherein the secure communication link supports TCP/IP protocols
13. (Original) The client device of claim 3, wherein the target device is a server.
14. (Original) The client device of claim 3, wherein the target device is a computer.
15. (Original) The client device of claim 3, wherein the target device is a phone.
16. (Original) A method executed by a client device for communicating with a target device, the method comprising:
 - (a) facilitating a connection with the target device over a secure communication link created based on (i) an address request generated by the client device, and (ii) a determination as a result of the address request that the target device is a device with which a secure communication link can be established when the requested address is identified in an address lookup; and
 - (b) allowing participation in audio/video communications with the target device over the secure communication link once the secure communication link is established.
17. (Original) The method of claim 16, wherein the client device is a computer.
18. (Original) The method of claim 16, wherein the client device is a phone.
19. (Original) The method of claim 16, wherein the address lookup is a network address lookup.
20. (Original) The method of claim 16, wherein the establishment of the secure communication link is based on a determination being made by a server that the target device is a device

with which a secure communication link can be established when the address request corresponds to a target device identified in the address lookup.

21. (Original) The method of claim 16, wherein the secure communication link is a virtual private network link.
22. (Original) The method of claim 16, wherein the address request includes a secure domain name.
23. (Original) The method of claim 16, wherein the secure communication link is a broadband connection.
24. (Original) The method of claim 16, wherein the secure communication link is an unmodulated transmission link.
25. (Original) The method of claim 16, wherein the secure communication link is a modulated transmission link.
26. (Original) The method of claim 16, where the secure communication link supports at least one of the following: FTM, TDM and CDMA.
27. (Original) The method of claim 16, wherein the secure communication link supports TCP/IP protocols
28. (Original) The method of claim 16, wherein the target device is a server.
29. (Original) The method of claim 16, wherein the target device is a computer.
30. (Original) The method of claim 16, wherein the target device is a phone.

REMARKS

Claims 1-30 are in the application, of which Claims 1 and 16 are the independent claims. Claims 1-30 stand rejected. The rejections are traversed and reconsideration is respectfully requested in view of the following remarks.

Double Patenting Rejections

Claims 1-30 were rejected on the ground of nonstatutory obviousness-type double patenting as being unpatentable over Claims 1-17 of U.S. Patent No. 6,502,135.

Claims 1-30 were rejected on the ground of nonstatutory obviousness-type double patenting as being unpatentable over Claims 1, 3-7, 13-16, and 33-40 of U.S. Patent No. 7,188,180.

Claims 1-30 were rejected on the ground of nonstatutory obviousness-type double patenting as being unpatentable over Claims 1, 8, 9, 12, 13, 14, 16, 17 and 23-33 of U.S. Patent No. 7,418,504.

Claims 1-30 were rejected on the ground of nonstatutory obviousness-type double patenting as being unpatentable over Claims 1, 8-11, and 14-35 of U.S. Patent No. 7,921,211.

Claims 1-30 were rejected on the ground of nonstatutory obviousness-type double patenting as being unpatentable over Claims 1-8, 10-13, and 17-18 of U.S. Patent No. 7,987,274.

Claims 1-30 were rejected on the ground of nonstatutory obviousness-type double patenting as being unpatentable over Claims 1-6, 8-9, and 14-22 of U.S. Patent No. 8,051,181.

Claims 1-30 were provisionally rejected on the ground of nonstatutory obviousness-type double patenting as being unpatentable over Claims 14-20 and 26-39 of U.S. Patent Application No. 13/080,680.

Claims 1-30 were provisionally rejected on the ground of nonstatutory obviousness-type double patenting as being unpatentable over Claims 1-11 and 16-26 of U.S. Patent Application No. 13/336,790.

Claims 1-30 were provisionally rejected on the ground of nonstatutory obviousness-type double patenting as being unpatentable over Claims 1-11 and 14-25 of U.S. Patent Application No. 13/337,757.

Claims 1-30 were provisionally rejected on the ground of nonstatutory obviousness-type double patenting as being unpatentable over Claims 1-10 and 15-24 of U.S. Patent Application No. 13/339,257.

Claims 1-30 were provisionally rejected on the ground of nonstatutory obviousness-type double patenting as being unpatentable over Claims 1-25 of U.S. Patent Application No. 13/336,958.

Claims 1-30 were provisionally rejected on the ground of nonstatutory obviousness-type double patenting as being unpatentable over Claims 1-30 of U.S. Patent Application No. 13/343,465.

In order to expedite prosecution, Terminal Disclaimers are being concurrently herewith. Reconsideration and withdrawal of the rejections are respectfully requested.

Rejections under 35 U.S.C. § 103

Claims 1-30 were rejected under 35 U.S.C. § 103(a) as being unpatentable over the reference, “Windows NT Server, Virtual Private Networking: An Overview” (hereinafter referenced as “*VPN Overview*”) and Aventail connect v3.1/v2.6 administrator’s Guide References” (hereinafter referenced as “*Aventail*”).

- ***Aventail* Has Not Been Shown to Be Prior Art**

Aventail was introduced in a Request for Reexamination of a patent (U.S. Patent No. 6,502,135) owned by the assignee of the instant application. Detailed arguments have been presented in the reexamination proceedings initiated in response to the Request (see Reexamination Control Number 95/001682), detailing the reasons why *Aventail* does not qualify as prior art. The following paragraphs summarize some of the arguments presented in the reexamination proceedings.

M.P.E.P. § 2128 sets forth the requirements for a reference to qualify as a printed publication. Specifically, M.P.E.P. § 2128 provides, in part:

A reference is a “printed publication” only “upon a satisfactory showing that such document has been disseminated or otherwise made available to the extent that persons interested and ordinarily skilled in the subject matter or art, exercising reasonable diligence, can locate it.” *In re Wyer*, 655 F.2d 221, 210 USPQ 790 (C.C.P.A. 1981) (quoting *I.C.E. Corp. v. Armco Steel Corp.*, 250 F. Supp. 738, 743, 148 USPQ 537, 540 (SDNY 1966)).

Therefore, a showing of dissemination and public accessibility are the keys to the legal determination of whether a document was “published.”

In the reexamination proceedings, the Requester submitted uncorroborated declarations to support its allegation that *Aventail* qualifies as a “printed publication.” However, these declarations are insufficient to establish that *Aventail* is prior art. Specifically, although the declarations state that *Aventail* was distributed with deployments of the *Aventail* products, no evidence of distribution, not even simply an e-mail from the alleged time period, showing distribution of *Aventail*, has been provided. Further, there is no evidence indicating that *Aventail* was available for download on the Internet in the relevant time period and *Aventail* was not published in any journals.

Applicants respectfully note that the party asserting the prior art bears the burden of establishing a date of publication. *See Carella v. Starlight Archery*, 804 F.2d 135, 139 (Fed. Cir. 1986) (finding that a mailer did not qualify as prior art because there was no evidence as to when the mailer was received by any of the addresses). *See also In re Lister*, 583 F.3d 1307, 1309-17 (Fed. Cir. 2009). However, since there is no evidence of publication of *Aventail*, other than the aforementioned uncorroborated declarations, which were not incorporated or relied on by the Office Action, the logical conclusion is that no evidence of publication exists. As a result, Applicants respectfully submit that each rejection based, in whole or in part, on *Aventail* is fatally defective. Accordingly, Applicants respectfully request that the rejections of Claims 1-30 under 35 U.S.C. § 103(a) be withdrawn.

- ***VPN Overview Has Not Been Shown to Be Prior Art***

The only indication of time/date in *VPN Overview* is a 1998 copyright year printed on the second page of this reference. However, this copyright date is not prima facie evidence of publication. Indeed, *VPN Overview*, on its face, is identified as nothing more than a “draft.” (*See VPN Overview*, page 1 (stating “White Paper – DRAFT”).) Furthermore, the distinction between a publication date and a copyright date is critical. To establish a date of publication, the reference must be shown to have “been disseminated or otherwise made available to the extent that persons interested and ordinarily skilled in the subject matter or art, exercising reasonable diligence, can locate it.” *In re Wyre*, 655 F.2d 221, 226 (C.C.P.A. 1981). Unlike a publication date, a copyright date merely establishes “the date that the document was created or printed” *Hilgraeve, Inc. v. Symantec Corp.*, 271 F. Supp. 2d 964, 975 (E.D. Mich. 2003). A

copyright date of a reference does not in and of itself constitute the date of publication of the reference, and a party asserting the reference as prior art bears the burden of proving when the reference became publicly accessible. *In re Lister*, 583 F.3d 1307, 1309-17 (Fed. Cir. 2009).

Even if the 1998 copyright date of *VPN Overview* is presumed accurate, *VPN Overview's* copyright assertion does not meet the standard of *In re Wyer* and/or *In re Lister*. For example, *VPN Overview's* copyright assertion is not evidence that *Aventail* was “disseminated or otherwise made available to the extent that persons interested and ordinarily skilled in the subject matter or art, exercising reasonable diligence, can locate it.” See *In re Wyer*, 655 F.2d at 226. At best, presuming the author of *VPN Overview* accurately represented its copyright date, this date is merely evidence of a date of creation, **not** of publication or dissemination. Without more, this unsupported assertion of the alleged copyright date of *VPN Overview* as the publication date does not meet the “publication” standard required for a document to be relied upon as prior art. The Office Action failed to provide any evidence that *VPN Overview* was actually distributed and publicly accessible. Therefore, there is no evidence that *VPN Overview* was a printed publication on the date asserted and each rejection based, in whole or in part, on this reference is fatally defective. Accordingly, Applicants respectfully request that the rejections of Claims 1-30 under 35 U.S.C. § 103(a) be withdrawn.

Without admitting that *Aventail* and/or *VPN Overview* were “printed publications” as of the dates asserted, Applicants assume, *arguendo*, that these references are publications as of the asserted dates for the purposes of this response.

- **The 35 U.S.C. § 103(a) Rejections of Claims 1-30 Are Improper and Should Be Withdrawn**

Applicants' Claim 1 recites:

A client device comprising:

- (a) memory configured and arranged to facilitate a connection of the client device with a target device over a secure communication link created based on (i) an address request generated by the client device, and (ii) a determination as a result of the address request that the target device is a device with which a secure communication link can be established when the requested address is identified in an address lookup;
- (b) an application program configured and arranged so as to allow participation in audio/video communications with the target device over the secure communication link once the secure communication link is established; and
- (c) a signal processing configuration arranged to execute the application program.

The present Office Action alleges, in part, that independent Claims 1 and 16, and certain dependent claims, are disclosed by *Aventail* because *Aventail* discloses:

A network device, comprising the features of:

send a request to look up a network address of a second network device based on an identifier associated with the second network device (*e.g.*, Window TCP/IP network application use WinSock to gain access to networks or the internet ... and the application executes a DNS ... and requests a connection ..., see page 8 of *Aventail*);

connect to the second network device, using the received network address of the second network device and communicate with the second network device using the secure communications service via the network communication link (*e.g.*, *Aventail*, Page 77- Depending on the security policy and the *Aventail* ExtraNet Server configuration, *Aventail* connect will automatically proxy their allowed application traffic into the private network. In this situation, *Aventail* connect will forward traffic destined for the private internal network to the *Aventail* ExtraNet Server. Then, based on the security policy, the *Aventail* ExtraNet Server will proxy mobile user traffic into the private network but only to those resources allowed).

Applicants respectfully submit that the cited portion of *Aventail* does not include any indication of facilitating “a connection of the client device with the target device over a secure communication link created based on (i) an address request generated by the client device,” as recited by Claim 1. The Office Action points generally to page 8 of *Aventail* in an attempt to show that the application of *Aventail* “executes a DNS” and “requests a connection.” However, page 8 of *Aventail* is not understood to disclose a secure communication link created based on an address request, much less disclose “a determination as a result of the address request that the target device is a device with which a secure communication link can be established when the requested address is identified in an address lookup” or “an application program configured and arranged so as to allow participation in audio/video communications with the target device over the secure communication link once the secure communication link is established.”

Moreover, the Office Action has not provided any reasoning as to how the cited portion of *Aventail*, which discloses that *Aventail* Connect proxies traffic into the private network “[d]epending on the security policy and the *Aventail* ExtraNet Server configuration” (*Aventail* at 77), discloses or makes obvious the claimed features.

Furthermore, the Office Action is completely silent as to how the cited references disclose the claimed feature of “an application program configured and arranged so as to allow participation in audio/video communications with the target device over the secure

communication link once the secure communication link is established.” Indeed, a review of the cited references reveals that this feature is not disclosed or made obvious by the cited references.

VPN Overview is an overview document that provides an overview of Virtual Private Networks, describes their basic requirements, and discusses some of the key technologies that permit private networking over public internetworks (*See VPN Overview*, Abstract). However, *VPN Overview* fails to remedy the deficiencies of *Aventail*.

Accordingly, the Request has not demonstrated, or even properly alleged that *Aventail* or *VPN Overview*, either alone or in combination, discloses or makes obvious the features of Claim 1. “The goal of examination is to clearly articulate any rejection early in the prosecution process so that the applicant has the opportunity to provide evidence of patentability and otherwise reply completely at the earliest opportunity” (M.P.E.P. § 706). Indeed, 37 C.F.R. § 1.104 provides that the “pertinence of each reference, if not apparent, must be clearly explained and each rejected claim specified.” In the subject rejection, the pertinence of *Aventail* and *VPN Overview* to Claim 1 is not apparent from the Office Action. On that basis alone, the rejection of Claim 1 is deficient and should be withdrawn.

Accordingly, reconsideration and withdrawal of the rejection of independent Claim 1 are respectfully requested.

Independent Claim 16 is directed, in part, to a method comprising:

(a) facilitating a connection with the target device over a secure communication link created based on (i) an address request generated by the client device, and (ii) a determination as a result of the address request that the target device is a device with which a secure communication link can be established when the requested address is identified in an address lookup; and

(b) allowing participation in audio/video communications with the target device over the secure communication link once the secure communication link is established.

For at least the explanations similar to those described above regarding *Aventail* and *VPN Overview*, Applicants submit that *Aventail* and *VPN Overview*, either alone or in combination, does not disclose or make obvious the features of independent Claim 16. Accordingly, reconsideration and withdrawal of the rejection of independent Claim 16 are respectfully requested.

The other claims currently under consideration in the application are dependent from their respective independent claims discussed above and therefore are believed to be allowable for at least similar reasons. Because each dependent claim is deemed to define an additional

aspect of the invention, the individual consideration of each on its own merits is respectfully requested. Reconsideration and withdrawal of the rejections of the dependent claims are respectfully requested.

The absence of a reply to a specific rejection, issue, or comment does not signify agreement with or concession of that rejection, issue, or comment. In addition, because the arguments made above may not be exhaustive, there may be other reasons for patentability of any or all claims that have not been expressed. Finally, nothing in this paper should be construed as an intent to concede, or an actual concession of, any issue with regard to any claim, or any cited art, except as specifically stated in this paper, and the amendment or cancellation of any claim does not necessarily signify concession of unpatentability of the claim prior to its amendment or cancellation.

CONCLUSION

In view of the foregoing amendments and remarks, the entire application is believed to be in condition for allowance, and such action is respectfully requested at the Examiner's earliest convenience. Should the Examiner have any questions, please call the undersigned at the phone number listed below.

To the extent necessary, a petition for an extension of time under 37 C.F.R. 1.136 is hereby made. Please charge any shortage in fees due in connection with the filing of this paper, including extension of time fees, to Deposit Account 502203 and please credit any excess fees to such deposit account.

Respectfully submitted,

McDERMOTT WILL & EMERY LLP

Date: June 1, 2012

/Toby H. Kusmer/
Toby H. Kusmer, P.C., Reg. No. 26,418
Ashley B. Tarokh, Reg. No. 68,651
Customer No. 23630
28 State Street
Boston, MA 02109-1775
Telephone: (617) 535-4000
Facsimile : (617)535-3800
E-mail: tkusmer@mwe.com

**TERMINAL DISCLAIMER TO OBIVATE A DOUBLE PATENTING
REJECTION OVER A "PRIOR" PATENT**Docket Number (Optional)
77580-155 (VRNK-1CP3CNFT5)

In re Application of: Victor Larson, et al.

Application No.: 13/342,795

Filed: January 3, 2012

For: System and Method Employing An Agile Network Protocol for Secure Communications Using Secure Domain Names

The owner*, Virnetx, Inc., of 100 percent interest in the instant application hereby disclaims, except as provided below, the terminal part of the statutory term of any patent granted on the instant application which would extend beyond the expiration date of the full statutory term of **prior patent** No. 6,502,135 as the term of said **prior patent** is presently shortened by any terminal disclaimer. The owner hereby agrees that any patent so granted on the instant application shall be enforceable only for and during such period that it and the **prior patent** are commonly owned. This agreement runs with any patent granted on the instant application and is binding upon the grantee, its successors or assigns.

In making the above disclaimer, the owner does not disclaim the terminal part of the term of any patent granted on the instant application that would extend to the expiration date of the full statutory term of the **prior patent**, "as the term of said **prior patent** is presently shortened by any terminal disclaimer," in the event that said **prior patent** later:

- expires for failure to pay a maintenance fee;
- is held unenforceable;
- is found invalid by a court of competent jurisdiction;
- is statutorily disclaimed in whole or terminally disclaimed under 37 CFR 1.321;
- has all claims canceled by a reexamination certificate;
- is reissued; or
- is in any manner terminated prior to the expiration of its full statutory term as presently shortened by any terminal disclaimer.

Check either box 1 or 2 below, if appropriate.

1. For submissions on behalf of a business/organization (e.g., corporation, partnership, university, government agency, etc.), the undersigned is empowered to act on behalf of the business/organization.

I hereby declare that all statements made herein of my own knowledge are true and that all statements made on information and belief are believed to be true; and further that these statements were made with the knowledge that willful false statements and the like so made are punishable by fine or imprisonment, or both, under Section 1001 of Title 18 of the United States Code and that such willful false statements may jeopardize the validity of the application or any patent issued thereon.

2. The undersigned is an attorney or agent of record. Reg. No. 47,025

/Toby H. Kusmer/

Signature

June 1, 2012

Date

Toby H. Kusmer

Typed or printed name

617.535.4065

Telephone Number

- Terminal disclaimer fee under 37 CFR 1.20(d) included.

WARNING: Information on this form may become public. Credit card information should not be included on this form. Provide credit card information and authorization on PTO-2038.

*Statement under 37 CFR 3.73(b) is required if terminal disclaimer is signed by the assignee (owner).
Form PTO/SB/96 may be used for making this certification. See MPEP § 324.

This collection of information is required by 37 CFR 1.321. The information is required to obtain or retain a benefit by the public which is to file (and by the USPTO to process) an application. Confidentiality is governed by 35 U.S.C. 122 and 37 CFR 1.11 and 1.14. This collection is estimated to take 12 minutes to complete, including gathering, preparing, and submitting the completed application form to the USPTO. Time will vary depending upon the individual case. Any comments on the amount of time you require to complete this form and/or suggestions for reducing this burden, should be sent to the Chief Information Officer, U.S. Patent and Trademark Office, U.S. Department of Commerce, P.O. Box 1450, Alexandria, VA 22313-1450. DO NOT SEND FEES OR COMPLETED FORMS TO THIS ADDRESS. **SEND TO: Commissioner for Patents, P.O. Box 1450, Alexandria, VA 22313-1450.**

If you need assistance in completing the form, call 1-800-PTO-9199 and select option 2.

Privacy Act Statement

The **Privacy Act of 1974 (P.L. 93-579)** requires that you be given certain information in connection with your submission of the attached form related to a patent application or patent. Accordingly, pursuant to the requirements of the Act, please be advised that: (1) the general authority for the collection of this information is 35 U.S.C. 2(b)(2); (2) furnishing of the information solicited is voluntary; and (3) the principal purpose for which the information is used by the U.S. Patent and Trademark Office is to process and/or examine your submission related to a patent application or patent. If you do not furnish the requested information, the U.S. Patent and Trademark Office may not be able to process and/or examine your submission, which may result in termination of proceedings or abandonment of the application or expiration of the patent.

The information provided by you in this form will be subject to the following routine uses:

1. The information on this form will be treated confidentially to the extent allowed under the Freedom of Information Act (5 U.S.C. 552) and the Privacy Act (5 U.S.C. 552a). Records from this system of records may be disclosed to the Department of Justice to determine whether disclosure of these records is required by the Freedom of Information Act.
2. A record from this system of records may be disclosed, as a routine use, in the course of presenting evidence to a court, magistrate, or administrative tribunal, including disclosures to opposing counsel in the course of settlement negotiations.
3. A record in this system of records may be disclosed, as a routine use, to a Member of Congress submitting a request involving an individual, to whom the record pertains, when the individual has requested assistance from the Member with respect to the subject matter of the record.
4. A record in this system of records may be disclosed, as a routine use, to a contractor of the Agency having need for the information in order to perform a contract. Recipients of information shall be required to comply with the requirements of the Privacy Act of 1974, as amended, pursuant to 5 U.S.C. 552a(m).
5. A record related to an International Application filed under the Patent Cooperation Treaty in this system of records may be disclosed, as a routine use, to the International Bureau of the World Intellectual Property Organization, pursuant to the Patent Cooperation Treaty.
6. A record in this system of records may be disclosed, as a routine use, to another federal agency for purposes of National Security review (35 U.S.C. 181) and for review pursuant to the Atomic Energy Act (42 U.S.C. 218(c)).
7. A record from this system of records may be disclosed, as a routine use, to the Administrator, General Services, or his/her designee, during an inspection of records conducted by GSA as part of that agency's responsibility to recommend improvements in records management practices and programs, under authority of 44 U.S.C. 2904 and 2906. Such disclosure shall be made in accordance with the GSA regulations governing inspection of records for this purpose, and any other relevant (*i.e.*, GSA or Commerce) directive. Such disclosure shall not be used to make determinations about individuals.
8. A record from this system of records may be disclosed, as a routine use, to the public after either publication of the application pursuant to 35 U.S.C. 122(b) or issuance of a patent pursuant to 35 U.S.C. 151. Further, a record may be disclosed, subject to the limitations of 37 CFR 1.14, as a routine use, to the public if the record was filed in an application which became abandoned or in which the proceedings were terminated and which application is referenced by either a published application, an application open to public inspection or an issued patent.
9. A record from this system of records may be disclosed, as a routine use, to a Federal, State, or local law enforcement agency, if the USPTO becomes aware of a violation or potential violation of law or regulation.

**TERMINAL DISCLAIMER TO OBIVATE A DOUBLE PATENTING
REJECTION OVER A "PRIOR" PATENT**Docket Number (Optional)
77580-155 (VRNK-1CP3CNFT5)

In re Application of: Victor Larson, et al.

Application No.: 13/342,795

Filed: January 3, 2012

For: System and Method Employing An Agile Network Protocol for Secure Communications Using Secure Domain Names

The owner*, Virnetx, Inc., of 100 percent interest in the instant application hereby disclaims, except as provided below, the terminal part of the statutory term of any patent granted on the instant application which would extend beyond the expiration date of the full statutory term of **prior patent** No. 7,987,274 as the term of said **prior patent** is presently shortened by any terminal disclaimer. The owner hereby agrees that any patent so granted on the instant application shall be enforceable only for and during such period that it and the **prior patent** are commonly owned. This agreement runs with any patent granted on the instant application and is binding upon the grantee, its successors or assigns.

In making the above disclaimer, the owner does not disclaim the terminal part of the term of any patent granted on the instant application that would extend to the expiration date of the full statutory term of the **prior patent**, "as the term of said **prior patent** is presently shortened by any terminal disclaimer," in the event that said **prior patent** later:

- expires for failure to pay a maintenance fee;
- is held unenforceable;
- is found invalid by a court of competent jurisdiction;
- is statutorily disclaimed in whole or terminally disclaimed under 37 CFR 1.321;
- has all claims canceled by a reexamination certificate;
- is reissued; or
- is in any manner terminated prior to the expiration of its full statutory term as presently shortened by any terminal disclaimer.

Check either box 1 or 2 below, if appropriate.

1. For submissions on behalf of a business/organization (e.g., corporation, partnership, university, government agency, etc.), the undersigned is empowered to act on behalf of the business/organization.

I hereby declare that all statements made herein of my own knowledge are true and that all statements made on information and belief are believed to be true; and further that these statements were made with the knowledge that willful false statements and the like so made are punishable by fine or imprisonment, or both, under Section 1001 of Title 18 of the United States Code and that such willful false statements may jeopardize the validity of the application or any patent issued thereon.

2. The undersigned is an attorney or agent of record. Reg. No. 47,025

/Toby H. Kusmer/
Signature

June 1, 2012
Date

Toby H. Kusmer
Typed or printed name

617.535.4065
Telephone Number

- Terminal disclaimer fee under 37 CFR 1.20(d) included.

WARNING: Information on this form may become public. Credit card information should not be included on this form. Provide credit card information and authorization on PTO-2038.

*Statement under 37 CFR 3.73(b) is required if terminal disclaimer is signed by the assignee (owner).
Form PTO/SB/96 may be used for making this certification. See MPEP § 324.

This collection of information is required by 37 CFR 1.321. The information is required to obtain or retain a benefit by the public which is to file (and by the USPTO to process) an application. Confidentiality is governed by 35 U.S.C. 122 and 37 CFR 1.11 and 1.14. This collection is estimated to take 12 minutes to complete, including gathering, preparing, and submitting the completed application form to the USPTO. Time will vary depending upon the individual case. Any comments on the amount of time you require to complete this form and/or suggestions for reducing this burden, should be sent to the Chief Information Officer, U.S. Patent and Trademark Office, U.S. Department of Commerce, P.O. Box 1450, Alexandria, VA 22313-1450. DO NOT SEND FEES OR COMPLETED FORMS TO THIS ADDRESS. **SEND TO: Commissioner for Patents, P.O. Box 1450, Alexandria, VA 22313-1450.**

If you need assistance in completing the form, call 1-800-PTO-9199 and select option 2.

Privacy Act Statement

The **Privacy Act of 1974 (P.L. 93-579)** requires that you be given certain information in connection with your submission of the attached form related to a patent application or patent. Accordingly, pursuant to the requirements of the Act, please be advised that: (1) the general authority for the collection of this information is 35 U.S.C. 2(b)(2); (2) furnishing of the information solicited is voluntary; and (3) the principal purpose for which the information is used by the U.S. Patent and Trademark Office is to process and/or examine your submission related to a patent application or patent. If you do not furnish the requested information, the U.S. Patent and Trademark Office may not be able to process and/or examine your submission, which may result in termination of proceedings or abandonment of the application or expiration of the patent.

The information provided by you in this form will be subject to the following routine uses:

1. The information on this form will be treated confidentially to the extent allowed under the Freedom of Information Act (5 U.S.C. 552) and the Privacy Act (5 U.S.C. 552a). Records from this system of records may be disclosed to the Department of Justice to determine whether disclosure of these records is required by the Freedom of Information Act.
2. A record from this system of records may be disclosed, as a routine use, in the course of presenting evidence to a court, magistrate, or administrative tribunal, including disclosures to opposing counsel in the course of settlement negotiations.
3. A record in this system of records may be disclosed, as a routine use, to a Member of Congress submitting a request involving an individual, to whom the record pertains, when the individual has requested assistance from the Member with respect to the subject matter of the record.
4. A record in this system of records may be disclosed, as a routine use, to a contractor of the Agency having need for the information in order to perform a contract. Recipients of information shall be required to comply with the requirements of the Privacy Act of 1974, as amended, pursuant to 5 U.S.C. 552a(m).
5. A record related to an International Application filed under the Patent Cooperation Treaty in this system of records may be disclosed, as a routine use, to the International Bureau of the World Intellectual Property Organization, pursuant to the Patent Cooperation Treaty.
6. A record in this system of records may be disclosed, as a routine use, to another federal agency for purposes of National Security review (35 U.S.C. 181) and for review pursuant to the Atomic Energy Act (42 U.S.C. 218(c)).
7. A record from this system of records may be disclosed, as a routine use, to the Administrator, General Services, or his/her designee, during an inspection of records conducted by GSA as part of that agency's responsibility to recommend improvements in records management practices and programs, under authority of 44 U.S.C. 2904 and 2906. Such disclosure shall be made in accordance with the GSA regulations governing inspection of records for this purpose, and any other relevant (*i.e.*, GSA or Commerce) directive. Such disclosure shall not be used to make determinations about individuals.
8. A record from this system of records may be disclosed, as a routine use, to the public after either publication of the application pursuant to 35 U.S.C. 122(b) or issuance of a patent pursuant to 35 U.S.C. 151. Further, a record may be disclosed, subject to the limitations of 37 CFR 1.14, as a routine use, to the public if the record was filed in an application which became abandoned or in which the proceedings were terminated and which application is referenced by either a published application, an application open to public inspection or an issued patent.
9. A record from this system of records may be disclosed, as a routine use, to a Federal, State, or local law enforcement agency, if the USPTO becomes aware of a violation or potential violation of law or regulation.

Under the Paperwork Reduction Act of 1995, no persons are required to respond to a collection of information unless it displays a valid OMB control number.

**TERMINAL DISCLAIMER TO OBVIATE A PROVISIONAL DOUBLE PATENTING
REJECTION OVER A PENDING "REFERENCE" APPLICATION**

Docket Number (Optional)

77580-155 (VRNK-1CP3CNFT5)

In re Application of: Victor Larson, et al.

Application No.: 13/342,795

Filed: January 3, 2012

For: System and Method Employing an Agile Network Protocol for Secure Communications Using Secure Domain Names

The owner*, Virnetx, Inc., of 100 percent interest in the instant application hereby disclaims, except as provided below, the terminal part of the statutory term of any patent granted on the instant application which would extend beyond the expiration date of the full statutory term of any patent granted on pending **reference** Application Number 13/080,680, filed April 6, 2011, as the term of any patent granted on said **reference** application may be shortened by any terminal disclaimer filed prior to the grant of any patent on the pending **reference** application. The owner hereby agrees that any patent so granted on the instant application shall be enforceable only for and during such period that it and any patent granted on the **reference** application are commonly owned. This agreement runs with any patent granted on the instant application and is binding upon the grantee, its successors or assigns.

In making the above disclaimer, the owner does not disclaim the terminal part of any patent granted on the instant application that would extend to the expiration date of the full statutory term of any patent granted on said **reference** application, "as the term of any patent granted on said **reference** application may be shortened by any terminal disclaimer filed prior to the grant of any patent on the pending **reference** application," in the event that: any such patent: granted on the pending **reference** application: expires for failure to pay a maintenance fee, is held unenforceable, is found invalid by a court of competent jurisdiction, is statutorily disclaimed in whole or terminally disclaimed under 37 CFR 1.321, has all claims canceled by a reexamination certificate, is reissued, or is in any manner terminated prior to the expiration of its full statutory term as shortened by any terminal disclaimer filed prior to its grant.

Check either box 1 or 2 below, if appropriate.

1. For submissions on behalf of a business/organization (e.g., corporation, partnership, university, government agency, etc.), the undersigned is empowered to act on behalf of the business/organization.

I hereby declare that all statements made herein of my own knowledge are true and that all statements made on information and belief are believed to be true; and further that these statements were made with the knowledge that willful false statements and the like so made are punishable by fine or imprisonment, or both, under Section 1001 of Title 18 of the United States Code and that such willful false statements may jeopardize the validity of the application or any patent issued thereon.

2. The undersigned is an attorney or agent of record. Reg. No. 47,025

/Toby H. Kusmer/
Signature

June 1, 2012
Date

Toby H. Kusmer
Typed or printed name

617.535.4065
Telephone Number

- Terminal disclaimer fee under 37 CFR 1.20(d) is included.

WARNING: Information on this form may become public. Credit card information should not be included on this form. Provide credit card information and authorization on PTO-2038.

*Statement under 37 CFR 3.73(b) is required if terminal disclaimer is signed by the assignee (owner).
Form PTO/SB/96 may be used for making this statement. See MPEP § 324.

This collection of information is required by 37 CFR 1.321. The information is required to obtain or retain a benefit by the public which is to file (and by the USPTO to process) an application. Confidentiality is governed by 35 U.S.C. 122 and 37 CFR 1.11 and 1.14. This collection is estimated to take 12 minutes to complete, including gathering, preparing, and submitting the completed application form to the USPTO. Time will vary depending upon the individual case. Any comments on the amount of time you require to complete this form and/or suggestions for reducing this burden, should be sent to the Chief Information Officer, U.S. Patent and Trademark Office, U.S. Department of Commerce, P.O. Box 1450, Alexandria, VA 22313-1450. DO NOT SEND FEES OR COMPLETED FORMS TO THIS ADDRESS. **SEND TO: Commissioner for Patents, P.O. Box 1450, Alexandria, VA 22313-1450.**

If you need assistance in completing the form, call 1-800-PTO-9199 and select option 2.

Privacy Act Statement

The **Privacy Act of 1974 (P.L. 93-579)** requires that you be given certain information in connection with your submission of the attached form related to a patent application or patent. Accordingly, pursuant to the requirements of the Act, please be advised that: (1) the general authority for the collection of this information is 35 U.S.C. 2(b)(2); (2) furnishing of the information solicited is voluntary; and (3) the principal purpose for which the information is used by the U.S. Patent and Trademark Office is to process and/or examine your submission related to a patent application or patent. If you do not furnish the requested information, the U.S. Patent and Trademark Office may not be able to process and/or examine your submission, which may result in termination of proceedings or abandonment of the application or expiration of the patent.

The information provided by you in this form will be subject to the following routine uses:

1. The information on this form will be treated confidentially to the extent allowed under the Freedom of Information Act (5 U.S.C. 552) and the Privacy Act (5 U.S.C. 552a). Records from this system of records may be disclosed to the Department of Justice to determine whether disclosure of these records is required by the Freedom of Information Act.
2. A record from this system of records may be disclosed, as a routine use, in the course of presenting evidence to a court, magistrate, or administrative tribunal, including disclosures to opposing counsel in the course of settlement negotiations.
3. A record in this system of records may be disclosed, as a routine use, to a Member of Congress submitting a request involving an individual, to whom the record pertains, when the individual has requested assistance from the Member with respect to the subject matter of the record.
4. A record in this system of records may be disclosed, as a routine use, to a contractor of the Agency having need for the information in order to perform a contract. Recipients of information shall be required to comply with the requirements of the Privacy Act of 1974, as amended, pursuant to 5 U.S.C. 552a(m).
5. A record related to an International Application filed under the Patent Cooperation Treaty in this system of records may be disclosed, as a routine use, to the International Bureau of the World Intellectual Property Organization, pursuant to the Patent Cooperation Treaty.
6. A record in this system of records may be disclosed, as a routine use, to another federal agency for purposes of National Security review (35 U.S.C. 181) and for review pursuant to the Atomic Energy Act (42 U.S.C. 218(c)).
7. A record from this system of records may be disclosed, as a routine use, to the Administrator, General Services, or his/her designee, during an inspection of records conducted by GSA as part of that agency's responsibility to recommend improvements in records management practices and programs, under authority of 44 U.S.C. 2904 and 2906. Such disclosure shall be made in accordance with the GSA regulations governing inspection of records for this purpose, and any other relevant (*i.e.*, GSA or Commerce) directive. Such disclosure shall not be used to make determinations about individuals.
8. A record from this system of records may be disclosed, as a routine use, to the public after either publication of the application pursuant to 35 U.S.C. 122(b) or issuance of a patent pursuant to 35 U.S.C. 151. Further, a record may be disclosed, subject to the limitations of 37 CFR 1.14, as a routine use, to the public if the record was filed in an application which became abandoned or in which the proceedings were terminated and which application is referenced by either a published application, an application open to public inspection or an issued patent.
9. A record from this system of records may be disclosed, as a routine use, to a Federal, State, or local law enforcement agency, if the USPTO becomes aware of a violation or potential violation of law or regulation.

Under the Paperwork Reduction Act of 1995, no persons are required to respond to a collection of information unless it displays a valid OMB control number.

**TERMINAL DISCLAIMER TO OBVIATE A PROVISIONAL DOUBLE PATENTING
REJECTION OVER A PENDING "REFERENCE" APPLICATION**

Docket Number (Optional)

77580-155 (VRNK-1CP3CNFT5)

In re Application of: Victor Larson, et al.

Application No.: 13/342,795

Filed: January 3, 2012

For: System and Method Employing an Agile Network Protocol for Secure Communications Using Secure Domain Names

The owner*, Virnetx, Inc., of 100 percent interest in the instant application hereby disclaims, except as provided below, the terminal part of the statutory term of any patent granted on the instant application which would extend beyond the expiration date of the full statutory term of any patent granted on pending **reference** Application Number 13/337,757, filed December 27, 2011, as the term of any patent granted on said **reference** application may be shortened by any terminal disclaimer filed prior to the grant of any patent on the pending **reference** application. The owner hereby agrees that any patent so granted on the instant application shall be enforceable only for and during such period that it and any patent granted on the **reference** application are commonly owned. This agreement runs with any patent granted on the instant application and is binding upon the grantee, its successors or assigns.

In making the above disclaimer, the owner does not disclaim the terminal part of any patent granted on the instant application that would extend to the expiration date of the full statutory term of any patent granted on said **reference** application, "as the term of any patent granted on said **reference** application may be shortened by any terminal disclaimer filed prior to the grant of any patent on the pending **reference** application," in the event that: any such patent: granted on the pending **reference** application: expires for failure to pay a maintenance fee, is held unenforceable, is found invalid by a court of competent jurisdiction, is statutorily disclaimed in whole or terminally disclaimed under 37 CFR 1.321, has all claims canceled by a reexamination certificate, is reissued, or is in any manner terminated prior to the expiration of its full statutory term as shortened by any terminal disclaimer filed prior to its grant.

Check either box 1 or 2 below, if appropriate.

1. For submissions on behalf of a business/organization (e.g., corporation, partnership, university, government agency, etc.), the undersigned is empowered to act on behalf of the business/organization.

I hereby declare that all statements made herein of my own knowledge are true and that all statements made on information and belief are believed to be true; and further that these statements were made with the knowledge that willful false statements and the like so made are punishable by fine or imprisonment, or both, under Section 1001 of Title 18 of the United States Code and that such willful false statements may jeopardize the validity of the application or any patent issued thereon.

2. The undersigned is an attorney or agent of record. Reg. No. 47,025

/Toby H. Kusmer/
Signature

June 1, 2012
Date

Toby H. Kusmer
Typed or printed name

617.535.4065
Telephone Number

- Terminal disclaimer fee under 37 CFR 1.20(d) is included.

WARNING: Information on this form may become public. Credit card information should not be included on this form. Provide credit card information and authorization on PTO-2038.

*Statement under 37 CFR 3.73(b) is required if terminal disclaimer is signed by the assignee (owner).
Form PTO/SB/96 may be used for making this statement. See MPEP § 324.

This collection of information is required by 37 CFR 1.321. The information is required to obtain or retain a benefit by the public which is to file (and by the USPTO to process) an application. Confidentiality is governed by 35 U.S.C. 122 and 37 CFR 1.11 and 1.14. This collection is estimated to take 12 minutes to complete, including gathering, preparing, and submitting the completed application form to the USPTO. Time will vary depending upon the individual case. Any comments on the amount of time you require to complete this form and/or suggestions for reducing this burden, should be sent to the Chief Information Officer, U.S. Patent and Trademark Office, U.S. Department of Commerce, P.O. Box 1450, Alexandria, VA 22313-1450. DO NOT SEND FEES OR COMPLETED FORMS TO THIS ADDRESS. **SEND TO: Commissioner for Patents, P.O. Box 1450, Alexandria, VA 22313-1450.**

If you need assistance in completing the form, call 1-800-PTO-9199 and select option 2.

Privacy Act Statement

The **Privacy Act of 1974 (P.L. 93-579)** requires that you be given certain information in connection with your submission of the attached form related to a patent application or patent. Accordingly, pursuant to the requirements of the Act, please be advised that: (1) the general authority for the collection of this information is 35 U.S.C. 2(b)(2); (2) furnishing of the information solicited is voluntary; and (3) the principal purpose for which the information is used by the U.S. Patent and Trademark Office is to process and/or examine your submission related to a patent application or patent. If you do not furnish the requested information, the U.S. Patent and Trademark Office may not be able to process and/or examine your submission, which may result in termination of proceedings or abandonment of the application or expiration of the patent.

The information provided by you in this form will be subject to the following routine uses:

1. The information on this form will be treated confidentially to the extent allowed under the Freedom of Information Act (5 U.S.C. 552) and the Privacy Act (5 U.S.C. 552a). Records from this system of records may be disclosed to the Department of Justice to determine whether disclosure of these records is required by the Freedom of Information Act.
2. A record from this system of records may be disclosed, as a routine use, in the course of presenting evidence to a court, magistrate, or administrative tribunal, including disclosures to opposing counsel in the course of settlement negotiations.
3. A record in this system of records may be disclosed, as a routine use, to a Member of Congress submitting a request involving an individual, to whom the record pertains, when the individual has requested assistance from the Member with respect to the subject matter of the record.
4. A record in this system of records may be disclosed, as a routine use, to a contractor of the Agency having need for the information in order to perform a contract. Recipients of information shall be required to comply with the requirements of the Privacy Act of 1974, as amended, pursuant to 5 U.S.C. 552a(m).
5. A record related to an International Application filed under the Patent Cooperation Treaty in this system of records may be disclosed, as a routine use, to the International Bureau of the World Intellectual Property Organization, pursuant to the Patent Cooperation Treaty.
6. A record in this system of records may be disclosed, as a routine use, to another federal agency for purposes of National Security review (35 U.S.C. 181) and for review pursuant to the Atomic Energy Act (42 U.S.C. 218(c)).
7. A record from this system of records may be disclosed, as a routine use, to the Administrator, General Services, or his/her designee, during an inspection of records conducted by GSA as part of that agency's responsibility to recommend improvements in records management practices and programs, under authority of 44 U.S.C. 2904 and 2906. Such disclosure shall be made in accordance with the GSA regulations governing inspection of records for this purpose, and any other relevant (*i.e.*, GSA or Commerce) directive. Such disclosure shall not be used to make determinations about individuals.
8. A record from this system of records may be disclosed, as a routine use, to the public after either publication of the application pursuant to 35 U.S.C. 122(b) or issuance of a patent pursuant to 35 U.S.C. 151. Further, a record may be disclosed, subject to the limitations of 37 CFR 1.14, as a routine use, to the public if the record was filed in an application which became abandoned or in which the proceedings were terminated and which application is referenced by either a published application, an application open to public inspection or an issued patent.
9. A record from this system of records may be disclosed, as a routine use, to a Federal, State, or local law enforcement agency, if the USPTO becomes aware of a violation or potential violation of law or regulation.

Under the Paperwork Reduction Act of 1995, no persons are required to respond to a collection of information unless it displays a valid OMB control number.

**TERMINAL DISCLAIMER TO OBVIATE A PROVISIONAL DOUBLE PATENTING
REJECTION OVER A PENDING "REFERENCE" APPLICATION**

Docket Number (Optional)

77580-155 (VRNK-1CP3CNFT5)

In re Application of: Victor Larson, et al.

Application No.: 13/342,795

Filed: January 3, 2012

For: System and Method Employing an Agile Network Protocol for Secure Communications Using Secure Domain Names

The owner*, Virnetx, Inc., of 100 percent interest in the instant application hereby disclaims, except as provided below, the terminal part of the statutory term of any patent granted on the instant application which would extend beyond the expiration date of the full statutory term of any patent granted on pending **reference** Application Number 13/336,790, filed December 23, 2011, as the term of any patent granted on said **reference** application may be shortened by any terminal disclaimer filed prior to the grant of any patent on the pending **reference** application. The owner hereby agrees that any patent so granted on the instant application shall be enforceable only for and during such period that it and any patent granted on the **reference** application are commonly owned. This agreement runs with any patent granted on the instant application and is binding upon the grantee, its successors or assigns.

In making the above disclaimer, the owner does not disclaim the terminal part of any patent granted on the instant application that would extend to the expiration date of the full statutory term of any patent granted on said **reference** application, "as the term of any patent granted on said **reference** application may be shortened by any terminal disclaimer filed prior to the grant of any patent on the pending **reference** application," in the event that: any such patent: granted on the pending **reference** application: expires for failure to pay a maintenance fee, is held unenforceable, is found invalid by a court of competent jurisdiction, is statutorily disclaimed in whole or terminally disclaimed under 37 CFR 1.321, has all claims canceled by a reexamination certificate, is reissued, or is in any manner terminated prior to the expiration of its full statutory term as shortened by any terminal disclaimer filed prior to its grant.

Check either box 1 or 2 below, if appropriate.

1. For submissions on behalf of a business/organization (e.g., corporation, partnership, university, government agency, etc.), the undersigned is empowered to act on behalf of the business/organization.

I hereby declare that all statements made herein of my own knowledge are true and that all statements made on information and belief are believed to be true; and further that these statements were made with the knowledge that willful false statements and the like so made are punishable by fine or imprisonment, or both, under Section 1001 of Title 18 of the United States Code and that such willful false statements may jeopardize the validity of the application or any patent issued thereon.

2. The undersigned is an attorney or agent of record. Reg. No. 47,025

/Toby H. Kusmer/
Signature

June 1, 2012
Date

Toby H. Kusmer
Typed or printed name

617.535.4065
Telephone Number

- Terminal disclaimer fee under 37 CFR 1.20(d) is included.

WARNING: Information on this form may become public. Credit card information should not be included on this form. Provide credit card information and authorization on PTO-2038.

*Statement under 37 CFR 3.73(b) is required if terminal disclaimer is signed by the assignee (owner).
Form PTO/SB/96 may be used for making this statement. See MPEP § 324.

This collection of information is required by 37 CFR 1.321. The information is required to obtain or retain a benefit by the public which is to file (and by the USPTO to process) an application. Confidentiality is governed by 35 U.S.C. 122 and 37 CFR 1.11 and 1.14. This collection is estimated to take 12 minutes to complete, including gathering, preparing, and submitting the completed application form to the USPTO. Time will vary depending upon the individual case. Any comments on the amount of time you require to complete this form and/or suggestions for reducing this burden, should be sent to the Chief Information Officer, U.S. Patent and Trademark Office, U.S. Department of Commerce, P.O. Box 1450, Alexandria, VA 22313-1450. DO NOT SEND FEES OR COMPLETED FORMS TO THIS ADDRESS. **SEND TO: Commissioner for Patents, P.O. Box 1450, Alexandria, VA 22313-1450.**

If you need assistance in completing the form, call 1-800-PTO-9199 and select option 2.

Privacy Act Statement

The **Privacy Act of 1974 (P.L. 93-579)** requires that you be given certain information in connection with your submission of the attached form related to a patent application or patent. Accordingly, pursuant to the requirements of the Act, please be advised that: (1) the general authority for the collection of this information is 35 U.S.C. 2(b)(2); (2) furnishing of the information solicited is voluntary; and (3) the principal purpose for which the information is used by the U.S. Patent and Trademark Office is to process and/or examine your submission related to a patent application or patent. If you do not furnish the requested information, the U.S. Patent and Trademark Office may not be able to process and/or examine your submission, which may result in termination of proceedings or abandonment of the application or expiration of the patent.

The information provided by you in this form will be subject to the following routine uses:

1. The information on this form will be treated confidentially to the extent allowed under the Freedom of Information Act (5 U.S.C. 552) and the Privacy Act (5 U.S.C. 552a). Records from this system of records may be disclosed to the Department of Justice to determine whether disclosure of these records is required by the Freedom of Information Act.
2. A record from this system of records may be disclosed, as a routine use, in the course of presenting evidence to a court, magistrate, or administrative tribunal, including disclosures to opposing counsel in the course of settlement negotiations.
3. A record in this system of records may be disclosed, as a routine use, to a Member of Congress submitting a request involving an individual, to whom the record pertains, when the individual has requested assistance from the Member with respect to the subject matter of the record.
4. A record in this system of records may be disclosed, as a routine use, to a contractor of the Agency having need for the information in order to perform a contract. Recipients of information shall be required to comply with the requirements of the Privacy Act of 1974, as amended, pursuant to 5 U.S.C. 552a(m).
5. A record related to an International Application filed under the Patent Cooperation Treaty in this system of records may be disclosed, as a routine use, to the International Bureau of the World Intellectual Property Organization, pursuant to the Patent Cooperation Treaty.
6. A record in this system of records may be disclosed, as a routine use, to another federal agency for purposes of National Security review (35 U.S.C. 181) and for review pursuant to the Atomic Energy Act (42 U.S.C. 218(c)).
7. A record from this system of records may be disclosed, as a routine use, to the Administrator, General Services, or his/her designee, during an inspection of records conducted by GSA as part of that agency's responsibility to recommend improvements in records management practices and programs, under authority of 44 U.S.C. 2904 and 2906. Such disclosure shall be made in accordance with the GSA regulations governing inspection of records for this purpose, and any other relevant (*i.e.*, GSA or Commerce) directive. Such disclosure shall not be used to make determinations about individuals.
8. A record from this system of records may be disclosed, as a routine use, to the public after either publication of the application pursuant to 35 U.S.C. 122(b) or issuance of a patent pursuant to 35 U.S.C. 151. Further, a record may be disclosed, subject to the limitations of 37 CFR 1.14, as a routine use, to the public if the record was filed in an application which became abandoned or in which the proceedings were terminated and which application is referenced by either a published application, an application open to public inspection or an issued patent.
9. A record from this system of records may be disclosed, as a routine use, to a Federal, State, or local law enforcement agency, if the USPTO becomes aware of a violation or potential violation of law or regulation.

Under the Paperwork Reduction Act of 1995, no persons are required to respond to a collection of information unless it displays a valid OMB control number.

**TERMINAL DISCLAIMER TO OBVIATE A PROVISIONAL DOUBLE PATENTING
REJECTION OVER A PENDING "REFERENCE" APPLICATION**Docket Number (Optional)
77580-155 (VRNK-1CP3CNFT5)

In re Application of: Victor Larson, et al.

Application No.: 13/342,795

Filed: January 3, 2012

For: System and Method Employing an Agile Network Protocol for Secure Communications Using Secure Domain Names

The owner*, Virnetx, Inc., of 100 percent interest in the instant application hereby disclaims, except as provided below, the terminal part of the statutory term of any patent granted on the instant application which would extend beyond the expiration date of the full statutory term of any patent granted on pending **reference** Application Number 13/336,958, filed December 23, 2011, as the term of any patent granted on said **reference** application may be shortened by any terminal disclaimer filed prior to the grant of any patent on the pending **reference** application. The owner hereby agrees that any patent so granted on the instant application shall be enforceable only for and during such period that it and any patent granted on the **reference** application are commonly owned. This agreement runs with any patent granted on the instant application and is binding upon the grantee, its successors or assigns.

In making the above disclaimer, the owner does not disclaim the terminal part of any patent granted on the instant application that would extend to the expiration date of the full statutory term of any patent granted on said **reference** application, "as the term of any patent granted on said **reference** application may be shortened by any terminal disclaimer filed prior to the grant of any patent on the pending **reference** application," in the event that: any such patent: granted on the pending **reference** application: expires for failure to pay a maintenance fee, is held unenforceable, is found invalid by a court of competent jurisdiction, is statutorily disclaimed in whole or terminally disclaimed under 37 CFR 1.321, has all claims canceled by a reexamination certificate, is reissued, or is in any manner terminated prior to the expiration of its full statutory term as shortened by any terminal disclaimer filed prior to its grant.

Check either box 1 or 2 below, if appropriate.

1. For submissions on behalf of a business/organization (e.g., corporation, partnership, university, government agency, etc.), the undersigned is empowered to act on behalf of the business/organization.

I hereby declare that all statements made herein of my own knowledge are true and that all statements made on information and belief are believed to be true; and further that these statements were made with the knowledge that willful false statements and the like so made are punishable by fine or imprisonment, or both, under Section 1001 of Title 18 of the United States Code and that such willful false statements may jeopardize the validity of the application or any patent issued thereon.

2. The undersigned is an attorney or agent of record. Reg. No. 47,025

/Toby H. Kusmer/
Signature

June 1, 2012
Date

Toby H. Kusmer
Typed or printed name

617.535.4065
Telephone Number

- Terminal disclaimer fee under 37 CFR 1.20(d) is included.

WARNING: Information on this form may become public. Credit card information should not be included on this form. Provide credit card information and authorization on PTO-2038.

*Statement under 37 CFR 3.73(b) is required if terminal disclaimer is signed by the assignee (owner).
Form PTO/SB/96 may be used for making this statement. See MPEP § 324.

This collection of information is required by 37 CFR 1.321. The information is required to obtain or retain a benefit by the public which is to file (and by the USPTO to process) an application. Confidentiality is governed by 35 U.S.C. 122 and 37 CFR 1.11 and 1.14. This collection is estimated to take 12 minutes to complete, including gathering, preparing, and submitting the completed application form to the USPTO. Time will vary depending upon the individual case. Any comments on the amount of time you require to complete this form and/or suggestions for reducing this burden, should be sent to the Chief Information Officer, U.S. Patent and Trademark Office, U.S. Department of Commerce, P.O. Box 1450, Alexandria, VA 22313-1450. DO NOT SEND FEES OR COMPLETED FORMS TO THIS ADDRESS. **SEND TO: Commissioner for Patents, P.O. Box 1450, Alexandria, VA 22313-1450.**

If you need assistance in completing the form, call 1-800-PTO-9199 and select option 2.

Privacy Act Statement

The **Privacy Act of 1974 (P.L. 93-579)** requires that you be given certain information in connection with your submission of the attached form related to a patent application or patent. Accordingly, pursuant to the requirements of the Act, please be advised that: (1) the general authority for the collection of this information is 35 U.S.C. 2(b)(2); (2) furnishing of the information solicited is voluntary; and (3) the principal purpose for which the information is used by the U.S. Patent and Trademark Office is to process and/or examine your submission related to a patent application or patent. If you do not furnish the requested information, the U.S. Patent and Trademark Office may not be able to process and/or examine your submission, which may result in termination of proceedings or abandonment of the application or expiration of the patent.

The information provided by you in this form will be subject to the following routine uses:

1. The information on this form will be treated confidentially to the extent allowed under the Freedom of Information Act (5 U.S.C. 552) and the Privacy Act (5 U.S.C. 552a). Records from this system of records may be disclosed to the Department of Justice to determine whether disclosure of these records is required by the Freedom of Information Act.
2. A record from this system of records may be disclosed, as a routine use, in the course of presenting evidence to a court, magistrate, or administrative tribunal, including disclosures to opposing counsel in the course of settlement negotiations.
3. A record in this system of records may be disclosed, as a routine use, to a Member of Congress submitting a request involving an individual, to whom the record pertains, when the individual has requested assistance from the Member with respect to the subject matter of the record.
4. A record in this system of records may be disclosed, as a routine use, to a contractor of the Agency having need for the information in order to perform a contract. Recipients of information shall be required to comply with the requirements of the Privacy Act of 1974, as amended, pursuant to 5 U.S.C. 552a(m).
5. A record related to an International Application filed under the Patent Cooperation Treaty in this system of records may be disclosed, as a routine use, to the International Bureau of the World Intellectual Property Organization, pursuant to the Patent Cooperation Treaty.
6. A record in this system of records may be disclosed, as a routine use, to another federal agency for purposes of National Security review (35 U.S.C. 181) and for review pursuant to the Atomic Energy Act (42 U.S.C. 218(c)).
7. A record from this system of records may be disclosed, as a routine use, to the Administrator, General Services, or his/her designee, during an inspection of records conducted by GSA as part of that agency's responsibility to recommend improvements in records management practices and programs, under authority of 44 U.S.C. 2904 and 2906. Such disclosure shall be made in accordance with the GSA regulations governing inspection of records for this purpose, and any other relevant (*i.e.*, GSA or Commerce) directive. Such disclosure shall not be used to make determinations about individuals.
8. A record from this system of records may be disclosed, as a routine use, to the public after either publication of the application pursuant to 35 U.S.C. 122(b) or issuance of a patent pursuant to 35 U.S.C. 151. Further, a record may be disclosed, subject to the limitations of 37 CFR 1.14, as a routine use, to the public if the record was filed in an application which became abandoned or in which the proceedings were terminated and which application is referenced by either a published application, an application open to public inspection or an issued patent.
9. A record from this system of records may be disclosed, as a routine use, to a Federal, State, or local law enforcement agency, if the USPTO becomes aware of a violation or potential violation of law or regulation.

Electronic Patent Application Fee Transmittal

Application Number:	13342795			
Filing Date:	03-Jan-2012			
Title of Invention:	SYSTEM AND METHOD EMPLOYING AN AGILE NETWORK PROTOCOL FOR SECURE COMMUNICATIONS USING SECURE DOMAIN NAMES			
First Named Inventor/Applicant Name:	Victor Larson			
Filer:	Toby H. Kusmer./Tricia Tedesco			
Attorney Docket Number:	77580-155(VR NK-1CP3CNFT5)			
Filed as Large Entity				
Utility under 35 USC 111(a) Filing Fees				
Description	Fee Code	Quantity	Amount	Sub-Total in USD(\$)
Basic Filing:				
Pages:				
Claims:				
Miscellaneous-Filing:				
Petition:				
Patent-Appeals-and-Interference:				
Post-Allowance-and-Post-Issuance:				
Extension-of-Time:				

Description	Fee Code	Quantity	Amount	Sub-Total in USD(\$)
Miscellaneous:				
Statutory or terminal disclaimer	1814	12	160	1920
Total in USD (\$)				1920

Electronic Acknowledgement Receipt

EFS ID:	12909504
Application Number:	13342795
International Application Number:	
Confirmation Number:	4180
Title of Invention:	SYSTEM AND METHOD EMPLOYING AN AGILE NETWORK PROTOCOL FOR SECURE COMMUNICATIONS USING SECURE DOMAIN NAMES
First Named Inventor/Applicant Name:	Victor Larson
Customer Number:	23630
Filer:	Toby H. Kusmer.
Filer Authorized By:	
Attorney Docket Number:	77580-155(VRNK-1CP3CNFT5)
Receipt Date:	01-JUN-2012
Filing Date:	03-JAN-2012
Time Stamp:	16:26:39
Application Type:	Utility under 35 USC 111(a)

Payment information:

Submitted with Payment	yes
Payment Type	Deposit Account
Payment was successfully received in RAM	\$1920
RAM confirmation Number	3466
Deposit Account	501133
Authorized User	

The Director of the USPTO is hereby authorized to charge indicated fees and credit any overpayment as follows:

Charge any Additional Fees required under 37 C.F.R. Section 1.16 (National application filing, search, and examination fees)

Charge any Additional Fees required under 37 C.F.R. Section 1.17 (Patent application and reexamination processing fees)

Charge any Additional Fees required under 37 C.F.R. Section 1.19 (Document supply fees)

Charge any Additional Fees required under 37 C.F.R. Section 1.20 (Post Issuance fees)

Charge any Additional Fees required under 37 C.F.R. Section 1.21 (Miscellaneous fees and charges)

File Listing:

Document Number	Document Description	File Name	File Size(Bytes)/ Message Digest	Multi Part /.zip	Pages (if appl.)
1	Amendment/Req. Reconsideration-After Non-Final Reject	ReplyA.pdf	135969	no	11
			74c5e19892e21bbd95146c3f71cfa26e435a b492		
Warnings:					
Information:					
2	Terminal Disclaimer Filed	TerminalDisclaimer-135.pdf	374513	no	2
			a316ad9d017bd0e456dd177ecd89bbc28f cbeb6		
Warnings:					
Information:					
3	Terminal Disclaimer Filed	TerminalDisclaimer-180.pdf	374450	no	2
			a9a621eb24da7e4fd1f1654e3d2e4aa5c24 0f94		
Warnings:					
Information:					
4	Terminal Disclaimer Filed	TerminalDisclaimer-181.pdf	374451	no	2
			4ac5d7e30c53f9c1e3a348e94b27bb2a725 d7f5a		
Warnings:					
Information:					
5	Terminal Disclaimer Filed	TerminalDisclaimer-211.pdf	374451	no	2
			6808b1f8608b092983a0a3970095e3343c3 dd8d6		
Warnings:					
Information:					
6	Terminal Disclaimer Filed	TerminalDisclaimer-257.pdf	342809	no	2
			77935a98e3cc7254c3e7cfd6bec2dc739d7a 8bcc		
Warnings:					
Information:					
7	Terminal Disclaimer Filed	TerminalDisclaimer-274.pdf	374451	no	2
			10675139a3626161b528da43370fe64cceb c8672		
Warnings:					
Information:					
8	Terminal Disclaimer Filed	TerminalDisclaimer-465.pdf	342809	no	2
			9e4d6fc6153c8fd18b1e5b106c0dda985ee cac4a		

Warnings:					
Information:					
9	Terminal Disclaimer Filed	TerminalDisclaimer-504.pdf	374451 8849a38fc38a03e36df8af8b3d1d6ff34c7ea4f1	no	2
Warnings:					
Information:					
10	Terminal Disclaimer Filed	TerminalDisclaimer-680.pdf	342792 ea56f525767a63ff1f313800efa4368934176bd4c	no	2
Warnings:					
Information:					
11	Terminal Disclaimer Filed	TerminalDisclaimer-757.pdf	342810 147f5c9f109e838f715f321f0b3428baa30a596f	no	2
Warnings:					
Information:					
12	Terminal Disclaimer Filed	TerminalDisclaimer-790.pdf	342809 6ba067c2e624ac6e2773f290e45f0ef2c720644d	no	2
Warnings:					
Information:					
13	Terminal Disclaimer Filed	TerminalDisclaimer-958.pdf	342812 ce60743d29478b33657fa5ee7b2beaac8d92a199	no	2
Warnings:					
Information:					
14	Fee Worksheet (SB06)	fee-info.pdf	30670 51fc1e497fcaab9a698336cf6a9e621f3844add	no	2
Warnings:					
Information:					
Total Files Size (in bytes):			4470247		

This Acknowledgement Receipt evidences receipt on the noted date by the USPTO of the indicated documents, characterized by the applicant, and including page counts, where applicable. It serves as evidence of receipt similar to a Post Card, as described in MPEP 503.

New Applications Under 35 U.S.C. 111

If a new application is being filed and the application includes the necessary components for a filing date (see 37 CFR 1.53(b)-(d) and MPEP 506), a Filing Receipt (37 CFR 1.54) will be issued in due course and the date shown on this Acknowledgement Receipt will establish the filing date of the application.

National Stage of an International Application under 35 U.S.C. 371

If a timely submission to enter the national stage of an international application is compliant with the conditions of 35 U.S.C. 371 and other applicable requirements a Form PCT/DO/EO/903 indicating acceptance of the application as a national stage submission under 35 U.S.C. 371 will be issued in addition to the Filing Receipt, in due course.

New International Application Filed with the USPTO as a Receiving Office

If a new international application is being filed and the international application includes the necessary components for an international filing date (see PCT Article 11 and MPEP 1810), a Notification of the International Application Number and of the International Filing Date (Form PCT/RO/105) will be issued in due course, subject to prescriptions concerning national security, and the date shown on this Acknowledgement Receipt will establish the international filing date of the application.

**TERMINAL DISCLAIMER TO OBIVATE A DOUBLE PATENTING
REJECTION OVER A "PRIOR" PATENT**Docket Number (Optional)
77580-155 (VRNK-1CP3CNFT5)

In re Application of: Victor Larson, et al.

Application No.: 13/342,795

Filed: January 3, 2012

For: System and Method Employing An Agile Network Protocol for Secure Communications Using Secure Domain Names

The owner*, Virnetx, Inc., of 100 percent interest in the instant application hereby disclaims, except as provided below, the terminal part of the statutory term of any patent granted on the instant application which would extend beyond the expiration date of the full statutory term of **prior patent** No. 7,418,504 as the term of said **prior patent** is presently shortened by any terminal disclaimer. The owner hereby agrees that any patent so granted on the instant application shall be enforceable only for and during such period that it and the **prior patent** are commonly owned. This agreement runs with any patent granted on the instant application and is binding upon the grantee, its successors or assigns.

In making the above disclaimer, the owner does not disclaim the terminal part of the term of any patent granted on the instant application that would extend to the expiration date of the full statutory term of the **prior patent**, "as the term of said **prior patent** is presently shortened by any terminal disclaimer," in the event that said **prior patent** later:

- expires for failure to pay a maintenance fee;
- is held unenforceable;
- is found invalid by a court of competent jurisdiction;
- is statutorily disclaimed in whole or terminally disclaimed under 37 CFR 1.321;
- has all claims canceled by a reexamination certificate;
- is reissued; or
- is in any manner terminated prior to the expiration of its full statutory term as presently shortened by any terminal disclaimer.

Check either box 1 or 2 below, if appropriate.

1. For submissions on behalf of a business/organization (e.g., corporation, partnership, university, government agency, etc.), the undersigned is empowered to act on behalf of the business/organization.

I hereby declare that all statements made herein of my own knowledge are true and that all statements made on information and belief are believed to be true; and further that these statements were made with the knowledge that willful false statements and the like so made are punishable by fine or imprisonment, or both, under Section 1001 of Title 18 of the United States Code and that such willful false statements may jeopardize the validity of the application or any patent issued thereon.

2. The undersigned is an attorney or agent of record. Reg. No. 47,025

/Toby H. Kusmer/
Signature

June 1, 2012
Date

Toby H. Kusmer
Typed or printed name

617.535.4065
Telephone Number

- Terminal disclaimer fee under 37 CFR 1.20(d) included.

WARNING: Information on this form may become public. Credit card information should not be included on this form. Provide credit card information and authorization on PTO-2038.

*Statement under 37 CFR 3.73(b) is required if terminal disclaimer is signed by the assignee (owner).
Form PTO/SB/96 may be used for making this certification. See MPEP § 324.

This collection of information is required by 37 CFR 1.321. The information is required to obtain or retain a benefit by the public which is to file (and by the USPTO to process) an application. Confidentiality is governed by 35 U.S.C. 122 and 37 CFR 1.11 and 1.14. This collection is estimated to take 12 minutes to complete, including gathering, preparing, and submitting the completed application form to the USPTO. Time will vary depending upon the individual case. Any comments on the amount of time you require to complete this form and/or suggestions for reducing this burden, should be sent to the Chief Information Officer, U.S. Patent and Trademark Office, U.S. Department of Commerce, P.O. Box 1450, Alexandria, VA 22313-1450. DO NOT SEND FEES OR COMPLETED FORMS TO THIS ADDRESS. **SEND TO: Commissioner for Patents, P.O. Box 1450, Alexandria, VA 22313-1450.**

If you need assistance in completing the form, call 1-800-PTO-9199 and select option 2.

Privacy Act Statement

The **Privacy Act of 1974 (P.L. 93-579)** requires that you be given certain information in connection with your submission of the attached form related to a patent application or patent. Accordingly, pursuant to the requirements of the Act, please be advised that: (1) the general authority for the collection of this information is 35 U.S.C. 2(b)(2); (2) furnishing of the information solicited is voluntary; and (3) the principal purpose for which the information is used by the U.S. Patent and Trademark Office is to process and/or examine your submission related to a patent application or patent. If you do not furnish the requested information, the U.S. Patent and Trademark Office may not be able to process and/or examine your submission, which may result in termination of proceedings or abandonment of the application or expiration of the patent.

The information provided by you in this form will be subject to the following routine uses:

1. The information on this form will be treated confidentially to the extent allowed under the Freedom of Information Act (5 U.S.C. 552) and the Privacy Act (5 U.S.C. 552a). Records from this system of records may be disclosed to the Department of Justice to determine whether disclosure of these records is required by the Freedom of Information Act.
2. A record from this system of records may be disclosed, as a routine use, in the course of presenting evidence to a court, magistrate, or administrative tribunal, including disclosures to opposing counsel in the course of settlement negotiations.
3. A record in this system of records may be disclosed, as a routine use, to a Member of Congress submitting a request involving an individual, to whom the record pertains, when the individual has requested assistance from the Member with respect to the subject matter of the record.
4. A record in this system of records may be disclosed, as a routine use, to a contractor of the Agency having need for the information in order to perform a contract. Recipients of information shall be required to comply with the requirements of the Privacy Act of 1974, as amended, pursuant to 5 U.S.C. 552a(m).
5. A record related to an International Application filed under the Patent Cooperation Treaty in this system of records may be disclosed, as a routine use, to the International Bureau of the World Intellectual Property Organization, pursuant to the Patent Cooperation Treaty.
6. A record in this system of records may be disclosed, as a routine use, to another federal agency for purposes of National Security review (35 U.S.C. 181) and for review pursuant to the Atomic Energy Act (42 U.S.C. 218(c)).
7. A record from this system of records may be disclosed, as a routine use, to the Administrator, General Services, or his/her designee, during an inspection of records conducted by GSA as part of that agency's responsibility to recommend improvements in records management practices and programs, under authority of 44 U.S.C. 2904 and 2906. Such disclosure shall be made in accordance with the GSA regulations governing inspection of records for this purpose, and any other relevant (*i.e.*, GSA or Commerce) directive. Such disclosure shall not be used to make determinations about individuals.
8. A record from this system of records may be disclosed, as a routine use, to the public after either publication of the application pursuant to 35 U.S.C. 122(b) or issuance of a patent pursuant to 35 U.S.C. 151. Further, a record may be disclosed, subject to the limitations of 37 CFR 1.14, as a routine use, to the public if the record was filed in an application which became abandoned or in which the proceedings were terminated and which application is referenced by either a published application, an application open to public inspection or an issued patent.
9. A record from this system of records may be disclosed, as a routine use, to a Federal, State, or local law enforcement agency, if the USPTO becomes aware of a violation or potential violation of law or regulation.

Under the Paperwork Reduction Act of 1995, no persons are required to respond to a collection of information unless it displays a valid OMB control number.

**TERMINAL DISCLAIMER TO OBVIATE A PROVISIONAL DOUBLE PATENTING
REJECTION OVER A PENDING "REFERENCE" APPLICATION**

Docket Number (Optional)

77580-155 (VRNK-1CP3CNFT5)

In re Application of: Victor Larson, et al.

Application No.: 13/342,795

Filed: January 3, 2012

For: System and Method Employing an Agile Network Protocol for Secure Communications Using Secure Domain Names

The owner*, Virnetx, Inc., of 100 percent interest in the instant application hereby disclaims, except as provided below, the terminal part of the statutory term of any patent granted on the instant application which would extend beyond the expiration date of the full statutory term of any patent granted on pending **reference** Application Number 13/343,465, filed January 4, 2012, as the term of any patent granted on said **reference** application may be shortened by any terminal disclaimer filed prior to the grant of any patent on the pending **reference** application. The owner hereby agrees that any patent so granted on the instant application shall be enforceable only for and during such period that it and any patent granted on the **reference** application are commonly owned. This agreement runs with any patent granted on the instant application and is binding upon the grantee, its successors or assigns.

In making the above disclaimer, the owner does not disclaim the terminal part of any patent granted on the instant application that would extend to the expiration date of the full statutory term of any patent granted on said **reference** application, "as the term of any patent granted on said **reference** application may be shortened by any terminal disclaimer filed prior to the grant of any patent on the pending **reference** application," in the event that: any such patent: granted on the pending **reference** application: expires for failure to pay a maintenance fee, is held unenforceable, is found invalid by a court of competent jurisdiction, is statutorily disclaimed in whole or terminally disclaimed under 37 CFR 1.321, has all claims canceled by a reexamination certificate, is reissued, or is in any manner terminated prior to the expiration of its full statutory term as shortened by any terminal disclaimer filed prior to its grant.

Check either box 1 or 2 below, if appropriate.

1. For submissions on behalf of a business/organization (e.g., corporation, partnership, university, government agency, etc.), the undersigned is empowered to act on behalf of the business/organization.

I hereby declare that all statements made herein of my own knowledge are true and that all statements made on information and belief are believed to be true; and further that these statements were made with the knowledge that willful false statements and the like so made are punishable by fine or imprisonment, or both, under Section 1001 of Title 18 of the United States Code and that such willful false statements may jeopardize the validity of the application or any patent issued thereon.

2. The undersigned is an attorney or agent of record. Reg. No. 47,025

/Toby H. Kusmer/
Signature

June 1, 2012
Date

Toby H. Kusmer
Typed or printed name

617.535.4065
Telephone Number

- Terminal disclaimer fee under 37 CFR 1.20(d) is included.

WARNING: Information on this form may become public. Credit card information should not be included on this form. Provide credit card information and authorization on PTO-2038.

*Statement under 37 CFR 3.73(b) is required if terminal disclaimer is signed by the assignee (owner).
Form PTO/SB/96 may be used for making this statement. See MPEP § 324.

This collection of information is required by 37 CFR 1.321. The information is required to obtain or retain a benefit by the public which is to file (and by the USPTO to process) an application. Confidentiality is governed by 35 U.S.C. 122 and 37 CFR 1.11 and 1.14. This collection is estimated to take 12 minutes to complete, including gathering, preparing, and submitting the completed application form to the USPTO. Time will vary depending upon the individual case. Any comments on the amount of time you require to complete this form and/or suggestions for reducing this burden, should be sent to the Chief Information Officer, U.S. Patent and Trademark Office, U.S. Department of Commerce, P.O. Box 1450, Alexandria, VA 22313-1450. DO NOT SEND FEES OR COMPLETED FORMS TO THIS ADDRESS. **SEND TO: Commissioner for Patents, P.O. Box 1450, Alexandria, VA 22313-1450.**

If you need assistance in completing the form, call 1-800-PTO-9199 and select option 2.

Privacy Act Statement

The **Privacy Act of 1974 (P.L. 93-579)** requires that you be given certain information in connection with your submission of the attached form related to a patent application or patent. Accordingly, pursuant to the requirements of the Act, please be advised that: (1) the general authority for the collection of this information is 35 U.S.C. 2(b)(2); (2) furnishing of the information solicited is voluntary; and (3) the principal purpose for which the information is used by the U.S. Patent and Trademark Office is to process and/or examine your submission related to a patent application or patent. If you do not furnish the requested information, the U.S. Patent and Trademark Office may not be able to process and/or examine your submission, which may result in termination of proceedings or abandonment of the application or expiration of the patent.

The information provided by you in this form will be subject to the following routine uses:

1. The information on this form will be treated confidentially to the extent allowed under the Freedom of Information Act (5 U.S.C. 552) and the Privacy Act (5 U.S.C. 552a). Records from this system of records may be disclosed to the Department of Justice to determine whether disclosure of these records is required by the Freedom of Information Act.
2. A record from this system of records may be disclosed, as a routine use, in the course of presenting evidence to a court, magistrate, or administrative tribunal, including disclosures to opposing counsel in the course of settlement negotiations.
3. A record in this system of records may be disclosed, as a routine use, to a Member of Congress submitting a request involving an individual, to whom the record pertains, when the individual has requested assistance from the Member with respect to the subject matter of the record.
4. A record in this system of records may be disclosed, as a routine use, to a contractor of the Agency having need for the information in order to perform a contract. Recipients of information shall be required to comply with the requirements of the Privacy Act of 1974, as amended, pursuant to 5 U.S.C. 552a(m).
5. A record related to an International Application filed under the Patent Cooperation Treaty in this system of records may be disclosed, as a routine use, to the International Bureau of the World Intellectual Property Organization, pursuant to the Patent Cooperation Treaty.
6. A record in this system of records may be disclosed, as a routine use, to another federal agency for purposes of National Security review (35 U.S.C. 181) and for review pursuant to the Atomic Energy Act (42 U.S.C. 218(c)).
7. A record from this system of records may be disclosed, as a routine use, to the Administrator, General Services, or his/her designee, during an inspection of records conducted by GSA as part of that agency's responsibility to recommend improvements in records management practices and programs, under authority of 44 U.S.C. 2904 and 2906. Such disclosure shall be made in accordance with the GSA regulations governing inspection of records for this purpose, and any other relevant (*i.e.*, GSA or Commerce) directive. Such disclosure shall not be used to make determinations about individuals.
8. A record from this system of records may be disclosed, as a routine use, to the public after either publication of the application pursuant to 35 U.S.C. 122(b) or issuance of a patent pursuant to 35 U.S.C. 151. Further, a record may be disclosed, subject to the limitations of 37 CFR 1.14, as a routine use, to the public if the record was filed in an application which became abandoned or in which the proceedings were terminated and which application is referenced by either a published application, an application open to public inspection or an issued patent.
9. A record from this system of records may be disclosed, as a routine use, to a Federal, State, or local law enforcement agency, if the USPTO becomes aware of a violation or potential violation of law or regulation.

**TERMINAL DISCLAIMER TO OBIVATE A DOUBLE PATENTING
REJECTION OVER A "PRIOR" PATENT**Docket Number (Optional)
77580-155 (VRNK-1CP3CNFT5)

In re Application of: Victor Larson, et al.

Application No.: 13/342,795

Filed: January 3, 2012

For: System and Method Employing An Agile Network Protocol for Secure Communications Using Secure Domain Names

The owner*, Virnetx, Inc., of 100 percent interest in the instant application hereby disclaims, except as provided below, the terminal part of the statutory term of any patent granted on the instant application which would extend beyond the expiration date of the full statutory term of **prior patent** No. 8,051,181 as the term of said **prior patent** is presently shortened by any terminal disclaimer. The owner hereby agrees that any patent so granted on the instant application shall be enforceable only for and during such period that it and the **prior patent** are commonly owned. This agreement runs with any patent granted on the instant application and is binding upon the grantee, its successors or assigns.

In making the above disclaimer, the owner does not disclaim the terminal part of the term of any patent granted on the instant application that would extend to the expiration date of the full statutory term of the **prior patent**, "as the term of said **prior patent** is presently shortened by any terminal disclaimer," in the event that said **prior patent** later:

- expires for failure to pay a maintenance fee;
- is held unenforceable;
- is found invalid by a court of competent jurisdiction;
- is statutorily disclaimed in whole or terminally disclaimed under 37 CFR 1.321;
- has all claims canceled by a reexamination certificate;
- is reissued; or
- is in any manner terminated prior to the expiration of its full statutory term as presently shortened by any terminal disclaimer.

Check either box 1 or 2 below, if appropriate.

1. For submissions on behalf of a business/organization (e.g., corporation, partnership, university, government agency, etc.), the undersigned is empowered to act on behalf of the business/organization.

I hereby declare that all statements made herein of my own knowledge are true and that all statements made on information and belief are believed to be true; and further that these statements were made with the knowledge that willful false statements and the like so made are punishable by fine or imprisonment, or both, under Section 1001 of Title 18 of the United States Code and that such willful false statements may jeopardize the validity of the application or any patent issued thereon.

2. The undersigned is an attorney or agent of record. Reg. No. 47,025

/Toby H. Kusmer/
Signature

June 1, 2012
Date

Toby H. Kusmer
Typed or printed name

617.535.4065
Telephone Number

- Terminal disclaimer fee under 37 CFR 1.20(d) included.

WARNING: Information on this form may become public. Credit card information should not be included on this form. Provide credit card information and authorization on PTO-2038.

*Statement under 37 CFR 3.73(b) is required if terminal disclaimer is signed by the assignee (owner).
Form PTO/SB/96 may be used for making this certification. See MPEP § 324.

This collection of information is required by 37 CFR 1.321. The information is required to obtain or retain a benefit by the public which is to file (and by the USPTO to process) an application. Confidentiality is governed by 35 U.S.C. 122 and 37 CFR 1.11 and 1.14. This collection is estimated to take 12 minutes to complete, including gathering, preparing, and submitting the completed application form to the USPTO. Time will vary depending upon the individual case. Any comments on the amount of time you require to complete this form and/or suggestions for reducing this burden, should be sent to the Chief Information Officer, U.S. Patent and Trademark Office, U.S. Department of Commerce, P.O. Box 1450, Alexandria, VA 22313-1450. DO NOT SEND FEES OR COMPLETED FORMS TO THIS ADDRESS. **SEND TO: Commissioner for Patents, P.O. Box 1450, Alexandria, VA 22313-1450.**

If you need assistance in completing the form, call 1-800-PTO-9199 and select option 2.

Privacy Act Statement

The **Privacy Act of 1974 (P.L. 93-579)** requires that you be given certain information in connection with your submission of the attached form related to a patent application or patent. Accordingly, pursuant to the requirements of the Act, please be advised that: (1) the general authority for the collection of this information is 35 U.S.C. 2(b)(2); (2) furnishing of the information solicited is voluntary; and (3) the principal purpose for which the information is used by the U.S. Patent and Trademark Office is to process and/or examine your submission related to a patent application or patent. If you do not furnish the requested information, the U.S. Patent and Trademark Office may not be able to process and/or examine your submission, which may result in termination of proceedings or abandonment of the application or expiration of the patent.

The information provided by you in this form will be subject to the following routine uses:

1. The information on this form will be treated confidentially to the extent allowed under the Freedom of Information Act (5 U.S.C. 552) and the Privacy Act (5 U.S.C. 552a). Records from this system of records may be disclosed to the Department of Justice to determine whether disclosure of these records is required by the Freedom of Information Act.
2. A record from this system of records may be disclosed, as a routine use, in the course of presenting evidence to a court, magistrate, or administrative tribunal, including disclosures to opposing counsel in the course of settlement negotiations.
3. A record in this system of records may be disclosed, as a routine use, to a Member of Congress submitting a request involving an individual, to whom the record pertains, when the individual has requested assistance from the Member with respect to the subject matter of the record.
4. A record in this system of records may be disclosed, as a routine use, to a contractor of the Agency having need for the information in order to perform a contract. Recipients of information shall be required to comply with the requirements of the Privacy Act of 1974, as amended, pursuant to 5 U.S.C. 552a(m).
5. A record related to an International Application filed under the Patent Cooperation Treaty in this system of records may be disclosed, as a routine use, to the International Bureau of the World Intellectual Property Organization, pursuant to the Patent Cooperation Treaty.
6. A record in this system of records may be disclosed, as a routine use, to another federal agency for purposes of National Security review (35 U.S.C. 181) and for review pursuant to the Atomic Energy Act (42 U.S.C. 218(c)).
7. A record from this system of records may be disclosed, as a routine use, to the Administrator, General Services, or his/her designee, during an inspection of records conducted by GSA as part of that agency's responsibility to recommend improvements in records management practices and programs, under authority of 44 U.S.C. 2904 and 2906. Such disclosure shall be made in accordance with the GSA regulations governing inspection of records for this purpose, and any other relevant (*i.e.*, GSA or Commerce) directive. Such disclosure shall not be used to make determinations about individuals.
8. A record from this system of records may be disclosed, as a routine use, to the public after either publication of the application pursuant to 35 U.S.C. 122(b) or issuance of a patent pursuant to 35 U.S.C. 151. Further, a record may be disclosed, subject to the limitations of 37 CFR 1.14, as a routine use, to the public if the record was filed in an application which became abandoned or in which the proceedings were terminated and which application is referenced by either a published application, an application open to public inspection or an issued patent.
9. A record from this system of records may be disclosed, as a routine use, to a Federal, State, or local law enforcement agency, if the USPTO becomes aware of a violation or potential violation of law or regulation.

**TERMINAL DISCLAIMER TO OBIVATE A DOUBLE PATENTING
REJECTION OVER A "PRIOR" PATENT**

Docket Number (Optional)

77580-155 (VRNK-1CP3CNFT5)

In re Application of: Victor Larson, et al.

Application No.: 13/342,795

Filed: January 3, 2012

For: System and Method Employing An Agile Network Protocol for Secure Communications Using Secure Domain Names

The owner*, Virnetx, Inc., of 100 percent interest in the instant application hereby disclaims, except as provided below, the terminal part of the statutory term of any patent granted on the instant application which would extend beyond the expiration date of the full statutory term of **prior patent** No. 7,188,180 as the term of said **prior patent** is presently shortened by any terminal disclaimer. The owner hereby agrees that any patent so granted on the instant application shall be enforceable only for and during such period that it and the **prior patent** are commonly owned. This agreement runs with any patent granted on the instant application and is binding upon the grantee, its successors or assigns.

In making the above disclaimer, the owner does not disclaim the terminal part of the term of any patent granted on the instant application that would extend to the expiration date of the full statutory term of the **prior patent**, "as the term of said **prior patent** is presently shortened by any terminal disclaimer," in the event that said **prior patent** later:

- expires for failure to pay a maintenance fee;
- is held unenforceable;
- is found invalid by a court of competent jurisdiction;
- is statutorily disclaimed in whole or terminally disclaimed under 37 CFR 1.321;
- has all claims canceled by a reexamination certificate;
- is reissued; or
- is in any manner terminated prior to the expiration of its full statutory term as presently shortened by any terminal disclaimer.

Check either box 1 or 2 below, if appropriate.

1. For submissions on behalf of a business/organization (e.g., corporation, partnership, university, government agency, etc.), the undersigned is empowered to act on behalf of the business/organization.

I hereby declare that all statements made herein of my own knowledge are true and that all statements made on information and belief are believed to be true; and further that these statements were made with the knowledge that willful false statements and the like so made are punishable by fine or imprisonment, or both, under Section 1001 of Title 18 of the United States Code and that such willful false statements may jeopardize the validity of the application or any patent issued thereon.

2. The undersigned is an attorney or agent of record. Reg. No. 47,025

/Toby H. Kusmer/

Signature

June 1, 2012

Date

Toby H. Kusmer

Typed or printed name

617.535.4065

Telephone Number

- Terminal disclaimer fee under 37 CFR 1.20(d) included.

WARNING: Information on this form may become public. Credit card information should not be included on this form. Provide credit card information and authorization on PTO-2038.

*Statement under 37 CFR 3.73(b) is required if terminal disclaimer is signed by the assignee (owner).
Form PTO/SB/96 may be used for making this certification. See MPEP § 324.

This collection of information is required by 37 CFR 1.321. The information is required to obtain or retain a benefit by the public which is to file (and by the USPTO to process) an application. Confidentiality is governed by 35 U.S.C. 122 and 37 CFR 1.11 and 1.14. This collection is estimated to take 12 minutes to complete, including gathering, preparing, and submitting the completed application form to the USPTO. Time will vary depending upon the individual case. Any comments on the amount of time you require to complete this form and/or suggestions for reducing this burden, should be sent to the Chief Information Officer, U.S. Patent and Trademark Office, U.S. Department of Commerce, P.O. Box 1450, Alexandria, VA 22313-1450. DO NOT SEND FEES OR COMPLETED FORMS TO THIS ADDRESS. **SEND TO: Commissioner for Patents, P.O. Box 1450, Alexandria, VA 22313-1450.**

If you need assistance in completing the form, call 1-800-PTO-9199 and select option 2.

Privacy Act Statement

The **Privacy Act of 1974 (P.L. 93-579)** requires that you be given certain information in connection with your submission of the attached form related to a patent application or patent. Accordingly, pursuant to the requirements of the Act, please be advised that: (1) the general authority for the collection of this information is 35 U.S.C. 2(b)(2); (2) furnishing of the information solicited is voluntary; and (3) the principal purpose for which the information is used by the U.S. Patent and Trademark Office is to process and/or examine your submission related to a patent application or patent. If you do not furnish the requested information, the U.S. Patent and Trademark Office may not be able to process and/or examine your submission, which may result in termination of proceedings or abandonment of the application or expiration of the patent.

The information provided by you in this form will be subject to the following routine uses:

1. The information on this form will be treated confidentially to the extent allowed under the Freedom of Information Act (5 U.S.C. 552) and the Privacy Act (5 U.S.C. 552a). Records from this system of records may be disclosed to the Department of Justice to determine whether disclosure of these records is required by the Freedom of Information Act.
2. A record from this system of records may be disclosed, as a routine use, in the course of presenting evidence to a court, magistrate, or administrative tribunal, including disclosures to opposing counsel in the course of settlement negotiations.
3. A record in this system of records may be disclosed, as a routine use, to a Member of Congress submitting a request involving an individual, to whom the record pertains, when the individual has requested assistance from the Member with respect to the subject matter of the record.
4. A record in this system of records may be disclosed, as a routine use, to a contractor of the Agency having need for the information in order to perform a contract. Recipients of information shall be required to comply with the requirements of the Privacy Act of 1974, as amended, pursuant to 5 U.S.C. 552a(m).
5. A record related to an International Application filed under the Patent Cooperation Treaty in this system of records may be disclosed, as a routine use, to the International Bureau of the World Intellectual Property Organization, pursuant to the Patent Cooperation Treaty.
6. A record in this system of records may be disclosed, as a routine use, to another federal agency for purposes of National Security review (35 U.S.C. 181) and for review pursuant to the Atomic Energy Act (42 U.S.C. 218(c)).
7. A record from this system of records may be disclosed, as a routine use, to the Administrator, General Services, or his/her designee, during an inspection of records conducted by GSA as part of that agency's responsibility to recommend improvements in records management practices and programs, under authority of 44 U.S.C. 2904 and 2906. Such disclosure shall be made in accordance with the GSA regulations governing inspection of records for this purpose, and any other relevant (*i.e.*, GSA or Commerce) directive. Such disclosure shall not be used to make determinations about individuals.
8. A record from this system of records may be disclosed, as a routine use, to the public after either publication of the application pursuant to 35 U.S.C. 122(b) or issuance of a patent pursuant to 35 U.S.C. 151. Further, a record may be disclosed, subject to the limitations of 37 CFR 1.14, as a routine use, to the public if the record was filed in an application which became abandoned or in which the proceedings were terminated and which application is referenced by either a published application, an application open to public inspection or an issued patent.
9. A record from this system of records may be disclosed, as a routine use, to a Federal, State, or local law enforcement agency, if the USPTO becomes aware of a violation or potential violation of law or regulation.

**TERMINAL DISCLAIMER TO OBIVATE A DOUBLE PATENTING
REJECTION OVER A "PRIOR" PATENT**Docket Number (Optional)
77580-155 (VRNK-1CP3CNFT5)

In re Application of: Victor Larson, et al.

Application No.: 13/342,795

Filed: January 3, 2012

For: System and Method Employing An Agile Network Protocol for Secure Communications Using Secure Domain Names

The owner*, Virnetx, Inc., of 100 percent interest in the instant application hereby disclaims, except as provided below, the terminal part of the statutory term of any patent granted on the instant application which would extend beyond the expiration date of the full statutory term of **prior patent** No. 7,921,211 as the term of said **prior patent** is presently shortened by any terminal disclaimer. The owner hereby agrees that any patent so granted on the instant application shall be enforceable only for and during such period that it and the **prior patent** are commonly owned. This agreement runs with any patent granted on the instant application and is binding upon the grantee, its successors or assigns.

In making the above disclaimer, the owner does not disclaim the terminal part of the term of any patent granted on the instant application that would extend to the expiration date of the full statutory term of the **prior patent**, "as the term of said **prior patent** is presently shortened by any terminal disclaimer," in the event that said **prior patent** later:

- expires for failure to pay a maintenance fee;
- is held unenforceable;
- is found invalid by a court of competent jurisdiction;
- is statutorily disclaimed in whole or terminally disclaimed under 37 CFR 1.321;
- has all claims canceled by a reexamination certificate;
- is reissued; or
- is in any manner terminated prior to the expiration of its full statutory term as presently shortened by any terminal disclaimer.

Check either box 1 or 2 below, if appropriate.

1. For submissions on behalf of a business/organization (e.g., corporation, partnership, university, government agency, etc.), the undersigned is empowered to act on behalf of the business/organization.

I hereby declare that all statements made herein of my own knowledge are true and that all statements made on information and belief are believed to be true; and further that these statements were made with the knowledge that willful false statements and the like so made are punishable by fine or imprisonment, or both, under Section 1001 of Title 18 of the United States Code and that such willful false statements may jeopardize the validity of the application or any patent issued thereon.

2. The undersigned is an attorney or agent of record. Reg. No. 47,025

/Toby H. Kusmer/

Signature

June 1, 2012

Date

Toby H. Kusmer

Typed or printed name

617.535.4065

Telephone Number

- Terminal disclaimer fee under 37 CFR 1.20(d) included.

WARNING: Information on this form may become public. Credit card information should not be included on this form. Provide credit card information and authorization on PTO-2038.

*Statement under 37 CFR 3.73(b) is required if terminal disclaimer is signed by the assignee (owner).
Form PTO/SB/96 may be used for making this certification. See MPEP § 324.

This collection of information is required by 37 CFR 1.321. The information is required to obtain or retain a benefit by the public which is to file (and by the USPTO to process) an application. Confidentiality is governed by 35 U.S.C. 122 and 37 CFR 1.11 and 1.14. This collection is estimated to take 12 minutes to complete, including gathering, preparing, and submitting the completed application form to the USPTO. Time will vary depending upon the individual case. Any comments on the amount of time you require to complete this form and/or suggestions for reducing this burden, should be sent to the Chief Information Officer, U.S. Patent and Trademark Office, U.S. Department of Commerce, P.O. Box 1450, Alexandria, VA 22313-1450. DO NOT SEND FEES OR COMPLETED FORMS TO THIS ADDRESS. **SEND TO: Commissioner for Patents, P.O. Box 1450, Alexandria, VA 22313-1450.**

If you need assistance in completing the form, call 1-800-PTO-9199 and select option 2.

Privacy Act Statement

The **Privacy Act of 1974 (P.L. 93-579)** requires that you be given certain information in connection with your submission of the attached form related to a patent application or patent. Accordingly, pursuant to the requirements of the Act, please be advised that: (1) the general authority for the collection of this information is 35 U.S.C. 2(b)(2); (2) furnishing of the information solicited is voluntary; and (3) the principal purpose for which the information is used by the U.S. Patent and Trademark Office is to process and/or examine your submission related to a patent application or patent. If you do not furnish the requested information, the U.S. Patent and Trademark Office may not be able to process and/or examine your submission, which may result in termination of proceedings or abandonment of the application or expiration of the patent.

The information provided by you in this form will be subject to the following routine uses:

1. The information on this form will be treated confidentially to the extent allowed under the Freedom of Information Act (5 U.S.C. 552) and the Privacy Act (5 U.S.C. 552a). Records from this system of records may be disclosed to the Department of Justice to determine whether disclosure of these records is required by the Freedom of Information Act.
2. A record from this system of records may be disclosed, as a routine use, in the course of presenting evidence to a court, magistrate, or administrative tribunal, including disclosures to opposing counsel in the course of settlement negotiations.
3. A record in this system of records may be disclosed, as a routine use, to a Member of Congress submitting a request involving an individual, to whom the record pertains, when the individual has requested assistance from the Member with respect to the subject matter of the record.
4. A record in this system of records may be disclosed, as a routine use, to a contractor of the Agency having need for the information in order to perform a contract. Recipients of information shall be required to comply with the requirements of the Privacy Act of 1974, as amended, pursuant to 5 U.S.C. 552a(m).
5. A record related to an International Application filed under the Patent Cooperation Treaty in this system of records may be disclosed, as a routine use, to the International Bureau of the World Intellectual Property Organization, pursuant to the Patent Cooperation Treaty.
6. A record in this system of records may be disclosed, as a routine use, to another federal agency for purposes of National Security review (35 U.S.C. 181) and for review pursuant to the Atomic Energy Act (42 U.S.C. 218(c)).
7. A record from this system of records may be disclosed, as a routine use, to the Administrator, General Services, or his/her designee, during an inspection of records conducted by GSA as part of that agency's responsibility to recommend improvements in records management practices and programs, under authority of 44 U.S.C. 2904 and 2906. Such disclosure shall be made in accordance with the GSA regulations governing inspection of records for this purpose, and any other relevant (*i.e.*, GSA or Commerce) directive. Such disclosure shall not be used to make determinations about individuals.
8. A record from this system of records may be disclosed, as a routine use, to the public after either publication of the application pursuant to 35 U.S.C. 122(b) or issuance of a patent pursuant to 35 U.S.C. 151. Further, a record may be disclosed, subject to the limitations of 37 CFR 1.14, as a routine use, to the public if the record was filed in an application which became abandoned or in which the proceedings were terminated and which application is referenced by either a published application, an application open to public inspection or an issued patent.
9. A record from this system of records may be disclosed, as a routine use, to a Federal, State, or local law enforcement agency, if the USPTO becomes aware of a violation or potential violation of law or regulation.

Under the Paperwork Reduction Act of 1995, no persons are required to respond to a collection of information unless it displays a valid OMB control number.

**TERMINAL DISCLAIMER TO OBVIATE A PROVISIONAL DOUBLE PATENTING
REJECTION OVER A PENDING "REFERENCE" APPLICATION**

Docket Number (Optional)

77580-155 (VRNK-1CP3CNFT5)

In re Application of: Victor Larson, et al.

Application No.: 13/342,795

Filed: January 3, 2012

For: System and Method Employing an Agile Network Protocol for Secure Communications Using Secure Domain Names

The owner*, Virnetx, Inc., of 100 percent interest in the instant application hereby disclaims, except as provided below, the terminal part of the statutory term of any patent granted on the instant application which would extend beyond the expiration date of the full statutory term of any patent granted on pending **reference** Application Number 13/339,257, filed December 28, 2011, as the term of any patent granted on said **reference** application may be shortened by any terminal disclaimer filed prior to the grant of any patent on the pending **reference** application. The owner hereby agrees that any patent so granted on the instant application shall be enforceable only for and during such period that it and any patent granted on the **reference** application are commonly owned. This agreement runs with any patent granted on the instant application and is binding upon the grantee, its successors or assigns.

In making the above disclaimer, the owner does not disclaim the terminal part of any patent granted on the instant application that would extend to the expiration date of the full statutory term of any patent granted on said **reference** application, "as the term of any patent granted on said **reference** application may be shortened by any terminal disclaimer filed prior to the grant of any patent on the pending **reference** application," in the event that: any such patent: granted on the pending **reference** application: expires for failure to pay a maintenance fee, is held unenforceable, is found invalid by a court of competent jurisdiction, is statutorily disclaimed in whole or terminally disclaimed under 37 CFR 1.321, has all claims canceled by a reexamination certificate, is reissued, or is in any manner terminated prior to the expiration of its full statutory term as shortened by any terminal disclaimer filed prior to its grant.

Check either box 1 or 2 below, if appropriate.

1. For submissions on behalf of a business/organization (e.g., corporation, partnership, university, government agency, etc.), the undersigned is empowered to act on behalf of the business/organization.

I hereby declare that all statements made herein of my own knowledge are true and that all statements made on information and belief are believed to be true; and further that these statements were made with the knowledge that willful false statements and the like so made are punishable by fine or imprisonment, or both, under Section 1001 of Title 18 of the United States Code and that such willful false statements may jeopardize the validity of the application or any patent issued thereon.

2. The undersigned is an attorney or agent of record. Reg. No. 47,025

/Toby H. Kusmer/
Signature

June 1, 2012
Date

Toby H. Kusmer
Typed or printed name

617.535.4065
Telephone Number

- Terminal disclaimer fee under 37 CFR 1.20(d) is included.

WARNING: Information on this form may become public. Credit card information should not be included on this form. Provide credit card information and authorization on PTO-2038.

*Statement under 37 CFR 3.73(b) is required if terminal disclaimer is signed by the assignee (owner).
Form PTO/SB/96 may be used for making this statement. See MPEP § 324.

This collection of information is required by 37 CFR 1.321. The information is required to obtain or retain a benefit by the public which is to file (and by the USPTO to process) an application. Confidentiality is governed by 35 U.S.C. 122 and 37 CFR 1.11 and 1.14. This collection is estimated to take 12 minutes to complete, including gathering, preparing, and submitting the completed application form to the USPTO. Time will vary depending upon the individual case. Any comments on the amount of time you require to complete this form and/or suggestions for reducing this burden, should be sent to the Chief Information Officer, U.S. Patent and Trademark Office, U.S. Department of Commerce, P.O. Box 1450, Alexandria, VA 22313-1450. DO NOT SEND FEES OR COMPLETED FORMS TO THIS ADDRESS. **SEND TO: Commissioner for Patents, P.O. Box 1450, Alexandria, VA 22313-1450.**

If you need assistance in completing the form, call 1-800-PTO-9199 and select option 2.

Privacy Act Statement

The **Privacy Act of 1974 (P.L. 93-579)** requires that you be given certain information in connection with your submission of the attached form related to a patent application or patent. Accordingly, pursuant to the requirements of the Act, please be advised that: (1) the general authority for the collection of this information is 35 U.S.C. 2(b)(2); (2) furnishing of the information solicited is voluntary; and (3) the principal purpose for which the information is used by the U.S. Patent and Trademark Office is to process and/or examine your submission related to a patent application or patent. If you do not furnish the requested information, the U.S. Patent and Trademark Office may not be able to process and/or examine your submission, which may result in termination of proceedings or abandonment of the application or expiration of the patent.

The information provided by you in this form will be subject to the following routine uses:

1. The information on this form will be treated confidentially to the extent allowed under the Freedom of Information Act (5 U.S.C. 552) and the Privacy Act (5 U.S.C. 552a). Records from this system of records may be disclosed to the Department of Justice to determine whether disclosure of these records is required by the Freedom of Information Act.
2. A record from this system of records may be disclosed, as a routine use, in the course of presenting evidence to a court, magistrate, or administrative tribunal, including disclosures to opposing counsel in the course of settlement negotiations.
3. A record in this system of records may be disclosed, as a routine use, to a Member of Congress submitting a request involving an individual, to whom the record pertains, when the individual has requested assistance from the Member with respect to the subject matter of the record.
4. A record in this system of records may be disclosed, as a routine use, to a contractor of the Agency having need for the information in order to perform a contract. Recipients of information shall be required to comply with the requirements of the Privacy Act of 1974, as amended, pursuant to 5 U.S.C. 552a(m).
5. A record related to an International Application filed under the Patent Cooperation Treaty in this system of records may be disclosed, as a routine use, to the International Bureau of the World Intellectual Property Organization, pursuant to the Patent Cooperation Treaty.
6. A record in this system of records may be disclosed, as a routine use, to another federal agency for purposes of National Security review (35 U.S.C. 181) and for review pursuant to the Atomic Energy Act (42 U.S.C. 218(c)).
7. A record from this system of records may be disclosed, as a routine use, to the Administrator, General Services, or his/her designee, during an inspection of records conducted by GSA as part of that agency's responsibility to recommend improvements in records management practices and programs, under authority of 44 U.S.C. 2904 and 2906. Such disclosure shall be made in accordance with the GSA regulations governing inspection of records for this purpose, and any other relevant (*i.e.*, GSA or Commerce) directive. Such disclosure shall not be used to make determinations about individuals.
8. A record from this system of records may be disclosed, as a routine use, to the public after either publication of the application pursuant to 35 U.S.C. 122(b) or issuance of a patent pursuant to 35 U.S.C. 151. Further, a record may be disclosed, subject to the limitations of 37 CFR 1.14, as a routine use, to the public if the record was filed in an application which became abandoned or in which the proceedings were terminated and which application is referenced by either a published application, an application open to public inspection or an issued patent.
9. A record from this system of records may be disclosed, as a routine use, to a Federal, State, or local law enforcement agency, if the USPTO becomes aware of a violation or potential violation of law or regulation.

Under the Paperwork Reduction Act of 1995, no persons are required to respond to a collection of information unless it displays a valid OMB control number.

PATENT APPLICATION FEE DETERMINATION RECORD Substitute for Form PTO-875	Application or Docket Number 13/342,795	Filing Date 01/03/2012	<input type="checkbox"/> To be Mailed
---	---	----------------------------------	---------------------------------------

APPLICATION AS FILED – PART I			OTHER THAN SMALL ENTITY				
(Column 1)		(Column 2)	SMALL ENTITY <input type="checkbox"/>		OR	SMALL ENTITY	
FOR	NUMBER FILED	NUMBER EXTRA	RATE (\$)	FEE (\$)		RATE (\$)	FEE (\$)
<input type="checkbox"/> BASIC FEE <small>(37 CFR 1.16(a), (b), or (c))</small>	N/A	N/A	N/A		OR	N/A	
<input type="checkbox"/> SEARCH FEE <small>(37 CFR 1.16(k), (j), or (m))</small>	N/A	N/A	N/A			N/A	
<input type="checkbox"/> EXAMINATION FEE <small>(37 CFR 1.16(o), (p), or (q))</small>	N/A	N/A	N/A			N/A	
TOTAL CLAIMS <small>(37 CFR 1.16(j))</small>	minus 20 =	*	X \$ =			X \$ =	
INDEPENDENT CLAIMS <small>(37 CFR 1.16(h))</small>	minus 3 =	*	X \$ =			X \$ =	
<input type="checkbox"/> APPLICATION SIZE FEE <small>(37 CFR 1.16(s))</small>	If the specification and drawings exceed 100 sheets of paper, the application size fee due is \$250 (\$125 for small entity) for each additional 50 sheets or fraction thereof. See 35 U.S.C. 41(a)(1)(G) and 37 CFR 1.16(s).						
<input type="checkbox"/> MULTIPLE DEPENDENT CLAIM PRESENT <small>(37 CFR 1.16(j))</small>							
* If the difference in column 1 is less than zero, enter "0" in column 2.			TOTAL			TOTAL	

APPLICATION AS AMENDED – PART II					OTHER THAN SMALL ENTITY				
(Column 1)		(Column 2)	(Column 3)		SMALL ENTITY		OR	SMALL ENTITY	
AMENDMENT	06/01/2012	CLAIMS REMAINING AFTER AMENDMENT	HIGHEST NUMBER PREVIOUSLY PAID FOR	PRESENT EXTRA	RATE (\$)	ADDITIONAL FEE (\$)		RATE (\$)	ADDITIONAL FEE (\$)
	Total <small>(37 CFR 1.16(i))</small>	* 30	Minus	** 30 = 0	X \$ =		OR	X \$60=	0
	Independent <small>(37 CFR 1.16(h))</small>	* 2	Minus	***2 = 0	X \$ =		OR	X \$250=	0
<input type="checkbox"/> Application Size Fee <small>(37 CFR 1.16(s))</small>									
<input type="checkbox"/> FIRST PRESENTATION OF MULTIPLE DEPENDENT CLAIM <small>(37 CFR 1.16(j))</small>							OR		
					TOTAL ADD'L FEE		OR	TOTAL ADD'L FEE	0

APPLICATION AS AMENDED – PART II					OTHER THAN SMALL ENTITY				
(Column 1)		(Column 2)	(Column 3)		SMALL ENTITY		OR	SMALL ENTITY	
AMENDMENT	CLAIMS REMAINING AFTER AMENDMENT	HIGHEST NUMBER PREVIOUSLY PAID FOR	PRESENT EXTRA	RATE (\$)	ADDITIONAL FEE (\$)		RATE (\$)	ADDITIONAL FEE (\$)	
	Total <small>(37 CFR 1.16(i))</small>	*	Minus	** =	X \$ =		OR	X \$ =	
	Independent <small>(37 CFR 1.16(h))</small>	*	Minus	*** =	X \$ =		OR	X \$ =	
<input type="checkbox"/> Application Size Fee <small>(37 CFR 1.16(s))</small>									
<input type="checkbox"/> FIRST PRESENTATION OF MULTIPLE DEPENDENT CLAIM <small>(37 CFR 1.16(j))</small>							OR		
					TOTAL ADD'L FEE		OR	TOTAL ADD'L FEE	

* If the entry in column 1 is less than the entry in column 2, write "0" in column 3.
 ** If the "Highest Number Previously Paid For" IN THIS SPACE is less than 20, enter "20".
 *** If the "Highest Number Previously Paid For" IN THIS SPACE is less than 3, enter "3".
 The "Highest Number Previously Paid For" (Total or Independent) is the highest number found in the appropriate box in column 1.

Legal Instrument Examiner:
/ANGELA s. WHITE/

This collection of information is required by 37 CFR 1.16. The information is required to obtain or retain a benefit by the public which is to file (and by the USPTO to process) an application. Confidentiality is governed by 35 U.S.C. 122 and 37 CFR 1.14. This collection is estimated to take 12 minutes to complete, including gathering, preparing, and submitting the completed application form to the USPTO. Time will vary depending upon the individual case. Any comments on the amount of time you require to complete this form and/or suggestions for reducing this burden, should be sent to the Chief Information Officer, U.S. Patent and Trademark Office, U.S. Department of Commerce, P.O. Box 1450, Alexandria, VA 22313-1450. DO NOT SEND FEES OR COMPLETED FORMS TO THIS ADDRESS. **SEND TO: Commissioner for Patents, P.O. Box 1450, Alexandria, VA 22313-1450.**

If you need assistance in completing the form, call 1-800-PTO-9199 and select option 2.

Application Number 	Application/Control No. 13/342,795	Applicant(s)/Patent under Reexamination LARSON ET AL.	

Document Code - DISQ	Internal Document – DO NOT MAIL
-----------------------------	--

TERMINAL DISCLAIMER	<input checked="" type="checkbox"/> APPROVED	<input type="checkbox"/> DISAPPROVED
Date Filed : 06/01/12	This patent is subject to a Terminal Disclaimer	

Approved/Disapproved by:

12 - Tds all approved.

Angie Walker

Electronic Acknowledgement Receipt

EFS ID:	12924933
Application Number:	13342795
International Application Number:	
Confirmation Number:	4180
Title of Invention:	SYSTEM AND METHOD EMPLOYING AN AGILE NETWORK PROTOCOL FOR SECURE COMMUNICATIONS USING SECURE DOMAIN NAMES
First Named Inventor/Applicant Name:	Victor Larson
Customer Number:	23630
Filer:	Toby H. Kusmer./Kerrie Jones
Filer Authorized By:	Toby H. Kusmer.
Attorney Docket Number:	77580-155(VRKN-1CP3CNFT5)
Receipt Date:	04-JUN-2012
Filing Date:	03-JAN-2012
Time Stamp:	14:03:25
Application Type:	Utility under 35 USC 111(a)

Payment information:

Submitted with Payment	no
------------------------	----

File Listing:

Document Number	Document Description	File Name	File Size(Bytes)/ Message Digest	Multi Part /.zip	Pages (if appl.)
1	Non Patent Literature	D1190.pdf	1334655 db4f0de7fd0cbf541b8b1f07a5be78f2d57735f7	no	35

Warnings:

The page size in the PDF is too large. The pages should be 8.5 x 11 or A4. If this PDF is submitted, the pages will be resized upon entry into the Image File Wrapper and may affect subsequent processing

Information:

2	Non Patent Literature	D1191.pdf	1685850	no	64
			d202562b825d6fb1fad06ab48ccc32894a96fad4		

Warnings:

The page size in the PDF is too large. The pages should be 8.5 x 11 or A4. If this PDF is submitted, the pages will be resized upon entry into the Image File Wrapper and may affect subsequent processing

Information:

3	Non Patent Literature	D1192.pdf	538172	no	39
			ae3fb0669fe7d52f5efae5364185a7f31e440e7a		

Warnings:

The page size in the PDF is too large. The pages should be 8.5 x 11 or A4. If this PDF is submitted, the pages will be resized upon entry into the Image File Wrapper and may affect subsequent processing

Information:

4	Non Patent Literature	D1193.pdf	1092988	no	41
			f3c54e9f23c88cb4e7ea577d4eadf08d178f62e1		

Warnings:

The page size in the PDF is too large. The pages should be 8.5 x 11 or A4. If this PDF is submitted, the pages will be resized upon entry into the Image File Wrapper and may affect subsequent processing

Information:

5	Non Patent Literature	D1194.pdf	475905	no	19
			b6252dcf3f6dcd1385f322612c124f06ae60d3		

Warnings:

The page size in the PDF is too large. The pages should be 8.5 x 11 or A4. If this PDF is submitted, the pages will be resized upon entry into the Image File Wrapper and may affect subsequent processing

Information:

6	Non Patent Literature	D1195.pdf	902251	no	33
			63bd1d7c6cdd131cd34a3ef3cd6baa2a6b9427c1		

Warnings:

The page size in the PDF is too large. The pages should be 8.5 x 11 or A4. If this PDF is submitted, the pages will be resized upon entry into the Image File Wrapper and may affect subsequent processing

Information:

7	Non Patent Literature	D1196.pdf	462285	no	17
			bb47612f473098de515196ff5df486a469e85166		

Warnings:

The page size in the PDF is too large. The pages should be 8.5 x 11 or A4. If this PDF is submitted, the pages will be resized upon entry into the Image File Wrapper and may affect subsequent processing

Information:

8	Non Patent Literature	D1197.pdf	1290635	no	48
			88c9dd3dfa5d66a114f5ba617af038121c2f468b		
Warnings:					
The page size in the PDF is too large. The pages should be 8.5 x 11 or A4. If this PDF is submitted, the pages will be resized upon entry into the Image File Wrapper and may affect subsequent processing					
Information:					
9	Non Patent Literature	D1198.pdf	1300599	no	48
			f58d460ea5bdd7f390859ccc146a6e7e3f78fd1f		
Warnings:					
The page size in the PDF is too large. The pages should be 8.5 x 11 or A4. If this PDF is submitted, the pages will be resized upon entry into the Image File Wrapper and may affect subsequent processing					
Information:					
10	Non Patent Literature	D1199.pdf	637158	no	24
			162acfa69253dd96c63c9b2a7e33333ec3031ab6		
Warnings:					
The page size in the PDF is too large. The pages should be 8.5 x 11 or A4. If this PDF is submitted, the pages will be resized upon entry into the Image File Wrapper and may affect subsequent processing					
Information:					
11	Non Patent Literature	D1200.pdf	697066	no	24
			4c3e7fa216a865ddf6e596077941d8f1c80bfafb4		
Warnings:					
The page size in the PDF is too large. The pages should be 8.5 x 11 or A4. If this PDF is submitted, the pages will be resized upon entry into the Image File Wrapper and may affect subsequent processing					
Information:					
12	Non Patent Literature	D1201A.pdf	1011692	no	100
			670146792fba847f89b09bd1cf5c3c8b6a41816d		
Warnings:					
Information:					
13	Non Patent Literature	D1201B.pdf	1163786	no	81
			72e6a8c69399fc4c741adcf6314191819717813		
Warnings:					
Information:					
14	Non Patent Literature	D1202A.pdf	1033550	no	100
			03d67d549a65b6f8d17ffd4f664f629c0902039a		
Warnings:					
Information:					

15	Non Patent Literature	D1202B.pdf	1338301	no	100
			2f977e2e9c75fa95079854b9be3a7cdc9cb099ac		
Warnings:					
Information:					
16	Non Patent Literature	D1202C.pdf	827794	no	41
			d1dbd6f0e330ace1bf3b2eb104d9113ff50a56c5		
Warnings:					
Information:					
17	Non Patent Literature	D1203A.pdf	1036611	no	100
			9d43da78dcf81ae6d47df735e9bef8155537af4		
Warnings:					
Information:					
18	Non Patent Literature	D1203B.pdf	1289345	no	100
			5a961e0418bfd42c7a87dd7016fd8210dceceaf6d		
Warnings:					
Information:					
19	Non Patent Literature	D1203C.pdf	1118664	no	78
			5429b9f31ebaec5271a9d2e8b6e22a6167ecf85f		
Warnings:					
Information:					
20	Non Patent Literature	D1204.pdf	103729	no	3
			cb05f5e2bc8b94824cd584c0216e234020d62d51		
Warnings:					
Information:					
21	Non Patent Literature	D1205.pdf	134207	no	19
			401222abc8109e44e80b981c192c3bb60dd0d6c9		
Warnings:					
Information:					
22	Non Patent Literature	D1206.pdf	106899	no	7
			225eff9edc51590a7c923fb400e5b70a1d03c27d		
Warnings:					
Information:					
23	Non Patent Literature	D1207.pdf	584668	no	60
			ebfbb21df2ac355190d88201f32765c5a19ff64d		
Warnings:					
Information:					

This Acknowledgement Receipt evidences receipt on the noted date by the USPTO of the indicated documents, characterized by the applicant, and including page counts, where applicable. It serves as evidence of receipt similar to a Post Card, as described in MPEP 503.

New Applications Under 35 U.S.C. 111

If a new application is being filed and the application includes the necessary components for a filing date (see 37 CFR 1.53(b)-(d) and MPEP 506), a Filing Receipt (37 CFR 1.54) will be issued in due course and the date shown on this Acknowledgement Receipt will establish the filing date of the application.

National Stage of an International Application under 35 U.S.C. 371

If a timely submission to enter the national stage of an international application is compliant with the conditions of 35 U.S.C. 371 and other applicable requirements a Form PCT/DO/EO/903 indicating acceptance of the application as a national stage submission under 35 U.S.C. 371 will be issued in addition to the Filing Receipt, in due course.

New International Application Filed with the USPTO as a Receiving Office

If a new international application is being filed and the international application includes the necessary components for an international filing date (see PCT Article 11 and MPEP 1810), a Notification of the International Application Number and of the International Filing Date (Form PCT/RO/105) will be issued in due course, subject to prescriptions concerning national security, and the date shown on this Acknowledgement Receipt will establish the international filing date of the application.

Subst. for form 1449/PTO				Complete if Known	
INFORMATION DISCLOSURE STATEMENT BY APPLICANT <i>(Use as many sheets as necessary)</i>				Application Number	13/342,795
				Filing Date	01-03-2012
				First Named Inventor	Victor Larson
				Art Unit	2453
				Examiner Name	Krisna Lim
				Docket Number	77580-155(VRNK-1CP3CNFT5)

U.S. PATENTS

EXAMINER'S INITIALS	CITE NO.	Patent Number	Publication Date	Name of Patentee or Applicant of Cited Document	Pages, Columns, Lines, Where Relevant Passages or Relevant Figures Appear

U.S. PATENT APPLICATION PUBLICATIONS

EXAMINER'S INITIALS	CITE NO.	Patent Number	Publication Date	Name of Patentee or Applicant of Cited Document	Pages, Columns, Lines, Where Relevant Passages or Relevant Figures Appear

FOREIGN PATENT DOCUMENTS

EXAMINER'S INITIALS	CITE NO.	Foreign Patent Document Country Code ³ -Number ⁴ -Kind Codes (if known)	Publication Date	Name of Patentee or Applicant of Cited Document	Pages, Columns, Lines Where Relevant Figures Appear	Translation	
						Yes	No

OTHER ART (Including Author, Title, Date, Pertinent Pages, Etc.)

EXAMINER'S INITIALS	CITE NO.	Include name of the author (in CAPITAL LETTERS), title of the article (when appropriate), title of the item (book, magazine, journal, serial, symposium, catalog, etc.), date, page(s), volume-issue number(s), publisher, city and/or country where published.
	D1131	Peter Alexander Invalidity Report
	D1132	Defendants' Second Supplemental Joint Invalidity Contentions
	D1133	Exhibit 118A, Altiga VPN System ¹ vs. Claims of the '135 Patent ²
	D1134	Exhibit 119A, Altiga VPN System ¹ vs. Claims of the '151 Patent ²
	D1135	Exhibit 120A, Altiga VPN System ¹ vs. Claims of the '180 Patent ²
	D1136	Exhibit 121A, Altiga VPN System ¹ vs. Claims of the '211 Patent ²
	D1137	Exhibit 122A, Altiga VPN System ¹ vs. Claims of the '504 Patent ²
	D1138	Exhibit 123A, Altiga VPN System ¹ vs. Claims of the '759 Patent ²
	D1139	Exhibit 12A, SSL 3.0 ¹ vs. Claims of the '135 Patent ²
	D1140	Exhibit 13A, SSL 3.0 ¹ vs. Claims of the '504 Patent ²
	D1141	Exhibit 14A, SSL 3.0 ¹ vs. Claims of the '211 Patent ²
	D1142	Exhibit 228A, Understanding OSF DCE 1.1 for AIX and OS/2 ¹ (APP_VX0556531-804) vs. Claims of the '135 Patent ²
	D1143	Exhibit 229A, Understanding OSF DCE 1.1 for AIX and OS/2 ¹ (APP_VX0556531-804) vs. Claims of the '151 Patent ²
	D1144	Exhibit 230A, Understanding OSF DCE 1.1 for AIX and OS/2 ¹ (APP_VX0556531-804) vs. Claims of the '180 Patent ²
	D1145	Exhibit 231A, Understanding OSF DCE 1.1 for AIX and OS/2 ¹ (APP_VX0556531-804) vs. Claims of the '211 Patent ²

Subst. for form 1449/PTO		Complete if Known	
INFORMATION DISCLOSURE STATEMENT BY APPLICANT <i>(Use as many sheets as necessary)</i>		Application Number	13/342,795
		Filing Date	01-03-2012
		First Named Inventor	Victor Larson
		Art Unit	2453
		Examiner Name	Krisna Lim
		Docket Number	77580-155(VR NK-1CP3CNFT5)
D1146	Exhibit 232A, Understanding OSF DCE 1.1 for AIX and OS/2 ¹ (APP_VX0556531-804) vs. Claims of the '504 Patent ²		
D1147	Exhibit 233A, Understanding OSF DCE 1.1 for AIX and OS/2 ¹ (APP_VX0556531-804) vs. Claims of the '759 Patent ²		
D1148	Exhibit 255, Schulzrinne ¹ vs. Claims of the '135 Patent ²		
D1149	Exhibit 256, Schulzrinne ¹ vs. Claims of the '504 Patent ²		
D1150	Exhibit 257, Schulzrinne ¹ vs. Claims of the '211 Patent ²		
D1151	Exhibit 258, Schulzrinne ¹ vs. Claims of the '151 Patent ²		
D1152	Exhibit 259, Schulzrinne ¹ vs. Claims of the '180 Patent ²		
D1153	Exhibit 260, Schulzrinne ¹ vs. Claims of the '759 Patent ²		
D1154	Exhibit 261, SSL 3.0 ¹ vs. Claims of the '151 Patent ²		
D1155	Exhibit 262, SSL 3.0 ¹ vs. Claims of the '759 Patent ²		
D1156	Exhibit 263, Wang ¹ vs. Claims of the '135 Patent ²		
D1157	Wang ¹ vs. Claims of the '504 Patent ²		
D1158	Wang ¹ vs. Claims of the '211 Patent ²		
D1159	Exhibit 1, Alexander CV.pdf		
D1160	Exhibit 2, Materials Considered by Peter Alexander		
D1161	Exhibit 3, Cross Reference Chart		
D1162	Exhibit 4, RFC 2543 ¹ vs. Claims of the '135 Patent		
D1163	Exhibit 5, RFC 2543 ¹ vs. Claims of the '504 Patent		
D1164	Exhibit 6, RFC 2543 ¹ vs. Claims of the '211 Patent		
D1165	Exhibit 7, The Schulzrinne Presentation ¹ vs. Claims of the '135 Patent		
D1166	Exhibit 8, The Schulzrinne Presentation ¹ vs. Claims of the '504 Patent		
D1167	Exhibit 9, The Schulzrinne Presentation ¹ vs. Claims of the '211 Patent		
D1168	Exhibit 10, The Schulzrinne Presentation ¹ vs. Claims of the '151 Patent		
D1169	Exhibit 11, The Schulzrinne Presentation ¹ vs. Claims of the '180 Patent		
D1170	Exhibit 12, The Schulzrinne Presentation ¹ vs. Claims of the '759 Patent		
D1171	Exhibit 13, SSL 3.0 ² vs. Claims of the '135 Patent		
D1172	Exhibit 14, SSL 3.0 ² vs. Claims of the '504 Patent		
D1173	Exhibit 15, SSL 3.0 ² vs. Claims of the '211 Patent		
D1174	Exhibit 16, SSL 3.0 ² vs. Claims of the '151 Patent		
D1175	Exhibit 17, SSL 3.0 ² vs. Claims of the '759 Patent		
D1176	Exhibit 18, Kiuchi ¹ vs. Claims of the '135 Patent		

Subst. for form 1449/PTO		Complete if Known	
		Application Number	13/342,795
INFORMATION DISCLOSURE STATEMENT BY APPLICANT <i>(Use as many sheets as necessary)</i>		Filing Date	01-03-2012
		First Named Inventor	Victor Larson
		Art Unit	2453
		Examiner Name	Krisna Lim
		Docket Number	77580-155(VR NK-1CP3CNFT5)
	D1177	Exhibit 19, Kiuchi ¹ vs. Claims of the '504 Patent	
	D1178	Exhibit 20, Kiuchi ¹ vs. Claims of the '211 Patent	
	D1179	Exhibit 21, Kiuchi ¹ vs. Claims of the '151 Patent	
	D1180	Exhibit 22, Kiuchi ¹ vs. Claims of the '180 Patent	
	D1181	Exhibit 23, Kiuchi ¹ vs. Claims of the '759 Patent	
	D1182	Exhibit 24, U.S. Patent No. 6,119,234 (hereinafter "Aziz") and RFC 2401 ² vs. Claims of the '135 Patent	
	D1183	Exhibit 25, U.S. Patent No. 6,119,234 (hereinafter "Aziz") and RFC 2401 ² vs. Claims of the '504 Patent	
	D1184	Exhibit 26, U.S. Patent No. 6,119,234 (hereinafter "Aziz") and RFC 2401 ² vs. Claims of the '211 Patent	
	D1185	Exhibit 27, U.S. Patent No. 6,119,234 (hereinafter "Aziz") and RFC 2401 ² vs. Claims of the '151 Patent	
	D1186	Exhibit 28	
	D1187	Exhibit 29, The Altiga System ¹ vs. Claims of the '135 Patent	
	D1188	Exhibit 30, The Altiga System ¹ vs. Claims of the '504 Patent	
	D1189	Exhibit 31, The Altiga System ¹ vs. Claims of the '211 Patent	
	D1190	Exhibit 32, The Altiga System ¹ vs. Claims of the '759 Patent	
	D1191	Exhibit 33, U.S. Patent No. 6,496,867 ("Beser") ¹ and RFC 2401 ² vs. Claims of the '135 Patent	
	D1192	Exhibit 34, U.S. Patent No. 6,496,867 ("Beser") ¹ and RFC 2401 ² vs. Claims of the '504 Patent	
	D1193	Exhibit 35, U.S. Patent No. 6,496,867 ("Beser") ¹ and RFC 2401 ² vs. Claims of the '211 Patent	
	D1194	Exhibit 36, U.S. Patent No. 6,496,867 ("Beser") ¹ and RFC 2401 ² vs. Claims of the '151 Patent	
	D1195	Exhibit 37, U.S. Patent No. 6,496,867 ("Beser") ¹ and RFC 2401 ² vs. Claims of the '180 Patent	
	D1196	Exhibit 38, Kent ¹ vs. Claims of the '759 Patent	
	D1197	Exhibit 39, RFC 2538, Storing Certificates in the Domain Name System (DNS) ¹ vs. Claims of the '504 Patent ²	
	D1198	Exhibit 40, RFC 2538, Storing Certificates in the Domain Name System (DNS) ¹ vs. Claims of the '211 Patent ²	
	D1199	Exhibit 41, Aziz ('646) ¹ vs. Claims of the '759 Patent	
	D1200	Exhibit 42, The PIX Firewall ¹ vs. Claims of the '759 Patent	
	D1201	Exhibit A-1, Kiuchi ¹ vs. Claims of the '135 Patent ²	
	D1202	Exhibit B-1, Kiuchi ¹ vs. Claims of the '211 Patent ²	
	D1203	Exhibit C-1, Kiuchi ¹ vs. Claims of the '504 Patent ²	

Subst. for form 1449/PTO		Complete if Known	
INFORMATION DISCLOSURE STATEMENT BY APPLICANT <i>(Use as many sheets as necessary)</i>		Application Number	13/342,795
		Filing Date	01-03-2012
		First Named Inventor	Victor Larson
		Art Unit	2453
		Examiner Name	Krisna Lim
		Docket Number	77580-155(VR NK-1CP3CNFT5)
	D1204	Exhibit D, Materials Considered	
	D1205	Exhibit E, Expert Report of Stuart G. Stubblebine, Ph.D.	
	D1206	Exhibit F, Expert Report of Stuart G. Stubblebine, Ph.D.	
	D1207	Exhibit G, Opening Expert Report of Dr. Stuart Stubblebine Regarding Invalidity of the '135, '211, and '504 Patents	
EXAMINER		DATE CONSIDERED	

*EXAMINER: Initial if reference considered, whether or not citation is in conformance with MPEP 609. Draw line through citation if not in conformance and not considered. Include copy of this form with next communication to applicant.

1 Applicant's unique citation designation number (optional). 2 Applicant is to place a check mark here if English language Translation is attached.

Subst. for form 1449/PTO		Complete if Known	
INFORMATION DISCLOSURE STATEMENT BY APPLICANT <i>(Use as many sheets as necessary)</i>		Application Number	13/342,795
		Filing Date	01-03-2012
		First Named Inventor	Victor Larson
		Art Unit	2453
		Examiner Name	Krisna Lim
		Docket Number	77580-155(VRNK-1CP3CNFT5)

CERTIFICATION STATEMENT

Please See 37 CFR 1.97 and 1.98 to make the appropriate selection(s)

- Information Disclosure Statement is being filed with the filing of the application or before the receipt of a first office action.
- That each item of information contained in the information disclosure statement was first cited in any communication from a foreign patent office in a counterpart foreign application not more than three months prior to the filing of the information disclosure statement; or
- That no item of information contained in the information disclosure statement was cited in a communication from a foreign patent office in a counterpart foreign application, and, to the knowledge of the person signing the certification after making reasonable inquiry, no item of information contained in the information disclosure statement was known to any individual designated in § 1.56(c) more than three months prior to the filing of the information disclosure statement.
- The Commissioner is hereby authorized to charge the fee pursuant to 37 CFR 1.17(P) in the amount of \$180.00, or further fees which may be due, to Deposit Account 50-1133.
- Information Disclosure Statement is being filed with the Request for Continued Examination. The Commissioner is hereby authorized to charge the fee pursuant to 37 CFR 1.17(P) in the amount of \$810.00, or further fees which may be due, to Deposit Account 50-1133.
- None

SIGNATURE

A signature of the applicant or representative is required in accordance with CFR 1.33, 10.18. Please see CFR 1.4(d) for the form of the signature.

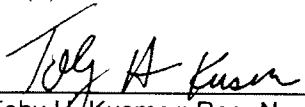
 Toby H. Kusmer; Reg. No.: 26,418
 McDermott Will & Emery LLP
 28 State Street
 Boston, MA 02109
 Tel. (617) 535-4000
 Fax (617) 535-3800

Date: 6/1/12

Electronic Acknowledgement Receipt

EFS ID:	12924845
Application Number:	13342795
International Application Number:	
Confirmation Number:	4180
Title of Invention:	SYSTEM AND METHOD EMPLOYING AN AGILE NETWORK PROTOCOL FOR SECURE COMMUNICATIONS USING SECURE DOMAIN NAMES
First Named Inventor/Applicant Name:	Victor Larson
Customer Number:	23630
Filer:	Toby H. Kusmer./Kerrie Jones
Filer Authorized By:	Toby H. Kusmer.
Attorney Docket Number:	77580-155(VRNL-1CP3CNFT5)
Receipt Date:	04-JUN-2012
Filing Date:	03-JAN-2012
Time Stamp:	13:58:00
Application Type:	Utility under 35 USC 111(a)

Payment information:

Submitted with Payment	no
------------------------	----

File Listing:

Document Number	Document Description	File Name	File Size(Bytes)/ Message Digest	Multi Part /.zip	Pages (if appl.)
1	Information Disclosure Statement (IDS) Form (SB08)	IDS.pdf	147096 <small>a7c8f4eaa5267a20e70be903c25ddf532b6549f</small>	no	5

Warnings:

Information:

This is not an USPTO supplied IDS fillable form					
The page size in the PDF is too large. The pages should be 8.5 x 11 or A4. If this PDF is submitted, the pages will be resized upon entry into the Image File Wrapper and may affect subsequent processing					
2	Non Patent Literature	D1131.pdf	3260103 74ef5d4512add8f0bf148558f4eb310f5e56d39f	no	220
Warnings:					
The page size in the PDF is too large. The pages should be 8.5 x 11 or A4. If this PDF is submitted, the pages will be resized upon entry into the Image File Wrapper and may affect subsequent processing					
Information:					
3	Non Patent Literature	D1132.pdf	30634 c8723f1c4a74665a8a7b9693283fcb0105383db6	no	3
Warnings:					
The page size in the PDF is too large. The pages should be 8.5 x 11 or A4. If this PDF is submitted, the pages will be resized upon entry into the Image File Wrapper and may affect subsequent processing					
Information:					
4	Non Patent Literature	D1133.pdf	10059093 09aa21c9dc0c849cf1a53c96b67ec06c66510bb7	no	251
Warnings:					
The page size in the PDF is too large. The pages should be 8.5 x 11 or A4. If this PDF is submitted, the pages will be resized upon entry into the Image File Wrapper and may affect subsequent processing					
Information:					
5	Non Patent Literature	D1134.pdf	3029226 cf4dc78e2cdc44a5ec325a160d2914dadf1dccb1f	no	73
Warnings:					
The page size in the PDF is too large. The pages should be 8.5 x 11 or A4. If this PDF is submitted, the pages will be resized upon entry into the Image File Wrapper and may affect subsequent processing					
Information:					
6	Non Patent Literature	D1135.pdf	3134578 9de62a9d4bd8509aec73914fb5968389d04eddc	no	78
Warnings:					
The page size in the PDF is too large. The pages should be 8.5 x 11 or A4. If this PDF is submitted, the pages will be resized upon entry into the Image File Wrapper and may affect subsequent processing					
Information:					
7	Non Patent Literature	D1136.pdf	3942265 c1aedbf7503ee346d7523817c89f9775da10e2e7	no	95
Warnings:					
The page size in the PDF is too large. The pages should be 8.5 x 11 or A4. If this PDF is submitted, the pages will be resized upon entry into the Image File Wrapper and may affect subsequent processing					
Information:					

8	Non Patent Literature	D1137.pdf	3959945	no	95
			af1fbc1d0ab2b9fda0f7525cfd756f1441f34e		
Warnings:					
The page size in the PDF is too large. The pages should be 8.5 x 11 or A4. If this PDF is submitted, the pages will be resized upon entry into the Image File Wrapper and may affect subsequent processing					
Information:					
9	Non Patent Literature	D1138.pdf	4082758	no	107
			d6503cc36bc9164429b08cff316e228f0d062f64		
Warnings:					
The page size in the PDF is too large. The pages should be 8.5 x 11 or A4. If this PDF is submitted, the pages will be resized upon entry into the Image File Wrapper and may affect subsequent processing					
Information:					
10	Non Patent Literature	D1139.Pdf	711320	no	25
			5b56b9f7528e3260f32dbfa7338765723b3e9718		
Warnings:					
The page size in the PDF is too large. The pages should be 8.5 x 11 or A4. If this PDF is submitted, the pages will be resized upon entry into the Image File Wrapper and may affect subsequent processing					
Information:					
11	Non Patent Literature	D1140.pdf	941221	no	33
			920ecc8cb24927577e5affea22e15f5ea041065		
Warnings:					
The page size in the PDF is too large. The pages should be 8.5 x 11 or A4. If this PDF is submitted, the pages will be resized upon entry into the Image File Wrapper and may affect subsequent processing					
Information:					
12	Non Patent Literature	D1141.pdf	943986	no	33
			cc9ce3cfea66f487906f3623efdc75f0f3ba22d5		
Warnings:					
The page size in the PDF is too large. The pages should be 8.5 x 11 or A4. If this PDF is submitted, the pages will be resized upon entry into the Image File Wrapper and may affect subsequent processing					
Information:					
13	Non Patent Literature	D1142.pdf	594440	no	21
			943e8097cbcd5b79c830067081585000604cc28		
Warnings:					
The page size in the PDF is too large. The pages should be 8.5 x 11 or A4. If this PDF is submitted, the pages will be resized upon entry into the Image File Wrapper and may affect subsequent processing					
Information:					
14	Non Patent Literature	D1143.pdf	427888	no	15
			dbf1cfb287d362939680b0859f9dcf8a4c1c249a3		
Warnings:					

The page size in the PDF is too large. The pages should be 8.5 x 11 or A4. If this PDF is submitted, the pages will be resized upon entry into the Image File Wrapper and may affect subsequent processing

Information:

15	Non Patent Literature	D1144.pdf	776663	no	25
			17bd93d8f5d51386a2fb7f1d715d828c8b60684		

Warnings:

The page size in the PDF is too large. The pages should be 8.5 x 11 or A4. If this PDF is submitted, the pages will be resized upon entry into the Image File Wrapper and may affect subsequent processing

Information:

16	Non Patent Literature	D1145.pdf	1405903	no	45
			c0080dfc7643c5a1fe4f738d53b563f890ee6005		

Warnings:

The page size in the PDF is too large. The pages should be 8.5 x 11 or A4. If this PDF is submitted, the pages will be resized upon entry into the Image File Wrapper and may affect subsequent processing

Information:

17	Non Patent Literature	D1146.pdf	1407006	no	44
			8475b7bfeb2c1744a65caf9745502e4bb2b9443f		

Warnings:

The page size in the PDF is too large. The pages should be 8.5 x 11 or A4. If this PDF is submitted, the pages will be resized upon entry into the Image File Wrapper and may affect subsequent processing

Information:

18	Non Patent Literature	D1147.pdf	805076	no	28
			febfe6db73530b40ff463b968fda277231c655e		

Warnings:

The page size in the PDF is too large. The pages should be 8.5 x 11 or A4. If this PDF is submitted, the pages will be resized upon entry into the Image File Wrapper and may affect subsequent processing

Information:

19	Non Patent Literature	D1148.pdf	2203321	no	90
			e0da9a90856cfa27f90663d6dcb447401fc1a0		

Warnings:

The page size in the PDF is too large. The pages should be 8.5 x 11 or A4. If this PDF is submitted, the pages will be resized upon entry into the Image File Wrapper and may affect subsequent processing

Information:

20	Non Patent Literature	D1149.pdf	3147948	no	122
			313483b73df5bad9b7e5c585809fe186eaf9bd4		

Warnings:

The page size in the PDF is too large. The pages should be 8.5 x 11 or A4. If this PDF is submitted, the pages will be resized upon entry into the Image File Wrapper and may affect subsequent processing

Information:

21	Non Patent Literature	D1150.pdf	3141643 004566a6bb562124250ce55d8a5c3c45d22ef9ba	no	122
Warnings:					
The page size in the PDF is too large. The pages should be 8.5 x 11 or A4. If this PDF is submitted, the pages will be resized upon entry into the Image File Wrapper and may affect subsequent processing					
Information:					
22	Non Patent Literature	D1151.pdf	1165021 a149ceed376546bef14a2492da53c5f8659e4306	no	49
Warnings:					
The page size in the PDF is too large. The pages should be 8.5 x 11 or A4. If this PDF is submitted, the pages will be resized upon entry into the Image File Wrapper and may affect subsequent processing					
Information:					
23	Non Patent Literature	D1152.pdf	1063902 602c401071cc6435a6e374d0425baea7ec7e2f0c	no	41
Warnings:					
The page size in the PDF is too large. The pages should be 8.5 x 11 or A4. If this PDF is submitted, the pages will be resized upon entry into the Image File Wrapper and may affect subsequent processing					
Information:					
24	Non Patent Literature	D1153.pdf	1955096 de7e2dcc9c5d454cf44184a5e59fec0d4c19ffd6	no	74
Warnings:					
The page size in the PDF is too large. The pages should be 8.5 x 11 or A4. If this PDF is submitted, the pages will be resized upon entry into the Image File Wrapper and may affect subsequent processing					
Information:					
25	Non Patent Literature	D1154.pdf	368908 38a2f0002d1d09600bffe5093c5b72ded5012b87	no	14
Warnings:					
The page size in the PDF is too large. The pages should be 8.5 x 11 or A4. If this PDF is submitted, the pages will be resized upon entry into the Image File Wrapper and may affect subsequent processing					
Information:					
26	Non Patent Literature	D1155.pdf	676883 582d52501bb5fb36479acdc93474e2736526f44	no	24
Warnings:					
The page size in the PDF is too large. The pages should be 8.5 x 11 or A4. If this PDF is submitted, the pages will be resized upon entry into the Image File Wrapper and may affect subsequent processing					
Information:					
27	Non Patent Literature	D1156.pdf	885422 50b9bc7c5f3ca481df882116c2baab4e9e0ffacb	no	59
Warnings:					

The page size in the PDF is too large. The pages should be 8.5 x 11 or A4. If this PDF is submitted, the pages will be resized upon entry into the Image File Wrapper and may affect subsequent processing

Information:

28	Non Patent Literature	D1157.pdf	767953	no	55
			d41d24160ebdf77fd170ab402f3435eff6ec04a		

Warnings:

The page size in the PDF is too large. The pages should be 8.5 x 11 or A4. If this PDF is submitted, the pages will be resized upon entry into the Image File Wrapper and may affect subsequent processing

Information:

29	Non Patent Literature	D1158.pdf	778344	no	56
			6e09d94cda3901ddad57c813442038fb8a3a62c9		

Warnings:

The page size in the PDF is too large. The pages should be 8.5 x 11 or A4. If this PDF is submitted, the pages will be resized upon entry into the Image File Wrapper and may affect subsequent processing

Information:

30	Non Patent Literature	D1159.pdf	313591	no	22
			a5c182ec921bf594fb600678478eaebe2040f79		

Warnings:

The page size in the PDF is too large. The pages should be 8.5 x 11 or A4. If this PDF is submitted, the pages will be resized upon entry into the Image File Wrapper and may affect subsequent processing

Information:

31	Non Patent Literature	D1160.pdf	99073	no	16
			6032e737141f46ebd3af06f94412abcb83d837b8		

Warnings:

The page size in the PDF is too large. The pages should be 8.5 x 11 or A4. If this PDF is submitted, the pages will be resized upon entry into the Image File Wrapper and may affect subsequent processing

Information:

32	Non Patent Literature	D1161.pdf	290550	no	24
			a95d6561c60f6b9e5533045b82f99451fa21b8f6		

Warnings:

The page size in the PDF is too large. The pages should be 8.5 x 11 or A4. If this PDF is submitted, the pages will be resized upon entry into the Image File Wrapper and may affect subsequent processing

Information:

33	Non Patent Literature	D1162.pdf	1071164	no	43
			cefb83da7af40e4e4e1bd46131ca7c0257fd50eb		

Warnings:

The page size in the PDF is too large. The pages should be 8.5 x 11 or A4. If this PDF is submitted, the pages will be resized upon entry into the Image File Wrapper and may affect subsequent processing

Information:

34	Non Patent Literature	D1163.pdf	1235283	no	46
			4a8264cf35a86a750143e5784708d2e8b2bb9eed		
Warnings:					
The page size in the PDF is too large. The pages should be 8.5 x 11 or A4. If this PDF is submitted, the pages will be resized upon entry into the Image File Wrapper and may affect subsequent processing					
Information:					
35	Non Patent Literature	D1164.pdf	1237581	no	46
			c9a70fa026e3620d395a48ea295b575e0ddde442		
Warnings:					
The page size in the PDF is too large. The pages should be 8.5 x 11 or A4. If this PDF is submitted, the pages will be resized upon entry into the Image File Wrapper and may affect subsequent processing					
Information:					
36	Non Patent Literature	D1165.pdf	769860	no	32
			c0d81fe0a644005773f699c729b137caad1154f		
Warnings:					
The page size in the PDF is too large. The pages should be 8.5 x 11 or A4. If this PDF is submitted, the pages will be resized upon entry into the Image File Wrapper and may affect subsequent processing					
Information:					
37	Non Patent Literature	D1166.pdf	967504	no	36
			9167ee2107e7842f5dbf109778dd645e73c687d6		
Warnings:					
The page size in the PDF is too large. The pages should be 8.5 x 11 or A4. If this PDF is submitted, the pages will be resized upon entry into the Image File Wrapper and may affect subsequent processing					
Information:					
38	Non Patent Literature	D1167.pdf	800290	no	36
			b3e1ebe23d038b9533000ac6dae9f22e9a48e55a		
Warnings:					
The page size in the PDF is too large. The pages should be 8.5 x 11 or A4. If this PDF is submitted, the pages will be resized upon entry into the Image File Wrapper and may affect subsequent processing					
Information:					
39	Non Patent Literature	D1168.pdf	358283	no	15
			07c75d941d270787c758fb814b3275ad44a37081		
Warnings:					
The page size in the PDF is too large. The pages should be 8.5 x 11 or A4. If this PDF is submitted, the pages will be resized upon entry into the Image File Wrapper and may affect subsequent processing					
Information:					
40	Non Patent Literature	D1169.pdf	275344	no	11
			86699e2f3e45e7101fc8b327707ad19a4b31330d		
Warnings:					

The page size in the PDF is too large. The pages should be 8.5 x 11 or A4. If this PDF is submitted, the pages will be resized upon entry into the Image File Wrapper and may affect subsequent processing

Information:

41	Non Patent Literature	D1170.pdf	790998	no	29
			be8a5cf43289b528b187880d172aa778c996d78f		

Warnings:

The page size in the PDF is too large. The pages should be 8.5 x 11 or A4. If this PDF is submitted, the pages will be resized upon entry into the Image File Wrapper and may affect subsequent processing

Information:

42	Non Patent Literature	D1171.pdf	897777	no	33
			bf7e82ab12db50ef85f6f9f78f5166184710ac08		

Warnings:

The page size in the PDF is too large. The pages should be 8.5 x 11 or A4. If this PDF is submitted, the pages will be resized upon entry into the Image File Wrapper and may affect subsequent processing

Information:

43	Non Patent Literature	D1172.pdf	1029160	no	38
			255f1de201cdad723b864cb2d579f346d99be789		

Warnings:

The page size in the PDF is too large. The pages should be 8.5 x 11 or A4. If this PDF is submitted, the pages will be resized upon entry into the Image File Wrapper and may affect subsequent processing

Information:

44	Non Patent Literature	D1173.pdf	1027665	no	39
			eea3f1926ba18599dcbd28b742b6234b0cd0e66		

Warnings:

The page size in the PDF is too large. The pages should be 8.5 x 11 or A4. If this PDF is submitted, the pages will be resized upon entry into the Image File Wrapper and may affect subsequent processing

Information:

45	Non Patent Literature	D1174.pdf	233030	no	10
			282372f14f4b702ec797403952907d7d987644b9		

Warnings:

The page size in the PDF is too large. The pages should be 8.5 x 11 or A4. If this PDF is submitted, the pages will be resized upon entry into the Image File Wrapper and may affect subsequent processing

Information:

46	Non Patent Literature	D1175.pdf	655028	no	25
			53451928937154d4e82356be3e8bdab6c9867c03		

Warnings:

The page size in the PDF is too large. The pages should be 8.5 x 11 or A4. If this PDF is submitted, the pages will be resized upon entry into the Image File Wrapper and may affect subsequent processing

Information:

47	Non Patent Literature	D1176.pdf	806842 398a53dd0e727476bd95f85158b35c9835b8fb2f	no	30
Warnings:					
The page size in the PDF is too large. The pages should be 8.5 x 11 or A4. If this PDF is submitted, the pages will be resized upon entry into the Image File Wrapper and may affect subsequent processing					
Information:					
48	Non Patent Literature	D1177.pdf	958598 0ea4898e8747bbb25aa702f4ea36cc41ac8f0ac8	no	35
Warnings:					
The page size in the PDF is too large. The pages should be 8.5 x 11 or A4. If this PDF is submitted, the pages will be resized upon entry into the Image File Wrapper and may affect subsequent processing					
Information:					
49	Non Patent Literature	D1178.pdf	952945 3e99f9a9a75f11b5fe496455dbb597c35eecd1f3b	no	35
Warnings:					
The page size in the PDF is too large. The pages should be 8.5 x 11 or A4. If this PDF is submitted, the pages will be resized upon entry into the Image File Wrapper and may affect subsequent processing					
Information:					
50	Non Patent Literature	D1179.pdf	194158 01b2ca2ea4cefb9749ca83bf321aafae7382b61	no	8
Warnings:					
The page size in the PDF is too large. The pages should be 8.5 x 11 or A4. If this PDF is submitted, the pages will be resized upon entry into the Image File Wrapper and may affect subsequent processing					
Information:					
51	Non Patent Literature	D1180.pdf	556180 be16cd1d96beead6880933a31e3c542c215307d5	no	19
Warnings:					
The page size in the PDF is too large. The pages should be 8.5 x 11 or A4. If this PDF is submitted, the pages will be resized upon entry into the Image File Wrapper and may affect subsequent processing					
Information:					
52	Non Patent Literature	D1181.pdf	675954 0ca6204c94a3811434cb097c1501d92b0cc0eed8e	no	25
Warnings:					
The page size in the PDF is too large. The pages should be 8.5 x 11 or A4. If this PDF is submitted, the pages will be resized upon entry into the Image File Wrapper and may affect subsequent processing					
Information:					
53	Non Patent Literature	D1182.pdf	1355829 5f6063f58323ad4d61b621d4a3d3368674501d54	no	51
Warnings:					

The page size in the PDF is too large. The pages should be 8.5 x 11 or A4. If this PDF is submitted, the pages will be resized upon entry into the Image File Wrapper and may affect subsequent processing

Information:

54	Non Patent Literature	D1183.pdf	1215891	no	45
			94dbf52038c4abde2eeaced2052f624eed3cbfdb		

Warnings:

The page size in the PDF is too large. The pages should be 8.5 x 11 or A4. If this PDF is submitted, the pages will be resized upon entry into the Image File Wrapper and may affect subsequent processing

Information:

55	Non Patent Literature	D1184.pdf	1202606	no	45
			8fadeccb40217f01d137fe78ee9de9c5f962f9ea1		

Warnings:

The page size in the PDF is too large. The pages should be 8.5 x 11 or A4. If this PDF is submitted, the pages will be resized upon entry into the Image File Wrapper and may affect subsequent processing

Information:

56	Non Patent Literature	D1185.pdf	448290	no	18
			867cb2b1db8748dee8f96e8856c993f08b1296e		

Warnings:

The page size in the PDF is too large. The pages should be 8.5 x 11 or A4. If this PDF is submitted, the pages will be resized upon entry into the Image File Wrapper and may affect subsequent processing

Information:

57	Non Patent Literature	D1186.pdf	9426	no	2
			d92dac638b115c40d00234dd5deff30818d8b016		

Warnings:

The page size in the PDF is too large. The pages should be 8.5 x 11 or A4. If this PDF is submitted, the pages will be resized upon entry into the Image File Wrapper and may affect subsequent processing

Information:

58	Non Patent Literature	D1187.pdf	1452336	no	35
			2b4a8e50ae71daa4c9f875ecb349217aaa287b16		

Warnings:

The page size in the PDF is too large. The pages should be 8.5 x 11 or A4. If this PDF is submitted, the pages will be resized upon entry into the Image File Wrapper and may affect subsequent processing

Information:

59	Non Patent Literature	D1188.pdf	1585677	no	40
			26d9e803edc97291c064561782a680fb039ebde8		

Warnings:

The page size in the PDF is too large. The pages should be 8.5 x 11 or A4. If this PDF is submitted, the pages will be resized upon entry into the Image File Wrapper and may affect subsequent processing

Information:

60	Non Patent Literature	D1189.pdf	1608409	no	41
			533bc627d8237002ebc34e68da820c64f38cd4d9		

Warnings:

The page size in the PDF is too large. The pages should be 8.5 x 11 or A4. If this PDF is submitted, the pages will be resized upon entry into the Image File Wrapper and may affect subsequent processing

Information:

Total Files Size (in bytes):	80888964
-------------------------------------	----------

This Acknowledgement Receipt evidences receipt on the noted date by the USPTO of the indicated documents, characterized by the applicant, and including page counts, where applicable. It serves as evidence of receipt similar to a Post Card, as described in MPEP 503.

New Applications Under 35 U.S.C. 111

If a new application is being filed and the application includes the necessary components for a filing date (see 37 CFR 1.53(b)-(d) and MPEP 506), a Filing Receipt (37 CFR 1.54) will be issued in due course and the date shown on this Acknowledgement Receipt will establish the filing date of the application.

National Stage of an International Application under 35 U.S.C. 371

If a timely submission to enter the national stage of an international application is compliant with the conditions of 35 U.S.C. 371 and other applicable requirements a Form PCT/DO/EO/903 indicating acceptance of the application as a national stage submission under 35 U.S.C. 371 will be issued in addition to the Filing Receipt, in due course.

New International Application Filed with the USPTO as a Receiving Office

If a new international application is being filed and the international application includes the necessary components for an international filing date (see PCT Article 11 and MPEP 1810), a Notification of the International Application Number and of the International Filing Date (Form PCT/RO/105) will be issued in due course, subject to prescriptions concerning national security, and the date shown on this Acknowledgement Receipt will establish the international filing date of the application.



UNITED STATES PATENT AND TRADEMARK OFFICE

UNITED STATES DEPARTMENT OF COMMERCE
United States Patent and Trademark Office
Address: COMMISSIONER FOR PATENTS
P.O. Box 1450
Alexandria, Virginia 22313-1450
www.uspto.gov

Table with 5 columns: APPLICATION NO., FILING DATE, FIRST NAMED INVENTOR, ATTORNEY DOCKET NO., CONFIRMATION NO.
13/342,795 01/03/2012 Victor Larson 77580-155(VRNK-1CP3CNFT5) 4180

23630 7590 06/14/2012
McDermott Will & Emery
600 13th Street, NW
Washington, DC 20005-3096

EXAMINER

LIM, KRISNA

ART UNIT PAPER NUMBER

2453

NOTIFICATION DATE DELIVERY MODE

06/14/2012

ELECTRONIC

Please find below and/or attached an Office communication concerning this application or proceeding.

The time period for reply, if any, is set in the attached communication.

Notice of the Office communication was sent electronically on above-indicated "Notification Date" to the following e-mail address(es):

mweipdocket@mwe.com

Applicant-Initiated Interview Summary	Application No. 13/342,795	Applicant(s) LARSON ET AL.	
	Examiner KRISNA LIM	Art Unit 2453	

All participants (applicant, applicant's representative, PTO personnel):

- (1) KRISNA LIM. (3) Knnenth Cheney.
(2) Mr. Toby Kusmer. (4) Ashley Tarokh.

Date of Interview: 07 June 2012.

Type: Telephonic Video Conference
 Personal [copy given to: applicant applicant's representative]

Exhibit shown or demonstration conducted: Yes No.
If Yes, brief description: _____.

Issues Discussed 101 112 102 103 Others
(For each of the checked box(es) above, please describe below the issue and detailed description of the discussion)

Claim(s) discussed: 1.

Identification of prior art discussed: VPN Overview and Aventail.

Substance of Interview

(For each issue discussed, provide a detailed description and indicate if agreement was reached. Some topics may include: identification or clarification of a reference or a portion thereof, claim interpretation, proposed amendments, arguments of any applied references etc...)

Counsel discussed the invention and the prior art and argued that prior art did not teach "a determination as a result of the address request that a target device is a device with which a secure communication link can be established when the requested address is identified in an address lookup".

Applicant recordation instructions: The formal written reply to the last Office action must include the substance of the interview. (See MPEP section 713.04). If a reply to the last Office action has already been filed, applicant is given a non-extendable period of the longer of one month or thirty days from this interview date, or the mailing date of this interview summary form, whichever is later, to file a statement of the substance of the interview

Examiner recordation instructions: Examiners must summarize the substance of any interview of record. A complete and proper recordation of the substance of an interview should include the items listed in MPEP 713.04 for complete and proper recordation including the identification of the general thrust of each argument or issue discussed, a general indication of any other pertinent matters discussed regarding patentability and the general results or outcome of the interview, to include an indication as to whether or not agreement was reached on the issues raised.

Attachment

/Krisna Lim/
Primary Examiner, Art Unit 2453

Summary of Record of Interview Requirements

Manual of Patent Examining Procedure (MPEP), Section 713.04, Substance of Interview Must be Made of Record

A complete written statement as to the substance of any face-to-face, video conference, or telephone interview with regard to an application must be made of record in the application whether or not an agreement with the examiner was reached at the interview.

Title 37 Code of Federal Regulations (CFR) § 1.133 Interviews

Paragraph (b)

In every instance where reconsideration is requested in view of an interview with an examiner, a complete written statement of the reasons presented at the interview as warranting favorable action must be filed by the applicant. An interview does not remove the necessity for reply to Office action as specified in §§ 1.111, 1.135. (35 U.S.C. 132)

37 CFR §1.2 Business to be transacted in writing.

All business with the Patent or Trademark Office should be transacted in writing. The personal attendance of applicants or their attorneys or agents at the Patent and Trademark Office is unnecessary. The action of the Patent and Trademark Office will be based exclusively on the written record in the Office. No attention will be paid to any alleged oral promise, stipulation, or understanding in relation to which there is disagreement or doubt.

The action of the Patent and Trademark Office cannot be based exclusively on the written record in the Office if that record is itself incomplete through the failure to record the substance of interviews.

It is the responsibility of the applicant or the attorney or agent to make the substance of an interview of record in the application file, unless the examiner indicates he or she will do so. It is the examiner's responsibility to see that such a record is made and to correct material inaccuracies which bear directly on the question of patentability.

Examiners must complete an Interview Summary Form for each interview held where a matter of substance has been discussed during the interview by checking the appropriate boxes and filling in the blanks. Discussions regarding only procedural matters, directed solely to restriction requirements for which interview recordation is otherwise provided for in Section 812.01 of the Manual of Patent Examining Procedure, or pointing out typographical errors or unreadable script in Office actions or the like, are excluded from the interview recordation procedures below. Where the substance of an interview is completely recorded in an Examiners Amendment, no separate Interview Summary Record is required.

The Interview Summary Form shall be given an appropriate Paper No., placed in the right hand portion of the file, and listed on the "Contents" section of the file wrapper. In a personal interview, a duplicate of the Form is given to the applicant (or attorney or agent) at the conclusion of the interview. In the case of a telephone or video-conference interview, the copy is mailed to the applicant's correspondence address either with or prior to the next official communication. If additional correspondence from the examiner is not likely before an allowance or if other circumstances dictate, the Form should be mailed promptly after the interview rather than with the next official communication.

The Form provides for recordation of the following information:

- Application Number (Series Code and Serial Number)
- Name of applicant
- Name of examiner
- Date of interview
- Type of interview (telephonic, video-conference, or personal)
- Name of participant(s) (applicant, attorney or agent, examiner, other PTO personnel, etc.)
- An indication whether or not an exhibit was shown or a demonstration conducted
- An identification of the specific prior art discussed
- An indication whether an agreement was reached and if so, a description of the general nature of the agreement (may be by attachment of a copy of amendments or claims agreed as being allowable). Note: Agreement as to allowability is tentative and does not restrict further action by the examiner to the contrary.
- The signature of the examiner who conducted the interview (if Form is not an attachment to a signed Office action)

It is desirable that the examiner orally remind the applicant of his or her obligation to record the substance of the interview of each case. It should be noted, however, that the Interview Summary Form will not normally be considered a complete and proper recordation of the interview unless it includes, or is supplemented by the applicant or the examiner to include, all of the applicable items required below concerning the substance of the interview.

A complete and proper recordation of the substance of any interview should include at least the following applicable items:

- 1) A brief description of the nature of any exhibit shown or any demonstration conducted,
- 2) an identification of the claims discussed,
- 3) an identification of the specific prior art discussed,
- 4) an identification of the principal proposed amendments of a substantive nature discussed, unless these are already described on the Interview Summary Form completed by the Examiner,
- 5) a brief identification of the general thrust of the principal arguments presented to the examiner,
(The identification of arguments need not be lengthy or elaborate. A verbatim or highly detailed description of the arguments is not required. The identification of the arguments is sufficient if the general nature or thrust of the principal arguments made to the examiner can be understood in the context of the application file. Of course, the applicant may desire to emphasize and fully describe those arguments which he or she feels were or might be persuasive to the examiner.)
- 6) a general indication of any other pertinent matters discussed, and
- 7) if appropriate, the general results or outcome of the interview unless already described in the Interview Summary Form completed by the examiner.

Examiners are expected to carefully review the applicant's record of the substance of an interview. If the record is not complete and accurate, the examiner will give the applicant an extendable one month time period to correct the record.

Examiner to Check for Accuracy

If the claims are allowable for other reasons of record, the examiner should send a letter setting forth the examiner's version of the statement attributed to him or her. If the record is complete and accurate, the examiner should place the indication, "Interview Record OK" on the paper recording the substance of the interview along with the date and the examiner's initials.

IN THE UNITED STATES PATENT AND TRADEMARK OFFICE

In re Application of: Victor Larson <i>et al.</i>	:	
	:	
Serial No.: 13/342,795	:	Confirmation No. 4180
	:	
Filed: January 3, 2012	:	Group Art Unit: 2453
	:	
Customer Number: 23630	:	Examiner: Lim, Krisna

For: System and Method Employing an Agile Network Protocol for Secure Communications
Using Secure Domain Names

Mail Stop Amendment
Commissioner for Patents
P.O. Box 1450
Alexandria, VA 22313-1450

Interview Summary

Madam,

Applicants thank Examiner Lim for a telephonic interview on June 8, 2012, with Applicants’ representatives, Toby Kusmer, Kenneth Cheney, and Ashley Tarokh.

During the interview, the parties discussed the rejections of the independent claims under 35 U.S.C. § 103(a) over *Aventail Connect v3.1/v2.6 Administrator’s Guide* (hereinafter referenced as “Aventail”) in view of *Windows NT Server, Virtual Private Networking: An Overview* (hereinafter referenced as “VPN Overview”). Applicants’ representatives argued that Aventail and VPN Overview fail to teach or suggest “a determination as a result of the address request that the target device is a device with which a secure communication link can be established when the requested address is identified in an address lookup,” as recited in Applicants’ Claim 1.

Serial No. 13/342,795

Applicants are grateful to Examiner Lim for his time and helpful comments.

Respectfully submitted,

McDERMOTT WILL & EMERY LLP

Date: June 15, 2012

/Toby H. Kusmer/

Toby H. Kusmer, P.C., Reg. No. 26,418

Customer No. 23630

28 State Street

Boston, MA 02109-1775

Telephone: (617) 535-4000

Facsimile : (617)535-3800

E-mail: tkusmer@mwe.com

Electronic Acknowledgement Receipt

EFS ID:	13026135
Application Number:	13342795
International Application Number:	
Confirmation Number:	4180
Title of Invention:	SYSTEM AND METHOD EMPLOYING AN AGILE NETWORK PROTOCOL FOR SECURE COMMUNICATIONS USING SECURE DOMAIN NAMES
First Named Inventor/Applicant Name:	Victor Larson
Customer Number:	23630
Filer:	Toby H. Kusmer./Tricia Tedesco
Filer Authorized By:	Toby H. Kusmer.
Attorney Docket Number:	77580-155(VR NK-1CP3CNFT5)
Receipt Date:	15-JUN-2012
Filing Date:	03-JAN-2012
Time Stamp:	14:28:36
Application Type:	Utility under 35 USC 111(a)

Payment information:

Submitted with Payment	no
------------------------	----

File Listing:

Document Number	Document Description	File Name	File Size(Bytes)/ Message Digest	Multi Part /.zip	Pages (if appl.)
1	Miscellaneous Incoming Letter	InterviewSummary.pdf	85222 <small>8191ece44684c49a18390d4027f3a317ab2d81f3</small>	no	2

Warnings:

Information:

This Acknowledgement Receipt evidences receipt on the noted date by the USPTO of the indicated documents, characterized by the applicant, and including page counts, where applicable. It serves as evidence of receipt similar to a Post Card, as described in MPEP 503.

New Applications Under 35 U.S.C. 111

If a new application is being filed and the application includes the necessary components for a filing date (see 37 CFR 1.53(b)-(d) and MPEP 506), a Filing Receipt (37 CFR 1.54) will be issued in due course and the date shown on this Acknowledgement Receipt will establish the filing date of the application.

National Stage of an International Application under 35 U.S.C. 371

If a timely submission to enter the national stage of an international application is compliant with the conditions of 35 U.S.C. 371 and other applicable requirements a Form PCT/DO/EO/903 indicating acceptance of the application as a national stage submission under 35 U.S.C. 371 will be issued in addition to the Filing Receipt, in due course.

New International Application Filed with the USPTO as a Receiving Office

If a new international application is being filed and the international application includes the necessary components for an international filing date (see PCT Article 11 and MPEP 1810), a Notification of the International Application Number and of the International Filing Date (Form PCT/RO/105) will be issued in due course, subject to prescriptions concerning national security, and the date shown on this Acknowledgement Receipt will establish the international filing date of the application.

Subst. for form 1449/PTO				Complete if Known		
INFORMATION DISCLOSURE STATEMENT BY APPLICANT <i>(Use as many sheets as necessary)</i>				Application Number	13/342,795	
				Filing Date	01-03-2012	
				First Named Inventor	Victor Larson	
				Art Unit	2453	
				Examiner Name	Krisna Lim	
				Docket Number	77580-155(VR NK-1CP3CNFT5)	
U.S. PATENTS						
EXAMINER'S INITIALS	CITE NO.	Patent Number	Publication Date	Name of Patentee or Applicant of Cited Document	Pages, Columns, Lines, Where Relevant Passages or Relevant Figures Appear	
U.S. PATENT APPLICATION PUBLICATIONS						
EXAMINER'S INITIALS	CITE NO.	Patent Number	Publication Date	Name of Patentee or Applicant of Cited Document	Pages, Columns, Lines, Where Relevant Passages or Relevant Figures Appear	
FOREIGN PATENT DOCUMENTS						
EXAMINER'S INITIALS	CITE NO.	Foreign Patent Document Country Codes - Number - Kind Codes (if known)	Publication Date	Name of Patentee or Applicant of Cited Document	Pages, Columns, Lines Where Relevant Figures Appear	Translation
						Yes No
OTHER ART (Including Author, Title, Date, Pertinent Pages, Etc.)						
EXAMINER'S INITIALS	CITE NO.	Include name of the author (in CAPITAL LETTERS), title of the article (when appropriate), title of the item (book, magazine, journal, serial, symposium, catalog, etc.), date, page(s), volume-issue number(s), publisher, city and/or country where published.				
	D1208	Cisco Comments and Petition for Reexamination 95/001,679 dated June 14, 2012				
	D1209	Exhibit S, Declaration of Nathaniel Polish, Ph.D.				
	D1210	Exhibit R, Excerpts from Patent Owner & Plaintiff VirnetX Inc.'s First Amended P.R. 3-1 and 3-2 Disclosure of Asserted Claims and Infringement Contentions				
EXAMINER				DATE CONSIDERED		

*EXAMINER: Initial if reference considered, whether or not citation is in conformance with MPEP 609. Draw line through citation if not in conformance and not considered. Include copy of this form with next communication to applicant.

1 Applicant's unique citation designation number (optional). 2 Applicant is to place a check mark here if English language Translation is attached.

Subst. for form 1449/PTO				Complete if Known	
INFORMATION DISCLOSURE STATEMENT BY APPLICANT <i>(Use as many sheets as necessary)</i>				Application Number	13/342,795
				Filing Date	01-03-2012
				First Named Inventor	Victor Larson
				Art Unit	2453
				Examiner Name	Krisna Lim
				Docket Number	77580-155(VR NK-1CP3CNFT5)

CERTIFICATION STATEMENT

Please See 37 CFR 1.97 and 1.98 to make the appropriate selection(s)

- Information Disclosure Statement is being filed with the filing of the application or before the receipt of a first office action.
- That each item of information contained in the information disclosure statement was first cited in any communication from a foreign patent office in a counterpart foreign application not more than three months prior to the filing of the information disclosure statement; or
- That no item of information contained in the information disclosure statement was cited in a communication from a foreign patent office in a counterpart foreign application, and, to the knowledge of the person signing the certification after making reasonable inquiry, no item of information contained in the information disclosure statement was known to any individual designated in § 1.56(c) more than three months prior to the filing of the information disclosure statement.
- The Commissioner is hereby authorized to charge the fee pursuant to 37 CFR 1.17(P) in the amount of \$180.00, or further fees which may be due, to Deposit Account 50-1133.
- Information Disclosure Statement is being filed with the Request for Continued Examination. The Commissioner is hereby authorized to charge the fee pursuant to 37 CFR 1.17(P) in the amount of \$810.00, or further fees which may be due, to Deposit Account 50-1133.
- None

SIGNATURE

A signature of the applicant or representative is required in accordance with CFR 1.33, 10.18. Please see CFR 1.4(d) for the form of the signature.

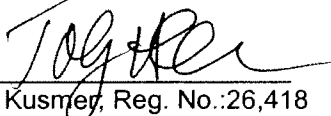

Date: 6/20/12

Toby H. Kusmer, Reg. No.:26,418
 McDermott Will & Emery LLP
 28 State Street
 Boston, MA 02109
 Tel. (617) 535-4000
 Fax (617) 535-3800

DM_US 36055603-1.077580.0155

Electronic Acknowledgement Receipt

EFS ID:	13061756
Application Number:	13342795
International Application Number:	
Confirmation Number:	4180
Title of Invention:	SYSTEM AND METHOD EMPLOYING AN AGILE NETWORK PROTOCOL FOR SECURE COMMUNICATIONS USING SECURE DOMAIN NAMES
First Named Inventor/Applicant Name:	Victor Larson
Customer Number:	23630
Filer:	Toby H. Kusmer./Kerrie Jones
Filer Authorized By:	Toby H. Kusmer.
Attorney Docket Number:	77580-155(VRNL-1CP3CNFT5)
Receipt Date:	20-JUN-2012
Filing Date:	03-JAN-2012
Time Stamp:	15:06:29
Application Type:	Utility under 35 USC 111(a)

Payment information:

Submitted with Payment	no
------------------------	----

File Listing:

Document Number	Document Description	File Name	File Size(Bytes)/ Message Digest	Multi Part /.zip	Pages (if appl.)
1	Information Disclosure Statement (IDS) Form (SB08)	IDS.pdf	63164 <small>8e334a79e01959f0f9d09ec3b0e68c660d3f815d</small>	no	2

Warnings:

Information:

This is not an USPTO supplied IDS fillable form

The page size in the PDF is too large. The pages should be 8.5 x 11 or A4. If this PDF is submitted, the pages will be resized upon entry into the Image File Wrapper and may affect subsequent processing

2	Non Patent Literature	D1208.pdf	3853013 eaf5c634379b23fdc67a94c4331fac1069b67b92	no	69
---	-----------------------	-----------	---	----	----

Warnings:

Information:

3	Non Patent Literature	D1209.pdf	239094 bb4f5028b8101ef3fb0a335e73250ba7bfa275c7	no	5
---	-----------------------	-----------	--	----	---

Warnings:

Information:

4	Non Patent Literature	D1210.pdf	3178926 9f310e31bbc977b000edec084c28265a8e43fe22	no	53
---	-----------------------	-----------	---	----	----

Warnings:

Information:

Total Files Size (in bytes):			7334197		
-------------------------------------	--	--	---------	--	--

This Acknowledgement Receipt evidences receipt on the noted date by the USPTO of the indicated documents, characterized by the applicant, and including page counts, where applicable. It serves as evidence of receipt similar to a Post Card, as described in MPEP 503.

New Applications Under 35 U.S.C. 111

If a new application is being filed and the application includes the necessary components for a filing date (see 37 CFR 1.53(b)-(d) and MPEP 506), a Filing Receipt (37 CFR 1.54) will be issued in due course and the date shown on this Acknowledgement Receipt will establish the filing date of the application.

National Stage of an International Application under 35 U.S.C. 371

If a timely submission to enter the national stage of an international application is compliant with the conditions of 35 U.S.C. 371 and other applicable requirements a Form PCT/DO/EO/903 indicating acceptance of the application as a national stage submission under 35 U.S.C. 371 will be issued in addition to the Filing Receipt, in due course.

New International Application Filed with the USPTO as a Receiving Office

If a new international application is being filed and the international application includes the necessary components for an international filing date (see PCT Article 11 and MPEP 1810), a Notification of the International Application Number and of the International Filing Date (Form PCT/RO/105) will be issued in due course, subject to prescriptions concerning national security, and the date shown on this Acknowledgement Receipt will establish the international filing date of the application.

Subst. for form 1449/PTO				Complete if Known		
INFORMATION DISCLOSURE STATEMENT BY APPLICANT <i>(Use as many sheets as necessary)</i>				Application Number	13/342,795	
				Filing Date	01-03-2012	
				First Named Inventor	Victor Larson	
				Art Unit	2453	
				Examiner Name	Krisna Lim	
				Docket Number	77580-155(VRNK-1CP3CNFT5)	
U.S. PATENTS						
EXAMINER'S INITIALS	CITE NO.	Patent Number	Publication Date	Name of Patentee or Applicant of Cited Document	Pages, Columns, Lines, Where Relevant Passages or Relevant Figures Appear	
U.S. PATENT APPLICATION PUBLICATIONS						
EXAMINER'S INITIALS	CITE NO.	Patent Number	Publication Date	Name of Patentee or Applicant of Cited Document	Pages, Columns, Lines, Where Relevant Passages or Relevant Figures Appear	
FOREIGN PATENT DOCUMENTS						
EXAMINER'S INITIALS	CITE NO.	Foreign Patent Document Country Codes - Number - Kind Codes (if known)	Publication Date	Name of Patentee or Applicant of Cited Document	Pages, Columns, Lines Where Relevant Figures Appear	Translation
						Yes No
OTHER ART (Including Author, Title, Date, Pertinent Pages, Etc.)						
EXAMINER'S INITIALS	CITE NO.	Include name of the author (in CAPITAL LETTERS), title of the article (when appropriate), title of the item (book, magazine, journal, serial, symposium, catalog, etc.), date, page(s), volume-issue number(s), publisher, city and/or country where published.				
	D1211	Third Party Requester Comments dated June 25, 2012 - After Non Final Office Action (95/001,788)				
	D1212	Reexam Affidavit/Declaration/Exhibit Filed by 3rd Party on June 25, 2012 (95/001,788)				
EXAMINER				DATE CONSIDERED		

*EXAMINER: Initial if reference considered, whether or not citation is in conformance with MPEP 609. Draw line through citation if not in conformance and not considered. Include copy of this form with next communication to applicant.

1 Applicant's unique citation designation number (optional). 2 Applicant is to place a check mark here if English language Translation is attached.

Subst. for form 1449/PTO				Complete if Known	
INFORMATION DISCLOSURE STATEMENT BY APPLICANT <i>(Use as many sheets as necessary)</i>				Application Number	13/342,795
				Filing Date	01-03-2012
				First Named Inventor	Victor Larson
				Art Unit	2453
				Examiner Name	Krisna Lim
				Docket Number	77580-155(VRNK-1CP3CNFT5)

CERTIFICATION STATEMENT

Please See 37 CFR 1.97 and 1.98 to make the appropriate selection(s)

- Information Disclosure Statement is being filed with the filing of the application or before the receipt of a first office action.
- That each item of information contained in the information disclosure statement was first cited in any communication from a foreign patent office in a counterpart foreign application not more than three months prior to the filing of the information disclosure statement; or
- That no item of information contained in the information disclosure statement was cited in a communication from a foreign patent office in a counterpart foreign application, and, to the knowledge of the person signing the certification after making reasonable inquiry, no item of information contained in the information disclosure statement was known to any individual designated in § 1.56(c) more than three months prior to the filing of the information disclosure statement.
- The Commissioner is hereby authorized to charge the fee pursuant to 37 CFR 1.17(P) in the amount of \$180.00, or further fees which may be due, to Deposit Account 50-1133.
- Information Disclosure Statement is being filed with the Request for Continued Examination. The Commissioner is hereby authorized to charge the fee pursuant to 37 CFR 1.17(P) in the amount of \$810.00, or further fees which may be due, to Deposit Account 50-1133.
- None

SIGNATURE

A signature of the applicant or representative is required in accordance with CFR 1.33, 10.18. Please see CFR 1.4(d) for the form of the signature.

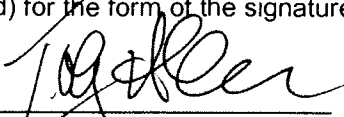

Date: 6/28/12

Toby H. Kusner; Reg. No.:26,418
 McDermott Will & Emery LLP
 28 State Street
 Boston, MA 02109
 Tel. (617) 535-4000
 Fax (617) 535-3800

DM_US 36238007-1.077580.0155

Electronic Acknowledgement Receipt

EFS ID:	13129645
Application Number:	13342795
International Application Number:	
Confirmation Number:	4180
Title of Invention:	SYSTEM AND METHOD EMPLOYING AN AGILE NETWORK PROTOCOL FOR SECURE COMMUNICATIONS USING SECURE DOMAIN NAMES
First Named Inventor/Applicant Name:	Victor Larson
Customer Number:	23630
Filer:	Toby H. Kusmer./Kerrie Jones
Filer Authorized By:	Toby H. Kusmer.
Attorney Docket Number:	77580-155(VRNL-1CP3CNFT5)
Receipt Date:	28-JUN-2012
Filing Date:	03-JAN-2012
Time Stamp:	13:35:19
Application Type:	Utility under 35 USC 111(a)

Payment information:

Submitted with Payment	no
------------------------	----

File Listing:

Document Number	Document Description	File Name	File Size(Bytes)/ Message Digest	Multi Part /.zip	Pages (if appl.)
1	Information Disclosure Statement (IDS) Form (SB08)	IDS.pdf	66166 <small>1046c362bb66e68ffed4c668840d2914ce2d1406</small>	no	2

Warnings:

Information:

This is not an USPTO supplied IDS fillable form

The page size in the PDF is too large. The pages should be 8.5 x 11 or A4. If this PDF is submitted, the pages will be resized upon entry into the Image File Wrapper and may affect subsequent processing

2	Non Patent Literature	D1211.pdf	1475748	no	37
			c6b9dbd8510b993a8930b1fd4a62698701 beeec7e		

Warnings:

The page size in the PDF is too large. The pages should be 8.5 x 11 or A4. If this PDF is submitted, the pages will be resized upon entry into the Image File Wrapper and may affect subsequent processing

Information:

3	Non Patent Literature	D1212.pdf	964426	no	19
			8301d1b5a831ff5c0e7d4b145f4c91f68810 a7bb		

Warnings:

The page size in the PDF is too large. The pages should be 8.5 x 11 or A4. If this PDF is submitted, the pages will be resized upon entry into the Image File Wrapper and may affect subsequent processing

Information:

Total Files Size (in bytes):	2506340
-------------------------------------	---------

This Acknowledgement Receipt evidences receipt on the noted date by the USPTO of the indicated documents, characterized by the applicant, and including page counts, where applicable. It serves as evidence of receipt similar to a Post Card, as described in MPEP 503.

New Applications Under 35 U.S.C. 111

If a new application is being filed and the application includes the necessary components for a filing date (see 37 CFR 1.53(b)-(d) and MPEP 506), a Filing Receipt (37 CFR 1.54) will be issued in due course and the date shown on this Acknowledgement Receipt will establish the filing date of the application.

National Stage of an International Application under 35 U.S.C. 371

If a timely submission to enter the national stage of an international application is compliant with the conditions of 35 U.S.C. 371 and other applicable requirements a Form PCT/DO/EO/903 indicating acceptance of the application as a national stage submission under 35 U.S.C. 371 will be issued in addition to the Filing Receipt, in due course.

New International Application Filed with the USPTO as a Receiving Office

If a new international application is being filed and the international application includes the necessary components for an international filing date (see PCT Article 11 and MPEP 1810), a Notification of the International Application Number and of the International Filing Date (Form PCT/RO/105) will be issued in due course, subject to prescriptions concerning national security, and the date shown on this Acknowledgement Receipt will establish the international filing date of the application.

Subst. for form 1449/PTO				Complete if Known			
INFORMATION DISCLOSURE STATEMENT BY APPLICANT <i>(Use as many sheets as necessary)</i>				Application Number	13/342,795		
				Filing Date	01-03-2012		
				First Named Inventor	Victor Larson		
				Art Unit	2453		
				Examiner Name	Krisna Lim		
				Docket Number	77580-155(VRNK-1CP3CNFT5)		
U.S. PATENTS							
EXAMINER'S INITIALS	CITE NO.	Patent Number	Publication Date	Name of Patentee or Applicant of Cited Document	Pages, Columns, Lines, Where Relevant Passages or Relevant Figures Appear		
U.S. PATENT APPLICATION PUBLICATIONS							
EXAMINER'S INITIALS	CITE NO.	Patent Number	Publication Date	Name of Patentee or Applicant of Cited Document	Pages, Columns, Lines, Where Relevant Passages or Relevant Figures Appear		
FOREIGN PATENT DOCUMENTS							
EXAMINER'S INITIALS	CITE NO.	Foreign Patent Document Country Codes -Number 4 -Kind Codes (if known)	Publication Date	Name of Patentee or Applicant of Cited Document	Pages, Columns, Lines Where Relevant Figures Appear	Translation	
						Yes	No
OTHER ART (Including Author, Title, Date, Pertinent Pages, Etc.)							
EXAMINER'S INITIALS	CITE NO.	Include name of the author (in CAPITAL LETTERS), title of the article (when appropriate), title of the item (book, magazine, journal, serial, symposium, catalog, etc.), date, page(s), volume-issue number(s), publisher, city and/or country where published.					
	D1213	Extended European Search Report dated 03/26/12 from Corresponding European Application Number 11005793.2 (077580-0144)					
	D1214	Bergadano, et al., "Secure WWW Transactions Using Standard HTTP and Java Applets," Proceedings of the 3rd USENIX Workshop on Electronic Commerce, 1998					
EXAMINER				DATE CONSIDERED			

*EXAMINER: Initial if reference considered, whether or not citation is in conformance with MPEP 609. Draw line through citation if not in conformance and not considered. Include copy of this form with next communication to applicant.

1 Applicant's unique citation designation number (optional). 2 Applicant is to place a check mark here if English language Translation is attached.

Subst. for form 1449/PTO				Complete if Known	
INFORMATION DISCLOSURE STATEMENT BY APPLICANT <i>(Use as many sheets as necessary)</i>				Application Number	13/342,795
				Filing Date	01-03-2012
				First Named Inventor	Victor Larson
				Art Unit	2453
				Examiner Name	Krisna Lim
				Docket Number	77580-155(VRNK-1CP3CNFT5)

CERTIFICATION STATEMENT

Please See 37 CFR 1.97 and 1.98 to make the appropriate selection(s)

- Information Disclosure Statement is being filed with the filing of the application or before the receipt of a first office action.
- That each item of information contained in the information disclosure statement was first cited in any communication from a foreign patent office in a counterpart foreign application not more than three months prior to the filing of the information disclosure statement; or
- That no item of information contained in the information disclosure statement was cited in a communication from a foreign patent office in a counterpart foreign application, and, to the knowledge of the person signing the certification after making reasonable inquiry, no item of information contained in the information disclosure statement was known to any individual designated in § 1.56(c) more than three months prior to the filing of the information disclosure statement.
- The Commissioner is hereby authorized to charge the fee pursuant to 37 CFR 1.17(P) in the amount of \$180.00, or further fees which may be due, to Deposit Account 50-1133.
- Information Disclosure Statement is being filed with the Request for Continued Examination. The Commissioner is hereby authorized to charge the fee pursuant to 37 CFR 1.17(P) in the amount of \$810.00, or further fees which may be due, to Deposit Account 50-1133.

SIGNATURE

A signature of the applicant or representative is required in accordance with CFR 1.33, 10.18. Please see CFR 1.4(d) for the form of the signature.

 Toby H. Kusmer; Reg. No.:26,418
 McDermott Will & Emery LLP
 28 State Street
 Boston, MA 02109
 Tel. (617) 535-4000
 Fax (617) 535-3800

Date: 7/24/12

DM_US 36888618-1.077580.0155

Electronic Patent Application Fee Transmittal

Application Number:	13342795
Filing Date:	03-Jan-2012
Title of Invention:	SYSTEM AND METHOD EMPLOYING AN AGILE NETWORK PROTOCOL FOR SECURE COMMUNICATIONS USING SECURE DOMAIN NAMES
First Named Inventor/Applicant Name:	Victor Larson
Filer:	Toby H. Kusmer./Kerrie Jones
Attorney Docket Number:	77580-155(VR NK-1CP3CNFT5)

Filed as Large Entity

Utility under 35 USC 111(a) Filing Fees

Description	Fee Code	Quantity	Amount	Sub-Total in USD(\$)
Basic Filing:				
Pages:				
Claims:				
Miscellaneous-Filing:				
Petition:				
Patent-Appeals-and-Interference:				
Post-Allowance-and-Post-Issuance:				
Extension-of-Time:				

Description	Fee Code	Quantity	Amount	Sub-Total in USD(\$)
Miscellaneous:				
Submission- Information Disclosure Stmt	1806	1	180	180
Total in USD (\$)				180

Electronic Acknowledgement Receipt

EFS ID:	13324703
Application Number:	13342795
International Application Number:	
Confirmation Number:	4180
Title of Invention:	SYSTEM AND METHOD EMPLOYING AN AGILE NETWORK PROTOCOL FOR SECURE COMMUNICATIONS USING SECURE DOMAIN NAMES
First Named Inventor/Applicant Name:	Victor Larson
Customer Number:	23630
Filer:	Toby H. Kusmer./Kerrie Jones
Filer Authorized By:	Toby H. Kusmer.
Attorney Docket Number:	77580-155(VR NK-1CP3CNFT5)
Receipt Date:	24-JUL-2012
Filing Date:	03-JAN-2012
Time Stamp:	14:13:25
Application Type:	Utility under 35 USC 111(a)

Payment information:

Submitted with Payment	yes
Payment Type	Deposit Account
Payment was successfully received in RAM	\$180
RAM confirmation Number	558
Deposit Account	501133
Authorized User	

File Listing:

Document Number	Document Description	File Name	File Size(Bytes)/ Message Digest	Multi Part /.zip	Pages (if appl.)
-----------------	----------------------	-----------	----------------------------------	------------------	------------------

1	Information Disclosure Statement (IDS) Form (SB08)	IDS.pdf	99619 b0e62bf59634c3bd30f5c0f6a0e9ad4b87908df3	no	2
Warnings:					
Information:					
This is not an USPTO supplied IDS fillable form					
The page size in the PDF is too large. The pages should be 8.5 x 11 or A4. If this PDF is submitted, the pages will be resized upon entry into the Image File Wrapper and may affect subsequent processing					
2	Non Patent Literature	D1213.pdf	136710 74b5ec1dd57786589fb190f9315fb0a9d662ba1e	no	6
Warnings:					
The page size in the PDF is too large. The pages should be 8.5 x 11 or A4. If this PDF is submitted, the pages will be resized upon entry into the Image File Wrapper and may affect subsequent processing					
Information:					
3	Non Patent Literature	D1214.pdf	484004 e0f438024380229ed5ea85618d3fd613b7b6488	no	12
Warnings:					
The page size in the PDF is too large. The pages should be 8.5 x 11 or A4. If this PDF is submitted, the pages will be resized upon entry into the Image File Wrapper and may affect subsequent processing					
Information:					
4	Fee Worksheet (SB06)	fee-info.pdf	30674 08a62bab520c4485bd8d4cd61f1c9f8b45cba4d7	no	2
Warnings:					
Information:					
Total Files Size (in bytes):				751007	
<p>This Acknowledgement Receipt evidences receipt on the noted date by the USPTO of the indicated documents, characterized by the applicant, and including page counts, where applicable. It serves as evidence of receipt similar to a Post Card, as described in MPEP 503.</p> <p><u>New Applications Under 35 U.S.C. 111</u> If a new application is being filed and the application includes the necessary components for a filing date (see 37 CFR 1.53(b)-(d) and MPEP 506), a Filing Receipt (37 CFR 1.54) will be issued in due course and the date shown on this Acknowledgement Receipt will establish the filing date of the application.</p> <p><u>National Stage of an International Application under 35 U.S.C. 371</u> If a timely submission to enter the national stage of an international application is compliant with the conditions of 35 U.S.C. 371 and other applicable requirements a Form PCT/DO/EO/903 indicating acceptance of the application as a national stage submission under 35 U.S.C. 371 will be issued in addition to the Filing Receipt, in due course.</p> <p><u>New International Application Filed with the USPTO as a Receiving Office</u> If a new international application is being filed and the international application includes the necessary components for an international filing date (see PCT Article 11 and MPEP 1810), a Notification of the International Application Number and of the International Filing Date (Form PCT/RO/105) will be issued in due course, subject to prescriptions concerning national security, and the date shown on this Acknowledgement Receipt will establish the international filing date of the application.</p>					



UNITED STATES PATENT AND TRADEMARK OFFICE

UNITED STATES DEPARTMENT OF COMMERCE
United States Patent and Trademark Office
Address: COMMISSIONER FOR PATENTS
P.O. Box 1450
Alexandria, Virginia 22313-1450
www.uspto.gov

Table with 5 columns: APPLICATION NO., FILING DATE, FIRST NAMED INVENTOR, ATTORNEY DOCKET NO., CONFIRMATION NO.
13/342,795 01/03/2012 Victor Larson 77580-155(VRNK-1CP3CNFT5) 4180

23630 7590 07/30/2012
McDermott Will & Emery
600 13th Street, NW
Washington, DC 20005-3096

EXAMINER

LIM, KRISNA

ART UNIT PAPER NUMBER

2453

NOTIFICATION DATE DELIVERY MODE

07/30/2012

ELECTRONIC

Please find below and/or attached an Office communication concerning this application or proceeding.

The time period for reply, if any, is set in the attached communication.

Notice of the Office communication was sent electronically on above-indicated "Notification Date" to the following e-mail address(es):

mweipdocket@mwe.com

Office Action Summary	Application No. 13/342,795	Applicant(s) LARSON ET AL.	
	Examiner KRISNA LIM	Art Unit 2453	

-- The MAILING DATE of this communication appears on the cover sheet with the correspondence address --

Period for Reply

A SHORTENED STATUTORY PERIOD FOR REPLY IS SET TO EXPIRE 3 MONTH(S) OR THIRTY (30) DAYS, WHICHEVER IS LONGER, FROM THE MAILING DATE OF THIS COMMUNICATION.

- Extensions of time may be available under the provisions of 37 CFR 1.136(a). In no event, however, may a reply be timely filed after SIX (6) MONTHS from the mailing date of this communication.
- If NO period for reply is specified above, the maximum statutory period will apply and will expire SIX (6) MONTHS from the mailing date of this communication.
- Failure to reply within the set or extended period for reply will, by statute, cause the application to become ABANDONED (35 U.S.C. § 133). Any reply received by the Office later than three months after the mailing date of this communication, even if timely filed, may reduce any earned patent term adjustment. See 37 CFR 1.704(b).

Status

- 1) Responsive to communication(s) filed on 01 June 2012.
- 2a) This action is **FINAL**. 2b) This action is non-final.
- 3) An election was made by the applicant in response to a restriction requirement set forth during the interview on _____; the restriction requirement and election have been incorporated into this action.
- 4) Since this application is in condition for allowance except for formal matters, prosecution as to the merits is closed in accordance with the practice under *Ex parte Quayle*, 1935 C.D. 11, 453 O.G. 213.

Disposition of Claims

- 5) Claim(s) 1-30 is/are pending in the application.
 - 5a) Of the above claim(s) _____ is/are withdrawn from consideration.
- 6) Claim(s) _____ is/are allowed.
- 7) Claim(s) 1-30 is/are rejected.
- 8) Claim(s) _____ is/are objected to.
- 9) Claim(s) _____ are subject to restriction and/or election requirement.

Application Papers

- 10) The specification is objected to by the Examiner.
- 11) The drawing(s) filed on _____ is/are: a) accepted or b) objected to by the Examiner.
 - Applicant may not request that any objection to the drawing(s) be held in abeyance. See 37 CFR 1.85(a).
 - Replacement drawing sheet(s) including the correction is required if the drawing(s) is objected to. See 37 CFR 1.121(d).
- 12) The oath or declaration is objected to by the Examiner. Note the attached Office Action or form PTO-152.

Priority under 35 U.S.C. § 119

- 13) Acknowledgment is made of a claim for foreign priority under 35 U.S.C. § 119(a)-(d) or (f).
 - a) All b) Some * c) None of:
 - 1. Certified copies of the priority documents have been received.
 - 2. Certified copies of the priority documents have been received in Application No. _____.
 - 3. Copies of the certified copies of the priority documents have been received in this National Stage application from the International Bureau (PCT Rule 17.2(a)).

* See the attached detailed Office action for a list of the certified copies not received.

Attachment(s)

- 1) Notice of References Cited (PTO-892)
- 2) Notice of Draftperson's Patent Drawing Review (PTO-948)
- 3) Information Disclosure Statement(s) (PTO/SB/08)
Paper No(s)/Mail Date _____.
- 4) Interview Summary (PTO-413)
Paper No(s)/Mail Date _____.
- 5) Notice of Informal Patent Application
- 6) Other: _____.

Art Unit: 2453

1. Claims 1-30 are still pending for examination.

2. The following is a quotation of 35 U.S.C. 103(a) which forms the basis for all obviousness rejections set forth in this Office action:

(a) A patent may not be obtained through the invention is not identically disclosed or described as set forth in section 102 of this title, if the differences between the subject matter sought to be patented and the prior art are such that the subject matter as a whole would have been obvious at the time the invention was made to a person having ordinary skill in the art to which said subject matter pertains. Patentability shall not be negated by the manner in which the invention was made.

The factual inquiries set forth in *Graham v. John Deere Co.*, 383 U.S. 1, 148 USPQ 459 (1966), that are applied for establishing a background for determining obviousness under 35 U.S.C. 103(a) are summarized as follows:

1. Determining the scope and contents of the prior art.
 2. Ascertaining the differences between the prior art and the claims at issue.
 3. Resolving the level of ordinary skill in the pertinent art.
 4. Considering objective evidence present in the application indicating obviousness or nonobviousness.
-
3. Claims 1-28 are rejected under 35 U.S.C. § 103(a) as being unpatentable over Wesinger [U.S. Patent No. 5,898,830].

 4. Wesinger disclosed the invention substantially as claimed. Taking claims 1, 4, 5, 6, 7, 16, 19, 20, 21 and 22 as exemplary claims, the reference disclose a client device comprising: a) memory configured and arranged to facilitate a connection (i.e., see Internet 120 of Fig. 1) of the client device (i.e. a client C) with a target device (i.e. a host D) over a secure communication link created (i.e., see col. 12, lines 23-27) based on (i) an address request generated by the client device (i.e., see col. 9, lines 1-25), and (ii) a determination as a result of the address request that the target device is a device with which a secure communication link can be established when the requested address is identified in an address lookup (i.e., see col. 8 (lines 65) to col. 9 (line 2), col. 9 (lines 53-60), col. 16 (line 57) to col. 17 (line 5), col. 12 (lines 23-27));

Art Unit: 2453

wherein the establishment of the secure communication link is based on a determination being made by a proxy module (i.e., a proxy server) that the target device is a device with which a secure communication link can be established when the address request corresponds to a target device identified in a DNS lookup table (i.e., see col. 8 (lines 33-48), col. 8 (line 65) to col. 9 (line 2), col. 9 (lines 19-25), col. 16 (line 57) to col. 17 (line 5) and col. 12 (lines 23-27));

wherein the address lookup is a network address lookup (i.e., see cols. 8-9);

Wherein the secure communication link is a virtual private network link (i.e., see col. 12 (lines 23-27)).

wherein the address request includes a secure domain name (i.e. see DNS of Fig. 1 and cols. 8-9).

5. As to claims 2-3, 9-15 and 23-30, those features (i.e., a computer, a server, a phone, a broadband connection, using modulation based on FDM, TDM, or CDMA, etc.) are well known the art at the time the invention was made and they are not patentably distinguishable features.

7. While Wesinger disclosed, at col. 9 (lines 16-25) the feature of "when a client C tries to initiate a connection to host D using the name D ... The DNS server for D returns the network address of D to a virtual host of the firewall 155. The virtual host returns its network address to the virtual host on the firewall 157 from which it received the lookup request, and so on, until a virtual host on the firewall 105 returns its network address (instead of the network address of D) to the client C", Wesinger did not mention as exactly as the claimed language of "the establishment of the secure communication link is based on a determination being made by a proxy module that the target device is a device with which a secure communication link can be established when the address request corresponds to a target device identified in a DNS lookup table". It would have been obvious to one of ordinary skill in the art to obviously recognize that Wesinger's passage above and the claimed language are obviously the same and the difference is how they are written which is obvious to one of ordinary skill in the art.

A shortened statutory period for response to this action is set to expire 3 (three) months and 0 (zero) days from the mail date of this letter.

Extensions of time may be available under the provisions of 37 CFR 1.136(a). In no event, however, may a reply be timely filed after SIX (6) MONTHS from the mailing date of this communication.

If NO period for reply is specified above, the maximum statutory period will apply and will expire SIX (6) MONTHS from the mailing date of this communication.

Failure to reply within the set or extended period for reply will, by statute, cause the application to become ABANDONED (35 U.S.C. § 133).

Any reply received by the Office later than three months after the mailing date of this communication, even if timely filed, may reduce any earned patent term adjustment. See 37 CFR 1.704(b).

Any inquiry concerning this communication or earlier communications from the examiner should be directed to Krisna Lim whose telephone number is 571-272-3956. The examiner can normally be reached on Tuesday to Friday from 7:10 AM to 5:40 PM.

If attempts to reach the examiner by telephone are unsuccessful, the examiner's supervisor, Krista Zele, can be reached on 571-272-7288. The fax phone number for the organization where this application or proceeding is assigned is 571-273-8300.

Information regarding the status of an application may be obtained from the Patent Application Information Retrieval (PAIR) system. Status information for published applications may be obtained from either Private PAIR or Public PAIR. Status information for unpublished applications is available through Private PAIR only. For more information about the PAIR system, see <http://pair-direct.uspto.gov>. Should you have questions on access to the Private PAIR system, contact the Electronic Business Center (EBC) at 866-217-9197 (toll-free) If you would like assistance from a USPTO Customer Service Representative or access to the automated information system, call 800-786-9199 (In USA or Canada) or 571-272-100.

Application/Control Number: 13/342,795
Art Unit: 2453

Page 5

KI

July 24, 2012

/Krisna Lim/

Primary Examiner Art Unit 2453

Subst. for form 1449/PTO				Complete if Known		
INFORMATION DISCLOSURE STATEMENT BY APPLICANT (Use as many sheets as necessary)				Application Number	13/342,795	
				Filing Date	01-03-2012	
				First Named Inventor	Victor Larson	
				Art Unit	2453	
				Examiner Name	Krisna Lim	
				Docket Number	77580-155(VRNK-1CP3CNFT5)	
U.S. PATENTS						
EXAMINER'S INITIALS	CITE NO.	Patent Number	Publication Date	Name of Patentee or Applicant of Cited Document	Pages, Columns, Lines, Where Relevant Passages or Relevant Figures Appear	
U.S. PATENT APPLICATION PUBLICATIONS						
EXAMINER'S INITIALS	CITE NO.	Patent Number	Publication Date	Name of Patentee or Applicant of Cited Document	Pages, Columns, Lines, Where Relevant Passages or Relevant Figures Appear	
FOREIGN PATENT DOCUMENTS						
EXAMINER'S INITIALS	CITE NO.	Foreign Patent Document Country Codes - Number - Kind Codes (if known)	Publication Date	Name of Patentee or Applicant of Cited Document	Pages, Columns, Lines Where Relevant Figures Appear	Translation Yes No
OTHER ART (Including Author, Title, Date, Pertinent Pages, Etc.)						
EXAMINER'S INITIALS	CITE NO.	Include name of the author (in CAPITAL LETTERS), title of the article (when appropriate), title of the item (book, magazine, journal, serial, symposium, catalog, etc.), date, page(s), volume-issue number(s), publisher, city and/or country where published.				
	A1121	Declaration of Angelos D. Keromytis, Ph.D.				
	A1122	Declaration of Dr. Robert Dunham Short III				
	A1123	Exhibit A-1, Verdict Form from VirnetX, Inc. v. Microsoft Corp., No. 6:07-CV-80 (E.D. Tex.)				
	A1124	Exhibit A-3, Declaration of Jason Nieh, Ph.D. (Control No. 95/001,269)				
	A1125	Exhibit A-4, Redacted Deposition of Chris Hopen from VirnetX, Inc. v. Cisco Systems, Inc., No. 6:07-CV 417 (E.D. Tex. April 11, 2012)				
	A1126	Exhibit B-1, Excerpt from Deposition of Defense FY 2000/2001 Biennial Budget Estimates, (Feb. 1999)				
	A1127	Exhibit B-2, Collection of Reports and Presentations on DARPA Projects				
	A1128	Exhibit B-3, Maryann Lawlor, Transient Partnerships Stretch Security Policy Management, Signal Magazine (Sept. 2001) http://www.afcea.org/signal/articles/anmviewer.asp?a=494&print=yes				
	A1129	Joel Snyder, Living in Your Own Private Idaho, Network World (January 28, 1998) http://www.networkworld.com/intranet/0126review.html .				
	A1130	Time Greene, CEO's Chew the VPN Fat, CNN.com (June 17, 1999), http://www.cnn.com/TECH/computing/9906/17/vpnfat.ent.idg/index.html?iref=allsearch				
EXAMINER /Krisna Lim/				DATE CONSIDERED 07/20/2012		

*EXAMINER: Initial if reference considered, whether or not citation is in conformance with MPEP 609. Draw line through citation if not in conformance and not considered. Include copy of this form with next communication to applicant.

1 Applicant's unique citation designation number (optional). 2 Applicant is to place a check mark here if English language Translation is attached.

Subst. for form 1449/PTO				Complete if Known	
INFORMATION DISCLOSURE STATEMENT BY APPLICANT <i>(Use as many sheets as necessary)</i>				Application Number	13/342,795
				Filing Date	01-03-2012
				First Named Inventor	Victor Larson
				Art Unit	2453
				Examiner Name	Krisna Lim
				Docket Number	77580-155(VRNK-1CP3CNFT5)

CERTIFICATION STATEMENT

Please See 37 CFR 1.97 and 1.98 to make the appropriate selection(s)

- Information Disclosure Statement is being filed with the filing of the application or before the receipt of a first office action.
- That each item of information contained in the information disclosure statement was first cited in any communication from a foreign patent office in a counterpart foreign application not more than three months prior to the filing of the information disclosure statement; or
- That no item of information contained in the information disclosure statement was cited in a communication from a foreign patent office in a counterpart foreign application, and, to the knowledge of the person signing the certification after making reasonable inquiry, no item of information contained in the information disclosure statement was known to any individual designated in § 1.56(c) more than three months prior to the filing of the information disclosure statement.
- The Commissioner is hereby authorized to charge the fee pursuant to 37 CFR 1.17(P) in the amount of \$180.00, or further fees which may be due, to Deposit Account 50-1133.
- Information Disclosure Statement is being filed with the Request for Continued Examination. The Commissioner is hereby authorized to charge the fee pursuant to 37 CFR 1.17(P) in the amount of \$810.00, or further fees which may be due, to Deposit Account 50-1133.
- None

SIGNATURE

A signature of the applicant or representative is required in accordance with CFR 1.33, 10.18. Please see CFR 1.4(d) for the form of the signature.

 Toby H. Kusmer, Reg. No. 26,418
 McDermott Will & Emery LLP
 28 State Street
 Boston, MA 02109
 Tel. (617) 535-4000
 Fax (617) 535-3800

Date: 5/10/12

DM_US 35091238-1.077580.0155

Subst. for form 1449/PTO				Complete if Known			
INFORMATION DISCLOSURE STATEMENT BY APPLICANT (Use as many sheets as necessary)				Application Number	13/342,795		
				Filing Date	01-03-2012		
				First Named Inventor	Victor Larson		
				Art Unit	2453		
				Examiner Name	Krisna Lim		
				Docket Number	77580-155(VRNK-1CP3CNFT5)		
U.S. PATENTS							
EXAMINER'S INITIALS	CITE NO.	Patent Number	Publication Date	Name of Patentee or Applicant of Cited Document	Pages, Columns, Lines, Where Relevant Passages or Relevant Figures Appear		
U.S. PATENT APPLICATION PUBLICATIONS							
EXAMINER'S INITIALS	CITE NO.	Patent Number	Publication Date	Name of Patentee or Applicant of Cited Document	Pages, Columns, Lines, Where Relevant Passages or Relevant Figures Appear		
FOREIGN PATENT DOCUMENTS							
EXAMINER'S INITIALS	CITE NO.	Foreign Patent Document Country Codes - Number - Kind Codes (if known)	Publication Date	Name of Patentee or Applicant of Cited Document	Pages, Columns, Lines Where Relevant Figures Appear	Translation	
						Yes	No
OTHER ART (Including Author, Title, Date, Pertinent Pages, Etc.)							
EXAMINER'S INITIALS	CITE NO.	Include name of the author (in CAPITAL LETTERS), title of the article (when appropriate), title of the item (book, magazine, journal, serial, symposium, catalog, etc.), date, page(s), volume-issue number(s), publisher, city and/or country where published.					
	D1131	Peter Alexander Invalidity Report					
	D1132	Defendants' Second Supplemental Joint Invalidity Contentions					
	D1133	Exhibit 118A, Altiga VPN System ¹ vs. Claims of the '135 Patent ²					
	D1134	Exhibit 119A, Altiga VPN System ¹ vs. Claims of the '151 Patent ²					
	D1135	Exhibit 120A, Altiga VPN System ¹ vs. Claims of the '180 Patent ²					
	D1136	Exhibit 121A, Altiga VPN System ¹ vs. Claims of the '211 Patent ²					
	D1137	Exhibit 122A, Altiga VPN System ¹ vs. Claims of the '504 Patent ²					
	D1138	Exhibit 123A, Altiga VPN System ¹ vs. Claims of the '759 Patent ²					
	D1139	Exhibit 12A, SSL 3.0 ¹ vs. Claims of the '135 Patent ²					
	D1140	Exhibit 13A, SSL 3.0 ¹ vs. Claims of the '504 Patent ²					
	D1141	Exhibit 14A, SSL 3.0 ¹ vs. Claims of the '211 Patent ²					
	D1142	Exhibit 228A, Understanding OSF DCE 1.1 for AIX and OS/2 ¹ (APP_VX0556531-804) vs. Claims of the '135 Patent ²					
	D1143	Exhibit 229A, Understanding OSF DCE 1.1 for AIX and OS/2 ¹ (APP_VX0556531-804) vs. Claims of the '151 Patent ²					
	D1144	Exhibit 230A, Understanding OSF DCE 1.1 for AIX and OS/2 ¹ (APP_VX0556531-804) vs. Claims of the '180 Patent ²					
	D1145	Exhibit 231A, Understanding OSF DCE 1.1 for AIX and OS/2 ¹ (APP_VX0556531-804) vs. Claims of the '211 Patent ²					

Subst. for form 1449/PTO		Complete if Known	
INFORMATION DISCLOSURE STATEMENT BY APPLICANT (Use as many sheets as necessary)		Application Number	13/342,795
		Filing Date	01-03-2012
		First Named Inventor	Victor Larson
		Art Unit	2453
		Examiner Name	Krisna Lim
		Docket Number	77580-155(VRNK-1CP3CNFT5)
D1146	Exhibit 232A, Understanding OSF DCE 1.1 for AIX and OS/2 ¹ (APP_VX0556531-804) vs. Claims of the '504 Patent ²		
D1147	Exhibit 233A, Understanding OSF DCE 1.1 for AIX and OS/2 ¹ (APP_VX0556531-804) vs. Claims of the '759 Patent ²		
D1148	Exhibit 255, Schulzrinne ¹ vs. Claims of the '135 Patent ²		
D1149	Exhibit 256, Schulzrinne ¹ vs. Claims of the '504 Patent ²		
D1150	Exhibit 257, Schulzrinne ¹ vs. Claims of the '211 Patent ²		
D1151	Exhibit 258, Schulzrinne ¹ vs. Claims of the '151 Patent ²		
D1152	Exhibit 259, Schulzrinne ¹ vs. Claims of the '180 Patent ²		
D1153	Exhibit 260, Schulzrinne ¹ vs. Claims of the '759 Patent ²		
D1154	Exhibit 261, SSL 3.0 ¹ vs. Claims of the '151 Patent ²		
D1155	Exhibit 262, SSL 3.0 ¹ vs. Claims of the '759 Patent ²		
D1156	Exhibit 263, Wang ¹ vs. Claims of the '135 Patent ²		
D1157	Wang ¹ vs. Claims of the '504 Patent ²		
D1158	Wang ¹ vs. Claims of the '211 Patent ²		
D1159	Exhibit 1, Alexander CV.pdf		
D1160	Exhibit 2, Materials Considered by Peter Alexander		
D1161	Exhibit 3, Cross Reference Chart		
D1162	Exhibit 4, RFC 2543 ¹ vs. Claims of the '135 Patent		
D1163	Exhibit 5, RFC 2543 ¹ vs. Claims of the '504 Patent		
D1164	Exhibit 6, RFC 2543 ¹ vs. Claims of the '211 Patent		
D1165	Exhibit 7, The Schulzrinne Presentation ¹ vs. Claims of the '135 Patent		
D1166	Exhibit 8, The Schulzrinne Presentation ¹ vs. Claims of the '504 Patent		
D1167	Exhibit 9, The Schulzrinne Presentation ¹ vs. Claims of the '211 Patent		
D1168	Exhibit 10, The Schulzrinne Presentation ¹ vs. Claims of the '151 Patent		
D1169	Exhibit 11, The Schulzrinne Presentation ¹ vs. Claims of the '180 Patent		
D1170	Exhibit 12, The Schulzrinne Presentation ¹ vs. Claims of the '759 Patent		
D1171	Exhibit 13, SSL 3.0 ² vs. Claims of the '135 Patent		
D1172	Exhibit 14, SSL 3.0 ² vs. Claims of the '504 Patent		
D1173	Exhibit 15, SSL 3.0 ² vs. Claims of the '211 Patent		
D1174	Exhibit 16, SSL 3.0 ² vs. Claims of the '151 Patent		
D1175	Exhibit 17, SSL 3.0 ² vs. Claims of the '759 Patent		
D1176	Exhibit 18, Kiuchi ¹ vs. Claims of the '135 Patent		

Subst. for form 1449/PTO		Complete if Known	
INFORMATION DISCLOSURE STATEMENT BY APPLICANT (Use as many sheets as necessary)		Application Number	13/342,795
		Filing Date	01-03-2012
		First Named Inventor	Victor Larson
		Art Unit	2453
		Examiner Name	Krisna Lim
		Docket Number	77580-155(VRNL-1CP3CNFT5)
D1177	Exhibit 19, Kiuchi ¹ vs. Claims of the '504 Patent		
D1178	Exhibit 20, Kiuchi ¹ vs. Claims of the '211 Patent		
D1179	Exhibit 21, Kiuchi ¹ vs. Claims of the '151 Patent		
D1180	Exhibit 22, Kiuchi ¹ vs. Claims of the '180 Patent		
D1181	Exhibit 23, Kiuchi ¹ vs. Claims of the '759 Patent		
D1182	Exhibit 24, U.S. Patent No. 6,119,234 (hereinafter "Aziz") and RFC 2401 ² vs. Claims of the '135 Patent		
D1183	Exhibit 25, U.S. Patent No. 6,119,234 (hereinafter "Aziz") and RFC 2401 ² vs. Claims of the '504 Patent		
D1184	Exhibit 26, U.S. Patent No. 6,119,234 (hereinafter "Aziz") and RFC 2401 ² vs. Claims of the '211 Patent		
D1185	Exhibit 27, U.S. Patent No. 6,119,234 (hereinafter "Aziz") and RFC 2401 ² vs. Claims of the '151 Patent		
D1186	Exhibit 28		
D1187	Exhibit 29, The Altiga System ¹ vs. Claims of the '135 Patent		
D1188	Exhibit 30, The Altiga System ¹ vs. Claims of the '504 Patent		
D1189	Exhibit 31, The Altiga System ¹ vs. Claims of the '211 Patent		
D1190	Exhibit 32, The Altiga System ¹ vs. Claims of the '759 Patent		
D1191	Exhibit 33, U.S. Patent No. 6,496,867 ("Beser") ¹ and RFC 2401 ² vs. Claims of the '135 Patent		
D1192	Exhibit 34, U.S. Patent No. 6,496,867 ("Beser") ¹ and RFC 2401 ² vs. Claims of the '504 Patent		
D1193	Exhibit 35, U.S. Patent No. 6,496,867 ("Beser") ¹ and RFC 2401 ² vs. Claims of the '211 Patent		
D1194	Exhibit 36, U.S. Patent No. 6,496,867 ("Beser") ¹ and RFC 2401 ² vs. Claims of the '151 Patent		
D1195	Exhibit 37, U.S. Patent No. 6,496,867 ("Beser") ¹ and RFC 2401 ² vs. Claims of the '180 Patent		
D1196	Exhibit 38, Kent ¹ vs. Claims of the '759 Patent		
D1197	Exhibit 39, RFC 2538, Storing Certificates in the Domain Name System (DNS) ¹ vs. Claims of the '504 Patent ²		
D1198	Exhibit 40, RFC 2538, Storing Certificates in the Domain Name System (DNS) ¹ vs. Claims of the '211 Patent ²		
D1199	Exhibit 41, Aziz ('646) ¹ vs. Claims of the '759 Patent		
D1200	Exhibit 42, The PIX Firewall ¹ vs. Claims of the '759 Patent		
D1201	Exhibit A-1, Kiuchi ¹ vs. Claims of the '135 Patent ²		
D1202	Exhibit B-1, Kiuchi ¹ vs. Claims of the '211 Patent ²		
D1203	Exhibit C-1, Kiuchi ¹ vs. Claims of the '504 Patent ²		

Subst. for form 1449/PTO		Complete if Known	
INFORMATION DISCLOSURE STATEMENT BY APPLICANT (Use as many sheets as necessary)		Application Number	13/342,795
		Filing Date	01-03-2012
		First Named Inventor	Victor Larson
		Art Unit	2453
		Examiner Name	Krisna Lim
		Docket Number	77580-155(VR NK-1CP3CNFT5)
	D1204	Exhibit D, Materials Considered	
	D1205	Exhibit E, Expert Report of Stuart G. Stubblebine, Ph.D.	
	D1206	Exhibit F, Expert Report of Stuart G. Stubblebine, Ph.D.	
	D1207	Exhibit G, Opening Expert Report of Dr. Stuart Stubblebine Regarding Invalidity of the '135, '211, and '504 Patents	
EXAMINER /Krisna Lim/		DATE CONSIDERED	07/20/2012

*EXAMINER: Initial if reference considered, whether or not citation is in conformance with MPEP 609. Draw line through citation if not in conformance and not considered. Include copy of this form with next communication to applicant.

1 Applicant's unique citation designation number (optional). 2 Applicant is to place a check mark here if English language Translation is attached.

Subst. for form 1449/PTO		Complete if Known	
INFORMATION DISCLOSURE STATEMENT BY APPLICANT <i>(Use as many sheets as necessary)</i>		Application Number	13/342,795
		Filing Date	01-03-2012
		First Named Inventor	Victor Larson
		Art Unit	2453
		Examiner Name	Krisna Lim
		Docket Number	77580-155(VRNK-1CP3CNFT5)

CERTIFICATION STATEMENT

Please See 37 CFR 1.97 and 1.98 to make the appropriate selection(s)

- Information Disclosure Statement is being filed with the filing of the application or before the receipt of a first office action.
- That each item of information contained in the information disclosure statement was first cited in any communication from a foreign patent office in a counterpart foreign application not more than three months prior to the filing of the information disclosure statement; or
- That no item of information contained in the information disclosure statement was cited in a communication from a foreign patent office in a counterpart foreign application, and, to the knowledge of the person signing the certification after making reasonable inquiry, no item of information contained in the information disclosure statement was known to any individual designated in § 1.56(c) more than three months prior to the filing of the information disclosure statement.
- The Commissioner is hereby authorized to charge the fee pursuant to 37 CFR 1.17(P) in the amount of \$180.00, or further fees which may be due, to Deposit Account 50-1133.
- Information Disclosure Statement is being filed with the Request for Continued Examination. The Commissioner is hereby authorized to charge the fee pursuant to 37 CFR 1.17(P) in the amount of \$810.00, or further fees which may be due, to Deposit Account 50-1133.
- None

SIGNATURE

A signature of the applicant or representative is required in accordance with CFR 1.33, 10.18. Please see CFR 1.4(d) for the form of the signature.

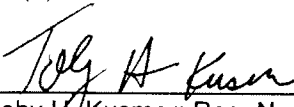
 Toby H. Kusmer; Reg. No.: 26,418
 McDermott Will & Emery LLP
 28 State Street
 Boston, MA 02109
 Tel. (617) 535-4000
 Fax (617) 535-3800

Date: 6/1/12

DM_US 35535997-1.077580.0155

Subst. for form 1449/PTO				Complete if Known		
INFORMATION DISCLOSURE STATEMENT BY APPLICANT (Use as many sheets as necessary)				Application Number	13/342,795	
				Filing Date	01-03-2012	
				First Named Inventor	Victor Larson	
				Art Unit	2453	
				Examiner Name	Krisna Lim	
				Docket Number	77580-155(VRNK-1CP3CNFT5)	
U.S. PATENTS						
EXAMINER'S INITIALS	CITE NO.	Patent Number	Publication Date	Name of Patentee or Applicant of Cited Document	Pages, Columns, Lines, Where Relevant Passages or Relevant Figures Appear	
U.S. PATENT APPLICATION PUBLICATIONS						
EXAMINER'S INITIALS	CITE NO.	Patent Number	Publication Date	Name of Patentee or Applicant of Cited Document	Pages, Columns, Lines, Where Relevant Passages or Relevant Figures Appear	
FOREIGN PATENT DOCUMENTS						
EXAMINER'S INITIALS	CITE NO.	Foreign Patent Document Country Codes - Number - Kind Codes (if known)	Publication Date	Name of Patentee or Applicant of Cited Document	Pages, Columns, Lines Where Relevant Figures Appear	Translation Yes No
OTHER ART (Including Author, Title, Date, Pertinent Pages, Etc.)						
EXAMINER'S INITIALS	CITE NO.	Include name of the author (in CAPITAL LETTERS), title of the article (when appropriate), title of the item (book, magazine, journal, serial, symposium, catalog, etc.), date, page(s), volume-issue number(s), publisher, city and/or country where published.				
	D1211	Third Party Requester Comments dated June 25, 2012 - After Non Final Office Action (95/001,788)				
	D1212	Reexam Affidavit/Declaration/Exhibit Filed by 3rd Party on June 25, 2012 (95/001,788)				
EXAMINER /Krisna Lim/				DATE CONSIDERED 07/20/2012		

*EXAMINER: Initial if reference considered, whether or not citation is in conformance with MPEP 609. Draw line through citation if not in conformance and not considered. Include copy of this form with next communication to applicant.

1 Applicant's unique citation designation number (optional). 2 Applicant is to place a check mark here if English language Translation is attached.

Subst. for form 1449/PTO				Complete if Known	
INFORMATION DISCLOSURE STATEMENT BY APPLICANT <i>(Use as many sheets as necessary)</i>				Application Number	13/342,795
				Filing Date	01-03-2012
				First Named Inventor	Victor Larson
				Art Unit	2453
				Examiner Name	Krisna Lim
				Docket Number	77580-155(VRNK-1CP3CNFT5)

CERTIFICATION STATEMENT

Please See 37 CFR 1.97 and 1.98 to make the appropriate selection(s)

- Information Disclosure Statement is being filed with the filing of the application or before the receipt of a first office action.
- That each item of information contained in the information disclosure statement was first cited in any communication from a foreign patent office in a counterpart foreign application not more than three months prior to the filing of the information disclosure statement; or
- That no item of information contained in the information disclosure statement was cited in a communication from a foreign patent office in a counterpart foreign application, and, to the knowledge of the person signing the certification after making reasonable inquiry, no item of information contained in the information disclosure statement was known to any individual designated in § 1.56(c) more than three months prior to the filing of the information disclosure statement.
- The Commissioner is hereby authorized to charge the fee pursuant to 37 CFR 1.17(P) in the amount of \$180.00, or further fees which may be due, to Deposit Account 50-1133.
- Information Disclosure Statement is being filed with the Request for Continued Examination. The Commissioner is hereby authorized to charge the fee pursuant to 37 CFR 1.17(P) in the amount of \$810.00, or further fees which may be due, to Deposit Account 50-1133.
- None

SIGNATURE

A signature of the applicant or representative is required in accordance with CFR 1.33, 10.18. Please see CFR 1.4(d) for the form of the signature.

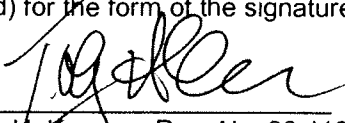

Toby H. Kusner; Reg. No.:26,418
McDermott Will & Emery LLP
28 State Street
Boston, MA 02109
Tel. (617) 535-4000
Fax (617) 535-3800

Date: 6/28/12

DM_US 36238007-1.077580.0155

03-09-12

13342795 - GAUT 2453

Approved for use through 07/31/2012. OMB 0651-0031
 U.S. Patent and Trademark Office; U.S. DEPARTMENT OF COMMERCE

Under the Paperwork Reduction Act of 1995, no persons are required to respond to a collection of information unless it displays a valid OMB control number.



Application Number	13/342,795
Filing Date	01-03-2012
First Named Inventor	Victor Larson
Art Unit	2453
Examiner Name	Krisna Lim
Attorney Docket Number	77580-155(VRNC-1CP3CNFT5)

Do not be used for all correspondence after initial filing)

Total Number of Pages in This Submission 52

ENCLOSURES (Check all that apply)

<input checked="" type="checkbox"/> Fee Transmittal Form <input checked="" type="checkbox"/> Fee Attached <input type="checkbox"/> Amendment/Reply <input type="checkbox"/> After Final <input type="checkbox"/> Affidavits/declaration(s) <input type="checkbox"/> Extension of Time Request <input type="checkbox"/> Express Abandonment Request <input checked="" type="checkbox"/> Information Disclosure Statement <input type="checkbox"/> Certified Copy of Priority Document(s) <input type="checkbox"/> Reply to Missing Parts/ Incomplete Application <input type="checkbox"/> Reply to Missing Parts under 37 CFR 1.52 or 1.53	<input type="checkbox"/> Drawing(s) <input type="checkbox"/> Licensing-related Papers <input type="checkbox"/> Petition <input type="checkbox"/> Petition to Convert to a Provisional Application <input type="checkbox"/> Power of Attorney, Revocation <input type="checkbox"/> Change of Correspondence Address <input type="checkbox"/> Terminal Disclaimer <input type="checkbox"/> Request for Refund <input type="checkbox"/> CD, Number of CD(s) _____ <input type="checkbox"/> Landscape Table on CD	<input type="checkbox"/> After Allowance Communication to TC <input type="checkbox"/> Appeal Communication to Board of Appeals and Interferences <input type="checkbox"/> Appeal Communication to TC (Appeal Notice, Brief, Reply Brief) <input type="checkbox"/> Proprietary Information <input type="checkbox"/> Status Letter <input checked="" type="checkbox"/> Other Enclosure(s) (please identify below):
<p>Remarks</p> <p>16 Boxes of Non Patent Literature documents which include; copies of references not previously submitted in a priority application (C8, C19, C21, C24; D257, D258, D261, D263, D264, D266, D292-D1111P).</p>		

SIGNATURE OF APPLICANT, ATTORNEY, OR AGENT

Firm Name	McDermott, Will and Emery		
Signature			
Printed name	Toby H. Kusmer		
Date	March 7, 2012	Reg. No.	26,418

CERTIFICATE OF TRANSMISSION/MAILING

I hereby certify that this correspondence is being facsimile transmitted to the USPTO or deposited with the United States Postal Service with sufficient postage as first class mail in an envelope addressed to: Commissioner for Patents, P.O. Box 1450, Alexandria, VA 22313-1450 on the date shown below:

Signature			
Typed or printed name		Date	

This collection of information is required by 37 CFR 1.5. The information is required to obtain or retain a benefit by the public which is to file (and by the USPTO to process) an application. Confidentiality is governed by 35 U.S.C. 122 and 37 CFR 1.11 and 1.14. This collection is estimated to 2 hours to complete, including gathering, preparing, and submitting the completed application form to the USPTO. Time will vary depending upon the individual case. Any comments on the amount of time you require to complete this form and/or suggestions for reducing this burden, should be sent to the Chief Information Officer, U.S. Patent and Trademark Office, U.S. Department of Commerce, P.O. Box 1450, Alexandria, VA 22313-1450. DO NOT SEND FEES OR COMPLETED FORMS TO THIS ADDRESS. SEND TO: Commissioner for Patents, P.O. Box 1450, Alexandria, VA 22313-1450.

If you need assistance in completing the form, call 1-800-PTO-9199 and select option 2.

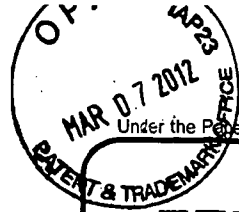

13921053095 GAU: 2453

Approved for use through 01/31/2014. OMB 0651-0032

U.S. Patent and Trademark Office; U.S. DEPARTMENT OF COMMERCE
Under the Paperwork Reduction Act of 1995 no persons are required to respond to a collection of information unless it displays a valid OMB control number.

FEE TRANSMITTAL

Complete if Known

Application Number	13/342,795
Filing Date	01-03-2012
First Named Inventor	Victor Larson
Examiner Name	Krisna Lim
Art Unit	2453
Attorney Docket No.	77580-155(VRNK-1CP3CNFT5)

Applicant claims small entity status. See 37 CFR 1.27

TOTAL AMOUNT OF PAYMENT (\$) 180.00

METHOD OF PAYMENT (check all that apply)

Check Credit Card Money Order None Other (please identify): _____

Deposit Account Deposit Account Number: 501133 Deposit Account Name: McDermott, Will and Emery

For the above-identified deposit account, the Director is hereby authorized to: (check all that apply)

Charge fee(s) indicated below Charge fee(s) indicated below, except for the filing fee

Charge any additional fee(s) or underpayments of fee(s) under 37 CFR 1.16 and 1.17 Credit any overpayments

WARNING: Information on this form may become public. Credit card information should not be included on this form. Provide credit card information and authorization on PTO-2038.

FEE CALCULATION

1. BASIC FILING, SEARCH, AND EXAMINATION FEES

Application Type	FILING FEES		SEARCH FEES		EXAMINATION FEES		Fees Paid (\$)
	Fee (\$)	Small Entity Fee (\$)	Fee (\$)	Small Entity Fee (\$)	Fee (\$)	Small Entity Fee (\$)	
Utility	380	190	620	310	250	125	_____
Design	250	125	120	60	160	80	_____
Plant	250	125	380	190	200	100	_____
Reissue	380	190	620	310	750	375	_____
Provisional	250	125	0	0	0	0	_____

2. EXCESS CLAIM FEES

Fee Description	Fee (\$)	Small Entity Fee (\$)
Each claim over 20 (including Reissues)	60	30
Each independent claim over 3 (including Reissues)	250	125
Multiple dependent claims	450	225

Total Claims	Extra Claims	Fee (\$)	Fee Paid (\$)	Multiple Dependent Claims	Fee (\$)	Fee Paid (\$)
_____ - 20 or HP = _____	x _____	= _____	_____	_____	_____	_____
HP = highest number of total claims paid for, if greater than 20.						
Indep. Claims	Extra Claims	Fee (\$)	Fee Paid (\$)			
_____ - 3 or HP = _____	x _____	= _____	_____			
HP = highest number of independent claims paid for, if greater than 3.						

3. APPLICATION SIZE FEE

If the specification and drawings exceed 100 sheets of paper (excluding electronically filed sequence or computer listings under 37 CFR 1.52(e)), the application size fee due is \$310 (\$155 for small entity) for each additional 50 sheets or fraction thereof. See 35 U.S.C. 41(a)(1)(G) and 37 CFR 1.16(s).

Total Sheets	Extra Sheets	Number of each additional 50 or fraction thereof	Fee (\$)	Fee Paid (\$)
_____ - 100 = _____	/ 50 = _____	(round up to a whole number) x _____	= _____	_____

4. OTHER FEE(S)

Description	Amount	Fees Paid (\$)
Non-English Specification, \$130 fee (no small entity discount)	_____	_____
Other (e.g., late filing surcharge): Information Disclosure Statement Filing Fee of \$180.00	_____	\$180.00

SUBMITTED BY

Signature		Registration No. (Attorney/Agent) 26,418	Telephone 617-535-4000
Name (Print/Type)	Toby H. Kusner		Date March 7, 2012

This collection of information is required by 37 CFR 1.136. The information is required to obtain or retain a benefit by the public which is to file (and by the USPTO to process) an application. Confidentiality is governed by 35 U.S.C. 122 and 37 CFR 1.14. This collection is estimated to take 30 minutes to complete, including gathering, preparing, and submitting the completed application form to the USPTO. Time will vary depending upon the individual case. Any comments on the amount of time you require to complete this form and/or suggestions for reducing this burden, should be sent to the Chief Information Officer, U.S. Patent and Trademark Office, U.S. Department of Commerce, P.O. Box 1450, Alexandria, VA 22313-1450. DO NOT SEND FEES OR COMPLETED FORMS TO THIS ADDRESS. SEND TO: Commissioner for Patents, P.O. Box 1450, Alexandria, VA 22313-1450.

If you need assistance in completing the form, call 1-800-PTO-9199 and select option 2.

Subst. for form 1449/PTO	Complete if Known	
	Application Number	13/342,795
INFORMATION DISCLOSURE STATEMENT BY APPLICANT <i>(Use as many sheets as necessary)</i>	Filing Date	01-03-2012
	First Named Inventor	Victor Larson
	Art Unit	2453
	Examiner Name	Krisna Lim
	Docket Number	77580-155(VRNL-1CP3CNFT5)

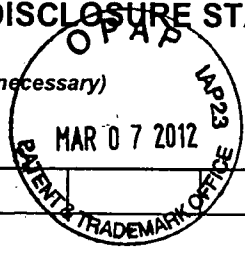

CERTIFICATION STATEMENT

Under 37 C.F.R. 1.98(d), copies of all patent, publication, pending U.S. application or other information that was previously submitted to, or cited by the USPTO in an earlier application are not required. Applicant will provide copies of the previously submitted references at the Examiner's request. Enclosed are copies of references not previously submitted in a priority application (C8, C19, C21, C24; D257, D258, D261, D263, D264, D266, D292-D1111).

The present application 13/342,795 claims priority from and is a continuation of a co-pending U.S. Application No. 13/049,552, filed March 16, 2011, which is a continuation of U.S. Application No. 11/840,560, filed August 17, 2007, now U.S. Patent No. 7,921,211, which is a continuation of U.S. Application No. 10/714,849, filed November 18, 2003, now U.S. Patent No. 7,418,504, which is a continuation of U.S. Application No. 09/558,210, filed April 26, 2000, now abandoned, which is a continuation-in-part of U.S. Application No. 09/504,783, filed on February 15, 2000, now U.S. Patent No. 6,502,135, issued December 31, 2002,

Please See 37 CFR 1.97 and 1.98 to make the appropriate selection(s)

- Information Disclosure Statement is being filed with the filing of the application or before the receipt of a first office action.
- That each item of information contained in the information disclosure statement was first cited in any communication from a foreign patent office in a counterpart foreign application not more than three months prior to the filing of the information disclosure statement; or
- That no item of information contained in the information disclosure statement was cited in a communication from a foreign patent office in a counterpart foreign application, and, to the knowledge of the person signing the certification after making reasonable inquiry, no item of information contained in the information disclosure statement was known to any individual designated in § 1.56(c) more than three months prior to the filing of the information disclosure statement.
- The Commissioner is hereby authorized to charge the fee pursuant to 37 CFR 1.17(P) in the amount of \$180.00, or further fees which may be due, to Deposit Account 50-1133.
- Information Disclosure Statement is being filed with the Request for Continued Examination. The Commissioner is hereby authorized to charge the fee pursuant to 37 CFR 1.17(P) in the amount of \$810.00, or further fees which may be due, to Deposit Account 50-1133.

SIGNATURE

A signature of the applicant or representative is required in accordance with CFR 1.33, 10.18. Please see CFR 1.4(d) for the form of the signature.

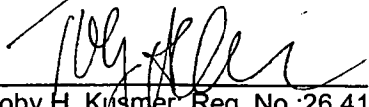
 Toby H. Kusmer, Reg. No.:26,418
 McDermott Will & Emery LLP
 28 State Street
 Boston, MA 02109
 Tel. (617) 535-4000
 Fax (617) 535-3800

Date: 3/7/12

03-09-12

13342795 - GAU. 2453

PTO/SB/21 (07-09)

Approved for use through 07/31/2012. OMB 0651-0031
U.S. Patent and Trademark Office; U.S. DEPARTMENT OF COMMERCE

Under the Paperwork Reduction Act of 1995, no persons are required to respond to a collection of information unless it displays a valid OMB control number.

 <p>TRANSMITTAL FORM</p> <p><i>to be used for all correspondence after initial filing</i></p>	Application Number	13/342,795	
	Filing Date	01-03-2012	
	First Named Inventor	Victor Larson	
	Art Unit	2453	
	Examiner Name	Krisna Lim	
Total Number of Pages in This Submission	52	Attorney Docket Number	77580-155(VRNL-1CP3CNFT5)

ENCLOSURES (Check all that apply)		
<input checked="" type="checkbox"/> Fee Transmittal Form	<input type="checkbox"/> Drawing(s)	<input type="checkbox"/> After Allowance Communication to TC
<input checked="" type="checkbox"/> Fee Attached	<input type="checkbox"/> Licensing-related Papers	<input type="checkbox"/> Appeal Communication to Board of Appeals and Interferences
<input type="checkbox"/> Amendment/Reply	<input type="checkbox"/> Petition	<input type="checkbox"/> Appeal Communication to TC (Appeal Notice, Brief, Reply Brief)
<input type="checkbox"/> After Final	<input type="checkbox"/> Petition to Convert to a Provisional Application	<input type="checkbox"/> Proprietary Information
<input type="checkbox"/> Affidavits/declaration(s)	<input type="checkbox"/> Power of Attorney, Revocation	<input type="checkbox"/> Status Letter
<input type="checkbox"/> Extension of Time Request	<input type="checkbox"/> Change of Correspondence Address	<input checked="" type="checkbox"/> Other Enclosure(s) (please identify below):
<input type="checkbox"/> Express Abandonment Request	<input type="checkbox"/> Terminal Disclaimer	
<input checked="" type="checkbox"/> Information Disclosure Statement	<input type="checkbox"/> Request for Refund	
<input type="checkbox"/> Certified Copy of Priority Document(s)	<input type="checkbox"/> CD, Number of CD(s) _____	
<input type="checkbox"/> Reply to Missing Parts/ Incomplete Application	<input type="checkbox"/> Landscape Table on CD	
<input type="checkbox"/> Reply to Missing Parts under 37 CFR 1.52 or 1.53	<p>Remarks</p> <p>16 Boxes of Non Patent Literature documents which include; copies of references not previously submitted in a priority application (C8, C19, C21, C24; D257, D258, D261, D263, D264, D266, D292-D111f).</p>	

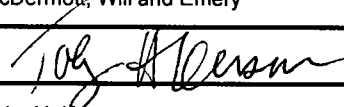
SIGNATURE OF APPLICANT, ATTORNEY, OR AGENT			
Firm Name	McDermott, Will and Emery		
Signature			
Printed name	Toby H. Kusmer		
Date	March 7, 2012	Reg. No.	26,418

CERTIFICATE OF TRANSMISSION/MAILING			
I hereby certify that this correspondence is being facsimile transmitted to the USPTO or deposited with the United States Postal Service with sufficient postage as first class mail in an envelope addressed to: Commissioner for Patents, P.O. Box 1450, Alexandria, VA 22313-1450 on the date shown below:			
Signature			
Typed or printed name		Date	

This collection of information is required by 37 CFR 1.5. The information is required to obtain or retain a benefit by the public which is to file (and by the USPTO to process) an application. Confidentiality is governed by 35 U.S.C. 122 and 37 CFR 1.11 and 1.14. This collection is estimated to 2 hours to complete, including gathering, preparing, and submitting the completed application form to the USPTO. Time will vary depending upon the individual case. Any comments on the amount of time you require to complete this form and/or suggestions for reducing this burden, should be sent to the Chief Information Officer, U.S. Patent and Trademark Office, U.S. Department of Commerce, P.O. Box 1450, Alexandria, VA 22313-1450. DO NOT SEND FEES OR COMPLETED FORMS TO THIS ADDRESS. SEND TO: Commissioner for Patents, P.O. Box 1450, Alexandria, VA 22313-1450.

If you need assistance in completing the form, call 1-800-PTO-9199 and select option 2.

Subst. for form 1449/PTO INFORMATION DISCLOSURE STATEMENT BY APPLICANT (Use as many sheets as necessary)	Complete if Known	
	Application Number	13/342,795
	Filing Date	01-03-2012
	First Named Inventor	Victor Larson
	Art Unit	2453
	Examiner Name	Krisna Lim
	Docket Number	77580-155(VRNL-1CP3CNFT5)

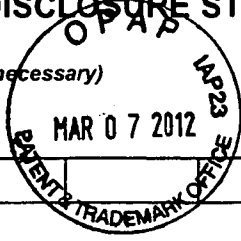

CERTIFICATION STATEMENT

Under 37 C.F.R. 1.98(d), copies of all patent, publication, pending U.S. application or other information that was previously submitted to, or cited by the USPTO in an earlier application are not required. Applicant will provide copies of the previously submitted references at the Examiner's request. **Enclosed are copies of references not previously submitted in a priority application (C8, C19, C21, C24; D257, D258, D261, D263, D264, D266, D292-D1111).**

The present application 13/342,795 claims priority from and is a continuation of a co-pending U.S. Application No. 13/049,552, filed March 16, 2011, which is a continuation of U.S. Application No. 11/840,560, filed August 17, 2007, now U.S. Patent No. 7,921,211, which is a continuation of U.S. Application No. 10/714,849, filed November 18, 2003, now U.S. Patent No. 7,418,504, which is a continuation of U.S. Application No. 09/558,210, filed April 26, 2000, now abandoned, which is a continuation-in-part of U.S. Application No. 09/504,783, filed on February 15, 2000, now U.S. Patent No. 6,502,135, issued December 31, 2002.

Please See 37 CFR 1.97 and 1.98 to make the appropriate selection(s)

- Information Disclosure Statement is being filed with the filing of the application or before the receipt of a first office action.
- That each item of information contained in the information disclosure statement was first cited in any communication from a foreign patent office in a counterpart foreign application not more than three months prior to the filing of the information disclosure statement; or
- That no item of information contained in the information disclosure statement was cited in a communication from a foreign patent office in a counterpart foreign application, and, to the knowledge of the person signing the certification after making reasonable inquiry, no item of information contained in the information disclosure statement was known to any individual designated in § 1.56(c) more than three months prior to the filing of the information disclosure statement.
- The Commissioner is hereby authorized to charge the fee pursuant to 37 CFR 1.17(P) in the amount of \$180.00, or further fees which may be due, to Deposit Account 50-1133.
- Information Disclosure Statement is being filed with the Request for Continued Examination. The Commissioner is hereby authorized to charge the fee pursuant to 37 CFR 1.17(P) in the amount of \$810.00, or further fees which may be due, to Deposit Account 50-1133.

SIGNATURE

A signature of the applicant or representative is required in accordance with CFR 1.33, 10.18. Please see CFR 1.4(d) for the form of the signature.

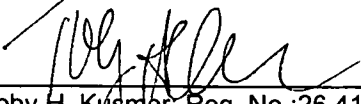
 Toby H. Kusmer, Reg. No.: 26,418
 McDermott Will & Emery LLP
 28 State Street
 Boston, MA 02109
 Tel. (617) 535-4000
 Fax (617) 535-3800

Date: 3/7/12

03/12/2012 HVUONG1 00000003 501133 13342795
 01 FC:1806 180.00 DA



13342795 GAU: 2453

Approved for use through 01/31/2014. OMB 0651-0032
U.S. Patent and Trademark Office; U.S. DEPARTMENT OF COMMERCE

Under the Paperwork Reduction Act of 1995 no persons are required to respond to a collection of information unless it displays a valid OMB control number

FEE TRANSMITTAL

Complete if Known

Application Number	13/342,795
Filing Date	01-03-2012
First Named Inventor	Victor Larson
Examiner Name	Krisna Lim
Art Unit	2453
Attorney Docket No.	77580-155(VR NK-1CP3CNFT5)

Applicant claims small entity status. See 37 CFR 1.27

TOTAL AMOUNT OF PAYMENT (\$) 180.00

METHOD OF PAYMENT (check all that apply)

Check Credit Card Money Order None Other (please identify): _____

Deposit Account Deposit Account Number: 501133 Deposit Account Name: McDermott, Will and Emery

For the above-identified deposit account, the Director is hereby authorized to: (check all that apply)

Charge fee(s) indicated below Charge fee(s) indicated below, except for the filing fee

Charge any additional fee(s) or underpayments of fee(s) under 37 CFR 1.16 and 1.17 Credit any overpayments

WARNING: Information on this form may become public. Credit card information should not be included on this form. Provide credit card information and authorization on PTO-2038.

FEE CALCULATION

1. BASIC FILING, SEARCH, AND EXAMINATION FEES

Application Type	FILING FEES		SEARCH FEES		EXAMINATION FEES		Fees Paid (\$)
	Fee (\$)	Small Entity Fee (\$)	Fee (\$)	Small Entity Fee (\$)	Fee (\$)	Small Entity Fee (\$)	
Utility	380	190	620	310	250	125	_____
Design	250	125	120	60	160	80	_____
Plant	250	125	380	190	200	100	_____
Reissue	380	190	620	310	750	375	_____
Provisional	250	125	0	0	0	0	_____

2. EXCESS CLAIM FEES

Fee Description	Fee (\$)	Small Entity Fee (\$)
Each claim over 20 (including Reissues)	60	30
Each independent claim over 3 (including Reissues)	250	125
Multiple dependent claims	450	225

Total Claims _____ **Extra Claims** _____ **Fee (\$)** _____ **Fee Paid (\$)** _____

_____ - 20 or HP = _____ x _____ = _____

HP = highest number of total claims paid for, if greater than 20.

Indep. Claims _____ **Extra Claims** _____ **Fee (\$)** _____ **Fee Paid (\$)** _____

_____ - 3 or HP = _____ x _____ = _____

HP = highest number of independent claims paid for, if greater than 3.

3. APPLICATION SIZE FEE

If the specification and drawings exceed 100 sheets of paper (excluding electronically filed sequence or computer listings under 37 CFR 1.52(e)), the application size fee due is \$310 (\$155 for small entity) for each additional 50 sheets or fraction thereof. See 35 U.S.C. 41(a)(1)(G) and 37 CFR 1.16(s).

Total Sheets _____ **Extra Sheets** _____ **Number of each additional 50 or fraction thereof** _____ **Fee (\$)** _____ **Fee Paid (\$)** _____

_____ - 100 = _____ / 50 = _____ (round up to a whole number) x _____ = _____

4. OTHER FEE(S)

Non-English Specification, \$130 fee (no small entity discount) **Fees Paid (\$)** _____

Other (e.g., late filing surcharge): Information Disclosure Statement Filing Fee of \$180.00 **Fees Paid (\$)** \$180.00

SUBMITTED BY

Signature		Registration No. (Attorney/Agent) 26,418	Telephone 617-535-4000
Name (Print/Type)	Toby H. Kusner		Date March 7, 2012

This collection of information is required by 37 CFR 1.136. The information is required to obtain or retain a benefit by the public which is to file (and by the USPTO to process) an application. Confidentiality is governed by 35 U.S.C. 122 and 37 CFR 1.14. This collection is estimated to take 30 minutes to complete, including gathering, preparing, and submitting the completed application form to the USPTO. Time will vary depending upon the individual case. Any comments on the amount of time you require to complete this form and/or suggestions for reducing this burden, should be sent to the Chief Information Officer, U.S. Patent and Trademark Office, U.S. Department of Commerce, P.O. Box 1450, Alexandria, VA 22313-1450. DO NOT SEND FEES OR COMPLETED FORMS TO THIS ADDRESS. SEND TO: Commissioner for Patents, P.O. Box 1450, Alexandria, VA 22313-1450.

If you need assistance in completing the form, call 1-800-PTO-9199 and select option 2.

ALL REFERENCES CONSIDERED EXCEPT WHERE LINED THROUGH. /K.L./

Petitioner Apple Inc. - Exhibit 1051, p. 592

**INFORMATION DISCLOSURE STATEMENT
BY APPLICANT**

(Use as many sheets as necessary)

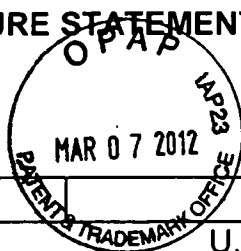

Application Number	13/342,795
Filing Date	01-03-2012
First Named Inventor	Victor Larson
Art Unit	2453
Examiner Name	Krisna Lim
Docket Number	77580-155(VRNK-1CP3CNFT5)

U.S. PATENTS

EXAMINER'S INITIALS	CITE NO.	Patent Number	Publication Date	Name of Patentee or Applicant of Cited Document	Pages, Columns, Lines, Where Relevant Passages or Relevant Figures Appear
		Patent Number	Patent Date	Inventor	
	A1	09/399,753	09/22/1998	Graig Miller et al.	
	A2	2,895,502	07/21/1959	Roper et al.	
	A3	4,761,334	08/1988	Sagoi et al.	
	A4	4,885,778	12/5/1989	Weiss, Kenneth	
	A5	4,920,484	4/24/1990	Ranade	
	A6	4,933,846	06/12/1990	Humphrey et al.	
	A7	4,952,930	08/28/1990	Franaszek et al.	
	A8	4,988,990	01/29/1991	Warrior	
	A9	5,164,988	11/17/1992	Matyas	
	A10	5,204,961	04/20/1993	Barlow	
	A11	5,276,735	01/04/1994	Boebert et al	
	A12	5,303,302	04/12/1994	Burrows	
	A13	5,311,593	05/10/1994	Carmi	
	A14	5,329,521	07/12/1994	Walsh et al.	
	A15	5,341,426	08/23/1994	Barney et al.	
	A16	5,367,643	11/22/1994	Chang et al	
	A17	5,384,848	01/24/1995	Kikuchi	
	A18	5,511,122	04/23/1996	Atkinson	
	A19	5,548,646	08/20/1996	Aziz et al.	
	A20	5,559,883	09/24/1996	Williams	
	A21	5,561,669	10/01/1996	Lenney et al	
	A22	5,588,060	12/24/1996	Aziz	
	A23	5,590,285	12/31/1996	Krause et al.	
	A24	5,625,626	04/29/1997	Umekita	
	A25	5,629,984	05/13/1997	McManis	
	A26	5,654,695	08/05/1997	Olnowich et al	
	A27	5,682,480	10/28/1997	Nakagawa	
	A28	5,689,566	11/18/1997	Nguyen	
	A29	5,689,641	11/18/1997	Ludwig et al.	
	A30	5,740,375	04/14/1998	Dunne et al.	
	A31	5,757,925	05/1998	Faybishenko	
	A32	5,764,906	06/1998	Edelstein et al.	
	A33	5,771,239	06/23/1998	Moroney et al.	
	A34	5,774,660	6/30/1998	Brendel et al	
	A35	5,787,172	07/28/1998	Arnold	
	A36	5,790,548	08/04/1998	Sitaraman et al.	
	A37	5,796,942	08/18/1998	Esbensen	
	A38	5,805,801	09/08/1998	Holloway et al.	
	A39	5,805,803	09/08/1998	Birrell et al.	
	A40	5,822,434	10/13/1998	Caronni et al.	
	A41	5,842,040	11/24/1998	Hughes et al.	
	A42	5,845,091	12/01/1998	Dunne et al.	
	A43	5,864,666	01/1999	Shrader, Theodore Jack London	
	A44	5,867,650	02/02/1998	Osterman	
	A45	5,870,610	02/09/1999	Beyda et al.	
	A46	5,878,231	05/02/1999	Baehr et al	
	A47	5,892,903	04/06/1999	Klaus	
	A48	5,898,830	04/27/1999	Wesinger, Jr. et al.	
	A49	5,905,859	05/18/1999	Holloway et al.	
	A50	5,918,018	06/29/1999	Gooderum et al.	

Subst. for form 1449/PTO

**INFORMATION DISCLOSURE STATEMENT
BY APPLICANT***(Use as many sheets as necessary)***Complete if Known**

Application Number	13/342,795
Filing Date	01-03-2012
First Named Inventor	Victor Larson
Art Unit	2453
Examiner Name	Krisna Lim
Docket Number	77580-155(VRNN-1CP3CNFT5)

	A51	5,918,019	06/29/1999	Valencia	
	A52	5,950,195	09/07/1999	Stockwell et al.	
	A53	5,950,519	09/14/1999	Anatoli	
	A54	5,960,204	09/28/1999	Yinger et al.	
	A55	5,996,016	11/30/1999	Thalheimer et al.	
	A56	6,006,259	12/21/1999	Adelman et al.	
	A57	6,006,272	12/21/1999	Aravamudan et al	
	A58	6,016,318	01/18/2000	Tomoike	
	A59	6,016,512	01/18/2000	Huitema	
	A60	6,041,342	03/21/2000	Yamaguchi	
	A61	6,052,788	04/2000	Wesinger et al.	
	A62	6,055,574	04/25/2000	Smorodinsky et al.	
	A63	6,061,346	05/2000	Nordman, Mikael	
	A64	6,061,736	05/09/2000	Rochberger et al	
	A65	6,079,020	06/20/2000	Liu	
	A66	6,081,900	06/2000	Subramaniam et al.	
	A67	6,092,200	07/18/2000	Muniyappa et al.	
	A68	6,101,182	08/2000	Sistanizadeh et al.	
	A69	6,119,171	09/12/2000	Alkhatib	
	A70	6,119,234	09/12/2000	Aziz et al.	
	A71	6,147,976	11/14/2000	Shand et al.	
	A72	6,157,957	12/05/2000	Berthaud	
	A73	6,158,011	12/05/2000	Chen et al.	
	A74	6,168,409	01/02/2001	Fare	
	A75	6,173,399	01/09/2001	Gilbrech	
	A76	6,175,867	01/16/2001	Taghadoss	
	A77	6,178,409	01/23/2001	Weber et al.	
	A78	6,178,505	01/23/2001	Schneider et al	
	A79	6,179,102	01/30/2001	Weber, et al.	
	A80	6,182,141	1/30/2001	Blum et al.	
	A81	6,199,112	03/2001	Wilson, Stephen K.	
	A82	6,202,081	03/2001	Naudus, Stanley T.	
	A83	6,222,842	04/24/2001	Sasyan et al.	
	A84	6,223,287	04/24/2001	Douglas et al.	
	A85	6,226,748	05/01/2001	Bots et al.	
	A86	6,226,751	05/01/2001	Arrow et al..	
	A87	6,233,618	05/15/2001	Shannon	
	A88	6,243,360	06/05/2001	Basilico	
	A89	6,243,749	06/05/2001	Sitaraman et al.	
	A90	6,243,754	06/05/2001	Guerin et al	
	A91	6,246,670	06/12/2001	Karlsson et al.	
	A92	6,256,671	07/03/2001	Strentzsch et al.	
	A93	6,262,987	07/17/01	Mogul, Jeffrey C.	
	A94	6,263,445	07/17/2001	Blumenau	
	A95	6,269,099	07/31/2001	Borella et al.	
	A96	6,286,047	09/04/2001	Ramanathan et al	
	A97	6,298,341	10/02/01	Mann, et al.	
	A98	6,301,223	10/9/2001	Hrastar et al	
	A99	6,308,213	10/23/2001	Valencia	
	A100	6,308,274	10/23/2001	Swift	
	A101	6,311,207	10/30/2001	Mighdoll et al	
	A102	6,314,463	11/2001	Abbott et al.	
	A103	6,324,161	11/27/2001	Kirch	
	A104	6,330,562	12/11/2001	Boden et al.	
	A105	6,332,158	12/18/2001	Risley et al.	
	A106	6,333,272	12/25/01	McMillin, et al.	
	A107	6,338,082	01/08/02	Schneider, Eric	

ALL REFERENCES CONSIDERED EXCEPT WHERE LINED THROUGH. /K.L./

Subst. for form 1449/PTO INFORMATION DISCLOSURE STATEMENT BY APPLICANT <i>(Use as many sheets as necessary)</i>				Complete if Known	
				Application Number	13/342,795
				Filing Date	01-03-2012
				First Named Inventor	Victor Larson
				Art Unit	2453
				Examiner Name	Krisna Lim
				Docket Number	77580-155(VRNK-1CP3CNFT5)
A108	6,353,614	03/05/2002	Borella et al.		
A109	6,425,003	07/23/2002	Herzog et al.		
A110	6,430,155	08/06/2002	Davie et al.		
A111	6,430,610	08/06/2002	Carter		
A112	6,487,598	11/26/2002	Valencia		
A113	6,496,867	12/17/2002	Beser et al.		
A114	6,502,135	12/2002	Munger et al.		
A115	6,505,232	01/07/2003	Mighdoll et al.		
A116	6,510,154	01/21/2003	Mayes et al.		
A117	6,549,516	04/15/2003	Albert et al.		
A118	6,557,037	04/2003	Provino, Joseph E.		
A119	6,560,634	05/06/2003	Broadhurst		
A120	6,571,296	05/27/2002	Dillon		
A121	6,571,338	05/27/2003	Shaio et al.		
A122	6,581,166	7/17/2003	Hirst et al.		
A123	6,606,708	08/12/2003	Devine et al.		
A124	6,615,357	9/2/2003	Boden et al.		
A125	6,618,761	09/09/2003	Munger et al.		
A126	6,671,702	12/30/2003	Kruglikov et al.		
A127	6,687,551	2/3/2004	Steindl		
A128	6,687,746	02/03/04	Shuster, et al.		
A129	6,701,437	03/02/2004	Hoke et al.		
A130	6,714,970	3/30/2004	Fiveash et al.		
A131	6,717,949	4/6/2004	Boden et al.		
A132	6,751,738	06/15/2004	Wesinger, Jr. et al..		
A133	6,752,166	06/22/04	Lull, et al.		
A134	6,757,740	06/29/04	Parekh, et al.		
A135	6,760,766	7/6/2004	Sahlqvist		
A136	6,813,777	11/2004	Weinberger et al.		
A137	6,826,616	11/30/2004	Larson et al.		
A138	6,839,759	1/4/2005	Larson et al.		
A139	6,937,597	08/30/2005	Rosenberg et al.		
A140	60/134,547	05/17/1999	Victory Sheymov		
A141	60/151,563	08/31/1999	Bryan Whittles		
A142	7,010,604	3/7/2006	Munger et al.		
A143	7,039,713	05/2006	Van Gunter et al.		
A144	7,072,964	07/04/2006	Whittle et al.		
A145	7,133,930	11/7/2006	Munger et al.		
A146	7,167,904	01/23/07	Devarajan, et al.		
A147	7,188,175	03/06/07	McKeeth, James A.		
A148	7,188,180	3/6/2007	Larson et al.		
A149	7,197,563	3/27/2007	Sheymov et al.		
A150	7,353,841	04/08/08	Kono, et al.		
A151	7,418,504	08/2008	Larson et al.		
A152	7,461,334	12/02/08	Lu, et al.		
A153	7,490,151	02/2009	Munger et al.		
A154	7,493,403	02/2009	Shull et al.		
A155	7,584,500	09/2009	Dillon et al.		
A156	7,764,231	07/27/2010	Karr et al.		
A157	7,852,861	12/2010	Wu et al.		
A158	7,921,211	04/2011	Larson et al.		
A159	7,933,990	04/2011	Munger et al.		
A160	8,051,181	11/2011	Larson et al.		

Subst. for form 1449/PTO			Complete if Known	
INFORMATION DISCLOSURE STATEMENT BY APPLICANT <i>(Use as many sheets as necessary)</i>			Application Number	13/342,795
			Filing Date	01-03-2012
			First Named Inventor	Victor Larson
			Art Unit	2453
			Examiner Name	Krisna Lim
			Docket Number	77580-155(VRNL-1CP3CNFT5)

U.S. PATENT APPLICATION PUBLICATIONS

EXAMINER'S INITIALS	CITE NO.	Patent Number	Publication Date	Name of Patentee or Applicant of Cited Document	Pages, Columns, Lines, Where Relevant Passages or Relevant Figures Appear
	B1	US2001/0049741	12/2001	Skene et al.	
	B2	US2002/0004898	1/10/02	Droge	
	B3	US2003/0196122	10/16/2003	Wesinger, Jr. et al.	
	B4	US2004/0199493	10/2004	Ruiz et al.	
	B5	US2004/0199520	10/2004	Ruiz et al.	
	B6	US2004/0199608	10/2004	Rechterman et al.	
	B7	US2004/0199620	10/2004	Ruiz et al.	
	B8	US2005/0055306	3/10/05	Miller et al.	
	B9	US2005/0108517	05/2005	Dillon et al.	
	B10	US2006/0059337	03/16/2006	Polyhonen et al.	
	B11	US2006/0123134	06/2006	Munger et al.	
	B12	US2007/0208869	09/2007	Adelman et al.	
	B13	US2007/0214284	09/2007	King et al.	
	B14	US2007/0266141	11/2007	Norton, Michael Anthony	
	B15	US2008/0005792	01/2008	*Larson et al.	
	B16	US2008/0144625	06/2008	Wu et al.	
	B17	US2008/0235507	09/2008	Ishikawa et al.	
	B18	US2009/0193498	07/2009	Agarwal et al.	
	B19	US2009/0193513	07/2009	Agarwal et al.	
	B20	US2009/0199258	08/2009	Deng et al.	
	B21	US2009/0199285	09/2009	Agarwal et al.	

FOREIGN PATENT DOCUMENTS

EXAMINER'S INITIALS	CITE NO.	Foreign Patent Document Country Code3 - Number 4 -Kind Code5 (if known)	Publication Date	Name of Patentee or Applicant of Cited Document	Pages, Columns, Lines Where Relevant Figures Appear	Translation	
						Yes	No
	C1	DE19924575	12/2/99	Provino et al.			
	C2	EP0814589	12/29/1997	AT&T Corp.			
	C3	EP0838930	4/29/1988	Digital Equipment Corporation			
	C4	EP0858189	8/12/98	Maciel et al.			
	C5	EP836306	4/15/1998	HEWLETT PACKARD CO			
	C6	GB2317792	04/01/1998	Secure Computing Corporation			
	C7	GB2334181	08/11/1999	NEC Technologies			
	C8	GB2340702	02/23/2000	Sun Microsystems Inc.			
	C9	JP04-363941	12/16/1992	Nippon Telegr & Teleph Corp			
	C10	JP09-018492	01/17/1997	Nippon Telegr & Teleph Corp			
	C11	JP10-070531	03/10/1998	Brother Ind Ltd.			
	C12	JP62-214744	9/21/1987	Hitachi Ltd.			
	C13	WO0070458	11/23/2000	Comsec Corporation			
	C14	WO0017775	3/30/00	Miller et al.			
	C15	WO01016766	03/08/2001	Science Applications International Corporation			
	C16	WO0150688	7/12/01	Kriens			
	C17	WO9827783	06/25/1998	Northern Telecom Limited			
	C18	WO9855930	12/10/98	Tang			

ALL REFERENCES CONSIDERED EXCEPT WHERE LINED THROUGH. /K.L./
Petitioner Apple Inc. - Exhibit 1051, p. 596

Subst. for form 1449/PTO				Complete if Known			
INFORMATION DISCLOSURE STATEMENT BY APPLICANT <i>(Use as many sheets as necessary)</i>				Application Number		13/342,795	
				Filing Date		01-03-2012	
				First Named Inventor		Victor Larson	
				Art Unit		2453	
				Examiner Name		Krisna Lim	
				Docket Number		77580-155(VRNL-1CP3CNFT5)	
	C19	WO9843396	10/01/1998	Northern Telecom Limited			
	C20	WO9859470	12/30/98	Kanter et al.			
	C21	WO9911019	03/04/1999	V One Corp			
	C22	WO9938081	7/29/99	Paulsen et al.			
	C23	WO9948303	9/23/99	Cox et al.			
	C24	WO01/61922	02/12/2001	Science Application International Corporation			

OTHER ART (Including Author, Title, Date, Pertinent Pages, Etc.)

EXAMINE R'S INITIALS	CITE NO.	Include name of the author (in CAPITAL LETTERS), title of the article (when appropriate), title of the item (book, magazine, journal, serial, symposium, catalog, etc.), date, page(s), volume-issue number(s), publisher, city and/or country where published.
	D1	Alan O. Frier et al., "The SSL Protocol Version 3.0", Nov. 18, 1996, printed from http://www.netscape.com/eng/ss13/draft302.txt on Feb. 4, 2002, 56 pages.
	D2	August Bequai, "Balancing Legal Concerns Over Crime and Security in Cyberspace", Computer & Security, vol. 17, No. 4, 1998, pp. 293-298.
	D3	D. B. Chapman et al., "Building Internet Firewalls", Nov. 1995, pp. 278-375.
	D4	D. Clark, "US Calls for Private Domain-Name System", Computer, IEEE Computer Society, Aug. 1, 1998, pp. 22-25.
	D5	Davila J et al, "Implementation of Virtual Private Networks at the Transport Layer", Information Security, Second International Work-shop, ISW'99. Proceedings (Lecture Springer-Verlag Berlin, Germany, [Online] 1999, pp. 85-102, XP002399276, ISBN 3-540-666
	D6	Dolev, Shlomi and Ostrovsky, Rafil, "Efficient Anonymous Multicast and Reception" (Extended Abstract), 16 pages.
	D7	Donald E. Eastlake, 3rd, "Domain Name System Security Extensions", INTERNET DRAFT, Apr. 1998, pp. 1-51.
	D8	F. Halsall, "Data Communications, Computer Networks and Open Systems", Chapter 4, Protocol Basics, 1996, pp. 198-203.
	D9	Glossary for the Linux FreeS/WAN project, printed from http://liberty.freeswan.org/freeswan_trees/freeswan-1.3/doc/glossary.html on Feb. 21, 2002, 25 pages.
	D10	J. Gilmore, "Swan: Securing the Internet against Wiretapping", printed from http://liberty.freeswan.org/freeswan_trees/freeswan-1.3/doc/rationale.html on Feb. 21, 2002, 4 pages.
	D11	James E. Bellaire, "New Statement of Rules-Naming Internet Domains", Internet Newsgroup, Jul. 30, 1995, 1 page.
	D12	Jim Jones et al., "Distributed Denial of Service Attacks: Defenses", Global Integrity Corporation, 2000, pp. 1-14.
	D13	Laurie Wells (LANCASTERBIBELMAIL MSN COM); "Subject: Security Icon" USENET Newsgroup, Oct. 19, 1998, XP002200606, 1 page.
	D14	Linux FreeS/WAN Index File, printed from http://liberty.freewan.org/freeswan_trees/freeswan-1.3/doc/ on Feb. 21, 2002, 3 Pages.
	D15	P. Srisuresh et al., "DNS extensions to Network address Translators (DNS_ALG)", Internet Draft, Jul. 1998, pp. 1-27.
	D16	Reiter, Michael K. and Rubin, Aviel D. (AT&T Labs-Research), "Crowds: Anonymity for Web Transactions", pp. 1-23.
	D17	RFC 2401 (dated Nov. 1998) Security Architecture for the Internet Protocol (RTP)
	D18	RFC 2543-SIP (dated March 1999): Session Initiation Protocol (SIP or SIPS)
	D19	Rich Winkel, "CAQ: Networking With Spooks: The NET & The Control Of Information", Internet Newsgroup, Jun. 21, 1997, 4 pages.
	D20	Rubin, Aviel D., Geer, Daniel, and Ranum, Marcus J. (Wiley Computer Publishing), "Web Security Sourcebook", pp. 82-94.
	D21	Search Report (dated Aug. 20, 2002), International Application No. PCT/US01/04340.
	D22	Search Report (dated Aug. 23, 2002), International Application No. PCT/US01/13260.
	D23	Search Report (dated Oct. 7, 2002), International Application No. PCT/US01/13261.

Subst. for form 1449/PTO INFORMATION DISCLOSURE STATEMENT BY APPLICANT <i>(Use as many sheets as necessary)</i>		Complete if Known	
		Application Number	13/342,795
		Filing Date	01-03-2012
		First Named Inventor	Victor Larson
		Art Unit	2453
		Examiner Name	Krisna Lim
	Docket Number	77580-155(VRNL-1CP3CNFT5)	
D24	Search Report, IPER (dated Nov. 13, 2002), International Application No. PCT/US01/04340.		
D25	Search Report, IPER (dated Feb. 06, 2002), International Application No. PCT/US01/13261.		
D26	Search Report, IPER (dated Jan. 14, 2003), International Application No. PCT/US01/13260.		
D27	Shankar, A.U. "A verified sliding window protocol with variable flow control". Proceedings of ACM SIGCOMM conference on Communications architectures & protocols. pp. 84-91, ACM Press, NY, NY 1986.		
D28	Shree Murthy et al., "Congestion-Oriented Shortest Multi-path Routing", Proceedings of IEEE INFOCOM, 1996, pp. 1028-1036.		
D29	W. Stallings, "Cryptography And Network Security", 2nd, Edition, Chapter 13, IP Security, Jun. 8, 1998, pp. 399-440.		
D30	Microsoft Corporation's Fourth Amended Invalidation Contentions dated Jan. 5, 2009, VirnetX Inc. and Science Applications International Corp. v. Microsoft Corporation.		
D31	Appendix A of the Microsoft Corporation's Fourth Amended Invalidation Contentions dated Jan. 5, 2009.		
D32	Concordance Table For the References Cited in Tables on pages 6-15, 71-80 and 116-124 of the Microsoft Corporation's Fourth Amended Invalidation Contentions dated Jan. 5, 2009.		
D33	1. P. Mockapetris, "DNS Encoding of Network Names and Other Types," Network Working Group, RFC 1101 (April 1989) RFC1101, DNS SRV)		
D34	R. Atkinson, "An Internetwork Authentication Architecture," Naval Research Laboratory, Center for High Assurance Computing Systems (8/5/93). (Atkinson NRL, KX Records)		
D35	Henning Schulzrinne, <i>Personal Mobility For Multimedia Services In The Internet</i> , Proceedings of the Interactive Distributed Multimedia Systems and Services European Workshop at 143 (1996). (Schulzrinne 96)		
D36	Microsoft Corp., <i>Microsoft Virtual Private Networking: Using Point-to-Point Tunneling Protocol for Low-Cost, Secure, Remote Access Across the Internet</i> (1996) (printed from 1998 PDC DVD-ROM). (Point to Point, Microsoft Prior Art VPN Technology)		
D37	"Safe Surfing: How to Build a Secure World Wide Web Connection," IBM Technical Support Organization, (March 1996). (Safe Surfing, WEBSITE ART)		
D38	Goldschlag, et al., "Hiding Routing Information," Workshop on Information Hiding, Cambridge, UK (May 1996). (Goldschlag II, Onion Routing)		
D39	"IPSec Minutes From Montreal", IPSEC Working Group Meeting Notes, http://www.sandleman.ca/ipsec/1996/08/msg00018.html (June 1996). (IPSec Minutes, FreeSWAN)		
D40	J. M. Galvin, "Public Key Distribution with Secure DNS," Proceedings of the Sixth USENIX UNIX Security Symposium, San Jose, California, July 1996. (Galvin, DNSSEC)		
D41	J. Gilmore, et al. "Re: Key Management, anyone? (DNS Keying)," IPsec Working Group Mailing List Archives (8/96). (Gilmore DNS, FreeSWAN)		
D42	H. Orman, et al. "Re: 'Re: DNS? was Re: Key Management, anyone?' IETF IPsec Working Group Mailing List Archive (8/96-9/96). (Orman DNS, FreeSWAN)		
D43	Arnt Gulbrandsen & Paul Vixie, <i>A DNS RR for specifying the location of services (DNS SRV)</i> , IETF RFC 2052 (October 1996). (RFC 2052, DNS SRV)		
D44	Freier, et al. "The SSL Protocol Version 3.0," Transport Layer Security Working Group (November 18, 1996). (SSL, UNDERLYING SECURITY TECHNOLOGY)		
D45	M. Handley, H. Schulzrinne, E. Schooler, Internet Engineering Task Force, Internet Draft, (12/02/1996). (RFC 2543 Internet Draft 1)		
D46	M.G. Reed, et al. "Proxies for Anonymous Routing," 12th Annual Computer Security Applications Conference, San Diego, CA, Dec. 9-13, 1996. (Reed, Onion Routing)		
D47	Kenneth F. Alden & Edward P. Wobber, <i>The AltaVista Tunnel: Using the Internet to Extend Corporate Networks</i> , Digital Technical Journal (1997) (Alden, AltaVista)		
D48	Automotive Industry Action Group, "ANX Release 1 Document Publication," AIAG (1997). (AIAG, ANX)		
D49	Automotive Industry Action Group, "ANX Release 1 Draft Document Publication," AIAG Publications (1997). (AIAG Release, ANX)		
D50	Aventail Corp. "Aventail VPN Data Sheet," available at http://www.archive.org/web/19970212013043/www.aventail.com/prod/vpndata.html (1997). (Data Sheet, Aventail)		
D51	Aventail Corp., "Directed VPN Vs. Tunnel," available at http://web.archive.org/web/19970620030312/www.aventail.com/educate/directvpn.html (1997). (Directed VPN, Aventail)		

ALL REFERENCES CONSIDERED EXCEPT WHERE LINED THROUGH. /K.L./
Petitioner Apple Inc. - Exhibit 1051, p. 598

Subst. for form 1449/PTO		Complete if Known	
		Application Number	13/342,795
		Filing Date	01-03-2012
		First Named Inventor	Victor Larson
		Art Unit	2453
		Examiner Name	Krisna Lim
		Docket Number	77580-155(VRNC-1CP3CNFT5)
D52	Aventail Corp., "Managing Corporate Access to the Internet," Aventail AutoSOCKS White Paper available at http://web.archive.org/199706200300312/www.aventail.com/educate/whitepaper/ipmw.html (1997). (Corporate Access, Aventail)		
D53	Aventail Corp., "VPN Server V2.0 Administration Guide," (1997). (VPN, Aventail)		
D54	Goldschlag, et al. "Privacy on the Internet," Naval Research Laboratory, Center for High Assurance Computer Systems (1997). (Goldschlag I, Onion Routing)		
D55	Microsoft Corp., <i>Installing Configuring and Using PPTP with Microsoft Clients and Servers</i> (1997). (Using PPTP, Microsoft Prior Art VPN Technology)		
D56	Microsoft Corp., <i>IP Security for Microsoft Windows NT Server 5.0</i> (1997) (printed from 1998 PDC DVD-ROM). (IP Security, Microsoft Prior Art VPN Technology)		
D57	Microsoft Corp., <i>Microsoft Windows NT Active Directory: An Introduction to the Next Generation Directory Services</i> (1997) (printed from 1998 PDC DVD-ROM). (Directory, Microsoft Prior Art VPN Technology)		
D58	Microsoft Corp., <i>Routing and Remote Access Service for Windows NT Server New Opportunities Today and Looking Ahead</i> (1997) (printed from 1998 PDC DVD-ROM). Routing, Microsoft Prior Art VPN Technology)		
D59	Microsoft Corp., <i>Understanding Point-to-Point Tunneling Protocol PPTP</i> (1997) (printed from 1998 PDC DVD-ROM). (Understanding PPTP, Microsoft Prior Art VPN Technology)		
D60	J. Mark Smith et al., <i>Protecting a Private Network: The AltaVista Firewall</i> , Digital Technical Journal (1997). (Smith, AltaVista)		
D61	Naganand Doraswamy <i>Implementation of Virtual Private Networks (VPNs) with IPsec</i> , <draft-ietf-ipsec-vpn-00.txt> (March 12, 1997). (Doraswamy)		
D62	M. Handley, H. Schulzrinne, E. Schooler, Internet Engineering Task Force, Internet Draft, (03/27/1997). (RFC 2543 Internet Draft 2)		
D63	Aventail Corp., "Aventail and Cybersafe to Provide Secure Authentication For Internet and Intranet Communication," Press Release, April 3, 1997. (Secure Authentication, Aventail)		
D64	D. Wagner, et al. "Analysis of the SSL 3.0 Protocol," (April 15, 1997). (Analysis, UNDERLYING SECURITY TECHNOLOGIES)		
D65	Automotive Industry Action Group, "ANXO Certification Authority Service and Directory Service Definition for ANX Release 1," AIAG Telecommunications Project Team and Bellcore (May 9, 1997). (AIAG Definition, ANX)		
D66	Automotive Industry Action Group, "ANXO Certification Process and ANX Registration Process Definition for ANX Release 1," AIAG Telecommunications Project Team and Bellcore (May 9, 1997). (AIAG Certification, ANX)		
D67	Aventail Corp., "Aventail Announces the First VPN Solution to Assure Interoperability Across Emerging Security Protocols," June 2, 1997. (First VPN, Aventail)		
D68	Syverson, et al. "Private Web Browsing," Naval Research Laboratory, Center for High Assurance Computer Systems (June 2, 1997). (Syverson, Onion Routing)		
D69	Bellcore, "Metrics, Criteria, and Measurement Technique Requirements for ANX Release 1," AIAG Telecommunications Project Team and Bellcore (June 16, 1997). (AIAG Requirements, ANX)		
D70	M. Handley, H. Schulzrinne, E. Schooler, Internet Engineering Task Force, Internet Draft, (07/31/1997). (RFC 2543 Internet Draft 3)		
D71	R. Atkinson, "Key Exchange Delegation Record for the DNS," Network Working Group, RFC 2230 (November 1997). (RFC 2230, KX Records)		
D72	M. Handley, H. Schulzrinne, E. Schooler, Internet Engineering Task Force, Internet Draft, (11/11/1997). (RFC 2543 Internet Draft 4)		
D73	1998 Microsoft Professional Developers Conference DVD ("1998 PDC DVD-ROM") (including screenshots captured there from and produced as MSFTVX 00018827-00018832). (Conference, Microsoft Prior Art VPN Technology)		
D74	Microsoft Corp., <i>Virtual Private Networking An Overview</i> (1998) (printed from 1998 PDC DVD-ROM) (Overview, Microsoft Prior Art VPN Technology)		
D75	Microsoft Corp., <i>Windows NT 5.0 Beta Has Public Premiere at Seattle Mini-Camp Seminar attendees get first look at the performance and capabilities of Windows NT 5.0</i> (1998) (available at http://www.microsoft.com/presspass/features/1998/10-19nt5.mspxpfrue). (NT Beta, Microsoft Prior Art VPN Technology)		
D76	"What ports does SSL use" available at stason.org/TULARC/security/ssl-talk/3-4-What-ports-does-ssl-use.html (1998). (Ports, DNS SRV)		

Subst. for form 1449/PTO INFORMATION DISCLOSURE STATEMENT BY APPLICANT <i>(Use as many sheets as necessary)</i>		Complete if Known	
		Application Number	13/342,795
		Filing Date	01-03-2012
		First Named Inventor	Victor Larson
		Art Unit	2453
		Examiner Name	Krisna Lim
	Docket Number	77580-155(VR NK-1CP3CNFT5)	
D77	Aventail Corp., "Aventail VPN V2.6 Includes Support for More Than Ten Authentication Methods Making Extranet VPN Development Secure and Simple," Press Release, January 19, 1998. (VPN V2.6, Aventail)		
D78	R. G. Moskowitz, "Network Address Translation Issues with IPsec," Internet Draft, Internet Engineering Task Force, February 6, 1998. (Moskowitz)		
D79	H. Schulzrinne, et al, "Internet Telephony Gateway Location," Proceedings of IEEE Infocom '98, The Conference on Computer Communications, Vol. 2 (March 29 - April 2, 1998). (Gateway, Schulzrinne)		
D80	C. Huitema, 45 al. "Simple Gateway Control Protocol," Version 1.0 (May 5, 1998). (SGCP)		
D81	DISA "Secret Internet Protocol Router Network," SIPRNET Program Management Office (D3113) DISN Networks, DISN Transmission Services (May 8, 1998). DISA, SIPRNET)		
D82	M. Handley, H. Schulzrinne, E. Schooler, Internet Engineering Task Force, Internet Draft, (05/14/1998). (RFC 2543 Internet Draft 5)		
D83	M. Handley, H. Schulzrinne, E. Schooler, Internet Engineering Task Force, Internet Draft, (06/17/1998). (RFC 2543 Internet Draft 6)		
D84	D. McDonald, et al. "PF_KEY Key Management API, Version 2," Network Working Group, RFC 2367 (July 1998). (RFC 2367)		
D85	M. Handley, H. Schulzrinne, E. Schooler, Internet Engineering Task Force, Internet Draft, (07/16/1998). (RFC 2543 Internet Draft 7)		
D86	M. Handley, H. Schulzrinne, E. Schooler, Internet Engineering Task Force, Internet Draft, (08/07/1998). (RFC 2543 Internet Draft 8)		
D87	Microsoft Corp., <i>Company Focuses on Quality and Customer Feedback</i> (August 18, 1998). (Focus, Microsoft Prior Art VPN Technology)		
D88	M. Handley, H. Schulzrinne, E. Schooler, Internet Engineering Task Force, Internet Draft, (09/18/1998). (RFC 2543 Internet Draft 9)		
D89	Atkinson, et al. "Security Architecture for the Internet Protocol," Network Working Group, RFC 2401 (November 1998). (RFC 2401, UNDERLYING SECURITY TECHNOLOGIES)		
D90	M. Handley, H. Schulzrinne, E. Schooler, Internet Engineering Task Force, Internet Draft, (11/12/1998). (RFC 2543 Internet Draft 10)		
D91	Donald Eastlake, <i>Domain Name System Security Extensions</i> , IETF DNS Security Working Group (December 1998). (DNSSEC-7)		
D92	M. Handley, H. Schulzrinne, E. Schooler, Internet Engineering Task Force, Internet Draft, (12/15/1998). (RFC 2543 Internet Draft 11)		
D93	Aventail Corp., "Aventail Connect 3.1/2.6 Administrator's Guide," (1999). (Aventail Administrator 3.1, Aventail)		
D94	Aventail Corp., "Aventail Connect 3.1/2.6 User's Guide," (1999). (Aventail User 3.1, Aventail)		
D95	Aventail Corp., "Aventail ExtraWeb Server v3.2 Administrator's Guide," (1999). (Aventail ExtraWeb 3.2, Aventail)		
D96	Kaufman et al, "Implementing IPsec," (Copyright 1999). (Implementing IPSEC, VPN REFERENCES)		
D97	Network Solutions, Inc. "Enabling SSL," NSI Registry (1999). (Enabling SSL, UNDERLYING SECURITY TECHNOLOGIES)		
D98	Check Point Software Technologies Ltd. (1999) (Check Point, Checkpoint FW)		
D99	Arnt Gulbrandsen & Paul Vixie, <i>A DNS RR for specifying the location of services (DNS SRV)</i> , <draft-ietf-dnsind-frc2052bis-02.txt> (January 1999). (Gulbrandsen 99, DNS SRV)		
D100	C. Scott, et al. <i>Virtual Private Networks</i> , O'Reilly and Associates, Inc., 2nd ed. (Jan. 1999). Scott VPNs)		
D101	M. Handley, H. Schulzrinne, E. Schooler, Internet Engineering Task Force, Internet Draft, (01/15/1999). (RFC 2543 Internet Draft 12)		
D102	Goldschlag, et al., "Onion Routing for Anonymous and Private Internet Connections," Naval Research Laboratory, Center for High Assurance Computer Systems (January 28, 1999). (Goldschlag III, Onion Routing)		
D103	H. Schulzrinne, "Internet Telephony: architecture and protocols - an IETF perspective," Computer Networks, Vol. 31, No. 3 (February 1999). (Telephony, Schulzrinne)		
D104	M. Handley, et al. "SIP: Session Initiation Protocol," Network Working Group, RFC 2543 and Internet Drafts (12/96-3/99). (Handley, RFC 2543)		
D105	FreeSWAN Project, <i>Linux FreeS/WAN Compatibility Guide</i> (March 4, 1999). (FreeSWAN Compatibility Guide, FreeSWAN)		

ALL REFERENCES CONSIDERED EXCEPT WHERE LINED THROUGH. /K.L./

Subst. for form 1449/PTO INFORMATION DISCLOSURE STATEMENT BY APPLICANT <i>(Use as many sheets as necessary)</i>		Complete if Known	
		Application Number	13/342,795
		Filing Date	01-03-2012
		First Named Inventor	Victor Larson
		Art Unit	2453
		Examiner Name	Krisna Lim
	Docket Number	77580-155(VRNL-1CP3CNFT5)	
D106	Telcordia Technologies, "ANX Release 1 Document Corrections," AIAG (May 11, 1999). (Telcordia, ANX)		
D107	Ken Hornstein & Jeffrey Altman, <i>Distributing Kerberos KDC and Realm Information with DNS</i> <draft-eitf-cat-krb-dns-locate-oo.txt> (June 21, 1999). (Hornstein, DNS SRV)		
D108	Bhattacharya, et al., "An LDAP Schema for Configuration and Administration of IPsec Based Virtual Private Networks (VPNs)", IETF Internet Draft (October 1999). (Bhattacharya LDAP VPN)		
D109	B. Patel, et al. "DHCP Configuration of IPSEC Tunnel Mode," IPSEC Working Group, Internet Draft 02 (10/15/1999). (Patel)		
D110	Goncalves, et al. <i>Check Point FireWall-1 Administration Guide</i> , McGraw-Hill Companies (2000). (Goncalves, Checkpoint FW)		
D111	"Building a Microsoft VPN: A Comprehensive Collection of Microsoft Resources," FirstVPN, (Jan 2000). (FirstVPN Microsoft)		
D112	Gulbrandsen, Vixie, & Esibov, <i>A DNS RR for specifying the location of services (DNS SRV)</i> , IETF RFC 2782 (February 2000). (RFC 2782, DNS SRV)		
D113	MITRE Organization, "Technical Description," Collaborative Operations in Joint Expeditionary Force Experiment (JEFX) 99 (February 2000). (MITRE, SIPRNET)		
D114	H. Schulzrinne, et al. "Application-Layer Mobility Using SIP," <i>Mobile Computing and Communications Review</i> , Vol. 4, No. 3. pp. 47-57 (July 2000). (Application, SIP)		
D115	Kindred et al., "Dynamic VPN Communities: Implementation and Experience," DARPA Information Survivability Conference and Exposition II (June 2001). (DARPA, VPN SYSTEMS)		
D116	ANX 101: Basic ANX Service Outline. (Outline, ANX)		
D117	ANX 201: Advanced ANX Service. (Advanced, ANX)		
D118	Appendix A: Certificate Profile for ANX IPsec Certificates. (Appendix, ANX)		
D119	Assured Digital Products. (Assured Digital)		
D120	Aventail Corp., "Aventail AutoSOCKS the Client Key to Network Security," Aventail Corporation White Paper. (Network Security, Aventail)		
D121	Cindy Moran, "DISN Data Networks: Secret Internet Protocol Router Network (SIPRNet)." (Moran, SIPRNET)		
D122	Data Fellows F-Secure VPN+ (F-Secure VPN+)		
D123	"Interim Operational Systems Doctrine for the Remote Access Security Program (RASP) Secret Dial-In Solution. (RASP, SIPRNET)		
D124	<i>Onion Routing</i> , "Investigation of Route Selection Algorithms," available at http://www.onion-router.net/Archives/Route/index.html . (Route Selection, Onion Routing)		
D125	Secure Computing, "Bullet-Proofing an Army Net," Washington Technology. (Secure, SIPRNET)		
D126	SPARTA "Dynamic Virtual Private Network." (Sparta, VPN SYSTEMS)		
D127	Standard Operation Procedure for Using the 1910 Secure Modems. (Standard, SIPRNET)		
D128	Publicly available emails relating to FreeSWAN (MSFTVX00018833-MSFTVX00019206). (FreeSWAN emails, FreeSWAN)		
D129	Kaufman et al., "Implementing IPsec," (Copyright 1999) (Implementing IPsec)		
D130	Network Associates <i>Gauntlet Firewall For Unix User's Guide Version 5.0</i> (1999). (Gauntlet User's Guide - Unix, Firewall Products)		
D131	Network Associates <i>Gauntlet Firewall For Windows NT Getting Started Guide Version 5.0</i> (1999) (Gauntlet Getting Started Guide - NT, Firewall Products)		
D132	Network Associates <i>Gauntlet Firewall For Unix Getting Started Guide Version 5.0</i> (1999) (Gauntlet Unix Getting Started Guide, Firewall Products)		
D133	Network Associates <i>Release Notes Gauntlet Firewall for Unix 5.0</i> (March 19, 1999) (Gauntlet Unix Release Notes, Firewall Products)		
D134	Network Associates <i>Gauntlet Firewall For Windows NT Administrator's Guide Version 5.0</i> (1999) (Gauntlet NT Administrator's Guide, Firewall Products)		
D135	Trusted Information Systems, Inc. <i>Gauntlet Internet Firewall Firewall-to-Firewall Encryption Guide Version 3.1</i> (1996) (Gauntlet Firewall-to-Firewall, Firewall Products)		
D136	Network Associates <i>Gauntlet Firewall Global Virtual Private Network User's Guide for Windows NT Version 5.0</i> (1999) (Gauntlet NT GVPN, GVPN)		
D137	Network Associates <i>Gauntlet Firewall For UNIX Global Virtual Private Network User's Guide Version 5.0</i> (1999) (Gauntlet Unix GVPN, GVPN)		
D138	Dan Sterne <i>Dynamic Virtual Private Networks</i> (May 23, 2000) (Sterne DVPN, DVPN)		
D139	Darrell Kindred <i>Dynamic Virtual Private Networks (DVPN)</i> (December 21, 1999) (Kindred DVPN, DVPN)		

ALL REFERENCES CONSIDERED EXCEPT WHERE LINED THROUGH. /K.L./

Subst. for form 1449/PTO INFORMATION DISCLOSURE STATEMENT BY APPLICANT <i>(Use as many sheets as necessary)</i>		Complete if Known	
		Application Number	13/342,795
		Filing Date	01-03-2012
		First Named Inventor	Victor Larson
		Art Unit	2453
		Examiner Name	Krisna Lim
	Docket Number	77580-155(VRNL-1CP3CNFT5)	
D140	Dan Sterne <i>et al.</i> <i>TIS Dynamic Security Perimeter Research Project Demonstration</i> (March 9, 1998) (Dynamic Security Perimeter, DVPN)		
D141	Darrell Kindred <i>Dynamic Virtual Private Networks Capability Description</i> (January 5, 2000) (Kindred DVPN Capability, DVPN) 11		
D142	October 7, and 28 1997 email from Domenic J. Turchi Jr. (SPARTA00001712-1714, 1808-1811) (Turchi DVPN email, DVPN)		
D143	James Just & Dan Sterne <i>Security Quickstart Task Update</i> (February 5, 1997) (Security Quickstart, DVPN)		
D144	Virtual Private Network Demonstration dated March 21, 1998 (SPARTA00001844-54) (DVPN Demonstration, DVPN)		
D145	GTE Internetworking & BBN Technologies DARPA <i>Information Assurance Program Integrated Feasibilit Demonstration (IFD) 1.1 Plan</i> (March 10, 1998) (IFD 1.1, DVPN)		
D146	Microsoft Corp. Windows NT Server Product Documentation: Administration Guide - Connection Point Services, <i>available at</i> http://www.microsoft.com/technet/archive/winntas/proddocs/inetconctservice/cpsops.mspx (Connection Point Services) (Although undated, this reference refers to the operation of prior art versions of Microsoft Windows. Accordingly, upon information and belief, this reference is prior art to the patents-in-suit.)		
D147	Microsoft Corp. Windows NT Server Product Documentation: Administration Kit Guide - Connection Manager, <i>available at</i> http://www.microsoft.com/technet/archive/winntas/proddocs/inetconctservice/cmak.mspx (Connection Manager) (Although undated, this reference refers to the operation of prior art versions of Microsoft Windows such as Windows NT 4.0. Accordingly, upon information and belief, this reference is prior art to the patents-in-suit.)		
D148	Microsoft Corp. Autodial Heuristics, <i>available at</i> http://support.microsoft.com/kb/164249 (Autodial Heuristics) (Although undated, this reference refers to the operation of prior art versions of Microsoft Windows such as Windows NT 4.0. Accordingly, upon information and belief, this reference is prior art to the patents-in-suit.)		
D149	Microsoft Corp., Cariplo: Distributed Component Object Model, (1996) <i>available at</i> http://msdn2.microsoft.com/en-us/library/ms809332(printer).aspx (Cariplo I)		
D150	Marc Levy, COM Internet Services (Apr. 23, 1999), <i>available at</i> http://msdn2.microsoft.com/en-us/library/ms809302(printer).aspx (Levy)		
D151	Markus Horstmann and Mary Kirtland, DCOM Architecture (July 23, 1997), <i>available at</i> http://msdn2.microsoft.com/en-us/library/ms809311(printer).aspx (Horstmann)		
D152	Microsoft Corp., DCOM: A Business Overview (Apr. 1997), <i>available at</i> http://msdn2.microsoft.com/en-us/library/ms809320(printer).aspx (DCOM Business Overview I)		
D153	Microsoft Corp., DCOM Technical Overview (Nov. 1996), <i>available at</i> http://msdn2.microsoft.com/en-us/library/ms809340(printer).aspx (DCOM Technical Overview I)		
D154	Microsoft Corp., DCOM Architecture White Paper (1998) <i>available in</i> PDC DVD-ROM (DCOM Architecture)		
D155	Microsoft Corp, DCOM – The Distributed Component Object Model, A Business Overview White Paper (Microsoft 1997) <i>available in</i> PDC DVD-ROM (DCOM Business Overview II)		
D156	Microsoft Corp., DCOM - Cariplo Home Banking Over The Internet White Paper (Microsoft 1996) <i>available in</i> PDC DVD-ROM (Cariplo II)		
D157	Microsoft Corp., DCOM Solutions in Action White Paper (Microsoft 1996) <i>available in</i> PDC DVD-ROM (DCOM Solutions in Action)		
D158	Microsoft Corp., DCOM Technical Overview White Paper (Microsoft 1996) <i>available in</i> 12 in PDC DVD-ROM (DCOM Technical Overview II)		
D159	125. Scott Suhy & Glenn Wood, DNS and Microsoft Windows NT 4.0, (1996) <i>available at</i> http://msdn2.microsoft.com/en-us/library/ms810277(printer).aspx (Suhy)		
D160	126. Aaron Skonnard, <i>Essential Winlnet</i> 313-423 (Addison Wesley Longman 1998) (Essential Winlnet)		
D161	Microsoft Corp. Installing, Configuring, and Using PPTP with Microsoft Clients and Servers, (1998) <i>available at</i> http://msdn2.microsoft.com/enus/library/ms811078(printer).aspx (Using PPTP)		
D162	Microsoft Corp., Internet Connection Services for MS RAS, Standard Edition, http://www.microsoft.com/technet/archive/winntas/proddocs/inetconctservice/bcgstart.mspx (Internet Connection Services I)		

Subst. for form 1449/PTO		Complete if Known	
		Application Number	13/342,795
		Filing Date	01-03-2012
		First Named Inventor	Victor Larson
		Art Unit	2453
		Examiner Name	Krisna Lim
		Docket Number	77580-155(VRNL-1CP3CNFT5)
D163	Microsoft Corp., Internet Connection Services for RAS, Commercial Edition, <i>available at</i> http://www.microsoft.com/technet/archive/winntas/proddocs/inetconctservice/bcgstrtc.mspx (Internet Connection Services II)		
D164	Microsoft Corp., Internet Explorer 5 Corporate Deployment Guide – Appendix B: Enabling Connections with the Connection Manager Administration Kit, <i>available at</i> http://www.microsoft.com/technet/prodtechnol/ie/deploy/deploy5/appendb.mspx (IE5 Corporate Development)		
D165	Mark Minasi, <i>Mastering Windows NT Server 4</i> 1359-1442 (6th ed., January 15, 1999) (Mastering Windows NT Server)		
D166	<i>Hands On, Self-Paced Training for Supporting Version 4.0</i> 371-473 (Microsoft Press 1998) (Hands On)		
D167	Microsoft Corp., MS Point-to-Point Tunneling Protocol (Windows NT 4.0), <i>available at</i> http://www.microsoft.com/technet/archive/winntas/maintain/featusability/pptpwp3.mspx (MS PPTP)		
D168	Kenneth Gregg, <i>et al.</i> , <i>Microsoft Windows NT Server Administrator's Bible</i> 173-206, 883-911, 974-1076 (IDG Books Worldwide 1999) (Gregg)		
D169	Microsoft Corp., Remote Access (Windows), <i>available at</i> http://msdn2.microsoft.com/enus/library/bb545687(VS.85.printer).aspx (Remote Access)		
D170	Microsoft Corp., Understanding PPTP (Windows NT 4.0), <i>available at</i> http://www.microsoft.com/technet/archive/winntas/plan/pptpudst.mspx (Understanding PPTP NT 4) (Although undated, this reference refers to the operation of prior art versions of Microsoft Windows such as Windows NT 4.0. Accordingly, upon information and belief, this reference is prior art to the patents-in-suit.)		
D171	Microsoft Corp., Windows NT 4.0: Virtual Private Networking, <i>available at</i> http://www.microsoft.com/technet/archive/winntas/deploy/confeat/vpntwk.mspx (NT4 VPN) (Although undated, this reference refers to the operation of prior art versions of Microsoft Windows such as Windows NT 4.0. Accordingly, upon information and belief, this reference is prior art to the patents-in-suit.)		
D172	Anthony Northrup, <i>NT Network Plumbing: Routers, Proxies, and Web Services</i> 299-399 (IDG Books Worldwide 1998) (Network Plumbing)		
D173	Microsoft Corp., Chapter 1 - Introduction to Windows NT Routing with Routing and Remote Access Service, <i>available at</i> http://www.microsoft.com/technet/archive/winntas/proddocs/rras40/rrasch01.mspx (Intro to RRAS) (Although undated, this reference refers to the operation of prior art versions of Microsoft Windows such as Windows NT 4.0. Accordingly, upon information and belief, this reference is prior art to the patents-in-suit.) 13		
D174	Microsoft Corp., Windows NT Server Product Documentation: Chapter 5 - Planning for Large-Scale Configurations, <i>available at</i> http://www.microsoft.com/technet/archive/winntas/proddocs/rras40/rrasch05.mspx (Large-Scale Configurations) (Although undated, this reference refers to the operation of prior art versions of Microsoft Windows such as Windows NT 4.0. Accordingly, upon information and belief, this reference is prior art to the patents-in-suit.)		
D175	F-Secure, <i>F-Secure NameSurfer</i> (May 1999) (from FSECURE 00000003) (NameSurfer 3)		
D176	F-Secure, <i>F-Secure VPN Administrator's Guide</i> (May 1999) (from FSECURE 00000003) (F-Secure VPN 3)		
D177	F-Secure, <i>F-Secure SSH User's & Administrator's Guide</i> (May 1999) (from FSECURE 00000003) (SSH Guide 3)		
D178	F-Secure, <i>F-Secure SSH2.0 for Windows NT and 95</i> (May 1999) (from FSECURE 00000003) (SSH 2.0 Guide 3)		
D179	F-Secure, <i>F-Secure VPN+ Administrator's Guide</i> (May 1999) (from FSECURE 00000003) (VPN+ Guide 3)		
D180	F-Secure, <i>F-Secure VPN+ 4.1</i> (1999) (from FSECURE 00000006) (VPN+ 4.1 Guide 6)		
D181	F-Secure, <i>F-Secure SSH</i> (1996) (from FSECURE 00000006) (F-Secure SSH 6)		
D182	F-Secure, <i>F-Secure SSH 2.0 for Windows NT and 95</i> (1998) (from FSECURE 00000006) (F-Secure SSH 2.0 Guide 6)		
D183	F-Secure, <i>F-Secure SSH User's & Administrator's Guide</i> (Sept. 1998) (from FSECURE 00000009) (SSH Guide 9)		
D184	F-Secure, <i>F-Secure SSH 2.0 for Windows NT and 95</i> (Sept. 1998) (from FSECURE 00000009) (F-Secure SSH 2.0 Guide 9)		

ALL REFERENCES CONSIDERED EXCEPT WHERE LINED THROUGH. /K.L./
Petitioner Apple Inc. - Exhibit 1051, p. 603

Subst. for form 1449/PTO		Complete if Known	
INFORMATION DISCLOSURE STATEMENT BY APPLICANT (Use as many sheets as necessary)		Application Number	13/342,795
		Filing Date	01-03-2012
		First Named Inventor	Victor Larson
		Art Unit	2453
		Examiner Name	Krisna Lim
		Docket Number	77580-155(VRNL-1CP3CNFT5)
D185	F-Secure, <i>F-Secure VPN+</i> (Sept. 1998) (from FSECURE 00000009) (VPN+ Guide 9)		
D186	F-Secure, <i>F-Secure Management Tools, Administrator's Guide</i> (1999) (from FSECURE 00000003) (F-Secure Management Tools)		
D187	F-Secure, <i>F-Secure Desktop, User's Guide</i> (1997) (from FSECURE 00000009) (FSecure Desktop User's Guide)		
D188	SafeNet, Inc., <i>VPN Policy Manager</i> (January 2000) (VPN Policy Manager)		
D189	F-Secure, <i>F-Secure VPN+ for Windows NT 4.0</i> (1998) (from FSECURE 00000009) (FSecure VPN+)		
D190	IRE, Inc., <i>SafeNet/Security Center Technical Reference Addendum</i> (June 22, 1999) (Safenet Addendum)		
D191	IRE, Inc., <i>System Description for VPN Policy Manager and SafeNet/SoftPK</i> (March 30, 2000) (VPN Policy Manager System Description)		
D192	IRE, Inc., <i>About SafeNet / VPN Policy Manager</i> (1999) (About Safenet VPN Policy Manager)		
D193	Trusted Information Systems, Inc., <i>Gauntlet Internet Firewall, Firewall Product Functional Summary</i> July 22, 1996) (Gauntlet Functional Summary)		
D194	Trusted Information Systems, Inc., <i>Running the Gauntlet Internet Firewall, An Administrator's Guide to Gauntlet Version 3.0</i> (May 31, 1995) (Running the Gauntlet Internet Firewall)		
D195	Ted Harwood, <i>Windows NT Terminal Server and Citrix Metaframe</i> (New Riders 1999) (Windows NT Harwood) 79		
D196	Todd W. Mathers and Shawn P. Genoway, <i>Windows NT Thing Client Solutions: Implementing Terminal Server and Citrix MetaFrame</i> (Macmillan Technical Publishing 1999) (Windows NT Mathers)		
D197	Bernard Aboba et al., <i>Securing L2TP using IPSEC</i> (February 2, 1999)		
D198	156. <i>Finding Your Way Through the VPN Maze</i> (1999) ("PGP")		
D199	Linux FreeSWAN Overview (1999) (Linux FreeSWAN Overview)		
D200	TimeStep, <i>The Business Case for Secure VPNs</i> (1998) ("TimeStep")		
D201	WatchGuard Technologies, Inc., <i>WatchGuard LiveSecurity for MSS Powerpoint</i> (Feb. 14 2000)		
D202	WatchGuard Technologies, Inc., <i>MSS Version 2.5, Add-On for WatchGuard SOHO Release Notes</i> (July 21, 2000)		
D203	WatchGuard Technologies, Inc., <i>MSS Firewall Specifications</i> (1999)		
D204	WatchGuard Technologies, Inc., <i>Request for Information, Security Services</i> (2000)		
D205	WatchGuard Technologies, Inc., <i>Protecting the Internet Distributed Enterprise, White Paper</i> (February 2000)		
D206	Air Force Research Laboratory, <i>Statement of Work for Information Assurance System Architecture and Integration, PR No. N-8-6106 (Contract No. F30602-98-C-0012)</i> (January 29, 1998)		
D207	Technologies, Inc., <i>WatchGuard Firebox System Powerpoint</i> (2000)		
D208	GTE Internetworking & BBN Technologies DARPA <i>Information Assurance Program Integrated Feasibility Demonstration 1FD 1.2 Report, Rev. 1.0</i> (September 21, 1998)		
D209	BBN Information Assurance Contract, <i>TIS Labs Monthly Status Report</i> (March 16-April 30, 1998)		
D210	DARPA, <i>Dynamic Virtual Private Network (VPN) Powerpoint</i>		
D211	GTE Internetworking, <i>Contractor's Program Progress Report</i> (March 16-April 30, 1998)		
D212	Darrell Kindred, <i>Dynamic Virtual Private Networks (DVPN) Countermeasure Characterization</i> (January 30, 2001)		
D213	<i>Virtual Private Networking Countermeasure Characterization</i> (March 30, 2000)		
D214	<i>Virtual Private Network Demonstration</i> (March 21, 1998)		
D215	Information Assurance/NAI Labs, <i>Dynamic Virtual Private Networks (VPNs) and Integrated Security Management</i> (2000)		
D216	Information Assurance/NAI Labs, <i>Create/Add DVPN Enclave</i> (2000)		
D217	NAI Labs, <i>IFE 3.1 Integration Demo</i> (2000)		
D218	Information Assurance, <i>Science Fair Agenda</i> (2000)		
D219	Darrell Kindred et al., <i>Proposed Threads for IFE 3.1</i> (January 13, 2000)		
D220	<i>IFE 3.1 Technology Dependencies</i> (2000)		
D221	<i>IFE 3.1 Topology</i> (February 9, 2000)		
D222	Information Assurance, <i>Information Assurance Integration: IFE 3.1, Hypothesis & Thread Development</i> January 10-11, 2000)		
D223	Information Assurance/NAI Labs, <i>Dynamic Virtual Private Networks Presentation</i> (2000)		
D224	Information Assurance/NAI Labs, <i>Dynamic Virtual Private Networks Presentation v.2</i> (2000)		

Subst. for form 1449/PTO INFORMATION DISCLOSURE STATEMENT BY APPLICANT <i>(Use as many sheets as necessary)</i>		Complete if Known	
		Application Number	13/342,795
		Filing Date	01-03-2012
		First Named Inventor	Victor Larson
		Art Unit	2453
		Examiner Name	Krisna Lim
	Docket Number	77580-155(VRNL-1CP3CNFT5)	
D225	Information Assurance/NAI Labs, Dynamic Virtual Private Networks Presentation v.3 (2000)		
D226	T. Braun et al., <i>Virtual Private Network Architecture</i> , Charging and Accounting Technology for the Internet (August 1, 1999) (VPNA)		
D227	Network Associates Products - <i>PGP Total Network Security Suite, Dynamic Virtual Private Networks</i> (1999)		
D228	Microsoft Corporation, <i>Microsoft Proxy Server 2.0</i> (1997) (Proxy Server 2.0, Microsoft Prior Art VPN Technology)		
D229	David Johnson et. al., <i>A Guide To Microsoft Proxy Server 2.0</i> (1999) (Johnson, Microsoft Prior Art VPN Technology)		
D230	Microsoft Corporation, <i>Setting Server Parameters</i> (1997 (copied from Proxy Server 2.0 CD labeled MSFTVX00157288) (Setting Server Parameters, Microsoft Prior Art VPN Technology)		
D231	Kevin Schuler, <i>Microsoft Proxy Server 2</i> (1998) (Schuler, Microsoft Prior Art VPN Technology)		
D232	Erik Rozell et. al., <i>MCSE Proxy Server 2 Study Guide</i> (1998) (Rozell, Microsoft Prior 15 Art VPN Technology)		
D233	M. Shane Stigler & Mark A Linsenbardt, <i>IIS 4 and Proxy Server 2</i> (1999) (Stigler, Microsoft Prior Art VPN Technology)		
D234	David G. Schaer, <i>MCSE Test Success: Proxy Server 2</i> (1998) (Schaer, Microsoft Prior Art VPN Technology)		
D235	John Savill, <i>The Windows NT and Windows 2000 Answer Book</i> (1999) (Savill, Microsoft Prior Art VPN Technology)		
D236	Network Associates <i>Gauntlet Firewall Global Virtual Private Network User's Guide for Windows NT Version 5.0</i> (1999) (Gauntlet NT GVPN, GVPN)		
D237	Network Associates <i>Gauntlet Firewall For UNIX Global Virtual Private Network User's Guide Version 5.0</i> (1999) (Gauntlet Unix GVPN, GVPN)		
D238	File History for U.S. Application Serial No. 09/653,201, Applicant(s): Whittle Bryan, et al., Filing Date 08/31/2000.		
D239	<i>AutoSOCKS v2. 1</i> , Datasheet, http://web.archive.org/web/19970212013409/www.aventail.com/prod/autoskds.html		
D240	Ran Atkinson, <i>Use of DNS to Distribute Keys</i> , 7 Sept. 1993, http://ops.ietf.org/lists/namedroppers/namedroppers, 1 99x/msg00945.html		
D241	FirstVPN Enterprise Networks, Overview		
D242	Chapter 1: Introduction to Firewall Technology, Administration Guide; 12/19/07, http://www.books24x7.com/book/id_762/viewer_r.asp?bookid=762&chunked=41065062		
D243	The TLS Protocol Version 1.0; January 1999; page 65 of 71.		
D244	Elizabeth D. Zwicky, et al., <i>Building Internet Firewalls</i> , 2nd Ed.		
D245	Virtual Private Networks - Assured Digital Incorporated - ADI 4500; http://web.archive.org/web/19990224050035/www.assured-digital.com/products/prodvpn/adia4500.htm		
D246	Accessware - The Third Wave in Network Security, Conclave from Internet Dynamics; http://web.archive.org/web/11980210013830/interdyn.com/Accessware.html		
D247	Extended System Press Release, Sept. 2, 1997; <i>Extended VPN Uses The Internet to Create Virtual Private Networks</i> , www.extendedsystems.com		
D248	Socks Version 5; Executive Summary; http://web.archive.org/web/199970620031945/www.aventail.com/educate/whitepaper/sockswp.html		
D249	Internet Dynamics First to Ship Integrated Security Solutions for Enterprise Intranets and Extranets; Sept. 15, 1997; http://web.archive.org/web/19980210014150/interdyn.com		
D250	Emails from various individuals to Linux IPsec re: DNS-LDAP Splicing		
D251	Fasbender, A., et al., Variable and Scalable Security: Protection of Location Information in Mobile IP, IEEE VTS, 46th, 1996, 5 pp.		
D252	David Kosiur, "Building and Managing Virtual Private Networks" (1998)		
D253	Request for Inter Partes Reexamination of Patent No. 6,502,135, dated Nov. 25, 2009.		
D254	Request for Inter Partes Reexamination of Patent No. 7,188,180, dated Nov. 25, 2009.		
D255	Yuan Dong Feng, "A novel scheme combining interleaving technique with cipher in Rayleigh fading channels," Proceedings of the International Conference on Communication technology, 2:S47-02-1-S47-02-4 (1998)		

Subst. for form 1449/PTO INFORMATION DISCLOSURE STATEMENT BY APPLICANT <i>(Use as many sheets as necessary)</i>		Complete if Known	
		Application Number	13/342,795
		Filing Date	01-03-2012
		First Named Inventor	Victor Larson
		Art Unit	2453
		Examiner Name	Krisna Lim
		Docket Number	77580-155(VR NK-1CP3CNFT5)
D256	Davies and Price, edited by Tadahiro Uezono, "Network Security", Japan, Nikkei McGraw-Hill, December 5, 1958, First Edition, first copy, p. 102-108		
D257	Davies et al., "An Introduction to Data Security in Teleprocessing and Electronic Funds Transfer," Security for Computer Networks, Second Edition, pp. 98-101 (1989)		
D258	Baumgartner et al, "Differentiated Services: A New Approach for Quality of Service in the Internet," International Conference on High Performance Networking, 255-273 (1998)		
D259	Chapman et al., "Domain Name System (DNS)," 278-296 (1995)		
D260	Davila et al., "Implementation of Virtual Private Networks at the Transport Layer," M. Mambo, Y. Zheng (Eds), Information Security (Second International) Workshop, ISW' 99. Lecture Notes in Computer Science (LNCS), Vol. 1729; 85-102 (1999)		
D261	De Raadt et al., "Cryptography in OpenBSD," 10 pages (1999)		
D262	Eastlake, "Domain Name System Security Extensions," Internet Citation, Retrieved from the Internet: URL:ftp://ftp.inet.no/pub/ietf/internet-drafts/draft-ietf-dnssec-secext2-05.txt (1998)		
D263	Gunter et al., "An Architecture for Managing QoS-Enabled VRNs Over the Internet," Proceedings 24th Conference on Local Computer Networks. LCN' 99 IEEE Comput. Soc Los Alamitos, CA, pages 122-131 (1999)		
D264	Shimizu, "Special Feature: Mastering the Internet with Windows 2000", Internet Magazine, 63:296-307 (2000)		
D265	Stallings, "Cryptography and Network Security," Principals and Practice, 2nd Edition, pages 399-440 (1999)		
D266	Takata, "U.S. Vendors Take Serious Action to Act Against Crackers – A Tracking Tool and a Highly Safe DNS Software are Released", Nikkei Communications, 257:87(1997)		
D267	Wells, Email (Lancasterb1be@mail.msn.com), Subject: "Security Icon," (1998)		
D268	Microsoft Corporation's Fifth Amended Invalidity Contentions dated September 18, 2009, VirnetX Inc. and Science Applications International Corp. v. Microsoft Corporation and invalidity claim charts for U.S. Patent Nos. 7,188,180 and 6,839,759		
D269	The IPSEC Protocol as described in Atkinson, et al., "Security Architecture for the Internet Protocol," Network Working Group, RFC 2401 (November 1998) ("RFC 2401"); http://web.archive.org/web/19991007070353/http://www.imib.med.tu-dresden.de/imib/Internet/Literatur/ipsec-docu_eng.html		
D270	S. Kent and R. Atkinson, "IP Authentication Header," RFC 2402 (November 1998); http://web.archive.org/web/19991007070353/http://www.imib.med.tu-dresden.de/imib/Internet/Literatur/ipsec-docu_eng.html		
D271	C. Madson and R. Glenn, "The Use of HMAC-MD5-96 within ESP and AH," RFC 2403 (November 1998); http://web.archive.org/web/19991007070353/http://www.imib.med.tu-dresden.de/imib/Internet/Literatur/ipsec-docu_eng.html		
D272	C. Madson and R. Glenn, "The Use HMAC-SHA-1-96 within ESP and AH," RFC 2404 (November 1998); http://web.archive.org/web/19991007070353/http://www.imib.med.tu-dresden.de/imib/Internet/Literatur/ipsec-docu_eng.html		
D273	C. Madson and N. Doraswamy, "The ESP DES-CBC Cipher Algorithm With Explicit IV", RFC 2405 (November 1998); http://web.archive.org/web/19991007070353/http://www.imib.med.tu-dresden.de/imib/Internet/Literatur/ipsec-docu_eng.html		

Subst. for form 1449/PTO INFORMATION DISCLOSURE STATEMENT BY APPLICANT <i>(Use as many sheets as necessary)</i>		Complete if Known	
		Application Number	13/342,795
		Filing Date	01-03-2012
		First Named Inventor	Victor Larson
		Art Unit	2453
		Examiner Name	Krisna Lim
		Docket Number	77580-155(VR NK-1CP3CNFT5)
D274	S. Kent and R. Atkinson, "IP Encapsulating Security Payload (ESP)," RFC 2406 (November 1998); http://web.archive.org/web/19991007070353/http://www.imib.med.tu-dresden.de/imib/Internet/Literatur/ipsec-docu_eng.html		
D275	Derrell Piper, "The Internet IP Security Domain of Interpretation for ISAKMP," RFC 2407 (November 1998); http://web.archive.org/web/19991007070353/http://www.imib.med.tu-dresden.de/imib/Internet/Literatur/ipsec-docu_eng.html		
D276	Douglas Maughan, et al, "Internet Security Association and Key Management Protocol (ISAKMP)," RFC 2408 (November 1998); http://web.archive.org/web/19991007070353/http://www.imib.med.tu-dresden.de/imib/Internet/Literatur/ipsec-docu_eng.html		
D277	D. Harkins and D. Carrell, "The Internet Key Exchange (IKE)," RFC 2409 (November 1998); http://web.archive.org/web/19991007070353/http://www.imib.med.tu-dresden.de/imib/Internet/Literatur/ipsec-docu_eng.html		
D278	R. Glenn and S. Kent, "The NULL Encryption Algorithm and Its Use With IPsec." RFC 2410 (November 1998); http://web.archive.org/web/19991007070353/http://www.imib.med.tu-dresden.de/imib/Internet/Literatur/ipsec-docu_eng.html		
D279	R. Thayer, et al., "IP Security Document Roadmap," RFC 2411 (November 1998); http://web.archive.org/web/19991007070353/http://www.imib.med.tu-dresden.de/imib/Internet/Literatur/ipsec-docu_eng.html		
D280	Hilarie K. Orman, "The OAKLEY Key Determination Protocol," RFC 2412 (November 1998) in combination with J.M. Galvin, "Public Key Distribution with Secure DNS," Proceedings of the Sixth USENIX UNIX Security Symposium, San Jose California (July 1996) ("Galvin")		
D281	DNS-related correspondence dated September 7, 1993 to September 20, 1993. (Pre KX, KX Records)		
D282	Aventail Corp., "AutoSOCKS v. 2.1 Datasheet," available at http://www.archive.org/web/19970212013409/www.aventail.com/prod/autosk2ds.html (1997). (AutoSOCKS, Aventail)		
D283	Aventail Corp., "Socks Version 5," Aventail Whitepaper, available at http://web.archive.org/web/19970620030312/www.aventail.com/educate/whitepaper/soc_kswp.html (1997). (Socks, Aventail)		
D284	Goncalves, et al. <i>Check Point FireWall -1 Administration Guide</i> , McGraw-Hill Companies (2000). (Goncalves, Checkpoint FW)		
D285	Assured Digital Products. (Assured Digital)		
D286	F-Secure, <i>F-Secure Evaluation Kit</i> (May 1999) (FSECURE 00000003) (Evaluation Kit 3)		
D287	F-Secure, <i>F-Secure Evaluation Kit</i> (Sept. 1998) (FSECURE 00000009) (Evaluation Kit 9)		
D288	IRE, Inc., <i>SafeNet/Soft-PK Version 4</i> (March 28, 2000) (Soft-PK Version 4)		
D289	IRE/SafeNet Inc., <i>VPN Technologies Overview</i> (March 28, 2000) (Safenet VPN Overview)		
D290	IRE, Inc., <i>SafeNet/VPN Policy Manager Quick Start Guide Version 1</i> (1999) (SafeNet VPN Policy Manager)		
D291	Information Assurance/NAI Labs, <i>Dynamic Virtual Private Networks Presentation v.3</i> (2000)		
D292	PCT International Search Report for related PCT Application No.: PCT/US01/13261, 8 pages .		
D293	PCT International Search Report for related PCT Application No.: PCT/US99/25323, 3 pages .		
D294	PCT International Search Report for related PCT Application No.: PCT/US99/25325, 3 pages .		
D295	Deposition Transcript for Gary Tomlinson dated February 27, 2009		
D296	Trial Transcript, VirnetX vs. Microsoft Corporation dated March 8, 2010, 8:45 AM		
D297	Trial Transcript, VirnetX vs. Microsoft Corporation dated March 8, 2010, 1:30 PM		
D298	Trial Transcript, VirnetX vs. Microsoft Corporation dated March 9, 2010, 9:00 AM		

Subst. for form 1449/PTO INFORMATION DISCLOSURE STATEMENT BY APPLICANT (Use as many sheets as necessary)			Complete if Known	
			Application Number	13/342,795
			Filing Date	01-03-2012
			First Named Inventor	Victor Larson
			Art Unit	2453
			Examiner Name	Krisna Lim
			Docket Number	77580-155(VR NK-1CP3CNFT5)
D299	Trial Transcript, VirnetX vs. Microsoft Corporation dated March 9, 2010, 1:30 PM			
D300	Trial Transcript, VirnetX vs. Microsoft Corporation dated March 10, 2010, 9:00 AM			
D301	Trial Transcript, VirnetX vs. Microsoft Corporation dated March 10, 2010, 1:00 PM			
D302	Trial Transcript, VirnetX vs. Microsoft Corporation dated March 11, 2010, 9:00 AM			
D303	Trial Transcript, VirnetX vs. Microsoft Corporation dated March 11, 2010, 1:30 PM			
D304	Trial Transcript, VirnetX vs. Microsoft Corporation dated March 12, 2010, 9:00 AM			
D305	Trial Transcript, VirnetX vs. Microsoft Corporation dated March 12, 2010, 1:15 PM			
D306	Trial Transcript, VirnetX vs. Microsoft Corporation dated March 15, 2010, 9:00 AM			
D307	Trial Transcript, VirnetX vs. Microsoft Corporation dated March 15, 2010, 12:35 PM			
D308	European Search Report dated January 24, 2011 from corresponding European Application Number 10011949.4			
D309	European Search Report dated March 17, 2011 from corresponding European Application Number 10184502.2			
D310	Hollenbeck et al., "Registry Registrar Protocol (RRP) Version 1.1.0; Internet Engineering Task Force, 34 pages (1999)			
D311	Tannenbaum, "Computer Networks," pages 202-219 (1996)			
D312	Defendants' Preliminary Joint Invalidation Contentions dated July 1, 2011			
D313	Appendix B: DNS References to Defendants' Preliminary Joint Invalidation Contentions dated July 1, 2011			
D314	Appendix A to Defendants' Preliminary Joint Invalidation Contentions dated July 1, 2011			
D315	Exhibit 1, IETF RFC 2065: Domain Name System Security Extensions; Published January 1997 ¹ vs. Claims of the '211 Patent ²			
D316	Exhibit 2, IETF RFC 2065: Domain Name System Security Extensions; Published January 1997 ¹ vs. Claims of the '504 Patent ²			
D317	Exhibit 3, RFC 2543 ¹ vs. Claims of the '135 Patent ²			
D318	Exhibit 4, RFC 2543 ¹ vs. Claims of the '211 Patent ²			
D319	Exhibit 5, RFC 2543 ¹ vs. Claims of the '504 Patent ²			
D320	Exhibit 6, SIP Draft v.2 ¹ vs. Claims of the '135 Patent ²			
D321	Exhibit 7, SIP Draft v.2 ¹ vs. Claims of the '211 Patent ²			

Subst. for form 1449/PTO INFORMATION DISCLOSURE STATEMENT BY APPLICANT <i>(Use as many sheets as necessary)</i>			Complete if Known	
			Application Number	13/342,795
			Filing Date	01-03-2012
			First Named Inventor	Victor Larson
			Art Unit	2453
			Examiner Name	Krisna Lim
			Docket Number	77580-155(VR NK-1CP3CNFT5)
D322	Exhibit 8, SIP Draft v.2 ¹ vs. Claims of the '504 Patent ²			
D323	Exhibit 9, H.323 ¹ vs. Claims of the '135 Patent ²			
D324	Exhibit 10, H.323 ¹ vs. Claims of the '211 Patent ²			
D325	Exhibit 11, H.323 ¹ vs. Claims of the '504 Patent ²			
D326	Exhibit 12, SSL 3.0 ¹ vs. Claims of the '135 Patent ² .			
D327	Exhibit 13, SSL 3.0 ¹ vs. Claims of the '211 Patent ²			
D328	Exhibit 14, SSL 3.0 ¹ vs. Claims of the '504 Patent ²			
D329	Exhibit 15, RFC 2487 ¹ vs. Claims of the '135 Patent ²			
D330	Exhibit 16, RFC 2487 ¹ vs. Claims of the '211 Patent ²			
D331	Exhibit 17, RFC 2487 ¹ vs. Claims of the '504 Patent ²			
D332	Exhibit 18, RFC 2595 ¹ vs. Claims of the '135 Patent ²			
D333	Exhibit 19, RFC 2595 ¹ vs. Claims of the '211 Patent ²			
D334	Exhibit 20, RFC 2595 ¹ vs. Claims of the '504 Patent ²			
D335	Exhibit 21, iPass ¹ vs. Claims of the '135 Patent ²			
D336	Exhibit 22, iPASS ¹ vs. Claims of the '211 Patent ²			
D337	Exhibit 23, iPASS ¹ vs. Claims of the '504 Patent ²			
D338	Exhibit 24, "US '034" ¹ vs. Claims of the '135 Patent ²			
D339	Exhibit 25, US Patent No. 6,453,034 ("US '034") ¹ vs. Claims of the '211 Patent ²			
D340	Exhibit 26, US Patent No. 6,453,034 ("US '034") ¹ vs. Claims of the '504 Patent ²			
D341	Exhibit 27, US '287 ¹ vs. Claims of the '135 Patent ²			
D342	Exhibit 28, US '287 ¹ vs. Claims of the '211 Patent ²			
D343	Exhibit 29, US '287 ¹ vs. Claims of the '504 Patent ²			
D344	Exhibit 30, Overview of Access VPNs ¹ vs. Claims of the '135 Patent ²			
D345	Exhibit 31, Overview of Access VPNs ¹ vs. Claims of the '211 Patent ²			
D346	Exhibit 32, Overview of Access VPNs ¹ vs. Claims of the '504 Patent ²			
D347	Exhibit 34, RFC 1928 ¹ vs. Claims of the '135 Patent ²			

Subst. for form 1449/PTO INFORMATION DISCLOSURE STATEMENT BY APPLICANT <i>(Use as many sheets as necessary)</i>			Complete if Known	
			Application Number	13/342,795
			Filing Date	01-03-2012
			First Named Inventor	Victor Larson
			Art Unit	2453
			Examiner Name	Krisna Lim
			Docket Number	77580-155(VR NK-1CP3CNFT5)
D348	Exhibit 35, RFC 1928 ¹ vs. Claims of the '211 Patent ²			
D349	Exhibit 36, RFC 1928 ¹ vs. Claims of the '504 Patent ²			
D350	Exhibit 37, RFC 2661 ¹ vs. Claims of the '135 Patent ²			
D351	Exhibit 38, RFC 2661 ¹ vs. Claims of the '211 Patent ²			
D352	Exhibit 39, RFC 2661 ¹ vs. Claims of the '504 Patent ²			
D353	Exhibit 40, SecureConnect ¹ vs. Claims of the '135 Patent ²			
D354	Exhibit 41, SecureConnect ¹ vs. Claims of the '211 Patent ²			
D355	Exhibit 42, SecureConnect ¹ vs. Claims of the '504 Patent ²			
D356	Exhibit 43, SFS-HTTP ¹ vs. Claims of the '135 Patent ²			
D357	Exhibit 44, SFS-HTTP ¹ vs. Claims of the '211 Patent ²			
D358	Exhibit 45, SFS-HTTP ¹ vs. Claims of the '504 Patent ²			
D359	Exhibit 46, US '883 ¹ vs. Claims of the '135 Patent ²			
D360	Exhibit 47, US '883 ¹ vs. Claims of the '211 Patent ²			
D361	Exhibit 48, US '883 ¹ vs. Claims of the '504 Patent ²			
D362	Exhibit 49, US '132 ¹ vs. Claims of the '135 Patent ²			
D363	Exhibit 50, US '132 ¹ vs. Claims of the '211 Patent ²			
D364	Exhibit 51, US '132 ¹ vs. Claims of the '504 Patent ²			
D365	Exhibit 52, US '213 ¹ vs. Claims of the '135 Patent ²			
D366	Exhibit 53, US '213 ¹ vs. Claims of the '211 Patent ²			
D367	Exhibit 54, US '213 ¹ vs. Claims of the '504 Patent ²			
D368	Exhibit 55, B&M VPNs ¹ vs. Claims of the '135 Patent ²			
D369	Exhibit 56, B&M VPNs ¹ vs. Claims of the '211 Patent ²			
D370	Exhibit 57, B&M VPNs ¹ vs. Claims of the '504 Patent ²			
D371	Exhibit 58, BorderManager ¹ vs. Claims of the '135 Patent ²			
D372	Exhibit 59, BorderManager ¹ vs. Claims of the '211 Patent ²			
D373	Exhibit 60, BorderManager ¹ vs. Claims of the '504 Patent ²			

Subst. for form 1449/PTO INFORMATION DISCLOSURE STATEMENT BY APPLICANT <i>(Use as many sheets as necessary)</i>			Complete if Known	
			Application Number	13/342,795
			Filing Date	01-03-2012
			First Named Inventor	Victor Larson
			Art Unit	2453
			Examiner Name	Krisna Lim
			Docket Number	77580-155(VRNK-1CP3CNFT5)
D374	Exhibit 61, Prestige 128 Plus ¹ vs. Claims of the '135 Patent ²			
D375	Exhibit 62, Prestige 128 Plus ¹ vs. Claims of the '211 Patent ²			
D376	Exhibit 63, Prestige 128 Plus ¹ vs. Claims of the '504 Patent ²			
D377	Exhibit 64, RFC 2401 ¹ vs. Claims of the '135 Patent ²			
D378	Exhibit 65, RFC 2401 ¹ vs. Claims of the '211 Patent ²			
D379	Exhibit 66, RFC 2401 ¹ vs. Claims of the '504 Patent ²			
D380	Exhibit 67, RFC 2486 ¹ vs. Claims of the '135 Patent ²			
D381	Exhibit 68, RFC 2486 ¹ vs. Claims of the '211 Patent ²			
D382	Exhibit 69, RFC 2486 ¹ vs. Claims of the '504 Patent ²			
D383	Exhibit 70, Understanding IPsec ¹ vs. Claims of the '135 Patent ²			
D384	Exhibit 71, Understanding IPsec ¹ vs. Claims of the '211 Patent ²			
D385	Exhibit 72, Understanding IPsec ¹ vs. Claims of the '504 Patent ²			
D386	Exhibit 73, US '820 ¹ vs. Claims of the '135 Patent ²			
D387	Exhibit 74, US '820 ¹ vs. Claims of the '211 Patent ²			
D388	Exhibit 75, US '820 ¹ vs. Claims of the '504 Patent ²			
D389	Exhibit 76, US '019 ¹ vs. Claims of the '211 Patent ²			
D390	Exhibit 77, US '019 ¹ vs. Claims of the '504 Patent ²			
D391	Exhibit 78, US '049 ¹ vs. Claims of the '135 Patent ²			
D392	Exhibit 79, US '049 ¹ vs. Claims of the '211 Patent ²			
D393	Exhibit 80, US '049 ¹ vs. Claims of the '504 Patent ²			
D394	Exhibit 81, US '748 ¹ vs. Claims of the '135 Patent ²			
D395	Exhibit 82, US '261 ¹ vs. Claims of the '135 Patent ²			
D396	Exhibit 83, US '261 ¹ vs. Claims of the '211 Patent ²			
D397	Exhibit 84, US '261 ¹ vs. Claims of the '504 Patent ²			
D398	Exhibit 85, US '900 ¹ vs. Claims of the '135 Patent ²			
D399	Exhibit 86, US '900 ¹ vs. Claims of the '211 Patent ²			

Subst. for form 1449/PTO			Complete if Known	
INFORMATION DISCLOSURE STATEMENT BY APPLICANT <i>(Use as many sheets as necessary)</i>			Application Number	13/342,795
			Filing Date	01-03-2012
			First Named Inventor	Victor Larson
			Art Unit	2453
			Examiner Name	Krisna Lim
			Docket Number	77580-155(VRNL-1CP3CNFT5)
D400	Exhibit 87, US '900 ¹ vs. Claims of the '504 Patent ²			
D401	Exhibit 88, US '671 ¹ vs. Claims of the '135 Patent ²			
D402	Exhibit 89, US '671 ¹ vs. Claims of the '211 Patent ²			
D403	Exhibit 90, US '671 ¹ vs. Claims of the '504 Patent ²			
D404	Exhibit 91, JP '704 ¹ vs. Claims of the '135 Patent ²			
D405	Exhibit 92, JP '704 ¹ vs. Claims of the '211 Patent ²			
D406	Exhibit 93, JP '704 ¹ vs. Claims of the '504 Patent ²			
D407	Exhibit 94, GB '841 ¹ vs. Claims of the '135 Patent ²			
D408	Exhibit 95, GB '841 ¹ vs. Claims of the '211 Patent ²			
D409	Exhibit 96, GB '841 ¹ vs. Claims of the '504 Patent ²			
D410	Exhibit 97, US '318 ¹ vs. Claims of the '135 Patent ²			
D411	Exhibit 98, US '318 ¹ vs. Claims of the '211 Patent ²			
D412	Exhibit 99, US '318 ¹ vs. Claims of the '504 Patent ²			
D413	Exhibit 100, VPN/VLAN ¹ vs. Claims of the '135 Patent ²			
D414	Exhibit 101, Nikkei ¹ vs. Claims of the '135 Patent ²			
D415	Exhibit 102, NIKKEI ¹ vs. Claims of the '211 Patent ²			
D416	Exhibit 103, NIKKEI ¹ vs. Claims of the '504 Patent ²			
D417	Exhibit 104, Special Anthology ¹ vs. Claims of the '135 Patent ²			
D418	Exhibit 105, Omron ¹ vs. Claims of the '135 Patent ²			
D419	Exhibit 106, Gauntlet System ¹ vs. Claims of the '135 Patent ²			
D420	Exhibit 107, Gauntlet System ¹ vs. Claims of the '151 Patent ²			
D421	Exhibit 108, Gauntlet System ¹ vs. Claims of the '180 Patent ²			
D422	Exhibit 109, Gauntlet System ¹ vs. Claims of the '211 Patent ²			
D423	Exhibit 110, Gauntlet System ¹ vs. Claims of the '504 Patent ²			
D424	Exhibit 111, Gauntlet System ¹ vs. Claims of the '759 Patent ²			
D425	Exhibit 112, IntraPort System ¹ vs. Claims of the '135 Patent ²			

Subst. for form 1449/PTO			Complete if Known	
INFORMATION DISCLOSURE STATEMENT BY APPLICANT <i>(Use as many sheets as necessary)</i>			Application Number	13/342,795
			Filing Date	01-03-2012
			First Named Inventor	Victor Larson
			Art Unit	2453
			Examiner Name	Krisna Lim
			Docket Number	77580-155(VR NK-1CP3CNFT5)
D426	Exhibit 113, IntraPort System ¹ vs. Claims of the '151 Patent ²			
D427	Exhibit 114, IntraPort System ¹ vs. Claims of the '180 Patent ²			
D428	Exhibit 115, IntraPort System ¹ vs. Claims of the '211 Patent ²			
D429	Exhibit 116, IntraPort System ¹ vs. Claims of the '504 Patent ²			
D430	Exhibit 117, IntraPort System ¹ vs. Claims of the '759 Patent ²			
D431	Exhibit 118, Altiga VPN System ¹ vs. Claims of the '135 Patent ²			
D432	Exhibit 119, Altiga VPN System ¹ vs. Claims of the '151 Patent ²			
D433	Exhibit 120, Altiga VPN System ¹ vs. Claims of the '180 Patent ²			
D434	Exhibit 121, Altiga VPN System ¹ vs. Claims of the '211 Patent ²			
D435	Exhibit 122, Altiga VPN System ¹ vs. Claims of the '504 Patent ²			
D436	Exhibit 123, Altiga VPN System ¹ vs. Claims of the '759 Patent ²			
D437	Exhibit 124, Kiuchi ¹ vs. Claims of the '135 Patent ²			
D438	Exhibit 125, Kiuchi ¹ vs. Claims of the '151 Patent ²			
D439	Exhibit 126, Kiuchi ¹ vs. Claims of the '180 Patent ²			
D440	Exhibit 127, Kiuchi ¹ vs. Claims of the '211 Patent ²			
D441	Exhibit 128, Kiuchi ¹ vs. Claims of the '504 Patent ²			
D442	Exhibit 129, Kiuchi ¹ vs. Claims of the '759 Patent ²			
D443	Exhibit 130, Overview of Access VPNs and Tunneling Technologies ("Overview") ¹ vs. Claims of the '135 Patent ²			
D444	Exhibit 131, Overview of Access VPNs and Tunneling Technologies ("Overview") ¹ vs. Claims of the '151 Patent ²			
D445	Exhibit 132, Overview of Access VPNs and Tunneling Technologies ("Overview") ¹ vs. Claims of the '180 Patent ²			
D446	Exhibit 133, Overview of Access VPNs and Tunneling Technologies ("Overview") ¹ vs. Claims of the '211 Patent ²			
D447	Exhibit 134, Overview of Access VPNs and Tunneling Technologies ("Overview") ¹ vs. Claims of the '504 Patent ²			
D448	Exhibit 135, Overview ¹ vs. Claims of the '759 Patent ²			
D449	Exhibit 136, RFC 2401 ¹ vs. Claims of the '759 Patent ²			

Subst. for form 1449/PTO INFORMATION DISCLOSURE STATEMENT BY APPLICANT <i>(Use as many sheets as necessary)</i>			Complete if Known	
			Application Number	13/342,795
			Filing Date	01-03-2012
			First Named Inventor	Victor Larson
			Art Unit	2453
			Examiner Name	Krisna Lim
			Docket Number	77580-155(VRNK-1CP3CNFT5)
D450	Exhibit 137, Schulzrinne ¹ vs. Claims of the '135 Patent ²			
D451	Exhibit 138, Schulzrinne ¹ vs. Claims of the '151 Patent ²			
D452	Exhibit 139, Schulzrinne ¹ vs. Claims of the '180 Patent ²			
D453	Exhibit 140, Schulzrinne ¹ vs. Claims of the '211 Patent ²			
D454	Exhibit 141, Schulzrinne ¹ vs. Claims of the '504 Patent ²			
D455	Exhibit 142, Schulzrinne ¹ vs. Claims of the '759 Patent ²			
D456	Exhibit 143, Solana ¹ vs. Claims of the '135 Patent ²			
D457	Exhibit 144, Solana ¹ vs. Claims of the '151 Patent ²			
D458	Exhibit 145, Solana ¹ vs. Claims of the '180 Patent ²			
D459	Exhibit 146, Solana ¹ vs. Claims of the '211 Patent ²			
D460	Exhibit 147, Solana ¹ vs. Claims of the '504 Patent ²			
D461	Exhibit 148, Solana ¹ vs. Claims of the '759 Patent ²			
D462	Exhibit 149, Atkinson ¹ vs. Claims of the '135 Patent ²			
D463	Exhibit 150, Atkinson ¹ vs. Claims of the '151 Patent ²			
D464	Exhibit 151, Atkinson ¹ vs. Claims of the '180 Patent ²			
D465	Exhibit 152, Atkinson ¹ vs. Claims of the '211 Patent ²			
D466	Exhibit 153, Atkinson ¹ vs. Claims of the '504 Patent ²			
D467	Exhibit 154, Atkinson ¹ vs. Claims of the '759 Patent ²			
D468	Exhibit 155, Marino ¹ vs. Claims of the '135 Patent ²			
D469	Exhibit 156, Marino ¹ vs. Claims of the '151 Patent ²			
D470	Exhibit 157, Marino ¹ vs. Claims of the '180 Patent ²			
D471	Exhibit 158, Marino ¹ vs. Claims of the '211 Patent ²			
D472	Exhibit 159, Marino ¹ vs. Claims of the '504 Patent ²			
D473	Exhibit 160, Marino ¹ vs. Claims of the '759 Patent ²			
D474	Exhibit 161, Aziz ('646) ¹ vs. Claims of the '759 Patent ²			
D475	Exhibit 162, Wesinger ¹ vs. Claims of the '135 Patent ²			

Subst. for form 1449/PTO INFORMATION DISCLOSURE STATEMENT BY APPLICANT <i>(Use as many sheets as necessary)</i>			Complete if Known	
			Application Number	13/342,795
			Filing Date	01-03-2012
			First Named Inventor	Victor Larson
			Art Unit	2453
			Examiner Name	Krisna Lim
			Docket Number	77580-155(VR NK-1CP3CNFT5)
D476	Exhibit 163, Wesinger ¹ vs. Claims of the '151 Patent ²			
D477	Exhibit 164, Wesinger ¹ vs. Claims of the '180 Patent ²			
D478	Exhibit 165, Wesinger ¹ vs. Claims of the '211 Patent ²			
D479	Exhibit 166, Wesinger ¹ vs. Claims of the '504 Patent ²			
D480	Exhibit 167, Wesinger ¹ vs. Claims of the '759 Patent ²			
D481	Exhibit 168, Aziz ('234) ¹ vs. Claims of the '135 Patent ²			
D482	Exhibit 169, Aziz ('234) ¹ vs. Claims of the '151 Patent ²			
D483	Exhibit 170, Aziz ('234) ¹ vs. Claims of the '180 Patent ²			
D484	Exhibit 171, Aziz ('234) ¹ vs. Claims of the '211 Patent ²			
D485	Exhibit 172, Aziz ('234) ¹ vs. Claims of the '504 Patent ²			
D486	Exhibit 173, Aziz ('234) ¹ vs. Claims of the '759 Patent ²			
D487	Exhibit 174, Schneider ¹ vs. Claims of the '759 Patent ²			
D488	Exhibit 175, Valencia ¹ vs. Claims of the '135 Patent ²			
D489	Exhibit 176, Valencia ¹ vs. Claims of the '151 Patent ²			
D490	Exhibit 177, Valencia ¹ vs. Claims of the '180 Patent ²			
D491	Exhibit 178, Valencia ¹ vs. Claims of the '211 Patent ²			
D492	Exhibit 179, Valencia ¹ vs. Claims of the '504 Patent ²			
D493	Exhibit 180, RFC 2401 in Combination with U.S. Patent No. 6,496,867 ¹ vs. Claims of the '180 Patent ²			
D494	Exhibit 181, Davison ¹ vs. Claims of the '135 Patent ²			
D495	Exhibit 182, Davison ¹ vs. Claims of the '151 Patent ²			
D496	Exhibit 183, Davison ¹ vs. Claims of the '180 Patent ²			
D497	Exhibit 184, Davison ¹ vs. Claims of the '211 Patent ²			
D498	Exhibit 185, Davison ¹ vs. Claims of the '504 Patent ²			
D499	Exhibit 186, Davison ¹ vs. Claims of the '759 Patent ²			
D500	Exhibit 187, AutoSOCKS v2.1 ¹ vs. Claims of the '135 Patent ²			
D501	Exhibit 188, AutoSOCKS v2.1 ¹ vs. Claims of the '151 Patent ²			

Subst. for form 1449/PTO INFORMATION DISCLOSURE STATEMENT BY APPLICANT <i>(Use as many sheets as necessary)</i>			Complete if Known	
			Application Number	13/342,795
			Filing Date	01-03-2012
			First Named Inventor	Victor Larson
			Art Unit	2453
			Examiner Name	Krisna Lim
			Docket Number	77580-155(VRNL-1CP3CNFT5)
D502	Exhibit 189, AutoSOCKS v2.1 Administrator's Guide ¹ vs. Claims of the '180 Patent ²			
D503	Exhibit 190, AutoSOCKS ¹ vs. Claims of the '759 Patent ²			
D504	Exhibit 191, Aventail Connect 3.01/2.51 ¹ vs. Claims of the '135 Patent ²			
D505	Exhibit 192, Aventail Connect v3.01/2.51 ¹ vs. Claims of the '151 Patent ²			
D506	Exhibit 193, Aventail Connect 3.01/2.51 ¹ vs. Claims of the '180 Patent ²			
D507	Exhibit 194, Aventail Connect 3.01/2.51 ¹ vs. Claims of the '759 Patent ²			
D508	Exhibit 195, Aventail Connect 3.1/2.6 Administrator's Guide ¹ vs. Claims of the '135 Patent ²			
D509	Exhibit 196, Aventail Connect 3.1/2.6 Administrator's Guide ¹ vs. Claims of the '151 Patent ²			
D510	Exhibit 197, Aventail Connect 3.1/2.6 ¹ vs. Claims of the '180 Patent ²			
D511	Exhibit 198, Aventail Connect 3.1/2.6 ¹ vs. Claims of the '759 Patent ²			
D512	Exhibit 199, BinGO! User's User's Guide/Extended Features Reference ¹ vs. Claims of the '151 Patent ²			
D513	Exhibit 200, BinGO! User's User's Guide/Extended Features Reference ¹ vs. Claims of the '135 Patent ²			
D514	Exhibit 201, BinGO! vs. Claims of the '180 Patent ²			
D515	Exhibit 202, BinGO! vs. Claims of the '759 Patent ²			
D516	Exhibit 203, Broadband Forum Technical Report TR-025 (Issue 1.0/5.0) ¹ vs. Claims of the '135 Patent ²			
D517	Exhibit 204, Domain Name System (DNS) Security ¹ vs. Claims of the '211 Patent ²			
D518	Exhibit 205, Domain Name System (DNS) Security ¹ vs. Claims of the '504 Patent ²			
D519	Exhibit 206, RFC 2230, Key Exchange Delegation Record for the DNS ¹ vs. Claims of the '211 Patent ²			
D520	Exhibit 207, RFC 2230, Key Exchange Delegation Record for the DNS ¹ vs. Claims of the '504 Patent ²			
D521	Exhibit 208, RFC 2538, Storing Certificates in the Domain Name System (DNS) ¹ vs. Claims of the '211 Patent ²			
D522	Exhibit 209, RFC 2538, Storing Certificates in the Domain Name System (DNS) ¹ vs. Claims of the '504 Patent ²			
D523	Exhibit 210, IETF RFC 2065: Domain Name System Security Extensions; Published January 1997 ¹ vs. Claims of the '504 Patent ²			

Subst. for form 1449/PTO INFORMATION DISCLOSURE STATEMENT BY APPLICANT <i>(Use as many sheets as necessary)</i>			Complete if Known	
			Application Number	13/342,795
			Filing Date	01-03-2012
			First Named Inventor	Victor Larson
			Art Unit	2453
			Examiner Name	Krisna Lim
			Docket Number	77580-155(VR NK-1CP3CNFT5)
D524	Exhibit 211, IETF RFC 2065: Domain Name System Security Extensions; Published January 1997 ¹ vs. Claims of the '211 Patent ²			
D525	Exhibit 212, RFC 2486, RFC 2661, RFC 2401, and Internet-Draft, "Secure Remote Access with L2TP" ¹ vs. Claims of the '135 Patent ²			
D526	Exhibit 213, U.S. Patent No. 7,100,195 in Combination with RFC 2401 and U.S. Patent No. 6,496,867 ¹ vs. Claims of the '135 Patent ²			
D527	Exhibit 214, U.S. Patent No. 7,100,195 in Combination with RFC 2401 and U.S. Patent No. 6,496,867 ¹ vs. Claims of the '151 Patent ²			
D528	Exhibit 215, U.S. Patent No. 6,643,701 ¹ vs. Claims of the '135 Patent ²			
D529	Exhibit 216, U.S. Patent No. 6,643,701 ¹ vs. Claims of the '151 Patent ²			
D530	Exhibit 217, U.S. Patent No. 6,496,867 in Combination with RFC 2401 ¹ vs. Claims of the '151 Patent ²			
D531	Exhibit 218, U.S. Patent No. 6,496,867 in Combination with RFC 2401 ¹ vs. Claims of the '135 Patent ²			
D532	Exhibit 219, U.S. Patent No. 6,496,867 ¹ vs. Claims of the '211 Patent ²			
D533	Exhibit 220, U.S. Patent No. 6,496,867 ¹ vs. Claims of the '504 Patent ²			
D534	Exhibit 221, RFC 2486, RFC 2661, RFC 2401, and Internet-Draft, "Secure Remote Access with L2TP" ¹ vs. Claims of the '151 Patent ²			
D535	Exhibit 222, U.S. Patent No. 6,557,037 ¹ vs. Claims of the '211 Patent ²			
D536	Exhibit 223, U.S. Patent No. 6,557,037 ¹ vs. Claims of the '504 Patent ²			
D537	Exhibit 224, RFC 2230, Key Exchange Delegation Record for the DNS ¹ vs. Claims of the '135 Patent ²			
D538	Exhibit 225, RFC 2230, Key Exchange Delegation Record for the DNS ¹ vs. Claims of the '151 Patent ²			
D539	Exhibit Cisco-1, Cisco's Prior Art Systems ¹ vs. Claims of the '135 Patent			
D540	Exhibit Cisco-2, Cisco's Prior Art Systems ¹ vs. Claims of the '151 Patent			
D541	Exhibit Cisco-3, Cisco's Prior Art Systems ¹ vs. Claims of the '180 Patent			
D542	Exhibit Cisco-4, Cisco's Prior Art Systems ¹ vs. Claims of the '211 Patent			
D543	Exhibit Cisco-5, Cisco's Prior Art Systems ¹ vs. Claims of the '504 Patent			
D544	Exhibit Cisco-6, Cisco's Prior Art Systems ¹ vs. Claims of the '759 Patent			
D545	Exhibit Cisco-7, Cisco's Prior Art PIX System ¹ vs. Claims of the '759 Patent			

Subst. for form 1449/PTO INFORMATION DISCLOSURE STATEMENT BY APPLICANT <i>(Use as many sheets as necessary)</i>		Complete if Known	
		Application Number	13/342,795
		Filing Date	01-03-2012
		First Named Inventor	Victor Larson
		Art Unit	2453
		Examiner Name	Krisna Lim
		Docket Number	77580-155(VR NK-1CP3CNFT5)
D546	Exhibit A: Copy of U.S. Patent No. 6,502,135		
D547	Exhibit A: Copy of U.S. Patent No. 7,490,151		
D548	Exhibit B: Certificate of Service to Request For Inter Partes Reexamination Under 35 U.S.C. § 311 (Patent No. 6,502,135)		
D549	Exhibit B: Certificate of Service to Request For Inter Partes Reexamination Under 35 U.S.C. § 311 (Patent No. 7,490,151)		
D550	Exhibit B-1: File History of U.S. Patent 6,502,135		
D551	Exhibit B-2: Reexamination Record No. 95/001,269		
D552	Exhibit C1: Claim Chart – Aventail Connect v3.1 (Patent No. 6,502,135)		
D553	Exhibit C2: Claim Chart Aventail Connect V3.01 (Patent No. 6,502,135)		
D554	Exhibit C-1: Copy of U.S. Patent No. 7,010,604		
D555	Exhibit C2: Claim Chart Aventail Autosocks (Patent No. 7,490,151)		
D556	Exhibit C1: Claim Chart Aventail Connect v3.01 (Patent No. 7,490,151)		
D557	Exhibit C-2: Provisional Application 60/106,261		
D558	Exhibit C3: Claim Chart Aventail AutoSOCKS (Patent No. 6,502,135)		
D559	Exhibit C3: Claim Chart BinGO (Patent No. 7,490,151)		
D560	Exhibit C-3: Provisional Application 60/137,704		
D561	Exhibit C4: Claim Chart Wang (Patent No. 6,502,135)		
D562	Exhibit C4: Claim Chart Beser (Patent No. 7,490,151)		
D563	Exhibit C5: Claim Chart Beser (Patent No. 6,502,135)		
D564	Exhibit C5: Claim Chart Wang (Patent No. 7,490,151)		
D565	Exhibit C6: Claim Chart BinGO (Patent No. 6,502,135)		
D566	Exhibit D: Memorandum Opinion in <i>VirnetX v. Microsoft</i> .		
D567	Exhibit D-1: Takahiro Kiuchi and Shigekoto Kaihara, "C-HTTP – The Development of a Secure, Closed HPPT-Based Network on the Internet," Published in the Proceedings of SNDSS 1996.		
D568	Exhibit D-10: D.E. Denning and G.M. Sacco, "Time-stamps in Key Distribution Protocols," Communications of the ACM, Vol. 24, N.8, pp. 533-536. August 1981.		
D569	Exhibit D-11: C.I. Dalton and J.F. Griffin, "Applying Military Grade Security to the Internet," Proceedings of the 8th Joint European Networking Conference (JENC 8), (May 12-15 1997).		

Subst. for form 1449/PTO			Complete if Known	
			Application Number	13/342,795
INFORMATION DISCLOSURE STATEMENT BY APPLICANT <i>(Use as many sheets as necessary)</i>			Filing Date	01-03-2012
			First Named Inventor	Victor Larson
			Art Unit	2453
			Examiner Name	Krisna Lim
			Docket Number	77580-155(VRNL-1CP3CNFT5)
D570	Exhibit D-12: Steven M. Bellovin and Michael Merritt, "Encrypted Key Exchange: Password-Based protocols Secure against Dictionary Attacks," 1992 IEEE Symposium on Security and Privacy (1992).			
D571	Exhibit D-2: Copy of U.S. Pat. No. 5,898,830			
D572	Exhibit D-3: Eduardo Solana and Jürgen Harms, "Flexible Internet Secure Transactions Based on Collaborative Domains," Security Protocols Workshop 1997, pp. 37-51.			
D573	Exhibit D-4: Copy of U.S. Pat. No. 6,119,234			
D574	Exhibit D-5: Jeff Sedayao, "Mosaic Will Kill My Network! - Studying Network Traffic Patterns of Mosaic Use," in Electron. Proc. 2nd World Wide Web Conf.'94: Mosaic and the Web, Chicago, IL, Oct. 1994.			
D575	Exhibit D-6: M. Luby Juels and R. Ostrovsky, "Security of Blind Digital Signatures," Crypto '97, LNCS 1294, pages 150-164, Springer-Verlag, Berlin, 1997.			
D576	Exhibit D-8: David M. Martin, "A Framework for Local Anonymity in the Internet," Technical Report. Boston University, Boston, MA, USA (Feb 21, 1998).			
D577	Exhibit D-9: Copy of U.S. Pat. No. 7,764,231			
D578	Exhibit E-1: Claim Charts Applying Kiuchi and Other References to Claims of the '135 Patent.			
D579	Exhibit E1: Declaration of Chris Hopen (Patent No. 6,502,135)			
D580	Exhibit E1: Declaration of Chris Hopen (Patent No. 7,490,151)			
D581	Exhibit E-2: Claim Charts Applying Wesinger and Other References to Claims of the '135 Patent.			
D582	Exhibit E2: Declaration of Michael Fratto (Patent No. 6,502,135)			
D583	Exhibit E2: Declaration of Michael Fratto (Patent No. 7,490,151)			
D584	Exhibit E-3: Claim Charts Applying Solana and Other References to Claims of the '135 Patent.			
D585	Exhibit E3: Declaration of James Chester (Patent No. 6,502,135)			
D586	Exhibit E3: Declaration of James Chester (Patent No. 7,490,151)			
D587	Exhibit E-4: Claim Charts Applying Aziz and Other References to Claims of the '135 Patent.			
D588	Exhibit X1: Aventail Connect Administrator's Guide v3.1/v2.6., PP 1-20 (1996-1999)			
D589	Exhibit X10: Copy of U.S. Patent No. 4,885,778			
D590	Exhibit X11: Copy of U.S. Patent No. 6,615,357			
D591	Exhibit X2: Aventail Connect Administrator's Guide v3.01/v2.51., PP 1-116 (1996-1999)			
D592	Exhibit X3: Aventail AutoSOCKS Administration & User's Guide v2.1., PP 1-70 (1996-1999)			
D593	Exhibit X4: Reed et al., "Proxies for Anonymous Routine," 12th Annual Computer Security Applications Conference, San Diego, CA, December -9-13, pp 1-10 (1996).			

Subst. for form 1449/PTO			Complete if Known	
			Application Number	13/342,795
INFORMATION DISCLOSURE STATEMENT BY APPLICANT (Use as many sheets as necessary)			Filing Date	01-03-2012
			First Named Inventor	Victor Larson
			Art Unit	2453
			Examiner Name	Krisna Lim
			Docket Number	77580-155(VRNL-1CP3CNFT5)
D594	Exhibit X5: Wang, The Broadband Forum Technical Report, "TR-025 – Core Network Architecture Recommendations for Access to Legacy Data Networks over ADSL," Issue 1.0; pp. 1-24 , v1.0 (1999).			
D595	Exhibit X6: Copy of U.S. Patent No. 6,496,867			
D596	Exhibit X7: BinGO! User's Guide Incorporating by Reference BinGO! Extended Feature Reference.			
D597	Exhibit X7: Kent et al., "Security Architecture for the Internet Protocol, " Network Working Group Request for Comments (RFC) 2401, pp 1-70 (1998).			
D598	Exhibit X8: Copy of U.S. Patent No. 6,182,141			
D599	Exhibit X9: BinGO! User's Guide v1.6 (1999).			
D600	Exhibit Y1: Aventail Extranet Server 3.0 Administrator's Guide.			
D601	Exhibit Y10: Hanks, S., et al., RFC1701, "Generic Routing Encapsulation (GRE)," 1994, Is Accessible at http://www.ietf.org/rfc/rfc1701.txt .			
D602	Exhibit Y10: Socolofsky, T. et al., RFC 1180, "A TCP/IP Tutorial," January 1991.			
D603	Exhibit Y11: Simpson, W., editor, RFC 1661, "The Point-to-Point Protocol (PPP)," July 1994.			
D604	Exhibit Y11: Simpson, W., RFC1994, "PPP Challenge Handshake Authentication Protocol (CHAP)," 1996, http://www.ietf.org/rfc/rfc1994.txt .			
D605	Exhibit Y12: Meyer, G., RFC 1968, "The PPP Encryption Control Protocol (ECP)," June 1996.			
D606	Exhibit Y12: Perkins, D., RFC1171, "The Point-To-Point Protocol for the Transmission of Multi-Protocol Datagrams over Point-To-Point Links," 1990, Is Accessible at http://www.ietf.org/rfc/rfc1171.txt .			
D607	Exhibit Y13: Kummert, H., RFC 2420, "The PPP Triple-DES Encryption Protocol (3DESE)," September, 1998.			
D608	Exhibit Y14: Townsley, W.M., et al., RFC 2661, "Layer Two Tunneling Protocol 'L2TP,'" August 1999.			
D609	Exhibit Y15: Pall, G.S., RFC 2118, "Microsoft Point-To-Point Encryption (MPPE) Protocol," March 1997.			
D610	Exhibit Y16: Gross, G., et al., RFC 2364, "PPP Over AAL5," July 1998.			
D611	Exhibit Y17: Srisuresh, P., RFC 2663, "IP Network Address Translator (NAT) Terminology and Considerations," August 1999.			
D612	Exhibit Y18: Heinanen, J., RFC 1483, "Multiprotocol Encapsulation over ATM Adaptation Layer 5," July 1993.			
D613	Exhibit Y2: Goldschlag et al., "Hiding Routing Information" (1996).			
D614	Exhibit Y3: Copy of U.S. Patent No. 5,950,519			
D615	Exhibit Y4: Ferguson, P. and Huston, G., "What Is a VPN", The Internet Protocol Journal, Vol 1., No. 1 (June 1998 ("Ferguson").			
D616	Exhibit Y5: Mockapetris, P., RFC 1034, "Domain Names – Concepts and Facilities," November 1987 ("RFC1034").			

Subst. for form 1449/PTO INFORMATION DISCLOSURE STATEMENT BY APPLICANT <i>(Use as many sheets as necessary)</i>			Complete if Known	
			Application Number	13/342,795
			Filing Date	01-03-2012
			First Named Inventor	Victor Larson
			Art Unit	2453
			Examiner Name	Krisna Lim
			Docket Number	77580-155(VRNL-1CP3CNFT5)
D617	Exhibit Y6: Mockapetris, P., RFC 1035, "Domain Names – Implementation and Specification," November 1987 ("RFC1035").			
D618	Exhibit Y8: Fielding, R., et al., RFC 2068, "Hypertext Transfer Protocol – HTTP/1.1," January 1997.			
D619	Exhibit Y8: Woodburn, R.A., et al., RFC1241, "A Scheme for an Internet Encapsulation Protocol: Version 1," 1991.			
D620	Exhibit Y9: Leech, M., et al., RFC 1928, "Socks Protocol Version 5," March 1996.			
D621	Exhibit Y9: Simpson, W., RFC1853, "IP in IP Tunneling," 1995, Is Accessible at http://www.ietf.org/rfc/rfc1583.txt .			
D622	Form PTO/SB/42, Listing Each Patent and Printed Publication Relied Upon to Provide a Substantial New Question of Patentability (Patent No. 6,502,135)			
D623	Form PTO/SB/42, Listing Each Patent and Printed Publication Relied Upon to Provide a Substantial New Question of Patentability (Patent No. 7,490,151)			
D624	Request for Inter Partes Reexamination (Patent No. 6,502,135)			
D625	Request for Inter Partes Reexamination Transmittal Form (PTO/SB/58) (Patent No. 6,502,135)			
D626	Request for Inter Partes Reexamination Transmittal Form (PTO/SB/58) (Patent No. 7,490,151)			
D627	Request for Inter Partes Reexamination Under 35 U.S.C. § 311 (Patent No. 6,502,135)			
D628	Request for Inter Partes Reexamination Under 35 U.S.C. § 311 (Patent No. 7,490,151)			
D629	Transmittal Letter (Patent No. 6,502,135)			
D630	Transmittal Letter (Patent No. 7,490,151)			
D631	Joint Claim Construction and Prehearing Statement			
D632	Exhibit A: Agreed Upon Terms; P.R. 4-3 Joint Claims Construction and Prehearing Statement			
D633	Exhibit B: Disputed Claim Terms; P.R. 4-3 Joint Claim Construction and Prehearing Statement			
D634	Exhibit C; VirnetX's Proposed Construction of Claim Terms and Supporting Evidence			
D635	Exhibit D; Defendants' Intrinsic and Extrinsic Support; P.R. 4-3 Joint Claim Construction and Prehearing Statement			
D636	File History of U.S. Patent 6,839,759			
D637	Exhibit B-4; VirnetX, Inc. v. Microsoft Corp., Case No. 6:07-cv-80, Microsoft's Motion for Partial Summary Judgment of Invalidity of U.S. Patent No. 6,839,759 (E.D. Tex. Dec. 18, 2009)			
D638	Exhibit D-2; Kent et al., "Security Architecture for the Internet Protocol," Internet Engineering Task Force, Internet Draft, (Feb. 1998)			
D639	Exhibit D-3; Aziz et al., U.S. Patent 5,548,646 to Aziz et al., "System for Signatureless Transmission and Reception of Data Packets Between Computer Networks," Filed Sept. 15, 1994 and issued Aug. 20, 1996			

Subst. for form 1449/PTO INFORMATION DISCLOSURE STATEMENT BY APPLICANT <i>(Use as many sheets as necessary)</i>		Complete if Known	
		Application Number	13/342,795
		Filing Date	01-03-2012
		First Named Inventor	Victor Larson
		Art Unit	2453
		Examiner Name	Krisna Lim
		Docket Number	77580-155(VR NK-1CP3CNFT5)
D640	Exhibit D-4; Yinger; U.S. Patent 5,960,204 to Yinger et al., "System and Method for Installing Applications on a Computer on an as needed basis, Filed on October 28, 1996 and Issued September 28, 1999		
D641	Exhibit D-8; Barlow; U.S. Patent 5,204,961 to Barlow, "Computer Network Operating with Multilevel Hierarchical Security with Selectable Common Trust Realms and Corresponding Security Protocols," Filed on June 25, 1990 and Issued April 20, 1993		
D642	Exhibit D-12; RFC 1122, Braden, "Requirements for Internet Hosts - Communication Layers," RFC 1122 (Oct. 1989)		
D643	Exhibit D-13; RFC 791; Information Sciences Institute, "Internet Protocol," DARPA Internet Program Specification RFC 791 (Sept. 1981)		
D644	Exhibit D-14; Caronni et al., "SKIP - Securing the Internet," 5th International Workshops on Enabling Technologies: Infrastructure for Collaborative Enterprises (WET ICE '96) (June 19-21, 1996)		
D645	Exhibit D-15; Maughan et al., "Internet Security Association and Key Management Protocol (ISAKMP)," IPSEC Work Group Draft (July 26, 1997)		
D646	Exhibit E-1; Claim Charts Applying Kiuchi as a Primary Reference to the '759 Patent.		
D647	Exhibit E-2; Claim Charts Applying Kent as a Primary Reference to the '759 Patent		
D648	Exhibit E-3; Claim Charts Applying Aziz as a Primary Reference to the '759 Patent		
D649	Exhibit E-4; Claim Charts Applying Kent in view of Caronni as a Primary Combination of References to the '759 Patent		
D650	Exhibit D-5; Edwards et al., "High Security Web Servers and Gateways," Computer Networks and ISDN System 29, pages 927-938 (Sept. 1997)		
D651	Exhibit D-10; Lee et al., "Hypertext Transfer Protocol - HTTP/1.0," RFC 1945 (May 1996)		
D652	Exhibit E-3; Claim Charts Applying Blum to Claims of the '151 Patent		
D653	Exhibit B-1, File History of U.S. Patent 7,490,151		
D654	Exhibit E-1, Claim Charts Applying Kiuchi, and Kiuchi and Martin to Claims of the '151 Patent		
D655	Exhibit E-2, Claim Charts Applying Wesinger, and Wesinger and Martin to Claims of the '151 Patent		
D656	Exhibit E-4, Claim Charts Applying Aziz and Edwards, and Aziz, Edwards, and Martin to Claims of the '151 Patent		
D657	Exhibit E-6, Claim Charts Applying Wesinger and Edwards, and Wesinger, Edwards, and Martin to Claims of the '151 Patent		
D658	VirnetX Inc., V. Mitel Networks Corp.; Defendants' Joint Invalidity Contentions		
D659	Exhibit 37, RFC 2661 ¹ vs. Claims of the '135 Patent ²		
D660	Exhibit 38, RFC 2661 ¹ vs. Claims of the '211 Patent ²		
D661	Exhibit 39, RFC 2661 ¹ vs. Claims of the '504 Patent ²		
D662	Exhibit 40, SecureConnect ¹ vs. Claims of the '135 Patent ²		

Subst. for form 1449/PTO INFORMATION DISCLOSURE STATEMENT BY APPLICANT <i>(Use as many sheets as necessary)</i>			Complete if Known		
			Application Number	13/342,795	
			Filing Date	01-03-2012	
			First Named Inventor	Victor Larson	
			Art Unit	2453	
			Examiner Name	Krisna Lim	
				Docket Number	77580-155(VRNK-1CP3CNFT5)
D663	Exhibit 41, SecureConnect ¹ vs. Claims of the '211 Patent ²				
D664	Exhibit 42, SecureConnect ¹ vs. Claims of the '504 Patent ²				
D665	Exhibit 43, SFS-HTTP ¹ vs. Claims of the '135 Patent ²				
D666	Exhibit 44, SFS-HTTP ¹ vs. Claims of the '211 Patent ²				
D667	Exhibit 45, SFS-HTTP ¹ vs. Claims of the '504 Patent ²				
D668	Exhibit 46, US '883 ¹ vs. Claims of the '135 Patent ²				
D669	Exhibit 47, US '883 ¹ vs. Claims of the '211 Patent ²				
D670	Exhibit 48, US '883 ¹ vs. Claims of the '504 Patent ²				
D671	Exhibit 49, Chuah ¹ vs. Claims of the '135 Patent ²				
D672	Exhibit 50, Chuah ¹ vs. Claims of the '211 Patent ²				
D673	Exhibit 51, Chuah ¹ vs. Claims of the '504 Patent ²				
D674	Exhibit 52, U.S. '648 ¹ vs. Claims of the '135 Patent ²				
D675	Exhibit 53, U.S. '648 ¹ vs. Claims of the '211 Patent ²				
D676	Exhibit 57, B&M VPNs ¹ vs. Claims of the '504 Patent ²				
D677	Exhibit 58, BorderManager ¹ vs. Claims of the '135 Patent ²				
D678	Exhibit 59, BorderManager ¹ vs. Claims of the '211 Patent ²				
D679	Exhibit 60, BorderManager ¹ vs. Claims of the '504 Patent ²				
D680	Exhibit 61, Prestige 128 Plus ¹ vs. Claims of the '135 Patent ²				
D681	Exhibit 62, Prestige 128 Plus ¹ vs. Claims of the '211 Patent ²				
D682	Exhibit 63, Prestige 128 Plus ¹ vs. Claims of the '504 Patent ²				
D683	Exhibit 64, RFC 2401 ¹ vs. Claims of the '135 Patent ²				
D684	Exhibit 65, RFC 2401 ¹ vs. Claims of the '211 Patent ²				
D685	Exhibit 66, RFC 2401 ¹ vs. Claims of the '504 Patent ²				
D686	Exhibit 67, US '072 ¹ vs. Claims of the '135 Patent ²				
D687	Exhibit 68, RFC 2486 ¹ vs. Claims of the '211 Patent ²				
D688	Exhibit 69, RFC 2486 ¹ vs. Claims of the '504 Patent ²				

Subst. for form 1449/PTO INFORMATION DISCLOSURE STATEMENT BY APPLICANT <i>(Use as many sheets as necessary)</i>			Complete if Known	
			Application Number	13/342,795
			Filing Date	01-03-2012
			First Named Inventor	Victor Larson
			Art Unit	2453
			Examiner Name	Krisna Lim
			Docket Number	77580-155(VRNK-1CP3CNFT5)
D689	Exhibit 70 Understanding IPsec ¹ vs. Claims of the '135 Patent ²			
D690	Exhibit 71, Understanding IPsec ¹ vs. Claims of the '211 Patent ²			
D691	Exhibit 72, Understanding IPsec ¹ vs. Claims of the '504 Patent ²			
D692	Exhibit 73, US '820 ¹ vs. Claims of the '135 Patent ²			
D693	Exhibit 74, US '820 ¹ vs. Claims of the '211 Patent ²			
D694	Exhibit 75, US '820 ¹ vs. Claims of the '504 Patent ²			
D695	Exhibit 76, US '019 ¹ vs. Claims of the '211 Patent ²			
D696	Exhibit 77, US '019 ¹ vs. Claims of the '504 Patent ²			
D697	Exhibit 78, US '049 ¹ vs. Claims of the '135 Patent ²			
D698	Exhibit 79, US '049 ¹ vs. Claims of the '211 Patent ²			
D699	Exhibit 80, US '049 ¹ vs. Claims of the '504 Patent ²			
D700	Exhibit 81, US '748 ¹ vs. Claims of the '135 Patent ²			
D701	Exhibit 82, US '261 ¹ vs. Claims of the '135 Patent ²			
D702	Exhibit 83, US '261 ¹ vs. Claims of the '211 Patent ²			
D703	Exhibit 84, US '261 ¹ vs. Claims of the '504 Patent ²			
D704	Exhibit 85, US '900 ¹ vs. Claims of the '135 Patent ²			
D705	Exhibit 86, US '900 ¹ vs. Claims of the '211 Patent ²			
D706	Exhibit 87, US '900 ¹ vs. Claims of the '504 Patent ²			
D707	Exhibit 88, US '671 ¹ vs. Claims of the '135 Patent ²			
D708	Exhibit 89, US '671 ¹ vs. Claims of the '211 Patent ²			
D709	Exhibit 90, US '671 ¹ vs. Claims of the '504 Patent ²			
D710	Exhibit 91, JP '704 ¹ vs. Claims of the '135 Patent ²			
D711	Exhibit 92, JP '704 ¹ vs. Claims of the '211 Patent ²			
D712	Exhibit 93, JP '704 ¹ vs. Claims of the '504 Patent ²			
D713	Exhibit 94, GB '841 ¹ vs. Claims of the '135 Patent ²			
D714	Exhibit 95, GB '841 ¹ vs. Claims of the '211 Patent ²			

Subst. for form 1449/PTO			Complete if Known	
			Application Number	13/342,795
INFORMATION DISCLOSURE STATEMENT BY APPLICANT <i>(Use as many sheets as necessary)</i>			Filing Date	01-03-2012
			First Named Inventor	Victor Larson
			Art Unit	2453
			Examiner Name	Krisna Lim
			Docket Number	77580-155(VR NK-1CP3CNFT5)
D715	Exhibit 96, GB '841 ¹ vs. Claims of the '504 Patent ²			
D716	Exhibit 97, US '318 ¹ vs. Claims of the '135 Patent ²			
D717	Exhibit 98, US '318 ¹ vs. Claims of the '211 Patent ²			
D718	Exhibit 99, US '318 ¹ vs. Claims of the '504 Patent ²			
D719	Exhibit 100, VPN/VLAN ¹ vs. Claims of the '135 Patent ²			
D720	Exhibit 101, Nikkei ¹ vs. Claims of the '135 Patent ²			
D721	Exhibit 102, Nikkei ¹ vs. Claims of the '211 Patent ²			
D722	Exhibit 103, Nikkei ¹ vs. Claims of the '504 Patent ²			
D723	Exhibit 104, Special Anthology ¹ vs. Claims of the '135 Patent ²			
D724	Exhibit 106-A, Gauntlet System ¹ vs. Claims of the '135 Patent ²			
D725	Exhibit 109-A, Gauntlet System ¹ vs. Claims of the '211 Patent ²			
D726	Exhibit 110-A, Gauntlet System ¹ vs. Claims of the '504 Patent ²			
D727	Exhibit 112, IntraPort System ¹ vs. Claims of the '135 Patent ²			
D728	Exhibit 115, IntraPort System ¹ vs. Claims of the '211 Patent ²			
D729	Exhibit 116, IntraPort System ¹ vs. Claims of the '504 Patent ²			
D730	Exhibit 118, Altiga VPN System ¹ vs. Claims of the '135 Patent ²			
D731	Exhibit 121, Altiga VPN System ¹ vs. Claims of the '211 Patent ²			
D732	Exhibit 122, Altiga VPN System ¹ vs. Claims of the '504 Patent ²			
D733	Exhibit 124, Kiuchi ¹ vs. Claims of the '135 Patent ²			
D734	Exhibit 127, Kiuchi ¹ vs. Claims of the '211 Patent ²			
D735	Exhibit 128, Kiuchi ¹ vs. Claims of the '504 Patent ²			
D736	Exhibit 137, Schulzrinne ¹ vs. Claims of the '135 Patent ²			
D737	Exhibit 137, Schulzrinne ¹ vs. Claims of the '135 (Final) Patent ²			
D738	Exhibit 140, Schulzrinne ¹ vs. Claims of the '211 Patent ²			
D739	Exhibit 141, Schulzrinne ¹ vs. Claims of the '504 Patent ²			
D740	Exhibit 143, Solana ¹ vs. Claims of the '135 Patent ²			

Subst. for form 1449/PTO INFORMATION DISCLOSURE STATEMENT BY APPLICANT <i>(Use as many sheets as necessary)</i>			Complete if Known	
			Application Number	13/342,795
			Filing Date	01-03-2012
			First Named Inventor	Victor Larson
			Art Unit	2453
			Examiner Name	Krisna Lim
			Docket Number	77580-155(VR NK-1CP3CNFT5)
D741	Exhibit 146, Solana ¹ vs. Claims of the '211 Patent ²			
D742	Exhibit 147, Solana ¹ vs. Claims of the '504 Patent ²			
D743	Exhibit 155, Marino ¹ vs. Claims of the '135 Patent ²			
D744	Exhibit 158, Marino ¹ vs. Claims of the '211 Patent ²			
D745	Exhibit 159, Marino ¹ vs. Claims of the '504 Patent ²			
D746	Exhibit 168, Aziz ¹ vs. Claims of the '135 Patent ²			
D747	Exhibit 171, U.S. '234 ¹ vs. Claims of the '211 Patent ²			
D748	Exhibit 172, Aziz ¹ vs. Claims of the '504 Patent ²			
D749	Exhibit 175, Valencia ¹ vs. Claims of the '135 Patent ²			
D750	Exhibit 178, Valencia ¹ vs. Claims of the '211 Patent ²			
D751	Exhibit 179, Valencia ¹ vs. Claims of the '504 Patent ²			
D752	Exhibit 181, Davison ¹ vs. Claims of the '135 Patent ²			
D753	Exhibit 184, Davison ¹ vs. Claims of the '211 Patent ²			
D754	Exhibit 185, Davison ¹ vs. Claims of the '504 Patent ²			
D755	Exhibit 200, BinGO! User's Guide/Extended Features Reference ¹ vs. Claims of the '135 Patent ²			
D756	Exhibit 203, Broadband Forum Technical Report TR-025 (Issue 1.0/5.0) ¹ vs. Claims of the '135 Patent ²			
D757	Exhibit 206, RFC 2230, Key Exchange Delegation Record for the DNS ¹ vs. Claims of the '211 Patent ²			
D758	Exhibit 207, RFC 2230, Key Exchange Delegation Record for the DNS ¹ vs. Claims of the '504 Patent ²			
D759	Exhibit 208, RFC 2538, Storing Certificates in the Domain Name System (DNS) ¹ vs. Claims of the '211 Patent ²			
D760	Exhibit 209, RFC 2538, Storing Certificates in the Domain Name System (DNS) ¹ vs. Claims of the '504 Patent ²			
D761	Exhibit 212, RFC 2486, RFC 2661, RFC 2401 and Internet-Draft, "Secure Remote Access with L2TP" ¹ vs. Claims of the '135 Patent ²			
D762	Exhibit 218, U.S. Patent No. 6,496,867 in combination with RFC 2401 ¹ vs. Claims of the '135 Patent ²			
D763	Exhibit 219, U.S. Patent No. 6,496,867 ¹ vs. Claims of the '211 Patent ²			
D764	Exhibit 220, U.S. Patent No. 6,496,867 ¹ vs. Claims of the '504 Patent ²			
D765	Exhibit 222, U.S. Patent No. 6,557,037 ¹ vs. Claims of the '211 Patent ²			

Subst. for form 1449/PTO			Complete if Known	
INFORMATION DISCLOSURE STATEMENT BY APPLICANT <i>(Use as many sheets as necessary)</i>			Application Number	13/342,795
			Filing Date	01-03-2012
			First Named Inventor	Victor Larson
			Art Unit	2453
			Examiner Name	Krisna Lim
			Docket Number	77580-155(VRNL-1CP3CNFT5)
D766	Exhibit 223, U.S. Patent No. 6,557,037 ¹ vs. Claims of the '504 Patent ²			
D767	Exhibit 224, RFC 2230, Key Exchange Delegation Record for the DNS ¹ vs. Claims of the '135 Patent ²			
D768	Exhibit 228, U.S. 588 ¹ vs. Claims of the '211 Patent ² (Final)			
D769	Exhibit 229, U.S. 588 ¹ vs. Claims of the '504 Patent ² (Final)			
D770	Exhibit 230, Microsoft VPN ¹ vs. Claims of the '135 Patent ² (Final)			
D771	Exhibit 231, Microsoft VPN ¹ vs. Claims of the '211 Patent ² (Final)			
D772	Exhibit XX, Microsoft VPN ¹ vs. Claims of the '504 Patent ²			
D773	Exhibit Cisco-1, Cisco's Prior Art System ¹ vs. Claims of the '135 Patent ²			
D774	Exhibit Cisco-4, Cisco's Prior Art System ¹ vs. Claims of the '211 Patent ²			
D775	Exhibit Cisco-5, Cisco's Prior Art System ¹ vs. Claims of the '504 Patent ²			
D776	Exhibit 225, US '037 ¹ vs. Claims of the '135 Patent ²			
D777	Exhibit 226, ITU-T Standardization Activities ¹ vs. Claims of the '135 Patent ²			
D778	Exhibit 227, US '393 ¹ vs. Claims of the '135 Patent ²			
D779	Exhibit 233, The Miller Application ¹ vs. Claim 13 of the '135 Patent ²			
D780	Exhibit 234, Aventail Connect 3.1/2.6 Administrator's Guide ("Aventail Connect") ¹ vs. Claims of the '504 Patent ²			
D781	Exhibit 235, Microsoft VPN ¹ vs. Claims of the '504 Patent ²			
D782	Exhibit 1, IETF RFC 2065: Domain Name System Security Extensions; published January 1997 ¹ vs. Claims of the '211 Patent ²			
D783	Exhibit 2, IETF RFC 2065: Domain Name System Security Extensions; published January 1997 ¹ vs. Claims of the '504 Patent ²			
D784	Exhibit 3, RFC 2543 ¹ vs. Claims of the '135 Patent ²			
D785	Exhibit 4, RFC 2543 ¹ vs. Claims of the '211 Patent ²			
D786	Exhibit 5, RFC 2543 ¹ vs. Claims of the '504 Patent ²			
D787	Exhibit 6, SIP Draft v.2 ¹ vs. Claims of the '135 Patent ²			
D788	Exhibit 7, SIP Draft v.2 ¹ vs. Claims of the '211 Patent ²			
D789	Exhibit 8, SIP Draft v.2 ¹ vs. Claims of the '504 Patent ²			
D790	Exhibit 9, H.323 ¹ vs. Claims of the '135 Patent ²			

Subst. for form 1449/PTO			Complete if Known	
			Application Number	13/342,795
INFORMATION DISCLOSURE STATEMENT BY APPLICANT <i>(Use as many sheets as necessary)</i>			Filing Date	01-03-2012
			First Named Inventor	Victor Larson
			Art Unit	2453
			Examiner Name	Krisna Lim
			Docket Number	77580-155(VRNK-1CP3CNFT5)
D791	Exhibit 10, H.323 ¹ vs. Claims of the '211 Patent ²			
D792	Exhibit 11, H.323 ¹ vs. Claims of the '504 Patent ²			
D793	Exhibit 12, SSL 3.0 ¹ vs. Claims of the '135 Patent ²			
D794	Exhibit 13, SSL 3.0 ¹ vs. Claims of the '211 Patent ²			
D795	Exhibit 14, SSL 3.0 ¹ vs. Claims of the '504 Patent ²			
D796	Exhibit 15, RFC 2487 ¹ vs. Claims of the '135 Patent ²			
D797	Exhibit 16, RFC 2487 ¹ vs. Claims of the '211 Patent ²			
D798	Exhibit 17, RFC 2487 ¹ vs. Claims of the '504 Patent ²			
D799	Exhibit 18, RFC 2595 ¹ vs. Claims of the '135 Patent ²			
D800	Exhibit 21, iPass ¹ vs. Claims of the '135 Patent ²			
D801	Exhibit 22, iPass ¹ vs. Claims of the '211 Patent ²			
D802	Exhibit 23, iPass ¹ vs. Claims of the '504 Patent ²			
D803	Exhibit 24, U.S. Patent No. 6,453,034 ('034 Patent") vs. Claims of the 135 Patent ¹			
D804	Exhibit 25, U.S. Patent No. 6,453,034 ('034 Patent") vs. Claims of the 211 Patent ¹			
D805	Exhibit 26, U.S. Patent No. 6,453,034 ('034 Patent") vs. Claims of the 504 Patent ¹			
D806	Exhibit 27, U.S. Patent No. 6,223,287 ("287 Patent") vs. Claims of the 135 Patent ¹			
D807	Exhibit 28, U.S. Patent No. 6,223,287 ("287 Patent") vs. Claims of the 211 Patent ¹			
D808	Exhibit 29, U.S. Patent No. 6,223,287 ("287 Patent") vs. Claims of the 504 Patent ¹			
D809	Exhibit 35, RFC 1928 ¹ vs. Claims of the '211 Patent ²			
D810	Exhibit 36, RFC 1928 ¹ vs. Claims of the '504 Patent ²			
D811	Exhibit 106, Gaunlet System and Gaunlet References ¹ vs. Claims of the '135 Patent ²			
D812	Exhibit 109, Gaunlet System and Gaunlet References ¹ vs. Claims of the '211 Patent ²			
D813	Exhibit 110, Gaunlet System ¹ vs. Claims of the '504 Patent ²			
D814	Exhibit 130, Overview of Access VPNs and Tunneling Technologies ("Overview") ¹ vs. Claims of the '135 Patent ²			
D815	Exhibit 133, Overview of Access VPNs and Tunneling Technologies ("Overview") ¹ vs. Claims of the '211 Patent ²			

Subst. for form 1449/PTO			Complete if Known	
			Application Number	13/342,795
INFORMATION DISCLOSURE STATEMENT BY APPLICANT <i>(Use as many sheets as necessary)</i>			Filing Date	01-03-2012
			First Named Inventor	Victor Larson
			Art Unit	2453
			Examiner Name	Krisna Lim
			Docket Number	77580-155(VR NK-1CP3CNFT5)
D816	Exhibit 134, Overview of Access VPNs and Tunneling Technologies ("Overview") ¹ vs. Claims of the '504 Patent ²			
D817	Exhibit 149, Atkinson ¹ vs. Claims of the '135 Patent ²			
D818	Exhibit 152, Atkinson ¹ vs. Claims of the '211 Patent ²			
D819	Exhibit 153, Atkinson ¹ vs. Claims of the '504 Patent ²			
D820	Exhibit 162, Wesinger ¹ vs. Claims of the '135 Patent ²			
D821	Exhibit 165, Wesinger ¹ vs. Claims of the '211 Patent ²			
D822	Exhibit 166, Wesinger ¹ vs. Claims of the '504 Patent ²			
D823	Exhibit 187, AutoSOCKS v2.1 ¹ vs. Claims of the '135 Patent ²			
D824	Exhibit 191, Aventail Connect 3.01/2.51 ("Aventail Connect") ¹ vs. Claims of the '135 Patent ²			
D825	Exhibit 195, Aventail Connect 3.1/2.6 Administrator's Guide ("Aventail Connect") ¹ vs. Claims of the '135 Patent ²			
D826	Exhibit 204, Domain Name System (DNS) Security ¹ vs. Claims of the '211 Patent ²			
D827	Exhibit 205, Domain Name System (DNS) Security ¹ ("DNS Security") vs. Claims of the '504 Patent ²			
D828	Exhibit 210, Lendenmann ¹ vs. Claims of the '211 Patent ²			
D829	Exhibit 211, Lendenmann ¹ vs. Claims of the '504 Patent ²			
D830	Exhibit 213, U.S. Patent No. 7,100,195 in combination with RFC 2401 and U.S. Patent No. 6,496,867 ¹ vs. Claims of the '135 Patent ²			
D831	Exhibit 215, Aziz ¹ vs. Claims of the '135 Patent ²			
D832	Cisco '180, Efiling Acknowledgment			
D833	Exhibit A, U.S. Patent 7,188,180			
D834	Exhibit B1, File History of U.S. Patent 7,188,180			
D835	Exhibit B2, File History of U.S. Patent Application No. 09/588,209			
D836	Exhibit B3, File History of Reexamination Control No. 95/001,270, Reexamination of U.S. 7,188,180 requested by Microsoft Corp			
D837	Exhibit D1, "Lendenmann": Rolf Lendenman, Understanding OSF DCE 1.1 For AIX and OS/2, IBM International Technical Support Organization (Oct. 1995).			
D838	Exhibit D5, "Schneier": Bruce Schneier, Applied Cryptography (1996)			
D839	Exhibit D6, RFC 793; Information Sciences Institute, "Transmission Control Protocol," DARPA Internet Program Specification RFC 793 (Sept. 1981)			
D840	Exhibit D7, "Schimpf"; Brian C. Schimpf, "Securing Web Access with DCE," Presented at Network and Distributed System Security (Feb. 10-11, 1997)			

Subst. for form 1449/PTO			Complete if Known	
			Application Number	13/342,795
INFORMATION DISCLOSURE STATEMENT BY APPLICANT <i>(Use as many sheets as necessary)</i>			Filing Date	01-03-2012
			First Named Inventor	Victor Larson
			Art Unit	2453
			Examiner Name	Krisna Lim
			Docket Number	77580-155(VRNL-1CP3CNFT5)
D841	Exhibit D8, "Rosenberry"; Ward Rosenberry, David Kenney, and Gerry Fisher, Understanding DCE (1993)			
D842	Exhibit D9, Masys; Daniel R. Masys & Dixie B. Baker, "Protecting Clinical Data on Web Client Computers: The PCASSO Approach," Proceedings of the AMIA '98 Annual Symposium, Orlando, Florida (Nov. 7-11, 1998)			
D843	Exhibit E1, Claim Charts Applying Lendenmann as a Primary Reference to the '180 Patent.			
D844	Exhibit E2, Claim Charts Applying Kiuchi as a Primary Reference to the '180 Patent			
D845	Exhibit E3, Claim Charts Applying Solana as a Primary Reference to the '180 Patent			
D846	Exhibit E4, Claim Charts Applying Schimpf and Rosenberry as a Primary Reference to the '180 Patent			
D847	Request for Inter Partes Reexamination of Patent No. 7,188,180			
D848	Modified PTO Form 1449			
D849	Request for Inter Partes Reexamination Transmittal Form No. 7,188,180			
D850	Exhibit A; U.S. Patent 7,921,211 with Terminal Disclaimer			
D851	Exhibit B, Certificate of Service to Request For Inter Partes Reexamination Under 35 U.S.C. § 311 (Patent No. 7,921,211)			
D852	Exhibit C1, Claim Chart – USP 7,921,211 Relative to Solana, Alone and in Conjunction with RFC 920, Reed and Beser			
D853	Exhibit C2, Claim Chart – USP 7,921,211 Relative to Solana in view of RFC 2504 and Further in conjunction with RFC 920, Reed, and Beser			
D854	Exhibit C3, Claim Chart – USP 7,921,211 Relative to Provino, Alone and in Conjunction with RFC 920, Reed, and Beser)			
D855	Exhibit C4, Claim Chart – USP 7,921,211 Relative to Provino in view of RFC 2230 and Further in Conjunction with RFC 920, Reed and Beser			
D856	Exhibit C5, Claim Chart – USP 7,921,211 Relative to Provino in view of RFC 2504 and in Further Conjunction with RFC 920, Reed and Beser			
D857	Exhibit C6, Claim Chart – USP 7,921,211 Relative to Beser, Alone and in Conjunction with RFC 920, RFC 2401, and Reed			
D858	Exhibit C7, Claim Chart – USP 7,921,211 Relative to RFC 2230, Alone and in Conjunction with RFC 920, RFC 2401, Reed, and Beser			
D859	Exhibit C8, Claim Chart – USP 7,921,211 Relative to RFC 2538, Alone and in Conjunction with RFC 920, RFC 2401, Reed, Beser, and RFC 2065			
D860	Exhibit D1, Asserted Claim and Infringement Contentions by Plaintiff VirnetX, Inc. in <i>VirnetX, Inc. v. Cisco Systems, Inc., Apple Inc., Aastra Technologies Ltd, NEC Corporation, NEC Corporation of America and Aastra USA, Inc.</i> , Civ. Act 6:2010cv00417 (E.D. Tex)			
D861	Exhibit D2, Asserted Claims and Infringement Contentions by Plaintiff VirnetX, Inc. against Apple based on 7,921,211 Patent			
D862	Exhibit X1, Solana, E. et al. "Flexible Internet Secure Transactions Based on Collaborative Domains"			

Subst. for form 1449/PTO		Complete if Known	
INFORMATION DISCLOSURE STATEMENT BY APPLICANT (Use as many sheets as necessary)		Application Number	13/342,795
		Filing Date	01-03-2012
		First Named Inventor	Victor Larson
		Art Unit	2453
		Examiner Name	Krisna Lim
		Docket Number	77580-155(VR NK-1CP3CNFT5)
D863	Exhibit X2, U.S. Patent 6,557,037		
D864	Exhibit X4, Atkinson, R., IETF RFC 2230, "Key Exchange Delegation Record for the DNS" (November 1997)		
D865	Exhibit X6, Kent, et al., IETF RFC 2401, "Security Architecture for the Internet Protocol" (November 1998) Is Accessible at: http://www.ietf.org/rfc/rfc2401.txt		
D866	Exhibit X7, Eastlake, D. et al., IETF RFC 2065, "Domain Name System Security Extensions" (January 1997) Is Accessible at: http://www.ietf.org/rfc/rfc2065.txt		
D867	Exhibit X9, Guttman, E. et al., IETF RFC 2504, "Users' Security Handbook" (February 1999) Is Accessible At: http://www.ietf.org/rfc/rfc2504.txt		
D868	Exhibit Y3, Braden, R., RFC 1123, "Requirements for Internet Hosts – Application and Support," October 1989 ("RFC1123").		
D869	Exhibit Y4, Atkinson, R., RFC 1825, "Security Architecture for the Internet Protocol (August 1995) Is Accessible At: http://www.ietf.org/rfc/rfc1825.txt		
D870	Exhibit Y5, Housley, R. et al., RFC 2459, "Internet X.509 Public Key Infrastructure Certificate and CRL Profile" (January 1999) Is accessible At: http://www.ietf.org/rfc/rfc2459.txt		
D871	Exhibit A, U.S. Patent 7,418,504		
D872	Exhibit B, Certificate of Service to Request For Inter Partes Reexamination Under 35 U.S.C. § 311 (Patent No. 7,418,504)		
D873	Exhibit C1, Claim Chart – USP 7,418,504 Relative to Solana, Alone and in Conjunction with RFC 920, Reed, and Beser		
D874	Exhibit C2, Claim Chart – USP 7,418,504 Relative to Solana in view of RFC 2504 and Further in Conjunction with RFC 920, Reed, and Beser		
D875	Exhibit C3, Claim Chart – USP 7,418,504 Relative to Provino, Alone and in Conjunction with RFC 920, Reed, and Beser		
D876	Exhibit C4, Claim Chart – USP 7,418,504 Relative to Provino in View of RFC 2230 and Further in Conjunction with RFC 920, Reed and Beser		
D877	Exhibit C5, Claim Chart – USP 7,418,504 Relative to Provino in View of RFC 2504 and in Further Conjunction with RFC 920, Reed, and Beser		
D878	Exhibit C6, Claim Chart – USP 7,418,504 Relative to Beser, Alone and in Conjunction with RFC 920, RFC 2401, and Reed		
D879	Exhibit C7, Claim Chart – USP 7,418,504 Relative to RFC 2230, Alone and in Conjunction with RFC 920, RFC 2401, Reed, and Beser		
D880	Exhibit C8, Claim Chart – USP 7,418,504 Relative to RFC 2538, Alone and in Conjunction with RFC 920, RFC 2401, Reed, Beser, and RFC 2065		
D881	Exhibit D1, Asserted Claims and Infringement Contentions by Plaintiff VirnetX Inc. in <i>VirnetX, Inc. v. Cisco Systems, Inc., Applce, Inc, Aastra Technologies Ltd., NEC Corporation, NEC Corporation of America and Aastra USA, Inc.</i> , Civ. Act. 6:2010cv00417 (E.D. Tex)		
D882	Exhibit D2, Asserted Claims and Infringement Contentions by Plaintiff VirnetX Inc. against Apple Inc. Based on the 7,418,504		
D883	Exhibit X5, Eastlake, D., et al., IETF RFC 2538, "Storing Certificates in the Domain Name System (DNS)" (March 1999)		
D884	Exhibit X6, Kent, S. IETF RFC 2401, "Security Architecture for the Internet Protocol, (November 1998) http://www.ietf.org/rfc/rfc2401.txt		

Subst. for form 1449/PTO INFORMATION DISCLOSURE STATEMENT BY APPLICANT <i>(Use as many sheets as necessary)</i>			Complete if Known	
			Application Number	13/342,795
			Filing Date	01-03-2012
			First Named Inventor	Victor Larson
			Art Unit	2453
			Examiner Name	Krisna Lim
			Docket Number	77580-155(VR NK-1CP3CNFT5)
D885	Exhibit X8, Postel, J. et al., IETF RFC 920, "Domain Requirements" (October 1984) Is Accessible at http://www.ietf.org/rfc/rfc920.txt			
D886	Exhibit X10, Reed, M. et al. "Proxies for Anonymous Routing," 12th Annual Computer Security Applications Conference, San Diego, CA, Dec. 9-13, 1996.			
D887	Request for Inter Partes Reexamination Transmittal form			
D888	Transmittal Letter			
D889	Request for Inter Partes Reexamination Under 35 U.S.C. § 311			
D890	Exhibit D-7, "Thomas": Brian Thomas, "Recipe for E-Commerce, IEEE Internet Computing, (Nov.-Dec. 1997)			
D891	Exhibit D-9, "Kent II": Stephen Kent & Randall Atkinson, "IP Encapsulating Security Payload (ESP)," Internet Engineering Task Force, Internet Draft (Feb. 1998)			
D892	Exhibit C1, Claim Chart – USP 7,921,211 Relative to Solana, Alone and in Conjunction with RFC 920, Reed and Beser (Came from Inval. Cisco dtd 11/18/11)			
D893	Exhibit C2, Claim Chart – USP 7,921,211 Relative to Solana in View of RFC 2504 and Further in Conjunction with RFC 920, Reed, and Beser			
D894	Exhibit C3, Claim Chart – USP 7,921,211 Relative to Provino, Alone and in Conjunction with RFC 920, Reed, and Beser			
D895	Exhibit C4, Claim Chart – USP 7,921,211 Relative to Provino in View of RFC 2230 and Further in Conjunction with RFC 920, Reed and Beser			
D896	Exhibit C5, Claim Chart – USP 7,921,211 Relative to Provino in View of RFC 2504 and in Further Conjunction with RFC 920, Reed and Beser			
D897	Exhibit C6, Claim Chart – USP 7,921,211 Relative to Beser, Alone and in Conjunction with RFC 920, RFC 2401, and Reed			
D898	Exhibit C7, Claim Chart – USP 7,921,211 Relative to RFC 2230, Alone and in Conjunction with RFC 920, Reed, and Beser			
D899	Exhibit C8, Claim Chart – USP 7,921,211 Relative to RFC 2538, Alone and in Conjunction with RFC 920, RFC 2401, Reed, Beser, and RFC 2065			
D900	211 Request for Inter Partes Reexamination			
D901	Exhibit C1, Claim Chart – USP 7,418,504 Relative to Solana, Alone and in Conjunction with RFC 920, Reed and Beser			
D902	Exhibit C2, Claim Chart – USP 7,418,504 Relative to Solana in View of RFC 2504 and Further in Conjunction with RFC 920, Reed, and Beser			
D903	Exhibit C3, Claim Chart – USP 7,418,504 Relative to Provino, Alone and in Conjunction with RFC 920, Reed, and Beser			
D904	Exhibit C5, Claim Chart – USP 7,418,504 Relative to Provino in View of RFC 2504 and in Further Conjunction with RFC 920, Reed and Beser			
D905	Exhibit C6, USP 7,418,504 Relative to Beser, Alone and in Conjunction with RFC 920, RFC 2401, and Reed			
D906	Exhibit C7, Claim Chart – USP 7,418,504 Relative to RFC 2230, Alone and in Conjunction with RFC 920, RFC 2401, Reed, and Beser			

Subst. for form 1449/PTO			Complete if Known	
INFORMATION DISCLOSURE STATEMENT BY APPLICANT <i>(Use as many sheets as necessary)</i>			Application Number	13/342,795
			Filing Date	01-03-2012
			First Named Inventor	Victor Larson
			Art Unit	2453
			Examiner Name	Krisna Lim
			Docket Number	77580-155(VRNL-1CP3CNFT5)
D907	Exhibit C8, Claim Chart – USP 7,418,504 Relative to RFC 2538, Alone and in Conjunction with RFC 920, RFC 2401, Reed, Beser, and RFC 2065			
D908	504 Request for Inter Partes Reexamination			
D909	Defendants' Supplemental Joint Invalidation Contentions			
D910	Exhibit 226, Securing Web Access with DCE ¹ vs. Claims of the '135 Patent ²			
D911	Exhibit 227, Securing Web Access with DCE ¹ vs. Claims of the '151 Patent ²			
D912	Exhibit 228, Understanding OSF DCE 1.1 for AIX and OS/2 ¹ vs. Claims of the '135 Patent ²			
D913	Exhibit 229, Understanding OSF DCE 1.1 for AIX and OS/2 ¹ vs. Claims of the '151 Patent ²			
D914	Exhibit 230, Understanding OSF DCE 1.1 for AIX and OS/2 ¹ vs. Claims of the '180 Patent ²			
D915	Exhibit 231, Understanding OSF DCE 1.1 for AIX and OS/2 ¹ vs. Claims of the '211 Patent ²			
D916	Exhibit 232, Understanding OSF DCE 1.1 for AIX and OS/2 ¹ vs. Claims of the '504 Patent ²			
D917	Exhibit 233, Understanding OSF DCE 1.1 for AIX and OS/2 ¹ vs. Claims of the '759 Patent ²			
D918	Exhibit 234, U.S. '648 ¹ vs. Claims of the '135 Patent			
D919	Exhibit 235, U.S. '648 ¹ vs. Claims of the '211 Patent			
D920	Exhibit 236, U.S. '648 ¹ vs. Claims of the '504 Patent ²			
D921	Exhibit 237, U.S. '648 ¹ vs. Claims of the '135 Patent ²			
D922	Exhibit 238, Gauntlet System ¹ vs. Claims of the '211 Patent ²			
D923	Exhibit 239, Gauntlet System ¹ vs. Claims of the '504 Patent ²			
D924	Exhibit 240, Gauntlet System ¹ vs. Claims of the '135 Patent ²			
D925	Exhibit 241, U.S. '588 ¹ vs. Claims of the '211 Patent ²			
D926	Exhibit 242, U.S. '588 ¹ vs. Claims of the '504 Patent ²			
D927	Exhibit 243, Microsoft VPN ¹ vs. Claims of the '135 Patent ²			
D928	Exhibit 244, Microsoft VPN ¹ vs. Claims of the '211 Patent ²			
D929	Exhibit 245, Microsoft VPN ¹ vs. Claims of the '504 Patent ²			
D930	Exhibit 246, ITU-T Standardization Activities ¹ vs. Claims of the '135 Patent ²			
D931	Exhibit 247, U.S. '393 ¹ vs. Claims of the '135 Patent ²			
D932	Exhibit 248, The Miller Application ¹ vs. Claim 13 of the '135 Patent ²			

Subst. for form 1449/PTO INFORMATION DISCLOSURE STATEMENT BY APPLICANT <i>(Use as many sheets as necessary)</i>			Complete if Known	
			Application Number	13/342,795
			Filing Date	01-03-2012
			First Named Inventor	Victor Larson
			Art Unit	2453
			Examiner Name	Krisna Lim
			Docket Number	77580-155(VRNL-1CP3CNFT5)
D933	Exhibit 249, Gauntlet System ¹ vs. Claims of the '151 Patent ²			
D934	Exhibit 250, ITU-T Standardization Activities ¹ vs. Claims of the '151 Patent ²			
D935	Exhibit 251, U.S. Patent No. 5,940,393 ¹ vs. Claims of the '151 Patent ²			
D936	Exhibit 252, Microsoft VPN ¹ vs. Claims of the '151 Patent ²			
D937	Exhibit 253, U.S. Patent No.6,324,648 ¹ vs. Claims of the '151 Patent ²			
D938	Exhibit 254, U.S. Patent No.6,857,072 ¹ vs. Claims of the '151 Patent ²			
D939	Exhibit A, Aventail Press Release, May 2, 1997			
D940	Exhibit B, InfoWorld, "Aventail Delivers Highly Secure, Flexible VPN Solution," InfoWorld, page 64D, (1997)			
D941	Exhibit C, Aventail AutoSOCKS v2.1 Administrator's Guide			
D942	Exhibit D, Aventail Press Release, October 12, 1998			
D943	Exhibit G, Aventail Press Release, May 26, 1999			
D944	Exhibit H, Aventail Press Release, August 9, 1999			
D945	Exhibit J, "Aventail ExtraNet Center 3.1: Security with Solid Management, Network Computing, June 28, 1999			
D946	Petition in Opposition to Patent Owner's Petition to Vacate Inter Partes ReExamination Determination on Certain Prior Art			
D947	Request for Inter Partes Reexamination Under 35 U.S.C. § 311			
D948	Exhibit B, Certificate of Service to Request for Inter Partes Reexamination Under U.S.C. § 311			
D949	Exhibit C1, Claim Chart Aventail Connect v3.1			
D950	Exhibit C2, Claim Chart Aventail Connect v3.01			
D951	Exhibit C3, Claim Chart Aventail AutoSOCKS			
D952	Exhibit C4, Claim Chart Wang			
D953	Exhibit C5, Claim Chart Beser			
D954	Exhibit C6, Claim Chart BINGO			
D955	Exhibit X6, U.S. Patent 6,496,867			
D956	Exhibit X10, U.S. Patent 4,885,778			
D957	Exhibit X11, U.S. Patent 6,615,357			

Subst. for form 1449/PTO			Complete if Known	
INFORMATION DISCLOSURE STATEMENT BY APPLICANT <i>(Use as many sheets as necessary)</i>			Application Number	13/342,795
			Filing Date	01-03-2012
			First Named Inventor	Victor Larson
			Art Unit	2453
			Examiner Name	Krisna Lim
			Docket Number	77580-155(VR NK-1CP3CNFT5)
D958	Exhibit Y3, U.S. Patent 5,950,519			
D959	Request for Inter Partes Reexamination Transmittal Form			
D960	Transmittal Letter			
D961	Exhibit D, v3.1 Administrator's Guide			
D962	Exhibit E-1, Claim Charts Applying Kiuchi to Various Claims of the '135 Patent			
D963	Exhibit E-2, Claim Charts Applying Wesinger to Various Claims of the '135 Patent			
D964	Exhibit E-3, Claim Charts Applying Solana to Various Claims of the '135 Patent			
D965	Exhibit E-4, Claim Charts Applying Aziz to Various Claims of the '135 Patent			
D966	Request for Inter Partes Reexamination Transmittal Form			
D967	Request for Inter Partes Reexamination			
D968	Request for Inter Partes Reexamination Transmittal Form 1449/PTO			
D969	Exhibit C1, Claim Chart Aventail Connect v3.01			
D970	Exhibit C2, Claim Chart Aventail AutoSOCKS			
D971	Exhibit C3, Claim Chart BINGO			
D972	Exhibit C4, Claim Chart Beser			
D973	Exhibit C5, Claim Chart Wang			
D974	Transmittal Letter			
D975	Request for Inter Partes Reexamination Under 35 U.S.C. § 311			
D976	Exhibit B, Certificate of Service to Request for Inter Partes Reexamination Under 35 U.S.C. § 311			
D977	Exhibit E-1, Claim Charts Applying Kiuchi, and Kiuchi and Martin to Claims of the '151 Patent			
D978	Exhibit E-2, Claim Charts Applying Wesinger, and Wesinger and Martin to Claims of the '151 Patent			
D979	Exhibit E-3, Claim Charts Applying Blum to Claims of the '151 Patent			
D980	Exhibit E-4, Claim Charts Applying Aziz and Edwards, and Aziz, Edwards, and Martin to Claims of the '151 Patent			
D981	Exhibit E-5, Claim Charts Applying Kiuchi and Edwards, and Kiuchi, Edwards, and Martin to Claims of the '151 Patent			
D982	Exhibit E-6, Claim Charts Applying Wesinger and Edwards, and Wesinger, Edwards, and Martin to Claims of the '151 Patent			

Subst. for form 1449/PTO		Complete if Known	
INFORMATION DISCLOSURE STATEMENT BY APPLICANT <i>(Use as many sheets as necessary)</i>		Application Number	13/342,795
		Filing Date	01-03-2012
		First Named Inventor	Victor Larson
		Art Unit	2453
		Examiner Name	Krisna Lim
		Docket Number	77580-155(VR NK-1CP3CNFT5)
D983	Exhibit A, U.S. Patent 6,839,759		
D984	Exhibit C-1, U.S. Patent 6,502,135		
D985	Exhibit E-1, Claim Charts Applying Kiuchi, as Primary Reference to the '759 Patent		
D986	Exhibit E-2, Claim Charts Applying Kent as a Primary Reference to the '759 Patent		
D987	Exhibit E-3, Claim Charts Applying Aziz as a Primary Reference to the '759 Patent		
D988	Exhibit E-4, Claim Charts Applying Kent in View of Caronni as a Primary Combination of References to the '759 Patent		
D989	Request for Inter Partes Reexamination Transmittal Form		
D990	Request for Inter Partes Reexamination		
D991	Request for Inter Partes Reexamination Transmittal(form 1449/PTO)		
D992	Certificate of Service to Request for Inter Partes Reexamination Under 35 U.S.C. § 311		
D993	Request for Inter Partes Reexamination		
D994	Request for Inter Partes Reexamination Transmittal Form		
D995	Request for Inter Partes Reexamination		
D996	Request for Inter Partes Reexamination Transmittal Form		
D997	Exhibit C1, Claim Chart – USP 7,921,211 Relative to Solana, Alone and in Conjunction with RFC 920, Reed and Beser		
D998	Exhibit C2, Claim Chart – USP 7,921,211 Relative to Solana in view of RFC 2504 and Further in conjunction with RFC 920, Reed, and Beser		
D999	Exhibit C3, Claim Chart – USP 7,921,211 Relative to Provino, Alone and in Conjunction with RFC 920, Reed, and Beser		
D1000	Exhibit C4, Claim Chart – USP 7,921,211 Relative to Provino in view of RFC 2230 and Further in Conjunction with RFC 920, Reed and Beser		
D1001	Exhibit C5, Claim Chart – USP 7,921,211 Relative to Provino in view of RFC 2504 and in Further Conjunction with RFC 920, Reed and Beser		
D1002	Exhibit C6, Claim Chart – USP 7,921,211 Relative to Beser, Alone and in Conjunction with RFC 920, RFC 2401, and Reed		
D1003	Exhibit C7, Claim Chart – USP 7,921,211 Relative to RFC 2230, Alone and in Conjunction with RFC 920, RFC 2401, Reed, and Beser		
D1004	Exhibit C8, Claim Chart – USP 7,921,211 Relative to RFC 2538, Alone and in Conjunction with RFC 920, RFC 2401, Reed, Beser, and RFC 2065		
D1005	Exhibit D1, Asserted Claim and Infringement Contentions by Plaintiff VirnetX, Inc. in <i>VirnetX, Inc. v. Cisco Systems, Inc., Apple Inc., Aastra Technologies Ltd, NEC Corporation, NEC Corporation of America and Aastra USA, Inc.</i> , Civ. Act 6:2010cv00417 (E.D. Tex)		
D1006	Exhibit D2, Asserted Claims and Infringement Contentions by Plaintiff VirnetX, Inc. against Apple based on 7,921,211 Patent		

Subst. for form 1449/PTO		Complete if Known	
INFORMATION DISCLOSURE STATEMENT BY APPLICANT <i>(Use as many sheets as necessary)</i>		Application Number	13/342,795
		Filing Date	01-03-2012
		First Named Inventor	Victor Larson
		Art Unit	2453
		Examiner Name	Krisna Lim
		Docket Number	77580-155(VR NK-1CP3CNFT5)
D1007	Exhibit B1, File History of U.S. Patent 7,418,504		
D1008	Exhibit B2, File History of U.S. Patent Application No. 09/558,210		
D1009	Exhibit D-10, Gaspoz et al., "VPN on DCE: From Reference Configuration to Implementation," Bringing Telecommunication Services to the People – IS&N '95, Third International Conference on Intelligence in Broadband Services and Networks, October 1995 Proceedings, Lecture Notes in Computer Science, Vol. 998 (Springer, 1995)		
D1010	Exhibit D-11, Copy of U.S. Patent No. 6,269,099		
D1011	Exhibit D-11, Copy of U.S. Patent No. 6,560,634		
D1012	Exhibit D-13, Pallen, "The World Wide Web," British Medical Journal, Vol. 311 at 1554 (Dec. 1995)		
D1013	Exhibit D-14, Rivest et al., "A Method for Obtaining Digital Signatures and Public-Key Cryptosystems," Communications of the ACM, 21:120-126 (Feb. 1978)		
D1014	Exhibit D-15, Copy of U.S. Patent No. 4,952,930		
D1015	Exhibit D-17, Pfaffenberger, Netscape Navigator 3.0: Surfing the Web and Exploring the Internet, Academic Press (1996)		
D1016	Exhibit D-18, Gittler et al., "The DCE Security Service," Hewlett-Packard Journal, pages 41-48 (Dec. 1995)		
D1017	Exhibit D-6, Copy of U.S. Patent No. 5,689,641		
D1018	Exhibit D-9, Lawton, "New Top-Level Domains Promise Descriptive Names," Sunworld Online, 1996		
D1019	Exhibit E-1, Copy of Catalog Listing by IBM for RS/6000 Redbooks Collection which includes a Link to the <i>Lendenmann</i> reference. The link to the <i>Lendenmann</i> reference was archived at archive.org on December 7, 1998 and retrieved by the Wayback Machine		
D1020	Exhibit E-10, copy of an Archived Version of the Lawton reference archived at archive.org on February 19, 1999 and retrieved by the Wayback Machine		
D1021	Exhibit E-11, Abstracts of the Proceedings of the Symposium on Network and Distributed System Security, 1996, Archived at archive.org on April 10, 1997, and retrieved by the Wayback Machine		
D1022	Exhibit E-12, 1996 Symposium on Network and Distributed System Security, Website Archived by archive.org (Apr. 10, 1997), Retrieved by the Wayback Machine at http://web.archive.org/web/19970410114853/http://computer.org/cspress/catalog/proc9.htm .		
D1023	Exhibit E-13, Copy of Search Results for ISBN 0-12-553153-2 (Pfaffenberger) from www.isbnsearch.org		
D1024	Exhibit F-1, Claim Charts applying Lendenmann as a Primary Reference to the '504 Patent.		
D1025	Exhibit F-2, Claim Charts applying Aziz as a Primary Reference to the '504 Patent		
D1026	Exhibit F-3, Claim Charts applying Kiuchi and Pfaffenberger as Primary References to the '504 Patent		
D1027	Exhibit E-2, First Page of U.S. Patent No. 5,913,217 published June 15, 1999 and citing a portion of the Lendenmann reference as a prior art reference		
D1028	Exhibit E-3, Request for Comments 2026, "The Internet Standards Process – Revision 3," October 1996		

Subst. for form 1449/PTO			Complete if Known	
INFORMATION DISCLOSURE STATEMENT BY APPLICANT <i>(Use as many sheets as necessary)</i>			Application Number	13/342,795
			Filing Date	01-03-2012
			First Named Inventor	Victor Larson
			Art Unit	2453
			Examiner Name	Krisna Lim
			Docket Number	77580-155(VRNL-1CP3CNFT5)
D1029	Exhibit E-4, First Page of U.S. 5,463,735, published October 31, 1995 and citing RFC 793 as a prior art Reference			
D1030	Exhibit E-5, Copy of catalog listing from Boston University Digital Common Website, listing the Martin reference with an issue date of February 21, 1998			
D1031	Exhibit E-6, Copy of Technical Reports Archive Listing from Boston University Computer Science Department which includes a link to the Martin paper. The link to the Martin paper was archived at archive.org on January 22, 1998 and Retrieved by the Wayback Machine			
D1032	Exhibit E-7, Boston University Computer Science Department Technical Reports Instructions, available at: http://www.cs.bu.edu/techreports/INSTRUCTIONS			
D1033	Exhibit E-8, U. Möller, "Implementation eines Anonymisierungsverfahrens für WWW-Zugriffe," Diplomarbeit, Universität Hamburg (July 16, 1999), citing to Martin at page 77.			
D1034	Exhibit E-9, First page of U.S. 5,737,423, published April 7, 1998 and citing Schneier as Prior Art Reference			
D1035	Request for Inter Partes ReExamination; U.S. Patent 7,418,504			
D1036	Request for Inter Partes ReExamination Transmittal Form; U.S. Patent 7,418,504			
D1037	Request for Inter Partes Reexamination Transmittal (Form 1449/PTO) 7,418,504			
D1038	Exhibit C1, Claim Chart – USP 7,921,211 relative to Solana, alone and in conjunction with RFC 920, Reed and Beser			
D1039	Exhibit C2, Claim Chart – USP 7,921,211 relative to Solana in view of RFC 2504 and further in conjunction with RFC 920, Reed, and Beser			
D1040	Exhibit C3, Claim Chart – USP 7,921,211 relative to Provino, alone and in conjunction with RFC 920, Reed, and Beser			
D1041	Exhibit C4, Claim Chart – USP 7,921,211 relative to Provino in view of RFC 2230 and further in conjunction with RFC 920, Reed and Beser			
D1042	Exhibit C5, Claim Chart – USP 7,921,211 relative to Provino in view of RFC 2504 and in further conjunction with RFC 920, Reed and Beser			
D1043	Exhibit C6, Claim Chart – USP 7,921,211 relative to Beser, Alone and in conjunction with RFC 920, RFC 2401, and Reed			
D1044	Exhibit C7, Claim Chart – USP 7,921,211 relative to RFC 2230, alone and in conjunction with RFC 2401, Reed, and Beser			
D1045	Exhibit C8, Claim Chart – USP 7,921,211 relative to RFC 2538, alone and in conjunction with RFC 920, RFC 2401, Reed, Beser, and RFC 2065			
D1046	Request for Inter Partes Reexamination under 35 U.S.C. § 311			
D1047	Exhibit C1, Claim Chart – USP 7,418,504 relative to Solana, alone and in conjunction with RFC 920, Reed and Beser			
D1048	Exhibit C2, Claim Chart – USP 7,418,504 relative to Solana in view of RFC 2504 and further in conjunction with RFC 920, Reed, and Beser			
D1049	Exhibit C3, Claim Chart – USP 7,418,504 relative to Provino, alone and in conjunction with RFC 920, Reed, and Beser			
D1050	Exhibit C5, Claim Chart – USP 7,418,504 relative to Provino in view of RFC 2504 and in further conjunction with RFC 920, Reed and Beser			

Subst. for form 1449/PTO INFORMATION DISCLOSURE STATEMENT BY APPLICANT <i>(Use as many sheets as necessary)</i>			Complete if Known	
			Application Number	13/342,795
			Filing Date	01-03-2012
			First Named Inventor	Victor Larson
			Art Unit	2453
			Examiner Name	Krisna Lim
	Docket Number	77580-155(VRNL-1CP3CNFT5)		
D1051	Exhibit C6, USP 7,418,504 relative to Beser, alone and in conjunction with RFC 920, RFC 2401, and Reed			
D1052	Exhibit C7, Claim Chart – USP 7,418,504 relative to RFC 2230, alone and in conjunction with RFC 920, RFC 2401, Reed, and Beser			
D1053	Exhibit C8, Claim Chart – USP 7,418,504 relative to RFC 2538, alone and in conjunction with RFC 920, RFC 2401, Reed, Beser, and RFC 2065			
D1054	Request for Inter Partes Reexamination under 35 U.S.C. § 311			
D1055	Exhibit 226, Securing Web Access with DCE ¹ vs. Claims of the '135 Patent ²			
D1056	Exhibit 227, Securing Web Access with DCE ¹ vs. Claims of the '151 Patent ²			
D1057	Exhibit 228, Understanding OSF DCE 1.1 for AIX and OS/2 ¹ vs. Claims of the '135 Patent ²			
D1058	Exhibit 229, Understanding OSF DCE 1.1 for AIX and OS/2 ¹ vs. Claims of the '151 Patent ²			
D1059	Exhibit 230, Understanding OSF DCE 1.1 for AIX and OS/2 ¹ vs. Claims of the '180 Patent ²			
D1060	Exhibit 231, Understanding OSF DCE 1.1 for AIX and OS/2 ¹ vs. Claims of the '211 Patent ²			
D1061	Exhibit 232, Understanding OSF DCE 1.1 for AIX and OS/2 ¹ vs. Claims of the '504 Patent ²			
D1062	Exhibit 233, Understanding OSF DCE 1.1 for AIX and OS/2 ¹ vs. Claims of the '759 Patent ²			
D1063	Exhibit 234, U.S. '648 ¹ vs. Claims of the '135 Patent ²			
D1064	Exhibit 235, U.S. '648 ¹ vs. Claims of the '211 Patent ²			
D1065	Exhibit 236, U.S. '648 ¹ vs. Claims of the '504 Patent ²			
D1066	Exhibit 237, U.S. '072 ¹ vs. Claims of the '135 Patent ²			
D1067	Exhibit 238, Gauntlet System ¹ vs. Claims of the '211 Patent ²			
D1068	Exhibit 239, Gauntlet System ¹ vs. Claims of the '504 Patent ²			
D1069	Exhibit 240, Gauntlet System ¹ vs. Claims of the '135 Patent ²			
D1070	Exhibit 241, U.S. '588 ¹ vs. Claims of the '211 Patent ²			
D1071	Exhibit 242, U.S. '588 ¹ vs. Claims of the '504 Patent ²			
D1072	Exhibit 243, Microsoft VPN ¹ vs. Claims of the '135 Patent ²			
D1073	Exhibit 244, Microsoft VPN ¹ vs. Claims of the '211 Patent ²			
D1074	Exhibit 245, Microsoft VPN ¹ vs. Claims of the '504 Patent ²			
D1075	Exhibit 246, ITU-T Standardization Activities ¹ vs. Claims of the '135 Patent ²			

Subst. for form 1449/PTO			Complete if Known	
			Application Number	13/342,795
INFORMATION DISCLOSURE STATEMENT BY APPLICANT (Use as many sheets as necessary)			Filing Date	01-03-2012
			First Named Inventor	Victor Larson
			Art Unit	2453
			Examiner Name	Krisna Lim
			Docket Number	77580-155(VRNL-1CP3CNFT5)
D1076	Exhibit 247, U.S. '393 ¹ vs. Claims of the '135 Patent ²			
D1077	Exhibit 248, The Miller Application ¹ vs. Claim 13 of the '135 Patent ²			
D1078	Exhibit 249, Gauntlet System ¹ vs. Claims of the '151 Patent ²			
D1079	Exhibit 250, ITU-T Standardization Activities ¹ vs. Claims of the '151 Patent ²			
D1080	Exhibit 251, U.S. Patent No. 5,940,393 ¹ vs. Claims of the '151 Patent ²			
D1081	Exhibit 252, Microsoft VPN ¹ vs. Claims of the '151 Patent ²			
D1082	Exhibit 253, U.S. Patent No.6,324,648 ¹ vs. Claims of the '151 Patent ²			
D1083	Exhibit 254, U.S. Patent No.6,857,072 ¹ vs. Claims of the '151 Patent ²			
D1084	Petition in Opposition to Patent Owner's Petition to Vacate <i>Inter Partes</i> Reexamination			
D1085	Petition in Opposition to Patent Owner's Petition to Vacate <i>Inter Partes</i> Reexamination			
D1086	Petition in Opposition to Patent Owner's Petition to Vacate <i>Inter Partes</i> Reexamination			
D1087	Exhibit B1, File History of U.S. Patent 7,921,211			
D1088	Exhibit B2, File History of U.S. Patent Application No. 10/714,849			
D1089	Exhibit B4, <i>VirnetX, Inc. v. Microsoft Corp.</i> , Case No. 6:07-cv-80, Memorandum Opinion on Claim Construction (E.D. Tex. Jul. 30, 2009)			
D1090	Exhibit D15, U.S. Patent 4,952,930			
D1091	Exhibit F1, Claim Charts Applying Lendenmann as a Primary Reference to the '211 Patent			
D1092	Exhibit F2, Claim Charts Applying Aziz as a Primary Reference to the '211 Patent			
D1093	Exhibit F3, Claim Charts Applying Kiuchi and Pfaffenberger as Primary References to the '211 Patent			
D1094	Exhibit 2, Letter and attachment from Ramzi Khazen, Counsel for VirnetX, to Dmitriy Kheyfits, Counsel for Cisco Systems (June 23, 2011)			
D1095	Exhibit P, Malkin, "Dial-In Virtual Private Networks Using Layer 3 Tunneling"			
D1096	Exhibit Q, Ortiz, "Virtual Private Networks: Leveraging the Internet"			
D1097	Exhibit R, Keromytix, "Creating Efficient Fail-Stop Cryptographic Protocols"			
D1098	Transcript of Markman Hearing Dated January 5, 2012			
D1099	Declaration of John P. J. Kelly, Ph.D			
D1100	Defendants' Responsive Claim Construction Brief; Exhibits A-P and 1-7			

Subst. for form 1449/PTO		Complete if Known	
INFORMATION DISCLOSURE STATEMENT BY APPLICANT <i>(Use as many sheets as necessary)</i>		Application Number	13/342,795
		Filing Date	01-03-2012
		First Named Inventor	Victor Larson
		Art Unit	2453
		Examiner Name	Krisna Lim
		Docket Number	77580-155(VR NK-1CP3CNFT5)
D1101	Joint Claim Construction and Prehearing Statement Dated 11/08/11		
D1102	Exhibit A: Agreed Upon Terms Dated 11/08/11		
D1103	Exhibit B: Disputed Claim Terms Dated 11/08/11		
D1104	Exhibit C: VirnetX's Proposed Construction of Claim Terms and Supporting Evidence Dated 11/08/11		
D1105	Exhibit D: Defendant's Intrinsic and Extrinsic Support Dated 11/08/11		
D1106	Declaration of Austin Curry in Support of VimetX Inc.'s Opening Claim Construction Brief		
D1107	Declaration of Mark T. Jones Opening Claims Construction Brief		
D1108	VirnetX Opening Claim Construction Brief		
D1109	VirnetX Reply Claim Construction Brief		
D1110	European Search Report from corresponding EP Application Number 11005789 (Our Ref.: 077580-0142)		
D1111	European Search Report from corresponding EP Application Number 11005792 (Our Ref.: 077580-0143)		

/Krisna Lim/

07/20/2012

Subst. for form 1449/PTO				Complete if Known			
INFORMATION DISCLOSURE STATEMENT BY APPLICANT (Use as many sheets as necessary)				Application Number		13/342,795	
				Filing Date		01-03-2012	
				First Named Inventor		Victor Larson	
				Art Unit		2453	
				Examiner Name		Krisna Lim	
				Docket Number		77580-155(VRNK-1CP3CNFT5)	
U.S. PATENTS							
EXAMINER'S INITIALS	CITE NO.	Patent Number	Publication Date	Name of Patentee or Applicant of Cited Document		Pages, Columns, Lines, Where Relevant Passages or Relevant Figures Appear	
	A161	6,131,121	10/10/2000	Mattaway et al.			
	A162	6,499,108	12/24/2002	Johnson			
U.S. PATENT APPLICATION PUBLICATIONS							
EXAMINER'S INITIALS	CITE NO.	Patent Number	Publication Date	Name of Patentee or Applicant of Cited Document		Pages, Columns, Lines, Where Relevant Passages or Relevant Figures Appear	
FOREIGN PATENT DOCUMENTS							
EXAMINER'S INITIALS	CITE NO.	Foreign Patent Document Country Codes -Number & -Kind Codes (if known)	Publication Date	Name of Patentee or Applicant of Cited Document		Pages, Columns, Lines Where Relevant Figures Appear	Translation Yes No
OTHER ART (Including Author, Title, Date, Pertinent Pages, Etc.)							
EXAMINER'S INITIALS	CITE NO.	Include name of the author (in CAPITAL LETTERS), title of the article (when appropriate), title of the item (book, magazine, journal, serial, symposium, catalog, etc.), date, page(s), volume-issue number(s), publisher, city and/or country where published.					
	A1112	ITU-T Recommendation H.323, "Infrastructure of Audiovisual Services – Systems and Terminal Equipment for Audiovisual Services. Packet-Based Multimedia Communications System," International Telecommunications Union, pages 1-128, February 1998					
	A1113	ITU-T Recommendation H.225.0, "Infrastructure of Audiovisual Services – Transmission Multiplexing and Synchronization. Call Signaling Protocols and Media Stream Packetization for Packet-Based Multimedia Communication systems," International Telecommunication Union, pages 1-155, February 1998					
	A1114	ITU-T Recommendation H.235, "Infrastructure of Audiovisual Services – Systems Aspects. Security and Encryption for H-Series (H.323 and other H.245-based) Multimedia Terminals," International Telecommunication Union, pages 1-39, February 1998					
	A1115	ITU-T Recommendation H.245, "Infrastructure of Audiovisual Services – Communication Procedures. Control Protocol for Multimedia Communication," International Telecommunication Union, pages 1-280, February 1998					
	A1116	Request for Inter Partes Reexamination Under 35 U.S.C. § 311 (Patent No.8,051,181)					
	A1117	Transmittal Letters (Patent No.8,051,181)					
	A1118	Exhibit X5, Droms, R., RFC 2131, "Dynamic Host Configuration Protocol," 1987					
EXAMINER /Krisna Lim/				DATE CONSIDERED 07/20/2012			

*EXAMINER: Initial if reference considered, whether or not citation is in conformance with MPEP 609. Draw line through citation if not in conformance and not considered. Include copy of this form with next communication to applicant.

1 Applicant's unique citation designation number (optional). 2 Applicant is to place a check mark here if English language Translation is attached.

Subst. for form 1449/PTO				Complete if Known	
INFORMATION DISCLOSURE STATEMENT BY APPLICANT <i>(Use as many sheets as necessary)</i>				Application Number	13/342,795
				Filing Date	01-03-2012
				First Named Inventor	Victor Larson
				Art Unit	2453
				Examiner Name	Krisna Lim
				Docket Number	77580-155(VR NK-1CP3CNFT5)

CERTIFICATION STATEMENT

Please See 37 CFR 1.97 and 1.98 to make the appropriate selection(s)

- Information Disclosure Statement is being filed with the filing of the application or before the receipt of a first office action.
- That each item of information contained in the information disclosure statement was first cited in any communication from a foreign patent office in a counterpart foreign application not more than three months prior to the filing of the information disclosure statement; or
- That no item of information contained in the information disclosure statement was cited in a communication from a foreign patent office in a counterpart foreign application, and, to the knowledge of the person signing the certification after making reasonable inquiry, no item of information contained in the information disclosure statement was known to any individual designated in § 1.56(c) more than three months prior to the filing of the information disclosure statement.
- The Commissioner is hereby authorized to charge the fee pursuant to 37 CFR 1.17(P) in the amount of \$180.00, or further fees which may be due, to Deposit Account 50-1133.
- Information Disclosure Statement is being filed with the Request for Continued Examination. The Commissioner is hereby authorized to charge the fee pursuant to 37 CFR 1.17(P) in the amount of \$810.00, or further fees which may be due, to Deposit Account 50-1133.
- None

SIGNATURE

A signature of the applicant or representative is required in accordance with CFR 1.33, 10.18. Please see CFR 1.4(d) for the form of the signature.

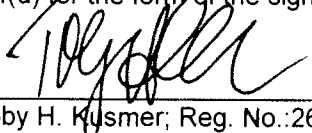
 Toby H. Kusmer; Reg. No.: 26,418
 McDermott Will & Emery LLP
 28 State Street
 Boston, MA 02109
 Tel. (617) 535-4000
 Fax (617) 535-3800

Date: 4/24/12

DM_US 33807606-1.077580.0155

03-09-12

13342795 - GAU:2453

Approved for use through 07/31/2012. OMB 0651-0031
 U.S. Patent and Trademark Office; U.S. DEPARTMENT OF COMMERCE

Under the Paperwork Reduction Act of 1995, no persons are required to respond to a collection of information unless it displays a valid OMB control number.

	Application Number	13/342,795
	Filing Date	01-03-2012
	First Named Inventor	Victor Larson
	Art Unit	2453
	Examiner Name	Krisna Lim
	Attorney Docket Number	77580-155(VR NK-1CP3CNFT5)
Total Number of Pages in This Submission		52

ENCLOSURES (Check all that apply)		
<input checked="" type="checkbox"/> Fee Transmittal Form	<input type="checkbox"/> Drawing(s)	<input type="checkbox"/> After Allowance Communication to TC
<input checked="" type="checkbox"/> Fee Attached	<input type="checkbox"/> Licensing-related Papers	<input type="checkbox"/> Appeal Communication to Board of Appeals and Interferences
<input type="checkbox"/> Amendment/Reply	<input type="checkbox"/> Petition	<input type="checkbox"/> Appeal Communication to TC (Appeal Notice, Brief, Reply Brief)
<input type="checkbox"/> After Final	<input type="checkbox"/> Petition to Convert to a Provisional Application	<input type="checkbox"/> Proprietary Information
<input type="checkbox"/> Affidavits/declaration(s)	<input type="checkbox"/> Power of Attorney, Revocation	<input type="checkbox"/> Status Letter
<input type="checkbox"/> Extension of Time Request	<input type="checkbox"/> Change of Correspondence Address	<input checked="" type="checkbox"/> Other Enclosure(s) (please identify below):
<input type="checkbox"/> Express Abandonment Request	<input type="checkbox"/> Terminal Disclaimer	
<input checked="" type="checkbox"/> Information Disclosure Statement	<input type="checkbox"/> Request for Refund	
<input type="checkbox"/> Certified Copy of Priority Document(s)	<input type="checkbox"/> CD, Number of CD(s) _____	
<input type="checkbox"/> Reply to Missing Parts/ Incomplete Application	<input type="checkbox"/> Landscape Table on CD	
<input type="checkbox"/> Reply to Missing Parts under 37 CFR 1.52 or 1.53	Remarks 16 Boxes of Non Patent Literature documents which include; copies of references not previously submitted in a priority application (C8, C19, C21, C24; D257, D258, D261, D263, D264, D266, D292-D1111).	

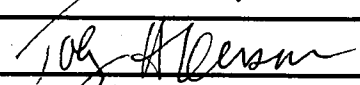
SIGNATURE OF APPLICANT, ATTORNEY, OR AGENT			
Firm Name	McDermott, Will and Emery		
Signature			
Printed name	Toby H. Kusmer		
Date	March 7, 2012	Reg. No.	26,418

CERTIFICATE OF TRANSMISSION/MAILING		
I hereby certify that this correspondence is being facsimile transmitted to the USPTO or deposited with the United States Postal Service with sufficient postage as first class mail in an envelope addressed to: Commissioner for Patents, P.O. Box 1450, Alexandria, VA 22313-1450 on the date shown below:		
Signature		
Typed or printed name		Date

This collection of information is required by 37 CFR 1.5. The information is required to obtain or retain a benefit by the public which is to file (and by the USPTO to process) an application. Confidentiality is governed by 35 U.S.C. 122 and 37 CFR 1.11 and 1.14. This collection is estimated to 2 hours to complete, including gathering, preparing, and submitting the completed application form to the USPTO. Time will vary depending upon the individual case. Any comments on the amount of time you require to complete this form and/or suggestions for reducing this burden, should be sent to the Chief Information Officer, U.S. Patent and Trademark Office, U.S. Department of Commerce, P.O. Box 1450, Alexandria, VA 22313-1450. DO NOT SEND FEES OR COMPLETED FORMS TO THIS ADDRESS. SEND TO: Commissioner for Patents, P.O. Box 1450, Alexandria, VA 22313-1450.

If you need assistance in completing the form, call 1-800-PTO-9199 and select option 2.



Under the Paperwork Reduction Act of 1995 no persons are required to respond to a collection of information unless it displays a valid OMB control number.

FEE TRANSMITTAL

Complete if Known

Application Number	13/342,795
Filing Date	01-03-2012
First Named Inventor	Victor Larson
Examiner Name	Krisna Lim
Art Unit	2453
Attorney Docket No.	77580-155(VRKN-1CP3CNFT5)

Applicant claims small entity status. See 37 CFR 1.27

TOTAL AMOUNT OF PAYMENT (\$) 180.00

METHOD OF PAYMENT (check all that apply)

Check Credit Card Money Order None Other (please identify): _____

Deposit Account Deposit Account Number: 501133 Deposit Account Name: McDermott, Will and Emery

For the above-identified deposit account, the Director is hereby authorized to: (check all that apply)

- Charge fee(s) indicated below Charge fee(s) indicated below, except for the filing fee
- Charge any additional fee(s) or underpayments of fee(s) under 37 CFR 1.16 and 1.17 Credit any overpayments

WARNING: Information on this form may become public. Credit card information should not be included on this form. Provide credit card information and authorization on PTO-2038.

FEE CALCULATION

1. BASIC FILING, SEARCH, AND EXAMINATION FEES

Application Type	FILING FEES		SEARCH FEES		EXAMINATION FEES		Fees Paid (\$)
	Fee (\$)	Small Entity Fee (\$)	Fee (\$)	Small Entity Fee (\$)	Fee (\$)	Small Entity Fee (\$)	
Utility	380	190	620	310	250	125	_____
Design	250	125	120	60	160	80	_____
Plant	250	125	380	190	200	100	_____
Reissue	380	190	620	310	750	375	_____
Provisional	250	125	0	0	0	0	_____

2. EXCESS CLAIM FEES

Fee Description	Fee (\$)	Small Entity Fee (\$)
Each claim over 20 (including Reissues)	60	30
Each independent claim over 3 (including Reissues)	250	125
Multiple dependent claims	450	225

Total Claims	Extra Claims	Fee (\$)	Fee Paid (\$)	Multiple Dependent Claims	Fee (\$)	Fee Paid (\$)
_____ - 20 or HP = _____	x _____	= _____	_____	_____	_____	_____

HP = highest number of total claims paid for, if greater than 20.

Indep. Claims	Extra Claims	Fee (\$)	Fee Paid (\$)
_____ - 3 or HP = _____	x _____	= _____	_____

HP = highest number of independent claims paid for, if greater than 3.

3. APPLICATION SIZE FEE

If the specification and drawings exceed 100 sheets of paper (excluding electronically filed sequence or computer listings under 37 CFR 1.52(e)), the application size fee due is \$310 (\$155 for small entity) for each additional 50 sheets or fraction thereof. See 35 U.S.C. 41(a)(1)(G) and 37 CFR 1.16(s).

Total Sheets	Extra Sheets	Number of each additional 50 or fraction thereof	Fee (\$)	Fee Paid (\$)
_____ - 100 = _____	/ 50 = _____	(round up to a whole number) x _____	= _____	_____

4. OTHER FEE(S)

Non-English Specification, \$130 fee (no small entity discount) Fees Paid (\$)
 Other (e.g., late filing surcharge): Information Disclosure Statement Filing Fee of \$180.00 \$180.00

SUBMITTED BY

Signature		Registration No. (Attorney/Agent) 26,418	Telephone 617-535-4000
Name (Print/Type)	Toby H. Kusner		Date March 7, 2012

This collection of information is required by 37 CFR 1.136. The information is required to obtain or retain a benefit by the public which is to file (and by the USPTO to process) an application. Confidentiality is governed by 35 U.S.C. 122 and 37 CFR 1.14. This collection is estimated to take 30 minutes to complete, including gathering, preparing, and submitting the completed application form to the USPTO. Time will vary depending upon the individual case. Any comments on the amount of time you require to complete this form and/or suggestions for reducing this burden, should be sent to the Chief Information Officer, U.S. Patent and Trademark Office, U.S. Department of Commerce, P.O. Box 1450, Alexandria, VA 22313-1450. DO NOT SEND FEES OR COMPLETED FORMS TO THIS ADDRESS. SEND TO: Commissioner for Patents, P.O. Box 1450, Alexandria, VA 22313-1450.

If you need assistance in completing the form, call 1-800-PTO-9199 and select option 2.

Subst. for form 1449/PTO	Complete if Known	
	Application Number	13/342,795
INFORMATION DISCLOSURE STATEMENT BY APPLICANT (Use as many sheets as necessary)	Filing Date	01-03-2012
	First Named Inventor	Victor Larson
	Art Unit	2453
	Examiner Name	Krisna Lim
	Docket Number	77580-155(VRNL-1CP3CNFT5)

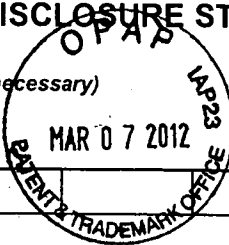

CERTIFICATION STATEMENT

Under 37 C.F.R. 1.98(d), copies of all patent, publication, pending U.S. application or other information that was previously submitted to, or cited by the USPTO in an earlier application are not required. Applicant will provide copies of the previously submitted references at the Examiner's request. Enclosed are copies of references not previously submitted in a priority application (C8, C19, C21, C24; D257, D258, D261, D263, D264, D266, D292-D1111).

The present application 13/342,795 claims priority from and is a continuation of a co-pending U.S. Application No. 13/049,552, filed March 16, 2011, which is a continuation of U.S. Application No. 11/840,560, filed August 17, 2007, now U.S. Patent No. 7,921,211, which is a continuation of U.S. Application No. 10/714,849, filed November 18, 2003, now U.S. Patent No. 7,418,504, which is a continuation of U.S. Application No. 09/558,210, filed April 26, 2000, now abandoned, which is a continuation-in-part of U.S. Application No. 09/504,783, filed on February 15, 2000, now U.S. Patent No. 6,502,135, issued December 31, 2002.

Please See 37 CFR 1.97 and 1.98 to make the appropriate selection(s)

- Information Disclosure Statement is being filed with the filing of the application or before the receipt of a first office action.
- That each item of information contained in the information disclosure statement was first cited in any communication from a foreign patent office in a counterpart foreign application not more than three months prior to the filing of the information disclosure statement; or
- That no item of information contained in the information disclosure statement was cited in a communication from a foreign patent office in a counterpart foreign application, and, to the knowledge of the person signing the certification after making reasonable inquiry, no item of information contained in the information disclosure statement was known to any individual designated in § 1.56(c) more than three months prior to the filing of the information disclosure statement.
- The Commissioner is hereby authorized to charge the fee pursuant to 37 CFR 1.17(P) in the amount of \$180.00, or further fees which may be due, to Deposit Account 50-1133.
- Information Disclosure Statement is being filed with the Request for Continued Examination. The Commissioner is hereby authorized to charge the fee pursuant to 37 CFR 1.17(P) in the amount of \$810.00, or further fees which may be due, to Deposit Account 50-1133.

SIGNATURE

A signature of the applicant or representative is required in accordance with CFR 1.33, 10.18. Please see CFR 1.4(d) for the form of the signature.

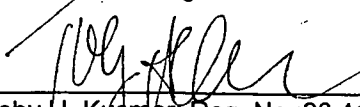
 Toby H. Kusmer, Reg. No.: 26,418
 McDermott Will & Emery LLP
 28 State Street
 Boston, MA 02109
 Tel. (617) 535-4000
 Fax (617) 535-3800

Date: 3/7/12

Subst. for form 1449/PTO				Complete if Known		
INFORMATION DISCLOSURE STATEMENT BY APPLICANT <i>(Use as many sheets as necessary)</i>				Application Number	13/342,795	
				Filing Date	01-03-2012	
				First Named Inventor	Victor Larson	
				Art Unit	2453	
				Examiner Name	Krisna Lim	
				Docket Number	77580-155(VR NK-1CP3CNFT5)	
U.S. PATENTS						
EXAMINER'S INITIALS	CITE NO.	Patent Number	Publication Date	Name of Patentee or Applicant of Cited Document	Pages, Columns, Lines, Where Relevant Passages or Relevant Figures Appear	
U.S. PATENT APPLICATION PUBLICATIONS						
EXAMINER'S INITIALS	CITE NO.	Patent Number	Publication Date	Name of Patentee or Applicant of Cited Document	Pages, Columns, Lines, Where Relevant Passages or Relevant Figures Appear	
FOREIGN PATENT DOCUMENTS						
EXAMINER'S INITIALS	CITE NO.	Foreign Patent Document Country Codes - Number - Kind Codes (if known)	Publication Date	Name of Patentee or Applicant of Cited Document	Pages, Columns, Lines Where Relevant Figures Appear	Translation Yes No
OTHER ART (Including Author, Title, Date, Pertinent Pages, Etc.)						
EXAMINER'S INITIALS	CITE NO.	Include name of the author (in CAPITAL LETTERS), title of the article (when appropriate), title of the item (book, magazine, journal, serial, symposium, catalog, etc.), date, page(s), volume-issue number(s), publisher, city and/or country where published.				
	A1119	Hopen Transcript dated April 11, 2012				
	A1120	VirnetX Claim Construction Opinion				
EXAMINER /Krisna Lim/				DATE CONSIDERED 07/20/2012		

*EXAMINER: Initial if reference considered, whether or not citation is in conformance with MPEP 609. Draw line through citation if not in conformance and not considered. Include copy of this form with next communication to applicant.

1 Applicant's unique citation designation number (optional). 2 Applicant is to place a check mark here if English language Translation is attached.

Subst. for form 1449/PTO				Complete if Known	
INFORMATION DISCLOSURE STATEMENT BY APPLICANT <i>(Use as many sheets as necessary)</i>				Application Number	13/342,795
				Filing Date	01-03-2012
				First Named Inventor	Victor Larson
				Art Unit	2453
				Examiner Name	Krisna Lim
				Docket Number	77580-155(VR NK-1CP3CNFT5)

CERTIFICATION STATEMENT

Please See 37 CFR 1.97 and 1.98 to make the appropriate selection(s)

- Information Disclosure Statement is being filed with the filing of the application or before the receipt of a first office action.
- That each item of information contained in the information disclosure statement was first cited in any communication from a foreign patent office in a counterpart foreign application not more than three months prior to the filing of the information disclosure statement; or
- That no item of information contained in the information disclosure statement was cited in a communication from a foreign patent office in a counterpart foreign application, and, to the knowledge of the person signing the certification after making reasonable inquiry, no item of information contained in the information disclosure statement was known to any individual designated in § 1.56(c) more than three months prior to the filing of the information disclosure statement.
- The Commissioner is hereby authorized to charge the fee pursuant to 37 CFR 1.17(P) in the amount of \$180.00, or further fees which may be due, to Deposit Account 50-1133.
- Information Disclosure Statement is being filed with the Request for Continued Examination. The Commissioner is hereby authorized to charge the fee pursuant to 37 CFR 1.17(P) in the amount of \$810.00, or further fees which may be due, to Deposit Account 50-1133.
- None

SIGNATURE

A signature of the applicant or representative is required in accordance with CFR 1.33, 10.18. Please see CFR 1.4(d) for the form of the signature.

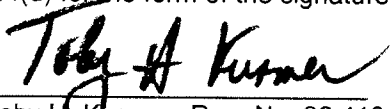

Toby H. Kusmer; Reg. No.: 26,418
 McDermott Will & Emery LLP
 28 State Street
 Boston, MA 02109
 Tel. (617) 535-4000
 Fax (617) 535-3800

Date: *May 3, 2012*

DM_US 34026985-1.077580.0155

Search Notes 	Application/Control No. 13342795	Applicant(s)/Patent Under Reexamination LARSON ET AL.
	Examiner KRISNA LIM	Art Unit 2453

SEARCHED			
Class	Subclass	Date	Examiner
709	223-227	02/23/2012	kl
	updated above	07/24/2012	kl

SEARCH NOTES		
Search Notes	Date	Examiner
EAST, Inventors	02/23/2012	kl
Inventors	07/24/2012	kl

INTERFERENCE SEARCH			
Class	Subclass	Date	Examiner

--	--

Index of Claims 	Application/Control No. 13342795	Applicant(s)/Patent Under Reexamination LARSON ET AL.
	Examiner KRISNA LIM	Art Unit 2453

✓	Rejected
=	Allowed

-	Cancelled
÷	Restricted

N	Non-Elected
I	Interference

A	Appeal
O	Objected

Claims renumbered in the same order as presented by applicant
 CPA
 T.D.
 R.1.47

CLAIM		DATE							
Final	Original	02/26/2012	07/24/2012						
	1	✓	✓						
	2	✓	✓						
	3	✓	✓						
	4	✓	✓						
	5	✓	✓						
	6	✓	✓						
	7	✓	✓						
	8	✓	✓						
	9	✓	✓						
	10	✓	✓						
	11	✓	✓						
	12	✓	✓						
	13	✓	✓						
	14	✓	✓						
	15	✓	✓						
	16	✓	✓						
	17	✓	✓						
	18	✓	✓						
	19	✓	✓						
	20	✓	✓						
	21	✓	✓						
	22	✓	✓						
	23	✓	✓						
	24	✓	✓						
	25	✓	✓						
	26	✓	✓						
	27	✓	✓						
	28	✓	✓						
	29	✓	✓						
	30	✓	✓						

Subst. for form 1449/PTO				Complete if Known		
INFORMATION DISCLOSURE STATEMENT BY APPLICANT <i>(Use as many sheets as necessary)</i>				Application Number	13/342,795	
				Filing Date	01-03-2012	
				First Named Inventor	Victor Larson	
				Art Unit	2453	
				Examiner Name	Krisna Lim	
				Docket Number	77580-155(VRNK-1CP3CNFT5)	
U.S. PATENTS						
EXAMINER'S INITIALS	CITE NO.	Patent Number	Publication Date	Name of Patentee or Applicant of Cited Document	Pages, Columns, Lines, Where Relevant Passages or Relevant Figures Appear	
U.S. PATENT APPLICATION PUBLICATIONS						
EXAMINER'S INITIALS	CITE NO.	Patent Number	Publication Date	Name of Patentee or Applicant of Cited Document	Pages, Columns, Lines, Where Relevant Passages or Relevant Figures Appear	
FOREIGN PATENT DOCUMENTS						
EXAMINER'S INITIALS	CITE NO.	Foreign Patent Document Country Codes - Number & -Kind Codes (if known)	Publication Date	Name of Patentee or Applicant of Cited Document	Pages, Columns, Lines Where Relevant Figures Appear	Translation
						Yes No
OTHER ART (Including Author, Title, Date, Pertinent Pages, Etc.)						
EXAMINER'S INITIALS	CITE NO.	Include name of the author (in CAPITAL LETTERS), title of the article (when appropriate), title of the item (book, magazine, journal, serial, symposium, catalog, etc.), date, page(s), volume-issue number(s), publisher, city and/or country where published.				
	D1208	Cisco Comments and Petition for Reexamination 95/001,679 dated June 14, 2012				
	D1209	Exhibit S, Declaration of Nathaniel Polish, Ph.D.				
	D1210	Exhibit R, Excerpts from Patent Owner & Plaintiff VirnetX Inc.'s First Amended P.R. 3-1 and 3-2 Disclosure of Asserted Claims and Infringement Contentions				
EXAMINER /Krisna Lim/				DATE CONSIDERED 07/20/2012		

*EXAMINER: Initial if reference considered, whether or not citation is in conformance with MPEP 609. Draw line through citation if not in conformance and not considered. Include copy of this form with next communication to applicant.

1 Applicant's unique citation designation number (optional). 2 Applicant is to place a check mark here if English language Translation is attached.

Subst. for form 1449/PTO				Complete if Known	
INFORMATION DISCLOSURE STATEMENT BY APPLICANT <i>(Use as many sheets as necessary)</i>				Application Number	13/342,795
				Filing Date	01-03-2012
				First Named Inventor	Victor Larson
				Art Unit	2453
				Examiner Name	Krisna Lim
				Docket Number	77580-155(VRNK-1CP3CNFT5)

CERTIFICATION STATEMENT

Please See 37 CFR 1.97 and 1.98 to make the appropriate selection(s)

- Information Disclosure Statement is being filed with the filing of the application or before the receipt of a first office action.
- That each item of information contained in the information disclosure statement was first cited in any communication from a foreign patent office in a counterpart foreign application not more than three months prior to the filing of the information disclosure statement; or
- That no item of information contained in the information disclosure statement was cited in a communication from a foreign patent office in a counterpart foreign application, and, to the knowledge of the person signing the certification after making reasonable inquiry, no item of information contained in the information disclosure statement was known to any individual designated in § 1.56(c) more than three months prior to the filing of the information disclosure statement.
- The Commissioner is hereby authorized to charge the fee pursuant to 37 CFR 1.17(P) in the amount of \$180.00, or further fees which may be due, to Deposit Account 50-1133.
- Information Disclosure Statement is being filed with the Request for Continued Examination. The Commissioner is hereby authorized to charge the fee pursuant to 37 CFR 1.17(P) in the amount of \$810.00, or further fees which may be due, to Deposit Account 50-1133.
- None

SIGNATURE

A signature of the applicant or representative is required in accordance with CFR 1.33, 10.18. Please see CFR 1.4(d) for the form of the signature.

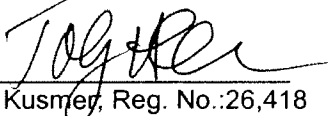

Date: 6/20/12

Toby H. Kusmer, Reg. No.:26,418
 McDermott Will & Emery LLP
 28 State Street
 Boston, MA 02109
 Tel. (617) 535-4000
 Fax (617) 535-3800

DM_US 36055603-1.077580.0155



UNITED STATES PATENT AND TRADEMARK OFFICE

UNITED STATES DEPARTMENT OF COMMERCE
United States Patent and Trademark Office
Address: COMMISSIONER FOR PATENTS
P.O. Box 1450
Alexandria, Virginia 22313-1450
www.uspto.gov

Table with 5 columns: APPLICATION NO., FILING DATE, FIRST NAMED INVENTOR, ATTORNEY DOCKET NO., CONFIRMATION NO.
13/342,795 01/03/2012 Victor Larson 77580-155(VRNK-1CP3CNFT5) 4180

23630 7590 08/29/2012
McDermott Will & Emery
600 13th Street, NW
Washington, DC 20005-3096

EXAMINER

LIM, KRISNA

ART UNIT PAPER NUMBER

2453

NOTIFICATION DATE DELIVERY MODE

08/29/2012

ELECTRONIC

Please find below and/or attached an Office communication concerning this application or proceeding.

The time period for reply, if any, is set in the attached communication.

Notice of the Office communication was sent electronically on above-indicated "Notification Date" to the following e-mail address(es):

mweipdocket@mwe.com

Applicant-Initiated Interview Summary	Application No. 13/342,795	Applicant(s) LARSON ET AL.	
	Examiner KRISNA LIM	Art Unit 2453	

All participants (applicant, applicant's representative, PTO personnel):

- (1) KRISNA LIM. (3) _____.
- (2) Toby Kusmer. (4) _____.

Date of Interview: 23 August 2012.

Type: Telephonic Video Conference
 Personal [copy given to: applicant applicant's representative]

Exhibit shown or demonstration conducted: Yes No.
If Yes, brief description: _____.

Issues Discussed 101 112 102 103 Others
(For each of the checked box(es) above, please describe below the issue and detailed description of the discussion)

Claim(s) discussed: 1.

Identification of prior art discussed: Wesinger (U.S. Patent No. 5,898,830).

Substance of Interview

(For each issue discussed, provide a detailed description and indicate if agreement was reached. Some topics may include: identification or clarification of a reference or a portion thereof, claim interpretation, proposed amendments, arguments of any applied references etc...)

Counsel and Examiner discussed the claimed language and the teaching of Wesinger; however no agreement is reached.

Applicant recordation instructions: The formal written reply to the last Office action must include the substance of the interview. (See MPEP section 713.04). If a reply to the last Office action has already been filed, applicant is given a non-extendable period of the longer of one month or thirty days from this interview date, or the mailing date of this interview summary form, whichever is later, to file a statement of the substance of the interview

Examiner recordation instructions: Examiners must summarize the substance of any interview of record. A complete and proper recordation of the substance of an interview should include the items listed in MPEP 713.04 for complete and proper recordation including the identification of the general thrust of each argument or issue discussed, a general indication of any other pertinent matters discussed regarding patentability and the general results or outcome of the interview, to include an indication as to whether or not agreement was reached on the issues raised.

Attachment

/Krisna Lim/
Primary Examiner, Art Unit 2453

Summary of Record of Interview Requirements

Manual of Patent Examining Procedure (MPEP), Section 713.04, Substance of Interview Must be Made of Record

A complete written statement as to the substance of any face-to-face, video conference, or telephone interview with regard to an application must be made of record in the application whether or not an agreement with the examiner was reached at the interview.

Title 37 Code of Federal Regulations (CFR) § 1.133 Interviews

Paragraph (b)

In every instance where reconsideration is requested in view of an interview with an examiner, a complete written statement of the reasons presented at the interview as warranting favorable action must be filed by the applicant. An interview does not remove the necessity for reply to Office action as specified in §§ 1.111, 1.135. (35 U.S.C. 132)

37 CFR §1.2 Business to be transacted in writing.

All business with the Patent or Trademark Office should be transacted in writing. The personal attendance of applicants or their attorneys or agents at the Patent and Trademark Office is unnecessary. The action of the Patent and Trademark Office will be based exclusively on the written record in the Office. No attention will be paid to any alleged oral promise, stipulation, or understanding in relation to which there is disagreement or doubt.

The action of the Patent and Trademark Office cannot be based exclusively on the written record in the Office if that record is itself incomplete through the failure to record the substance of interviews.

It is the responsibility of the applicant or the attorney or agent to make the substance of an interview of record in the application file, unless the examiner indicates he or she will do so. It is the examiner's responsibility to see that such a record is made and to correct material inaccuracies which bear directly on the question of patentability.

Examiners must complete an Interview Summary Form for each interview held where a matter of substance has been discussed during the interview by checking the appropriate boxes and filling in the blanks. Discussions regarding only procedural matters, directed solely to restriction requirements for which interview recordation is otherwise provided for in Section 812.01 of the Manual of Patent Examining Procedure, or pointing out typographical errors or unreadable script in Office actions or the like, are excluded from the interview recordation procedures below. Where the substance of an interview is completely recorded in an Examiners Amendment, no separate Interview Summary Record is required.

The Interview Summary Form shall be given an appropriate Paper No., placed in the right hand portion of the file, and listed on the "Contents" section of the file wrapper. In a personal interview, a duplicate of the Form is given to the applicant (or attorney or agent) at the conclusion of the interview. In the case of a telephone or video-conference interview, the copy is mailed to the applicant's correspondence address either with or prior to the next official communication. If additional correspondence from the examiner is not likely before an allowance or if other circumstances dictate, the Form should be mailed promptly after the interview rather than with the next official communication.

The Form provides for recordation of the following information:

- Application Number (Series Code and Serial Number)
- Name of applicant
- Name of examiner
- Date of interview
- Type of interview (telephonic, video-conference, or personal)
- Name of participant(s) (applicant, attorney or agent, examiner, other PTO personnel, etc.)
- An indication whether or not an exhibit was shown or a demonstration conducted
- An identification of the specific prior art discussed
- An indication whether an agreement was reached and if so, a description of the general nature of the agreement (may be by attachment of a copy of amendments or claims agreed as being allowable). Note: Agreement as to allowability is tentative and does not restrict further action by the examiner to the contrary.
- The signature of the examiner who conducted the interview (if Form is not an attachment to a signed Office action)

It is desirable that the examiner orally remind the applicant of his or her obligation to record the substance of the interview of each case. It should be noted, however, that the Interview Summary Form will not normally be considered a complete and proper recordation of the interview unless it includes, or is supplemented by the applicant or the examiner to include, all of the applicable items required below concerning the substance of the interview.

A complete and proper recordation of the substance of any interview should include at least the following applicable items:

- 1) A brief description of the nature of any exhibit shown or any demonstration conducted,
- 2) an identification of the claims discussed,
- 3) an identification of the specific prior art discussed,
- 4) an identification of the principal proposed amendments of a substantive nature discussed, unless these are already described on the Interview Summary Form completed by the Examiner,
- 5) a brief identification of the general thrust of the principal arguments presented to the examiner,
(The identification of arguments need not be lengthy or elaborate. A verbatim or highly detailed description of the arguments is not required. The identification of the arguments is sufficient if the general nature or thrust of the principal arguments made to the examiner can be understood in the context of the application file. Of course, the applicant may desire to emphasize and fully describe those arguments which he or she feels were or might be persuasive to the examiner.)
- 6) a general indication of any other pertinent matters discussed, and
- 7) if appropriate, the general results or outcome of the interview unless already described in the Interview Summary Form completed by the examiner.

Examiners are expected to carefully review the applicant's record of the substance of an interview. If the record is not complete and accurate, the examiner will give the applicant an extendable one month time period to correct the record.

Examiner to Check for Accuracy

If the claims are allowable for other reasons of record, the examiner should send a letter setting forth the examiner's version of the statement attributed to him or her. If the record is complete and accurate, the examiner should place the indication, "Interview Record OK" on the paper recording the substance of the interview along with the date and the examiner's initials.

Subst. for form 1449/PTO				Complete if Known			
INFORMATION DISCLOSURE STATEMENT BY APPLICANT <i>(Use as many sheets as necessary)</i>				Application Number	13/342,795		
				Filing Date	01-03-2012		
				First Named Inventor	Victor Larson		
				Art Unit	2453		
				Examiner Name	Krisna Lim		
				Docket Number	77580-155(VR NK-1CP3CNFT5)		
U.S. PATENTS							
EXAMINER'S INITIALS	CITE NO.	Patent Number	Publication Date	Name of Patentee or Applicant of Cited Document	Pages, Columns, Lines, Where Relevant Passages or Relevant Figures Appear		
U.S. PATENT APPLICATION PUBLICATIONS							
EXAMINER'S INITIALS	CITE NO.	Patent Number	Publication Date	Name of Patentee or Applicant of Cited Document	Pages, Columns, Lines, Where Relevant Passages or Relevant Figures Appear		
FOREIGN PATENT DOCUMENTS							
EXAMINER'S INITIALS	CITE NO.	Foreign Patent Document Country Codes - Number 4 - Kind Codes (if known)	Publication Date	Name of Patentee or Applicant of Cited Document	Pages, Columns, Lines Where Relevant Figures Appear	Translation	
						Yes	No
OTHER ART (Including Author, Title, Date, Pertinent Pages, Etc.)							
EXAMINER'S INITIALS	CITE NO.	Include name of the author (in CAPITAL LETTERS), title of the article (when appropriate), title of the item (book, magazine, journal, serial, symposium, catalog, etc.), date, page(s), volume-issue number(s), publisher, city and/or country where published.					
	D1215	Alexander Invalidity Expert Report dtd May 22, 2012 with Exhibits					
	D1216	Deposition of Peter Alexander dtd July 27, 2012					
	D1217	Cisco '151 Comments by Third Party Requester dtd August 17, 2012 with Exhibits					
	D1218	Cisco '151 Petition to Waive Page Limit Requirement for Third Party Comments dtd August 17, 2012					
	D1219	Deposition of Stuart Stubblebine dtd August 22, 2012					
EXAMINER				DATE CONSIDERED			

*EXAMINER: Initial if reference considered, whether or not citation is in conformance with MPEP 609. Draw line through citation if not in conformance and not considered. Include copy of this form with next communication to applicant.

1 Applicant's unique citation designation number (optional). 2 Applicant is to place a check mark here if English language Translation is attached.

Subst. for form 1449/PTO				Complete if Known	
INFORMATION DISCLOSURE STATEMENT BY APPLICANT <i>(Use as many sheets as necessary)</i>				Application Number	13/342,795
				Filing Date	01-03-2012
				First Named Inventor	Victor Larson
				Art Unit	2453
				Examiner Name	Krisna Lim
				Docket Number	77580-155(VR NK-1CP3CNFT5)

CERTIFICATION STATEMENT

Please See 37 CFR 1.97 and 1.98 to make the appropriate selection(s)

- Information Disclosure Statement is being filed with the filing of the application or before the receipt of a first office action.
- That each item of information contained in the information disclosure statement was first cited in any communication from a foreign patent office in a counterpart foreign application not more than three months prior to the filing of the information disclosure statement; or
- That no item of information contained in the information disclosure statement was cited in a communication from a foreign patent office in a counterpart foreign application, and, to the knowledge of the person signing the certification after making reasonable inquiry, no item of information contained in the information disclosure statement was known to any individual designated in § 1.56(c) more than three months prior to the filing of the information disclosure statement.
- The Commissioner is hereby authorized to charge any required fees to Deposit Account 50-1133.
- Information Disclosure Statement is being filed with the Request for Continued Examination. The Commissioner is hereby authorized to charge the fee pursuant to 37 CFR 1.17(P) in the amount of \$810.00, or further fees which may be due, to Deposit Account 50-1133.

SIGNATURE

A signature of the applicant or representative is required in accordance with CFR 1.33, 10.18. Please see CFR 1.4(d) for the form of the signature.

 Hasan M. Rashid; Reg. No.: 62,390
 McDermott Will & Emery LLP
 28 State Street
 Boston, MA 02109
 Tel. (617) 535-4000
 Fax (617) 535-3800

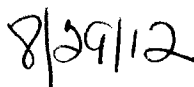
Date: 

Electronic Acknowledgement Receipt

EFS ID:	13625364
Application Number:	13342795
International Application Number:	
Confirmation Number:	4180
Title of Invention:	SYSTEM AND METHOD EMPLOYING AN AGILE NETWORK PROTOCOL FOR SECURE COMMUNICATIONS USING SECURE DOMAIN NAMES
First Named Inventor/Applicant Name:	Victor Larson
Customer Number:	23630
Filer:	Toby H. Kusmer./Kerrie Jones
Filer Authorized By:	Toby H. Kusmer.
Attorney Docket Number:	77580-155(VRNL-1CP3CNFT5)
Receipt Date:	30-AUG-2012
Filing Date:	03-JAN-2012
Time Stamp:	12:49:51
Application Type:	Utility under 35 USC 111(a)

Payment information:

Submitted with Payment	no
------------------------	----

File Listing:

Document Number	Document Description	File Name	File Size(Bytes)/ Message Digest	Multi Part /.zip	Pages (if appl.)
1	Information Disclosure Statement (IDS) Form (SB08)	IDS.pdf	66833 82f595082dbb2bb22913aae20c8ada774b65f8ac	no	2

Warnings:

Information:

This is not an USPTO supplied IDS fillable form					
The page size in the PDF is too large. The pages should be 8.5 x 11 or A4. If this PDF is submitted, the pages will be resized upon entry into the Image File Wrapper and may affect subsequent processing					
2	Non Patent Literature	D1215part1_.pdf	6004542 ba8668057be3412bd85bc98b35f3fbc3063d76a	no	1446
Warnings:					
Information:					
3	Non Patent Literature	D1215part2.pdf	3005505 cbda41f5d61322bb782a091b07a127ac9538b03	no	96
Warnings:					
The page size in the PDF is too large. The pages should be 8.5 x 11 or A4. If this PDF is submitted, the pages will be resized upon entry into the Image File Wrapper and may affect subsequent processing					
Information:					
4	Non Patent Literature	D1216.pdf	253751 2bedf1012dc0d5ca841e8957fd504aaa3c8d9a2e	no	55
Warnings:					
Information:					
5	Non Patent Literature	D1217.pdf	11161127 15c3902ff98d5442223a0deb429324c4c088740f	no	211
Warnings:					
Information:					
6	Non Patent Literature	D1218.pdf	171392 4de801f2c5f80805bb67088e6b5e9cc7c3df0153	no	4
Warnings:					
Information:					
7	Non Patent Literature	D1219.pdf	300469 88a75e44bb96dc311611481970f8b2ebfb3d2fee	no	69
Warnings:					
Information:					
Total Files Size (in bytes):			20963619		

This Acknowledgement Receipt evidences receipt on the noted date by the USPTO of the indicated documents, characterized by the applicant, and including page counts, where applicable. It serves as evidence of receipt similar to a Post Card, as described in MPEP 503.

New Applications Under 35 U.S.C. 111

If a new application is being filed and the application includes the necessary components for a filing date (see 37 CFR 1.53(b)-(d) and MPEP 506), a Filing Receipt (37 CFR 1.54) will be issued in due course and the date shown on this Acknowledgement Receipt will establish the filing date of the application.

National Stage of an International Application under 35 U.S.C. 371

If a timely submission to enter the national stage of an international application is compliant with the conditions of 35 U.S.C. 371 and other applicable requirements a Form PCT/DO/EO/903 indicating acceptance of the application as a national stage submission under 35 U.S.C. 371 will be issued in addition to the Filing Receipt, in due course.

New International Application Filed with the USPTO as a Receiving Office

If a new international application is being filed and the international application includes the necessary components for an international filing date (see PCT Article 11 and MPEP 1810), a Notification of the International Application Number and of the International Filing Date (Form PCT/RO/105) will be issued in due course, subject to prescriptions concerning national security, and the date shown on this Acknowledgement Receipt will establish the international filing date of the application.

Subst. for form 1449/PTO				Complete if Known		
INFORMATION DISCLOSURE STATEMENT BY APPLICANT <i>(Use as many sheets as necessary)</i>				Application Number	13/342,795	
				Filing Date	01-03-2012	
				First Named Inventor	Victor Larson	
				Art Unit	2453	
				Examiner Name	Krisna Lim	
				Docket Number	77580-155(VR NK-1CP3CNFT5)	
U.S. PATENTS						
EXAMINER'S INITIALS	CITE NO.	Patent Number	Publication Date	Name of Patentee or Applicant of Cited Document	Pages, Columns, Lines, Where Relevant Passages or Relevant Figures Appear	
U.S. PATENT APPLICATION PUBLICATIONS						
EXAMINER'S INITIALS	CITE NO.	Patent Number	Publication Date	Name of Patentee or Applicant of Cited Document	Pages, Columns, Lines, Where Relevant Passages or Relevant Figures Appear	
FOREIGN PATENT DOCUMENTS						
EXAMINER'S INITIALS	CITE NO.	Foreign Patent Document Country Codes - Number - Kind Codes (if known)	Publication Date	Name of Patentee or Applicant of Cited Document	Pages, Columns, Lines Where Relevant Figures Appear	Translation Yes No
OTHER ART (Including Author, Title, Date, Pertinent Pages, Etc.)						
EXAMINER'S INITIALS	CITE NO.	Include name of the author (in CAPITAL LETTERS), title of the article (when appropriate), title of the item (book, magazine, journal, serial, symposium, catalog, etc.), date, page(s), volume-issue number(s), publisher, city and/or country where published.				
	D1220	Defendants' Motion For Reconsideration of the Construction of the Term "Secure Communication Link," 7 pages, June 2012				
	D1221	Green, "Cisco Leverages Altiga Technology for VPN's," 2 pages, 2000 http://www.crn.com/news/channel-programs/18807923/cisco-leverages-altiga-technology-for-vpns.htm				
	D1222	Altiga Networks Archived at http://web.archive.org/web/20000823023437/http://www.altiga.com/products/ 1999 and Retrieved by the Wayback Machine				
	D1223	Kiuchi, "C-HTTP The Development of a Secure, Closed HTTP-Based Network on the Internet," Department of Epidemiology and Biostatistics, Faculty of Medicine, University of Tokyo, Japan				
EXAMINER				DATE CONSIDERED		

*EXAMINER: Initial if reference considered, whether or not citation is in conformance with MPEP 609. Draw line through citation if not in conformance and not considered. Include copy of this form with next communication to applicant.

1 Applicant's unique citation designation number (optional). 2 Applicant is to place a check mark here if English language Translation is attached.

Subst. for form 1449/PTO				Complete if Known	
INFORMATION DISCLOSURE STATEMENT BY APPLICANT <i>(Use as many sheets as necessary)</i>				Application Number	13/342,795
				Filing Date	01-03-2012
				First Named Inventor	Victor Larson
				Art Unit	2453
				Examiner Name	Krisna Lim
				Docket Number	77580-155(VRNK-1CP3CNFT5)

CERTIFICATION STATEMENT

Please See 37 CFR 1.97 and 1.98 to make the appropriate selection(s)

- Information Disclosure Statement is being filed with the filing of the application or before the receipt of a first office action.
- That each item of information contained in the information disclosure statement was first cited in any communication from a foreign patent office in a counterpart foreign application not more than three months prior to the filing of the information disclosure statement; or
- That no item of information contained in the information disclosure statement was cited in a communication from a foreign patent office in a counterpart foreign application, and, to the knowledge of the person signing the certification after making reasonable inquiry, no item of information contained in the information disclosure statement was known to any individual designated in § 1.56(c) more than three months prior to the filing of the information disclosure statement.
- The Commissioner is hereby authorized to charge any required fees to Deposit Account 50-1133.
- Information Disclosure Statement is being filed with the Request for Continued Examination. The Commissioner is hereby authorized to charge the fee pursuant to 37 CFR 1.17(P) in the amount of \$810.00, or further fees which may be due, to Deposit Account 50-1133.

SIGNATURE

A signature of the applicant or representative is required in accordance with CFR 1.33, 10.18. Please see CFR 1.4(d) for the form of the signature.

 Toby H. Kusmer, Reg. No.: 26,418
 McDermott Will & Emery LLP
 28 State Street
 Boston, MA 02109
 Tel. (617) 535-4000
 Fax (617) 535-3800

Date: 

Electronic Acknowledgement Receipt

EFS ID:	13822312
Application Number:	13342795
International Application Number:	
Confirmation Number:	4180
Title of Invention:	SYSTEM AND METHOD EMPLOYING AN AGILE NETWORK PROTOCOL FOR SECURE COMMUNICATIONS USING SECURE DOMAIN NAMES
First Named Inventor/Applicant Name:	Victor Larson
Customer Number:	23630
Filer:	Toby H. Kusmer./Kerrie Jones
Filer Authorized By:	Toby H. Kusmer.
Attorney Docket Number:	77580-155(VRNK-1CP3CNFT5)
Receipt Date:	24-SEP-2012
Filing Date:	03-JAN-2012
Time Stamp:	16:29:05
Application Type:	Utility under 35 USC 111(a)

Payment information:

Submitted with Payment	no
------------------------	----

File Listing:

Document Number	Document Description	File Name	File Size(Bytes)/ Message Digest	Multi Part /.zip	Pages (if appl.)
1	Information Disclosure Statement (IDS) Form (SB08)	IDS.pdf	72147 <small>bbc3b9658a1e0cbf9c8ccfdc88ddeefcba14595</small>	no	2

Warnings:

Information:

This is not an USPTO supplied IDS fillable form					
The page size in the PDF is too large. The pages should be 8.5 x 11 or A4. If this PDF is submitted, the pages will be resized upon entry into the Image File Wrapper and may affect subsequent processing					
2	Non Patent Literature	D1220.pdf	123661 9ce2ace217ce1e1fbae718ae13ac16c5629341a3	no	7
Warnings:					
The page size in the PDF is too large. The pages should be 8.5 x 11 or A4. If this PDF is submitted, the pages will be resized upon entry into the Image File Wrapper and may affect subsequent processing					
Information:					
3	Non Patent Literature	D1221.pdf	142693 2ebd0940ee6e4b3f4a822663b789030d32c09246	no	2
Warnings:					
The page size in the PDF is too large. The pages should be 8.5 x 11 or A4. If this PDF is submitted, the pages will be resized upon entry into the Image File Wrapper and may affect subsequent processing					
Information:					
4	Non Patent Literature	D1222.pdf	69973 babcedd540231da1cc3e3494f36e2cbdfb1f7d7	no	1
Warnings:					
The page size in the PDF is too large. The pages should be 8.5 x 11 or A4. If this PDF is submitted, the pages will be resized upon entry into the Image File Wrapper and may affect subsequent processing					
Information:					
5	Non Patent Literature	D1223.pdf	638867 00410f7202c99c99c2f118d5fbc6a3adb83461be	no	42
Warnings:					
The page size in the PDF is too large. The pages should be 8.5 x 11 or A4. If this PDF is submitted, the pages will be resized upon entry into the Image File Wrapper and may affect subsequent processing					
Information:					
Total Files Size (in bytes):			1047341		

This Acknowledgement Receipt evidences receipt on the noted date by the USPTO of the indicated documents, characterized by the applicant, and including page counts, where applicable. It serves as evidence of receipt similar to a Post Card, as described in MPEP 503.

New Applications Under 35 U.S.C. 111

If a new application is being filed and the application includes the necessary components for a filing date (see 37 CFR 1.53(b)-(d) and MPEP 506), a Filing Receipt (37 CFR 1.54) will be issued in due course and the date shown on this Acknowledgement Receipt will establish the filing date of the application.

National Stage of an International Application under 35 U.S.C. 371

If a timely submission to enter the national stage of an international application is compliant with the conditions of 35 U.S.C. 371 and other applicable requirements a Form PCT/DO/EO/903 indicating acceptance of the application as a national stage submission under 35 U.S.C. 371 will be issued in addition to the Filing Receipt, in due course.

New International Application Filed with the USPTO as a Receiving Office

If a new international application is being filed and the international application includes the necessary components for an international filing date (see PCT Article 11 and MPEP 1810), a Notification of the International Application Number and of the International Filing Date (Form PCT/RO/105) will be issued in due course, subject to prescriptions concerning national security, and the date shown on this Acknowledgement Receipt will establish the international filing date of the application.

Subst. for form 1449/PTO				Complete if Known	
INFORMATION DISCLOSURE STATEMENT BY APPLICANT <i>(Use as many sheets as necessary)</i>				Application Number	13/342,795
				Filing Date	01-03-2012
				First Named Inventor	Victor Larson
				Art Unit	2453
				Examiner Name	Krisna Lim
				Docket Number	77580-155(VR NK-1CP3CNFT5)

U.S. PATENTS

EXAMINER'S INITIALS	CITE NO.	Patent Number	Publication Date	Name of Patentee or Applicant of Cited Document	Pages, Columns, Lines, Where Relevant Passages or Relevant Figures Appear

U.S. PATENT APPLICATION PUBLICATIONS

EXAMINER'S INITIALS	CITE NO.	Patent Number	Publication Date	Name of Patentee or Applicant of Cited Document	Pages, Columns, Lines, Where Relevant Passages or Relevant Figures Appear

FOREIGN PATENT DOCUMENTS

EXAMINER'S INITIALS	CITE NO.	Foreign Patent Document Country Codes - Number 4 - Kind Codes (if known)	Publication Date	Name of Patentee or Applicant of Cited Document	Pages, Columns, Lines Where Relevant Figures Appear	Translation	
						Yes	No

OTHER ART (Including Author, Title, Date, Pertinent Pages, Etc.)

EXAMINER'S INITIALS	CITE NO.	Include name of the author (in CAPITAL LETTERS), title of the article (when appropriate), title of the item (book, magazine, journal, serial, symposium, catalog, etc.), date, page(s), volume-issue number(s), publisher, city and/or country where published.
	D1224	Lee et al., "Uniform Resource Locators (URL)," Network Working Group, RFC 1738, December 1994 (25 pages)
	D1225	VPN 3000 Concentrator Series, User Guide; Release 2.5 July 2000 (489 pages)
	D1226	VPN 3000 Concentrator Series, Getting Started; Release 2.5 July 2000 (122 pages)
	D1227	Fratto, Altiga Concentrates on VPN Security (Hardware Review Evaluation), Network Computing, March 22, 1999 (2 pages)
	D1228	Response to RFP: Altiga, Network World Fusion, May 10, 1999 (7 pages)
	D1229	Altiga Proves Multi-Vendor Interoperability for Seamless VPN Deployment; VPN Workshop Marks Significant Development in the VPN Market, July 12, 1999 (2 pages)
	D1230	Altiga VPN Concentrator Series (C50) Versus Nortel Networks Contivity Extranet Switch 4000 and 4500, VPN Tunneling competitive Evaluation, 1999 (6 pages)
	D1231	VPN 3000 Client User Guide, Release 2.5, July 2000 (94 pages)
	D1232	Digital Certificates Design Specification for Release 2.0, May 17, 1999 (21 pages)
	D1233	Altiga IPsec Client Architecture, Revision 1.0, April 5, 1999 (34 pages)
	D1234	Altiga IPsec Functional Specification, Revision 2.1, (17 pages)
	D1235	Altiga Product Requirements, Revision 1.7, May 26, 1998 (17 pages)
	D1236	Altiga Network Lists Feature Functional Specification, Revision 1.0, (7 pages)
	D1237	Altiga Split Tunneling Functional/Design Specification, (15 pages)

Subst. for form 1449/PTO		Complete if Known	
INFORMATION DISCLOSURE STATEMENT BY APPLICANT <i>(Use as many sheets as necessary)</i>		Application Number	13/342,795
		Filing Date	01-03-2012
		First Named Inventor	Victor Larson
		Art Unit	2453
		Examiner Name	Krisna Lim
		Docket Number	77580-155(VRNK-1CP3CNFT5)
	D1238	Altiga Digital Certificate Support for IPsec Client V2.1 Functional Specification, August 12, 1999 (24 pages)	
	D1239	Altiga IPsec LAN to LAN Tunnel Autodiscovery Functional Specification, (5 pages)	
	D1240	Altiga Split Tunneling Testplan, Revision 1.0, (8 pages)	
	D1241	Altiga VPN Concentrator Getting Started, Revision 1, March 1999 (116 pages)	
	D1242	Altiga VPN Concentrator Getting Started, Version 2, June 1999 (102 pages)	
	D1243	Altiga VPN Concentrator Getting Started, Version 3, December 1999 (130 pages)	
	D1244	Altiga VPN Concentrator Getting Started, Version 4, March 2000 (138 pages)	
	D1245	Altiga VPN Concentrator User Guide, Revision 1, March 1999 (304 pages)	
	D1246	Altiga VPN Concentrator User Guide, Revision 1.1, March 1999 (304 pages)	
	D1247	Altiga VPN Concentrator User Guide, Version 3, June 1999 (478 pages)	
	D1248	Altiga VPN Concentrator User Guide, Version 4, December 1999 (472 pages)	
	D1249	Altiga VPN Concentrator User Guide, Version 5, March 2000 (606 pages)	
	D1250	Altiga VPN Client Installation and User Guide, Version 2, July 1999 (92 pages)	
	D1251	Altiga VPN Concentrator VPN Client Installation and User Guide, Version 3, December 1999 (113 pages)	
	D1252	Altiga VPN Concentrator VPN Client Installation and User Guide, Version 4, March 2000 (118 pages)	
	D1253	Altiga Networks VPN Concentrator and VPN Client, as well as their Public Demonstrations and Testing, are also Described in Marketing Materials and Publications (4 pages)	
EXAMINER		DATE CONSIDERED	

*EXAMINER: Initial if reference considered, whether or not citation is in conformance with MPEP 609. Draw line through citation if not in conformance and not considered. Include copy of this form with next communication to applicant.

1 Applicant's unique citation designation number (optional). 2 Applicant is to place a check mark here if English language Translation is attached.

Subst. for form 1449/PTO				Complete if Known	
INFORMATION DISCLOSURE STATEMENT BY APPLICANT <i>(Use as many sheets as necessary)</i>				Application Number	13/342,795
				Filing Date	01-03-2012
				First Named Inventor	Victor Larson
				Art Unit	2453
				Examiner Name	Krisna Lim
				Docket Number	77580-155(VR NK-1CP3CNFT5)

CERTIFICATION STATEMENT

Please See 37 CFR 1.97 and 1.98 to make the appropriate selection(s)

- Information Disclosure Statement is being filed with the filing of the application or before the receipt of a first office action.
- That each item of information contained in the information disclosure statement was first cited in any communication from a foreign patent office in a counterpart foreign application not more than three months prior to the filing of the information disclosure statement; or
- That no item of information contained in the information disclosure statement was cited in a communication from a foreign patent office in a counterpart foreign application, and, to the knowledge of the person signing the certification after making reasonable inquiry, no item of information contained in the information disclosure statement was known to any individual designated in § 1.56(c) more than three months prior to the filing of the information disclosure statement.
- The Commissioner is hereby authorized to charge any required fees to Deposit Account 50-1133.
- Information Disclosure Statement is being filed with the Request for Continued Examination. The Commissioner is hereby authorized to charge the fee pursuant to 37 CFR 1.17(P) in the amount of \$810.00, or further fees which may be due, to Deposit Account 50-1133.

SIGNATURE

A signature of the applicant or representative is required in accordance with CFR 1.33, 10.18. Please see CFR 1.4(d) for the form of the signature.

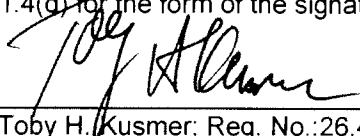

Toby H. Kusmer; Reg. No.: 26,418
 McDermott Will & Emery LLP
 28 State Street
 Boston, MA 02109
 Tel. (617) 535-4000
 Fax (617) 535-3800

Date: 10/3/12

DM_US 39145362-1.077580.0155

Electronic Acknowledgement Receipt

EFS ID:	13917897
Application Number:	13342795
International Application Number:	
Confirmation Number:	4180
Title of Invention:	SYSTEM AND METHOD EMPLOYING AN AGILE NETWORK PROTOCOL FOR SECURE COMMUNICATIONS USING SECURE DOMAIN NAMES
First Named Inventor/Applicant Name:	Victor Larson
Customer Number:	23630
Filer:	Toby H. Kusmer./Kerrie Jones
Filer Authorized By:	Toby H. Kusmer.
Attorney Docket Number:	77580-155(VRNL-1CP3CNFT5)
Receipt Date:	05-OCT-2012
Filing Date:	03-JAN-2012
Time Stamp:	12:25:34
Application Type:	Utility under 35 USC 111(a)

Payment information:

Submitted with Payment	no
------------------------	----

File Listing:

Document Number	Document Description	File Name	File Size(Bytes)/ Message Digest	Multi Part /.zip	Pages (if appl.)
1	Information Disclosure Statement (IDS) Form (SB08)	IDS.pdf	98171 <small>606d36afbabc8b43d262d1ab3cd64b327aa822b0</small>	no	3

Warnings:

Information:

This is not an USPTO supplied IDS fillable form					
The page size in the PDF is too large. The pages should be 8.5 x 11 or A4. If this PDF is submitted, the pages will be resized upon entry into the Image File Wrapper and may affect subsequent processing					
2	Non Patent Literature	D1224.PDF	1385009 c0c023e1ffc4909f65537ac685570ce89000f0	no	25
Warnings:					
Information:					
3	Non Patent Literature	D1225Part1.pdf	9707771 6ae528c44629d766c9fc4b776551d2680e925075	no	244
Warnings:					
The page size in the PDF is too large. The pages should be 8.5 x 11 or A4. If this PDF is submitted, the pages will be resized upon entry into the Image File Wrapper and may affect subsequent processing					
Information:					
4	Non Patent Literature	D1225Part2.pdf	8053147 7222d5e4fd698a15af27a75609a6ac57f6c9b5f7	no	245
Warnings:					
The page size in the PDF is too large. The pages should be 8.5 x 11 or A4. If this PDF is submitted, the pages will be resized upon entry into the Image File Wrapper and may affect subsequent processing					
Information:					
5	Non Patent Literature	D1226.PDF	9200782 8580c9a4640bf44fb6e2957b63f29a731ecfd9df	no	122
Warnings:					
Information:					
6	Non Patent Literature	D1227.PDF	1923180 c3f5782b90fe6dd48d635c349d737d268f6c9ff2e	no	2
Warnings:					
Information:					
7	Non Patent Literature	D1228.PDF	4527086 38650c0ad2503042490658953182f34c882385d5	no	7
Warnings:					
Information:					
8	Non Patent Literature	D1229.PDF	1921619 8a30921b2a6d77e3745af10f4b4208a362fbdd58	no	2
Warnings:					
Information:					
9	Non Patent Literature	D1230.PDF	7300485 bc94176849e0031bdfa94581437d293ad31e622a	no	6

Warnings:					
Information:					
10	Non Patent Literature	D1231.PDF	6455029 1dae9c7575280f98a1b9665ebecf8047f644e308	no	94
Warnings:					
Information:					
11	Non Patent Literature	D1232.PDF	936879 a64c3cc70a981e525fa1c2a0856466016fec4742	no	21
Warnings:					
Information:					
12	Non Patent Literature	D1233.PDF	2643873 0ad9db0a2c4d60a911bbea292e560645569beb42	no	34
Warnings:					
Information:					
13	Non Patent Literature	D1234.PDF	1337280 26f30a98ca4b3c06dee097790ecccd22ed1cd625	no	17
Warnings:					
Information:					
14	Non Patent Literature	D1235.PDF	1118077 570378cf0fef9a9f0db5934767a10631a9697ccb	no	17
Warnings:					
Information:					
15	Non Patent Literature	D1236.PDF	516087 43622ea13fa2edcf841bf78b01ea08c61eccfef68	no	7
Warnings:					
Information:					
16	Non Patent Literature	D1237.PDF	978889 cb31cc3954935b83adff852ae9cd68114d72e63d9	no	15
Warnings:					
Information:					
17	Non Patent Literature	D1238.PDF	2081715 7b840029a950da75a9c9adb76c6f30c69e188862	no	24
Warnings:					
Information:					
18	Non Patent Literature	D1239.PDF	329750 2d833f9187957eedcb0e407a1356ea87c36e052e	no	5

Warnings:					
Information:					
19	Non Patent Literature	D1240.PDF	507540 a74f5d5f6e671ac2414f2eae9bb487ffb0e2	no	8
Warnings:					
Information:					
20	Non Patent Literature	D1241.PDF	6401651 62ec4bfa8bce771c05b216d7c47c403a52973f36	no	116
Warnings:					
Information:					
21	Non Patent Literature	D1242.PDF	5607358 8f2f53edf2efb6f020153bbe73c2b562a03bb4f7	no	102
Warnings:					
Information:					
22	Non Patent Literature	D1243.PDF	7301095 3e89def78808ab4f8f5ce0b234cd3322f595cd61	no	130
Warnings:					
Information:					
23	Non Patent Literature	D1244.PDF	7945433 417911827dcb8d869eb9e217f1414dc9c4a46f9d	no	138
Warnings:					
Information:					
24	Non Patent Literature	D1245.PDF	17791506 735e0d644c3a58450a4b6cf096d32db096ca6d70	no	304
Warnings:					
Information:					
25	Non Patent Literature	D1246.PDF	17791522 be912d02c9c8a1b615568dab376ef177ef963f86	no	304
Warnings:					
Information:					
26	Non Patent Literature	D1247part1.pdf	4478737 1b2222ad6d47bcf50238e51eae6b681ee70f4342	no	244
Warnings:					
The page size in the PDF is too large. The pages should be 8.5 x 11 or A4. If this PDF is submitted, the pages will be resized upon entry into the Image File Wrapper and may affect subsequent processing					
Information:					

27	Non Patent Literature	D1247part2.pdf	4380602 f9d82845d47589474fc6f26b8fe686384cc ef5	no	234
Warnings:					
The page size in the PDF is too large. The pages should be 8.5 x 11 or A4. If this PDF is submitted, the pages will be resized upon entry into the Image File Wrapper and may affect subsequent processing					
Information:					
28	Non Patent Literature	D1248part1.pdf	5121910 110aa00905f6405dd299e00b45cf87c676 21cd0	no	239
Warnings:					
The page size in the PDF is too large. The pages should be 8.5 x 11 or A4. If this PDF is submitted, the pages will be resized upon entry into the Image File Wrapper and may affect subsequent processing					
Information:					
29	Non Patent Literature	D1248part2.pdf	4580517 8369e89c947d049595d9e6451f6f84006b9 49fc4	no	233
Warnings:					
The page size in the PDF is too large. The pages should be 8.5 x 11 or A4. If this PDF is submitted, the pages will be resized upon entry into the Image File Wrapper and may affect subsequent processing					
Information:					
30	Non Patent Literature	D1249part1.pdf	4350698 6ce20ea7a52e3038ca51c565713640627d2 30135	no	205
Warnings:					
The page size in the PDF is too large. The pages should be 8.5 x 11 or A4. If this PDF is submitted, the pages will be resized upon entry into the Image File Wrapper and may affect subsequent processing					
Information:					
31	Non Patent Literature	D1249part2.pdf	4232123 2bdcf1c426a5631c6be840dc2307b3a0751 b50b2	no	198
Warnings:					
The page size in the PDF is too large. The pages should be 8.5 x 11 or A4. If this PDF is submitted, the pages will be resized upon entry into the Image File Wrapper and may affect subsequent processing					
Information:					
32	Non Patent Literature	D1249part3.pdf	3557941 200eca2c1f3735e756074449c981de15557 3a10	no	203
Warnings:					
The page size in the PDF is too large. The pages should be 8.5 x 11 or A4. If this PDF is submitted, the pages will be resized upon entry into the Image File Wrapper and may affect subsequent processing					
Information:					
33	Non Patent Literature	D1250.PDF	4663415 eedc19be973a322d4836e6d220271020c08 2e15f	no	92
Warnings:					

Information:					
34	Non Patent Literature	D1251.PDF	5973935	no	113
			fac713d79db8ae257186853a6ddb06f093b63bec		
Warnings:					
Information:					
35	Non Patent Literature	D1252.PDF	6581540	no	118
			2caebcf0aacfb81210ecf5bbcf02440006b76a065		
Warnings:					
Information:					
36	Non Patent Literature	D1253.PDF	1740859	no	4
			7ea0a705b2f08195bb7ab0b072b732bef178620e		
Warnings:					
Information:					
Total Files Size (in bytes):				173523211	
<p>This Acknowledgement Receipt evidences receipt on the noted date by the USPTO of the indicated documents, characterized by the applicant, and including page counts, where applicable. It serves as evidence of receipt similar to a Post Card, as described in MPEP 503.</p> <p><u>New Applications Under 35 U.S.C. 111</u> If a new application is being filed and the application includes the necessary components for a filing date (see 37 CFR 1.53(b)-(d) and MPEP 506), a Filing Receipt (37 CFR 1.54) will be issued in due course and the date shown on this Acknowledgement Receipt will establish the filing date of the application.</p> <p><u>National Stage of an International Application under 35 U.S.C. 371</u> If a timely submission to enter the national stage of an international application is compliant with the conditions of 35 U.S.C. 371 and other applicable requirements a Form PCT/DO/EO/903 indicating acceptance of the application as a national stage submission under 35 U.S.C. 371 will be issued in addition to the Filing Receipt, in due course.</p> <p><u>New International Application Filed with the USPTO as a Receiving Office</u> If a new international application is being filed and the international application includes the necessary components for an international filing date (see PCT Article 11 and MPEP 1810), a Notification of the International Application Number and of the International Filing Date (Form PCT/RO/105) will be issued in due course, subject to prescriptions concerning national security, and the date shown on this Acknowledgement Receipt will establish the international filing date of the application.</p>					

Document code: WFEE

United States Patent and Trademark Office
Sales Receipt for Accounting Date: 10/15/2012

FPATTERS	SALE	#00000001	Mailroom Dt:	10/05/2012	501133	13342795
		01	FC : 1806		180.00	DA



UNITED STATES PATENT AND TRADEMARK OFFICE

UNITED STATES DEPARTMENT OF COMMERCE
United States Patent and Trademark Office
Address: COMMISSIONER FOR PATENTS
P.O. Box 1450
Alexandria, Virginia 22313-1450
www.uspto.gov

Table with 5 columns: APPLICATION NO., FILING DATE, FIRST NAMED INVENTOR, ATTORNEY DOCKET NO., CONFIRMATION NO.
13/342,795 01/03/2012 Victor Larson 77580-155(VRNK-1CP3CNFT5) 4180

23630 7590 10/18/2012
McDermott Will & Emery
The McDermott Building
500 North Capitol Street, N.W.
Washington, DC 20001

EXAMINER

LIM, KRISNA

ART UNIT PAPER NUMBER

2453

NOTIFICATION DATE DELIVERY MODE

10/18/2012

ELECTRONIC

Please find below and/or attached an Office communication concerning this application or proceeding.

The time period for reply, if any, is set in the attached communication.

Notice of the Office communication was sent electronically on above-indicated "Notification Date" to the following e-mail address(es):

mweipdocket@mwe.com

Applicant-Initiated Interview Summary	Application No. 13/342,795	Applicant(s) LARSON ET AL.	
	Examiner KRISNA LIM	Art Unit 2453	

All participants (applicant, applicant's representative, PTO personnel):

- (1) KRISNA LIM. (3) Mr. Robert Short.
(2) Mr. Toby Kusmer (Reg. No. 26,418). (4) _____.

Date of Interview: 11 October 2012.

Type: Telephonic Video Conference
 Personal [copy given to: applicant applicant's representative]

Exhibit shown or demonstration conducted: Yes No.
If Yes, brief description: _____.

Issues Discussed 101 112 102 103 Others
(For each of the checked box(es) above, please describe below the issue and detailed description of the discussion)

Claim(s) discussed: 1.

Identification of prior art discussed: Wesinger (Patent No. 5,898,830).

Substance of Interview

(For each issue discussed, provide a detailed description and indicate if agreement was reached. Some topics may include: identification or clarification of a reference or a portion thereof, claim interpretation, proposed amendments, arguments of any applied references etc...)

Mr. Short discussed the background and the gist of the invention. Mr. Short distinguished the gist feature of the invention in comparison to the firewall, the switch and the router of the prior arts. Mr. Short and Mr. Kusmer discussed the gist features of the invention. For example, the invention is focus on the feature of "intercepting domain name request look up and determining the request corresponding to the secure web site".

Applicant recordation instructions: The formal written reply to the last Office action must include the substance of the interview. (See MPEP section 713.04). If a reply to the last Office action has already been filed, applicant is given a non-extendable period of the longer of one month or thirty days from this interview date, or the mailing date of this interview summary form, whichever is later, to file a statement of the substance of the interview

Examiner recordation instructions: Examiners must summarize the substance of any interview of record. A complete and proper recordation of the substance of an interview should include the items listed in MPEP 713.04 for complete and proper recordation including the identification of the general thrust of each argument or issue discussed, a general indication of any other pertinent matters discussed regarding patentability and the general results or outcome of the interview, to include an indication as to whether or not agreement was reached on the issues raised.

Attachment

/Krisna Lim/
Primary Examiner, Art Unit 2453

Summary of Record of Interview Requirements

Manual of Patent Examining Procedure (MPEP), Section 713.04, Substance of Interview Must be Made of Record

A complete written statement as to the substance of any face-to-face, video conference, or telephone interview with regard to an application must be made of record in the application whether or not an agreement with the examiner was reached at the interview.

Title 37 Code of Federal Regulations (CFR) § 1.133 Interviews

Paragraph (b)

In every instance where reconsideration is requested in view of an interview with an examiner, a complete written statement of the reasons presented at the interview as warranting favorable action must be filed by the applicant. An interview does not remove the necessity for reply to Office action as specified in §§ 1.111, 1.135. (35 U.S.C. 132)

37 CFR §1.2 Business to be transacted in writing.

All business with the Patent or Trademark Office should be transacted in writing. The personal attendance of applicants or their attorneys or agents at the Patent and Trademark Office is unnecessary. The action of the Patent and Trademark Office will be based exclusively on the written record in the Office. No attention will be paid to any alleged oral promise, stipulation, or understanding in relation to which there is disagreement or doubt.

The action of the Patent and Trademark Office cannot be based exclusively on the written record in the Office if that record is itself incomplete through the failure to record the substance of interviews.

It is the responsibility of the applicant or the attorney or agent to make the substance of an interview of record in the application file, unless the examiner indicates he or she will do so. It is the examiner's responsibility to see that such a record is made and to correct material inaccuracies which bear directly on the question of patentability.

Examiners must complete an Interview Summary Form for each interview held where a matter of substance has been discussed during the interview by checking the appropriate boxes and filling in the blanks. Discussions regarding only procedural matters, directed solely to restriction requirements for which interview recordation is otherwise provided for in Section 812.01 of the Manual of Patent Examining Procedure, or pointing out typographical errors or unreadable script in Office actions or the like, are excluded from the interview recordation procedures below. Where the substance of an interview is completely recorded in an Examiners Amendment, no separate Interview Summary Record is required.

The Interview Summary Form shall be given an appropriate Paper No., placed in the right hand portion of the file, and listed on the "Contents" section of the file wrapper. In a personal interview, a duplicate of the Form is given to the applicant (or attorney or agent) at the conclusion of the interview. In the case of a telephone or video-conference interview, the copy is mailed to the applicant's correspondence address either with or prior to the next official communication. If additional correspondence from the examiner is not likely before an allowance or if other circumstances dictate, the Form should be mailed promptly after the interview rather than with the next official communication.

The Form provides for recordation of the following information:

- Application Number (Series Code and Serial Number)
- Name of applicant
- Name of examiner
- Date of interview
- Type of interview (telephonic, video-conference, or personal)
- Name of participant(s) (applicant, attorney or agent, examiner, other PTO personnel, etc.)
- An indication whether or not an exhibit was shown or a demonstration conducted
- An identification of the specific prior art discussed
- An indication whether an agreement was reached and if so, a description of the general nature of the agreement (may be by attachment of a copy of amendments or claims agreed as being allowable). Note: Agreement as to allowability is tentative and does not restrict further action by the examiner to the contrary.
- The signature of the examiner who conducted the interview (if Form is not an attachment to a signed Office action)

It is desirable that the examiner orally remind the applicant of his or her obligation to record the substance of the interview of each case. It should be noted, however, that the Interview Summary Form will not normally be considered a complete and proper recordation of the interview unless it includes, or is supplemented by the applicant or the examiner to include, all of the applicable items required below concerning the substance of the interview.

A complete and proper recordation of the substance of any interview should include at least the following applicable items:

- 1) A brief description of the nature of any exhibit shown or any demonstration conducted,
- 2) an identification of the claims discussed,
- 3) an identification of the specific prior art discussed,
- 4) an identification of the principal proposed amendments of a substantive nature discussed, unless these are already described on the Interview Summary Form completed by the Examiner,
- 5) a brief identification of the general thrust of the principal arguments presented to the examiner,
(The identification of arguments need not be lengthy or elaborate. A verbatim or highly detailed description of the arguments is not required. The identification of the arguments is sufficient if the general nature or thrust of the principal arguments made to the examiner can be understood in the context of the application file. Of course, the applicant may desire to emphasize and fully describe those arguments which he or she feels were or might be persuasive to the examiner.)
- 6) a general indication of any other pertinent matters discussed, and
- 7) if appropriate, the general results or outcome of the interview unless already described in the Interview Summary Form completed by the examiner.

Examiners are expected to carefully review the applicant's record of the substance of an interview. If the record is not complete and accurate, the examiner will give the applicant an extendable one month time period to correct the record.

Examiner to Check for Accuracy

If the claims are allowable for other reasons of record, the examiner should send a letter setting forth the examiner's version of the statement attributed to him or her. If the record is complete and accurate, the examiner should place the indication, "Interview Record OK" on the paper recording the substance of the interview along with the date and the examiner's initials.

IN THE UNITED STATES PATENT AND TRADEMARK OFFICE

In re Application of: Victor Larson <i>et al.</i>	:	
	:	
Serial No.: 13/342,795	:	Confirmation No. 4180
	:	
Filed: January 3, 2012	:	Group Art Unit: 2453
	:	
Customer Number: 23630	:	Examiner: Lim, Krisna

For: System and Method Employing an Agile Network Protocol for Secure Communications Using Secure Domain Names

Mail Stop Amendment
Commissioner for Patents
P.O. Box 1450
Alexandria, VA 22313-1450

REPLY "B"

Sir:

This Reply is being filed in response to the Office Action mailed from the United States Patent and Trademark office on July 30, 2012.

Applicants appreciate the Examiner’s thorough examination of the subject application and request reconsideration and further examination in view of the following:

Claims begin on page 2 of this paper.

Remarks begin on page 5 of this paper.

IN THE CLAIMS

The claims are being presented solely for the convenience of the Office. No claims are being added, amended, deleted, or canceled.

LISTING OF CLAIMS:

1. (Original) A client device comprising:
 - (a) memory configured and arranged to facilitate a connection of the client device with a target device over a secure communication link created based on (i) an address request generated by the client device, and (ii) a determination as a result of the address request that the target device is a device with which a secure communication link can be established when the requested address is identified in an address lookup;
 - (b) an application program configured and arranged so as to allow participation in audio/video communications with the target device over the secure communication link once the secure communication link is established; and
 - (c) a signal processing configuration arranged to execute the application program.
2. (Original) The client device of claim 1, wherein the client device is a computer.
3. (Original) The client device of claim 1, wherein the client device is a phone.
4. (Original) The client device of claim 3, wherein the establishment of the secure communication link is based on a determination being made by a server that the target device is a device with which a secure communication link can be established when the address request corresponds to a target device identified in the address lookup.
5. (Original) The client device of claim 4, wherein the address lookup is a network address lookup.
6. (Original) The client device of claim 3, wherein the secure communication link is a virtual private network link.
7. (Original) The client device of claim 3, wherein the address request includes a secure domain name.

8. (Original) The client device of claim 3, wherein the address request includes a domain name, and the establishment of the secure communication link is based on the determination being made by a proxy module that the target device is a device with which a secure communication link can be established when the secure domain name corresponds to a target device identified in a DNS lookup table.
9. (Original) The client device of claim 3, wherein the secure communication link is a broadband connection.
10. (Original) The client device of claim 3, wherein the secure communication link is a modulated transmission link.
11. (Original) The client device of claim 3, where the secure communication link supports at least one of the following: FTM, TDM and CDMA.
12. (Original) The client device of claim 3, wherein the secure communication link supports TCP/IP protocols
13. (Original) The client device of claim 3, wherein the target device is a server.
14. (Original) The client device of claim 3, wherein the target device is a computer.
15. (Original) The client device of claim 3, wherein the target device is a phone.
16. (Original) A method executed by a client device for communicating with a target device, the method comprising:
 - (a) facilitating a connection with the target device over a secure communication link created based on (i) an address request generated by the client device, and (ii) a determination as a result of the address request that the target device is a device with which a secure communication link can be established when the requested address is identified in an address lookup; and
 - (b) allowing participation in audio/video communications with the target device over the secure communication link once the secure communication link is established.
17. (Original) The method of claim 16, wherein the client device is a computer.

18. (Original) The method of claim 16, wherein the client device is a phone.
19. (Original) The method of claim 16, wherein the address lookup is a network address lookup.
20. (Original) The method of claim 16, wherein the establishment of the secure communication link is based on a determination being made by a server that the target device is a device with which a secure communication link can be established when the address request corresponds to a target device identified in the address lookup.
21. (Original) The method of claim 16, wherein the secure communication link is a virtual private network link.
22. (Original) The method of claim 16, wherein the address request includes a secure domain name.
23. (Original) The method of claim 16, wherein the secure communication link is a broadband connection.
24. (Original) The method of claim 16, wherein the secure communication link is an unmodulated transmission link.
25. (Original) The method of claim 16, wherein the secure communication link is a modulated transmission link.
26. (Original) The method of claim 16, where the secure communication link supports at least one of the following: FTM, TDM and CDMA.
27. (Original) The method of claim 16, wherein the secure communication link supports TCP/IP protocols
28. (Original) The method of claim 16, wherein the target device is a server.
29. (Original) The method of claim 16, wherein the target device is a computer.
30. (Original) The method of claim 16, wherein the target device is a phone.

REMARKS

Claims 1-30 are pending in the application, of which Claims 1 and 16 are the independent claims. No claims have been amended or canceled. In the Office Action mailed July 30, 2012 (“Office Action”), claims 1-30 stand rejected under 35 U.S.C. § 103(a) based on U.S. Patent No. 5,898,830 (“*Wesinger*”). The rejections are traversed and reconsideration is respectfully requested in view of the following remarks.

Interview Summary

Applicants thank the Examiner for the courtesy extended to Applicants’ representative Toby H. Kusmer, Reg. No. 26,418, during the personal interview conducted in the U.S. Patent and Trademark Office on August 23, 2012 (“first interview”), as well as to Toby H. Kusmer and Dr. Robert Short III at the personal interview conducted on October 18, 2012 (“second interview”). The Examiner mailed Interview Summaries on August 30, 2012, and October 18, 2012, summarizing certain aspects of the interviews. Applicants thank the Examiner for the Interview Summaries, and submit the following comments to address and clarify the Examiner’s summary of those discussions.

During the first interview, Applicants’ representative provided an overview of the claimed subject matter and discussed patentable distinctions of the claimed subject matter over the asserted reference, *Wesinger*. However, no agreement was reached regarding the allowability of the claims.

During the second interview, Applicants’ representative and Dr. Short provided an overview of the claimed subject matter. Additionally, the Examiner, Applicants’ representative, and Dr. Short discussed distinctions between the claimed subject matter and firewall systems such as in *Wesinger*. The Examiner suggested that one example feature discussed by Applicants’ representative and Dr. Short during the interview – interception of a request to lookup a network address of a network device and a determination whether the network device is available for a secure communication service – was distinguishable over the prior art. The Examiner suggested that Applicants amend the claims accordingly.

In the second Interview Summary, the Examiner summarized the discussions of such allowable features as the “gist of the invention.” Although Applicants agree that “interception of a request to look up a network address of a network device and a determination whether the

network device is available for a secure communications service” is one feature that is distinguishable from the cited art, Applicants disagree with the second Interview Summary to the extent that it suggests that the above mentioned “intercepting” feature is the *only* novel and nonobvious aspect of Applicants’ disclosed and/or claimed embodiments. Indeed, as discussed during the interview and described below, Applicants’ disclosed and claimed embodiments include other novel and nonobvious aspects of the claimed subject matter. Other novel and unobvious aspects of the claimed subject include features that are found in the currently pending claims and in the claims presented prior to this Response. Thus, while Applicants appreciate the Examiner’s suggestion to expedite allowance of this application, Applicants decline to amend the claims because they are already patentably distinguishable from *Wesinger* and other cited prior art, for at least the reasons below.

Claim Rejections – 35 U.S.C. § 103

To support an obvious rejection, “all of the claim limitations must be taught or suggested by the prior art applied and that all words in a claim must be considered in judging the patentability of that claim against the prior art.” *Ex Parte Karl Burgess*, Appeal 2008-2820, 2009 WL 291172 (B.P.A.I. 2009), at *3 (citing *In re Royka*, 490 F.2d 981, 984-85 (CCPA 1974), *In re Wilson*, 424 F.2d 1382, 1385 (CCPA 1970)) (emphasis added). A rejection based on obviousness “cannot be sustained with mere conclusory statements; instead, there must be some articulated reasoning with some rational underpinning to support the legal conclusion of obviousness.” *KSR Int’l Co. v. Teleflex Inc.*, 126 S. Ct. 1727, 1741 (2007) (citing *In re Kahn*, 441 F.3d at 988). Here, the Office Action fails to demonstrate that each and every limitation of claims 1-28 are disclosed or suggested in *Wesinger*.

Wesinger discloses a firewall that is configured as two or more sets of virtual hosts, with DNS mappings between the virtual hosts and respective remote hosts to be accessed through network interfaces of the firewall. (*Wesinger* Abstract.) At most, these virtual hosts and DNS mappings enable transparent communications through the firewall. The firewall “selectively allows ‘acceptable’ computer transmissions to pass through it and disallows other non-acceptable computer transmissions.” (*Id.* at 1:8-12.)

In *Wesinger*, “[w]hen a connection request is received, the firewall spawns a process, or execution thread, to create a virtual host VHN to handle that connection request.” (*Id.* at 15:9-

12.) “Each virtual host has a separate configuration sub-file (sub-database) C1, C2, etc., that may be derived from a master configuration file, or database, 510. The configuration sub-files are text files that may be used to enable or disable different functions for each virtual host, specify which connections and types of traffic will be allowed and which will be denied, etc.” (*Id.* at 14:46-52.) “Also as part of the configuration file of each virtual host, an access rules database is provided governing access to and through the virtual host, i.e., which connections will be allowed and which connections will be denied.” (*Id.* at 15:24-28.) The process in *Wesinger* uses the access rules database to “allow only a connection from a specified secure client.” (*Id.* at 10:14-16.)

Wesinger also discusses processing of DNS requests:

When client C tries to initiate a connection to host D using the name of D, DNS operates in the usual manner to propagate a name request to successive levels of the network until D is found. The DNS server for D returns the network address of D to a virtual host on the firewall 155. The virtual host returns its network address to the virtual host on the firewall 157 from which it received the lookup request, and so on, until a virtual host on the firewall 105 returns its network address (instead of the network address of D) to the client C.

(*Id.* at 9:16-24.) Accordingly, when client C uses a name of D in a DNS request, C gets back an address for a virtual host of firewall 105, which faces C. (*See id.* at Fig. 1).

Wesinger describes processes and components different from the embodiments recited in claims 1-30. For example, independent claim 1 is representative and recites:

A client device comprising:

(a) memory configured and arranged to facilitate a connection of the client device with a target device over a secure communication link created based on (i) an address request generated by the client device, and (ii) a determination as a result of the address request that the target device is a device with which a secure communication link can be established when the requested address is identified in an address lookup;

(b) an application program configured and arranged so as to allow participation in audio/video communications with the target device over the secure communication link once the secure communication link is established; and

(c) a signal processing configuration arranged to execute the application program.

Wesinger does not teach, for example, a server that makes a “***determination as a result of the address request that the target device is a device with which a secure communication link can be established when the requested address is identified in an address lookup.***” *Wesinger*

describes that a firewall (a virtual host) merely checks parameters of a requested connection to determine whether the connection should be allowed. (*See Wesinger* at 9:53-60.) *Wesinger* is not concerned with whether the alleged target device is a device with which a secure communication link can be established, much less established when the requested address is identified in an address lookup. Consequently, *Wesinger* does not teach the claimed determination.

Wesinger briefly states that encryption may be used in combination with firewalls, but does not describe those firewalls as providing any determination of whether a second device is available for a secure communications service. (*See Wesinger* at 4:39-42; 12:22-28.) In fact, *Wesinger* describes that “[o]nce a connection has been allowed, the virtual host process invokes code that performs . . . channel processing (encryption . . .).” (*Id.* at 17:1-7.) Invoking code for encryption or the like *after a connection has already been established* does **not** teach or suggest a “determination as a result of the address request that the target device is a device with which a secure communication link *can be established* when the requested address is identified in an address lookup.”

Applicants also note that the Office Action does not specify which portions of *Wesinger* render obvious the feature of “an application program configured and arranged so as to allow participation in audio/video communications with the target device over the secure communication link once the secure communication link is established,” as recited by claim 1. Indeed, *Wesinger* is not concerned with audio/video communications. For at least that reason alone, a rejection based on *Wesinger* cannot be maintained. *KSR Int’l Co.*, 126 S. Ct. at 1741.

Accordingly, Applicants respectfully request that the rejection under 35 U.S.C. § 103 be withdrawn.

Independent claim 16, though of different scope from independent claim 1, recites similar features to those discussed above in connection with claim 1. Thus, for at least the explanations similar to those described above regarding independent claim 1, *Wesinger* is not understood to teach or suggest at least the foregoing features of independent claim 16. Since the cited references do not teach or suggest the features of claim 16, reconsideration and withdrawal of the rejection of independent claim 16 under § 103(a) are respectfully requested.

Claims 2-15 and 17-30 depend from claims 1 and 16, respectively. These dependent claims currently under consideration in the application are believed to be allowable for at least reasons similar to those discussed above with respect to claims 1 and 16. Additionally, dependent claims 2-15 and 17-30 are allowable for the additional reason that each of the claims recite additional features not disclosed or suggested by the cited references. Because each dependent claim is deemed to define an additional aspect of the invention, the individual consideration of each on its own merits is respectfully requested. Accordingly, reconsideration and withdrawal of the rejections of the dependent claims are respectfully requested.

CONCLUSION

Applicants respectfully submit that all of the pending claims, claims 1-28, are in condition for allowance. Applicants respectfully invite the Examiner to contact the undersigned attorney to promptly address any questions or issues regarding the allowability of the pending claims.

Applicants' remarks in support of patentability of one claim should not be imputed to any other claim, even if similar terminology is used. Any absence of a reply to a specific rejection, issue, or comment does not signify agreement with or concession of that rejection, issue, or comment. In addition, because Applicants' remarks are not intended to be exhaustive, as there may be other reasons for patentability of any or all claims that have not been expressed. Finally, nothing in this response should be construed as an intent to concede any issue with regard to any claim, and the amendment or cancellation of any claim does not necessarily signify concession of unpatentability of the claim prior to its amendment or cancellation.

To the extent necessary, a petition for an extension of time under 37 C.F.R. 1.136 is hereby made. Please charge any shortage in fees due in connection with the filing of this paper, including extension of time fees, to Deposit Account 502203 and please credit any excess fees to such deposit account.

Serial No. : 13/342,795

Respectfully submitted,

McDERMOTT WILL & EMERY LLP

Date: October 30, 2012

/Toby H. Kusmer/

Toby H. Kusmer, P.C., Reg. No. 26,418

Customer No. 23630

28 State Street

Boston, MA 02109-1775

Telephone: (617) 535-4000

Facsimile : (617)535-3800

E-mail: tkusmer@mwe.com

Kenneth C. Cheney, Reg. No. 61,841

4 Park Plaza

Suite 1700

Irvine, California 92614-2559

Telephone: (949) 757-7111

Facsimile: (949) 851-9348

E-mail: kcheney@mwe.com

Electronic Acknowledgement Receipt

EFS ID:	14107637
Application Number:	13342795
International Application Number:	
Confirmation Number:	4180
Title of Invention:	SYSTEM AND METHOD EMPLOYING AN AGILE NETWORK PROTOCOL FOR SECURE COMMUNICATIONS USING SECURE DOMAIN NAMES
First Named Inventor/Applicant Name:	Victor Larson
Customer Number:	23630
Filer:	Toby H. Kusmer./Kimila Carraway
Filer Authorized By:	Toby H. Kusmer.
Attorney Docket Number:	77580-155(VR NK-1CP3CNFT5)
Receipt Date:	30-OCT-2012
Filing Date:	03-JAN-2012
Time Stamp:	20:35:02
Application Type:	Utility under 35 USC 111(a)

Payment information:

Submitted with Payment	no
------------------------	----

File Listing:

Document Number	Document Description	File Name	File Size(Bytes)/ Message Digest	Multi Part /.zip	Pages (if appl.)
1		077580_0155_VR NK-1CP3CNFT 5_Reply_B.pdf	113111 <small>69a7e0917ad3e5716212b5a1c1c0632e9032e382</small>	yes	10

Multipart Description/PDF files in .zip description			
Document Description		Start	End
Amendment/Req. Reconsideration-After Non-Final Reject		1	1
Claims		2	4
Applicant Arguments/Remarks Made in an Amendment		5	10

Warnings:

Information:

Total Files Size (in bytes):	113111
-------------------------------------	--------

This Acknowledgement Receipt evidences receipt on the noted date by the USPTO of the indicated documents, characterized by the applicant, and including page counts, where applicable. It serves as evidence of receipt similar to a Post Card, as described in MPEP 503.

New Applications Under 35 U.S.C. 111

If a new application is being filed and the application includes the necessary components for a filing date (see 37 CFR 1.53(b)-(d) and MPEP 506), a Filing Receipt (37 CFR 1.54) will be issued in due course and the date shown on this Acknowledgement Receipt will establish the filing date of the application.

National Stage of an International Application under 35 U.S.C. 371

If a timely submission to enter the national stage of an international application is compliant with the conditions of 35 U.S.C. 371 and other applicable requirements a Form PCT/DO/EO/903 indicating acceptance of the application as a national stage submission under 35 U.S.C. 371 will be issued in addition to the Filing Receipt, in due course.

New International Application Filed with the USPTO as a Receiving Office

If a new international application is being filed and the international application includes the necessary components for an international filing date (see PCT Article 11 and MPEP 1810), a Notification of the International Application Number and of the International Filing Date (Form PCT/RO/105) will be issued in due course, subject to prescriptions concerning national security, and the date shown on this Acknowledgement Receipt will establish the international filing date of the application.

Under the Paperwork Reduction Act of 1995, no persons are required to respond to a collection of information unless it displays a valid OMB control number.

PATENT APPLICATION FEE DETERMINATION RECORD Substitute for Form PTO-875	Application or Docket Number 13/342,795	Filing Date 01/03/2012	<input type="checkbox"/> To be Mailed
---	---	----------------------------------	---------------------------------------

APPLICATION AS FILED – PART I			OTHER THAN SMALL ENTITY			
	(Column 1)	(Column 2)	SMALL ENTITY <input type="checkbox"/>	OR		
FOR	NUMBER FILED	NUMBER EXTRA	RATE (\$)	FEE (\$)	RATE (\$)	FEE (\$)
<input type="checkbox"/> BASIC FEE <small>(37 CFR 1.16(a), (b), or (c))</small>	N/A	N/A	N/A		N/A	
<input type="checkbox"/> SEARCH FEE <small>(37 CFR 1.16(k), (j), or (m))</small>	N/A	N/A	N/A		N/A	
<input type="checkbox"/> EXAMINATION FEE <small>(37 CFR 1.16(o), (p), or (q))</small>	N/A	N/A	N/A		N/A	
TOTAL CLAIMS <small>(37 CFR 1.16(j))</small>	minus 20 =	*	X \$ =		X \$ =	
INDEPENDENT CLAIMS <small>(37 CFR 1.16(h))</small>	minus 3 =	*	X \$ =		X \$ =	
<input type="checkbox"/> APPLICATION SIZE FEE <small>(37 CFR 1.16(s))</small>	If the specification and drawings exceed 100 sheets of paper, the application size fee due is \$250 (\$125 for small entity) for each additional 50 sheets or fraction thereof. See 35 U.S.C. 41(a)(1)(G) and 37 CFR 1.16(s).					
<input type="checkbox"/> MULTIPLE DEPENDENT CLAIM PRESENT <small>(37 CFR 1.16(j))</small>						
* If the difference in column 1 is less than zero, enter "0" in column 2.			TOTAL		TOTAL	

APPLICATION AS AMENDED – PART II					OTHER THAN SMALL ENTITY			
	(Column 1)	(Column 2)	(Column 3)					
AMENDMENT	10/30/2012	CLAIMS REMAINING AFTER AMENDMENT	HIGHEST NUMBER PREVIOUSLY PAID FOR	PRESENT EXTRA	RATE (\$)	ADDITIONAL FEE (\$)	RATE (\$)	ADDITIONAL FEE (\$)
	Total <small>(37 CFR 1.16(i))</small>	* 30	Minus ** 30	= 0	X \$ =		OR X \$62=	0
	Independent <small>(37 CFR 1.16(h))</small>	* 2	Minus ***3	= 0	X \$ =		OR X \$250=	0
	<input type="checkbox"/> Application Size Fee <small>(37 CFR 1.16(s))</small>							
	<input type="checkbox"/> FIRST PRESENTATION OF MULTIPLE DEPENDENT CLAIM <small>(37 CFR 1.16(j))</small>							
					TOTAL ADD'L FEE		OR TOTAL ADD'L FEE	0

	(Column 1)	(Column 2)	(Column 3)					
AMENDMENT		CLAIMS REMAINING AFTER AMENDMENT	HIGHEST NUMBER PREVIOUSLY PAID FOR	PRESENT EXTRA	RATE (\$)	ADDITIONAL FEE (\$)	RATE (\$)	ADDITIONAL FEE (\$)
	Total <small>(37 CFR 1.16(i))</small>	*	Minus **	=	X \$ =		OR X \$ =	
	Independent <small>(37 CFR 1.16(h))</small>	*	Minus ***	=	X \$ =		OR X \$ =	
	<input type="checkbox"/> Application Size Fee <small>(37 CFR 1.16(s))</small>							
	<input type="checkbox"/> FIRST PRESENTATION OF MULTIPLE DEPENDENT CLAIM <small>(37 CFR 1.16(j))</small>							
					TOTAL ADD'L FEE		OR TOTAL ADD'L FEE	

* If the entry in column 1 is less than the entry in column 2, write "0" in column 3.
 ** If the "Highest Number Previously Paid For" IN THIS SPACE is less than 20, enter "20".
 *** If the "Highest Number Previously Paid For" IN THIS SPACE is less than 3, enter "3".
 The "Highest Number Previously Paid For" (Total or Independent) is the highest number found in the appropriate box in column 1.

Legal Instrument Examiner:
/STELLA LITTLE/

This collection of information is required by 37 CFR 1.16. The information is required to obtain or retain a benefit by the public which is to file (and by the USPTO to process) an application. Confidentiality is governed by 35 U.S.C. 122 and 37 CFR 1.14. This collection is estimated to take 12 minutes to complete, including gathering, preparing, and submitting the completed application form to the USPTO. Time will vary depending upon the individual case. Any comments on the amount of time you require to complete this form and/or suggestions for reducing this burden, should be sent to the Chief Information Officer, U.S. Patent and Trademark Office, U.S. Department of Commerce, P.O. Box 1450, Alexandria, VA 22313-1450. DO NOT SEND FEES OR COMPLETED FORMS TO THIS ADDRESS. **SEND TO: Commissioner for Patents, P.O. Box 1450, Alexandria, VA 22313-1450.**
 If you need assistance in completing the form, call 1-800-PTO-9199 and select option 2.



UNITED STATES PATENT AND TRADEMARK OFFICE

UNITED STATES DEPARTMENT OF COMMERCE
United States Patent and Trademark Office
Address: COMMISSIONER FOR PATENTS
P.O. Box 1450
Alexandria, Virginia 22313-1450
www.uspto.gov

Table with 5 columns: APPLICATION NO., FILING DATE, FIRST NAMED INVENTOR, ATTORNEY DOCKET NO., CONFIRMATION NO.
13/342,795 01/03/2012 Victor Larson 77580-155(VRNK-1CP3CNFT5) 4180

23630 7590 12/05/2012
McDermott Will & Emery
The McDermott Building
500 North Capitol Street, N.W.
Washington, DC 20001

EXAMINER

LIM, KRISNA

ART UNIT PAPER NUMBER

2453

NOTIFICATION DATE DELIVERY MODE

12/05/2012

ELECTRONIC

Please find below and/or attached an Office communication concerning this application or proceeding.

The time period for reply, if any, is set in the attached communication.

Notice of the Office communication was sent electronically on above-indicated "Notification Date" to the following e-mail address(es):

mweipdocket@mwe.com

Office Action Summary	Application No.	Applicant(s)	
	13/342,795	LARSON ET AL.	
	Examiner	Art Unit	
	KRISNA LIM	2453	

-- The MAILING DATE of this communication appears on the cover sheet with the correspondence address --

Period for Reply

A SHORTENED STATUTORY PERIOD FOR REPLY IS SET TO EXPIRE 3 MONTH(S) OR THIRTY (30) DAYS, WHICHEVER IS LONGER, FROM THE MAILING DATE OF THIS COMMUNICATION.

- Extensions of time may be available under the provisions of 37 CFR 1.136(a). In no event, however, may a reply be timely filed after SIX (6) MONTHS from the mailing date of this communication.
- If NO period for reply is specified above, the maximum statutory period will apply and will expire SIX (6) MONTHS from the mailing date of this communication.
- Failure to reply within the set or extended period for reply will, by statute, cause the application to become ABANDONED (35 U.S.C. § 133). Any reply received by the Office later than three months after the mailing date of this communication, even if timely filed, may reduce any earned patent term adjustment. See 37 CFR 1.704(b).

Status

- 1) Responsive to communication(s) filed on 30 October 2012.
- 2a) This action is **FINAL**. 2b) This action is non-final.
- 3) An election was made by the applicant in response to a restriction requirement set forth during the interview on ____; the restriction requirement and election have been incorporated into this action.
- 4) Since this application is in condition for allowance except for formal matters, prosecution as to the merits is closed in accordance with the practice under *Ex parte Quayle*, 1935 C.D. 11, 453 O.G. 213.

Disposition of Claims

- 5) Claim(s) 1-30 is/are pending in the application.
- 5a) Of the above claim(s) ____ is/are withdrawn from consideration.
- 6) Claim(s) ____ is/are allowed.
- 7) Claim(s) 1-30 is/are rejected.
- 8) Claim(s) ____ is/are objected to.
- 9) Claim(s) ____ are subject to restriction and/or election requirement.

* If any claims have been determined allowable, you may be eligible to benefit from the **Patent Prosecution Highway** program at a participating intellectual property office for the corresponding application. For more information, please see http://www.uspto.gov/patents/init_events/pph/index.jsp or send an inquiry to PPHfeedback@uspto.gov.

Application Papers

- 10) The specification is objected to by the Examiner.
- 11) The drawing(s) filed on ____ is/are: a) accepted or b) objected to by the Examiner.
 Applicant may not request that any objection to the drawing(s) be held in abeyance. See 37 CFR 1.85(a).
 Replacement drawing sheet(s) including the correction is required if the drawing(s) is objected to. See 37 CFR 1.121(d).

Priority under 35 U.S.C. § 119

- 12) Acknowledgment is made of a claim for foreign priority under 35 U.S.C. § 119(a)-(d) or (f).
- a) All b) Some * c) None of:
1. Certified copies of the priority documents have been received.
2. Certified copies of the priority documents have been received in Application No. ____.
3. Copies of the certified copies of the priority documents have been received in this National Stage application from the International Bureau (PCT Rule 17.2(a)).

* See the attached detailed Office action for a list of the certified copies not received.

Attachment(s)

- 1) Notice of References Cited (PTO-892)
- 2) Information Disclosure Statement(s) (PTO/SB/08)
 Paper No(s)/Mail Date ____.
- 3) Interview Summary (PTO-413)
 Paper No(s)/Mail Date. ____.
- 4) Other: ____.

Art Unit: 2453

1. Claims 1-30 are still pending for examination.
2. The following is a quotation of 35 § U.S.C. 103 (a) which forms the basis for all obviousness rejections set forth in this Office action:

(a) A patent may not be obtained through the invention is not identically disclosed or described as set forth in section 102 of this title, if the differences between the subject matter sought to be patented and the prior art are such that the subject matter as a whole would have been obvious at the time the invention was made to a person having ordinary skill in the art to which said subject matter pertains. Patentability shall not be negated by the manner in which the invention was made.

The factual inquiries set forth in *Graham v. John Deere Co.*, 383 U.S. 1, 148 USPQ 459 (1966), that are applied for establishing a background for determining obviousness under 35 U.S.C. 103(a) are summarized as follows:

1. Determining the scope and contents of the prior art.
 2. Ascertaining the differences between the prior art and the claims at issue.
 3. Resolving the level of ordinary skill in the pertinent art.
 4. Considering objective evidence present in the application indicating obviousness or nonobviousness.
3. Claims 1-30 are rejected under 35 U.S.C. § 103(a) as being unpatentable over Wesinger [U.S. Patent No. 5,898,830].
.
 4. Wesinger disclosed the invention substantially as claimed. Taking claims 1,4, 5, 6, 7, 16, 19, 20, 21 and 22 as exemplary claims, the reference disclose a client device comprising: a) memory configured and arranged to facilitate a connection (i.e., see Internet 120 of Fig. 1) of the client device (i.e. a client C) with a target device (i.e. a host D) over a secure communication link created (i.e., Wesinger at col. 12 (lines 23-27) disclosed "... **combining encryption capabilities allows for the creation of virtual private networks-networks in which two remote machine communicate securely** ...") based on (i) an address request generated by the client device (i.e., see col. 9, lines

Art Unit: 2453

1-25), and (ii) a determination as a result of the address request that the target device is a device with which a secure communication link can be established (i.e. Wesinger disclosed at col. 12 (lines 4-27) channel processing may be used to perform virus protection.... Encryption and decryption are particularly important to **Internet and network communication ... encryption could be performed**") when the requested address is identified in an address lookup (i.e. Wesinger disclosed at col. 8 (line 25) to col. 9 (line 25) " ... DNS is a ... system that translates host name address to IP address and IP address to host name ... stored in DNS tables ... When client C tries to initiates a connection to host D The DNS server for D returns the network address D ... from which it receives the look up request ..." Moreover see Wesinger's teaching at col. 9 (lines 53-60), col. 16 (line 57) to col. 17 (line 5), col. 12 (lines 23-27)),

wherein the establishment of the secure communication link (i.e., Wesinger at col. 12 (lines 23-27) disclosed "... **combining encryption capabilities allows for the creation of virtual private networks-networks in which two remote machine communicate securely ...**") is based on a determination being made by a proxy module (i.e., a proxy server) that the target device is a device with which a secure communication link can be established when the address request corresponds to a target device identified in a DNS lookup table (i.e. Wesinger disclosed at col. 8 (line 25) to col. 9 (line 25) " ... DNS is a ... system that translates host name address to IP address and IP address to host name ... stored in DNS tables ... When client C tries to initiates a connection to host D The DNS server for D returns the network address D ... from which it receives the look up request ..."; Moreover, see col. 8 (lines 33-48), col. 8 (line 65) to col. 9 (line 2), col. 9 (lines 19-25), col. 16 (line 57) to col. 17 (line 5) and col. 12 (lines 23-27)),

wherein the address lookup is a network address lookup (i.e. Wesinger disclosed at col. 8 (line 25) to col. 9 (line 25) " ... DNS is a ... system that translates host name address to IP address and IP address to host name ... stored in DNS tables ... When client C tries to initiates a connection to host D The DNS server for D returns the network address D ... from which it receives the look up request ...",

Art Unit: 2453

wherein the secure communication link is a virtual private network link (i.e., Wesinger at col. 12 (lines 23-27) disclosed "... **combining encryption capabilities allows for the creation of virtual private networks-networks in which two remote machine communicate securely ...**"), and

wherein the address request includes a secure domain name (i.e. see DNS of Fig. 1 and cols. 8-9).

5. As to claims 2-3, 9-15 and 23-30, those features (i.e., a computer, a server, a phone, a broadband connection, using modulation based on FDM, TDM, or CDMA, etc.) are well known the art at the time the invention was made and they are not patentably distinguishable features.

6. Applicant's arguments filed 10/24/2012 have been fully considered but they are not persuasive. In the remark, applicants argued that:

a) Wesinger does not teach a server that makes a "determination as a result of the address request that the target device is a device with which a secure communication link can be established when the requested address is identified in an address lookup."

b) Wesinger is not concerned with whether the alleged target device is a device with which a secure communication link can be established; much less established when the requested address is identified in an address lookup.

c) Applicants also note that the Office Action does not specify which portions of Wesinger render obvious the feature of "an application program configured and arranged so as to allow participation in audio/video communications with the target device over the secure communication link once the secure communication link is established," as recited by claim 1. Indeed, Wesinger is not concerned with audio/video

Art Unit: 2453

communications. For at least that reason alone, a rejection based on Wesinger cannot be maintained.

7. As to paragraphs 6 a) to 6 c), Examiner respectfully disagrees because at paragraph 4 above Wesinger clear disclosed those features. As to a specific application program configured and arranged so as to **allow** participation in **audio/video communications** with the target device over the secure communication link, it would have been obvious to one of ordinary skill in the art at the time the invention was made to recognize having such audio/video to communicate over the secure communication link would have been a matter of choice, and it would not be a patentably distinguishable feature.

8. THIS ACTION IS MADE FINAL. Applicant is reminded of the extension of time policy as set forth in 37 CFR 1.136(a).

A shortened statutory period for reply to this final action is set to expire THREE MONTHS from the mailing date of this action. In the event a first reply is filed within TWO MONTHS of the mailing date of this final action and the advisory action is not mailed until after the end of the THREE-MONTH shortened statutory period, then the shortened statutory period will expire on the date the advisory action is mailed, and any extension fee pursuant to 37 CFR 1.136(a) will be calculated from the mailing date of the advisory action. In no event, however, will the statutory period for reply expire later than SIX MONTHS from the mailing date of this final action.

Any inquiry concerning this communication or earlier communications from the examiner should be directed to Krisna Lim whose telephone number is 571-272-3956. The examiner can normally be reached on Tuesday to Friday from 7:10 AM to 5:40 PM.

Art Unit: 2453

If attempts to reach the examiner by telephone are unsuccessful, the examiner's supervisor, Krista Zele, can be reached on 571-272-7288. The fax phone number for the organization where this application or proceeding is assigned is 571-273-8300.

Information regarding the status of an application may be obtained from the Patent Application Information Retrieval (PAIR) system. Status information for published applications may be obtained from either Private PAIR or Public PAIR. Status information for unpublished applications is available through Private PAIR only. For more information about the PAIR system, see <http://pair-direct.uspto.gov>. Should you have questions on access to the Private PAIR system, contact the Electronic Business Center (EBC) at 866-217-9197 (toll-free) If you would like assistance from a USPTO Customer Service Representative or access to the automated information system, call 800-786-9199 (In USA or Canada) or 571-272-100.

KI

November 30, 2012

/Krisna Lim/

Primary Examiner Art Unit 2453

Subst. for form 1449/PTO		Complete if Known				
INFORMATION DISCLOSURE STATEMENT BY APPLICANT (Use as many sheets as necessary)		Application Number		13/342,795		
		Filing Date		01-03-2012		
		First Named Inventor		Victor Larson		
		Art Unit		2453		
		Examiner Name		Krisna Lim		
		Docket Number		77580-155(VRNK-1CP3CNFT5)		
U.S. PATENTS						
EXAMINER'S INITIALS	CITE NO.	Patent Number	Publication Date	Name of Patentee or Applicant of Cited Document	Pages, Columns, Lines, Where Relevant Passages or Relevant Figures Appear	
	A161	6,131,121	10/10/2000	Mattaway et al.		
	A162	6,499,108	12/24/2002	Johnson		
U.S. PATENT APPLICATION PUBLICATIONS						
EXAMINER'S INITIALS	CITE NO.	Patent Number	Publication Date	Name of Patentee or Applicant of Cited Document	Pages, Columns, Lines, Where Relevant Passages or Relevant Figures Appear	
FOREIGN PATENT DOCUMENTS						
EXAMINER'S INITIALS	CITE NO.	Foreign Patent Document Country Codes -Number & -Kind Codes (if known)	Publication Date	Name of Patentee or Applicant of Cited Document	Pages, Columns, Lines Where Relevant Figures Appear	Translation Yes No
OTHER ART (Including Author, Title, Date, Pertinent Pages, Etc.)						
EXAMINER'S INITIALS	CITE NO.	Include name of the author (in CAPITAL LETTERS), title of the article (when appropriate), title of the item (book, magazine, journal, serial, symposium, catalog, etc.), date, page(s), volume-issue number(s), publisher, city and/or country where published.				
	A1112	ITU-T Recommendation H.323, "Infrastructure of Audiovisual Services – Systems and Terminal Equipment for Audiovisual Services. Packet-Based Multimedia Communications System," International Telecommunications Union, pages 1-128, February 1998				
	A1113	ITU-T Recommendation H.225.0, "Infrastructure of Audiovisual Services – Transmission Multiplexing and Synchronization. Call Signaling Protocols and Media Stream Packetization for Packet-Based Multimedia Communication systems," International Telecommunication Union, pages 1-155, February 1998				
	A1114	ITU-T Recommendation H.235, "Infrastructure of Audiovisual Services – Systems Aspects. Security and Encryption for H-Series (H.323 and other H.245-based) Multimedia Terminals," International Telecommunication Union, pages 1-39, February 1998				
	A1115	ITU-T Recommendation H.245, "Infrastructure of Audiovisual Services – Communication Procedures. Control Protocol for Multimedia Communication," International Telecommunication Union, pages 1-280, February 1998				
	A1116	Request for Inter Partes Reexamination Under 35 U.S.C. § 311 (Patent No.8,051,181)				
	A1117	Transmittal Letters (Patent No.8,051,181)				
	A1118	Exhibit X5, Droms, R., RFC 2131, "Dynamic Host Configuration Protocol," 1987				
EXAMINER /Krisna Lim/			DATE CONSIDERED 07/20/2012			

*EXAMINER: Initial if reference considered, whether or not citation is in conformance with MPEP 609. Draw line through citation if not in conformance and not considered. Include copy of this form with next communication to applicant.

1 Applicant's unique citation designation number (optional). 2 Applicant is to place a check mark here if English language Translation is attached.

Subst. for form 1449/PTO				Complete if Known	
INFORMATION DISCLOSURE STATEMENT BY APPLICANT <i>(Use as many sheets as necessary)</i>				Application Number	13/342,795
				Filing Date	01-03-2012
				First Named Inventor	Victor Larson
				Art Unit	2453
				Examiner Name	Krisna Lim
				Docket Number	77580-155(VRNL-1CP3CNFT5)

CERTIFICATION STATEMENT

Please See 37 CFR 1.97 and 1.98 to make the appropriate selection(s)

- Information Disclosure Statement is being filed with the filing of the application or before the receipt of a first office action.
- That each item of information contained in the information disclosure statement was first cited in any communication from a foreign patent office in a counterpart foreign application not more than three months prior to the filing of the information disclosure statement; or
- That no item of information contained in the information disclosure statement was cited in a communication from a foreign patent office in a counterpart foreign application, and, to the knowledge of the person signing the certification after making reasonable inquiry, no item of information contained in the information disclosure statement was known to any individual designated in § 1.56(c) more than three months prior to the filing of the information disclosure statement.
- The Commissioner is hereby authorized to charge the fee pursuant to 37 CFR 1.17(P) in the amount of \$180.00, or further fees which may be due, to Deposit Account 50-1133.
- Information Disclosure Statement is being filed with the Request for Continued Examination. The Commissioner is hereby authorized to charge the fee pursuant to 37 CFR 1.17(P) in the amount of \$810.00, or further fees which may be due, to Deposit Account 50-1133.
- None

SIGNATURE

A signature of the applicant or representative is required in accordance with CFR 1.33, 10.18. Please see CFR 1.4(d) for the form of the signature.

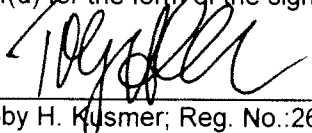
 Toby H. Kusmer; Reg. No.:26,418
 McDermott Will & Emery LLP
 28 State Street
 Boston, MA 02109
 Tel. (617) 535-4000
 Fax (617) 535-3800

Date: 4/24/12

Subst. for form 1449/PTO				Complete if Known		
INFORMATION DISCLOSURE STATEMENT BY APPLICANT <i>(Use as many sheets as necessary)</i>				Application Number	13/342,795	
				Filing Date	01-03-2012	
				First Named Inventor	Victor Larson	
				Art Unit	2453	
				Examiner Name	Krisna Lim	
				Docket Number	77580-155(VRNK-1CP3CNFT5)	
U.S. PATENTS						
EXAMINER'S INITIALS	CITE NO.	Patent Number	Publication Date	Name of Patentee or Applicant of Cited Document	Pages, Columns, Lines, Where Relevant Passages or Relevant Figures Appear	
U.S. PATENT APPLICATION PUBLICATIONS						
EXAMINER'S INITIALS	CITE NO.	Patent Number	Publication Date	Name of Patentee or Applicant of Cited Document	Pages, Columns, Lines, Where Relevant Passages or Relevant Figures Appear	
FOREIGN PATENT DOCUMENTS						
EXAMINER'S INITIALS	CITE NO.	Foreign Patent Document Country Codes - Number - Kind Codes (if known)	Publication Date	Name of Patentee or Applicant of Cited Document	Pages, Columns, Lines Where Relevant Figures Appear	Translation Yes No
OTHER ART (Including Author, Title, Date, Pertinent Pages, Etc.)						
EXAMINER'S INITIALS	CITE NO.	Include name of the author (in CAPITAL LETTERS), title of the article (when appropriate), title of the item (book, magazine, journal, serial, symposium, catalog, etc.), date, page(s), volume-issue number(s), publisher, city and/or country where published.				
	D1208	Cisco Comments and Petition for Reexamination 95/001,679 dated June 14, 2012				
	D1209	Exhibit S, Declaration of Nathaniel Polish, Ph.D.				
	D1210	Exhibit R, Excerpts from Patent Owner & Plaintiff VirnetX Inc.'s First Amended P.R. 3-1 and 3-2 Disclosure of Asserted Claims and Infringement Contentions				
EXAMINER /Krisna Lim/			DATE CONSIDERED 07/20/2012			

*EXAMINER: Initial if reference considered, whether or not citation is in conformance with MPEP 609. Draw line through citation if not in conformance and not considered. Include copy of this form with next communication to applicant.

1 Applicant's unique citation designation number (optional). 2 Applicant is to place a check mark here if English language Translation is attached.

Subst. for form 1449/PTO				Complete if Known	
INFORMATION DISCLOSURE STATEMENT BY APPLICANT <i>(Use as many sheets as necessary)</i>				Application Number	13/342,795
				Filing Date	01-03-2012
				First Named Inventor	Victor Larson
				Art Unit	2453
				Examiner Name	Krisna Lim
				Docket Number	77580-155(VR NK-1CP3CNFT5)

CERTIFICATION STATEMENT

Please See 37 CFR 1.97 and 1.98 to make the appropriate selection(s)

- Information Disclosure Statement is being filed with the filing of the application or before the receipt of a first office action.
- That each item of information contained in the information disclosure statement was first cited in any communication from a foreign patent office in a counterpart foreign application not more than three months prior to the filing of the information disclosure statement; or
- That no item of information contained in the information disclosure statement was cited in a communication from a foreign patent office in a counterpart foreign application, and, to the knowledge of the person signing the certification after making reasonable inquiry, no item of information contained in the information disclosure statement was known to any individual designated in § 1.56(c) more than three months prior to the filing of the information disclosure statement.
- The Commissioner is hereby authorized to charge the fee pursuant to 37 CFR 1.17(P) in the amount of \$180.00, or further fees which may be due, to Deposit Account 50-1133.
- Information Disclosure Statement is being filed with the Request for Continued Examination. The Commissioner is hereby authorized to charge the fee pursuant to 37 CFR 1.17(P) in the amount of \$810.00, or further fees which may be due, to Deposit Account 50-1133.
- None

SIGNATURE

A signature of the applicant or representative is required in accordance with CFR 1.33, 10.18. Please see CFR 1.4(d) for the form of the signature.

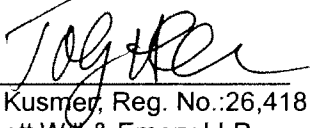
 Toby H. Kusmer, Reg. No.:26,418
 McDermott Will & Emery LLP
 28 State Street
 Boston, MA 02109
 Tel. (617) 535-4000
 Fax (617) 535-3800

Date: 6/20/12

DM_US 36055603-1.077580.0155

Subst. for form 1449/PTO				Complete if Known				
INFORMATION DISCLOSURE STATEMENT BY APPLICANT (Use as many sheets as necessary)				Application Number		13/342,795		
				Filing Date		01-03-2012		
				First Named Inventor		Victor Larson		
				Art Unit		2453		
				Examiner Name		Krisna Lim		
				Docket Number		77580-155(VR NK-1CP3CNFT5)		
U.S. PATENTS								
EXAMINER'S INITIALS	CITE NO.	Patent Number	Publication Date	Name of Patentee or Applicant of Cited Document		Pages, Columns, Lines, Where Relevant Passages or Relevant Figures Appear		
U.S. PATENT APPLICATION PUBLICATIONS								
EXAMINER'S INITIALS	CITE NO.	Patent Number	Publication Date	Name of Patentee or Applicant of Cited Document		Pages, Columns, Lines, Where Relevant Passages or Relevant Figures Appear		
FOREIGN PATENT DOCUMENTS								
EXAMINER'S INITIALS	CITE NO.	Foreign Patent Document Country Codes -Number 4 -Kind Codes (if known)	Publication Date	Name of Patentee or Applicant of Cited Document		Pages, Columns, Lines Where Relevant Figures Appear	Translation	
							Yes	No
OTHER ART (Including Author, Title, Date, Pertinent Pages, Etc.)								
EXAMINER'S INITIALS	CITE NO.	Include name of the author (in CAPITAL LETTERS), title of the article (when appropriate), title of the item (book, magazine, journal, serial, symposium, catalog, etc.), date, page(s), volume-issue number(s), publisher, city and/or country where published.						
	D1213	Extended European Search Report dated 03/26/12 from Corresponding European Application Number 11005793.2 (077580-0144)						
	D1214	Bergadano, et al., "Secure WWW Transactions Using Standard HTTP and Java Applets," Proceedings of the 3rd USENIX Workshop on Electronic Commerce, 1998						
EXAMINER /Krisna Lim/				DATE CONSIDERED 11/30/2012				

*EXAMINER: Initial if reference considered, whether or not citation is in conformance with MPEP 609. Draw line through citation if not in conformance and not considered. Include copy of this form with next communication to applicant.

1 Applicant's unique citation designation number (optional). 2 Applicant is to place a check mark here if English language Translation is attached.

Subst. for form 1449/PTO				Complete if Known	
INFORMATION DISCLOSURE STATEMENT BY APPLICANT <i>(Use as many sheets as necessary)</i>				Application Number	13/342,795
				Filing Date	01-03-2012
				First Named Inventor	Victor Larson
				Art Unit	2453
				Examiner Name	Krisna Lim
				Docket Number	77580-155(VRNK-1CP3CNFT5)

CERTIFICATION STATEMENT

Please See 37 CFR 1.97 and 1.98 to make the appropriate selection(s)

- Information Disclosure Statement is being filed with the filing of the application or before the receipt of a first office action.
- That each item of information contained in the information disclosure statement was first cited in any communication from a foreign patent office in a counterpart foreign application not more than three months prior to the filing of the information disclosure statement; or
- That no item of information contained in the information disclosure statement was cited in a communication from a foreign patent office in a counterpart foreign application, and, to the knowledge of the person signing the certification after making reasonable inquiry, no item of information contained in the information disclosure statement was known to any individual designated in § 1.56(c) more than three months prior to the filing of the information disclosure statement.
- The Commissioner is hereby authorized to charge the fee pursuant to 37 CFR 1.17(P) in the amount of \$180.00, or further fees which may be due, to Deposit Account 50-1133.
- Information Disclosure Statement is being filed with the Request for Continued Examination. The Commissioner is hereby authorized to charge the fee pursuant to 37 CFR 1.17(P) in the amount of \$810.00, or further fees which may be due, to Deposit Account 50-1133.

SIGNATURE

A signature of the applicant or representative is required in accordance with CFR 1.33, 10.18. Please see CFR 1.4(d) for the form of the signature.

 Toby H. Kusmer; Reg. No.:26,418
 McDermott Will & Emery LLP
 28 State Street
 Boston, MA 02109
 Tel. (617) 535-4000
 Fax (617) 535-3800

Date: 7/24/12

DM_US 36888618-1.077580.0155

Subst. for form 1449/PTO				Complete if Known		
INFORMATION DISCLOSURE STATEMENT BY APPLICANT (Use as many sheets as necessary)				Application Number	13/342,795	
				Filing Date	01-03-2012	
				First Named Inventor	Victor Larson	
				Art Unit	2453	
				Examiner Name	Krisna Lim	
				Docket Number	77580-155(VR NK-1CP3CNFT5)	
U.S. PATENTS						
EXAMINER'S INITIALS	CITE NO.	Patent Number	Publication Date	Name of Patentee or Applicant of Cited Document	Pages, Columns, Lines, Where Relevant Passages or Relevant Figures Appear	
U.S. PATENT APPLICATION PUBLICATIONS						
EXAMINER'S INITIALS	CITE NO.	Patent Number	Publication Date	Name of Patentee or Applicant of Cited Document	Pages, Columns, Lines, Where Relevant Passages or Relevant Figures Appear	
FOREIGN PATENT DOCUMENTS						
EXAMINER'S INITIALS	CITE NO.	Foreign Patent Document Country Codes - Number 4 - Kind Codes (if known)	Publication Date	Name of Patentee or Applicant of Cited Document	Pages, Columns, Lines Where Relevant Figures Appear	Translation Yes No
OTHER ART (Including Author, Title, Date, Pertinent Pages, Etc.)						
EXAMINER'S INITIALS	CITE NO.	Include name of the author (in CAPITAL LETTERS), title of the article (when appropriate), title of the item (book, magazine, journal, serial, symposium, catalog, etc.), date, page(s), volume-issue number(s), publisher, city and/or country where published.				
	D1215	Alexander Invalidity Expert Report dtd May 22, 2012 with Exhibits				
	D1216	Deposition of Peter Alexander dtd July 27, 2012				
	D1217	Cisco '151 Comments by Third Party Requester dtd August 17, 2012 with Exhibits				
	D1218	Cisco '151 Petition to Waive Page Limit Requirement for Third Party Comments dtd August 17, 2012				
	D1219	Deposition of Stuart Stubblebine dtd August 22, 2012				
EXAMINER /Krisna Lim/				DATE CONSIDERED 11/30/2012		

*EXAMINER: Initial if reference considered, whether or not citation is in conformance with MPEP 609. Draw line through citation if not in conformance and not considered. Include copy of this form with next communication to applicant.

1 Applicant's unique citation designation number (optional). 2 Applicant is to place a check mark here if English language Translation is attached.

Subst. for form 1449/PTO				Complete if Known	
INFORMATION DISCLOSURE STATEMENT BY APPLICANT <i>(Use as many sheets as necessary)</i>				Application Number	13/342,795
				Filing Date	01-03-2012
				First Named Inventor	Victor Larson
				Art Unit	2453
				Examiner Name	Krisna Lim
				Docket Number	77580-155(VR NK-1CP3CNFT5)

CERTIFICATION STATEMENT

Please See 37 CFR 1.97 and 1.98 to make the appropriate selection(s)

- Information Disclosure Statement is being filed with the filing of the application or before the receipt of a first office action.
- That each item of information contained in the information disclosure statement was first cited in any communication from a foreign patent office in a counterpart foreign application not more than three months prior to the filing of the information disclosure statement; or
- That no item of information contained in the information disclosure statement was cited in a communication from a foreign patent office in a counterpart foreign application, and, to the knowledge of the person signing the certification after making reasonable inquiry, no item of information contained in the information disclosure statement was known to any individual designated in § 1.56(c) more than three months prior to the filing of the information disclosure statement.
- The Commissioner is hereby authorized to charge any required fees to Deposit Account 50-1133.
- Information Disclosure Statement is being filed with the Request for Continued Examination. The Commissioner is hereby authorized to charge the fee pursuant to 37 CFR 1.17(P) in the amount of \$810.00, or further fees which may be due, to Deposit Account 50-1133.

SIGNATURE

A signature of the applicant or representative is required in accordance with CFR 1.33, 10.18. Please see CFR 1.4(d) for the form of the signature.

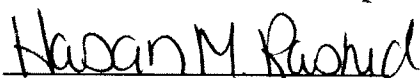

Hasan M. Rashid; Reg. No.: 62,390
McDermott Will & Emery LLP
28 State Street
Boston, MA 02109
Tel. (617) 535-4000
Fax (617) 535-3800

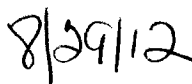
Date: 

DM_US 37791643-1.077580.0155

Subst. for form 1449/PTO				Complete if Known		
INFORMATION DISCLOSURE STATEMENT BY APPLICANT (Use as many sheets as necessary)				Application Number	13/342,795	
				Filing Date	01-03-2012	
				First Named Inventor	Victor Larson	
				Art Unit	2453	
				Examiner Name	Krisna Lim	
				Docket Number	77580-155(VR NK-1CP3CNFT5)	
U.S. PATENTS						
EXAMINER'S INITIALS	CITE NO.	Patent Number	Publication Date	Name of Patentee or Applicant of Cited Document	Pages, Columns, Lines, Where Relevant Passages or Relevant Figures Appear	
U.S. PATENT APPLICATION PUBLICATIONS						
EXAMINER'S INITIALS	CITE NO.	Patent Number	Publication Date	Name of Patentee or Applicant of Cited Document	Pages, Columns, Lines, Where Relevant Passages or Relevant Figures Appear	
FOREIGN PATENT DOCUMENTS						
EXAMINER'S INITIALS	CITE NO.	Foreign Patent Document Country Codes - Number - Kind Codes (if known)	Publication Date	Name of Patentee or Applicant of Cited Document	Pages, Columns, Lines Where Relevant Figures Appear	Translation Yes No
OTHER ART (Including Author, Title, Date, Pertinent Pages, Etc.)						
EXAMINER'S INITIALS	CITE NO.	Include name of the author (in CAPITAL LETTERS), title of the article (when appropriate), title of the item (book, magazine, journal, serial, symposium, catalog, etc.), date, page(s), volume-issue number(s), publisher, city and/or country where published.				
	D1220	Defendants' Motion For Reconsideration of the Construction of the Term "Secure Communication Link," 7 pages, June 2012				
	D1221	Green, "Cisco Leverages Altiga Technology for VPN's," 2 pages, 2000 http://www.crn.com/news/channel-programs/18807923/cisco-leverages-altiga-technology-for-vpns.htm				
	D1222	Altiga Networks Archived at http://web.archive.org/web/20000823023437/http://www.altiga.com/products/ 1999 and Retrieved by the Wayback Machine				
	D1223	Kiuchi, "C-HTTP The Development of a Secure, Closed HTTP-Based Network on the Internet," Department of Epidemiology and Biostatistics, Faculty of Medicine, University of Tokyo, Japan				
EXAMINER /Krisna Lim/				DATE CONSIDERED 11/30/2012		

*EXAMINER: Initial if reference considered, whether or not citation is in conformance with MPEP 609. Draw line through citation if not in conformance and not considered. Include copy of this form with next communication to applicant.

1 Applicant's unique citation designation number (optional). 2 Applicant is to place a check mark here if English language Translation is attached.

Subst. for form 1449/PTO				Complete if Known	
INFORMATION DISCLOSURE STATEMENT BY APPLICANT (Use as many sheets as necessary)				Application Number	13/342,795
				Filing Date	01-03-2012
				First Named Inventor	Victor Larson
				Art Unit	2453
				Examiner Name	Krisna Lim
				Docket Number	77580-155(VRNK-1CP3CNFT5)

CERTIFICATION STATEMENT

Please See 37 CFR 1.97 and 1.98 to make the appropriate selection(s)

- Information Disclosure Statement is being filed with the filing of the application or before the receipt of a first office action.
- That each item of information contained in the information disclosure statement was first cited in any communication from a foreign patent office in a counterpart foreign application not more than three months prior to the filing of the information disclosure statement; or
- That no item of information contained in the information disclosure statement was cited in a communication from a foreign patent office in a counterpart foreign application, and, to the knowledge of the person signing the certification after making reasonable inquiry, no item of information contained in the information disclosure statement was known to any individual designated in § 1.56(c) more than three months prior to the filing of the information disclosure statement.
- The Commissioner is hereby authorized to charge any required fees to Deposit Account 50-1133.
- Information Disclosure Statement is being filed with the Request for Continued Examination. The Commissioner is hereby authorized to charge the fee pursuant to 37 CFR 1.17(P) in the amount of \$810.00, or further fees which may be due, to Deposit Account 50-1133.

SIGNATURE

A signature of the applicant or representative is required in accordance with CFR 1.33, 10.18. Please see CFR 1.4(d) for the form of the signature.

 Toby H. Kusmer, Reg. No.: 26,418
 McDermott Will & Emery LLP
 28 State Street
 Boston, MA 02109
 Tel. (617) 535-4000
 Fax (617) 535-3800

Date: 

DM_US 38997363-1.077580.0155

Index of Claims 	Application/Control No. 13342795	Applicant(s)/Patent Under Reexamination LARSON ET AL.
	Examiner KRISNA LIM	Art Unit 2453

✓	Rejected
=	Allowed

-	Cancelled
÷	Restricted

N	Non-Elected
I	Interference

A	Appeal
O	Objected

Claims renumbered in the same order as presented by applicant
 CPA
 T.D.
 R.1.47

CLAIM		DATE							
Final	Original	02/26/2012	07/24/2012	11/30/2012					
	1	✓	✓	✓					
	2	✓	✓	✓					
	3	✓	✓	✓					
	4	✓	✓	✓					
	5	✓	✓	✓					
	6	✓	✓	✓					
	7	✓	✓	✓					
	8	✓	✓	✓					
	9	✓	✓	✓					
	10	✓	✓	✓					
	11	✓	✓	✓					
	12	✓	✓	✓					
	13	✓	✓	✓					
	14	✓	✓	✓					
	15	✓	✓	✓					
	16	✓	✓	✓					
	17	✓	✓	✓					
	18	✓	✓	✓					
	19	✓	✓	✓					
	20	✓	✓	✓					
	21	✓	✓	✓					
	22	✓	✓	✓					
	23	✓	✓	✓					
	24	✓	✓	✓					
	25	✓	✓	✓					
	26	✓	✓	✓					
	27	✓	✓	✓					
	28	✓	✓	✓					
	29	✓	✓	✓					
	30	✓	✓	✓					

Subst. for form 1449/PTO				Complete if Known		
INFORMATION DISCLOSURE STATEMENT BY APPLICANT (Use as many sheets as necessary)				Application Number	13/342,795	
				Filing Date	01-03-2012	
				First Named Inventor	Victor Larson	
				Art Unit	2453	
				Examiner Name	Krisna Lim	
				Docket Number	77580-155(VR NK-1CP3CNFT5)	
U.S. PATENTS						
EXAMINER'S INITIALS	CITE NO.	Patent Number	Publication Date	Name of Patentee or Applicant of Cited Document	Pages, Columns, Lines, Where Relevant Passages or Relevant Figures Appear	
U.S. PATENT APPLICATION PUBLICATIONS						
EXAMINER'S INITIALS	CITE NO.	Patent Number	Publication Date	Name of Patentee or Applicant of Cited Document	Pages, Columns, Lines, Where Relevant Passages or Relevant Figures Appear	
FOREIGN PATENT DOCUMENTS						
EXAMINER'S INITIALS	CITE NO.	Foreign Patent Document Country Codes - Number - Kind Codes (if known)	Publication Date	Name of Patentee or Applicant of Cited Document	Pages, Columns, Lines Where Relevant Figures Appear	Translation Yes No
OTHER ART (Including Author, Title, Date, Pertinent Pages, Etc.)						
EXAMINER'S INITIALS	CITE NO.	Include name of the author (in CAPITAL LETTERS), title of the article (when appropriate), title of the item (book, magazine, journal, serial, symposium, catalog, etc.), date, page(s), volume-issue number(s), publisher, city and/or country where published.				
	D1211	Third Party Requester Comments dated June 25, 2012 - After Non Final Office Action (95/001,788)				
	D1212	Reexam Affidavit/Declaration/Exhibit Filed by 3rd Party on June 25, 2012 (95/001,788)				
EXAMINER /Krisna Lim/				DATE CONSIDERED 07/20/2012		

*EXAMINER: Initial if reference considered, whether or not citation is in conformance with MPEP 609. Draw line through citation if not in conformance and not considered. Include copy of this form with next communication to applicant.

1 Applicant's unique citation designation number (optional). 2 Applicant is to place a check mark here if English language Translation is attached.

Subst. for form 1449/PTO INFORMATION DISCLOSURE STATEMENT BY APPLICANT <i>(Use as many sheets as necessary)</i>				Complete if Known	
				Application Number	13/342,795
				Filing Date	01-03-2012
				First Named Inventor	Victor Larson
				Art Unit	2453
				Examiner Name	Krisna Lim
				Docket Number	77580-155(VRNK-1CP3CNFT5)

CERTIFICATION STATEMENT

Please See 37 CFR 1.97 and 1.98 to make the appropriate selection(s)

- Information Disclosure Statement is being filed with the filing of the application or before the receipt of a first office action.
- That each item of information contained in the information disclosure statement was first cited in any communication from a foreign patent office in a counterpart foreign application not more than three months prior to the filing of the information disclosure statement; or
- That no item of information contained in the information disclosure statement was cited in a communication from a foreign patent office in a counterpart foreign application, and, to the knowledge of the person signing the certification after making reasonable inquiry, no item of information contained in the information disclosure statement was known to any individual designated in § 1.56(c) more than three months prior to the filing of the information disclosure statement.
- The Commissioner is hereby authorized to charge the fee pursuant to 37 CFR 1.17(P) in the amount of \$180.00, or further fees which may be due, to Deposit Account 50-1133.
- Information Disclosure Statement is being filed with the Request for Continued Examination. The Commissioner is hereby authorized to charge the fee pursuant to 37 CFR 1.17(P) in the amount of \$810.00, or further fees which may be due, to Deposit Account 50-1133.
- None

SIGNATURE

A signature of the applicant or representative is required in accordance with CFR 1.33, 10.18. Please see CFR 1.4(d) for the form of the signature.

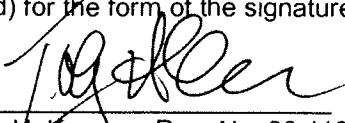

Toby H. Kusner; Reg. No.:26,418
 McDermott Will & Emery LLP
 28 State Street
 Boston, MA 02109
 Tel. (617) 535-4000
 Fax (617) 535-3800

Date: 6/28/12

DM_US 36238007-1.077580.0155

03-09-12

13342795 - GAUT 2453

Approved for use through 07/31/2012. OMB 0651-0031
 U.S. Patent and Trademark Office; U.S. DEPARTMENT OF COMMERCE

Under the Paperwork Reduction Act of 1995, no persons are required to respond to a collection of information unless it displays a valid OMB control number.

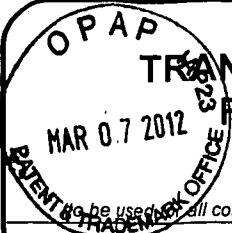
 <p>Do not be used for all correspondence after initial filing</p>	Application Number	13/342,795
	Filing Date	01-03-2012
	First Named Inventor	Victor Larson
	Art Unit	2453
	Examiner Name	Krisna Lim
	Attorney Docket Number	77580-155(VRNK-1CP3CNFT5)
Total Number of Pages in This Submission		52

ENCLOSURES (Check all that apply)		
<input checked="" type="checkbox"/> Fee Transmittal Form	<input type="checkbox"/> Drawing(s)	<input type="checkbox"/> After Allowance Communication to TC
<input checked="" type="checkbox"/> Fee Attached	<input type="checkbox"/> Licensing-related Papers	<input type="checkbox"/> Appeal Communication to Board of Appeals and Interferences
<input type="checkbox"/> Amendment/Reply	<input type="checkbox"/> Petition	<input type="checkbox"/> Appeal Communication to TC (Appeal Notice, Brief, Reply Brief)
<input type="checkbox"/> After Final	<input type="checkbox"/> Petition to Convert to a Provisional Application	<input type="checkbox"/> Proprietary Information
<input type="checkbox"/> Affidavits/declaration(s)	<input type="checkbox"/> Power of Attorney, Revocation	<input type="checkbox"/> Status Letter
<input type="checkbox"/> Extension of Time Request	<input type="checkbox"/> Change of Correspondence Address	<input checked="" type="checkbox"/> Other Enclosure(s) (please identify below):
<input type="checkbox"/> Express Abandonment Request	<input type="checkbox"/> Terminal Disclaimer	
<input checked="" type="checkbox"/> Information Disclosure Statement	<input type="checkbox"/> Request for Refund	
<input type="checkbox"/> Certified Copy of Priority Document(s)	<input type="checkbox"/> CD, Number of CD(s) _____	
<input type="checkbox"/> Reply to Missing Parts/ Incomplete Application	<input type="checkbox"/> Landscape Table on CD	
<input type="checkbox"/> Reply to Missing Parts under 37 CFR 1.52 or 1.53	Remarks 16 Boxes of Non Patent Literature documents which include; copies of references not previously submitted in a priority application (C8, C19, C21, C24; D257, D258, D261, D263, D264, D266, D292-D1111P).	

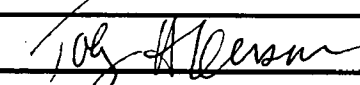
SIGNATURE OF APPLICANT, ATTORNEY, OR AGENT			
Firm Name	McDermott, Will and Emery		
Signature			
Printed name	Toby H. Kusmer		
Date	March 7, 2012	Reg. No.	26,418

CERTIFICATE OF TRANSMISSION/MAILING			
I hereby certify that this correspondence is being facsimile transmitted to the USPTO or deposited with the United States Postal Service with sufficient postage as first class mail in an envelope addressed to: Commissioner for Patents, P.O. Box 1450, Alexandria, VA 22313-1450 on the date shown below:			
Signature			
Typed or printed name		Date	

This collection of information is required by 37 CFR 1.5. The information is required to obtain or retain a benefit by the public which is to file (and by the USPTO to process) an application. Confidentiality is governed by 35 U.S.C. 122 and 37 CFR 1.11 and 1.14. This collection is estimated to 2 hours to complete, including gathering, preparing, and submitting the completed application form to the USPTO. Time will vary depending upon the individual case. Any comments on the amount of time you require to complete this form and/or suggestions for reducing this burden, should be sent to the Chief Information Officer, U.S. Patent and Trademark Office, U.S. Department of Commerce, P.O. Box 1450, Alexandria, VA 22313-1450. DO NOT SEND FEES OR COMPLETED FORMS TO THIS ADDRESS. SEND TO: Commissioner for Patents, P.O. Box 1450, Alexandria, VA 22313-1450.

If you need assistance in completing the form, call 1-800-PTO-9199 and select option 2.

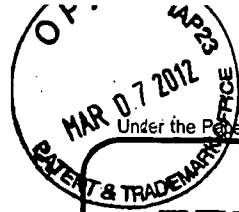

13321053095 GAU: 2453

Approved for use through 01/31/2014. OMB 0651-0032

U.S. Patent and Trademark Office; U.S. DEPARTMENT OF COMMERCE
Under the Paperwork Reduction Act of 1995 no persons are required to respond to a collection of information unless it displays a valid OMB control number.

FEE TRANSMITTAL

Complete if Known

Application Number	13/342,795
Filing Date	01-03-2012
First Named Inventor	Victor Larson
Examiner Name	Krisna Lim
Art Unit	2453
Attorney Docket No.	77580-155(VRNK-1CP3CNFT5)

Applicant claims small entity status. See 37 CFR 1.27

TOTAL AMOUNT OF PAYMENT (\$) 180.00

METHOD OF PAYMENT (check all that apply)

Check Credit Card Money Order None Other (please identify): _____

Deposit Account Deposit Account Number: 501133 Deposit Account Name: McDermott, Will and Emery

For the above-identified deposit account, the Director is hereby authorized to: (check all that apply)

Charge fee(s) indicated below Charge fee(s) indicated below, except for the filing fee

Charge any additional fee(s) or underpayments of fee(s) under 37 CFR 1.16 and 1.17 Credit any overpayments

WARNING: Information on this form may become public. Credit card information should not be included on this form. Provide credit card information and authorization on PTO-2038.

FEE CALCULATION

1. BASIC FILING, SEARCH, AND EXAMINATION FEES

Application Type	FILING FEES		SEARCH FEES		EXAMINATION FEES		Fees Paid (\$)
	Fee (\$)	Small Entity Fee (\$)	Fee (\$)	Small Entity Fee (\$)	Fee (\$)	Small Entity Fee (\$)	
Utility	380	190	620	310	250	125	_____
Design	250	125	120	60	160	80	_____
Plant	250	125	380	190	200	100	_____
Reissue	380	190	620	310	750	375	_____
Provisional	250	125	0	0	0	0	_____

2. EXCESS CLAIM FEES

Fee Description	Fee (\$)	Small Entity Fee (\$)
Each claim over 20 (including Reissues)	60	30
Each independent claim over 3 (including Reissues)	250	125
Multiple dependent claims	450	225

Total Claims	Extra Claims	Fee (\$)	Fee Paid (\$)	Multiple Dependent Claims	Fee (\$)	Fee Paid (\$)
_____ - 20 or HP = _____	x _____	= _____	_____	_____	_____	_____
HP = highest number of total claims paid for, if greater than 20.						
Indep. Claims	Extra Claims	Fee (\$)	Fee Paid (\$)			
_____ - 3 or HP = _____	x _____	= _____	_____			
HP = highest number of independent claims paid for, if greater than 3.						

3. APPLICATION SIZE FEE

If the specification and drawings exceed 100 sheets of paper (excluding electronically filed sequence or computer listings under 37 CFR 1.52(e)), the application size fee due is \$310 (\$155 for small entity) for each additional 50 sheets or fraction thereof. See 35 U.S.C. 41(a)(1)(G) and 37 CFR 1.16(s).

Total Sheets	Extra Sheets	Number of each additional 50 or fraction thereof	Fee (\$)	Fee Paid (\$)
_____ - 100 = _____	/ 50 = _____	(round up to a whole number) x _____	= _____	_____

4. OTHER FEE(S)

Description	Fee (\$)	Fees Paid (\$)
Non-English Specification, \$130 fee (no small entity discount)	_____	_____
Other (e.g., late filing surcharge): Information Disclosure Statement Filing Fee of \$180.00	_____	\$180.00

SUBMITTED BY

Signature		Registration No. (Attorney/Agent) 26,418	Telephone 617-535-4000
Name (Print/Type)	Toby H. Kusner		Date March 7, 2012

This collection of information is required by 37 CFR 1.136. The information is required to obtain or retain a benefit by the public which is to file (and by the USPTO to process) an application. Confidentiality is governed by 35 U.S.C. 122 and 37 CFR 1.14. This collection is estimated to take 30 minutes to complete, including gathering, preparing, and submitting the completed application form to the USPTO. Time will vary depending upon the individual case. Any comments on the amount of time you require to complete this form and/or suggestions for reducing this burden, should be sent to the Chief Information Officer, U.S. Patent and Trademark Office, U.S. Department of Commerce, P.O. Box 1450, Alexandria, VA 22313-1450. DO NOT SEND FEES OR COMPLETED FORMS TO THIS ADDRESS. SEND TO: Commissioner for Patents, P.O. Box 1450, Alexandria, VA 22313-1450.

If you need assistance in completing the form, call 1-800-PTO-9199 and select option 2.

Subst. for form 1449/PTO

Complete if Known

INFORMATION DISCLOSURE STATEMENT
BY APPLICANT

(Use as many sheets as necessary)

Application Number	13/342,795
Filing Date	01-03-2012
First Named Inventor	Victor Larson
Art Unit	2453
Examiner Name	Krisna Lim
Docket Number	77580-155(VRNL-1CP3CNFT5)

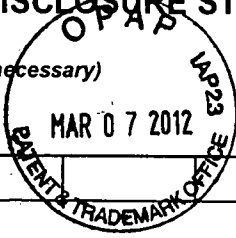

CERTIFICATION STATEMENT

Under 37 C.F.R. 1.98(d), copies of all patent, publication, pending U.S. application or other information that was previously submitted to, or cited by the USPTO in an earlier application are not required. Applicant will provide copies of the previously submitted references at the Examiner's request. Enclosed are copies of references not previously submitted in a priority application (C8, C19, C21, C24; D257, D258, D261, D263, D264, D266, D292-D1111).

The present application 13/342,795 claims priority from and is a continuation of a co-pending U.S. Application No. 13/049,552, filed March 16, 2011, which is a continuation of U.S. Application No. 11/840,560, filed August 17, 2007, now U.S. Patent No. 7,921,211, which is a continuation of U.S. Application No. 10/714,849, filed November 18, 2003, now U.S. Patent No. 7,418,504, which is a continuation of U.S. Application No. 09/558,210, filed April 26, 2000, now abandoned, which is a continuation-in-part of U.S. Application No. 09/504,783, filed on February 15, 2000, now U.S. Patent No. 6,502,135, issued December 31, 2002,

Please See 37 CFR 1.97 and 1.98 to make the appropriate selection(s)

- Information Disclosure Statement is being filed with the filing of the application or before the receipt of a first office action.
- That each item of information contained in the information disclosure statement was first cited in any communication from a foreign patent office in a counterpart foreign application not more than three months prior to the filing of the information disclosure statement; or
- That no item of information contained in the information disclosure statement was cited in a communication from a foreign patent office in a counterpart foreign application, and, to the knowledge of the person signing the certification after making reasonable inquiry, no item of information contained in the information disclosure statement was known to any individual designated in § 1.56(c) more than three months prior to the filing of the information disclosure statement.
- The Commissioner is hereby authorized to charge the fee pursuant to 37 CFR 1.17(P) in the amount of \$180.00, or further fees which may be due, to Deposit Account 50-1133.
- Information Disclosure Statement is being filed with the Request for Continued Examination. The Commissioner is hereby authorized to charge the fee pursuant to 37 CFR 1.17(P) in the amount of \$810.00, or further fees which may be due, to Deposit Account 50-1133.

SIGNATURE

A signature of the applicant or representative is required in accordance with CFR 1.33, 10.18. Please see CFR 1.4(d) for the form of the signature.

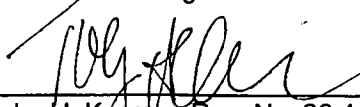
Toby H. Kusmer, Reg. No.: 26,418
McDermott Will & Emery LLP
28 State Street
Boston, MA 02109
Tel. (617) 535-4000
Fax (617) 535-3800

Date: 3/7/12

Subst. for form 1449/PTO				Complete if Known			
INFORMATION DISCLOSURE STATEMENT BY APPLICANT <i>(Use as many sheets as necessary)</i>				Application Number	13/342,795		
				Filing Date	01-03-2012		
				First Named Inventor	Victor Larson		
				Art Unit	2453		
				Examiner Name	Krisna Lim		
				Docket Number	77580-155(VRNK-1CP3CNFT5)		
U.S. PATENTS							
EXAMINER'S INITIALS	CITE NO.	Patent Number	Publication Date	Name of Patentee or Applicant of Cited Document	Pages, Columns, Lines, Where Relevant Passages or Relevant Figures Appear		
U.S. PATENT APPLICATION PUBLICATIONS							
EXAMINER'S INITIALS	CITE NO.	Patent Number	Publication Date	Name of Patentee or Applicant of Cited Document	Pages, Columns, Lines, Where Relevant Passages or Relevant Figures Appear		
FOREIGN PATENT DOCUMENTS							
EXAMINER'S INITIALS	CITE NO.	Foreign Patent Document Country Codes - Number - Kind Codes <i>(if known)</i>	Publication Date	Name of Patentee or Applicant of Cited Document	Pages, Columns, Lines Where Relevant Figures Appear	Translation	
						Yes	No
OTHER ART (Including Author, Title, Date, Pertinent Pages, Etc.)							
EXAMINER'S INITIALS	CITE NO.	Include name of the author (in CAPITAL LETTERS), title of the article (when appropriate), title of the item (book, magazine, journal, serial, symposium, catalog, etc.), date, page(s), volume-issue number(s), publisher, city and/or country where published.					
	A1119	Hopen Transcript dated April 11, 2012					
	A1120	VirnetX Claim Construction Opinion					
EXAMINER /Krisna Lim/				DATE CONSIDERED 07/20/2012			

*EXAMINER: Initial if reference considered, whether or not citation is in conformance with MPEP 609. Draw line through citation if not in conformance and not considered. Include copy of this form with next communication to applicant.

1 Applicant's unique citation designation number (optional). 2 Applicant is to place a check mark here if English language Translation is attached.

Subst. for form 1449/PTO				Complete if Known	
INFORMATION DISCLOSURE STATEMENT BY APPLICANT <i>(Use as many sheets as necessary)</i>				Application Number	13/342,795
				Filing Date	01-03-2012
				First Named Inventor	Victor Larson
				Art Unit	2453
				Examiner Name	Krisna Lim
				Docket Number	77580-155(VR NK-1CP3CNFT5)

CERTIFICATION STATEMENT

Please See 37 CFR 1.97 and 1.98 to make the appropriate selection(s)

- Information Disclosure Statement is being filed with the filing of the application or before the receipt of a first office action.
- That each item of information contained in the information disclosure statement was first cited in any communication from a foreign patent office in a counterpart foreign application not more than three months prior to the filing of the information disclosure statement; or
- That no item of information contained in the information disclosure statement was cited in a communication from a foreign patent office in a counterpart foreign application, and, to the knowledge of the person signing the certification after making reasonable inquiry, no item of information contained in the information disclosure statement was known to any individual designated in § 1.56(c) more than three months prior to the filing of the information disclosure statement.
- The Commissioner is hereby authorized to charge the fee pursuant to 37 CFR 1.17(P) in the amount of \$180.00, or further fees which may be due, to Deposit Account 50-1133.
- Information Disclosure Statement is being filed with the Request for Continued Examination. The Commissioner is hereby authorized to charge the fee pursuant to 37 CFR 1.17(P) in the amount of \$810.00, or further fees which may be due, to Deposit Account 50-1133.
- None

SIGNATURE

A signature of the applicant or representative is required in accordance with CFR 1.33, 10.18. Please see CFR 1.4(d) for the form of the signature.

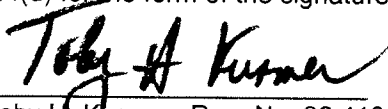

Toby H. Kusmer; Reg. No.: 26,418
 McDermott Will & Emery LLP
 28 State Street
 Boston, MA 02109
 Tel. (617) 535-4000
 Fax (617) 535-3800

Date: *May 3, 2012*

DM_US 34026985-1.077580.0155

Subst. for form 1449/PTO				Complete if Known		
INFORMATION DISCLOSURE STATEMENT BY APPLICANT (Use as many sheets as necessary)				Application Number	13/342,795	
				Filing Date	01-03-2012	
				First Named Inventor	Victor Larson	
				Art Unit	2453	
				Examiner Name	Krisna Lim	
				Docket Number	77580-155(VRNK-1CP3CNFT5)	
U.S. PATENTS						
EXAMINER'S INITIALS	CITE NO.	Patent Number	Publication Date	Name of Patentee or Applicant of Cited Document	Pages, Columns, Lines, Where Relevant Passages or Relevant Figures Appear	
U.S. PATENT APPLICATION PUBLICATIONS						
EXAMINER'S INITIALS	CITE NO.	Patent Number	Publication Date	Name of Patentee or Applicant of Cited Document	Pages, Columns, Lines, Where Relevant Passages or Relevant Figures Appear	
FOREIGN PATENT DOCUMENTS						
EXAMINER'S INITIALS	CITE NO.	Foreign Patent Document Country Codes - Number - Kind Codes (if known)	Publication Date	Name of Patentee or Applicant of Cited Document	Pages, Columns, Lines Where Relevant Figures Appear	Translation Yes No
OTHER ART (Including Author, Title, Date, Pertinent Pages, Etc.)						
EXAMINER'S INITIALS	CITE NO.	Include name of the author (in CAPITAL LETTERS), title of the article (when appropriate), title of the item (book, magazine, journal, serial, symposium, catalog, etc.), date, page(s), volume-issue number(s), publisher, city and/or country where published.				
	A1121	Declaration of Angelos D. Keromytis, Ph.D.				
	A1122	Declaration of Dr. Robert Dunham Short III				
	A1123	Exhibit A-1, Verdict Form from VirnetX, Inc. v. Microsoft Corp., No. 6:07-CV-80 (E.D. Tex.)				
	A1124	Exhibit A-3, Declaration of Jason Nieh, Ph.D. (Control No. 95/001,269)				
	A1125	Exhibit A-4, Redacted Deposition of Chris Hopen from VirnetX, Inc. v. Cisco Systems, Inc., No. 6:07-CV 417 (E.D. Tex. April 11, 2012)				
	A1126	Exhibit B-1, Excerpt from Deposition of Defense FY 2000/2001 Biennial Budget Estimates, (Feb. 1999)				
	A1127	Exhibit B-2, Collection of Reports and Presentations on DARPA Projects				
	A1128	Exhibit B-3, Maryann Lawlor, Transient Partnerships Stretch Security Policy Management, Signal Magazine (Sept. 2001) http://www.afcea.org/signal/articles/anmviewer.asp?a=494&print=yes				
	A1129	Joel Snyder, Living in Your Own Private Idaho, Network World (January 28, 1998) http://www.networkworld.com/intranet/0126review.html .				
	A1130	Time Greene, CEO's Chew the VPN Fat, CNN.com (June 17, 1999), http://www.cnn.com/TECH/computing/9906/17/vpnfat.ent.idg/index.html?iref=allsearch				
EXAMINER /Krisna Lim/				DATE CONSIDERED 07/20/2012		

*EXAMINER: Initial if reference considered, whether or not citation is in conformance with MPEP 609. Draw line through citation if not in conformance and not considered. Include copy of this form with next communication to applicant.

1 Applicant's unique citation designation number (optional). 2 Applicant is to place a check mark here if English language Translation is attached.

Subst. for form 1449/PTO				Complete if Known	
INFORMATION DISCLOSURE STATEMENT BY APPLICANT <i>(Use as many sheets as necessary)</i>				Application Number	13/342,795
				Filing Date	01-03-2012
				First Named Inventor	Victor Larson
				Art Unit	2453
				Examiner Name	Krisna Lim
				Docket Number	77580-155(VRNK-1CP3CNFT5)

CERTIFICATION STATEMENT

Please See 37 CFR 1.97 and 1.98 to make the appropriate selection(s)

- Information Disclosure Statement is being filed with the filing of the application or before the receipt of a first office action.
- That each item of information contained in the information disclosure statement was first cited in any communication from a foreign patent office in a counterpart foreign application not more than three months prior to the filing of the information disclosure statement; or
- That no item of information contained in the information disclosure statement was cited in a communication from a foreign patent office in a counterpart foreign application, and, to the knowledge of the person signing the certification after making reasonable inquiry, no item of information contained in the information disclosure statement was known to any individual designated in § 1.56(c) more than three months prior to the filing of the information disclosure statement.
- The Commissioner is hereby authorized to charge the fee pursuant to 37 CFR 1.17(P) in the amount of \$180.00, or further fees which may be due, to Deposit Account 50-1133.
- Information Disclosure Statement is being filed with the Request for Continued Examination. The Commissioner is hereby authorized to charge the fee pursuant to 37 CFR 1.17(P) in the amount of \$810.00, or further fees which may be due, to Deposit Account 50-1133.
- None

SIGNATURE

A signature of the applicant or representative is required in accordance with CFR 1.33, 10.18. Please see CFR 1.4(d) for the form of the signature.

 Toby H. Kusmer, Reg. No.: 26,418
 McDermott Will & Emery LLP
 28 State Street
 Boston, MA 02109
 Tel. (617) 535-4000
 Fax (617) 535-3800

Date: 5/10/12

DM_US 35091238-1.077580.0155

Subst. for form 1449/PTO				Complete if Known		
INFORMATION DISCLOSURE STATEMENT BY APPLICANT (Use as many sheets as necessary)				Application Number	13/342,795	
				Filing Date	01-03-2012	
				First Named Inventor	Victor Larson	
				Art Unit	2453	
				Examiner Name	Krisna Lim	
				Docket Number	77580-155(VR NK-1CP3CNFT5)	
U.S. PATENTS						
EXAMINER'S INITIALS	CITE NO.	Patent Number	Publication Date	Name of Patentee or Applicant of Cited Document	Pages, Columns, Lines, Where Relevant Passages or Relevant Figures Appear	
U.S. PATENT APPLICATION PUBLICATIONS						
EXAMINER'S INITIALS	CITE NO.	Patent Number	Publication Date	Name of Patentee or Applicant of Cited Document	Pages, Columns, Lines, Where Relevant Passages or Relevant Figures Appear	
FOREIGN PATENT DOCUMENTS						
EXAMINER'S INITIALS	CITE NO.	Foreign Patent Document Country Codes - Number 4 - Kind Codes (if known)	Publication Date	Name of Patentee or Applicant of Cited Document	Pages, Columns, Lines Where Relevant Figures Appear	Translation Yes No
OTHER ART (Including Author, Title, Date, Pertinent Pages, Etc.)						
EXAMINER'S INITIALS	CITE NO.	Include name of the author (in CAPITAL LETTERS), title of the article (when appropriate), title of the item (book, magazine, journal, serial, symposium, catalog, etc.), date, page(s), volume-issue number(s), publisher, city and/or country where published.				
	D1224	Lee et al., "Uniform Resource Locators (URL)," Network Working Group, RFC 1738, December 1994 (25 pages)				
	D1225	VPN 3000 Concentrator Series, User Guide; Release 2.5 July 2000 (489 pages)				
	D1226	VPN 3000 Concentrator Series, Getting Started; Release 2.5 July 2000 (122 pages)				
	D1227	Fratto, Altiga Concentrates on VPN Security (Hardware Review Evaluation), Network Computing, March 22, 1999 (2 pages)				
	D1228	Response to RFP: Altiga, Network World Fusion, May 10, 1999 (7 pages)				
	D1229	Altiga Proves Multi-Vendor Interoperability for Seamless VPN Deployment; VPN Workshop Marks Significant Development in the VPN Market, July 12, 1999 (2 pages)				
	D1230	Altiga VPN Concentrator Series (C50) Versus Nortel Networks Contivity Extranet Switch 4000 and 4500, VPN Tunneling competitive Evaluation, 1999 (6 pages)				
	D1231	VPN 3000 Client User Guide, Release 2.5, July 2000 (94 pages)				
	D1232	Digital Certificates Design Specification for Release 2.0, May 17, 1999 (21 pages)				
	D1233	Altiga IPsec Client Architecture, Revision 1.0, April 5, 1999 (34 pages)				
	D1234	Altiga IPsec Functional Specification, Revision 2.1, (17 pages)				
	D1235	Altiga Product Requirements, Revision 1.7, May 26, 1998 (17 pages)				
	D1236	Altiga Network Lists Feature Functional Specification, Revision 1.0, (7 pages)				
	D1237	Altiga Split Tunneling Functional/Design Specification, (15 pages)				

Subst. for form 1449/PTO		Complete if Known	
INFORMATION DISCLOSURE STATEMENT BY APPLICANT (Use as many sheets as necessary)		Application Number	13/342,795
		Filing Date	01-03-2012
		First Named Inventor	Victor Larson
		Art Unit	2453
		Examiner Name	Krisna Lim
		Docket Number	77580-155(VRNK-1CP3CNFT5)
	D1238	Altiga Digital Certificate Support for IPsec Client V2.1 Functional Specification, August 12, 1999 (24 pages)	
	D1239	Altiga IPsec LAN to LAN Tunnel Autodiscovery Functional Specification, (5 pages)	
	D1240	Altiga Split Tunneling Testplan, Revision 1.0, (8 pages)	
	D1241	Altiga VPN Concentrator Getting Started, Revision 1, March 1999 (116 pages)	
	D1242	Altiga VPN Concentrator Getting Started, Version 2, June 1999 (102 pages)	
	D1243	Altiga VPN Concentrator Getting Started, Version 3, December 1999 (130 pages)	
	D1244	Altiga VPN Concentrator Getting Started, Version 4, March 2000 (138 pages)	
	D1245	Altiga VPN Concentrator User Guide, Revision 1, March 1999 (304 pages)	
	D1246	Altiga VPN Concentrator User Guide, Revision 1.1, March 1999 (304 pages)	
	D1247	Altiga VPN Concentrator User Guide, Version 3, June 1999 (478 pages)	
	D1248	Altiga VPN Concentrator User Guide, Version 4, December 1999 (472 pages)	
	D1249	Altiga VPN Concentrator User Guide, Version 5, March 2000 (606 pages)	
	D1250	Altiga VPN Client Installation and User Guide, Version 2, July 1999 (92 pages)	
	D1251	Altiga VPN Concentrator VPN Client Installation and User Guide, Version 3, December 1999 (113 pages)	
	D1252	Altiga VPN Concentrator VPN Client Installation and User Guide, Version 4, March 2000 (118 pages)	
	D1253	Altiga Networks VPN Concentrator and VPN Client, as well as their Public Demonstrations and Testing, are also Described in Marketing Materials and Publications (4 pages)	
EXAMINER		DATE CONSIDERED	
/Krisna Lim/		11/30/2012	

*EXAMINER: Initial if reference considered, whether or not citation is in conformance with MPEP 609. Draw line through citation if not in conformance and not considered. Include copy of this form with next communication to applicant.

1 Applicant's unique citation designation number (optional). 2 Applicant is to place a check mark here if English language Translation is attached.

Subst. for form 1449/PTO				Complete if Known	
INFORMATION DISCLOSURE STATEMENT BY APPLICANT <i>(Use as many sheets as necessary)</i>				Application Number	13/342,795
				Filing Date	01-03-2012
				First Named Inventor	Victor Larson
				Art Unit	2453
				Examiner Name	Krisna Lim
				Docket Number	77580-155(VRNK-1CP3CNFT5)

CERTIFICATION STATEMENT

Please See 37 CFR 1.97 and 1.98 to make the appropriate selection(s)

- Information Disclosure Statement is being filed with the filing of the application or before the receipt of a first office action.
- That each item of information contained in the information disclosure statement was first cited in any communication from a foreign patent office in a counterpart foreign application not more than three months prior to the filing of the information disclosure statement; or
- That no item of information contained in the information disclosure statement was cited in a communication from a foreign patent office in a counterpart foreign application, and, to the knowledge of the person signing the certification after making reasonable inquiry, no item of information contained in the information disclosure statement was known to any individual designated in § 1.56(c) more than three months prior to the filing of the information disclosure statement.
- The Commissioner is hereby authorized to charge any required fees to Deposit Account 50-1133.
- Information Disclosure Statement is being filed with the Request for Continued Examination. The Commissioner is hereby authorized to charge the fee pursuant to 37 CFR 1.17(P) in the amount of \$810.00, or further fees which may be due, to Deposit Account 50-1133.

SIGNATURE

A signature of the applicant or representative is required in accordance with CFR 1.33, 10.18. Please see CFR 1.4(d) for the form of the signature.

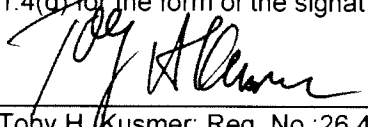
 Toby H. Kusmer; Reg. No.: 26,418
 McDermott Will & Emery LLP
 28 State Street
 Boston, MA 02109
 Tel. (617) 535-4000
 Fax (617) 535-3800

Date: 10/3/12

DM_US 39145362-1.077580.0155

Subst. for form 1449/PTO				Complete if Known		
INFORMATION DISCLOSURE STATEMENT BY APPLICANT (Use as many sheets as necessary)				Application Number	13/342,795	
				Filing Date	01-03-2012	
				First Named Inventor	Victor Larson	
				Art Unit	2453	
				Examiner Name	Krisna Lim	
				Docket Number	77580-155(VRNK-1CP3CNFT5)	
U.S. PATENTS						
EXAMINER'S INITIALS	CITE NO.	Patent Number	Publication Date	Name of Patentee or Applicant of Cited Document	Pages, Columns, Lines, Where Relevant Passages or Relevant Figures Appear	
U.S. PATENT APPLICATION PUBLICATIONS						
EXAMINER'S INITIALS	CITE NO.	Patent Number	Publication Date	Name of Patentee or Applicant of Cited Document	Pages, Columns, Lines, Where Relevant Passages or Relevant Figures Appear	
FOREIGN PATENT DOCUMENTS						
EXAMINER'S INITIALS	CITE NO.	Foreign Patent Document Country Codes - Number - Kind Codes (if known)	Publication Date	Name of Patentee or Applicant of Cited Document	Pages, Columns, Lines Where Relevant Figures Appear	Translation Yes No
OTHER ART (Including Author, Title, Date, Pertinent Pages, Etc.)						
EXAMINER'S INITIALS	CITE NO.	Include name of the author (in CAPITAL LETTERS), title of the article (when appropriate), title of the item (book, magazine, journal, serial, symposium, catalog, etc.), date, page(s), volume-issue number(s), publisher, city and/or country where published.				
	D1131	Peter Alexander Invalidity Report				
	D1132	Defendants' Second Supplemental Joint Invalidity Contentions				
	D1133	Exhibit 118A, Altiga VPN System ¹ vs. Claims of the '135 Patent ²				
	D1134	Exhibit 119A, Altiga VPN System ¹ vs. Claims of the '151 Patent ²				
	D1135	Exhibit 120A, Altiga VPN System ¹ vs. Claims of the '180 Patent ²				
	D1136	Exhibit 121A, Altiga VPN System ¹ vs. Claims of the '211 Patent ²				
	D1137	Exhibit 122A, Altiga VPN System ¹ vs. Claims of the '504 Patent ²				
	D1138	Exhibit 123A, Altiga VPN System ¹ vs. Claims of the '759 Patent ²				
	D1139	Exhibit 12A, SSL 3.0 ¹ vs. Claims of the '135 Patent ²				
	D1140	Exhibit 13A, SSL 3.0 ¹ vs. Claims of the '504 Patent ²				
	D1141	Exhibit 14A, SSL 3.0 ¹ vs. Claims of the '211 Patent ²				
	D1142	Exhibit 228A, Understanding OSF DCE 1.1 for AIX and OS/2 ¹ (APP_VX0556531-804) vs. Claims of the '135 Patent ²				
	D1143	Exhibit 229A, Understanding OSF DCE 1.1 for AIX and OS/2 ¹ (APP_VX0556531-804) vs. Claims of the '151 Patent ²				
	D1144	Exhibit 230A, Understanding OSF DCE 1.1 for AIX and OS/2 ¹ (APP_VX0556531-804) vs. Claims of the '180 Patent ²				
	D1145	Exhibit 231A, Understanding OSF DCE 1.1 for AIX and OS/2 ¹ (APP_VX0556531-804) vs. Claims of the '211 Patent ²				

Subst. for form 1449/PTO		Complete if Known	
INFORMATION DISCLOSURE STATEMENT BY APPLICANT (Use as many sheets as necessary)		Application Number	13/342,795
		Filing Date	01-03-2012
		First Named Inventor	Victor Larson
		Art Unit	2453
		Examiner Name	Krisna Lim
		Docket Number	77580-155(VRNK-1CP3CNFT5)
D1146	Exhibit 232A, Understanding OSF DCE 1.1 for AIX and OS/2 ¹ (APP_VX0556531-804) vs. Claims of the '504 Patent ²		
D1147	Exhibit 233A, Understanding OSF DCE 1.1 for AIX and OS/2 ¹ (APP_VX0556531-804) vs. Claims of the '759 Patent ²		
D1148	Exhibit 255, Schulzrinne ¹ vs. Claims of the '135 Patent ²		
D1149	Exhibit 256, Schulzrinne ¹ vs. Claims of the '504 Patent ²		
D1150	Exhibit 257, Schulzrinne ¹ vs. Claims of the '211 Patent ²		
D1151	Exhibit 258, Schulzrinne ¹ vs. Claims of the '151 Patent ²		
D1152	Exhibit 259, Schulzrinne ¹ vs. Claims of the '180 Patent ²		
D1153	Exhibit 260, Schulzrinne ¹ vs. Claims of the '759 Patent ²		
D1154	Exhibit 261, SSL 3.0 ¹ vs. Claims of the '151 Patent ²		
D1155	Exhibit 262, SSL 3.0 ¹ vs. Claims of the '759 Patent ²		
D1156	Exhibit 263, Wang ¹ vs. Claims of the '135 Patent ²		
D1157	Wang ¹ vs. Claims of the '504 Patent ²		
D1158	Wang ¹ vs. Claims of the '211 Patent ²		
D1159	Exhibit 1, Alexander CV.pdf		
D1160	Exhibit 2, Materials Considered by Peter Alexander		
D1161	Exhibit 3, Cross Reference Chart		
D1162	Exhibit 4, RFC 2543 ¹ vs. Claims of the '135 Patent		
D1163	Exhibit 5, RFC 2543 ¹ vs. Claims of the '504 Patent		
D1164	Exhibit 6, RFC 2543 ¹ vs. Claims of the '211 Patent		
D1165	Exhibit 7, The Schulzrinne Presentation ¹ vs. Claims of the '135 Patent		
D1166	Exhibit 8, The Schulzrinne Presentation ¹ vs. Claims of the '504 Patent		
D1167	Exhibit 9, The Schulzrinne Presentation ¹ vs. Claims of the '211 Patent		
D1168	Exhibit 10, The Schulzrinne Presentation ¹ vs. Claims of the '151 Patent		
D1169	Exhibit 11, The Schulzrinne Presentation ¹ vs. Claims of the '180 Patent		
D1170	Exhibit 12, The Schulzrinne Presentation ¹ vs. Claims of the '759 Patent		
D1171	Exhibit 13, SSL 3.0 ² vs. Claims of the '135 Patent		
D1172	Exhibit 14, SSL 3.0 ² vs. Claims of the '504 Patent		
D1173	Exhibit 15, SSL 3.0 ² vs. Claims of the '211 Patent		
D1174	Exhibit 16, SSL 3.0 ² vs. Claims of the '151 Patent		
D1175	Exhibit 17, SSL 3.0 ² vs. Claims of the '759 Patent		
D1176	Exhibit 18, Kiuchi ¹ vs. Claims of the '135 Patent		

Subst. for form 1449/PTO		Complete if Known	
INFORMATION DISCLOSURE STATEMENT BY APPLICANT (Use as many sheets as necessary)		Application Number	13/342,795
		Filing Date	01-03-2012
		First Named Inventor	Victor Larson
		Art Unit	2453
		Examiner Name	Krisna Lim
		Docket Number	77580-155(VRNK-1CP3CNFT5)
D1177	Exhibit 19, Kiuchi ¹ vs. Claims of the '504 Patent		
D1178	Exhibit 20, Kiuchi ¹ vs. Claims of the '211 Patent		
D1179	Exhibit 21, Kiuchi ¹ vs. Claims of the '151 Patent		
D1180	Exhibit 22, Kiuchi ¹ vs. Claims of the '180 Patent		
D1181	Exhibit 23, Kiuchi ¹ vs. Claims of the '759 Patent		
D1182	Exhibit 24, U.S. Patent No. 6,119,234 (hereinafter "Aziz") and RFC 2401 ² vs. Claims of the '135 Patent		
D1183	Exhibit 25, U.S. Patent No. 6,119,234 (hereinafter "Aziz") and RFC 2401 ² vs. Claims of the '504 Patent		
D1184	Exhibit 26, U.S. Patent No. 6,119,234 (hereinafter "Aziz") and RFC 2401 ² vs. Claims of the '211 Patent		
D1185	Exhibit 27, U.S. Patent No. 6,119,234 (hereinafter "Aziz") and RFC 2401 ² vs. Claims of the '151 Patent		
D1186	Exhibit 28		
D1187	Exhibit 29, The Altiga System ¹ vs. Claims of the '135 Patent		
D1188	Exhibit 30, The Altiga System ¹ vs. Claims of the '504 Patent		
D1189	Exhibit 31, The Altiga System ¹ vs. Claims of the '211 Patent		
D1190	Exhibit 32, The Altiga System ¹ vs. Claims of the '759 Patent		
D1191	Exhibit 33, U.S. Patent No. 6,496,867 ("Beser") ¹ and RFC 2401 ² vs. Claims of the '135 Patent		
D1192	Exhibit 34, U.S. Patent No. 6,496,867 ("Beser") ¹ and RFC 2401 ² vs. Claims of the '504 Patent		
D1193	Exhibit 35, U.S. Patent No. 6,496,867 ("Beser") ¹ and RFC 2401 ² vs. Claims of the '211 Patent		
D1194	Exhibit 36, U.S. Patent No. 6,496,867 ("Beser") ¹ and RFC 2401 ² vs. Claims of the '151 Patent		
D1195	Exhibit 37, U.S. Patent No. 6,496,867 ("Beser") ¹ and RFC 2401 ² vs. Claims of the '180 Patent		
D1196	Exhibit 38, Kent ¹ vs. Claims of the '759 Patent		
D1197	Exhibit 39, RFC 2538, Storing Certificates in the Domain Name System (DNS) ¹ vs. Claims of the '504 Patent ²		
D1198	Exhibit 40, RFC 2538, Storing Certificates in the Domain Name System (DNS) ¹ vs. Claims of the '211 Patent ²		
D1199	Exhibit 41, Aziz ('646) ¹ vs. Claims of the '759 Patent		
D1200	Exhibit 42, The PIX Firewall ¹ vs. Claims of the '759 Patent		
D1201	Exhibit A-1, Kiuchi ¹ vs. Claims of the '135 Patent ²		
D1202	Exhibit B-1, Kiuchi ¹ vs. Claims of the '211 Patent ²		
D1203	Exhibit C-1, Kiuchi ¹ vs. Claims of the '504 Patent ²		

Subst. for form 1449/PTO		Complete if Known	
INFORMATION DISCLOSURE STATEMENT BY APPLICANT (Use as many sheets as necessary)		Application Number	13/342,795
		Filing Date	01-03-2012
		First Named Inventor	Victor Larson
		Art Unit	2453
		Examiner Name	Krisna Lim
		Docket Number	77580-155(VRNK-1CP3CNFT5)
	D1204	Exhibit D, Materials Considered	
	D1205	Exhibit E, Expert Report of Stuart G. Stubblebine, Ph.D.	
	D1206	Exhibit F, Expert Report of Stuart G. Stubblebine, Ph.D.	
	D1207	Exhibit G, Opening Expert Report of Dr. Stuart Stubblebine Regarding Invalidity of the '135, '211, and '504 Patents	
EXAMINER /Krisna Lim/		DATE CONSIDERED 07/20/2012	

*EXAMINER: Initial if reference considered, whether or not citation is in conformance with MPEP 609. Draw line through citation if not in conformance and not considered. Include copy of this form with next communication to applicant.

1 Applicant's unique citation designation number (optional). 2 Applicant is to place a check mark here if English language Translation is attached.

Subst. for form 1449/PTO		Complete if Known	
INFORMATION DISCLOSURE STATEMENT BY APPLICANT <i>(Use as many sheets as necessary)</i>		Application Number	13/342,795
		Filing Date	01-03-2012
		First Named Inventor	Victor Larson
		Art Unit	2453
		Examiner Name	Krisna Lim
		Docket Number	77580-155(VRNK-1CP3CNFT5)

CERTIFICATION STATEMENT

Please See 37 CFR 1.97 and 1.98 to make the appropriate selection(s)

- Information Disclosure Statement is being filed with the filing of the application or before the receipt of a first office action.
- That each item of information contained in the information disclosure statement was first cited in any communication from a foreign patent office in a counterpart foreign application not more than three months prior to the filing of the information disclosure statement; or
- That no item of information contained in the information disclosure statement was cited in a communication from a foreign patent office in a counterpart foreign application, and, to the knowledge of the person signing the certification after making reasonable inquiry, no item of information contained in the information disclosure statement was known to any individual designated in § 1.56(c) more than three months prior to the filing of the information disclosure statement.
- The Commissioner is hereby authorized to charge the fee pursuant to 37 CFR 1.17(P) in the amount of \$180.00, or further fees which may be due, to Deposit Account 50-1133.
- Information Disclosure Statement is being filed with the Request for Continued Examination. The Commissioner is hereby authorized to charge the fee pursuant to 37 CFR 1.17(P) in the amount of \$810.00, or further fees which may be due, to Deposit Account 50-1133.
- None

SIGNATURE

A signature of the applicant or representative is required in accordance with CFR 1.33, 10.18. Please see CFR 1.4(d) for the form of the signature.

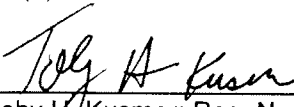

 Toby H. Kusmer; Reg. No.: 26,418
 McDermott Will & Emery LLP
 28 State Street
 Boston, MA 02109
 Tel. (617) 535-4000
 Fax (617) 535-3800

Date: 6/1/12

DM_US 35535997-1.077580.0155

Approved for use through 07/31/2012. OMB 0651-0031
 U.S. Patent and Trademark Office; U.S. DEPARTMENT OF COMMERCE

Under the Paperwork Reduction Act of 1995, no persons are required to respond to a collection of information unless it displays a valid OMB control number.

 <p>TRANSMITTAL FORM</p> <p><i>to be used for all correspondence after initial filing</i></p>	Application Number	13/342,795	
	Filing Date	01-03-2012	
	First Named Inventor	Victor Larson	
	Art Unit	2453	
	Examiner Name	Krisna Lim	
Total Number of Pages in This Submission	52	Attorney Docket Number	77580-155(VRNL-1CP3CNFT5)

ENCLOSURES (Check all that apply)		
<input checked="" type="checkbox"/> Fee Transmittal Form	<input type="checkbox"/> Drawing(s)	<input type="checkbox"/> After Allowance Communication to TC
<input checked="" type="checkbox"/> Fee Attached	<input type="checkbox"/> Licensing-related Papers	<input type="checkbox"/> Appeal Communication to Board of Appeals and Interferences
<input type="checkbox"/> Amendment/Reply	<input type="checkbox"/> Petition	<input type="checkbox"/> Appeal Communication to TC (Appeal Notice, Brief, Reply Brief)
<input type="checkbox"/> After Final	<input type="checkbox"/> Petition to Convert to a Provisional Application	<input type="checkbox"/> Proprietary Information
<input type="checkbox"/> Affidavits/declaration(s)	<input type="checkbox"/> Power of Attorney, Revocation	<input type="checkbox"/> Status Letter
<input type="checkbox"/> Extension of Time Request	<input type="checkbox"/> Change of Correspondence Address	<input checked="" type="checkbox"/> Other Enclosure(s) (please identify below):
<input type="checkbox"/> Express Abandonment Request	<input type="checkbox"/> Terminal Disclaimer	
<input checked="" type="checkbox"/> Information Disclosure Statement	<input type="checkbox"/> Request for Refund	
<input type="checkbox"/> Certified Copy of Priority Document(s)	<input type="checkbox"/> CD, Number of CD(s) _____	
<input type="checkbox"/> Reply to Missing Parts/ Incomplete Application	<input type="checkbox"/> Landscape Table on CD	
<input type="checkbox"/> Reply to Missing Parts under 37 CFR 1.52 or 1.53	Remarks 16 Boxes of Non Patent Literature documents which include; copies of references not previously submitted in a priority application (C8, C19, C21, C24; D257, D258, D261, D263, D264, D266, D292-D111f).	

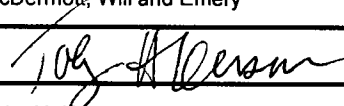
SIGNATURE OF APPLICANT, ATTORNEY, OR AGENT			
Firm Name	McDermott, Will and Emery		
Signature			
Printed name	Toby H. Kusmer		
Date	March 7, 2012	Reg. No.	26,418

CERTIFICATE OF TRANSMISSION/MAILING			
I hereby certify that this correspondence is being facsimile transmitted to the USPTO or deposited with the United States Postal Service with sufficient postage as first class mail in an envelope addressed to: Commissioner for Patents, P.O. Box 1450, Alexandria, VA 22313-1450 on the date shown below:			
Signature			
Typed or printed name		Date	

This collection of information is required by 37 CFR 1.5. The information is required to obtain or retain a benefit by the public which is to file (and by the USPTO to process) an application. Confidentiality is governed by 35 U.S.C. 122 and 37 CFR 1.11 and 1.14. This collection is estimated to 2 hours to complete, including gathering, preparing, and submitting the completed application form to the USPTO. Time will vary depending upon the individual case. Any comments on the amount of time you require to complete this form and/or suggestions for reducing this burden, should be sent to the Chief Information Officer, U.S. Patent and Trademark Office, U.S. Department of Commerce, P.O. Box 1450, Alexandria, VA 22313-1450. DO NOT SEND FEES OR COMPLETED FORMS TO THIS ADDRESS. SEND TO: Commissioner for Patents, P.O. Box 1450, Alexandria, VA 22313-1450.

If you need assistance in completing the form, call 1-800-PTO-9199 and select option 2.

Subst. for form 1449/PTO INFORMATION DISCLOSURE STATEMENT BY APPLICANT (Use as many sheets as necessary)	Complete if Known	
	Application Number	13/342,795
	Filing Date	01-03-2012
	First Named Inventor	Victor Larson
	Art Unit	2453
	Examiner Name	Krisna Lim
	Docket Number	77580-155(VRNL-1CP3CNFT5)

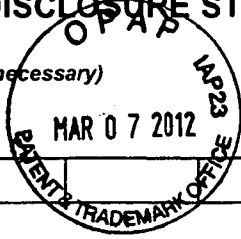

CERTIFICATION STATEMENT

Under 37 C.F.R. 1.98(d), copies of all patent, publication, pending U.S. application or other information that was previously submitted to, or cited by the USPTO in an earlier application are not required. Applicant will provide copies of the previously submitted references at the Examiner's request. **Enclosed are copies of references not previously submitted in a priority application (C8, C19, C21, C24; D257, D258, D261, D263, D264, D266, D292-D1111).**

The present application 13/342,795 claims priority from and is a continuation of a co-pending **U.S. Application No. 13/049,552, filed March 16, 2011, which is a continuation of U.S. Application No. 11/840,560, filed August 17, 2007, now U.S. Patent No. 7,921,211, which is a continuation of U.S. Application No. 10/714,849, filed November 18, 2003, now U.S. Patent No. 7,418,504, which is a continuation of U.S. Application No. 09/558,210, filed April 26, 2000, now abandoned, which is a continuation-in-part of U.S. Application No. 09/504,783, filed on February 15, 2000, now U.S. Patent No. 6,502,135, issued December 31, 2002.**

Please See 37 CFR 1.97 and 1.98 to make the appropriate selection(s)

- Information Disclosure Statement is being filed with the filing of the application or before the receipt of a first office action.
- That each item of information contained in the information disclosure statement was first cited in any communication from a foreign patent office in a counterpart foreign application not more than three months prior to the filing of the information disclosure statement; or
- That no item of information contained in the information disclosure statement was cited in a communication from a foreign patent office in a counterpart foreign application, and, to the knowledge of the person signing the certification after making reasonable inquiry, no item of information contained in the information disclosure statement was known to any individual designated in § 1.56(c) more than three months prior to the filing of the information disclosure statement.
- The Commissioner is hereby authorized to charge the fee pursuant to 37 CFR 1.17(P) in the amount of \$180.00, or further fees which may be due, to Deposit Account 50-1133.
- Information Disclosure Statement is being filed with the Request for Continued Examination. The Commissioner is hereby authorized to charge the fee pursuant to 37 CFR 1.17(P) in the amount of \$810.00, or further fees which may be due, to Deposit Account 50-1133.

SIGNATURE

A signature of the applicant or representative is required in accordance with CFR 1.33, 10.18. Please see CFR 1.4(d) for the form of the signature.

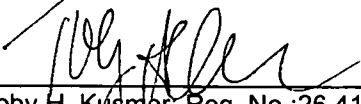
 Toby H. Kusmer, Reg. No.: 26,418
 McDermott Will & Emery LLP
 28 State Street
 Boston, MA 02109
 Tel. (617) 535-4000
 Fax (617) 535-3800

Date: 3/7/12

03/12/2012 HVUONG1 00000003 501133 13342795
 01 FC:1806 180.00 DA



Under the Paperwork Reduction Act of 1995 no persons are required to respond to a collection of information unless it displays a valid OMB control number

FEE TRANSMITTAL

Complete if Known

Application Number	13/342,795
Filing Date	01-03-2012
First Named Inventor	Victor Larson
Examiner Name	Krisna Lim
Art Unit	2453
Attorney Docket No.	77580-155(VR NK-1CP3CNFT5)

Applicant claims small entity status. See 37 CFR 1.27

TOTAL AMOUNT OF PAYMENT (\$) 180.00

METHOD OF PAYMENT (check all that apply)

Check Credit Card Money Order None Other (please identify): _____

Deposit Account Deposit Account Number: 501133 Deposit Account Name: McDermott, Will and Emery

For the above-identified deposit account, the Director is hereby authorized to: (check all that apply)

Charge fee(s) indicated below Charge fee(s) indicated below, except for the filing fee

Charge any additional fee(s) or underpayments of fee(s) under 37 CFR 1.16 and 1.17 Credit any overpayments

WARNING: Information on this form may become public. Credit card information should not be included on this form. Provide credit card information and authorization on PTO-2038.

FEE CALCULATION

1. BASIC FILING, SEARCH, AND EXAMINATION FEES

Application Type	FILING FEES		SEARCH FEES		EXAMINATION FEES		Fees Paid (\$)
	Fee (\$)	Small Entity Fee (\$)	Fee (\$)	Small Entity Fee (\$)	Fee (\$)	Small Entity Fee (\$)	
Utility	380	190	620	310	250	125	_____
Design	250	125	120	60	160	80	_____
Plant	250	125	380	190	200	100	_____
Reissue	380	190	620	310	750	375	_____
Provisional	250	125	0	0	0	0	_____

2. EXCESS CLAIM FEES

Fee Description	Fee (\$)	Small Entity Fee (\$)
Each claim over 20 (including Reissues)	60	30
Each independent claim over 3 (including Reissues)	250	125
Multiple dependent claims	450	225

Total Claims **Extra Claims** **Fee (\$)** **Fee Paid (\$)**

_____ - 20 or HP = _____ x _____ = _____

HP = highest number of total claims paid for, if greater than 20.

Indep. Claims **Extra Claims** **Fee (\$)** **Fee Paid (\$)**

_____ - 3 or HP = _____ x _____ = _____

HP = highest number of independent claims paid for, if greater than 3.

3. APPLICATION SIZE FEE

If the specification and drawings exceed 100 sheets of paper (excluding electronically filed sequence or computer listings under 37 CFR 1.52(e)), the application size fee due is \$310 (\$155 for small entity) for each additional 50 sheets or fraction thereof. See 35 U.S.C. 41(a)(1)(G) and 37 CFR 1.16(s).

Total Sheets	Extra Sheets	Number of each additional 50 or fraction thereof	Fee (\$)	Fee Paid (\$)
_____ - 100 = _____	_____ / 50 = _____	_____ (round up to a whole number)	x _____ = _____	_____

4. OTHER FEE(S)

Non-English Specification, \$130 fee (no small entity discount)

Other (e.g., late filing surcharge): Information Disclosure Statement Filing Fee of \$180.00

Fees Paid (\$)

\$180.00

SUBMITTED BY

Signature		Registration No. (Attorney/Agent) 26,418	Telephone 617-535-4000
Name (Print/Type)	Toby H. Kusner		Date March 7, 2012

This collection of information is required by 37 CFR 1.136. The information is required to obtain or retain a benefit by the public which is to file (and by the USPTO to process) an application. Confidentiality is governed by 35 U.S.C. 122 and 37 CFR 1.14. This collection is estimated to take 30 minutes to complete, including gathering, preparing, and submitting the completed application form to the USPTO. Time will vary depending upon the individual case. Any comments on the amount of time you require to complete this form and/or suggestions for reducing this burden, should be sent to the Chief Information Officer, U.S. Patent and Trademark Office, U.S. Department of Commerce, P.O. Box 1450, Alexandria, VA 22313-1450. DO NOT SEND FEES OR COMPLETED FORMS TO THIS ADDRESS. SEND TO: Commissioner for Patents, P.O. Box 1450, Alexandria, VA 22313-1450.

If you need assistance in completing the form, call 1-800-PTO-9199 and select option 2.

ALL REFERENCES CONSIDERED EXCEPT WHERE LINED THROUGH. /K.L./

**INFORMATION DISCLOSURE STATEMENT
BY APPLICANT**

(Use as many sheets as necessary)

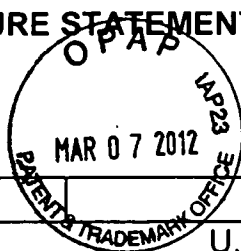

Application Number	13/342,795
Filing Date	01-03-2012
First Named Inventor	Victor Larson
Art Unit	2453
Examiner Name	Krisna Lim
Docket Number	77580-155(VRNK-1CP3CNFT5)

U.S. PATENTS

EXAMINER'S INITIALS	CITE NO.	Patent Number	Publication Date	Name of Patentee or Applicant of Cited Document	Pages, Columns, Lines, Where Relevant Passages or Relevant Figures Appear
---------------------	----------	---------------	------------------	---	---

		Patent Number	Patent Date	Inventor	
	A1	09/399,753	09/22/1998	Graig Miller et al.	
	A2	2,895,502	07/21/1959	Roper et al.	
	A3	4,761,334	08/1988	Sagoi et al.	
	A4	4,885,778	12/5/1989	Weiss, Kenneth	
	A5	4,920,484	4/24/1990	Ranade	
	A6	4,933,846	06/12/1990	Humphrey et al.	
	A7	4,952,930	08/28/1990	Franaszek et al.	
	A8	4,988,990	01/29/1991	Warrior	
	A9	5,164,988	11/17/1992	Matyas	
	A10	5,204,961	04/20/1993	Barlow	
	A11	5,276,735	01/04/1994	Boebert et al	
	A12	5,303,302	04/12/1994	Burrows	
	A13	5,311,593	05/10/1994	Carmi	
	A14	5,329,521	07/12/1994	Walsh et al.	
	A15	5,341,426	08/23/1994	Barney et al.	
	A16	5,367,643	11/22/1994	Chang et al	
	A17	5,384,848	01/24/1995	Kikuchi	
	A18	5,511,122	04/23/1996	Atkinson	
	A19	5,548,646	08/20/1996	Aziz et al.	
	A20	5,559,883	09/24/1996	Williams	
	A21	5,561,669	10/01/1996	Lenney et al	
	A22	5,588,060	12/24/1996	Aziz	
	A23	5,590,285	12/31/1996	Krause et al.	
	A24	5,625,626	04/29/1997	Umekita	
	A25	5,629,984	05/13/1997	McManis	
	A26	5,654,695	08/05/1997	Olnowich et al	
	A27	5,682,480	10/28/1997	Nakagawa	
	A28	5,689,566	11/18/1997	Nguyen	
	A29	5,689,641	11/18/1997	Ludwig et al.	
	A30	5,740,375	04/14/1998	Dunne et al.	
	A31	5,757,925	05/1998	Faybishenko	
	A32	5,764,906	06/1998	Edelstein et al.	
	A33	5,771,239	06/23/1998	Moroney et al.	
	A34	5,774,660	6/30/1998	Brendel et al	
	A35	5,787,172	07/28/1998	Arnold	
	A36	5,790,548	08/04/1998	Sitaraman et al.	
	A37	5,796,942	08/18/1998	Esbensen	
	A38	5,805,801	09/08/1998	Holloway et al.	
	A39	5,805,803	09/08/1998	Birrell et al.	
	A40	5,822,434	10/13/1998	Caronni et al.	
	A41	5,842,040	11/24/1998	Hughes et al.	
	A42	5,845,091	12/01/1998	Dunne et al.	
	A43	5,864,666	01/1999	Shrader, Theodore Jack London	
	A44	5,867,650	02/02/1998	Osterman	
	A45	5,870,610	02/09/1999	Beyda et al.	
	A46	5,878,231	05/02/1999	Baehr et al	
	A47	5,892,903	04/06/1999	Klaus	
	A48	5,898,830	04/27/1999	Wesinger, Jr. et al.	
	A49	5,905,859	05/18/1999	Holloway et al.	
	A50	5,918,018	06/29/1999	Gooderum et al.	

ALL REFERENCES CONSIDERED EXCEPT WHERE LINED THROUGH. /K.L./
Petitioner Apple Inc. - Exhibit 1051, p. 730

Subst. for form 1449/PTO

**INFORMATION DISCLOSURE STATEMENT
BY APPLICANT***(Use as many sheets as necessary)***Complete if Known**

Application Number	13/342,795
Filing Date	01-03-2012
First Named Inventor	Victor Larson
Art Unit	2453
Examiner Name	Krisna Lim
Docket Number	77580-155(VRNN-1CP3CNFT5)

	A51		5,918,019	06/29/1999	Valencia
	A52		5,950,195	09/07/1999	Stockwell et al.
	A53		5,950,519	09/14/1999	Anatoli
	A54		5,960,204	09/28/1999	Yinger et al.
	A55		5,996,016	11/30/1999	Thalheimer et al.
	A56		6,006,259	12/21/1999	Adelman et al.
	A57		6,006,272	12/21/1999	Aravamudan et al
	A58		6,016,318	01/18/2000	Tomoike
	A59		6,016,512	01/18/2000	Huitema
	A60		6,041,342	03/21/2000	Yamaguchi
	A61		6,052,788	04/2000	Wesinger et al.
	A62		6,055,574	04/25/2000	Smorodinsky et al.
	A63		6,061,346	05/2000	Nordman, Mikael
	A64		6,061,736	05/09/2000	Rochberger et al
	A65		6,079,020	06/20/2000	Liu
	A66		6,081,900	06/2000	Subramaniam et al.
	A67		6,092,200	07/18/2000	Muniyappa et al.
	A68		6,101,182	08/2000	Sistanizadeh et al.
	A69		6,119,171	09/12/2000	Alkhatib
	A70		6,119,234	09/12/2000	Aziz et al.
	A71		6,147,976	11/14/2000	Shand et al.
	A72		6,157,957	12/05/2000	Berthaud
	A73		6,158,011	12/05/2000	Chen et al.
	A74		6,168,409	01/02/2001	Fare
	A75		6,173,399	01/09/2001	Gilbrech
	A76		6,175,867	01/16/2001	Taghadoss
	A77		6,178,409	01/23/2001	Weber et al.
	A78		6,178,505	01/23/2001	Schneider et al
	A79		6,179,102	01/30/2001	Weber, et al.
	A80		6,182,141	1/30/2001	Blum et al.
	A81		6,199,112	03/2001	Wilson, Stephen K.
	A82		6,202,081	03/2001	Naudus, Stanley T.
	A83		6,222,842	04/24/2001	Sasyan et al.
	A84		6,223,287	04/24/2001	Douglas et al.
	A85		6,226,748	05/01/2001	Bots et al.
	A86		6,226,751	05/01/2001	Arrow et al..
	A87		6,233,618	05/15/2001	Shannon
	A88		6,243,360	06/05/2001	Basilico
	A89		6,243,749	06/05/2001	Sitaraman et al.
	A90		6,243,754	06/05/2001	Guerin et al
	A91		6,246,670	06/12/2001	Karlsson et al.
	A92		6,256,671	07/03/2001	Strentzsch et al.
	A93		6,262,987	07/17/01	Mogul, Jeffrey C.
	A94		6,263,445	07/17/2001	Blumenau
	A95		6,269,099	07/31/2001	Borella et al.
	A96		6,286,047	09/04/2001	Ramanathan et al
	A97		6,298,341	10/02/01	Mann, et al.
	A98		6,301,223	10/9/2001	Hrastar et al
	A99		6,308,213	10/23/2001	Valencia
	A100		6,308,274	10/23/2001	Swift
	A101		6,311,207	10/30/2001	Mighdoll et al
	A102		6,314,463	11/2001	Abbott et al.
	A103		6,324,161	11/27/2001	Kirch
	A104		6,330,562	12/11/2001	Boden et al.
	A105		6,332,158	12/18/2001	Risley et al.
	A106		6,333,272	12/25/01	McMillin, et al.
	A107		6,338,082	01/08/02	Schneider, Eric

ALL REFERENCES CONSIDERED EXCEPT WHERE LINED THROUGH. /K.L./

Subst. for form 1449/PTO INFORMATION DISCLOSURE STATEMENT BY APPLICANT <i>(Use as many sheets as necessary)</i>				Complete if Known	
				Application Number	13/342,795
				Filing Date	01-03-2012
				First Named Inventor	Victor Larson
				Art Unit	2453
				Examiner Name	Krisna Lim
				Docket Number	77580-155(VRNK-1CP3CNFT5)
A108	6,353,614	03/05/2002	Borella et al.		
A109	6,425,003	07/23/2002	Herzog et al.		
A110	6,430,155	08/06/2002	Davie et al.		
A111	6,430,610	08/06/2002	Carter		
A112	6,487,598	11/26/2002	Valencia		
A113	6,496,867	12/17/2002	Beser et al.		
A114	6,502,135	12/2002	Munger et al.		
A115	6,505,232	01/07/2003	Mighdoll et al.		
A116	6,510,154	01/21/2003	Mayes et al.		
A117	6,549,516	04/15/2003	Albert et al.		
A118	6,557,037	04/2003	Provino, Joseph E.		
A119	6,560,634	05/06/2003	Broadhurst		
A120	6,571,296	05/27/2002	Dillon		
A121	6,571,338	05/27/2003	Shaio et al.		
A122	6,581,166	7/17/2003	Hirst et al.		
A123	6,606,708	08/12/2003	Devine et al.		
A124	6,615,357	9/2/2003	Boden et al.		
A125	6,618,761	09/09/2003	Munger et al.		
A126	6,671,702	12/30/2003	Kruglikov et al.		
A127	6,687,551	2/3/2004	Steindl		
A128	6,687,746	02/03/04	Shuster, et al.		
A129	6,701,437	03/02/2004	Hoke et al.		
A130	6,714,970	3/30/2004	Fiveash et al.		
A131	6,717,949	4/6/2004	Boden et al.		
A132	6,751,738	06/15/2004	Wesinger, Jr. et al..		
A133	6,752,166	06/22/04	Lull, et al.		
A134	6,757,740	06/29/04	Parekh, et al.		
A135	6,760,766	7/6/2004	Sahlqvist		
A136	6,813,777	11/2004	Weinberger et al.		
A137	6,826,616	11/30/2004	Larson et al.		
A138	6,839,759	1/4/2005	Larson et al.		
A139	6,937,597	08/30/2005	Rosenberg et al.		
A140	60/134,547	05/17/1999	Victory Sheymov		
A141	60/151,563	08/31/1999	Bryan Whittles		
A142	7,010,604	3/7/2006	Munger et al.		
A143	7,039,713	05/2006	Van Gunter et al.		
A144	7,072,964	07/04/2006	Whittle et al.		
A145	7,133,930	11/7/2006	Munger et al.		
A146	7,167,904	01/23/07	Devarajan, et al.		
A147	7,188,175	03/06/07	McKeeth, James A.		
A148	7,188,180	3/6/2007	Larson et al.		
A149	7,197,563	3/27/2007	Sheymov et al.		
A150	7,353,841	04/08/08	Kono, et al.		
A151	7,418,504	08/2008	Larson et al.		
A152	7,461,334	12/02/08	Lu, et al.		
A153	7,490,151	02/2009	Munger et al.		
A154	7,493,403	02/2009	Shull et al.		
A155	7,584,500	09/2009	Dillon et al.		
A156	7,764,231	07/27/2010	Karr et al.		
A157	7,852,861	12/2010	Wu et al.		
A158	7,921,211	04/2011	Larson et al.		
A159	7,933,990	04/2011	Munger et al.		
A160	8,051,181	11/2011	Larson et al.		

Subst. for form 1449/PTO			Complete if Known	
INFORMATION DISCLOSURE STATEMENT BY APPLICANT <i>(Use as many sheets as necessary)</i>			Application Number	13/342,795
			Filing Date	01-03-2012
			First Named Inventor	Victor Larson
			Art Unit	2453
			Examiner Name	Krisna Lim
			Docket Number	77580-155(VRNL-1CP3CNFT5)

U.S. PATENT APPLICATION PUBLICATIONS

EXAMINER'S INITIALS	CITE NO.	Patent Number	Publication Date	Name of Patentee or Applicant of Cited Document	Pages, Columns, Lines, Where Relevant Passages or Relevant Figures Appear
	B1	US2001/0049741	12/2001	Skene et al.	
	B2	US2002/0004898	1/10/02	Droge	
	B3	US2003/0196122	10/16/2003	Wesinger, Jr. et al.	
	B4	US2004/0199493	10/2004	Ruiz et al.	
	B5	US2004/0199520	10/2004	Ruiz et al.	
	B6	US2004/0199608	10/2004	Rechterman et al.	
	B7	US2004/0199620	10/2004	Ruiz et al.	
	B8	US2005/0055306	3/10/05	Miller et al.	
	B9	US2005/0108517	05/2005	Dillon et al.	
	B10	US2006/0059337	03/16/2006	Polyhonen et al.	
	B11	US2006/0123134	06/2006	Munger et al.	
	B12	US2007/0208869	09/2007	Adelman et al.	
	B13	US2007/0214284	09/2007	King et al.	
	B14	US2007/0266141	11/2007	Norton, Michael Anthony	
	B15	US2008/0005792	01/2008	*Larson et al.	
	B16	US2008/0144625	06/2008	Wu et al.	
	B17	US2008/0235507	09/2008	Ishikawa et al.	
	B18	US2009/0193498	07/2009	Agarwal et al.	
	B19	US2009/0193513	07/2009	Agarwal et al.	
	B20	US2009/0199258	08/2009	Deng et al.	
	B21	US2009/0199285	09/2009	Agarwal et al.	

FOREIGN PATENT DOCUMENTS

EXAMINER'S INITIALS	CITE NO.	Foreign Patent Document Country Code3 - Number 4 -Kind Code5 <i>(if known)</i>	Publication Date	Name of Patentee or Applicant of Cited Document	Pages, Columns, Lines Where Relevant Figures Appear	Translation	
						Yes	No
	C1	DE19924575	12/2/99	Provino et al.			
	C2	EP0814589	12/29/1997	AT&T Corp.			
	C3	EP0838930	4/29/1988	Digital Equipment Corporation			
	C4	EP0858189	8/12/98	Maciel et al.			
	C5	EP836306	4/15/1998	HEWLETT PACKARD CO			
	C6	GB2317792	04/01/1998	Secure Computing Corporation			
	C7	GB2334181	08/11/1999	NEC Technologies			
	C8	GB2340702	02/23/2000	Sun Microsystems Inc.			
	C9	JP04-363941	12/16/1992	Nippon Telegr & Teleph Corp			
	C10	JP09-018492	01/17/1997	Nippon Telegr & Teleph Corp			
	C11	JP10-070531	03/10/1998	Brother Ind Ltd.			
	C12	JP62-214744	9/21/1987	Hitachi Ltd.			
	C13	WO0070458	11/23/2000	Comsec Corporation			
	C14	WO0017775	3/30/00	Miller et al.			
	C15	WO01016766	03/08/2001	Science Applications International Corporation			
	C16	WO0150688	7/12/01	Kriens			
	C17	WO9827783	06/25/1998	Northern Telecom Limited			
	C18	WO9855930	12/10/98	Tang			

ALL REFERENCES CONSIDERED EXCEPT WHERE LINED THROUGH. /K.L./
Petitioner Apple Inc. - Exhibit 1051, p. 733

Subst. for form 1449/PTO				Complete if Known			
INFORMATION DISCLOSURE STATEMENT BY APPLICANT <i>(Use as many sheets as necessary)</i>				Application Number		13/342,795	
				Filing Date		01-03-2012	
				First Named Inventor		Victor Larson	
				Art Unit		2453	
				Examiner Name		Krisna Lim	
				Docket Number		77580-155(VRNL-1CP3CNFT5)	
	C19	WO9843396	10/01/1998	Northern Telecom Limited			
	C20	WO9859470	12/30/98	Kanter et al.			
	C21	WO9911019	03/04/1999	V One Corp			
	C22	WO9938081	7/29/99	Paulsen et al.			
	C23	WO9948303	9/23/99	Cox et al.			
	C24	WO01/61922	02/12/2001	Science Application International Corporation			

OTHER ART (Including Author, Title, Date, Pertinent Pages, Etc.)

EXAMINE R'S INITIALS	CITE NO.	Include name of the author (in CAPITAL LETTERS), title of the article (when appropriate), title of the item (book, magazine, journal, serial, symposium, catalog, etc.), date, page(s), volume-issue number(s), publisher, city and/or country where published.
	D1	Alan O. Frier et al., "The SSL Protocol Version 3.0", Nov. 18, 1996, printed from http://www.netscape.com/eng/ss13/draft302.txt on Feb. 4, 2002, 56 pages.
	D2	August Bequai, "Balancing Legal Concerns Over Crime and Security in Cyberspace", Computer & Security, vol. 17, No. 4, 1998, pp. 293-298.
	D3	D. B. Chapman et al., "Building Internet Firewalls", Nov. 1995, pp. 278-375.
	D4	D. Clark, "US Calls for Private Domain-Name System", Computer, IEEE Computer Society, Aug. 1, 1998, pp. 22-25.
	D5	Davila J et al, "Implementation of Virtual Private Networks at the Transport Layer", Information Security, Second International Work-shop, ISW'99. Proceedings (Lecture Springer-Verlag Berlin, Germany, [Online] 1999, pp. 85-102, XP002399276, ISBN 3-540-666
	D6	Dolev, Shlomi and Ostrovsky, Rafil, "Efficient Anonymous Multicast and Reception" (Extended Abstract), 16 pages.
	D7	Donald E. Eastlake, 3rd, "Domain Name System Security Extensions", INTERNET DRAFT, Apr. 1998, pp. 1-51.
	D8	F. Halsall, "Data Communications, Computer Networks and Open Systems", Chapter 4, Protocol Basics, 1996, pp. 198-203.
	D9	Glossary for the Linux FreeS/WAN project, printed from http://liberty.freeswan.org/freeswan_trees/freeswan-1.3/doc/glossary.html on Feb. 21, 2002, 25 pages.
	D10	J. Gilmore, "Swan: Securing the Internet against Wiretapping", printed from http://liberty.freeswan.org/freeswan_trees/freeswan-1.3/doc/rationale.html on Feb. 21, 2002, 4 pages.
	D11	James E. Bellaire, "New Statement of Rules-Naming Internet Domains", Internet Newsgroup, Jul. 30, 1995, 1 page.
	D12	Jim Jones et al., "Distributed Denial of Service Attacks: Defenses", Global Integrity Corporation, 2000, pp. 1-14.
	D13	Laurie Wells (LANCASTERBIBELMAIL MSN COM); "Subject: Security Icon" USENET Newsgroup, Oct. 19, 1998, XP002200606, 1 page.
	D14	Linux FreeS/WAN Index File, printed from http://liberty.freewan.org/freeswan_trees/freeswan-1.3/doc/ on Feb. 21, 2002, 3 Pages.
	D15	P. Srisuresh et al., "DNS extensions to Network address Translators (DNS_ALG)", Internet Draft, Jul. 1998, pp. 1-27.
	D16	Reiter, Michael K. and Rubin, Aviel D. (AT&T Labs-Research), "Crowds: Anonymity for Web Transactions", pp. 1-23.
	D17	RFC 2401 (dated Nov. 1998) Security Architecture for the Internet Protocol (RTP)
	D18	RFC 2543-SIP (dated March 1999): Session Initiation Protocol (SIP or SIPS)
	D19	Rich Winkel, "CAQ: Networking With Spooks: The NET & The Control Of Information", Internet Newsgroup, Jun. 21, 1997, 4 pages.
	D20	Rubin, Aviel D., Geer, Daniel, and Ranum, Marcus J. (Wiley Computer Publishing), "Web Security Sourcebook", pp. 82-94.
	D21	Search Report (dated Aug. 20, 2002), International Application No. PCT/US01/04340.
	D22	Search Report (dated Aug. 23, 2002), International Application No. PCT/US01/13260.
	D23	Search Report (dated Oct. 7, 2002), International Application No. PCT/US01/13261.

Subst. for form 1449/PTO INFORMATION DISCLOSURE STATEMENT BY APPLICANT <i>(Use as many sheets as necessary)</i>		Complete if Known	
		Application Number	13/342,795
		Filing Date	01-03-2012
		First Named Inventor	Victor Larson
		Art Unit	2453
		Examiner Name	Krisna Lim
	Docket Number	77580-155(VRNL-1CP3CNFT5)	
D24	Search Report, IPER (dated Nov. 13, 2002), International Application No. PCT/US01/04340.		
D25	Search Report, IPER (dated Feb. 06, 2002), International Application No. PCT/US01/13261.		
D26	Search Report, IPER (dated Jan. 14, 2003), International Application No. PCT/US01/13260.		
D27	Shankar, A.U. "A verified sliding window protocol with variable flow control". Proceedings of ACM SIGCOMM conference on Communications architectures & protocols. pp. 84-91, ACM Press, NY, NY 1986.		
D28	Shree Murthy et al., "Congestion-Oriented Shortest Multi-path Routing", Proceedings of IEEE INFOCOM, 1996, pp. 1028-1036.		
D29	W. Stallings, "Cryptography And Network Security", 2nd, Edition, Chapter 13, IP Security, Jun. 8, 1998, pp. 399-440.		
D30	Microsoft Corporation's Fourth Amended Invalidation Contentions dated Jan. 5, 2009, VirnetX Inc. and Science Applications International Corp. v. Microsoft Corporation.		
D31	Appendix A of the Microsoft Corporation's Fourth Amended Invalidation Contentions dated Jan. 5, 2009.		
D32	Concordance Table For the References Cited in Tables on pages 6-15, 71-80 and 116-124 of the Microsoft Corporation's Fourth Amended Invalidation Contentions dated Jan. 5, 2009.		
D33	1. P. Mockapetris, "DNS Encoding of Network Names and Other Types," Network Working Group, RFC 1101 (April 1989) RFC1101, DNS SRV)		
D34	R. Atkinson, "An Internetwork Authentication Architecture," Naval Research Laboratory, Center for High Assurance Computing Systems (8/5/93). (Atkinson NRL, KX Records)		
D35	Henning Schulzrinne, <i>Personal Mobility For Multimedia Services In The Internet</i> , Proceedings of the Interactive Distributed Multimedia Systems and Services European Workshop at 143 (1996). (Schulzrinne 96)		
D36	Microsoft Corp., <i>Microsoft Virtual Private Networking: Using Point-to-Point Tunneling Protocol for Low-Cost, Secure, Remote Access Across the Internet</i> (1996) (printed from 1998 PDC DVD-ROM). (Point to Point, Microsoft Prior Art VPN Technology)		
D37	"Safe Surfing: How to Build a Secure World Wide Web Connection," IBM Technical Support Organization, (March 1996). (Safe Surfing, WEBSITE ART)		
D38	Goldschlag, et al., "Hiding Routing Information," Workshop on Information Hiding, Cambridge, UK (May 1996). (Goldschlag II, Onion Routing)		
D39	"IPSec Minutes From Montreal", IPSEC Working Group Meeting Notes, http://www.sandleman.ca/ipsec/1996/08/msg00018.html (June 1996). (IPSec Minutes, FreeSWAN)		
D40	J. M. Galvin, "Public Key Distribution with Secure DNS," Proceedings of the Sixth USENIX UNIX Security Symposium, San Jose, California, July 1996. (Galvin, DNSSEC)		
D41	J. Gilmore, et al. "Re: Key Management, anyone? (DNS Keying)," IPsec Working Group Mailing List Archives (8/96). (Gilmore DNS, FreeSWAN)		
D42	H. Orman, et al. "Re: 'Re: DNS? was Re: Key Management, anyone?' IETF IPsec Working Group Mailing List Archive (8/96-9/96). (Orman DNS, FreeSWAN)		
D43	Arnt Gulbrandsen & Paul Vixie, <i>A DNS RR for specifying the location of services (DNS SRV)</i> , IETF RFC 2052 (October 1996). (RFC 2052, DNS SRV)		
D44	Freier, et al. "The SSL Protocol Version 3.0," Transport Layer Security Working Group (November 18, 1996). (SSL, UNDERLYING SECURITY TECHNOLOGY)		
D45	M. Handley, H. Schulzrinne, E. Schooler, Internet Engineering Task Force, Internet Draft, (12/02/1996). (RFC 2543 Internet Draft 1)		
D46	M.G. Reed, et al. "Proxies for Anonymous Routing," 12th Annual Computer Security Applications Conference, San Diego, CA, Dec. 9-13, 1996. (Reed, Onion Routing)		
D47	Kenneth F. Alden & Edward P. Wobber, <i>The AltaVista Tunnel: Using the Internet to Extend Corporate Networks</i> , Digital Technical Journal (1997) (Alden, AltaVista)		
D48	Automotive Industry Action Group, "ANX Release 1 Document Publication," AIAG (1997). (AIAG, ANX)		
D49	Automotive Industry Action Group, "ANX Release 1 Draft Document Publication," AIAG Publications (1997). (AIAG Release, ANX)		
D50	Aventail Corp. "Aventail VPN Data Sheet," available at http://www.archive.org/web/19970212013043/www.aventail.com/prod/vpndata.html (1997). (Data Sheet, Aventail)		
D51	Aventail Corp., "Directed VPN Vs. Tunnel," available at http://web.archive.org/web/19970620030312/www.aventail.com/educate/directvpn.html (1997). (Directed VPN, Aventail)		

ALL REFERENCES CONSIDERED EXCEPT WHERE LINED THROUGH. /K.L./
Petitioner Apple Inc. - Exhibit 1051, p. 735

Subst. for form 1449/PTO		Complete if Known	
		Application Number	13/342,795
		Filing Date	01-03-2012
		First Named Inventor	Victor Larson
		Art Unit	2453
		Examiner Name	Krisna Lim
		Docket Number	77580-155(VRNL-1CP3CNFT5)
D52	Aventail Corp., "Managing Corporate Access to the Internet," Aventail AutoSOCKS White Paper available at http://web.archive.org/199706200300312/www.aventail.com/educate/whitepaper/ipmw.html (1997). (Corporate Access, Aventail)		
D53	Aventail Corp., "VPN Server V2.0 Administration Guide," (1997). (VPN, Aventail)		
D54	Goldschlag, et al. "Privacy on the Internet," Naval Research Laboratory, Center for High Assurance Computer Systems (1997). (Goldschlag I, Onion Routing)		
D55	Microsoft Corp., <i>Installing Configuring and Using PPTP with Microsoft Clients and Servers</i> (1997). (Using PPTP, Microsoft Prior Art VPN Technology)		
D56	Microsoft Corp., <i>IP Security for Microsoft Windows NT Server 5.0</i> (1997) (printed from 1998 PDC DVD-ROM). (IP Security, Microsoft Prior Art VPN Technology)		
D57	Microsoft Corp., <i>Microsoft Windows NT Active Directory: An Introduction to the Next Generation Directory Services</i> (1997) (printed from 1998 PDC DVD-ROM). (Directory, Microsoft Prior Art VPN Technology)		
D58	Microsoft Corp., <i>Routing and Remote Access Service for Windows NT Server New Opportunities Today and Looking Ahead</i> (1997) (printed from 1998 PDC DVD-ROM). Routing, Microsoft Prior Art VPN Technology)		
D59	Microsoft Corp., <i>Understanding Point-to-Point Tunneling Protocol PPTP</i> (1997) (printed from 1998 PDC DVD-ROM). (Understanding PPTP, Microsoft Prior Art VPN Technology)		
D60	J. Mark Smith et al., <i>Protecting a Private Network: The AltaVista Firewall</i> , Digital Technical Journal (1997). (Smith, AltaVista)		
D61	Naganand Doraswamy <i>Implementation of Virtual Private Networks (VPNs) with IPsec</i> , <draft-ietf-ipsec-vpn-00.txt> (March 12, 1997). (Doraswamy)		
D62	M. Handley, H. Schulzrinne, E. Schooler, Internet Engineering Task Force, Internet Draft, (03/27/1997). (RFC 2543 Internet Draft 2)		
D63	Aventail Corp., "Aventail and Cybersafe to Provide Secure Authentication For Internet and Intranet Communication," Press Release, April 3, 1997. (Secure Authentication, Aventail)		
D64	D. Wagner, et al. "Analysis of the SSL 3.0 Protocol," (April 15, 1997). (Analysis, UNDERLYING SECURITY TECHNOLOGIES)		
D65	Automotive Industry Action Group, "ANXO Certification Authority Service and Directory Service Definition for ANX Release 1," AIAG Telecommunications Project Team and Bellcore (May 9, 1997). (AIAG Definition, ANX)		
D66	Automotive Industry Action Group, "ANXO Certification Process and ANX Registration Process Definition for ANX Release 1," AIAG Telecommunications Project Team and Bellcore (May 9, 1997). (AIAG Certification, ANX)		
D67	Aventail Corp., "Aventail Announces the First VPN Solution to Assure Interoperability Across Emerging Security Protocols," June 2, 1997. (First VPN, Aventail)		
D68	Syverson, et al. "Private Web Browsing," Naval Research Laboratory, Center for High Assurance Computer Systems (June 2, 1997). (Syverson, Onion Routing)		
D69	Bellcore, "Metrics, Criteria, and Measurement Technique Requirements for ANX Release 1," AIAG Telecommunications Project Team and Bellcore (June 16, 1997). (AIAG Requirements, ANX)		
D70	M. Handley, H. Schulzrinne, E. Schooler, Internet Engineering Task Force, Internet Draft, (07/31/1997). (RFC 2543 Internet Draft 3)		
D71	R. Atkinson, "Key Exchange Delegation Record for the DNS," Network Working Group, RFC 2230 (November 1997). (RFC 2230, KX Records)		
D72	M. Handley, H. Schulzrinne, E. Schooler, Internet Engineering Task Force, Internet Draft, (11/11/1997). (RFC 2543 Internet Draft 4)		
D73	1998 Microsoft Professional Developers Conference DVD ("1998 PDC DVD-ROM") (including screenshots captured there from and produced as MSFTVX 00018827-00018832). (Conference, Microsoft Prior Art VPN Technology)		
D74	Microsoft Corp., <i>Virtual Private Networking An Overview</i> (1998) (printed from 1998 PDC DVD-ROM) (Overview, Microsoft Prior Art VPN Technology)		
D75	Microsoft Corp., <i>Windows NT 5.0 Beta Has Public Premiere at Seattle Mini-Camp Seminar attendees get first look at the performance and capabilities of Windows NT 5.0</i> (1998) (available at http://www.microsoft.com/presspass/features/1998/10-19nt5.mspxpfrue). (NT Beta, Microsoft Prior Art VPN Technology)		
D76	"What ports does SSL use" available at stason.org/TULARC/security/ssl-talk/3-4-What-ports-does-ssl-use.html (1998). (Ports, DNS SRV)		

ALL REFERENCES CONSIDERED EXCEPT WHERE LINED THROUGH. /K.L./
Petitioner Apple Inc. - Exhibit 1051, p. 736

Subst. for form 1449/PTO		Complete if Known	
		Application Number	13/342,795
		Filing Date	01-03-2012
		First Named Inventor	Victor Larson
		Art Unit	2453
		Examiner Name	Krisna Lim
		Docket Number	77580-155(VR NK-1CP3CNFT5)
D77	Aventail Corp., "Aventail VPN V2.6 Includes Support for More Than Ten Authentication Methods Making Extranet VPN Development Secure and Simple," Press Release, January 19, 1998. (VPN V2.6, Aventail)		
D78	R. G. Moskowitz, "Network Address Translation Issues with IPsec," Internet Draft, Internet Engineering Task Force, February 6, 1998. (Moskowitz)		
D79	H. Schulzrinne, et al, "Internet Telephony Gateway Location," Proceedings of IEEE Infocom '98, The Conference on Computer Communications, Vol. 2 (March 29 - April 2, 1998). (Gateway, Schulzrinne)		
D80	C. Huitema, 45 al. "Simple Gateway Control Protocol," Version 1.0 (May 5, 1998). (SGCP)		
D81	DISA "Secret Internet Protocol Router Network," SIPRNET Program Management Office (D3113) DISN Networks, DISN Transmission Services (May 8, 1998). DISA, SIPRNET)		
D82	M. Handley, H. Schulzrinne, E. Schooler, Internet Engineering Task Force, Internet Draft, (05/14/1998). (RFC 2543 Internet Draft 5)		
D83	M. Handley, H. Schulzrinne, E. Schooler, Internet Engineering Task Force, Internet Draft, (06/17/1998). (RFC 2543 Internet Draft 6)		
D84	D. McDonald, et al. "PF_KEY Key Management API, Version 2," Network Working Group, RFC 2367 (July 1998). (RFC 2367)		
D85	M. Handley, H. Schulzrinne, E. Schooler, Internet Engineering Task Force, Internet Draft, (07/16/1998). (RFC 2543 Internet Draft 7)		
D86	M. Handley, H. Schulzrinne, E. Schooler, Internet Engineering Task Force, Internet Draft, (08/07/1998). (RFC 2543 Internet Draft 8)		
D87	Microsoft Corp., <i>Company Focuses on Quality and Customer Feedback</i> (August 18, 1998). (Focus, Microsoft Prior Art VPN Technology)		
D88	M. Handley, H. Schulzrinne, E. Schooler, Internet Engineering Task Force, Internet Draft, (09/18/1998). (RFC 2543 Internet Draft 9)		
D89	Atkinson, et al. "Security Architecture for the Internet Protocol," Network Working Group, RFC 2401 (November 1998). (RFC 2401, UNDERLYING SECURITY TECHNOLOGIES)		
D90	M. Handley, H. Schulzrinne, E. Schooler, Internet Engineering Task Force, Internet Draft, (11/12/1998). (RFC 2543 Internet Draft 10)		
D91	Donald Eastlake, <i>Domain Name System Security Extensions</i> , IETF DNS Security Working Group (December 1998). (DNSSEC-7)		
D92	M. Handley, H. Schulzrinne, E. Schooler, Internet Engineering Task Force, Internet Draft, (12/15/1998). (RFC 2543 Internet Draft 11)		
D93	Aventail Corp., "Aventail Connect 3.1/2.6 Administrator's Guide," (1999). (Aventail Administrator 3.1, Aventail)		
D94	Aventail Corp., "Aventail Connect 3.1/2.6 User's Guide," (1999). (Aventail User 3.1, Aventail)		
D95	Aventail Corp., "Aventail ExtraWeb Server v3.2 Administrator's Guide," (1999). (Aventail ExtraWeb 3.2, Aventail)		
D96	Kaufman et al, "Implementing IPsec," (Copyright 1999). (Implementing IPSEC, VPN REFERENCES)		
D97	Network Solutions, Inc. "Enabling SSL," NSI Registry (1999). (Enabling SSL, UNDERLYING SECURITY TECHNOLOGIES)		
D98	Check Point Software Technologies Ltd. (1999) (Check Point, Checkpoint FW)		
D99	Arnt Gulbrandsen & Paul Vixie, <i>A DNS RR for specifying the location of services (DNS SRV)</i> , <draft-ietf-dnsind-frc2052bis-02.txt> (January 1999). (Gulbrandsen 99, DNS SRV)		
D100	C. Scott, et al. <i>Virtual Private Networks</i> , O'Reilly and Associates, Inc., 2nd ed. (Jan. 1999). Scott VPNs)		
D101	M. Handley, H. Schulzrinne, E. Schooler, Internet Engineering Task Force, Internet Draft, (01/15/1999). (RFC 2543 Internet Draft 12)		
D102	Goldschlag, et al., "Onion Routing for Anonymous and Private Internet Connections," Naval Research Laboratory, Center for High Assurance Computer Systems (January 28, 1999). (Goldschlag III, Onion Routing)		
D103	H. Schulzrinne, "Internet Telephony: architecture and protocols - an IETF perspective," <i>Computer Networks</i> , Vol. 31, No. 3 (February 1999). (Telephony, Schulzrinne)		
D104	M. Handley, et al. "SIP: Session Initiation Protocol," Network Working Group, RFC 2543 and Internet Drafts (12/96-3/99). (Handley, RFC 2543)		
D105	FreeSWAN Project, <i>Linux FreeS/WAN Compatibility Guide</i> (March 4, 1999). (FreeSWAN Compatibility Guide, FreeSWAN)		

ALL REFERENCES CONSIDERED EXCEPT WHERE LINED THROUGH. /K.L./
 Petitioner Apple Inc. - Exhibit 1051, p. 737

Subst. for form 1449/PTO INFORMATION DISCLOSURE STATEMENT BY APPLICANT <i>(Use as many sheets as necessary)</i>		Complete if Known	
		Application Number	13/342,795
		Filing Date	01-03-2012
		First Named Inventor	Victor Larson
		Art Unit	2453
		Examiner Name	Krisna Lim
	Docket Number	77580-155(VRNL-1CP3CNFT5)	
D106	Telcordia Technologies, "ANX Release 1 Document Corrections," AIAG (May 11, 1999). (Telcordia, ANX)		
D107	Ken Hornstein & Jeffrey Altman, <i>Distributing Kerberos KDC and Realm Information with DNS</i> <draft-eitf-cat-krb-dns-locate-oo.txt> (June 21, 1999). (Hornstein, DNS SRV)		
D108	Bhattacharya, et al., "An LDAP Schema for Configuration and Administration of IPsec Based Virtual Private Networks (VPNs)", IETF Internet Draft (October 1999). (Bhattacharya LDAP VPN)		
D109	B. Patel, et al. "DHCP Configuration of IPSEC Tunnel Mode," IPSEC Working Group, Internet Draft 02 (10/15/1999). (Patel)		
D110	Goncalves, et al. <i>Check Point FireWall-1 Administration Guide</i> , McGraw-Hill Companies (2000). (Goncalves, Checkpoint FW)		
D111	"Building a Microsoft VPN: A Comprehensive Collection of Microsoft Resources," FirstVPN, (Jan 2000). (FirstVPN Microsoft)		
D112	Gulbrandsen, Vixie, & Esibov, <i>A DNS RR for specifying the location of services (DNS SRV)</i> , IETF RFC 2782 (February 2000). (RFC 2782, DNS SRV)		
D113	MITRE Organization, "Technical Description," Collaborative Operations in Joint Expeditionary Force Experiment (JEFX) 99 (February 2000). (MITRE, SIPRNET)		
D114	H. Schulzrinne, et al. "Application-Layer Mobility Using SIP," <i>Mobile Computing and Communications Review</i> , Vol. 4, No. 3. pp. 47-57 (July 2000). (Application, SIP)		
D115	Kindred et al., "Dynamic VPN Communities: Implementation and Experience," DARPA Information Survivability Conference and Exposition II (June 2001). (DARPA, VPN SYSTEMS)		
D116	ANX 101: Basic ANX Service Outline. (Outline, ANX)		
D117	ANX 201: Advanced ANX Service. (Advanced, ANX)		
D118	Appendix A: Certificate Profile for ANX IPsec Certificates. (Appendix, ANX)		
D119	Assured Digital Products. (Assured Digital)		
D120	Aventail Corp., "Aventail AutoSOCKS the Client Key to Network Security," Aventail Corporation White Paper. (Network Security, Aventail)		
D121	Cindy Moran, "DISN Data Networks: Secret Internet Protocol Router Network (SIPRNet)." (Moran, SIPRNET)		
D122	Data Fellows F-Secure VPN+ (F-Secure VPN+)		
D123	"Interim Operational Systems Doctrine for the Remote Access Security Program (RASP) Secret Dial-In Solution. (RASP, SIPRNET)		
D124	<i>Onion Routing</i> , "Investigation of Route Selection Algorithms," available at http://www.onion-router.net/Archives/Route/index.html . (Route Selection, Onion Routing)		
D125	Secure Computing, "Bullet-Proofing an Army Net," Washington Technology. (Secure, SIPRNET)		
D126	SPARTA "Dynamic Virtual Private Network." (Sparta, VPN SYSTEMS)		
D127	Standard Operation Procedure for Using the 1910 Secure Modems. (Standard, SIPRNET)		
D128	Publicly available emails relating to FreeSWAN (MSFTVX00018833-MSFTVX00019206). (FreeSWAN emails, FreeSWAN)		
D129	Kaufman et al., "Implementing IPsec," (Copyright 1999) (Implementing IPsec)		
D130	Network Associates <i>Gauntlet Firewall For Unix User's Guide Version 5.0</i> (1999). (Gauntlet User's Guide - Unix, Firewall Products)		
D131	Network Associates <i>Gauntlet Firewall For Windows NT Getting Started Guide Version 5.0</i> (1999) (Gauntlet Getting Started Guide - NT, Firewall Products)		
D132	Network Associates <i>Gauntlet Firewall For Unix Getting Started Guide Version 5.0</i> (1999) (Gauntlet Unix Getting Started Guide, Firewall Products)		
D133	Network Associates <i>Release Notes Gauntlet Firewall for Unix 5.0</i> (March 19, 1999) (Gauntlet Unix Release Notes, Firewall Products)		
D134	Network Associates <i>Gauntlet Firewall For Windows NT Administrator's Guide Version 5.0</i> (1999) (Gauntlet NT Administrator's Guide, Firewall Products)		
D135	Trusted Information Systems, Inc. <i>Gauntlet Internet Firewall Firewall-to-Firewall Encryption Guide Version 3.1</i> (1996) (Gauntlet Firewall-to-Firewall, Firewall Products)		
D136	Network Associates <i>Gauntlet Firewall Global Virtual Private Network User's Guide for Windows NT Version 5.0</i> (1999) (Gauntlet NT GVPN, GVPN)		
D137	Network Associates <i>Gauntlet Firewall For UNIX Global Virtual Private Network User's Guide Version 5.0</i> (1999) (Gauntlet Unix GVPN, GVPN)		
D138	Dan Sterne <i>Dynamic Virtual Private Networks</i> (May 23, 2000) (Sterne DVPN, DVPN)		
D139	Darrell Kindred <i>Dynamic Virtual Private Networks (DVPN)</i> (December 21, 1999) (Kindred DVPN, DVPN)		

ALL REFERENCES CONSIDERED EXCEPT WHERE LINED THROUGH. /K.L./

Subst. for form 1449/PTO INFORMATION DISCLOSURE STATEMENT BY APPLICANT <i>(Use as many sheets as necessary)</i>		Complete if Known	
		Application Number	13/342,795
		Filing Date	01-03-2012
		First Named Inventor	Victor Larson
		Art Unit	2453
		Examiner Name	Krisna Lim
	Docket Number	77580-155(VRNL-1CP3CNFT5)	
D140	Dan Sterne <i>et al.</i> <i>TIS Dynamic Security Perimeter Research Project Demonstration</i> (March 9, 1998) (Dynamic Security Perimeter, DVPN)		
D141	Darrell Kindred <i>Dynamic Virtual Private Networks Capability Description</i> (January 5, 2000) (Kindred DVPN Capability, DVPN) 11		
D142	October 7, and 28 1997 email from Domenic J. Turchi Jr. (SPARTA00001712-1714, 1808-1811) (Turchi DVPN email, DVPN)		
D143	James Just & Dan Sterne <i>Security Quickstart Task Update</i> (February 5, 1997) (Security Quickstart, DVPN)		
D144	Virtual Private Network Demonstration dated March 21, 1998 (SPARTA00001844-54) (DVPN Demonstration, DVPN)		
D145	GTE Internetworking & BBN Technologies DARPA <i>Information Assurance Program Integrated Feasibilit Demonstration (IFD) 1.1 Plan</i> (March 10, 1998) (IFD 1.1, DVPN)		
D146	Microsoft Corp. Windows NT Server Product Documentation: Administration Guide - Connection Point Services, <i>available at</i> http://www.microsoft.com/technet/archive/winntas/proddocs/inetconctservice/cpsops.mspx (Connection Point Services) (Although undated, this reference refers to the operation of prior art versions of Microsoft Windows. Accordingly, upon information and belief, this reference is prior art to the patents-in-suit.)		
D147	Microsoft Corp. Windows NT Server Product Documentation: Administration Kit Guide - Connection Manager, <i>available at</i> http://www.microsoft.com/technet/archive/winntas/proddocs/inetconctservice/cmak.mspx (Connection Manager) (Although undated, this reference refers to the operation of prior art versions of Microsoft Windows such as Windows NT 4.0. Accordingly, upon information and belief, this reference is prior art to the patents-in-suit.)		
D148	Microsoft Corp. Autodial Heuristics, <i>available at</i> http://support.microsoft.com/kb/164249 (Autodial Heuristics) (Although undated, this reference refers to the operation of prior art versions of Microsoft Windows such as Windows NT 4.0. Accordingly, upon information and belief, this reference is prior art to the patents-in-suit.)		
D149	Microsoft Corp., Cariplo: Distributed Component Object Model, (1996) <i>available at</i> http://msdn2.microsoft.com/en-us/library/ms809332(printer).aspx (Cariplo I)		
D150	Marc Levy, COM Internet Services (Apr. 23, 1999), <i>available at</i> http://msdn2.microsoft.com/en-us/library/ms809302(printer).aspx (Levy)		
D151	Markus Horstmann and Mary Kirtland, DCOM Architecture (July 23, 1997), <i>available at</i> http://msdn2.microsoft.com/en-us/library/ms809311(printer).aspx (Horstmann)		
D152	Microsoft Corp., DCOM: A Business Overview (Apr. 1997), <i>available at</i> http://msdn2.microsoft.com/en-us/library/ms809320(printer).aspx (DCOM Business Overview I)		
D153	Microsoft Corp., DCOM Technical Overview (Nov. 1996), <i>available at</i> http://msdn2.microsoft.com/en-us/library/ms809340(printer).aspx (DCOM Technical Overview I)		
D154	Microsoft Corp., DCOM Architecture White Paper (1998) <i>available in</i> PDC DVD-ROM (DCOM Architecture)		
D155	Microsoft Corp, DCOM – The Distributed Component Object Model, A Business Overview White Paper (Microsoft 1997) <i>available in</i> PDC DVD-ROM (DCOM Business Overview II)		
D156	Microsoft Corp., DCOM - Cariplo Home Banking Over The Internet White Paper (Microsoft 1996) <i>available in</i> PDC DVD-ROM (Cariplo II)		
D157	Microsoft Corp., DCOM Solutions in Action White Paper (Microsoft 1996) <i>available in</i> PDC DVD-ROM (DCOM Solutions in Action)		
D158	Microsoft Corp., DCOM Technical Overview White Paper (Microsoft 1996) <i>available in</i> 12 in PDC DVD-ROM (DCOM Technical Overview II)		
D159	125. Scott Suhy & Glenn Wood, DNS and Microsoft Windows NT 4.0, (1996) <i>available at</i> http://msdn2.microsoft.com/en-us/library/ms810277(printer).aspx (Suhy)		
D160	126. Aaron Skonnard, <i>Essential Winlnet</i> 313-423 (Addison Wesley Longman 1998) (Essential Winlnet)		
D161	Microsoft Corp. Installing, Configuring, and Using PPTP with Microsoft Clients and Servers, (1998) <i>available at</i> http://msdn2.microsoft.com/enus/library/ms811078(printer).aspx (Using PPTP)		
D162	Microsoft Corp., Internet Connection Services for MS RAS, Standard Edition, http://www.microsoft.com/technet/archive/winntas/proddocs/inetconctservice/bcgstart.mspx (Internet Connection Services I)		

Subst. for form 1449/PTO		Complete if Known	
INFORMATION DISCLOSURE STATEMENT BY APPLICANT <i>(Use as many sheets as necessary)</i>		Application Number	13/342,795
		Filing Date	01-03-2012
		First Named Inventor	Victor Larson
		Art Unit	2453
		Examiner Name	Krisna Lim
		Docket Number	77580-155(VRNL-1CP3CNFT5)
D163	Microsoft Corp., Internet Connection Services for RAS, Commercial Edition, <i>available at</i> http://www.microsoft.com/technet/archive/winntas/proddocs/inetconctservice/bcgstrtc.mspx (Internet Connection Services II)		
D164	Microsoft Corp., Internet Explorer 5 Corporate Deployment Guide – Appendix B: Enabling Connections with the Connection Manager Administration Kit, <i>available at</i> http://www.microsoft.com/technet/prodtechnol/ie/deploy/deploy5/appendb.mspx (IE5 Corporate Development)		
D165	Mark Minasi, <i>Mastering Windows NT Server 4</i> 1359-1442 (6th ed., January 15, 1999) (Mastering Windows NT Server)		
D166	<i>Hands On, Self-Paced Training for Supporting Version 4.0</i> 371-473 (Microsoft Press 1998) (Hands On)		
D167	Microsoft Corp., MS Point-to-Point Tunneling Protocol (Windows NT 4.0), <i>available at</i> http://www.microsoft.com/technet/archive/winntas/maintain/featusability/pptpwp3.mspx (MS PPTP)		
D168	Kenneth Gregg, <i>et al.</i> , <i>Microsoft Windows NT Server Administrator's Bible</i> 173-206, 883-911, 974-1076 (IDG Books Worldwide 1999) (Gregg)		
D169	Microsoft Corp., Remote Access (Windows), <i>available at</i> http://msdn2.microsoft.com/enus/library/bb545687(VS.85.printer).aspx (Remote Access)		
D170	Microsoft Corp., Understanding PPTP (Windows NT 4.0), <i>available at</i> http://www.microsoft.com/technet/archive/winntas/plan/pptpudst.mspx (Understanding PPTP NT 4) (Although undated, this reference refers to the operation of prior art versions of Microsoft Windows such as Windows NT 4.0. Accordingly, upon information and belief, this reference is prior art to the patents-in-suit.)		
D171	Microsoft Corp., Windows NT 4.0: Virtual Private Networking, <i>available at</i> http://www.microsoft.com/technet/archive/winntas/deploy/confeat/vpntwk.mspx (NT4 VPN) (Although undated, this reference refers to the operation of prior art versions of Microsoft Windows such as Windows NT 4.0. Accordingly, upon information and belief, this reference is prior art to the patents-in-suit.)		
D172	Anthony Northrup, <i>NT Network Plumbing: Routers, Proxies, and Web Services</i> 299-399 (IDG Books Worldwide 1998) (Network Plumbing)		
D173	Microsoft Corp., Chapter 1 - Introduction to Windows NT Routing with Routing and Remote Access Service, <i>available at</i> http://www.microsoft.com/technet/archive/winntas/proddocs/rras40/rrasch01.mspx (Intro to RRAS) (Although undated, this reference refers to the operation of prior art versions of Microsoft Windows such as Windows NT 4.0. Accordingly, upon information and belief, this reference is prior art to the patents-in-suit.) 13		
D174	Microsoft Corp., Windows NT Server Product Documentation: Chapter 5 - Planning for Large-Scale Configurations, <i>available at</i> http://www.microsoft.com/technet/archive/winntas/proddocs/rras40/rrasch05.mspx (Large-Scale Configurations) (Although undated, this reference refers to the operation of prior art versions of Microsoft Windows such as Windows NT 4.0. Accordingly, upon information and belief, this reference is prior art to the patents-in-suit.)		
D175	F-Secure, <i>F-Secure NameSurfer</i> (May 1999) (from FSECURE 00000003) (NameSurfer 3)		
D176	F-Secure, <i>F-Secure VPN Administrator's Guide</i> (May 1999) (from FSECURE 00000003) (F-Secure VPN 3)		
D177	F-Secure, <i>F-Secure SSH User's & Administrator's Guide</i> (May 1999) (from FSECURE 00000003) (SSH Guide 3)		
D178	F-Secure, <i>F-Secure SSH2.0 for Windows NT and 95</i> (May 1999) (from FSECURE 00000003) (SSH 2.0 Guide 3)		
D179	F-Secure, <i>F-Secure VPN+ Administrator's Guide</i> (May 1999) (from FSECURE 00000003) (VPN+ Guide 3)		
D180	F-Secure, <i>F-Secure VPN+ 4.1</i> (1999) (from FSECURE 00000006) (VPN+ 4.1 Guide 6)		
D181	F-Secure, <i>F-Secure SSH</i> (1996) (from FSECURE 00000006) (F-Secure SSH 6)		
D182	F-Secure, <i>F-Secure SSH 2.0 for Windows NT and 95</i> (1998) (from FSECURE 00000006) (F-Secure SSH 2.0 Guide 6)		
D183	F-Secure, <i>F-Secure SSH User's & Administrator's Guide</i> (Sept. 1998) (from FSECURE 00000009) (SSH Guide 9)		
D184	F-Secure, <i>F-Secure SSH 2.0 for Windows NT and 95</i> (Sept. 1998) (from FSECURE 00000009) (F-Secure SSH 2.0 Guide 9)		

Subst. for form 1449/PTO		Complete if Known	
INFORMATION DISCLOSURE STATEMENT BY APPLICANT (Use as many sheets as necessary)		Application Number	13/342,795
		Filing Date	01-03-2012
		First Named Inventor	Victor Larson
		Art Unit	2453
		Examiner Name	Krisna Lim
		Docket Number	77580-155(VRNL-1CP3CNFT5)
D185	F-Secure, <i>F-Secure VPN+</i> (Sept. 1998) (from FSECURE 00000009) (VPN+ Guide 9)		
D186	F-Secure, <i>F-Secure Management Tools, Administrator's Guide</i> (1999) (from FSECURE 00000003) (F-Secure Management Tools)		
D187	F-Secure, <i>F-Secure Desktop, User's Guide</i> (1997) (from FSECURE 00000009) (FSecure Desktop User's Guide)		
D188	SafeNet, Inc., <i>VPN Policy Manager</i> (January 2000) (VPN Policy Manager)		
D189	F-Secure, <i>F-Secure VPN+ for Windows NT 4.0</i> (1998) (from FSECURE 00000009) (FSecure VPN+)		
D190	IRE, Inc., <i>SafeNet/Security Center Technical Reference Addendum</i> (June 22, 1999) (Safenet Addendum)		
D191	IRE, Inc., <i>System Description for VPN Policy Manager and SafeNet/SoftPK</i> (March 30, 2000) (VPN Policy Manager System Description)		
D192	IRE, Inc., <i>About SafeNet / VPN Policy Manager</i> (1999) (About Safenet VPN Policy Manager)		
D193	Trusted Information Systems, Inc., <i>Gauntlet Internet Firewall, Firewall Product Functional Summary</i> July 22, 1996) (Gauntlet Functional Summary)		
D194	Trusted Information Systems, Inc., <i>Running the Gauntlet Internet Firewall, An Administrator's Guide to Gauntlet Version 3.0</i> (May 31, 1995) (Running the Gauntlet Internet Firewall)		
D195	Ted Harwood, <i>Windows NT Terminal Server and Citrix Metaframe</i> (New Riders 1999) (Windows NT Harwood) 79		
D196	Todd W. Mathers and Shawn P. Genoway, <i>Windows NT Thing Client Solutions: Implementing Terminal Server and Citrix MetaFrame</i> (Macmillan Technical Publishing 1999) (Windows NT Mathers)		
D197	Bernard Aboba et al., <i>Securing L2TP using IPSEC</i> (February 2, 1999)		
D198	156. <i>Finding Your Way Through the VPN Maze</i> (1999) ("PGP")		
D199	Linux FreeSWAN Overview (1999) (Linux FreeSWAN Overview)		
D200	TimeStep, <i>The Business Case for Secure VPNs</i> (1998) ("TimeStep")		
D201	WatchGuard Technologies, Inc., <i>WatchGuard LiveSecurity for MSS Powerpoint</i> (Feb. 14 2000)		
D202	WatchGuard Technologies, Inc., <i>MSS Version 2.5, Add-On for WatchGuard SOHO Release Notes</i> (July 21, 2000)		
D203	WatchGuard Technologies, Inc., <i>MSS Firewall Specifications</i> (1999)		
D204	WatchGuard Technologies, Inc., <i>Request for Information, Security Services</i> (2000)		
D205	WatchGuard Technologies, Inc., <i>Protecting the Internet Distributed Enterprise, White Paper</i> (February 2000)		
D206	Air Force Research Laboratory, <i>Statement of Work for Information Assurance System Architecture and Integration, PR No. N-8-6106 (Contract No. F30602-98-C-0012)</i> (January 29, 1998)		
D207	Technologies, Inc., <i>WatchGuard Firebox System Powerpoint</i> (2000)		
D208	GTE Internetworking & BBN Technologies DARPA <i>Information Assurance Program Integrated Feasibility Demonstration 1FD 1.2 Report, Rev. 1.0</i> (September 21, 1998)		
D209	BBN Information Assurance Contract, <i>TIS Labs Monthly Status Report</i> (March 16-April 30, 1998)		
D210	DARPA, <i>Dynamic Virtual Private Network (VPN) Powerpoint</i>		
D211	GTE Internetworking, <i>Contractor's Program Progress Report</i> (March 16-April 30, 1998)		
D212	Darrell Kindred, <i>Dynamic Virtual Private Networks (DVPN) Countermeasure Characterization</i> (January 30, 2001)		
D213	<i>Virtual Private Networking Countermeasure Characterization</i> (March 30, 2000)		
D214	<i>Virtual Private Network Demonstration</i> (March 21, 1998)		
D215	Information Assurance/NAI Labs, <i>Dynamic Virtual Private Networks (VPNs) and Integrated Security Management</i> (2000)		
D216	Information Assurance/NAI Labs, <i>Create/Add DVPN Enclave</i> (2000)		
D217	NAI Labs, <i>IFE 3.1 Integration Demo</i> (2000)		
D218	Information Assurance, <i>Science Fair Agenda</i> (2000)		
D219	Darrell Kindred et al., <i>Proposed Threads for IFE 3.1</i> (January 13, 2000)		
D220	<i>IFE 3.1 Technology Dependencies</i> (2000)		
D221	<i>IFE 3.1 Topology</i> (February 9, 2000)		
D222	Information Assurance, <i>Information Assurance Integration: IFE 3.1, Hypothesis & Thread Development</i> January 10-11, 2000)		
D223	Information Assurance/NAI Labs, <i>Dynamic Virtual Private Networks Presentation</i> (2000)		
D224	Information Assurance/NAI Labs, <i>Dynamic Virtual Private Networks Presentation v.2</i> (2000)		

Subst. for form 1449/PTO INFORMATION DISCLOSURE STATEMENT BY APPLICANT <i>(Use as many sheets as necessary)</i>		Complete if Known	
		Application Number	13/342,795
		Filing Date	01-03-2012
		First Named Inventor	Victor Larson
		Art Unit	2453
		Examiner Name	Krisna Lim
	Docket Number	77580-155(VRNL-1CP3CNFT5)	
D225	Information Assurance/NAI Labs, Dynamic Virtual Private Networks Presentation v.3 (2000)		
D226	T. Braun et al., <i>Virtual Private Network Architecture</i> , Charging and Accounting Technology for the Internet (August 1, 1999) (VPNA)		
D227	Network Associates Products - <i>PGP Total Network Security Suite, Dynamic Virtual Private Networks</i> (1999)		
D228	Microsoft Corporation, <i>Microsoft Proxy Server 2.0</i> (1997) (Proxy Server 2.0, Microsoft Prior Art VPN Technology)		
D229	David Johnson et. al., <i>A Guide To Microsoft Proxy Server 2.0</i> (1999) (Johnson, Microsoft Prior Art VPN Technology)		
D230	Microsoft Corporation, <i>Setting Server Parameters</i> (1997 (copied from Proxy Server 2.0 CD labeled MSFTVX00157288) (Setting Server Parameters, Microsoft Prior Art VPN Technology)		
D231	Kevin Schuler, <i>Microsoft Proxy Server 2</i> (1998) (Schuler, Microsoft Prior Art VPN Technology)		
D232	Erik Rozell et. al., <i>MCSE Proxy Server 2 Study Guide</i> (1998) (Rozell, Microsoft Prior 15 Art VPN Technology)		
D233	M. Shane Stigler & Mark A Linsenbardt, <i>IIS 4 and Proxy Server 2</i> (1999) (Stigler, Microsoft Prior Art VPN Technology)		
D234	David G. Schaer, <i>MCSE Test Success: Proxy Server 2</i> (1998) (Schaer, Microsoft Prior Art VPN Technology)		
D235	John Savill, <i>The Windows NT and Windows 2000 Answer Book</i> (1999) (Savill, Microsoft Prior Art VPN Technology)		
D236	Network Associates <i>Gauntlet Firewall Global Virtual Private Network User's Guide for Windows NT Version 5.0</i> (1999) (Gauntlet NT GVPN, GVPN)		
D237	Network Associates <i>Gauntlet Firewall For UNIX Global Virtual Private Network User's Guide Version 5.0</i> (1999) (Gauntlet Unix GVPN, GVPN)		
D238	File History for U.S. Application Serial No. 09/653,201, Applicant(s): Whittle Bryan, et al., Filing Date 08/31/2000.		
D239	<i>AutoSOCKS v2. 1</i> , Datasheet, http://web.archive.org/web/19970212013409/www.aventail.com/prod/autoskds.html		
D240	Ran Atkinson, <i>Use of DNS to Distribute Keys</i> , 7 Sept. 1993, http://ops.ietf.org/lists/namedroppers/namedroppers, 1 99x/msg00945.html		
D241	FirstVPN Enterprise Networks, Overview		
D242	Chapter 1: Introduction to Firewall Technology, Administration Guide; 12/19/07, http://www.books24x7.com/book/id_762/viewer_r.asp?bookid=762&chunked=41065062		
D243	The TLS Protocol Version 1.0; January 1999; page 65 of 71.		
D244	Elizabeth D. Zwicky, et al., <i>Building Internet Firewalls</i> , 2nd Ed.		
D245	Virtual Private Networks - Assured Digital Incorporated - ADI 4500; http://web.archive.org/web/19990224050035/www.assured-digital.com/products/prodvpn/adia4500.htm		
D246	Accessware - The Third Wave in Network Security, Conclave from Internet Dynamics; http://web.archive.org/web/11980210013830/interdyn.com/Accessware.html		
D247	Extended System Press Release, Sept. 2, 1997; <i>Extended VPN Uses The Internet to Create Virtual Private Networks</i> , www.extendedsystems.com		
D248	Socks Version 5; Executive Summary; http://web.archive.org/web/199970620031945/www.aventail.com/educate/whitepaper/sockswp.html		
D249	Internet Dynamics First to Ship Integrated Security Solutions for Enterprise Intranets and Extranets; Sept. 15, 1997; http://web.archive.org/web/19980210014150/interdyn.com		
D250	Emails from various individuals to Linux IPsec re: DNS-LDAP Splicing		
D251	Fasbender, A., et al., Variable and Scalable Security: Protection of Location Information in Mobile IP, IEEE VTS, 46th, 1996, 5 pp.		
D252	David Kosiur, "Building and Managing Virtual Private Networks" (1998)		
D253	Request for Inter Partes Reexamination of Patent No. 6,502,135, dated Nov. 25, 2009.		
D254	Request for Inter Partes Reexamination of Patent No. 7,188,180, dated Nov. 25, 2009.		
D255	Yuan Dong Feng, "A novel scheme combining interleaving technique with cipher in Rayleigh fading channels," Proceedings of the International Conference on Communication technology, 2:S47-02-1-S47-02-4 (1998)		

Subst. for form 1449/PTO INFORMATION DISCLOSURE STATEMENT BY APPLICANT <i>(Use as many sheets as necessary)</i>		Complete if Known	
		Application Number	13/342,795
		Filing Date	01-03-2012
		First Named Inventor	Victor Larson
		Art Unit	2453
		Examiner Name	Krisna Lim
		Docket Number	77580-155(VRNL-1CP3CNFT5)
D256	Davies and Price, edited by Tadahiro Uezono, "Network Security", Japan, Nikkei McGraw-Hill, December 5, 1958, First Edition, first copy, p. 102-108		
D257	Davies et al., "An Introduction to Data Security in Teleprocessing and Electronic Funds Transfer," Security for Computer Networks, Second Edition, pp. 98-101 (1989)		
D258	Baumgartner et al, "Differentiated Services: A New Approach for Quality of Service in the Internet," International Conference on High Performance Networking, 255-273 (1998)		
D259	Chapman et al., "Domain Name System (DNS)," 278-296 (1995)		
D260	Davila et al., "Implementation of Virtual Private Networks at the Transport Layer," M. Mambo, Y. Zheng (Eds), Information Security (Second International) Workshop, ISW' 99. Lecture Notes in Computer Science (LNCS), Vol. 1729; 85-102 (1999)		
D261	De Raadt et al., "Cryptography in OpenBSD," 10 pages (1999)		
D262	Eastlake, "Domain Name System Security Extensions," Internet Citation, Retrieved from the Internet: URL:ftp://ftp.inet.no/pub/ietf/internet-drafts/draft-ietf-dnssec-secext2-05.txt (1998)		
D263	Gunter et al., "An Architecture for Managing QoS-Enabled VRNs Over the Internet," Proceedings 24th Conference on Local Computer Networks. LCN' 99 IEEE Comput. Soc Los Alamitos, CA, pages 122-131 (1999)		
D264	Shimizu, "Special Feature: Mastering the Internet with Windows 2000", Internet Magazine, 63:296-307 (2000)		
D265	Stallings, "Cryptography and Network Security," Principals and Practice, 2nd Edition, pages 399-440 (1999)		
D266	Takata, "U.S. Vendors Take Serious Action to Act Against Crackers – A Tracking Tool and a Highly Safe DNS Software are Released", Nikkei Communications, 257:87(1997)		
D267	Wells, Email (Lancasterb1be@mail.msn.com), Subject: "Security Icon," (1998)		
D268	Microsoft Corporation's Fifth Amended Invalidity Contentions dated September 18, 2009, VirnetX Inc. and Science Applications International Corp. v. Microsoft Corporation and invalidity claim charts for U.S. Patent Nos. 7,188,180 and 6,839,759		
D269	The IPSEC Protocol as described in Atkinson, et al., "Security Architecture for the Internet Protocol," Network Working Group, RFC 2401 (November 1998) ("RFC 2401"); http://web.archive.org/web/19991007070353/http://www.imib.med.tu-dresden.de/imib/Internet/Literatur/ipsec-docu_eng.html		
D270	S. Kent and R. Atkinson, "IP Authentication Header," RFC 2402 (November 1998); http://web.archive.org/web/19991007070353/http://www.imib.med.tu-dresden.de/imib/Internet/Literatur/ipsec-docu_eng.html		
D271	C. Madson and R. Glenn, "The Use of HMAC-MD5-96 within ESP and AH," RFC 2403 (November 1998); http://web.archive.org/web/19991007070353/http://www.imib.med.tu-dresden.de/imib/Internet/Literatur/ipsec-docu_eng.html		
D272	C. Madson and R. Glenn, "The Use HMAC-SHA-1-96 within ESP and AH," RFC 2404 (November 1998); http://web.archive.org/web/19991007070353/http://www.imib.med.tu-dresden.de/imib/Internet/Literatur/ipsec-docu_eng.html		
D273	C. Madson and N. Doraswamy, "The ESP DES-CBC Cipher Algorithm With Explicit IV", RFC 2405 (November 1998); http://web.archive.org/web/19991007070353/http://www.imib.med.tu-dresden.de/imib/Internet/Literatur/ipsec-docu_eng.html		

Subst. for form 1449/PTO INFORMATION DISCLOSURE STATEMENT BY APPLICANT <i>(Use as many sheets as necessary)</i>		Complete if Known	
		Application Number	13/342,795
		Filing Date	01-03-2012
		First Named Inventor	Victor Larson
		Art Unit	2453
		Examiner Name	Krisna Lim
		Docket Number	77580-155(VR NK-1CP3CNFT5)
D274	S. Kent and R. Atkinson, "IP Encapsulating Security Payload (ESP)," RFC 2406 (November 1998); http://web.archive.org/web/19991007070353/http://www.imib.med.tu-dresden.de/imib/Internet/Literatur/ipsec-docu_eng.html		
D275	Derrell Piper, "The Internet IP Security Domain of Interpretation for ISAKMP," RFC 2407 (November 1998); http://web.archive.org/web/19991007070353/http://www.imib.med.tu-dresden.de/imib/Internet/Literatur/ipsec-docu_eng.html		
D276	Douglas Maughan, et al, "Internet Security Association and Key Management Protocol (ISAKMP)," RFC 2408 (November 1998); http://web.archive.org/web/19991007070353/http://www.imib.med.tu-dresden.de/imib/Internet/Literatur/ipsec-docu_eng.html		
D277	D. Harkins and D. Carrell, "The Internet Key Exchange (IKE)," RFC 2409 (November 1998); http://web.archive.org/web/19991007070353/http://www.imib.med.tu-dresden.de/imib/Internet/Literatur/ipsec-docu_eng.html		
D278	R. Glenn and S. Kent, "The NULL Encryption Algorithm and Its Use With IPsec." RFC 2410 (November 1998); http://web.archive.org/web/19991007070353/http://www.imib.med.tu-dresden.de/imib/Internet/Literatur/ipsec-docu_eng.html		
D279	R. Thayer, et al., "IP Security Document Roadmap," RFC 2411 (November 1998); http://web.archive.org/web/19991007070353/http://www.imib.med.tu-dresden.de/imib/Internet/Literatur/ipsec-docu_eng.html		
D280	Hilarie K. Orman, "The OAKLEY Key Determination Protocol," RFC 2412 (November 1998) in combination with J.M. Galvin, "Public Key Distribution with Secure DNS," Proceedings of the Sixth USENIX UNIX Security Symposium, San Jose California (July 1996) ("Galvin")		
D281	DNS-related correspondence dated September 7, 1993 to September 20, 1993. (Pre KX, KX Records)		
D282	Aventail Corp., "AutoSOCKS v. 2.1 Datasheet," available at http://www.archive.org/web/19970212013409/www.aventail.com/prod/autosk2ds.html (1997). (AutoSOCKS, Aventail)		
D283	Aventail Corp., "Socks Version 5," Aventail Whitepaper, available at http://web.archive.org/web/19970620030312/www.aventail.com/educate/whitepaper/soc_kswp.html (1997). (Socks, Aventail)		
D284	Goncalves, et al. <i>Check Point FireWall -1 Administration Guide</i> , McGraw-Hill Companies (2000). (Goncalves, Checkpoint FW)		
D285	Assured Digital Products. (Assured Digital)		
D286	F-Secure, <i>F-Secure Evaluation Kit</i> (May 1999) (FSECURE 00000003) (Evaluation Kit 3)		
D287	F-Secure, <i>F-Secure Evaluation Kit</i> (Sept. 1998) (FSECURE 00000009) (Evaluation Kit 9)		
D288	IRE, Inc., <i>SafeNet/Soft-PK Version 4</i> (March 28, 2000) (Soft-PK Version 4)		
D289	IRE/SafeNet Inc., <i>VPN Technologies Overview</i> (March 28, 2000) (Safenet VPN Overview)		
D290	IRE, Inc., <i>SafeNet/VPN Policy Manager Quick Start Guide Version 1</i> (1999) (SafeNet VPN Policy Manager)		
D291	Information Assurance/NAI Labs, <i>Dynamic Virtual Private Networks Presentation v.3</i> (2000)		
D292	PCT International Search Report for related PCT Application No.: PCT/US01/13261, 8 pages .		
D293	PCT International Search Report for related PCT Application No.: PCT/US99/25323, 3 pages .		
D294	PCT International Search Report for related PCT Application No.: PCT/US99/25325, 3 pages .		
D295	Deposition Transcript for Gary Tomlinson dated February 27, 2009		
D296	Trial Transcript, VirnetX vs. Microsoft Corporation dated March 8, 2010, 8:45 AM		
D297	Trial Transcript, VirnetX vs. Microsoft Corporation dated March 8, 2010, 1:30 PM		
D298	Trial Transcript, VirnetX vs. Microsoft Corporation dated March 9, 2010, 9:00 AM		

Subst. for form 1449/PTO INFORMATION DISCLOSURE STATEMENT BY APPLICANT (Use as many sheets as necessary)			Complete if Known	
			Application Number	13/342,795
			Filing Date	01-03-2012
			First Named Inventor	Victor Larson
			Art Unit	2453
			Examiner Name	Krisna Lim
			Docket Number	77580-155(VR NK-1CP3CNFT5)
D299	Trial Transcript, VirnetX vs. Microsoft Corporation dated March 9, 2010, 1:30 PM			
D300	Trial Transcript, VirnetX vs. Microsoft Corporation dated March 10, 2010, 9:00 AM			
D301	Trial Transcript, VirnetX vs. Microsoft Corporation dated March 10, 2010, 1:00 PM			
D302	Trial Transcript, VirnetX vs. Microsoft Corporation dated March 11, 2010, 9:00 AM			
D303	Trial Transcript, VirnetX vs. Microsoft Corporation dated March 11, 2010, 1:30 PM			
D304	Trial Transcript, VirnetX vs. Microsoft Corporation dated March 12, 2010, 9:00 AM			
D305	Trial Transcript, VirnetX vs. Microsoft Corporation dated March 12, 2010, 1:15 PM			
D306	Trial Transcript, VirnetX vs. Microsoft Corporation dated March 15, 2010, 9:00 AM			
D307	Trial Transcript, VirnetX vs. Microsoft Corporation dated March 15, 2010, 12:35 PM			
D308	European Search Report dated January 24, 2011 from corresponding European Application Number 10011949.4			
D309	European Search Report dated March 17, 2011 from corresponding European Application Number 10184502.2			
D310	Hollenbeck et al., "Registry Registrar Protocol (RRP) Version 1.1.0; Internet Engineering Task Force, 34 pages (1999)			
D311	Tannenbaum, "Computer Networks," pages 202-219 (1996)			
D312	Defendants' Preliminary Joint Invalidation Contentions dated July 1, 2011			
D313	Appendix B: DNS References to Defendants' Preliminary Joint Invalidation Contentions dated July 1, 2011			
D314	Appendix A to Defendants' Preliminary Joint Invalidation Contentions dated July 1, 2011			
D315	Exhibit 1, IETF RFC 2065: Domain Name System Security Extensions; Published January 1997 ¹ vs. Claims of the '211 Patent ²			
D316	Exhibit 2, IETF RFC 2065: Domain Name System Security Extensions; Published January 1997 ¹ vs. Claims of the '504 Patent ²			
D317	Exhibit 3, RFC 2543 ¹ vs. Claims of the '135 Patent ²			
D318	Exhibit 4, RFC 2543 ¹ vs. Claims of the '211 Patent ²			
D319	Exhibit 5, RFC 2543 ¹ vs. Claims of the '504 Patent ²			
D320	Exhibit 6, SIP Draft v.2 ¹ vs. Claims of the '135 Patent ²			
D321	Exhibit 7, SIP Draft v.2 ¹ vs. Claims of the '211 Patent ²			

Subst. for form 1449/PTO INFORMATION DISCLOSURE STATEMENT BY APPLICANT <i>(Use as many sheets as necessary)</i>			Complete if Known	
			Application Number	13/342,795
			Filing Date	01-03-2012
			First Named Inventor	Victor Larson
			Art Unit	2453
			Examiner Name	Krisna Lim
			Docket Number	77580-155(VR NK-1CP3CNFT5)
D322	Exhibit 8, SIP Draft v.2 ¹ vs. Claims of the '504 Patent ²			
D323	Exhibit 9, H.323 ¹ vs. Claims of the '135 Patent ²			
D324	Exhibit 10, H.323 ¹ vs. Claims of the '211 Patent ²			
D325	Exhibit 11, H.323 ¹ vs. Claims of the '504 Patent ²			
D326	Exhibit 12, SSL 3.0 ¹ vs. Claims of the '135 Patent ² .			
D327	Exhibit 13, SSL 3.0 ¹ vs. Claims of the '211 Patent ²			
D328	Exhibit 14, SSL 3.0 ¹ vs. Claims of the '504 Patent ²			
D329	Exhibit 15, RFC 2487 ¹ vs. Claims of the '135 Patent ²			
D330	Exhibit 16, RFC 2487 ¹ vs. Claims of the '211 Patent ²			
D331	Exhibit 17, RFC 2487 ¹ vs. Claims of the '504 Patent ²			
D332	Exhibit 18, RFC 2595 ¹ vs. Claims of the '135 Patent ²			
D333	Exhibit 19, RFC 2595 ¹ vs. Claims of the '211 Patent ²			
D334	Exhibit 20, RFC 2595 ¹ vs. Claims of the '504 Patent ²			
D335	Exhibit 21, iPass ¹ vs. Claims of the '135 Patent ²			
D336	Exhibit 22, iPASS ¹ vs. Claims of the '211 Patent ²			
D337	Exhibit 23, iPASS ¹ vs. Claims of the '504 Patent ²			
D338	Exhibit 24, "US '034" ¹ vs. Claims of the '135 Patent ²			
D339	Exhibit 25, US Patent No. 6,453,034 ("US '034") ¹ vs. Claims of the '211 Patent ²			
D340	Exhibit 26, US Patent No. 6,453,034 ("US '034") ¹ vs. Claims of the '504 Patent ²			
D341	Exhibit 27, US '287 ¹ vs. Claims of the '135 Patent ²			
D342	Exhibit 28, US '287 ¹ vs. Claims of the '211 Patent ²			
D343	Exhibit 29, US '287 ¹ vs. Claims of the '504 Patent ²			
D344	Exhibit 30, Overview of Access VPNs ¹ vs. Claims of the '135 Patent ²			
D345	Exhibit 31, Overview of Access VPNs ¹ vs. Claims of the '211 Patent ²			
D346	Exhibit 32, Overview of Access VPNs ¹ vs. Claims of the '504 Patent ²			
D347	Exhibit 34, RFC 1928 ¹ vs. Claims of the '135 Patent ²			

Subst. for form 1449/PTO INFORMATION DISCLOSURE STATEMENT BY APPLICANT <i>(Use as many sheets as necessary)</i>			Complete if Known	
			Application Number	13/342,795
			Filing Date	01-03-2012
			First Named Inventor	Victor Larson
			Art Unit	2453
			Examiner Name	Krisna Lim
			Docket Number	77580-155(VR NK-1CP3CNFT5)
D348	Exhibit 35, RFC 1928 ¹ vs. Claims of the '211 Patent ²			
D349	Exhibit 36, RFC 1928 ¹ vs. Claims of the '504 Patent ²			
D350	Exhibit 37, RFC 2661 ¹ vs. Claims of the '135 Patent ²			
D351	Exhibit 38, RFC 2661 ¹ vs. Claims of the '211 Patent ²			
D352	Exhibit 39, RFC 2661 ¹ vs. Claims of the '504 Patent ²			
D353	Exhibit 40, SecureConnect ¹ vs. Claims of the '135 Patent ²			
D354	Exhibit 41, SecureConnect ¹ vs. Claims of the '211 Patent ²			
D355	Exhibit 42, SecureConnect ¹ vs. Claims of the '504 Patent ²			
D356	Exhibit 43, SFS-HTTP ¹ vs. Claims of the '135 Patent ²			
D357	Exhibit 44, SFS-HTTP ¹ vs. Claims of the '211 Patent ²			
D358	Exhibit 45, SFS-HTTP ¹ vs. Claims of the '504 Patent ²			
D359	Exhibit 46, US '883 ¹ vs. Claims of the '135 Patent ²			
D360	Exhibit 47, US '883 ¹ vs. Claims of the '211 Patent ²			
D361	Exhibit 48, US '883 ¹ vs. Claims of the '504 Patent ²			
D362	Exhibit 49, US '132 ¹ vs. Claims of the '135 Patent ²			
D363	Exhibit 50, US '132 ¹ vs. Claims of the '211 Patent ²			
D364	Exhibit 51, US '132 ¹ vs. Claims of the '504 Patent ²			
D365	Exhibit 52, US '213 ¹ vs. Claims of the '135 Patent ²			
D366	Exhibit 53, US '213 ¹ vs. Claims of the '211 Patent ²			
D367	Exhibit 54, US '213 ¹ vs. Claims of the '504 Patent ²			
D368	Exhibit 55, B&M VPNs ¹ vs. Claims of the '135 Patent ²			
D369	Exhibit 56, B&M VPNs ¹ vs. Claims of the '211 Patent ²			
D370	Exhibit 57, B&M VPNs ¹ vs. Claims of the '504 Patent ²			
D371	Exhibit 58, BorderManager ¹ vs. Claims of the '135 Patent ²			
D372	Exhibit 59, BorderManager ¹ vs. Claims of the '211 Patent ²			
D373	Exhibit 60, BorderManager ¹ vs. Claims of the '504 Patent ²			

Subst. for form 1449/PTO INFORMATION DISCLOSURE STATEMENT BY APPLICANT <i>(Use as many sheets as necessary)</i>			Complete if Known	
			Application Number	13/342,795
			Filing Date	01-03-2012
			First Named Inventor	Victor Larson
			Art Unit	2453
			Examiner Name	Krisna Lim
			Docket Number	77580-155(VRNK-1CP3CNFT5)
D374	Exhibit 61, Prestige 128 Plus ¹ vs. Claims of the '135 Patent ²			
D375	Exhibit 62, Prestige 128 Plus ¹ vs. Claims of the '211 Patent ²			
D376	Exhibit 63, Prestige 128 Plus ¹ vs. Claims of the '504 Patent ²			
D377	Exhibit 64, RFC 2401 ¹ vs. Claims of the '135 Patent ²			
D378	Exhibit 65, RFC 2401 ¹ vs. Claims of the '211 Patent ²			
D379	Exhibit 66, RFC 2401 ¹ vs. Claims of the '504 Patent ²			
D380	Exhibit 67, RFC 2486 ¹ vs. Claims of the '135 Patent ²			
D381	Exhibit 68, RFC 2486 ¹ vs. Claims of the '211 Patent ²			
D382	Exhibit 69, RFC 2486 ¹ vs. Claims of the '504 Patent ²			
D383	Exhibit 70, Understanding IPsec ¹ vs. Claims of the '135 Patent ²			
D384	Exhibit 71, Understanding IPsec ¹ vs. Claims of the '211 Patent ²			
D385	Exhibit 72, Understanding IPsec ¹ vs. Claims of the '504 Patent ²			
D386	Exhibit 73, US '820 ¹ vs. Claims of the '135 Patent ²			
D387	Exhibit 74, US '820 ¹ vs. Claims of the '211 Patent ²			
D388	Exhibit 75, US '820 ¹ vs. Claims of the '504 Patent ²			
D389	Exhibit 76, US '019 ¹ vs. Claims of the '211 Patent ²			
D390	Exhibit 77, US '019 ¹ vs. Claims of the '504 Patent ²			
D391	Exhibit 78, US '049 ¹ vs. Claims of the '135 Patent ²			
D392	Exhibit 79, US '049 ¹ vs. Claims of the '211 Patent ²			
D393	Exhibit 80, US '049 ¹ vs. Claims of the '504 Patent ²			
D394	Exhibit 81, US '748 ¹ vs. Claims of the '135 Patent ²			
D395	Exhibit 82, US '261 ¹ vs. Claims of the '135 Patent ²			
D396	Exhibit 83, US '261 ¹ vs. Claims of the '211 Patent ²			
D397	Exhibit 84, US '261 ¹ vs. Claims of the '504 Patent ²			
D398	Exhibit 85, US '900 ¹ vs. Claims of the '135 Patent ²			
D399	Exhibit 86, US '900 ¹ vs. Claims of the '211 Patent ²			

Subst. for form 1449/PTO			Complete if Known	
INFORMATION DISCLOSURE STATEMENT BY APPLICANT <i>(Use as many sheets as necessary)</i>			Application Number	13/342,795
			Filing Date	01-03-2012
			First Named Inventor	Victor Larson
			Art Unit	2453
			Examiner Name	Krisna Lim
			Docket Number	77580-155(VRNL-1CP3CNFT5)
D400	Exhibit 87, US '900 ¹ vs. Claims of the '504 Patent ²			
D401	Exhibit 88, US '671 ¹ vs. Claims of the '135 Patent ²			
D402	Exhibit 89, US '671 ¹ vs. Claims of the '211 Patent ²			
D403	Exhibit 90, US '671 ¹ vs. Claims of the '504 Patent ²			
D404	Exhibit 91, JP '704 ¹ vs. Claims of the '135 Patent ²			
D405	Exhibit 92, JP '704 ¹ vs. Claims of the '211 Patent ²			
D406	Exhibit 93, JP '704 ¹ vs. Claims of the '504 Patent ²			
D407	Exhibit 94, GB '841 ¹ vs. Claims of the '135 Patent ²			
D408	Exhibit 95, GB '841 ¹ vs. Claims of the '211 Patent ²			
D409	Exhibit 96, GB '841 ¹ vs. Claims of the '504 Patent ²			
D410	Exhibit 97, US '318 ¹ vs. Claims of the '135 Patent ²			
D411	Exhibit 98, US '318 ¹ vs. Claims of the '211 Patent ²			
D412	Exhibit 99, US '318 ¹ vs. Claims of the '504 Patent ²			
D413	Exhibit 100, VPN/VLAN ¹ vs. Claims of the '135 Patent ²			
D414	Exhibit 101, Nikkei ¹ vs. Claims of the '135 Patent ²			
D415	Exhibit 102, NIKKEI ¹ vs. Claims of the '211 Patent ²			
D416	Exhibit 103, NIKKEI ¹ vs. Claims of the '504 Patent ²			
D417	Exhibit 104, Special Anthology ¹ vs. Claims of the '135 Patent ²			
D418	Exhibit 105, Omron ¹ vs. Claims of the '135 Patent ²			
D419	Exhibit 106, Gauntlet System ¹ vs. Claims of the '135 Patent ²			
D420	Exhibit 107, Gauntlet System ¹ vs. Claims of the '151 Patent ²			
D421	Exhibit 108, Gauntlet System ¹ vs. Claims of the '180 Patent ²			
D422	Exhibit 109, Gauntlet System ¹ vs. Claims of the '211 Patent ²			
D423	Exhibit 110, Gauntlet System ¹ vs. Claims of the '504 Patent ²			
D424	Exhibit 111, Gauntlet System ¹ vs. Claims of the '759 Patent ²			
D425	Exhibit 112, IntraPort System ¹ vs. Claims of the '135 Patent ²			

Subst. for form 1449/PTO			Complete if Known	
			Application Number	13/342,795
INFORMATION DISCLOSURE STATEMENT BY APPLICANT <i>(Use as many sheets as necessary)</i>			Filing Date	01-03-2012
			First Named Inventor	Victor Larson
			Art Unit	2453
			Examiner Name	Krisna Lim
			Docket Number	77580-155(VR NK-1CP3CNFT5)
D426	Exhibit 113, IntraPort System ¹ vs. Claims of the '151 Patent ²			
D427	Exhibit 114, IntraPort System ¹ vs. Claims of the '180 Patent ²			
D428	Exhibit 115, IntraPort System ¹ vs. Claims of the '211 Patent ²			
D429	Exhibit 116, IntraPort System ¹ vs. Claims of the '504 Patent ²			
D430	Exhibit 117, IntraPort System ¹ vs. Claims of the '759 Patent ²			
D431	Exhibit 118, Altiga VPN System ¹ vs. Claims of the '135 Patent ²			
D432	Exhibit 119, Altiga VPN System ¹ vs. Claims of the '151 Patent ²			
D433	Exhibit 120, Altiga VPN System ¹ vs. Claims of the '180 Patent ²			
D434	Exhibit 121, Altiga VPN System ¹ vs. Claims of the '211 Patent ²			
D435	Exhibit 122, Altiga VPN System ¹ vs. Claims of the '504 Patent ²			
D436	Exhibit 123, Altiga VPN System ¹ vs. Claims of the '759 Patent ²			
D437	Exhibit 124, Kiuchi ¹ vs. Claims of the '135 Patent ²			
D438	Exhibit 125, Kiuchi ¹ vs. Claims of the '151 Patent ²			
D439	Exhibit 126, Kiuchi ¹ vs. Claims of the '180 Patent ²			
D440	Exhibit 127, Kiuchi ¹ vs. Claims of the '211 Patent ²			
D441	Exhibit 128, Kiuchi ¹ vs. Claims of the '504 Patent ²			
D442	Exhibit 129, Kiuchi ¹ vs. Claims of the '759 Patent ²			
D443	Exhibit 130, Overview of Access VPNs and Tunneling Technologies ("Overview") ¹ vs. Claims of the '135 Patent ²			
D444	Exhibit 131, Overview of Access VPNs and Tunneling Technologies ("Overview") ¹ vs. Claims of the '151 Patent ²			
D445	Exhibit 132, Overview of Access VPNs and Tunneling Technologies ("Overview") ¹ vs. Claims of the '180 Patent ²			
D446	Exhibit 133, Overview of Access VPNs and Tunneling Technologies ("Overview") ¹ vs. Claims of the '211 Patent ²			
D447	Exhibit 134, Overview of Access VPNs and Tunneling Technologies ("Overview") ¹ vs. Claims of the '504 Patent ²			
D448	Exhibit 135, Overview ¹ vs. Claims of the '759 Patent ²			
D449	Exhibit 136, RFC 2401 ¹ vs. Claims of the '759 Patent ²			