



(12) **United States Patent**
Parker et al.

(10) **Patent No.:** **US 6,886,956 B2**
(45) **Date of Patent:** ***May 3, 2005**

(54) **LIGHT EMITTING PANEL ASSEMBLIES FOR USE IN AUTOMOTIVE APPLICATIONS AND THE LIKE**

(56) **References Cited**

(75) Inventors: **Jeffery R. Parker**, Richfield, OH (US);
Mark D. Miller, Parma, OH (US);
Thomas A. Hough, Lakewood, OH (US)

2,945,313 A 7/1960 Hardesty
3,043,947 A 7/1962 Albinger, Jr.
3,070,913 A 1/1963 Miller

U.S. PATENT DOCUMENTS

(Continued)

(73) Assignee: **Solid State Opto Limited (VG)**

FOREIGN PATENT DOCUMENTS

(*) Notice: Subject to any disclaimer, the term of this patent is extended or adjusted under 35 U.S.C. 154(b) by 0 days.

AU A-78486/91 12/1991
EP 0 453 092 A1 10/1991
GB 523706 3/1939
GB 2285518 A 7/1995
WO WO 92/05535 4/1992
WO WO 96/17207 6/1996
WO WO 96/27757 9/1996

This patent is subject to a terminal disclaimer.

(21) Appl. No.: **10/298,367**

(22) Filed: **Nov. 18, 2002**

(65) **Prior Publication Data**

US 2003/0095398 A1 May 22, 2003

Primary Examiner—Fayez G. Assaf

(74) *Attorney, Agent, or Firm*—Renner, Otto, Boisselle & Sklar, LLP

Related U.S. Application Data

(60) Continuation of application No. 10/005,090, filed on Dec. 5, 2001, now Pat. No. 6,508,563, which is a continuation of application No. 09/703,088, filed on Oct. 31, 2000, now Pat. No. 6,367,940, which is a continuation of application No. 09/167,949, filed on Oct. 7, 1998, now Pat. No. 6,158,867, which is a division of application No. 08/585,062, filed on Jan. 16, 1996, now Pat. No. 5,895,115.

(51) **Int. Cl.**⁷ **G01D 11/28**

(52) **U.S. Cl.** **362/29; 362/85; 362/26; 362/30; 362/487; 362/543**

(58) **Field of Search** **362/278, 503, 362/540, 85, 511, 543, 545, 487, 459, 26, 27, 29, 30; 40/556**

(57) **ABSTRACT**

Light emitting panel assemblies include in one form of the invention a light emitting panel member made of a transparent resiliently deformable elastomeric material that absorbs impact without breakage for use in automotive lighting applications of various types. In another form of the invention, a rigid light emitting panel member may be used with dome switches for switch area lighting or to backlight control buttons/key pads. Also, a rigid light emitting panel member may be used as a structural member, and two or more such light emitting panel members may be stacked together and used to light an instrument panel or the like.

33 Claims, 5 Drawing Sheets

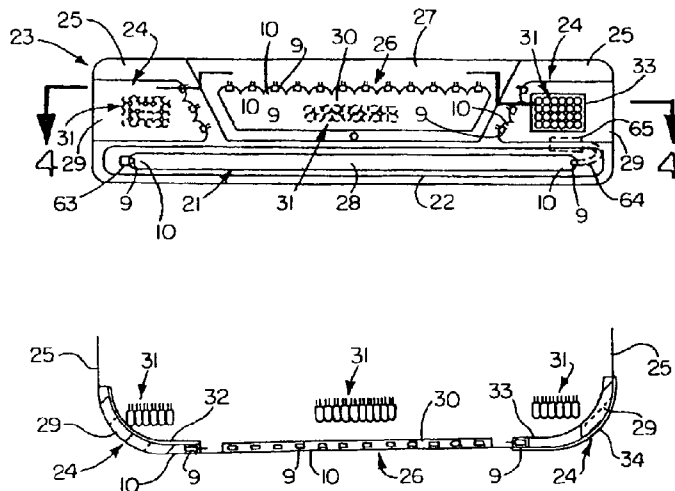

U.S. PATENT DOCUMENTS

3,328,570 A	6/1967	Balchunas	5,207,493 A	5/1993	Murase et al.
3,543,014 A	11/1970	Bustad	5,262,928 A	11/1993	Kashima et al.
3,571,585 A	3/1971	Schermerhorn	5,283,673 A	2/1994	Murase et al.
3,752,974 A	8/1973	Baker et al.	5,303,322 A	4/1994	Winston et al.
3,761,703 A	9/1973	Mund et al.	5,307,244 A	4/1994	Gaudette
3,892,959 A	7/1975	Pulles	5,339,179 A	8/1994	Rudisill et al.
3,958,113 A	5/1976	Termohlen	5,349,503 A	9/1994	Blonder et al.
4,043,636 A	8/1977	Eberhardt et al.	5,375,043 A	12/1994	Tokunaga
4,118,111 A	10/1978	Laesser	5,377,084 A	12/1994	Kojima et al.
4,177,501 A	12/1979	Karlin	5,390,085 A	2/1995	Mari-Roca et al.
4,183,628 A	1/1980	Laesser	5,394,308 A	2/1995	Watanabe et al.
4,257,084 A	3/1981	Reynolds	5,396,350 A	3/1995	Beeson et al.
4,282,560 A	8/1981	Kringel et al.	5,442,523 A	8/1995	Kashima et al.
4,290,093 A	9/1981	Thompson et al.	5,467,208 A	11/1995	Kokawa et al.
4,446,508 A	5/1984	Kinzie	5,467,417 A	11/1995	Nakamura et al.
4,542,449 A	9/1985	Whitehead	5,485,291 A	1/1996	Qiao et al.
4,573,766 A	3/1986	Bournay, Jr. et al.	5,506,929 A	4/1996	Tai et al.
4,630,895 A	12/1986	Abdala, Jr. et al.	5,521,342 A	5/1996	Barley et al.
4,638,131 A	1/1987	Kidd et al.	5,576,078 A	11/1996	Schatz
4,714,983 A	12/1987	Lang	5,579,134 A	11/1996	Lengyel
4,729,185 A	3/1988	Baba	5,598,280 A	1/1997	Nishio et al.
4,733,335 A *	3/1988	Serizawa et al. 362/503	5,598,281 A	1/1997	Zimmerman et al.
4,751,615 A	6/1988	Abrams	5,600,462 A	2/1997	Suzuki et al.
4,763,984 A	8/1988	Awai et al.	5,613,751 A *	3/1997	Parker et al. 362/31
4,765,701 A	8/1988	Cheslak	5,618,095 A	4/1997	Kashima et al.
4,906,070 A	3/1990	Cobb, Jr.	5,664,862 A	9/1997	Redmond et al.
4,974,122 A	11/1990	Shaw	5,671,994 A	9/1997	Tai et al.
4,975,808 A	12/1990	Bond et al.	5,711,592 A	1/1998	Hotta
4,978,952 A	12/1990	Irwin	5,719,649 A	2/1998	Shono et al.
4,989,956 A	2/1991	Wu et al.	5,771,328 A	6/1998	Wortman et al.
5,005,108 A	4/1991	Pristash et al.	5,775,791 A	7/1998	Yoshikawa et al.
5,027,258 A	6/1991	Schoniger et al.	5,779,338 A	7/1998	Ishikawa et al.
5,056,892 A	10/1991	Cobb, Jr.	5,808,784 A	9/1998	Ando et al.
5,070,431 A	12/1991	Kitazawa et al.	5,851,062 A	12/1998	Shinohara et al.
5,093,765 A	3/1992	Kashima et al.	5,961,198 A	10/1999	Hira et al.
5,128,842 A	7/1992	Kenmochi	5,971,559 A	10/1999	Ishikawa et al.
5,134,549 A	7/1992	Yokoyama	6,091,547 A	7/2000	Gardiner et al.
5,136,483 A	8/1992	Schoniger et al.			

* cited by examiner

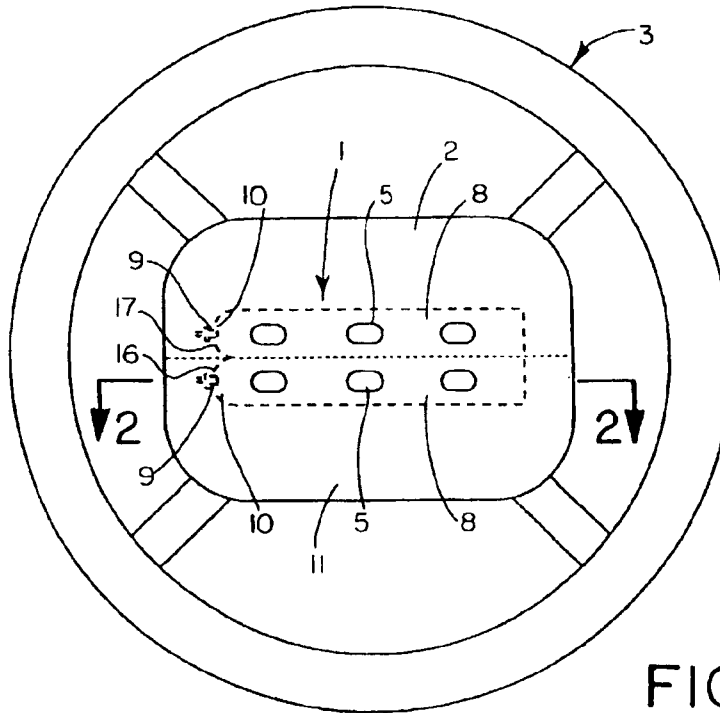

FIG. 1

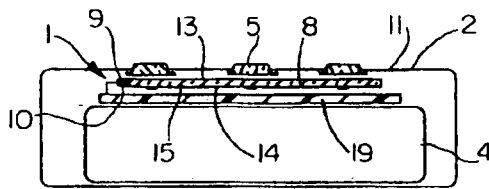

FIG. 2

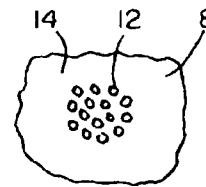

FIG. 2A

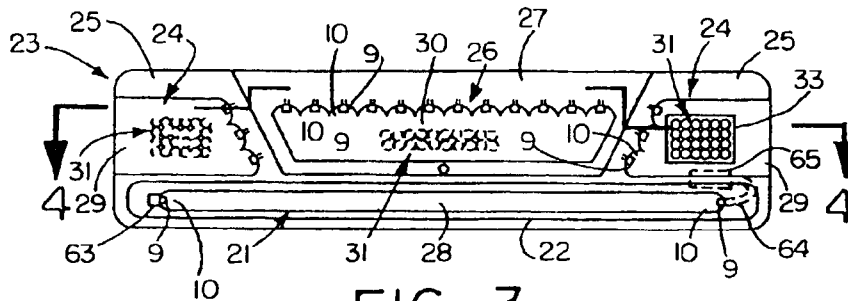
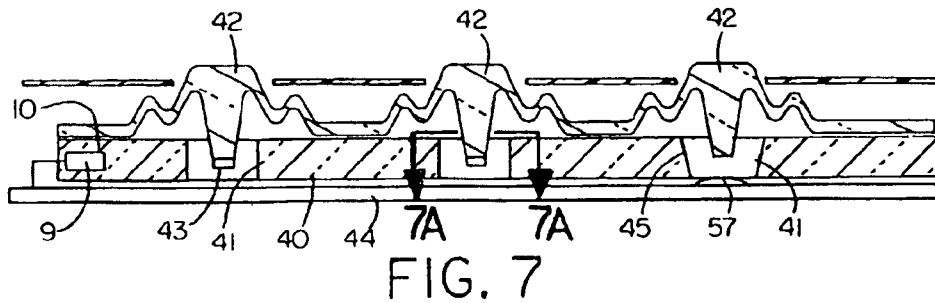
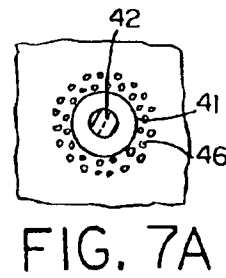
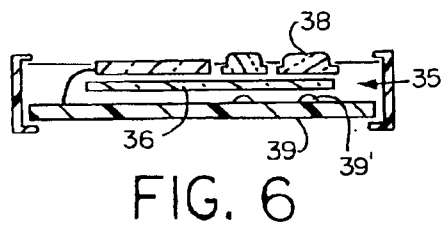
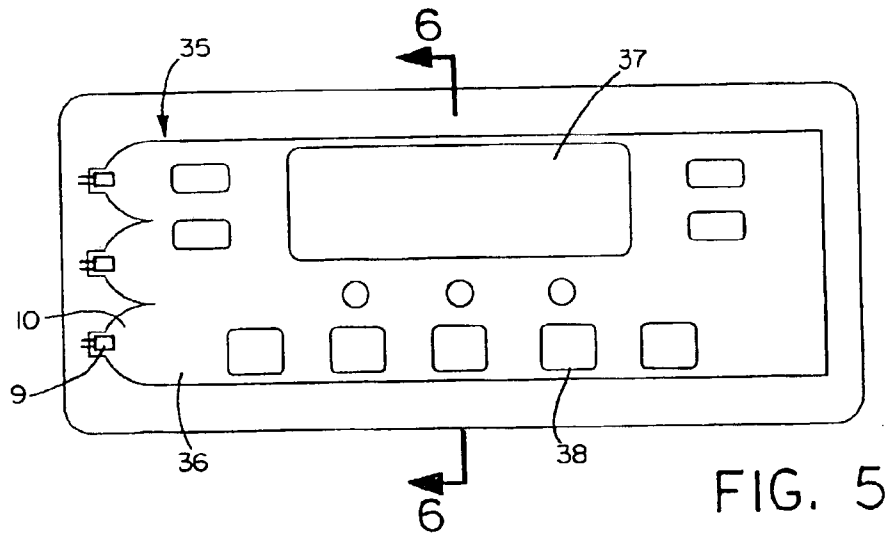
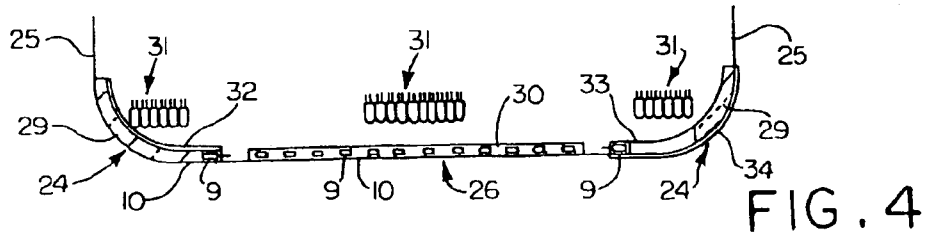
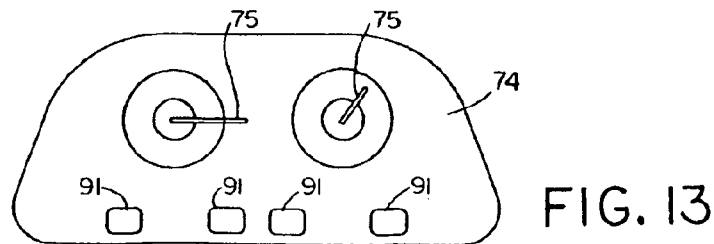
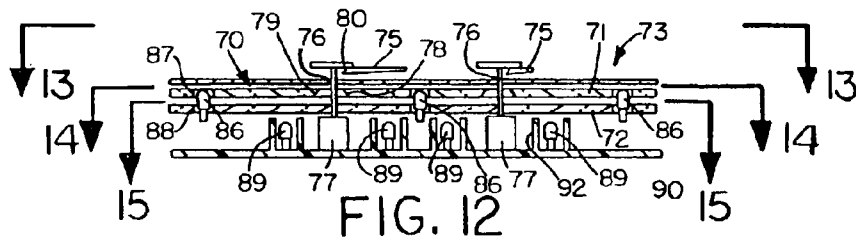
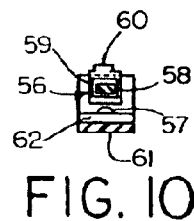
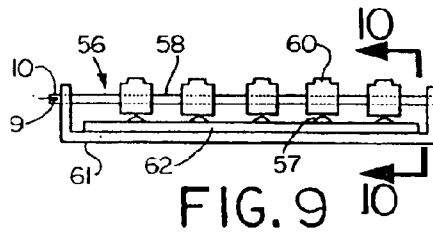
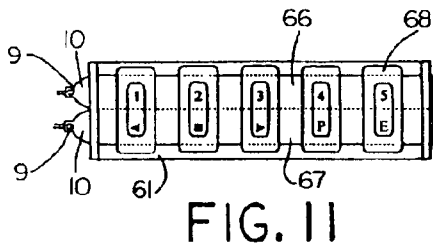
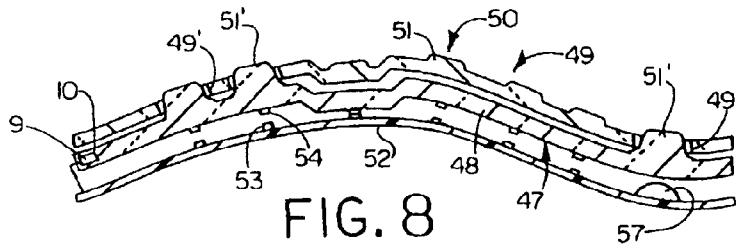

FIG. 3





Explore Litigation Insights

Docket Alarm provides insights to develop a more informed litigation strategy and the peace of mind of knowing you're on top of things.

Real-Time Litigation Alerts



Keep your litigation team up-to-date with **real-time alerts** and advanced team management tools built for the enterprise, all while greatly reducing PACER spend.

Our comprehensive service means we can handle Federal, State, and Administrative courts across the country.

Advanced Docket Research



With over 230 million records, Docket Alarm's cloud-native docket research platform finds what other services can't. Coverage includes Federal, State, plus PTAB, TTAB, ITC and NLRB decisions, all in one place.

Identify arguments that have been successful in the past with full text, pinpoint searching. Link to case law cited within any court document via Fastcase.

Analytics At Your Fingertips



Learn what happened the last time a particular judge, opposing counsel or company faced cases similar to yours.

Advanced out-of-the-box PTAB and TTAB analytics are always at your fingertips.

API

Docket Alarm offers a powerful API (application programming interface) to developers that want to integrate case filings into their apps.

LAW FIRMS

Build custom dashboards for your attorneys and clients with live data direct from the court.

Automate many repetitive legal tasks like conflict checks, document management, and marketing.

FINANCIAL INSTITUTIONS

Litigation and bankruptcy checks for companies and debtors.

E-DISCOVERY AND LEGAL VENDORS

Sync your system to PACER to automate legal marketing.