



US005467417A

United States Patent [19]

[11] Patent Number: **5,467,417**

Nakamura et al.

[45] Date of Patent: **Nov. 14, 1995**

[54] **PRISM PLATE FOR EFFICIENTLY EMITTING LIGHT FLUX WITHIN A PREDETERMINED RANGE, AND LIQUID CRYSTAL INDICATOR AND INDICATOR ILLUMINATION METHOD USING THE SAME**

5,211,463	5/1993	Kalmanash	362/26
5,220,377	6/1993	Suzuki et al.	355/27
5,271,077	12/1993	Brockman et al.	385/31
5,337,381	8/1994	Biswas et al.	385/36
5,339,382	8/1994	Whitehead	385/146
5,353,133	10/1994	Bernkopf	359/41
5,363,458	11/1994	Pan et al.	385/31

[75] Inventors: **Shigeru Nakamura**, Tachikawa; **Akira Arimoto**, Kodaira; **Kenkichi Suzuki**, **Katsuhiko Shibata**, both of Mobara, all of Japan

Primary Examiner—Brian Healy
Attorney, Agent, or Firm—Evenson, McKeown, Edwards & Lenahan

[73] Assignee: **Hitachi, Ltd.**, Japan

[21] Appl. No.: **117,789**

[57] ABSTRACT

[22] Filed: **Sep. 8, 1993**

An information indicator suitable for information processors such as personal computers, word processors and the like includes a light source, a scattering plate which scatters light from the light source, an indicator plate irradiated with scattered light from the scattering plate, and a prism plate operatively arranged with respect to the scattering plate and the indicator plate and having a prism-like protuberance structure formed at a side thereof. The prism plate is so disposed that the prism-like protuberance structure faces the scattering plate, and the angle 2θ constituting the prism-like protuberance structure is defined by the formula, $2\theta > \frac{2}{3} \times (\frac{\pi}{2} + 2 \times \arcsin(n/n'))$, in this inequality, n is the refractive index of said prism plate medium, and n' is the refractive index of a material in which the prism plate is arranged.

[30] Foreign Application Priority Data

Sep. 16, 1992 [JP] Japan 4-246178

[51] Int. Cl.⁶ **G02B 6/34**; F21V 9/04

[52] U.S. Cl. **385/36**; 385/37; 385/147; 385/901; 362/26; 362/31; 362/32; 362/302; 362/309; 359/48; 359/49; 359/40; 359/69; 359/70; 359/834

[58] Field of Search 385/901, 902, 385/146, 147, 133, 31, 36, 37; 362/31, 32, 26, 27, 302, 309; 359/48, 49, 42, 50, 40, 69, 70

[56] References Cited

U.S. PATENT DOCUMENTS

5,050,946 9/1991 Hathaway et al. 385/33

7 Claims, 4 Drawing Sheets

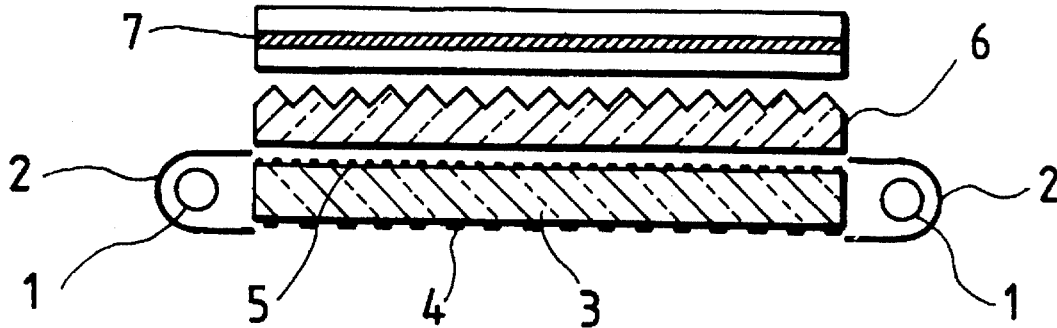

FIG. 1

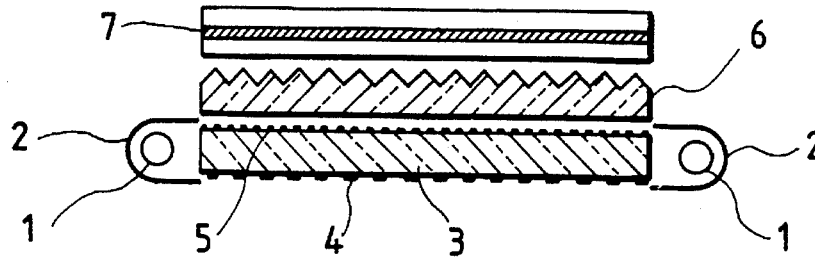

FIG. 2

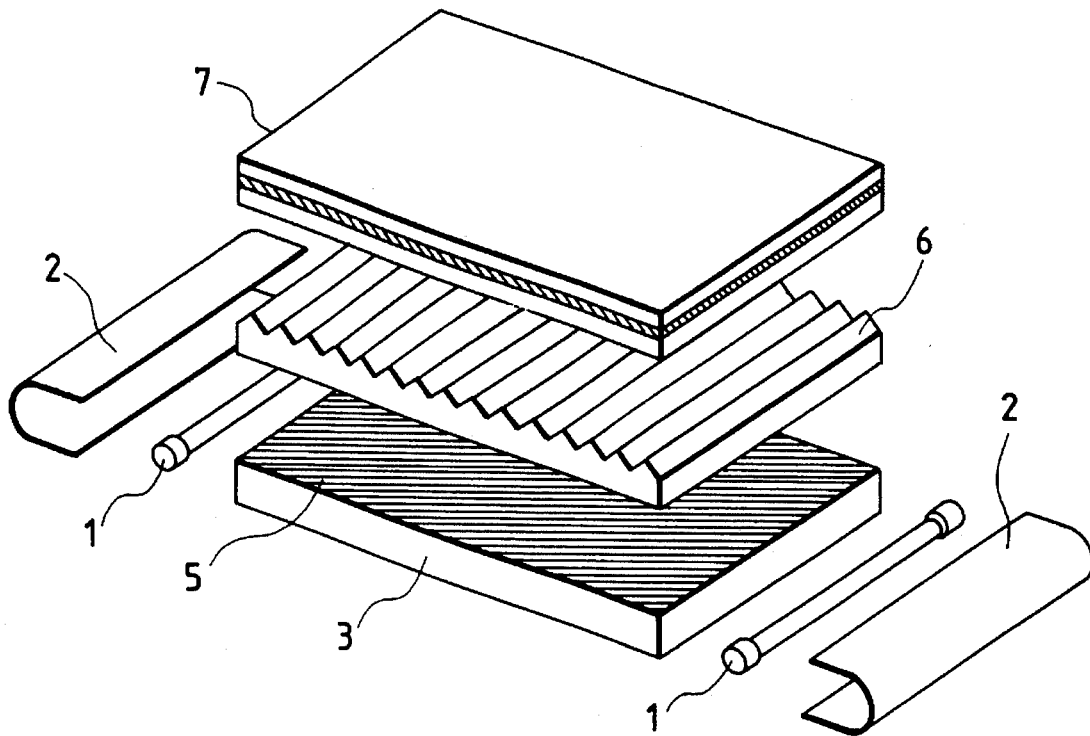

FIG. 3

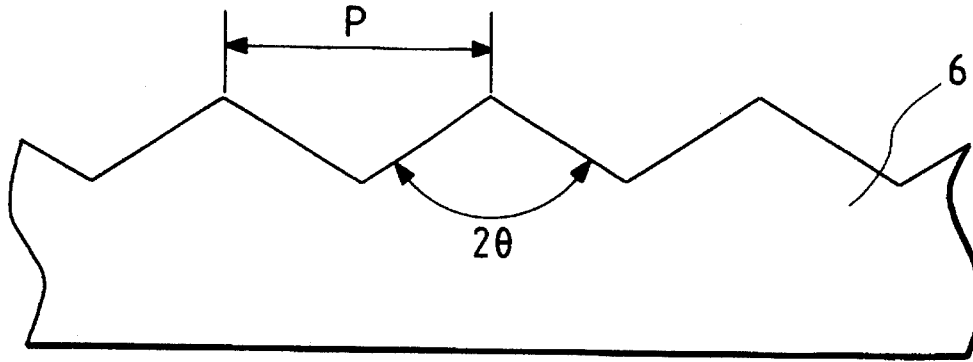

FIG. 4

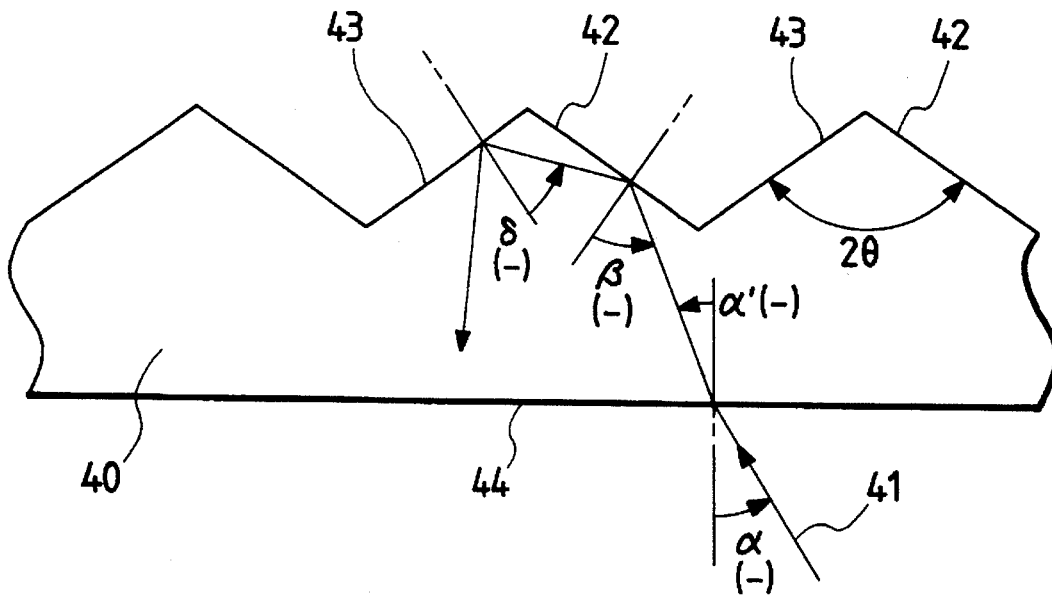

FIG. 5

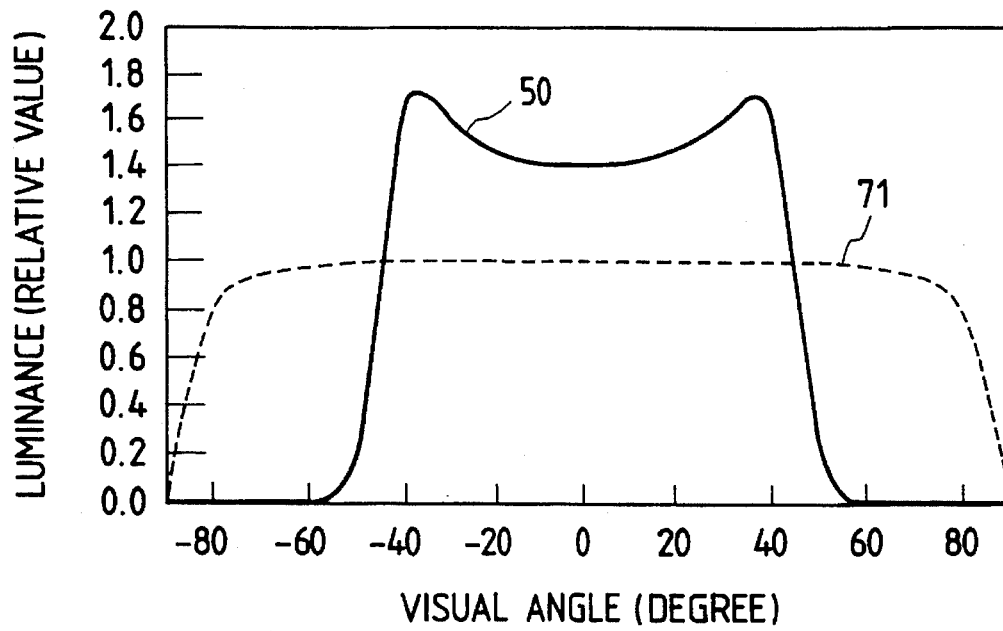

FIG. 6

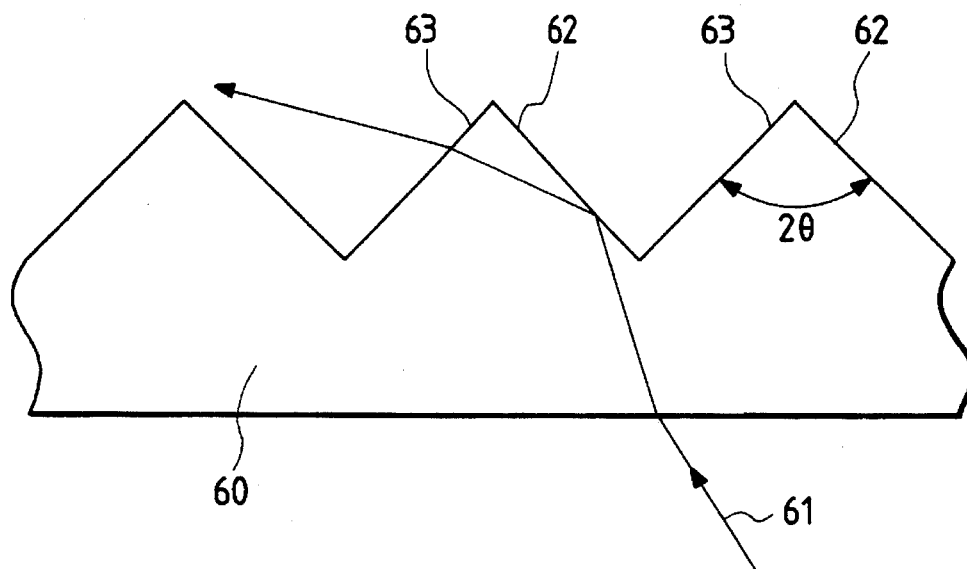

FIG. 7

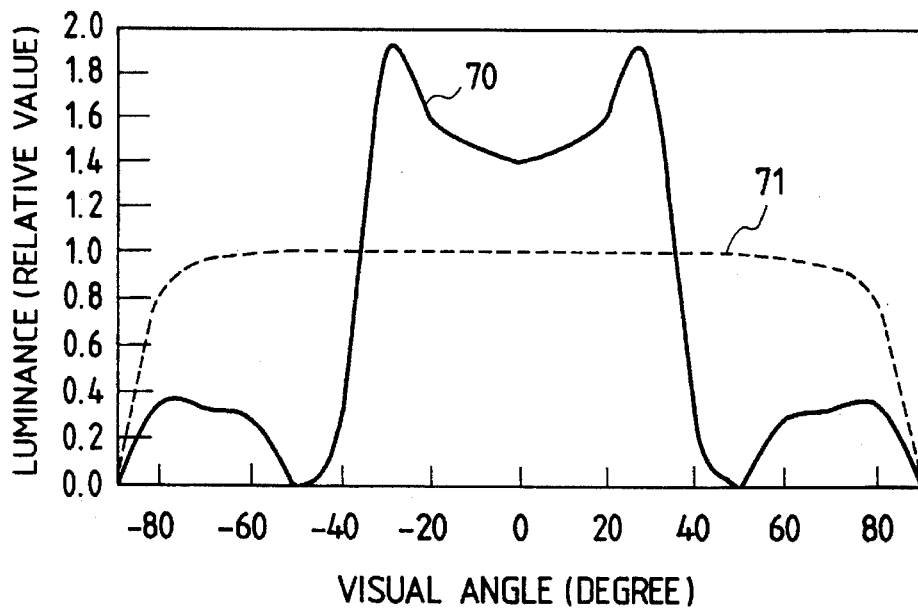

FIG. 8(a)

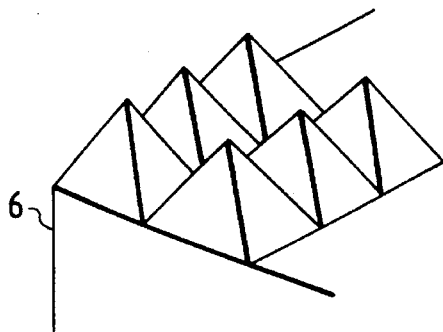
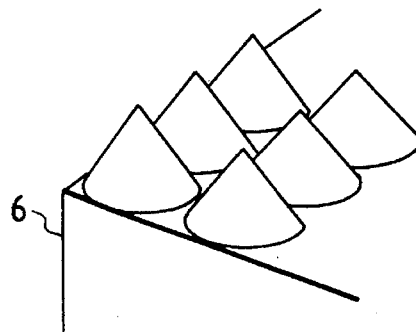

FIG. 8(b)



Explore Litigation Insights

Docket Alarm provides insights to develop a more informed litigation strategy and the peace of mind of knowing you're on top of things.

Real-Time Litigation Alerts



Keep your litigation team up-to-date with **real-time alerts** and advanced team management tools built for the enterprise, all while greatly reducing PACER spend.

Our comprehensive service means we can handle Federal, State, and Administrative courts across the country.

Advanced Docket Research



With over 230 million records, Docket Alarm's cloud-native docket research platform finds what other services can't. Coverage includes Federal, State, plus PTAB, TTAB, ITC and NLRB decisions, all in one place.

Identify arguments that have been successful in the past with full text, pinpoint searching. Link to case law cited within any court document via Fastcase.

Analytics At Your Fingertips



Learn what happened the last time a particular judge, opposing counsel or company faced cases similar to yours.

Advanced out-of-the-box PTAB and TTAB analytics are always at your fingertips.

API

Docket Alarm offers a powerful API (application programming interface) to developers that want to integrate case filings into their apps.

LAW FIRMS

Build custom dashboards for your attorneys and clients with live data direct from the court.

Automate many repetitive legal tasks like conflict checks, document management, and marketing.

FINANCIAL INSTITUTIONS

Litigation and bankruptcy checks for companies and debtors.

E-DISCOVERY AND LEGAL VENDORS

Sync your system to PACER to automate legal marketing.