

Fig. 1

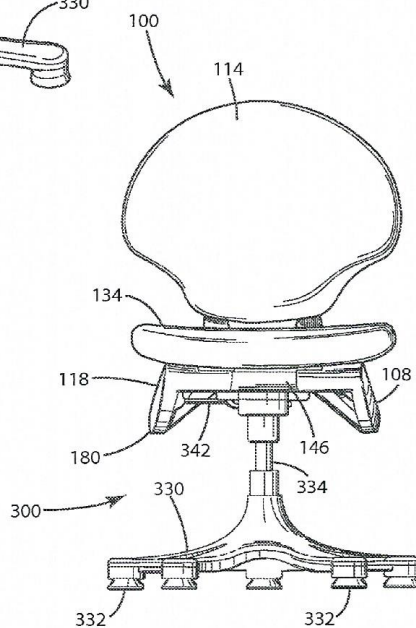

Fig. 2

Ex. 1001 (774)