

(19) **United States**

(12) **Patent Application Publication** (10) **Pub. No.: US 2002/0116415 A1**

Dutta et al. (43) **Pub. Date: Aug. 22, 2002**

(54) **METHOD TO REFORMAT REGIONS WITH CLUTTERED HYPERLINKS** (52) **U.S. Cl. 707/516**

(75) **Inventors: Rabindranath Dutta, Austin, TX (US); Karthikeyan Ramamoorthy, Austin, TX (US)**

(57) **ABSTRACT**

Correspondence Address:

Duke W. Yee
Carstens, Yee & Cahoon, LLP
P.O. Box 802334
Dallas, TX 75380 (US)

(73) **Assignee: International Business Machines Corporation, Armonk, NY (US)**

(21) **Appl. No.: 09/791,152**

(22) **Filed: Feb. 22, 2001**

Publication Classification

(51) **Int. Cl.⁷ G06F 15/00**

A method for presenting a page, having a set of links, on a data processing system is provided. The page is preprocessed to form a processed page, wherein the processed page is unrepresented within the data processing system. A determination is made as to whether or not the links within the page fall within a proximity policy. Responsive to a determination that the page falls outside of the proximity policy, the page is reformatted to fall within the proximity policy. The mechanism of the present invention includes a preprocessing process and a policy structure for reformatting an electronic document page. The policy structure of the present invention allows the user to specify the appearance of the electronic document page. The policy structure as defined by the user is stored such that when the user returns to the page, the page may be displayed according to the policy structure defined by the user.

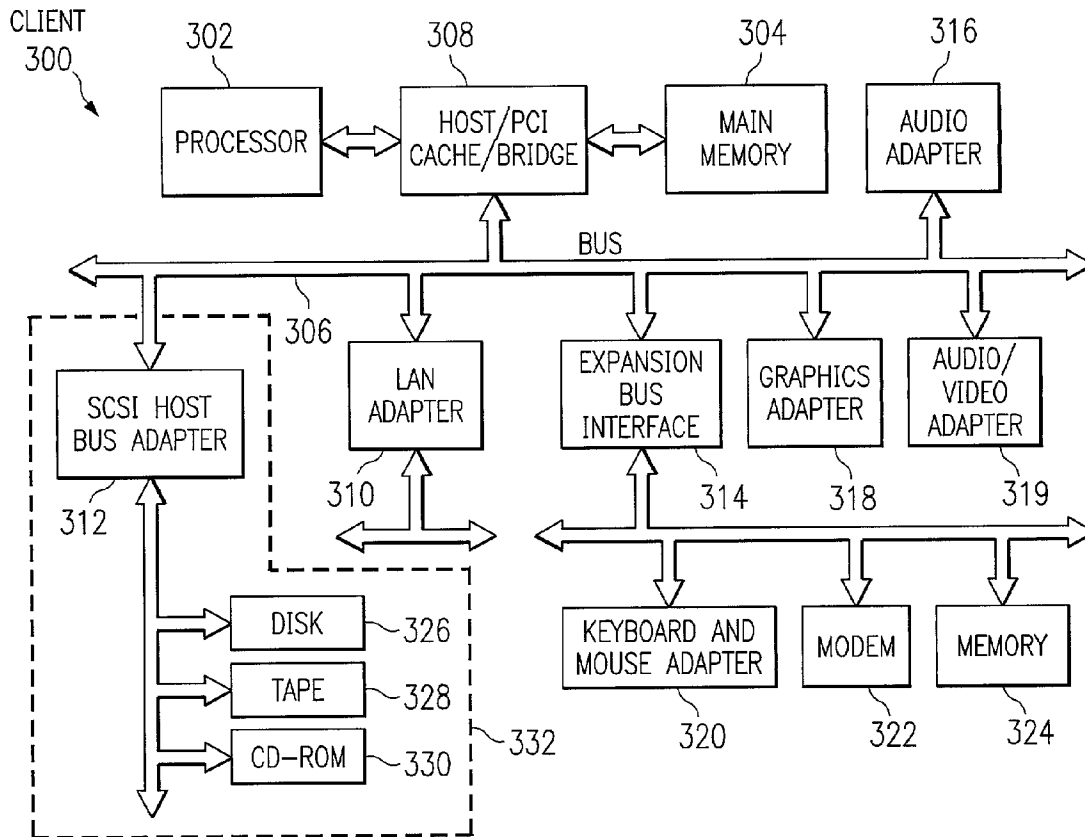

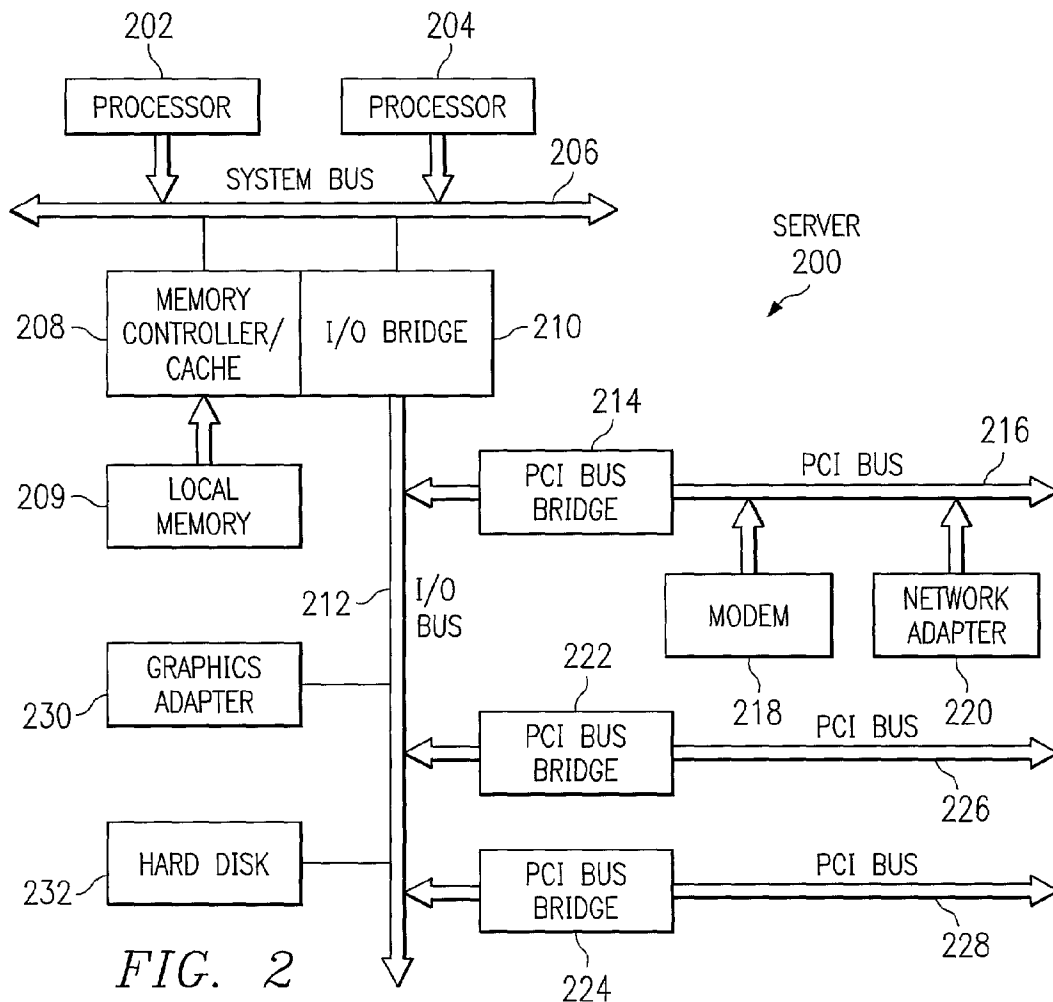
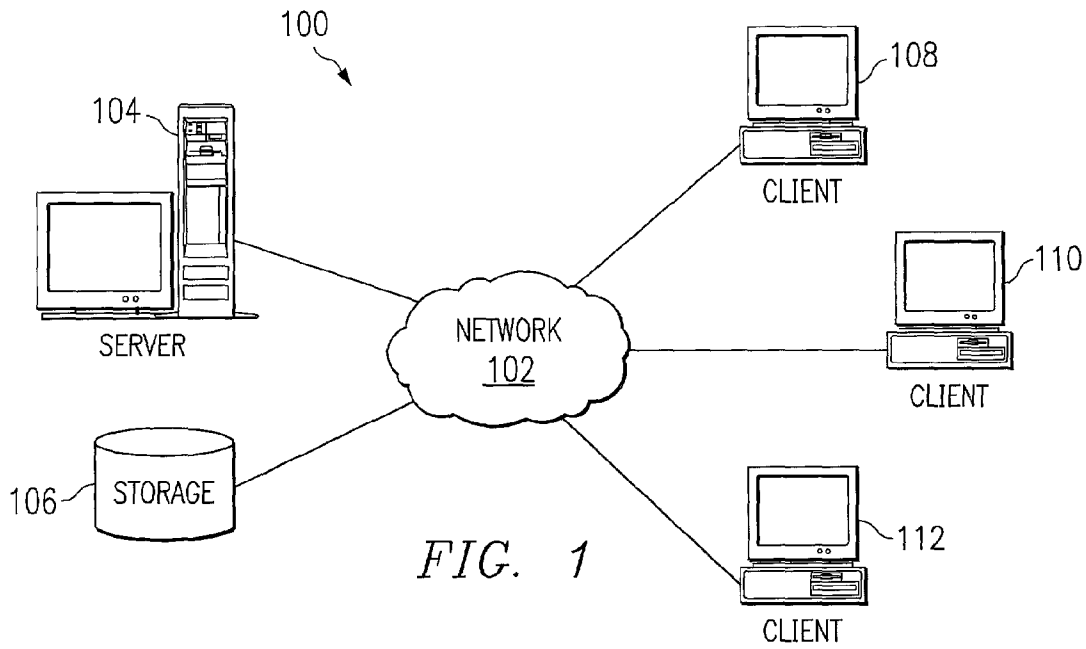

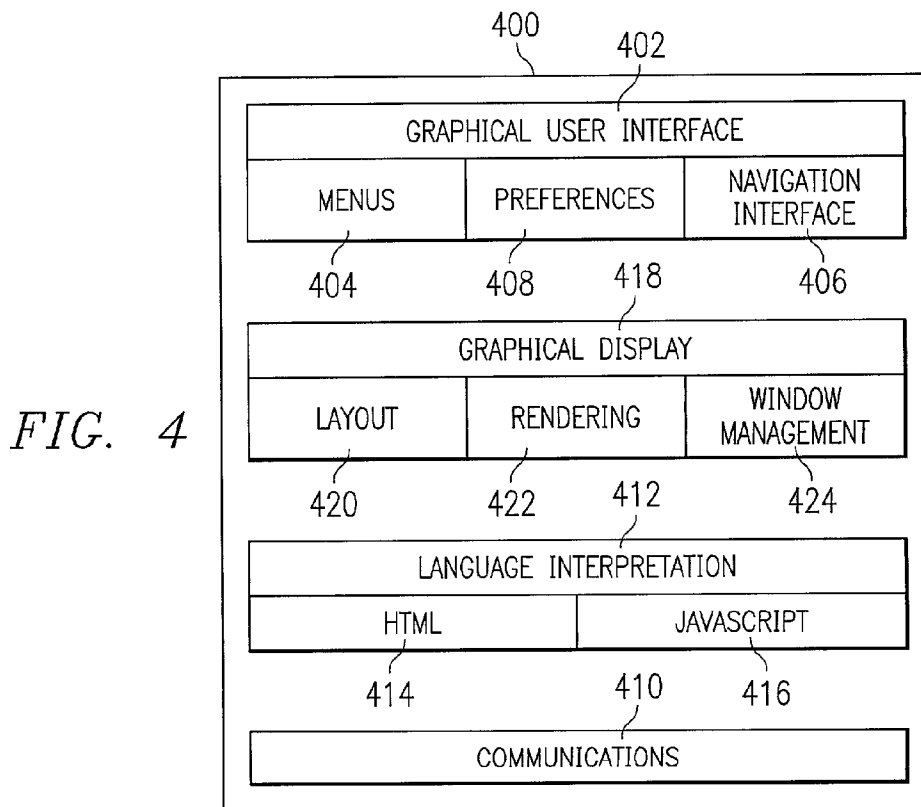
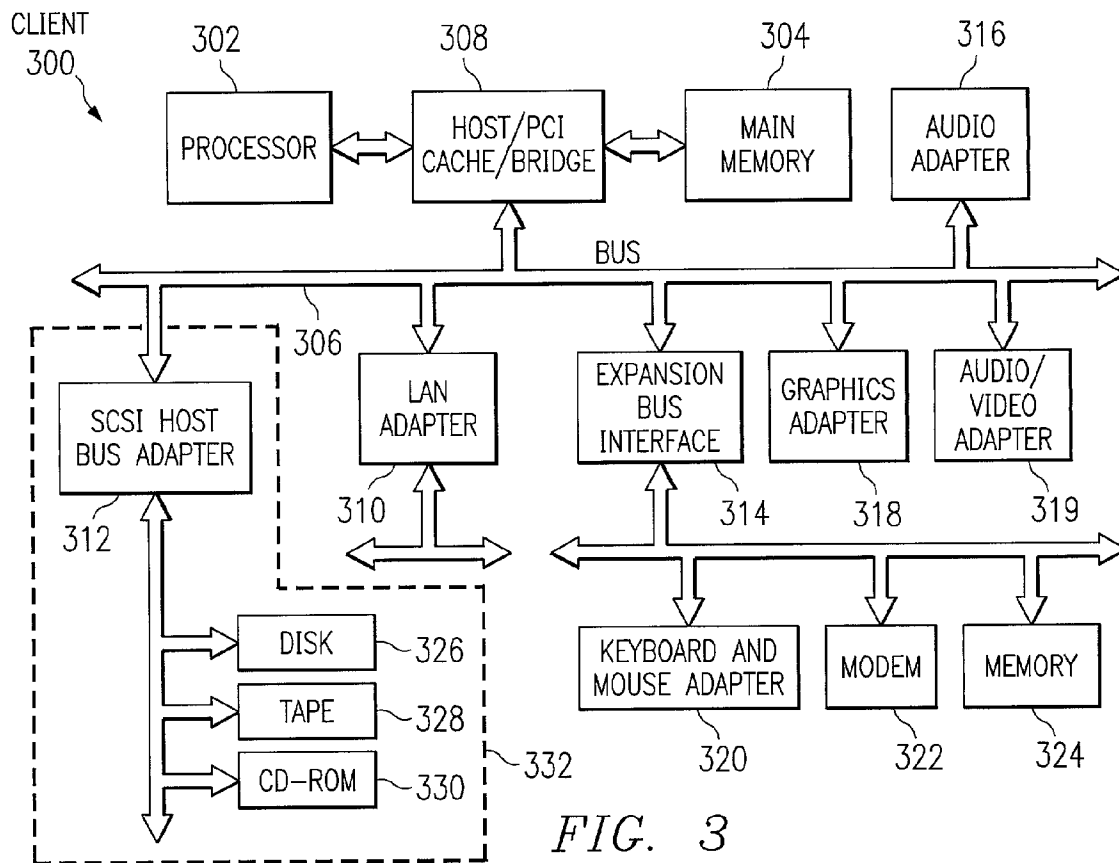

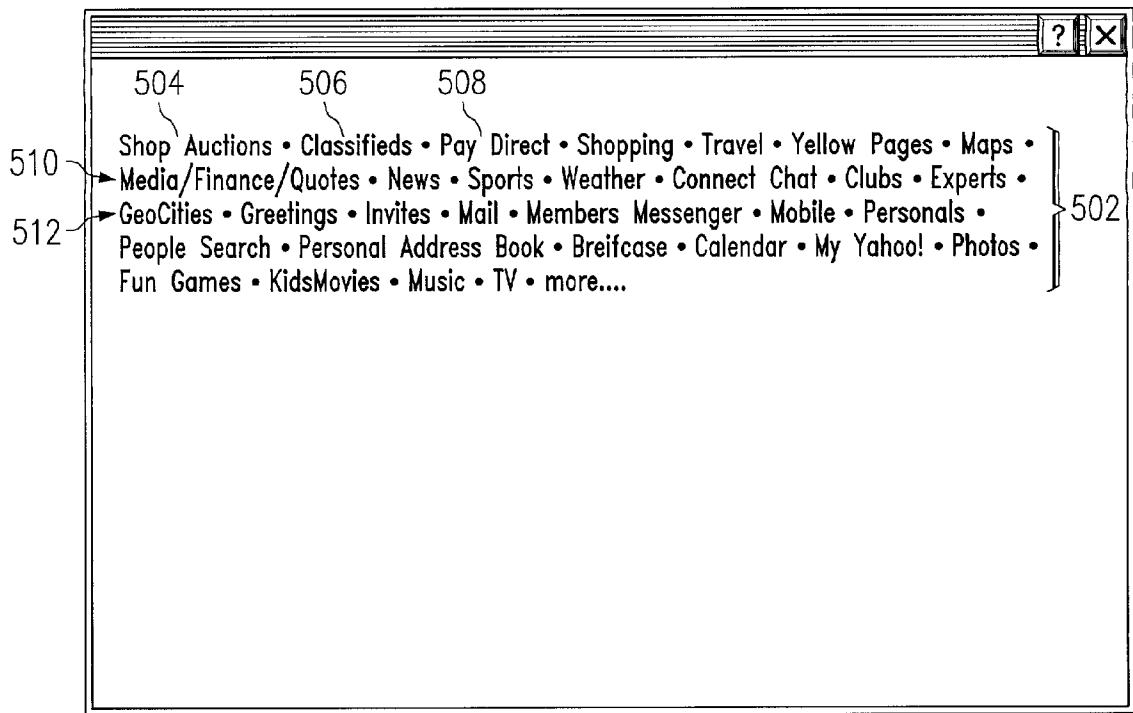

FIG. 5A

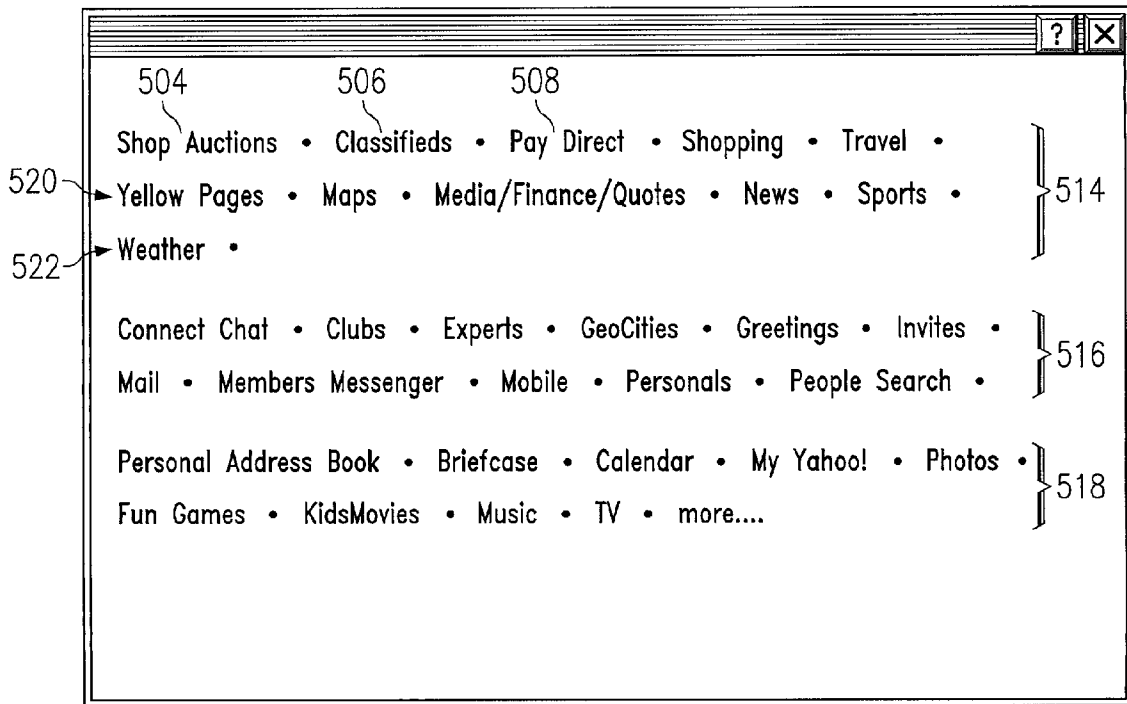
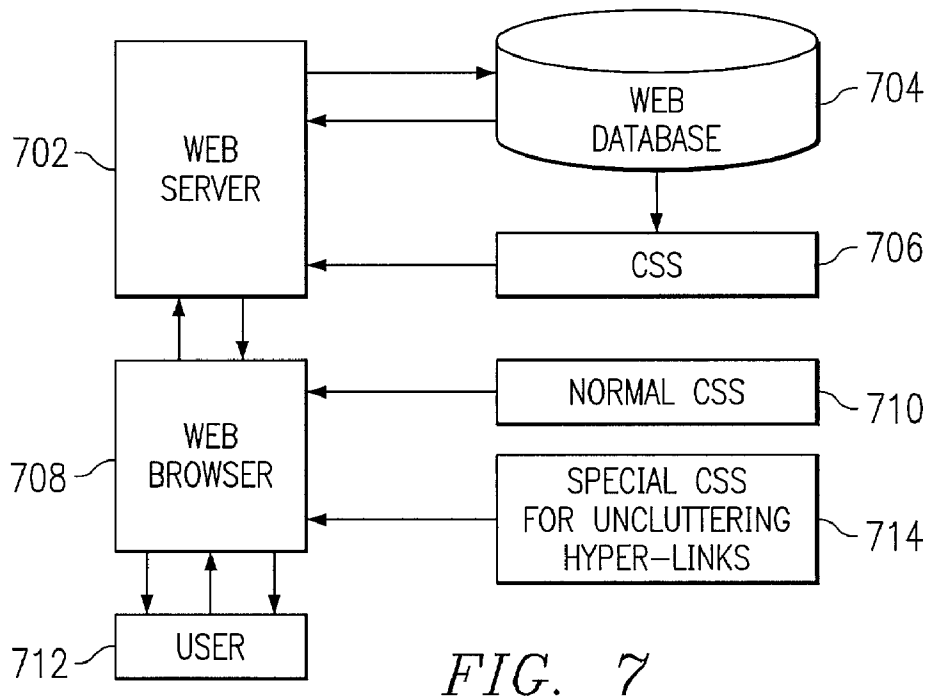
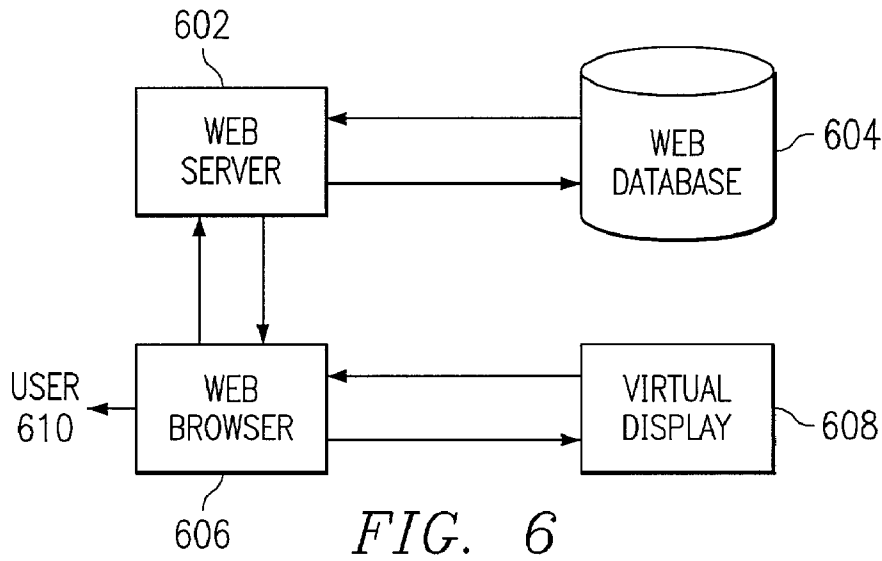

FIG. 5B



Explore Litigation Insights

Docket Alarm provides insights to develop a more informed litigation strategy and the peace of mind of knowing you're on top of things.

Real-Time Litigation Alerts



Keep your litigation team up-to-date with **real-time alerts** and advanced team management tools built for the enterprise, all while greatly reducing PACER spend.

Our comprehensive service means we can handle Federal, State, and Administrative courts across the country.

Advanced Docket Research



With over 230 million records, Docket Alarm's cloud-native docket research platform finds what other services can't. Coverage includes Federal, State, plus PTAB, TTAB, ITC and NLRB decisions, all in one place.

Identify arguments that have been successful in the past with full text, pinpoint searching. Link to case law cited within any court document via Fastcase.

Analytics At Your Fingertips



Learn what happened the last time a particular judge, opposing counsel or company faced cases similar to yours.

Advanced out-of-the-box PTAB and TTAB analytics are always at your fingertips.

API

Docket Alarm offers a powerful API (application programming interface) to developers that want to integrate case filings into their apps.

LAW FIRMS

Build custom dashboards for your attorneys and clients with live data direct from the court.

Automate many repetitive legal tasks like conflict checks, document management, and marketing.

FINANCIAL INSTITUTIONS

Litigation and bankruptcy checks for companies and debtors.

E-DISCOVERY AND LEGAL VENDORS

Sync your system to PACER to automate legal marketing.