

Dynamic Spectral Power Equalization Using Micro-Opto-Mechanics

Joseph E. Ford and James A. Walker

Abstract—We present a voltage-controlled spectral attenuator for gain shaping and power equalization in wavelength division multiplexed single-mode fiber systems. A micro-opto-mechanical modulator array, where electrostatic deflection of a silicon nitride quarter-wave dielectric layer suspended over a silicon substrate creates a column of variable reflectivity mirrors, is packaged using bulk optics and a diffraction grating to disperse the input spectrum across the device and collect the reflected light into a separate output fiber. The packaged component has 9-dB excess loss, 20-dB dynamic range and 10- μ s response. We demonstrate equalization of the amplified spontaneous emission spectrum from an erbium-doped fiber amplifier and of individual laser signals with 10-dB initial variation to less than 0.5-dB variation over a 24-nm passband-free spectrum.

Index Terms—Attenuators, gain control, level control, micro-electromechanical devices, optical components, optical equalizers, wavelength-division multiplexing.

I. INTRODUCTION

NONUNIFORM signal intensity levels in wavelength-division-multiplexed (WDM) communication systems lead to transmission errors. Power equalization can be done by signal pre-emphasis and fixed fiber gratings. However, transmission link properties can change over time, and the network operator may not have precise, dynamic control over source powers. A passive optical component providing dynamic control over wavelength power levels could correct changing signal levels with a simple, local control algorithm and provide maximum flexibility to the network operator.

The mechanical antireflection switch (MARS) micromechanical modulator was originally developed for digital data transmission [1], and later used as a high-speed analog variable attenuator [2], [3]. The structure, shown in Fig. 1, is basically a quarter-wave dielectric antireflection coating suspended above a silicon substrate. A silicon nitride layer with $\frac{1}{4}\lambda$ optical thickness, separated from the silicon substrate by a fixed $\frac{3}{4}\lambda$ spacer, acts as a dielectric mirror with about 70% reflectivity. Voltage applied to electrodes on top of the membrane creates an electrostatic force and pulls the membrane closer to the substrate, while membrane tension provides a linear restoring force. When the membrane gap is reduced to $\lambda/2$, the layer becomes an antireflection coating with close to zero reflectivity. The 0.4- μ m vertical deflection is small compared to the 200–500- μ m-wide membrane. The mechanical resonance frequency of such devices is on the order of megahertz. Their

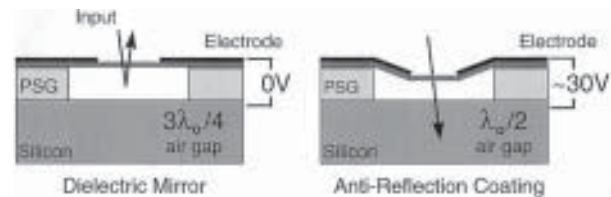

Fig. 1. MARS micromechanical modulator concept.

optical response ranges from 0.1 to 10 μ s, depending on the surface geometry and material parameters. Mechanically, the device moves by elastic deformation, similar to a tuning fork. Electrically, the device behaves as a tiny capacitor, with zero-static power dissipation regardless of reflectivity state.

Starting from the MARS modulator, we can create a WDM equalizer by simply fabricating a column of analog modulators and placing them into a fiber-coupled spectrometer that has been modified to collect the reflected and attenuated signals into a separate output fiber [4]. Fig. 2 shows the free-space optical system and the resulting optomechanical package. Light from the input fiber is collimated, diffracts from a gold-coated 600-lines/mm blazed grating, then focused by a 50-mm lens onto the device. The focus lens is vertically displaced so that the reflected light is spatially separated from the input. The reflected and attenuated signal is collected by a second pass through the grating, reflects from a small fold mirror, and focused into a separate output fiber. The grating insertion loss depends on polarization, and can vary from about 0.6 to 1.1 dB at 1.5 μ m. We avoid polarization-dependent loss (PDL) by placing a quarter-wave plate in the collimated beam path to rotate the polarization of the reflected light for the second pass through the grating. Using a gold mirror at the device plane the total fiber-to-fiber insertion loss of the WDM package is 4.6 dB, with 0.2-dB PDL.

There are two approaches to making the equalizer device. A *segmented* array of mechanically and electrically discrete modulators offers arbitrary attenuation on each predefined wavelength channel. However, a mechanically *continuous* modulator surface actuated by individual electrodes offers a continuous operating wavelength spectrum with no passbands. The choice depends on system application. The segmented device can equalize amplifier inputs with widely varying levels as, for example, might be the case in a network with active WDM add-drop. The continuous device can equalize a transmission link despite changes in amplifier gain profiles and transmission loss, without restricting the network to a particular set of operating wavelengths.

Manuscript received May 1, 1998; revised June 17, 1998.

The authors are with Bell Laboratories, Lucent Technologies, Holmdel, NJ 07733 USA.

Publisher Item Identifier S 1041-1135(98)07139-0.

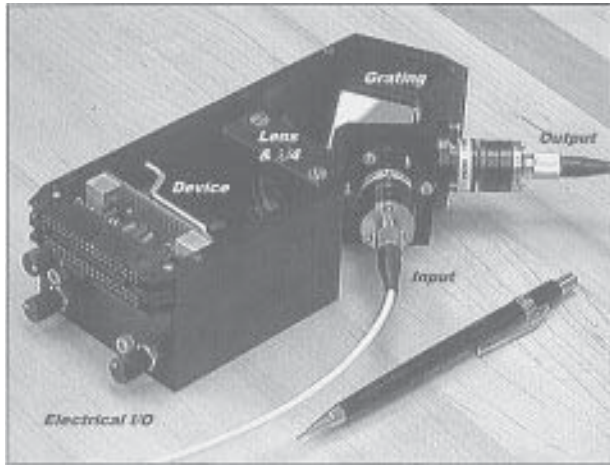
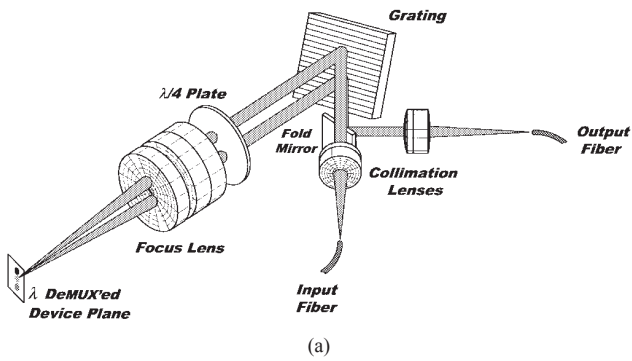

Fig. 2. (a) Optical design. (b) Optomechanical WDM package.

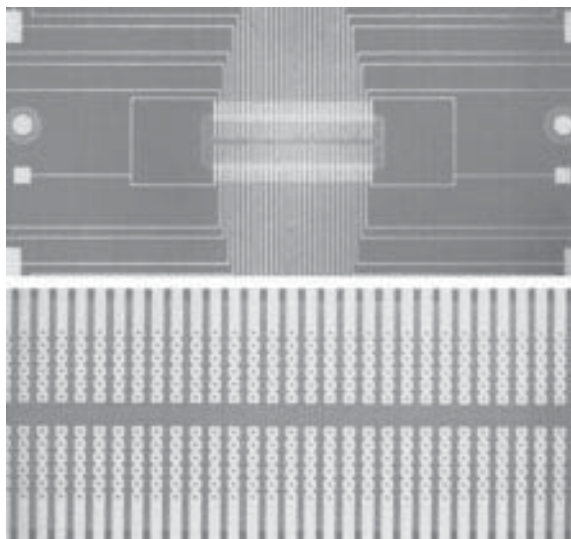

Fig. 3. MARS variable-reflectivity strip mirror.

In this letter, we demonstrate the passband-free WDM equalizer. Fig. 3 shows the device with a unbroken modulator strip with electrodes applying force at discrete steps along a continuous narrow membrane. The membrane deflects like a rubber sheet, with smooth, shallow depressions (of up to $0.4 \mu\text{m}$ across a $290\text{-}\mu\text{m}$ suspended width) created wherever

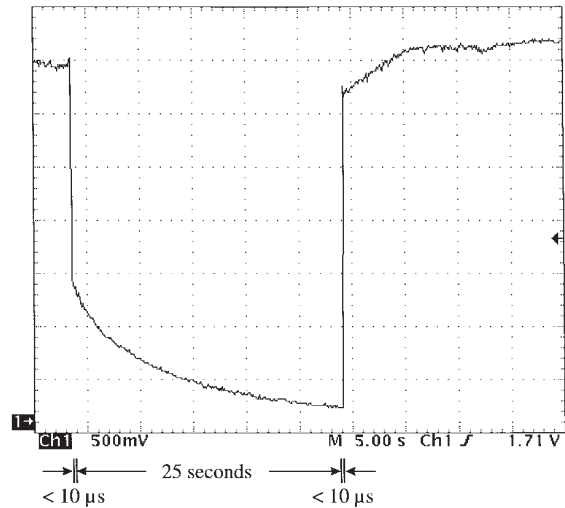

Fig. 4. Dynamic attenuation response to 60-V square-wave drive.

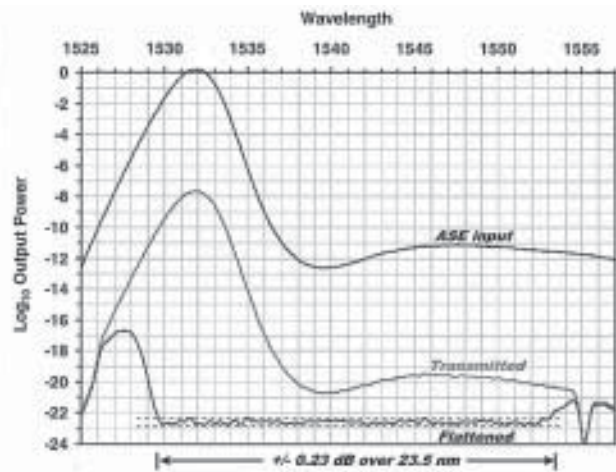

Fig. 5. Equalized erbium-doped fiber amplifier ASE.

voltage is applied. This increases mechanical coupling between channels, but creates the best possible optical surface. The optically active region was a strip $40 \mu\text{m}$ wide by approximately 1 mm long, with 32 (connected) electrodes spaced at a $28\text{-}\mu\text{m}$ pitch (corresponding to 0.8 nm in wavelength).

II. EXPERIMENTAL RESULTS

The total excess loss of the FC-connectorized equalizer was less than 9 dB with 0.1-dB ripple over an approximately 28-nm usable bandwidth. The center wavelength could be adjusted to lie anywhere within the $1.5\text{-}\mu\text{m}$ band. Applying 0–60 V to any one electrode created a 3-nm-wide feature with an approximately Gaussian profile (on a logarithmic scale) and up to 22-dB additional attenuation. Intermediate regions between two nearby features were somewhat attenuated. For example, the midpoint between two 15-dB depressions separated by 7 nm had 5-dB loss. In other words, the equalizer could create wavelength transmission functions that vary smoothly

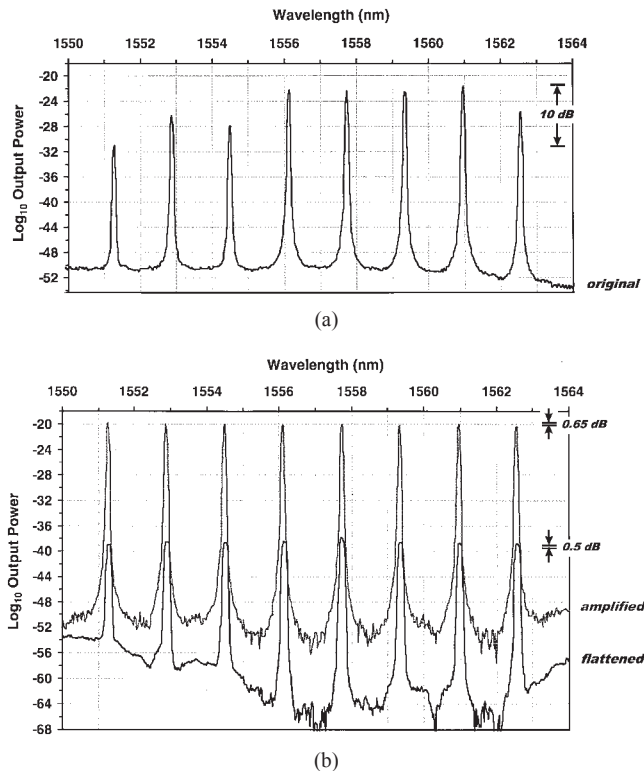

Fig. 6. (a) Nonuniform laser input. (b) Flattened and amplified output.

compared to the 3-nm minimum feature made by a single charged electrode.

Fig. 4 shows the equalizer time dynamics at one arbitrary wavelength. The MARS modulator has less than 10- μ s response to a voltage step, but displays a slow relaxation effect from static charge buildup on the dielectric membrane. This mechanism was also responsible for a slow (hours) drift in attenuation as a screening charge develops on the membrane. Closed-loop feedback can achieve a fast response and maintain a specified attenuation setting (with a 1–2 dB penalty in dynamic range). When the drive voltage used in Fig. 5 was increased, the response time to full (20-dB) attenuation was less than 10 μ s.

For the following experiments, the equalizer's electronic control was simply a row of 32 manually-adjusted trim-potentiometers acting as voltage dividers for a common voltage supply provided by seven 9-V batteries in series.

Fig. 5 shows how the equalizer can flatten nonuniform amplifier gain. The upper curve is the original amplified spontaneous emission (ASE) output of an erbium-doped fiber amplifier with >12-dB dynamic range. The middle curve shows this signal transmitted through the packaged equalizer (with zero applied voltage). With an appropriate voltage setting, the ASE signal (in effect, the amplifier gain) was flattened to

<0.5 dB over a 23.5-nm bandwidth. Ripples in loss are due to scatter off the gold electrodes and small surface features in the membrane. Revising the equalizer design to widen the optical window and minimize stress concentration will significantly reduce the ripple.

The continuous-strip equalizer was also used to demonstrate flattening of multiple laser inputs. Fig. 6(a) shows eight laser signals at 200-GHz pitch (transmitted through the switched-off equalizer) with signal levels that vary by an order of magnitude. When the equalizer is suitably adjusted (Fig. 6, bottom) the transmitted signal levels were equalized to <0.4-dB variation. The smooth variation in the additional loss incurs an additional 8-dB loss below the original minimum power. However, the original signal level can be recovered using an amplifier. Fig. 6 also shows the output after amplification, where in fact the attenuation control was readjusted to compensate for amplifier nonuniformity, yielding 0.65-dB total level variation.

III. CONCLUSION

This letter reports the first demonstration of a micro-opto-mechanical WDM equalizer suitable for telecommunications networks. The packaged device has less than 9-dB excess loss, 20-dB dynamic range and 10- μ s response over a 24-nm passband-free optical spectrum. Such a component, used in conjunction with an amplifier and with active feedback from a WDM detector, can form a self-contained system capable of dynamic correction of signal levels in a WDM transmission system.

ACKNOWLEDGMENT

The authors thank Lucent colleagues K. Goossen for MARS modulator design, M. Nuss for originally suggesting the equalizer application, C.-C. Chang for his lab expertise, C. Doerr for the multifrequency laser, and B. Ellard and F. Beisser for custom machining and electronics.

REFERENCES

- [1] K. W. Goossen, J. A. Walker, and S. C. Arney, "Silicon modulator based on mechanically-active anti-reflection layer with 1 Mbit/s capability for fiber in the loop applications," *IEEE Photon. Technol. Lett.*, vol. 6, pp. 1119–1121, Sept. 1994.
- [2] J. E. Ford, J. A. Walker, K. W. Goossen, and D. S. Greywall, "Micro-mechanical fiber-optic attenuator with 3 microsecond response," *J. Lightwave Technol.*, submitted for publication.
- [3] J. E. Ford, J. A. Walker, and K. W. Goossen, "Fiber-coupled variable attenuator using a MARS modulator," *SPIE Proc.*, vol. 3226, pp. 86–93, 1997.
- [4] J. E. Ford, J. A. Walker, M. C. Nuss, and D. A. B. Miller, "32 channel WDM graphic equalizer," in *Tech. Dig. IEEE/LEOS 1996 Summer Topical Meet. Broadband Optical Networks*, Keystone, CO, Aug. 1996, pp. 26–27.