



UNITED STATES PATENT AND TRADEMARK OFFICE

UNITED STATES DEPARTMENT OF COMMERCE  
United States Patent and Trademark Office  
Address: COMMISSIONER FOR PATENTS  
P. O. Box 1450  
Alexandria, Virginia 22313-1450  
www.uspto.gov

APPLICATION NO.	ISSUE DATE	PATENT NO.	ATTORNEY DOCKET NO.	CONFIRMATION NO.
12/815,930	09/06/2011	RE42678	C2393-1101RE2	2344

48789 7590 08/17/2011  
LAW OFFICES OF BARRY N. YOUNG  
P. O. Box 448  
PALO ALTO, CA 94302-0448

**ISSUE NOTIFICATION**

The projected patent number and issue date are specified above.

**Determination of Patent Term Extension or Adjustment under 35 U.S.C. 154 (b)**

A reissue patent is for "the unexpired part of the term of the original patent." See 35 U.S.C. 251. Accordingly, the above-identified reissue application is not eligible for Patent Term Extension or Adjustment under 35 U.S.C. 154(b).

Any questions regarding the Patent Term Extension or Adjustment determination should be directed to the Office of Patent Legal Administration at (571)-272-7702. Questions relating to issue and publication fee payments should be directed to the Application Assistance Unit (AAU) of the Office of Data Management (ODM) at (571)-272-4200.

APPLICANT(s) (Please see PAIR WEB site <http://pair.uspto.gov> for additional applicants):

Jeffrey P. Wilde, Morgan Hill, CA;  
Joseph E. Davis, Morgan Hill, CA;

**PART B - FEE(S) TRANSMITTAL**

Complete and send this form, together with applicable fee(s), to: **Mail** **Mail Stop ISSUE FEE**  
**Commissioner for Patents**  
**P.O. Box 1450**  
**Alexandria, Virginia 22313-1450**  
 or **Fax** (571)-273-2885

**INSTRUCTIONS:** This form should be used for transmitting the ISSUE FEE and PUBLICATION FEE (if required). Blocks 1 through 5 should be completed where appropriate. All further correspondence including the Patent, advance orders and notification of maintenance fees will be mailed to the current correspondence address as indicated unless corrected below or directed otherwise in Block 1, by (a) specifying a new correspondence address; and/or (b) indicating a separate "FEE ADDRESS" for maintenance fee notifications.

CURRENT CORRESPONDENCE ADDRESS (Note: Use Block 1 for any change of address)

Note: A certificate of mailing can only be used for domestic mailings of the Fee(s) Transmittal. This certificate cannot be used for any other accompanying papers. Each additional paper, such as an assignment or formal drawing, must have its own certificate of mailing or transmission.

48789 7590 04/11/2011  
**LAW OFFICES OF BARRY N. YOUNG**  
 200 PAGE MILL ROAD  
 SUITE 102  
 PALO ALTO, CA 94306

**Certificate of Mailing or Transmission**  
 I hereby certify that this Fee(s) Transmittal is being deposited with the United States Postal Service with sufficient postage for first class mail in an envelope addressed to the Mail Stop ISSUE FEE address above, or being facsimile transmitted to the USPTO (571) 273-2885, on the date indicated below.

Barry N. Young	(Depositor's name)
<i>Barry N. Young</i>	(Signature)
May 19, 2011	(Date)

APPLICATION NO.	FILING DATE	FIRST NAMED INVENTOR	ATTORNEY DOCKET NO.	CONFIRMATION NO.
12/815,930	06/15/2010	Jeffrey P. Wilde	C2393-1101RE2	2344

**TITLE OF INVENTION: RECONFIGURABLE OPTICAL ADD-DROP MULTIPLEXERS WITH SERVO CONTROL AND DYNAMIC SPECTRAL POWER MANAGEMENT CAPABILITIES**

APPLN. TYPE	SMALL ENTITY	ISSUE FEE DUE	PUBLICATION FEE DUE	PREV. PAID ISSUE FEE	TOTAL FEE(S) DUE	DATE DUE
nonprovisional	NO	\$1510	\$0	\$0	\$1510	07/11/2011

EXAMINER	ART UNIT	CLASS-SUBCLASS
HEALY, BRIAN	2883	385-024000

1. Change of correspondence address or indication of "Fee Address" (37 CFR 1.303).

Change of correspondence address (or Change of Correspondence Address form PTO/SB/122) attached.

"Fee Address" indication (or "Fee Address" Indication form PTO/SB/47, Rev 03-02 or more recent) attached. Use of a Customer Number is required.

2. For printing on the patent front page, list

(1) the names of up to 3 registered patent attorneys or agents OR, alternatively, 1. Barry N. Young

(2) the name of a single firm (having as a member a registered attorney or agent) and the names of up to 2 registered patent attorneys or agents. If no name is listed, no name will be printed. 2. \_\_\_\_\_

3. \_\_\_\_\_

3. ASSIGNEE NAME AND RESIDENCE DATA TO BE PRINTED ON THE PATENT (print or type)

PLEASE NOTE: Unless an assignee is identified below, no assignee data will appear on the patent. If an assignee is identified below, the document has been filed for recordation as set forth in 37 CFR 3.11. Completion of this form is NOT a substitute for filing an assignment.

(A) NAME OF ASSIGNEE: Capella Photonics, Inc.

(B) RESIDENCE: (CITY and STATE OR COUNTRY) San Jose, California

Please check the appropriate assignee category or categories (will not be printed on the patent):  Individual  Corporation or other private group entity  Government

4a. The following fee(s) are submitted:

Issue Fee

Publication Fee (No small entity discount permitted)

Advance Order - # of Copies \_\_\_\_\_

4b. Payment of Fee(s): (Please first reapply any previously paid issue fee shown above)

A check is enclosed.

Payment by credit card. Form PTO-2038 is attached. (EFS-Web)

The Director is hereby authorized to charge the required fee(s), any deficiency, or credit any overpayment, to Deposit Account Number \_\_\_\_\_ (enclose an extra copy of this form)

5. Change in Entity Status (from status indicated above)

a. Applicant claims SMALL ENTITY status. See 37 CFR 1.27.  b. Applicant is no longer claiming SMALL ENTITY status. See 37 CFR 1.27(g)(2).

NOTE: The Issue Fee and Publication Fee (if required) will not be accepted from anyone other than the applicant; a registered attorney or agent; or the assignee or other party in interest as shown by the records of the United States Patent and Trademark Office.

Authorized Signature: *Barry N. Young* Date: May 19, 2011

Typed or printed name: Barry N. Young Registration No.: 27,744

This collection of information is required by 37 CFR 1.311. The information is required to obtain or retain a benefit by the public which is to file (and by the USPTO to process) an application. Confidentiality is governed by 35 U.S.C. 122 and 37 CFR 1.14. This collection is estimated to take 12 minutes to complete, including gathering, preparing, and submitting the completed application form to the USPTO. Time will vary depending upon the individual case. Any comments on the amount of time you require to complete this form and/or suggestions for reducing this burden, should be sent to the Chief Information Officer, U.S. Patent and Trademark Office, U.S. Department of Commerce, P.O. Box 1450, Alexandria, Virginia 22313-1450. DO NOT SEND FEES OR COMPLETED FORMS TO THIS ADDRESS. SEND TO: Commissioner for Patents, P.O. Box 1450, Alexandria, Virginia 22313-1450.

Under the Paperwork Reduction Act of 1995, no persons are required to respond to a collection of information unless it displays a valid OMB control number.

## Electronic Patent Application Fee Transmittal

<b>Application Number:</b>	12815930			
<b>Filing Date:</b>	15-Jun-2010			
<b>Title of Invention:</b>	RECONFIGURABLE OPTICAL ADD-DROP MULTIPLEXERS WITH SERVO CONTROL AND DYNAMIC SPECTRAL POWER MANAGEMENT CAPABILITIES			
<b>First Named Inventor/Applicant Name:</b>	Jeffrey P. Wilde			
<b>Filer:</b>	Barry N. Young			
<b>Attorney Docket Number:</b>	C2393-1101RE2			
Filed as Large Entity				
<b>Utility under 35 USC 111(a) Filing Fees</b>				
Description	Fee Code	Quantity	Amount	Sub-Total in USD(\$)
<b>Basic Filing:</b>				
<b>Pages:</b>				
<b>Claims:</b>				
<b>Miscellaneous-Filing:</b>				
<b>Petition:</b>				
<b>Patent-Appeals-and-Interference:</b>				
<b>Post-Allowance-and-Post-Issuance:</b>				
Utility Appl issue fee	1501	1	1510	1510
<b>Extension-of-Time:</b>				

Description	Fee Code	Quantity	Amount	Sub-Total in USD(\$)
<b>Miscellaneous:</b>				
<b>Total in USD (\$)</b>				<b>1510</b>

## Electronic Acknowledgement Receipt

<b>EFS ID:</b>	10132129
<b>Application Number:</b>	12815930
<b>International Application Number:</b>	
<b>Confirmation Number:</b>	2344
<b>Title of Invention:</b>	RECONFIGURABLE OPTICAL ADD-DROP MULTIPLEXERS WITH SERVO CONTROL AND DYNAMIC SPECTRAL POWER MANAGEMENT CAPABILITIES
<b>First Named Inventor/Applicant Name:</b>	Jeffrey P. Wilde
<b>Customer Number:</b>	48789
<b>Filer:</b>	Barry N. Young
<b>Filer Authorized By:</b>	
<b>Attorney Docket Number:</b>	C2393-1101RE2
<b>Receipt Date:</b>	19-MAY-2011
<b>Filing Date:</b>	15-JUN-2010
<b>Time Stamp:</b>	20:57:30
<b>Application Type:</b>	Utility under 35 USC 111(a)

### Payment information:

Submitted with Payment	yes
Payment Type	Credit Card
Payment was successfully received in RAM	\$ 1510
RAM confirmation Number	5942
Deposit Account	
Authorized User	

### File Listing:

Document Number	Document Description	File Name	File Size(Bytes)/ Message Digest	Multi Part /.zip	Pages (if appl.)
-----------------	----------------------	-----------	-------------------------------------	------------------	------------------

1	Issue Fee Payment (PTO-85B)	PTOL-85.pdf	296160 ac066b0bd0933e05748504dceb8215415c b71952	no	1
<b>Warnings:</b>					
<b>Information:</b>					
2	Fee Worksheet (PTO-875)	fee-info.pdf	30180 a6c5b4e1550157383025924184d58851191 ab195	no	2
<b>Warnings:</b>					
<b>Information:</b>					
<b>Total Files Size (in bytes):</b>				326340	
<p>This Acknowledgement Receipt evidences receipt on the noted date by the USPTO of the indicated documents, characterized by the applicant, and including page counts, where applicable. It serves as evidence of receipt similar to a Post Card, as described in MPEP 503.</p> <p><b><u>New Applications Under 35 U.S.C. 111</u></b>  If a new application is being filed and the application includes the necessary components for a filing date (see 37 CFR 1.53(b)-(d) and MPEP 506), a Filing Receipt (37 CFR 1.54) will be issued in due course and the date shown on this Acknowledgement Receipt will establish the filing date of the application.</p> <p><b><u>National Stage of an International Application under 35 U.S.C. 371</u></b>  If a timely submission to enter the national stage of an international application is compliant with the conditions of 35 U.S.C. 371 and other applicable requirements a Form PCT/DO/EO/903 indicating acceptance of the application as a national stage submission under 35 U.S.C. 371 will be issued in addition to the Filing Receipt, in due course.</p> <p><b><u>New International Application Filed with the USPTO as a Receiving Office</u></b>  If a new international application is being filed and the international application includes the necessary components for an international filing date (see PCT Article 11 and MPEP 1810), a Notification of the International Application Number and of the International Filing Date (Form PCT/RO/105) will be issued in due course, subject to prescriptions concerning national security, and the date shown on this Acknowledgement Receipt will establish the international filing date of the application.</p>					



UNITED STATES PATENT AND TRADEMARK OFFICE

UNITED STATES DEPARTMENT OF COMMERCE
United States Patent and Trademark Office
Address: COMMISSIONER FOR PATENTS
P.O. Box 1450
Alexandria, Virginia 22313-1450
www.uspto.gov

NOTICE OF ALLOWANCE AND FEE(S) DUE

48789 7590 04/11/2011
LAW OFFICES OF BARRY N. YOUNG
200 PAGE MILL ROAD
SUITE 102
PALO ALTO, CA 94306

EXAMINER

HEALY, BRIAN

ART UNIT PAPER NUMBER

2883

DATE MAILED: 04/11/2011

Table with 5 columns: APPLICATION NO., FILING DATE, FIRST NAMED INVENTOR, ATTORNEY DOCKET NO., CONFIRMATION NO.
Values: 12/815,930, 06/15/2010, Jeffrey P. Wilde, C2393-1101RE2, 2344

TITLE OF INVENTION: RECONFIGURABLE OPTICAL ADD-DROP MULTIPLEXERS WITH SERVO CONTROL AND DYNAMIC SPECTRAL POWER MANAGEMENT CAPABILITIES

Table with 7 columns: APPLN. TYPE, SMALL ENTITY, ISSUE FEE DUE, PUBLICATION FEE DUE, PREV. PAID ISSUE FEE, TOTAL FEE(S) DUE, DATE DUE
Values: nonprovisional, NO, \$1510, \$0, \$0, \$1510, 07/11/2011

THE APPLICATION IDENTIFIED ABOVE HAS BEEN EXAMINED AND IS ALLOWED FOR ISSUANCE AS A PATENT. PROSECUTION ON THE MERITS IS CLOSED. THIS NOTICE OF ALLOWANCE IS NOT A GRANT OF PATENT RIGHTS. THIS APPLICATION IS SUBJECT TO WITHDRAWAL FROM ISSUE AT THE INITIATIVE OF THE OFFICE OR UPON PETITION BY THE APPLICANT. SEE 37 CFR 1.313 AND MPEP 1308.

THE ISSUE FEE AND PUBLICATION FEE (IF REQUIRED) MUST BE PAID WITHIN THREE MONTHS FROM THE MAILING DATE OF THIS NOTICE OR THIS APPLICATION SHALL BE REGARDED AS ABANDONED. THIS STATUTORY PERIOD CANNOT BE EXTENDED. SEE 35 U.S.C. 151. THE ISSUE FEE DUE INDICATED ABOVE DOES NOT REFLECT A CREDIT FOR ANY PREVIOUSLY PAID ISSUE FEE IN THIS APPLICATION. IF AN ISSUE FEE HAS PREVIOUSLY BEEN PAID IN THIS APPLICATION (AS SHOWN ABOVE), THE RETURN OF PART B OF THIS FORM WILL BE CONSIDERED A REQUEST TO REAPPLY THE PREVIOUSLY PAID ISSUE FEE TOWARD THE ISSUE FEE NOW DUE.

HOW TO REPLY TO THIS NOTICE:

I. Review the SMALL ENTITY status shown above.

If the SMALL ENTITY is shown as YES, verify your current SMALL ENTITY status:

A. If the status is the same, pay the TOTAL FEE(S) DUE shown above.

B. If the status above is to be removed, check box 5b on Part B - Fee(s) Transmittal and pay the PUBLICATION FEE (if required) and twice the amount of the ISSUE FEE shown above, or

If the SMALL ENTITY is shown as NO:

A. Pay TOTAL FEE(S) DUE shown above, or

B. If applicant claimed SMALL ENTITY status before, or is now claiming SMALL ENTITY status, check box 5a on Part B - Fee(s) Transmittal and pay the PUBLICATION FEE (if required) and 1/2 the ISSUE FEE shown above.

II. PART B - FEE(S) TRANSMITTAL, or its equivalent, must be completed and returned to the United States Patent and Trademark Office (USPTO) with your ISSUE FEE and PUBLICATION FEE (if required). If you are charging the fee(s) to your deposit account, section "4b" of Part B - Fee(s) Transmittal should be completed and an extra copy of the form should be submitted. If an equivalent of Part B is filed, a request to reapply a previously paid issue fee must be clearly made, and delays in processing may occur due to the difficulty in recognizing the paper as an equivalent of Part B.

III. All communications regarding this application must give the application number. Please direct all communications prior to issuance to Mail Stop ISSUE FEE unless advised to the contrary.

IMPORTANT REMINDER: Utility patents issuing on applications filed on or after Dec. 12, 1980 may require payment of maintenance fees. It is patentee's responsibility to ensure timely payment of maintenance fees when due.

**PART B - FEE(S) TRANSMITTAL**

Complete and send this form, together with applicable fee(s), to: **Mail** **Mail Stop ISSUE FEE**  
**Commissioner for Patents**  
**P.O. Box 1450**  
**Alexandria, Virginia 22313-1450**  
**or Fax** **(571)-273-2885**

**INSTRUCTIONS:** This form should be used for transmitting the ISSUE FEE and PUBLICATION FEE (if required). Blocks 1 through 5 should be completed where appropriate. All further correspondence including the Patent, advance orders and notification of maintenance fees will be mailed to the current correspondence address as indicated unless corrected below or directed otherwise in Block 1, by (a) specifying a new correspondence address; and/or (b) indicating a separate "FEE ADDRESS" for maintenance fee notifications.

CURRENT CORRESPONDENCE ADDRESS (Note: Use Block 1 for any change of address)

Note: A certificate of mailing can only be used for domestic mailings of the Fee(s) Transmittal. This certificate cannot be used for any other accompanying papers. Each additional paper, such as an assignment or formal drawing, must have its own certificate of mailing or transmission.

48789 7590 04/11/2011  
**LAW OFFICES OF BARRY N. YOUNG**  
**200 PAGE MILL ROAD**  
**SUITE 102**  
**PALO ALTO, CA 94306**

**Certificate of Mailing or Transmission**

I hereby certify that this Fee(s) Transmittal is being deposited with the United States Postal Service with sufficient postage for first class mail in an envelope addressed to the Mail Stop ISSUE FEE address above, or being facsimile transmitted to the USPTO (571) 273-2885, on the date indicated below.

(Depositor's name)
(Signature)
(Date)

APPLICATION NO.	FILING DATE	FIRST NAMED INVENTOR	ATTORNEY DOCKET NO.	CONFIRMATION NO.
12/815,930	06/15/2010	Jeffrey P. Wilde	C2393-1101RE2	2344

TITLE OF INVENTION: RECONFIGURABLE OPTICAL ADD-DROP MULTIPLEXERS WITH SERVO CONTROL AND DYNAMIC SPECTRAL POWER MANAGEMENT CAPABILITIES

APPLN. TYPE	SMALL ENTITY	ISSUE FEE DUE	PUBLICATION FEE DUE	PREV. PAID ISSUE FEE	TOTAL FEE(S) DUE	DATE DUE
nonprovisional	NO	\$1510	\$0	\$0	\$1510	07/11/2011

EXAMINER	ART UNIT	CLASS-SUBCLASS
HEALY, BRIAN	2883	385-024000

1. Change of correspondence address or indication of "Fee Address" (37 CFR 1.363).

- Change of correspondence address (or Change of Correspondence Address form PTO/SB/122) attached.  
 "Fee Address" indication (or "Fee Address" Indication form PTO/SB/47; Rev 03-02 or more recent) attached. Use of a Customer Number is required.

2. For printing on the patent front page, list

- (1) the names of up to 3 registered patent attorneys or agents OR, alternatively, 1 \_\_\_\_\_  
 (2) the name of a single firm (having as a member a registered attorney or agent) and the names of up to 2 registered patent attorneys or agents. If no name is listed, no name will be printed. 2 \_\_\_\_\_  
 3 \_\_\_\_\_

3. ASSIGNEE NAME AND RESIDENCE DATA TO BE PRINTED ON THE PATENT (print or type)

PLEASE NOTE: Unless an assignee is identified below, no assignee data will appear on the patent. If an assignee is identified below, the document has been filed for recordation as set forth in 37 CFR 3.11. Completion of this form is NOT a substitute for filing an assignment.

(A) NAME OF ASSIGNEE

(B) RESIDENCE: (CITY and STATE OR COUNTRY)

Please check the appropriate assignee category or categories (will not be printed on the patent):  Individual  Corporation or other private group entity  Government

4a. The following fee(s) are submitted:

- Issue Fee  
 Publication Fee (No small entity discount permitted)  
 Advance Order - # of Copies \_\_\_\_\_

4b. Payment of Fee(s): (Please first reapply any previously paid issue fee shown above)

- A check is enclosed.  
 Payment by credit card. Form PTO-2038 is attached.  
 The Director is hereby authorized to charge the required fee(s), any deficiency, or credit any overpayment, to Deposit Account Number \_\_\_\_\_ (enclose an extra copy of this form).

5. Change in Entity Status (from status indicated above)

- a. Applicant claims SMALL ENTITY status. See 37 CFR 1.27.  b. Applicant is no longer claiming SMALL ENTITY status. See 37 CFR 1.27(g)(2).

NOTE: The Issue Fee and Publication Fee (if required) will not be accepted from anyone other than the applicant; a registered attorney or agent; or the assignee or other party in interest as shown by the records of the United States Patent and Trademark Office.

Authorized Signature \_\_\_\_\_

Date \_\_\_\_\_

Typed or printed name \_\_\_\_\_

Registration No. \_\_\_\_\_

This collection of information is required by 37 CFR 1.311. The information is required to obtain or retain a benefit by the public which is to file (and by the USPTO to process) an application. Confidentiality is governed by 35 U.S.C. 122 and 37 CFR 1.14. This collection is estimated to take 12 minutes to complete, including gathering, preparing, and submitting the completed application form to the USPTO. Time will vary depending upon the individual case. Any comments on the amount of time you require to complete this form and/or suggestions for reducing this burden, should be sent to the Chief Information Officer, U.S. Patent and Trademark Office, U.S. Department of Commerce, P.O. Box 1450, Alexandria, Virginia 22313-1450. DO NOT SEND FEES OR COMPLETED FORMS TO THIS ADDRESS. SEND TO: Commissioner for Patents, P.O. Box 1450, Alexandria, Virginia 22313-1450.

Under the Paperwork Reduction Act of 1995, no persons are required to respond to a collection of information unless it displays a valid OMB control number.





UNITED STATES PATENT AND TRADEMARK OFFICE

UNITED STATES DEPARTMENT OF COMMERCE
United States Patent and Trademark Office
Address: COMMISSIONER FOR PATENTS
P.O. Box 1450
Alexandria, Virginia 22313-1450
www.uspto.gov

Table with 5 columns: APPLICATION NO., FILING DATE, FIRST NAMED INVENTOR, ATTORNEY DOCKET NO., CONFIRMATION NO.
Row 1: 12/815,930, 06/15/2010, Jeffrey P. Wilde, C2393-1101RE2, 2344
Row 2: 48789, 7590, 04/11/2011, (Empty), (Empty)
Row 3: (Empty), (Empty), (Empty), EXAMINER, (Empty)
Row 4: (Empty), (Empty), (Empty), HEALY, BRIAN, (Empty)
Row 5: (Empty), (Empty), (Empty), ART UNIT, PAPER NUMBER
Row 6: (Empty), (Empty), (Empty), 2883, (Empty)

LAW OFFICES OF BARRY N. YOUNG
200 PAGE MILL ROAD
SUITE 102
PALO ALTO, CA 94306

DATE MAILED: 04/11/2011

Determination of Patent Term Extension or Adjustment under 35 U.S.C. 154 (b)

A reissue patent is for "the unexpired part of the term of the original patent." See 35 U.S.C. 251. Accordingly, the above-identified reissue application is not eligible for Patent Term Extension or Adjustment under 35 U.S.C. 154(b).

Any questions regarding the Patent Term Extension or Adjustment determination should be directed to the Office of Patent Legal Administration at (571)-272-7702. Questions relating to issue and publication fee payments should be directed to the Customer Service Center of the Office of Patent Publication at 1-(888)-786-0101 or (571)-272-4200.

## Privacy Act Statement

The Privacy Act of 1974 (P.L. 93-579) requires that you be given certain information in connection with your submission of the attached form related to a patent application or patent. Accordingly, pursuant to the requirements of the Act, please be advised that: (1) the general authority for the collection of this information is 35 U.S.C. 2(b)(2); (2) furnishing of the information solicited is voluntary; and (3) the principal purpose for which the information is used by the U.S. Patent and Trademark Office is to process and/or examine your submission related to a patent application or patent. If you do not furnish the requested information, the U.S. Patent and Trademark Office may not be able to process and/or examine your submission, which may result in termination of proceedings or abandonment of the application or expiration of the patent.

The information provided by you in this form will be subject to the following routine uses:

1. The information on this form will be treated confidentially to the extent allowed under the Freedom of Information Act (5 U.S.C. 552) and the Privacy Act (5 U.S.C. 552a). Records from this system of records may be disclosed to the Department of Justice to determine whether disclosure of these records is required by the Freedom of Information Act.
2. A record from this system of records may be disclosed, as a routine use, in the course of presenting evidence to a court, magistrate, or administrative tribunal, including disclosures to opposing counsel in the course of settlement negotiations.
3. A record in this system of records may be disclosed, as a routine use, to a Member of Congress submitting a request involving an individual, to whom the record pertains, when the individual has requested assistance from the Member with respect to the subject matter of the record.
4. A record in this system of records may be disclosed, as a routine use, to a contractor of the Agency having need for the information in order to perform a contract. Recipients of information shall be required to comply with the requirements of the Privacy Act of 1974, as amended, pursuant to 5 U.S.C. 552a(m).
5. A record related to an International Application filed under the Patent Cooperation Treaty in this system of records may be disclosed, as a routine use, to the International Bureau of the World Intellectual Property Organization, pursuant to the Patent Cooperation Treaty.
6. A record in this system of records may be disclosed, as a routine use, to another federal agency for purposes of National Security review (35 U.S.C. 181) and for review pursuant to the Atomic Energy Act (42 U.S.C. 218(c)).
7. A record from this system of records may be disclosed, as a routine use, to the Administrator, General Services, or his/her designee, during an inspection of records conducted by GSA as part of that agency's responsibility to recommend improvements in records management practices and programs, under authority of 44 U.S.C. 2904 and 2906. Such disclosure shall be made in accordance with the GSA regulations governing inspection of records for this purpose, and any other relevant (i.e., GSA or Commerce) directive. Such disclosure shall not be used to make determinations about individuals.
8. A record from this system of records may be disclosed, as a routine use, to the public after either publication of the application pursuant to 35 U.S.C. 122(b) or issuance of a patent pursuant to 35 U.S.C. 151. Further, a record may be disclosed, subject to the limitations of 37 CFR 1.14, as a routine use, to the public if the record was filed in an application which became abandoned or in which the proceedings were terminated and which application is referenced by either a published application, an application open to public inspection or an issued patent.
9. A record from this system of records may be disclosed, as a routine use, to a Federal, State, or local law enforcement agency, if the USPTO becomes aware of a violation or potential violation of law or regulation.

<b>Notice of Allowability</b>	<b>Application No.</b>	<b>Applicant(s)</b>	
	12/815,930	WILDE ET AL.	
	<b>Examiner</b>	<b>Art Unit</b>	
	BRIAN M. HEALY	2883	

**-- The MAILING DATE of this communication appears on the cover sheet with the correspondence address--**

All claims being allowable, PROSECUTION ON THE MERITS IS (OR REMAINS) CLOSED in this application. If not included herewith (or previously mailed), a Notice of Allowance (PTOL-85) or other appropriate communication will be mailed in due course. **THIS NOTICE OF ALLOWABILITY IS NOT A GRANT OF PATENT RIGHTS.** This application is subject to withdrawal from issue at the initiative of the Office or upon petition by the applicant. See 37 CFR 1.313 and MPEP 1308.

1.  This communication is responsive to the response filed 1/31/2011.
2.  The allowed claim(s) is/are 1-67.
3.  Acknowledgment is made of a claim for foreign priority under 35 U.S.C. § 119(a)-(d) or (f).
  - a)  All    b)  Some\*    c)  None    of the:
    1.  Certified copies of the priority documents have been received.
    2.  Certified copies of the priority documents have been received in Application No. \_\_\_\_\_.
    3.  Copies of the certified copies of the priority documents have been received in this national stage application from the International Bureau (PCT Rule 17.2(a)).

\* Certified copies not received: \_\_\_\_\_.

Applicant has THREE MONTHS FROM THE "MAILING DATE" of this communication to file a reply complying with the requirements noted below. Failure to timely comply will result in ABANDONMENT of this application. **THIS THREE-MONTH PERIOD IS NOT EXTENDABLE.**

4.  A SUBSTITUTE OATH OR DECLARATION must be submitted. Note the attached EXAMINER'S AMENDMENT or NOTICE OF INFORMAL PATENT APPLICATION (PTO-152) which gives reason(s) why the oath or declaration is deficient.
5.  CORRECTED DRAWINGS ( as "replacement sheets") must be submitted.
  - (a)  including changes required by the Notice of Draftsperson's Patent Drawing Review ( PTO-948) attached
    - 1)  hereto or 2)  to Paper No./Mail Date \_\_\_\_\_.
  - (b)  including changes required by the attached Examiner's Amendment / Comment or in the Office action of Paper No./Mail Date \_\_\_\_\_.

Identifying indicia such as the application number (see 37 CFR 1.84(c)) should be written on the drawings in the front (not the back) of each sheet. Replacement sheet(s) should be labeled as such in the header according to 37 CFR 1.121(d).
6.  DEPOSIT OF and/or INFORMATION about the deposit of BIOLOGICAL MATERIAL must be submitted. Note the attached Examiner's comment regarding REQUIREMENT FOR THE DEPOSIT OF BIOLOGICAL MATERIAL.

**Attachment(s)**

- |                                                                                                                                                                                                                                                                                                                                                                                                                                                                |                                                                                                                                                                                                                                                                                                                                                                                                                                      |
|----------------------------------------------------------------------------------------------------------------------------------------------------------------------------------------------------------------------------------------------------------------------------------------------------------------------------------------------------------------------------------------------------------------------------------------------------------------|--------------------------------------------------------------------------------------------------------------------------------------------------------------------------------------------------------------------------------------------------------------------------------------------------------------------------------------------------------------------------------------------------------------------------------------|
| <ol style="list-style-type: none"> <li>1. <input checked="" type="checkbox"/> Notice of References Cited (PTO-892)</li> <li>2. <input type="checkbox"/> Notice of Draftsperson's Patent Drawing Review (PTO-948)</li> <li>3. <input type="checkbox"/> Information Disclosure Statements (PTO/SB/08),<br/>Paper No./Mail Date _____</li> <li>4. <input type="checkbox"/> Examiner's Comment Regarding Requirement for Deposit of Biological Material</li> </ol> | <ol style="list-style-type: none"> <li>5. <input type="checkbox"/> Notice of Informal Patent Application</li> <li>6. <input type="checkbox"/> Interview Summary (PTO-413),<br/>Paper No./Mail Date _____</li> <li>7. <input type="checkbox"/> Examiner's Amendment/Comment</li> <li>8. <input checked="" type="checkbox"/> Examiner's Statement of Reasons for Allowance</li> <li>9. <input type="checkbox"/> Other _____</li> </ol> |
|----------------------------------------------------------------------------------------------------------------------------------------------------------------------------------------------------------------------------------------------------------------------------------------------------------------------------------------------------------------------------------------------------------------------------------------------------------------|--------------------------------------------------------------------------------------------------------------------------------------------------------------------------------------------------------------------------------------------------------------------------------------------------------------------------------------------------------------------------------------------------------------------------------------|

/BRIAN M. HEALY/  
PRIMARY EXAMINER  
ART UNIT: 2883

## DETAILED ACTION

### *Allowable Subject Matter*

1. The following is an examiner's statement of reasons for allowance: The closest references of record are (Note these references were made of record on PTOL-1449) Bouevitch et. al., U.S.P. No. 6,498,872 which teaches (Figs.1-12) an optical device which is used in conjunction with configurable optical add/drop multiplexers (COADM) which includes optical fiber input/output ports 80a,80b,99a,99b which sends wavelength of light which are collimated through lens 90 to spherical reflector 10 which is incident of diffraction grating 20 to MEMS reflector(s) 51,52.which are movable in either the horizontal or vertical directions to return specific wavelengths  $\lambda_1$ ,  $\lambda_2$  to the output ports 3. Bouevitch et. al., U.S.P. No. 6,498,872 does not teach or suggest using channel micromirrors which are both individually and continuously controllable to reflect received spectral channels to any one of the output ports and to control the power of the received spectral channels coupled to the output ports.

2. Additional secondary references Wagener et. al., U.S.P. No. 6,631,222 (Figs.1-4), Jin et. al., U.S.P. No. 6,256,430 (Figs.1-7) and Ma et. al., U.S.P. No. 6,567,574 (Figs.1-12) all teach that at the time the invention was made it was know that pivotable micromirrors or MEMS can be used with wavelength multiplexers to switch or select wavelengths between input and output ports.

3. None of the aforementioned references, either taken alone or in combination with each other, teach or suggest the claimed wavelength separating routing device which includes multiple fiber collimators, a wavelength separator, a beam-focuser and a

Art Unit: 2883

spatial array of channel micro mirrors which are pivotable about two axes and are both individually and continuously controllable to reflect received spectral channels to any one of the output ports and to control the power of the received spectral channels coupled to the output ports. These limitations are recited in amended claim 1.

**Therefore the patentability of amended claim 1 is confirmed.**

4. Dependent claims 2-20 are inclusive of the limitations of amended claim 1, as well as other additionally recited limitations. Please see the dependent claims for the specifics of these additionally recited limitations. **The patentability of dependent claims 2-20 is confirmed.**

5. In addition, none of the aforementioned references, either taken alone or in combination with each other, teach or suggest the claimed servo-based optical apparatus comprising multiple fiber collimators providing multi-wavelength optical signal and a plurality of output ports, a wavelength separator, a beam focuser, a spatial array of individually controllable channel micromirrors and a servo-control assembly in communication with the channel micromirrors and the output ports for maintaining a predetermined coupling of each reflected spectral channels into one of the output ports.

6. These limitations are recited in original claim 21. **Therefore the patentability of original claim 21 is confirmed.**

7. Dependent claims 22-30 are inclusive of the limitations of original claim 21, as well as other additionally recited limitations. Please see the dependent claims for the specifics of these additionally recited limitations. **The patentability of dependent claims 22-30 is confirmed.**

8. In addition, none of the aforementioned references, either taken alone or in combination with each other, teach or suggest the claimed optical apparatus comprising: an array of fiber collimators providing multi-wavelength optical signal and a plurality of output ports, a wavelength separator, a beam focuser, a spatial array of individually controllable channel micromirrors being individually and continuously controllable to reflect spectral channels into selected ones of output ports and a one-dimensional (or two dimensional) array of collimator-alignment mirrors for adjusting an alignment of multi-wavelength optical signal from the input port and directing spectral channels into the output ports. These limitations are recited in original claim 31 (and original claim 37 is the same as that of claim 31 except has a two-dimensional array of collimator-alignment mirrors). **Therefore the patentability of original claims 31 and 37 is confirmed.**

9. Dependent claims 32-36 and 38-43 are inclusive of the limitations of original claim 31 and 37, as well as other additionally recited limitations. Please see the dependent claims for the specifics of these additionally recited limitations. **The patentability of dependent claims 32-36 and 38-43 is confirmed.**

10. The limitation of independent amended claim 44 is similar to that of claim 1 with the addition of a plurality of output ports including a pass-through port and one or more drop points. **Therefore the patentability of amended claim 44 is confirmed.**

11. Dependent claims 45-60 are inclusive of the limitations of amended claim 44, as well as other additionally recited limitations. Please see the dependent claims for the

specifics of these additionally recited limitations. **The patentability of dependent claims 45-60 is confirmed.**

12. In addition, none of the aforementioned references, either taken alone or in combination with each other, teach or suggest the claimed method of performing dynamic wavelength separating and routing comprising: receiving a multi-wavelength optical signal from an input port, separating the multi-wavelength optical signal into multiple spectral channels, focusing the spectral channels onto a spatial array of corresponding beam-deflecting elements whereby each beam deflecting element receives one of the spectral channels, dynamically and continuously controlling the beam-deflecting elements in two dimensions to direct the spectral channels into any selected ones of the output ports and to control the power of the spectral channels coupled into the selected output ports. These limitations are recited in amended claim 61. **Therefore the patentability of amended claim 61 is confirmed.**

13. Dependent claims 62-67 are inclusive of the limitations of amended claim 61, as well as other additionally recited limitations. Please see the dependent claims for the specifics of these additionally recited limitations. **The patentability of dependent claims 62-67 is confirmed.**

14. Please note that Applicant has cancelled or omitted newly submitted claim 68 in response to the previous office action. See the remarks of 1.31/2010.

Any comments considered necessary by applicant must be submitted no later than the payment of the issue fee and, to avoid processing delays, should preferably

accompany the issue fee. Such submissions should be clearly labeled "Comments on Statement of Reasons for Allowance."

The oath or declaration, filed 01/31/2010 is sufficient to overcome the rejection of claims based on 35 U.S.C. 251. See previous office action.

This reissue application is a reissue of U.S. Patent Application 11/027,586, filed 12/31/2004, now RE39,397, which is a Reissue of U.S. Patent Application, filed 08/23/2001, now U.S.P. No. 6,625,346 which claims the benefit of 60/277,217.

The references which were made of record in RE39,397, will also be made of record in the present Application.

Any inquiry concerning this communication or earlier communications from the examiner should be directed to BRIAN M. HEALY whose telephone number is (571)272-2347. The examiner can normally be reached on M-F 6AM-5PM.

If attempts to reach the examiner by telephone are unsuccessful, the examiner's supervisor, Mark Robinson can be reached on (571)272-2319. The fax phone number for the organization where this application or proceeding is assigned is 571-273-8300.



Application/Control Number: 12/815,930  
Art Unit: 2883

Page 7

Information regarding the status of an application may be obtained from the Patent Application Information Retrieval (PAIR) system. Status information for published applications may be obtained from either Private PAIR or Public PAIR. Status information for unpublished applications is available through Private PAIR only. For more information about the PAIR system, see <http://pair-direct.uspto.gov>. Should you have questions on access to the Private PAIR system, contact the Electronic Business Center (EBC) at 866-217-9197 (toll-free). If you would like assistance from a USPTO Customer Service Representative or access to the automated information system, call 800-786-9199 (IN USA OR CANADA) or 571-272-1000.

**/BRIAN M. HEALY/  
Primary Examiner  
Art Unit 2883**

<b>Notice of References Cited</b>	Application/Control No. 12/815,930	Applicant(s)/Patent Under Reexamination WILDE ET AL.	
	Examiner BRIAN M. HEALY	Art Unit 2883	Page 1 of 1

**U.S. PATENT DOCUMENTS**

*		Document Number Country Code-Number-Kind Code	Date MM-YYYY	Name	Classification
*	A	US-6,625,346	09-2003	Wilde, Jeffrey P.	385/24
*	B	US-5,629,790	05-1997	Neukermans et al.	359/198.1
*	C	US-5,835,458	11-1998	Bischel et al.	369/44.12
*	D	US-5,960,133	09-1999	Tomlinson, W. John	385/18
*	E	US-5,974,207	10-1999	Aksyuk et al.	385/24
*	F	US-6,204,946	03-2001	Aksyuk et al.	398/9
*	G	US-6,205,269	03-2001	Morton, Paul A.	385/24
*	H	US-6,222,954	04-2001	Riza, Nabeel Agha	385/18
*	I	US-6,263,135	07-2001	Wade, Robert Kent	385/37
*	J	US-6,289,155	09-2001	Wade, Robert Kent	385/37
*	K	US-6,418,250	07-2002	Corbosiero et al.	385/24
*	L	US-2002/0131691 A1	09-2002	Garrett et al.	385/24
*	M	US-2003/0043471 A1	03-2003	Belser et al.	359/634

**FOREIGN PATENT DOCUMENTS**

*		Document Number Country Code-Number-Kind Code	Date MM-YYYY	Country	Name	Classification
	N					
	O					
	P					
	Q					
	R					
	S					
	T					

**NON-PATENT DOCUMENTS**

*		Include as applicable: Author, Title Date, Publisher, Edition or Volume, Pertinent Pages)
	U	
	V	
	W	
	X	

\*A copy of this reference is not being furnished with this Office action. (See MPEP § 707.05(a).)  
Dates in MM-YYYY format are publication dates. Classifications may be US or foreign.

<b>Application Number</b> 	Application No. 12/815,930	Applicant(s) Wilde et al.
	Notice of Reissue Published in OG on 08/03/10	
Original Patent Number of Patent To Be Reissued is RE39397		The Maintenance fee status is: <input checked="" type="checkbox"/> up to date. <input type="checkbox"/> not required.
This reissue patent is subject to A Terminal Disclaimer that: <input type="checkbox"/> was filed during the prosecution of the reissue application. <input type="checkbox"/> was of record prior to the filing of the reissue application.		
Physical surrender of the letters patent <input type="checkbox"/> was made. <input type="checkbox"/> was not made, but a statement of loss/inaccessibility was provided. <input checked="" type="checkbox"/> is not required		

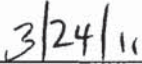
<b>Final SPRE Review</b>  <hr/> (INITIALS)
 <hr/> (DATE)

U.S. Patent and Trademark Office



<b>Index of Claims</b> 	<b>Application/Control No.</b> 12815930	<b>Applicant(s)/Patent Under Reexamination</b> WILDE ET AL.
	<b>Examiner</b> BRIAN M HEALY	<b>Art Unit</b> 2883

✓	<b>Rejected</b>	-	<b>Cancelled</b>	N	<b>Non-Elected</b>	A	<b>Appeal</b>
=	<b>Allowed</b>	÷	<b>Restricted</b>	I	<b>Interference</b>	O	<b>Objected</b>

Claims renumbered in the same order as presented by applicant
  CPA
  T.D.
  R.1.47

CLAIM		DATE								
Final	Original	10/22/2010	12/29/2010	02/15/2011						
1	1	✓	✓	=						
2	2	✓	✓	=						
3	3	✓	✓	=						
4	4	✓	✓	=						
5	5	✓	✓	=						
6	6	✓	✓	=						
7	7	✓	✓	=						
8	8	✓	✓	=						
9	9	✓	✓	=						
10	10	✓	✓	=						
11	11	✓	✓	=						
12	12	✓	✓	=						
13	13	✓	✓	=						
14	14	✓	✓	=						
15	15	✓	✓	=						
16	16	✓	✓	=						
17	17	✓	✓	=						
18	18	✓	✓	=						
19	19	✓	✓	=						
20	20	✓	✓	=						
21	21	✓	✓	=						
22	22	✓	✓	=						
23	23	✓	✓	=						
24	24	✓	✓	=						
25	25	✓	✓	=						
26	26	✓	✓	=						
27	27	✓	✓	=						
28	28	✓	✓	=						
29	29	✓	✓	=						
30	30	✓	✓	=						
31	31	✓	✓	=						
32	32	✓	✓	=						
33	33	✓	✓	=						
34	34	✓	✓	=						
35	35	✓	✓	=						
36	36	✓	✓	=						

<b>Index of Claims</b> 	<b>Application/Control No.</b> 12815930	<b>Applicant(s)/Patent Under Reexamination</b> WILDE ET AL.
	<b>Examiner</b> BRIAN M HEALY	<b>Art Unit</b> 2883

✓	<b>Rejected</b>	-	<b>Cancelled</b>	N	<b>Non-Elected</b>	A	<b>Appeal</b>
=	<b>Allowed</b>	+	<b>Restricted</b>	I	<b>Interference</b>	O	<b>Objected</b>

Claims renumbered in the same order as presented by applicant
  CPA
  T.D.
  R.1.47

CLAIM		DATE							
Final	Original	10/22/2010	12/29/2010	02/15/2011					
37	37	✓	✓	=					
38	38	✓	✓	=					
39	39	✓	✓	=					
40	40	✓	✓	=					
41	41	✓	✓	=					
42	42	✓	✓	=					
43	43	✓	✓	=					
44	44	✓	✓	=					
45	45	✓	✓	=					
46	46	✓	✓	=					
47	47	✓	✓	=					
48	48	✓	✓	=					
49	49	✓	✓	=					
50	50	✓	✓	=					
51	51	✓	✓	=					
52	52	✓	✓	=					
53	53	✓	✓	=					
54	54	✓	✓	=					
55	55	✓	✓	=					
56	56	✓	✓	=					
57	57	✓	✓	=					
58	58	✓	✓	=					
59	59	✓	✓	=					
60	60	✓	✓	=					
61	61	✓	✓	=					
62	62	✓	✓	=					
63	63	✓	✓	=					
64	64	✓	✓	=					
65	65	✓	✓	=					
66	66	✓	✓	=					
67	67	✓	✓	=					
	68	✓	✓	-					

<b>Search Notes</b>  	<b>Application/Control No.</b>  12815930	<b>Applicant(s)/Patent Under Reexamination</b>  WILDE ET AL.
	<b>Examiner</b>  BRIAN M HEALY	<b>Art Unit</b>  2883

<b>SEARCHED</b>			
<b>Class</b>	<b>Subclass</b>	<b>Date</b>	<b>Examiner</b>
385	24,11,37,34	10/22/2010	/BH/
	UPDATE:(SAME AS ABOVE)	2/15/2011	/BH/

<b>SEARCH NOTES</b>			
<b>Search Notes</b>		<b>Date</b>	<b>Examiner</b>
SEARCHED"EAST"(prior art)(SEARCH TERMS, CLASS/SUBCLASSES AND DATABASES USED ARE LISTED ON printout)		10/22/2010	/BH/
UPDATE"EAST" (prior art and interference)(SAME AS ABOVE)		2/15/2011	/BH/
PALM INVENTOR'S SEARCH		2/15/2011	/BH/
STIC LITIGATION SEARCH			
Consulted USP RE39,397 and USP No.6,625,346.		2/15/2011	/BH/
STIC LITIGATION SEARCH (NO LITIGATION FOUND)		2/16/2011	/BH/

<b>INTERFERENCE SEARCH</b>			
<b>Class</b>	<b>Subclass</b>	<b>Date</b>	<b>Examiner</b>
385	24,11,37,34	2/15/2011	/BH/

--	--

**UNITED STATES PATENT AND TRADEMARK OFFICE**

UNITED STATES DEPARTMENT OF COMMERCE  
 United States Patent and Trademark Office  
 Address: COMMISSIONER FOR PATENTS  
 P.O. Box 1450  
 Alexandria, Virginia 22313-1450  
 www.uspto.gov

**BIB DATA SHEET**
**CONFIRMATION NO. 2344**

SERIAL NUMBER	FILING or 371(c) DATE RULE	CLASS	GROUP ART UNIT	ATTORNEY DOCKET NO. C2393-1101RE2		
12/815,930	06/15/2010	385	2883			
<b>APPLICANTS</b> Jeffrey P. Wilde, Morgan Hill, CA; Joseph E. Davis, Morgan Hill, CA;						
<b>** CONTINUING DATA *****</b> This application is a REI of 11/027,586 12/31/2004 PAT R,E39,397 which is a REI of 09/938,426 08/23/2001 PAT 6,625,346 which claims benefit of 60/277,217 03/19/2001						
<b>** FOREIGN APPLICATIONS *****</b>						
<b>** IF REQUIRED, FOREIGN FILING LICENSE GRANTED **</b> 07/02/2010						
Foreign Priority claimed <input type="checkbox"/> Yes <input checked="" type="checkbox"/> No 35 USC 119(a-d) conditions met <input type="checkbox"/> Yes <input checked="" type="checkbox"/> No Verified and Acknowledged <u>/BRIAN HEALY/</u> Examiner's Signature		<input type="checkbox"/> Met after Allowance Initials	<b>STATE OR COUNTRY</b> CA	<b>SHEETS DRAWINGS</b> 12	<b>TOTAL CLAIMS</b> 68	<b>INDEPENDENT CLAIMS</b> 7
<b>ADDRESS</b> LAW OFFICES OF BARRY N. YOUNG 200 PAGE MILL ROAD SUITE 102 PALO ALTO, CA 94306 UNITED STATES						
<b>TITLE</b> Reconfigurable Optical Add-Drop Multiplexers with Servo Control and Dynamic Spectral Power Management Capabilities						
<b>FILING FEE RECEIVED</b> 4896	FEES: Authority has been given in Paper No. _____ to charge/credit DEPOSIT ACCOUNT No. _____ for following:		<input type="checkbox"/> All Fees <input type="checkbox"/> 1.16 Fees (Filing) <input type="checkbox"/> 1.17 Fees (Processing Ext. of time) <input type="checkbox"/> 1.18 Fees (Issue) <input type="checkbox"/> Other _____ <input type="checkbox"/> Credit			





# EIC 2800 SEARCH REPORT



**STIC Database Tracking Number: 356224**

**To: BRIAN HEALY**  
**Location: JEF-4D05**  
**Art Unit: 2883**  
**Wednesday, February 16, 2011**  
  
**Case Serial Number: 11/027586**

**From: DIANE JACKSON**  
**Location: EIC2800**  
**JEF-4B68**  
**Phone: (571)272-3260**  
  
**diane.jackson@uspto.gov**

## Search Notes

**Hi,**

**Attached are litigation search results in Lexis Nexis, and CourtLink and Q-Pat/Orbit.**

**No Litigation was found for Serial Number 11/027586 – Patents RE39397 and 6625346.**

**If you have any questions, please feel free to contact me.**

**Thanks,**

**Diane**

356224

Jackson, Diane

From: Healy, Brian

FEB 16 2011

Sent: Tuesday, February 15, 2011 10:28 AM

To: STIC-EIC2800

Subject: Need litigation search for reissue 11/027,586 corresponding to PAT Re39,397 which is a reissue of 09/938,426, now USP 6,625,346

Dear Sir or Madam, My name is Brian Healy (employee No 62975) and I am a Primary Examiner working on a reissue. I Need a litigation search for reissue 11/027,586 corresponding to PAT Re39,397 which is a reissue of 09/938,426, now USP 6,625,346. Thanks, Brian Healy, Primary Examiner, Art Unit: 2883 (571) 272-2347

RE 39,397  
6,625,346

2/15/2011

**Healy, Brian**

---

**From:** Jackson, Diane  
**Sent:** Wednesday, February 16, 2011 9:34 AM  
**To:** Healy, Brian  
**Subject:** Litigation Search Results for 11/027586 - Patents RE39397 and 6625346 - Nothing found ...Please see attached pdf - Thank you for using your EIC2800!  
**Attachments:** Litigation11027586.pdf..pdf

Hi Examiner HEALY,

Attached as a pdf are your Litigation Search Results for 11/027586 - Patents RE39397 and 6625346.

Thanks again for using your EIC2800!

Diane Jackson  
United States Patent and Trademark Office  
EIC 2800 - Jefferson 4B68 (STIC)  
Technical Information Specialist  
571-272-2540 [diane.jackson@uspto.gov](mailto:diane.jackson@uspto.gov)

2/16/2011

Application Number Information

Application Number: 11/027586 [Assignments](#)  
 Filing or 371(c) Date: 12/31/2004 [eDan](#)  
 Effective Date: 12/31/2004  
 Application Received: 01/03/2005  
 Patent Number: [RE39397](#)  
 Issue Date: 11/14/2006  
 Date of Abandonment: 00/00/0000  
 Attorney Docket Number: C2393-1101  
 Status: 150 / PATENTED CASE  
 Confirmation Number: 5930  
 Title of Invention: RECONFIGURABLE OPTICAL ADD-DROP MULTIPLEXERS WITH SERVO CONTROL AND DYNAMIC SPECTRAL POWER MANAGEMENT CAPABILITIES

Examiner Number: 62975 / [HEALY, BRIAN](#)  
 Group Art Unit: 2883 [JFW Madras](#)  
 Class/Subclass: 385/024.000  
 Lost Case: NO  
 Interference Number:  
 Unmatched Petition: NO  
 L&R Code: Secrecy Code:1  
 Third Level Review: NO  
 Secrecy Order: NO  
 Status Date: 10/25/2006  
 Oral Hearing: NO

Bar Code	PALM Location	Location Date	Charge to Loc	Charge to Name	Employee Name	Location
----------	---------------	---------------	---------------	----------------	---------------	----------

Appln Info	Contents	Petition Info	Atty/Agent Info	Continuity/Reexam	Foreign Data	Inventors	Address	Fees	Post Info	Pre.G
------------	----------	---------------	-----------------	-------------------	--------------	-----------	---------	------	-----------	-------

Search Another: Application #   or Patent#

PCT /  /   or PG PUBS #

Attorney Docket #

Bar Code #

To go back, right click here and select Back. To go forward, right click here and select Forward. To refresh, right click here and select Refresh.  
 Back to [OASIS](#) Home page

[http://EXPWEB1:8001/cgi-bin/expo/GenInfo/snquery.pl?APPL\\_ID=11027586](http://EXPWEB1:8001/cgi-bin/expo/GenInfo/snquery.pl?APPL_ID=11027586)

# Continuity/Reexam Information for 11/027586

### Parent Data

11027586, filed 12/31/2004 is a reissue of 09938426, filed 08/23/2001, now U.S. Patent #6625346 and having 1 RCE-type filing therein  
09938426 Claims Priority from Provisional Application 60277217, filed 03/19/2001

### Child Data

12815930, filed on 06/15/2010 is a reissue of 11027586, filed on 12/31/2004

Appln Info	Contents	Petition Info	Atty/Agent Info	Continuity/Reexam	Foreign Data	Inventors	Address	Fees	Post Info	Pre G
------------	----------	---------------	-----------------	-------------------	--------------	-----------	---------	------	-----------	-------

Search Another: Application #   or Patent#

PCT /  /   or PG PUBS #

Attorney Docket #

Bar Code #

To go back, right click here and select Back. To go forward, right click here and select Forward. To refresh, right click here and select Refresh.  
Back to [OASIS](#) Home page

Application Number Information

Application Number Information

Application Number: 09/938426 [Order This File](#) [Assignments](#)  
 Filing or 371(c) Date: 08/23/2001 [eDan](#)  
 Effective Date: 08/23/2001  
 Application Received: 08/27/2001  
 Pat. Num./Pub. Num: 6625346/20020131687  
 Issue Date: 09/23/2003  
 Date of Abandonment: 00/00/0000  
 Attorney Docket Number: 210393-991101  
 Status: 150 /PATENTED CASE  
 Confirmation Number: 2587  
 Title of Invention: RECONFIGURABLE OPTICAL ADD-DROP MULTIPLEXERS WITH SERVO CONTROL AND DYNAMIC SPECTRAL POWER MANAGEMENT CAPABILITIES

Examiner Number: 62975 /[HEALY, BRIAN](#)  
 Group Art Unit: 2874  
 Class/Subclass: 385/024.000  
 Lost Case: NO  
 Interference Number:  
 Unmatched Petition: NO  
 L&R Code: Secrecy Code:1  
 Third Level Review: NO

Secrecy Order: NO  
 Status Date: 09/04/2003

Oral Hearing: NO

Bar Code	PALM Location	Location Date	Charge to Loc	Charge to Name	Employee Name	Location
09938426	9200	11/23/2009	No Charge to Location	No Charge to Name	SIDDIOU VIOAR	

Appln Info [Contents](#) [Petition Info](#) [Atty/Agent Info](#) [Continuity/Reexam](#) [Foreign Data](#) [Inventors](#) [Address](#) [Fees](#) [Post Info](#) [Pre C](#)

Search Another: Application #   or Patent#    
 PCT /  /   or PG PUBS #    
 Attorney Docket #    
 Bar Code #

To go back, right click here and select Back. To go forward, right click here and select Forward. To refresh, right click here and select Refresh.  
 Back to [QASIS](#) Home page

[http://EXPWEB1:8001/cgi-bin/expo/GenInfo/snquery.pl?APPL\\_ID=09938426](http://EXPWEB1:8001/cgi-bin/expo/GenInfo/snquery.pl?APPL_ID=09938426)

**Single Search - with Terms and Connectors**

Enter keywords - Search multiple dockets & documents



[View Demo](#)  
[Search Tips](#)

[My CourtLink](#)

[Search](#)

[Dockets & Documents](#)

[Track](#)

[Alert](#)

[Strategic Profiles](#)

[My Account](#)



[Search](#) > [Patent Search](#) > Searching

Patent Search RE39397 2/16/2011

No cases found.

[Return to Search](#)

(Charges for search still apply)



[About LexisNexis](#) | [Terms & Conditions](#) | [Pricing](#) | [Privacy](#) | [Customer Support](#) - 1-888-311-1966  
Copyright © 2011 LexisNexis®. All rights reserved.

<b>My Lexis™</b>	<b>Search</b>	<b>Get a Document</b>	<b>Shepard's®</b>	<b>More</b>	<b>History</b>	<b>Alerts</b>
<b>All</b>	<b>Legal</b>	<b>News &amp; Business</b>	<b>Public Records</b>	<b>Find A Source</b>	Add/Edit Subtabs	

Legal > Area of Law - By Topic > Patent Law > Find Patents > Utility, Design and Plant Patents

**Search** View Tutorial | Help

**Broaden this search with additional sources**

**Utility, Design and Plant Patents** (Source you selected)

Chisum on Patents

Patent Law Digest

Patent Case Management Judicial Guide

Intellectual Property Counseling and Litigation

Court of Appeals for the Federal Circuit Practice & Procedure

[View all sources](#)

**Select Search Type and Enter Search Terms**

<b>Terms &amp; Connectors</b>	(RE39397 or RE39,397) or (RE or REissu!) w/3 (39397 or 39,397)	<input type="button" value="Suggest terms for my search"/>
Natural Language		<input type="button" value="Check spelling"/>
Easy Search™		
Semantic Search What's this?		

**Restrict by Document Segment**

Select a document segment, enter search terms for the segment, then click Add.

Select a Segment

**Note:** Segment availability differs between sources. Segments may not be applied consistently across sources.

**Restrict by Date**

No Date Restrictions  From  To  Date formats...

---

<p><b>Search Connectors</b></p> <table border="0"> <tr><td>and</td><td>and</td><td>w/p</td><td>in same paragraph</td></tr> <tr><td>or</td><td>or</td><td>w/seg</td><td>in same segment</td></tr> <tr><td>w/N</td><td>within N words</td><td>w/s</td><td>in same sentence</td></tr> <tr><td>pre/N</td><td>precedes by N words</td><td>and not</td><td>and not</td></tr> </table> <p><a href="#">More Connectors &amp; Commands...</a></p>	and	and	w/p	in same paragraph	or	or	w/seg	in same segment	w/N	within N words	w/s	in same sentence	pre/N	precedes by N words	and not	and not	<p><b>How Do I...?</b></p> <p>Combine sources? Restrict by date? Restrict by document segment? Use wildcards as placeholders for one or more characters in a search term?</p> <p><a href="#">View Tutorials</a></p>
and	and	w/p	in same paragraph														
or	or	w/seg	in same segment														
w/N	within N words	w/s	in same sentence														
pre/N	precedes by N words	and not	and not														

In



<a href="#">My Lexis™</a>	<a href="#">Search</a>	<a href="#">Get a Document</a>	<a href="#">Shepard's®</a>	<a href="#">More</a>	<a href="#">History</a>	<a href="#">Alerts</a>
---------------------------	------------------------	--------------------------------	----------------------------	----------------------	-------------------------	------------------------

FOCUS™ Terms  Search Within   Using Semantic Concepts  
 What's this? [Advanced...](#)

[View Tutorial](#)

Source: [Legal > Area of Law - By Topic > Patent Law > Find Patents > Utility, Design and Plant Patents](#) [\[i\]](#)  
 Terms: **(RE39397 or RE39,397) or (RE or REIssu!) w/3 (39397 or 39,397)** ([Edit Search](#) | [Suggest Terms for My Search](#))

Select for FOCUS™ or Delivery

027586 (11) RE 39397 November 14, 2006

UNITED STATES PATENT AND TRADEMARK OFFICE GRANTED PATENT

**RE 39397**

Get Drawing Sheet 1 of 12  
 Access PDF of Official Patent \*  
 Order Patent File History / Wrapper from REEDFAX®  
 Link to Claims Section

November 14, 2006

Reconfigurable optical add-drop multiplexers with servo control and dynamic spectral power management capabilities

**INVENTOR:** Wilde, Jeffrey P. - Morgan Hill, California, United States (US) Davis, Joseph E. - Morgan Hill, California, United States (US)

**APPL-NO:** 027586 (11)

**FILED-DATE:** December 31, 2004

**GRANTED-DATE:** November 14, 2006

**ASSIGNEE-AT-ISSUE:** Capella Photonics, Inc., San Jose, California, United States (US), United States company or corporation (02)

**ASSIGNEE-AFTER-ISSUE:** May 5, 2009 - SECURITY AGREEMENT, SILICON VALLEY BANK 3003 TASMAN DRIVE SANTA CLARA CALIFORNIA 95054, Reel and Frame Number: 022641/0593  
 July 9, 2009 - SECURITY AGREEMENT, TEATON CAPITAL COMPANY 3000 SAND HILL ROAD, SUITE 3-210 MENLO PARK CALIFORNIA 94025, Reel and Frame Number: 022932/0669

**LEGAL-REP:** Young, Barry N. -

**PUB-TYPE:** November 14, 2006 - Reissue Patent (E1)

**PUB-COUNTRY:** United States (US)

**REL-DATA:**  
 Reissue of: 09938426, August 23, 2001, GRANTED PATENT 06625346, September 23, 2003  
 Provisional Application Ser. No. 60277217, March 19, 2001, PENDING

**US-MAIN-CL:** 385#24

[My Lexis™](#) | 
 [Search](#) | 
 [Get a Document](#) | 
 [Shepard's®](#) | 
 [More](#) | 
 [History](#) | 
 [Alerts](#)

[All](#) | 
 [Legal](#) | 
 [News & Business](#) | 
 [Public Records](#) | 
 [Find A Source](#) | 
 [Add/Edit Subtabs](#)

Legal > Area of Law - By Topic > Patent Law > Find Cases > Intellectual Property Cases, Administrative Decisions & Regulations [i](#)

Search [View Tutorial](#) | [Help](#)

**Broaden this search with additional sources**

- Intellectual Property Cases, Administrative Decisions & Regulations [i](#) (Source you selected)
  - Chisum on Patents [i](#)
  - Patent Law Digest [i](#)
  - Patent Case Management Judicial Guide [i](#)
  - Intellectual Property Counseling and Litigation [i](#)
  - Court of Appeals for the Federal Circuit Practice & Procedure [i](#)
- [View all sources](#)

**Select Search Type and Enter Search Terms**

<b>Terms &amp; Connectors</b>	(RE39397 or RE39,397) or (RE or REIssu!) w/3 (39397 or 39,397)
Natural Language	
Easy Search™	

Suggest terms for my search

Check spelling

**Restrict by Document Segment**

Select a document segment, enter search terms for the segment, then click Add.

Select a Segment

**Note:** Segment availability differs between sources. Segments may not be applied consistently across sources.

**Restrict by Date**

No Date Restrictions 
  From  To  Date formats...

**Search Connectors**

and	and	w/p	in same paragraph
or	or	w/seg	in same segment
w/N	within N words	w/s	in same sentence
pre/N	precedes by N words	and not	and not

[More Connectors & Commands...](#)

**How Do I...?**

[Combine sources?](#)  
[Restrict by date?](#)  
[Restrict by document segment?](#)  
[Use wildcards as placeholders for one or more characters in a search term?](#)  
[View Tutorials](#)

In

[About LexisNexis](#) | 
 [Privacy Policy](#) | 
 [Terms & Conditions](#) | 
 [Contact Us](#)  
 Copyright © 2011 LexisNexis, a division of Reed Elsevier Inc. All rights reserved.

**No Documents Found**

No documents were found for your search terms  
"(RE39397 or RE39,397) or (RE or REissu!) w/3 (39397 or 39,397)"

Click "Save this search as an Alert" to schedule your search to run in the future.

- OR -

Click "Edit Search" to return to the search form and modify your search.

Suggestions:

- Check for spelling errors.
- Remove some search terms.
- Use more common search terms, such as those listed in "Suggested Words and Concepts."
- Use a less restrictive date range.

| [Save this Search as an Alert](#) || [Edit Search](#) |

In

[About LexisNexis](#) | [Privacy Policy](#) | [Terms & Conditions](#) | [Contact Us](#)  
Copyright © 2011 LexisNexis, a division of Reed Elsevier Inc. All rights reserved.

<b>My Lexis™</b>	<b>Search</b>	<b>Get a Document</b>	<b>Shepard's®</b>	<b>More</b>	<b>History</b>	<b>Alerts</b>
------------------	---------------	-----------------------	-------------------	-------------	----------------	---------------

**All**   **Legal**   **News & Business**   **Public Records**   **Find A Source**   Add/Edit Subtabs

Legal > Federal Legal - U.S. > Find Statutes, Regulations, Administrative Materials & Court Rules > Administrative Agency Materials > Federal Agency Decisions, Combined [i](#)

Search View Tutorial | Help

**Broaden this search with additional sources**

- Federal Agency Decisions, Combined** [i](#) (Source you selected)
- Jury Verdicts and Settlements, Combined [i](#)
- LexisNexis Jury Verdicts and Settlements [i](#)
- U.S. Supreme Court Briefs [i](#)
- Martindale-Hubbell(R) Listings, All [i](#)
- Martindale-Hubbell(R) Law Directory - U.S. Government Attorney Profiles [i](#)

[View all sources](#)

**Select Search Type and Enter Search Terms**

Terms & Connectors	(RE39397 or RE39,397) or (RE or REIssu!) w/3 (39397 or 39,397)
Natural Language	
Easy Search™	

Suggest terms for my search

**Search**

Check spelling

**Restrict by Document Segment**

Select a document segment, enter search terms for the segment, then click Add.

**Note:** Segment availability differs between sources. Segments may not be applied consistently across sources.

**Restrict by Date**

From  To  [Date formats...](#)

**Search Connectors**

- |       |                     |         |                   |
|-------|---------------------|---------|-------------------|
| and   | and                 | w/p     | in same paragraph |
| or    | or                  | w/seg   | in same segment   |
| w/N   | within N words      | w/s     | in same sentence  |
| pre/N | precedes by N words | and not | and not           |

[More Connectors & Commands...](#)

**How Do I...?**

- Combine sources?
- Restrict by date?
- Restrict by document segment?
- Use wildcards as placeholders for one or more characters in a search term?

[View Tutorials](#)

In

[About LexisNexis](#) | [Privacy Policy](#) | [Terms & Conditions](#) | [Contact Us](#)  
 Copyright © 2011 LexisNexis, a division of Reed Elsevier Inc. All rights reserved.

**No Documents Found**

No documents were found for your search terms  
"(RE39397 or RE39,397) or (RE or REissu!) w/3 (39397 or 39,397)"

Click "Save this search as an Alert" to schedule your search to run in the future.

- OR -

Click "Edit Search" to return to the search form and modify your search.

Suggestions:

- Check for spelling errors.
- Remove some search terms.
- Use more common search terms, such as those listed in "Suggested Words and Concepts."
- Use a less restrictive date range.

| [Save this Search as an Alert](#) || [Edit Search](#) |

In

[About LexisNexis](#) | [Privacy Policy](#) | [Terms & Conditions](#) | [Contact Us](#)  
Copyright © 2011 LexisNexis, a division of Reed Elsevier Inc. All rights reserved.

<b>My Lexis™</b>	<b>Search</b>	<b>Get a Document</b>	<b>Shepard's®</b>	<b>More</b>	<b>History</b>	<b>Alerts</b>
<b>All</b>	<b>Legal</b>	<b>News &amp; Business</b>	<b>Public Records</b>	<b>Find A Source</b>	<small>Add/Edit Subtabs</small>	

Legal > / . . . / > Legal US News, All

[View Tutorial](#) | [Help](#)

**Search**

Select Search Type and Enter Search Terms

<b>Terms &amp; Connectors</b>	(RE39397 or RE39,397) or (RE or REissu!) w/3 (39397 or 39,397)	<input type="button" value="Search"/>	<input type="button" value="Suggest terms for my search"/>
Natural Language			<input type="button" value="Check spelling"/>
Easy Search™			

**Restrict by Document Segment**

Select a document segment, enter search terms for the segment, then click Add.

Note: Segment availability differs between sources. Segments may not be applied consistently across sources.

**Restrict by Date**

From  To  Date formats...

---

<p><b>Search Connectors</b></p> <table style="width: 100%;"> <tr> <td>and</td><td>and</td><td>w/p</td><td>in same paragraph</td> </tr> <tr> <td>or</td><td>or</td><td>w/seg</td><td>in same segment</td> </tr> <tr> <td>w/N</td><td>within N words</td><td>w/s</td><td>in same sentence</td> </tr> <tr> <td>pre/N</td><td>precedes by N words</td><td>and not</td><td>and not</td> </tr> </table> <p><a href="#">More Connectors &amp; Commands...</a></p>	and	and	w/p	in same paragraph	or	or	w/seg	in same segment	w/N	within N words	w/s	in same sentence	pre/N	precedes by N words	and not	and not	<p><b>How Do I...?</b></p> <p>Combine sources?  Restrict by date?  Restrict by document segment?  Use wildcards as placeholders for one or more characters in a search term?</p> <p><a href="#">View Tutorials</a></p>
and	and	w/p	in same paragraph														
or	or	w/seg	in same segment														
w/N	within N words	w/s	in same sentence														
pre/N	precedes by N words	and not	and not														

In

**No Documents Found**

No documents were found for your search terms  
**"(RE39397 or RE39,397) or (RE or REissu!) w/3 (39397 or 39,397)"**

Click "Save this search as an Alert" to schedule your search to run in the future.

- OR -

Click "Edit Search" to return to the search form and modify your search.

Suggestions:

- Check for spelling errors.
- Remove some search terms.
- Use more common search terms, such as those listed in "Suggested Words and Concepts."
- Use a less restrictive date range.

| [Save this Search as an Alert](#) || [Edit Search](#) |

in

[About LexisNexis](#) | [Privacy Policy](#) | [Terms & Conditions](#) | [Contact Us](#)  
Copyright © 2011 LexisNexis, a division of Reed Elsevier Inc. All rights reserved.

<a href="#">My Lexis™</a>	<a href="#">Search</a>	<a href="#">Get a Document</a>	<a href="#">Shepard's®</a>	<a href="#">More</a>	<a href="#">History</a>	<a href="#">Alerts</a>
---------------------------	------------------------	--------------------------------	----------------------------	----------------------	-------------------------	------------------------

Source: [Legal > Federal Legal - U.S. > Find Statutes, Regulations, Administrative Materials & Court Rules > United States Code Service \(USCS\) Materials > United States Code Service - Titles 1 through 51](#)

Copyright © 2011 by Matthew Bender & Company, Inc., a member of the LexisNexis Group. All rights reserved.

**United States Code Service - Titles 1 through 51**

[View Tutorial](#) | [Help](#)

Terms and Connectors  Natural Language

(RE39397 or RE39,397) or (RE or REissu!) w/3 (39397 or 39,397)

Search:  Full-text of source documents  
 Table of Contents (TOC) only

Advanced

Search Selected Only

[Clear All Selections](#) | [Hide Book Headers](#)

- TITLE 1. GENERAL PROVISIONS
- TITLE 2. THE CONGRESS
- TITLE 3. THE PRESIDENT
- TITLE 4. FLAG AND SEAL, SEAT OF GOVERNMENT, AND THE STATES
- TITLE 5. GOVERNMENT ORGANIZATION AND EMPLOYEES
- TITLE 6. DOMESTIC SECURITY
- TITLE 7. AGRICULTURE
- TITLE 8. ALIENS AND NATIONALITY
- TITLE 9. ARBITRATION
- TITLE 10. ARMED FORCES
- TITLE 11. BANKRUPTCY
- TITLE 12. BANKS AND BANKING
- TITLE 13. CENSUS
- TITLE 14. COAST GUARD
- TITLE 15. COMMERCE AND TRADE
- TITLE 16. CONSERVATION
- TITLE 17. COPYRIGHTS
- TITLE 18. CRIMES AND CRIMINAL PROCEDURE
- TITLE 19. CUSTOMS DUTIES
- TITLE 20. EDUCATION
- TITLE 21. FOOD AND DRUGS
- TITLE 22. FOREIGN RELATIONS AND INTERCOURSE
- TITLE 23. HIGHWAYS
- TITLE 24. HOSPITALS AND ASYLUMS
- TITLE 25. INDIANS
- TITLE 26. INTERNAL REVENUE CODE
- TITLE 27. INTOXICATING LIQUORS
- TITLE 28. JUDICIARY AND JUDICIAL PROCEDURE
- TITLE 29. LABOR
- TITLE 30. MINERAL LANDS AND MINING
- TITLE 31. MONEY AND FINANCE
- TITLE 32. NATIONAL GUARD
- TITLE 33. NAVIGATION AND NAVIGABLE WATERS
- TITLE 34. [NAVY]
- TITLE 35. PATENTS
- TITLE 36. PATRIOTIC AND NATIONAL OBSERVANCES, CEREMONIES, AND ORGANIZATIONS
- TITLE 37. PAY AND ALLOWANCES OF THE UNIFORMED SERVICES
- TITLE 38. VETERANS' BENEFITS
- TITLE 39. POSTAL SERVICE
- TITLE 40. PUBLIC BUILDINGS, PROPERTY, AND WORKS







[http://www.lexis.com/research/retrieve?\\_m=651e00fd4a9f13e763d2f609b75f549b&csi=6362&\\_fmtstr=TOC&wchp=dGLbVlb-z...](http://www.lexis.com/research/retrieve?_m=651e00fd4a9f13e763d2f609b75f549b&csi=6362&_fmtstr=TOC&wchp=dGLbVlb-z...) 2/16/2011



-   **TITLE 41. PUBLIC CONTRACTS**
-   **TITLE 42. THE PUBLIC HEALTH AND WELFARE**
-   **TITLE 43. PUBLIC LANDS**
-   **TITLE 44. PUBLIC PRINTING AND DOCUMENTS**
-   **TITLE 45. RAILROADS**
-   **TITLE 46. SHIPPING**
-   **TITLE 47. TELEGRAPHS, TELEPHONES, AND RADIOTELEGRAPHS**
-   **TITLE 48. TERRITORIES AND INSULAR POSSESSIONS**
-   **TITLE 49. TRANSPORTATION**
-   **TITLE 50. WAR AND NATIONAL DEFENSE**
-   **TITLE 51. NATIONAL AND COMMERCIAL SPACE PROGRAMS**

↔ 1 - 51 of 51 ↔

**Key:**

-  Click to expand level.\*
-  Click to collapse level.\*
-  Click to expand document subheadings.\*
-  Click to collapse document subheadings.\*
-  Click link to display full text of document.\*
-  Click to generate a TOC linking url.

\* Hover your cursor over this icon to display the Multiple Level Expand navigation menu.

Source: [Legal > Federal Legal - U.S. > Find Statutes, Regulations, Administrative Materials & Court Rules > United States Code Service \(USCS\) Materials > United States Code Service - Titles 1 through 51](#) 

In

[About LexisNexis](#) | [Privacy Policy](#) | [Terms & Conditions](#) | [Contact Us](#)  
Copyright © 2011 LexisNexis, a division of Reed Elsevier Inc. All rights reserved.

**No Documents Found**

No documents were found for your search terms

**"(RE39397 or RE39,397) or (RE or REIssu!) w/3 (39397 or 39,397)"**

Click "Save this search as an Alert" to schedule your search to run in the future.

- OR -

Click "Edit Search" to return to the search form and modify your search.

Suggestions:

- Check for spelling errors.
- Remove some search terms.
- Use more common search terms, such as those listed in "Suggested Words and Concepts."
- Use a less restrictive date range.

| [Save this Search as an Alert](#) || [Edit Search](#) |

In

[About LexisNexis](#) | [Privacy Policy](#) | [Terms & Conditions](#) | [Contact Us](#)  
Copyright © 2011 LexisNexis, a division of Reed Elsevier Inc. All rights reserved.

**Single Search - with Terms and Connectors**

Enter keywords - Search multiple dockets & documents

**Search**

[View Demo](#)  
[Search Tips](#)

[My CourtLink](#)

[Search](#)

[Dockets & Documents](#)

[Track](#)

[Alert](#)

[Strategic Profiles](#)

[My Account](#)



[Search](#) > [Patent Search](#) > Searching

Patent Search 6625346 2/16/2011

No cases found.

**Return to Search**

(Charges for search still apply)



[About LexisNexis](#) | [Terms & Conditions](#) | [Pricing](#) | [Privacy](#) | [Customer Support](#) - 1-888-311-1966  
Copyright © 2011 LexisNexis®. All rights reserved.

<b>My Lexis™</b>	<b>Search</b>	<b>Get a Document</b>	<b>Shepard's®</b>	<b>More</b>	<b>History</b>	<b>Alerts</b>
------------------	---------------	-----------------------	-------------------	-------------	----------------	---------------

FOCUS™ Terms  Search Within   Using Semantic Concepts  
 What's this?  [Advanced...](#)

[View Tutorial](#)

Source: [Legal](#) > [Area of Law - By Topic](#) > [Patent Law](#) > [Find Patents](#) > [Utility, Design and Plant Patents](#) 

Terms: **Patno=6625346** ([Edit Search](#) | [Suggest Terms for My Search](#))

938426 (09) 6625346 September 23, 2003

UNITED STATES PATENT AND TRADEMARK OFFICE GRANTED PATENT

**6625346**

Get Drawing Sheet 1 of 12  
 Access PDF of Official Patent \*  
 Order Patent File History / Wrapper from REEDFAX®  
[Link to Claims Section](#)

September 23, 2003

Reconfigurable optical add-drop multiplexers with servo control and dynamic spectral power management capabilities

**REISSUE:**

December 31, 2004 - Reissue Application filed Ex. Gp.: 2874; Re. S.N. 11/027,586 , (O.G. March 15, 2005)  
 November 14, 2006 - This patent was reissued as Reissue Patent RE 39,397 (O.G. November 14, 2006) ,

**INVENTOR:** Wilde, Jeffrey P. - Los Gatos, CALIFORNIA

**APPL-NO:** 938426 (09)

**FILED-DATE:** August 23, 2001

**GRANTED-DATE:** September 23, 2003

**PRIORITY:** August 23, 2001 - 10938426, United States of America (US)

**ASSIGNEE-PRE-ISSUE:**

August 23, 2001 - ASSIGNMENT OF ASSIGNORS INTEREST (SEE DOCUMENT FOR DETAILS)., CAPELLA PHOTONICS, INC. 19 GREAT OAKS BLVD., SUITE 20SAN JOSE, CALIFORNIA, 95119, Reel and Frame Number: 012118/0994

**ASSIGNEE-AT-ISSUE:**

Capella Photonics, Inc., San Jose, CALIFORNIA , United States company or corporation (02)

**ASSIGNEE-AFTER-ISSUE:**

May 5, 2009 - SECURITY AGREEMENT, ZACCARIA, BERT L., 475 SANSOME STREET, SUITE 1850, SANTA CLARA, CALIFORNIA, UNITED STATES OF AMERICA (US), 95054, Reel and Frame Number: 022641/0593  
 July 9, 2009 - SECURITY AGREEMENT, TEATON CAPITAL COMPANY, 3000 SAND HILL ROAD, SUITE 3-210, MENLO PARK, CALIFORNIA, UNITED STATES OF AMERICA (US), 94025, Reel and Frame Number: 022932/0669

**LEGAL-REP:** Gray Cary Ware & Freidenrich LLP

**PUB-TYPE:** September 23, 2003 - Patent with a pre-grant publication (B2)

[http://www.lexis.com/research/retrieve?\\_m=3c2a361330ac4d0e28d72d7a68075df8&cscvc=b1&cform=searchForm&\\_fmtstr=FUL...](http://www.lexis.com/research/retrieve?_m=3c2a361330ac4d0e28d72d7a68075df8&cscvc=b1&cform=searchForm&_fmtstr=FUL...) 2/16/2011

My Lexis™ Search Get a Document Shepard's® More History Alerts

All Legal News & Business Public Records Find A Source Add/Edit Subtabs

Legal > Area of Law - By Topic > Patent Law > Find Cases > Intellectual Property Cases, Administrative Decisions & Regulations

Search View Tutorial | Help

**Broaden this search with additional sources**

- Intellectual Property Cases, Administrative Decisions & Regulations (Source you selected)
- Chisum on Patents
- Patent Law Digest
- Patent Case Management Judicial Guide
- Intellectual Property Counseling and Litigation
- Court of Appeals for the Federal Circuit Practice & Procedure

[View all sources](#)

**Select Search Type and Enter Search Terms**

Terms & Connectors (6625346 or 6,625,346) Suggest terms for my search

Natural Language

Easy Search™

Check spelling

**Restrict by Document Segment**

Select a document segment, enter search terms for the segment, then click Add.

Select a Segment

**Note:** Segment availability differs between sources. Segments may not be applied consistently across sources.

**Restrict by Date**

No Date Restrictions  From  To  Date formats...

<p><b>Search Connectors</b></p> <p>and and w/p in same paragraph</p> <p>or or w/seg in same segment</p> <p>w/N within N words w/s in same sentence</p> <p>pre/N precedes by N words and not and not</p> <p><a href="#">More Connectors &amp; Commands...</a></p>	<p><b>How Do I...?</b></p> <p>Combine sources?</p> <p>Restrict by date?</p> <p>Restrict by document segment?</p> <p>Use wildcards as placeholders for one or more characters in a search term?</p> <p><a href="#">View Tutorials</a></p>
------------------------------------------------------------------------------------------------------------------------------------------------------------------------------------------------------------------------------------------------------------------	------------------------------------------------------------------------------------------------------------------------------------------------------------------------------------------------------------------------------------------

**No Documents Found**

No documents were found for your search terms  
"(6625346 or 6,625,346)"

Click "Save this search as an Alert" to schedule your search to run in the future.

- OR -

Click "Edit Search" to return to the search form and modify your search.

**Suggestions:**

- Check for spelling errors.
- Remove some search terms.
- Use more common search terms, such as those listed in "Suggested Words and Concepts."
- Use a less restrictive date range.

| [Save this Search as an Alert](#) || [Edit Search](#) |

In

[About LexisNexis](#) | [Privacy Policy](#) | [Terms & Conditions](#) | [Contact Us](#)  
Copyright © 2011 LexisNexis, a division of Reed Elsevier Inc. All rights reserved.

<b>My Lexis™</b>	<b>Search</b>	<b>Get a Document</b>	<b>Shepard's®</b>	<b>More</b>	<b>History</b>	<b>Alerts</b>
<b>All</b>	<b>Legal</b>	<b>News &amp; Business</b>	<b>Public Records</b>	<b>Find A Source</b>	Add/Edit Subtabs	

Legal > Federal Legal - U.S. > Find Statutes, Regulations, Administrative Materials & Court Rules > Administrative Agency Materials > Federal Agency Decisions, Combined [i](#)

View Tutorial | Help

**Search**

**Broaden this search with additional sources**

**Federal Agency Decisions, Combined** [i](#) (Source you selected)

Jury Verdicts and Settlements, Combined [i](#)

LexisNexis Jury Verdicts and Settlements [i](#)

U.S. Supreme Court Briefs [i](#)

Martindale-Hubbell(R) Listings, All [i](#)

Martindale-Hubbell(R) Law Directory - U.S. Government Attorney Profiles [i](#)

[View all sources](#)

**Select Search Type and Enter Search Terms**

<b>Terms &amp; Connectors</b>	(6625346 or 6,625,346)	<input type="button" value="Search"/>
Natural Language		Suggest terms for my search
Easy Search™		Check spelling

**Restrict by Document Segment**

Select a document segment, enter search terms for the segment, then click Add.

Select a Segment

**Note:** Segment availability differs between sources. Segments may not be applied consistently across sources.

**Restrict by Date**

No Date Restrictions  From  To  Date formats...

<p><b>Search Connectors</b></p> <p>and    and                    w/p    in same paragraph</p> <p>or     or                        w/seg  in same segment</p> <p>w/N    within N words        w/s    in same sentence</p> <p>pre/N  precedes by N words    and not    and not</p> <p><a href="#">More Connectors &amp; Commands...</a></p>	<p><b>How Do I...?</b></p> <p>Combine sources?</p> <p>Restrict by date?</p> <p>Restrict by document segment?</p> <p>Use wildcards as placeholders for one or more characters in a search term?</p> <p><a href="#">View Tutorials</a></p>
-------------------------------------------------------------------------------------------------------------------------------------------------------------------------------------------------------------------------------------------------------------------------------------------------------------------------------------------	------------------------------------------------------------------------------------------------------------------------------------------------------------------------------------------------------------------------------------------

in

About LexisNexis | Privacy Policy | Terms & Conditions | Contact Us  
 Copyright © 2011 LexisNexis, a division of Reed Elsevier Inc. All rights reserved.

**No Documents Found**

No documents were found for your search terms  
"(6625346 or 6,625,346)"

Click "Save this search as an Alert" to schedule your search to run in the future.

- OR -

Click "Edit Search" to return to the search form and modify your search.

Suggestions:

- Check for spelling errors.
- Remove some search terms.
- Use more common search terms, such as those listed in "Suggested Words and Concepts."
- Use a less restrictive date range.

| [Save this Search as an Alert](#) || [Edit Search](#) |

In

[About LexisNexis](#) | [Privacy Policy](#) | [Terms & Conditions](#) | [Contact Us](#)  
Copyright © 2011 LexisNexis, a division of Reed Elsevier Inc. All rights reserved.



[My Lexis™](#) | [Search](#) | [Get a Document](#) | [Shepard's®](#) | [More](#) | [History](#) | [Alerts](#)  
[All](#) | [Legal](#) | [News & Business](#) | [Public Records](#) | [Find A Source](#) | [Add/Edit Subtabs](#)

Legal > / ... / > Legal US News, All

View Tutorial | Help

**Search**

Select Search Type and Enter Search Terms

Terms & Connectors	(6625346 or 6,625,346)	Suggest terms for my search <input type="button" value="Search"/>  Check spelling
Natural Language		
Easy Search™		

**Restrict by Document Segment**

Select a document segment, enter search terms for the segment, then click Add.

Select a Segment

**Note:** Segment availability differs between sources. Segments may not be applied consistently across sources.

**Restrict by Date**

No Date Restrictions  From  To  Date formats...

---

<p><b>Search Connectors</b></p> <table style="width: 100%; border-collapse: collapse;"> <tr> <td style="padding: 2px;">and</td> <td style="padding: 2px;">and</td> <td style="padding: 2px;">w/p</td> <td style="padding: 2px;">in same paragraph</td> </tr> <tr> <td style="padding: 2px;">or</td> <td style="padding: 2px;">or</td> <td style="padding: 2px;">w/seg</td> <td style="padding: 2px;">in same segment</td> </tr> <tr> <td style="padding: 2px;">w/N</td> <td style="padding: 2px;">within N words</td> <td style="padding: 2px;">w/s</td> <td style="padding: 2px;">in same sentence</td> </tr> <tr> <td style="padding: 2px;">pre/N</td> <td style="padding: 2px;">precedes by N words</td> <td style="padding: 2px;">and not</td> <td style="padding: 2px;">and not</td> </tr> </table> <p>More Connectors &amp; Commands...</p>	and	and	w/p	in same paragraph	or	or	w/seg	in same segment	w/N	within N words	w/s	in same sentence	pre/N	precedes by N words	and not	and not	<p><b>How Do I...?</b></p> <p>Combine sources?</p> <p>Restrict by date?</p> <p>Restrict by document segment?</p> <p>Use wildcards as placeholders for one or more characters in a search term?</p> <p>View Tutorials</p>
and	and	w/p	in same paragraph														
or	or	w/seg	in same segment														
w/N	within N words	w/s	in same sentence														
pre/N	precedes by N words	and not	and not														

In

**No Documents Found**

No documents were found for your search terms  
"(6625346 or 6,625,346)"

Click "Save this search as an Alert" to schedule your search to run in the future.

- OR -

Click "Edit Search" to return to the search form and modify your search.

**Suggestions:**

- Check for spelling errors.
- Remove some search terms.
- Use more common search terms, such as those listed in "Suggested Words and Concepts."
- Use a less restrictive date range.

| [Save this Search as an Alert](#) || [Edit Search](#) |

In

[About LexisNexis](#) | [Privacy Policy](#) | [Terms & Conditions](#) | [Contact Us](#)  
Copyright © 2011 LexisNexis, a division of Reed Elsevier Inc. All rights reserved.

<a href="#">My Lexis™</a>	<a href="#">Search</a>	<a href="#">Get a Document</a>	<a href="#">Shepard's®</a>	<a href="#">More</a>	<a href="#">History</a>	<a href="#">Alerts</a>
---------------------------	------------------------	--------------------------------	----------------------------	----------------------	-------------------------	------------------------

Source: [Legal > Federal Legal - U.S. > Find Statutes, Regulations, Administrative Materials & Court Rules > United States Code Service \(USCS\) Materials > United States Code Service - Titles 1 through 51](#)

Copyright © 2011 by Matthew Bender & Company, Inc., a member of the LexisNexis Group. All rights reserved.

**United States Code Service - Titles 1 through 51** [View Tutorial | Help](#)

Terms and Connectors    Natural Language

6625346 or 6,625,346

**Search:**  Full-text of source documents  Table of Contents (TOC) only  Advanced

Search Selected Only

[Clear All Selections](#) | [Hide Book Headers](#)

- TITLE 1. GENERAL PROVISIONS
- TITLE 2. THE CONGRESS
- TITLE 3. THE PRESIDENT
- TITLE 4. FLAG AND SEAL, SEAT OF GOVERNMENT, AND THE STATES
- TITLE 5. GOVERNMENT ORGANIZATION AND EMPLOYEES
- TITLE 6. DOMESTIC SECURITY
- TITLE 7. AGRICULTURE
- TITLE 8. ALIENS AND NATIONALITY
- TITLE 9. ARBITRATION
- TITLE 10. ARMED FORCES
- TITLE 11. BANKRUPTCY
- TITLE 12. BANKS AND BANKING
- TITLE 13. CENSUS
- TITLE 14. COAST GUARD
- TITLE 15. COMMERCE AND TRADE
- TITLE 16. CONSERVATION
- TITLE 17. COPYRIGHTS
- TITLE 18. CRIMES AND CRIMINAL PROCEDURE
- TITLE 19. CUSTOMS DUTIES
- TITLE 20. EDUCATION
- TITLE 21. FOOD AND DRUGS
- TITLE 22. FOREIGN RELATIONS AND INTERCOURSE
- TITLE 23. HIGHWAYS
- TITLE 24. HOSPITALS AND ASYLUMS
- TITLE 25. INDIANS
- TITLE 26. INTERNAL REVENUE CODE
- TITLE 27. INTOXICATING LIQUORS
- TITLE 28. JUDICIARY AND JUDICIAL PROCEDURE
- TITLE 29. LABOR
- TITLE 30. MINERAL LANDS AND MINING
- TITLE 31. MONEY AND FINANCE
- TITLE 32. NATIONAL GUARD
- TITLE 33. NAVIGATION AND NAVIGABLE WATERS
- TITLE 34. [NAVY]
- TITLE 35. PATENTS
- TITLE 36. PATRIOTIC AND NATIONAL OBSERVANCES, CEREMONIES, AND ORGANIZATIONS
- TITLE 37. PAY AND ALLOWANCES OF THE UNIFORMED SERVICES
- TITLE 38. VETERANS' BENEFITS
- TITLE 39. POSTAL SERVICE
- TITLE 40. PUBLIC BUILDINGS, PROPERTY, AND WORKS

[http://www.lexis.com/research/retrieve?\\_m=b380efe93cd9f2602c3ec1b043ec386e&csi=6362&\\_fmtstr=TOC&wchp=dGLbVlb-z...](http://www.lexis.com/research/retrieve?_m=b380efe93cd9f2602c3ec1b043ec386e&csi=6362&_fmtstr=TOC&wchp=dGLbVlb-z...) 2/16/2011

	<input type="checkbox"/>	TITLE 41. PUBLIC CONTRACTS
	<input type="checkbox"/>	TITLE 42. THE PUBLIC HEALTH AND WELFARE
	<input type="checkbox"/>	TITLE 43. PUBLIC LANDS
	<input type="checkbox"/>	TITLE 44. PUBLIC PRINTING AND DOCUMENTS
	<input type="checkbox"/>	TITLE 45. RAILROADS
	<input type="checkbox"/>	TITLE 46. SHIPPING
	<input type="checkbox"/>	TITLE 47. TELEGRAPHS, TELEPHONES, AND RADIOTELEGRAPHS
	<input type="checkbox"/>	TITLE 48. TERRITORIES AND INSULAR POSSESSIONS
	<input type="checkbox"/>	TITLE 49. TRANSPORTATION
	<input type="checkbox"/>	TITLE 50. WAR AND NATIONAL DEFENSE
	<input type="checkbox"/>	TITLE 51. NATIONAL AND COMMERCIAL SPACE PROGRAMS

1 - 51 of 51

Key:

- Click to expand level.\*
  - Click to collapse level.\*
  - Click to expand document subheadings.\*
  - Click to collapse document subheadings.\*
  - Click link to display full text of document.\*
  - Click to generate a TOC linking url.
- \* Hover your cursor over this icon to display the Multiple Level Expand navigation menu.

Source: [Legal > Federal Legal - U.S. > Find Statutes, Regulations, Administrative Materials & Court Rules > United States Code Service \(USCS\) Materials > United States Code Service - Titles 1 through 51](#) [i](#)

In

About LexisNexis | Privacy Policy | Terms & Conditions | Contact Us  
Copyright © 2011 LexisNexis, a division of Reed Elsevier Inc. All rights reserved.

**No Documents Found**

No documents were found for your search terms  
**"6625346 or 6,625,346"**

Click "Save this search as an Alert" to schedule your search to run in the future.

- OR -

Click "Edit Search" to return to the search form and modify your search.

Suggestions:

- Check for spelling errors.
- Remove some search terms.
- Use more common search terms, such as those listed in "Suggested Words and Concepts."
- Use a less restrictive date range.

| [Save this Search as an Alert](#) | | [Edit Search](#) |

In

[About LexisNexis](#) | [Privacy Policy](#) | [Terms & Conditions](#) | [Contact Us](#)  
Copyright © 2011 LexisNexis, a division of Reed Elsevier Inc. All rights reserved.

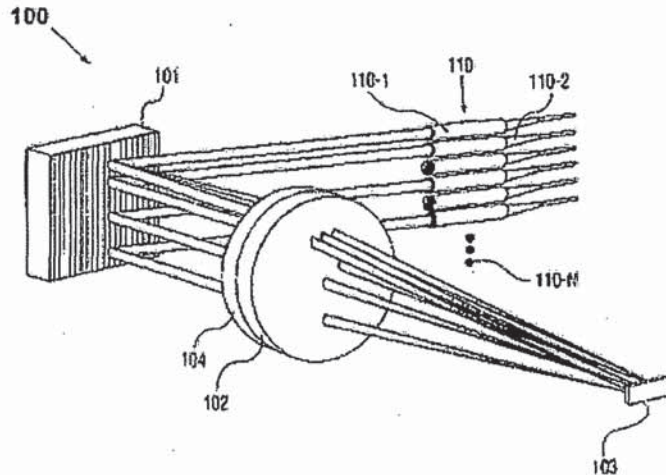

Reconfigurable optical add-drop multiplexers with servo control and dynamic spectral power management capabilities  
 IN WILDE JEFFREY P

PA BINGHAM RAYMOND H  
 BLACK DIAMOND VENTURES XIV  
 BRENDAN JOSEPH CASSIN & ISABEL B CASSIN THE CASSIN FAMILY TRUST U D T DATED 1 31 96  
 BRENDAN JOSEPH CASSIN THE CASSIN 1997 CHARITABLE TRUST UTA DATED 1 28 97  
 CAPELLA PHOTONICS  
 CAPELLA PHOTONICS  
 CASSIN FAMILY A CALIFORNIA PARTNERSHIP  
 DONALD L LUCAS SUCC TTEE DONALD L LUCAS PROFIT SHARING TRUST DTD 1 1 84  
 DONALD L LUCAS TTEE DONALD L & LYGIA LUCAS TRUST DTD 12 3 84  
 FORMATIVE VENTURES EMERGING TECHNOLOGIES FUND  
 LEVENSOHN VENTURE III  
 LEVENSOHN VENTURE III ANNEX FUND  
 LUCAS BROTHERS FOUNDATION  
 LUCAS VENTURE I  
 LVP III FUND  
 ROBERT S CASSIN CHARITABLE TRUST UTA DATED 2 20 97  
 RUSTIC CANYON VENTURES SBIC  
 SAINTS CAPITAL FALCON  
 SAND HILL FINANCIAL  
 SILICON VALLEY BANK  
 TEATON CAPITAL  
 ZACCARIA BERT L

Published As	Publ. number	Pub. date	Appl. number	Appl. date	Publ. Stage
	US2002131698	20020919	2002US-0143651	20020508	A1 - First published patent application
	US2002131688	20020919	2001US-0005714	20011107	A1 - First published patent application
	US2002131690	20020919	2002US-0080493	20020129	A1 - First published patent application
	US2002131687	20020919	2001US-0938426	20010823	A1 - First published patent application
	US2002131691	20020919	2002US-0076145	20020214	A1 - First published patent application
	US6549699	20030415			B2 - Granted patent as second publication
	US6625346	20030923			B2 - Granted patent as second publication
	US6661948	20031209			B2 - Granted patent as second publication
	US6687431	20040203			B2 - Granted patent as second publication
	US6760511	20040706			B2 - Granted patent as second publication
	IN1476/CHENP/2003	20050729	2003IN-CN01476	20030918	A - Application laid open
	IN200748	20060602			B - Patent
	USRE39331	20061010	2004US-0027584	20041231	E1 - Reissue Patent
	USRE39397	20061114	2004US-0027586	20041231	E1 - Reissue Patent
	USRE39411	20061128	2004US-0027588	20041231	E1 - Reissue Patent
	USRE39515	20070313	2004US-0027589	20041231	E1 - Reissue Patent
	USRE39525	20070320	2004US-0027587	20041231	E1 - Reissue Patent

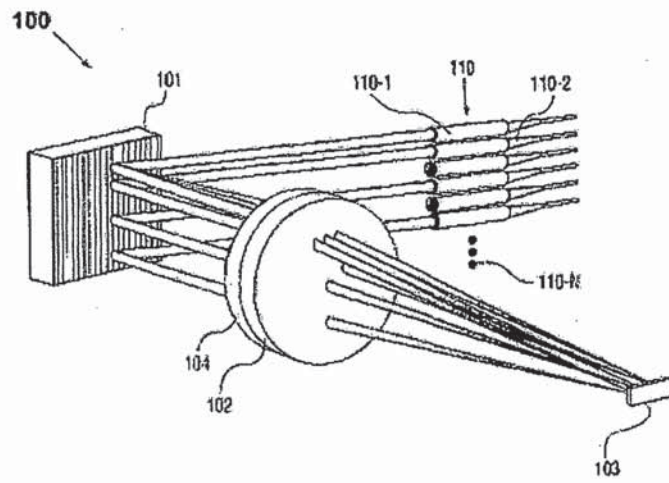

Date/Code/Action:

Alive: US2002131698 A1, US6661948 B2

20020508US/AS-A [NMC] ASSIGNMENT  
OWNER: CAPELLA PHOTONICS, INC. STE. 20 19 GREAT OAKS BLVD; EFFECTIVE DATE: 20020507  
ASSIGNMENT OF ASSIGNORS INTEREST;ASSIGNOR:WILDE, JEFFREY  
P. /AR;REEL/FRAME:012899/0447

20020508US/AS-A [NMC] ASSIGNMENT  
OWNER: CAPELLA PHOTONICS, INC., CALIFORNIA; EFFECTIVE DATE: 20020507  
ASSIGNMENT OF ASSIGNORS INTEREST;ASSIGNOR:WILDE, JEFFREY  
P.;REEL/FRAME:012899/0447

20020508US/API [EXM;POS] FILING DETAILS  
US14365102 20020508 [2002US-0143651]

20020919US/A1 [EXM;POS] First published patent application  
US2002131698 A1 20020919 [US20020131698]

20031209US/B2 [PIF;POS] Granted patent as second publication  
US6661948 B2 20031209 [US6661948]

20050301US/RF-A [OPP] REISSUE APPLICATION FILED  
EFFECTIVE DATE: 20041231

20090505US/AS-A [NMC] ASSIGNMENT  
OWNER: SILICON VALLEY BANK, CALIFORNIA; EFFECTIVE DATE: 20090501  
SECURITY AGREEMENT;ASSIGNOR:CAPELLA PHOTONICS, INC.;REEL/FRAME:022641/0593

20090505US/AS-A [NMC] ASSIGNMENT  
OWNER: BINGHAM, RAYMOND H., CALIFORNIA; EFFECTIVE DATE: 20090501  
SECURITY AGREEMENT;ASSIGNOR:CAPELLA PHOTONICS, INC.;REEL/FRAME:022641/0593

20090505US/AS-A [NMC] ASSIGNMENT  
OWNER: BLACK DIAMOND VENTURES XIV, LLC., CALIFORNIA; EFFECTIVE DATE: 20090501  
SECURITY AGREEMENT;ASSIGNOR:CAPELLA PHOTONICS, INC.;REEL/FRAME:022641/0593

20090505US/AS-A [NMC] ASSIGNMENT  
OWNER: DONALD L. LUCAS, SUCC TTEE DONALD L. LUCAS PROFIT; EFFECTIVE DATE: 20090501  
SECURITY AGREEMENT;ASSIGNOR:CAPELLA PHOTONICS, INC.;REEL/FRAME:022641/0593

20090505US/AS-A [NMC] ASSIGNMENT  
OWNER: DONALD L. LUCAS, TTEE DONALD L. AND LYGIA LUCAS TR; EFFECTIVE DATE: 20090501  
SECURITY AGREEMENT;ASSIGNOR:CAPELLA PHOTONICS, INC.;REEL/FRAME:022641/0593

20090505US/AS-A [NMC] ASSIGNMENT  
OWNER: LUCAS VENTURE GROUP I, LLC, CALIFORNIA; EFFECTIVE DATE: 20090501  
SECURITY AGREEMENT;ASSIGNOR:CAPELLA PHOTONICS, INC.;REEL/FRAME:022641/0593

20090505US/AS-A [NMC] ASSIGNMENT  
OWNER: THE LUCAS BROTHERS FOUNDATION, CALIFORNIA; EFFECTIVE DATE: 20090501  
SECURITY AGREEMENT;ASSIGNOR:CAPELLA PHOTONICS, INC.;REEL/FRAME:022641/0593

20090505US/AS-A [NMC] ASSIGNMENT  
OWNER: BRENDAN JOSEPH CASSIN AND ISABEL B. CASSIN, TRUSTE; EFFECTIVE DATE:  
20090501  
SECURITY AGREEMENT;ASSIGNOR:CAPELLA PHOTONICS, INC.;REEL/FRAME:022641/0593

20090505US/AS-A [NMC] ASSIGNMENT  
OWNER: CASSIN FAMILY PARTNERS, A CALIFORNIA LIMITED PARTN; EFFECTIVE DATE:  
20090501  
SECURITY AGREEMENT;ASSIGNOR:CAPELLA PHOTONICS, INC.;REEL/FRAME:022641/0593

20090505US/AS-A [NMC] ASSIGNMENT  
OWNER: ROBERT S. CASSIN CHARITABLE TRUST UTA DATED 2/20/9; EFFECTIVE DATE: 20090501  
SECURITY AGREEMENT;ASSIGNOR:CAPELLA PHOTONICS, INC.;REEL/FRAME:022641/0593

20090505US/AS-A [NMC] ASSIGNMENT  
OWNER: LEVENSOHN VENTURE PARTNERS III ANNEX FUND, L.P., C; EFFECTIVE DATE: 20090501  
SECURITY AGREEMENT;ASSIGNOR:CAPELLA PHOTONICS, INC.;REEL/FRAME:022641/0593

20090505US/AS-A [NMC] ASSIGNMENT  
OWNER: LEVENSOHN VENTURE PARTNERS III, L.P., CALIFORNIA; EFFECTIVE DATE: 20090501  
SECURITY AGREEMENT;ASSIGNOR:CAPELLA PHOTONICS, INC.;REEL/FRAME:022641/0593

20090505US/AS-A [NMC] ASSIGNMENT  
OWNER: LVP III ASSOCIATES FUND, L.P., CALIFORNIA; EFFECTIVE DATE: 20090501  
SECURITY AGREEMENT;ASSIGNOR:CAPELLA PHOTONICS, INC.;REEL/FRAME:022641/0593

20090505US/AS-A [NMC] ASSIGNMENT  
OWNER: SAINTS CAPITAL FALCON, L.P., CALIFORNIA; EFFECTIVE DATE: 20090501  
SECURITY AGREEMENT;ASSIGNOR:CAPELLA PHOTONICS, INC.;REEL/FRAME:022641/0593



ASSIGNMENT  
20090505US/AS-A [NMC]OWNER: RUSTIC CANYON VENTURES, SBIC, LP, CALIFORNIA; EFFECTIVE DATE: 20090501  
SECURITY AGREEMENT;ASSIGNOR:CAPELLA PHOTONICS, INC.;REEL/FRAME:022641/0593

---

ASSIGNMENT  
20090505US/AS-A [NMC]OWNER: ZACCARIA, BERT L., ARIZONA; EFFECTIVE DATE: 20090501  
SECURITY AGREEMENT;ASSIGNOR:CAPELLA PHOTONICS, INC.;REEL/FRAME:022641/0593

---

ASSIGNMENT  
20090505US/AS-A [NMC]OWNER: BRENDAN JOSEPH CASSIN, TRUSTEES OF THE CASSIN 1997; EFFECTIVE DATE:  
20090501  
SECURITY AGREEMENT;ASSIGNOR:CAPELLA PHOTONICS, INC.;REEL/FRAME:022641/0593

---

ASSIGNMENT  
20090709US/AS-A [NMC]OWNER: TEATON CAPITAL COMPANY, CALIFORNIA; EFFECTIVE DATE: 20090501  
SECURITY AGREEMENT;ASSIGNOR:CAPELLA PHONTONICS, INC.;REEL/FRAME:022932/0669

---

ASSIGNMENT  
20090709US/AS-A [NMC]OWNER: SAND HILL FINANCIAL COMPANY, CALIFORNIA; EFFECTIVE DATE: 20090501  
SECURITY AGREEMENT;ASSIGNOR:CAPELLA PHONTONICS, INC.;REEL/FRAME:022932/0669

---

ASSIGNMENT  
20090709US/AS-A [NMC]OWNER: FORMATIVE VENTURES EMERGING TECHNOLOGIES FUND, LP,; EFFECTIVE DATE:  
20090501SECURITY AGREEMENT;ASSIGNOR:CAPELLA PHONTONICS,  
INC.;REEL/FRAME:022932/0669

---

Alive: US2002131688 A1, US6687431 B2

---

20011107US/API [EXM;POS] FILING DETAILS  
US571401 20011107 [2001US-0005714]

20020411US/AS-A [NMC] ASSIGNMENT  
OWNER: CAPELLA PHOTONICS, INC. 19 GREAT OAKS BLVD., SUITE; EFFECTIVE DATE: 20011026  
ASSIGNMENT OF ASSIGNORS INTEREST;ASSIGNORS:CHEN, TAI /AR;REEL/FRAME:012797/0705

20020411US/AS-A [NMC] ASSIGNMENT  
OWNER: CAPELLA PHOTONICS, INC., CALIFORNIA; EFFECTIVE DATE: 20011026  
ASSIGNMENT OF ASSIGNORS INTEREST;ASSIGNORS:CHEN, TAI;WILDE, JEFFREY  
P.;REEL/FRAME:012797/0705

20020919US/A1 [EXM;POS] First published patent application  
US2002131688 A1 20020919 [US20020131688]

20040203US/B2 [PIF;POS] Granted patent as second publication  
US6687431 B2 20040203 [US6687431]

20050329US/RF-A [OPP] REISSUE APPLICATION FILED  
EFFECTIVE DATE: 20041231

20090505US/AS-A [NMC] ASSIGNMENT  
OWNER: SILICON VALLEY BANK, CALIFORNIA; EFFECTIVE DATE: 20090501  
SECURITY AGREEMENT;ASSIGNOR:CAPELLA PHOTONICS, INC.;REEL/FRAME:022641/0593

20090505US/AS-A [NMC] ASSIGNMENT  
OWNER: BINGHAM, RAYMOND H., CALIFORNIA; EFFECTIVE DATE: 20090501  
SECURITY AGREEMENT;ASSIGNOR:CAPELLA PHOTONICS, INC.;REEL/FRAME:022641/0593

20090505US/AS-A [NMC] ASSIGNMENT  
OWNER: BLACK DIAMOND VENTURES XIV, LLC., CALIFORNIA; EFFECTIVE DATE: 20090501  
SECURITY AGREEMENT;ASSIGNOR:CAPELLA PHOTONICS, INC.;REEL/FRAME:022641/0593

20090505US/AS-A [NMC] ASSIGNMENT  
OWNER: DONALD L. LUCAS, SUCC TTEE DONALD L. LUCAS PROFIT; EFFECTIVE DATE: 20090501  
SECURITY AGREEMENT;ASSIGNOR:CAPELLA PHOTONICS, INC.;REEL/FRAME:022641/0593

20090505US/AS-A [NMC] ASSIGNMENT  
OWNER: DONALD L. LUCAS, TTEE DONALD L. AND LYGIA LUCAS TR; EFFECTIVE DATE: 20090501  
SECURITY AGREEMENT;ASSIGNOR:CAPELLA PHOTONICS, INC.;REEL/FRAME:022641/0593

20090505US/AS-A [NMC] ASSIGNMENT  
OWNER: LUCAS VENTURE GROUP I, LLC, CALIFORNIA; EFFECTIVE DATE: 20090501  
SECURITY AGREEMENT;ASSIGNOR:CAPELLA PHOTONICS, INC.;REEL/FRAME:022641/0593

20090505US/AS-A [NMC] ASSIGNMENT  
OWNER: THE LUCAS BROTHERS FOUNDATION, CALIFORNIA; EFFECTIVE DATE: 20090501  
SECURITY AGREEMENT;ASSIGNOR:CAPELLA PHOTONICS, INC.;REEL/FRAME:022641/0593

20090505US/AS-A [NMC] ASSIGNMENT  
OWNER: BRENDAN JOSEPH CASSIN AND ISABEL B. CASSIN, TRUSTE; EFFECTIVE DATE:  
20090501  
SECURITY AGREEMENT;ASSIGNOR:CAPELLA PHOTONICS, INC.;REEL/FRAME:022641/0593

20090505US/AS-A [NMC] ASSIGNMENT  
OWNER: CASSIN FAMILY PARTNERS, A CALIFORNIA LIMITED PARTN; EFFECTIVE DATE:  
20090501  
SECURITY AGREEMENT;ASSIGNOR:CAPELLA PHOTONICS, INC.;REEL/FRAME:022641/0593

20090505US/AS-A [NMC] ASSIGNMENT  
OWNER: ROBERT S. CASSIN CHARITABLE TRUST UTA DATED 2/20/9; EFFECTIVE DATE: 20090501  
SECURITY AGREEMENT;ASSIGNOR:CAPELLA PHOTONICS, INC.;REEL/FRAME:022641/0593

20090505US/AS-A [NMC] ASSIGNMENT  
OWNER: LEVENSOHN VENTURE PARTNERS III ANNEX FUND, L.P., C; EFFECTIVE DATE: 20090501  
SECURITY AGREEMENT;ASSIGNOR:CAPELLA PHOTONICS, INC.;REEL/FRAME:022641/0593

20090505US/AS-A [NMC] ASSIGNMENT  
OWNER: LEVENSOHN VENTURE PARTNERS III, L.P., CALIFORNIA; EFFECTIVE DATE: 20090501  
SECURITY AGREEMENT;ASSIGNOR:CAPELLA PHOTONICS, INC.;REEL/FRAME:022641/0593

20090505US/AS-A [NMC] ASSIGNMENT  
OWNER: LVP III ASSOCIATES FUND, L.P., CALIFORNIA; EFFECTIVE DATE: 20090501  
SECURITY AGREEMENT;ASSIGNOR:CAPELLA PHOTONICS, INC.;REEL/FRAME:022641/0593

20090505US/AS-A [NMC] ASSIGNMENT  
OWNER: SAINTS CAPITAL FALCON, L.P., CALIFORNIA; EFFECTIVE DATE: 20090501  
SECURITY AGREEMENT;ASSIGNOR:CAPELLA PHOTONICS, INC.;REEL/FRAME:022641/0593

20090505US/AS-A [NMC] ASSIGNMENT  
OWNER: RUSTIC CANYON VENTURES, SBIC, LP, CALIFORNIA; EFFECTIVE DATE: 20090501  
SECURITY AGREEMENT;ASSIGNOR:CAPELLA PHOTONICS, INC.;REEL/FRAME:022641/0593

20090505US/AS-A [NMC] ASSIGNMENT  
OWNER: ZACCARIA, BERT L., ARIZONA; EFFECTIVE DATE: 20090501  
SECURITY AGREEMENT;ASSIGNOR:CAPELLA PHOTONICS, INC.;REEL/FRAME:022641/0593

20090505US/AS-A [NMC] ASSIGNMENT  
OWNER: BRENDAN JOSEPH CASSIN, TRUSTEES OF THE CASSIN 1997; EFFECTIVE DATE:  
20090501  
SECURITY AGREEMENT;ASSIGNOR:CAPELLA PHOTONICS, INC.;REEL/FRAME:022641/0593

20090709US/AS-A [NMC] ASSIGNMENT  
OWNER: TEATON CAPITAL COMPANY, CALIFORNIA; EFFECTIVE DATE: 20090501  
SECURITY AGREEMENT;ASSIGNOR:CAPELLA PHOTONICS, INC.;REEL/FRAME:022932/0669

ASSIGNMENT  
20090709US/AS-A [NMC] OWNER: SAND HILL FINANCIAL COMPANY, CALIFORNIA; EFFECTIVE DATE: 20090501  
SECURITY AGREEMENT; ASSIGNOR: CAPELLA PHONONICS, INC.; REEL/FRAME: 022932/0669

---

ASSIGNMENT  
20090709US/AS-A [NMC] OWNER: FORMATIVE VENTURES EMERGING TECHNOLOGIES FUND, LP.; EFFECTIVE DATE:  
20090501 SECURITY AGREEMENT; ASSIGNOR: CAPELLA PHONONICS,  
INC.; REEL/FRAME: 022932/0669

---

**Alive: US2002131690 A1, US6549699 B2**

---

20020129US/AS-A [NMC] ASSIGNMENT  
OWNER: CAPELLA PHOTONICS, INC. 19 GREAT OAKS BLVD., SUITE; EFFECTIVE DATE: 20020122  
ASSIGNMENT OF ASSIGNORS INTEREST;ASSIGNORS:BELSER, KARL ARNOLD;WILDE, JEFFREY  
P.;REEL/FRAME:012553/0119

---

20020129US/AS-A [NMC] ASSIGNMENT  
OWNER: CAPELLA PHOTONICS, INC. 19 GREAT OAKS BLVD., SUITE; EFFECTIVE DATE: 20020122  
ASSIGNMENT OF ASSIGNORS INTEREST;ASSIGNORS:BELSER, KARL  
ARNOLD /AR;REEL/FRAME:012553/0119

---

20020129US/AS-A [NMC] ASSIGNMENT  
OWNER: CAPELLA PHOTONICS, INC., CALIFORNIA; EFFECTIVE DATE: 20020122  
ASSIGNMENT OF ASSIGNORS INTEREST;ASSIGNORS:BELSER, KARL ARNOLD;WILDE, JEFFREY  
P.;REEL/FRAME:012553/0119

---

20020129US/API [EXM;POS] FILING DETAILS  
US6049302 20020129 [2002US-0060493]

---

20020919US/A1 [EXM;POS] First published patent application  
US2002131690 A1 20020919 [US20020131690]

---

20030415US/B2 [PIF;POS] Granted patent as second publication  
US6549699 B2 20030415 [US6549699]

---

20050308US/RF-A [OPP] REISSUE APPLICATION FILED  
EFFECTIVE DATE: 20041231

---

20090505US/AS-A [NMC] ASSIGNMENT  
OWNER: SILICON VALLEY BANK, CALIFORNIA; EFFECTIVE DATE: 20090501  
SECURITY AGREEMENT;ASSIGNOR:CAPELLA PHOTONICS, INC.;REEL/FRAME:022641/0593

---

20090505US/AS-A [NMC] ASSIGNMENT  
OWNER: BINGHAM, RAYMOND H., CALIFORNIA; EFFECTIVE DATE: 20090501  
SECURITY AGREEMENT;ASSIGNOR:CAPELLA PHOTONICS, INC.;REEL/FRAME:022641/0593

---

20090505US/AS-A [NMC] ASSIGNMENT  
OWNER: BLACK DIAMOND VENTURES XIV, LLC., CALIFORNIA; EFFECTIVE DATE: 20090501  
SECURITY AGREEMENT;ASSIGNOR:CAPELLA PHOTONICS, INC.;REEL/FRAME:022641/0593

---

20090505US/AS-A [NMC] ASSIGNMENT  
OWNER: DONALD L. LUCAS, SUCC TTEE DONALD L. LUCAS PROFIT; EFFECTIVE DATE: 20090501  
SECURITY AGREEMENT;ASSIGNOR:CAPELLA PHOTONICS, INC.;REEL/FRAME:022641/0593

---

20090505US/AS-A [NMC] ASSIGNMENT  
OWNER: DONALD L. LUCAS, TTEE DONALD L. AND LYGIA LUCAS TR; EFFECTIVE DATE: 20090501  
SECURITY AGREEMENT;ASSIGNOR:CAPELLA PHOTONICS, INC.;REEL/FRAME:022641/0593

---

20090505US/AS-A [NMC] ASSIGNMENT  
OWNER: LUCAS VENTURE GROUP I, LLC, CALIFORNIA; EFFECTIVE DATE: 20090501  
SECURITY AGREEMENT;ASSIGNOR:CAPELLA PHOTONICS, INC.;REEL/FRAME:022641/0593

---

20090505US/AS-A [NMC] ASSIGNMENT  
OWNER: THE LUCAS BROTHERS FOUNDATION, CALIFORNIA; EFFECTIVE DATE: 20090501  
SECURITY AGREEMENT;ASSIGNOR:CAPELLA PHOTONICS, INC.;REEL/FRAME:022641/0593

---

20090505US/AS-A [NMC] ASSIGNMENT  
OWNER: BRENDAN JOSEPH CASSIN AND ISABEL B. CASSIN, TRUSTE; EFFECTIVE DATE:  
20090501  
SECURITY AGREEMENT;ASSIGNOR:CAPELLA PHOTONICS, INC.;REEL/FRAME:022641/0593

---

20090505US/AS-A [NMC] ASSIGNMENT  
OWNER: CASSIN FAMILY PARTNERS, A CALIFORNIA LIMITED PARTN; EFFECTIVE DATE:  
20090501  
SECURITY AGREEMENT;ASSIGNOR:CAPELLA PHOTONICS, INC.;REEL/FRAME:022641/0593

---

20090505US/AS-A [NMC] ASSIGNMENT  
OWNER: ROBERT S. CASSIN CHARITABLE TRUST UTA DATED 2/20/9; EFFECTIVE DATE: 20090501  
SECURITY AGREEMENT;ASSIGNOR:CAPELLA PHOTONICS, INC.;REEL/FRAME:022641/0593

---

20090505US/AS-A [NMC] ASSIGNMENT  
OWNER: LEVENSOHN VENTURE PARTNERS III ANNEX FUND, L.P., C; EFFECTIVE DATE: 20090501  
SECURITY AGREEMENT;ASSIGNOR:CAPELLA PHOTONICS, INC.;REEL/FRAME:022641/0593

ASSIGNMENT  
 20090505US/AS-A [NMC]OWNER: LEVENSOHN VENTURE PARTNERS III, L.P., CALIFORNIA; EFFECTIVE DATE: 20090501  
 SECURITY AGREEMENT;ASSIGNOR:CAPELLA PHOTONICS, INC.;REEL/FRAME:022641/0593

ASSIGNMENT  
 20090505US/AS-A [NMC]OWNER: LVP III ASSOCIATES FUND, L.P., CALIFORNIA; EFFECTIVE DATE: 20090501  
 SECURITY AGREEMENT;ASSIGNOR:CAPELLA PHOTONICS, INC.;REEL/FRAME:022641/0593

ASSIGNMENT  
 20090505US/AS-A [NMC]OWNER: SAINTS CAPITAL FALCON, L.P., CALIFORNIA; EFFECTIVE DATE: 20090501  
 SECURITY AGREEMENT;ASSIGNOR:CAPELLA PHOTONICS, INC.;REEL/FRAME:022641/0593

ASSIGNMENT  
 20090505US/AS-A [NMC]OWNER: RUSTIC CANYON VENTURES, SBIC, LP, CALIFORNIA; EFFECTIVE DATE: 20090501  
 SECURITY AGREEMENT;ASSIGNOR:CAPELLA PHOTONICS, INC.;REEL/FRAME:022641/0593

ASSIGNMENT  
 20090505US/AS-A [NMC]OWNER: ZACCARIA, BERT L., ARIZONA; EFFECTIVE DATE: 20090501  
 SECURITY AGREEMENT;ASSIGNOR:CAPELLA PHOTONICS, INC.;REEL/FRAME:022641/0593

ASSIGNMENT  
 20090505US/AS-A [NMC]OWNER: BRENDAN JOSEPH CASSIN, TRUSTEES OF THE CASSIN 1997; EFFECTIVE DATE:  
 20090501  
 SECURITY AGREEMENT;ASSIGNOR:CAPELLA PHOTONICS, INC.;REEL/FRAME:022641/0593

ASSIGNMENT  
 20090709US/AS-A [NMC]OWNER: TEATON CAPITAL COMPANY, CALIFORNIA; EFFECTIVE DATE: 20090501  
 SECURITY AGREEMENT;ASSIGNOR:CAPELLA PHOTONICS, INC.;REEL/FRAME:022932/0669

ASSIGNMENT  
 20090709US/AS-A [NMC]OWNER: SAND HILL FINANCIAL COMPANY, CALIFORNIA; EFFECTIVE DATE: 20090501  
 SECURITY AGREEMENT;ASSIGNOR:CAPELLA PHOTONICS, INC.;REEL/FRAME:022932/0669

ASSIGNMENT  
 20090709US/AS-A [NMC]OWNER: FORMATIVE VENTURES EMERGING TECHNOLOGIES FUND, LP,; EFFECTIVE DATE:  
 20090501SECURITY AGREEMENT;ASSIGNOR:CAPELLA PHOTONICS,  
 INC.;REEL/FRAME:022932/0669

Alive: US2002131687 A1, US6625346 B2

ASSIGNMENT  
 20010823US/AS-A [NMC] OWNER: CAPELLA PHOTONICS, INC. 19 GREAT OAKS BLVD., SUITE; EFFECTIVE DATE: 20010823  
 ASSIGNMENT OF ASSIGNORS INTEREST;ASSIGNOR:WILDE, JEFFREY  
 P.;AR;REEL/FRAME:012118/0994

---

ASSIGNMENT  
 20010823US/AS-A [NMC] OWNER: CAPELLA PHOTONICS, INC., CALIFORNIA; EFFECTIVE DATE: 20010823  
 ASSIGNMENT OF ASSIGNORS INTEREST;ASSIGNOR:WILDE, JEFFREY  
 P.;REEL/FRAME:012118/0994

---

FILING DETAILS  
 20010823US/API [EXM;POS] US93842601 20010823 [2001US-0938426]

---

First published patent application  
 20020919US/A1 [EXM;POS] US2002131687 A1 20020919 [US20020131687]

---

Granted patent as second publication  
 20030923US/B2 [PIF;POS] US6625346 B2 20030923 [US6625346]

---

REISSUE APPLICATION FILED  
 20050315US/RF-A [OPP] EFFECTIVE DATE: 20041231

---

ASSIGNMENT  
 20090505US/AS-A [NMC] OWNER: SILICON VALLEY BANK, CALIFORNIA; EFFECTIVE DATE: 20090501  
 SECURITY AGREEMENT;ASSIGNOR:CAPELLA PHOTONICS, INC.;REEL/FRAME:022641/0593

---

ASSIGNMENT  
 20090505US/AS-A [NMC] OWNER: BINGHAM, RAYMOND H., CALIFORNIA; EFFECTIVE DATE: 20090501  
 SECURITY AGREEMENT;ASSIGNOR:CAPELLA PHOTONICS, INC.;REEL/FRAME:022641/0593

---

ASSIGNMENT  
 20090505US/AS-A [NMC] OWNER: BLACK DIAMOND VENTURES XIV, LLC., CALIFORNIA; EFFECTIVE DATE: 20090501  
 SECURITY AGREEMENT;ASSIGNOR:CAPELLA PHOTONICS, INC.;REEL/FRAME:022641/0593

---

ASSIGNMENT  
 20090505US/AS-A [NMC] OWNER: DONALD L. LUCAS, SUCC TTEE DONALD L. LUCAS PROFIT; EFFECTIVE DATE: 20090501  
 SECURITY AGREEMENT;ASSIGNOR:CAPELLA PHOTONICS, INC.;REEL/FRAME:022641/0593

---

ASSIGNMENT  
 20090505US/AS-A [NMC] OWNER: DONALD L. LUCAS, TTEE DONALD L. AND LYGIA LUCAS TR; EFFECTIVE DATE: 20090501  
 SECURITY AGREEMENT;ASSIGNOR:CAPELLA PHOTONICS, INC.;REEL/FRAME:022641/0593

---

ASSIGNMENT  
 20090505US/AS-A [NMC] OWNER: LUCAS VENTURE GROUP I, LLC, CALIFORNIA; EFFECTIVE DATE: 20090501  
 SECURITY AGREEMENT;ASSIGNOR:CAPELLA PHOTONICS, INC.;REEL/FRAME:022641/0593

---

ASSIGNMENT  
 20090505US/AS-A [NMC] OWNER: THE LUCAS BROTHERS FOUNDATION, CALIFORNIA; EFFECTIVE DATE: 20090501  
 SECURITY AGREEMENT;ASSIGNOR:CAPELLA PHOTONICS, INC.;REEL/FRAME:022641/0593

---

ASSIGNMENT  
 20090505US/AS-A [NMC] OWNER: BRENDAN JOSEPH CASSIN AND ISABEL B. CASSIN, TRUSTE; EFFECTIVE DATE:  
 20090501  
 SECURITY AGREEMENT;ASSIGNOR:CAPELLA PHOTONICS, INC.;REEL/FRAME:022641/0593

---

ASSIGNMENT  
 20090505US/AS-A [NMC] OWNER: CASSIN FAMILY PARTNERS, A CALIFORNIA LIMITED PARTN; EFFECTIVE DATE:  
 20090501  
 SECURITY AGREEMENT;ASSIGNOR:CAPELLA PHOTONICS, INC.;REEL/FRAME:022641/0593

---

ASSIGNMENT  
 20090505US/AS-A [NMC] OWNER: ROBERT S. CASSIN CHARITABLE TRUST UTA DATED 2/20/9; EFFECTIVE DATE: 20090501  
 SECURITY AGREEMENT;ASSIGNOR:CAPELLA PHOTONICS, INC.;REEL/FRAME:022641/0593

---

ASSIGNMENT  
 20090505US/AS-A [NMC] OWNER: LEVENSOHN VENTURE PARTNERS III ANNEX FUND, L.P., C; EFFECTIVE DATE: 20090501  
 SECURITY AGREEMENT;ASSIGNOR:CAPELLA PHOTONICS, INC.;REEL/FRAME:022641/0593

---

ASSIGNMENT  
 20090505US/AS-A [NMC] OWNER: LEVENSOHN VENTURE PARTNERS III, L.P., CALIFORNIA; EFFECTIVE DATE: 20090501  
 SECURITY AGREEMENT;ASSIGNOR:CAPELLA PHOTONICS, INC.;REEL/FRAME:022641/0593

---

ASSIGNMENT  
 20090505US/AS-A [NMC] OWNER: LVP III ASSOCIATES FUND, L.P., CALIFORNIA; EFFECTIVE DATE: 20090501  
 SECURITY AGREEMENT;ASSIGNOR:CAPELLA PHOTONICS, INC.;REEL/FRAME:022641/0593

---

ASSIGNMENT  
 20090505US/AS-A [NMC] OWNER: SAINTS CAPITAL FALCON, L.P., CALIFORNIA; EFFECTIVE DATE: 20090501  
 SECURITY AGREEMENT;ASSIGNOR:CAPELLA PHOTONICS, INC.;REEL/FRAME:022641/0593

---

ASSIGNMENT  
 20090505US/AS-A [NMC] OWNER: RUSTIC CANYON VENTURES, SBIC, LP, CALIFORNIA; EFFECTIVE DATE: 20090501  
 SECURITY AGREEMENT;ASSIGNOR:CAPELLA PHOTONICS, INC.;REEL/FRAME:022641/0593

ASSIGNMENT  
20090505US/AS-A [NMC] OWNER: ZACCARIA, BERT L., ARIZONA; EFFECTIVE DATE: 20090501  
SECURITY AGREEMENT;ASSIGNOR:CAPELLA PHOTONICS, INC.;REEL/FRAME:022641/0593

---

ASSIGNMENT  
20090505US/AS-A [NMC] OWNER: BRENDAN JOSEPH CASSIN, TRUSTEES OF THE CASSIN 1997; EFFECTIVE DATE:  
20090501  
SECURITY AGREEMENT;ASSIGNOR:CAPELLA PHOTONICS, INC.;REEL/FRAME:022641/0593

---

ASSIGNMENT  
20090709US/AS-A [NMC] OWNER: TEATON CAPITAL COMPANY, CALIFORNIA; EFFECTIVE DATE: 20090501  
SECURITY AGREEMENT;ASSIGNOR:CAPELLA PHONONICS, INC.;REEL/FRAME:022932/0669

---

ASSIGNMENT  
20090709US/AS-A [NMC] OWNER: SAND HILL FINANCIAL COMPANY, CALIFORNIA; EFFECTIVE DATE: 20090501  
SECURITY AGREEMENT;ASSIGNOR:CAPELLA PHONONICS, INC.;REEL/FRAME:022932/0669

---

ASSIGNMENT  
20090709US/AS-A [NMC] OWNER: FORMATIVE VENTURES EMERGING TECHNOLOGIES FUND, LP.; EFFECTIVE DATE:  
20090501 SECURITY AGREEMENT;ASSIGNOR:CAPELLA PHONONICS,  
INC.;REEL/FRAME:022932/0669

Alive: US2002131691 A1, US6760511 B2

ASSIGNMENT  
 20020214US/AS-A [NMC] OWNER: CAPELLA PHOTONICS, INC. 19 GREAT OAKS BLVD., SUITE  
 ASSIGNMENT OF ASSIGNORS INTEREST;ASSIGNORS:GARRETT, MARK  
 H. /AR;REEL/FRAME:012593/0177;SIGNING DATES FROM 20020115 TO 20020122

---

ASSIGNMENT  
 20020214US/AS-A [NMC] OWNER: CAPELLA PHOTONICS, INC., CALIFORNIA  
 ASSIGNMENT OF ASSIGNORS INTEREST;ASSIGNORS:GARRETT, MARK H.;MANSURIPUR,  
 MASUD;WILDE, JEFFREY P.;AND OTHERS;REEL/FRAME:012593/0177;SIGNING DATES FROM  
 20020115 TO 20020122

---

FILING DETAILS  
 20020214US/API [EXM;POS] US7614502 20020214 [2002US-0076145]

---

First published patent application  
 20020919US/A1 [EXM;POS] US2002131691 A1 20020919 [US20020131691]

---

Granted patent as second publication  
 20040706US/B2 [PIF;POS] US6760511 B2 20040706 [US6760511]

---

REISSUE APPLICATION FILED  
 20050308US/RF-A [OPP] EFFECTIVE DATE: 20041231

---

ASSIGNMENT  
 20090505US/AS-A [NMC] OWNER: SILICON VALLEY BANK, CALIFORNIA; EFFECTIVE DATE: 20090501  
 SECURITY AGREEMENT;ASSIGNOR:CAPELLA PHOTONICS, INC.;REEL/FRAME:022641/0593

---

ASSIGNMENT  
 20090505US/AS-A [NMC] OWNER: BINGHAM, RAYMOND H., CALIFORNIA; EFFECTIVE DATE: 20090501  
 SECURITY AGREEMENT;ASSIGNOR:CAPELLA PHOTONICS, INC.;REEL/FRAME:022641/0593

---

ASSIGNMENT  
 20090505US/AS-A [NMC] OWNER: BLACK DIAMOND VENTURES XIV, LLC., CALIFORNIA; EFFECTIVE DATE: 20090501  
 SECURITY AGREEMENT;ASSIGNOR:CAPELLA PHOTONICS, INC.;REEL/FRAME:022641/0593

---

ASSIGNMENT  
 20090505US/AS-A [NMC] OWNER: DONALD L. LUCAS, SUCC TTEE DONALD L. LUCAS PROFIT; EFFECTIVE DATE: 20090501  
 SECURITY AGREEMENT;ASSIGNOR:CAPELLA PHOTONICS, INC.;REEL/FRAME:022641/0593

---

ASSIGNMENT  
 20090505US/AS-A [NMC] OWNER: DONALD L. LUCAS, TTEE DONALD L. AND LYGIA LUCAS TR; EFFECTIVE DATE: 20090501  
 SECURITY AGREEMENT;ASSIGNOR:CAPELLA PHOTONICS, INC.;REEL/FRAME:022641/0593

---

ASSIGNMENT  
 20090505US/AS-A [NMC] OWNER: LUCAS VENTURE GROUP I, LLC, CALIFORNIA; EFFECTIVE DATE: 20090501  
 SECURITY AGREEMENT;ASSIGNOR:CAPELLA PHOTONICS, INC.;REEL/FRAME:022641/0593

---

ASSIGNMENT  
 20090505US/AS-A [NMC] OWNER: THE LUCAS BROTHERS FOUNDATION, CALIFORNIA; EFFECTIVE DATE: 20090501  
 SECURITY AGREEMENT;ASSIGNOR:CAPELLA PHOTONICS, INC.;REEL/FRAME:022641/0593

---

ASSIGNMENT  
 20090505US/AS-A [NMC] OWNER: BRENDAN JOSEPH CASSIN AND ISABEL B. CASSIN, TRUSTE; EFFECTIVE DATE:  
 20090501  
 SECURITY AGREEMENT;ASSIGNOR:CAPELLA PHOTONICS, INC.;REEL/FRAME:022641/0593

---

ASSIGNMENT  
 20090505US/AS-A [NMC] OWNER: CASSIN FAMILY PARTNERS, A CALIFORNIA LIMITED PARTN; EFFECTIVE DATE:  
 20090501  
 SECURITY AGREEMENT;ASSIGNOR:CAPELLA PHOTONICS, INC.;REEL/FRAME:022641/0593



20090505US/AS-A [NMC] ASSIGNMENT  
OWNER: ROBERT S. CASSIN CHARITABLE TRUST UTA DATED 2/20/9; EFFECTIVE DATE: 20090501  
SECURITY AGREEMENT;ASSIGNOR:CAPELLA PHOTONICS, INC.;REEL/FRAME:022641/0593

---

20090505US/AS-A [NMC] ASSIGNMENT  
OWNER: LEVENSOHN VENTURE PARTNERS III ANNEX FUND, L.P., C; EFFECTIVE DATE: 20090501  
SECURITY AGREEMENT;ASSIGNOR:CAPELLA PHOTONICS, INC.;REEL/FRAME:022641/0593

---

20090505US/AS-A [NMC] ASSIGNMENT  
OWNER: LEVENSOHN VENTURE PARTNERS III, L.P., CALIFORNIA; EFFECTIVE DATE: 20090501  
SECURITY AGREEMENT;ASSIGNOR:CAPELLA PHOTONICS, INC.;REEL/FRAME:022641/0593

---

20090505US/AS-A [NMC] ASSIGNMENT  
OWNER: LVP III ASSOCIATES FUND, L.P., CALIFORNIA; EFFECTIVE DATE: 20090501  
SECURITY AGREEMENT;ASSIGNOR:CAPELLA PHOTONICS, INC.;REEL/FRAME:022641/0593

---

20090505US/AS-A [NMC] ASSIGNMENT  
OWNER: SAINTS CAPITAL FALCON, L.P., CALIFORNIA; EFFECTIVE DATE: 20090501  
SECURITY AGREEMENT;ASSIGNOR:CAPELLA PHOTONICS, INC.;REEL/FRAME:022641/0593

---

20090505US/AS-A [NMC] ASSIGNMENT  
OWNER: RUSTIC CANYON VENTURES, SBIC, LP, CALIFORNIA; EFFECTIVE DATE: 20090501  
SECURITY AGREEMENT;ASSIGNOR:CAPELLA PHOTONICS, INC.;REEL/FRAME:022641/0593

---

20090505US/AS-A [NMC] ASSIGNMENT  
OWNER: ZACCARIA, BERT L., ARIZONA; EFFECTIVE DATE: 20090501  
SECURITY AGREEMENT;ASSIGNOR:CAPELLA PHOTONICS, INC.;REEL/FRAME:022641/0593

---

20090505US/AS-A [NMC] ASSIGNMENT  
OWNER: BRENDAN JOSEPH CASSIN, TRUSTEES OF THE CASSIN 1997; EFFECTIVE DATE:  
20090501  
SECURITY AGREEMENT;ASSIGNOR:CAPELLA PHOTONICS, INC.;REEL/FRAME:022641/0593

---

20090709US/AS-A [NMC] ASSIGNMENT  
OWNER: TEATON CAPITAL COMPANY, CALIFORNIA; EFFECTIVE DATE: 20090501  
SECURITY AGREEMENT;ASSIGNOR:CAPELLA PHOTONICS, INC.;REEL/FRAME:022932/0669

---

20090709US/AS-A [NMC] ASSIGNMENT  
OWNER: SAND HILL FINANCIAL COMPANY, CALIFORNIA; EFFECTIVE DATE: 20090501  
SECURITY AGREEMENT;ASSIGNOR:CAPELLA PHOTONICS, INC.;REEL/FRAME:022932/0669

---

20090709US/AS-A [NMC] ASSIGNMENT  
OWNER: FORMATIVE VENTURES EMERGING TECHNOLOGIES FUND, LP.; EFFECTIVE DATE:  
20090501  
SECURITY AGREEMENT;ASSIGNOR:CAPELLA PHOTONICS,  
INC.;REEL/FRAME:022932/0669

**IN1476/CHENP/2003 A, IN200748 B**

Legal Status N/A

Alive: USRE39331 E1

20041231US/API [EXM;POS] FILING DETAILS  
US11027584 20041231 [2004US-0027584]

20061010US/E1 [PIF;POS] Reissue Patent  
USRE39331 E1 20061010 [USRE39331]

20090505US/AS-A [NMC] ASSIGNMENT  
OWNER: SILICON VALLEY BANK, CALIFORNIA; EFFECTIVE DATE: 20090501  
SECURITY AGREEMENT;ASSIGNOR:CAPELLA PHOTONICS, INC.;REEL/FRAME:022641/0593

20090505US/AS-A [NMC] ASSIGNMENT  
OWNER: BINGHAM, RAYMOND H., CALIFORNIA; EFFECTIVE DATE: 20090501  
SECURITY AGREEMENT;ASSIGNOR:CAPELLA PHOTONICS, INC.;REEL/FRAME:022641/0593

20090505US/AS-A [NMC] ASSIGNMENT  
OWNER: BLACK DIAMOND VENTURES XIV, LLC., CALIFORNIA; EFFECTIVE DATE: 20090501  
SECURITY AGREEMENT;ASSIGNOR:CAPELLA PHOTONICS, INC.;REEL/FRAME:022641/0593

20090505US/AS-A [NMC] ASSIGNMENT  
OWNER: DONALD L. LUCAS, SUCC TTEE DONALD L. LUCAS PROFIT; EFFECTIVE DATE: 20090501  
SECURITY AGREEMENT;ASSIGNOR:CAPELLA PHOTONICS, INC.;REEL/FRAME:022641/0593

20090505US/AS-A [NMC] ASSIGNMENT  
OWNER: DONALD L. LUCAS, TTEE DONALD L. AND LYGIA LUCAS TR; EFFECTIVE DATE: 20090501  
SECURITY AGREEMENT;ASSIGNOR:CAPELLA PHOTONICS, INC.;REEL/FRAME:022641/0593

20090505US/AS-A [NMC] ASSIGNMENT  
OWNER: LUCAS VENTURE GROUP I, LLC, CALIFORNIA; EFFECTIVE DATE: 20090501  
SECURITY AGREEMENT;ASSIGNOR:CAPELLA PHOTONICS, INC.;REEL/FRAME:022641/0593

20090505US/AS-A [NMC] ASSIGNMENT  
OWNER: THE LUCAS BROTHERS FOUNDATION, CALIFORNIA; EFFECTIVE DATE: 20090501  
SECURITY AGREEMENT;ASSIGNOR:CAPELLA PHOTONICS, INC.;REEL/FRAME:022641/0593

20090505US/AS-A [NMC] ASSIGNMENT  
OWNER: BRENDAN JOSEPH CASSIN AND ISABEL B. CASSIN, TRUSTE; EFFECTIVE DATE:  
20090501  
SECURITY AGREEMENT;ASSIGNOR:CAPELLA PHOTONICS, INC.;REEL/FRAME:022641/0593

20090505US/AS-A [NMC] ASSIGNMENT  
OWNER: CASSIN FAMILY PARTNERS, A CALIFORNIA LIMITED PARTN; EFFECTIVE DATE:  
20090501  
SECURITY AGREEMENT;ASSIGNOR:CAPELLA PHOTONICS, INC.;REEL/FRAME:022641/0593

20090505US/AS-A [NMC] ASSIGNMENT  
OWNER: ROBERT S. CASSIN CHARITABLE TRUST UTA DATED 2/20/9; EFFECTIVE DATE: 20090501  
SECURITY AGREEMENT;ASSIGNOR:CAPELLA PHOTONICS, INC.;REEL/FRAME:022641/0593

20090505US/AS-A [NMC] ASSIGNMENT  
OWNER: LEVENSOHN VENTURE PARTNERS III ANNEX FUND, L.P., C; EFFECTIVE DATE: 20090501  
SECURITY AGREEMENT;ASSIGNOR:CAPELLA PHOTONICS, INC.;REEL/FRAME:022641/0593

20090505US/AS-A [NMC] ASSIGNMENT  
OWNER: LEVENSOHN VENTURE PARTNERS III, L.P., CALIFORNIA; EFFECTIVE DATE: 20090501  
SECURITY AGREEMENT;ASSIGNOR:CAPELLA PHOTONICS, INC.;REEL/FRAME:022641/0593

20090505US/AS-A [NMC] ASSIGNMENT  
OWNER: LVP III ASSOCIATES FUND, L.P., CALIFORNIA; EFFECTIVE DATE: 20090501  
SECURITY AGREEMENT;ASSIGNOR:CAPELLA PHOTONICS, INC.;REEL/FRAME:022641/0593

20090505US/AS-A [NMC] ASSIGNMENT  
OWNER: SAINTS CAPITAL FALCON, L.P., CALIFORNIA; EFFECTIVE DATE: 20090501  
SECURITY AGREEMENT;ASSIGNOR:CAPELLA PHOTONICS, INC.;REEL/FRAME:022641/0593

20090505US/AS-A [NMC] ASSIGNMENT  
OWNER: RUSTIC CANYON VENTURES, SBIC, LP, CALIFORNIA; EFFECTIVE DATE: 20090501  
SECURITY AGREEMENT;ASSIGNOR:CAPELLA PHOTONICS, INC.;REEL/FRAME:022641/0593

20090505US/AS-A [NMC] ASSIGNMENT  
OWNER: ZACCARIA, BERT L., ARIZONA; EFFECTIVE DATE: 20090501  
SECURITY AGREEMENT;ASSIGNOR:CAPELLA PHOTONICS, INC.;REEL/FRAME:022641/0593

20090505US/AS-A [NMC] ASSIGNMENT  
OWNER: BRENDAN JOSEPH CASSIN, TRUSTEES OF THE CASSIN 1997; EFFECTIVE DATE:  
20090501  
SECURITY AGREEMENT;ASSIGNOR:CAPELLA PHOTONICS, INC.;REEL/FRAME:022641/0593

20090709US/AS-A [NMC] ASSIGNMENT  
OWNER: TEATON CAPITAL COMPANY, CALIFORNIA; EFFECTIVE DATE: 20090501  
SECURITY AGREEMENT;ASSIGNOR:CAPELLA PHOTONICS, INC.;REEL/FRAME:022932/0669

20090709US/AS-A [NMC] ASSIGNMENT  
OWNER: SAND HILL FINANCIAL COMPANY, CALIFORNIA; EFFECTIVE DATE: 20090501  
SECURITY AGREEMENT;ASSIGNOR:CAPELLA PHOTONICS, INC.;REEL/FRAME:022932/0669

20090709US/AS-A [NMC] ASSIGNMENT  
OWNER: FORMATIVE VENTURES EMERGING TECHNOLOGIES FUND, LP.; EFFECTIVE DATE:  
20090501  
SECURITY AGREEMENT;ASSIGNOR:CAPELLA PHOTONICS,  
INC.;REEL/FRAME:022932/0669

Alive: USRE39397 E1

20041231US/API [EXM;POS] FILING DETAILS  
US11027586 20041231 [2004US-0027586]

20061114US/E1 [PIF;POS] Reissue Patent  
USRE39397 E1 20061114 [USRE39397]

20090505US/AS-A [NMC] ASSIGNMENT  
OWNER: SILICON VALLEY BANK, CALIFORNIA; EFFECTIVE DATE: 20090501  
SECURITY AGREEMENT;ASSIGNOR:CAPELLA PHOTONICS, INC.;REEL/FRAME:022641/0593

20090505US/AS-A [NMC] ASSIGNMENT  
OWNER: BINGHAM, RAYMOND H., CALIFORNIA; EFFECTIVE DATE: 20090501  
SECURITY AGREEMENT;ASSIGNOR:CAPELLA PHOTONICS, INC.;REEL/FRAME:022641/0593

20090505US/AS-A [NMC] ASSIGNMENT  
OWNER: BLACK DIAMOND VENTURES XIV, LLC., CALIFORNIA; EFFECTIVE DATE: 20090501  
SECURITY AGREEMENT;ASSIGNOR:CAPELLA PHOTONICS, INC.;REEL/FRAME:022641/0593

20090505US/AS-A [NMC] ASSIGNMENT  
OWNER: DONALD L. LUCAS, SUCC TTEE DONALD L. LUCAS PROFIT; EFFECTIVE DATE: 20090501  
SECURITY AGREEMENT;ASSIGNOR:CAPELLA PHOTONICS, INC.;REEL/FRAME:022641/0593

20090505US/AS-A [NMC] ASSIGNMENT  
OWNER: DONALD L. LUCAS, TTEE DONALD L. AND LYGIA LUCAS TR; EFFECTIVE DATE: 20090501  
SECURITY AGREEMENT;ASSIGNOR:CAPELLA PHOTONICS, INC.;REEL/FRAME:022641/0593

20090505US/AS-A [NMC] ASSIGNMENT  
OWNER: LUCAS VENTURE GROUP I, LLC, CALIFORNIA; EFFECTIVE DATE: 20090501  
SECURITY AGREEMENT;ASSIGNOR:CAPELLA PHOTONICS, INC.;REEL/FRAME:022641/0593

20090505US/AS-A [NMC] ASSIGNMENT  
OWNER: THE LUCAS BROTHERS FOUNDATION, CALIFORNIA; EFFECTIVE DATE: 20090501  
SECURITY AGREEMENT;ASSIGNOR:CAPELLA PHOTONICS, INC.;REEL/FRAME:022641/0593

20090505US/AS-A [NMC] ASSIGNMENT  
OWNER: BRENDAN JOSEPH CASSIN AND ISABEL B. CASSIN, TRUSTE; EFFECTIVE DATE:  
20090501  
SECURITY AGREEMENT;ASSIGNOR:CAPELLA PHOTONICS, INC.;REEL/FRAME:022641/0593

20090505US/AS-A [NMC] ASSIGNMENT  
OWNER: CASSIN FAMILY PARTNERS, A CALIFORNIA LIMITED PARTN; EFFECTIVE DATE:  
20090501  
SECURITY AGREEMENT;ASSIGNOR:CAPELLA PHOTONICS, INC.;REEL/FRAME:022641/0593

20090505US/AS-A [NMC] ASSIGNMENT  
OWNER: ROBERT S. CASSIN CHARITABLE TRUST UTA DATED 2/20/9; EFFECTIVE DATE: 20090501  
SECURITY AGREEMENT;ASSIGNOR:CAPELLA PHOTONICS, INC.;REEL/FRAME:022641/0593

20090505US/AS-A [NMC] ASSIGNMENT  
OWNER: LEVENSOHN VENTURE PARTNERS III ANNEX FUND, L.P., C; EFFECTIVE DATE: 20090501  
SECURITY AGREEMENT;ASSIGNOR:CAPELLA PHOTONICS, INC.;REEL/FRAME:022641/0593

20090505US/AS-A [NMC] ASSIGNMENT  
OWNER: LEVENSOHN VENTURE PARTNERS III, L.P., CALIFORNIA; EFFECTIVE DATE: 20090501  
SECURITY AGREEMENT;ASSIGNOR:CAPELLA PHOTONICS, INC.;REEL/FRAME:022641/0593

20090505US/AS-A [NMC] ASSIGNMENT  
OWNER: LVP III ASSOCIATES FUND, L.P., CALIFORNIA; EFFECTIVE DATE: 20090501  
SECURITY AGREEMENT;ASSIGNOR:CAPELLA PHOTONICS, INC.;REEL/FRAME:022641/0593

20090505US/AS-A [NMC] ASSIGNMENT  
OWNER: SAINTS CAPITAL FALCON, L.P., CALIFORNIA; EFFECTIVE DATE: 20090501  
SECURITY AGREEMENT;ASSIGNOR:CAPELLA PHOTONICS, INC.;REEL/FRAME:022641/0593

20090505US/AS-A [NMC] ASSIGNMENT  
OWNER: RUSTIC CANYON VENTURES, SBIC, LP, CALIFORNIA; EFFECTIVE DATE: 20090501  
SECURITY AGREEMENT;ASSIGNOR:CAPELLA PHOTONICS, INC.;REEL/FRAME:022641/0593

20090505US/AS-A [NMC] ASSIGNMENT  
OWNER: ZACCARIA, BERT L., ARIZONA; EFFECTIVE DATE: 20090501  
SECURITY AGREEMENT;ASSIGNOR:CAPELLA PHOTONICS, INC.;REEL/FRAME:022641/0593

20090505US/AS-A [NMC] ASSIGNMENT  
OWNER: BRENDAN JOSEPH CASSIN, TRUSTEES OF THE CASSIN 1997; EFFECTIVE DATE:  
20090501  
SECURITY AGREEMENT;ASSIGNOR:CAPELLA PHOTONICS, INC.;REEL/FRAME:022641/0593

20090709US/AS-A [NMC] ASSIGNMENT  
OWNER: TEATON CAPITAL COMPANY, CALIFORNIA; EFFECTIVE DATE: 20090501  
SECURITY AGREEMENT;ASSIGNOR:CAPELLA PHOTONICS, INC.;REEL/FRAME:022932/0669

20090709US/AS-A [NMC] ASSIGNMENT  
OWNER: SAND HILL FINANCIAL COMPANY, CALIFORNIA; EFFECTIVE DATE: 20090501  
SECURITY AGREEMENT;ASSIGNOR:CAPELLA PHOTONICS, INC.;REEL/FRAME:022932/0669

20090709US/AS-A [NMC] ASSIGNMENT  
OWNER: FORMATIVE VENTURES EMERGING TECHNOLOGIES FUND, LP.; EFFECTIVE DATE:  
20090501  
SECURITY AGREEMENT;ASSIGNOR:CAPELLA PHOTONICS,  
INC.;REEL/FRAME:022932/0669

Alive: USRE39411 E1

20041231US/API [EXM;POS] FILING DETAILS  
US11027588 20041231 [2004US-0027588]

20061128US/E1 [PIF;POS] Reissue Patent  
USRE39411 E1 20061128 [USRE39411]

20090505US/AS-A [NMC] ASSIGNMENT  
OWNER: SILICON VALLEY BANK, CALIFORNIA; EFFECTIVE DATE: 20090501  
SECURITY AGREEMENT;ASSIGNOR:CAPELLA PHOTONICS, INC.;REEL/FRAME:022641/0593

20090505US/AS-A [NMC] ASSIGNMENT  
OWNER: BINGHAM, RAYMOND H., CALIFORNIA; EFFECTIVE DATE: 20090501  
SECURITY AGREEMENT;ASSIGNOR:CAPELLA PHOTONICS, INC.;REEL/FRAME:022641/0593

20090505US/AS-A [NMC] ASSIGNMENT  
OWNER: BLACK DIAMOND VENTURES XIV, LLC., CALIFORNIA; EFFECTIVE DATE: 20090501  
SECURITY AGREEMENT;ASSIGNOR:CAPELLA PHOTONICS, INC.;REEL/FRAME:022641/0593

20090505US/AS-A [NMC] ASSIGNMENT  
OWNER: DONALD L. LUCAS, SUCC TTEE DONALD L. LUCAS PROFIT; EFFECTIVE DATE: 20090501  
SECURITY AGREEMENT;ASSIGNOR:CAPELLA PHOTONICS, INC.;REEL/FRAME:022641/0593

20090505US/AS-A [NMC] ASSIGNMENT  
OWNER: DONALD L. LUCAS, TTEE DONALD L. AND LYGIA LUCAS TR; EFFECTIVE DATE: 20090501  
SECURITY AGREEMENT;ASSIGNOR:CAPELLA PHOTONICS, INC.;REEL/FRAME:022641/0593

20090505US/AS-A [NMC] ASSIGNMENT  
OWNER: LUCAS VENTURE GROUP I, LLC, CALIFORNIA; EFFECTIVE DATE: 20090501  
SECURITY AGREEMENT;ASSIGNOR:CAPELLA PHOTONICS, INC.;REEL/FRAME:022641/0593

20090505US/AS-A [NMC] ASSIGNMENT  
OWNER: THE LUCAS BROTHERS FOUNDATION, CALIFORNIA; EFFECTIVE DATE: 20090501  
SECURITY AGREEMENT;ASSIGNOR:CAPELLA PHOTONICS, INC.;REEL/FRAME:022641/0593

20090505US/AS-A [NMC] ASSIGNMENT  
OWNER: BRENDAN JOSEPH CASSIN AND ISABEL B. CASSIN, TRUSTE; EFFECTIVE DATE:  
20090501  
SECURITY AGREEMENT;ASSIGNOR:CAPELLA PHOTONICS, INC.;REEL/FRAME:022641/0593

20090505US/AS-A [NMC] ASSIGNMENT  
OWNER: CASSIN FAMILY PARTNERS, A CALIFORNIA LIMITED PARTN; EFFECTIVE DATE:  
20090501  
SECURITY AGREEMENT;ASSIGNOR:CAPELLA PHOTONICS, INC.;REEL/FRAME:022641/0593

20090505US/AS-A [NMC] ASSIGNMENT  
OWNER: ROBERT S. CASSIN CHARITABLE TRUST UTA DATED 2/20/9; EFFECTIVE DATE: 20090501  
SECURITY AGREEMENT;ASSIGNOR:CAPELLA PHOTONICS, INC.;REEL/FRAME:022641/0593

20090505US/AS-A [NMC] ASSIGNMENT  
OWNER: LEVENSOHN VENTURE PARTNERS III ANNEX FUND, L.P., C; EFFECTIVE DATE: 20090501  
SECURITY AGREEMENT;ASSIGNOR:CAPELLA PHOTONICS, INC.;REEL/FRAME:022641/0593

20090505US/AS-A [NMC] ASSIGNMENT  
OWNER: LEVENSOHN VENTURE PARTNERS III, L.P., CALIFORNIA; EFFECTIVE DATE: 20090501  
SECURITY AGREEMENT;ASSIGNOR:CAPELLA PHOTONICS, INC.;REEL/FRAME:022641/0593

20090505US/AS-A [NMC] ASSIGNMENT  
OWNER: LVP III ASSOCIATES FUND, L.P., CALIFORNIA; EFFECTIVE DATE: 20090501  
SECURITY AGREEMENT;ASSIGNOR:CAPELLA PHOTONICS, INC.;REEL/FRAME:022641/0593

20090505US/AS-A [NMC] ASSIGNMENT  
OWNER: SAINTS CAPITAL FALCON, L.P., CALIFORNIA; EFFECTIVE DATE: 20090501  
SECURITY AGREEMENT;ASSIGNOR:CAPELLA PHOTONICS, INC.;REEL/FRAME:022641/0593

20090505US/AS-A [NMC] ASSIGNMENT  
OWNER: RUSTIC CANYON VENTURES, SBIC, LP, CALIFORNIA; EFFECTIVE DATE: 20090501  
SECURITY AGREEMENT;ASSIGNOR:CAPELLA PHOTONICS, INC.;REEL/FRAME:022641/0593

20090505US/AS-A [NMC] ASSIGNMENT  
OWNER: ZACCARIA, BERT L, ARIZONA; EFFECTIVE DATE: 20090501  
SECURITY AGREEMENT;ASSIGNOR:CAPELLA PHOTONICS, INC.;REEL/FRAME:022641/0593

20090505US/AS-A [NMC] ASSIGNMENT  
OWNER: BRENDAN JOSEPH CASSIN, TRUSTEES OF THE CASSIN 1997; EFFECTIVE DATE:  
20090501  
SECURITY AGREEMENT;ASSIGNOR:CAPELLA PHOTONICS, INC.;REEL/FRAME:022641/0593

20090709US/AS-A [NMC] ASSIGNMENT  
OWNER: TEATON CAPITAL COMPANY, CALIFORNIA; EFFECTIVE DATE: 20090501  
SECURITY AGREEMENT;ASSIGNOR:CAPELLA PHOTONICS, INC.;REEL/FRAME:022932/0669

20090709US/AS-A [NMC] ASSIGNMENT  
OWNER: SAND HILL FINANCIAL COMPANY, CALIFORNIA; EFFECTIVE DATE: 20090501  
SECURITY AGREEMENT;ASSIGNOR:CAPELLA PHOTONICS, INC.;REEL/FRAME:022932/0669

20090709US/AS-A [NMC] ASSIGNMENT  
OWNER: FORMATIVE VENTURES EMERGING TECHNOLOGIES FUND, LP.; EFFECTIVE DATE:  
20090501  
SECURITY AGREEMENT;ASSIGNOR:CAPELLA PHOTONICS,  
INC.;REEL/FRAME:022932/0669

Alive: USRE39515 E1

20041231US/API [EXM;POS] FILING DETAILS  
US2758904 20041231 [2004US-0027589]

20070313US/E1 [PIF;POS] Reissue Patent  
USRE39515 E1 20070313 [USRE39515]

20090112US/PRDP-A [POS;RES] PATENT REINSTATED DUE TO THE ACCEPTANCE OF A LATE MAINTENANCE FEE  
EFFECTIVE DATE: 20070313

ASSIGNMENT  
20090505US/AS-A [NMC] OWNER: SILICON VALLEY BANK, CALIFORNIA; EFFECTIVE DATE: 20090501  
SECURITY AGREEMENT;ASSIGNOR:CAPELLA PHOTONICS, INC.;REEL/FRAME:022641/0593

ASSIGNMENT  
20090505US/AS-A [NMC] OWNER: BINGHAM, RAYMOND H., CALIFORNIA; EFFECTIVE DATE: 20090501  
SECURITY AGREEMENT;ASSIGNOR:CAPELLA PHOTONICS, INC.;REEL/FRAME:022641/0593

ASSIGNMENT  
20090505US/AS-A [NMC] OWNER: BLACK DIAMOND VENTURES XIV, LLC., CALIFORNIA; EFFECTIVE DATE: 20090501  
SECURITY AGREEMENT;ASSIGNOR:CAPELLA PHOTONICS, INC.;REEL/FRAME:022641/0593

ASSIGNMENT  
20090505US/AS-A [NMC] OWNER: DONALD L. LUCAS, SUCC TTEE DONALD L. LUCAS PROFIT; EFFECTIVE DATE: 20090501  
SECURITY AGREEMENT;ASSIGNOR:CAPELLA PHOTONICS, INC.;REEL/FRAME:022641/0593

ASSIGNMENT  
20090505US/AS-A [NMC] OWNER: DONALD L. LUCAS, TTEE DONALD L. AND LYGIA LUCAS TR; EFFECTIVE DATE: 20090501  
SECURITY AGREEMENT;ASSIGNOR:CAPELLA PHOTONICS, INC.;REEL/FRAME:022641/0593

ASSIGNMENT  
20090505US/AS-A [NMC] OWNER: LUCAS VENTURE GROUP I, LLC, CALIFORNIA; EFFECTIVE DATE: 20090501  
SECURITY AGREEMENT;ASSIGNOR:CAPELLA PHOTONICS, INC.;REEL/FRAME:022641/0593

ASSIGNMENT  
20090505US/AS-A [NMC] OWNER: THE LUCAS BROTHERS FOUNDATION, CALIFORNIA; EFFECTIVE DATE: 20090501  
SECURITY AGREEMENT;ASSIGNOR:CAPELLA PHOTONICS, INC.;REEL/FRAME:022641/0593

ASSIGNMENT  
20090505US/AS-A [NMC] OWNER: BRENDAN JOSEPH CASSIN AND ISABEL B. CASSIN, TRUSTE; EFFECTIVE DATE:  
20090501  
SECURITY AGREEMENT;ASSIGNOR:CAPELLA PHOTONICS, INC.;REEL/FRAME:022641/0593

ASSIGNMENT  
20090505US/AS-A [NMC] OWNER: CASSIN FAMILY PARTNERS, A CALIFORNIA LIMITED PARTN; EFFECTIVE DATE:  
20090501  
SECURITY AGREEMENT;ASSIGNOR:CAPELLA PHOTONICS, INC.;REEL/FRAME:022641/0593

ASSIGNMENT  
20090505US/AS-A [NMC] OWNER: ROBERT S. CASSIN CHARITABLE TRUST UTA DATED 2/20/9; EFFECTIVE DATE: 20090501  
SECURITY AGREEMENT;ASSIGNOR:CAPELLA PHOTONICS, INC.;REEL/FRAME:022641/0593

ASSIGNMENT  
20090505US/AS-A [NMC] OWNER: LEVENSOHN VENTURE PARTNERS III ANNEX FUND, L.P., C; EFFECTIVE DATE: 20090501  
SECURITY AGREEMENT;ASSIGNOR:CAPELLA PHOTONICS, INC.;REEL/FRAME:022641/0593

ASSIGNMENT  
20090505US/AS-A [NMC] OWNER: LEVENSOHN VENTURE PARTNERS III, L.P., CALIFORNIA; EFFECTIVE DATE: 20090501  
SECURITY AGREEMENT;ASSIGNOR:CAPELLA PHOTONICS, INC.;REEL/FRAME:022641/0593

ASSIGNMENT  
20090505US/AS-A [NMC] OWNER: LVP III ASSOCIATES FUND, L.P., CALIFORNIA; EFFECTIVE DATE: 20090501  
SECURITY AGREEMENT;ASSIGNOR:CAPELLA PHOTONICS, INC.;REEL/FRAME:022641/0593

ASSIGNMENT  
20090505US/AS-A [NMC] OWNER: SAINTS CAPITAL FALCON, L.P., CALIFORNIA; EFFECTIVE DATE: 20090501  
SECURITY AGREEMENT;ASSIGNOR:CAPELLA PHOTONICS, INC.;REEL/FRAME:022641/0593

ASSIGNMENT  
20090505US/AS-A [NMC] OWNER: RUSTIC CANYON VENTURES, SBIC, LP, CALIFORNIA; EFFECTIVE DATE: 20090501  
SECURITY AGREEMENT;ASSIGNOR:CAPELLA PHOTONICS, INC.;REEL/FRAME:022641/0593

ASSIGNMENT  
20090505US/AS-A [NMC] OWNER: ZACCARIA, BERT L., ARIZONA; EFFECTIVE DATE: 20090501  
SECURITY AGREEMENT;ASSIGNOR:CAPELLA PHOTONICS, INC.;REEL/FRAME:022641/0593

ASSIGNMENT  
20090505US/AS-A [NMC] OWNER: BRENDAN JOSEPH CASSIN, TRUSTEES OF THE CASSIN 1997; EFFECTIVE DATE:  
20090501  
SECURITY AGREEMENT;ASSIGNOR:CAPELLA PHOTONICS, INC.;REEL/FRAME:022641/0593

ASSIGNMENT  
20090709US/AS-A [NMC] OWNER: TEATON CAPITAL COMPANY, CALIFORNIA; EFFECTIVE DATE: 20090501  
SECURITY AGREEMENT;ASSIGNOR:CAPELLA PHOTONICS, INC.;REEL/FRAME:022932/0669

ASSIGNMENT  
20090709US/AS-A [NMC] OWNER: SAND HILL FINANCIAL COMPANY, CALIFORNIA; EFFECTIVE DATE: 20090501  
SECURITY AGREEMENT;ASSIGNOR:CAPELLA PHOTONICS, INC.;REEL/FRAME:022932/0669

ASSIGNMENT  
20090709US/AS-A [NMC] OWNER: FORMATIVE VENTURES EMERGING TECHNOLOGIES FUND, LP.; EFFECTIVE DATE:  
20090501  
SECURITY AGREEMENT;ASSIGNOR:CAPELLA PHOTONICS,  
INC.;REEL/FRAME:022932/0669

Alive: USRE39525 E1

20041231US/API [EXM;POS] FILING DETAILS  
US11027587 20041231 [2004US-0027587]

20070320US/E1 [PIF;POS] Reissue Patent  
USRE39525 E1 20070320 [USRE39525]

20090505US/AS-A [NMC] ASSIGNMENT  
OWNER: SILICON VALLEY BANK, CALIFORNIA; EFFECTIVE DATE: 20090501  
SECURITY AGREEMENT;ASSIGNOR:CAPELLA PHOTONICS, INC.;REEL/FRAME:022641/0593

20090505US/AS-A [NMC] ASSIGNMENT  
OWNER: BINGHAM, RAYMOND H., CALIFORNIA; EFFECTIVE DATE: 20090501  
SECURITY AGREEMENT;ASSIGNOR:CAPELLA PHOTONICS, INC.;REEL/FRAME:022641/0593

20090505US/AS-A [NMC] ASSIGNMENT  
OWNER: BLACK DIAMOND VENTURES XIV, LLC., CALIFORNIA; EFFECTIVE DATE: 20090501  
SECURITY AGREEMENT;ASSIGNOR:CAPELLA PHOTONICS, INC.;REEL/FRAME:022641/0593

20090505US/AS-A [NMC] ASSIGNMENT  
OWNER: DONALD L. LUCAS, SUCC TTEE DONALD L. LUCAS PROFIT; EFFECTIVE DATE: 20090501  
SECURITY AGREEMENT;ASSIGNOR:CAPELLA PHOTONICS, INC.;REEL/FRAME:022641/0593

20090505US/AS-A [NMC] ASSIGNMENT  
OWNER: DONALD L. LUCAS, TTEE DONALD L. AND LYGIA LUCAS TR; EFFECTIVE DATE: 20090501  
SECURITY AGREEMENT;ASSIGNOR:CAPELLA PHOTONICS, INC.;REEL/FRAME:022641/0593

20090505US/AS-A [NMC] ASSIGNMENT  
OWNER: LUCAS VENTURE GROUP I, LLC, CALIFORNIA; EFFECTIVE DATE: 20090501  
SECURITY AGREEMENT;ASSIGNOR:CAPELLA PHOTONICS, INC.;REEL/FRAME:022641/0593

20090505US/AS-A [NMC] ASSIGNMENT  
OWNER: THE LUCAS BROTHERS FOUNDATION, CALIFORNIA; EFFECTIVE DATE: 20090501  
SECURITY AGREEMENT;ASSIGNOR:CAPELLA PHOTONICS, INC.;REEL/FRAME:022641/0593

20090505US/AS-A [NMC] ASSIGNMENT  
OWNER: BRENDAN JOSEPH CASSIN AND ISABEL B. CASSIN, TRUSTE; EFFECTIVE DATE:  
20090501  
SECURITY AGREEMENT;ASSIGNOR:CAPELLA PHOTONICS, INC.;REEL/FRAME:022641/0593

20090505US/AS-A [NMC] ASSIGNMENT  
OWNER: CASSIN FAMILY PARTNERS, A CALIFORNIA LIMITED PARTN; EFFECTIVE DATE:  
20090501  
SECURITY AGREEMENT;ASSIGNOR:CAPELLA PHOTONICS, INC.;REEL/FRAME:022641/0593

20090505US/AS-A [NMC] ASSIGNMENT  
OWNER: ROBERT S. CASSIN CHARITABLE TRUST UTA DATED 2/20/9; EFFECTIVE DATE: 20090501  
SECURITY AGREEMENT;ASSIGNOR:CAPELLA PHOTONICS, INC.;REEL/FRAME:022641/0593

20090505US/AS-A [NMC] ASSIGNMENT  
OWNER: LEVENSOHN VENTURE PARTNERS III ANNEX FUND, L.P., C; EFFECTIVE DATE: 20090501  
SECURITY AGREEMENT;ASSIGNOR:CAPELLA PHOTONICS, INC.;REEL/FRAME:022641/0593

20090505US/AS-A [NMC] ASSIGNMENT  
OWNER: LEVENSOHN VENTURE PARTNERS III, L.P., CALIFORNIA; EFFECTIVE DATE: 20090501  
SECURITY AGREEMENT;ASSIGNOR:CAPELLA PHOTONICS, INC.;REEL/FRAME:022641/0593

20090505US/AS-A [NMC] ASSIGNMENT  
OWNER: LVP III ASSOCIATES FUND, L.P., CALIFORNIA; EFFECTIVE DATE: 20090501  
SECURITY AGREEMENT;ASSIGNOR:CAPELLA PHOTONICS, INC.;REEL/FRAME:022641/0593

20090505US/AS-A [NMC] ASSIGNMENT  
OWNER: SAINTS CAPITAL FALCON, L.P., CALIFORNIA; EFFECTIVE DATE: 20090501  
SECURITY AGREEMENT;ASSIGNOR:CAPELLA PHOTONICS, INC.;REEL/FRAME:022641/0593

20090505US/AS-A [NMC] ASSIGNMENT  
OWNER: RUSTIC CANYON VENTURES, SBIC, LP, CALIFORNIA; EFFECTIVE DATE: 20090501  
SECURITY AGREEMENT;ASSIGNOR:CAPELLA PHOTONICS, INC.;REEL/FRAME:022641/0593

20090505US/AS-A [NMC] ASSIGNMENT  
OWNER: ZACCARIA, BERT L., ARIZONA; EFFECTIVE DATE: 20090501  
SECURITY AGREEMENT;ASSIGNOR:CAPELLA PHOTONICS, INC.;REEL/FRAME:022641/0593

20090505US/AS-A [NMC] ASSIGNMENT  
OWNER: BRENDAN JOSEPH CASSIN, TRUSTEES OF THE CASSIN 1997; EFFECTIVE DATE:  
20090501  
SECURITY AGREEMENT;ASSIGNOR:CAPELLA PHOTONICS, INC.;REEL/FRAME:022641/0593

20090709US/AS-A [NMC] ASSIGNMENT  
OWNER: TEATON CAPITAL COMPANY, CALIFORNIA; EFFECTIVE DATE: 20090501  
SECURITY AGREEMENT;ASSIGNOR:CAPELLA PHOTONICS, INC.;REEL/FRAME:022932/0669

20090709US/AS-A [NMC] ASSIGNMENT  
OWNER: SAND HILL FINANCIAL COMPANY, CALIFORNIA; EFFECTIVE DATE: 20090501  
SECURITY AGREEMENT;ASSIGNOR:CAPELLA PHOTONICS, INC.;REEL/FRAME:022932/0669

20090709US/AS-A [NMC] ASSIGNMENT  
OWNER: FORMATIVE VENTURES EMERGING TECHNOLOGIES FUND, LP.; EFFECTIVE DATE:  
20090501  
SECURITY AGREEMENT;ASSIGNOR:CAPELLA PHOTONICS,  
INC.;REEL/FRAME:022932/0669

## EAST Search History

## EAST Search History (Prior Art)

Ref #	Hits	Search Query	DBs	Default Operator	Plurals	Time Stamp
L1	21	(385/24,11,37,34.ccls.) and (wavelength near5 (separating or routing)) and (optic\$ near5 (fiber or fibre) near5 collimators) and (wavelength near5 (separator or splitter))	US-PGPUB; USPAT; USOCR; FPRS; EPO; JPO; DERWENT; IBM_TDB	OR	OFF	2011/02/15 12:24
L2	20	(385/24,11,37,34.ccls.) and (wavelength near5 (separating or routing)) and (optic\$ near5 (fiber or fibre) near5 collimators) and (wavelength near5 (separator or splitter)) and (lens or (beam near5 focus\$)) and ((mirror or mems or micromirror or micro-mirror) near5 (pivot or pivotable or rotate or rotatable))	US-PGPUB; USPAT; USOCR; FPRS; EPO; JPO; DERWENT; IBM_TDB	OR	OFF	2011/02/15 12:26
L3	26	(wavelength near5 (separating or routing)) and (optic\$ near5 (fiber or fibre) near5 collimators) and (wavelength near5 (separator or splitter)) and (lens or (beam near5 focus\$)) and ((mirror or mems or micromirror or micro-mirror) near5 (pivot or pivotable or rotate or rotatable))	US-PGPUB; USPAT; USOCR; FPRS; EPO; JPO; DERWENT; IBM_TDB	OR	OFF	2011/02/15 12:26

L4	25	(wavelength near5 (separating or routing)) and (optic\$ near5 (fiber or fibre) near5 collimators) and (wavelength near5 (separator or splitter)) and (lens or (beam near5 focus\$)) and ((mirror or mems or micromirror or micro-mirror) near5 (pivot or pivotable or rotate or rotatable)) and (control near5 power near5 spectral near5 channels)	US-PGPUB; USPAT; USOCR; FPRS; EPO; JPO; DERWENT; IBM_TDB	OR	OFF	2011/02/15 12:27
L5	0	(wavelength near5 (separating or routing)) and (optic\$ near5 (fiber or fibre) near5 collimators) and (wavelength near5 (separator or splitter)) and (lens or (beam near5 focus\$)) and ((mirror or mems or micromirror or micro-mirror) near5 (pivot or pivotable or rotate or rotatable)) and (control near5 power near5 received near5 channels)	US-PGPUB; USPAT; USOCR; FPRS; EPO; JPO; DERWENT; IBM_TDB	OR	OFF	2011/02/15 12:30
L6	26	(wavelength near5 (separating or routing)) and (optic\$ near5 (fiber or fibre) near5 collimators) and (wavelength near5 (separator or splitter)) and (lens or (beam near5 focus\$)) and ((mirror or mems or micromirror or micro-mirror) near5 (pivot or pivotable or rotate or rotatable)) and ((control or monitor) near5 power near5 channels)	US-PGPUB; USPAT; USOCR; FPRS; EPO; JPO; DERWENT; IBM_TDB	OR	OFF	2011/02/15 12:30



L7	24	(wavelength near5 (separating or routing)) and (optic\$ near5 (fiber or fibre) near5 collimators) and (wavelength near5 (separator or splitter)) and (lens or (beam near5 focus\$)) and ((mirror or mems or micromirror or micro-mirror) near5 (pivot or pivotable or rotate or rotatable)) and ((control or monitor) near5 power near5 channels) and (servo near5 control)	US-PGPUB; USPAT; USOCR; FPRS; EPO; JPO; DERWENT; IBM_TDB	OR	OFF	2011/02/15 12:31
L8	18	(wavelength near5 (separating or routing)) and (optic\$ near5 (fiber or fibre) near5 collimators) and (wavelength near5 (separator or splitter)) and (lens or (beam near5 focus\$)) and ((mirror or mems or micromirror or micro-mirror) near5 (pivot or pivotable or rotate or rotatable)) and ((control or monitor) near5 power near5 channels) and (servo near5 control) and (collimator near5 alignment near5 rotatable near5 (one or two) near5 axes)	US-PGPUB; USPAT; USOCR; FPRS; EPO; JPO; DERWENT; IBM_TDB	OR	OFF	2011/02/15 12:32
L9	23	(wavelength near5 (separating or routing)) and (optic\$ near5 (fiber or fibre) near5 collimators) and (wavelength near5 (separator or splitter)) and (lens or (beam near5 focus\$)) and ((mirror or mems or micromirror or micro-mirror) near5 (pivot or pivotable or rotate or rotatable)) and ((control or monitor) near5 power near5 channels) and (servo	US-PGPUB; USPAT; USOCR; FPRS; EPO; JPO; DERWENT; IBM_TDB	OR	OFF	2011/02/15 12:33

		near5 control) and (gratings near5 (diffraction or holographic or echelle or curved))				
L10	17	(wavelength near5 (separating or routing)) and (optic\$ near5 (fiber or fibre) near5 collimators) and (wavelength near5 (separator or splitter)) and (lens or (beam near5 focus\$)) and ((mirror or mems or micromirror or micro-mirror) near5 (pivot or pivotable or rotate or rotatable)) and ((control or monitor) near5 power near5 channels) and (servo near5 control) and (prisms nera5 dispersing)	US-PGPUB; USPAT; USOCR; FPRS; EPO; JPO; DERWENT; IBM_TDB	OR	OFF	2011/02/15 12:34
L11	3	(wavelength near5 (separating or routing)) and (optic\$ near5 (fiber or fibre) near5 collimators) and (wavelength near5 (separator or splitter)) and (lens or (beam near5 focus\$)) and ((mirror or mems or micromirror or micro-mirror) near5 (pivot or pivotable or rotate or rotatable)) and ((control or monitor) near5 power near5 channels) and (servo near5 control) and (auxiliary near5 (collimators or separators or lens or focus or micromirror or micro-mirror or mems))	US-PGPUB; USPAT; USOCR; FPRS; EPO; JPO; DERWENT; IBM_TDB	OR	OFF	2011/02/15 12:37
S1	2	"6498872".pn.	US-PGPUB; USPAT; USOCR; FPRS; EPO; JPO; DERWENT; IBM_TDB	OR	OFF	2011/02/15 10:36

S2	2	"6567574".pn.	US-PGPUB; USPAT; USOCR; FPRS; EPO; JPO; DERWENT; IBM_TDB	OR	OFF	2011/02/15 10:38
S3	2	"6256430".pn.	US-PGPUB; USPAT; USOCR; FPRS; EPO; JPO; DERWENT; IBM_TDB	OR	OFF	2011/02/15 10:40
S4	2	"6631222".pn.	US-PGPUB; USPAT; USOCR; FPRS; EPO; JPO; DERWENT; IBM_TDB	OR	OFF	2011/02/15 10:41
S5	2	"6625346".pn.	US-PGPUB; USPAT; USOCR; FPRS; EPO; JPO; DERWENT; IBM_TDB	OR	OFF	2011/02/15 10:44
S6	1	re39397.pn.	US-PGPUB; USPAT; USOCR; FPRS; EPO; JPO; DERWENT; IBM_TDB	OR	OFF	2011/02/15 10:46

## EAST Search History (Interference)

Ref #	Hits	Search Query	DBs	Default Operator	Plurals	Time Stamp
L12	2	(wavelength near5 (separating or routing)) and (optic\$ near5 (fiber or fibre) near5 collimators) and (wavelength near5 (separator or splitter)) and (lens or (beam near5 focus \$)) and ((mirror or mems or micromirror or micro-mirror) near5 (pivot or pivotable or rotate or rotatable)) and ((control or monitor) near5 power near5 channels) and (servo near5 control) and (auxiliary near5	USPAT; UPAD	OR	OFF	2011/02/15 12:37

		(collimators or separators or lens or focus or micromirror or micro-mirror or mems))				
L13	11	(wavelength near5 (separating or routing)) and (optic\$ near5 (fiber or fibre) near5 collimators) and (wavelength near5 (separator or splitter)) and (lens or (beam near5 focus \$)) and ((mirror or mems or micromirror or micro-mirror) near5 (pivot or pivotable or rotate or rotatable)) and ((control or monitor) near5 power near5 channels) and (servo near5 control) and (prisms nera5 dispersing)	USPAT; UPAD	OR	OFF	2011/02/15 12:37
L14	13	(385/24,11,37,34.ccls.) and (wavelength near5 (separating or routing)) and (optic\$ near5 (fiber or fibre) near5 collimators) and (wavelength near5 (separator or splitter)) and (lens or (beam near5 focus \$)) and ((mirror or mems or micromirror or micro-mirror) near5 (pivot or pivotable or rotate or rotatable))	USPAT; UPAD	OR	OFF	2011/02/15 12:38
L15	14	(385/24,11,37,34.ccls.) and (wavelength near5 (separating or routing)) and (optic\$ near5 (fiber or fibre) near5 collimators) and (wavelength near5 (separator or splitter))	USPAT; UPAD	OR	OFF	2011/02/15 12:38

2/15/2011 12:39:13 PM

C:\Documents and Settings\bhealy\My Documents\EAST\Workspaces\12815930.wsp

### EAST Search History (Prior Art)

Ref #	Hits	Search Query	DBs	Default Operator	Plurals	Time Stamp
L1	21	(385/24,11,37,34.ccls.) and (wavelength near5 (separating or routing)) and (optic\$ near5 (fiber or fibre) near5 collimators) and (wavelength near5 (separator or splitter))	US-PGPUB; USPAT; USOCR; FPRS; EPO; JPO; DERWENT; IBM_TDB	OR	OFF	2011/02/15 12:24
L2	20	(385/24,11,37,34.ccls.) and (wavelength near5 (separating or routing)) and (optic\$ near5 (fiber or fibre) near5 collimators) and (wavelength near5 (separator or splitter)) and (lens or (beam near5 focus\$)) and ((mirror or mems or micromirror or micro-mirror) near5 (pivot or pivotable or rotate or rotatable))	US-PGPUB; USPAT; USOCR; FPRS; EPO; JPO; DERWENT; IBM_TDB	OR	OFF	2011/02/15 12:26
L3	26	(wavelength near5 (separating or routing)) and (optic\$ near5 (fiber or fibre) near5 collimators) and (wavelength near5 (separator or splitter)) and (lens or (beam near5 focus\$)) and ((mirror or mems or micromirror or micro-mirror) near5 (pivot or pivotable or rotate or rotatable))	US-PGPUB; USPAT; USOCR; FPRS; EPO; JPO; DERWENT; IBM_TDB	OR	OFF	2011/02/15 12:26
L4	25	(wavelength near5 (separating or routing)) and (optic\$ near5 (fiber or fibre) near5 collimators) and (wavelength near5 (separator or splitter)) and (lens or (beam near5 focus\$)) and ((mirror or mems or micromirror or micro-mirror) near5 (pivot or pivotable or rotate or rotatable)) and (control near5 power near5 spectral near5 channels)	US-PGPUB; USPAT; USOCR; FPRS; EPO; JPO; DERWENT; IBM_TDB	OR	OFF	2011/02/15 12:27
L5	0	(wavelength near5 (separating or routing)) and (optic\$ near5 (fiber or fibre) near5 collimators) and (wavelength near5 (separator or splitter)) and (lens or (beam near5 focus\$)) and ((mirror or mems or micromirror or micro-mirror) near5 (pivot or pivotable or rotate or rotatable)) and (control near5 power near5 received near5 channels)	US-PGPUB; USPAT; USOCR; FPRS; EPO; JPO; DERWENT; IBM_TDB	OR	OFF	2011/02/15 12:30

### EAST Search History (Prior Art)

L6	26	(wavelength near5 (separating or routing)) and (optic\$ near5 (fiber or fibre) near5 collimators) and (wavelength near5 (separator or splitter)) and (lens or (beam near5 focus\$)) and ((mirror or mems or micromirror or micro-mirror) near5 (pivot or pivotable or rotate or rotatable)) and ((control or monitor) near5 power near5 channels)	US-PGPUB; USPAT; USOCR; FPRS; EPO; JPO; DERWENT; IBM_TDB	OR	OFF	2011/02/15 12:30
L7	24	(wavelength near5 (separating or routing)) and (optic\$ near5 (fiber or fibre) near5 collimators) and (wavelength near5 (separator or splitter)) and (lens or (beam near5 focus\$)) and ((mirror or mems or micromirror or micro-mirror) near5 (pivot or pivotable or rotate or rotatable)) and ((control or monitor) near5 power near5 channels) and (servo near5 control)	US-PGPUB; USPAT; USOCR; FPRS; EPO; JPO; DERWENT; IBM_TDB	OR	OFF	2011/02/15 12:31
L8	18	(wavelength near5 (separating or routing)) and (optic\$ near5 (fiber or fibre) near5 collimators) and (wavelength near5 (separator or splitter)) and (lens or (beam near5 focus\$)) and ((mirror or mems or micromirror or micro-mirror) near5 (pivot or pivotable or rotate or rotatable)) and ((control or monitor) near5 power near5 channels) and (servo near5 control) and (collimator near5 alignment near5 rotatable near5 (one or two) near5 axes)	US-PGPUB; USPAT; USOCR; FPRS; EPO; JPO; DERWENT; IBM_TDB	OR	OFF	2011/02/15 12:32
L9	23	(wavelength near5 (separating or routing)) and (optic\$ near5 (fiber or fibre) near5 collimators) and (wavelength near5 (separator or splitter)) and (lens or (beam near5 focus\$)) and ((mirror or mems or micromirror or micro-mirror) near5 (pivot or pivotable or rotate or rotatable)) and ((control or monitor) near5 power near5 channels) and (servo near5 control) and (gratings near5 (diffraction or holographic or echelle or curved))	US-PGPUB; USPAT; USOCR; FPRS; EPO; JPO; DERWENT; IBM_TDB	OR	OFF	2011/02/15 12:33

### EAST Search History (Prior Art)

L10	17	(wavelength near5 (separating or routing)) and (optic\$ near5 (fiber or fibre) near5 collimators) and (wavelength near5 (separator or splitter)) and (lens or (beam near5 focus\$)) and ((mirror or mems or micromirror or micro-mirror) near5 (pivot or pivotable or rotate or rotatable)) and ((control or monitor) near5 power near5 channels) and (servo near5 control) and (prisms nera5 dispersing)	US-PGPUB; USPAT; USOCR; FPRS; EPO; JPO; DERWENT; IBM_TDB	OR	OFF	2011/02/15 12:34
L11	3	(wavelength near5 (separating or routing)) and (optic\$ near5 (fiber or fibre) near5 collimators) and (wavelength near5 (separator or splitter)) and (lens or (beam near5 focus\$)) and ((mirror or mems or micromirror or micro-mirror) near5 (pivot or pivotable or rotate or rotatable)) and ((control or monitor) near5 power near5 channels) and (servo near5 control) and (auxiliary near5 (collimators or separators or lens or focus or micromirror or micro-mirror or mems))	US-PGPUB; USPAT; USOCR; FPRS; EPO; JPO; DERWENT; IBM_TDB	OR	OFF	2011/02/15 12:37
S1	2	"6498872".pn.	US-PGPUB; USPAT; USOCR; FPRS; EPO; JPO; DERWENT; IBM_TDB	OR	OFF	2011/02/15 10:36
S2	2	"6567574".pn.	US-PGPUB; USPAT; USOCR; FPRS; EPO; JPO; DERWENT; IBM_TDB	OR	OFF	2011/02/15 10:38
S3	2	"6256430".pn.	US-PGPUB; USPAT; USOCR; FPRS; EPO; JPO; DERWENT; IBM_TDB	OR	OFF	2011/02/15 10:40

### EAST Search History (Prior Art)

S4	2	"6631222".pn.	US-PGPUB; USPAT; USOCR; FPRS; EPO; JPO; DERWENT; IBM_TDB	OR	OFF	2011/02/15 10:41
S5	2	"6625346".pn.	US-PGPUB; USPAT; USOCR; FPRS; EPO; JPO; DERWENT; IBM_TDB	OR	OFF	2011/02/15 10:44
S6	1	re39397.pn.	US-PGPUB; USPAT; USOCR; FPRS; EPO; JPO; DERWENT; IBM_TDB	OR	OFF	2011/02/15 10:46

### EAST Search History (Interference)

Ref #	Hits	Search Query	DBs	Default Operator	Plurals	Time Stamp
L12	2	(wavelength near5 (separating or routing)) and (optic\$ near5 (fiber or fibre) near5 collimators) and (wavelength near5 (separator or splitter)) and (lens or (beam near5 focus\$)) and ((mirror or mems or micromirror or micro-mirror) near5 (pivot or pivotable or rotate or rotatable)) and ((control or monitor) near5 power near5 channels) and (servo near5 control) and (auxiliary near5 (collimators or separators or lens or focus or micromirror or micro-mirror or mems))	USPAT; UPAD	OR	OFF	2011/02/15 12:37



### EAST Search History (Interference)

L13	11	(wavelength near5 (separating or routing)) and (optic\$ near5 (fiber or fibre) near5 collimators) and (wavelength near5 (separator or splitter)) and (lens or (beam near5 focus\$)) and ((mirror or mems or micromirror or micro-mirror) near5 (pivot or pivotable or rotate or rotatable)) and ((control or monitor) near5 power near5 channels) and (servo near5 control) and (prisms nera5 dispersing)	USPAT; UPAD	OR	OFF	2011/02/15 12:37
L14	13	(385/24,11,37,34.ccls.) and (wavelength near5 (separating or routing)) and (optic\$ near5 (fiber or fibre) near5 collimators) and (wavelength near5 (separator or splitter)) and (lens or (beam near5 focus\$)) and ((mirror or mems or micromirror or micro-mirror) near5 (pivot or pivotable or rotate or rotatable))	USPAT; UPAD	OR	OFF	2011/02/15 12:38
L15	14	(385/24,11,37,34.ccls.) and (wavelength near5 (separating or routing)) and (optic\$ near5 (fiber or fibre) near5 collimators) and (wavelength near5 (separator or splitter))	USPAT; UPAD	OR	OFF	2011/02/15 12:38

**IN THE UNITED STATES PATENT AND TRADEMARK OFFICE**

Applicant: Jeffrey P. Wilde, et. al

Serial No.: 12/815,930

Group Art Unit: 2883

Filed: 06/15/2010

Examiner: Healy, Brian

Title: Reconfigurable Optical Add-Drop Multiplexers with Servo Control and Dynamic Spectral Power Management Capabilities

(Reissue of Patent No. RE 39,397; Issued November 14, 2006)

**AMENDMENT**

**And**

**SUBMISSION OF SECOND REPLACEMENT REISSUE DECLARATION**

**Mail Stop REISSUE**

Commissioner for Patents

P.O. Box 1450

Alexandria, Virginia 22313-1450

Dear Sir:

In response to the Office Action of January 7, 2011, please amend this application as indicated, and replace the Replacement Reissue Application Declaration by Assignee submitted December 3, 2010, with the attached Second Replacement Reissue Application Declaration by Assignee.

**Amendment to Claims**

1. (Amended) A wavelength-separating-routing apparatus, comprising:
  - a) multiple fiber collimators, providing an input port for a multi-wavelength optical signal and a plurality of output ports;
  - b) a wavelength-separator, for separating said multi-wavelength optical signal from said input port into multiple spectral channels;
  - c) a beam-focuser, for focusing said spectral channels into corresponding spectral spots; and
  - d) a spatial array of channel micromirrors positioned such that each channel micromirror receives one of said spectral channels, said channel micromirrors being pivotal about two axes and being individually and continuously controllable to reflect said corresponding received spectral channels into any selected ones of said output ports and to control the power of said received spectral channels coupled into said output ports.
  
2. (Original) The wavelength-separating-routing apparatus of claim 1 further comprising a servo-control assembly, in communication with said channel micromirrors and said output ports, for providing control of said channel micromirrors and thereby maintaining a predetermined coupling of each reflected spectral channel into one of said output ports.
  
3. (Original) The wavelength-separating-routing apparatus of claim 2 wherein said servo-control assembly comprises a spectral monitor for monitoring power levels

of said spectral channels coupled into said output ports, and a processing unit responsive to said power levels for providing control of said channel micromirrors.

4. (Original) The wavelength-separating-routing apparatus of claim 3 wherein said servo-control assembly maintains said power levels at a predetermined value.

5. (Original) The wavelength-separating-routing apparatus of claim 1 further comprising an array of collimator-alignment mirrors, in optical communication with said wavelength-separator and said fiber collimators, for adjusting an alignment of said multi-wavelength optical signal from said input port and directing said reflected spectral channels into said output ports.

6. (Original) The wavelength-separating-routing apparatus of claim 5 wherein each collimator-alignment mirror is rotatable about one axis.

7. (Original) The wavelength-separating-routing apparatus of claim 5 wherein each collimator-alignment mirror is rotatable about two axes.

8. (Original) The wavelength-separating-routing apparatus of claim 5 further comprising first and second arrays of imaging lenses, in a telecentric arrangement with said collimator-alignment mirrors and said fiber collimators.

9. (Original) The wavelength-separating-routing apparatus of claim 1 wherein

each channel micromirror is continuously pivotable about one axis.

10. (Original) The wavelength-separating-routing apparatus of claim 1 wherein each channel micromirror is pivotable about two axes.

11. (Original) The wavelength-separating-routing apparatus of claim 10 wherein said fiber collimators are arranged in a two-dimensional array.

12. (Original) The wavelength-separating-routing apparatus of claim 1 wherein each channel micromirror is a silicon micromachined mirror.

13. (Original) The wavelength-separating-routing apparatus of claim 1 wherein said fiber collimators are arranged in a one-dimensional array.

14. (Original) The wavelength-separating-routing apparatus of claim 1 wherein said beam-focuser comprises a focusing lens having first and second focal points.

15. (Original) The wavelength-separating-routing apparatus of claim 14 wherein said wavelength-separator and said channel micromirrors are placed respectively at said first and second focal points of said focusing lens.

16. (Original) The wavelength-separating-routing apparatus of claim 1

wherein said beam-focuser comprises an assembly of lenses.

17. (Original) The wavelength-separating-routing apparatus of claim 1 wherein said wavelength-separator comprises an element selected from the group consisting of ruled diffraction gratings, holographic diffraction gratings, echelle gratings, curved diffraction gratings, and dispersing gratings.

18. (Original) The wavelength-separating-routing apparatus of claim 1 further comprising a quarter-wave plate optically interposed between said wavelength-separator and said channel micromirrors.

19. (Original) The wavelength-separating-routing apparatus of claim 1 wherein each output port carries a single one of said spectral channels.

20. (Original) The wavelength-separating-routing apparatus of claim 19 further comprising one or more optical sensors, optically coupled to said output ports.

21. (Original) A servo-based optical apparatus comprising:

- a) multiple fiber collimators, providing an input port for a multi-wavelength optical signal and a plurality of output ports;
- b) a wavelength-separator, for separating said multi-wavelength optical signal from said input port into multiple spectral channels;

c) a beam-focuser, for focusing said spectral channels into corresponding spectral spots; and

d) a spatial array of channel micromirrors positioned such that each channel micromirror receives one of said spectral channels, said channel micromirrors being individually controllable to reflect said spectral channels into selected ones of said output ports; and

e) a servo-control assembly, in communication with said channel micromirrors and said output ports, for maintaining a predetermined coupling of each reflected spectral channel into one of said output ports.

22. (Original) The servo-based optical apparatus of claim 21 wherein said servo-control assembly comprises a spectral monitor for monitoring power levels of said spectral channels coupled into said output ports, and a processing unit responsive to said power levels for providing control of said channel micromirrors.

23. (Original) The servo-based optical apparatus of claim 22 wherein said servo-control assembly maintains said power levels at a predetermined value.

24. (Original) The servo-based optical apparatus of claim 21 further comprising an array of collimator-alignment mirrors, in optical communication with said wavelength-separator and said fiber collimators, for adjusting an alignment of said multi-wavelength optical signal from said input port and directing said reflected spectral channels into said output ports.

25. (Original) The servo-based optical apparatus of claim 24 further comprising first and second arrays of imaging lenses, in a telecentric arrangement with said collimator-alignment mirrors and said fiber collimators.

26. (Original) The servo-based optical apparatus of claim 24 wherein each collimator-alignment mirror is rotatable about at least one axis.

27. (Original) The servo-based optical apparatus of claim 21 wherein each channel micromirror is continuously pivotable about at least one axis.

28. (Original) The servo-based optical apparatus of claim 21 wherein each channel micromirror is a silicon micromachined mirror.

29. (Original) The servo-based optical apparatus of claim 21 wherein said wavelength-separator comprises an element selected from the group consisting of ruled diffraction gratings, holographic diffraction gratings, echelle gratings, curved diffraction gratings, and dispersing prisms.

30. (Original) The servo-based optical apparatus of claim 21 wherein said beam-focuser comprises one or more lenses.

31. (Original) An optical apparatus comprising:



a) an array of fiber collimators, providing an input port for a multi-wavelength optical signal and a plurality of output ports;

b) a wavelength-separator, for separating said multi-wavelength optical signal from said input port into multiple spectral channels;

c) a beam-focuser, for focusing said spectral channels into corresponding spectral spots;

d) a spatial array of channel micromirrors positioned such that each channel micromirror receives one of said spectral channels, said channel micromirrors being individually and continuously controllable to reflect said spectral channels into selected ones of said output ports; and

e) a one-dimensional array of collimator-alignment mirrors, for adjusting an alignment of said multi-wavelength optical signal from said input port and directing said reflected spectral channels into said output ports.

32. (Original) The optical apparatus of claim 31 further comprising a servo-control assembly, in communication with said channel micromirrors, said collimator-alignment mirrors, and said output ports, for providing control of said channel micromirrors along with said collimator-alignment mirrors and thereby maintaining a predetermined coupling of each reflected spectral channel into one of said output ports.

33. (Original) The optical apparatus of claim 32 wherein said servo-control assembly comprises

a spectral monitor for monitoring power levels of said spectral channels coupled into said output ports, and

a processing unit responsive to said power levels for providing control of said channel micromirrors and said collimator-alignment mirrors.

34. (Original) The optical apparatus of claim 31 wherein each channel micromirror is continuously pivotable about at least one axis.

35. (Original) The optical apparatus of claim 31 wherein each collimator-alignment mirror is rotatable about at least one axis.

36. (Original) The optical apparatus of claim 31 further comprising first and second arrays of imaging lenses, in a telecentric arrangement with said collimator-alignment mirrors and said fiber collimators.

37. (Original) An optical apparatus comprising:

a) an array of fiber collimators, providing an input port for a multi-wavelength optical signal and a plurality of output ports;

b) a wavelength-separator, for separating said multi-wavelength optical signal from said input port into multiple spectral channels;

c) a beam-focuser, for focusing said spectral channels into corresponding spectral spots;

d) a spatial array of channel micromirrors positioned such that each channel micromirror receives one of said spectral channels, said channel micromirrors being individually and continuously controllable to reflect said spectral channels into selected ones of said output ports; and

e) a two-dimensional array of collimator-alignment mirrors, for adjusting an alignment of said multi-wavelength optical signal from said input port and directing said reflected spectral channels into said output ports.

38. (Original) The optical apparatus of claim 37 further comprising a servo-control assembly, in communication with said channel micromirrors, and

collimator-alignment mirrors, and said output ports, for providing control of said channel micromirrors along with said collimator-alignment mirrors and thereby maintaining a predetermined coupling of each reflected spectral channel into one of said output ports.

39. (Original) The optical apparatus of claim 38 wherein said servo-control assembly comprises a spectral monitor for monitoring power levels of said spectral channels coupled into said output ports, and a processing unit responsive to said power levels for providing control of said channel micromirrors and said collimator-alignment mirrors.

40. (Original) The optical apparatus of claim 37 wherein each collimator-

alignment mirror is rotatable about at least one axis.

41. (Original) The optical apparatus of claim 37 wherein each channel micromirror is continuously pivotable about at least one axis.

42. (Original) The optical apparatus of claim 41 wherein each channel micromirrors is pivotable about two axes, and wherein said fiber collimators are arranged in a two-dimensional array.

43. (Original) The optical apparatus of claim 37 further comprising first and second arrays of imaging lenses, in a telecentric arrangement with said collimator-alignment mirrors and said fiber collimators.

44. (Amended) An optical system comprising a wavelength-separating-routing apparatus, wherein said wavelength-separating-routing apparatus includes:

a) an array of fiber collimators, providing an input port for a multi-wavelength optical signal and a plurality of output ports including a pass-through port and one or more drop ports;

b) a wavelength-separator, for separating said multi-wavelength optical signal from said input port into multiple spectral channels;

c) a beam-focuser, for focusing said spectral channels into corresponding spectral spots; and

a spatial array of channel micromirrors positioned such that each channel micromirror receives one of said spectral channels, said channel micromirrors being pivotal about two axes and being individually and continuously controllable to reflect said corresponding received spectral channels into any selected ones of said output ports and to control the power of said received spectral channels coupled into said output ports, whereby said pass-through port receives a subset of said spectral channels.

45. (Original) The optical system of claim 44 further comprising a servo-control assembly, in communication with said channel micromirrors and said output ports, for providing control of said channel micromirrors and thereby maintaining a predetermined coupling of each reflected spectral channel into one of said output ports.

46. (Original) The optical system of claim 45 wherein said servo-control assembly comprises a spectral monitor for monitoring power levels of said spectral channels coupled into said output ports, and a processing unit responsive to said power levels for providing control of said channel micromirrors.

47. (Original) The optical system of claim 44 further comprising an array of collimator-alignment mirrors, in optical communication with said wavelength-separator and said fiber collimators, for adjusting an alignment of said multi-wavelength optical signal from said input port and directing said reflected spectral

channels into said output ports.

48. (Original) The optical system of claim 47 further comprising first and second arrays of imaging lenses, in a telecentric arrangement with said collimator-alignment mirrors and said fiber collimators.

49. (Original) The optical system of claim 47 wherein each collimator-alignment mirror is rotatable about at least one axis.

50. (Original) The optical system of claim 44 wherein each channel micromirror is pivotable about at least one axis.

51. (Original) The optical system of claim 44 wherein each channel micromirror is a silicon micromachined mirror.

52. (Original) The optical system of claim 44 wherein said beam-focuser comprises a focusing lens having first and second focal points, and wherein said wavelength-separator and said channel micromirrors are placed respectively at said first and second focal points.

53. (Original) The optical system of claim 44 wherein said wavelength-separator comprises an element selected from the group consisting of ruled diffraction gratings, holographic diffraction gratings, echelle gratings, curved

diffraction gratings, and dispersing prisms.

54. (Original) The optical system of claim 44 further comprising a quarter-wave plate optically interposed between said wavelength-separator and said channel micromirrors.

55. (Original) The optical system of claim 44 further comprising an auxiliary wavelength-separating-routing apparatus, including:

a) multiple auxiliary fiber collimators, providing a plurality of auxiliary input ports and an exiting port;

b) an auxiliary wavelength-separator;

c) an auxiliary beam-focuser; and

d) a spatial array of auxiliary channel micromirrors;

wherein said subset of said spectral channels in said pass-through port and one or more add spectral channels are directed into said auxiliary input ports, and multiplexed into an output optical signal directed into said exiting port by way of said auxiliary wavelength-separator, said auxiliary beam-focuser and said auxiliary channel micromirrors.

56. (Original) The optical system of claim 55 wherein said auxiliary channel micromirrors are individually pivotable.

57. (Original) The optical system of claim 55 wherein each auxiliary channel

micromirror is pivotable continuously about at least one axis.

58. (Original) The optical system of claim 55 wherein each auxiliary channel micromirror is a silicon micromachined mirror.

59. (Original) The optical system of claim 55 wherein said auxiliary wavelength-separator comprises an element selected from the group consisting of ruled diffraction gratings, holographic diffraction gratings, echelle gratings, curved diffraction gratings, and dispersing prisms.

60. (Original) The optical system of claim 55 wherein said pass-through port constitutes one of said auxiliary input ports.

61. (Amended) A method of performing dynamic wavelength separating and routing, comprising:

- a) receiving a multi-wavelength optical signal from an input port;
- b) separating said multi-wavelength optical signal into multiple spectral channels;
- c) focusing said spectral channels onto a spatial array of corresponding beam-deflecting elements, whereby each beam-deflecting element receives one of said spectral channels; and
- d) dynamically and continuously controlling said beam-deflecting elements, thereby directing in two dimensions to direct said spectral channels into a plurality



any selected ones of said output ports and to control the power of the spectral channels coupled into said selected output ports.

62. (Amended) The method of claim 61 further comprising the step of providing feedback control of said beam-deflecting elements, ~~thereby maintaining to~~ maintain a predetermining coupling of each spectral channel directed into one of said output ports.

63. (Original) The method of claim 62 further comprising the step of maintaining power levels of said spectral channels directed into said output ports at a predetermining value.

64. (Original) The method of claim 61 wherein each spectral channel is directed into a separate output port.

65. (Original) The method of claim 61 wherein a subset of said spectral channels is directed into one of said output ports, thereby providing one or more pass-through spectral channels.

66. (Original) The method of claim 65 further comprising the step of multiplexing said pass-through spectral channels with one or more add spectral channels, so as to provide an output optical signal.

67. (Original) The method of claim 61 wherein said beam-deflecting elements comprise an array of silicon micromachined mirrors.

**Remarks**

Applicant thanks the Examiner for his helpful suggestions as to changes to the reissue declaration to overcome the rejection of the claims under 35 U.S.C. §251 because of a defective reissue oath or declaration. Enclosed is a Second Replacement Reissue Declaration that adopts the Examiner's suggestions. Accordingly, it is submitted that the enclosed Second Replacement Reissue Declaration is proper and overcomes the rejection under 35 U.S.C. §251.

Claim 68 which was rejected under 35 U.S.C. §251 as being broadening has been cancelled (omitted) in this Second Preliminary Amendment. Otherwise, the enclosed Amendment is identical to the Preliminary Amendment submitted upon filing of this reissue application.

In view of the foregoing, favorable reconsideration of this application and early action on the merits are respectfully requested.

Date: January 31, 2011

Respectfully Submitted,

/Barry N. Young/

---

Barry N. Young  
Attorney for Assignee  
Reg. No. 27,744

*Customer No. 48789*  
Law Offices of Barry N. Young  
200 Page Mill Road, Suite 102  
Palo Alto, CA 94306-2061

Phone: (650) 326-2701  
Fax: (650) 326-2799  
[byoung@young-iplaw.com](mailto:byoung@young-iplaw.com)

## Electronic Acknowledgement Receipt

<b>EFS ID:</b>	9348551
<b>Application Number:</b>	12815930
<b>International Application Number:</b>	
<b>Confirmation Number:</b>	2344
<b>Title of Invention:</b>	Reconfigurable Optical Add-Drop Multiplexers with Servo Control and Dynamic Spectral Power Management Capabilities
<b>First Named Inventor/Applicant Name:</b>	Jeffrey P. Wilde
<b>Customer Number:</b>	48789
<b>Filer:</b>	Barry N. Young
<b>Filer Authorized By:</b>	
<b>Attorney Docket Number:</b>	C2393-1101RE2
<b>Receipt Date:</b>	31-JAN-2011
<b>Filing Date:</b>	15-JUN-2010
<b>Time Stamp:</b>	20:29:32
<b>Application Type:</b>	Utility under 35 USC 111(a)

### Payment information:

Submitted with Payment	no
------------------------	----

### File Listing:

Document Number	Document Description	File Name	File Size(Bytes)/ Message Digest	Multi Part /.zip	Pages (if appl.)
1	Reissue dec filed in accordance with MPEP 1414.	2nd_Rpl_Declr.pdf	3214143 <small>ab4564cca3359ca8b3923df4d8aa573faab3660f</small>	no	3

### Warnings:

### Information:

2		Amd_1-31-11.pdf	51355 5769c8a28cc3f5862dee0ef6911a5ab041cd f30e	yes	19
<b>Multipart Description/PDF files in .zip description</b>					
<b>Document Description</b>		<b>Start</b>	<b>End</b>		
Amendment/Req. Reconsideration-After Non-Final Reject		1	1		
Claims		2	17		
Applicant Arguments/Remarks Made in an Amendment		18	19		
<b>Warnings:</b>					
<b>Information:</b>					
<b>Total Files Size (in bytes):</b>			3265498		
<p>This Acknowledgement Receipt evidences receipt on the noted date by the USPTO of the indicated documents, characterized by the applicant, and including page counts, where applicable. It serves as evidence of receipt similar to a Post Card, as described in MPEP 503.</p> <p><b><u>New Applications Under 35 U.S.C. 111</u></b> If a new application is being filed and the application includes the necessary components for a filing date (see 37 CFR 1.53(b)-(d) and MPEP 506), a Filing Receipt (37 CFR 1.54) will be issued in due course and the date shown on this Acknowledgement Receipt will establish the filing date of the application.</p> <p><b><u>National Stage of an International Application under 35 U.S.C. 371</u></b> If a timely submission to enter the national stage of an international application is compliant with the conditions of 35 U.S.C. 371 and other applicable requirements a Form PCT/DO/EO/903 indicating acceptance of the application as a national stage submission under 35 U.S.C. 371 will be issued in addition to the Filing Receipt, in due course.</p> <p><b><u>New International Application Filed with the USPTO as a Receiving Office</u></b> If a new international application is being filed and the international application includes the necessary components for an international filing date (see PCT Article 11 and MPEP 1810), a Notification of the International Application Number and of the International Filing Date (Form PCT/RO/105) will be issued in due course, subject to prescriptions concerning national security, and the date shown on this Acknowledgement Receipt will establish the international filing date of the application.</p>					

**IN THE UNITED STATES PATENT AND TRADEMARK OFFICE**

Applicant: Jeffrey P. Wilde, et. al

Serial No. 12/815,930

Group Art Unit: 2883

Filed: 06/15/2010

Examiner: Healy, Brian

Title: Reconfigurable Optical Add-Drop Multiplexers With Servo Control and Dynamic Spectral Power Management Capability

(Reissue of Patent No. RE39,397, issued November 14, 2006)

**SECOND REPLACEMENT REISSUE APPLICATION DECLARATION BY ASSIGNEE**

I, Larry Schwerin, hereby declare that:

The residence, mailing address and citizenship of the Inventors of the above-identified patent for which reissue is sought are as stated below.

I am authorized to act on behalf of the following Assignee: CAPELLA PHOTONICS, INC., A DELAWARE CORPORATION, and my title with said assignee is President and Chief Executive Officer. The entire title and interest in said Patent is vested in said Assignee, and I consent on behalf of said Assignee to the filing of this Reissue Application for the above Patent.

Inventor's Full Name:	Jeffrey P. Wilde
Residence/Mailing Address:	2310 Rockwood Ranch Road Morgan Hill, CA 95037
Citizenship:	US

Inventor's Full Name:	Joseph E. Davis
Residence/Mailing Address:	18765 St. Marks Avenue Morgan Hill, CA 95037
Citizenship:	US

I believe said above named Inventors to be the original and first inventors of the subject matter which is described and claimed in said above identified Patent for which a reissue patent is sought, the specification of which:

was filed as Application No. 12/815,930 on 06/15/2010;

and was amended by Preliminary Amendments filed on 06/15/2010 and herewith.

I have reviewed and understand the contents of the above-identified specification, including the claims, as amended by any amendment referred to above.

I acknowledge the duty to disclose information which is material to patentability as defined in 37 C.F.R. §1.56.

I verily believe the original Patent to be wholly or partially inoperative or invalid for the reason that the patentee claimed more than he had a right to claim in the Patent.

At least one error upon which reissue is based is described as follows:  
Claim 1 is deemed to be too broad and invalid in view of U.S. Patent No. 6,498,872 to Bouevitch and further in view of one or more of U.S. Patent No. 6,567,574 to Ma, U.S. Patent No. 6,256,430 to Jin, or U.S. Patent No. 6,631,222 to Wagener by failing to include limitations regarding the pivotability of channel micromirrors and control of power of received spectral channels coupled to output ports, as indicated by the amendments to Claim 1 in the Preliminary Amendments referred to above.

All errors corrected in this Reissue Application arose without deceptive intent on the part of the Applicant.

I hereby appoint the practitioners associated with **Customer No. 48489** as our attorneys or agents to prosecute the application identified above, and to transact all business in the United States Patent and Trademark Office connected therewith.

Please direct all communications to:  
Barry N. Young  
Reg. No. 27,744  
200 Page Mill Road, Suite 102  
Palo Alto, CA 94306



(650) 326-2701  
[Byoung@young-iplaw.com](mailto:Byoung@young-iplaw.com)

I hereby declare that all statements made herein of my own knowledge are true and that all statements made on information and belief are believed to be true, and further that these statements were made with the knowledge that willful false statements and the like so made are punishable by fine or imprisonment, or both, under 18 U.S.C. §1001, and that such willful false statements may jeopardize the validity of the application, any patent issuing thereon, or any patent to which this Declaration is directed.

Dated: June 30, 2011

By: 

Larry Schwerin  
President and Chief Executive Officer  
Capella Photonics, Inc.  
5390 Hellyer Avenue  
San Jose, CA 95138

Under the Paperwork Reduction Act of 1995, no persons are required to respond to a collection of information unless it displays a valid OMB control number.

<b>PATENT APPLICATION FEE DETERMINATION RECORD</b> Substitute for Form PTO-875					Application or Docket Number <b>12/815,930</b>		Filing Date <b>06/15/2010</b>		<input type="checkbox"/> To be Mailed		
APPLICATION AS FILED – PART I							OTHER THAN				
(Column 1)			(Column 2)		SMALL ENTITY <input type="checkbox"/>		OR		SMALL ENTITY		
FOR	NUMBER FILED	NUMBER EXTRA	RATE (\$)	FEE (\$)	OR		RATE (\$)	FEE (\$)			
<input type="checkbox"/> BASIC FEE <small>(37 CFR 1.16(a), (b), or (c))</small>	N/A	N/A	N/A				N/A				
<input type="checkbox"/> SEARCH FEE <small>(37 CFR 1.16(k), (l), or (m))</small>	N/A	N/A	N/A				N/A				
<input type="checkbox"/> EXAMINATION FEE <small>(37 CFR 1.16(o), (p), or (q))</small>	N/A	N/A	N/A				N/A				
TOTAL CLAIMS <small>(37 CFR 1.16(j))</small>	minus 20 =	*	X \$ =				X \$ =				
INDEPENDENT CLAIMS <small>(37 CFR 1.16(h))</small>	minus 3 =	*	X \$ =				X \$ =				
<input type="checkbox"/> APPLICATION SIZE FEE <small>(37 CFR 1.16(s))</small>			If the specification and drawings exceed 100 sheets of paper, the application size fee due is \$250 (\$125 for small entity) for each additional 50 sheets or fraction thereof. See 35 U.S.C. 41(a)(1)(G) and 37 CFR 1.16(s).								
<input type="checkbox"/> MULTIPLE DEPENDENT CLAIM PRESENT <small>(37 CFR 1.16(j))</small>											
* If the difference in column 1 is less than zero, enter "0" in column 2.											
APPLICATION AS AMENDED – PART II					OTHER THAN						
(Column 1)		(Column 2)		(Column 3)		SMALL ENTITY		OR		SMALL ENTITY	
AMENDMENT	<b>01/31/2011</b>	CLAIMS REMAINING AFTER AMENDMENT	HIGHEST NUMBER PREVIOUSLY PAID FOR	PRESENT EXTRA	RATE (\$)	ADDITIONAL FEE (\$)	OR		RATE (\$)	ADDITIONAL FEE (\$)	
	Total <small>(37 CFR 1.16(j))</small>	* 67	Minus	** 68	=	0			X \$52=	0	
	Independent <small>(37 CFR 1.16(h))</small>	* 6	Minus	*** 7	=	0			X \$220=	0	
	<input type="checkbox"/> Application Size Fee <small>(37 CFR 1.16(s))</small>										
	<input type="checkbox"/> FIRST PRESENTATION OF MULTIPLE DEPENDENT CLAIM <small>(37 CFR 1.16(j))</small>										
					TOTAL ADD'L FEE						TOTAL ADD'L FEE
AMENDMENT	Total <small>(37 CFR 1.16(j))</small>	*	Minus	**	=			X \$ =			
	Independent <small>(37 CFR 1.16(h))</small>	*	Minus	***	=			X \$ =			
	<input type="checkbox"/> Application Size Fee <small>(37 CFR 1.16(s))</small>										
	<input type="checkbox"/> FIRST PRESENTATION OF MULTIPLE DEPENDENT CLAIM <small>(37 CFR 1.16(j))</small>										
					TOTAL ADD'L FEE				TOTAL ADD'L FEE		
	* If the entry in column 1 is less than the entry in column 2, write "0" in column 3.										
** If the "Highest Number Previously Paid For" IN THIS SPACE is less than 20, enter "20".											
*** If the "Highest Number Previously Paid For" IN THIS SPACE is less than 3, enter "3".											
The "Highest Number Previously Paid For" (Total or Independent) is the highest number found in the appropriate box in column 1.											
Legal Instrument Examiner: /VANESSA BARBER/											

This collection of information is required by 37 CFR 1.16. The information is required to obtain or retain a benefit by the public which is to file (and by the USPTO to process) an application. Confidentiality is governed by 35 U.S.C. 122 and 37 CFR 1.14. This collection is estimated to take 12 minutes to complete, including gathering, preparing, and submitting the completed application form to the USPTO. Time will vary depending upon the individual case. Any comments on the amount of time you require to complete this form and/or suggestions for reducing this burden, should be sent to the Chief Information Officer, U.S. Patent and Trademark Office, U.S. Department of Commerce, P.O. Box 1450, Alexandria, VA 22313-1450. DO NOT SEND FEES OR COMPLETED FORMS TO THIS ADDRESS. **SEND TO: Commissioner for Patents, P.O. Box 1450, Alexandria, VA 22313-1450.**

If you need assistance in completing the form, call 1-800-PTO-9199 and select option 2.



UNITED STATES PATENT AND TRADEMARK OFFICE

UNITED STATES DEPARTMENT OF COMMERCE  
United States Patent and Trademark Office  
Address: COMMISSIONER FOR PATENTS  
P.O. Box 1450  
Alexandria, Virginia 22313-1450  
www.uspto.gov

APPLICATION NO.	FILING DATE	FIRST NAMED INVENTOR	ATTORNEY DOCKET NO.	CONFIRMATION NO.
12/815,930	06/15/2010	Jeffrey P. Wilde	C2393-1101RE2	2344
48789	7590	01/07/2011	EXAMINER	
LAW OFFICES OF BARRY N. YOUNG			HEALY, BRIAN	
200 PAGE MILL ROAD			ART UNIT	PAPER NUMBER
SUITE 102			2883	
PALO ALTO, CA 94306			NOTIFICATION DATE	DELIVERY MODE
			01/07/2011	ELECTRONIC

**Please find below and/or attached an Office communication concerning this application or proceeding.**

The time period for reply, if any, is set in the attached communication.

Notice of the Office communication was sent electronically on above-indicated "Notification Date" to the following e-mail address(es):

BYOUNG@YOUNG-IPLAW.COM  
BNYOUNG7@GMAIL.COM

<b>Office Action Summary</b>	<b>Application No.</b>	<b>Applicant(s)</b>	
	12/815,930	WILDE ET AL.	
	<b>Examiner</b>	<b>Art Unit</b>	
	BRIAN M. HEALY	2883	

**-- The MAILING DATE of this communication appears on the cover sheet with the correspondence address --**

**Period for Reply**

A SHORTENED STATUTORY PERIOD FOR REPLY IS SET TO EXPIRE 3 MONTH(S) OR THIRTY (30) DAYS, WHICHEVER IS LONGER, FROM THE MAILING DATE OF THIS COMMUNICATION.

- Extensions of time may be available under the provisions of 37 CFR 1.136(a). In no event, however, may a reply be timely filed after SIX (6) MONTHS from the mailing date of this communication.
- If NO period for reply is specified above, the maximum statutory period will apply and will expire SIX (6) MONTHS from the mailing date of this communication.
- Failure to reply within the set or extended period for reply will, by statute, cause the application to become ABANDONED (35 U.S.C. § 133). Any reply received by the Office later than three months after the mailing date of this communication, even if timely filed, may reduce any earned patent term adjustment. See 37 CFR 1.704(b).

**Status**

- 1)  Responsive to communication(s) filed on 03 December 2010.
- 2a)  This action is **FINAL**.
- 2b)  This action is non-final.
- 3)  Since this application is in condition for allowance except for formal matters, prosecution as to the merits is closed in accordance with the practice under *Ex parte Quayle*, 1935 C.D. 11, 453 O.G. 213.

**Disposition of Claims**

- 4)  Claim(s) 1-68 is/are pending in the application.
  - 4a) Of the above claim(s) \_\_\_\_\_ is/are withdrawn from consideration.
- 5)  Claim(s) \_\_\_\_\_ is/are allowed.
- 6)  Claim(s) 1-68 is/are rejected.
- 7)  Claim(s) \_\_\_\_\_ is/are objected to.
- 8)  Claim(s) \_\_\_\_\_ are subject to restriction and/or election requirement.

**Application Papers**

- 9)  The specification is objected to by the Examiner.
- 10)  The drawing(s) filed on 15 June 2010 is/are: a)  accepted or b)  objected to by the Examiner.
  - Applicant may not request that any objection to the drawing(s) be held in abeyance. See 37 CFR 1.85(a).
  - Replacement drawing sheet(s) including the correction is required if the drawing(s) is objected to. See 37 CFR 1.121(d).
- 11)  The oath or declaration is objected to by the Examiner. Note the attached Office Action or form PTO-152.

**Priority under 35 U.S.C. § 119**

- 12)  Acknowledgment is made of a claim for foreign priority under 35 U.S.C. § 119(a)-(d) or (f).
    - a)  All    b)  Some \*    c)  None of:
      - 1.  Certified copies of the priority documents have been received.
      - 2.  Certified copies of the priority documents have been received in Application No. \_\_\_\_\_.
      - 3.  Copies of the certified copies of the priority documents have been received in this National Stage application from the International Bureau (PCT Rule 17.2(a)).
- \* See the attached detailed Office action for a list of the certified copies not received.

**Attachment(s)**

- 1)  Notice of References Cited (PTO-892)
- 2)  Notice of Draftsperson's Patent Drawing Review (PTO-948)
- 3)  Information Disclosure Statement(s) (PTO/SB/08)  
Paper No(s)/Mail Date \_\_\_\_\_.
- 4)  Interview Summary (PTO-413)  
Paper No(s)/Mail Date. \_\_\_\_\_.
- 5)  Notice of Informal Patent Application
- 6)  Other: see attached office action.

## DETAILED ACTION

### *Reissue Applications*

1. Applicant is reminded of the continuing obligation under 37 CFR 1.178(b), to timely apprise the Office of any prior or concurrent proceeding in which Patent No. RE39,397 and USP No. 6,625,346 is or was involved. These proceedings would include interferences, reissues, reexaminations, and litigation.

Applicant is further reminded of the continuing obligation under 37 CFR 1.56, to timely appraise the Office of any information which is material to patentability of the claims under consideration in this reissue application.

These obligations rest with each individual associated with the filing and prosecution of this application for reissue. See also MPEP §§ 1404, 1442.01 and 1442.04.

2. The reissue oath/declaration filed with this application is defective because it fails to identify at least one error which is relied upon to support the reissue application. See 37 CFR 1.175(a)(1) and MPEP § 1414.

3. The reissue declaration filed December 3, 2010, asserts that the patent was wholly or partially inoperative or invalid because the patentee claims more than he had a right to claim and identified the error that serves as basis for reissue being :

4. **Some of the claims** are deemed to be too broad and invalid in view of U.S. Patent No. 6,498,872 to Bouevitch and further in view of one or more of U.S. Patent No. 6,567,574 to Ma, U.S. Patent No. 6,256,430 to Jin or U.S. Patent No. 6,631,222 to

Wagener, as indicated by the amendments to the claims in the Preliminary Amendment referred to above and filed with this application.”

5. The declaration, as filed, lacks specificity because it merely states, “Some of the claims” are deemed to be too broad, which is a statement which does not identify in the oath or declaration which (or at least one) of the claims are too broad and asks the reader to incorporate from the amendment to figure out what is being referred to (“as indicated by the amendments to the claims in the preliminary amendment”).

6. In the remarks of 12/03/2010, Applicant’s main point concerning the previous office action is that rule 175 (37 CFR 1.175) does not require reference to specific claim language. On page 3 of Applicant’s remarks it was stated, “It is respectfully submitted that the requirement to specifically identify “any error” by reference to “the specific claim language” as stated in the rejection (the previous office action) goes beyond the requirements of the current version of rule 175.”

7. The current text of 37 CFR 1.175(a)(1) reads as follows: “The applicant believes the original patent to be wholly or partly inoperative or invalid by reason of a defective specification or drawing, or by reason of the patentee claiming more or less than the patentee had the right to claim in the patent, stating at least one error being relied upon as the basis for reissue.”

8. The words “stating at least one error” were highlighted because this is the basis for Applicant’s arguments regarding the need for specificity. The Examiner takes note of the fact that the word “state”(used as a verb) is defined by the current Merriam-Webster dictionary (current online edition) as “to express the particulars of especially in words.”

Thus it can be seen that to “state at least one error” would include “the particulars of (or specificity of) at least one error.” While a dictionary definition is somewhat anecdotal the need for specificity of at least one error has been expanded upon in MPEP 1414 ( c ) which states : “It is not sufficient for an oath/declaration to merely state “this application is being filed to correct errors in the patent which may be noted from the changes made in the disclosure.” Rather, the oath/declaration must specifically identify an error. In addition, it is not sufficient to merely reproduce the claims with brackets and underlining and state that such will identify the error. **See In re Constant, 827 F.2d 728,729, 3 USPQ 2d 1479 (Fed Cir.), cert. Denied, 484 U.S. 894 (1987).** Any error in the claims must be identified by reference **to the specific claim(s) and the specific claim language wherein lies the error.**”

9. In Applicant’s remarks of 12/03/2010, it was stated that Applicant’s counsel, Mr. Barry Young, telephoned Mr. Robert Clarke and Mr. Pincus Laufer of the UPPTO Office of Legal Administration regarding Applicant’s counsel’s understanding that the changes to rule 175 in 1997 eliminated the need for specificity (as discussed above). Examiner Healy contacted Mr. Laufer in a communication on December 28,2010 and Mr. Laufer stated that it was a misunderstanding if Mr. Young came away from their conversation that rule 175 eliminated the need for specificity of at least one error in the oath or declaration.

10. Applicant should note that if all that were necessary to state that “some of the claims are too broad” then “stating at least one error being relied upon for reissue” would be excess verbiage. The MPEP (See MPEP 1414) has been updated over time

to clarify what constitutes an adequate statement of error, using examples based on the improper declarations the office has received.

11. The Examiner would like to suggest some language which would be acceptable in the oath or declaration. This is not a requirement but a suggestion designed to advance the prosecution of the present application.

12. “[Some of the claims are] **Claim 1 is** deemed to be too broad and invalid in view of U.S. Patent No. 6,498,872 to Bouevitch and further in view of one or more of U.S. Patent No. 6,567,574 to Ma, U.S. Patent No. 6,256,430 to Jin or U.S. Patent No. 6,631,222 to Wagener, **by not including limitations regarding the pivotability of channel micromirrors and control of power of received spectral channels**, as indicated by the amendments to [the claims] **Claim 1** in the Preliminary Amendment referred to above and filed with this application.”

13. For further guidance regarding acceptable declaration language Applicant is referred to MPEP 1414 (II) ( c ).

14. Claim 68 is rejected under 35 U.S.C. 251 as being broadened in a reissue application filed outside the two year statutory period. Broadening claims made after two years from the patent issue date is prohibited by the reissue statute, 35 USC 251. Claim 68 appears to be broader than original patent claim 1. Even though claim 68 is narrower than original claim 1 in some respects, it is broader than claim 1 in that “beam reflecting elements” (recited in newly presented claim 68) is broader than “channel micro mirrors” (recited in original claim 1) because beam reflecting elements covers reflectors that includes but not limited to mirrors and micro mirrors. Claim 68 is also



broader than claim 1 because it does not require than the beam-deflecting elements be individually controllable since dynamically controllable is not limited to individually controllable. A claim is broader in scope than the original claims if it contains within its scope any conceivable product or process which would not have infringed the original patent. A claim is broadened if it is broader in any one respect even though it may be narrower in other respects.

15. Claims 1-68 are rejected as being based upon a defective reissue oath or declaration under 35 U.S.C. 251 as set forth above. See 37 CFR 1.175.

The nature of the defect(s) in the oath or declaration is set forth in the discussion above in this Office action (see above discussion).

Because the added rejection regarding improper claim broadening was not necessitated by Applicant's amendment, **this office action has NOT been made final.**

Any inquiry concerning this communication or earlier communications from the examiner should be directed to BRIAN M. HEALY whose telephone number is (571)272-2347. The examiner can normally be reached on M-F 6AM-5PM.

If attempts to reach the examiner by telephone are unsuccessful, the examiner's supervisor, Mark Robinson can be reached on (571)272-2319. The fax phone number for the organization where this application or proceeding is assigned is 571-273-8300.

Application/Control Number: 12/815,930  
Art Unit: 2883

Page 7

Information regarding the status of an application may be obtained from the Patent Application Information Retrieval (PAIR) system. Status information for published applications may be obtained from either Private PAIR or Public PAIR. Status information for unpublished applications is available through Private PAIR only. For more information about the PAIR system, see <http://pair-direct.uspto.gov>. Should you have questions on access to the Private PAIR system, contact the Electronic Business Center (EBC) at 866-217-9197 (toll-free). If you would like assistance from a USPTO Customer Service Representative or access to the automated information system, call 800-786-9199 (IN USA OR CANADA) or 571-272-1000.

**/BRIAN M. HEALY/  
Primary Examiner  
Art Unit 2883**

\*\*\*

<b>Index of Claims</b>  <b>*1281593</b>  <b>0*</b>	<b>Application/Control No.</b>  12815930	<b>Applicant(s)/Patent Under Reexamination</b>  WILDE ET AL.
	<b>Examiner</b>  BRIAN M HEALY	<b>Art Unit</b>  2883

✓	Rejected	-	Cancelled	N	Non-Elected	A	Appeal
=	Allowed	÷	Restricted	I	Interference	O	Objected

Claims renumbered in the same order as presented by applicant
  CPA
  T.D.
  R.1.47

CLAIM		DATE						
Final	Original	10/22/2010	12/29/2010					
	1	✓	✓					
	2	✓	✓					
	3	✓	✓					
	4	✓	✓					
	5	✓	✓					
	6	✓	✓					
	7	✓	✓					
	8	✓	✓					
	9	✓	✓					
	10	✓	✓					
	11	✓	✓					
	12	✓	✓					
	13	✓	✓					
	14	✓	✓					
	15	✓	✓					
	16	✓	✓					
	17	✓	✓					
	18	✓	✓					
	19	✓	✓					
	20	✓	✓					
	21	✓	✓					
	22	✓	✓					
	23	✓	✓					
	24	✓	✓					
	25	✓	✓					
	26	✓	✓					
	27	✓	✓					
	28	✓	✓					
	29	✓	✓					
	30	✓	✓					
	31	✓	✓					
	32	✓	✓					
	33	✓	✓					

<b>Index of Claims</b>  <b>*1281593</b>  <b>0*</b>	<b>Application/Control No.</b>  12815930	<b>Applicant(s)/Patent Under Reexamination</b>  WILDE ET AL.
	<b>Examiner</b>  BRIAN M HEALY	<b>Art Unit</b>  2883

✓	Rejected	-	Cancelled	N	Non-Elected	A	Appeal
=	Allowed	÷	Restricted	I	Interference	O	Objected

Claims renumbered in the same order as presented by applicant
  CPA
  T.D.
  R.1.47

CLAIM		DATE							
Final	Original	10/22/2010	12/29/2010						
	34	✓	✓						
	35	✓	✓						
	36	✓	✓						
	37	✓	✓						
	38	✓	✓						
	39	✓	✓						
	40	✓	✓						
	41	✓	✓						
	42	✓	✓						
	43	✓	✓						
	44	✓	✓						
	45	✓	✓						
	46	✓	✓						
	47	✓	✓						
	48	✓	✓						
	49	✓	✓						
	50	✓	✓						
	51	✓	✓						
	52	✓	✓						
	53	✓	✓						
	54	✓	✓						
	55	✓	✓						
	56	✓	✓						
	57	✓	✓						
	58	✓	✓						
	59	✓	✓						
	60	✓	✓						
	61	✓	✓						
	62	✓	✓						
	63	✓	✓						
	64	✓	✓						
	65	✓	✓						
	66	✓	✓						

<i>Index of Claims</i>  <b>*1281593</b>  <b>0*</b>	<b>Application/Control No.</b>  12815930	<b>Applicant(s)/Patent Under Reexamination</b>  WILDE ET AL.
	<b>Examiner</b>  BRIAN M HEALY	<b>Art Unit</b>  2883

✓	Rejected	-	Cancelled	N	Non-Elected	A	Appeal
=	Allowed	÷	Restricted	I	Interference	O	Objected

<input type="checkbox"/> Claims renumbered in the same order as presented by applicant		<input type="checkbox"/> CPA		<input type="checkbox"/> T.D.		<input type="checkbox"/> R.1.47			
CLAIM		DATE							
Final	Original	10/22/2010	12/29/2010						
	67	✓	✓						
	68	✓	✓						

**IN THE UNITED STATES PATENT AND TRADEMARK OFFICE**

Applicant: Jeffrey P. Wilde, et. al

Serial No.: 12/815,930

Group Art Unit: 2883

Filed: 06/15/2010

Examiner: Healy, Brian

Title: Reconfigurable Optical Add-Drop Multiplexers with Servo Control and Dynamic Spectral Power Management Capabilities

(Reissue of Patent No. RE 39,397; Issued November 14, 2006)

**RESPONSE**

**And**

**SUBMISSION OF REPLACEMENT REISSUE DECLARATION**

**Mail Stop REISSUE**

Commissioner for Patents

P.O. Box 1450

Alexandria, Virginia 22313-1450

Dear Sir:

In response to the Office Action of October 28, 2010, rejecting the claims under 35 U.S.C. §251 for a defective reissue oath/declaration, attached is a Replacement Reissue Application Declaration by Assignee to replace the originally filed Reissue Application Declaration By The Assignee (form PTO/SB/52).

### Remarks

For the reasons below, it is submitted that the enclosed Replacement Declaration corrects deficiencies in the originally submitted declaration, and complies fully with the requirements of 37 C.F.R. §1.175. Accordingly, favorable reconsideration of this application is respectfully requested.

The Replacement Declaration of Assignee submitted herewith states, in relevant part:

"I verily believe the original Patent to be wholly or partially inoperative or invalid for the reason that the patentee claimed more than he had a right to claim in the Patent.

At least one error upon which reissue is based is described as follows: Some of the claims are deemed to be too broad and invalid in view of U.S. Patent No. 6,498,872 to Bouevitch and further in view of one or more of U.S. Patent No. 6,567,574 to Ma, U.S. Patent No. 6,256,430 to Jin, or U.S. Patent No. 6,631,222 to Wagener, as indicated by the amendments to the claims in the Preliminary Amendment referred to above and filed with this application.

All errors corrected in this Reissue Application arose without deceptive intent on the part of the Applicant."

The current version of 37 C.F.R. §1.175 ("Rule 175"), which was effective December 1, 1997, provides in §1.175(a) (1) that the reissue oath or declaration must state:

"The applicant believes the original patent to be wholly or partially inoperative or invalid by reason of . . . the patentee claiming more of less than the patentee had a right to claim in the patent, stating at least one error being relied upon as the basis for reissue". (*see attached copy of Rule 175 reproduced from the M.P.E.P.*)

In his rejection based upon a defective oath/declaration, the Examiner stated in the Office Action that the original oath/declaration “. . . fails to clearly and specifically identify in the original claim language wherein lies the error” (*emphasis added*) (citing the M.P.E.P. §1414 and 37 C.F.R. §1.175), and stated that “[A]ny error in the claims must be identified by reference to the specific claim(s) and **the specific language wherein lies the error**” (*emphasis in original*).

It is respectfully submitted that the requirement to specifically identify “any error” by reference to “the specific claim language”, as stated in the rejection, goes beyond the requirements of the current version of Rule 175.

The current version of 37 C.F.R. §1.175 (effective December 1, 1997) changed former subsection (a) (1) of the Rule to its present form as quoted above. Additionally, it eliminated entirely former subsections (a) (2), (a) (3) and (a) (5). [Subsection (a) (4) which permitted so-called “no defect” reissues was eliminated in 1982.] Eliminated subsection (a) (2) had required the applicant to particularly specify defects in the specification or drawing. Eliminated subsection (a)(3) applied when the applicant claimed an error by reason of claiming more or less than he had a right to claim, and required the applicant to distinctly specify the excess or insufficiency in the claims. Finally, eliminated subsection (a) (5) required the applicant to particularly specify the errors relied upon and how they arose. All of the previous requirements of these subsections for specific information regarding the nature and origin of each



error being corrected have been eliminated and replaced by the present version of §1.175(a)(1) quoted above.

All that is required by Rule 175(a) (1) is that the applicant state at least one error being relied upon for reissue. The Rule does not require that more than one error to be identified in the oath or declaration, and does not require reference in the oath or declaration to the specific claim language where the error lies, as stated.

It is respectfully submitted that the statement in the enclosed Replacement Declaration: "Some of the claims are deemed to be too broad and invalid in view of U.S. Patent No. 6,498,872 to Bouevitch and further in view of one or more of U.S. Patent No. 6,567,574 to Ma, U.S. Patent No. 6,256,430 to Jin, or U.S. Patent No. 6,631,222 to Wagener, as indicated by the amendments to the claims in the Preliminary Amendment referred to above and filed with this application" is sufficient to satisfy the requirements of §1.175(a)(1), and that it is not necessary in the reissue declaration to refer to specific claims or to specific claim language.

The undersigned Counsel for Applicant confirmed in a telephone conference on December 1, 2010 with Mr. Robert Clarke (Ext. 7735) and Mr. Pincus Laufer (Ext. 7726) of the USPTO Office of Legal Administration that Counsel's understanding of the changes to the Rule in 1997, as described above, are correct, and that it is not necessary to identify in the reissue declaration the specific claim language where an error lies. It is sufficient to refer to a claim amendment.

Accordingly, it is respectfully submitted that the attached Replacement Reissue Application Declaration by Assignee satisfies the requirements of 37 C.F.R. §1.175 and overcomes the rejection under 35 U.S.C. 251.

In view of the foregoing, favorable reconsideration of this application and early action on the merits are respectfully requested.

Date: December 3, 2010

Respectfully Submitted,

/Barry N. Young/

---

Barry N. Young  
Attorney for Assignee  
Reg. No. 27,744

*Customer No. 48789*  
Law Offices of Barry N. Young  
200 Page Mill Road, Suite 102  
Palo Alto, CA 94306-2061  
Phone: (650) 326-2701  
Fax: (650) 326-2799  
[byoung@young-iplaw.com](mailto:byoung@young-iplaw.com)

Docket No: C2393-1101R2

**IN THE UNITED STATES PATENT AND TRADEMARK OFFICE**

Applicant: Jeffrey P. Wilde, et. al

Serial No. 12/815,930

Group Art Unit: 2883

Filed: 06/15/2010

Examiner: Healy, Brian

Title: Reconfigurable Optical Add-Drop Multiplexers With Servo Control and Dynamic Spectral Power Management Capability

(Reissue of Patent No. RE39,397, issued November 14, 2006)

**REPLACEMENT REISSUE APPLICATION DECLARATION BY ASSIGNEE**

I, Larry Schwerin, hereby declare that:

The residence, mailing address and citizenship of the Inventors of the above-identified patent for which reissue is sought are as stated below.

I am authorized to act on behalf of the following Assignee: CAPELLA PHOTONICS, INC., A DELAWARE CORPORATION, and my title with said assignee is President and Chief Executive Officer. The entire title and interest in said Patent is vested in said Assignee, and I consent on behalf of said Assignee to the filing of this Reissue Application for the above Patent.

Inventor's Full Name:	Jeffrey P. Wilde
Residence/Mailing Address:	2310 Rockwood Ranch Road Morgan Hill, CA 95037
Citizenship:	US

Inventor's Full Name:	Joseph E. Davis
Residence/Mailing Address:	18765 St. Marks Avenue Morgan Hill, CA 95037
Citizenship:	US

Docket No: C2393-1101R2

I believe said above named Inventors to be the original and first inventors of the subject matter which is described and claimed in said above identified Patent for which a reissue patent is sought, the specification of which:

was filed as Application No. 12/815,930 on 06/15/2010;

and was amended by Preliminary Amendment filed on 06/15/2010.

I have reviewed and understand the contents of the above-identified specification, including the claims, as amended by any amendment referred to above.

I acknowledge the duty to disclose information which is material to patentability as defined in 37 C.F.R. §1.56.

I verily believe the original Patent to be wholly or partially inoperative or invalid for the reason that the patentee claimed more than he had a right to claim in the Patent.

At least one error upon which reissue is based is described as follows:  
Some of the claims are deemed to be too broad and invalid in view of U.S. Patent No. 6,498,872 to Bouevitch and further in view of one or more of U.S. Patent No. 6,567,574 to Ma, U.S. Patent No. 6,256,430 to Jin, or U.S. Patent No. 6,631,222 to Wagener, as indicated by the amendments to the claims in the Preliminary Amendment referred to above and filed with this application.

All errors corrected in this Reissue Application arose without deceptive intent on the part of the Applicant.

I hereby appoint the practitioners associated with **Customer No. 48489** as our attorneys or agents to prosecute the application identified above, and to transact all business in the United States Patent and Trademark Office connected therewith.

Please direct all communications to:  
Barry N. Young  
Reg. No. 27,744  
200 Page Mill Road, Suite 102  
Palo Alto, CA 94306  
(650) 326-2701  
[Byoung@young-jplaw.com](mailto:Byoung@young-jplaw.com)

I hereby declare that all statements made herein of my own knowledge are true and that all statements made on information and belief are believed to be true, and further that these statements were made with the knowledge that willful false statements and the like so made are punishable by fine or imprisonment, or both, under 18 U.S.C. §1001, and that such willful false statements may jeopardize the validity of the

Docket No: C2393-1101R2

application, any patent issuing thereon, or any patent to which this Declaration is directed.

Dated: Dec 2, 2010

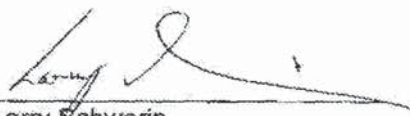
By:   
Larry Schwerin  
President and Chief Executive Officer  
Capella Photonics, Inc.  
5390 Hellyer Avenue  
San Jose, CA 95138

(c) *Status of claims and support for claim changes.* Whenever there is an amendment to the claims pursuant to paragraph (b) of this section, there must also be supplied, on pages separate from the pages containing the changes, the status (*i.e.*, pending or canceled), as of the date of the amendment, of all patent claims and of all added claims, and an explanation of the support in the disclosure of the patent for the changes made to the claims.

(d) *Changes shown by markings.* Any changes relative to the patent being reissued which are made to the specification, including the claims, upon filing, or by an amendment paper in the reissue application, must include the following markings:

(1) The matter to be omitted by reissue must be enclosed in brackets; and

(2) The matter to be added by reissue must be underlined, except for amendments submitted on compact discs (§§ 1.96 and 1.821(c)). Matter added by reissue on compact discs must be preceded with "<U>" and end with ">U>" to properly identify the material being added.

(e) *Numbering of patent claims preserved.* Patent claims may not be renumbered. The numbering of any claim added in the reissue application must follow the number of the highest numbered patent claim.

(f) *Amendment of disclosure may be required.* The disclosure must be amended, when required by the Office, to correct inaccuracies of description and definition, and to secure substantial correspondence between the claims, the remainder of the specification, and the drawings.

(g) *Amendments made relative to the patent.* All amendments must be made relative to the patent specification, including the claims, and drawings, which are in effect as of the date of filing of the reissue application.

[Revised, 65 FR 54604, Sept. 8, 2000, effective Nov. 7, 2000; para. (b)(3) revised, 68 FR 38611, June 30, 2003, effective July 30, 2003; para. (b) introductory text revised, 69 FR 56481, Sept. 21, 2004, effective Oct. 21, 2004]

#### § 1.174 [Reserved]

[24 FR 10332, Dec. 22, 1959; para. (a), 48 FR 2713, Jan. 20, 1983, effective Feb. 27, 1983; removed and reserved, 65 FR 54604, Sept. 8, 2000, effective Nov. 7, 2000]

#### § 1.175 Reissue oath or declaration.

(a) The reissue oath or declaration in addition to complying with the requirements of § 1.63, must also state that:

(1) The applicant believes the original patent to be wholly or partly inoperative or invalid by reason of a defective specification or drawing, or by reason of the patentee claiming more or less than the patentee had the right to claim in the patent, stating at least one error being relied upon as the basis for reissue; and

(2) All errors being corrected in the reissue application up to the time of filing of the oath or declaration under this paragraph arose without any deceptive intention on the part of the applicant.

(b)(1) For any error corrected, which is not covered by the oath or declaration submitted under paragraph (a) of this section, applicant must submit a supplemental oath or declaration stating that every such error arose without any deceptive intention on the part of the applicant. Any supplemental oath or declaration required by this paragraph must be submitted before allowance and may be submitted:

(i) With any amendment prior to allowance; or

(ii) In order to overcome a rejection under 35 U.S.C. 251 made by the examiner where it is indicated that the submission of a supplemental oath or declaration as required by this paragraph will overcome the rejection.

(2) For any error sought to be corrected after allowance, a supplemental oath or declaration must accompany the requested correction stating that the error(s) to be corrected arose without any deceptive intention on the part of the applicant.

(c) Having once stated an error upon which the reissue is based, as set forth in paragraph (a)(1), unless all errors previously stated in the oath or declaration are no longer being corrected, a subsequent oath or declaration under paragraph (b) of this section need not specifically identify any other error or errors being corrected.

(d) The oath or declaration required by paragraph (a) of this section may be submitted under the provisions of § 1.53(f).

(e) The filing of any continuing reissue application which does not replace its parent reissue application must include an oath or declaration which, pursuant to paragraph (a)(1) of this section, identifies

at least one error in the original patent which has not been corrected by the parent reissue application or an earlier reissue application. All other requirements relating to oaths or declarations must also be met.

[24 FR 10332, Dec. 22, 1959; 29 FR 18503, Dec. 29, 1964; 34 FR 18857, Nov. 26, 1969; para. (a), 47 FR 21752, May 19, 1982, effective July 1, 1982; para. (a), 48 FR 2713, Jan. 20, 1983, effective Feb. 27, 1983; para. (a)(7), 57 FR 2021, Jan. 17, 1992, effective Mar. 16, 1992; revised, 62 FR 53131, Oct. 10, 1997, effective Dec. 1, 1997; para. (c) added, 69 FR 56481, Sept. 21, 2004, effective Oct. 21, 2004]

#### § 1.176 Examination of reissue.

(a) A reissue application will be examined in the same manner as a non-reissue, non-provisional application, and will be subject to all the requirements of the rules related to non-reissue applications. Applications for reissue will be acted on by the examiner in advance of other applications.

(b) Restriction between subject matter of the original patent claims and previously unclaimed subject matter may be required (restriction involving only subject matter of the original patent claims will not be required). If restriction is required, the subject matter of the original patent claims will be held to be constructively elected unless a disclaimer of all the patent claims is filed in the reissue application, which disclaimer cannot be withdrawn by applicant.

[42 FR 5595, Jan. 28, 1977; revised, 65 FR 54604, Sept. 8, 2000, effective Nov. 7, 2000]

#### § 1.177 Issuance of multiple reissue patents.

(a) The Office may reissue a patent as multiple reissue patents. If applicant files more than one application for the reissue of a single patent, each such application must contain or be amended to contain in the first sentence of the specification a notice stating that more than one reissue application has been filed and identifying each of the reissue applications by relationship, application number and filing date. The Office may correct by certificate of correction under § 1.322 any reissue patent resulting from an application to which this paragraph applies that does not contain the required notice.

(b) If applicant files more than one application for the reissue of a single patent, each claim of the

patent being reissued must be presented in each of the reissue applications as an amended, unamended, or canceled (shown in brackets) claim, with each such claim bearing the same number as in the patent being reissued. The same claim of the patent being reissued may not be presented in its original unamended form for examination in more than one of such multiple reissue applications. The numbering of any added claims in any of the multiple reissue applications must follow the number of the highest numbered original patent claim.

(c) If any one of the several reissue applications by itself fails to correct an error in the original patent as required by 35 U.S.C. 251 but is otherwise in condition for allowance, the Office may suspend action in the allowable application until all issues are resolved as to at least one of the remaining reissue applications. The Office may also merge two or more of the multiple reissue applications into a single reissue application. No reissue application containing only unamended patent claims and not correcting an error in the original patent will be passed to issue by itself.

[47 FR 41278, Sept. 17, 1982, effective date Oct. 1, 1982; revised, 54 FR 6893, Feb. 15, 1989, 54 FR 9432, March 7, 1989, effective Apr. 17, 1989; revised, 60 FR 20195, Apr. 25, 1995, effective June 8, 1995; revised, 65 FR 54604, Sept. 8, 2000, effective Nov. 7, 2000]

#### § 1.178 Original patent; continuing duty of applicant.

(a) The application for reissue of a patent shall constitute an offer to surrender that patent, and the surrender shall take effect upon reissue of the patent. Until a reissue application is granted, the original patent shall remain in effect.

(b) In any reissue application before the Office, the applicant must call to the attention of the Office any prior or concurrent proceedings in which the patent (for which reissue is requested) is or was involved, such as interferences, reissues, reexaminations, or litigations and the results of such proceedings (see also § 1.173(a)(1)).

[24 FR 10332, Dec. 22, 1959; 34 FR 18857, Nov. 26, 1969; revised, 65 FR 54604, Sept. 8, 2000, effective Nov. 7, 2000; para. (a) revised, 69 FR 56481, Sept. 21, 2004, effective Sept. 21, 2004]

## Electronic Acknowledgement Receipt

<b>EFS ID:</b>	8967864
<b>Application Number:</b>	12815930
<b>International Application Number:</b>	
<b>Confirmation Number:</b>	2344
<b>Title of Invention:</b>	Reconfigurable Optical Add-Drop Multiplexers with Servo Control and Dynamic Spectral Power Management Capabilities
<b>First Named Inventor/Applicant Name:</b>	Jeffrey P. Wilde
<b>Customer Number:</b>	48789
<b>Filer:</b>	Barry N. Young
<b>Filer Authorized By:</b>	
<b>Attorney Docket Number:</b>	C2393-1101RE2
<b>Receipt Date:</b>	03-DEC-2010
<b>Filing Date:</b>	15-JUN-2010
<b>Time Stamp:</b>	21:34:15
<b>Application Type:</b>	Utility under 35 USC 111(a)

### Payment information:

Submitted with Payment	no
------------------------	----

### File Listing:

Document Number	Document Description	File Name	File Size(Bytes)/ Message Digest	Multi Part /.zip	Pages (if appl.)
1	Amendment/Req. Reconsideration-After Non-Final Reject	Resp_12-3-10.pdf	31328 <small>d06e1511f9011c4c51148c09305253ad20b d6dc</small>	no	5

**Warnings:**

**Information:**



2	Reissue dec filed in accordance with MPEP 1414.	Rpl_RE_Declr_Assignee.pdf	445665 3d65f2d595655d704791aaca009fe0d72bf73b5	no	3
<b>Warnings:</b>					
<b>Information:</b>					
3	Miscellaneous Incoming Letter	Rule_1-175.pdf	476513 b8e5571b0be8ee84e7914b2a866e0484dec3cc48	no	2
<b>Warnings:</b>					
<b>Information:</b>					
<b>Total Files Size (in bytes):</b>				953506	
<p>This Acknowledgement Receipt evidences receipt on the noted date by the USPTO of the indicated documents, characterized by the applicant, and including page counts, where applicable. It serves as evidence of receipt similar to a Post Card, as described in MPEP 503.</p> <p><b><u>New Applications Under 35 U.S.C. 111</u></b>  If a new application is being filed and the application includes the necessary components for a filing date (see 37 CFR 1.53(b)-(d) and MPEP 506), a Filing Receipt (37 CFR 1.54) will be issued in due course and the date shown on this Acknowledgement Receipt will establish the filing date of the application.</p> <p><b><u>National Stage of an International Application under 35 U.S.C. 371</u></b>  If a timely submission to enter the national stage of an international application is compliant with the conditions of 35 U.S.C. 371 and other applicable requirements a Form PCT/DO/EO/903 indicating acceptance of the application as a national stage submission under 35 U.S.C. 371 will be issued in addition to the Filing Receipt, in due course.</p> <p><b><u>New International Application Filed with the USPTO as a Receiving Office</u></b>  If a new international application is being filed and the international application includes the necessary components for an international filing date (see PCT Article 11 and MPEP 1810), a Notification of the International Application Number and of the International Filing Date (Form PCT/RO/105) will be issued in due course, subject to prescriptions concerning national security, and the date shown on this Acknowledgement Receipt will establish the international filing date of the application.</p>					



UNITED STATES PATENT AND TRADEMARK OFFICE

UNITED STATES DEPARTMENT OF COMMERCE  
United States Patent and Trademark Office  
Address: COMMISSIONER FOR PATENTS  
P.O. Box 1450  
Alexandria, Virginia 22313-1450  
www.uspto.gov

APPLICATION NO.	FILING DATE	FIRST NAMED INVENTOR	ATTORNEY DOCKET NO.	CONFIRMATION NO.
12/815,930	06/15/2010	Jeffrey P. Wilde	C2393-1101RE2	2344
48789	7590	10/28/2010	EXAMINER	
LAW OFFICES OF BARRY N. YOUNG			HEALY, BRIAN	
200 PAGE MILL ROAD			ART UNIT	PAPER NUMBER
SUITE 102			2883	
PALO ALTO, CA 94306			NOTIFICATION DATE	DELIVERY MODE
			10/28/2010	ELECTRONIC

**Please find below and/or attached an Office communication concerning this application or proceeding.**

The time period for reply, if any, is set in the attached communication.

Notice of the Office communication was sent electronically on above-indicated "Notification Date" to the following e-mail address(es):

BYOUNG@YOUNG-IPLAW.COM  
BNYOUNG7@GMAIL.COM

<b>Office Action Summary</b>	<b>Application No.</b> 12/815,930	<b>Applicant(s)</b> WILDE ET AL.	
	<b>Examiner</b> BRIAN M. HEALY	<b>Art Unit</b> 2883	

-- The MAILING DATE of this communication appears on the cover sheet with the correspondence address --

**Period for Reply**

A SHORTENED STATUTORY PERIOD FOR REPLY IS SET TO EXPIRE 3 MONTH(S) OR THIRTY (30) DAYS, WHICHEVER IS LONGER, FROM THE MAILING DATE OF THIS COMMUNICATION.

- Extensions of time may be available under the provisions of 37 CFR 1.136(a). In no event, however, may a reply be timely filed after SIX (6) MONTHS from the mailing date of this communication.
- If NO period for reply is specified above, the maximum statutory period will apply and will expire SIX (6) MONTHS from the mailing date of this communication.
- Failure to reply within the set or extended period for reply will, by statute, cause the application to become ABANDONED (35 U.S.C. § 133). Any reply received by the Office later than three months after the mailing date of this communication, even if timely filed, may reduce any earned patent term adjustment. See 37 CFR 1.704(b).

**Status**

- 1)  Responsive to communication(s) filed on \_\_\_\_.
- 2a)  This action is **FINAL**.                      2b)  This action is non-final.
- 3)  Since this application is in condition for allowance except for formal matters, prosecution as to the merits is closed in accordance with the practice under *Ex parte Quayle*, 1935 C.D. 11, 453 O.G. 213.

**Disposition of Claims**

- 4)  Claim(s) 1-68 is/are pending in the application.  
    4a) Of the above claim(s) \_\_\_\_ is/are withdrawn from consideration.
- 5)  Claim(s) \_\_\_\_ is/are allowed.
- 6)  Claim(s) 1-68 is/are rejected.
- 7)  Claim(s) \_\_\_\_ is/are objected to.
- 8)  Claim(s) \_\_\_\_ are subject to restriction and/or election requirement.

**Application Papers**

- 9)  The specification is objected to by the Examiner.
- 10)  The drawing(s) filed on 6/15/2010 is/are: a)  accepted or b)  objected to by the Examiner.  
    Applicant may not request that any objection to the drawing(s) be held in abeyance. See 37 CFR 1.85(a).  
    Replacement drawing sheet(s) including the correction is required if the drawing(s) is objected to. See 37 CFR 1.121(d).
- 11)  The oath or declaration is objected to by the Examiner. Note the attached Office Action or form PTO-152.

**Priority under 35 U.S.C. § 119**

- 12)  Acknowledgment is made of a claim for foreign priority under 35 U.S.C. § 119(a)-(d) or (f).  
    a)  All    b)  Some \*    c)  None of:
1.  Certified copies of the priority documents have been received.
2.  Certified copies of the priority documents have been received in Application No. \_\_\_\_.
3.  Copies of the certified copies of the priority documents have been received in this National Stage application from the International Bureau (PCT Rule 17.2(a)).
- \* See the attached detailed Office action for a list of the certified copies not received.

**Attachment(s)**

- |                                                                                                                                   |                                                                                         |
|-----------------------------------------------------------------------------------------------------------------------------------|-----------------------------------------------------------------------------------------|
| 1) <input checked="" type="checkbox"/> Notice of References Cited (PTO-892)                                                       | 4) <input type="checkbox"/> Interview Summary (PTO-413)<br>Paper No(s)/Mail Date. ____. |
| 2) <input type="checkbox"/> Notice of Draftsperson's Patent Drawing Review (PTO-948)                                              | 5) <input type="checkbox"/> Notice of Informal Patent Application                       |
| 3) <input checked="" type="checkbox"/> Information Disclosure Statement(s) (PTO/SB/08)<br>Paper No(s)/Mail Date <u>20100615</u> . | 6) <input type="checkbox"/> Other: ____.                                                |

## DETAILED ACTION

### *Reissue Applications*

1. The reissue oath/declaration filed with this application is defective (see 37 CFR 1.175 and MPEP § 1414) because of the following:
  2. 1) The reissue oath/declaration states that the original patent to be wholly or partly inoperative or invalid by reasons of the patentee claiming more or less that he had a right to claim in the patent. The mpep states in 1414 and 37 CFR 1.175; “ A statement that the original patent is “wholly or partly inoperative or invalid” by reason of patentee claiming more or less than the patentee had a right to claim in the patent is improper, a **claim cannot claim “more or less” at the same time.**
  3. In the oath/declaration, assignee states; Claims 1,44 and 61 **may have claimed** more than there was a right to claim in view of the cited prior art. This language fails to clearly and specifically identify in the original claim language wherein lies the error. The mpep states in 1414 and 37 CFR 1.175; “Any error in the claims must be identified by reference to the specific claim(s) and **the specific claim language wherein lies the error.**”
  4. In the oath/declaration, assignee states; “Applicants failed to include an apparatus claim (per claim 68) that corresponds substantially to method claim 61.” Merely the fact that Applicant “failed to claim” a certain claim is not an error onto itself which would render the original claim language “partially or wholly” imperative or invalid. A statement of failure to include a claim directed to a certain limitation and then presenting a newly added claim would not be considered a sufficient “error” statement

because Applicant had not specifically pointed out what the original claim(s) lacked that the added claim has or viceversa (see mpep 1414)

5. Claims 1-68 are rejected as being based upon a defective reissue oath/declaration under 35 U.S.C. 251 as set forth above. See 37 CFR 1.175.

The nature of the defect(s) in the reissue or declaration is set forth in the discussion above in this Office action.

A copy of ptol-1449 will be included in this office action.

The following reference is also cited by the Examiner as being pertinent and/or related art: Wilde et. al. US RE39,397E (Note entire reference).

If the rejection based upon 35 U.S.C. 251 is overcome, a subsequent office action will treat claims 1-68 on their merits.

Any inquiry concerning this communication or earlier communications from the examiner should be directed to BRIAN M. HEALY whose telephone number is (571)272-2347. The examiner can normally be reached on M-F 6AM-5PM.

If attempts to reach the examiner by telephone are unsuccessful, the examiner's supervisor, Mark Robinson can be reached on (571)272-2319. The fax phone number for the organization where this application or proceeding is assigned is 571-273-8300.

Application/Control Number: 12/815,930  
Art Unit: 2883

Page 4

Information regarding the status of an application may be obtained from the Patent Application Information Retrieval (PAIR) system. Status information for published applications may be obtained from either Private PAIR or Public PAIR. Status information for unpublished applications is available through Private PAIR only. For more information about the PAIR system, see <http://pair-direct.uspto.gov>. Should you have questions on access to the Private PAIR system, contact the Electronic Business Center (EBC) at 866-217-9197 (toll-free). If you would like assistance from a USPTO Customer Service Representative or access to the automated information system, call 800-786-9199 (IN USA OR CANADA) or 571-272-1000.

**/BRIAN M. HEALY/  
Primary Examiner  
Art Unit 2883**

\*\*\*

<b>Notice of References Cited</b>	Application/Control No. 12/815,930	Applicant(s)/Patent Under Reexamination WILDE ET AL.	
	Examiner BRIAN M. HEALY	Art Unit 2883	Page 1 of 1

**U.S. PATENT DOCUMENTS**

*	Document Number Country Code-Number-Kind Code	Date MM-YYYY	Name	Classification
*	A US-RE39,397 E	11-2006	Wilde et al.	385/24
B	US-			
C	US-			
D	US-			
E	US-			
F	US-			
G	US-			
H	US-			
I	US-			
J	US-			
K	US-			
L	US-			
M	US-			

**FOREIGN PATENT DOCUMENTS**

*	Document Number Country Code-Number-Kind Code	Date MM-YYYY	Country	Name	Classification
N					
O					
P					
Q					
R					
S					
T					

**NON-PATENT DOCUMENTS**

*	Document Number Country Code-Number-Kind Code	Date MM-YYYY	Country	Name	Classification
		Include as applicable: Author, Title Date, Publisher, Edition or Volume, Pertinent Pages)			
U					
V					
W					
X					

\*A copy of this reference is not being furnished with this Office action. (See MPEP § 707.05(a).)  
Dates in MM-YYYY format are publication dates. Classifications may be US or foreign.

Receipt date: 06/15/2010

12815930 - GAU: 2883

Doc code: IDS

Doc description: Information Disclosure Statement (IDS) Filed

PTO/SB/06a (01-10)  
 Approved for use through 02/31/2012. OMB 0961-0031  
 U.S. Patent and Trademark Office, U.S. DEPARTMENT OF COMMERCE  
 Under the Paperwork Reduction Act of 1995, no persons are required to respond to a collection of information unless it contains a valid OMB control number.

<b>INFORMATION DISCLOSURE STATEMENT BY APPLICANT</b> ( Not for submission under 37 CFR 1.99)	Application Number	Filed Herewith
	Filing Date	Filed Herewith
	First Named Inventor	Jeffrey P. Wilde, et. al
	Art Unit	Unknown
	Examiner Name	Unknown
	Attorney Docket Number	G2393-1101RE2

Class/Subclass

U.S.PATENTS						
Examiner Initial*	Cite No	Patent Number	Kind Code	Issue Date	Name of Patentee or Applicant of cited Document	Pages, Columns, Lines where Relevant Passages or Relevant Figures Appear
/B.H./	1	7183633	B2	2007-02-27	Daneman et. al	all 257/678
/B.H./	2	6989921	B2	2006-01-24	Bernstein et. al	all 359/290
/B.H./	3	6810169	B2	2004-10-26	Bouevitch et. al	all 385/24
/B.H./	4	6631222	B1	2003-10-07	Wegener et. al	all 385/16
/B.H./	5	6600851	B2	2003-07-29	Aksyuk et. al	all 385/18
/B.H./	6	6567574	B1	2003-05-20	Ma et. al	all 385/16
/B.H./	7	6496872	B2	2002-12-24	Bouevitch et. al	all 709/318
/B.H./	8	6256430	B1	2001-07-03	Jin et. al	all 385/18

EFS Web 2.1.17

/Brian Healy/

10/22/2010



Receipt date: 06/15/2010

12815930 - GAU: 2883

<b>INFORMATION DISCLOSURE STATEMENT BY APPLICANT</b> ( Not for submission under 37 CFR 1.99)	Application Number		Filed Herewith	
	Filing Date		Filed Herewith	
	First Named Inventor		Jeffrey P. Wilde, et. al	
	Art Unit		Unknown	
	Examiner Name		Unknown	
	Attorney Docket Number		C2393-1101RE2	

**Class/Subclass**

/B.H./	9	6028689		2000-01-24	Michalick et. al	all	359/224
/B.H./	10	5414540		1995-05-09	Patel et. al	all	359/39
/B.H./	11	5629790	A	1997-05-01	Neukermans et. al	all	359/198
/B.H./	12	5746271		1998-04-28	Ford et. al	all	359/130
/B.H./	13	5835458	A	1998-11-01	Bischel et. al	all	369/44.12
/B.H./	14	5960133	A	1999-09-01	Tomlinson	all	385/18
/B.H./	15	5974207	A	1999-10-01	Aksyuk et. al	all	385/24
/B.H./	16	6204946	B1	2001-03-01	Aksyuk et. al	all	359/131
/B.H./	17	6205269	B1	2001-03-01	Morton	all	385/24
/B.H./	18	6222954	B1	2001-04-01	Riza	all	385/18
/B.H./	19	6253135	B1	2001-07-01	Wade	all	385/37

EFS Web 2.1.17

/Brian Healy/

10/22/2010

Receipt date: 06/15/2010

12815930 - GAU: 2883

<b>INFORMATION DISCLOSURE STATEMENT BY APPLICANT</b> ( Not for submission under 37 CFR 1.99)	Application Number	Filed Herewith
	Filing Date	Filed Herewith
	First Named Inventor	Jeffrey P. Wilde, et. al
	Art Unit	Unknown
	Examiner Name	Unknown
	Attorney Docket Number	C2393-1101RE2

**Class/Subclass**

/B.H./	20	6269155	B1	2001-09-01	Wade	all 385/37
/B.H./	21	6307657	B1	2001-10-23	Ford	all 359/130
/B.H./	22	6418250	B1	2002-07-01	Corbosiero et. al	all 385/24
/B.H./	23	6625346		2003-09-23	Wilde et. al	385/24
/B.H./	24	6634810	B1	2003-10-21	Ford et. al	all 398/88
/B.H./	25	6898348	B2	2005-05-24	Morozov et al	all 385/37

If you wish to add additional U.S. Patent citation information please click the Add button.

**U.S. PATENT APPLICATION PUBLICATIONS**

Examiner initial*	Cite No	Publication Number	Kind Code	Publication Date	Name of Patentee or Applicant of cited Document	Pages, Columns, Lines where Relevant Passages or Relevant Figures Appear
/B.H./	1	20020131691	A1	2002-09-01	Garrett et al.	all 385/24
/B.H./	2	20030043471	A1	2003-03-01	Beiser et. al	all 359/634

If you wish to add additional U.S. Published Application citation information please click the Add button.

**FOREIGN PATENT DOCUMENTS**

Receipt date: 06/15/2010

12815930 - GAU: 2883

<b>INFORMATION DISCLOSURE STATEMENT BY APPLICANT</b> ( Not for submission under 37 CFR 1.99)	Application Number	Filed Herewith
	Filing Date	Filed Herewith
	First Named Inventor	Jeffrey P. Wilde, et. al
	Art Unit	Unknown
	Examiner Name	Unknown
	Attorney Docket Number	G2393-1101RE2

Examiner Initial*	Cite No	Foreign Document Number <sup>3</sup>	Country Code <sup>2</sup> j	Kind Code <sup>4</sup>	Publication Date	Name of Patentee or Applicant of cited Document	Pages, Columns, Lines where Relevant Passages or Relevant Figures Appear	T <sup>5</sup>
	1							<input type="checkbox"/>

If you wish to add additional Foreign Patent Document citation information please click the Add button

**NON-PATENT LITERATURE DOCUMENTS**

Examiner Initials*	Cite No	Include name of the author (in CAPITAL LETTERS), title of the article (when appropriate), title of the item (book, magazine, journal, serial, symposium, catalog, etc), date, pages(s), volume-issue number(s), publisher, city and/or country where published.	T <sup>5</sup>
	1		<input type="checkbox"/>

If you wish to add additional non-patent literature document citation information please click the Add button

**EXAMINER SIGNATURE**

Examiner Signature	/Brian Healy/	Date Considered	10/22/2010
--------------------	---------------	-----------------	------------

\*EXAMINER: Initial if reference considered, whether or not citation is in conformance with MPEP 609. Draw line through a citation if not in conformance and not considered. Include copy of this form with next communication to applicant.

<sup>1</sup> See Kind Codes of USPTO Patent Documents at www.USPTO.GOV or MPEP 901.04. <sup>2</sup> Enter office that issued the document, by the two-letter code (WIPO Standard ST.3). <sup>3</sup> For Japanese patent documents, the indication of the year of the reign of the Emperor must precede the serial number of the patent document. <sup>4</sup> Kind of document by the appropriate symbols as indicated on the document under WIPO Standard ST.16 if possible. <sup>5</sup> Applicant is to place a check mark here if English language translation is attached.

<b>Search Notes</b>  	<b>Application/Control No.</b> 12815930	<b>Applicant(s)/Patent Under Reexamination</b> WILDE ET AL.
	<b>Examiner</b> BRIAN M HEALY	<b>Art Unit</b> 2883

SEARCHED			
Class	Subclass	Date	Examiner
385	24,11,37,34	10/22/2010	/BH/

SEARCH NOTES		
Search Notes	Date	Examiner
SEARCHED"EAST"(prior art)(SEARCH TERMS, CLASS/SUBCLASSES AND DATABASES USED ARE LISTED ON printout)	10/22/2010	/BH/

INTERFERENCE SEARCH			
Class	Subclass	Date	Examiner

--	--

<b>Index of Claims</b>  	<b>Application/Control No.</b> 12815930	<b>Applicant(s)/Patent Under Reexamination</b> WILDE ET AL.
	<b>Examiner</b> BRIAN M HEALY	<b>Art Unit</b> 2883

✓	<b>Rejected</b>	-	<b>Cancelled</b>	N	<b>Non-Elected</b>	A	<b>Appeal</b>
=	<b>Allowed</b>	÷	<b>Restricted</b>	I	<b>Interference</b>	O	<b>Objected</b>

Claims renumbered in the same order as presented by applicant
  CPA
  T.D.
  R.1.47

CLAIM		DATE							
Final	Original	10/22/2010							
	1	✓							
	2	✓							
	3	✓							
	4	✓							
	5	✓							
	6	✓							
	7	✓							
	8	✓							
	9	✓							
	10	✓							
	11	✓							
	12	✓							
	13	✓							
	14	✓							
	15	✓							
	16	✓							
	17	✓							
	18	✓							
	19	✓							
	20	✓							
	21	✓							
	22	✓							
	23	✓							
	24	✓							
	25	✓							
	26	✓							
	27	✓							
	28	✓							
	29	✓							
	30	✓							
	31	✓							
	32	✓							
	33	✓							
	34	✓							
	35	✓							
	36	✓							

<b>Index of Claims</b>  	<b>Application/Control No.</b>  12815930	<b>Applicant(s)/Patent Under Reexamination</b>  WILDE ET AL.
	<b>Examiner</b>  BRIAN M HEALY	<b>Art Unit</b>  2883

✓	<b>Rejected</b>	-	<b>Cancelled</b>	N	<b>Non-Elected</b>	A	<b>Appeal</b>
=	<b>Allowed</b>	÷	<b>Restricted</b>	I	<b>Interference</b>	O	<b>Objected</b>

Claims renumbered in the same order as presented by applicant
  CPA
  T.D.
  R.1.47

CLAIM		DATE							
Final	Original	10/22/2010							
	37	✓							
	38	✓							
	39	✓							
	40	✓							
	41	✓							
	42	✓							
	43	✓							
	44	✓							
	45	✓							
	46	✓							
	47	✓							
	48	✓							
	49	✓							
	50	✓							
	51	✓							
	52	✓							
	53	✓							
	54	✓							
	55	✓							
	56	✓							
	57	✓							
	58	✓							
	59	✓							
	60	✓							
	61	✓							
	62	✓							
	63	✓							
	64	✓							
	65	✓							
	66	✓							
	67	✓							
	68	✓							



UNITED STATES PATENT AND TRADEMARK OFFICE

UNITED STATES DEPARTMENT OF COMMERCE  
 United States Patent and Trademark Office  
 Address: COMMISSIONER FOR PATENTS  
 P.O. Box 1450  
 Alexandria, Virginia 22313-1450  
 www.uspto.gov

BIB DATA SHEET

CONFIRMATION NO. 2344

<b>SERIAL NUMBER</b> 12/815,930	<b>FILING or 371(c) DATE</b> 06/15/2010	<b>CLASS</b> 385	<b>GROUP ART UNIT</b> 2883	<b>ATTORNEY DOCKET NO.</b> C2393-1101RE2		
<b>APPLICANTS</b> Jeffrey P. Wilde, Morgan Hill, CA; Joseph E. Davis, Morgan Hill, CA;						
<b>** CONTINUING DATA *****</b> This application is a REI of 11/027,586 12/31/2004 PAT R,E39,397 which is a REI of 09/938,426 08/23/2001 PAT 6,625,346 which claims benefit of 60/277,217 03/19/2001						
<b>** FOREIGN APPLICATIONS *****</b>						
<b>** IF REQUIRED, FOREIGN FILING LICENSE GRANTED **</b> 07/02/2010						
Foreign Priority claimed <input type="checkbox"/> Yes <input checked="" type="checkbox"/> No		<input type="checkbox"/> Met after Allowance		<b>STATE OR COUNTRY</b>	<b>SHEETS DRAWINGS</b>	<b>TOTAL CLAIMS</b>
35 USC 119(a-d) conditions met <input type="checkbox"/> Yes <input checked="" type="checkbox"/> No		Initials		CA	12	68
Verified and Acknowledged		/BRIAN HEALY/ Examiner's Signature		INDEPENDENT CLAIMS 7		
<b>ADDRESS</b> LAW OFFICES OF BARRY N. YOUNG 200 PAGE MILL ROAD SUITE 102 PALO ALTO, CA 94306 UNITED STATES						
<b>TITLE</b> Reconfigurable Optical Add-Drop Multiplexers with Servo Control and Dynamic Spectral Power Management Capabilities						
<b>FILING FEE RECEIVED</b> 4896	FEES: Authority has been given in Paper No. _____ to charge/credit DEPOSIT ACCOUNT No. _____ for following:				<input type="checkbox"/> All Fees <input type="checkbox"/> 1.16 Fees (Filing) <input type="checkbox"/> 1.17 Fees (Processing Ext. of time) <input type="checkbox"/> 1.18 Fees (Issue) <input type="checkbox"/> Other _____ <input type="checkbox"/> Credit	

## EAST Search History

## EAST Search History (Prior Art)

Ref #	Hits	Search Query	DBs	Default Operator	Plurals	Time Stamp
L1	2	"7183633".pn.	US-PGPUB; USPAT; USOCR; FPRS; EPO; JPO; DERWENT; IBM_TDB	OR	OFF	2010/10/22 12:34
L2	2	"6989921".pn.	US-PGPUB; USPAT; USOCR; FPRS; EPO; JPO; DERWENT; IBM_TDB	OR	OFF	2010/10/22 12:34
L3	2	"6810169".pn.	US-PGPUB; USPAT; USOCR; FPRS; EPO; JPO; DERWENT; IBM_TDB	OR	OFF	2010/10/22 12:35
L4	2	"6631222".pn.	US-PGPUB; USPAT; USOCR; FPRS; EPO; JPO; DERWENT; IBM_TDB	OR	OFF	2010/10/22 12:36
L5	3	"6600851".pn.	US-PGPUB; USPAT; USOCR; FPRS; EPO; JPO; DERWENT; IBM_TDB	OR	OFF	2010/10/22 12:36
L6	6	"656574".pn.	US-PGPUB; USPAT; USOCR; FPRS; EPO; JPO; DERWENT; IBM_TDB	OR	OFF	2010/10/22 12:37
L7	2	"6567574".pn.	US-PGPUB; USPAT; USOCR; FPRS; EPO; JPO; DERWENT; IBM_TDB	OR	OFF	2010/10/22 12:37



L8	2	"6496872".pn.	US-PGPUB; USPAT; USOCR; FPRS; EPO; JPO; DERWENT; IBM_TDB	OR	OFF	2010/10/22 12:38
L9	2	"6256430".pn.	US-PGPUB; USPAT; USOCR; FPRS; EPO; JPO; DERWENT; IBM_TDB	OR	OFF	2010/10/22 12:38
L10	2	"6028689".pn.	US-PGPUB; USPAT; USOCR; FPRS; EPO; JPO; DERWENT; IBM_TDB	OR	OFF	2010/10/22 12:40
L11	2	"5414540".pn.	US-PGPUB; USPAT; USOCR; FPRS; EPO; JPO; DERWENT; IBM_TDB	OR	OFF	2010/10/22 12:41
L12	2	"5629790".pn.	US-PGPUB; USPAT; USOCR; FPRS; EPO; JPO; DERWENT; IBM_TDB	OR	OFF	2010/10/22 12:41
L13	2	"5745271".pn.	US-PGPUB; USPAT; USOCR; FPRS; EPO; JPO; DERWENT; IBM_TDB	OR	OFF	2010/10/22 12:42
L14	2	"5835458".pn.	US-PGPUB; USPAT; USOCR; FPRS; EPO; JPO; DERWENT; IBM_TDB	OR	OFF	2010/10/22 12:42
L15	2	"6253135".pn.	US-PGPUB; USPAT; USOCR; FPRS; EPO; JPO; DERWENT; IBM_TDB	OR	OFF	2010/10/22 12:43

L16	2	"6263135".pn.	US-PGPUB; USPAT; USOCR; FPRS; EPO; JPO; DERWENT; IBM_TDB	OR	OFF	2010/10/22 12:43
L17	2	"6222954".pn.	US-PGPUB; USPAT; USOCR; FPRS; EPO; JPO; DERWENT; IBM_TDB	OR	OFF	2010/10/22 12:44
L18	2	"6205269".pn.	US-PGPUB; USPAT; USOCR; FPRS; EPO; JPO; DERWENT; IBM_TDB	OR	OFF	2010/10/22 12:45
L19	2	"6204946".pn.	US-PGPUB; USPAT; USOCR; FPRS; EPO; JPO; DERWENT; IBM_TDB	OR	OFF	2010/10/22 12:45
L20	2	"5974207".pn.	US-PGPUB; USPAT; USOCR; FPRS; EPO; JPO; DERWENT; IBM_TDB	OR	OFF	2010/10/22 12:46
L21	2	"5960133".pn.	US-PGPUB; USPAT; USOCR; FPRS; EPO; JPO; DERWENT; IBM_TDB	OR	OFF	2010/10/22 12:46
L22	2	"6289155".pn.	US-PGPUB; USPAT; USOCR; FPRS; EPO; JPO; DERWENT; IBM_TDB	OR	OFF	2010/10/22 12:47
L23	2	"6307657".pn.	US-PGPUB; USPAT; USOCR; FPRS; EPO; JPO; DERWENT; IBM_TDB	OR	OFF	2010/10/22 12:48

L24	2	"6418250".pn.	US-PGPUB; USPAT; USOCR; FPRS; EPO; JPO; DERWENT; IBM_TDB	OR	OFF	2010/10/22 12:48
L25	2	"6625346".pn.	US-PGPUB; USPAT; USOCR; FPRS; EPO; JPO; DERWENT; IBM_TDB	OR	OFF	2010/10/22 12:49
L26	2	"6634810".pn.	US-PGPUB; USPAT; USOCR; FPRS; EPO; JPO; DERWENT; IBM_TDB	OR	OFF	2010/10/22 12:49
L27	2	"6898348".pn.	US-PGPUB; USPAT; USOCR; FPRS; EPO; JPO; DERWENT; IBM_TDB	OR	OFF	2010/10/22 12:50
L28	2	"20020131691"	US-PGPUB; USPAT; USOCR; FPRS; EPO; JPO; DERWENT; IBM_TDB	OR	OFF	2010/10/22 12:50
L29	3	"20030043471"	US-PGPUB; USPAT; USOCR; FPRS; EPO; JPO; DERWENT; IBM_TDB	OR	OFF	2010/10/22 12:51
L30	0	(385/24,11,37,34.ccls.) and (collimator\$ near (multi-wavelength or multiwavelength)) and (wavelength near separator) and micromirror\$	US-PGPUB; USPAT; USOCR; FPRS; EPO; JPO; DERWENT; IBM_TDB	OR	OFF	2010/10/22 12:54
L31	0	(385/24,11,37,34.ccls.) and (collimator\$ near (multi-wavelength or multiwavelength)) and (wavelength near separator) and (micromirror\$ or micro- mirror)	US-PGPUB; USPAT; USOCR; FPRS; EPO; JPO; DERWENT; IBM_TDB	OR	OFF	2010/10/22 12:54

L32	0	(collimator\$ near (multi-wavelength or multiwavelength)) and (wavelength near separator) and (micromirror\$ or micro-mirror)	US-PGPUB; USPAT; USOCR; FPRS; EPO; JPO; DERWENT; IBM_TDB	OR	OFF	2010/10/22 12:55
L33	203	(spatial near array near (mems or micromirror or micro-mirror))	US-PGPUB; USPAT; USOCR; FPRS; EPO; JPO; DERWENT; IBM_TDB	OR	OFF	2010/10/22 12:56
L34	0	(spatial near array near (mems or micromirror or micro-mirror)) and ((fiber or fibre) near collimator \$)	US-PGPUB; USPAT; USOCR; FPRS; EPO; JPO; DERWENT; IBM_TDB	OR	OFF	2010/10/22 12:56
L35	0	(spatial near array near (mems or micromirror or micro-mirror)) and ((fiber or fibre) near (collimating or collimator or collimation))	US-PGPUB; USPAT; USOCR; FPRS; EPO; JPO; DERWENT; IBM_TDB	OR	OFF	2010/10/22 12:58
L36	0	(spatial near array near (mems or micromirror or micro-mirror)) and (wavelength near separator)	US-PGPUB; USPAT; USOCR; FPRS; EPO; JPO; DERWENT; IBM_TDB	OR	OFF	2010/10/22 12:58
L37	3	(spatial near array near (mems or micromirror or micro-mirror)) and (wavelength near (separating or separator or router or routing))	US-PGPUB; USPAT; USOCR; FPRS; EPO; JPO; DERWENT; IBM_TDB	OR	OFF	2010/10/22 12:59

### EAST Search History (Interference)

< This search history is empty >

10/ 22/ 2010 1:01:11 PM

C:\ Documents and Settings\ bhealy\ My Documents\ EAST\ Workspaces\ 12815930.wsp



UNITED STATES PATENT AND TRADEMARK OFFICE

UNITED STATES DEPARTMENT OF COMMERCE
United States Patent and Trademark Office
Address: COMMISSIONER FOR PATENTS
P.O. Box 1450
Alexandria, Virginia 22313-1450
www.uspto.gov

Table with 7 columns: APPLICATION NUMBER, FILING or 371(c) DATE, GRP ART UNIT, FIL FEE REC'D, ATTY.DOCKET.NO, TOT CLAIMS, IND CLAIMS. Row 1: 12/815,930, 06/15/2010, 2883, 4896, C2393-1101RE2, 68, 7

CONFIRMATION NO. 2344

FILING RECEIPT



48789
LAW OFFICES OF BARRY N. YOUNG
200 PAGE MILL ROAD
SUITE 102
PALO ALTO, CA 94306

Date Mailed: 07/06/2010

Receipt is acknowledged of this reissue patent application. The application will be taken up for examination in due course. Applicant will be notified as to the results of the examination. Any correspondence concerning the application must include the following identification information: the U.S. APPLICATION NUMBER, FILING DATE, NAME OF APPLICANT, and TITLE OF INVENTION. Fees transmitted by check or draft are subject to collection. Please verify the accuracy of the data presented on this receipt. If an error is noted on this Filing Receipt, please submit a written request for a Filing Receipt Correction. Please provide a copy of this Filing Receipt with the changes noted thereon. If you received a "Notice to File Missing Parts" for this application, please submit any corrections to this Filing Receipt with your reply to the Notice. When the USPTO processes the reply to the Notice, the USPTO will generate another Filing Receipt incorporating the requested corrections

Applicant(s)

Jeffrey P. Wilde, Morgan Hill, CA;
Joseph E. Davis, Morgan Hill, CA;

Assignment For Published Patent Application

Capella Photonics, Inc

Power of Attorney: The patent practitioners associated with Customer Number 48789

Domestic Priority data as claimed by applicant

This application is a REI of 11/027,586 12/31/2004 PAT R,E39,397
which is a REI of 09/938,426 08/23/2001 PAT 6,625,346
which claims benefit of 60/277,217 03/19/2001

Foreign Applications

If Required, Foreign Filing License Granted: 07/02/2010

The country code and number of your priority application, to be used for filing abroad under the Paris Convention, is US 12/815,930

Projected Publication Date: None, application is not eligible for pre-grant publication

Non-Publication Request: No

Early Publication Request: No