

EXHIBIT 1205

U.S. PATENT NO. 4,970,653, ISSUED TO KENUE ON NOV. 13, 1990

("KENUE")

TRW Automotive U.S. LLC: EXHIBIT 1205
PETITION FOR *INTER PARTES* REVIEW
OF U.S. PATENT NUMBER 8,599,001

- [54] VISION METHOD OF DETECTING LANE BOUNDARIES AND OBSTACLES
- [75] Inventor: Surender K. Kenue, Southfield, Mich.
- [73] Assignee: General Motors Corporation, Detroit, Mich.
- [21] Appl. No.: 334,033
- [22] Filed: Apr. 6, 1989
- [51] Int. Cl.⁵ G06F 15/50
- [52] U.S. Cl. 364/461; 364/424.02; 358/103
- [58] Field of Search 364/424.02, 461, 424.02; 180/167, 168, 169; 318/587, 103
- [56] **References Cited**

U.S. PATENT DOCUMENTS

- 4,566,032 1/1986 Hirooka et al. 364/424.02
- 4,573,547 3/1986 Yoshimura et al. 180/168
- 4,819,169 4/1989 Saitoh et al. 364/424.02
- 4,847,774 7/1989 Tomikawa et al. 364/424.02
- 4,862,047 8/1989 Suzuki et al. 318/587

4,868,752 9/1989 Fujii et al. 364/424.02

OTHER PUBLICATIONS

Dickmanns, E. D. and Zapp, A., "A Curvature-Based Scheme for Improving Road Vehicle Guidance by Computer Vision," Proc. SPIE on Mobile Robots, vol. 727, Oct. 1986, pp. 161-168.

Primary Examiner—Gary Chin
Attorney, Agent, or Firm—Howard N. Conkey

[57] ABSTRACT

An image processing method operates on an image from a ccd camera viewing a roadway scene in front of a vehicle to detect lane markers and determine the relationship of the vehicle to the lane. Obstacles in the lane near the vehicle are detected and a warning is given to the driver. The method uses template matching techniques or a Hough algorithm to detect the lane markers or road edges.

10 Claims, 7 Drawing Sheets

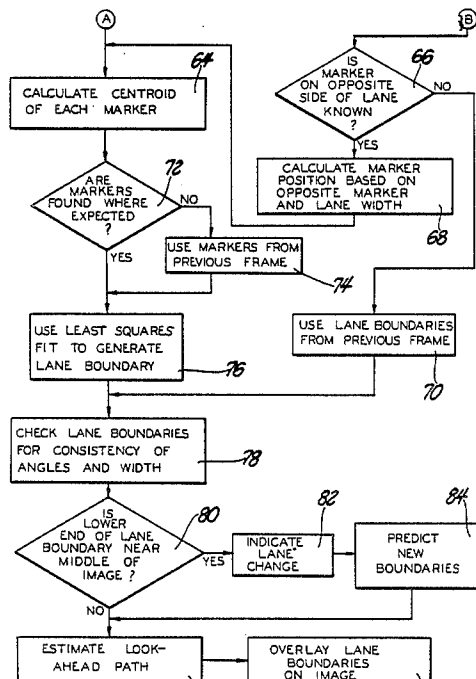
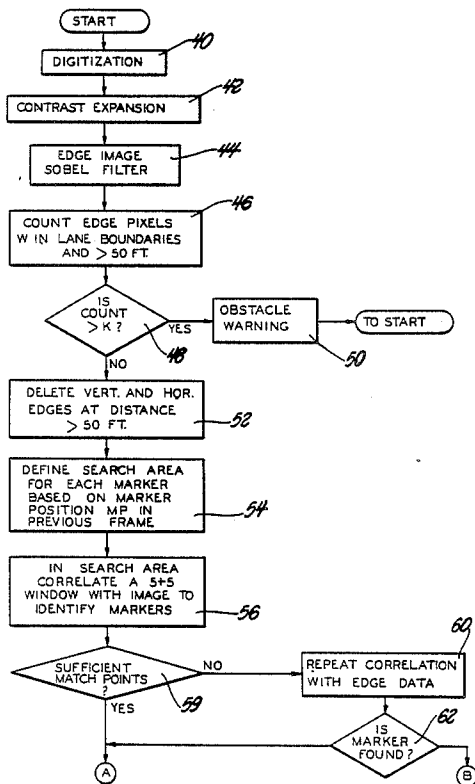

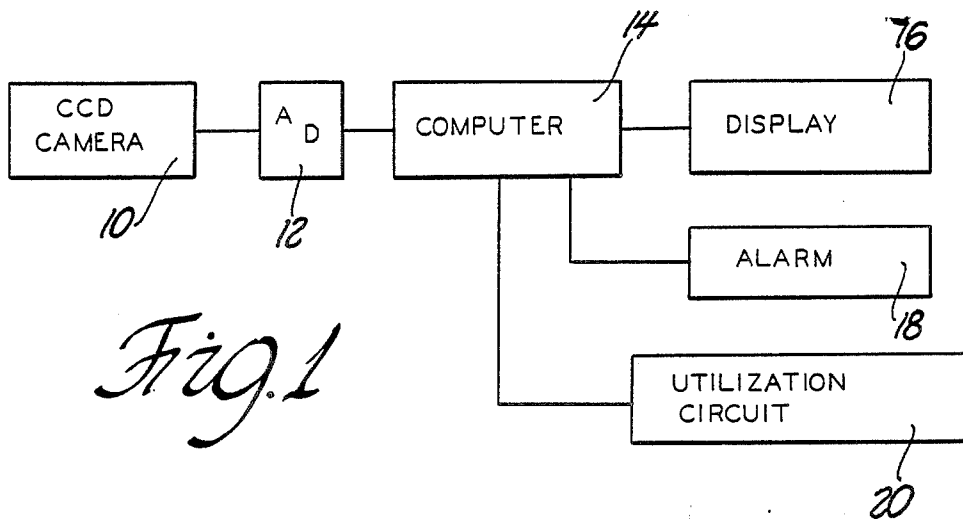

Fig. 1

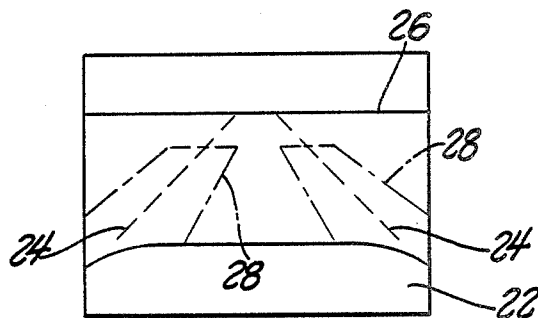

Fig. 2

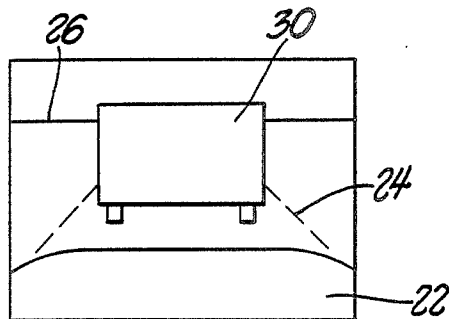
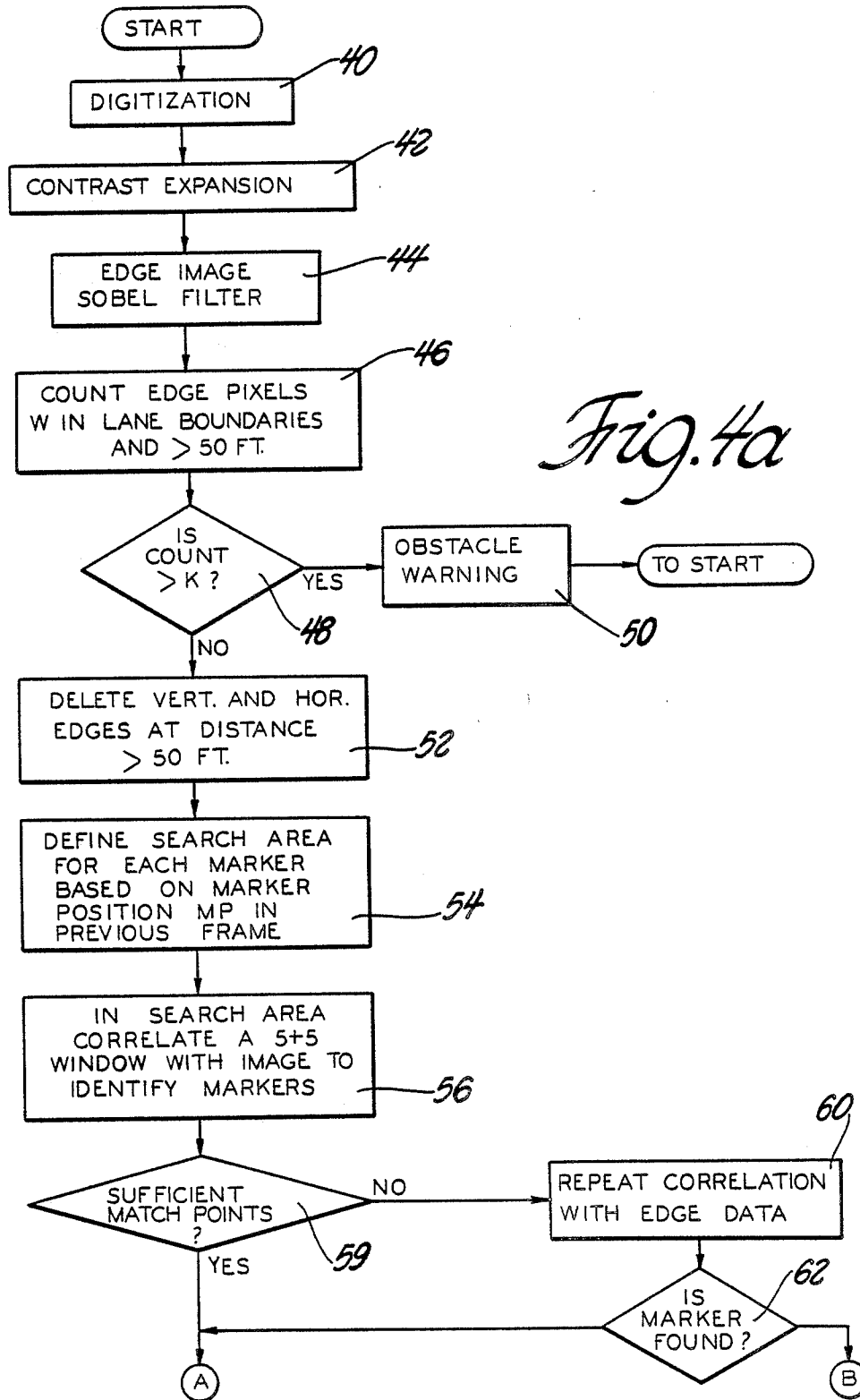

Fig. 3



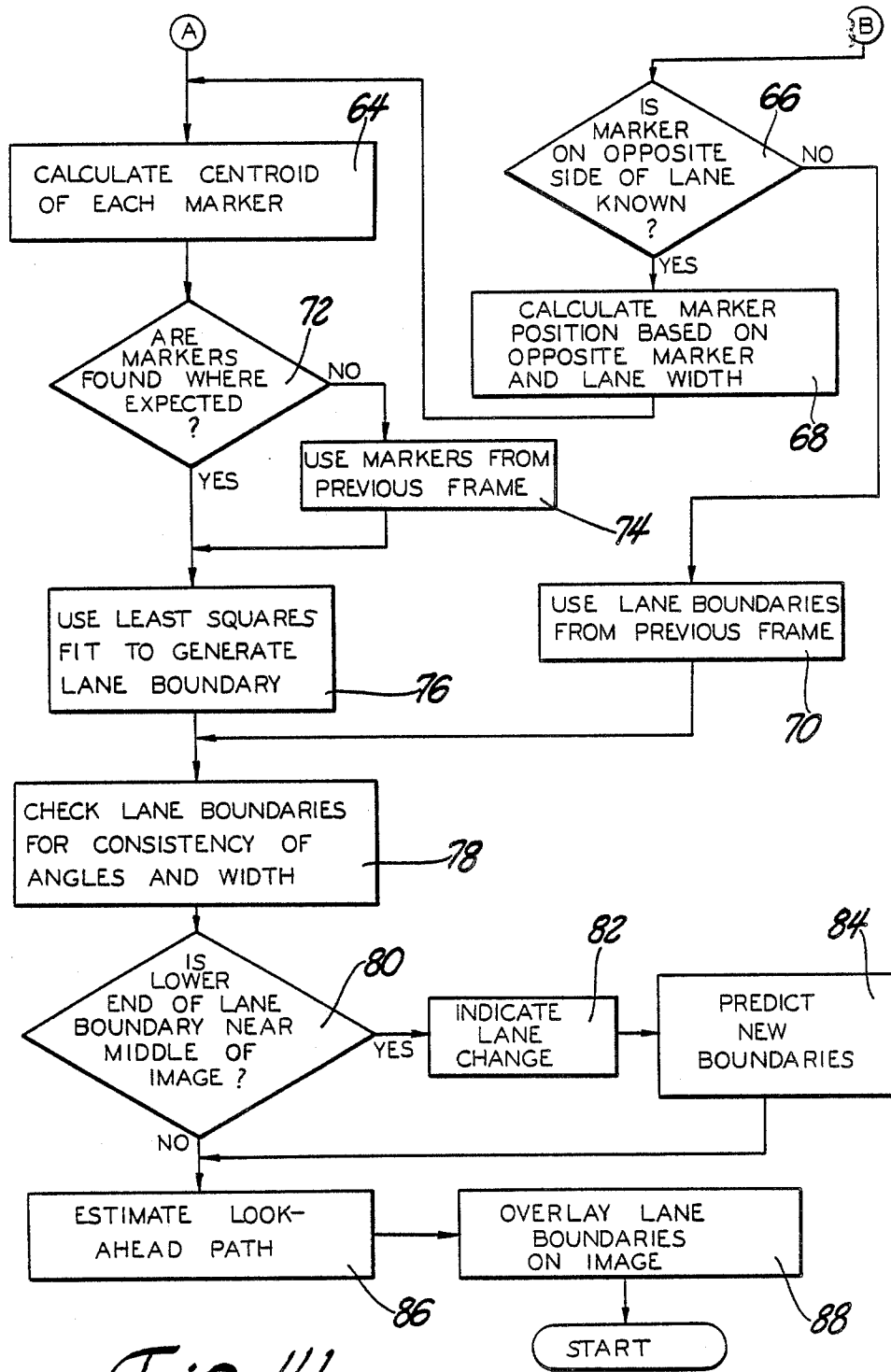

Fig. 4b

Explore Litigation Insights

Docket Alarm provides insights to develop a more informed litigation strategy and the peace of mind of knowing you're on top of things.

Real-Time Litigation Alerts



Keep your litigation team up-to-date with **real-time alerts** and advanced team management tools built for the enterprise, all while greatly reducing PACER spend.

Our comprehensive service means we can handle Federal, State, and Administrative courts across the country.

Advanced Docket Research



With over 230 million records, Docket Alarm's cloud-native docket research platform finds what other services can't. Coverage includes Federal, State, plus PTAB, TTAB, ITC and NLRB decisions, all in one place.

Identify arguments that have been successful in the past with full text, pinpoint searching. Link to case law cited within any court document via Fastcase.

Analytics At Your Fingertips



Learn what happened the last time a particular judge, opposing counsel or company faced cases similar to yours.

Advanced out-of-the-box PTAB and TTAB analytics are always at your fingertips.

API

Docket Alarm offers a powerful API (application programming interface) to developers that want to integrate case filings into their apps.

LAW FIRMS

Build custom dashboards for your attorneys and clients with live data direct from the court.

Automate many repetitive legal tasks like conflict checks, document management, and marketing.

FINANCIAL INSTITUTIONS

Litigation and bankruptcy checks for companies and debtors.

E-DISCOVERY AND LEGAL VENDORS

Sync your system to PACER to automate legal marketing.