

EXHIBIT 1108

U.S. PATENT NO. 4,930,742, ISSUED TO SCHOFIELD ON JUNE 5, 1990

("SCHOFIELD")

TRW Automotive U.S. LLC: EXHIBIT 1108  
PETITION FOR *INTER PARTES* REVIEW  
OF U.S. PATENT NUMBER 8,599,001

[54] REARVIEW MIRROR AND ACCESSORY MOUNT FOR VEHICLES

[75] Inventors: Kenneth Schofield; William W. Gallmeyer; Theodore C. Zwiep, all of Holland, Mich.

[73] Assignee: Donnelly Corporation, Holland, Mich.

[21] Appl. No.: 173,307

[22] Filed: Mar. 25, 1988

[51] Int. Cl.<sup>5</sup> ..... A47F 7/14

[52] U.S. Cl. .... 248/475.1; 248/225.1; 248/558; 350/631; 403/408.1

[58] Field of Search ..... 248/467, 475.1, 225.1, 248/222.1, 224.4, 558; 350/631; 403/388, 408.1

[56] References Cited

U.S. PATENT DOCUMENTS

- D. 231,769 6/1974 Searer et al. .
- 354,976 12/1986 Field .
- 1,110,568 9/1914 Ogden .
- 1,164,613 12/1915 Jewell .
- 1,206,871 12/1916 Locke .
- 1,353,253 9/1920 Livingston et al. .
- 1,377,355 5/1921 Knapp .
- 1,388,292 8/1921 Noisom .
- 1,615,936 2/1927 Donovan .
- 1,657,334 1/1928 Adams .
- 1,667,545 4/1928 Goddard .
- 1,761,393 6/1930 Hoegger .
- 1,912,902 6/1933 Kramer .
- 2,048,939 7/1936 Leathorn .
- 2,161,771 6/1939 Alexander .
- 2,303,108 11/1942 Blackburn .

(List continued on next page.)

FOREIGN PATENT DOCUMENTS

- 851492 1/1956 Canada .
- 523597 4/1956 Canada .
- 468473 7/1914 France .
- 617921 2/1927 France .
- 686239 7/1930 France .
- 811385 4/1937 France .
- 1311945 11/1962 France .
- 2233826 1/1975 France .
- 478282 2/1953 Italy .

- 58-185339 10/1983 Japan .
- 933078 8/1963 United Kingdom .
- 1008411 10/1965 United Kingdom .
- 1020794 2/1966 United Kingdom .
- 1053545 1/1967 United Kingdom .
- 1053546 1/1967 United Kingdom .
- 1387591 3/1975 United Kingdom .
- 2046687A 11/1980 United Kingdom .

OTHER PUBLICATIONS

Exhibit A-Photographs of General Motors wire cover Part No. 16507661-it is believed this part has been on sale for more than one year in the United States.

(List continued on next page.)

Primary Examiner-David L. Talbott  
Attorney, Agent, or Firm-Price, Heneveld, Cooper, DeWitt & Litton

[57] ABSTRACT

A mounting adaptor is disclosed for removably securing an interior rearview mirror assembly to a mounting support on the inner surface of a vehicle window such as a windshield. The adaptor preferably has a recessed channel on one side for receiving a window mounting button and a projection on the opposite surface simulating a window mounting button for removably mounting a rearview mirror assembly. The projection may be shaped to receive the same or a different mirror assembly channel mount as compared to the support on the window to allow conversion from one assembly to another without changing the window support. The adaptor may also include a support for a vehicular accessory such as a microphone, compass, headlight dimmer, light, moisture sensor, radar detector or the like. Such accessory is thus supported for convenient use by the driver or other vehicle occupant and in a highly advantageous operating position without interference with the rearview mirror, its replacement, interchangeability or adjustability. A wire cover may also be included on the adaptor.

An assembly combining a microphone and a support for mounting a rearview mirror adjacent a driver within a vehicle is also disclosed.

20 Claims, 5 Drawing Sheets

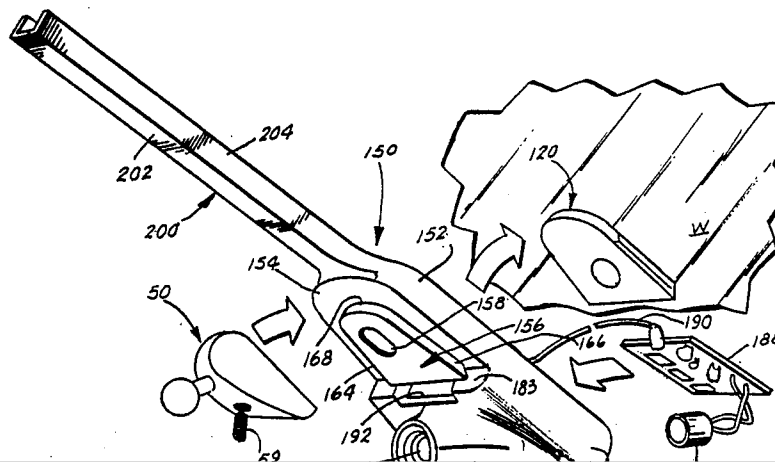

## U.S. PATENT DOCUMENTS

2,405,912	8/1946	Tinnerman .	
2,414,223	1/1947	De Virgilis .	
2,417,269	3/1947	Robertson .	
2,428,649	10/1947	Brown .	
2,461,315	2/1949	De Virgilis .	
2,509,422	5/1950	Clapp .	
2,570,569	10/1951	Leathorn .	
2,600,751	6/1952	Gazda .	
2,685,859	8/1954	Donnell .	
2,737,852	3/1956	Porter et al. .	
2,884,478	4/1959	Becker et al. .	
3,006,048	10/1961	Windish .	
3,035,160	5/1962	Cleminshaw .	
3,104,830	9/1963	Rock .	
3,131,251	4/1964	Ryan .	
3,188,038	6/1965	Grout .....	248/222.1
3,377,117	4/1968	Biscow .	
3,425,657	2/1969	Doyle .	
3,428,286	2/1969	Del Pesco .	
3,459,470	8/1969	Hahn .	
3,515,365	6/1970	Jones et al. .	
3,534,938	10/1970	Jordan et al. .	
3,576,359	4/1971	Cesh .	
3,624,347	11/1971	Todd et al. .	
3,711,632	1/1973	Ghirardi .	
3,778,537	12/1973	Miller .	
3,928,894	12/1975	Bury et al. .	
4,033,245	7/1977	DeRees .	
4,039,818	8/1977	Hickman .	
4,094,591	6/1978	Lafont .	
4,096,349	6/1978	Donato .	
4,174,864	11/1979	Viertel et al. .	
4,175,833	11/1979	Talbot .	
4,219,693	8/1980	French .	
4,245,874	1/1981	Bishop .	
4,254,931	3/1981	Aikens et al. .	
4,384,167	5/1983	Nestor .	
4,443,831	4/1984	Godfrey et al. .	
4,498,738	2/1985	Kumai .	
4,588,267	5/1986	Pastore .	
4,591,956	5/1986	Majchrzak .	

## OTHER PUBLICATIONS

Exhibit B-Photographs of Gentex wire clip-it is believed that this clip has been on sale in the United States for more than one year.

Exhibit C-Photographs of a prototype wire cover structure developed by Donnelly Corporation, Holland, Michigan and disclosed to General Motors/Chevrolet Truck on Mar. 13, 1986.

Exhibit D-Drawings from co-pending patent application Serial No. 07/021,636, filed Mar. 4, 1987 assigned to the common assignee, Donnelly Corporation, and illustrating various forms of a wire cover device adapted to extend from a rearview mirror mount to a vehicle interior headliner.

Exhibit I-photographs and sample of a mirror mounting attachment sold by General Motors Corporation and believed to be first released by General Motors Service Parts Division on Jul. 9, 1987.

Exhibit II-photographs and sample of a mirror mounting attachment manufactured and sold by Wink Corporation at least one year prior to the filing date of the present application, namely, Mar. 25, 1988.

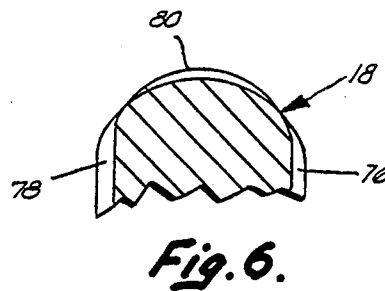
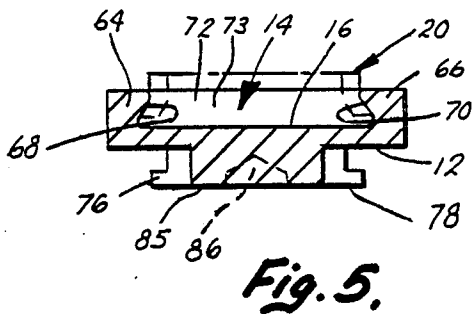
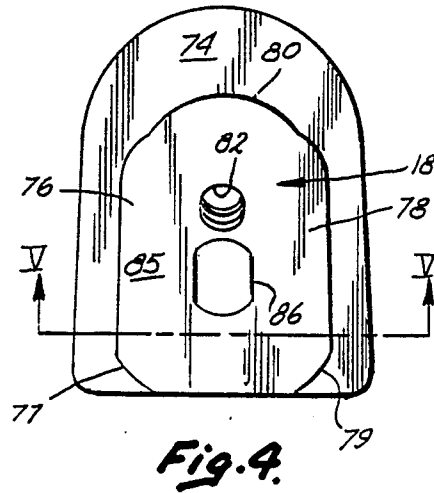
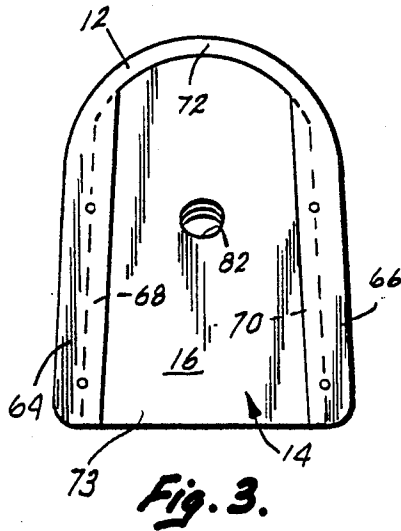
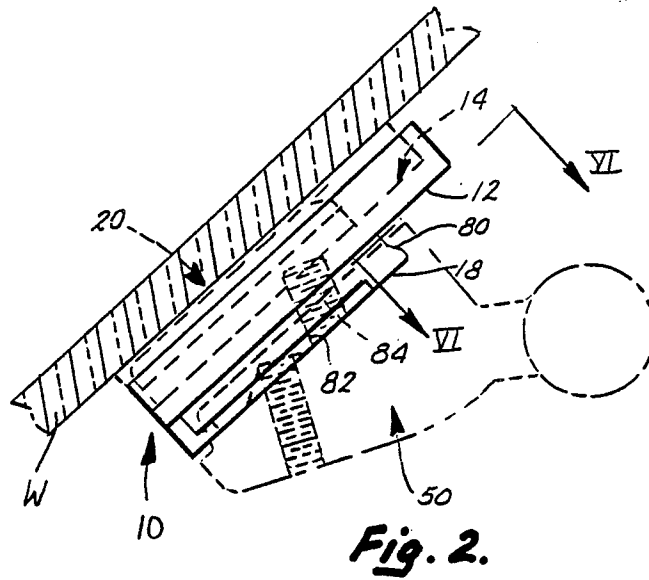
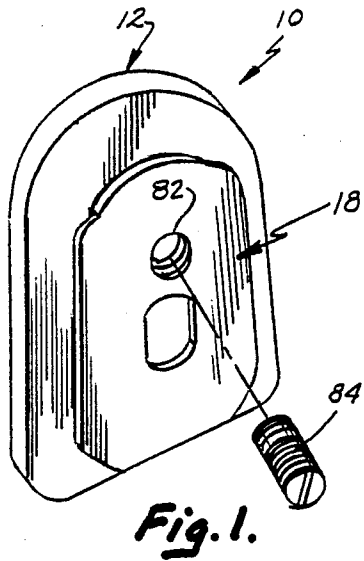

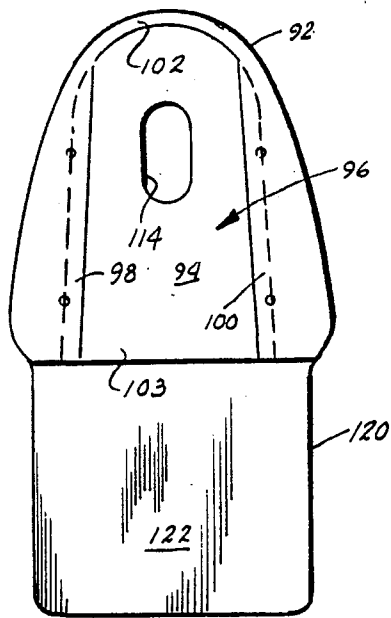

Fig. 14.

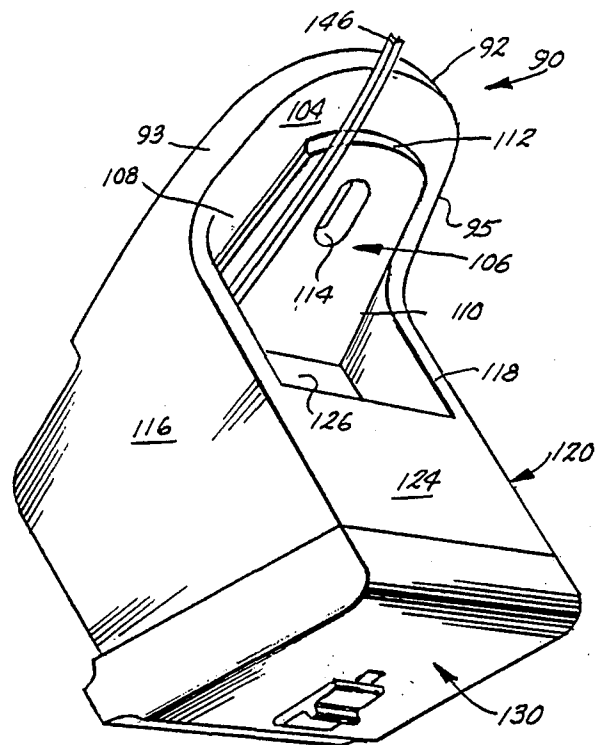

Fig. 13.

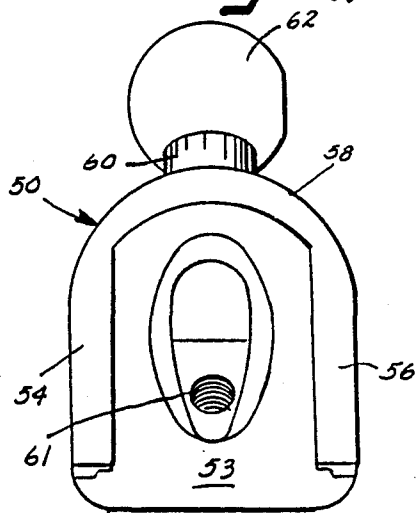

Fig. 12.

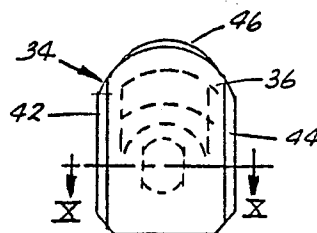

Fig. 9.

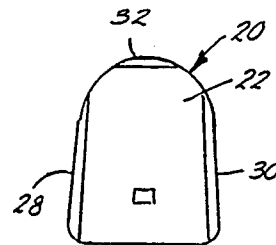

Fig. 7.

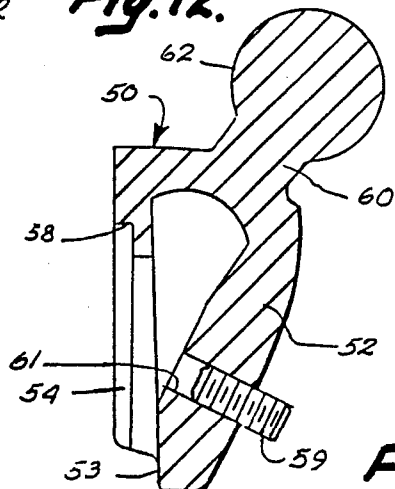

Fig. 11.

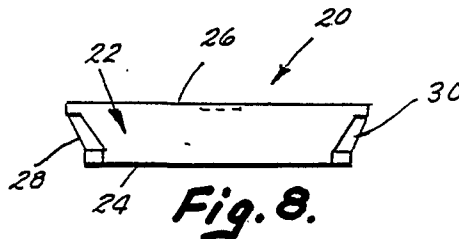

Fig. 8.

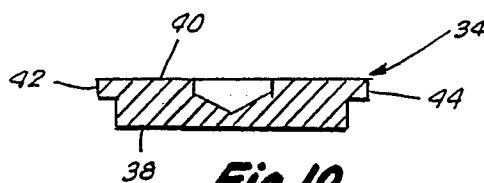

Fig. 10.

# Explore Litigation Insights

Docket Alarm provides insights to develop a more informed litigation strategy and the peace of mind of knowing you're on top of things.

## Real-Time Litigation Alerts



Keep your litigation team up-to-date with **real-time alerts** and advanced team management tools built for the enterprise, all while greatly reducing PACER spend.

Our comprehensive service means we can handle Federal, State, and Administrative courts across the country.

## Advanced Docket Research



With over 230 million records, Docket Alarm's cloud-native docket research platform finds what other services can't. Coverage includes Federal, State, plus PTAB, TTAB, ITC and NLRB decisions, all in one place.

Identify arguments that have been successful in the past with full text, pinpoint searching. Link to case law cited within any court document via Fastcase.

## Analytics At Your Fingertips



Learn what happened the last time a particular judge, opposing counsel or company faced cases similar to yours.

Advanced out-of-the-box PTAB and TTAB analytics are always at your fingertips.

## API

Docket Alarm offers a powerful API (application programming interface) to developers that want to integrate case filings into their apps.

## LAW FIRMS

Build custom dashboards for your attorneys and clients with live data direct from the court.

Automate many repetitive legal tasks like conflict checks, document management, and marketing.

## FINANCIAL INSTITUTIONS

Litigation and bankruptcy checks for companies and debtors.

## E-DISCOVERY AND LEGAL VENDORS

Sync your system to PACER to automate legal marketing.