

**IN THE UNITED STATES DISTRICT COURT
FOR THE EASTERN DISTRICT OF TEXAS
MARSHALL DIVISION**

SOLOCRON MEDIA, LLC,

Plaintiff,

v.

VERIZON COMMUNICATIONS INC., CELLCO
PARTNERSHIP D/B/A VERIZON WIRELESS,
AT&T MOBILITY LLC, SPRINT SPECTRUM L.P.,
AND T-MOBILE USA, INC.,

Defendants.

Case No. 2:13-cv-1059-JRG

[JURY TRIAL DEMANDED]

DECLARATION OF ERIN FLAUCHER

I, Erin Flaucher, do hereby declare that I am over twenty-one years of age and have personal knowledge of the facts declared herein:

1. I am a Paralegal employed by Microsoft Corporation (“Microsoft”) located at One Microsoft Way, Redmond, WA 98052. I have been employed by Microsoft since October 2009.

2. I make this declaration for the purpose of confirming the business records of certain products and authenticating certain documents. The facts set forth in this Declaration are based upon information provided to me. I am competent to testify to all matters stated, and if called upon to do so, I would testify to the facts set forth in this Declaration.

3. To the best of my knowledge, the Nokia 9110 Communicator (“the

9110 Product”) was introduced to the public on March 18, 1998 at the CeBIT ‘98 exhibition in Hannover, Germany. A true and correct copy of a press release dated March 18, 1998 is attached to this Declaration as Exhibit A.

4. The 9110 Product was first released to the public for sale in January of 1999.

5. It is my understanding based upon information from the Microsoft Mobile Oy Product Lifecycle Capability Organization, which maintains certain records on products that as part of the release and sale of the 9110 Product, Nokia created a parts package with the designation of 0069108. This 0069108 parts package constituted items that were included in the box when a 9110 Product was sold and included (among other items): a 9110 Product; a copy of a compact disc (CD) with the parts code of 0840003; a copy of the English version of the User’s Manual with the parts code of 9357168, a copy of the English version of the Quick Guide with the parts code of 9357169. The 0069108 parts package was approved to be added to the sales package by Nokia on January 26, 1998. On June 22, 1999, the 9110 Quick Guide with a parts code of 9351912 was added to the parts package 0069108.

6. It is my understanding based upon information from the Microsoft Mobile Oy Product Lifecycle Capability Organization, which maintains certain records on products that Nokia created another parts package with the designation

of 0069141 version 1.1 with a description of this package being “Nokia 9110 Communicator European 3 sales package, EN transceiver, EN user guide and quick and accessory guide and Europlug.” This 0069141 version 1 parts package constituted items that were included in the box when a 9110 Product was sold and included (among other items): a 9110 Product; a copy of a compact disc (CD) with the parts code of 0840003; a copy of the English version of the User’s Manual with the parts code of 9357168, a copy of the English version of the Quick Guide with the parts code of 9357169; and a copy of a disk with the parts code of 00840003. The 0069141, version 1.1 parts package was released by Nokia on June 18, 1999. Under Nokia’s standard business practices, the items in the 0069141, version 1.1 parts package would have been provided to purchasers of the 0069141 shortly after the release date of the product and available to the public as of that date.

7. Exhibit B is a listing for the parts code 0840003 of files that were on that CD when it was included in the packages above.

8. Exhibit C is a screenshot of the top level directory for the CD with parts code 0840003 referenced above. For clarity, Exhibit C shows the following:

Name	Date Modified	Type	Size
data	18.1.1999	File folder	
9110	1.12.1998	Application	226 KB
9110	21.10.1997	Icon	1KB

autorun	14.11.1998	Setup Information	901 KB
OPENING	8.12.1998	BMP File	901 KB
README	17.11.1998	Text Document	13 KB
VSTART	11.1.1999	Configuration sett...	1 KB
VSTART32	14.11.1998	Application	180 KB

9. Exhibit D is a copy of the cover for the CD with parts code 0840003 referenced above.

10. Exhibit E is a sales report for the 9110 Product. Exhibit E is a true and correct copy of the original report that was retrieved from Microsoft Mobile Oy's databases. Microsoft Mobile Oy is an indirect subsidiary of Microsoft Corporation. Exhibit E is a Microsoft Mobile Oy business record showing units distributed to consumers for the 9110 Product sold in 1999.

11. Each sales package for the Nokia 9110 product in 1999 that the Microsoft Mobile Oy Product Lifecycle Capability Organization has checked at my request included CD 0840003 except for a sales package which was a "replacement" package. Exhibit E shows sales for all parts packages that included the 9110 product and includes sales of parts packages 0069108 and 0069141.

12. Exhibit E accurately reflects the information kept by Microsoft Mobile Oy in the regular course of business and was recorded at or near the time of transactions by employees or representatives of the predecessor of Microsoft

Mobile Oy (which was Nokia Corporation (“Nokia”)) with knowledge. It is the regular practice of Microsoft Mobile Oy’s business to keep such records, and current employees of Microsoft Mobile Oy who were formerly employees of the predecessor Nokia Corporation confirmed that it was the regular practice of Nokia Corporation’s business to keep such records.

13. Issue 2 of the User’s Manual for the Product was included on the CD with parts code 0840003. This User’s Manual is in the file Data\DOCS\MANUALS\USERG\ug_en2.pdf as shown in Exhibit F. As noted on its front cover, Issue 2 had the identification of “9357168” on its front cover. A true and correct copy of this User’s Manual, as it was on the CD 0840003, is attached to this Declaration as Exhibit F.

14. The CD 0840003 included a document entitled “Nokia 9110 Communicator WWW Browser Style Guide.” This Style Guide is in the file Data\DOCS\CORP_USE\LM_EN\ BROWSREN.PDF as shown in Exhibit G. A true and correct copy of this Style Guide, as it was on the CD 0840003, is attached to this Declaration as Exhibit G.

15. The CD 0840003 also included a document entitled “PC Suite for Nokia 9110 Communicator User’s Guide.” This PC Suite User’s Guide is in the file Data\DOCS\PCGUIDES\Suite_en.PDF as shown in Exhibit H. A true and correct copy of this PC Suite User’s Guide, as it was on the CD 0840003, is

attached to this Declaration as Exhibit H.

16. The CD 0840003 also included two directories that contained files with an extension of .WAV. These directories were Data\WAVSOUND\ and Data\9110_SW\SOUNDS\ as shown in Exhibit B.

I declare under penalty of perjury under the laws of the United States of America that the foregoing is true and correct. Executed on the ___ day of November 2014, in the United States of America.



Erin Flaucher

List of Exhibits:

- Exhibit A March 18, 1998 Press Release on 9110 Product
- Exhibit B List of files on CD for parts code 0840003
- Exhibit C screenshot of the directory for 0840003 CD
- Exhibit D Cover for CD 0840003
- Exhibit E sales report for the 9110 product
- Exhibit F 9110 User's Manual Issue 2 on CD 0840003
- Exhibit G Nokia 9110 Communicator WWW Browser Style Guide on CD 0840003
- Exhibit H PC Suite for Nokia 9110 Communicator User's Guide on CD 0840003

Exhibit A

NOKIA INTRODUCES ITS SECOND GENERATION COMMUNICATOR -THE POCKET-SIZED NOKIA 9110 COMMUNICATOR COMBINES AN ULTIMATE MOBILE OFFICE WITH A SUPERB PHONE

18 March, 1998

The Nokia 9110 Communicator has several new applications leading the wireless office into a new era. It enables an easy transfer of information between the communicator and a PC. First in the industry, it enables wireless imaging and comes with an optional Memory Card for extra data storage. The Nokia 9110 Communicator has a back lit, high quality screen, and optimized functionality of the user-interface.

"The new Nokia 9110 Communicator is a truly outstanding, complete communications tool with a wide range of applications optimized for use in corporate and vertical markets, such as field sales, transportation, security and fleet management. This device increases productivity and reduces costs by giving easy yet efficient access to required information while on the move, in the office or at home," says Anssi Vanjoki, Senior Vice President, Nokia Mobile Phones.

All applications work together seamlessly

The Nokia 9110 Communicator is an excellent, pocket-sized mobile office. All applications - GSM phone with handsfree, telefax, Internet and intranets, e-mail, short message service (SMS) and calendar - work together seamlessly. For example, the user can check e-mail, download a file, edit it, save it and then send it by fax. After the fax is sent, the user can call using the handsfree to discuss and view the fax on the screen at the same time. The multiview calendar, contacts database and texts are Windows compatible.

To enhance the functionality and usability with PCs, Nokia has included in the sales package a new software, the PC Suite for Nokia 9110 Communicator. This software allows the user to transfer information and software between the communicator and computers using Windows 95 and Windows NT 4.0 operating systems.

The need to access data on the move has been one of the key drivers for the industry in creating data communication solutions. As wireless services have evolved beyond voice, value-added services play an increasingly important role not only in business use but also personal lifestyle uses with the emergence of electronic banking and commerce, electronic postcards and infotainment, for example.

"Nokia's goal is to offer value-added services through compact, user-friendly devices that are not technologically intimidating. The new Nokia 9110 Communicator has an easy-to-use design, but features revolutionary applications such as wireless imaging; this shows that wireless multimedia is not about the future but about today," notes Mr Vanjoki.

Wireless imaging and memory extension capabilities

First in the world, the Nokia 9110 Communicator enables wireless image sending and receiving. With the application called Digital Camera Connectivity, the user can receive pictures via infrared from digital cameras which support the Ir-TranP protocol. Photographs can be sent over the air for further processing. Pictures can also be attached to mail or fax sending.

As another industry first, Nokia has selected the Memory Card for extending user data memory in the Nokia 9110 Communicator. The Memory Card, about the size of a postage stamp, is the world's smallest removable data storage card providing memory up to 4 MB.

The Nokia 9110 Communicator will be able to store audio, travel guides, dictionaries, still images, software, large directories and documents in the MultiMediaCard. The card, developed by SanDisk and Siemens, will be sold as a standard Nokia accessory.

Superb mobile phone

The phone user interface of the Nokia 9110 Communicator is based on the Nokia 6100 series, making the communicator a phone with the latest features, outstanding audio and speech quality and excellent operating times. The phone provides up to 6 hours of talk time and the stand by time is up to 200 hours (8 days). With the 'profile' function, the user can adjust the phone settings according various situations from meeting to outdoor mode.

The Nokia 9110 Communicator has a 486 based AMD embedded processor and a GEOS 3.0 operating system platform. The product is ready for data speed of 14.4 kbit/s, and supports several standard e-mail protocols. A total of 12 language versions are available.

As the industry leader in wireless data, Nokia established a totally new product category by introducing the first Nokia 9000 Communicator already two years ago. At present, the Nokia Communicators are sold in over 30 markets worldwide.

Headquartered in Finland, Nokia is a broad-scope telecommunications company supplying mobile phones, mobile and fixed telecommunications networks, data communications solutions, multimedia terminals and PC monitors. With sales in 130 countries, net sales totaled FIM 52.6 billion (\$9.8 billion) in 1997. Nokia employs more than 36,000 people worldwide.

For further information, please contact:

Ilkka Raiskinen,

Vice President, Business Development, Europe and Africa

Nokia Mobile Phones

tel. +358 10 5051

Nokia Mobile Phones, Communications

tel. +358 10 5051

[Back to press releases](#)

NOKIA

Exhibit B

	A	B
1		
2	File Name	Path
3	Oppc.dir	Data\
4	068k.dir	Data\
5	9110_31.exe	Data\
6	9110_95.exe	Data\
7	9110DAN.dir	Data\
8	9110DEU.dir	Data\
9	9110ENG.dir	Data\
10	9110FIN.dir	Data\
11	9110FRA.dir	Data\
12	9110ITA.dir	Data\
13	9110NOR.dir	Data\
14	9110POR.dir	Data\
15	9110SPA.dir	Data\
16	9110SWE.dir	Data\
17	DAN.cst	Data\
18	DEU.cst	Data\
19	ENG.cst	Data\
20	FIN.cst	Data\
21	FRE.cst	Data\
22	Graphics.cst	Data\
23	INTRO.dir	Data\
24	ITA.cst	Data\
25	load.dir	Data\
26	loader.dir	Data\
27	NOR.cst	Data\
28	POR.cst	Data\
29	quit.dir	Data\
30	SCRIPT.cst	Data\
31	shared.cst	Data\
32	SPA.cst	Data\
33	SWE.cst	Data\
34	9lives.ins	Data\9110 SW\9lives\
35	COMLIB.GEO	Data\9110 SW\9lives\
36	NINE.GEO	Data\9110 SW\9lives\
37	NINE____.000	Data\9110 SW\9lives\
38	10010010.spt	Data\9110 SW\BANK\
39	38070724.spt	Data\9110 SW\BANK\
40	CEPT.GEO	Data\9110 SW\BANK\
41	LICENSE.TXT	Data\9110 SW\BANK\
42	LOGOPIC.BMP	Data\9110 SW\BANK\
43	obanking.000	Data\9110 SW\BANK\
44	OBANKING.GEO	Data\9110 SW\BANK\
45	obanking.ins	Data\9110 SW\BANK\
46	OBUNINST.GEO	Data\9110 SW\BANK\

	A	B
47	obuninst.ins	Data\9110 SW\BANK\
48	OBUPDATE.GEO	Data\9110 SW\BANK\
49	converte.000	Data\9110 SW\EXT APPS\DA\
50	convrt.geo	Data\9110 SW\EXT APPS\DA\
51	Convrt.ins	Data\9110 SW\EXT APPS\DA\
52	ftknox.geo	Data\9110 SW\EXT APPS\DA\
53	ftknox.ins	Data\9110 SW\EXT APPS\DA\
54	ftknox__.000	Data\9110 SW\EXT APPS\DA\
55	CONVERTE.000	Data\9110 SW\EXT APPS\DE\
56	CONVRT.GEO	Data\9110 SW\EXT APPS\DE\
57	Convrt.ins	Data\9110 SW\EXT APPS\DE\
58	FTKNOX.GEO	Data\9110 SW\EXT APPS\DE\
59	ftknox.ins	Data\9110 SW\EXT APPS\DE\
60	FTKNOX__.000	Data\9110 SW\EXT APPS\DE\
61	converte.000	Data\9110 SW\EXT APPS\EN\
62	convrt.geo	Data\9110 SW\EXT APPS\EN\
63	Convrt.ins	Data\9110 SW\EXT APPS\EN\
64	ftknox.geo	Data\9110 SW\EXT APPS\EN\
65	ftknox.ins	Data\9110 SW\EXT APPS\EN\
66	ftknox__.000	Data\9110 SW\EXT APPS\EN\
67	CONVERTE.000	Data\9110 SW\EXT APPS\ES\
68	CONVRT.GEO	Data\9110 SW\EXT APPS\ES\
69	Convrt.ins	Data\9110 SW\EXT APPS\ES\
70	FTKNOX.GEO	Data\9110 SW\EXT APPS\ES\
71	ftknox.ins	Data\9110 SW\EXT APPS\ES\
72	FTKNOX__.000	Data\9110 SW\EXT APPS\ES\
73	CONVERTE.000	Data\9110 SW\EXT APPS\FI\
74	CONVRT.GEO	Data\9110 SW\EXT APPS\FI\
75	Convrt.ins	Data\9110 SW\EXT APPS\FI\
76	FTKNOX.GEO	Data\9110 SW\EXT APPS\FI\
77	ftknox.ins	Data\9110 SW\EXT APPS\FI\
78	FTKNOX__.000	Data\9110 SW\EXT APPS\FI\
79	converte.000	Data\9110 SW\EXT APPS\FR\
80	CONVRT.GEO	Data\9110 SW\EXT APPS\FR\
81	Convrt.ins	Data\9110 SW\EXT APPS\FR\
82	FTKNOX.GEO	Data\9110 SW\EXT APPS\FR\
83	ftknox.ins	Data\9110 SW\EXT APPS\FR\
84	ftknox__.000	Data\9110 SW\EXT APPS\FR\
85	CONVERTE.000	Data\9110 SW\EXT APPS\IT\
86	CONVRT.GEO	Data\9110 SW\EXT APPS\IT\
87	Convrt.ins	Data\9110 SW\EXT APPS\IT\
88	FTKNOX.GEO	Data\9110 SW\EXT APPS\IT\
89	ftknox.ins	Data\9110 SW\EXT APPS\IT\
90	FTKNOX__.000	Data\9110 SW\EXT APPS\IT\
91	CONVERTE.000	Data\9110 SW\EXT APPS\NO\
92	CONVRT.GEO	Data\9110 SW\EXT APPS\NO\

	A	B
93	Convrt.ins	Data\9110 SW\EXT APPS\NO\
94	FTKNOX.GEO	Data\9110 SW\EXT APPS\NO\
95	ftknox.ins	Data\9110 SW\EXT APPS\NO\
96	FTKNOX__.000	Data\9110 SW\EXT APPS\NO\
97	CONVERTE.000	Data\9110 SW\EXT APPS\PT\
98	CONVRT.GEO	Data\9110 SW\EXT APPS\PT\
99	Convrt.ins	Data\9110 SW\EXT APPS\PT\
100	FTKNOX.GEO	Data\9110 SW\EXT APPS\PT\
101	ftknox.ins	Data\9110 SW\EXT APPS\PT\
102	FTKNOX__.000	Data\9110 SW\EXT APPS\PT\
103	Converte.000	Data\9110 SW\EXT APPS\SV\
104	CONVRT.GEO	Data\9110 SW\EXT APPS\SV\
105	Convrt.ins	Data\9110 SW\EXT APPS\SV\
106	FTKNOX.GEO	Data\9110 SW\EXT APPS\SV\
107	ftknox.ins	Data\9110 SW\EXT APPS\SV\
108	FTKNOX__.000	Data\9110 SW\EXT APPS\SV\
109	FTPC.GEO	Data\9110 SW\FTP\FTP DA\
110	ftpc.ins	Data\9110 SW\FTP\FTP DA\
111	FTPC____.000	Data\9110 SW\FTP\FTP DA\
112	FTPC.GEO	Data\9110 SW\FTP\FTP DE\
113	ftpc.ins	Data\9110 SW\FTP\FTP DE\
114	ftpc____.000	Data\9110 SW\FTP\FTP DE\
115	FTPC.GEO	Data\9110 SW\FTP\FTP EN\
116	FTPC.INS	Data\9110 SW\FTP\FTP EN\
117	FTPC____.000	Data\9110 SW\FTP\FTP EN\
118	FTPC.GEO	Data\9110 SW\FTP\FTP ES\
119	ftpc.ins	Data\9110 SW\FTP\FTP ES\
120	Ftpc____.000	Data\9110 SW\FTP\FTP ES\
121	FTPC.GEO	Data\9110 SW\FTP\FTP FI\
122	ftpc.ins	Data\9110 SW\FTP\FTP FI\
123	FTPC____.000	Data\9110 SW\FTP\FTP FI\
124	FTPC.GEO	Data\9110 SW\FTP\FTP FR\
125	ftpc.ins	Data\9110 SW\FTP\FTP FR\
126	ftpc____.000	Data\9110 SW\FTP\FTP FR\
127	FTPC.GEO	Data\9110 SW\FTP\FTP IT\
128	FTPC.INS	Data\9110 SW\FTP\FTP IT\
129	FTPC____.000	Data\9110 SW\FTP\FTP IT\
130	FTPC.GEO	Data\9110 SW\FTP\FTP NO\
131	FTPC.INS	Data\9110 SW\FTP\FTP NO\
132	FTPC____.000	Data\9110 SW\FTP\FTP NO\
133	FTPC.GEO	Data\9110 SW\FTP\FTP PT\
134	ftpc.ins	Data\9110 SW\FTP\FTP PT\
135	FTPC____.000	Data\9110 SW\FTP\FTP PT\
136	FTPC.GEO	Data\9110 SW\FTP\FTP SV\
137	ftpc.ins	Data\9110 SW\FTP\FTP SV\
138	FTPC____.000	Data\9110 SW\FTP\FTP SV\

	A	B
139	PHOTO1.JPG	Data\9110 SW\IMAGE\
140	PHOTO2.JPG	Data\9110 SW\IMAGE\
141	PICTURE1.JPG	Data\9110 SW\IMAGE\
142	PICTURE2.JPG	Data\9110 SW\IMAGE\
143	INNO_DE.INS	Data\9110 SW\INNOLINK\
144	INNO_DK.INS	Data\9110 SW\INNOLINK\
145	INNO_ESP.INS	Data\9110 SW\INNOLINK\
146	INNO_FIN.INS	Data\9110 SW\INNOLINK\
147	INNO_FR.INS	Data\9110 SW\INNOLINK\
148	INNO_IT.INS	Data\9110 SW\INNOLINK\
149	INNO_NOR.INS	Data\9110 SW\INNOLINK\
150	INNO_SWE.INS	Data\9110 SW\INNOLINK\
151	INNO_UK.INS	Data\9110 SW\INNOLINK\
152	LICENSE.CSV	Data\9110 SW\INNOLINK\
153	SPRED.GEO	Data\9110 SW\INNOLINK\
154	MINITEL.GEO	Data\9110 SW\MINITEL\
155	MINITEL.INS	Data\9110 SW\MINITEL\
156	MINITEL_.000	Data\9110 SW\MINITEL\
157	ascii.geo	Data\9110 SW\PRINTER\
158	ascii.ins	Data\9110 SW\PRINTER\
159	canon.geo	Data\9110 SW\PRINTER\
160	canon.ins	Data\9110 SW\PRINTER\
161	dj340.geo	Data\9110 SW\PRINTER\
162	dj340.ins	Data\9110 SW\PRINTER\
163	pn60i.geo	Data\9110 SW\PRINTER\
164	pn60i.ins	Data\9110 SW\PRINTER\
165	PUZZLE.GEO	Data\9110 SW\PUZZLE\
166	Puzzle.ins	Data\9110 SW\PUZZLE\
167	REVERSI.GEO	Data\9110 SW\REVERSI\
168	Reversi.ins	Data\9110 SW\REVERSI\
169	celesta3.ins	Data\9110 SW\SMARTFOR\
170	Courier.dsc	Data\9110 SW\SMARTFOR\
171	Courier.hlp	Data\9110 SW\SMARTFOR\
172	Courier.ins	Data\9110 SW\SMARTFOR\
173	Courier.txt	Data\9110 SW\SMARTFOR\
174	Health.dsc	Data\9110 SW\SMARTFOR\
175	Health.hlp	Data\9110 SW\SMARTFOR\
176	Health.ins	Data\9110 SW\SMARTFOR\
177	Health.txt	Data\9110 SW\SMARTFOR\
178	Mda.geo	Data\9110 SW\SMARTFOR\
179	Mda____.000	Data\9110 SW\SMARTFOR\
180	Mdalib.geo	Data\9110 SW\SMARTFOR\
181	Mdautils.geo	Data\9110 SW\SMARTFOR\
182	Multi.dsc	Data\9110 SW\SMARTFOR\
183	Multi.hlp	Data\9110 SW\SMARTFOR\
184	Multi.ins	Data\9110 SW\SMARTFOR\

	A	B
185	Multi.txt	Data\9110 SW\SMARTFOR\
186	Project.dsc	Data\9110 SW\SMARTFOR\
187	Project.hlp	Data\9110 SW\SMARTFOR\
188	Project.ins	Data\9110 SW\SMARTFOR\
189	Project.txt	Data\9110 SW\SMARTFOR\
190	Prospect.dsc	Data\9110 SW\SMARTFOR\
191	Prospect.hlp	Data\9110 SW\SMARTFOR\
192	Prospect.ins	Data\9110 SW\SMARTFOR\
193	Prospect.txt	Data\9110 SW\SMARTFOR\
194	Sales.dsc	Data\9110 SW\SMARTFOR\
195	Sales.hlp	Data\9110 SW\SMARTFOR\
196	Sales.ins	Data\9110 SW\SMARTFOR\
197	Sales.txt	Data\9110 SW\SMARTFOR\
198	Service.dsc	Data\9110 SW\SMARTFOR\
199	Service.hlp	Data\9110 SW\SMARTFOR\
200	Service.ins	Data\9110 SW\SMARTFOR\
201	Service.txt	Data\9110 SW\SMARTFOR\
202	smslib.geo	Data\9110 SW\SMARTFOR\
203	Timetrac.dsc	Data\9110 SW\SMARTFOR\
204	Timetrac.hlp	Data\9110 SW\SMARTFOR\
205	Timetrac.ins	Data\9110 SW\SMARTFOR\
206	Timetrac.txt	Data\9110 SW\SMARTFOR\
207	BOJOING.WAV	Data\9110 SW\SOUNDS\
208	BTLWALZ.WAV	Data\9110 SW\SOUNDS\
209	CARTOON.WAV	Data\9110 SW\SOUNDS\
210	COW.WAV	Data\9110 SW\SOUNDS\
211	DIDIDI.WAV	Data\9110 SW\SOUNDS\
212	DONK.WAV	Data\9110 SW\SOUNDS\
213	EFFECT.WAV	Data\9110 SW\SOUNDS\
214	FLABOOM.WAV	Data\9110 SW\SOUNDS\
215	GADAGA.WAV	Data\9110 SW\SOUNDS\
216	GRANVALS.WAV	Data\9110 SW\SOUNDS\
217	HITCH.WAV	Data\9110 SW\SOUNDS\
218	HORSE.WAV	Data\9110 SW\SOUNDS\
219	LAUGH.WAV	Data\9110 SW\SOUNDS\
220	LION.WAV	Data\9110 SW\SOUNDS\
221	MELODY.WAV	Data\9110 SW\SOUNDS\
222	PARTY1.WAV	Data\9110 SW\SOUNDS\
223	PARTY2.WAV	Data\9110 SW\SOUNDS\
224	POULTRY.WAV	Data\9110 SW\SOUNDS\
225	PRRR.WAV	Data\9110 SW\SOUNDS\
226	PRRRRR.WAV	Data\9110 SW\SOUNDS\
227	RAINFOR.WAV	Data\9110 SW\SOUNDS\
228	ROOSTER.WAV	Data\9110 SW\SOUNDS\
229	SOUND.WAV	Data\9110 SW\SOUNDS\
230	TJONG.WAV	Data\9110 SW\SOUNDS\

	A	B
231	TWANG.WAV	Data\9110 SW\SOUNDS\
232	VAGVAG.WAV	Data\9110 SW\SOUNDS\
233	WHIZFNK.WAV	Data\9110 SW\SOUNDS\
234	ZIRR.WAV	Data\9110 SW\SOUNDS\
235	CALX.GEO	Data\9110 SW\SYS APPS\Da\
236	Calx.ins	Data\9110 SW\SYS APPS\Da\
237	CALX____.000	Data\9110 SW\SYS APPS\Da\
238	CONTAX.GEO	Data\9110 SW\SYS APPS\Da\
239	Contax.ins	Data\9110 SW\SYS APPS\Da\
240	CONTAX___.000	Data\9110 SW\SYS APPS\Da\
241	TRANSF___.000	Data\9110 SW\SYS APPS\Da\
242	TRANSFR.GEO	Data\9110 SW\SYS APPS\Da\
243	Transfr.ins	Data\9110 SW\SYS APPS\Da\
244	CALX.GEO	Data\9110 SW\SYS APPS\De\
245	CALX.INS	Data\9110 SW\SYS APPS\De\
246	CALX____.000	Data\9110 SW\SYS APPS\De\
247	CONTAX.GEO	Data\9110 SW\SYS APPS\De\
248	CONTAX.INS	Data\9110 SW\SYS APPS\De\
249	CONTAX___.000	Data\9110 SW\SYS APPS\De\
250	TRANSF___.000	Data\9110 SW\SYS APPS\De\
251	TRANSFR.GEO	Data\9110 SW\SYS APPS\De\
252	TRANSFR.INS	Data\9110 SW\SYS APPS\De\
253	CALX.GEO	Data\9110 SW\SYS APPS\En\
254	CALX.INS	Data\9110 SW\SYS APPS\En\
255	CALX____.000	Data\9110 SW\SYS APPS\En\
256	CONTAX.GEO	Data\9110 SW\SYS APPS\En\
257	CONTAX.INS	Data\9110 SW\SYS APPS\En\
258	CONTAX___.000	Data\9110 SW\SYS APPS\En\
259	TRANSF___.000	Data\9110 SW\SYS APPS\En\
260	TRANSFR.GEO	Data\9110 SW\SYS APPS\En\
261	TRANSFR.INS	Data\9110 SW\SYS APPS\En\
262	CALX.GEO	Data\9110 SW\SYS APPS\Es\
263	Calx.ins	Data\9110 SW\SYS APPS\Es\
264	CALX____.000	Data\9110 SW\SYS APPS\Es\
265	CONTAX.GEO	Data\9110 SW\SYS APPS\Es\
266	Contax.ins	Data\9110 SW\SYS APPS\Es\
267	CONTAX___.000	Data\9110 SW\SYS APPS\Es\
268	TRANSF___.000	Data\9110 SW\SYS APPS\Es\
269	TRANSFR.GEO	Data\9110 SW\SYS APPS\Es\
270	Transfr.ins	Data\9110 SW\SYS APPS\Es\
271	CALX.GEO	Data\9110 SW\SYS APPS\Fi\
272	CALX.INS	Data\9110 SW\SYS APPS\Fi\
273	CALX____.000	Data\9110 SW\SYS APPS\Fi\
274	CONTAX.GEO	Data\9110 SW\SYS APPS\Fi\
275	CONTAX.INS	Data\9110 SW\SYS APPS\Fi\
276	CONTAX___.000	Data\9110 SW\SYS APPS\Fi\

	A	B
277	TRANSF__000	Data\9110 SW\SYS APPS\Fi\
278	TRANSFR.GEO	Data\9110 SW\SYS APPS\Fi\
279	TRANSFR.INS	Data\9110 SW\SYS APPS\Fi\
280	CALX.GEO	Data\9110 SW\SYS APPS\Fr\
281	Calx.ins	Data\9110 SW\SYS APPS\Fr\
282	calx__000	Data\9110 SW\SYS APPS\Fr\
283	CONTAX.GEO	Data\9110 SW\SYS APPS\Fr\
284	Contax.ins	Data\9110 SW\SYS APPS\Fr\
285	contax__000	Data\9110 SW\SYS APPS\Fr\
286	transf__000	Data\9110 SW\SYS APPS\Fr\
287	TRANSFR.GEO	Data\9110 SW\SYS APPS\Fr\
288	Transfr.ins	Data\9110 SW\SYS APPS\Fr\
289	CALX.GEO	Data\9110 SW\SYS APPS\It\
290	CALX.INS	Data\9110 SW\SYS APPS\It\
291	CALX__000	Data\9110 SW\SYS APPS\It\
292	CONTAX.GEO	Data\9110 SW\SYS APPS\It\
293	CONTAX.INS	Data\9110 SW\SYS APPS\It\
294	CONTAX__000	Data\9110 SW\SYS APPS\It\
295	TRANSF__000	Data\9110 SW\SYS APPS\It\
296	TRANSFR.GEO	Data\9110 SW\SYS APPS\It\
297	TRANSFR.INS	Data\9110 SW\SYS APPS\It\
298	CALX.GEO	Data\9110 SW\SYS APPS\No\
299	CALX.INS	Data\9110 SW\SYS APPS\No\
300	CALX__000	Data\9110 SW\SYS APPS\No\
301	CONTAX.GEO	Data\9110 SW\SYS APPS\No\
302	CONTAX.INS	Data\9110 SW\SYS APPS\No\
303	CONTAX__000	Data\9110 SW\SYS APPS\No\
304	TRANSF__000	Data\9110 SW\SYS APPS\No\
305	TRANSFR.GEO	Data\9110 SW\SYS APPS\No\
306	TRANSFR.INS	Data\9110 SW\SYS APPS\No\
307	CALX.GEO	Data\9110 SW\SYS APPS\Pt\
308	Calx.ins	Data\9110 SW\SYS APPS\Pt\
309	CALX__000	Data\9110 SW\SYS APPS\Pt\
310	CONTAX.GEO	Data\9110 SW\SYS APPS\Pt\
311	Contax.ins	Data\9110 SW\SYS APPS\Pt\
312	CONTAX__000	Data\9110 SW\SYS APPS\Pt\
313	TRANSF__000	Data\9110 SW\SYS APPS\Pt\
314	TRANSFR.GEO	Data\9110 SW\SYS APPS\Pt\
315	Transfr.ins	Data\9110 SW\SYS APPS\Pt\
316	CALX.GEO	Data\9110 SW\SYS APPS\Sv\
317	Calx.ins	Data\9110 SW\SYS APPS\Sv\
318	CALX__000	Data\9110 SW\SYS APPS\Sv\
319	CONTAX.GEO	Data\9110 SW\SYS APPS\Sv\
320	Contax.ins	Data\9110 SW\SYS APPS\Sv\
321	CONTAX__000	Data\9110 SW\SYS APPS\Sv\
322	Transf__000	Data\9110 SW\SYS APPS\Sv\

	A	B
323	TRANSFR.GEO	Data\9110 SW\SYS APPS\Sv\
324	Transfr.ins	Data\9110 SW\SYS APPS\Sv\
325	Dbfile.dsc	Data\9110 SW\TASKASSI\
326	Dbfile.hlp	Data\9110 SW\TASKASSI\
327	MDA.GEO	Data\9110 SW\TASKASSI\
328	Mda____.000	Data\9110 SW\TASKASSI\
329	MDALIB.GEO	Data\9110 SW\TASKASSI\
330	MDAUTILS.GEO	Data\9110 SW\TASKASSI\
331	Sfotask.geo	Data\9110 SW\TASKASSI\
332	Sfotask.ins	Data\9110 SW\TASKASSI\
333	smslib.geo	Data\9110 SW\TASKASSI\
334	Taskass.txt	Data\9110 SW\TASKASSI\
335	GTELNET.GEO	Data\9110 SW\TELNET\TELNETDA\
336	telnet.ins	Data\9110 SW\TELNET\TELNETDA\
337	TELNET__.000	Data\9110 SW\TELNET\TELNETDA\
338	GTELNET.GEO	Data\9110 SW\TELNET\TELNETDE\
339	TELNET.INS	Data\9110 SW\TELNET\TELNETDE\
340	TELNET__.000	Data\9110 SW\TELNET\TELNETDE\
341	GTELNET.GEO	Data\9110 SW\TELNET\TELNETEN\
342	TELNET.INS	Data\9110 SW\TELNET\TELNETEN\
343	TELNET__.000	Data\9110 SW\TELNET\TELNETEN\
344	GTELNET.GEO	Data\9110 SW\TELNET\TELNETES\
345	telnet.ins	Data\9110 SW\TELNET\TELNETES\
346	TELNET__.000	Data\9110 SW\TELNET\TELNETES\
347	GTELNET.GEO	Data\9110 SW\TELNET\TELNETFI\
348	TELNET.INS	Data\9110 SW\TELNET\TELNETFI\
349	TELNET__.000	Data\9110 SW\TELNET\TELNETFI\
350	GTELNET.GEO	Data\9110 SW\TELNET\TELNETFR\
351	telnet.ins	Data\9110 SW\TELNET\TELNETFR\
352	telnet__.000	Data\9110 SW\TELNET\TELNETFR\
353	GTELNET.GEO	Data\9110 SW\TELNET\TELNETIT\
354	TELNET.INS	Data\9110 SW\TELNET\TELNETIT\
355	TELNET__.000	Data\9110 SW\TELNET\TELNETIT\
356	GTELNET.GEO	Data\9110 SW\TELNET\TELNETNO\
357	TELNET.INS	Data\9110 SW\TELNET\TELNETNO\
358	TELNET__.000	Data\9110 SW\TELNET\TELNETNO\
359	GTELNET.GEO	Data\9110 SW\TELNET\TELNETPT\
360	telnet.ins	Data\9110 SW\TELNET\TELNETPT\
361	TELNET__.000	Data\9110 SW\TELNET\TELNETPT\
362	GTELNET.GEO	Data\9110 SW\TELNET\TELNETSV\
363	telnet.ins	Data\9110 SW\TELNET\TELNETSV\
364	Telnet__.000	Data\9110 SW\TELNET\TELNETSV\
365	BANKING.PDF	Data\DOCS\
366	MAILCONF.PDF	Data\DOCS\
367	AT_COMM.HTM	Data\DOCS\AT\
368	LOGO.GIF	Data\DOCS\AT\

	A	B
369	RESPONSE.GIF	Data\DOCS\AT\
370	SYNTAX.GIF	Data\DOCS\AT\
371	Thumbs.db	Data\DOCS\AT\
372	CELESTA.PDF	Data\DOCS\CELESTA\SMART UG\
373	BROWSRDA.PDF	Data\DOCS\CORP USE\LM DA\
374	DIALINDA.PDF	Data\DOCS\CORP USE\LM DA\
375	EMAIL_DA.PDF	Data\DOCS\CORP USE\LM DA\
376	RMTCFGDA.PDF	Data\DOCS\CORP USE\LM DA\
377	SMSFRMDA.PDF	Data\DOCS\CORP USE\LM DA\
378	BROWSRDE.PDF	Data\DOCS\CORP USE\LM DE\
379	DIALINDE.PDF	Data\DOCS\CORP USE\LM DE\
380	EMAIL_DE.PDF	Data\DOCS\CORP USE\LM DE\
381	Rmtcfgde.PDF	Data\DOCS\CORP USE\LM DE\
382	SMSFRMDE.PDF	Data\DOCS\CORP USE\LM DE\
383	BROWSREN.PDF	Data\DOCS\CORP USE\LM EN\
384	DIALINEN.PDF	Data\DOCS\CORP USE\LM EN\
385	EMAIL_EN.PDF	Data\DOCS\CORP USE\LM EN\
386	RMTCFGEN.PDF	Data\DOCS\CORP USE\LM EN\
387	SMSFRMEN.PDF	Data\DOCS\CORP USE\LM EN\
388	BROWSRES.PDF	Data\DOCS\CORP USE\LM ES\
389	DIALINES.PDF	Data\DOCS\CORP USE\LM ES\
390	EMAIL_ES.PDF	Data\DOCS\CORP USE\LM ES\
391	RMTCFGES.PDF	Data\DOCS\CORP USE\LM ES\
392	SMSFRMES.PDF	Data\DOCS\CORP USE\LM ES\
393	BROWSRFI.PDF	Data\DOCS\CORP USE\LM FI\
394	DIALINFI.PDF	Data\DOCS\CORP USE\LM FI\
395	EMAIL_FI.PDF	Data\DOCS\CORP USE\LM FI\
396	RMTCFGFI.PDF	Data\DOCS\CORP USE\LM FI\
397	SMSFRMFI.PDF	Data\DOCS\CORP USE\LM FI\
398	BROWSRFR.PDF	Data\DOCS\CORP USE\LM FR\
399	DIALINFR.PDF	Data\DOCS\CORP USE\LM FR\
400	EMAIL_FR.PDF	Data\DOCS\CORP USE\LM FR\
401	RMTCFGFR.PDF	Data\DOCS\CORP USE\LM FR\
402	SMSFRMFR.PDF	Data\DOCS\CORP USE\LM FR\
403	BROWSRIT.PDF	Data\DOCS\CORP USE\LM IT\
404	DIALINIT.PDF	Data\DOCS\CORP USE\LM IT\
405	EMAIL_IT.PDF	Data\DOCS\CORP USE\LM IT\
406	RMTCFGIT.PDF	Data\DOCS\CORP USE\LM IT\
407	SMSFRMIT.PDF	Data\DOCS\CORP USE\LM IT\
408	BROWSRNO.PDF	Data\DOCS\CORP USE\LM NO\
409	DIALINNO.PDF	Data\DOCS\CORP USE\LM NO\
410	EMAIL_NO.PDF	Data\DOCS\CORP USE\LM NO\
411	RMTCFGNO.PDF	Data\DOCS\CORP USE\LM NO\
412	SMSFRMNO.PDF	Data\DOCS\CORP USE\LM NO\
413	BROWSRPT.PDF	Data\DOCS\CORP USE\LM PT\
414	DIALINPT.PDF	Data\DOCS\CORP USE\LM PT\

	A	B
415	EMAIL_PT.PDF	Data\DOCS\CORP USE\LM_PT\
416	RMTCFGPT.PDF	Data\DOCS\CORP USE\LM_PT\
417	SMSFRMPT.PDF	Data\DOCS\CORP USE\LM_PT\
418	BROWSRSV.PDF	Data\DOCS\CORP USE\LM_SV\
419	DIALINSV.PDF	Data\DOCS\CORP USE\LM_SV\
420	EMAIL_SV.PDF	Data\DOCS\CORP USE\LM_SV\
421	RMTCFGSV.PDF	Data\DOCS\CORP USE\LM_SV\
422	SMSFRMSV.PDF	Data\DOCS\CORP USE\LM_SV\
423	INNOLINK.PDF	Data\DOCS\INNOLINK\
424	Contents.txt	Data\DOCS\MANUALS\QUICKG\
425	QG_REL6.PDF	Data\DOCS\MANUALS\QUICKG\
426	QGAG_AP1.PDF	Data\DOCS\MANUALS\QUICKG\
427	qgag_cs2.pdf	Data\DOCS\MANUALS\QUICKG\
428	qgag_da2.pdf	Data\DOCS\MANUALS\QUICKG\
429	qgag_de2.pdf	Data\DOCS\MANUALS\QUICKG\
430	qgag_el2.pdf	Data\DOCS\MANUALS\QUICKG\
431	qgag_en2.pdf	Data\DOCS\MANUALS\QUICKG\
432	qgag_es2.pdf	Data\DOCS\MANUALS\QUICKG\
433	qgag_et2.pdf	Data\DOCS\MANUALS\QUICKG\
434	qgag_fi2.pdf	Data\DOCS\MANUALS\QUICKG\
435	QGAG_FR1.PDF	Data\DOCS\MANUALS\QUICKG\
436	qgag_hr2.pdf	Data\DOCS\MANUALS\QUICKG\
437	qgag_hu2.pdf	Data\DOCS\MANUALS\QUICKG\
438	qgag_it2.pdf	Data\DOCS\MANUALS\QUICKG\
439	qgag_lt2.pdf	Data\DOCS\MANUALS\QUICKG\
440	qgag_lv2.pdf	Data\DOCS\MANUALS\QUICKG\
441	qgag_nl2.pdf	Data\DOCS\MANUALS\QUICKG\
442	QGAG_NO1.PDF	Data\DOCS\MANUALS\QUICKG\
443	qgag_pl2.pdf	Data\DOCS\MANUALS\QUICKG\
444	QGAG_PT1.PDF	Data\DOCS\MANUALS\QUICKG\
445	qgag_ro2.pdf	Data\DOCS\MANUALS\QUICKG\
446	qgag_ru2.pdf	Data\DOCS\MANUALS\QUICKG\
447	qgag_sk2.pdf	Data\DOCS\MANUALS\QUICKG\
448	qgag_sl2.pdf	Data\DOCS\MANUALS\QUICKG\
449	qgag_sv2.pdf	Data\DOCS\MANUALS\QUICKG\
450	qgag_tr2.pdf	Data\DOCS\MANUALS\QUICKG\
451	Contents.txt	Data\DOCS\MANUALS\USERG\
452	ug_da2.pdf	Data\DOCS\MANUALS\USERG\
453	ug_de2_2.pdf	Data\DOCS\MANUALS\USERG\
454	ug_en2.pdf	Data\DOCS\MANUALS\USERG\
455	ug_es2.pdf	Data\DOCS\MANUALS\USERG\
456	ug_fi2.pdf	Data\DOCS\MANUALS\USERG\
457	ug_it2.pdf	Data\DOCS\MANUALS\USERG\
458	ug_nl2.pdf	Data\DOCS\MANUALS\USERG\
459	ug_pl2.pdf	Data\DOCS\MANUALS\USERG\
460	UG_PT.PDF	Data\DOCS\MANUALS\USERG\

	A	B
461	ug_sv2.pdf	Data\DOCS\MANUALS\USERG\
462	UM_AP1.PDF	Data\DOCS\MANUALS\USERG\
463	UM_FR1.PDF	Data\DOCS\MANUALS\USERG\
464	UM_NO1.PDF	Data\DOCS\MANUALS\USERG\
465	W95CABLE.PDF	Data\DOCS\MODEM\
466	W95IR.PDF	Data\DOCS\MODEM\
467	W98CABLE.PDF	Data\DOCS\MODEM\
468	W98IR.PDF	Data\DOCS\MODEM\
469	Suite_da.pdf	Data\DOCS\PCGUIDES\
470	Suite_de.pdf	Data\DOCS\PCGUIDES\
471	Suite_en.pdf	Data\DOCS\PCGUIDES\
472	Suite_es.pdf	Data\DOCS\PCGUIDES\
473	Suite_fi.pdf	Data\DOCS\PCGUIDES\
474	Suite_fr.pdf	Data\DOCS\PCGUIDES\
475	Suite_it.pdf	Data\DOCS\PCGUIDES\
476	Suite_no.pdf	Data\DOCS\PCGUIDES\
477	Suite_pr.pdf	Data\DOCS\PCGUIDES\
478	Suite_sw.pdf	Data\DOCS\PCGUIDES\
479	N9110.PPT	Data\DOCS\SLIDES\
480	Thumbs.db	Data\DOCS\SLIDES\
481	SFOWIN.PDF	Data\DOCS\SMARTWIN\
482	byebg0.jpg	Data\DOCS\Teamware\
483	byebg1.jpg	Data\DOCS\Teamware\
484	byebg2.jpg	Data\DOCS\Teamware\
485	byebg3.jpg	Data\DOCS\Teamware\
486	byebg4.jpg	Data\DOCS\Teamware\
487	byebg5.jpg	Data\DOCS\Teamware\
488	byetxt0.gif	Data\DOCS\Teamware\
489	byetxt1.gif	Data\DOCS\Teamware\
490	byetxt2.gif	Data\DOCS\Teamware\
491	byetxt3.gif	Data\DOCS\Teamware\
492	byetxt4.gif	Data\DOCS\Teamware\
493	htmlbar.gif	Data\DOCS\Teamware\
494	htmlbut0.gif	Data\DOCS\Teamware\
495	htmlbut1.gif	Data\DOCS\Teamware\
496	htmlbut2.gif	Data\DOCS\Teamware\
497	htmlbut3.gif	Data\DOCS\Teamware\
498	index.htm	Data\DOCS\Teamware\
499	messbg0.jpg	Data\DOCS\Teamware\
500	messbg1.jpg	Data\DOCS\Teamware\
501	messbg2.jpg	Data\DOCS\Teamware\
502	messimg0.gif	Data\DOCS\Teamware\
503	messtxt0.gif	Data\DOCS\Teamware\
504	messtxt1.gif	Data\DOCS\Teamware\
505	messtxt2.gif	Data\DOCS\Teamware\
506	messtxt3.gif	Data\DOCS\Teamware\

	A	B
507	nojava.gif	Data\DOCS\Teamware\
508	NokiaCD.class	Data\DOCS\Teamware\
509	postbg0.jpg	Data\DOCS\Teamware\
510	postbg1.jpg	Data\DOCS\Teamware\
511	postbg2.jpg	Data\DOCS\Teamware\
512	postbg3.jpg	Data\DOCS\Teamware\
513	posting0.jpg	Data\DOCS\Teamware\
514	posting1.jpg	Data\DOCS\Teamware\
515	posttxt0.gif	Data\DOCS\Teamware\
516	posttxt1.gif	Data\DOCS\Teamware\
517	posttxt2.gif	Data\DOCS\Teamware\
518	posttxt3.gif	Data\DOCS\Teamware\
519	posttxt4.gif	Data\DOCS\Teamware\
520	posttxt5.gif	Data\DOCS\Teamware\
521	robobg0.jpg	Data\DOCS\Teamware\
522	robobg1.jpg	Data\DOCS\Teamware\
523	robobg2.jpg	Data\DOCS\Teamware\
524	robobg3.jpg	Data\DOCS\Teamware\
525	robobg4.jpg	Data\DOCS\Teamware\
526	robotxt0.gif	Data\DOCS\Teamware\
527	robotxt1.gif	Data\DOCS\Teamware\
528	robotxt2.gif	Data\DOCS\Teamware\
529	robotxt3.gif	Data\DOCS\Teamware\
530	transp.gif	Data\DOCS\Teamware\
531	vFace.class	Data\DOCS\Teamware\
532	viewbg0.jpg	Data\DOCS\Teamware\
533	viewbg1.jpg	Data\DOCS\Teamware\
534	viewtxt0.gif	Data\DOCS\Teamware\
535	viewtxt1.gif	Data\DOCS\Teamware\
536	viewtxt2.gif	Data\DOCS\Teamware\
537	vMatrix.class	Data\DOCS\Teamware\
538	vObject.class	Data\DOCS\Teamware\
539	vVertex.class	Data\DOCS\Teamware\
540	APPFND16.EXE	Data\PC SW\
541	APPFND32.EXE	Data\PC SW\
542	AR16E301.EXE	Data\PC SW\ACROBAT\WIN16\
543	AR32E301.EXE	Data\PC SW\ACROBAT\WIN32\
544	COURIE~1.DSC	Data\PC SW\CELESTA\
545	HEALTH~1.DSC	Data\PC SW\CELESTA\
546	MULTIP~1.DSC	Data\PC SW\CELESTA\
547	PROJEC~1.DSC	Data\PC SW\CELESTA\
548	PROSPE~1.DSC	Data\PC SW\CELESTA\
549	SALESR~1.DSC	Data\PC SW\CELESTA\
550	SERVIC~1.DSC	Data\PC SW\CELESTA\
551	_INST32I.EX_	Data\PC SW\CELESTA\DISK1\
552	_ISDEL.EXE	Data\PC SW\CELESTA\DISK1\

	A	B
553	_SETUP.1	Data\PC SW\CELESTA\DISK1\
554	_SETUP.DLL	Data\PC SW\CELESTA\DISK1\
555	_SETUP.LIB	Data\PC SW\CELESTA\DISK1\
556	DISK1.ID	Data\PC SW\CELESTA\DISK1\
557	SETUP.EXE	Data\PC SW\CELESTA\DISK1\
558	SETUP.INI	Data\PC SW\CELESTA\DISK1\
559	SETUP.INS	Data\PC SW\CELESTA\DISK1\
560	SETUP.ISS	Data\PC SW\CELESTA\DISK1\
561	SETUP.PKG	Data\PC SW\CELESTA\DISK1\
562	_SETUP.2	Data\PC SW\CELESTA\DISK2\
563	DISK2.ID	Data\PC SW\CELESTA\DISK2\
564	_SETUP.3	Data\PC SW\CELESTA\DISK3\
565	DISK3.ID	Data\PC SW\CELESTA\DISK3\
566	_INST16.EX_	Data\PC SW\CONVRT\
567	_ISDEL.EXE	Data\PC SW\CONVRT\
568	_SETUP.DLL	Data\PC SW\CONVRT\
569	_SYS1.CAB	Data\PC SW\CONVRT\
570	_USER1.CAB	Data\PC SW\CONVRT\
571	DATA.TAG	Data\PC SW\CONVRT\
572	DATA1.CAB	Data\PC SW\CONVRT\
573	LANG.DAT	Data\PC SW\CONVRT\
574	LAYOUT.BIN	Data\PC SW\CONVRT\
575	LICENSE.TXT	Data\PC SW\CONVRT\
576	OS.DAT	Data\PC SW\CONVRT\
577	SETUP.BMP	Data\PC SW\CONVRT\
578	SETUP.EXE	Data\PC SW\CONVRT\
579	SETUP.INI	Data\PC SW\CONVRT\
580	SETUP.INS	Data\PC SW\CONVRT\
581	SETUP.LID	Data\PC SW\CONVRT\
582	MDMN9110.INF	Data\PC SW\FAXMODEM\
583	_INST32I.EX_	Data\PC SW\INTELLIM\UK\DISK1\
584	_ISDEL.EXE	Data\PC SW\INTELLIM\UK\DISK1\
585	_SETUP.DLL	Data\PC SW\INTELLIM\UK\DISK1\
586	_SETUP.LIB	Data\PC SW\INTELLIM\UK\DISK1\
587	DISK1.ID	Data\PC SW\INTELLIM\UK\DISK1\
588	PROGRAM.1	Data\PC SW\INTELLIM\UK\DISK1\
589	README.TXT	Data\PC SW\INTELLIM\UK\DISK1\
590	SETUP.EXE	Data\PC SW\INTELLIM\UK\DISK1\
591	SETUP.INI	Data\PC SW\INTELLIM\UK\DISK1\
592	SETUP.INS	Data\PC SW\INTELLIM\UK\DISK1\
593	SETUP.PKG	Data\PC SW\INTELLIM\UK\DISK1\
594	DISK2.ID	Data\PC SW\INTELLIM\UK\DISK2\
595	PROGRAM.2	Data\PC SW\INTELLIM\UK\DISK2\
596	DISK3.ID	Data\PC SW\INTELLIM\UK\DISK3\
597	PROGRAM.3	Data\PC SW\INTELLIM\UK\DISK3\
598	DISK4.ID	Data\PC SW\INTELLIM\UK\DISK4\

	A	B
599	PROGRAM.4	Data\PC SW\INTELLIM\UK\DISK4\
600	README.TXT	Data\PC SW\NSERVER\
601	SAMPLE.INS	Data\PC SW\NSERVER\
602	SERVER.EXE	Data\PC SW\NSERVER\
603	_INST32I.EX_	Data\PC SW\PC SUITE\DA\DISK1\
604	_isdel.exe	Data\PC SW\PC SUITE\DA\DISK1\
605	_SETUP.DLL	Data\PC SW\PC SUITE\DA\DISK1\
606	_setup.lib	Data\PC SW\PC SUITE\DA\DISK1\
607	DISK1.ID	Data\PC SW\PC SUITE\DA\DISK1\
608	Readme.txt	Data\PC SW\PC SUITE\DA\DISK1\
609	setup.exe	Data\PC SW\PC SUITE\DA\DISK1\
610	setup.ini	Data\PC SW\PC SUITE\DA\DISK1\
611	SETUP.INS	Data\PC SW\PC SUITE\DA\DISK1\
612	setup.pkg	Data\PC SW\PC SUITE\DA\DISK1\
613	system.1	Data\PC SW\PC SUITE\DA\DISK1\
614	DISK2.ID	Data\PC SW\PC SUITE\DA\DISK2\
615	program.1	Data\PC SW\PC SUITE\DA\DISK2\
616	system.2	Data\PC SW\PC SUITE\DA\DISK2\
617	DISK3.ID	Data\PC SW\PC SUITE\DA\DISK3\
618	program.2	Data\PC SW\PC SUITE\DA\DISK3\
619	ascii.z	Data\PC SW\PC SUITE\DA\DISK4\
620	DISK4.ID	Data\PC SW\PC SUITE\DA\DISK4\
621	org97gs.z	Data\PC SW\PC SUITE\DA\DISK4\
622	outlook.z	Data\PC SW\PC SUITE\DA\DISK4\
623	program.3	Data\PC SW\PC SUITE\DA\DISK4\
624	schdplus.z	Data\PC SW\PC SUITE\DA\DISK4\
625	_INST32I.EX_	Data\PC SW\PC SUITE\DE\DISK1\
626	_isdel.exe	Data\PC SW\PC SUITE\DE\DISK1\
627	_SETUP.DLL	Data\PC SW\PC SUITE\DE\DISK1\
628	_setup.lib	Data\PC SW\PC SUITE\DE\DISK1\
629	DISK1.ID	Data\PC SW\PC SUITE\DE\DISK1\
630	README.TXT	Data\PC SW\PC SUITE\DE\DISK1\
631	setup.exe	Data\PC SW\PC SUITE\DE\DISK1\
632	setup.ini	Data\PC SW\PC SUITE\DE\DISK1\
633	SETUP.INS	Data\PC SW\PC SUITE\DE\DISK1\
634	setup.pkg	Data\PC SW\PC SUITE\DE\DISK1\
635	system.1	Data\PC SW\PC SUITE\DE\DISK1\
636	DISK2.ID	Data\PC SW\PC SUITE\DE\DISK2\
637	program.1	Data\PC SW\PC SUITE\DE\DISK2\
638	system.2	Data\PC SW\PC SUITE\DE\DISK2\
639	DISK3.ID	Data\PC SW\PC SUITE\DE\DISK3\
640	program.2	Data\PC SW\PC SUITE\DE\DISK3\
641	ascii.z	Data\PC SW\PC SUITE\DE\DISK4\
642	DISK4.ID	Data\PC SW\PC SUITE\DE\DISK4\
643	org97gs.z	Data\PC SW\PC SUITE\DE\DISK4\
644	outlook.z	Data\PC SW\PC SUITE\DE\DISK4\

	A	B
645	program.3	Data\PC SW\PC SUITE\DE\DISK4\
646	schdplus.z	Data\PC SW\PC SUITE\DE\DISK4\
647	_INST32I.EX_	Data\PC SW\PC SUITE\EN\DISK1\
648	_isdel.exe	Data\PC SW\PC SUITE\EN\DISK1\
649	_SETUP.DLL	Data\PC SW\PC SUITE\EN\DISK1\
650	_setup.lib	Data\PC SW\PC SUITE\EN\DISK1\
651	DISK1.ID	Data\PC SW\PC SUITE\EN\DISK1\
652	README.TXT	Data\PC SW\PC SUITE\EN\DISK1\
653	setup.exe	Data\PC SW\PC SUITE\EN\DISK1\
654	setup.ini	Data\PC SW\PC SUITE\EN\DISK1\
655	SETUP.INS	Data\PC SW\PC SUITE\EN\DISK1\
656	setup.pkg	Data\PC SW\PC SUITE\EN\DISK1\
657	system.1	Data\PC SW\PC SUITE\EN\DISK1\
658	DISK2.ID	Data\PC SW\PC SUITE\EN\DISK2\
659	program.1	Data\PC SW\PC SUITE\EN\DISK2\
660	system.2	Data\PC SW\PC SUITE\EN\DISK2\
661	DISK3.ID	Data\PC SW\PC SUITE\EN\DISK3\
662	program.2	Data\PC SW\PC SUITE\EN\DISK3\
663	ascii.z	Data\PC SW\PC SUITE\EN\DISK4\
664	DISK4.ID	Data\PC SW\PC SUITE\EN\DISK4\
665	org97gs.z	Data\PC SW\PC SUITE\EN\DISK4\
666	outlook.z	Data\PC SW\PC SUITE\EN\DISK4\
667	program.3	Data\PC SW\PC SUITE\EN\DISK4\
668	schdplus.z	Data\PC SW\PC SUITE\EN\DISK4\
669	_INST32I.EX_	Data\PC SW\PC SUITE\ES\DISK1\
670	_isdel.exe	Data\PC SW\PC SUITE\ES\DISK1\
671	_SETUP.DLL	Data\PC SW\PC SUITE\ES\DISK1\
672	_setup.lib	Data\PC SW\PC SUITE\ES\DISK1\
673	DISK1.ID	Data\PC SW\PC SUITE\ES\DISK1\
674	README.TXT	Data\PC SW\PC SUITE\ES\DISK1\
675	setup.exe	Data\PC SW\PC SUITE\ES\DISK1\
676	setup.ini	Data\PC SW\PC SUITE\ES\DISK1\
677	SETUP.INS	Data\PC SW\PC SUITE\ES\DISK1\
678	setup.pkg	Data\PC SW\PC SUITE\ES\DISK1\
679	system.1	Data\PC SW\PC SUITE\ES\DISK1\
680	DISK2.ID	Data\PC SW\PC SUITE\ES\DISK2\
681	program.1	Data\PC SW\PC SUITE\ES\DISK2\
682	system.2	Data\PC SW\PC SUITE\ES\DISK2\
683	DISK3.ID	Data\PC SW\PC SUITE\ES\DISK3\
684	program.2	Data\PC SW\PC SUITE\ES\DISK3\
685	ascii.z	Data\PC SW\PC SUITE\ES\DISK4\
686	DISK4.ID	Data\PC SW\PC SUITE\ES\DISK4\
687	org97gs.z	Data\PC SW\PC SUITE\ES\DISK4\
688	outlook.z	Data\PC SW\PC SUITE\ES\DISK4\
689	program.3	Data\PC SW\PC SUITE\ES\DISK4\
690	schdplus.z	Data\PC SW\PC SUITE\ES\DISK4\

	A	B
691	_INST32I.EX_	Data\PC SW\PC SUITE\FI\DISK1\
692	_isdel.exe	Data\PC SW\PC SUITE\FI\DISK1\
693	_SETUP.DLL	Data\PC SW\PC SUITE\FI\DISK1\
694	_setup.lib	Data\PC SW\PC SUITE\FI\DISK1\
695	DISK1.ID	Data\PC SW\PC SUITE\FI\DISK1\
696	Readme.txt	Data\PC SW\PC SUITE\FI\DISK1\
697	setup.exe	Data\PC SW\PC SUITE\FI\DISK1\
698	setup.ini	Data\PC SW\PC SUITE\FI\DISK1\
699	SETUP.INS	Data\PC SW\PC SUITE\FI\DISK1\
700	setup.pkg	Data\PC SW\PC SUITE\FI\DISK1\
701	system.1	Data\PC SW\PC SUITE\FI\DISK1\
702	DISK2.ID	Data\PC SW\PC SUITE\FI\DISK2\
703	program.1	Data\PC SW\PC SUITE\FI\DISK2\
704	system.2	Data\PC SW\PC SUITE\FI\DISK2\
705	DISK3.ID	Data\PC SW\PC SUITE\FI\DISK3\
706	program.2	Data\PC SW\PC SUITE\FI\DISK3\
707	ascii.z	Data\PC SW\PC SUITE\FI\DISK4\
708	DISK4.ID	Data\PC SW\PC SUITE\FI\DISK4\
709	org97gs.z	Data\PC SW\PC SUITE\FI\DISK4\
710	outlook.z	Data\PC SW\PC SUITE\FI\DISK4\
711	program.3	Data\PC SW\PC SUITE\FI\DISK4\
712	schdplus.z	Data\PC SW\PC SUITE\FI\DISK4\
713	_INST32I.EX_	Data\PC SW\PC SUITE\FR\DISK1\
714	_isdel.exe	Data\PC SW\PC SUITE\FR\DISK1\
715	_SETUP.DLL	Data\PC SW\PC SUITE\FR\DISK1\
716	_setup.lib	Data\PC SW\PC SUITE\FR\DISK1\
717	DISK1.ID	Data\PC SW\PC SUITE\FR\DISK1\
718	README.TXT	Data\PC SW\PC SUITE\FR\DISK1\
719	setup.exe	Data\PC SW\PC SUITE\FR\DISK1\
720	setup.ini	Data\PC SW\PC SUITE\FR\DISK1\
721	SETUP.INS	Data\PC SW\PC SUITE\FR\DISK1\
722	setup.pkg	Data\PC SW\PC SUITE\FR\DISK1\
723	system.1	Data\PC SW\PC SUITE\FR\DISK1\
724	DISK2.ID	Data\PC SW\PC SUITE\FR\DISK2\
725	program.1	Data\PC SW\PC SUITE\FR\DISK2\
726	system.2	Data\PC SW\PC SUITE\FR\DISK2\
727	DISK3.ID	Data\PC SW\PC SUITE\FR\DISK3\
728	program.2	Data\PC SW\PC SUITE\FR\DISK3\
729	ascii.z	Data\PC SW\PC SUITE\FR\DISK4\
730	DISK4.ID	Data\PC SW\PC SUITE\FR\DISK4\
731	org97gs.z	Data\PC SW\PC SUITE\FR\DISK4\
732	outlook.z	Data\PC SW\PC SUITE\FR\DISK4\
733	program.3	Data\PC SW\PC SUITE\FR\DISK4\
734	schdplus.z	Data\PC SW\PC SUITE\FR\DISK4\
735	_INST32I.EX_	Data\PC SW\PC SUITE\IT\DISK1\
736	_isdel.exe	Data\PC SW\PC SUITE\IT\DISK1\

	A	B
737	_SETUP.DLL	Data\PC SW\PC SUITE\IT\DISK1\
738	_setup.lib	Data\PC SW\PC SUITE\IT\DISK1\
739	DISK1.ID	Data\PC SW\PC SUITE\IT\DISK1\
740	README.TXT	Data\PC SW\PC SUITE\IT\DISK1\
741	setup.exe	Data\PC SW\PC SUITE\IT\DISK1\
742	setup.ini	Data\PC SW\PC SUITE\IT\DISK1\
743	SETUP.INS	Data\PC SW\PC SUITE\IT\DISK1\
744	setup.pkg	Data\PC SW\PC SUITE\IT\DISK1\
745	system.1	Data\PC SW\PC SUITE\IT\DISK1\
746	DISK2.ID	Data\PC SW\PC SUITE\IT\DISK2\
747	program.1	Data\PC SW\PC SUITE\IT\DISK2\
748	system.2	Data\PC SW\PC SUITE\IT\DISK2\
749	DISK3.ID	Data\PC SW\PC SUITE\IT\DISK3\
750	program.2	Data\PC SW\PC SUITE\IT\DISK3\
751	ascii.z	Data\PC SW\PC SUITE\IT\DISK4\
752	DISK4.ID	Data\PC SW\PC SUITE\IT\DISK4\
753	org97gs.z	Data\PC SW\PC SUITE\IT\DISK4\
754	outlook.z	Data\PC SW\PC SUITE\IT\DISK4\
755	program.3	Data\PC SW\PC SUITE\IT\DISK4\
756	schdplus.z	Data\PC SW\PC SUITE\IT\DISK4\
757	_INST32I.EX_	Data\PC SW\PC SUITE\NO\DISK1\
758	_isdel.exe	Data\PC SW\PC SUITE\NO\DISK1\
759	_SETUP.DLL	Data\PC SW\PC SUITE\NO\DISK1\
760	_setup.lib	Data\PC SW\PC SUITE\NO\DISK1\
761	DISK1.ID	Data\PC SW\PC SUITE\NO\DISK1\
762	Readme.txt	Data\PC SW\PC SUITE\NO\DISK1\
763	setup.exe	Data\PC SW\PC SUITE\NO\DISK1\
764	setup.ini	Data\PC SW\PC SUITE\NO\DISK1\
765	SETUP.INS	Data\PC SW\PC SUITE\NO\DISK1\
766	setup.pkg	Data\PC SW\PC SUITE\NO\DISK1\
767	system.1	Data\PC SW\PC SUITE\NO\DISK1\
768	DISK2.ID	Data\PC SW\PC SUITE\NO\DISK2\
769	program.1	Data\PC SW\PC SUITE\NO\DISK2\
770	system.2	Data\PC SW\PC SUITE\NO\DISK2\
771	DISK3.ID	Data\PC SW\PC SUITE\NO\DISK3\
772	program.2	Data\PC SW\PC SUITE\NO\DISK3\
773	ascii.z	Data\PC SW\PC SUITE\NO\DISK4\
774	DISK4.ID	Data\PC SW\PC SUITE\NO\DISK4\
775	org97gs.z	Data\PC SW\PC SUITE\NO\DISK4\
776	outlook.z	Data\PC SW\PC SUITE\NO\DISK4\
777	program.3	Data\PC SW\PC SUITE\NO\DISK4\
778	schdplus.z	Data\PC SW\PC SUITE\NO\DISK4\
779	_INST32I.EX_	Data\PC SW\PC SUITE\PT\DISK1\
780	_isdel.exe	Data\PC SW\PC SUITE\PT\DISK1\
781	_SETUP.DLL	Data\PC SW\PC SUITE\PT\DISK1\
782	_setup.lib	Data\PC SW\PC SUITE\PT\DISK1\

	A	B
783	DISK1.ID	Data\PC SW\PC SUITE\PT\DISK1\
784	README.txt	Data\PC SW\PC SUITE\PT\DISK1\
785	setup.exe	Data\PC SW\PC SUITE\PT\DISK1\
786	setup.ini	Data\PC SW\PC SUITE\PT\DISK1\
787	SETUP.INS	Data\PC SW\PC SUITE\PT\DISK1\
788	setup.pkg	Data\PC SW\PC SUITE\PT\DISK1\
789	system.1	Data\PC SW\PC SUITE\PT\DISK1\
790	DISK2.ID	Data\PC SW\PC SUITE\PT\DISK2\
791	program.1	Data\PC SW\PC SUITE\PT\DISK2\
792	system.2	Data\PC SW\PC SUITE\PT\DISK2\
793	DISK3.ID	Data\PC SW\PC SUITE\PT\DISK3\
794	program.2	Data\PC SW\PC SUITE\PT\DISK3\
795	ascii.z	Data\PC SW\PC SUITE\PT\DISK4\
796	DISK4.ID	Data\PC SW\PC SUITE\PT\DISK4\
797	org97gs.z	Data\PC SW\PC SUITE\PT\DISK4\
798	outlook.z	Data\PC SW\PC SUITE\PT\DISK4\
799	program.3	Data\PC SW\PC SUITE\PT\DISK4\
800	schdplus.z	Data\PC SW\PC SUITE\PT\DISK4\
801	_INST32I.EX_	Data\PC SW\PC SUITE\SV\DISK1\
802	_isdel.exe	Data\PC SW\PC SUITE\SV\DISK1\
803	_SETUP.DLL	Data\PC SW\PC SUITE\SV\DISK1\
804	_setup.lib	Data\PC SW\PC SUITE\SV\DISK1\
805	DISK1.ID	Data\PC SW\PC SUITE\SV\DISK1\
806	Readme.txt	Data\PC SW\PC SUITE\SV\DISK1\
807	setup.exe	Data\PC SW\PC SUITE\SV\DISK1\
808	setup.ini	Data\PC SW\PC SUITE\SV\DISK1\
809	SETUP.INS	Data\PC SW\PC SUITE\SV\DISK1\
810	setup.pkg	Data\PC SW\PC SUITE\SV\DISK1\
811	system.1	Data\PC SW\PC SUITE\SV\DISK1\
812	DISK2.ID	Data\PC SW\PC SUITE\SV\DISK2\
813	program.1	Data\PC SW\PC SUITE\SV\DISK2\
814	system.2	Data\PC SW\PC SUITE\SV\DISK2\
815	DISK3.ID	Data\PC SW\PC SUITE\SV\DISK3\
816	program.2	Data\PC SW\PC SUITE\SV\DISK3\
817	ascii.z	Data\PC SW\PC SUITE\SV\DISK4\
818	DISK4.ID	Data\PC SW\PC SUITE\SV\DISK4\
819	org97gs.z	Data\PC SW\PC SUITE\SV\DISK4\
820	outlook.z	Data\PC SW\PC SUITE\SV\DISK4\
821	program.3	Data\PC SW\PC SUITE\SV\DISK4\
822	schdplus.z	Data\PC SW\PC SUITE\SV\DISK4\
823	COMMDLG.DL_	Data\PC SW\PP PC\WIN16\
824	COMPOBJ.DL_	Data\PC SW\PP PC\WIN16\
825	MSCREATE.DIR	Data\PC SW\PP PC\WIN16\
826	MSSETUP.DLL	Data\PC SW\PP PC\WIN16\
827	OLE2.DL_	Data\PC SW\PP PC\WIN16\
828	OLE2.REG	Data\PC SW\PP PC\WIN16\

	A	B
829	OLE2CONV.DL_	Data\PC SW\PP PC\WIN16\
830	OLE2DISP.DL_	Data\PC SW\PP PC\WIN16\
831	OLE2NLS.DL_	Data\PC SW\PP PC\WIN16\
832	OLE2PROX.DL_	Data\PC SW\PP PC\WIN16\
833	PP7TRANS.DL_	Data\PC SW\PP PC\WIN16\
834	PPTVIEW.DL_	Data\PC SW\PP PC\WIN16\
835	PPTVIEW.EX_	Data\PC SW\PP PC\WIN16\
836	PPVIEW.DLL	Data\PC SW\PP PC\WIN16\
837	README.TXT	Data\PC SW\PP PC\WIN16\
838	STDOLE.TL_	Data\PC SW\PP PC\WIN16\
839	STORAGE.DL_	Data\PC SW\PP PC\WIN16\
840	TTEMBED.DL_	Data\PC SW\PP PC\WIN16\
841	TTEMBEXT.DL_	Data\PC SW\PP PC\WIN16\
842	TYPELIB.DL_	Data\PC SW\PP PC\WIN16\
843	VSETUP.EXE	Data\PC SW\PP PC\WIN16\
844	VSHARE.38_	Data\PC SW\PP PC\WIN16\
845	ACMSETUP.HLP	Data\PC SW\PP PC\WIN32\
846	MSCREATE.DIR	Data\PC SW\PP PC\WIN32\
847	MSSETUP.DLL	Data\PC SW\PP PC\WIN32\
848	PPVIEW.DLL	Data\PC SW\PP PC\WIN32\
849	PPVIEW.INF	Data\PC SW\PP PC\WIN32\
850	SETUP.EXE	Data\PC SW\PP PC\WIN32\
851	SETUP.STF	Data\PC SW\PP PC\WIN32\
852	ACM.EXE	Data\PC SW\VOXWARE\
853	MOWIN.EXE	Data\PC SW\WINMOVE\
854	BOJOING.WAV	Data\WAVSOUND\
855	BTLWALZ.WAV	Data\WAVSOUND\
856	CARTOON.WAV	Data\WAVSOUND\
857	COW.WAV	Data\WAVSOUND\
858	DIDIDI.WAV	Data\WAVSOUND\
859	DONK.WAV	Data\WAVSOUND\
860	EFFECT.WAV	Data\WAVSOUND\
861	FLABOOM.WAV	Data\WAVSOUND\
862	GADAGA.WAV	Data\WAVSOUND\
863	GRANVALS.WAV	Data\WAVSOUND\
864	HITCH.WAV	Data\WAVSOUND\
865	HORSE.WAV	Data\WAVSOUND\
866	LAUGH.WAV	Data\WAVSOUND\
867	LION.WAV	Data\WAVSOUND\
868	MELODY.WAV	Data\WAVSOUND\
869	PARTY1.WAV	Data\WAVSOUND\
870	PARTY2.WAV	Data\WAVSOUND\
871	POULTRY.WAV	Data\WAVSOUND\
872	PRRR.WAV	Data\WAVSOUND\
873	PRRRRR.WAV	Data\WAVSOUND\
874	RAINFOR.WAV	Data\WAVSOUND\

	A	B
875	ROOSTER.WAV	Data\WAVSOUND\
876	SOUND.WAV	Data\WAVSOUND\
877	TJONG.WAV	Data\WAVSOUND\
878	TWANG.WAV	Data\WAVSOUND\
879	VAGVAG.WAV	Data\WAVSOUND\
880	WHIZFNK.WAV	Data\WAVSOUND\
881	ZIRR.WAV	Data\WAVSOUND\
882	INETURL.X16	Data\XTRAS\
883	INETURL.X32	Data\XTRAS\
884	MIX32.X32	Data\XTRAS\
885	NETFILE.X16	Data\XTRAS\
886	NETFILE.X32	Data\XTRAS\
887	NETLINGO.X16	Data\XTRAS\
888	NETLINGO.X32	Data\XTRAS\
889	SOUNDI~1.X32	Data\XTRAS\
890	SWADCMPR.X32	Data\XTRAS\
891	SWASTRM.X32	Data\XTRAS\
892	DSBL_PLG.TXT	Data\XTRAS\FILTER~1\
893	MMPSF16.DLL	Data\XTRAS\FILTER~1\
894	MMPSF32.DLL	Data\XTRAS\FILTER~1\
895	PSHOPFLT.X32	Data\XTRAS\FILTER~1\
896	POMLIT~1.3	Data\XTRAS\GRAYMA~1\
897	POMLITE.X16	Data\XTRAS\GRAYMA~1\POMLIT~1.3\
898	POMLITE.X32	Data\XTRAS\GRAYMA~1\POMLIT~1.3\
899	POPMENU.X32	Data\XTRAS\GRAYMA~1\SCRIPT~1\
900	SCRIPCOL.X32	Data\XTRAS\GRAYMA~1\SCRIPT~1\
901	SCRIPT~1.DXR	Data\XTRAS\GRAYMA~1\SCRIPT~1\
902	SOMLITE.TXT	Data\XTRAS\GRAYMA~1\SCRIPT~1\
903	AVIAGE~1.X32	Data\XTRAS\MEDIAS~1\
904	DIRCD.ICO	Data\XTRAS\MEDIAS~1\
905	FILEIO.X32	Data\XTRAS\MEDIAS~1\
906	FILEIO16.X16	Data\XTRAS\MEDIAS~1\
907	MUIDIA~1.X32	Data\XTRAS\MEDIAS~1\
908	MWM.AVI	Data\XTRAS\MEDIAS~1\
909	QTVRW.X16	Data\XTRAS\MEDIAS~1\
910	QTVRW32.X32	Data\XTRAS\MEDIAS~1\
911	SWACMPR.X32	Data\XTRAS\MEDIAS~1\
912	SWACNVRT.X32	Data\XTRAS\MEDIAS~1\
913	SWADCMPR.X16	Data\XTRAS\MEDIAS~1\
914	SWADCMPR.X32	Data\XTRAS\MEDIAS~1\
915	SWAOPT.X32	Data\XTRAS\MEDIAS~1\
916	SWASTRM.X16	Data\XTRAS\MEDIAS~1\
917	SWASTRM.X32	Data\XTRAS\MEDIAS~1\
918	SWASTTNG.X32	Data\XTRAS\MEDIAS~1\
919	BMPIMP~1.X32	Data\XTRAS\MIXREA~1\
920	EBBMP9.INI	Data\XTRAS\MIXREA~1\

	A	B
921	GIFEXP~1.X32	Data\XTRAS\MIXREA~1\
922	GIFIMP~1.X32	Data\XTRAS\MIXREA~1\
923	IMAGEM~1.X32	Data\XTRAS\MIXREA~1\
924	ISGDI32.INI	Data\XTRAS\MIXREA~1\
925	JPEGEX~1.X32	Data\XTRAS\MIXREA~1\
926	JPEGIM~1.X32	Data\XTRAS\MIXREA~1\
927	LRGIMP~1.X32	Data\XTRAS\MIXREA~1\
928	MACPAI~1.X32	Data\XTRAS\MIXREA~1\
929	MIX16.X16	Data\XTRAS\MIXREA~1\
930	MIX32.X32	Data\XTRAS\MIXREA~1\
931	MIXBMP.X16	Data\XTRAS\MIXREA~1\
932	MIXGIF.X16	Data\XTRAS\MIXREA~1\
933	MIXJPEG.X16	Data\XTRAS\MIXREA~1\
934	MIXLRG.X16	Data\XTRAS\MIXREA~1\
935	MIXMCPNT.X16	Data\XTRAS\MIXREA~1\
936	MIXPAL.X16	Data\XTRAS\MIXREA~1\
937	MIXPNG.X16	Data\XTRAS\MIXREA~1\
938	MIXPS30.X16	Data\XTRAS\MIXREA~1\
939	MIXSOUND.X16	Data\XTRAS\MIXREA~1\
940	MIXTARGA.X16	Data\XTRAS\MIXREA~1\
941	MIXTIFF.X16	Data\XTRAS\MIXREA~1\
942	PALETT~1.X32	Data\XTRAS\MIXREA~1\
943	PHOTOS~1.X32	Data\XTRAS\MIXREA~1\
944	PHOTOS~2.X32	Data\XTRAS\MIXREA~1\
945	PICTAG~1.X32	Data\XTRAS\MIXREA~1\
946	PNGIMP~1.X32	Data\XTRAS\MIXREA~1\
947	QUICKT~1.X32	Data\XTRAS\MIXREA~1\
948	SOUNDI~1.X32	Data\XTRAS\MIXREA~1\
949	SUNAU~1.X32	Data\XTRAS\MIXREA~1\
950	TARGAI~1.X32	Data\XTRAS\MIXREA~1\
951	TIFFIM~1.X32	Data\XTRAS\MIXREA~1\
952	XRESAGT.X32	Data\XTRAS\MIXREA~1\
953	DIRMMX.X32	Data\XTRAS\MMX\
954	INETURL.X16	Data\XTRAS\NETSUP~1\
955	INETURL.X32	Data\XTRAS\NETSUP~1\
956	NETFILE.X16	Data\XTRAS\NETSUP~1\
957	NETFILE.X32	Data\XTRAS\NETSUP~1\
958	NETLINGO.X16	Data\XTRAS\NETSUP~1\
959	NETLINGO.X32	Data\XTRAS\NETSUP~1\
960	9110.EXE	
961	9110.ICO	
962	autorun.inf	
963	OPENING.BMP	
964	README.TXT	
965	VSTART.INI	
966	VSTART32.EXE	

Exhibit C

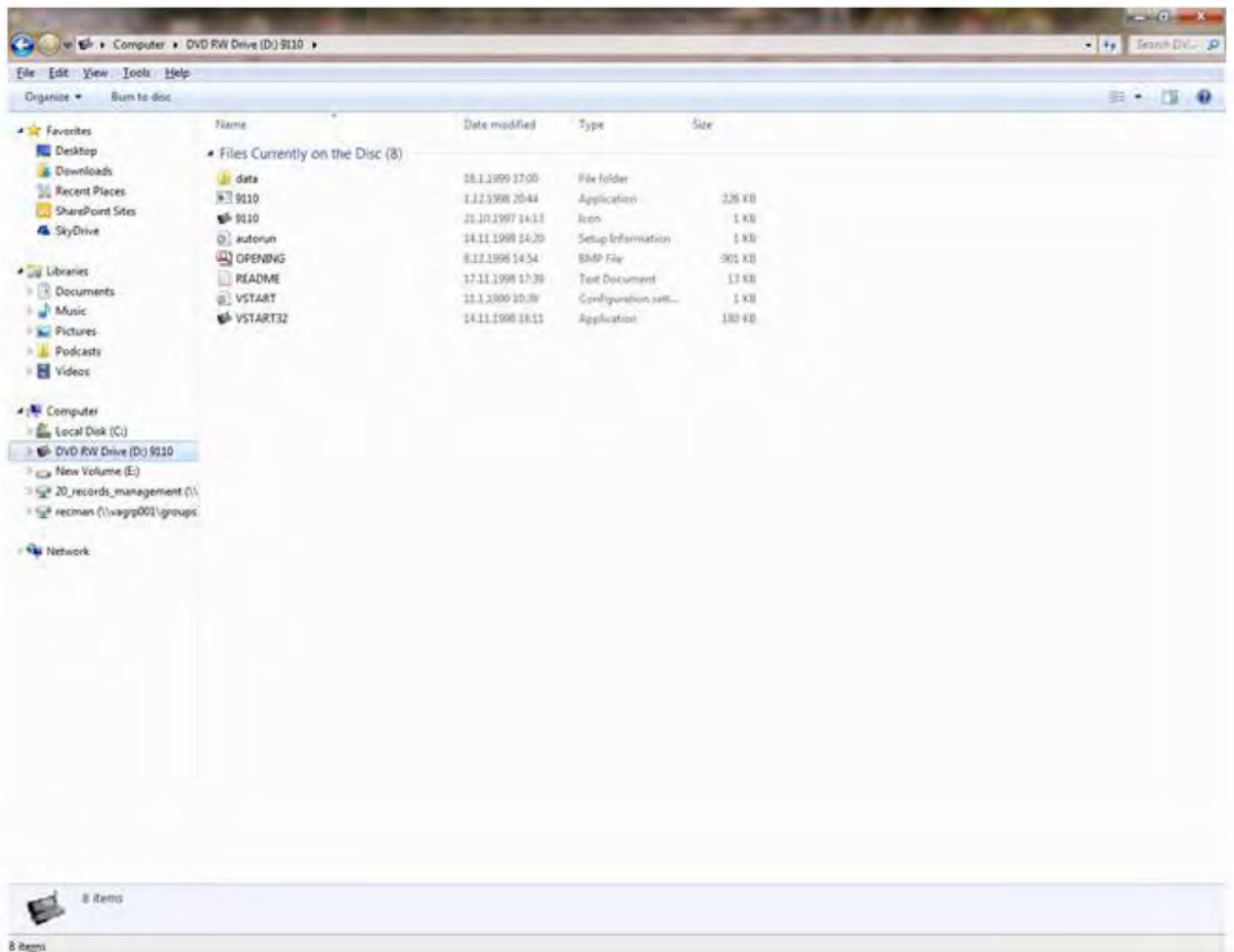

Exhibit D

Copyright © 1998. Nokia Mobile Phones Ltd. All rights reserved.
Nokia is a registered trademark of Nokia Corporation, Finland.
Specifications are subject to change without notice.
Other product and company names mentioned herein may be
trademarks of their respective owners.

www.nokia.com

www.forum.nokia.com

NOKIA
CONNECTING PEOPLE

NOKIA
9110
Communicator

Software for your Nokia 9110 Communicator and PC/Macintosh



Includes:

- PC Suite for Nokia 9110 Communicator
- Data backup/restore and import/export software for Macintosh
- Licensed add-on software for your Nokia 9110 Communicator

Auch auf Deutsch, Aussi en français,
Anche in italiano, También en español,
Myös suomeksi, Også på dansk,
Också på svenska, Også på norsk,
Também em português

NOKIA
CONNECTING PEOPLE

0840003 version 1.2

Verizon Wireless
Exhibit 1082-0037

This CD-ROM contains:

PC Software

- PC Suite for Nokia 9110 Communicator
 - Kit for backup/restore functions to the PC (Windows 95/98, NT 4.0)
 - Data synchronisation with popular PC software (Outlook 97/98, Schedule+ 7.x, Lotus Organiser 97 GS)
 - Automatic fax file conversion: allows you to transfer faxes to a compatible PC for viewing and printing
 - Contacts editing on the PC
- Adobe Acrobat Reader for viewing CD-ROM user guides.
- Powerpoint Viewer for viewing CD-ROM product presentation
- Nokia Server Software for use with Windows 3.11 and Macintosh



Communicator Software

- Additional free software for your Nokia 9110 Communicator
- Trial version of spreadsheet application for Nokia 9110 Communicator
- Additional software on this CD-ROM may be subject to change

More Information:

- Nokia 9110 Communicator Quick and User Guides in electronic format
- Product demo slide show
- Quick Setup Guide: how to get the most out of your Nokia 9110 Communicator, email and dial-in systems
- Quick Setup Guide: using your Nokia 9110 Communicator as a fax-modem
- Tutorial: Getting Started with Nokia 9110 Communicator





NOKIA
CONNECTING PEOPLE

Nokia is a registered trademark of Nokia Corporation, Finland. Copyright © 1998. Nokia Mobile Phones. All rights reserved.

Nokia 9110 Communicator

Nokia Mobile Phones

Verizon Wireless
Exhibit 1082-0039

Exhibit E

Curtype:	EUR (PVA)
Views:	Periodic
Accounts:	Volume Sold
Names:	Regions Total

	1998	1999	1999	1999	1999	1999	1999	1999	1999	1999
	Period 1	Period 1	Period 2	Period 3	Period 4	Period 5	Period 6	Period 7	Period 8	Period 9
1AHO Communicator - GSM900 - Spock - DCT3 - 9110		330.00	13,449.00	22,460.00	34,780.00	23,908.00	29,976.00	27,309.00	21,241.00	20,727.00

1999	1999	1999	2000	2000	2000	2000	2000	2000	2000	2000	2000	2000	2000
Period 10	Period 11	Period 12	Period 1	Period 2	Period 3	Period 4	Period 5	Period 6	Period 7	Period 8	Period 9	Period 10	Period 11
23,546.00	27,366.00	28,066.00	14,665.00	12,032.00	16,150.00	20,302.00	15,737.00	14,101.00	12,446.00	14,310.00	18,404.00	18,643.00	14,248.00

2000	2001	2001	2001	2001	2001	2001	2001	2001	2001	2001	2001	2001	2002
Period 12	Period 1	Period 2	Period 3	Period 4	Period 5	Period 6	Period 7	Period 8	Period 9	Period 10	Period 11	Period 12	Period 1
19,031.00	16,756.00	8,392.00	1,436.00	1,344.00	394.00	16.00	-47.00	-52.00	13.00	23.00	2.00	0.00	23.00

2002	2002	2002	2002	2002	2002	2002	2002	2002	2002	2002
Period 2	Period 3	Period 4	Period 5	Period 6	Period 7	Period 8	Period 9	Period 10	Period 11	Period 12
44.00	43.00	98.00	20.00	36.00	3.00	23.00	17.00	86.00	177.00	7.00

Exhibit F

User's manual

9357168
ISSUE 2 EN

Verizon Wireless
Exhibit 1082-0046

Nokia is a registered trademark of Nokia Corporation, Finland.

Copyright. © 1995-1998 Nokia Mobile Phones. All rights reserved.

Nokia Mobile Phones operates a policy of continuous improvement. Therefore, we reserve the right to make changes and improvements to any of the products described in this guide without prior notice.

Nokia Mobile Phones is not responsible for any loss of data, income or any consequential damage howsoever caused. Geoworks® application software and GEOS® operating system software copyright © 1990-1998 Geoworks. All rights reserved. United States Patent 5,327,529.

Hardware and software floating point math library copyright © 1984-1991 Dimensions Research, Inc.

This product includes software developed by the University of California, Berkeley and its contributors. Copyright 1979, 1980, 1983, 1986, 1988, 1989, 1991, 1992, 1993, 1994 The Regents of the University of California. All rights reserved. The software is provided by The Regents and contributors "as is" and any express or implied warranties, including, but not limited to, the implied warranties of merchantability and fitness for a particular purpose are disclaimed. In no event shall The Regents or contributors be liable for any direct, indirect, incidental, special, exemplary, or consequential damages (including, but not limited to, procurement of substitute goods or services; loss of use, data, or profits; or business interruption) however caused and on any theory of liability, whether in contract, strict liability, or tort (including negligence or otherwise) arising in any way out of the use of this software, even if advised of the possibility of such damage.

The GEOS® software of this product includes Nimbus Q from Digital Typeface Corp. and typefaces from URW, GmbH. This device contains Embedded DOS-ROM (R), Embedded BIOS (R) software licensed from General Software, Inc. Copyright © 1998 General Software, Inc. General Software, Embedded DOS, and Embedded BIOS are trademarks or registered trademarks of General Software, Inc.

Portions of this work are derived from the Standard C Library, © 1992 by P.J. Plauger, published by Prentice-Hall, and are used with permission.

HP Database Engine Version 1.0 copyright © Hewlett-Packard Company 1994. All rights reserved.

The PPP software is copyright © 1991, 1992, 1993, 1994 Morning Star Technologies, all rights reserved. It contains software developed at Carnegie Mellon University, which is copyright © 1989 Carnegie Mellon University, all rights reserved. It contains software developed at the University of California, Berkeley, which is copyright © 1989 Regents of the University of California, all rights reserved. It contains software that is copyright © 1990, RSA Data Security, Inc., all rights reserved.

C-client Internet mail routines original version/copyright 1988 by the Leland Stanford Junior University, copyright 1995 by the University of Washington. The University of Washington and the Leland Stanford Junior University disclaim all warranties, express or implied, with regard to this software, including without limitation all implied warranties of merchantability and fitness for a particular purpose; and in no event shall the University of Washington or the Leland Stanford Junior University be liable for any special, indirect or consequential damages or any damages whatsoever resulting from loss of use, data or profits, whether in an action of contract, tort (including negligence) or strict liability, arising out of or in connection with the use or performance of this software.

This product includes software based in part on the work of the independent JPE-G group.

CellularWare is a trademark of Nokia Mobile Phones.

AT is a trademark of Hayes Microcomputer Products, Inc.

Hayes is a registered trademark of Hayes Microcomputer Products, Inc.

Microsoft and MS-DOS are registered trademarks and Windows is a trademark of Microsoft corporation.

Geoworks® and GEOS® are Registered Trademarks of Geoworks, and GeoDOS is a Trademark of Geoworks in the United States of America and other countries.

Intellisync is a trademark of Puma Technology, Inc.

All other brand and product names are trademarks or registered trademarks of their respective holders.

This product contains the RSA Software.



The products described in this manual conform to the European Council directives EMC Directive (89/336/EEC) and TTE Directive (91/263/EEC).

END USER LICENSE AGREEMENT FOR SECURITY SOCKETS LAYER -SOFTWARE ("SSL")

READ THE FOLLOWING TERMS AND CONDITIONS CAREFULLY BEFORE USING THE SSL. USE OF THE SSL SOFTWARE INDICATES YOUR ACCEPTANCE OF THESE TERMS AND CONDITIONS.

In this license agreement ("License Agreement"), you, the purchaser of the license rights granted by this Agreement, are referred to as "Licensee." In accordance with the terms and conditions of this License Agreement, Nokia Mobile Phones Ltd. ("Licensor") grants licensee a non-exclusive sublicense to use SSL Software ("Software"), which contains the RSA Software licensed to Licensor by RSA Data Security, Inc. ("RSA").

This License Agreement is effective until terminated. Licensor may terminate this License Agreement if Licensee breaches any of the terms and conditions. In the event of termination by Licensor, Licensee will return the communicator device of Licensor to Licensee for removal of the Software. All provisions of this Agreement relating to disclaimers of warranties, limitation of liability, remedies, or damages, and Licensor's proprietary rights shall survive termination.

The Software is delivered in object code only.

Licensor shall utilize the Software solely as part of the communicator device from Licensor and solely for personal or internal use and without right to license, assign or otherwise transfer such Software to any other person or entity.

Licensee shall not modify, translate, reverse engineer, decompile or disassemble the Software or any part thereof.

Licensee agrees not to remove or destroy any proprietary, trademark or copyright markings or notices placed upon or contained within the Software or any related materials or documentation.

By reason of this Agreement or the performance hereof, Licensee shall acquire no rights of any kind in any trademark, trade name, logo or product designation under which the Software was or is marketed and Licensee shall not make any use of the same for any reason.

IN NO EVENT WILL LICENSOR OR RSA BE LIABLE TO LICENSEE FOR INDIRECT, INCIDENTAL, SPECIAL, CONSEQUENTIAL OR EXEMPLARY DAMAGES ARISING OUT OF OR RELATED TO THIS AGREEMENT, INCLUDING BUT NOT LIMITED TO LOST PROFITS, BUSINESS INTERRUPTION OR LOSS OF BUSINESS INFORMATION, EVEN IF SUCH PARTY HAS BEEN ADVISED OF THE POSSIBILITY OF SUCH DAMAGES AND REGARDLESS OF WHETHER ANY ACTION OR CLAIM IS BASED ON WARRANTY, CONTRACT, TORT OR OTHERWISE. UNDER NO CIRCUMSTANCES SHALL LICENSOR'S OR RSA'S TOTAL LIABILITY ARISING OUT OF OR RELATED TO THIS AGREEMENT EXCEED THE TOTAL AMOUNT PAID BY LICENSEE.

THIS AGREEMENT IS EXPRESSLY MADE SUBJECT TO ANY LAWS, REGULATIONS, ORDERS OR OTHER RESTRICTIONS ON THE EXPORT FROM THE UNITED STATES OF AMERICA OF THE SOFTWARE OR OF INFORMATION ABOUT THE SOFTWARE WHICH MAY BE IMPOSED FROM TIME TO TIME BY THE GOVERNMENT OF THE UNITED STATES OF AMERICA. NOTWITHSTANDING ANYTHING CONTAINED IN THIS AGREEMENT TO THE CONTRARY, LICENSEE SHALL NOT EXPORT OR REEXPORT, DIRECTLY OR INDIRECTLY, ANY SOFTWARE OR INFORMATION PERTAINING THERETO TO ANY COUNTRY TO WHICH SUCH EXPORT OR REEXPORT IS RESTRICTED OR PROHIBITED, OR AS TO WHICH SUCH GOVERNMENT OR ANY AGENCY THEREOF REQUIRES AN EXPORT LICENSE OR OTHER GOVERNMENTAL APPROVAL AT THE TIME OF EXPORT OR REEXPORT WITHOUT FIRST OBTAINING SUCH LICENSE OR APPROVAL.



FOR YOUR SAFETY Read these simple guidelines. Breaking the rules may be dangerous or illegal. Further detailed information is given in this manual.



ROAD SAFETY COMES FIRST Do not use the communicator while driving; park the vehicle first.



INTERFERENCE All wireless phones may get interference which could affect performance.



SWITCH OFF IN HOSPITALS Follow any regulations or rules. Switch off the phone near medical equipment.



SWITCH OFF IN AIRCRAFT Wireless phones can cause interference. Using them on aircraft is illegal.



SWITCH OFF WHEN REFUELLING Do not use the phone at a refuelling point. Do not use near fuel or chemicals.



SWITCH OFF NEAR BLASTING Do not use the phone where blasting is in progress. Observe restrictions, and follow any regulations or rules.



USE SENSIBLY Use only in the normal position (to ear). Do not touch the antenna unnecessarily.



USE QUALIFIED SERVICE Only qualified service personnel must install or repair equipment.



ACCESSORIES AND BATTERIES Use only approved accessories and batteries. Do not connect incompatible products.



MAKING CALLS VIA THE PHONE Close the cover and ensure the phone is switched on and in service. Enter the phone number, including the area code, then press . To end a call press . To answer a call press .



EMERGENCY CALLS Close the device cover. Ensure the phone is switched on and in service. Hold for several seconds, to clear the display. Enter the emergency number, then press . Give your location. Do not end the call until told to do so.



MAKE BACKUP COPIES Remember to make backup copies of all important data.



CONNECTING TO OTHER DEVICES When connecting to any other device, read its user's guide for detailed safety instructions. Do not connect incompatible products.



INFRARED PRECAUTIONS Do not point the IR beam at anyone's eye or allow it to interfere with other IR devices.

Table of contents

Table of contents	6
Introduction	1
About this manual	2
Facts about your communicator	3
Facts about cellular data transmission	4
Getting started	7
First start-up	7
Communicator display	10
Communicator keyboard	14
Communicator applications	15
Connectors	16
Battery	17
Special features	21
Communicator features	21
Document features	24
To transfer data from older communicator models	27
PC connectivity	29
To use the PC Suite	29
To use the Nokia Communicator Server	36
Contacts	39
Contacts directory	39
To make contact cards	41
Contact groups	44
Logs	45
Telephone	47
To make a call	47
To answer a call	48

Handsfree mode	49
Multiple calls	50
Telephone settings	53
Flight profile	57
Fax	59
To send faxes	59
To receive faxes	61
Fax settings	62
Short messages	65
To send short messages	66
To receive messages	67
Standard messages	68
Business cards	69
SMS settings	70
Internet	73
Internet settings	74
Mail	77
Mail settings	77
To send mail	80
To fetch mail	82
To read mail	83
World Wide Web	85
WWW settings	85
Bookmarks	86
To navigate in WWW	89
Terminal	92
Telnet	95
Text Web	97
Notes	99
To edit documents	101
Downloaded files and read-only documents	102
Notes settings	103

Calendar	105
Monthly schedule	105
Weekly schedule	106
Daily schedule	107
Calendar booking	109
Alarms	111
To-do list	111
System	113
System settings	113
Security	115
User data	118
Memory	118
Infrared activation	119
Digital camera connectivity	119
Remote synchronisation	120
Fax modem	121
Data removal	122
Install/Remove software	122
Backup/Restore	123
Memory card tool	123
About this product	123
Extras	125
Calculator	125
Clock	126
Composer	129
Voice recorder	132
Phone	135
Display indicators	136
To make a call	137
To answer a call	138
To manage calls	138
To search for phone numbers	139
To use speed dialling	139
To send DTMF tones	140

Keypad lock	140
Help	141
To use the menus	141
Messages (Menu 1)	143
Call register (Menu 2)	144
Profiles (Menu 3)	146
Settings (Menu 4)	147
Call divert (Menu 5)	151
Recorder (Menu 6)	152
Troubleshooting	153
Care and maintenance	159
Important safety information	161
Glossary	165
Index	169

1. Introduction

Congratulations on purchasing the Nokia 9110 Communicator. The Nokia 9110 Communicator is a complete communications tool: it is a wireless phone, messaging device, access terminal and a palmtop organizer in one pocketable package.



Figure 1

The Nokia 9110 Communicator consists of two parts: the phone and the communicator interface. The phone is on the device cover (figure 1) and the communicator interface is under the cover (figure 2).

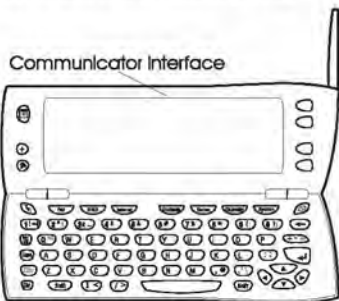

Figure 2

Both of these parts use the same resources and work closely together – they are not separate devices. For example, the phone uses the names and phone numbers stored in the Contacts directory of the communicator interface, and the communicator interface uses the phone for communicating with the "outside world", for example, when sending or receiving faxes and connecting to the Internet.

The communicator interface contains many organiser and communications applications. The large keyboard, command buttons and display make using the applications easy. The communicator interface has no power on/off button – it switches itself on when you open the cover and switches off when you close the cover.

Tip: Press the **i** button on the communicator interface keyboard to find basic information about the communicator applications.

The phone is designed for making and answering calls quickly. It looks and operates like other Nokia wireless phones, except that the earpiece and microphone are on the rear of the device. The phone is switched on and off by pressing the **Ⓚ** button on the cover.

IMPORTANT! Do not switch on the phone when wireless phone use is prohibited or when it may cause interference or danger.

About this manual

This chapter explains how the Nokia 9110 Communicator operates. The following chapter, "Getting started", helps you begin using the Nokia 9110 Communicator. It explains the start-up procedure and gives information about the various aspects of the device, such as the keyboard and the display. "Special features" explains special functions, and "PC connectivity" shows how to connect your communicator to a PC.

The rest of this manual deals with the communicator applications and the phone. There is a short glossary of Internet and cellular terms and abbreviations at the back of this manual.

If you are switching from the Nokia 9000 Communicator or the Nokia 9000i Communicator to the Nokia 9110 Communicator, please, see "To transfer data from older communicator models" on page 27.

Note: In this manual, the names of the commands on the display are in **bold** and the settings and options are in *italics*.

Facts about your communicator

Services

The GSM system provides a number of various wireless services, but they are not automatically enabled to the wireless phone user. Even though the Nokia 9110 Communicator represents the latest development in wireless phone technology, using its various communications applications requires that you have subscribed to these services and that your network operator has activated these services for you. Services that need to be subscribed to are typically the short message service, Internet and fax.

Because the number of special services depends on what services are available in your home network, it is, unfortunately, impossible to provide a comprehensive list of the services and settings you need in this manual. Therefore, this manual gives general information about the additional services. Please, contact your network operator for further information about the availability and the details of services in your home network.

If a service requires a separate phone number or specific settings, they must be stored in the settings of the communicator. For example:

Sending and receiving short messages requires that this service is supported by the network you are using and activated for your SIM card, and that the phone number of the message centre is stored in the settings of the SMS application.

Internet access requires that data service is supported by the network you are using and activated for your SIM card. In addition, you must have obtained an Internet access point from an Internet service provider.

Access codes

The Nokia 9110 Communicator uses several access codes to protect against unauthorised use of your communicator and SIM card. The access codes you need most often are the lock code, which is provided in the sales package, and the PIN code, which is provided with the SIM card.

You can change access codes that are used by both the phone and the communicator interface via either of them, provided that the code can be changed. For more details on the access codes, see "Security" on page 115.

The Internet applications of the communicator use passwords and user names to protect from unauthorised use of the Internet and its services. These passwords are changed in the settings of the Internet applications.

Contact information

All contact information, such as names, addresses, phone numbers, that you store, goes into the Contacts directory. The phone, the communicator interface, and each of the applications have their own views of the Contacts directory. The information shown depends on the information the selected application can use. For example, when you are making a call via the phone, you can view the name and the phone number(s) of the contact. Possible fax numbers, e-mail addresses, job titles, etc., are not shown.

Facts about cellular data transmission

The Nokia 9110 Communicator employs the data transmission capabilities of the GSM network to send faxes, short messages and e-mail, and to establish connections with remote computers.

Cellular data connections can be made from most locations where your wireless phone operates. However, it is recommended that you move the communicator to a location where the strongest possible cellular signal can be obtained. When the signal is strong, data transmission is efficient. In general, you should not expect the same performance from cellular data communications as from landline communications due to the inherent characteristics of the cellular environment. The following factors may impair cellular connections:

Noise

Radio interference from electronic appliances and equipment, as well as from other wireless phones in metropolitan areas where wireless phones are prevalent.

Handover

As the wireless phone user moves from one network cell to another, the signal strength of the channel drops and the cellular telephone exchange may hand the user over to a different cell and frequency, where the signal is stronger. A cell handover may also occur when the user is stationary due to varying cellular traffic loads. Such handovers may cause slight delays.

Electrostatic discharge

A discharge of static electricity from a finger or a conductor may cause erroneous functions in electric devices. The discharge may result in "garbled" display and unstable software operation. Cellular connections may become unreliable, data may be corrupted, and the transmission halted. In this case you need to end the existing call (if any), switch off the phone (if on) and remove the battery. Then replace the battery and establish a new cellular connection.

Dead spots and dropouts

Dead spots are areas where radio signals cannot be received. Dropouts occur when the wireless phone user passes through an area where the radio signal is blocked or reduced by geographic or structural obstructions.

Signal impairment

Distance and obstacles can cause out-of-phase reflected signals that result in a loss of signal strength.

Low signal strength

Due to either distance or obstacles, the radio signal strength from a cell site may not be strong or stable enough to provide a reliable cellular connection for communication. Therefore, to ensure the best possible communication, remember to consider the following points:

The data connection works best when the communicator is in a stationary position. Attempting cellular communication while in a moving vehicle is not recommended. Fax transmission is more easily impaired than data or short message transmission.

Do not place the communicator on a metal surface.

Check that the cellular signal strength on the communicator displays is sufficient. See "Communicator display" on page 10 and "To make a call" on page 137. Moving the communicator within a room especially towards a window, may result in a stronger signal. If the cellular signals are not strong enough to support a voice call, data connection should not be attempted until you can find a location with better signal reception.

Note: When the antenna is up, the signal is stronger.

2. Getting started

This chapter explains how to start up your communicator and install a SIM card, how the communicator operates, and how to supply power to the communicator.

When you open the sales package, check that it contains the following:

- Nokia 9110 Communicator
- This User's manual, the combined Quick guide and Accessories guide, and the Solution guide
- High Power Battery
- AC charger
- RS-232 Adapter Cable
- Diskette package
- CD-ROM with PC connectivity software
- Stickers with the serial number and the lock code of the communicator

For information about the Nokia 9110 Communicator accessories, see the Accessories guide.

First start-up

- 1 Close the device cover and make sure that the phone is switched off. If it is on, press **0**.

A valid miniature SIM card is required for sending and receiving calls and messages. The card is supplied by your network operator or service provider. If you do not have a SIM card yet, go to step 6.

Note: Keep all miniature SIM cards out of small children's reach.

- 2 If the battery is connected to the communicator, remove the battery: press the catch at the top of the battery and lift the battery away from the battery cavity. See figure 1.

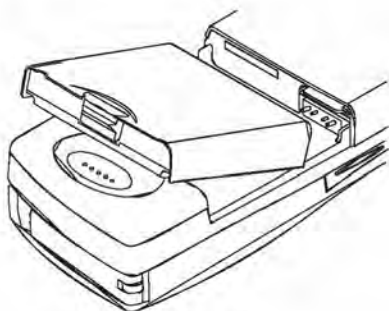

Figure 1

- 3 Slide the SIM card into the SIM card slot: make sure that the gold contacts of the SIM card are facing down and that the bevelled corner of the card is on the right. See figure 2.

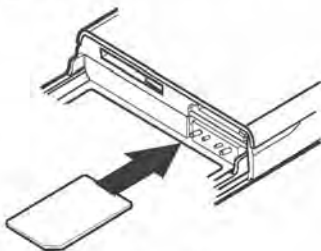

Figure 2

- 4 When the SIM card is properly inserted into the SIM card slot, the bevelled corner will remain visible. See figure 3.

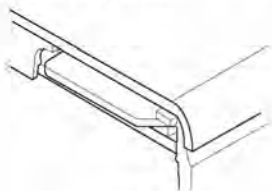

Figure 3

Note: If an unacceptable SIM card is inserted, the message INVALID SIM CARD will be displayed. Should this happen, contact your dealer or network operator.

- 5 When you are sure that the SIM card is correctly installed, replace the battery.

Note: The battery does not fit into place if the SIM card is not correctly installed. Do not force the battery into place! Check that you have inserted the SIM card into the slot as described above. If the SIM card is incorrectly installed, remove it by pulling it away from the slot, and insert it again.

- 6 If there is little or no charge in the battery, it is recommended that you connect the communicator to the charger and start charging the battery before continuing with the start-up procedure. See "Battery" on page 17.
- 7 Open the cover of the communicator. You will see a welcome screen while the communicator performs a self-test.
- 8 After the self-test is complete, you will see a list of countries on the display, see figure 4. Scroll the dark grey selection frame using the arrow keys on the keyboard over the name of your home country. Press the button on the right side of the display next to the command **OK**. The capital of your home country will be set as your home city. You can change your home city later in the Clock application, see "Clock" on page 126.

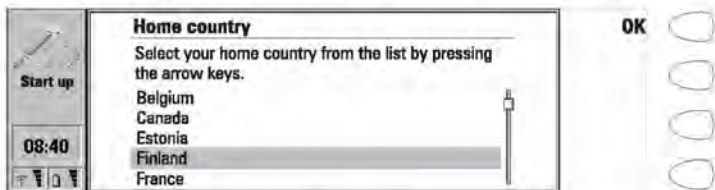

Figure 4

- 9 Write the current date in the input field using the format *dd.mm.yy*, for example 22.03.98. Press **OK**. You can later change the date format in the System settings. Time and date can be changed in the settings of the Clock application.

10 Write the current time using the 24-hour format *hh:mm*, for example 17:25, and press **OK**. You can later change the time format in the System settings.

11 Enter your contact information in the user data card and press **OK**. You can later change the information in the User data application under System.

The first start-up is now completed.

After the start-up, do not immediately remove the battery, as the battery charges the backup battery that supplies power to the real-time clock of the communicator.

Note: When taking the phone into use, observe the instructions given by your network operator.

To copy the SIM card contents to the Contacts directory

If the installed SIM card contains names or numbers, you will be asked after the start-up procedure if you want to copy the SIM card contents into the memory of your communicator. If the phone is switched off, the question will be asked the next time the phone is on and you open the cover of the communicator.

If you want to do the copying later, press **Cancel**, and do it in the Contacts application, see "Contacts directory" on page 39.

All phone numbers copied from the SIM card to the communicator memory will go to the *Tel* field of the contact cards. Therefore, you must move all wireless phone numbers manually into the *Tel(GSM)* field. See "To make contact cards" on page 41. The quickest way to copy a phone number is to select the number with the key combination Shift-Ctrl-left arrow, cut it with Ctrl-X, and paste it to the right contact card field with Ctrl-V.

Communicator display

The communicator interface is switched on by opening the cover. See figure 5.

The applications are run in the middle of the display. The indicators (figure 6) show application and system-related information. The commands always correspond to the column of four command buttons on the right side of the display. The functions of the Menu, Zoom and Backlight buttons are explained in "Communicator features" on page 21.

The scroll bar indicates that there are more items than currently shown on the display. The display can be scrolled with the up and down arrow keys.

Whenever the selection frame is shown, you can select items by moving the selection frame over the desired item with the up and down arrow keys.

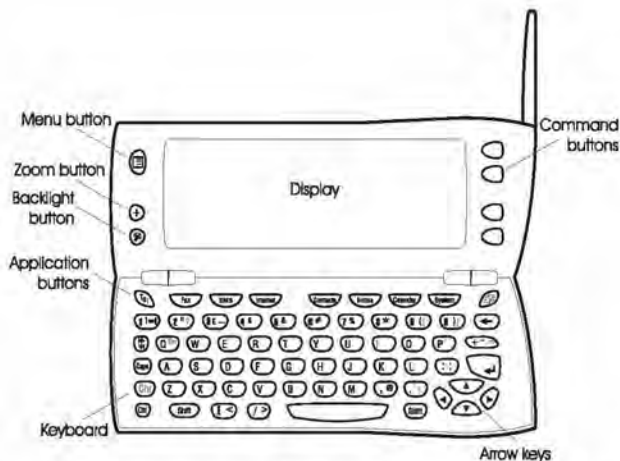

Figure 5

When the search field appears at the bottom of the display, you can search for items by entering text into the search field with the keyboard.

After the correct item has been selected, press the command button next to the command you wish to apply to the item, for example, **Open**.

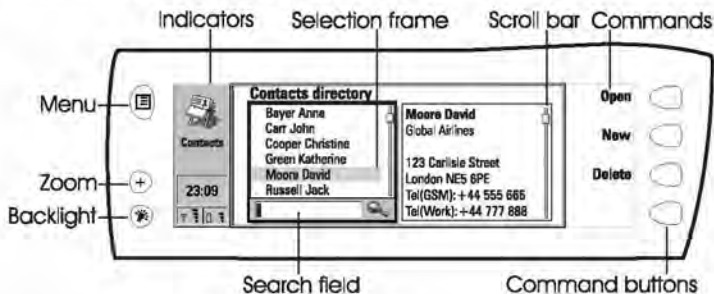

Figure 6

The following figures illustrate certain communicator conventions:

- ① When a command is dimmed, it cannot be used, see figure 7.
- ② When a cursor appears on a dotted line, enter a value with the keyboard, see figure 7.

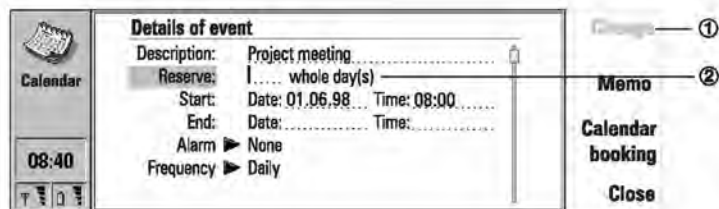

Figure 7

③ A pop-up box. Select an item and press **OK** or **Cancel**, see figure 8.

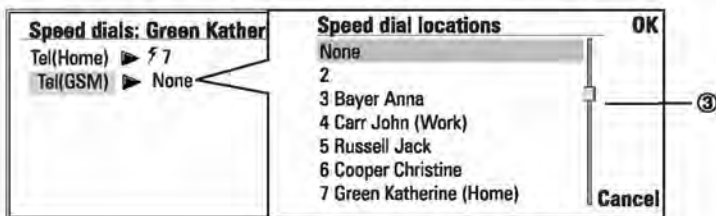

Figure 8

When a setting with ▶ next to it is selected, pressing **Change** toggles the value or opens a pop-up box. See figure 8. When a setting with [Change] next to it is selected, pressing **Change** opens a new settings view. When you press a command with ▶ next to it, the commands change.







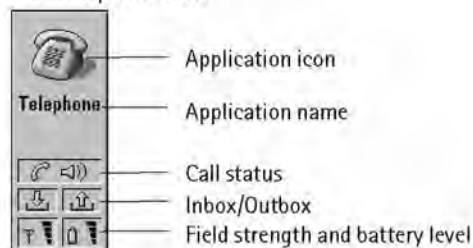



Indicators

The application icon and the application name in the indicator area show the application you are in at the moment.



The icons that appear on the Call status and Inbox/Outbox indicator rows change according to the application and current situation. The battery level and field strength indicators are the same as shown on the phone display when the phone is on.





Call status

-  – You have a voice call, and the handsfree loudspeaker and microphone are on. See "Handsfree mode" on page 50.
-  – A voice call with the handsfree off. The loudspeaker and microphone are muted.
-  – An open data connection, see chapter 9 "Internet" on page 73.
-  – The communicator is receiving or sending a fax, see chapter 7 "Fax" on page 59.
-  – The communicator is trying to establish an infrared connection, see chapter 4 "PC connectivity" on page 29.
-  – An infrared connection has been established.
-  – The infrared connection is obstructed.
-  – The communicator is connected to a PC, see chapter 4 "PC connectivity" on page 29.
-  – The communicator is being used as a fax modem, see "Fax modem" on page 120.
-  – The communicator is in a special operating environment, in this case in the meeting profile. See "Telephone settings" on page 53.
-  – Time can be adjusted in the Clock application, see "Clock" on page 126.

Inbox/Outbox

-  – The inbox indicator informs you that you have received a fax, short message or mail.
-  – The Document outbox contains unsent messages, see "Communicator features" on page 21.

Battery level

-  – The battery is low and should be recharged.
-  – The battery is charging. The bar scrolls until the battery is fully charged. The outlet plug icon indicates that the communicator is connected to an external power source.
-  – The battery is fully charged. All the four bars are displayed.

Field strength

-  – The communicator is connected to a cellular network. When all the four bars are shown, the cellular signal reception is good. If the signal is weak, make sure the antenna is up. You can also try



to improve the reception by moving the communicator slightly or by using it in the handsfree mode.

- The phone is on, but it is outside network coverage.
- The phone is off. The communicator cannot send or receive calls or messages.

Communicator keyboard

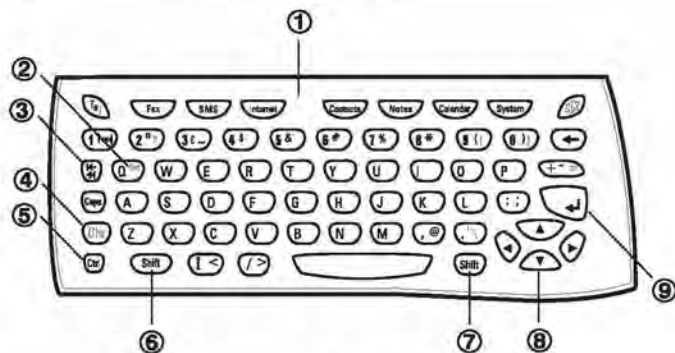

Figure 9

In addition to the normal character and number keys, the keyboard has a number of special keys, as shown in figure 9.

① Application buttons

The buttons at the top of the keyboard start the corresponding applications.

② ESC

To cancel an action, you can either press **Cancel** or Chr-Q. The Chr-Q key combination can only be used when **Cancel** is among the available commands. All information notes shown on the display can also be dismissed by pressing Chr-Q instead of OK.

③ Tabulator

When writing or editing documents, the tabulator key moves the cursor to the next tabulator stop. In settings, for example, the tabulator key can be used to move the cursor to the next field.

④ Character (Chr)

The character key is used to generate characters not on the communicator keyboard. A single press of the character key opens a table of special

characters. Some special characters are also printed on a key as the third character. These, and certain other characters can be generated by pressing and holding the character key while pressing the corresponding key, see "To edit documents" on page 101.

⑤ Control (Ctrl)

Pressed together with certain keyboard keys, the control key generates shortcut commands which can be used in viewing and writing text, see "Document features" on page 24.

⑥ and ⑦ Shift

When you press the Shift key and then a letter key, an uppercase letter is inserted in front of the cursor. The Shift key does not need to be held down when pressing a key; once you have pressed Shift, the next key press always generates a shifted character. In writing and editing text, Shift and the arrow keys (⑧) can be used to select text, see "Document features" on page 24.

⑧ Arrow keys

The arrow keys can be used to move the cursor or the selection frame. In some applications, the arrow keys have special functions, see "Document features" on page 24.

⑨ Enter

When the cursor is shown, pressing Enter moves the cursor to the beginning of the next line or adds a new line. Enter can also be used to select contacts in the Contacts directory and to open folders and documents. When information notes are shown, you may press Enter instead of OK. In options and settings, when a value can be toggled, you may press Enter instead of Change.

Communicator applications

The coloured application buttons on the communicator keyboard are used to start the corresponding applications.

Telephone – Used for managing voice calls.

Fax – Enables you to send any of your own documents as a fax. Received faxes can be read or forwarded.

SMS – Enables you to send short messages. Received short messages can be read, replied, or forwarded.

Internet – Includes Internet and modem-based applications.

Contacts – Used for managing contact information, such as names, numbers and addresses. You can exchange contact information as business cards via the SMS application.

Notes – Used for writing and storing documents.

Calendar – Contains an appointment book and a to-do list. You can book events in other calendars and set alarms to events.

System – Contains PC connectivity, security and other system-related applications.

Extras (🗂️) – Includes various items, such as Calculator, Clock, and Composer.

To use the applications

When the cover is opened, the application that was on the display when you closed the cover, appears in the same state. However, if you have made or answered a voice call via the phone and switch to the communicator interface by opening the cover, the Telephone application starts automatically.

To switch to another application, press the corresponding application button. You can do this even during a call. You need not exit any application before starting another. All inactive applications remain in the background until you start them again.

To send or receive calls or messages with any of the communications applications, remember that the phone must be switched on and in a service area with adequate cellular signal strength.

Note: Information needs not be specifically saved. When you press **Close**, switch to another application, or close the device cover, the Nokia 9110 Communicator saves all data.

Connectors

The Nokia 9110 can be connected to a variety of devices. The connectors are (figure 10):

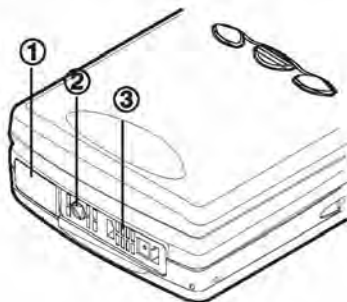

Figure 10

- ① IrDA-SIR infrared port for connecting to a PC, a printer, a digital camera, or another communicator. For information on infrared connection, see chapter 4 "PC connectivity" on page 29.
- ② Connector for the charger plug.
- ③ Connector for the RS-232 cable plug and the headset plug.

Battery

The Nokia 9110 Communicator is powered by a rechargeable Lithium-ion battery. The High Power Battery provides 3 to 6 hours of talk/fax/terminal time or 60 to 170 hours of standby time. Furthermore, up to 400 hours of standby time may be achieved when the phone is off.

Use only batteries and accessories approved by the communicator manufacturer for use with this particular communicator model. Use only chargers approved by the communicator manufacturer for charging a Lithium-ion battery.

Note: The communicator can be used normally during charging.

To charge a battery

- 1 Make sure that the battery is properly installed in the battery compartment.
- 2 Connect the charger lead to the connector at the bottom of the communicator, as shown in figure 11.



Figure 11

- 3 Connect the charger to an AC wall outlet. If the phone is switched on, the CHARGING message appears on the display and the segments of the battery indicator bar on the right side of the phone display will start scrolling.

- 4 When the battery is fully charged, the bars stop scrolling and four bars are displayed. You may now remove the charger plug from the communicator.

When the charge in the battery is low and only a few minutes of operation time remain, a warning tone will sound, and the message BATTERY IS LOW will be repeated at regular intervals on the phone display. When the charge level becomes too low for operation, the RECHARGE BATTERY message will be displayed, accompanied by a warning tone. If you do not connect the communicator to a charger, the communicator switches itself off.

Note: If the battery is fully discharged, it will take 30 - 60 seconds before the CHARGING message appears on the display and the battery indicator bar starts scrolling. After that, it may take 10-30 seconds before you can switch the phone on.

To use the battery

Use only batteries approved by the communicator manufacturer and recharge the battery only with the chargers approved by the manufacturer. With approved chargers and accessories, the battery can be charged continuously.

The battery need not be fully discharged before recharging. When a charger is not in use, disconnect it from the power source. Do not leave the battery connected to a charger for longer than a week, since excessive charging may shorten its life. If left unused, a fully charged battery will discharge itself over time.

The battery can be charged and discharged hundreds of times, but it will eventually wear out. When the operating time (talk-time and standby time) is noticeably shorter than normal, it is time to buy a new battery.

Temperature extremes will affect the ability of your battery to charge: allow it to cool down or warm up first.

Battery operation time is affected by the following: whether both the phone and the communicator interface are on, radio signal strength, various phone settings, the use of the backlight, and the length of the screen blanker period, see "System settings" on page 113.

It is recommended always to keep a charged battery in the communicator. Keeping the battery charged maximises the lifetime of the backup battery supplying power to the real-time clock of the communicator. In case the backup battery is drained, it will be automatically charged the next time a charged battery is reconnected to the communicator.

Always close the device cover before removing the battery. Closing the cover will save all data.

Note

Use the battery only for its intended purpose.

Never use any charger or battery which is damaged or worn out.

Do not short-circuit the battery. Accidental short-circuiting can occur when a metallic object (coin, clip or pen) causes direct connection of the + and - terminals of the battery (metal strips at the bottom of the battery), for example, when you carry a spare battery in your pocket or purse. Short-circuiting the terminals may damage the battery or the connecting object.

Leaving the battery in hot or cold places, such as in a closed car in summer or winter conditions, will reduce the capacity and lifetime of the battery. Always try to keep the battery between +15°C (+59°F) and +25°C (+77°F). A communicator with a hot or cold battery may temporarily not work, even when the battery is fully charged. The performance of Lithium-ion batteries is particularly limited in temperatures below 0°C (+32°F).

Do not dispose of batteries in a fire!



Batteries must be recycled or disposed of properly. Batteries must not be disposed of in municipal waste.

3. Special features

This chapter explains functions that are common to most of the applications. "Communicator features" on page 21 goes through various features of the device, and "Document features" on page 24 explains functions that apply to writing and viewing of documents.

Communicator features

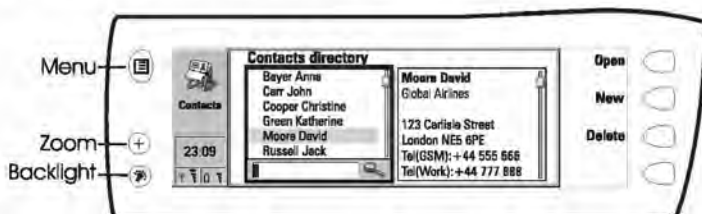



Figure 1

To use the Menu button

- 1 Press the  button on the left of the communicator display to open up a set of options which depend on the application you are in.
- 2 Move the selection frame over the desired option and press **Select**.

The chosen option affects only the document, card or item that is currently selected, open, or being sent. The Menu may also contain the option *Settings* with which you can change the settings of the application. The values of these settings will be used as defaults for that application.

To use the Zoom button

Press the  button on the left of the display to magnify the view on the display. Zooming is not available on every occasion.

To use the Backlight button

Press the  button on the left of the display to turn the backlight of the communicator display on and off. The backlight can be adjusted in the System settings. See "System settings" on page 113.

To use the Help button

Press the **?** button on the communicator keyboard to open up a help text on the current function. The application icon in the indicator area on the left side of the display reminds you of the application where you requested help.

The help deals with issues relating to the item that was on the display when you pressed the Help button. If no special help is available for the current item, a list of available help topics is shown instead.

To view the list of all help topics for the current application, press **Application help**. The following commands become available:

Open – Opens the selected topic.

General help – Shows the common help topics.

Close – Closes the help.

To view the list of general communicator topics, press **General help**. The following commands become available:

Open – Opens the selected topic.

Application help – Returns to the help topics list of the current item.

Close – Closes the help.

If the help topic you wanted was not among the help topics of the current item or in the general help, close the help, start the correct application and press the Help button again.

To use the memory card

A memory card may contain documents, contact databases, applications, backups, printer drivers, etc. When a memory card is inserted in the communicator, the memory card contents are marked with the memory card icon  in the corresponding applications. For example, the documents on the memory card are located in a folder shown in the folders list of the Notes application.

The items on the memory card can be used in the same way as corresponding items in the communicator. You can for example install and remove software to and from the memory card with the Install/Remove software application, and send messages to contacts in the contacts directory of the memory card.

Note: The memory card is not included in the sales package, but can be purchased separately.

To insert the memory card

- 1 Close the device cover and make sure that the phone is switched off. If it is on, press **⓪**.
- 2 Remove the battery: press the catch at the top of the battery and lift the battery away from the battery cavity.

- 3 Open the hatch at the back of the communicator: carefully open the lid by easing it up from the ridges on both sides.
- 4 Slide the memory card under the memory card holder. Make sure that the gold contacts of the card are facing down and that the bevelled corner of the card is on the right. See Figure 2.

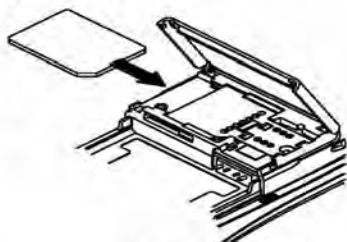

Figure 2

- 5 When the card is securely in place, close the hatch, and replace the battery.

IMPORTANT! Keep all memory cards out of small children's reach.

Make sure that the hatch is closed before replacing the battery!

Do not remove the memory card in the middle of an operation. Be sure to close all memory card applications before removing the card.

If you are installing an application to the memory card and you need to reboot the communicator, do not remove the card until the reboot is complete. Otherwise the application files may be lost.

If you have an application or a tone on both the memory card and the communicator, the one in the communicator is used.

To select several items

Where multiselection is available, you can select several items at once. The commands you use affect all the selected items. Multiselection works in most lists. For example, you can select several contacts and remove them at once in the Contacts directory, or select several documents and copy them to a memory card at the same time in the Notes application.

There are two ways to select several items:

- 1 Scroll to the item and press Ctrl-space bar. Or,
- 2 Press and hold Shift and move up or down the list with the arrow keys to the last selected item.

To remove an item from the selection, scroll to the item and press Ctrl-space bar again.

To cancel the entire selection, press Chr-Q.

If you want to select every item in a list, press Ctrl-A. If you want to cancel the selection, press Ctrl-A again.

Document features

To name a document

Every time you close a new document for the first time, you will be asked to enter a name for the document in the input field. The highlighted name in the input field is the communicator's suggestion for the name.

To use shortcuts

There are several shortcuts you can use in the document applications. The following table lists the available shortcuts:

Shortcut	Function
Ctrl-A	Selects all
Ctrl-C	Copies selected text
Ctrl-X	Cuts selected text
Ctrl-V	Pastes selected text
Ctrl-Z	Cancels the most recent operation
Ctrl-B	Applies bold
Ctrl-I	Applies italics
Ctrl-U	Applies underlining
Ctrl-T	Adds current time
Ctrl-D	Adds current date
Ctrl-M	Adds user's name
Ctrl-H	Moves the cursor to the beginning or the end of the document
Ctrl-E	
Ctrl-N	Opens the next item
Ctrl-P	Opens the previous item
Chr-left or right arrow	Moves the cursor to the beginning or end of the line
Chr-up or down arrow	Scrolls the list or document view up or down
Shift-Ctrl-left or right arrow	Selects the previous or the next word
Shift-right/left/up/down arrow	While Shift is held down, each press of an arrow key selects one text character or line
Shift-Chr-up or down arrow	Selects text page by page inside a document

To print

Press the Menu button and select *Print*. You can print various items, such as documents, pictures, and SMS messages.

The connection type, header, paper size and the default printer must be defined in advance in the System settings. See "System settings" on page 113.

Note: For information on supported printers, see the Documentation section on the CD-ROM supplied in the communicator sales package, or see the Nokia Wireless Data Forum home page in the World Wide Web at <http://www.forum.nokia.com>.

Please, refer to the user's guide of the printer for detailed safety instructions on the device.

To change the printing options, press **Options** in the printing view. The available options depend on the application you are in.

To print using the infrared connection

- 1 Go to the System application and set infrared as the connection type. See "System settings" on page 113.
- 2 Make sure the infrared port of the communicator faces the infrared port of the printer. Keep the infrared connection clear. If the connection is obstructed for too long, for example, if something is moved between the infrared sensors or the communicator is moved, printing is interrupted.
- 3 After the communicator has checked that you do not already have an active connection, it starts to scan for a printer. This means that you cannot print while you are, for example, transferring files from the communicator to a PC.
- 4 If the printer cannot be found, a failure note is shown and the active application returns to the display.
If the correct printer is found, the printer driver is selected automatically and the display shows the name of the document and the selected printer. If the printer found is not recognised, press **Printers** and select the correct printer driver.
If the communicator does not have the correct driver for the printer, you can try printing the document using one of the available printer drivers.
- 5 Press **Start** to start printing.

Tip: More printer drivers can be installed with the PC Suite for Nokia 9110 Communicator program or from the CD-ROM included in the communicator sales package. See "To use the PC Suite" on page 29.

To print using the cable connection

- 1 Go to the System application and set cable as the connection type. See "System settings" on page 113.
- 2 Connect the communicator to a serial printer with the RS-232 adapter cable DLR-2.
- 3 Press **Printers** and select the correct printer driver.
- 4 Press **Start** to start printing.

Document outbox

When you send faxes, short messages and mail, they always go first to the Document outbox. The outbox prepares your document and then sends it via the phone. If the phone is off, or the cellular signal strength is inadequate, the document will not be sent until the phone is switched on and the signal strength is sufficient. If the phone or fax called is off or busy during the first attempt, the Document outbox attempts to send the document nine more times. If the sending still fails, the communicator informs you of this with a note.

The Document outbox can be accessed in the main views of the Fax, SMS, Mail and Notes applications, where it is shown at the bottom of the folders list. To open the Document outbox, select it from the folders list and press **Open**.

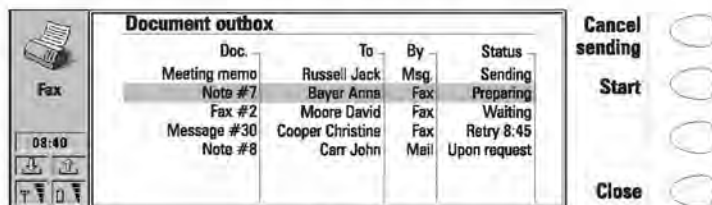

Figure 3

The main statuses that documents can have in the outbox are:

Sending – The document is currently being sent.

Waiting – The document is waiting for sending to become possible, e.g. when the phone is switched on, cellular signal strength becomes adequate, previous phone call ends.

Retry [time] – Sending of the document failed and it will be sent again at the time specified in the square brackets.

At [time] – The fax is waiting to be sent at the time you have specified. See "Fax settings" on page 62.

Sending [current page/total pages] – The number of the fax page that is being sent and the total number of the pages.

Upon request – E-mail messages may have this status if the *Send mail* setting has been set to *Upon request* in the Mail settings. See "Mail settings" on page 77. These messages will not be sent until you select one and press **Start**. All mail with the *Upon request* status will be sent during the same connection.

To speed up manually the sending of documents that have the *Waiting*, *Retry*, *At [time]* or *Upon request* status, select the document and press **Start**. The document(s) will be sent as soon as possible.

A document is removed from the Document outbox if sending succeeds or you cancel the sending by pressing **Cancel sending**.

Received communication note

When you open the cover of the communicator and have missed calls, received faxes, short messages or mail, or there are unsent documents in the Document outbox, a note will be shown, see figure 4. The note can be dismissed by pressing **Cancel**.

To read the received documents or to check who has made the missed calls, select the corresponding item on the list and press **View**.

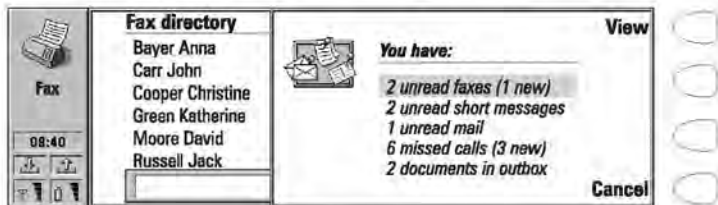

Figure 4

To transfer data from older communicator models

If you have an English version of the Nokia 9000 Communicator or the Nokia 9000i Communicator, you can make backups of the data in it with the Nokia Communicator Server program, and restore the data to any language version of the Nokia 9110 Communicator. You can transfer data in a similar way between the same language versions, e.g. from a Finnish version of the Nokia 9000i Communicator to a Finnish version of the Nokia 9110 Communicator.

Note: Never restore the settings from Nokia 9000 or 9000i communicators to the Nokia 9110 Communicator.

To transfer data between different language versions

- 1 If the languages are not compatible, e.g. if you want to transfer data from a Finnish version of the Nokia 9000i Communicator to a French version of the Nokia 9110 Communicator, move your contacts and calendar data with the Nokia Communicator Server program onto a PC using the Import/Export contacts and Import/Export calendar data applications.
- 2 Move your documents with the Nokia Communicator Server program onto a PC using the File transfer application.
- 3 Start the PC Suite for Nokia 9110 Communicator program on the PC and transfer the contacts, calendar data, and documents to the Nokia 9110 Communicator.

4. PC connectivity

This chapter explains how to install the PC connectivity software on a PC, how to connect your communicator to the PC, and how to use the connectivity programs.

To use the PC Suite



Figure 1

You can connect your communicator to a suitable PC with the PC Suite for Nokia 9110 Communicator program. The PC Suite and its user's guide are found on the CD-ROM supplied in the communicator sales package.

The PC Suite works with Windows 95/98 and NT 4.0, and requires IBM-compatible 486 PC or higher.

When using the PC Suite, you only need to connect your communicator to a PC; everything else is done on the PC.

Note: Making or answering phone calls during a PC connection is not recommended as it might disrupt the operation.

To install the PC Suite on a PC

The CD-ROM should launch itself automatically after you have inserted it into the CD drive of your PC. If not, please, follow these steps:

- 1 Click the Windows "Start" button; then click "Run".
- 2 If your PC has Windows 95, 98 or NT 4.0 (or later), type `d:\9110_95.exe` in the command line. If your PC has Windows 3.x, type `d:\9110_31.exe`. Substitute the letter "d" with the letter of the CD drive.
- 3 Press Enter.
- 4 Follow the instructions shown on the screen.

Note: The PC Suite for Nokia 9110 Communicator program can be found in the Menu under the heading "PC and Macintosh software".

To use the PC Suite with an infrared connection

- 1 The IrDA software must be installed and running on the PC. To check if the IrDA driver is already installed on the PC, go to the Control Panel. If there is an icon called Infrared, the driver has been installed.
- 2 Make sure that the infrared port of the communicator faces the infrared port of the PC. Keep the infrared link clear: check the infrared indicators in the indicator area, see "Communicator display" on page 10. If the infrared link is obstructed for too long, for example, if something is moved between the infrared sensors or the communicator is moved, the operation is interrupted.
- 3 Start the PC Suite software on the PC. In the Preference dialog, select IR as the data transfer protocol, and the correct COM port.
- 4 Start the Infrared activation application on your communicator and press **Activate**. See "Infrared activation" on page 118.

To use the PC Suite with a cable connection

- 1 Connect the 9-pin end of the RS-232 adapter cable DLR-2 to the COM port of the PC, and the other end to the connector at the bottom of the communicator. See "Connectors" on page 16.
- 2 Start the PC Suite software on the PC.

Note: Remember to make backup copies of all important data!

Tip: You can also use the optional deskstand for easy PC connectivity. See the Accessories guide.

Contacts

The Contacts function of the PC Suite lets you create, edit and update contact cards on your Nokia 9110 Communicator, and transfer them between a PC and your communicator. To start the Contacts application, click on the Contacts icon in the main screen.

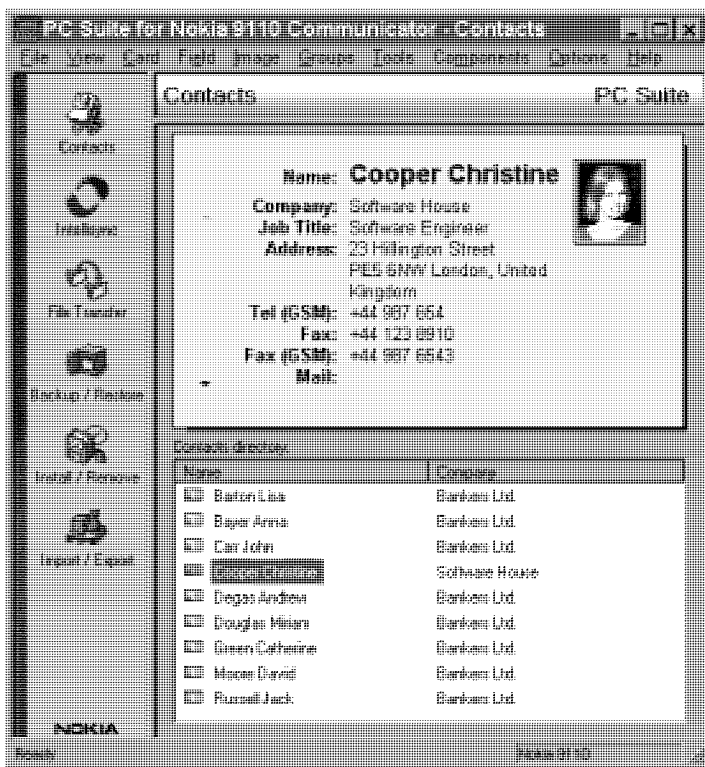

Figure 2

Intellisync

With the Intellisync function you can synchronise data between your communicator and a PC.

- 1 Connect your communicator to the PC.
- 2 Start the PC Suite program on the PC and click the Intellisync icon in the main screen.
- 3 The Local (i.e. PC) tab is automatically selected. Click the Settings button.

Note: You may be presented with a dialog containing the tabs Format and File. In the Format tab, select the address format that you are using for addresses in your communicator. The Contacts Format 5 is recommended. In the File tab, indicate if you want to synchronise Contacts on the communicator memory, or on the memory card. After this, click OK.

- 4 This displays the PC Suite Configuration dialog with the Calendar, Contacts, and To-do list applications of your communicator.
- 5 Click on the communicator application you want to configure.
- 6 Click the Choose button to enter the Choose Translator dialog. The Choose Translator dialog lists all the PC applications that are compatible with the communicator application you selected.
- 7 Click the OK button in the Choose Translator dialog to return to the Configuration dialog. Now the PC application you selected appears next to the name of the communicator application.

Note: The first time you select Microsoft Outlook in the Choose Translator dialog, use the Browse button to locate the data in your Outlook folder which you wish to synchronise.

- 8 Specify the application and, if necessary, the file you want to synchronise.

Note: In order to synchronise data successfully between your communicator and a PC application, click on the Advanced button after selecting the application with which to do the synchronisation. In the Advanced settings dialog, click on Field Mapping and match the fields of the PC application with those fields of the communicator that have been marked with asterisks, see figure 3.

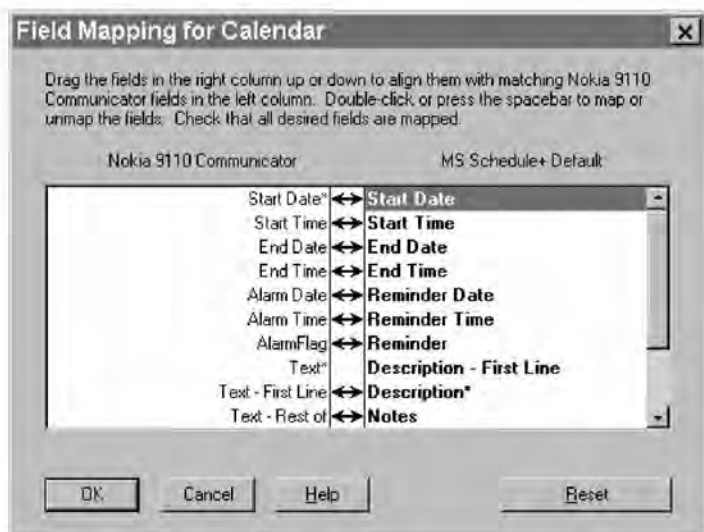

Figure 3

- 9 When you are ready to perform the operation, click the OK button at the bottom of the Configuration dialog.
- 10 Click the Synchronise button on the PC Suite opening screen.
- 11 If prompted, resolve data conflicts.
- 12 A confirmation prompt appears, showing you how many adds, changes, and deletes will be applied to each of your systems if you proceed with the operation. Click Accept to proceed, or Cancel to discontinue.

File transfer

The File Transfer application lets you move, copy, paste, rename, and remove communicator and PC files.

Note: Faxes are transferred from the communicator to a PC in TIFF format; this means that you need to use Windows Imaging to view more than the first page of a fax.

- 1 Establish a connection between your communicator and a PC. See above.

- 2 Start the PC Suite program on the PC and click the File Transfer icon in the main screen.
- 3 Select an item by clicking on it in the File Transfer screen with the mouse and drag and drop it to the appropriate PC directory or communicator folder.

Backup / Restore



Figure 4

The Backup/Restore function enables you to create backups of your communicator data on a PC and later restore the data in the communicator.

- 1 Establish a connection between your communicator and a PC, see above.
- 2 Start the PC Suite program on the PC and click the Backup/Restore icon in the main screen.

- 3 Click on the Backup tab and select one of the following options: All device data backs up all of the data in your communicator, Selected device data allows you to select whether to backup your Calendar data, Contacts, Documents, or Settings, or select Memory card data to backup the information on your memory card.
- 4 In the "Backup Path" box, specify the location where you want the backups to be stored. The backup name is assigned automatically.
- 5 Enter a number between 1 and 99 in the "Number of backup stores" box.
- 6 Click the Backup button.

To restore data, click on the Restore tab. Specify the location of the backup in the "Backup stored in" box. In the lower box, click on the data you want to restore. Click Restore to restore the backup to your communicator.

Install / Remove

The Install/Remove Software function lets you install and remove software from your communicator.

Note: If you install to the Nokia 9110 Communicator software made for the older communicator models, be aware that the greyscales of the devices are different. Therefore, the display may seem lighter. Although this difference does not affect the functioning of the software, always try to install the version made especially for the Nokia 9110 Communicator.

- 1 Establish a connection between your communicator and a PC, see above.
- 2 Start the PC Suite program on the PC and click the Install/Remove icon in the main screen.
- 3 Click the Install tab and enter the location of the software you want to install in the "Select Path" box.
- 4 Click on the software you want to install in the box below.
- 5 Click the Install button.

To remove software from your communicator, click the Remove tab. Select the software you want to remove in the box and click the Remove button.

Import / Export

The Import/Export function can be used to transfer calendar and contacts files between your communicator and a PC.

- 1 Establish a connection between your communicator and a PC, as shown above.
- 2 Start the PC Suite program on the PC and click the Import/Export icon in the main screen.

- 3 Click the Export tab and choose one of three options: Calendar data; Contacts; Contacts File on Memory Card.
- 4 In the "Select the PC file to create" box, specify the name and path of the PC file you want to create.
- 5 Click the Export button.

To import a file from a PC to your communicator, click the Import tab and select which items to import. Specify the PC file that you want to transfer to your communicator and click the Import button.

To use the Nokia Communicator Server

For Windows 3.11 and Apple Macintosh users the CD-ROM in the communicator sales package contains the Nokia Communicator Server program. With the Nokia Communicator Server you can install and use the communicator applications that require PC connectivity, see chapter 12 "System" on page 113. You need to connect your communicator to a PC and start the necessary application on the communicator.

Note: The English version of the File transfer, Import/export contacts, and Import/Export calendar data applications that can be used with the Nokia Communicator Server can be installed to your communicator from the diskette included in the sales package. Other language versions are found on the CD-ROM.

The Nokia Communicator Server also works with Windows 95 and NT.

Tip: You do not need this software if you use the PC Suite for Nokia 9110 Communicator. See "To use the PC Suite" on page 29.

To install the Nokia Communicator Server on a PC

- 1 Insert the diskette into the diskette drive.
- 2 In the Windows Program Manager, click on the "File" menu.
- 3 Click on menu item "Run" and type `a:\server` in the command line. Substitute the letter "a" with the letter of the diskette drive.
- 4 Press Enter.
- 5 Follow the instructions shown on the screen.

To use the Nokia Communicator Server with an infrared connection

- 1 Follow the first two steps for installing the PC Suite.
- 2 Start the Nokia Communicator Server software on the PC.
- 3 Start the desired PC connectivity application on your communicator. Remember to set infrared as the connection type.

To use the Nokia Communicator Server with a cable connection

- 1 Connect the 9-pin end of the RS-232 adapter cable DLR-2 to the COM port of the PC, and the other end to the connector at the bottom of the communicator. See "Connectors" on page 16.
- 2 Start the Nokia Communicator Server software on the PC. Check that the COM port reported by the software is correct.
- 3 Start the desired PC connectivity application on your communicator. Remember to set cable as the connection type.

Tip: For information on how to install new software on your communicator with the Nokia Communicator Server, see "Install/Remove software" on page 122.

5. Contacts

The Contacts application is used for creating, editing, and managing all contact information, such as phone numbers, addresses and speed dials, and for viewing logs of all incoming and outgoing voice, data and fax calls and SMS messages.

The Telephone, Fax, SMS, Calendar and Mail applications all use information found in the Contacts directory.

Tip: You will find the Club Nokia Careline contact cards in the Contacts directory. Club Nokia Careline answers questions and offers instructions over the phone.

Contacts directory

The Contacts main view shows two windows: on the left is the Contacts directory, which is a list of all contact cards, and on the right is the currently selected contact card. The active window is surrounded by a dark frame. You can toggle between the windows with the Tab key. The contact cards are listed in the Contacts directory in alphabetical order according to the name in the *Name* field of each card.



Figure 1

To find contact cards

- 1 Move the selection frame in the Contacts directory with the arrow keys until the contact you are searching for is shown within the selection frame. Or,
- 2 Enter text into the search field. The search looks for matches in the *Name*, *Company* and *Address* fields. The search results can be cleared by removing characters one by one from the search field with the backspace key.

To open the selected contact card, press **Open**.

To remove the selected contact card, press **Delete**.

Note: If you have a memory card inserted in the communicator, the memory card contact databases are shown as folders in the Contacts main view. When you open a folder, you can only call and send messages to the contacts in that database.

To use the Menu button

Pressing the Menu button in the Contacts directory opens a new set of options:

Individual log – Opens the Individual log of the selected contact, see "Logs" on page 45.

General log – Opens the General log.

Duplicate card – Creates a duplicate of the selected card.

SIM card memory – Shows the contents of your SIM card.

Copy to SIM – Copies the selected contact(s) to the SIM card memory.

Create group – Creates a new contact group, see "Contact groups" on page 44.

List groups – Opens a list of all contact groups.

New contacts database – Creates a new contacts database to the memory card.

Rename contacts database – You can give the memory card contacts database a new name.

Copy contacts – You can copy contacts to and from your memory card.

Move contacts – You can move contacts to and from your memory card.

Contact info – Shows the number of contacts and the amount of contact data.

Settings – Enables you to change the following settings:

Contact card template – You can define which fields are included in all new contact cards you create. Changes made to the template affect all new, but not existing contact cards. You cannot enter text into the fields of the template.

Log length – You can define how recent contacts will be listed in the General and Individual logs. Select the new log length and press **OK**. The possible values are: *Zero / 10 days / 30 days / 1 year / User defined: days (0 – 365 days)*.

To make contact cards

- 1 To make a new contact card, press **New** in the Contacts main view.
- 2 When the new contact card opens, enter the contact information in the various fields. Use the arrow keys to move from one field to another. You can add lines to the *Address* and *Note* fields with the Enter key.
- 3 To return to the Contacts directory, press **Close**.

Tip: When entering phone numbers into the *Tel* fields, storing a + character in front of the country code will allow you to use the same phone number abroad.

When storing phone numbers or DTMF sequences, you can use hyphens and spaces to arrange the appearance of the strings. This will not affect the way the numbers or DTMF tones will be dialed.

Tip: It is possible to import contacts from a PC or certain handheld devices by using the IntelliMigrate program on the CD-ROM supplied in the sales package of the communicator.

To add new fields to a contact card

- 1 Press **Fields** in the currently opened contact card. See figure 2.
- 2 Press **Add field**. A pop-up box opens, listing the available fields.
- 3 Select a field and press **OK**. There can only be one *Name*, *Job title*, *Company*, *Note* and *Password* field.

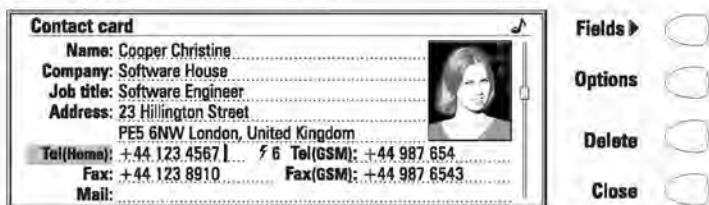

Figure 2

Note: The *Tel/Fax* field is for alternating calls, the *Tel(Server)* field for sending bookings to remote calendar servers, and the *Password* field for the calendar booking password. See "Multiple calls" on page 50, and "Calendar booking" on page 109.

To customise the label of a field

- 1 Press **Fields** in the currently opened contact card.
- 2 Select a field and press **Change label**.
- 3 Select one of the predefined labels or scroll down to the field with a dotted line and write the label text, e.g. *Modem*, and press **OK**.

To remove the selected field, press **Delete field**. The *Name* field cannot be removed.

Note: Remember to put wireless phone numbers into the *Tel(GSM)* fields of the contact cards. Otherwise you cannot send SMS messages to these numbers.

Contact card options

When you press **Options** in an opened contact card, the following options become available:

Ringtone – You can set a specific ringing tone for each contact in the Contacts directory. Select a tone from the list, and press **Select**. The 🎵 icon appears at the top of the contact card. See figure 2. In order to use this function, however, the Individual ringing tones setting must first be set on. See "Telephone settings" on page 53.

Attached image – You can attach a picture of the contact to the contact card. You can then send the picture with a business card, and the picture is shown on the display when the person calls you.

The picture must first be stored in JPG format in the Contact images subfolder of the Downloaded files folder, where it is then selected. Choose a picture and press **OK**.

When a picture is attached to a contact card, it is automatically adjusted to the proper size. If there is an old picture in the contact card, it will be replaced by the new picture. If you want to keep the original picture, make a copy of it and give it a different name, or move the copy to another folder, before you attach the new picture.

Note: If you want to attach a picture to a contact card located in the contacts database of the memory card, the picture must first be stored in the Contact images folder of the memory card.

Speed dials – You can set a speed dial number for the selected contact card.

To set speed dials

Speed dialling is a quick way to call frequently used phone numbers. You can assign speed dials to eight phone numbers. Number 1 is reserved for calling your voice mailbox. For information on how to use the speed dials, see "To use speed dialling" on page 139.

- 1 Press **Options** in an opened contact card and select *Speed dials*. All phone number fields of the contact card are shown.
- 2 Select a field to which you want to assign a speed dial and press **Change**.
- 3 Select a number and press **OK**. The speed dial number will be shown in the contact card with the icon . See figure 2.

To change or remove speed dials

- 1 Select the speed dial you want to change or remove and press **Change**.
- 2 Move the selection frame to the new location and press **OK**. If you want to remove a speed dial location, choose *None*.

To store DTMF tones

For information on how to send DTMF tones, see "Multiple calls" on page 50, or "To send DTMF tones" on page 140.

If you need both a voice and a DTMF phone number for the contact, store the DTMF sequence in the *Tc* field, in which case the phone number and the DTMF sequence must be separated by one of the special characters in table 1. Or add a *DTMF* field to the contact card with the **Add field** command.

Character	Function
* and #	May be used if the DTMF service requires them.
p (pause)	Inserts a pause of 2.5 seconds in front of, or between, DTMF digits.
w (wait)	When the "w" character is stored in a sequence, the rest of the sequence is not sent until you press Send again in the Telephone application.

Table 1

To use the Menu button

Pressing the Menu button in an opened contact card opens a new set of options:

Duplicate card – Creates a copy of the current card.

Copy contents – Copies the contents of the card to a clipboard. You can add this information to documents by pressing Ctrl-V.

Next card – Opens the next contact card in the directory.

Previous card – Opens the previous contact card in the directory.

Fetch – If you have selected the *URL* field of a contact card with the selection frame, pressing *Fetch* starts the WWW application and opens a connection to the first URL address in the field.

Belongs to groups – Shows all the groups of which the current contact is a member.

To view the contact information on your SIM card

1 Press the Menu button in the Contacts directory, and select the *SIM card memory* option.

2 Select the contact with the selection frame and press **Open**.

To add a new contact to the SIM card memory, press **New**.

To remove the selected contact(s) from the SIM card memory, press **Clear**.

To return to the Contacts main view, press **Close**.

If you press the Menu button in an opened SIM contact card, the following options become available:

Sort by name/Sort by location – Arranges the contacts in alphabetical order or in the order of their memory location.

Copy SIM contacts – Copies the selected contact(s) to the Contacts directory.

SIM info – Shows the amount of data in the SIM card memory.

Note: The SIM card cannot be accessed if the Fixed dialling function is on. See "Settings (Menu 4)" on page 147.

Contact groups

You can create contact groups in order to be able to send mail or short messages to a group of people at the same time. See figure 3.

To create a group

1 Use multiselection in the Contacts directory to select the contacts you

want to include in the group.

- 2 Press the Menu button and select the *Create group* option

You can also create an empty group by pressing the Menu button and selecting *Create group*, and add members later. See below.

When you close a new group contact card for the first time, you will be asked to enter the name of the group.

To add new contacts to a group

- 1 Open the group contact card and press **Add**. A list of contacts opens.
- 2 Select the contact(s) you want and press **Add**.

To remove contacts from a group, open the group contact card, select the contact(s) to be removed and press **Remove**.

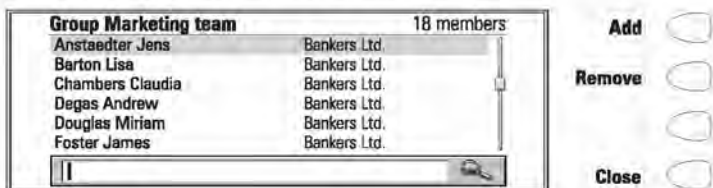

Figure 3

To use the Menu button

When you press the Menu button in an opened group contact card, the following options become available:

Rename group – Allows you to give the group a new name.

Belongs to groups – Shows all the groups to which the selected contact belongs.

List of groups – Opens a list of all contact groups.

Logs

The Contacts application shows all communication events as two logs: the General log shows all, or certain types of, communication events in chronological order. The Individual log shows a list of all communication events relating to the selected contact.

Note: Remote mailbox, Terminal and Internet connections are logged as data calls.

To access the logs

- 1 Press the Menu button in the Contacts directory.
- 2 Select either *Individual log* or *General log*.

To erase the contents of the log

- 1 Press **Clear list**.
- 2 A pop-up box opens to let you define how old communications you want to remove. The clearing procedure reflects on the other log as well.

To make a new contact card

- 1 Open the General log.
- 2 Select a log event and press **Create card**. If the contact card already exists, the command is dimmed.

To view only certain communication types

- 1 Open the General log and press **Filter**.
- 2 Select the communication type you want to view and press **OK**.

6. Telephone

The Telephone application is started by pressing the Tel. application button on the keyboard. Some of the operations explained here can also be made via the phone.

You can have two separate phone lines, see "Telephone settings" on page 53.

Note: Opening or closing the cover does not affect active phone calls. If you have made a voice call via the phone and you open the cover, the Telephone application starts automatically. You can continue the call after pressing **Audio on**. See "Handsfree mode" on page 49.

To make a call

In order to make phone calls, a valid SIM card must be inserted and the phone must be switched on. There are three ways to make a call.

Note: When making a call, make sure that the antenna at the top of the communicator is up.

To make the call manually

- 1 Enter the telephone number in the search field.
- 2 Press **Call**.

To call a number in the Telephone directory

When you have no active voice calls, the Telephone main view shows the Telephone directory, see figure 1. Contact cards that do not contain any phone numbers appear dimmed in the directory and cannot be selected.

- 1 Select a contact in the Telephone directory either by scrolling or by using the search field.
- 2 Press **Call**. If the contact has more than one phone number, a pop-up box opens, listing all the contact's phone numbers. Choose a number from the list and press **Call**.

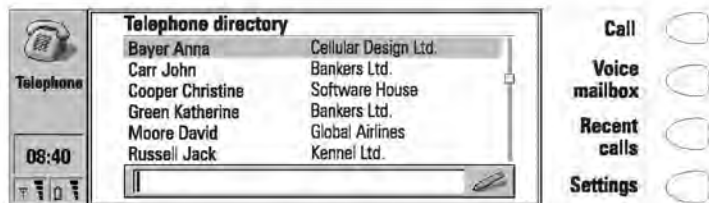

Figure 1

To call a number in the Recent calls list

- 1 Press the **Recent calls** command.
- 2 Select the Dialed, Received or Missed calls list and press **Open**.
- 3 Select a number from the list and press **Call**.

Tip: When you open the Dialed, Received or Missed calls list and select a contact, **Create card** enables you to make a contact card for the contact.

Once you have made the call, you can close the cover and continue the call with the phone, unless you want to use the handsfree option, see "Handsfree mode" on page 49.

To use the Menu button

When you press the Menu button in the Telephone directory, the following options become available:

SIM card memory – Displays the memory locations on the SIM card.



Show call costs – You can check the cost of your previous calls.

To answer a call

- 1 When you receive a call while having the communicator cover open, a note about the incoming call is shown on the display. If you are called by a person who has a contact card in your Contacts directory, as in the figure 2, the caller's name is shown on the note, if this feature is supported by the network. To answer the call, press **Answer**. Or,
- 2 Close the device cover and answer the call via the phone by pressing .

Note: You cannot have two active calls at the same time. If the Call waiting network service is activated in your SIM card, the active call is automatically put on hold when you answer the new incoming call.

If you do not want to take the call, press **End call** or . The caller will hear the alerting tone change to a "line busy" tone.

Tip: If you do not want your communicator to alert, a quick way to make the communicator silent is to close the cover and press the  key on the phone. Press the key again until the selection frame is on the Silent profile. To select the profile, press and hold .

To use the Menu button

If you press the Menu button while having a call active, the following options become available:

Send DTMF – Allows you to send DTMF tones. Select one of the predefined sequences, or enter a new sequence in the input field.

Voice recorder – Enables you to record voice memos. See "Voice recorder" on page 132.

More info – Allows you to view the other party's contact card and individual log.

Settings – Enables you to change the Telephone settings, see "Telephone settings" on page 53.

Handsfree mode

When you have a call, the handsfree mode allows you to speak and listen to the communicator from a short distance when the cover is open. This function is not available when the cover is closed.

The Telephone setting *Audio when cover opened* determines whether the handsfree mode is activated automatically after you open the cover. To set the handsfree mode on manually, press **Audio on**.

After the audio has been set on, the command changes to **Volume**. Press **Volume** to adjust the speaker volume or to turn the audio off. The indicator shows the chosen volume level.

Multiple calls

When you have made a call, information about the call is shown on the display. In addition to the active call, you can have a call on hold and a waiting call at the same time. The conference call, which can accommodate up to five remote participants, is handled as a single call.

To switch between multiple calls, use the arrow keys. The command buttons change according to the status of the selected call. For example, a call on hold can be changed to an active call by pressing **Activate**.

The call within the dark frame is selected Call cost counter



Figure 2

The call information may include the following (see figure 2):

The name or phone number of the caller and a picture, if available.

The status of the call: active, on hold, waiting, or conference, and whether the audio is off.

The call timer displays how much time has expired since the beginning of the call. The timer also counts the time spent on hold.

The call cost counter shows the cumulative cost of the call, if this network service is available and the call cost setting is on. You can determine whether to calculate the call costs in currency or charging units in the Telephone settings, see "Telephone settings" on page 53.

To end a call, select the call with the arrow keys and press **End call**.

Note: The actual invoice for calls and services from your service provider may vary, depending upon network features, rounding-off for billing, taxes and so forth.

To make a new call

- 1 If you already have an active call and a call on hold, drop one of the calls or merge them into a conference call.
- 2 Press **New call** and make the new call normally. The previous call will be put on hold.

To make a conference call

The conference call is a network service. Contact your network operator to check if this service is available. In a conference call, you and up to five remote persons can hear each other simultaneously.

- 1 Make the first call normally.
- 2 Once this person has answered, make a call to the second participant by pressing **New call**. The first call is put on hold.
- 3 Wait until the second person answers the call.
- 4 To include the first participant in the call, press **Conference call**. If you want to include a new person in the conference call, repeat this operation.
- 5 When all participants have been included in the conference call, the best voice quality is achieved by closing the cover and continuing the call via the phone.

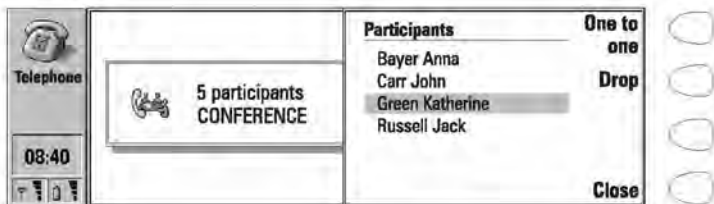

Figure 3

To end the call with a conference call participant

- 1 Press **Conference** commands.
- 2 Select the caller from the list of participants (figure 3) and press **Drop**.

To talk privately with one of the conference call participants

- 1 Press **Conference** commands.
- 2 Select a participant from the list and press **One to one**. The call is now split into two: the conference call is on hold and the one-to-one call is active.
- 3 Once you have finished the private conversation, you can connect the person back into the conference call by pressing **Conference call**.

To transfer calls

The call transfer is a network service which enables you to connect two calls together and disconnect yourself from both calls.

- 1 When you have one call on hold, and another call active or an outgoing call alerting, press **Transfer** to connect the calls together.

Note: Calls can be transferred only if all calls are voice calls, not fax or data calls, and none of the calls is a conference call.

To answer a waiting call

Call waiting is a network service to which you must subscribe before you can use it. Call waiting is set on in the Telephone settings, see "Telephone settings" on page 53.

- 1 When you receive a new call while you already have an active call, you will hear a sound and see a note informing you of the new incoming call.
- 2 Press **Answer**. The previous call will be put on hold.

To send DTMF tones when you have an active call

- 1 Key in the digits from the communicator keyboard. Each keystroke will generate a DTMF tone which will be transmitted directly.
Besides the numbers 0 - 9, you can also use the characters **p**, **w**, ***** and **#** when sending DTMF tones. For information on the functions of these characters, see "To make contact cards" on page 41.

Or alternatively,

- 1 Press the Menu button and select *Send DTMF*. The DTMF sequences stored in the other party's contact card are shown. For information on how to store DTMF sequences, see "To make contact cards" on page 41.
- 2 Select a DTMF sequence. You can edit the sequence, or, if there are no stored sequences, you can write a new DTMF sequence into the input field.
- 3 Press **Send**.

Tip: You cannot access the stored DTMF sequences during a conference call. However, you can send DTMF tones during a conference call by keying in the digits from the keyboard.

To make alternating calls

An alternating call is made as a voice call, but it changes into a fax call. An alternating call can be made to a fax box, for example: you initiate the call as

a voice call, but it changes into a fax call when your fax box starts to send you your faxes.

To make alternating calls, you need to add a special *Tel/Fax* field to the contact cards of the recipients of your alternating calls. See "To make contact cards" on page 41.

You can also change the mode of the call from voice to fax manually by pressing **Change call mode**.

Alternating calls cannot be put on hold or incorporated into a conference call.

Telephone settings

Press **Settings** in the Telephone main view to open a list of several settings groups.

To change the settings

- 1 Select a settings group and press **Change** to open it.
- 2 Select a setting and press **Change**. The current value of the setting is displayed after the setting name, unless the setting is one the network services: call diverting, barring or waiting. See the following sections.

Profile settings

The profile settings are used for selecting the operating environment for the communicator, and for modifying the profile features. One profile is always in use.



Figure 4

Profile in use – Press **Change** and select the profile you want to use. Press OK.

Profiles – With this setting you can modify the profiles. The available profiles are:

General – The normal profile of the communicator.

Silent – You can set this profile on when you want all the alert tones to remain silent.

Meeting – You can specify how the communicator operates when you are in a meeting.

Outdoor – You can specify how the communicator operates when you are outdoors.

Pager – You can set this profile on, when you want the communicator to act as a pager, i.e. the ringing tone is silent and only received SMS messages alert.

Flight – Sets on the flight profile, see "Flight profile" on page 57.

Car – The car profile is set on automatically when the communicator is connected to a car kit.

Headset – The headset profile is set on automatically when a headset is connected to the communicator.

Press **Rename** to change the names of the profiles.

Press **Edit** to modify the following features of a profile:

All alert tones – You can set the incoming call alert and other alarms to:

Ringing – The normal alert tone is used.

Ascending – The normal alert tone is used, but the volume of the tone increases gradually.

Ring once – The alert tone sounds only once.

Beep once – A single beep is heard when you receive a call or a message.

Caller groups – The alert tone will only sound when you receive a call from a member of the selected caller group. See below.

Silent – All the sounds, except the alarm clock, are turned off.

Whatever the chosen setting, an incoming call is always indicated by a note.

Ringing volume – Adjusts the ringing volume: 1 is the lowest, 5 the highest.

Ringing tone – Determines the ringing tone. To compose your own ringing tones, see "Composer" on page 129, and to record a ringing tone with the Digital voice recorder, see "Voice recorder" on page 132.

Communicator key click – Sets the communicator keyboard sound to *Off*, *Type 1* or *Type 2*.

Phone key click – Adjusts the phone keypad sound: 1 is the lowest, 3 the highest, *Off* turns off the keypad sound.

Divert all voice calls – You can divert all your incoming voice calls to another phone number. The option *Default diverts* uses the diverts set in the Network settings. See below.

Phone lights – The phone display and keypad lights are either permanently on, or they remain on for the pre-set time period. Available in the car profile only.

Automatic answer – All calls are automatically answered. Available in the car profile only.

Caller groups – Set one or several contact groups to *Yes*, and only those messages, calls, faxes etc. that come from people belonging to these groups, alert.

Call settings

Own number sending – You can select whether to keep your phone number hidden from the recipients of your phone calls. Do not use this function unless it has been activated for your SIM card.

On – Your number is shown to all the recipients of your calls.

Off – Your number is hidden from all the recipients of your calls.

Preset – The value stored in the network is used.

Next on – Your number is shown to the recipient of your next call.

Next off – Your number is hidden from the recipient of your next call.

Call cost settings – You can set on the call cost counter and modify its settings. Changing the settings requires the PIN2 code.

Audio when cover opened – Determines whether the handsfree mode is set on automatically after you open the cover.

Call timer display – If set to *On*, the call timer is shown during calls.

Automatic redialling – When this function is set on and you call a number that is busy or does not answer, the communicator will attempt to call the number until the call is connected.

Phone line in use – If your network and SIM card support this feature, you can have two different subscriptions for voice calls. These subscriptions are referred to as Line 1 and Line 2. Each line may have separate settings for some functions. With this setting, you can determine which phone line is currently in use for all outgoing calls.

Default call mode – In some networks you have the same phone number for all your voice, fax and data calls. If you want to receive any calls, you must set your phone to some answering mode. The available modes are *Voice*, *Fax*, *Data* and *Voice/Fax*.

Network settings

The network services may not be supported by all operators, or you may have to subscribe to them.

Information about the status of these services is stored in the network. Therefore, the current settings are not shown until you request the information from the network by pressing **Get status**.

While the communicator is making a request to the network, a query note is shown on the display. After a successful request, the new status now appears in the settings list.

To cancel all call diverts or barrings, press **Cancel call diverts** or **Cancel call barrings**.

Voice call diverting – This network service allows you to direct your incoming voice calls to another phone number.

- 1 Choose a divert option:
 - Divert all calls* – All incoming calls are diverted.
 - Divert when phone is busy* – Incoming calls are diverted when the phone is busy.
 - Divert when not answered* – Incoming calls are diverted when you do not answer them. *Delay* allows you to choose the time period after which the call is diverted. The available time periods are 5, 10, 15, 20, 25 and 30 seconds.
 - Divert if not reachable* – Incoming calls are diverted when the phone is switched off or outside the network service area.
- 2 Press **Change**, and select one of the following options:
 - To* – Enter the number to which you want to divert the calls.
 - To voice mailbox* – Calls will be diverted to your voice mailbox. The phone number of the voice mailbox must be set in Other settings.
 - Off* – Calls are not diverted.

Note: If you have subscribed to the Alternate phone line service, this setting applies only to the selected phone line.

Voice call barring – This network service enables you to restrict outgoing and incoming voice calls. If you take the call barring into use or change the barring settings, you will need the barring password, which you obtain from the network operator. The available options are:

All outgoing calls – Calls cannot be made.

All international calls – Calls cannot be made to foreign countries.

International except home country – Calls can be made only within the current country and to your home country, i.e. the country where your network operator is located.

All incoming calls – Calls cannot be received.

Incoming calls when abroad – Calls cannot be received when you are outside your home country.

Note: When security features which restrict calls are in use (call barring, call diverting), calls may be possible to certain emergency numbers in some networks (e.g. 112 or other official emergency number).

Call waiting – When this network service is set on, the network will notify you of a new incoming voice call while you have an active call. You will hear a

sound and see the caller's name or phone number, and the text WAITING on the display.

Other settings

Voice mailbox number — Set a new or change the phone number of your voice mailbox. You can call your voice mailbox by pressing **Voice mailbox** in the Telephone main view.

Note: Your network operator may be able to update your voice mailbox number via a special SMS message. Contact your network operator for details.

Individual ringing tones — You can set the individual ringing tones function on or off. See "To make contact cards" on page 41.

Flight profile

The flight profile prevents you from accidentally turning on your phone in an aircraft.

To set on the flight profile

- 1 Press **Settings** in the Telephone main view.
- 2 Choose *Profiles* and press **Change**.
- 3 Scroll to *Profile in use*, press **Change** and select *Flight*.
- 4 Press **OK**.

With the flight profile active, you may read previously downloaded mail, write mail, notes, short messages, faxes, or update your calendar. Once you have left the aircraft, you can turn off the flight profile by pressing **Exit profile**, turn on the phone by pressing **1**, and your short messages, faxes and mail will be sent automatically.

When the communicator is in the flight profile, emergency calls must be made from the phone:

- 1 Press **1**. The phone display will read FLIGHT PROFILE ACTIVE.
- 2 While the FLIGHT PROFILE ACTIVE text is visible (for approximately five seconds) you can dial the emergency number, e.g. 112.
- 3 Press .

IMPORTANT! Never use the phone when in an aircraft. If the aircraft personnel allow use of the communicator interface, you **MUST** activate the flight profile. The flight profile will allow use of the communicator interface only and will prevent use of the phone.

Be aware that all communications applications, Telephone, Fax, SMS, Mail, and Internet, require use of the phone.



Figure 5

7. Fax

Fax is started by pressing the Fax application button on the communicator keyboard.

To send and receive faxes, the phone must be on; the network you are using must support fax calls; and the fax service must be activated for your SIM card. Contact your home service provider for details.

When a fax is being sent or received, the FAX indicator appears in the indicator row of the display.

Note: Voice calls cannot be made or received when a fax is being sent or received.

The Fax main view shows:

Own texts folder – Contains all created faxes, short messages, memos, notes and mail stored on the communicator.

Received faxes folder – Contains all received faxes.

Document outbox – See "Document features" on page 24.

To send faxes

To write a new fax

- 1 Press **Write fax** in the Fax main view.
- 2 Write the fax.
- 3 Press **Recipient**. The Fax directory opens.

To send your own text as a fax

- 1 Select the Own texts folder in the Fax main view and press **Open**.
- 2 Select a document and press **Open**.
- 3 Press **Recipient** to access the Fax directory.

To forward a received fax

- 1 Select the Received faxes folder in the Fax main view and press **Open**.
- 2 Select a fax and press **Open**.
- 3 Press **Forward** to access the Fax directory.

Tip: Forward options allows you to select the specific pages you want to send: *All, This page, or Pages*. Choose *Pages* to enter the page numbers, first through last, e.g. 3-5, that you want to forward.

To select a recipient

- 1 Select a contact in the Fax directory and press **Select**. See figure 1. The names of contacts who have no fax number are dimmed and cannot be selected.
- 2 If the selected contact has several fax numbers, a pop-up box opens. Choose a number from the list and press **Select**.

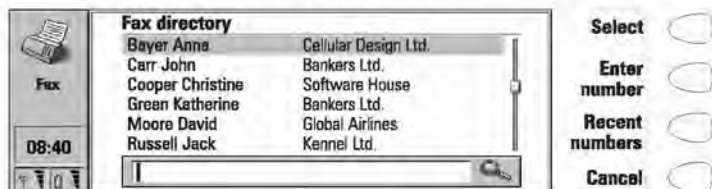

Figure 1

If there is no contact card in the Contacts directory for the recipient to whom you are sending the fax, press **Enter number** to enter the fax number manually, or obtain the information from the Recent numbers list by pressing **Recent numbers**. The list contains the fax numbers with which you have recently had contact. Choose a number and press **Select**.

Tip: If you press **Clear both lists** in the Recent numbers view, all information in the lists is removed. When you open one of the lists and select a contact, **Create card** enables you to create a contact card for the contact.

Fax cover page and send options

The fax cover page contains three fields, see figure 2. You can edit the entries in all the cover page fields. The *From* field is always filled automatically according to the User data card in the System application. See "User data" on page 118.

To adjust the fax sending options, press **Send options**. The send options are: *Cover page, Send resolution, Logo file, Signature file, Begin sending, Resend, and ECM*. For more information, see "Fax settings" on page 62. To change an option, select it and press **Change**.

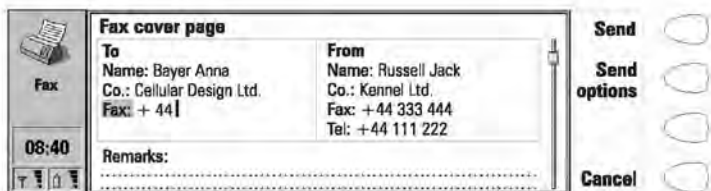

Figure 2

To send the fax, press **Send**. The fax is handed over to the Document outbox, which will send the fax as soon as possible.

Note: In case the sending fails, be sure to save all your important faxes.

To receive faxes

Faxes are received automatically, provided that this service is available and that the phone is on and within cellular coverage. All received faxes go to the Received faxes folder.

If you do not wish to receive the fax, close the cover and press .

When a new fax has been received, you will hear a tone - unless the system is set to a silent profile - and an information note is shown on the display.

To read a received fax

There are two ways to read a received fax:

- 1 When you receive a note informing you that you have received a fax, press **View**. Or,
- 2 Press **Cancel** to dismiss the note. You can then open the Received faxes folder, where unread faxes are marked with . Select the fax and press **Open**. The fax viewer opens.

You can use the up and down arrow keys to scroll the fax. The left and right arrow keys can be used for horizontal scrolling.

To remove the viewed fax, press **Delete**.

Tip: A list of shortcuts for viewing faxes and other operations can be found in "Document features" on page 24.



Figure 3

To zoom the viewed fax

- 1 Press **View**. A new set of commands becomes available. See figure 3.
- 2 Each press of **Zoom in** enlarges the document on the display. The fax can be scrolled horizontally with the left and right arrow keys.
Each press of **Zoom out** reduces the image.
Each press of **Rotate** rotates the fax 90 degrees clockwise with each press of the command button.

To return to the previous commands, press **Back**.

Tip: You can also use the Zoom button to magnify the fax on the display.

To print the viewed fax

- 1 Press the Menu button.
- 2 Select **Print**.

Tip: You can transfer received faxes to a PC with the PC Suite program. Please note, however, that these faxes will be converted to the TIFF format. To view all the pages of a fax on a PC, use a graphics program (e.g. Windows Imaging).

Fax settings

Press **Settings** in the Fax main view to change the settings of all your faxes.

Cover page – Provides you with the following options:

Header – The cover page contents will be attached to the beginning of the first fax page.

Separate page – Only the cover page contents are shown on the first page of the fax.

None – No cover page information will be attached to the fax. The first page of the document will be the first page of the fax.

Begin sending – Lets you choose when the fax is sent:

Immediately – The fax is sent right away.

At [time] – You can determine the time when the fax is sent. Use the time format *hh:mm*. This option enables you to take advantage of cheaper calling times.

Receive resolution:

Standard – The fax will be received using 200 (width) x 100 (height) dots per inch (dpi) resolution.

Fine – (200 x 200 dpi). Receiving faxes with fine resolution will take longer and requires approximately twice as much memory as with standard resolution.

Send resolution:

Standard – 200 x 100 dpi.

Fine – (200 x 200 dpi). Sending faxes with fine resolution takes longer and temporarily requires more free memory than when using standard resolution.

Logo file – Enables you to add for example the logo of your company to the fax cover page. The logo file must first be stored in the GIF or JPG format in the Downloaded files folder. The logo is not shown on the display.

No image – No logo is attached to the fax.

[File name] – All the available files in the Downloaded files folder are listed in the pop-up box. Select the one you want to attach to the fax.

Signature file – Allows you to add your signature to the fax cover page. The signature file must first be stored in GIF or JPG format in the Downloaded files folder. The signature is placed under the *Remarks* field, but not shown on the display.

No image – No signature is attached to the fax.

[File name] – All the available files in the Downloaded files folder are listed in the pop-up box. Select the one you want to attach to the fax.

Fax call barring – This network service allows you to place restrictions on outgoing and incoming faxes.

Fax call diverting – This network service allows you to divert incoming faxes to another fax machine. For more information and instructions on how to change diverting and barring settings, see "Telephone settings" on page 53.

Resend – Allows you to choose which pages will be sent again if the fax sending has failed and the Document outbox tries to send the fax again.

All pages – All pages are resent.

Missed pages – Only the pages which were not sent completely are resent.

ECM – When the Error Correction Mode is *On*, any pages containing errors are automatically received again, until the defects are corrected.

Fax polling – Some networks provide this service which allows you to make a fax call to a fax machine, then receive information by fax. Contact your network service provider for further details.

Note: When you set *Fax polling* to *On*, **Fax polling** becomes one of the commands in the Fax main view.

Alternate fax receiving – As a default, this setting must be set to *As fax*. If your network requires you to receive alternate voice/fax calls, you must set this to *As voice/fax*. This setting applies also to the Fax modem application.

8. Short messages

The Short Messages application is started by pressing the SMS application button on the keyboard.

The Short Message Service (SMS) enables you to send and receive short text messages of up to 160 characters over the digital cellular network. If the message is longer, it will be sent as several short messages.

To send and receive short messages, the Short Message Service must be supported by the network you are using and activated for your SIM card; the SMS message centre number must be stored in the settings of the SMS application; and the phone must be on. Contact your home service provider for details.

SMS messages can be sent or received even during a voice or data call. Messages can be read in any wireless phone that has the capability. If the receiving phone is off at the time of sending, the SMS message centre continues to attempt to send the message until the validity period allowed by the network expires.

The SMS main view shows the following folders:

Own texts — Texts that you have written.

Received messages — Messages that you have received.

Standard messages — Predefined message templates.

Business cards — All contact cards in the Contacts directory.

Info messages — Informative messages sent by the network.

Delivery reports — Information about the status of sent messages.

Document outbox — See "Document features" on page 24.

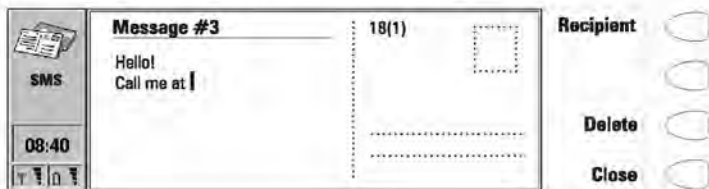

Figure 1

To send short messages

To write a new short message

- 1 Press **Write message** in the SMS main view to open the short message editor, which resembles a postcard. A character counter showing how many characters you have typed and in how many messages they will be sent appears at the top of the postcard, see figure 1.
- 2 Write the message.
- 3 When the message is ready to be sent, press **Recipient**. The SMS directory opens.

Note: You can only send short messages to wireless phone numbers stored in the *Tel(GSM)* field of contact cards.

To send a previously written document

- 1 Select the Own texts folder and press **Open**.
- 2 Select a document and press **Open**. When you open a text containing formatting, you will be asked whether you wish to make a copy of the text (press **Copy**), or edit the original text (press **Edit**). Editing will lose the formatting of the original text.
- 3 When the message is ready to be sent, press **Recipient**. The SMS directory opens.

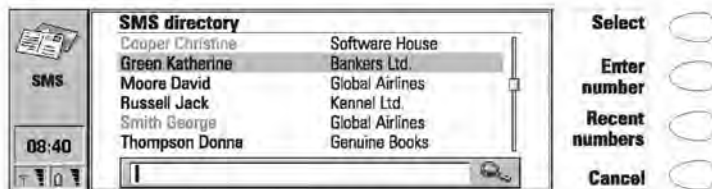

Figure 2

To select a recipient

There are three ways to select a recipient for your short message:

- 1 Select a contact in the SMS directory, and press **Select**. Or,
- 2 Press **Enter number** and enter the phone number manually. Or,
- 3 Press **Recent numbers** to get a list of recent short message numbers, open one of the lists, select a contact, and press **Select**.

Tip: If you press **Clear both lists** in the Recent numbers view, all information in the lists is removed. When you open one of the lists and select a contact, **Create card** enables you to create a contact card for the contact.

If you want to add more recipients to the message, press **Add recipient**.

If you want to select the recipients from your SIM card, press the Menu button, select *SIM card memory*, and choose the recipients.

Tip: To send the message to several recipients, use multiselection, see "Document features" on page 24, or create a contact group, see "Contact groups" on page 45.

To send the message

- 1 If necessary, adjust the sending options for the current message by pressing **Send options**. Press **Change** to set a new value for the current message. The send options, *Reply via same centre*, *Validity period*, *Message centre in use*, *Message conversion* and *Request delivery report*, are the same as in the SMS settings, see "SMS settings" on page 70.
- 2 Press **Send**. If your message is longer than 160 characters, it will be sent as several short messages, provided that your network supports this feature.

To receive messages

Short messages are received automatically, provided that this service is available and that the phone is on and within network coverage. A received short message can be a normal short message, business card or a service card. All received short messages go to the Received messages folder.

When a new short message has arrived, a tone will sound – unless the device is set to a silent profile – and an information note is shown on the display.

When you open a received message, the stamp on the right half of the message is postmarked, and the time and date the message was sent are shown below the sender's name or number.

To read a message

There are two ways to read a received message:

- 1 When you receive a note informing you of a received short message, press **View** to read the message. Or,
- 2 Press **Cancel** to dismiss the note. You can then open the Received messages folder where unread received messages are marked with 

and unread received business cards with . Select the message and press **Open**.

To reply to a received message

- 1 Select the Received messages folder and press **Open**.
- 2 Open the selected document and press **Reply**. The contents of the received message are not included in the new message automatically. If you want to include them, press the Menu button and choose the *Reply (include text)* option.
- 3 Write the message and press **Send**.

To forward a received message

- 1 Select the Received messages folder and press **Open**.
- 2 Open the selected document, press **Forward**. The contents of the received message are included in the new message.
- 3 Press **Recipient** and select a recipient from the SMS directory.
- 4 To send the message, press **Send**.

To use the Menu button

When you press the Menu button in an opened received message, you can also use the following options:

Find number – If the message contains phone numbers, press **Next number** to toggle between these numbers and to select one of them. Press **Call** to make a phone call to the number.

Reply (include text) – Replies to a SMS message and includes the received SMS in your reply.

Find URL – If the message contains URL addresses, press **Next URL** to toggle between these addresses and to select one of them. Press **Fetch** to start the WWW application and to open a connection to the selected address.

Print – Prints the message.

Service cards

A DTMF service provider may send DTMF sequences to its subscribers in the form of a service card that can be stored in the Contacts directory. For more information on DTMF tones, see "To send DTMF tones" on page 140.

Standard messages

You can store frequently used short messages as standard messages, and send them instead of writing a new message every time. Standard messages are stored in the Standard messages folder.

To write a new standard message, open the Standard messages folder and press **Write message**. The commands in a new standard message are:

Recipient— Opens the SMS directory.

Delete — Removes the standard message from the Standard messages list.

Close — Returns to the Standard messages folder.

Business cards



Figure 3

A business card is a special short message containing personal information about a contact, just like a normal business card. You can send your own business card or any contact card as a business card.

Business cards sent from a device that supports the Nokia 9110 Communicator contact card format can be saved directly as new contact cards in the Contacts directory. Just open the received business card and press **Create card**.

Tip: When you have received a business card, press **Reply** to send your own business card to the sender.

To send a contact card as a business card

- 1 Open the Business cards folder.
- 2 Select a business card and press **Open**.
- 3 Press **Options** to define which fields to include in the business card. **Change** toggles the fields on or off.
If you are sending the business card to a Nokia 9000 Communicator or a wireless phone, select *Compact*. This makes the business card to a compatible format. If you are sending the business card to another Nokia 9110 Communicator or a Nokia 9000i Communicator, select *Generic*.
- 4 Press **Recipient** to select a recipient for the business card. Or, if you want to send the business card to another communicator via the infrared link, press **Transfer via IR** (be sure to activate the Infrared activation application in the receiving communicator).
- 5 Press **Send**.

Note: Sending a business card with an attached picture makes the message very long and may be expensive.

SMS settings

Press **Settings** in the SMS application main view to change the settings. The settings you define here are used until you change them again.

Message centre settings – In order to be able to send short messages, you must have stored the number of the message centre in this setting and selected which message centre you want to use in *Message centre in use*. You can add new or edit existing message centre numbers in *Message centres*.

Note: The message centre number may be included in some SIM cards. If you use several SIM cards in your communicator, make sure that this setting contains the appropriate message centre number.

Reply via same centre: Yes / No – This network service allows the recipient of your short message to reply using your short message centre. By setting this option to *Yes*, you allow the recipient to reply to your message, even if the recipient does not subscribe to the Short Message Service, provided that the recipient has the means to type a reply message.

Validity period: 1 h / 6 h / 24 h / One week / Maximum – If the recipient of a message cannot be reached within the set validity period, the message is removed from the message centre. If *Maximum* is chosen, the validity period is set to the maximum value allowed by the message centre. Note that the network must support this feature.

Message conversion: None (sent as a normal short message) / *Fax / X.400 / Paging / E-mail / ERMES / Speech* (message synthesised from a short message) – In order to receive a converted message, the recipient must have an appropriate device available, and the network must support this feature. For example, if you choose *Fax*, the recipient must have a telefax machine or similar device connected to the number.

Request delivery report: Yes/No/Show immediately – When this network service is set to *Yes*, the status of the sent message (*Delivered, Pending, Failed*) is shown in the Delivery reports folder. When set to *Show immediately*, you will receive a note when the message has been delivered to the recipient.

Send long messages: Yes/No – If set to *No*, messages that are longer than 160 characters are sent as several SMS messages. If set to *Yes*, messages that are longer than 160 characters are sent as several messages, but if the recipient

has a Nokia 9110 Communicator or a Nokia 9000i Communicator, the messages are received as one long message.

Receive info messages: Yes/No/View index – If your network supports this feature, it will send you information about various topics. If you choose *View index*, the network will send you a list of topics, and you can select those topics on which you wish to receive information.

Info service mode: Display and save/ Display only/Save only – If this is set to *Display and save*, messages are displayed and saved in the Info messages folder. If you select *Save only*, info messages are not displayed but saved in the folder. If you select *Display only*, messages are displayed but not saved.

Info service language – You can select in which languages you want to receive info messages. Select either *All*, or a maximum of four languages.

Info service topics – Message topics vary according to the operator. You can define here what type of messages you want to receive. For more information about the Info service, contact your service provider.

9. Internet

To obtain access to the Internet, the cellular network you use must support data calls; the data service must be activated for your SIM card; you must have obtained an Internet Access Point (IAP) from an Internet service provider; and you must have entered the proper Internet settings.

Your service provider will give you instructions on how to configure the Internet settings. Follow the instructions carefully.

Tip: With one Internet application active, you can quickly switch to another by pressing the Internet application button. In this way you do not have to make a new data call.

To start an Internet application

- 1 Press the Internet application button on the communicator keyboard.
- 2 Select an application with the selection frame and press **Select**.
- 3 To close an application, press **Close**.
- 4 To disconnect from the Internet, press **Hang up**. The "Disconnecting" note will be shown on the display and the data call will end.

Note: Depending on the network configuration and load, establishing an Internet connection may take up to one minute or even longer.

Internet applications

Mail – An electronic mail application which lets you send and receive e-mail all over the world using the Internet.

World Wide Web (WWW) – A hypertext-based system for finding and accessing resources on the Internet.

Telnet – Allows your communicator to connect to computers that provide terminal services through the Internet.

Terminal – Allows your communicator to connect to computers, such as mainframe computers, that provide direct dial-in terminal services. Both Telnet and Terminal emulate the VT100 terminal.

Text Web – Used for obtaining information from the Internet via SMS.

Tip: There is a glossary of Internet terms and abbreviations at the back of this manual.

To set up your Internet access point

If you do not already have an internet access point (IAP) or you want a new one, this service provides you a convenient way to set up the internet connection.

Before being able to use the Internet services, you need to configure an Internet connection. You can subscribe to the Internet services of selected providers in your country directly with your Nokia 9110 Communicator, provided that the data service is activated for your SIM card. See the instructions below.

- 1 Open the WWW application.
- 2 Select the bookmark "Internet setup" and press **Go**.
- 3 Select your home country in the list with the arrow keys and press **Go**.
- 4 Confirm the operation by pressing **Accept**.
- 5 Select the hyperlink to the Internet service providers and press **Go**. You will be connected to the WWW site where you can select your preferred service provider. The connection is established via a data call.
- 6 When the connection has been made, follow the instructions on the display to select a service provider and to subscribe to their Internet services.

Internet settings

Information concerning the settings must be obtained from your Internet service provider. The service provider may be able to configure the access point for you via a special SMS message, or a WWW page, which sets all the necessary Internet access settings.

To define the Internet settings manually, press **Settings** in the main view of the Internet application.

Note: The Internet settings apply to Mail, WWW and Telnet.

To define an Internet access point

- 1 In the Internet settings main view choose *Internet access* and press **Change**.
- 2 To define a new Internet access point, press **New**. To modify or change an existing IAP, press **Edit**.

Note: The exact values of the settings are provided by your Internet service provider.

The Internet settings are:

Modem initialisation – Enables you to define the modem settings of your communicator:

Autobauding – The data transmission rate is determined automatically. Most networks support this option.

Fixed 9600 b/s – A fixed data transmission rate is used. If you have problems with making a data call, try this option.

Fixed 14400 b/s – Can be used if supported by the network. Do not use this option, unless you are sure your network supports it.

Custom – When a data call is established, the modem is initialised according to the string you enter here.

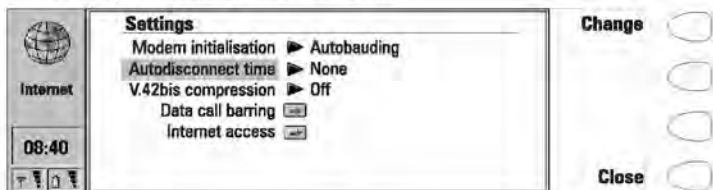

Figure 1

Autodisconnect time: None/2/5/10 minutes – The connection to the Internet will automatically close after the inactivity period defined here.

V.42bis compression: On/Off – Speeds up data transfer, e.g. sending or receiving mail, when supported by the cellular network. Set this to *Off*, unless you are sure your network supports this option.

Data call barring – You can restrict your data calls in the same way as your voice calls, see "Telephone settings" on page 53. To see the current barring mode, press **Get status**. To cancel all barrings, press **Cancel data barrings**.

Internet access – Lists the defined Internet access points. You can configure the communicator differently for each Internet access point. Press **Edit** to change the settings of an existing access point. Press **New** to define a new access point. Press **Delete** to remove an access point.

Provider name – The name of the Internet service provider. If you define the access point manually, the name can be edited freely.

Phone number – The telephone number of the Internet access point.

User name – Enter your user name if required by the Internet service provider. The user name may be needed in the PPP authentication process.

Prompt password: Yes/No – If you must enter a new password every time you log on to a server, or you do not want to save your password, set this to Yes.

Password – Enter your password if required by the Internet service provider. The password may be needed in the PPP authentication process.

Advanced settings – Opens a new set of options with which you can further adjust the Internet access point, if required:

Modem initialisation – Enter any modem initialisation string containing AT commands here, if needed. This initialisation string is executed after the initialisation string you define in the *Modem initialisation: Custom* option of the Internet settings.

Login customisation: None/Manual – Some Internet access points do not automatically enable PPP. In such cases you need to choose either *Manual*, as it allows you to enter your login name and password manually in a terminal connection, or press **New** in the pop-up box, to write and save a new login script.

If you choose *None*, your password and user name are automatically taken from the Internet access point settings.

For more information on login scripts, see the *scripts.txt* file on the diskette supplied with the communicator.

PPP compression: On/Off – Speeds up data transfer when supported by the remote PPP server. If you have problems with establishing a connection, try setting this to *Off*.

IP address – The IP address of the communicator.

Default gateway – The IP address of the system that is a gateway out of the local network.

Network mask – Shows which portion of the IP address of the communicator identifies the network.

Primary nameserver – The IP address of the primary nameserver.

Secondary nameserver – The IP address of the secondary nameserver.

Tip: Some Internet service providers refer to these nameservers as DNS1 and DNS2.

Mail

The Nokia 9110 Communicator mail system is compliant with the Internet standards SMTP, IMAP4, POP3, MIME1 and MIME2.

Mail is started in the Internet main view by selecting Mail and pressing the **Select** command button. The Mail main view shows the following folders:

Own texts – Contains the documents you have written with the communicator. The documents may contain formatted text, but the text will appear in the editor without formatting.

Received mail – Contains mail fetched from the Remote mailbox. See "To fetch mail" on page 82.

Document outbox – The outgoing communications manager of the communicator.

Remote mailbox – Your electronic mailbox service which receives all your mail. This service may be offered by a network operator, your company, or an Internet service provider. The required mailbox and Internet access point settings are described in "Mail settings" on page 77.

Mail settings

Be sure to define your Internet access point as described in "Internet settings" on page 74.

To define the mail settings

- 1 Press **Settings** in the Mail main view.
- 2 Select the item you want to change, and press **Change**.

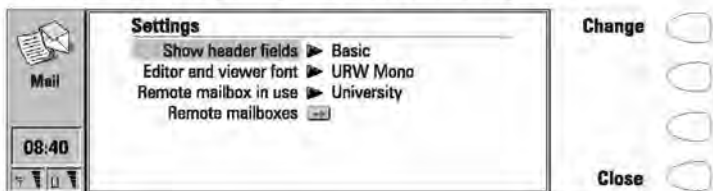

Figure 2

Show header fields – The term header field refers to the information given at the top of an e-mail message. This setting controls which header fields within the received message will be shown when the message is opened:

None – Shows no header fields, although the sender and the subject of the message are still shown in the name of the message.

Basic – Shows the *Date*, *From*, *To* and *Subject* fields.

All – Shows all possible fields.

Editor and viewer font: URW Mono / URW Roman / URW Sans — Determines the font used in the mail editor and viewer.

Remote mailbox in use — Determines the mailbox to which the connection is made.

Remote mailboxes — Press **Change** to open the Remote mailboxes view, where you can add new mailboxes, and edit and remove existing ones. When you press **New** or **Edit** in the Remote mailboxes view, the following options become available:

Remote mailbox name — Enter the name of the remote mailbox. The name can be entered freely.

Internet access — Select which Internet access point you want to use for connecting to this mailbox.

Sending settings — Press **Change** to define the settings of the mail messages you send from this mailbox. The settings are:

Own mail address — You must enter the e-mail address given to you by your Internet service provider. The address must contain the @ character. Replies to your messages will be sent to this address.

Note: E-mail addresses cannot contain accented characters, such as é or ä.

Sending host — The IP address or host name of the computer that sends your Internet mail.

Send mail: Immediately / Upon request / During next connection — Choose *Immediately* to send mail automatically; *Upon request* if you want to write several mail messages and send them at your convenience; or *During next connection* if you want your mail sent the next time you make a connection to the Internet access point that your mailbox uses. See "To send mail" on page 80.

Copy to own mail address: Yes/No — If set to Yes, a copy of the mail will be automatically sent to the address defined in *Own mail address*.

MIME character encoding: On / Off — Allows another MIME-compliant mail system to read the character set used in your communicator. Only when text containing special characters, e.g. á, ä, ß, is sent to a non-MIME-compliant mail system, should the MIME character encoding be turned off. When the MIME character encoding is off, special characters are automatically converted to ASCII characters: á becomes a and so on.

Signature file — Allows you to add your signature to the mail message. The signature file must first be stored as a text file in the Own texts folder, where it is then selected.

Receiving settings – Press **Change** to define the settings of the mail messages you receive to this mailbox. Your remote mailbox service provider will supply you with the required information. The settings are:

User name and Password – These may be required to connect to the server and to open your mailbox.

The password characters appear as asterisks (*) on the display. The user name and password stored here will automatically be offered to the server. If you enter your user name and password incorrectly, you will be prompted to enter them again when you connect to the Remote mailbox. If you enter your user name and password incorrectly three times, the connection to the Remote mailbox will end. For information on how to change the password, contact your remote mailbox service provider.

Receiving host – The IP address or host name of the computer that receives your e-mail.

Folder – *INBOX* is the default folder for your incoming mail. Do not change this setting without consulting your remote mailbox service provider. This setting is only available when the mail protocol is IMAP4.

Protocol: IMAP4 / POP3 – Choose the mail protocol your remote mailbox service provider recommends.

Fetch headers: All / Recent – Determines whether all mail or just the mail received since the last connection will be shown in the Remote mailbox. It is possible to have old or unread mail in the Remote mailbox.

Fetch attachments: Yes / No – Determines whether possible mail attachments are fetched or not. This option is only available if the mail protocol is IMAP4. Note that text attachments are always fetched.

Delete fetched: Yes / No – Determines whether fetched mail will be automatically removed from the Remote mailbox. All fetched mail goes to the Received mail folder.

Timed fetching settings – With this setting you can set your communicator to fetch mail automatically.

Timed fetching: On/Off – Determines whether the timed fetching function is in use or not.

Start at: Date and Time – You can specify the date and time when the communicator starts to fetch your mail. Use the date and time formats specified in the System settings.

Time limit: None/5/10/30/60 min – You can set the time limit for the fetching operation. This way your communicator will not fetch too large messages, which would take too much time.

Frequency: None/ Daily/ Weekly/ Working days/ Every other week/ Monthly— Determines how often mail is fetched.

Size limit: None/5/10/50/100/250 kB— You can set the size limit for the mail to be fetched. This way your communicator will not fetch too large messages, which would take too much time and occupy too much memory.

To send mail

To write new mail

- 1 Press **Write mail** in the Mail main view. An empty mail editor opens.
- 2 Write the message. You can change the font within the Mail settings.
- 3 When the message is ready to be sent, press **Recipient**. The Mail directory opens.

To send previously written documents

- 1 Select the Own texts folder in the Mail main view and press **Open**.
- 2 Select a document and press **Open**. If the document contains text formattings, you will be asked if you want to edit the original and lose all formattings, or create a copy in the Own texts folder and edit the copy instead.
- 3 When the document is ready to be sent, press **Recipient** to open the Mail directory.

To select a recipient

There are two ways to select a recipient for your mail message:

- 1 Select the contact(s) in the Mail directory with the selection frame and press **Select**. If a contact has several mail addresses, a pop-up box opens, listing the available mail addresses. Select an address and press **Select**. Or,
- 2 Enter the recipient's address manually by pressing **Enter address**. Remember that the mail address must contain the @ character, and that the address cannot contain accented characters.

The Mail envelope opens whenever you are about to send mail, see figure 3. All the field entries are editable.

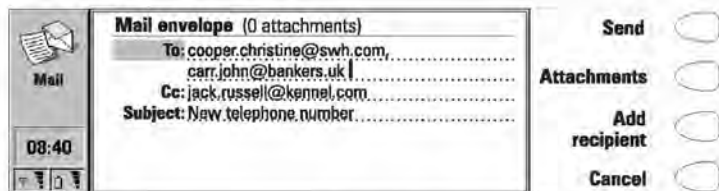

Figure 3

To add addresses to the To or Cc fields of the Mail envelope

- 1 Select whether to add a new recipient to the *To* or the *Cc* field by scrolling to the appropriate field.
- 2 Press **Add recipient**.
- 3 Select the recipients as described above.

Note: Multiple addresses in the *To* and *Cc* fields must be separated by a comma.

To determine how the current mail message will be sent

Press the Menu button in the mail envelope and select *Send options*. To change a setting, press **Change**. The possible options are:

Send mail: Immediately/ Upon request/ During next connection

Copy to own mail address: Yes / No

MIME character encoding: On/ Off

For more information, see "Mail settings" on page 77.

To send mail upon request

When you have several mail messages to send, you may want to use the *Upon request* option. This way you may send all your mail during the same data call.

- 1 Write your mail, select the recipient, press the Menu button and select *Send options*.
- 2 Select the *Send mail: Upon request* option and then press **Send** to send the mail.
- 3 Go to the Document outbox and press **Open**.
- 4 Press **Start** to send your mail.

You can also select the *During next connection* option, with which your mail will be sent automatically the next time you make a connection to the Internet access point your Remote mailbox uses.

To add attachments to the message

- 1 Press **Attachments**.
- 2 A list of attachments opens. To add documents to the list, press **Add**.
- 3 Select the document(s) from the Own texts and Downloaded files folders and press **Select**.
- 4 When all the desired attachments are in the list, press **Close**.
- 5 To send the message, press **Send**.

To fetch mail

E-mail addressed to you is not automatically received by your communicator, but by a Remote mailbox, see figure 4. This is to let you determine which messages you want to read and when. To read your mail, you must first connect to your Remote mailbox and then select the messages you wish to fetch onto your communicator. Connection to the Remote mailbox is established via a data call.

If your Remote mailbox server is capable of sending you special short messages, you will hear a tone - unless the system is set to a silent profile - and see a note when new mail arrives in your Remote mailbox. The message may also contain information about the mail message, in which case you can either fetch or remove the mail by pressing **Fetch** or **Delete** in this SMS message.

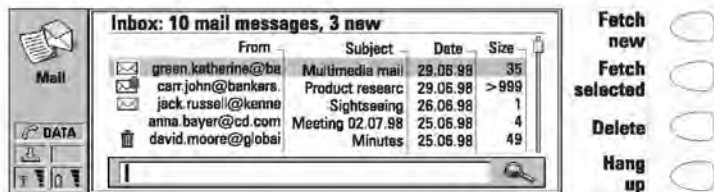





Figure 4

To connect to the Remote mailbox

The Mail and Internet access point settings must be configured correctly. Read "Mail settings" on page 77, and follow the instructions given by your Remote mailbox and Internet service providers.

- 1 Move the selection frame in the Mail main view over the Remote mailbox and press **Connect**.

Unread messages in the Remote mailbox are marked with , unread messages with attachments with  and deleted messages with .

To fetch all new mail

- 1 Once you have connected to the Remote mailbox, press **Fetch new**.
- 2 All mail with the  icon is fetched to the Received mail folder.
- 3 After all new mail has been fetched, connection to the Remote mailbox is closed and the Received mail folder opens.

To fetch a selected message

- 1 Select the mail message(s) you want to fetch and press **Fetch selected**.
- 2 After the mail has been fetched, the Remote mailbox view returns.

To remove a mail message

- 1 Set the *Delete fetched* setting to *Yes* in the Mail settings. All fetched messages are removed from the Remote mailbox. Or,
- 2 Select the message(s) you want to remove with the selection frame, and press **Delete**. If you want to cancel the removing, press **Undelete**.

The messages will be removed when you exit the Remote mailbox. However, all fetched messages will be retained in the Received mail folder.

To use the Menu button

If you press the Menu button in the Remote mailbox, the following options become available:

Change folder – Opens another mail folder.

Create folder – Creates a new folder.

Copy – Copies the selected mail message(s) to another folder.

Move – Moves the selected mail message(s) to another folder.

Remove folder – Removes the selected folder and its contents and subfolders.

Rename folder – Gives the folder a new name.

Off-line – Ends the data call.

On-line – Re-establishes the data call.

To disconnect from the Remote mailbox

- 1 Press **Hang up**.
- 2 If you have messages marked as deleted, you will be prompted to confirm the deletion.
- 3 The connection to the Remote mailbox closes, and the Mail application main view returns to the display. If you have fetched messages, the Received mail folder opens on the display.

To read mail

Mail that you fetch from your Remote mailbox is stored in the Received mail folder.

To read a mail message

- 1 Select the Received mail folder in the Mail main view and press **Open**. Mail messages that have not yet been opened in the communicator are marked with .
- 2 Select the message, and press **Open**.

When you open a received mail, the following commands become available:

Attachments – Lists all MIME attachments: text, image, audio, video or application. If the message does not contain any attachments, this command

is dimmed. When viewing the list of attachments, you may select an attachment and choose from the following options:

View – Opens the attachment if there is enough memory and if the message can be opened in the communicator.

Save – Saves the attachment in the Downloaded files folder.

Close – Returns you to the previous screen.

Delete – Removes the open mail message.

Close – Returns you to the Received mail folder.



Figure 5

To use the Menu button

If you press the Menu button in an opened mail message, the following options become available:

Reply (include text) – Replies to a mail message and includes the received mail in your reply. If the received mail message is a MIME document, only the first text part is copied to the message and may be edited. Attachments cannot be included in the reply message.

Reply – Replies to a mail message without including the received mail in your reply.

Reply all (include text) – Replies to all the persons who received the mail and includes the received mail in your reply.

Reply all – Replies to all the persons who received the mail without including the received mail in your reply.

Forward – Forwards the received mail and the possible mail attachments.

Find URL – This option searches for a URL address in the message. If there is a URL, you can open a connection to the selected address by pressing **Fetch**.

Hierarchical structure – Shows the hierarchical structure of the mail message.

Print – Prints the message.

Scroll to any of these and press **Select**.

World Wide Web

The Nokia 9110 Communicator supports HTML 3.2, with the exception of some features. SSL, the security protocol, is also supported. See "Glossary" on page 167. The WWW browser does not support Java or Java script.

To connect to the World Wide Web, the Internet service must be activated for your SIM card, and you need an account with an Internet service provider.

To open the World Wide Web application, select WWW in the Internet main view, and press **Select**.

To exit the WWW, press **Close** or **Hang up** in the Bookmarks list, which is the main view of the application. This ends the data call and closes the WWW application.

For information on how to create tailored WWW pages for the Nokia 9110 Communicator, see the documents on the CD-ROM.

WWW settings

To change the WWW settings:

- 1 Open the WWW application and press the Menu button.
- 2 Select *Settings*.
- 3 To change a setting, select it and press **Change**.

The WWW settings are:

Autoload images: Yes / No – If set to *Yes*, the communicator automatically fetches the inline JPG or GIF images on a WWW page. When set to *No*, WWW pages are fetched without images and shown much faster.

Clear cache on exit: Yes / No – Most recently fetched WWW pages are kept in the temporary memory of the communicator, the "cache". If set to *Yes*, the cache, history list and cookie file are automatically emptied after you close the WWW application. If set to *No*, the cache stores as much information as possible. When you restart the WWW application, the most recently stored information is fetched from the cache without making a new data call.

Accept all cookies: Yes / No – Determines whether the cookies functionality is enabled. See "Glossary" on page 167.

Default access point – Defines the Internet access point used as a default in the WWW application.

Proxies – To change the proxy settings, press **Change**.

Internet access point – You can select an IAP to be used for this particular WWW page.

HTTP proxy – The hostname of the HTTP proxy server used with the selected IAP.

HTTP proxy port – The proxy port of the proxy server.

Security proxy— The proxy that is used with SSL secure connections.

Security proxy port— The security proxy port of the proxy server.

No proxy for— You may define domains for which the HTTP proxy is not needed. Domain names are separated with commas, for example nokia.com, edu.fi. You may specify the domains as accurately as you wish.

Bookmarks

The WWW main view shows the Bookmarks list. When you select a bookmark from the list, the name of the Internet access point used for connecting to the bookmark is shown on the top right corner. The date when the bookmark was last fetched is shown beside the name of the bookmark. See figure 6.

Below the Bookmarks list is the address field where you can enter the URL address of the WWW page you want to fetch. If you select a bookmark from the list, the address field shows the URL address of the bookmark.

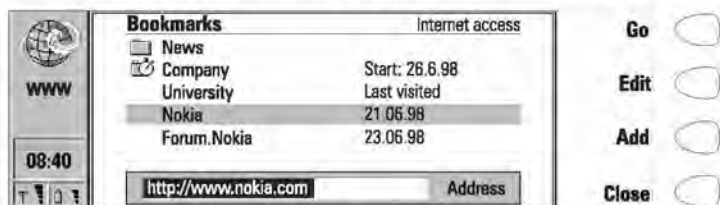

Figure 6

To fetch a WWW page

- 1 Select an entry in the Bookmarks list or enter a URL in the address field.
- 2 Press Go.

Tip: To fetch WWW pages stored in the Own texts or Downloaded files folders of the communicator or the memory card, use the prefix "file:/// " (note: three slashes) instead of "http://".

To add a new bookmark

- 1 Press Add, or if you want to modify an existing bookmark, press Edit.
- 2 Enter the name you want for the bookmark in the *Name* field.
- 3 Enter the URL address of the bookmark, e.g. www.nokia.com, in the *Address* field.

To set advanced bookmark properties

Select *Details* and press **Change**. The advanced settings are:

User name — If a user name is needed to fetch the bookmark, enter your user name here.

Password — If a password is needed to fetch the bookmark, enter your password here.

Internet access selection: Automatic/Manual — If you select *Automatic*, the current or the default IAP is used for this bookmark. If you set this to *Manual*, only the IAP defined in the following setting is used.

Internet access — This setting is available only if the previous setting is set to *Manual*. You can select which IAP to use for the bookmark.

To fetch items with a page already open

You can fetch a WWW page even if you have a page already open:

- 1 Press the Menu button and select *Bookmarks*. A simplified form of the Bookmarks list opens.
- 2 Select an entry in the Bookmarks list or enter the URL in the address field.
- 3 Press **Go**.

To close the Bookmarks list, press **Close**.

To use the Menu button

If you press the Menu button in the Bookmarks list, the following options become available:

History — Contains a list of browsed documents. To fetch a page from the list, select the page and press **Go**. To empty the history list and the cache, press **Clear history**.

Find — You can search for names and addresses in the Bookmarks list.

Open file — You can open files from the Own texts and Downloaded files folders.

Move — You can move the selected bookmark from one folder to another.

Delete — Removes the selected bookmark or bookmark folder.

Create folder — Creates a new bookmark folder.

Import bookmarks — Imports a bookmark file from the Own texts or Downloaded files folder to the Bookmarks list.

Export bookmarks — Converts the bookmark file to the HTML format and saves it to the Own texts folder.

Clear cache — Empties all caches and temporary files.

Settings — Opens the WWW settings. See "WWW settings" on page 85.

To make a smart bookmark

A smart bookmark contains a WWW page which your communicator fetches at certain time. These WWW pages can only consist of text or images, and they cannot be SSL secure.

- 1 Create a new bookmark folder by pressing the Menu button and selecting *Create folder*.
- 2 When the new folder is ready, press *Edit*. The following options become available:

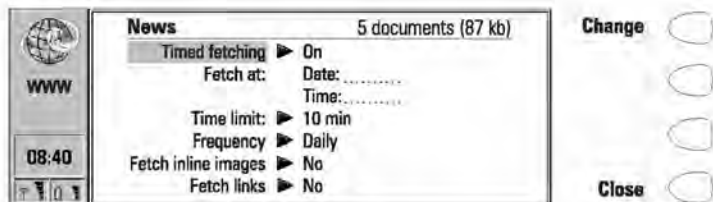

Figure 7

Timed fetching: On/Off – When this is set to *On*, a clock symbol appears in the folder, and the WWW pages in the folder are fetched according to the settings defined below.

Fetch at – You can define the time and date when the pages are fetched. The date and time formats are set in the System settings.

Time limit: None/5/10/30/60 min – You can set a time limit for the fetching process. This way the data call will not last too long and thus become very expensive.

Frequency: None/Daily/Weekly/Working days/Every other week/Monthly – This setting enables frequent fetching of the WWW pages.

Fetch inline images: Yes/No – You can decide whether the inline images in the WWW pages are fetched.

Fetch links: Yes/No – If set to *Yes*, all links to other texts and images in the defined WWW pages are fetched. If set to *No*, only the WWW pages are fetched.

- 3 Press *Close*.
- 4 Select the page(s) you want to fetch with the selection frame and press the Menu button.
- 5 Select *Move* and then choose the folder which you just created. The bookmark(s) will be moved to that folder.

Pages fetched with the smart bookmarks function are stored in a folder cache. To empty the cache, press the Menu button in the smart bookmarks view and

select *Empty folder cache*. If you select *Go*, all the items in the folder are fetched in the folder cache.

Note: SSL secure WWW pages are never stored in the cache.

To navigate in WWW

- 1 Select a bookmark in the Bookmarks list or enter a URL address into the address field and press **Go**.
- 2 If the WWW page was already recently fetched, the page is fetched from the cache. If not, the page is fetched from the Internet by making a data call to the selected Internet access point.
- 3 Some servers have access restrictions that require a valid user name and password. In this case, you will be asked to enter the user name and password before the WWW page can be fetched. The communicator stores the passwords and user names that you enter to gain access to that domain, and the next time you connect to the same domain, they will be offered automatically.

Note: Stored passwords to individual web sites are removed when the communicator is rebooted or the cache emptied.

- 4 When the WWW page is being fetched, the line on top of the display shows the status of the connection, the title of the page, and how many bytes of the page have been received.

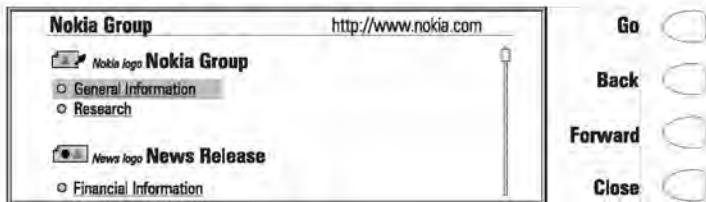

Figure 8

When the page is on the display, use the arrow keys to scroll the view and to choose hyperlinks and hotspots. Each arrow key press selects the nearest hyperlink or hotspot, or moves the view one line up or down. See figure 8.

Tip: To select the next or previous hyperlink on the WWW page, press the Tab key or Shift + Tab, respectively.

To use the navigation commands

After the WWW page has been fetched, the following commands become available:

Go — If there is a link to another WWW page in the currently open page, select the link with the selection frame and press **Go** to fetch the page. If the selected item is a button for sending or resetting a form, **Go** either sends the form or resets it to default values.

Get image — If the selected item is an inline image icon, the first command changes to **Get image** with which you can fetch the image. If the image is of an unsupported format, the image icon looks broken on the display and cannot be selected.

Change — If the selected item is a selection list, check box or radio button, the first command is **Change**. With **Change**, you can tick the box or button on and off.

If you have a form open, **Change** allows you to attach a file to it. You can select the attachment from the Own texts, Received messages/mail and Downloaded files folders. Press **Open** to open the folder, choose the desired file and press **Select**.

Back — If you have browsed through at least two WWW pages, **Back** allows you to fetch the previous page.

Forward — If you have browsed through at least two WWW pages, and viewed the previous page with the **Back** command, you can fetch the next page by pressing **Forward**.

Close — Returns to the Bookmarks list.

Cancel — Interrupts the fetch operation.

Tip: You can copy text on the WWW page by pressing Ctrl-C. You can then for example open the Notes application, open a new document and paste the copied text into the document by pressing Ctrl-V. You can also print the copied text in the Notes application.

To use the Menu button

When you have a WWW page open and you press the Menu button, the following options become available:

Add bookmark — Adds the current address to the Bookmarks list.

History — Contains a list of browsed documents.

Find — You can search for various items, such as words in the WWW page.

Open file — You can open files from the Own texts and Downloaded files folders.

Bookmarks—Opens the Bookmarks list where you can select a new page to be fetched.

Go off-line—Ends the data call.

Reload—Reloads the current WWW page from the network.

Tip: You can also reload a WWW page by pressing Ctrl-R.

Activate automatic update (Ctrl-U)—With this option the opened WWW page updates itself continuously in every 10, 30 or 60 seconds. This is very convenient for example when browsing stock exchange WWW pages.

Note: The continuous updating disables the *Autodisconnect time* function. Therefore, the data call does not go off-line, which may make the call expensive.

Disable automatic update (Ctrl-U)—Stops the continuous updating of the WWW page.

Save—Saves the page contents or the image to the Downloaded files folder, or adds the address of the page to the Bookmarks list.

Clear cache—Empties all caches and temporary files.

Settings—Opens the WWW settings. See "WWW settings" on page 85.

To view images

Images that are part of the fetched WWW page are called inline images. By default, inline images are not fetched with the WWW page, but will be displayed as icons, unless the option *Autoload images* is set to *Yes* in the WWW settings. To fetch an image, select the image icon and press **Get image**. The communicator is capable of fetching images that are in JPG or GIF format.

Inline images can also be image maps. An inline image map acts like a hyperlink. A fetched image map contains a cursor that can be moved with the arrow keys. When you press **Go**, the pixel coordinates of the cursor are sent to the server, and the corresponding WWW page is fetched.

Images that are separate documents and not part of a hypertext document are called external images. When an external image is fetched, it is viewed separately from the hypertext document in the image viewer. The commands in the external image viewer are the same as in the fax viewer.

To download add-on software

The WWW application can be used to install applications and plug-ins on your communicator. If you install plug-ins, the WWW application activates them when necessary.

- 1 Go to the WWW page where the add-on software package exists.
- 2 Select the hyperlink that points to the software package.
- 3 Press **Go** to fetch the package. After the software package has been successfully fetched, the software installation view opens.

Press **Install**. If there is sufficient memory available, the software will be installed.

Caution: Beware of viruses. Only install on the communicator software you have obtained from sources that offer adequate protection against viruses.

Terminal

The Terminal application is started in the Internet main view by selecting Terminal and pressing **Select**. The Terminal application is used to connect directly, not via the Internet, to a remote computer by way of a data call.

The Terminal main view shows the defined Terminal connections. The Terminal application is similar to the Telnet application, in that both of them emulate the VT100 terminal display. See figure 10.

To connect with a pre-defined Terminal connection, select the connection and press **Connect**.

To create new or edit existing connections, press **Define**.

To change the settings for incoming data calls, press **Settings**, select the setting and press **Change**. The available settings are:

Local echo for incoming data call – If set to *On*, characters typed from the communicator keyboard are echoed locally to the communicator. If set to *Off*, they are echoed to the remote host computer.

Line end for incoming data call – Defines which character is generated with the Enter key in incoming data. The alternatives are: Carriage return (*CR*), Linefeed (*LF*), and Carriage return - Linefeed (*CR/LF*)

To define Terminal connections

After you have pressed **Define** in the Terminal main view, the defined Terminal connections are shown.

To remove the selected connection, press **Delete**.

To edit existing connections, press **Edit**, or press **New** to define new Terminal connections. The following settings become available:

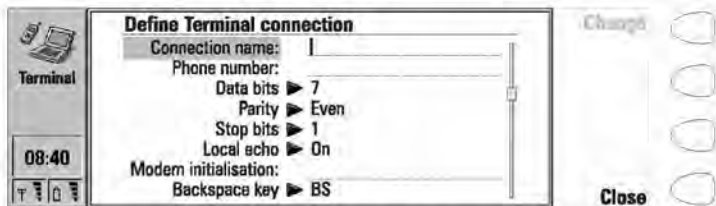

Figure 9

Connection name – Write the name of the connection. The name can be defined freely.

Phone number – The phone number for accessing the service. The phone number may include spaces and hyphens.

Data bits: 7/8 – Service/host-specific communication parameter.

Parity: None/Odd/Even – Service/host-specific communication parameter.

Stop bits: 1/2 – Service/host-specific communication parameter.

Local echo: On/Off – If set to *On*, characters typed from the communicator keyboard are echoed locally to the communicator. If set to *Off*, they are echoed to the remote host computer.

Modem initialisation – Enter here a modem initialisation string containing AT commands, if needed. This initialisation string is executed after the string you define in the *Modem initialisation: Custom* option of the Internet settings.

Backspace key: BS/DEL – Defines whether the keyboard backspace key is used as a backspace or delete key.

Line end – Defines which character is generated with the Enter key in the terminal session. The alternatives are: Carriage return (*CR*), Linefeed (*LF*), and Carriage return - Linefeed (*CR/LF*).

Terminal connection

When you have connected to the remote system, the following commands become available:

Press **Keys** to emulate the VT100 special keys, which are not available on the communicator keyboard. The special keys include:

Four function keys: PF1-4. The specific function of these keys depends on the service or program to which you are connected.

All VT100 application keypad keys: numbers 1-9, hyphen, comma, period, enter.

The following VT100 functions: reset terminal, Ctrl-\, Ctrl-], Ctrl-~, Ctrl-?.

The selected special character is entered to the left of the cursor by pressing **Insert**.

The arrow keys can be used for scrolling the view. Scrolling does not affect the cursor position. Pressing any keyboard key returns the view to the cursor position.

Press **Hang up** to close the connection to the host, end the data call and return to the Terminal main view.

To transfer text

The purpose of the text transfer function is to enable you to send text from the communicator to the host computer, or to copy text from the host computer to the communicator. This function can be used, for example, to send pre-written mail messages to the company mainframe computer, or alternatively, copy received mail and then read it later, off line.

To send text to the host computer

- 1 Press **Send text**.
- 2 Open one of the folders shown and select the document you want to send.
- 3 Press **Send**. If you want to stop the sending procedure, press **Stop sending**.

While the text is being sent, the keyboard is inactive.

To copy text from the host computer

- 1 Prepare the text reading application on the host.
- 2 Press **Capture text**. All interaction with the host will be recorded in a file in the Downloaded files folder. Control characters, except line changes, will not be stored.

Press **Stop capture** to end the text capture process.

Telnet

The Telnet application is similar to the Terminal application, in that both of them emulate the VT100 terminal display. See figure 10.

Note: The Telnet application can be installed to your communicator from the CD-ROM included in the sales package.

Once a Telnet connection is established, you must in most cases enter your login name and a password in order to be able to use the services provided by the host computer. The Telnet main view shows all pre-defined Telnet hosts.

To connect to a pre-defined Telnet host, select the host and press **Connect**.

To create new or edit existing connections, press **Define**.

To define Telnet connections

After you have pressed **Define** in the Telnet main view, the defined Telnet connections are shown.

To remove the selected connection, press **Delete**.

To edit existing connections, press **Edit**, and to define new Telnet connections, press **New**. The following settings become available:

Connection name – Write the name of the connection. The name can be defined freely.

Destination host – Enter the connection address. The host is identified by either a numeric IP address or a textual host name. If required, place the name of the destination TCP port after the IP address, separated by a colon (:).

Internet access points – Select an Internet access point from those currently defined. To change the IAP, press **Change** and select a new IAP from the list.

Backspace key: BS/DEL – Defines whether the keyboard backspace key is used as a backspace (*BS*) or delete (*DEL*) key.

Telnet connection

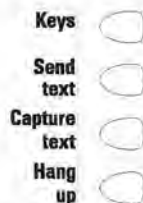
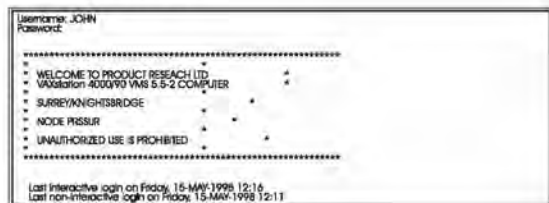

Figure 10

When you have connected to the remote system, press **Keys** to emulate the VT100 special keys, which are not available on the communicator keyboard. The special keys include:

Four function keys: PF1-4. The specific function of these keys depends on the service or program to which you are connected.

All VT100 application keypad keys: numbers 1-9, hyphen, comma, period, Enter.

The following VT100 functions: reset terminal, Ctrl-[, Ctrl-], Ctrl-~, Ctrl-?.

In a Telnet connection, these special keys include the following commands that can be used in the remote systems that support them:

Interrupt – Interrupts the current process on the remote computer.

Skip command output – Prevents the commands from being shown on the display.

Are you there? – Enquires whether the remote system is still running, if the execution of a task seems to take too long.

Select a special character and press **Insert**. The inserted special character sends a control signal to the remote computer; it is not shown on the display.

The arrow keys can be used for scrolling the view. Scrolling does not affect the cursor position. Pressing any keyboard key returns the view to the cursor position.

Press **Hang up** to close the connection to the host, end the data call and return to the Telnet application main view.

Note: The text transfer function is also available in Telnet. See "To transfer text" on page 94.

Text Web

With Text Web you can fetch information from the Internet, using SMS. Such information can include for example flight schedules, weather reports and stock news. You can also access services provided by your network operator and Nokia.

Nokia services

The contents are maintained by Nokia, and they cannot be changed. Nokia updates the contents from time to time.

Operator services

The Operator services allows the network operator to provide various services to the subscribers. The operator-specific items may vary from subscriber to subscriber, and can be updated by the network operator.

To define services

- 1 To define new service access points, press **Settings** in the Text Web main view.
- 2 Press **New** to open an empty service information card, or press **Edit** to modify an existing service. Enter the title of the service, the server number, which is a message centre number, and the service number, which is a phone number.

To fetch information

- 1 In the Text Web main view, scroll to one of the service access points that you have defined and press **Select**.
- 2 Enter in the space provided a keyword that describes the type of information you are looking for. If you press **Get keywords**, you will receive a list of available keywords. **History list** contains keywords that you have used previously.
- 3 To send the keyword, press **Send**. When you receive a reply from the service provider, the TTML browser opens up.

To use the browser

Press the arrow keys on the keyboard to move from one hotspot to another.

To follow a hyperlink, press **Fetch**. With **Change** you can tick off boxes and buttons.

To add the form to the Saved forms list, press **Save** and select *Save form*. To copy the text to the Downloaded files folder, select *Copy text*.

To send the form, press **Send**.

Quiz of the Day

An adult ostrich weighs

100 kg

150 kg

200 kg

Name: _____

Information may be used for advertising

Change ○

Send ○

Save ○

Close ○

Figure 11

Saved forms

Saved forms is a "hotlist" to which you can add items from the other services. It grants you quick access to Internet services.

To open the selected form, press **Open**. The TTML browser opens up with the same commands as above.

To rename a service, press **Rename** in the Saved forms main view. To remove the selected form, press **Delete**.

10. Notes

Notes is used for writing texts and managing various documents stored on the communicator.

Note: When you open a document, the document is opened in the appropriate editor or viewer. The available commands vary according to the editor/viewer.

Folders in the Notes main view are:

Own texts – Written mail, faxes, short messages, notes and memos

Received faxes/ messages/ mail – All received documents

Downloaded files – Documents downloaded with the Internet applications

Document outbox – Documents waiting to be sent

If you have a memory card inserted in the communicator, the memory card icon will be shown at the bottom of the folders list. See figure 1.

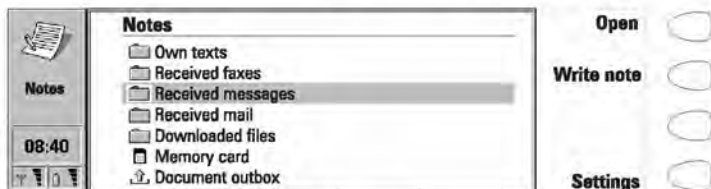

Figure 1

To write a document

- 1 Press **Write note**. The note editor opens.
- 2 Write the document.

To read a document

- 1 Select a folder and press **Open**.
- 2 Select a document from the list and press **Open**.

Note: If the opened document is very large, i.e. dozens of pages long, the time required before the document opens, is longer than with smaller documents.

To print a document

- 1 Open the document.
- 2 Press the Menu button and select *Print*.

For more information, see "Document features" on page 24.

To remove a document

- 1 Select a folder and press **Open**.
- 2 Select a document from the list and press **Delete**.

To make a subfolder

- 1 Select a folder and press **Open**.
- 2 Press the Menu button and select *Create folder*.
- 3 Write down the name of the folder and press **OK**.

To remove a subfolder

- 1 Select the folder under which the subfolder is located and press **Open**.
- 2 Select the subfolder and press **Delete**.

Note: Calendar memos and Contact images are permanent subfolders and thus cannot be removed.

To use the Menu button

When you press the Menu button in an opened folder, the following options become available:

Rename – You can give a new name to the selected subfolder or document. Permanent folders cannot be renamed.

Copy – You can choose a folder into which the selected document will be copied.

Move – You can choose a folder into which the selected document will be moved.

Create folder – You can make a new subfolder.

Copy to sounds – You can add the selected tune to the list of ringing tones.

Transfer via IR – You can copy files to another Nokia 9110 Communicator via the infrared link. The IR port of the receiving device must be activated before the operation. See "Infrared activation" on page 118.

To edit documents

For information about the available editing shortcuts see "Document features" on page 24.

Documents that open in the Notes editor can be directly edited and formatted. To format the text, press **Style**. Choose from the following options:

Font: URW Mono / URW Roman / URW Sans (true type fonts)

Size: 10 / 12 / 14 / 18 / 24 / 36 / User defined (measured in points)

Bold (Ctrl-B): On / Off

Italics (Ctrl-I): On / Off

Underlined (Ctrl-U): On / Off

Justification: Left / Centred / Right / Full

Margins— Opens a new view where you can choose a value for the top, bottom, left and right margins. The unit of measurement is either inches or centimetres, chosen in the System settings, see "System settings" on page 113.

A new style setting affects all new text from the cursor point forward. The margin settings, however, apply to the whole document. If you wish to change the settings permanently, do it in the main view settings, see "Notes settings" on page 103.

Special characters

The special character key, Chr, on the communicator keyboard is used to create characters that are not included on the keyboard. The character key can always be used when you are able to enter characters from the keyboard.

To insert special characters from the character table

- 1 Press and release the Chr key. The character table opens on the display, see figure 2.
- 2 Move the selection frame over the desired character with the arrow keys.
- 3 Press **Insert** to close the character table and to insert the selected character to the left of the cursor.

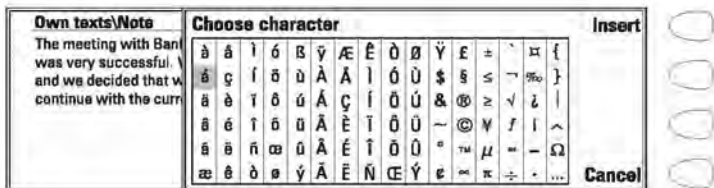

Figure 2

To insert special characters from the keyboard

- 1 Press and hold the Chr key and simultaneously press a key with a special character printed on the key as the third character. The special key will be inserted on the display.

In addition, special characters can be generated using certain unmarked keys, for example, "a" and "e":

- 1 Press and hold the Chr key and simultaneously press a letter key. The first special character is displayed.
- 2 Continue to hold down the Chr key and press the letter key again. The second special character is shown in the place of the first, and so on, until the first character is shown again. The case of the special character is determined by whether Shift or the Caps lock key has been pressed.

To send documents

When you press **Send** in the Notes editor, the following options become available:

Send as fax – You can send the document as a fax. This option opens the fax directory. The sending procedure from this point on is similar to that described in "To send faxes" on page 59.

Send as short message – You can send the document as a short message. The sending procedure is similar to that described in "To send short messages" on page 66.

Send as mail – You can send the document as an e-mail message. The sending procedure is similar to that described in "To send mail" on page 80.

Downloaded files and read-only documents

All downloaded and captured texts can be opened in the Note editor.

Received short messages, received mail and ASCII text files transferred to the communicator are read-only documents. Read-only documents themselves cannot be edited, but an editable copy can be created:

- 1 Open a read-only document. The contents are shown as plain text.
- 2 Press any character key. You will be asked if you want to create an editable copy.
- 3 Press **Create** to close the original file and copy its contents to a new text file. If the original file is in DOS format, it will be removed after an editable copy has been created.
- 4 Edit the new note normally.

The contents of a received fax cannot be converted into text or edited. Opening a fax activates the fax viewer and opening an image activates the image viewer.

Notes settings

You can change the default settings of the note editor by pressing **Settings** in the Notes main view. The settings are valid until they are changed again.

To change the settings, choose a setting and press **Change**.

Font: URW Mono / URW Roman / URW Sans

Size: 10 points / 12 / 14 / 18 / 24 / 36 / User defined

Margins – Opens a new view where you can define values for the top, bottom, left or right margin. The unit of measurement used in this setting is either inches or centimetres, and it can be changed in the System settings.

11. Calendar

In the Calendar application, you can check your scheduled events, keep a list of tasks in the To-do list, set alarms and link memos to events, and book events in other people's calendars.

Tip: In order to optimise the amount of data stored on your communicator and the operation of the Calendar, it is recommended that you regularly remove old calendar events with the Data removal function. See "Data removal" on page 121.

Monthly schedule

The monthly schedule shows the days of the current month in rows according to the number of the week. The week number is shown in the column on the left.

Today's date is shown in a frame (in the figure 1, August 6th).

The currently selected date has a dark background with white digits (August 28th). Use the arrow keys to select another date.

Dates that have scheduled events are marked in **bold** (August 9th).

If the selected date contains scheduled events (as in the figure, August 28th), they are shown in a separate daily events list on the right side of the display. The schedule can be edited by selecting the date and pressing **Day** or the Enter key.

If the whole date has been reserved for an event, the event is shown in the daily events list in **bold** (as "Design conference" in figure 1).

To write yourself reminders of important matters, press **To-do list**.



Figure 1

Tip: To add events to the monthly and weekly schedules, just start writing the event description. The Details view opens automatically.

Weekly schedule

The weekly schedule shows the timetable of the selected week.

Today's date is outlined by a square frame (Tuesday 17th in figure 2).

The currently selected time box is shaded (Thursday 19th, 12:00 in figure 2).

All the events are marked with grey bars according to their start and end times. The bars are thinner if the events of the day overlap (Friday 20th in figure 2).

If the whole day has been reserved for an event, all the time boxes are marked with a dark grey bar (Tuesday 17th in figure 2).

To open the daily or the monthly schedule, press **Day** or **Month**, respectively.

You can use the arrow keys to scroll inside a day in the weekly schedule.

If you scroll to a time box containing an event, the bar across the bottom of the weekly schedule will show the basic details of the event. See figure 2. The numbers to the right of the event description indicate the number of events contained within that time box, e.g. "2/3" means that you are seeing the details of the second of three events.

If a time box contains more than one event, you may view the basic details of each event by scrolling to the time box and pressing the Tab key on the keyboard. The details will be shown on the bar across the bottom of the weekly schedule. To view the previous event, press Shift and Tab.

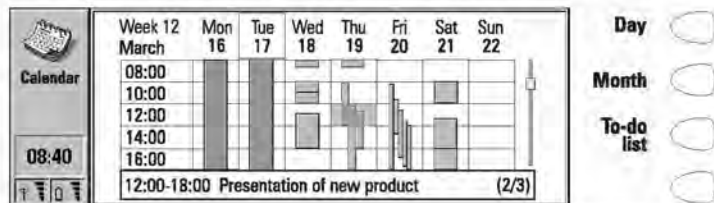

Figure 2

Daily schedule

Open the daily schedule by pressing **Day** in the monthly or weekly schedule. The daily events list displays the schedule for the selected day. The contents of the entries are freely editable.

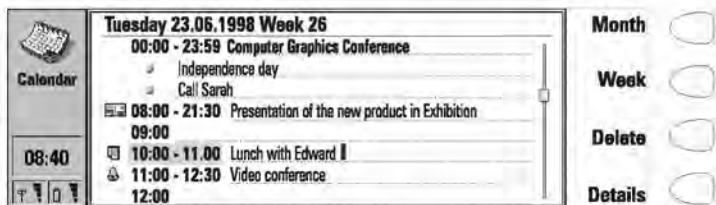







Figure 3

Daily schedule symbols

-  — Attached alarms
-  — Calendar bookings
-  — Attached memos
-  — Recurring events
-  — Annual events

The symbols appear in the order of priority before the event description. See figure 3.

To add events

- 1 Move the selection frame over the starting time of the event.
- 2 Type the event on the dotted line. If you want to add an event without a start time, write the event, press **Details** and remove the start time. The event will be shown with a dot in front.

Tip: If the starting time already contains an event, press **Enter** to create a new row with the same starting time.

To remove events

Select the event and press **Delete**. If you remove or edit recurring events, you will be asked if you want to apply the changes to all or only to the selected event.

To adjust the details of the selected event

Press **Details**. A new view opens, allowing you to adjust the following details:

Description — The description of the event.

Reserve whole day(s) – You can write down the number of days required for the event.

Start:

Date – The date of the event. The default date is that of the selected day. The date format is set in the System settings.

Time – The time when the event starts.

End:

Date – The date when the event ends.

Time – The time when the event ends.

Alarm – Sets an alarm for the selected event. See "Alarms" on page 111.

Frequency – You can define how often the event repeats. The options are *None /Daily /Weekly /Monthly /Annually /Every other week /Working days*.

Repeat until: [date] – You can write down the last date of the recurring event.

Event sent to – Lists all the people to whom you have booked the event. The list shows the status of the sent event:

Accepted or Confirmed – The recipient has accepted the booking.

Discarded – The recipient has rejected the booking.

No reply – No information has been received from the recipient.

Forced – The booking was sent as a reservation.

To attach memos to an event

- 1 Move the selection frame over the desired event and press **Details** in the daily schedule.
- 2 Press **Memo**.
- 3 Write the memo. The following command buttons are available:
 - Send** – You can send the memo as a fax, SMS or mail.
 - Style** – You can format the text.
 - Delete** – Removes the memo.
 - Close** – Links the memo to the selected event.

Memos are stored in the Calendar memos subfolder of the Own texts folder.

To use the Menu button

When you press the Menu button in the monthly, daily and weekly schedules, the following options become available:

To-do list – Opens the To-do list. Available in the daily schedule only.

Pending requests – Opens the list of pending calendar event requests.

Today – Shows the current day.

Next month/week/day (Ctrl-N) – Shows the next month, week or day.

Previous month/week/day (Ctrl-P) – Shows the previous month, week or day.

Settings – Enables you to change the following options:

Booking password – You can set a password to protect your calendar from receiving reservations from anyone except those who have your password. The maximum length of the password is 8 characters. When a password is written in the field, all characters appear as asterisks.

Default alarm – When you set an alarm to an event, the alarm will go off 10 minutes before the scheduled time of the event, unless you specify otherwise here.

Beginning of week – You can select which day is considered to be the first day of the week.

Calendar booking

Calendar booking enables you to send event requests or reservations to other communicators or calendar servers. The difference between an event request and an event reservation is that the recipient may decide whether to accept or discard an event request, but event reservations can only be accepted.

Booking password

Sending event reservations requires that you know the recipient's booking password. If you add the recipient's password to the booking password field of the recipient's contact card, the password is automatically taken from there when you send a reservation.

When you send a reservation with an incorrect password, the recipient's communicator discards the reservation.

You can give your own booking password to those whom you allow to send reservations to your calendar. If you do not set a password, your communicator accepts all reservations.

Define your booking password in the Calendar settings.

Note: The recipient's booking password is not needed when you send event requests.

To make requests and reservations

- 1 Select an event in the daily schedule or write a new one.
- 2 Press **Calendar booking** in the Details view.
- 3 Select whether to send the event as a request or a reservation.
- 4 Press **Transfer via IR** to send the booking to another Nokia 9110 Communicator via the infrared link, or press **Send as SMS** to open the SMS directory where you can select the recipient for the booking. Note

that the recipient must have a phone number in the *Tel(GSM)* field, or, if you are sending the booking to a calendar server, a server number in the *Tel(Server)* field.

- 5 Press **Send** to send the booking.

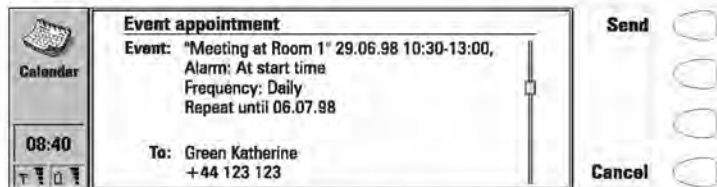

Figure 4

To receive requests

When you receive an event request, a note appears on the display showing the details of the event, and the name or number of the sender. On the left side of the note is your schedule for the day, where you can check whether you have other appointments at the same time.

If you press **Accept** or **Deny**, your communicator sends a reply to the sender informing about your decision. Accepted events are moved to your calendar.

The received request can be dismissed by pressing **Cancel**.

If you press **Hold**, the event request is moved to the Pending requests list to wait for your decision. This list is accessed by pressing the Menu button in the monthly, weekly or daily schedule and selecting *Pending requests*. On the right side of the list is your schedule for the day, where you can check whether you have other appointments at the same time. The commands in the Pending requests list are **Accept** and **Deny**, the function of which is explained above; and **Delete**, which removes the event from the list.

Note: Old events are not removed when new events are added, even if they have the same date and time.

To receive reservations

When you receive an event reservation, a note appears on the display giving the details of the event. When you press **OK**, the reservation is moved to your calendar. If you press **Confirm**, the event is moved to your calendar and a confirmation note is sent to the sender of the reservation.

To cancel bookings

There are two ways to cancel bookings that you have sent:

- 1 Remove the event from your own calendar. Your communicator will check the "Event sent to" list (see "Daily schedule" on page 107) and send a

special SMS to all the participants who share the event, removing the event in their calendars as well. Or,

- 2 Select a participant in the "Event sent to" list and press **Cancel event**. The event is removed from the participant's calendar.

To change a booking that you have sent

Select the event and press **Details**. Make the desired changes. The changes are sent to the calendars of the persons to whom you have sent the booking.

Alarms

To set an alarm to the currently selected event

- 1 Press **Details** in the daily schedule.
- 2 Select the *Alarm* option and press **Change**.
- 3 Select one of the alarm options:
 - None* – No alarm is attached to the event.
 - At start time* – The alarm will sound at the start time.
 - ... minutes before event* – The alarm will go off as set in the Calendar settings unless you specify otherwise here.

Tip: To set alarms that are not related to any calendar event, use the Clock application, see "Clock" on page 126.

You can choose the alarm tone in the System sounds settings of the System application.

An active alarm is indicated by the bell icon in the daily schedule (in the figure 3, the 11:00 event). When the alarm sounds, a note is shown on both displays.

The alarm sound can be turned off by pressing any key. If you have set the communicator to a silent profile in the Telephone settings, only the alarm note will be shown.

Tip: After a calendar alarm has occurred, you can move the message contents of the alarm to the To-do list by pressing **Move to To-do list**.

To-do list

The To-do list is a list of tasks which must be completed eventually, but are not connected to any specific time or day. The entries in the To-do list are

numbered, and they can be given different statuses. High priority entries are shown at the top of the list. See figure 5.

To access the To-do list

- 1 Press the **To-do list** command button in the monthly or weekly schedule.
Or,
- 2 Press the Menu button and select the *To-do list* option in the daily schedule.

To change the status of the selected task

- 1 Press **Priority**. A pop-up box opens.
- 2 Change the status of the entry to *High priority* or *Normal priority*, or mark the task as *Completed*, as the task number four in figure 5.

To write down a new to-do task, press **New**. An empty entry field is added at the end of the To-do list.

To remove the currently selected task from the list, press **Delete**.

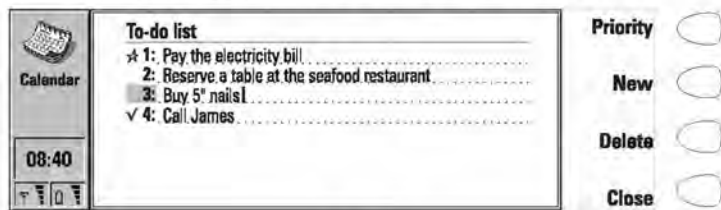

Figure 5

12. System

System contains the following applications: Security, User data, Memory, Infrared activation, Digital camera connectivity, Remote synchronisation, Fax modem, Data removal, Install/Remove software, Backup/Restore, Memory card tool, and About this product.

To start a System application

- 1 Press the System application button.
- 2 Scroll to the application and press **Select**.
- 3 If a System application is active, you must close it by pressing **Close** in the main view of the application before you can start another.

Note: When one of the PC connectivity applications or the fax modem is in use, the communicator consumes more power than normally. To extend the battery operation time, these applications should be closed when they are not used.

System settings

To change the System settings

- 1 Press **Settings** in the System main view.
- 2 Select the setting you want to change.
- 3 Press **Change**.

The System settings include all system-related permanent settings:

System sounds – Covers all the sounds in the communicator. The available settings are:

Default ringing tone – You can select one of the tones in the pop-up box or compose a special ringing tone for your telephone with the Composer application. See "Composer" on page 129. You can also use the sounds you have recorded with the Digital voice recorder as ringing tones. See "Voice recorder" on page 132. If a tone or sound is erased, the default ringing tone Grande valse will replace it.

Alternate ringing tone – If your SIM card supports the alternate line service, you can select a different ringing tone for Line 2. See "Telephone settings" on page 53.

Notification tones: On/Off – Determines whether a sound is heard, for example, when the memory is too low.

Application tones: Calendar alarm, Clock alarm, Received fax, Received SMS, Received mail – For each of these items you can set a specific ringing tone. You would then be able to tell by the tone whether you have received a fax or a short message, for example.

The *None* option allows you to turn the selected tone off, with the exception of the clock alarm. Note that when the phone is turned off, only calendar and clock alarm ringing tones can be heard. This requires, however, that the ringing tones are set through the System settings.

Print settings – You can select the default settings for printing. For more about printing, see "Document features" on page 24.

Connection type – Select whether to use infrared or cable connection.

Header – Set this on if you want to print your name and the date and time of printing on the top of each page.

Paper size – Choose either A4 or Letter.

Default printer – Select the printer used in the cable connection.

Baud rate: 9600/19200/57600/115200 – Select the data transmission rate used in the cable connection.

Flow control: Software/None – You can select whether to let the software control the data flow.

Data bits: 7/8 – Host-specific communication parameter for the cable connection.

Parity: None/Odd/Even – Host-specific communication parameter for the cable connection.

Stop bits: 1/2 – Host-specific communication parameter for the cable connection.

Backlight period – You can set the time period for which the backlight is switched on. The available settings are 15/30/45 seconds/1/2/3/4/5 minutes. The backlight can also be turned off by pressing the  button.

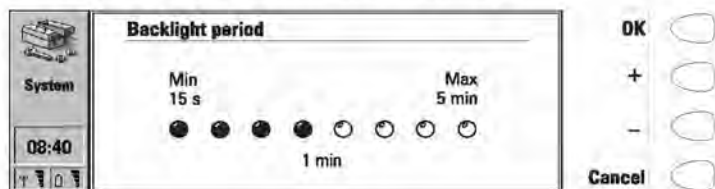

Figure 1

Note: Extensive use of the backlight may drain the battery.

Screen blanker period – You can set the time period after which the display will blank out if the device remains inactive. This feature saves the battery and increases the operation time of the communicator. The time-out period can be from 2 to 15 minutes. The screen blanker cannot be turned off.

Contrast control – The contrast view shows a test picture and a set of commands that can be used to adjust the picture. The + command button increases the contrast. The – command button decreases the contrast. When the setting seems satisfactory, press OK.

Preferences – Preferences lets you change date and time formats and the unit of measurement:

Date format: *dd.mm.yy / mm.dd.yy / yy.mm.dd.* – For example, 22.03.98 / 03.22.98 / 98.03.22.

Time format: *24 hour / AM/PM* – For example, 09:35 / 9:35 AM.

Unit of measure – Choose either *Centimetre* or *Inch* as the basic unit of measure.

Security

Note: The predetermined default lock code 12345 is provided in the sales package of the communicator. For security reasons, it is imperative that you change the lock code. Change the code either in the Security options menu of the phone (see "Settings (Menu 4)" on page 147), or via the communicator interface (see "To change the security settings" on page 116). Keep the new code secret and in a safe place, separate from the communicator.

To lock the communicator automatically

- 1 Press **Settings** in the main view of the Security application.
- 2 Select *Autolock period* and press **Change**.
- 3 Enter your lock code at the prompt, and define the autolock period. When the communicator remains inactive for the defined period, it will lock itself.

To lock the communicator manually

- 1 Press **Lock system** in the main view of the Security application.
- 2 If the *Autolock period* is in use, the device will lock immediately. If the *Autolock period* is off, you must enter your lock code before the device is locked.

After the communicator has been locked, it cannot be used until the correct lock code is given. However, incoming voice calls can be answered via the phone, and faxes and short messages are received normally.

Note: When the communicator is locked, it may be possible to make a call via the phone to the emergency number programmed into your phone, e.g. 112 or other official emergency number.

To unlock the communicator

- 1 Enter your lock code in the input field.
- 2 Press **OK**.

To change the security settings

- 1 Press **Settings** in the Security main view.
- 2 Select the setting and press **Change**.
- 3 When you are prompted for a code, enter it and press **OK**.

Choose a new value.

Tip: Most of the security features can also be changed in the Security options menu of the phone. See "Settings (Menu 4)" on page 147.

The codes are shown as asterisks. If you are changing a code, you will be prompted for the current code and then the new code twice. The code cannot be changed if the corresponding security feature is not in use. For example, if the PIN code request is set to *Off*, the PIN code cannot be changed.

Pressing **Close** will close the security settings and return to the Security main view.

Security settings

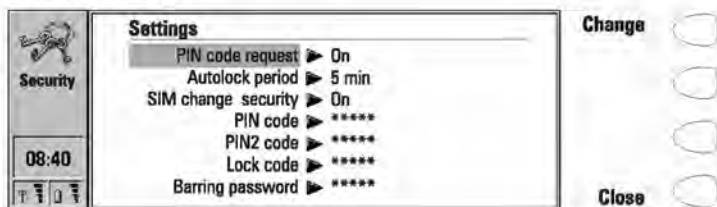

Figure 2

PIN code request: On / Off – If you set the PIN code request on, the communicator requests the code every time the phone is turned on by pressing **⓪**. This setting cannot be changed if the phone is switched off or if there is no valid SIM card inserted.

If you enter the PIN code incorrectly three times in a row, you will need a PUK code to unblock the SIM card. When the SIM card is blocked, you cannot send or receive any documents or calls, except emergency calls. Otherwise, the communicator can be used normally.

Note: Some SIM cards do not allow you to turn the PIN code request off.

Autolock period: Autolock off/1/2/5/15/30/60 minutes – Determines the security time-out period, after which the communicator will lock. The timer is reset by any input, calls, data transfer, printing, etc.

SIM change security: On / Off – When active, every time the phone is switched on this security option checks whether the SIM card in the communicator has been changed. If the SIM card has been changed and the new SIM card has not been used with your communicator previously, the communicator locks itself until the lock code is correctly entered. The communicator recognises five different SIM cards as the owner's cards.

PIN code – This setting allows you to change the PIN code. The changing procedure is described at the beginning of this "Security" section. The new PIN code must be 4 to 8 digits long. Changing the PIN code requires that the PIN code request is set on, the phone is on, and that there is a valid SIM card inserted in the communicator.

PIN2 code – This setting enables you to change the PIN2 code. The PIN2 code is required to access some functions, such as the call cost settings, which must be supported by your SIM card. If you enter an incorrect PIN2 code three times in succession, you will need a PUK2 code to unblock the PIN2 code. The length of the PIN2 code is 4 to 8 digits.

Lock code – This setting allows you to change the lock code. The changing procedure is described at the beginning of this "Security" section. The new code must be 5 digits long.

If you key in an incorrect lock code several times in succession, the communicator must be sent back to the dealer to be unlocked.

Barring password – This setting allows you to change the barring password. The new code must be 4 digits long. To change the password, the phone must be on and within the network coverage, the Call barring service must be activated for your SIM card which must be valid and inserted in the communicator.

If you enter an incorrect barring password three times, the password is blocked and you must ask the network operator for a new password.

Note: Avoid using codes that are similar to emergency numbers to prevent accidental dialling of the emergency number.

User data

The User data card contains your personal information. You can freely edit the information in the *Name, Company, Job title, Address, Tel, Fax, Tel(GSM), Fax(GSM), Mail* and *URL* fields.

The User data will automatically be included in the corresponding fields of the fax cover page in the Fax application. Likewise, the SMS application uses this information when you send your own business card.

When you press **Attach image** in the user data card, you can attach your own picture to the card. The picture must first be stored in JPG format in the Contact images subfolder of the Downloaded files folder.

Memory

This application shows the amount of available free memory for storing data and installing new software. Press **Details** to open up a list of folders and other data in the communicator. The list shows how much memory each of them takes up, and it is updated each time you press **Details**.

If your memory card is inserted in the communicator, press **Memory card** to check the amount of available memory in the card.

If the memory is getting low, you should remove some documents. Before removing, you can print, fax or mail them, or transfer them to a PC or a memory card.

Infrared activation

If you want to use the PC Suite for Nokia 9110 Communicator program (see "To use the PC Suite" on page 29) with the infrared connection, or if you want to receive data from another device via the infrared, you need to use the Infrared activation application.

Note: A maximum of 20 files can be transferred at a time.

- 1 Make sure that the infrared port of the communicator faces the infrared port of the PC or another device.
- 2 Open the Infrared activation application on the communicator.
- 3 Press **Activate**.
- 4 To end the infrared connection, press **Disable**.

To transfer data between two communicators

- 1 Make sure that the infrared ports of the communicators face each other.
- 2 Open the Infrared activation application on the receiving communicator.
- 3 In the sending communicator, go to the application from where you want to transfer data, and press **Transfer via IR**.

Tip: The infrared link can also be activated by pressing Chr-1 on the communicator keyboard.

Digital camera connectivity

The Digital camera connectivity application enables you to transfer images between your communicator and a digital still camera or another communicator via the infrared connection.

Note: The infrared protocol of the digital camera must be IrTran-P in order to be compatible with the Nokia 9110 Communicator.

When you start the application, press **Image list** to open a list of the images in the Downloaded files folder. However, you can only select image files with the extensions UPF or JPG.

To transfer images from another device to the communicator

The connection to a digital camera or another communicator is always established by the receiving communicator.

- 1 Make sure that the infrared port of your communicator faces the infrared port of the other device.
- 2 Open the Digital camera connectivity application and press **Image list**.
- 3 Press **Receive** to start transferring the selected UPF images from the other device to your communicator.

To transfer images from the communicator to another device

- 1 Open the Digital camera connectivity application and press **Image list**.
- 2 Select the UPF image(s) you want to transfer.
- 3 Make sure that the infrared port of your communicator faces the infrared port of the other device, and press **Send**.

To rename the selected image, press **Rename** and write the new name in the input field. Do not change the extension at the end of the name.

To use the Menu button

When you press the Menu button in the Image list, the following options become available:

Open – Opens the image. When the image is open, you can print it, or send it as SMS, fax or e-mail.

Delete – Removes the image.

Convert to JPEG – Converts the selected image(s) from UPF to JPG format.

Convert to UPF – Converts the selected image(s) from JPG to UPF format.

Image information – Presents information about the image. You can also view the information with the Ctrl-i key combination.

Remote synchronisation

To synchronise your calendar data with a PC calendar, use the Remote synchronisation application. With this application, you connect to the PC via the Internet. Note that you need an Internet access point, see "Internet settings" on page 74.

The PC Suite for Nokia 9110 Communicator program must be running on the PC to which you are connecting.

To synchronise calendar data

- 1 Press **Settings** and define the destination host, which is the IP address of the server PC, and select the Internet access point used.
- 2 Press **Start**. A data call is made, and the calendar data is sent from your communicator to the destination host.
- 3 When the synchronised calendar data has been sent back to your communicator, the data call ends.

Fax modem

Before your PC can recognise the communicator as a fax modem, the PC needs to be properly configured. Consult the user's guide of your PC on how to install new modems. PCs with Microsoft Windows 95 or NT 3.51 or higher operating systems can use the modem information file found on the diskette supplied in the communicator sales package. See also the Documentation section on the CD-ROM.

Using the communicator as a fax modem requires that data calls are supported by the network you are using and that this service is activated for your SIM card. Contact your home service provider for details.

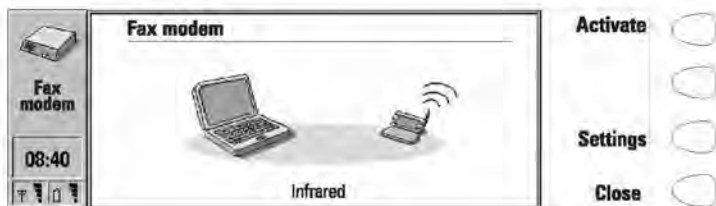

Figure 3

- 1 Press **Settings** and select the connection type. The functioning of a cable connection when the communicator is used as a fax modem is not guaranteed.
- 2 Connect the communicator to the PC via an infrared link as described in "To use the PC Suite" on page 29.
- 3 Wait until the connection is established.
- 4 Press **Activate** in the Fax modem main view. This will change the communicator to a fax modem. When the communicator is used as a fax modem, the call status indicator shows the text MODEM.
- 5 To stop using the communicator as a fax modem, press **Disable**.

The operations of a modem can be controlled by AT commands and S-registers. These commands give the advanced user an opportunity to control all the features of the modem. Should you need to enter the commands manually, consult the documentation of the PC application that you are using. A list of common AT commands based on the ETSI 07.07 standard and supported by the Nokia 9110 Communicator are available in the *atcomm.txt* file on the diskette included in the sales package of your communicator.

When the communicator is used as a fax modem, its normal communication features are disabled. Otherwise, the applications remain functional.

If an active PC connection is idle for longer than 20 minutes, the fax modem is automatically disabled to conserve power. However, when the communicator is connected to an electrical outlet, for example, while charging a battery, the time-out is not active.

Data removal

The Data removal application comes in handy if you want to remove personal information from the communicator, for example, before lending it to someone else. In this way you need not remove data one by one.

- 1 Select what kind of data you want to remove. The removable data is arranged in four groups: *All device data*, *Calendar data*, *Documents*, *Contacts and speed dials*.
- 2 Press **Delete**.
- 3 Before any data is removed, you must enter your lock code. See "Security" on page 115. When removing calendar data, you can choose to remove all calendar data or only events that occur before a given date.

Note: Even if you choose the *All device data* option, your Internet settings will not be removed. If you want to restore your communicator to the same state it was in at the time of purchase, see chapter 15 "Troubleshooting" on page 153.

Install/Remove software

The Install/Remove software application enables you to install new software from a PC to the communicator and later remove the software.

Caution: Beware of viruses! Only install on the Nokia 9110 Communicator software you have obtained from sources that offer adequate protection against viruses.

To use this application, you need to start the Nokia Communicator Server on your PC and connect your communicator to the PC. See "To use the Nokia Communicator Server" on page 36.

Press **Install** and select the software you want to install, or press **Remove** and select the software you want to remove.

The set of applications that were on the communicator at the time of purchase cannot be removed. This is to ensure that the basic functions of the communicator are always available.

Tip: To save the memory space of the communicator, you can install software to a memory card.

Backup/Restore

The Backup/Restore application enables you to make backups of various data on your communicator, and to restore it later. Data is backed up in sets which are stored in separate directories on the PC.

To use this application, you need to start the Nokia Communicator Server on your PC and connect your communicator to the PC. See "To use the Nokia Communicator Server" on page 36.

Select whether to backup *All data*, *Documents*, *Contacts*, or *Calendar* and press **Backup**. A backup directory will be created if necessary.

The restoration procedure is carried out in the same way as the backup operation, except that instead of **Backup** you must press **Restore**. When data is restored, files with similar names in the destination folder will be overwritten.

Note: While the Backup/Restore is in progress, the other applications of the communicator cannot be used. To interrupt the operation, for example, to make an emergency call, press **Cancel** and confirm by pressing **Interrupt**.

To make backups or restore data between a Nokia 9000 Communicator or a Nokia 9000i Communicator and a Nokia 9110 Communicator, see "To transfer data from older communicator models" on page 27.

Tip: While travelling, you can make backups of important documents to a memory card.

Memory card tool

The Memory card tool application can only be started if there is a memory card inserted in the communicator.

With this application, you can format and rename the memory card, and check the condition of the files.

About this product

This application displays information about the Nokia 9110 Communicator.

13. Extras

Press the  button on the keyboard to open the Extras application group, which contains Calculator, Clock, Composer and Voice recorder. With Extras you can also launch applications located on your memory card.

Note: More applications can be installed to your communicator from the CD-ROM included in the sales package.

To start one of the applications, select it and press **Select**.

To close an active application, press **Close**.

Tip: With one Extras application active, you can quickly switch to another by pressing the  button.

Calculator



Figure 1

The Calculator contains an input field at the bottom of the screen, and above it a list where previous calculations, if any, can be seen. The most recent calculations are shown at the bottom of the list.

The list can be scrolled with the arrow keys, and it can be emptied by pressing **Clear list**.

The results of the calculations appear in **bold**. As long as you have not pressed Enter or "=", you can move in the calculation string with the arrow keys and edit the string.

The following characters can be used for the corresponding operations:

Character	Function
Numbers 0 to 9	
. (full stop)	decimal point
+	addition
-	subtraction
*	multiplication
/	division
()	brackets
= or Enter	sum
Esc	clears the entry field

To add functions in the input field

- 1 Press **Functions**.
- 2 Select one of the available categories and press **Select**. You will see a list of functions and you can select the one you want. You can select several functions before returning to the Calculator main view.

To copy calculations in the input field

- 1 Press **Copy** to select and copy a calculation or a result back to the input field for modification or recalculation.
- 2 To copy a calculation, press **Copy calculation**, and to copy a result, press **Copy result**.
- 3 Press **Back**. The selected item will be copied to the input field.

To change the mode of the calculator

When you press the Menu button in the Calculator main view and select *Settings*, you can change the mode of the calculator. Select either *Radians*, *Degrees*, or *Gradients*, and press **OK**.

Clock

The Clock shows the time and date in your home city and country, as well as in several other cities and countries in the world. The Clock also includes an alarm clock.

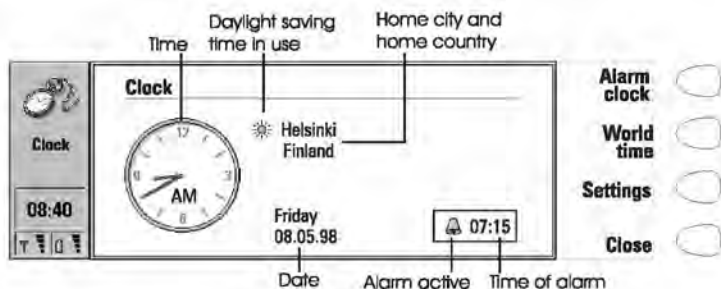

Figure 2

To set an alarm

An alarm can be set to occur within the next 24 hours. Alarms that occur later than this are set in the Calendar application.

- 1 Press **Alarm clock** in the Clock main view.
- 2 Press **+** or **-** to adjust the time shown in the alarm clock display. Each press changes the time by one minute, but if you hold the button down a while longer, the time will start to change in 15-minute steps.
- 3 Press **OK** to accept the set alarm. When an alarm is set, the bell icon and the time of the alarm are shown in the Clock main view.

There can only be one active alarm. If an alarm is already active, the command names are different. A counter on the lower right side of the screen shows how much time remains to the time of the alarm.

Press **Change alarm time** if you want to readjust the time of the alarm.

Press **Delete alarm** to cancel the alarm.

Note: Alarms will occur according to the home city time. When in a different time zone, remember to change the home city.

To turn off the alarm sound

- 1 When the alarm sounds, press any phone or communicator keyboard key to silence it.
- 2 Press the **OK** command button. If you do not press **OK**, the alarm will sound four more times or until you press the **OK** button. However, if the alarm interval is set to zero, the alarm will sound only once. Set the alarm interval in the clock settings.

World time

World time (figure 3) is accessed with the **World time** command in the Clock main view.

The *Home* box shows the name of the currently selected home city, country, time, date and whether daylight saving time is in use.

The *Destination* box shows the same information for the currently selected destination city, as well as the international call prefixes needed to make a call from the home city to the destination city.

The world map shows the currently selected destination city in cross hairs.



Figure 3

To select the destination city

- 1 Press **Set destination**.
- 2 Select a city from the list by scrolling the list with the arrow keys.
- 3 Press **OK**.

Tip: A quick way to select a city from the list of cities is to type the first letter of the city with the keyboard. The selection frame jumps to the first city starting with that letter.

To edit and add cities

- 1 Press **Cities** in the world time view to open a list of cities.
- 2 To make changes to existing cities, press **Edit city**. The city information is presented in the form of a card with the following fields:

City – The name shown in the list of cities. Can be entered manually.

Country – The name of the country associated with the city. The country name is selected from the list of countries.

Area code – The area code required when calling the city. The area code can be entered with or without a national prefix. Only numbers can be entered.

GMT offset – Indicates by how much the local time differs from the Greenwich Mean Time. Select a value for the offset from a list. The offset can range from –12 to +12 hours.

Set position – Opens a world map view where you can determine the position of the city by moving the cross hairs with the arrow keys. When the city is where you want it to appear, press **OK**.

To create a new city card, press **Add city**.

To remove a city from the list, press **Delete city**. The current home city cannot be removed; you will have to change the home city first.

To change the Clock settings

- 1 Press **Settings** in the Clock main view.
- 2 Select the setting you want to change and press **Change**, or type the new time or date from the keyboard.

Home city – Select the home city by scrolling the list of cities with the arrow keys. When your home city has been selected, press **OK**. If you select a city that is in a different time zone than your current home city, the system time will change.

Time – Enter the new time. The time format is selected in the System settings.

Date – Enter the new date. The date format is selected in the System settings.

Alarm interval: 0/1/2/3/4/5 minutes – Choose the interval between alarms. If you select 0, the alarm will go off only once.

Daylight saving – You can set the daylight saving time of the home city and destination city *On* or *Off*. This setting remains the same even if the home/destination city is changed.

Note: Changing the time or daylight saving time of the home city will also adjust the time of the whole time zone, as well as the system time. If a set alarm is skipped because of a changed time, the alarm will go off immediately.

Composer

The Composer application enables you to create your own, customised ringing tones.

To start the composer for the selected tune, press **Open**.

To compose a new tune press **Compose**.

To play the selected tune, press **Play**. While the tune is being played, the command changes into **Stop playing**.

Note: You can change the phone ringing tone in the Profile settings of the Telephone application or in the System sounds setting of the System application. See "Telephone settings" on page 53 and "System settings" on page 113.

To edit a tune

- 1 Open a tune or press **Compose**. A cursor appears at the bottom of the screen, indicating the currently selected note or rest.
- 2 To create a note or to alter the pitch of the note, press the up or down arrow keys. Each press changes the pitch of the note. A rest will appear after all possible note levels have been scrolled through.
- 3 To move the cursor, press the left or right arrow keys.

Note: To edit the preset tunes that were in the communicator at the time of purchase, press the Menu button and select *Copy*.



Figure 4

When a composition is being made, the following commands are available:

Duration changes the length of the selected note. Choose a quarter note, half note, whole note, sixteenth note, or eighth note. Press the command button until the value you want is shown.

Tempo opens a pop-up box with a new set of commands. Tempo is measured in beats per minute. To alter the tempo, remove the old value with the backspace key and enter the new value in the input field.

To accept the tempo, press **OK**.

To test the tempo, press **Test**. The tune will be played with the tempo

shown in the entry field.

To use the default tempo 160 beats/min., press **Default**.

Play plays the composition shown on the staff.

To remove a composition, press the Menu button, and select *Delete*.

To restore the tune to what it was before editing, press the Menu button and select *Undo changes*.

Close returns to the Composer main view.

To use shortcuts

While editing, you can use the following shortcuts:

Character	Function
Enter	Plays the tune
: (colon)	Staccato
- (hyphen)	Inserts a rest
Space bar	Inserts an empty column to the left of the cursor.
Backspace	Deletes the selected column containing a note or a rest.
. (full stop)	Lengthens the duration of the note or rest by half

Tip: For quick composing, press the corresponding letter key on the keyboard to generate a note. For example, pressing D generates the note D. When you press Shift and a letter key, a sharp note is generated, e.g. Shift-D generates D sharp.

To use the Menu button

When you press the Menu button in the Composer main view, the following options become available:

Copy – Copies the selected tune.

Delete – Removes the selected tune(s).

Rename – You can write the new name into the input field.

Send as SMS – Opens up the SMS directory where you can select a recipient for the composition(s). To send the composition(s), press **Send**.

When you receive a composition via SMS, a note showing the name or number of the sender and the name of the sent composition will appear on the display.

To add the composition to the list of tunes, press **Accept**. To discard the composition, press **Cancel**.

Transfer via IR – Enables you to send tunes from one communicator to another via the infrared link. The IR port of the receiving device must be activated before the operation. See "Infrared activation" on page 118.

Copy to memory card – Copies the selected tune(s) to the memory card.

Copy from memory card – Copies the selected tune(s) from the memory card to your communicator.

Voice recorder

The Voice recorder allows you to record telephone conversations and voice memos. You can also listen to your recordings and other sound files. The maximum length of a recording is 30 seconds.

Tip: With the Voice recorder you can record sounds and speech and set them as ringing tones. See "Telephone settings" on page 53.

The main view of the Voice recorder shows a list of all the sound files currently stored in your communicator. To open the selected file, press **Open**. **New file** creates a new file into which sound can be recorded. **Delete** allows you to remove the selected file.

When you open a sound file, you will see the length, which is measured in seconds, and the size, which is measured in kilobytes, of the file.

Note: Local laws may apply to recording conversations. Do not use this feature illegally.

To play a recording

- 1 Open the file and press **Play**.
- 2 The **Pause** command temporarily stops the playing of the sound file. To start playing again, press **Continue**.
- 3 To stop playing, press **Stop**.

To record

- 1 Open the file into which you want the sound to be recorded, and press **Record**. If you are recording a telephone conversation, both parties will hear a tone when the recording starts.

- 2 You can stop the recording for a while by pressing **Pause** and then start again by pressing **Continue**.
- 3 To stop the recording, press **Stop**.

Note: To record sound and speech you need to have the phone turned on and within range of network coverage.

To use the Menu button

When you press the Menu button in the Voice recorder main view, the following commands become available:

Rename – Renames the selected recording.

Copy to memory card – Copies the selected recording to the memory card.

Copy from memory card – Copies the selected recording from the memory card to your communicator.

Note: Sound files that the voice recorder can play have a .WAV extension and support the following audio format: 8, 11, 22 or 44khz, PCM/A-law, Stereo/Mono, 8bit.

14. Phone



Figure 1

When operating the phone, keys are pressed one at a time. Two keys are never to be pressed simultaneously. The phone keypad is not functional when the device cover is open.

- ① – Switches the phone on and off.
- ☎ – Switches between different profiles. See "Profiles (Menu 3)" on page 146.
- ∨ ^ – Scroll through menus, submenus or settings. If there are no active calls, the scroll keys can be used to browse through the memory contents. When a call is active, pressing the scroll keys adjusts the volume level.
- ☎ – Dials a phone number and answers a call.
- ☎ – Ends any active call, cancels a dialled call, or clears the display.

- 0 ... 9 – The number and alphabet keys. To call your voice mailbox, press and hold 1.
- * # – Used for special purposes in certain functions. If you have subscribed to two phone lines, you can switch between them by pressing and holding #.
- – The function of these two selection keys depends on the text shown on the bottom line of the display. See figure 2.

Note: Hold the phone as you would any other telephone with the antenna pointed up and over your shoulder.

As with any other radio transmitting device, do not touch the antenna unnecessarily when the phone is switched on. Contact with the antenna affects call quality and may cause the phone to operate at a higher power level than otherwise needed.

To use the selection keys

When this manual instructs you to press a command key, press the selection key under the command name. For example, pressing **Menu**, i.e. the selection key under the text *Menu*, gains access to the menu functions, and **Names**, i.e. the selection key under the text *Names*, to the search functions. The commands vary according to the situation and previous selection.

The selection must often be confirmed by pressing **OK**. Whenever the **Back** command is shown, it can be used to return to the previous menu level without making any changes.

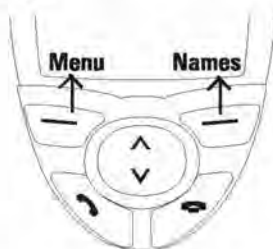

Figure 2

Display indicators

The display indicators inform you about the current operation of the phone. The indicators described below are shown when the phone is ready for use, with no characters entered by the user on the display.

OPERATOR

Indicates in which cellular network the phone is currently used.

 and bar

Indicates the current signal strength at your location. The more bars are visible, the stronger is the signal.

 and bar

Indicates how much charge there is left in the battery. The more bars are visible, the more charge is in the battery

To make a call

You can make and receive calls only when the phone is switched on, the communicator has a valid SIM card fitted, and it is located in the service area of the cellular network.

Note: In some networks emergency calls to the international emergency number 112 may be made without a SIM card. Check with your network operator. For more information about making emergency calls, see "Emergency calls" on page 165.

- 1 Key in the area code and the phone number of the person you wish to call. If you make a mistake, you can remove the digits one at a time by pressing **Clear** repeatedly, or clear the whole display by pressing and holding **Clear**.

For international calls, start by pressing ***** twice quickly. The international call character **+** appears on the display, which informs the network centre to select the country-specific international prefix. Enter the country code, area code and the phone number.



- 2 Press  to dial the phone number.
- 3 When the phone number disappears and the text *Call 1* is shown, the call is connected.

When a call is active, you can use the **▼** and **▲** keys to lower or raise the volume level of the earpiece.

Note: The microphone and earpiece are on the rear of the device.

- 4 After the conversation, end the call by pressing .

To answer a call

- 1 When you receive a call, the phone gives a ringing tone and the text *Call* flashes on the display. If you have selected a silent profile in Menu 3, only the keypad and display lights will flash.
If the caller can be identified, the caller's name or phone number, and the text *Calling* will be displayed.
- 2 To answer the call, press . You can answer the call even while using the search or menu functions.
If you do not want to answer the call, simply press . The caller will hear the alerting tone change to a busy tone.
- 3 After the conversation, end the call by pressing .

To manage calls

There are a number of functions you can use during a call. To access the functions, simply press **Options**, scroll to the function and press **Select**.

Menu – You can access *Menu*.

Answer – You can answer an incoming call.

Reject – You can reject an incoming call.

Record – You can record your conversation with this option. See "Recorder (Menu 6)" on page 152.

Hold / Unhold – *Hold* allows you to put the current call on hold, so that another call can be made. The original call can be activated again by selecting *Unhold*. If the held call is the only call, you can unhold it by pressing  or the **Unhold** command.

Swap – This function makes a held call active and put a currently active call on hold. You can thus alternate between two calls.

New call – Puts the active call on hold and dials a new phone number.

Send DTMF – Transmits DTMF tones. See "To send DTMF tones" on page 140.

End this call – Ends the active call.

End all calls – Ends both the active and the held call.

Mute / Unmute – Switches the microphone of the communicator off or on. If the communicator is connected to a handsfree car kit, *Mute* also turns off the microphone of the car kit.

Conference – If you have one call active and another call on hold, this option merges them into a conference call.

Conference / One to one – *Conference* includes a new participant in a conference call. During a conference call, *One to one* allows you to converse privately with a selected participant.

Transfer— The voice call transfer enables you to connect two voice calls together and disconnect yourself from both calls. See "Multiple calls" on page 50.

Data— When you have an alternating call active, this option changes the mode of the call from voice to fax. See "Multiple calls" on page 50.





Voice— When you have an alternating call active, this option changes the mode of the call from fax to voice.

Play last— Plays the last recording made with the recorder. The other party will also hear the recording.



Tip: If you have one active and one held call, press **Swap** to make the held call active and to put the currently active call on hold. In this way, you may converse with one party without ending the other call. You can also press  to swap between the calls if no numbers have been keyed in.

To search for phone numbers

You may fetch phone numbers from memory by the name with which the required phone number was stored. Note that the phone uses memory (SIM or Telephone) which is chosen in the Telephone application by pressing **Menu** and **Select**.

- 1 Press **Names**.
- 2 Key in the name of the person whom you want to call, or the first letter(s) of the name.
- 3 Press **OK**. The name closest to the keyed in characters will appear.
- 4 If the name found was not the one you searched for, scroll through the names with  or  until you reach the correct one.
- 5 To call the person, press . If the person has several phone numbers, scroll the selection frame onto the one you want and press .

To view the phone number stored with the name

- 1 When the desired name is on the display, press **Detail**. The phone number is displayed. If the person has several phone numbers, scroll through the numbers with  or  until you reach the correct one.
- 2 To call the number, press .

To use speed dialling

Speed dialling is a handy way to call frequently-used phone numbers. You can define up to eight speed dial numbers in the communicator memory. For information on how to set speed dials, see "To make contact cards" on page 41.

- 1 Key in the number of the speed dial location where you have stored the





phone number.

- 2 Press . The phone will display the phone number briefly, and then dial it. Speed dialling is not possible during a call.

Note: Number 1 is the speed dial location of your voice mailbox. To call your voice mailbox, press 1 and then , or just press and hold 1.

Last number redial

The communicator stores the last phone numbers you have dialled.

- 1 If there are any characters on the display, clear the display by pressing .
- 2 Press . The last dialled number will appear on the display.
- 3 You can scroll the numbers with  or  until the desired number is displayed.
- 4 Press  to dial the number.

You can also recall recent received calls and recent missed calls, see "Call register (Menu 2)" on page 144.

To send DTMF tones

If you need to send long DTMF strings, it is more convenient to send them via the communicator interface, see "Multiple calls" on page 50.

To send DTMF tones manually

- 1 Make a call to the desired phone number.
- 2 Key in the digits you want to send as DTMF tones. The digits are sent one by one to the network. DTMF tones can be transmitted even when the phone key click is set off.

Keypad lock

The keypad lock prevents the keypad keys being accidentally pressed when the communicator is, for example, in your pocket.

When the keypad is locked, you can answer calls normally by pressing . During a call, the keypad is unlocked and the communicator can be operated in the usual way. After the call, the keypad is automatically locked again.

The keypad will be automatically unlocked when the communicator is connected to a car kit. When the communicator is removed from the car kit, without having been switched off, the keypad will be locked automatically again.

To lock the keypad

- 1 Press **Menu** and then the ***** key within 3 seconds.

While the keypad is locked, the  icon and the **Unlock** command are displayed.

To unlock the keypad

- 1 Press **Unlock** and then the ***** key within 3 seconds.

Note: When the keypad is locked, calls may be possible to the emergency number programmed into your communicator (e.g. 112 or other official emergency number).

Help

Most menu functions are provided with a help text, which gives a brief description of the displayed function.

To view the help text

- 1 Scroll to the menu function about which you want help.
- 2 Wait for 10 seconds. The first page of the help text will appear. The text scrolls automatically. However, if you want to scroll it manually, press the scroll keys or **More**.
- 3 To exit from the help function, press **Back**.

To use the menus

The phone offers a set of menu functions that allow you to tailor the phone to your particular use. In each menu and submenu, you can check and alter the settings of functions. The menus and submenus can be entered by scrolling the menu or using the appropriate shortcuts.

You can access the menu functions even during a call.

To scroll the menus

- 1 Press **Menu**.
- 2 Press either **▼** or **▲** to scroll the list of menus until you reach the desired menu.
- 3 Press **Select** to enter the menu. If the menu contains any submenus, reach the one you want with either **▼** or **▲**.
- 4 Press **Select**. The selection frame is on the current setting.

- 5 Scroll the list of setting options until the selection frame is on the desired option.
- 6 Press **OK** to select the option. If you do not want to change the setting, you can return to the previous menu level by pressing **Back**.

To use menu shortcuts

All the menus, submenus and settings are numbered. This number is shown in the upper right corner of the display.

- 1 Press **Menu**.
- 2 Key in the number of the main menu under which the desired submenu is located.
- 3 Key in the number of the submenu where the function can be found.
- 4 Key in the number of the desired setting option.

For instance, to change the incoming call alert in the general profile to ring only once (Menu 3-1-2-1-3): press **Menu** to enter the menu facility, **3** to enter the Profiles menu, **1** to select the General profile, **2** to personalise the profile, **1** to modify the alert tones, and **3** to select *Ring once*.

To exit from the menu

- 1 Press  or press and hold **Back**.

Menu structure

The following menu table lists the names of the main menus and their submenus. Third-level menus are not shown here.

Menu	Function	Submenus
MENU 1	MESSAGES Y	1 Received short messages, 2 Info service, 3 Service command editor, 4 Voice messages
MENU 2	CALL REGISTER	1 Missed calls Y, 2 Received calls Y, 3 Dialed calls, 4 Erase recent call lists, 5 Show call duration Y, 6 Show call costs Y, 7 Call cost settings
MENU 3	PROFILES	1 General, 2 Silent, 3 Meeting, 4 Outdoor, 5 Pager, 6 Flight, 7 Headset, 8 Car
MENU 4	SETTINGS	1 Call settings, 2 Phone settings, 3 Security settings, 4 Restore factory settings
MENU 5	CALL DIVERT Y	1 Divert all voice calls, 2 Divert when busy, 3 Divert when not answered, 4 Divert if not reachable, 5 Divert all fax calls, 6 Divert all data calls, 7 Cancel all diverts
MENU 6	RECORDER	

Some menu functions are network services, indicated by the **Y** symbol in the menu table. To use such a function, your network must support it and you must subscribe to it. Note that network services are specific to each SIM card. If you change the SIM card, and you have not obtained the service for the new card, you will not be able to use the service.

Messages (Menu 1)

The Short Message Service (SMS) is a network service. Contact your service provider for details. The phone can be used for listening to voice messages in voice mailboxes and for reading received short messages. However, reading short messages is more convenient via the larger display of the communicator interface. To send short messages, use the SMS application of the communicator.

Received short messages (Menu 1-1)

When you receive a short message, the text *Message received* and the  indicator will be displayed and a tone will sound, unless the communicator is set to a silent profile.

A note is also shown when you receive faxes or mail. To read received faxes or mail, you must use the respective applications of the communicator interface.

- 1 To read the message immediately, press **Read**. To read the message later, press **Exit**.
- 2 Press **Read** again to view the received message.
The messages are listed in the order they were received. To read the second message on the list, press **v** to select it and then press **Read**.

Once you have read the message, you can press **Back** or **Option**. The options available in the phone are:

Erase – Erases the selected message from the memory.

Use number – Copies the phone number from the message and moves it onto the phone display. You can now call the number with .

Details – Shows the sender's name or number, the date and time the message was sent, and the number of the message centre.

Tip: You can dial the phone number in the message by pressing  while viewing the message.

Info service (Menu 1-2)

This network service allows you to receive short messages on various topics. You may read messages on topics that you have pre-defined on the communicator interface, see "SMS settings" on page 70.

- 1 Press **Select** to view the list of available choices.

2 Use **▼** or **▲** to scroll through the choice list. To get a list of messages, press **Read**.

Pressing **Select** gives you the following options:

On – Sets info message reception on.

Off – Turns info message reception off.

Topic index – Fetches a list of available topics from the network.

Read – Shows a list of received info messages. Scroll to the one you want to read and press **OK**.

Language – Sets the language for the messages. Scroll to the desired language and press **Mark**.

Service command editor (Menu 1-3)

In this menu, you can send service requests, such as activation commands for network services, to your service provider. Key in the sequence you want, and press **Send**.

Voice messages (Menu 1-4)

Listen to voice messages (Menu 1-4-1)

When you enter this menu, the communicator dials the phone number stored in menu 1-4-2. If required, key in the access code for your mailbox or answering machine when the connection has been made.

Voice mailbox number (Menu 1-4-2)

The phone number that you enter here will be dialed when you select the Listen to voice messages function in Menu 1-4-1. A voice mailbox can be a network service or your personal answering machine. You may enter a new or edit an existing phone number. The number will be used until you change the number again.

Call register (Menu 2)

In this menu, you can check and erase phone numbers of calls that you have missed (Menu 2-1), received (Menu 2-2) or dialed (Menu 2-3). Note that the Received calls and Missed calls functions are network services which work only in networks that allow you to view the caller's phone number.

Note: The communicator only registers missed calls when the phone is switched on and within network coverage.

Erase recent call lists (Menu 2-4)

Caution: The phone numbers are erased without warning. You cannot undo the operation.

Show call duration (Menu 2-5)

In this menu, you can view the duration of your outgoing and incoming calls and reset the timers.

Last call duration (Menu 2-5-1)

Shows the duration of the last outgoing or incoming call in hours, minutes and seconds, e.g. 00:02:15.

All calls' duration (Menu 2-5-2)

Shows the total duration of all calls made or received with any SIM card that you have used with the communicator.

Received calls' duration (Menu 2-5-3)

Shows the total duration of calls received with any SIM card that you have used with the communicator.

Dialled calls' duration (Menu 2-5-4)

Shows the total duration of calls made with any SIM card that you have used with the communicator.

Clear timers (Menu 2-5-5)

Resets all timers. There is no way to undo the reset operation.

Note: The actual time invoiced for calls and services by your service provider may vary, depending upon network features, rounding-off for billing, taxes and so forth.

Show call costs (Menu 2-6)

This network service allows you to check various call costs. The costs are shown in charging units or units of currency that you have set in Menu 2-7-2. The call cost is shown for each SIM card separately. For these settings you need the PIN2 code. Contact your service provider for more information.

Last call cost (Menu 2-6-1)

Shows the cost of the last, or current, call.

All calls' cost (Menu 2-6-2)

Shows the total cost of all calls made with the current SIM card.

Clear counters (Menu 2-6-3)

Resets all cost counters. Resetting requires the PIN2 code. This service is not available with SIM cards that do not support the PIN2 code. There is no way to undo the reset operation.

Call cost settings (Menu 2-7)

Call costs' limit (Menu 2-7-1)

This function allows you to limit the total costs of outgoing calls to a specified number of charging units or units of the currency that you have set in Menu 2-7-2. For this service you need the PIN2 code.

Changing the call cost limit also requires the PIN2 code. To turn the limit on, select *On*. Key in the cost limit in charging units or currency units. If you define the limit in currency units, you can press * or # to insert a decimal point.

After the limit has been turned on, the number of the remaining units is shown on the display when in idle mode. When all units have been used, no calls can be made.

To turn the limit off, select *Off*.

Note: In some networks calls to the emergency number programmed into your communicator (e.g. 112 or other official emergency number) may be made even if there are no charging units left.

Show costs in (Menu 2-7-2)

You may select whether the call costs and call cost limits will be displayed in currency or charging units. Contact your network operator for the prices of charging units. Changing the call cost unit requires the PIN2 code.

To show the limits in currency units, select *Currency*, or *Units* to show the limits in charging units. If you selected *Currency*, key in the charging unit price. Use * or # to insert a decimal point. Next, enter the currency name.



Profiles (Menu 3)

The profile settings are used for selecting the operating environment for the communicator, and for modifying the profile features. One profile is always in use.

To set on a profile

- 1 Press **Menu**.
- 2 Scroll with **▼** and **▲** to Profiles and press **Select**.

- 3 Scroll to the desired profile, for example *Meeting*.
- 4 Press **Options**.
- 5 Scroll to *Activate* and press **Select**. The name of the selected profile is shown on the display, except when the general profile is selected.

Tip: A quick way to set on a profile is to press the  key on the phone keypad. Press the key again until the selection frame is on the desired profile. To select the profile, press and hold .

For more information about the different profiles, see "Telephone settings" on page 53.



To change the profile settings

- 1 Go to the Profiles menu and press **Select**.
- 2 Scroll to the desired profile and press **Options**.
- 3 Scroll to *Personalise* and press **Select**. For more information about the various profile settings, see "Telephone settings" on page 53.

Settings (Menu 4)

Call settings (Menu 4-1)

Anykey answer (Menu 4-1-1)

When set on, you can answer an incoming call by pressing any key on the phone keypad, except  or .

Automatic redialling (Menu 4-1-2)

When this function is set on and you call a number that is busy or does not answer, the communicator will attempt to call the number until the call is connected.

Press  to end the call attempts.

Speed dialling (Menu 4-1-3)

When set on, you can dial phone numbers stored in the speed dial locations by simply pressing and holding the assigned speed dial key.

Call waiting (Menu 4-1-4)

Call waiting is a network service. Contact your operator for subscription. See "Telephone settings" on page 53.

Choose *Activate* to enable call waiting, *Cancel* to disable call waiting, or *Status* to show call types with which call waiting may be used.

Own number sending (Menu 4-1-5)

You can set your phone number to be displayed or hidden from the recipient of your call. This function works only in networks that allow you to view callers' phone numbers, provided that this service has been activated for your SIM card. Do not use this function unless it has been activated for your SIM card.

Choose *Preset*, *On*, *Off*, *Next on*, or *Next off*. *Preset* selects the setting, *On* or *Off*, that you have agreed upon with your network operator. When you change the SIM card, the *Preset* setting is automatically selected.

Phone line in use (Menu 4-1-6)

If your network supports this service, you can have two phone lines in your communicator. You can select which line you want to use for making calls. For more information, see "Telephone settings" on page 53.

Phone settings (Menu 4-2)

Clock (Menu 4-2-1)

You can select whether the time is shown on the display.

Cell info display (Menu 4-2-2)

When this function is set on, the phone will indicate when it is using a network cell based on Micro-Cellular Network technology. The setting will remain in effect even if the SIM card is changed or the phone is switched off.

Note: The communicator consumes more power when the Cell info display is on.

Name list (Menu 4-2-3)

When searching for names and numbers, you can select whether to show three names, or one name at a time on the display.

List of own numbers (Menu 4-2-4)

You can store and manage phone numbers assigned to your SIM card. This function is a memory aid, from which you can check your own phone numbers.

Welcome note (Menu 4-2-5)

You can write a message of up to 30 characters which appears on the display when you switch on the phone.

- 1 Scroll to the *Welcome note* setting and press **Select**.
- 2 Key in the message.
- 3 Press **Options** and scroll to *Save* and press **OK**.

Network selection (Menu 4-2-6)

The communicator can be set to select automatically one of the cellular networks available in your area. You may also select the desired network manually in this menu.

When the *Automatic* option is selected, the communicator tries to utilise the network on which it was last registered. Outside of the home network service area, the communicator will select one of the networks that have a roaming agreement with the home network.

In the *Manual* mode, when you pick up a network manually from the network list, the communicator will always attempt to register on that network. If the communicator cannot reach, or loses contact with, the selected network, you are prompted to select another network.

Tip: Network selection comes in handy when you want to select a particular network, e.g. due to lower call charges.

Security settings (Menu 4-3)

The purpose of the security system is to prevent unauthorised use or altering of important settings. In most cases, activating or changing the security options requires the appropriate access code. See "Security" on page 115.

Note: When security features which restrict calls are in use (call diverting, call barring, fixed dialling, closed user group, or system lock), calls may be possible to certain emergency numbers in some networks (e.g. 112 or other official emergency number).

PIN code request (Menu 4-3-1)

On or Off. See "Security" on page 115.

Voice call barring (Menu 4-3-2)

Call barring is a network service; contact your operator for subscription. See "Telephone settings" on page 53.

- 1 Scroll to one of the following barring modes and press **Select**.
All outgoing calls

All international calls
International except to home country
All incoming calls
Incoming calls when abroad
Cancel all barrings

- 2 If you want to take the selected barring mode into use, scroll to *Activate*; if you want to disable the selected barring mode, select *Cancel*, or if you want to check the status of the barring mode, select *Status*, and press OK.

Fixed dialling (Menu 4-3-3)

You may restrict your outgoing calls to a pre-determined set of phone numbers, if supported by your SIM card. When the function is set on, you can only call a phone number which is included in the fixed dialling list or which begins with the same digits as a phone number on the list.

Enter the PIN2 code. Select *On*, *Off* or *Numbers*, with which to edit the fixed dialling list.

If you selected *Numbers*, the following options become available: *Search*, *Add entry* or *Erase all*. Selecting *Search* and subsequently *Options* opens *Edit* and *Erase*. The *Erase* and *Edit* options affect the name and the phone number that was on the display when you selected *Numbers*.

Note: The SIM card contents cannot be accessed if the Fixed dialling is on.

Closed user group (Menu 4-3-4)

This network service allows you to set the communicator to accept calls to and from a selected group of people. For details on creating a user group and activating this service, contact your network operator. You may be a member of up to 10 user groups.

Select one of the following options:

Preset – Uses a user group that the SIM card owner has agreed upon with the network operator.

On – Uses a particular user group. Calls can be made to or received from the members of the selected group only.

Off – Calls can be made and received in the normal way. You can use this option only if you are entitled to do so.

SIM change security (Menu 4-3-5)

The same settings can be found in the Security settings. See "Security" on page 115.

Change access codes (Menu 4-3-6)

In this submenu, you can change the lock code, the PIN code, the PIN2 code and the barring password. See "Security" on page 115.

The access codes may only include the digits 0 to 9.

System lock (Menu 4-3-7)

To lock the communicator, press **Select** and enter your lock code. The communicator locks immediately. Even if you remove and replace the battery and switch on the phone, the communicator will remain locked.

To unlock the communicator, press **Unlock** and enter the lock code.

Restore factory settings (Menu 4-4)

You can reset the settings of the menu functions to their original values. When you activate this setting, you will be prompted for your five-digit lock code. This function will not affect stored phone numbers and names, access codes, earpiece volume setting, call timers, cost counters, selected application tones or short messages.

Call divert (Menu 5)

The call divert network service allows you to direct your incoming voice calls to another phone number when you do not want to be disturbed, or when the phone is switched off or outside the network coverage area. The call diverting functions are described in more detail in "Telephone settings" on page 53.

- 1 Scroll to one of the following divert options and press **Select**:

- Divert all voice calls*
- Divert when busy*
- Divert when not answered*
- Divert if not reachable*
- Divert all fax calls*
- Divert all data calls*
- Cancel all diverts*

- 2 Scroll to *Activate*. You will be asked for the phone number to which you wish to divert the incoming calls.

The *Cancel* option sets the divert mode off. *Status* shows what kind of calls are being diverted.

Recorder (Menu 6)

With the Recorder you can record your telephone conversations and voice memos, and listen to them. The maximum length of a recording is 30 seconds. See also "Voice recorder" on page 132.

Note: Local laws may apply to recording conversations. Do not use this feature illegally.

To record your own speech

- 1 In the Recorder menu, press **Select**.
- 2 Scroll to *Record* and press **Select**.
- 3 To stop the recording, press **Stop**.

To record your Telephone conversation

- 1 When you have an active call, press **Record**. When the recording starts, both parties will hear a tone.
- 2 To stop the recording, press **Stop**.

To record your telephone conversation when you have more than one call

- 1 If you have for example one call active and another on hold, press **Options**.
- 2 Scroll to *Record* and press **Select**. When the recording starts, both parties will hear a tone.
- 3 To stop the recording, press **Stop**.

To play a recording

- 1 In the Recorder menu, press **Select**.
- 2 Scroll to *List* and press **Select**.
- 3 Scroll to the recording you want to listen to, press **Options** and then **Play**.

To play a recording when you have an active call

- 1 Press **Option**.
- 2 Scroll to *Playlast* and press **Select**. Or, if you want to play an older recording, follow the steps above. The other party will also hear the recording.

15. Troubleshooting

Tip: You will find the Club Nokia Careline phone numbers in the Accessories guide. Club Nokia Careline answers questions and offers instructions over the phone.

You can also visit Nokia Wireless Data Forum at <http://www.forum.nokia.com> for information and support material related to the communicator.

1. Phone or communicator interface does not start; both displays remain blank

Make sure that the battery is properly installed and charged.

Make sure that the contacts on the battery and the charging stand are clean.

The battery charge may be too low for operation. Check the display and listen for the low battery warning tones. Charge the battery as described in "Battery" on page 17. If the NOT CHARGING message is displayed, the charging is suspended. In that case, check that the temperature of the battery is not above +45°C (+113°F). Wait for a while, disconnect the charger, connect it again and retry. If charging still fails, contact your local Nokia dealer.

2. Power comes on, but the phone does not work

Reboot the communicator by removing the battery and replacing it again.

Try charging the communicator. If you see the battery charging indicator on the phone but the phone does not work, contact your local Nokia dealer.

Check the field strength indicator: you might be outside the network service area. See the answer to problem number 6.

Make sure that the telephone service is activated for your SIM card.

Check if there is an error message on the display after switching on. If so, contact your local dealer.

Check that the SIM card is correctly installed, see "First start-up" on page 7.

3. Communicator interface does not activate or applications stop responding

Close the cover and open it again. If this does not help, close the cover and remove the battery. Replace the battery and open the cover again. Wait while the communicator performs a self-test and starts.

Try charging the communicator.

See also problem 4.

4. Internal memory or system errors

Sometimes, for example, removing the battery in mid-operation may cause errors in the file system of the communicator. If you receive internal memory or system error messages and/or reboot prompts, or if the device does not respond to commands normally, resetting the communicator helps you recover from most of these problems. Try the reset operations in the order they have been listed: if checking the file system does not help, try removing temporary files, or format the file system.

To reset the communicator

- 1 Close the cover.
- 2 Remove the memory card if inserted.
- 3 Remove the battery.
- 4 Place the connector end of the battery in the battery cavity, but do not press the other end in place yet. The connector end is the one with the four metal strips.
- 5 Place the communicator on a flat surface with the phone display upwards. Do not let the battery slip from its place.
- 6 Open the cover.
- 7 Press and hold down the required key combination (see below) and simultaneously push the battery end of the communicator down, so that the battery clicks into place. Hold down the keys until you see progress messages or a confirmation prompt on the display.
- 8 In some cases you must confirm the action by pressing a command button.

After the reset, the communicator will reboot and start normally.

To check the file system

Symptoms: The Memory application in the System application group shows too much (over 2 megabytes) or too little memory, even if you have just removed some documents, or the communicator applications crash when opening a document.

Key combination: Shift-Tab-left arrow

Caution: If there are problems in the file system, the corrupted files will be removed. If there are no problems, this operation does not affect any documents or settings.

To remove temporary files

Symptoms: The communicator is in a reboot cycle or a note saying that an .ini file is corrupted is displayed.

Key combination: Shift-Tab-right arrow

Caution: All temporary files will be removed. The Document outbox will be cleared, the default application settings restored, but for example, the SMS

message centre number, Internet access point and Remote mailbox settings will be lost.

Stored documents will not be affected.

To format the file system

Symptoms: The communicator is in a reboot cycle or does not boot up.

First, check that your battery is not empty.

Key combination: Shift-Tab-F

Caution: Formats the file system. All data you have entered will be lost. This operation will restore your communicator to the state it was in at the time of purchase.

Remember that backed up data can be restored in all cases.

If these measures do not help, contact your local dealer.

5. Cannot make or receive calls

Make sure that the phone is not off. Close the cover and switch on the phone.

If you get the message INVALID SIM CARD, your SIM cannot be used in the communicator. Contact you dealer or network operator.

Check the status of your call barrings and diverts, see "Telephone settings" on page 53.

The phone may be busy: data or fax is being sent or received, or the communicator is being used as a fax modem. Wait for the data/fax transmission to end, or drop the call by pressing the  key on the phone keypad.

6. Call quality is poor

Your location may not allow better call quality. This problem may occur especially in a moving car or train. Move to a location where the radio signal reception is better. See "Facts about cellular data transmission" on page 4.

Reception is usually better above ground level, outdoors and while stationary. Sometimes even moving the communicator slightly will improve reception. You can also try using the communicator in the handsfree mode, see "Handsfree mode" on page 50. Remember to turn the antenna to an upright position.

7. Cannot divert or bar voice, fax or data calls

You may have not subscribed to the service in question, or it is not supported by the network, or the message centre number and the number to which you want to divert your calls may be missing or incorrect.

Fax diverts and barrings are set in the settings of the Fax application. Data barring is set in the Internet settings. Data calls cannot be diverted.

8. Cannot select a contact

If you cannot select a contact in the Telephone, Fax, SMS or Mail directory, the contact card does not have a telephone number, fax number, wireless phone number or an e-mail address. Add the missing information to the contact card in the Contacts application.

9. Cannot send or receive faxes, short messages or mail

Make sure that you have subscribed to these network services.

The phone may be off, or the communicator is low on memory. See problem 16.

The number format you use may be invalid, or the called number has not answered within 10 tries, or you are calling to a wrong phone number.

The phone may be busy: data or fax is being sent or received, the communicator is being used as a fax modem. Wait for the data/fax transmission to end, or drop the call by pressing the  key on the phone keypad.

Fax/data barrings or fax diverts may be active. Fax barrings/diverts are set in the settings of the Fax application, data barrings are set in the Internet settings.

Fax reception: Your SIM card may not have a fax number.

Mail reception: Your SIM card may not have a phone number for data connections. Contact your service provider.

Mail sending: You have not subscribed to a remote mailbox service, or the mail server delivering your mail does not comply with the SMTP protocol. Contact your e-mail service provider. If you are using the *Upon request* sending option, mail must be sent in the Document outbox, see "To send mail" on page 80.

Short message sending: You have not subscribed to the Short Message Service or the message centre number is missing or incorrect. Contact your service provider.

The reason for failure may also depend on the network: the network does not support SMS, fax, or data/mail; the network is out of order or busy; the field strength is not adequate for sending.

10. Cannot establish a Terminal or Internet connection

The Internet, Mail, WWW, or Terminal settings and configurations may be missing or incorrect. Check your Internet access point configurations in the Internet main settings. Contact your Internet service provider for the correct settings. See "Internet settings" on page 74.

If you receive internal error messages, remove and replace the battery and try again. If the problem persists, see problem 4.

If you receive service provider error messages when connecting to your Remote mailbox, contact your remote mailbox service provider. Your Remote mailbox may contain corrupted mail messages or the mail server settings may be incorrect.

11. Infrared problems

The communicator may be connected to a PC, laptop, printer, digital camera, wireless phone or another communicator via the infrared link.

If you are using the PC Suite for Nokia 9110 Communicator program on your PC, or if you want to receive data from another communicator or a digital camera, you will have to start the Infrared activation application on your communicator before the connection is made. See "Infrared activation" on page 118.

If you are using the Nokia Communicator Server program on the PC, the infrared connection is established automatically when you use one of the PC connectivity applications of the communicator.

The PC to which you want to establish the connection must have an IrDA compatible infrared port; installed and activated IrDA drivers; and Microsoft Windows 95. For more information on IrDA drivers and their use in Windows 95, contact Microsoft.

For further information, see the Documentation section on the CD-ROM in the sales package of the communicator.

12. Printing problems

If you are using the infrared connection, the infrared port of the printer must be compatible to the IrDA standard. See "Document features" on page 24.

If you fail to establish an infrared connection, transfer the file to a PC and use the PC to print the document. Alternatively, you can fax the document to the nearest fax machine. See "To send faxes" on page 59.

Check that your printing settings are correct, see "System settings" on page 113.

You may be using an incorrect printer driver, see "Document features" on page 24.

13. PC connectivity problems

Make sure that the correct PC connectivity program is installed and running on your PC. See chapter 4 "PC connectivity" on page 29.

Check the cable or infrared connection used. If you use an infrared connection, the IR ports must be facing each other.

Check that you are using the correct COM port.

14. Fax modem problems

When you use the communicator as a fax modem, make sure that the communicator and the PC use the same baud rate. If you use the infrared connection, the baud rate is set automatically. If you use the cable connection, set the baud rate in the Fax modem settings. For the PC, the baud rate is set in the connectivity software of the PC.

If you use the cable connection, fully compatible operation with all PC fax and terminal software cannot be guaranteed. Consult your dealer. If you have problems with your PC fax software, use the infrared connection.

If you have problems establishing a data connection with the remote modem, try fixing the data transmission rate by using an AT command. Common AT commands based on the ETSI 07.07 standard and supported by the Nokia 9110 Communicator are listed in the *atcomm.txt* file on the diskette supplied with the communicator. For information on how to use the AT commands, consult the documentation of the telecommunication or fax application that you use on your PC.

15. Access code problems

The lock code is included in the sales package of the communicator. If you forget or lose the lock code, contact your communicator dealer.

If you forget or lose a PIN or PUK code, or if you have not received such a code, contact your network operator.

For information about Internet or Terminal passwords, contact your Internet service provider.

16. Low on memory

If you notice that the memory of your communicator is getting low, or you receive a warning note about insufficient memory, check the Memory application.

- 1 Press **Details** to see what kind of data takes up most memory. See "Memory" on page 118.
- 2 Make a backup of all important data.
- 3 Remove items which use a lot of memory, such as documents, received faxes, or old calendar data, either manually or with the Data removal application. See "Memory" on page 118. Or you can transfer the items to your memory card.

Note: Downloaded images, received faxes, and recordings may take up significant amounts of memory space.

17. Distorted characters in Terminal

If the data bits/stop bits/parity settings are different from those defined to the data service by the operator, characters may look distorted on the display.

18. ISDN connection

If you use an ISDN connection, go to the Internet settings and select *Internet access*. Select the access point you use or define a new one. In the *Advanced settings*, go to *Modem initialisation*. Enter the AT command AT+CBST=71 on the dotted line.

16. Care and maintenance

Your Nokia 9110 Communicator is a product of superior design and craftsmanship and should be treated with care. The suggestions below will help you to fulfil any warranty obligations and to enjoy this product for many years.

When using your communicator, battery, charger OR any accessory:

Keep it and all its parts and accessories out of small children's reach.

Keep it dry. Precipitation, humidity and liquids contain minerals that will corrode electronic circuits.

Do not use or store it in dusty, dirty areas. Its moving parts can be damaged.

Do not store it in hot areas. High temperatures can shorten the life of electronic devices, damage batteries, and warp or melt certain plastics.

Do not store it in cold areas. When the communicator warms up (to its normal temperature), moisture can form inside the communicator, which may damage electronic circuit boards.

Do not attempt to open it. Non-expert handling of the device may damage it.

Do not drop, knock or shake it. Rough handling can break internal circuit boards.

Do not use harsh chemicals, cleaning solvents, or strong detergents to clean it. Wipe it with a soft cloth slightly dampened in a mild soap-and-water solution.

Do not paint it. Paint can clog the device's moving parts and prevent proper operation.

Use only the supplied or an approved replacement antenna. Unauthorised antennas, modifications or attachments could damage the communicator and may violate regulations governing radio devices.

If the communicator, battery, charger or any accessory is not working properly, take it to your nearest qualified service facility. The personnel there will assist you and, if necessary, arrange for service.

17. Important safety information

Traffic safety

Do not use a communicator while driving a vehicle. If using a communicator, park the vehicle first. Always secure the communicator in its holder; do not place the communicator on the passenger seat or where it can break loose in a collision or sudden stop.

The use of an alert device to operate a vehicle's lights or horn on public roads is not permitted.

Remember road safety always comes first!

Operating environment

Remember to follow any special regulations in force in any area and always switch off the phone of your communicator whenever it is forbidden to use it, or when it may cause interference or danger.

When connecting the communicator or any accessory to another device, read its user's guide for detailed safety instructions. Do not connect incompatible products.

As with other mobile radio transmitting equipment, users are advised that for the satisfactory operation of the equipment and for the safety of personnel, it is recommended that the equipment should only be used in the normal operating position (held to your ear with the antenna pointing over your shoulder).

Do not point the infrared beam at anyone's eye or allow it to interfere with other infrared devices.

Electronic devices

Most modern electronic equipment is shielded from radio frequency (RF) signals. However, certain electronic equipment may not be shielded against the RF signals from your communicator.

Pacemakers: Pacemaker manufacturers recommend that a minimum separation of 20 cm (6 inches) be maintained between a hand-held wireless phone and a pacemaker to avoid potential interference with the pacemaker. These recommendations are consistent with the independent research by and recommendations of Wireless Technology Research. Persons with pacemakers:

Should always keep the communicator more than 20 cm (6 inches) from their pacemaker when the phone is switched on;

Should not carry the communicator in a breast pocket;

Should use the ear opposite the pacemaker to minimise the potential for interference.

If you have any reason to suspect that interference is taking place, switch off the phone of your communicator immediately.

Hearing aids: Some digital wireless phones may interfere with some hearing aids. In the event of such interference, you may want to consult your service provider.

Other medical devices: Operation of any radio transmitting equipment, including communicators, may interfere with the functionality of inadequately protected medical devices. Consult a physician or the manufacturer of the medical device to determine if they are adequately shielded from external RF energy or if you have any questions. Switch off the phone of your communicator in health care facilities when any regulations posted in these areas instruct you to do so. Hospitals or health care facilities may be using equipment that could be sensitive to external RF energy.

Vehicles: RF signals may affect improperly installed or inadequately shielded electronic systems in motor vehicles (e.g. electronic fuel injection systems, electronic anti-skid (anti-lock) braking systems, electronic speed control systems, air bag systems). Check with the manufacturer or its representative regarding your vehicle. You should also consult the manufacturer of any equipment that has been added to your vehicle.

Posted facilities: Switch off the phone of your communicator in any facility where posted notices so require.

Potentially explosive atmospheres

Switch off the phone of your communicator when in any area with a potentially explosive atmosphere and obey all signs and instructions. Sparks in such areas could cause an explosion or fire resulting in bodily injury or even death.

Users are advised to switch off the phone when at a refuelling point (service station). Users are reminded of the need to observe restrictions on the use of radio equipment in fuel depots (fuel storage and distribution areas), chemical plants or where blasting operations are in progress.

Areas with a potentially explosive atmosphere are often but not always clearly marked. They include below deck on boats; chemical transfer or storage facilities; vehicles using liquified petroleum gas (such as propane or butane); areas where the air contains chemicals or particles, such as grain, dust or metal powders; and any other area where you would normally be advised to turn off your vehicle engine.

Vehicles

Only qualified personnel should service the communicator, or install the communicator in a vehicle. Faulty installation or service may be dangerous and may invalidate any warranty which may apply to the unit.

Check regularly that all wireless phone equipment in your vehicle is mounted and operating properly.

Do not store or carry flammable liquids, gases or explosive materials in the same compartment as the communicator, its parts or accessories.

For vehicles equipped with an air bag, remember that an air bag inflates with great force. Do not place objects, including both installed or portable wireless equipment in the area over the air bag or in the air bag deployment area. If in-vehicle wireless equipment is improperly installed and the air bag inflates, serious injury could result.

Switch off the phone of your communicator before boarding an aircraft. The use of wireless telephones in an aircraft may be dangerous to the operation of the aircraft, disrupt the wireless telephone network and may be illegal.

Failure to observe these instructions may lead to suspension or denial of telephone services to the offender, or legal action or both.



Emergency calls

IMPORTANT!

The Nokia 9110 Communicator, like any wireless phone, operates using radio signals, wireless and landline networks as well as user-programmed functions which cannot guarantee connection in all conditions. Therefore you should never rely solely upon any wireless phone for essential communications (e.g. medical emergencies).

Remember, to make or receive any calls the phone must be switched on and in a service area with adequate signal strength. Emergency calls may not be possible on all wireless phone networks or when certain network services and/or phone features are in use. Check with local service providers.

To make an emergency call

- 1 If the device cover is open, close the cover.
- 2 If the phone is not on, switch it on by pressing the  key. Some networks may require that a valid SIM card is properly inserted in the communicator.
- 3 Press and hold the  key for several seconds to ready the phone for calls, and to end possible active data or fax calls.
- 4 Key in the emergency number for your present location (e.g. 112 or other official emergency number). Emergency numbers vary by location.
- 5 Press the  key.

If certain features are in use (call barring, fixed dialling, closed user group, system lock, keypad lock, etc.), you may first need to turn those features off before you can make an emergency call. Consult this document and your local cellular service provider.

When making an emergency call, remember to give all the necessary information as accurately as possible. Remember that your communicator may be the only means of communication at the scene of an accident - do not cut off the call until given permission to do so.

To use this manual

The wireless phone described in this manual is approved for use in the GSM networks.

A number of features included in this manual are called network services. They are special services provided by wireless service providers. Before you can take advantage of any of these network services, you must subscribe to the service(s) you require from your home service provider and obtain instructions for their use. You can then activate these functions as described in this manual. The manual activation commands for various services are not presented in this manual (e.g., using the * and # characters for activating or deactivating services). The Nokia 9110 Communicator, nevertheless, is capable of handling commands given in that form. For these commands, please consult with your service providers.

WARNING! This apparatus is intended for use when supplied with power from a Lithium-ion battery and chargers ACP-9E, ACP-9X and ACP-9A. Other usage will invalidate any approval given to this apparatus and may be dangerous.

Use only batteries, chargers, and accessories approved by the communicator manufacturer for use with this particular communicator model. The use of any other types will invalidate any approval or warranty applying to the communicator, and may be dangerous.

For availability of approved accessories, please check with your dealer.

When you disconnect the power cord of any accessory, grasp and pull the plug, not the cord.

Glossary

A **AT commands**

Operations of a fax modem can be controlled by AT commands. These commands give the advanced user an opportunity to control all the features of the modem. A list of common AT commands based on the ETSI 07.07 standard and supported by the Nokia 9110 Communicator are available in the *atcomm.txt* file on the diskette included in the sales package of your communicator.

B **Barring password**

The barring password is a 4-digit code needed to change fax and voice call barrings, see "Telephone settings" on page 53. The password is not located in your communicator or SIM card, but in the network. You obtain the password from your network operator when you subscribe to the call barring service.

C **Cookies**

Cookies are little pieces of information, given by the server to you, to store information about your visits to a web site. When you accept cookies, the server is able to evaluate your use of the web site; what you are interested in, what you want to read, etc.

D **Domain name and Host name**

The terms "domain name" and "host name" are sometimes, slightly inaccurately, used as synonyms. In a fully qualified domain name, e.g. *www.forum.nokia.com*, the first part of the name is the name of the host, and the following parts are names of domains to which the host belongs. Each host name corresponds to a certain IP address. Host names are used because they are easier to remember than IP addresses.

DTMF (Dual Tone Multi-Frequency) tones

DTMF tones are the tones you hear when you press the number keys on the phone keypad. DTMF tones allow you to communicate with voice mailboxes, computerised telephony systems, etc.

H **Hotspot**

A WWW page may contain hotspots, such as selection lists, text entry fields, and reset/submit buttons, which enable you to input information into the World Wide Web.

HTML (Hypertext Markup Language)

A language used to define the appearance and content of WWW documents.

HTTP (Hypertext Transfer Protocol)

A document transfer protocol used in the WWW.

Hyperlink

Hyperlinks are used to move from one WWW page to another.

I IAP (Internet Access Point)

The point where your communicator connects to the Internet by way of a data call. An Internet access point can be provided, for example, by a commercial Internet service provider or by your own company.

Images, inline, external

Images within a fetched WWW page are inline images. Larger images are often placed as external images and have to be viewed separately.

IMAP4 (Internet Mail Access Protocol, version 4)

A protocol used for accessing your Remote mailbox.

IP (Internet Protocol) address

All computers and other devices connected to the Internet using the Internet Protocol have their own individual addresses. The address consists of four numbers separated by points: for example, 131.227.21.167.

L Lock code

The lock code is a five-digit code needed to lock and unlock the communicator. The lock code is also required when you change certain settings. You will find the lock code on a sticker in the sales package of your communicator. Keep it secret and in a safe place, separate from the communicator.

M MCN (Micro-Cellular Network) technology

Microcells are used for increasing the capacity of wireless networks in urban areas.

MIME (Multipurpose Internet Mail Extensions)

A standard Internet format which permits including multiple mail objects in a single message. The mail objects can be, for example, formatted multifont text messages and non-textual elements, such as images and audio fragments.

P PIN (Personal Identity Number) code

The PIN code protects your phone from unauthorised use. The PIN code is supplied with the SIM card. If the PIN code request is set on, the code is required each time the phone is switched on. The PIN code must be 4 to 8 digits long.

PIN2 code

The PIN2 code is supplied with some SIM cards. The PIN2 code is required to access certain functions supported by the SIM card. The length of the PIN2 code is 4 to 8 digits.

Plug-in

A plug-in is add-on software that can be downloaded from the WWW. The communicator uses plug-ins to display a document that the WWW application itself cannot show.

POP3 (Post Office Protocol, version 3)

A common mail protocol that can be used for accessing the Remote mailbox.

PPP (Point to Point Protocol)

A common networking software protocol which enables any computer with a modem and a phone line to connect directly to the Internet.

Protocol

A formal set of rules that govern how data is transferred between two devices.

Proxy

In some networks, the connection between the WWW and the site you want to connect to is blocked by a firewall. The firewall protects the network from unauthorised external access. A proxy is an intermediary program that enables access through the firewall. A proxy can also serve as a network cache to speed up the fetching process.

PUK (PIN Unblocking Key) code

The PUK is an 8-digit code supplied with the SIM card. The code is required when you want to change a disabled PIN code. If you enter an incorrect PUK code ten times in succession, the SIM card is rejected and you cannot make or receive any calls, except emergency calls. When the SIM is rejected, you will need a new SIM card.

You cannot change the PUK code. If you lose the code, contact your network operator.

PUK2 code

The PUK2 code is supplied with some SIM cards. The code is required when you want to change a disabled PIN2 code. If you enter an incorrect PUK2 code ten times in succession, you will not be able to access the functions which require the PIN2 code. To use these functions again, you will need to obtain a new SIM card from your network operator.

You cannot change the PUK2 code.

S **SIM (Subscriber Identity Module) card**

The SIM card contains all the information the cellular network needs to identify the network user. The SIM card also contains security-related information.

SMTP (Simple Mail Transport Protocol)

An Internet protocol governing the transfer of electronic mail.

SSL (Secure Socket Layer)

A security protocol that prevents eavesdropping, tampering, or message forgery over the Internet. Documents using SSL are identified with the prefix HTTPS.

T **TCP Port**

Identifies the data port of the destination computer.

TCP/IP (Transmission Control Protocol/Internet Protocol)

A protocol that governs data communication in the Internet and in the TCP/IP networks.

U **URL (Uniform Resource Locator)**

Link information required by the WWW to connect to a given WWW host computer. The URL usually starts with *http://* followed by *www*. For example, the Nokia Wireless Data Forum home page can be found at <http://www.forum.nokia.com>. URLs are often referred to with phrases like "Home page location," "Site location," "can be found at..."

V **Voice mailbox**

A voice mailbox is a network service or a personal answering machine where people can leave you voice messages.

Index

A

- Alarms
 - Calendar 111
 - Clock 127
- Alternate phone line service 148
- AT commands 121, 165
- Autolock 117

B

- Backlight
 - Settings 114
 - Turning on 21
- Barring password 118
- Battery 17
 - Charging 17
- Booking events 109
 - Cancelling and changing bookings 110
- Business cards 69

C

- Cable connection 30
- Cache 85
 - Emptying 91
- Calendar
 - Adding events 107
 - Alarms 111
 - Booking password 109
 - Cancelling and changing bookings 110
 - Memos 108
 - Receiving bookings 110
 - Sending bookings 109
- Caller groups 54
- Calls
 - Alternate lines 148
 - Alternating calls 52
 - Answering 48, 138
 - Answering a waiting call 52

- Anykey answer 147
- Automatic redialling 147
- Barring 56, 149
- Closed user group 150
- Conference call 51, 138
- Diverting 55, 151
- Fixed dialling 150
- Making a call 47, 137
- Making a new call 51, 138
- Making an emergency call 163
- Poor call quality 4, 155
- Putting on hold 138
- Recording conversation 49, 138, 152
- Showing costs 48, 145
- Showing duration 145
- Switching between calls 50
- Transferring 52, 139
- Waiting call 56, 147
- Chr key 101
- Cities
 - Changing home city 129
 - Editing and adding 128
 - Selecting destination city 128
- Cleaning the communicator 159
- Clock settings 129
- Codes
 - Lock code 118
 - PIN code 117
 - PIN2 code 117
 - PUK code 167
 - PUK2 code 168
- Composing tunes 129
- Conference call 51
- Contact card
 - Adding fields 41
 - Attaching an image 42
 - Creating 41
 - Customising fields 42
 - Setting an individual ringing tone 42
 - Template 40

- Contact groups
 - Creating 44
- Contrast control 115
- Costs 48

- D
 - Date format 115
 - Delivery reports 71
 - Diverting calls 55
 - Document outbox 26
 - Documents
 - Printing 100
 - Reading 99
 - Read-only documents 102
 - Sending 102
 - Transferring via IR 100
 - Writing 99
 - Downloaded files
 - Installing 91
 - Opening 102
 - DTMF tones
 - Sending 52, 140
 - Special characters 43
 - Storing 43

- E

- F
 - Emergency calls 163

 - Fax
 - Adding a logo 63
 - Adding a signature 63
 - Barring 63
 - Cover page settings 62
 - Diverting 63
 - Forwarding 59
 - Printing 62
 - Receiving 61
 - Sending 60
 - Setting sending time 63
 - Writing 59
 - Fixed dialling 150
 - Flight profile

- Setting on 57
- Folders
 - Creating 100
 - Removing 100
- Font 101
- Formatting the file system 155

G

- General log 45

H

- Handsfree mode 49
- Help
 - Application help 22
 - General help 22
 - Phone 141

I

- Images
 - Contact images 42
 - Transferring 119
 - WWW images 91
- Import/Export
 - Calendar 35
 - Contacts 35
- Indicators 12
- Individual log 45
- Info service
 - Reading 143
 - Settings 71, 144
- Infrared connection
 - Connecting to a communicator 119
 - Connecting to a PC 30
 - Connecting to a printer 25
- Internet
 - Access requirements 73
 - Autodisconnect time 75
 - Data call barring 75
 - Defining an access point 74

K

- Keyboard 14
- Keypad 135

L

- Lock code 118
- Locking
 - Communicator 115, 151
 - Keypad 141
- Logs 45

M

- Mail
 - Adding a signature 80
 - Adding attachments 81
 - Fetching 82
 - Fetching attachments 79
 - Font 78
 - Forwarding 84
 - Opening attachments 83
 - Printing 84
 - Reading 83
 - Remote mailbox 82
 - Removing messages 83
 - Replying 84
 - Sending 80
 - Sending upon request 81
 - Timed fetching 80
 - Writing 80
- Margins 101
- Memory
 - Cache 85
 - Details 118
 - SIM memory 44
- Memory card 22
 - Inserting 22
- Menu button 21
- Message centre number 70
- Messages
 - Info messages 71, 143
 - Short messages 65, 143
- Multiselection 23

N

- Network
 - Selecting 149

- Settings 55
- Nokia CareLine contact card 39, 105
- Nokia Communicator Server
 - Installing 36
- Nokia Wireless Data Forum 153
- Notes
 - Sending 102
 - Writing 99

O

- Own number sending 55, 148

P

- Passwords
 - Barring password 118
 - Booking password 109
 - Internet password 76
 - Mail password 79
 - WWW password 87, 89
- PC connectivity
 - Cable connection 30
 - Infrared connection 30
- PC Suite for Nokia 9110 Communicator
 - Installing 30
- PIN code 117
- PIN2 code 117
- Printing 25
 - Cable connection 26
 - Documents 100
 - Faxes 62
 - Infrared connection 25
 - Mail messages 84
 - Settings 114
 - SMS messages 68
- Profiles
 - Modifying 53, 147
 - Setting on 146
- PUK code 167
- PUK2 code 168

R

- Read-only documents
 - Opening 102

- Received communication note 27
- Receiving
 - Fax 61
 - Mail 82
 - SMS 67
- Recorder
 - Playing a recording 132, 152
 - Recording 132, 152
- Remote mailbox 77, 82
- Resetting the communicator 154
- Ringling tones
 - Alternate ringing tone 113
 - Composing 129
 - Recording 132
 - Selecting 113
 - Sending 131
 - Setting individual tones 42
 - Settings 54

S

- Safety information
 - Electronic devices 161
 - Operating environment 161
 - Traffic safety 161
 - Vehicles 162
- Screen blanker 115
- Search field 11, 39
- Selection frame 10
- Sending
 - Documents 102
 - DTMF tones 52
 - Mail 80
 - SMS 66
- Service cards 68
- Shortcuts 24
- Signal strength 5
 - Indicator 13, 137
- SIM card
 - Installing 7, 22
 - Viewing contents 44
- SMS

- Forwarding 68
- Receiving 67, 143
- Replying 68
- Sending 66
- Setting message centre number 70
- Writing 66
- Special characters 101
- Speed dialling
 - Settings 43
 - Using 139
- Standard messages 68

T

- Telnet
 - Defining connections 95
 - Special keys 96
- Terminal
 - Defining connections 93
 - Special keys 94
- Text Web
 - Defining services 97
 - Fetching information 97
- Time format 115
- Tones
 - Adding ringing tones 100
 - Application tones 114
 - Composing 129
 - Notification tone 114
 - Recording 132
 - Ringing tones 54, 113
 - Sending 131
 - Silencing 53
- Transferring
 - Calls 52
 - Data from older communicator models 27
 - Data from other handheld devices 41
 - Text (Telnet, Terminal) 94

U

- Unit of measure 115
- Unlocking
 - Communicator 116, 151

- V
 - Keypad 141
 - Voice mailbox
 - Calling 57, 136, 140, 144
 - Setting number 57, 144
 - Volume
 - Adjusting loudspeaker 49
 - Communicator key click 54
 - Phone key click 54
 - Ringtone 54
- W
 - Welcome note 148
 - World time 128
 - World Wide Web
 - Access requirements 85
 - Adding bookmarks 86
 - Copying text 90
 - Creating a bookmark folder 87
 - Downloading software 91
 - Fetching a page 86
 - Following a hyperlink 90
 - Navigation commands 90
 - Saving a page 91
 - Saving the HTML format 87
 - Timed fetching 88
 - Viewing images 91
- Z
 - Zoom button 21

Exhibit G

NOKIA

**WWW BROWSER STYLE
GUIDE**

1 (12)

**Mobile Phones
2.6**

01.10.98

**Nokia 9110 Communicator
WWW Browser Style Guide**

TABLE OF CONTENTS

- 1. About This Document..... 4**
- 2. HTML Considerations..... 4**
- 3. Supported Protocols and MIME Types 4**
- 4. Page Layout Considerations 6**
 - 4. 1. The Text 6**
 - 4. 2. Tables 6**
 - 4. 3. Frames 7**
 - 4. 4. Movement Within a Page..... 7**
 - 4. 5. Hierarchy 7**
- 5. Graphics Considerations 7**
 - 5. 1. Display Attributes 8**
- 6. Data Transfer Speed Considerations..... 8**
- 7. Multimedia Considerations 9**
- 8. Link Considerations 9**
- 9. Other Considerations 9**
- 10. Checklist..... 10**
 - 10. 1. Graphics 10**
 - 10. 2. Text 11**
 - 10. 3. HTML 3.2 DTD Commands Not supported By Communicator Browser..... 11**
 - 10. 4. Hierarchy 11**
 - 10. 5. Links 11**
 - 10. 6. Usability..... 11**
 - 10. 7. Browser Identification..... 12**
- 11. References 12**

NOKIA

**WWW BROWSER STYLE
GUIDE**

3 (12)

**Mobile Phones
2.6**

01.10.98

1. ABOUT THIS DOCUMENT

This is a design guide for content providers seeking to produce usable WWW pages with HTML for the Nokia 9110 Communicator browser. This guide outlines some of the basic considerations that should be taken into account when designing web sites for the communicator.

A basic understanding of the words WWW, HTML, HTTP, browser, page, screen, pixel and bit is necessary to benefit from this document. Additional reference material is listed at the end of this guide.

This guide is not a general HTML style guide [Lynch, 1995], a general communicator design guide [GO, 1992] nor an HTML syntax check [Halsoft, 1995]. For more information on these subjects, refer to the references section at the end of this document. If a conflict between the suggestions of this document and other referenced documents arises, this document should be given preference.

2. HTML CONSIDERATIONS

The basic HTML for the communicator should be based on the HTML 3.2. There are some minor exceptions and limitations which must be taken into account. These restrictions are set mainly by the size of the view and by the layout capabilities of the system. E.g. it is not always possible to handle element positioning or image sizing as defined in HTML source code. These and other design suggestions will be discussed in this document.

The browser parser in the communicator is not strict and will not attempt to interpret HTML tags it does not support. Note that the basic screen and graphic design for the communicator is radically different from a desktop computer. To maximise the properties of both platforms, WWW page versions should be created for both the communicator and PC platforms. HTML comments, excessive white space, non-usable tags, and heavy graphics should be avoided to ensure maximum download speed.

3. SUPPORTED PROTOCOLS AND MIME TYPES

The protocols that can be used in fetch operation by default are listed in the following table.

Protocol	Description
File	Protocol for fetching local files.
Http	Hypertext transfer protocol.

Https	<p>Protocol for SSL (Secure Socket Layer). SSL is a transparent software layer that is located above TCP/IP and below the application protocols in the protocol stack. SSL enables to transfer the user's sensitive data over a public network securely.</p> <p>WWW browser of the Nokia 9110 Communicator has SSL version 3 capability.</p>
Mailto	<p>Protocol to send email from WWW page. Opens up a Mail editor.</p>
Gsms	<p>Protocol to send short messages from WWW page. Opens up a SMS editor.</p>
Gsm-sms	<p>Protocol to send short messages from WWW page. Opens up a SMS editor.</p>
Vnd.nokia.sms	<p>Protocol to send short messages from WWW page. Opens up a SMS editor.</p>
Phone	<p>Protocol for establishing voice call from WWW page.</p>
Tel	<p>Protocol for establishing voice call from WWW page.</p>
Vnd.nokia.phone	<p>Protocol for establishing voice call from WWW page.</p>

The following MIME types are supported by WWW:

/		Unknown MIME types
Application/vnd.nokia.ringing-tone	.rng	Communicator ringing tones
Application/ringing-tone	.rng	Communicator ringing tones
Application/x-nokia-9000-communicator-add-on-software	.aos	AOS files
Application/vnd.nokia.configuration-message	.ncm	Configuring Smart Message file
Audio/wav	.wav	Wav audio file
Audio/x-wav	.wav	Wav audio file
Image/gif	.gif	GIF image
Image/jpeg	.jpg, .jpe	JPEG image

Text/html	.html, .htm	Html file
Text/plain	.txt	Plain text file

4. PAGE LAYOUT CONSIDERATIONS

The size of the 9110 Communicator screen is 200 x 640 pixels. The pixel shape is rectangular and the pixel pitch is 0,17mm. The display is able to show 16 grey tones. The area displaying WWW-page content is 200 X 540 pixels, as a part of the screen is covered by the browser options and window.

4. 1. The Text

The standard text size is 12 points, with support for both mono-spaced and variable-spaced typefaces. Underline, bold and italics styles are also supported. All text links are displayed as underlined. All levels of headings (H1-H6) are supported. Text to be read first should be formatted to fit on the first screen of the page.

Note that preformatted text (<PRE> tag) should be avoided as the user cannot resize the window of the browser. Approximately 75 characters fit on a single line when the basic text size is used. This is dependent on which letters are in the text (i's are thinner than m's).

Underlined text should not be used, since the communicator underlines all links. Underlined text, therefore, appears as a link to the user.

When displaying pre-sized text, lines which are too long for the screen continue onto the next line making all the text available to the reader.

It is not useful to use pictures as bullets when making lists. This can mix the list up and could cause the user wonder what the pictures are for if they are not auto-loading images.

4. 2. Tables

The Nokia 9110 Communicator Browser supports tables. There is a table button, which is a button icon opens a separate table viewer to display the table. Table viewer is horizontally and vertically scrollable note. It contains a cursor that can be moved to enable select and copy of the table contents.

Arrow keys move the cursor by cells. It is possible to move the cursor inside the cell with Ctrl + arrow key. Shift + arrow selects the text in one cell. Ctrl + h moves the focus to upper left corner of the table. Ctrl + e moves the focus to lower right corner of the table. Chr + arrow scrolls one screenful in the selected direction.

**Mobile Phones
2.6****01.10.98**

Title line in the viewer displays the string from the CAPTION tag on the left side. Right side of the title line shows the cell coordinates for the current position of the cursor, for example 2,3 for column 2 and row 3.

As long as HTML table does not contain images or links and the rows fit to one row (app. 60 chars) in the Browser view, the table is displayed in the browser view. If the table contains images or links and several small cells, the table is displayed in the Browser view, but the table button is available. If the table contains images or links but several small cells are not found, the table is displayed in the Browser view without table button. If the table contains form elements the table viewer is not available.

4. 3. Frames

Each frame will be displayed as a link. If a web page has four frames, the communicator will show four corresponding links. When a link is selected, it will take the browser to a new page which shows the content of the frame chosen.

NOTE: It may cause user problems, if cookies are used within a frame document. User should then load the correct frame before cookie is handled.

4. 4. Movement Within a Page

The user moves from one discrete link to another by using the scroll keys on the communicator. The scroll keys move the browser to the next line or next hyperlink. The active area of the page also changes accordingly. The Chr and scroll keys can be used to scroll a full screen of material at once. Ctrl -H can be used to move to the beginning of the page and Ctrl-E to move to the end of the page. There is no cursor for continuous scrolling through the page. Since free movement within a page is restricted, links should be carefully placed. Hierarchical pages are easier for the user to navigate than a single long page.

4. 5. Hierarchy

A good rule is that a page should not have more than five hyperlinks unless it is a selection menu listed with proper sub-headings. A maximum of three hierarchical levels are recommended for casual browsing. If more than three hierarchical levels are required, the designer should ensure easy navigation between the levels. This is especially important in sub-categorised hierarchies of three or more levels. Give the user a chance to go back easily to a sub-category home page as well as to the main home page. Again, avoid long pages as downloading and navigating them can be slow.

5. GRAPHICS CONSIDERATIONS

The graphics display attributes of the communicator should be taken into account when incorporating graphic images. In addition to the size and depth attributes of the display,

other important considerations are the communication speed of the browser, the speed of the HTTP protocol, and the use of image maps (ISMAP). When displaying paragraph text, approximately 75 characters can be displayed. Use the ALT attribute to specify a text string that the browser can display as an alternative to the in-line image.

5. 1. Display Attributes

Pre-rasterizing of all pictures with more than 8 shades of gray is recommended. A stochastic raster with 8 shades of gray works best in most cases. Images with large uniform color areas look better than heavily screened images. Images placed horizontally in a normal-sized screen (desktop or laptop PC) will be displayed vertically on the communicator. Pictures can be loaded faster using RLE compression, which is important because of the transfer rate.

An external picture should not be larger than 570 X 200 pixels, because this size fills the whole screen. The maximum dimensions for inline pictures are 540 X 200 pixels. If a picture exceeds the maximum width, the picture will be zoomed out using standard factors (1:2, 1:3, etc.). For example, if the inline image width is 541 pixels it will be zoomed out using the factor of 1:2 and be displayed as 270 pixels wide. An image with a 540 pixel width will be shown full-size using the entire screen width. The height of an image is not so important, as the screen can be scrolled up and down.

GIF, JPG, and UPF (Uni Picture Format, format of the IrTran-P digital camera images) format pictures can be viewed with an external image viewer, but progressive JPEG compression should not be used. A maximum of four images per page is recommended. General image size should not exceed 10 kilobytes. Since a user can turn off image auto-loading, it is advisable to warn the user if you are offering a graphics-intensive page.

6. DATA TRANSFER SPEED CONSIDERATIONS

The HTTP protocol specifies a "slow start", which slows down the start of each HTTP transfer. The HTTP protocol is also connectionless, requiring all images on a page to be retrieved with their own HTTP request. Each request takes time to execute due to negotiation overhead of the protocol. Considering the data transfer speed of the communicator (9600 bit/s or 14400 bit/s if supported by the GSM network), the number of images on a page should be evaluated carefully and all image sizes should be kept to a minimum. It should not take more than 10 seconds to fetch and display a typical page on the communicator browser.

It is often better to use one large image map rather than separate images, because one image loads faster than several smaller images. Since image maps are somewhat slower to navigate than text links, they should only be used where needed.

**Mobile Phones
2.6****01.10.98**

7. MULTIMEDIA CONSIDERATIONS

The 9110 Communicator Browser supports WAV format. WAV audio files can be fetched and files can be played using Digital Voice recorder.

The WAV files can not be played simultaneously with an active data call. When an audio file is downloaded and there is an active data call, the file is stored in Tones folder. Animated GIFs are not supported. Only the first picture from the series will be displayed. If the animation is saved to the Downloaded files folder, the animation will be played as whole when opened.

8. LINK CONSIDERATIONS

All links are displayed as underlined text. To avoid confusion between links and other text, do not use underlining for text emphasis. Note that the emphasis tag () may also produce an underlining effect for the text emphasized.

Link placement should allow users to clearly distinguish between links on the page. For example, two short words (links) side-by-side may not appear as separate links to the user. Links that go semantically together should usually be placed so that the user does not have to scroll down to the next screen in order to access the next link.

Links that together form a set of choices, from which the user selects one link, should all be visible at the same time on the screen. This helps the user to see the hyperlink options in a glance, without having to scroll up and down the page. The chance that a link will not be noticed is reduced if links are grouped properly.

The mail-to HREF-link is supported, but communicator does not support other data transfer protocols (i.e. wais, ftp, gopher) and they should not be offered. If there is a need for these services, an http gateway should be set up to provide these services for the user.

The user can keep a list of personal bookmarks on the communicator, but this capability should not be used to force the user to add new links to the list in order to properly navigate a certain WWW hierarchy.

9. OTHER CONSIDERATIONS

WWW browser of the Nokia 9110 Communicator has two different cache systems. The basic "online" cache stores the documents that are fetched with normal fetch operations. This cache has maximum size of 300 kb. Older documents are removed when the cache is full and new documents are fetched. The other "offline cache" stores only documents that are fetched with timed fetching. This cache does not have a fixed maximum size. All fetched items, except secure documents and documents that are fetched with HTTP headers "Cache-Control:no-cache" or "Pragma:no-cache", are stored in the cache.

Authentication (inserting a name and password in a dialog) is also supported and can be used. Forms or dialogs requiring heavy text input should be avoided so the user is not overwhelmed with data entry. Users are likely to avoid pages that are too cumbersome to use. When the authorization data is asked for the second time in the same domain, application offers automatically the username and password from the earlier contact. If this fails the authorization dialogue is opened with default username. Successful authorization is transparent to the user.

The Nokia 9110 Communicator WWW browser supports client pull (HTTP-EQUIV="Refresh") feature. It is also possible to set an automatic update to certain pages.

For best results, we recommend providing links to pages specifically designed for the communicator browser, as well as other browsers, based on the browser identification information which can be queried with the HTTP protocol. Pages should be optimized with the appropriate level of HTML DTD, graphics, and links for each browser. When designed properly, these pages offer maximum usability and can be used as templates for the creation of additional pages. Templates allow the automatic generation of additional pages with similar design elements and functions. Changes to the browser can be accommodated by changes to the template, rather than to all of the individual pages created for the browser.

The communicator browser name is "Nokia-Communicator-WWW-Browser/3.0 (Geos 3.0 Nokia-9110)". The browser can identify itself by including the User-Agent request-header field with requests. The User-Agent request-header field contains information about the user agent originating the request. To ensure that users receive pages that are compatible with the Nokia 9110 Communicator, use a script that checks the User-Agent request-header field and returns the communicator-optimized pages.

10. CHECKLIST

A list of the major guidelines for designing WWW pages for the communicator is offered here as a tool for checking page sketches or final designs. This checklist should be used each time new pages are designed, or existing pages are modified. When designing pages for the first time, an HTML manual [Tilton, 1995] and WWW design style guide [Lynch, 1995] should be consulted first.

10. 1. Graphics

- Use only HTML 3.2. Limitations are listed in this document.
- The maximum file size of a single image is 10 kB.
- Use a maximum of four images per page.
- Images have been reduced to 10 grays or less.
- The maximum image dimensions are 540 X 200 pixels.
- Do not use progressive JPEG compression on images.
- Horizontally placed images can be displayed vertically.
- The ALT attribute is used with in-line images.

**Mobile Phones
2.6****01.10.98**

- **It is recommended not to use frames.**

10. 2. Text

- **Underlining is not used for text emphasis.**
- **Most important text is visible at the top of the screen.**

10. 3. HTML 3.2 DTD Commands Not supported By Communicator Browser

- **APPLET element**
- **BASEFONT element**
- **FONT element**
- **ISINDEX element**
- **LINK element**
- **SCRIPT element**
- **STYLE element**
- **U element**
- **Attributes in A element: rel, rev**
- **Attributes in BODY element: bgcolor, text, link, vlink, alink, background**
- **Attribute in BR element: clear**
- **Attributes in HR element: align, noshade, size, width**
- **Attributes in IMG element: align, width, height, border, hspace, vspace**
- **Attributes in OL element: type, compact**
- **Attribute in PRE element: width**
- **Attribute in SELECT element: size**
- **Attributes in TABLE element: align, border, cellspacing, cellpadding**
- **Attribute in CAPTION element: align**
- **Attribute in TD element: nowrap, rowspan, colspan, align, valign**
- **Attribute in TH element: nowrap, rowspan, colspan, align, valign**
- **Attributes in TR element: align, valign**
- **Attributes in UL element: type, compact**

10. 4. Hierarchy

- **No more than five major links on a page (unless with lists)**
- **No more than three major levels of hierarchy (unless the hierarchy is categorized into sub-hierarchies)**
- **Navigation back to the home page and sub-category home page is available.**

10. 5. Links

- **Links are grouped to enable selection without scrolling**
- **Links should be visually separate from each other**

10. 6. Usability

- **Each page takes about 10 seconds to load and display**
- **No links that point to multimedia data types**

**Mobile Phones
2.6****01.10.98**

10. 7. Browser Identification

- **The server identifies the 9110 browser and uses an optimized layout template.**

11. REFERENCES

[WebTechs, 1996] Web Techs HTML Validation Service.

<http://www.webtechs.com/html-val-svc>

[W3C, 1998] W3C HTML Validation Service. *<http://validator.w3.org>*

[Lynch & Horton, 1997] Yale C/AIM Web Style Guide. Patrick J. Lynch and Sarah Horton, 1995. *<http://info.med.yale.edu/caim/manual/index.html>*

[REC html32] HTML 3.2 Reference Specification, 1996. *<http://www.w3.org/TR/REC-html32.html>*

[Tilton, 1998] Composing Good HTML, James Tilton, 1998.

<http://www.cs.cmu.edu/~tilt/cgh>

Exhibit H

PC Suite
for Nokia 9110
Communicator
User's Guide

Copyright Notice

No part of this publication may be reproduced, transmitted, transcribed, stored in a retrieval system, or translated into any computer language, in any form or by any means, without the express written permission of Puma Technology, Inc.

Intellisync® is a registered trademark of Puma Technology, Inc.

Nokia 9110 Communicator is a trademark of Nokia Corporation.

All other company and product names are trademarks of their respective companies.

© Copyright Puma Technology, Inc. 1998. All rights reserved.

Puma Technology, Inc., 2550 North First Street, Suite 500, San Jose, CA 95131

END-USER NOTICE AND LICENCE AGREEMENT FROM PUMA TECHNOLOGY, INC.

NOTICE TO END-USER: CAREFULLY READ THE FOLLOWING LEGAL AGREEMENT (“LICENCE”). INSTALLATION OR USE OF THE ENCLOSED PUMA SOFTWARE (“SOFTWARE”) ON YOUR COMPUTER SYSTEM CONSTITUTES YOUR ACCEPTANCE OF THESE TERMS. IF YOU DO NOT AGREE TO THE TERMS OF THIS LICENCE, PROMPTLY DELETE THE SOFTWARE FROM YOUR COMPUTER SYSTEM, DESTROY ANY COPIES YOU MADE OF THE SOFTWARE OR ANY INSTALLATION DISKETTES OF THE SOFTWARE INCLUDED WITH YOUR SYSTEM, AND DISPOSE OF ALL WRITTEN MATERIALS IN YOUR POSSESSION REGARDING THE SOFTWARE.

Licence Grant: In the case of PC Suite for Nokia 9110 Communicator Software, Puma grants to You, as an individual, a licence to install and use one copy of the Software on a single computer at a time. Your licence to use the Software is conditioned upon Your compliance with the terms of this Agreement. A Licence is required for each end-user of the Software. A Licence is required for each installation of the Software, unless the Software is (i.) installed temporarily on a PC owned by a third party so that you can accomplish a file transfer, and (ii.) is immediately deleted from such PC. You may make one (1) copy of the Software for archival purposes only.

Copyright: The Software is protected by United States copyright law and international treaty provisions. You acknowledge that no title to the intellectual property in the Software is transferred to You. You further acknowledge that title and full ownership rights to the Software will remain the exclusive property of Puma, and You will not acquire any rights to the Software except as expressly set forth in this licence. You agree that any copies of the Software will contain the same proprietary notices which appear on and in the Software.

Prohibited Uses: Without obtaining prior written permission from Puma, You may not (a.) use, copy, modify, alter, or transfer the Software or documentation except as expressly provided in this Licence; (b.) translate, disassemble, decompile, reverse program or otherwise reverse engineer the Software; (c.) sublicense or lease the Software or its documentation; or (d.) use the Software in a multi-user, network, or multiple computer environment or in a rental, time sharing or computer service business. Without prejudice to any other rights, Puma may terminate this Licence if You fail to comply with its terms and conditions. In such event, You must destroy all copies of the Software.

Limited Warranty: Puma warrants that the Software will perform substantially in accordance with the accompanying written materials for a period of thirty (30) days from the date of purchase. Any implied warranties relating to the Software are limited to such thirty (30) day period.

End-User Remedies: If the Software does not conform to the “Limited Warranty” section above, Puma’s entire liability and your sole and exclusive remedy shall be, at Puma’s option, either to (a.) correct the error, or (b.) help you work around the error. The Limited Warranty is void if failure of the Software has resulted from accident, abuse, or misapplication. Any replacement software will be warranted for the remainder of the original Limited Warranty period.

No Other Warranties: PUMA DOES NOT WARRANT THAT THE SOFTWARE IS ERROR FREE, EXCEPT FOR THE EXPRESS LIMITED WARRANTY IN THE “LIMITED WARRANTY” SECTION. PUMA DISCLAIMS ALL OTHER WARRANTIES WITH RESPECT TO THE SOFTWARE, EITHER EXPRESS OR IMPLIED, INCLUDING BUT NOT LIMITED TO IMPLIED WARRANTIES OF MERCHANTABILITY, FITNESS FOR A PARTICULAR PURPOSE AND NONINFRINGEMENT OF THIRD PARTY RIGHTS. SOME JURISDICTIONS DO NOT ALLOW THE EXCLUSION OF IMPLIED WARRANTIES OR LIMITATIONS OF HOW LONG AN IMPLIED WARRANTY MAY LAST, OR THE EXCLUSION OF LIMITATION OF INCIDENTAL DAMAGES, SO THE ABOVE LIMITATIONS OR EXCLUSIONS MAY NOT APPLY TO YOU. THIS WARRANTY GIVES YOU SPECIFIC LEGAL RIGHTS AND YOU MAY ALSO HAVE OTHER RIGHTS WHICH VARY FROM JURISDICTION TO JURISDICTION.

No Liability for Consequential Damages: IN NO EVENT SHALL PUMA BE LIABLE TO YOU FOR ANY CONSEQUENTIAL, SPECIAL, INCIDENTAL, OR INDIRECT DAMAGES OF ANY KIND ARISING OUT OF THE PERFORMANCE OR USE OF THE SOFTWARE, EVEN IF PUMA HAS BEEN ADVISED OF THE POSSIBILITY OF SUCH DAMAGES.

U.S. Government Restricted Rights: Use, duplication or disclosure of the Software by any agency, department or other entity of the Government is restricted in accordance with FAR 12.212 for civilian agencies and DFARS 227.7202 for military agencies. The Software is a commercial product. Use of the Software by the Government is further restricted by the terms of this Licence.

Table of Contents

CHAPTER 1 : BEFORE YOU BEGIN.....	1
INTRODUCTION TO PC SUITE FOR NOKIA 9110	
COMMUNICATOR.....	2
System Requirements	3
Installing the Software.....	3
Program Icons	5
The Opening Screen.....	6
PC Suite Menu Commands.....	6
Shortcut Commands	6
Component Icons.....	7
The Preferences Dialogue	8
Communicator Recognition	9
Preparing Your Communicator for a Data Transfer	11
Desk Stand Button Settings	11
CHAPTER 2 : THE CONTACTS APPLICATION.....	13
USING THE CONTACTS APPLICATION	14
The Contacts Main Screen.....	14
Opening and Saving a Database	15
Creating a Contact Card Template.....	15
Adding Contact Cards	16
Card Menu Commands.....	16
Editing Contact Cards	17
Editing Contact Card Fields	17
Adding Pictures to Contact Cards	20
Creating and Editing Contact Groups	21
Finding and Filtering Contact Information	22
Importing Records from Another Database	26
Updating to your Communicator.....	27
Updating from your Communicator	27
Synchronising your Contacts	28
CONTACTS MENU COMMANDS	29

CHAPTER 3 : INTELLISYNC	33
QUICK START TUTORIAL.....	34
Synchronising Data	34
Re-Running the Operation.....	40
Taskbar Synchronisation	40
INTELLISYNC ADVANCED SETTINGS DIALOGUES.....	42
Advanced Settings Tabs.....	42
The Date Range Tab.....	43
The Field Mapping Dialogue	61
INTELLISYNC SPECIAL TOPICS	65
Synchronisation and History Files.....	66
Intellisync Address Formats.....	67
Importing and Exporting Data	70
Synchronisation and Data Truncation.....	71
Full Re-Synchronisation	72
The Same Record Changed and Deleted Dialogue	73
The Sync Log File	74
Remote Synchronisation	76
INTELLISYNC GLOSSARY.....	77
INTELLISYNC MENU COMMANDS.....	82
CHAPTER 4 : FILE TRANSFER FUNCTIONS	85
USING THE FILE TRANSFER FUNCTIONS	86
File Transfer Window Panes.....	87
Selecting Files	87
Copying Files and Folders	87
Moving Files and Folders	88
Deleting Files and Folders	89
Renaming Files and Folders.....	89
File Properties	90
FILE TRANSFER MENU COMMANDS	91
CHAPTER 5 : BACKUP AND RESTORE	93
BACKING UP YOUR DATA	94
RESTORING A BACKUP	97
BACKUP/RESTORE MENU COMMANDS	99

CHAPTER 6 : INSTALLING AND REMOVING SOFTWARE	101
INSTALLING SOFTWARE TO YOUR COMMUNICATOR.....	102
REMOVING SOFTWARE FROM YOUR COMMUNICATOR.....	103
INSTALL/REMOVE MENU COMMANDS.....	104
CHAPTER 7 : IMPORTING AND EXPORTING CALENDAR AND CONTACTS FILES.....	105
THE IMPORT/EXPORT COMMANDS.....	106
EXPORTING A CALENDAR OR CONTACTS FILE TO YOUR PC....	107
IMPORTING A CALENDAR OR CONTACTS FILE FROM YOUR PC TO YOUR COMMUNICATOR.....	109
Importing a Contacts File.....	110
IMPORT/EXPORT MENU COMMANDS	111
INDEX.....	112

<p>Notice: The contents of this manual reflect the PC Suite for Nokia 9110 Communicator program at press-time. For information about changes to the software (or system support) that may have occurred since the manual was printed, refer to the Readme file or on-line Help.</p>

Chapter 1 : Before You Begin

This chapter introduces PC Suite for Nokia 9110 Communicator and instructs you on how to get started using the software.

Topics include:

- ◆ Introduction to PC Suite for Nokia 9110 Communicator
- ◆ System Requirements
- ◆ Installing the Software
- ◆ Program Icons
- ◆ The Opening Screen
- ◆ PC Suite Menu Commands
- ◆ Shortcut Commands
- ◆ Component Icons
- ◆ Before Configuration
- ◆ The Preferences Dialogue
- ◆ Communicator Recognition
- ◆ Preparing Your Communicator for a Data Transfer
- ◆ Desk Stand Button Settings

Introduction to PC Suite for Nokia 9110 Communicator

PC Suite for Nokia 9110 Communicator is a **suite** of functions that allow for the easy transfer of data between your Nokia 9110 Communicator and the PC applications you rely on most.

- ◆ PC Suite's Intellisync[®] component lets you synchronise your Nokia 9110 Communicator's Contacts, Calendar, and To-do list applications with a host of popular Windows applications.
- ◆ The Contacts application provides a PC Contacts file that is compatible, field-for-field, with your communicator's Contacts application.
- ◆ The Backup/Restore component lets you back up the data on your Nokia 9110 Communicator for safe keeping, and restore it if need be.
- ◆ Import/Export functions import and export Calendar and Contacts files between your communicator and PC.
- ◆ The Install/Remove component installs software to and removes software from your communicator.
- ◆ File Transfer functions let you select, move, copy, paste, rename, and delete communicator or PC files in a Windows Explorer-type environment.

System Requirements

In order to use PC Suite for Nokia 9110 Communicator, your PC must meet the following minimum system requirements:

- ◆ Windows 95, Windows NT 4.0
- ◆ IBM-compatible 486 PC or higher
- ◆ 15 MB available hard disk space
- ◆ VGA monitor or better
- ◆ CD ROM drive
- ◆ One available serial or infrared port

Installing the Software

Follow these steps to install the PC Suite software on your PC:

1. Insert your CD into your CD ROM drive. The program should launch itself automatically. If it does not, continue following these instructions.
2. Click the Windows **Start** button; then click **Run**.
3. Type **d:\9110.exe** in the command line (substitute the letter “d” with the letter of your CD drive).
4. Press **Enter**.
5. A series of screens is presented. Follow on-screen instructions, and note:
 - ◆ You are asked to specify the PC COM port you will use to connect your communicator to your PC. If you will be connecting via infrared, check the box labelled **Infrared Port**.

- ◆ You are given the option of performing a **Complete** or **Custom** installation. If you choose **Custom**, you are presented with a screen labelled **Select Components**. This screen lists the PC applications supported by the PC suite Intellisync function. Un-checking an application in this screen removes support for that system. (Thus, cutting down on the disk space used by PC Suite.)

Note: If you un-check a PC application in this screen, but later want to restore support for that system, re-install PC Suite and check the application in the Select Components screen. (Don't un-install Intellisync before re-installing.) To avoid losing custom settings (including field mapping) un-check **PC Suite Program Files** in the Select Components screen. A re-installation of the software is the only case in which you should un-check PC Suite Program Files.

When installation is complete, a program group containing a set of PC Suite icons will have been created.

- ▶ To access the program group, click **Programs** on the Windows **Start** menu. Then click on **PC Suite for Nokia 9110 Communicator**.

Program Icons

When you install the PC Suite for Nokia 9110 Communicator software, a set of icons is created.



The **PC Suite for Nokia 9110 Communicator** icon accesses the PC Suite opening screen.



The **Help** icon accesses the on-line Help system.



The **Readme** icon displays a text file containing last-minute information not included in the manual or Help topics.



The **Uninstall** icon can be used to remove the PC Suite software from your PC.

The Opening Screen

Click the  **PC Suite for Nokia 9110 Communicator** icon in the PC Suite program group to start the PC Suite software. From the opening screen, all PC Suite components can be accessed via icons or menu commands.

The first time you open the PC Suite application, the Contacts component is open. Thereafter, the last-visited PC Suite component is open when you start the software.

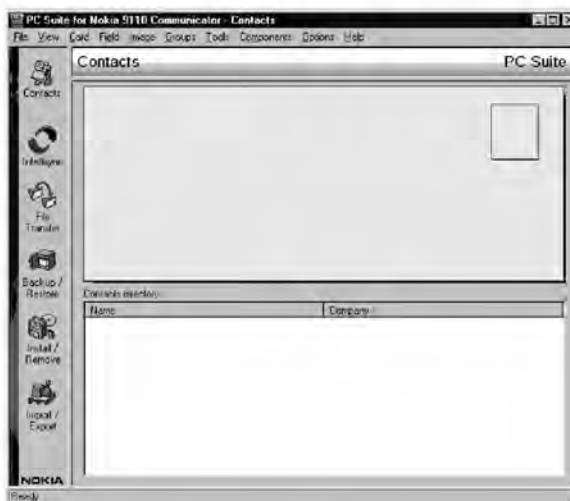

PC Suite Menu Commands

Each PC Suite component displays its own set of command menus at the top of the screen. Refer to the component-specific sections of this manual for information on the menus that apply to each component.

Shortcut Commands

Most PC Suite commands that are executed by mouse-clicking on a button or menu item can also be initiated from your keyboard. Simply hold down the Alt key and press the letter that is underlined in the button or menu item.

Component Icons

Component icons are located on the left side of the PC Suite opening screen. These work as follows:

Note that you can “drag and drop” component icons to re-order them on the PC Suite screen.



The **Contacts** icon starts the Contacts application, which installs with PC Suite to provide field-for-field compatibility with your Nokia 9110 Communicator’s Contacts application.



The **Synchronise** icon accesses the Intellisync component, which synchronises, imports, or exports data between records in your communicator and PC application.



The **Import/Export** icon accesses the PC Suite Import/Export function, which transfers Calendar and Contacts files between your communicator and your PC.



The **Backup/Restore** icon accesses PC Suite’s Backup and Restore functions, which can be used to backup and, if need be, restore, the data on your Nokia 9110 Communicator.



The **Install/Remove** icon accesses PC Suite’s Install/Remove component, which can install software to, and remove software from, your Nokia 9110 Communicator’s main memory or memory card.



The **File Transfer** icon displays a Windows Explorer-type dialogue that lets you cut, copy, paste, and move files between your communicator and your PC.

The Preferences Dialogue

Selecting the **P**references command from the PC Suite Options menu displays the **P**references dialogue. Before using PC Suite, make sure the settings in this dialogue are configured correctly.

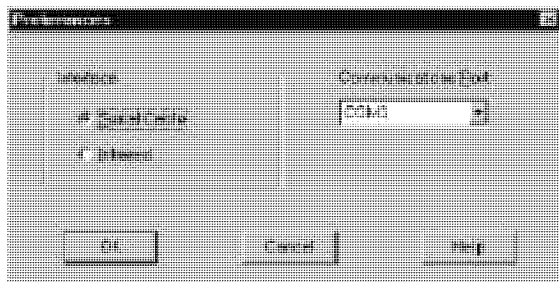

- ◆ Select the radio button labelled **S**erial **C**able if you are using a serial cable to connect your communicator to your PC.
- ◆ Select **I**nfrared if you are using infrared communication.
- ◆ The **C**ommunications **P**ort setting specifies the COM port you are using to connect your communicator to your PC. If you are using infrared, make sure you specify the port that is assigned for infrared connection.

Communicator Recognition

PC Suite functions allow you to configure operations—for example, Backup and Intellisync Synchronisations—for multiple communicators.

Because each Nokia 9110 Communicator has a unique ID number, PC Suite for Nokia 9110 Communicator has the ability to recognise individual communicators when they are connected to your PC.

To configure an operation for a particular communicator, you simply connect the communicator to your PC (or establish an infrared connection) and configure an operation. Thereafter, any time you connect that communicator and give a PC Suite command to run a configured operation, PC Suite recognises the communicator and runs the operation defined for that communicator.

Naming your Communicator

The very first time you connect a particular communicator to your PC—whether by serial cable or via infrared—PC Suite asks you for a Name to associate with the communicator.



Assigning a name to each communicator allows PC Suite to associate each communicator (and the operations that are configured for that communicator) with a value that is more easily recognised than the communicator's ID number.

Pressing the **View** button in this prompt displays the "Registered Communicators" dialogue, which lists the communicators, if any, that have been connected and named.

This dialogue can be used to rename a communicator, or delete a communicator from the list of recognised communicators.

Deleting a communicator name in this dialogue deletes all files and settings associated with that communicator.

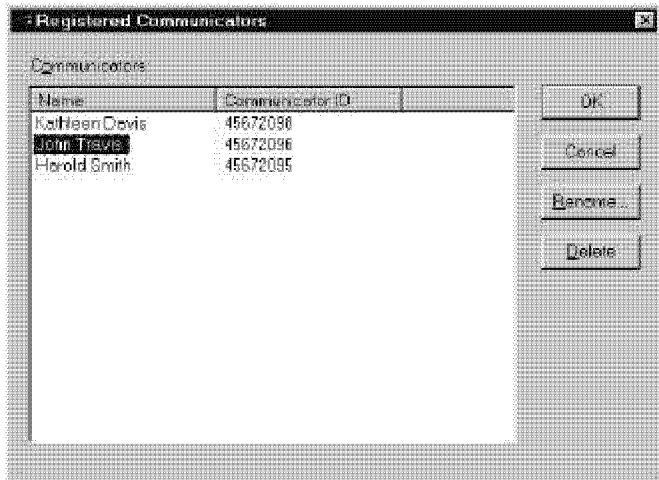

Note: The Registered Communicators dialogue can also be accessed from the Options menu.

Preparing Your Communicator for a Data Transfer

Refer to “**The Preferences Dialogue**” in this chapter for information on the PC Suite COM port setting.

PC Suite data transfer operations can occur via serial cable or infrared connection.

To prepare your communicator for a data transfer via serial cable: Connect your serial cable to your communicator and to the appropriate PC COM port. If you are using a desk stand, place your communicator in its desk stand with the desk stand serial cable connected to your PC COM port.

To prepare your communicator for a data transfer via infrared: Press the **System** button on your communicator. Select **IR activation** on the System menu. Then point your communicator at your PC infrared port or adapter.

Desk Stand Button Settings

If you use a desk stand, you can program the desk stand  synchronisation button to run the currently configured **Backup** and/or **Synchronise** operation whenever the program is active.

Click **Desk Stand Button Settings** in the Options menu to display the following dialogue:

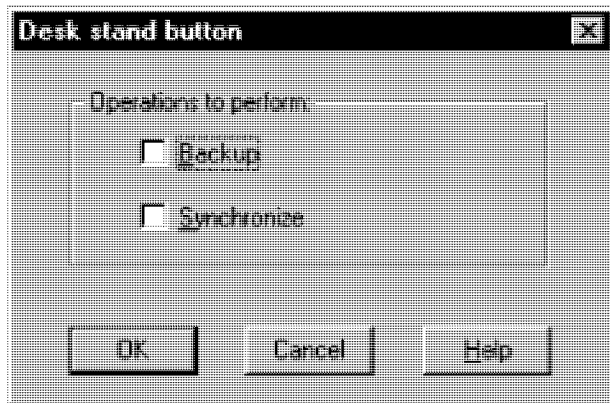

This dialogue contains check boxes labelled **Backup** and **Synchronise**. Neither is checked by default.

- ◆ Check **Backup** if you want the desk stand synchronisation button to run the currently configured Backup operation.
- ◆ Check **Synchronise** if you want the desk stand synchronisation button to run the currently configured Intellisync operation.

If you check both **Backup** and **Synchronise**, both operations are performed when you click the desk stand synchronisation button, with the Backup operation occurring first.

Click **OK** to save your selection(s) and exit the dialogue. Clicking **Cancel** exits the dialogue without saving.

Chapter 2 : The Contacts Application

PC Suite for Nokia 9110 Communicator's Contacts component lets you create, edit, and update contact cards like those on your Nokia 9110 Communicator, and transfer them between your PC and your communicator.

Topics in this chapter include:

- ◆ Using the Contacts Application
- ◆ The Contacts Main Screen
- ◆ Opening and Saving a Database
- ◆ Creating a Contact Card Template
- ◆ Adding Contact Cards
- ◆ Card Menu Commands
- ◆ Editing Contact Cards
- ◆ Editing Contact Card Fields
- ◆ Adding Pictures to Contact Cards
- ◆ Creating and Editing Contact Groups
- ◆ Finding and Filtering Contact Information
- ◆ Importing Records from Another Database
- ◆ Updating to your Communicator
- ◆ Updating from your Communicator
- ◆ Synchronising your Contacts
- ◆ Contacts Menu Commands

Using the Contacts Application

PC Suite for Nokia 9110 Communicator's Contacts application lets you create, edit, and update contact cards like those on your Nokia 9110 Communicator, and transfer them between your PC and your communicator.

The Contacts Main Screen

To access the Contacts application, click on the Contacts icon in the PC Suite opening screen.



To sort cards alphabetically by name, click on the **Name** heading in the lower part of the screen.

Clicking the Name heading toggles between alphabetical and reverse-alphabetical order.

To sort records similarly by Company, click the **Company** heading.

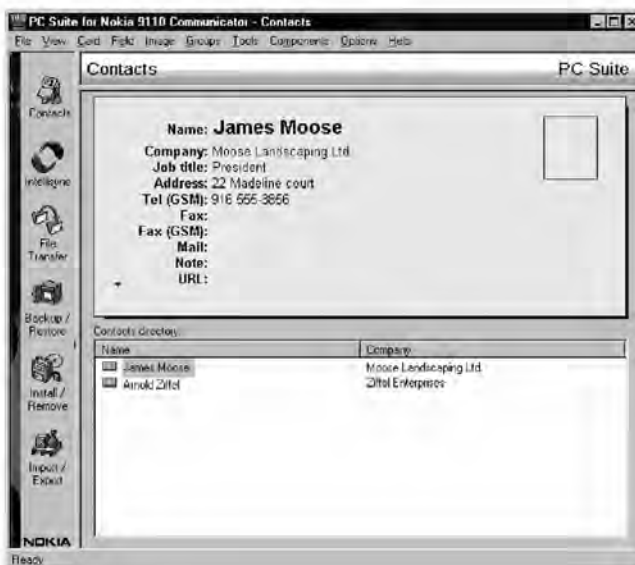

The Contacts main screen contains two windows. The lower window contains all the contact cards in the selected database. The top window shows the open contact card.

To open a contact card, click on a Contact name in the lower window.

Opening and Saving a Database

When you save a database, attached .JPG and .BMP image files are saved in a sub-directory. (Both .JPG and .BMP images saved in this sub-directory are converted to 16 bit grey scale JPEG format files.)

Changing the Contact card template does not affect the form of existing cards.

Note that menu options are sometimes disabled in the Field menu. For example, when the **Name** field is selected, *Change Label* and *Delete* are not available because you are not allowed to delete or rename the Name field.

To create a new Contacts database, or open an existing database, click **Open** on the File menu and specify a database name and location. Use **File/Save** or **File/Save As** to save the current database.

Creating a Contact Card Template

Before you start creating Contact cards, you may want to alter the default Contact card template.

Follow these steps to create a template for the Contact cards you will create in Contacts:

1. Open the **Card** menu at the top of the Contacts main screen, and select **Template** to display the default Contact card template.

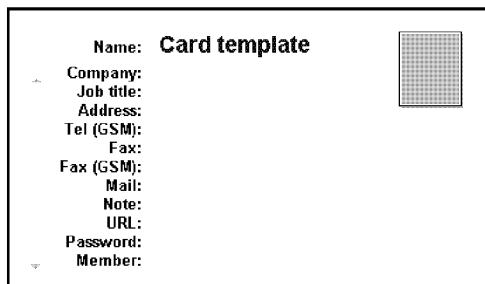

2. In this template, you can add fields, rename fields, or delete fields from the default template. Simply select a field in the template and open the **Field** menu.

Field menu options include **Change Label**, **Add**, and **Delete**.

When the template is as you want it, you are ready to add new Contact cards to Contacts.

Adding Contact Cards

Follow these steps to create a new Contact card:

1. Click **Card** to open the Card menu.
2. Click **New**. This displays an empty Contact card (based on the current template) in the top window.
3. Fill out the card. Use the Enter key or up and down arrow keys to move between fields in the card template. (Note that as soon as you enter a Name value and move to another field, the new Contact card appears in the lower window.
4. Repeat these steps for each card you want to create.
5. To save the new cards you've created, use the **File/Save** command.

Card Menu Commands

As described, the Template and New commands on the Contacts Card menu let you create a Contact card template and create new cards using the current template.

The complete set of Card menu commands is as follows:

- ◆ **New:** Lets you create a new Contact card.
- ◆ **Delete:** Deletes the open Contact card, or the Contact card selected in the Contacts directory portion of the screen.
- ◆ **Duplicate:** Copies the currently selected Contact card.
- ◆ **Copy Contents:** Copies the contents of the currently selected card to the Windows clipboard.
- ◆ **Template:** Displays the current Contact card template.

Editing Contact Cards

Editing Contacts cards in the Contacts application is easy. Simply select the card you want to edit, select the field whose value you want to change, and re-type the value.

Editing Contact Card Fields

You can also use the Field menu to edit the **fields** list for a particular card. Field menu commands include **Change Label**, **Add**, and **Delete**.

Changing a Field Label

The **Change Label** command on the Field menu lets you change the current field label to a label selected in a displayed list.

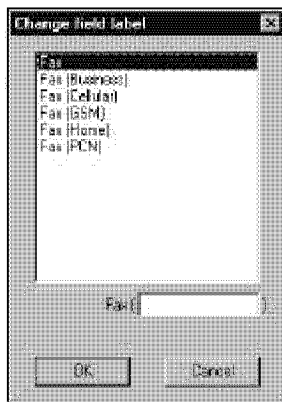

Note the text entry field at the lower right corner of list box. Typing a value here adds a parenthetical to the value selected in the list.

When you've specified the field label you want to use, click **OK** to redisplay the Contact card.

Note that you cannot change some field labels (e.g., Name, Company). When such fields are selected, the Change Label menu option is disabled.

Adding a Field

The Add command on the Field menu lets you add fields to the open Contact card. When you give the Add command, a list of fields displays.

See “The Add Field Labels List,” next, for more information on the list of fields that you can select.

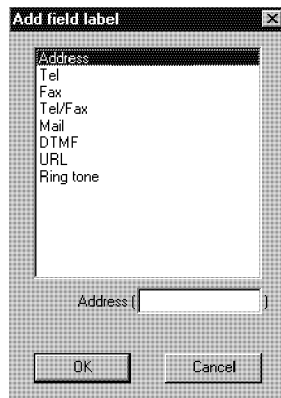

Note the text entry box at the lower right corner of the Add field dialog. Typing a value here adds a parenthetical value to the field selected in the list—for example, Address (Business).

Once you’ve selected a field in this list, click **OK** to add the field to the open Contact card. Clicking **Cancel** exits without adding a field.

The Add Field List

The Add Field List contains the following fields:

Company	The name of the company where the contact works.
Job title	The job title of the contact.
Address	The address of the contact.
Tel	The telephone number of the contact.
Fax	The fax number of the contact.
Tel/Fax	If the contact has one phone number for both the telephone and the fax machine, write the number here.
Mail	The e-mail address of the contact.
DTMF	The DTMF (dial tone message format) string needed for communicating with the contact.
Note	You can add important information such as birthday or office hours in this field.
URL	The WWW address of the contact.
Password	The calendar booking password of the contact.
Ringtone	The individual ringing tone set for the contact in the Nokia 9110 Communicator. Note that if you set an individual ringing tone to one that does not exist on the communicator, the default tone is played.
Member	The group(s) in which the contact is a member.

Deleting a Field

To delete a field from the open Contact card, highlight the field and give the File/Delete command.

Adding Pictures to Contact Cards

The Contacts application lets you add pictures to your Contact cards. A picture must first be stored on the PC in the .JPG or .BMP format.

To add a picture to the open Contact card, click on the picture frame at the upper right corner of the Contact card, or click **Image** and select **Add**. This displays a Choose Image dialogue.

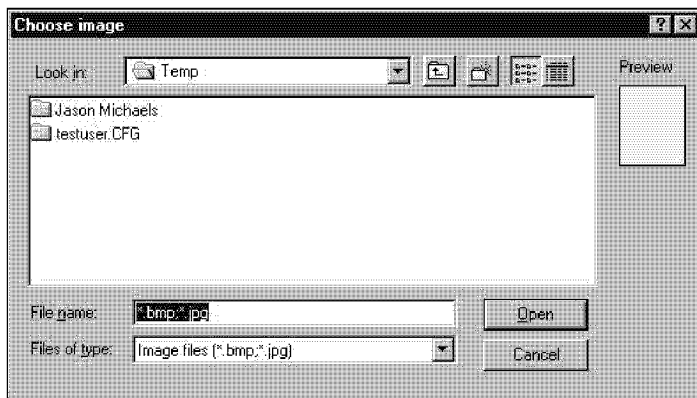

In this dialogue, use standard Windows file location methods to find the file containing the picture you want to use. To select the picture file, highlight the filename and click **Open**. Then click **OK** to add the picture to the card.

If you want to add just a section of a picture to the card, use your mouse to select a rectangular portion of the picture before clicking the **OK** button.

Removing Pictures from Contacts Cards

To remove a picture from the opened contact card, click **Image** and select **Delete**.

Creating and Editing Contact Groups

By default, Contact cards have a **Member** field. This field allows you to specify a group that the contact belongs to.

When you place the cursor in the Member field, a Select Group dialogue is displayed, listing the groups that are currently defined. To select from this list, highlight a group name and click **OK**.

To add to or change the Contact Group list, open the **Groups** menu and select **Edit**. This displays the Contact Group



dialogue.

- ◆ **To add a new group to this list:** Click the **New** button and type a new Group name when prompted. Then click **OK**.
- ◆ **To assign a group in this list to the open Contact card:** Highlight the group name and click **Select**.

- ◆ **To remove a group from the Contact Group list:**
Highlight the Group name and click **Delete**.

Finding and Filtering Contact Information

The Contacts application's Tools menu contains commands that let you find and filter Contacts information.

Finding a Contact

To quickly find a Contact card, you can search for any text string using the Find command on the Tools menu.

Open the Tools menu and click **Find**. Then enter a string to be searched for.

When the string is located, the cards are resorted, and the Contact card containing the string is moved to the top of the list and displayed. If the string occurs in more than one card, additional cards containing the specified string are listed immediately below the displayed card.

Getting Contact Information

Giving the **Contact info** command on the Tools menu displays a dialogue containing general information about the currently open database—e.g., the number of records, the number of defined groups, etc.

Filtering Contacts into a New Database

The **Filter** command on the Tools menu is an efficient and versatile tool for filtering contacts from a large database into another database.

You can create search criteria row by row, and you can control the relationships between the criteria with the logical operators AND, OR, and NOT, and with parentheses. You can add as many search criteria as you want.

Search Criteria

At its simplest, a search criterion can be as follows:

Field = text

To create a search criterion, you select the name of a Contact card field from the Field list, and type in some text. For example:

Company = Bankers Ltd.

With this search criterion, all Contact cards that have **Bankers Ltd.** in the Company field would be fetched from the database.

You can also add wildcards (?) and (*) into the text criterion.

? corresponds to any single character. For example:

Name = ?im

finds all Contact cards in which the Name field begins with any character and ends with im (i.e. Kim, Tim, etc.).

* corresponds to any string of characters. For example:

Company = Bank*

searches for Contact cards in which the Company field begins with **Bank** (i.e. Bankers Ltd., Banking, BankSaving).

The text field is case insensitive; that is, capital and lower-case letters are treated equally.

You can also select an asterisk (*) as the Contact field. For example:

*** = Bank***

finds Contact cards in which any field begins with **Bank**.

Using the Logical Operators

The logical operators **NOT**, **AND**, and **OR** allow you to create more complex filters.

- ◆ **NOT** negates the search criterion. For example:

NOT Company = Bankers Ltd.

searches for all Contact cards in which the Company is **not** Bankers Ltd.

- ◆ **AND** joins two search criteria together, so that both of them apply to the search. For example:

Name = James

AND Company = Bankers Ltd.

finds all Contact cards in which the Name is **James** and the Company is **Bankers Ltd.**

- ◆ **OR** joins two search criteria together, but only one of them needs to be true for a Contact card to be selected. For example:

Name = James

OR Company = Bankers Ltd.

searches for Contact cards in which the Name is **James** or the Company is **Bankers Ltd.**

Using Parentheses

Using parentheses, you can combine search criteria. For example:

Name = James

AND (Company = Bankers Ltd. OR Company = Global Air)

finds all the contacts named **James** who work either for **Bankers** or **Global Air**.

Note: The closing parenthesis is selected in the input field located on the far right of the Filter contacts dialogue. Note, however, that it only becomes available when a starting parenthesis is selected.

To Use Filtering

When you open the Filter contacts dialogue, the first row gives an example of a search criterion:

Name = *

This matches all Name fields in the database. Edit this sample criterion using the following steps. Then add additional criteria as needed.

To edit or create a criterion:

1. If necessary, select a logical operator on the far left. In the first row, you can only select NOT.
2. In the Field column, select a field or a wildcard character.
3. Enter text (and/or wildcards) in the text input field.

To create new search criteria, use the **Insert** key. Remove existing ones with the **Delete** key.

Parentheses can be added to filters using the second and last input fields.

Executing the Filter

The open database is the source file from which records will be filtered. To open a different database, click the **Browse** button and select a new file.

Click the **Filter** button to perform the filtering operation. When the filtering is complete, the results, displayed in a separate window, can be saved.

Note that if you save the filtered records to an existing file, the contents of the file are overwritten (you are prompted to confirm the overwrite).

Note: Pictures (.JPG or .BMP files) are saved in a Contact images subfolder of the database you save.

Importing Records from Another Database

The Contacts application lets you add records from one Contacts database into another. Simply give the **Import from file** command on the File menu and specify a file. The records (including images) in the file you choose will be added to the open database.

Refer to “Synchronising Your Contacts” later in this chapter for more information on how the “Update” commands work.

Updating to your Communicator

The Contacts application’s File/Update to Communicator command updates your communicator with records from the open database. That is, records in the open database that are not already contained in your communicator are added to the communicator.

Follow these steps:

1. Start Contacts and open the Contacts database that contains the records you want transferred to your communicator.
2. Connect your communicator to your PC COM port or establish an infrared connection.

If you’re prompted to do so, enter a name for your communicator.

3. Open the File menu and click **Update to Communicator**.

Updating from your Communicator

The Contacts application’s File/Update from Communicator command updates the open Contacts database with records from your communicator. That is, records in your communicator that are not already contained in the open database are added to the database.

Follow these steps:

1. Start Contacts and open the database that you want updated.
2. Connect your communicator to your PC COM port or establish an infrared connection. If you’re prompted to do so, enter a name for your communicator.
3. Open the File menu and click **Update from Communicator**.

Synchronising your Contacts

If you were to give the **Update to Communicator** and **Update From Communicator** commands one after the other, each of your systems would contain the same set of Contact records. However, synchronising records in this fashion can result in the creation of “duplicate” records.

Why? During the updating process, records in your two systems are compared. If a record in the system you are updating from is not identical, field for field, to a record in the other system, it is transferred. This means, for example, that if each of your systems has a Contact card for John Johansen, but the phone numbers in the two cards are different, a duplicate card (containing a different phone number) is created in the target system when you give the “Update” command.

If you want to synchronise your Contact records and avoid the possibility of creating duplicate records, use the Intellisync synchronisation function described in Chapter 3.

Contacts Menu Commands

FILE	
Open	Opens a Contacts database.
Save	Saves the open database.
Save As	Saves the open database to a given location.
Import from file	Imports records from another file into the open database.
Update to communicator	Updates communicator with records in the open database.
Update from communicator	Updates the open database with Contact records from your communicator.
Exit	Exits PC Suite.

VIEW	
Status Bar	Toggles status bar on and off.

CARD	
New	Creates a new Contact card.
Delete	Deletes the open Contact card.
Duplicate	Copies the open Contact card.
Copy Contacts	Copies the contents of the open card to the Windows Clipboard.
Template	Lets you change the default Contact card template.

FIELD	
Change label	Lets you change the selected field label.
Add	Lets you add a field to the open Contact card.
Delete	Deletes the field selected in the open Contact card.

IMAGE	
Add	Lets you add a picture to the open Contact card.
Delete	Deletes the picture from the open card.

GROUPS	
Edit	Lets you edit the Groups list.

TOOLS	
Find	Lets you find a Contact card containing a given string.
Contact Info	Shows you how much data is in the open database.
Filter Contacts	Lets you conduct an advanced search of the open database, and save " matching" records to another database.

COMPONENTS	
Contacts	Starts Contacts application component.
Intellisync	Accesses Intellisync component.
File Transfer	Accesses File Transfer component.
Backup/Restore	Accesses Backup/Restore component.
Install/Remove	Accesses Install/Remove component.
Import/Export	Accesses Import/Export component.

OPTIONS	
Desk Stand Button Settings	Displays desk stand button options.
Registered Communicators	Lists the communicators that have been connected and named.
Preferences	Displays the Preferences Dialogue.

HELP	
Contents	Displays on-line Help Contents.
Commands	Displays command information.
Using Help	Accesses Help for on-line Help.
About PC Suite	Displays "About PC Suite" dialogue.

Chapter 3 : Intellisync

Intellisync's Synchronisation function compares records in your Nokia 9110 Communicator to records in your PC application. It then makes whatever changes are necessary in each system to ensure that each contains the same up-to-date information.

This chapter explains how Intellisync works, and guides you, step-by-step, through the process of running your first synchronisation.

Sections include:

- ◆ Quick Start Tutorial
- ◆ Intellisync Advanced Settings Dialogues
- ◆ Intellisync Special Topics
- ◆ Intellisync Glossary
- ◆ Intellisync Menu Commands

Quick Start Tutorial

Refer to “Synchronisation and History Files” under “Intellisync Special Topics” for information on how synchronisation is achieved.

See “Importing and Exporting Data” in “Intellisync Special Topics” for information specific to Intellisync Import and Export operations.

Refer to “Communicator Recognition” in Chapter 1 for information on how you can use PC Suite for Nokia 9110 Communicator with multiple communicators.

This “Quick Start” tutorial describes the most basic Intellisync dialogues, and guides you through the process of setting up and running your first Intellisync synchronisation. For information about Intellisync “Advanced Settings,” refer to “Intellisync Advanced Settings Dialogues” later in this chapter.

Note: For simplicity, this tutorial emphasises **synchronisation**. However, the steps shown here can also be used to configure Intellisync **imports** and **exports** of data. The only difference is in the choice of a button in the Intellisync Choose Translator dialogue.

Synchronising Data

Intellisync is designed to simplify the synchronisation of data between your communicator and your PC. Synchronisation can be accomplished with little more than the press of a button. Before you can execute an operation for the first time, however, you must configure the operation you want to perform.

Once you have set up your configuration parameters for a particular communicator, you never need to configure again unless you want to change the nature of the operation.

Before starting this tutorial, read “**Intellisync Address Formats**” under “Intellisync Special Topics” in this chapter.



Refer to “**Remote Synchronisation**” under “Intellisync Special Topics” for information about performing remote synchronisations.

Follow these steps to set up and perform your first synchronisation:

1. Click the PC Suite for Nokia 9110 Communicator icon in the PC Suite program folder to display the PC Suite opening screen.
2. Click the Intellisync icon on the opening screen to access



Intellisync. The Local tab is selected by default.

3. Connect your communicator’s serial cable to the appropriate PC COM port. (If you’re using a desk stand, place your communicator into its desk stand.) If you’re using infrared, establish an infrared connection between your communicator and PC.

If you’re prompted to do so, enter a name for your communicator.

4. Click the **Settings** button.

5. You may be presented with a dialogue containing the tabs **Format** and **File**. This dialogue only displays the first time you configure an operation for a particular communicator. (Thereafter you can change settings in this dialogue using the Contacts command on the Options menu.)

Refer to “Address Formats” under “Intellisync Special Topics” for complete information on selecting an Address Format—including what you should do if none of the formats correspond to the formatting of your data.

- ◆ In the **Format** tab, select the address format that you are using for addresses in your communicator (see margin note).
- ◆ In the **File** tab, indicate if you want to synchronise Contacts on the communicator’s main memory, or on the Memory card. If you choose the latter, specify the file you want synchronised.

When you’ve made your selections, click **OK** to display the Configuration dialogue.

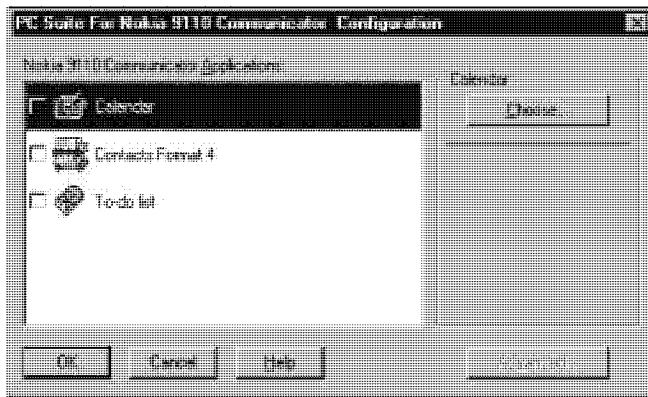

The Configuration dialogue contains an “Applications” list containing your communicator’s Calendar, Contacts, and To-do list applications.

6. Click on the Nokia 9110 Communicator application you want to configure.
7. Click **Choose** to enter the Choose Translator dialogue.

This dialogue lists all the PC applications that are compatible with the Nokia 9110 Communicator application you selected.

When it's present, checking the **Apply to all applications** check box at the bottom of the Choose Translator dialogue configures all compatible Nokia 9110 Communicator "applications" with the PC application and file you selected. If all of the data you want synchronised is in a single file or folder, check this option to configure all of your communicator's applications at once.

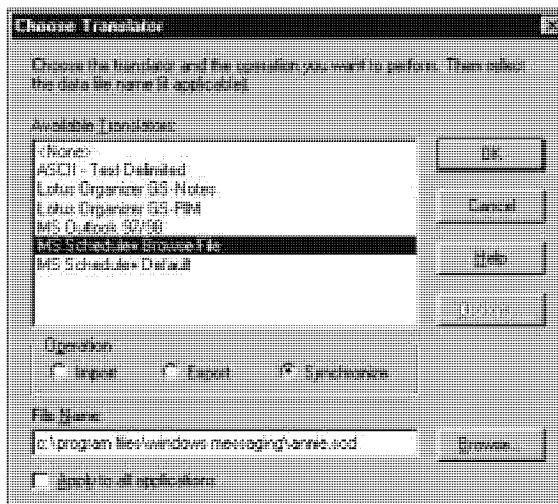

8. Specify the application and (if necessary) the file you want to synchronise. (Use the **Browse** button for file selection to avoid making typos when typing in complicated paths.)

Notes:

- If you are synchronising with Outlook, you will specify a folder instead of a file. Use the **Browse** button for folder selection.
- If you are synchronising with Schedule+ 7.0, you must select **Schedule+ Default** (you do not need to specify a file; the open or last used file is used by default). If you are using Schedule+ 7.0a or 7.5, you can select either **Schedule+ Default** or **Schedule+ Browse File**. However, if you want to select a file, you must select **Schedule+ Browse File**. Otherwise the open or last used file is selected automatically.

For information about Options dialogue settings, click the **Help** button and refer to the **Supported Systems** on-line Help topic for the PC application you are using.

9. If necessary, select the operation you want to perform. **Synchronise** is normally selected by default. (Synchronise is not supported for ASCII - Text Delimited.)
10. If the **Options** button is enabled, click it. This accesses special application-specific settings that apply to the selected PC application. If necessary, adjust settings in the Options dialogue. Then click **OK**.
11. Click the **OK** button in the Choose Translator dialogue to return to the Configuration dialogue.

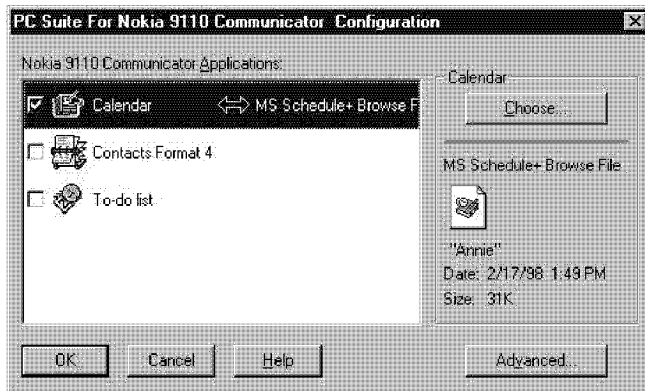

Now the PC application you selected appears next to the communicator's application name, and a two-way arrow appears between the application names. (A one-way arrow appears if you selected Import or Export.)

Note the check box adjacent to the highlighted applications. By default, this box is checked, indicating that the data is activated for synchronisation. (If you un-check this box, the data will not be synchronised.)

Refer to "Intellisync Advanced Settings Dialogues" later in this chapter for information on "Advanced" settings.

12. To review or alter settings or field mapping for a particular application, select the **Advanced** button to access the Intellisync Advanced Settings dialogue. (Intellisync provides default values for all "Advanced" settings.)

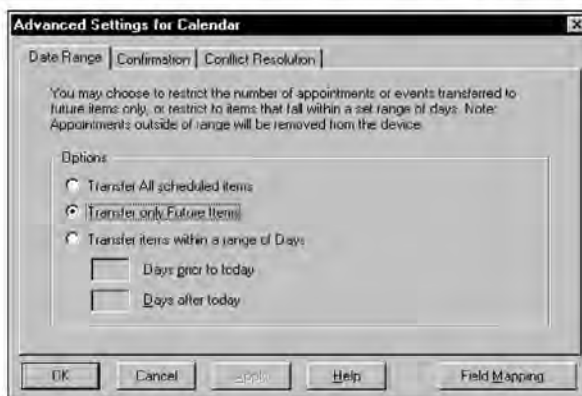

13. When you're ready to exit the Advanced Settings dialogue, click **OK** or **Cancel**.
14. Repeat steps 6 through 13 for each Nokia 9110 Communicator application you want to synchronise (not necessary if you checked **Apply to all applications** in the Choose Translator dialogue).
15. When you're ready to perform the operation, click the **OK** button at the bottom of the Configuration dialogue.
16. Click the **Synchronise** button on the Intellisync opening screen.
17. If prompted, resolve data conflicts.
18. A confirmation prompt appears, showing you how many adds, changes, and deletes will be applied to each of your systems if you proceed with the operation. Click **Accept** to proceed, or **Cancel**.

Refer to "The Conflict Resolution Tab" under "Intellisync Advanced Settings Dialogues" for information on how to resolve data conflicts during synchronisations. See "The Confirmation Tab" in the same section for information on the confirmation prompt.

Intellisync History Files

For each set of data you synchronise, a **history file** is used to determine the changes that must be made in each of your systems in order to achieve synchronisation. This file is created by the first synchronisation of the data. Therefore, a “first-run” synchronisation is different from (and may take longer than) subsequent synchronisations. A first-run synchronisation simply merges the contents of your two systems. The Conflict Resolution setting in the Advanced Settings dialogue is used to resolve conflicts between the systems.

See “The Conflict Resolution Tab” under “Intellisync Advanced Settings Dialogues” for information on the Conflict Resolution setting.

For information on how history files are used in the process of synchronisation, see “Synchronisation and History Files” under “Intellisync Special Topics.”

If you use a desk stand with your communicator, refer to “Desk Stand Button Settings” in Chapter 1 for information on how you can program your desk stand synchronisation button to execute the currently configured Intellisync operation.

Re-Running the Operation

Now that you have configured a synchronisation, re-executing the operation is basically a one-step operation. To re-run the operation, simply prepare your communicator for synchronisation and click the **Synchronise** button on the Intellisync opening screen.

Taskbar Synchronisation

To run a synchronisation from the taskbar, simply click on the program icon on the taskbar, press the right mouse button, and select **Synchronise** from the pop-up menu.

Synchronisation Notes:

- Refer to “The Filters Tab” under “Intellisync Advanced Settings Dialogues” for information about filtering records for synchronisation.
- During Intellisync transfers of data between your communicator and the Contacts application, pictures attached to Contacts cards are ignored. Use PC Suite File Transfer commands to transfer .JPG and .BMP files between your communicator and PC.
- Some PC applications have to be running during synchronisations. If you are synchronising with one of these applications, you may see Intellisync open the application during the operation. (Refer to the Supported Systems section of on-line Help for information about whether or not the system you’re using needs to be open or closed during data transfers.)
- Data can be transferred between records in your communicator and your PC applications because fields in the two systems are “mapped” (linked). Intellisync provides default “field mapping,” but you may want to alter mapping to re-direct (or prevent) the flow of data. Refer to “The Field Mapping Dialogue” under “Intellisync Advanced Settings Dialogues” for complete information.
- Once you have synchronised a particular set of data, changing field mapping causes the next synchronisation of that data to be, in effect, a first-run synchronisation. Refer to “Intellisync History Files” and “Synchronisation and History Files” in this chapter for an explanation of first-run synchronisations.
- When you synchronise a Nokia 9110 Communicator application, it is automatically synchronised with all sections in the selected PC application that are compatible with that application.
- For information about how to perform synchronisations remotely, see “Remote Synchronisation” under “Intellisync Special Topics.”

Intellisync Advanced Settings Dialogues

When you run a synchronisation, the operation is affected by settings contained in a set of Intellisync “Advanced Settings” dialogues. This section describes these dialogues.

Topics include:

- ◆ Advanced Settings Tabs
- ◆ The Field Mapping Dialogue

Advanced Settings Tabs

Refer to the Quick Start Tutorial for information on the Intellisync **Configuration** and **Choose Translator** dialogues.

When you click the **Advanced** button in the Intellisync Configuration dialogue, the tabbed **Advanced Settings** dialogue for the selected Nokia 9110 Communicator application appears.

Clicking the **OK** button in this dialogue saves the current setting and exits the dialogue. Clicking **Apply** saves without exiting.

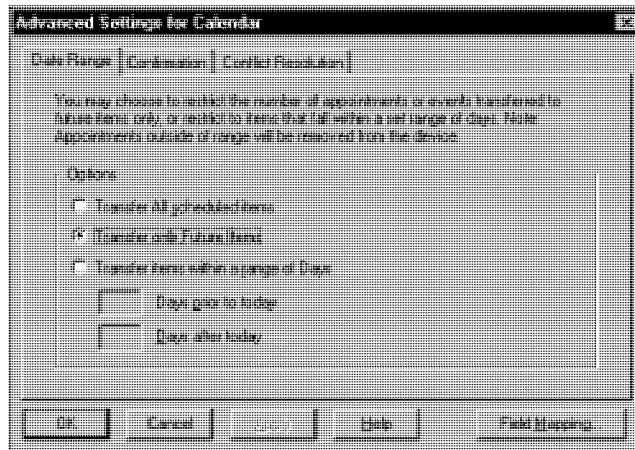

If a setting doesn't apply to the Nokia 9110 Communicator application currently selected in the Configuration dialogue, it is not presented. For example, when the Contacts application is selected, neither the Date Range nor the To-do List tabs are displayed.

The tabs in this dialogue contains the following settings and features:

- ◆ **Date Range:** Determines the range of Date Book items to be included in the operation.
- ◆ **To-do List:** Determines if all To-do items, or only pending To-do items will be included in the operation.
- ◆ **Confirmation:** Determines when and if a confirmation prompt will appear before a synchronisation takes place.
- ◆ **Conflict Resolution:** Determines how data conflicts will be resolved if they are detected during a synchronisation.
- ◆ **Filters:** Lets you create filters that exclude some records from synchronisation (or import/export).

The Date Range Tab

The Date Range setting in this tab determines the range of **Calendar** items that will be included in a data transfer.

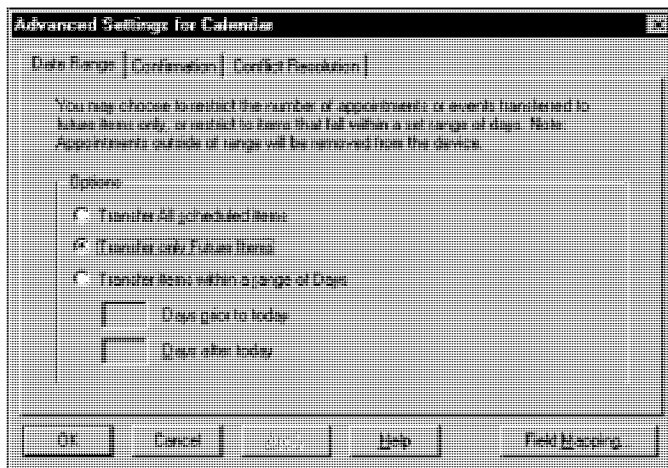

You are presented with three options in this dialogue:

- ◆ **Transfer All Scheduled Items:** Transfers all dated items.
 - ◆ **Transfer Only Future Items:** Transfers only future items.
 - ◆ **Transfer Items Within a Range of Days:** Transfers items within a specified number of days before and after “today.”
- ▶ To select an option, click on the radio button next to the one you want.
- ▶ If you select the **Transfer items with a Range of Days** option, enter numbers in the boxes labelled **Days prior to today** and **Days after today**.

Notes:

- The “**Range of Days**” option allows you to create a relative date range that automatically moves with time. For example, if you have selected the range **30 days prior to today**, and **30 days after today**, the two month range adjusts itself automatically. That is, as today moves forward in time, so does the relative date range.
- When you run a synchronisation, records that were included in the previous synchronisation will be synchronised whether or not they fall within the currently specified date range. (Intellisync identifies these items by looking at the history file for the previous synchronisation). Note, however, that only those items that fall within the currently specified date range will be included in the update of the history file (and therefore synchronised during the next synchronisation of the data).

The To-do List Tab

The To-do setting in this tab determines whether all To-do list items or only pending To-do list items will be included in an operation.

Transfer All Items is the default setting at installation.

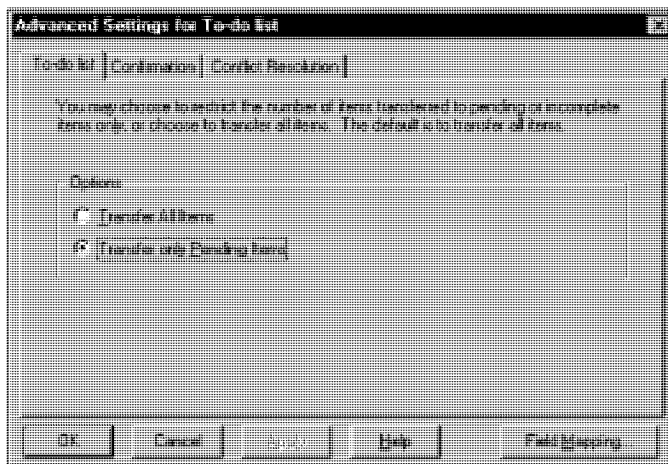

- ▶ If you select **Transfer All Items**, all To-do list items, including those marked “completed,” will be included in the operation.
- ▶ If you select **Transfer only Pending Items**, To-do list items that are marked “completed” will not be included in the operation.

The Confirmation Tab

Confirmation prompts are only displayed during synchronisations. They do not appear during Intellisync imports or exports of data.

Before the results of a synchronisation are applied, you may be prompted to confirm the operation. The confirmation prompt—which lets you proceed with or cancel the operation, display details about what will occur, or execute a “full re-synchronisation”—is a safeguard against accidentally modifying or deleting the wrong data.

The setting in the Confirmation tab determines the conditions under which a confirmation dialogue appears.

At installation, both options are selected.

Un-checking Confirm Record Deletions is not recommended.

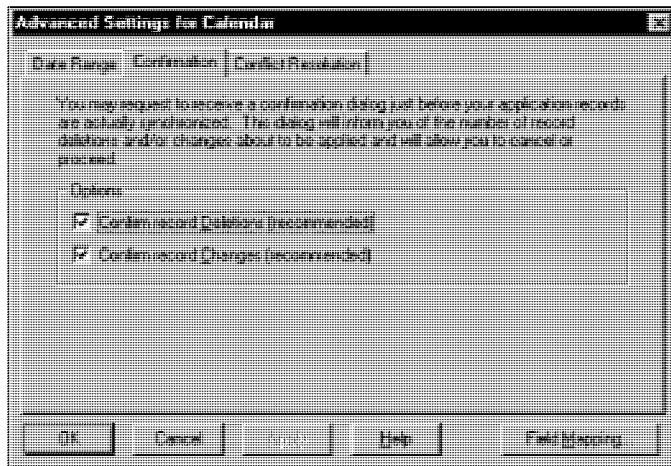

Two options are presented: **Confirm Record Deletions** and **Confirm Record Changes**.

Either, both, or neither can be selected.

- ▶ When **Confirm Record Deletions** is checked, the prompt appears if a synchronisation will result in the deletion of records.
- ▶ When **Confirm Record Changes** is checked, the prompt appears any time a synchronisation will add or change records.
- ▶ If **neither** of these options is checked, a confirmation prompt will only appear if the operation will result in the deletion of **all** records from a system.

This is a typical confirmation prompt:

A separate confirmation prompt is displayed for each Nokia 9110 Communicator application you are synchronising.

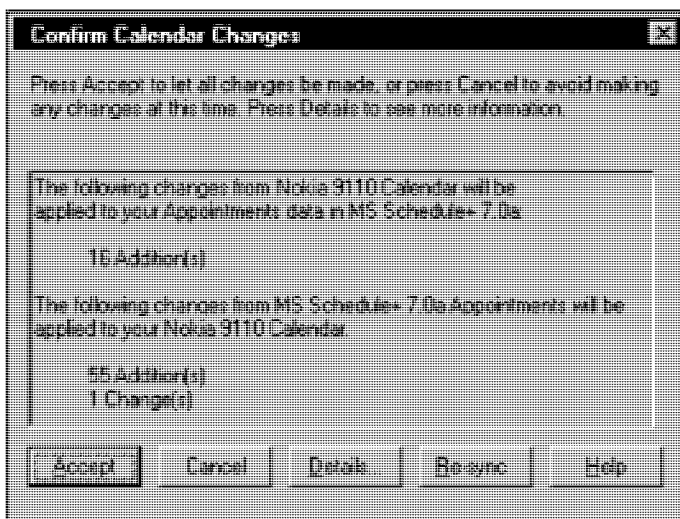

Note the five buttons at the bottom of the Confirmation prompt:

- **Accept:** Accepts the set of changes shown and continues the synchronisation.
- **Cancel:** Cancels the synchronisation.

Refer to “Full Re-Synchronisation” in “Intellisync Special Topics” for information on **full re-synchronisation**.

- **Details:** Displays a “**Details**” dialogue box showing a detailed description of what will occur if the synchronisation proceeds.
- **Re-sync:** Performs a full re-synchronisation—in effect, a “first -run” synchronisation.
- **Help:** Opens the Intellisync on-line Help system.

The Details Dialogue

The confirmation prompt that may appear before a synchronisation takes place contains a **Details** button. Use this button when you want to review the exact actions that will occur if the synchronisation proceeds.

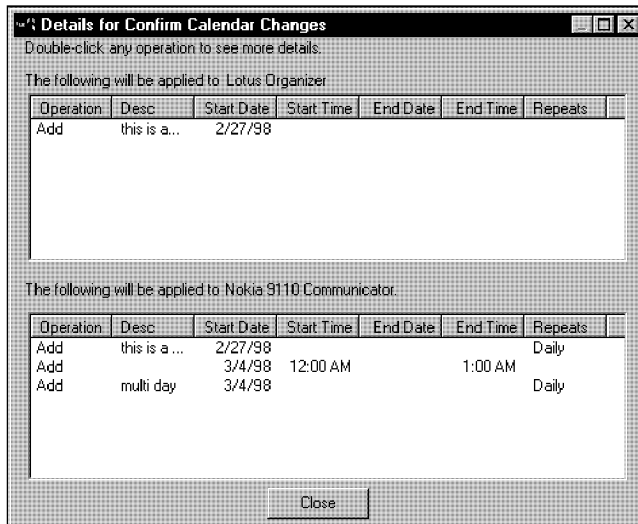

The Details dialogue contains a field-by-field representation of each of the records that will be affected by the synchronisation and, for each, notes the operation that will take place (Add, Change, Delete).

If changes will occur in both of your applications, a separate area of the dialogue will be shown for each.

The operation that will take place for each record is indicated in the first column of the Details dialogue.

To see **more** details about any single record, double click on the operation for that record. This displays an “Additional Details” dialogue.

Note that both the original and the new values are represented in this dialogue.

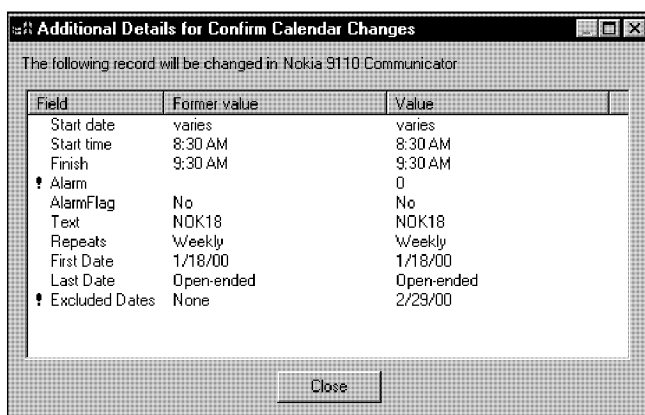

Notes:

- Details dialogues can be resized. When you resize a dialogue, the position and size is remembered the next time you display a Details dialogue.
- Data in “Additional Details” dialogues can be sorted, in either ascending or descending order, by double clicking on the column heading (clicking the same column heading again sorts the column in the opposite order).
- To see the full contents of a field whose value is truncated in the Additional Details dialogue, double click on the field name. For a changed item, both the former and new values are displayed.

The Conflict Resolution Tab

When a **data conflict** occurs during a data transfer, and Intellisync can't resolve it using the normal synchronization process, the **Conflict Resolution** setting selected in this tab is used to resolve it.

To specify a Conflict Resolution setting, select the radio button next to the option you want.

Notify me when conflicts occur is the default setting.

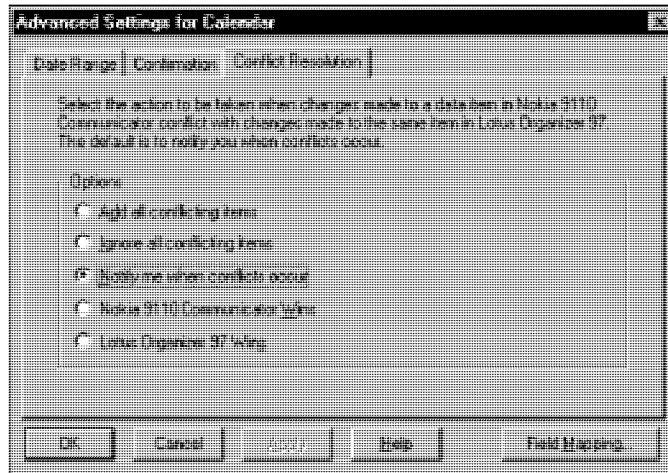

What is a Data Conflict?

A data conflict exists when records in your two systems that should be equivalent contain conflicting data in one or more mapped fields.

More specifically, a data conflict exists when two records contain the same **key field** values, but different values in other mapped fields.

Refer to "Field Mapping and Freeform Fields" under "The Field Mapping Dialogue" for information on how Intellisync interprets your communicator's Name field.

Refer to "Synchronisation and History Files" under "Intellisync Special Topics" for information on first-run synchronisations. See "Full Re-Synchronisation" in Intellisync Special Topics for details on full re-synchronisation.

Key Fields

Fields designated as "key" are those that are the most fundamental to a particular record. For example, First Name and Last Name fields are key fields in Contacts records.

The use of key fields in detecting data conflicts is premised on the following: When key fields in a Nokia record match the key fields in a PC application record, other mapped fields in the two records should also match. In other words, if both of your systems have an address record for Ron Ogg, the values in Title, Company, etc. should match. If they do not, a data conflict exists.

Note: Letter case counts in key fields. If you have a record for Diana VanWinkle in your PC application, and one for Diana Vanwinkle in your communicator, Intellisync does not recognise the names (or, therefore, the records) as equivalent. Synchronisation causes both records to occur in each system.

See **Key Fields** in on-line Help for information about which fields are key fields for each data type.

The occasions when the Conflict Resolution setting is needed to resolve data conflicts are as follows:

- ◆ First-run and full-re-synchronisations.
- ◆ Imports and Exports of data.
- ◆ When new records have been added to each system since the last synchronisation, and those records conflict. (For example, if you have added an address record for Brian Sawyer to each of your systems, but the Company fields don't match.)
- ◆ When mapped fields have been edited in both systems since the last synchronisation, but edited differently. (For example, if you have updated Brian's home phone number in both records, but made a typographical error in one of them.)

Conflict Resolution options work as follows:

- ◆ **Add all conflicting items:** Adds a new record to each system (or, for one-way transfers, to the target system). The original conflicting records remain intact.
- ◆ **Ignore all conflicting items:** Makes no change to either system.
- ◆ **Notify me when conflicts occur:** Displays a dialogue box each time a data conflict occurs, letting you decide which data to use on a case-by-case basis.
- ◆ **Nokia 9110 Communicator Wins:** Uses data from your communicator when conflicts occur. Use this option when your communicator contains the most current information.
- ◆ **Other Application Wins:** Uses PC data when conflicts occur. Use this option when your PC application contains the most current information.

Notify me when conflicts occur is the default setting.

See “The Conflict Resolution Dialogue Box,” below, for more information about the Notify setting.

The Conflict Resolution Dialogue Box

When **Notify** is the Conflict Resolution setting, a dialogue is presented each time Intellisync needs help resolving a conflict.

Note the check box labelled “Apply to all conflicts.” If you check this box, the action you choose in this dialogue will be automatically applied to any other conflicts detected for the current Nokia 9110 Communicator application.

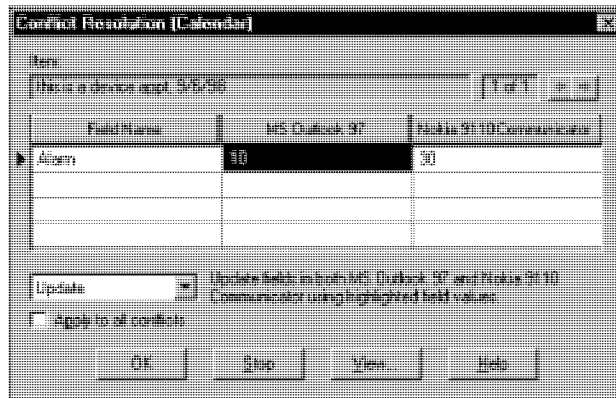

The Conflict Resolution dialogue shows the conflicting fields from both systems. The field name is displayed in the left column. The PC application's field value is in the centre, and the Nokia 9110 Communicator application's field value is on the right.

A box at the top labelled "**Item**" contains a **key field value**. This helps to identify the conflicting record.

If a record in one system conflicts with more than one record in the other system, the box to the right of the Item box will say **1 of 2**, or **1 of 3**, (etc.), and left and right arrow controls will let you switch between conflicts.

To resolve a conflict in the Conflict Resolution dialogue box, you can select one of the following options from the list box below the grid: Add, Ignore, Update, or Replace (Import/Export only).

- ◆ **Add:** Adds a new record to each system (or, for one-way data transfers, to the target system). The original conflicting records remain intact.
- ◆ **Ignore:** Makes no change to either record.
- ◆ **Replace:** (Import/Export only) Replaces the target record with a record containing mapped values from the source record. Unmapped fields in the original record will be lost.
- ◆ **Update:** Updates one or both records (as necessary) with the value or values you have highlighted in the grid. Use Update instead of Replace to avoid losing un-mapped fields in the target record.

Conflict Resolution Dialogue Buttons

The Conflict Resolution dialogue box also contains the following four buttons:

- **OK:** Initiates the specified action and continues the operation.
- **Stop:** Takes no action and terminates the operation.

- **View:** Displays a dialogue showing the full contents of the selected field. Use this to display complete values when lengthy values are truncated in the Conflict Resolution dialogue box.
- **Help:** Displays on-line Help text.

Conflict Resolution Notes:

- Refer to “The Same Record Changed and Deleted Dialogue” under “Intellisync Special Topics” for information about a special Conflict Resolution dialogue that appears when a record has been deleted in one system and changed in the other system since the last synchronisation.
- Remember: Except for “first-run” synchronisations, the Conflict Resolution setting is not normally needed to resolve conflicts when you’re synchronising your two systems. In most cases, Intellisync knows how to edit records to achieve synchronisation.
- Conflict Resolution is applied individually to each pair of configured applications. This means that any time you change the Conflict Resolution setting, the change will apply only to the currently selected applications.
- Since “Notify” (the default) is the only setting that lets you see each data conflict and decide for yourself how the conflict should be resolved, it is the recommended setting.

The Filters Tab

The Filters tab of the Advanced Settings dialogue lets you “filter” records for synchronisation, import, or export.

The names of the filters you create are shown in the Filters tab.

A pre-existing filter, Exclude Private Data, lets you exclude records marked Confidential, or Private, etc.

To activate a filter for use, click on it (you can only use one at a time.) Click <None Selected> if you do not want to apply a filter to the next synchronisation.

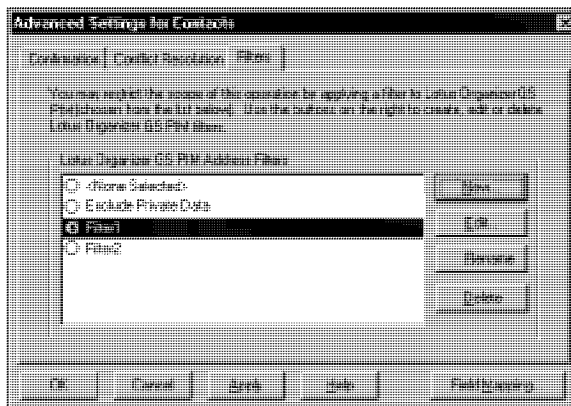

By default all records in the applications you configure for synchronisation are included when you run an Intellisync operation (unless they are excluded by the Date Range or To-do list setting).

If you want to synchronise (or import/export) only a subset of items, you can filter records using Intellisync’s filtering function.

For example, the following filter instructs Intellisync to include only address records that have a Last Name value starting with A through M, and have the Company value of Bankers Ltd.

**Last Name is between A and M AND
Company equals Bankers Ltd.**

Filters Tab Commands

The Filters tab contains the following command buttons:

When you click **New**, you are prompted to name the filter before creating it.

- The **New** button is used to create a new filter for the currently selected communicator and PC applications.
- The **Edit** button lets you edit an existing filter.
- The **Rename** button lets you rename an existing filter.
- The **Delete** button deletes the highlighted filter.

Conditions and Rules Tabs

Clicking the **New** or **Edit** button in the Filters tab displays two additional tabs: **Conditions** and **Rules**.

The Conditions Tab

The Conditions tab is where you specify the condition(s) that a record must meet in order to be included in a data transfer. Each condition consists of a **Field**, an **Operator**, and a **Value**.

For example, here are some conditions that could be applied to various applications:

Field	Operator	Value(s)
Last Name	is between	A and G
Company	equals	Global Air
Title	equals	President
Date	is between	01/01/1998 and 07/01/1998
Start Date	on or after	01/07/98

The Rules Tab

The Rules tab contains options corresponding to the logical operators AND and OR.

All Conditions must be met = AND

One or more conditions must be met = OR

Select an option in the Rules tab when you want to include more than one condition in a filter.

Note: Only one logical operator can be applied to any given filter. You cannot create filters that contain both AND and OR.

By combining **conditions** with a **logical operator** selected from the Rules tab, you can create filters like the following:

Date after 11/06/97 AND

Time after 14:00

Company equals Bankers Ltd. OR

Company equals Global Air OR

Company equals Software House Ltd.

The first filter would include only records with date values after 11/15/97 and time values after 14:00. (Note that times are shown in 24-hour format—e.g., 14:00 for 2 p.m.)

The second filter would include only records with a Company value of Bankers Ltd., Global Air, or Software House Ltd.

Creating a Filter

Follow these steps to create a filter:

1. Click the **New** button in the Filters tab. When prompted for a filter name, type a name and then click **OK**. This displays the Conditions dialogue.

If you want to change the Operator or Value entry for a condition in this dialogue, change the entry and click **Update**. Clicking **Remove** deletes the highlighted condition.

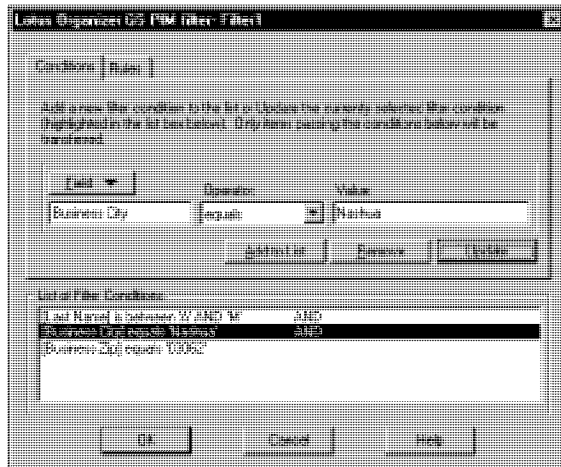

2. Click the **Field** button to display the field list for the selected PC application. Highlight the field you want to filter on. This places it in the Field text box.
3. Select an **operator** for the condition by highlighting an option in the Operator list box. (See below for the list of operators you can choose from.)
4. Enter a value or values in the Value text box to complete the condition. Then click the **Add to List** button to place the condition in the Conditions List in the lower part of the dialogue.

Note that a logical operator will not appear in the Conditions tab until a second condition is added.

5. To add other conditions to the filter, click the **Rules** tab and select **All Conditions must be met (AND)** or **One or more conditions must be met (OR)**. Then click the Conditions tab and specify additional conditions.
6. When the filter is complete, click **OK** to save it.

Conditions Tab Operators

There are four operator types that may be offered in the Conditions tab: **String**, **Date**, **Time**, and **Boolean**. Choices available for each type are as follows:

The Boolean operators **is true** and **is false** are used for fields like **Completed?** and **Confidential?** that are either checked or unchecked.

is true = checked
is false = unchecked

String	Date	Time	Boolean
starts with	equals	equals	is true
contains	does not equal	does not equal	is false
does not contain	after	after	
equals	before	before	
does not equal	on or after	on or after	
is empty	on or before	on or before	
is not empty	is between	is between	
is between	today minus ? days	now minus ? minutes	
	today plus ? days	now plus ? minutes	

Filtering Notes:

- Filtering can be applied to Intellisync imports and exports as well as synchronisations.
- If you filter on a field that is not mapped, Intellisync can filter on the PC side, but not on the communicator side. In other words, records will be excluded from your PC application, but not from your communicator.
- If you filter on a field that is contained in only one of your systems, the filter will only exclude records in that system.
- You cannot use both AND and OR in a single filter. However, you can use the operator **is between** to create conditions like **Last Name is between A and C**. This, in effect, says “If Last Name starts with A, **or** Last Name starts with B, **or** Last Name starts with C.” You can then use the AND operator to create a filter like the following which, in effect, does utilise both logical operators.
Last Name *is between* A and C AND
Company *equals* Kennel Ltd.
- If you change or select a different filter after you’ve run a synchronisation with Outlook, the next synchronisation will be, in effect, a first-run synchronisation.
- A filter only applies to the Nokia 9110 Communicator and PC applications that were selected in the Configuration dialogue when the filter was created—e.g., Address Book, To Do List, etc. Filters must be created separately for each set of applications you want to synchronise.
- Clicking on a filter name in the Filters tab activates that filter for the next synchronisation. (Only one can be selected at a time.) When a filter is active, its name appears in the bottom right corner of the Configuration dialogue when the application to which it applies is highlighted.
- Click <None Selected> in the Filters tab if you do not want to apply a filter you’ve created to the next synchronisation.

The Field Mapping Dialogue

In order for data to be transferred between your communicator and your PC application file, corresponding fields in each application must be linked to one another, or “**mapped.**” Intellisync provides default “field mapping,” which links equivalent fields in your two systems. But you can edit mapping to re-direct (or prevent) the flow of data as needed.

- ▶ To access field mapping for selected applications, click the **Field Mapping** button at the bottom of the Advanced Settings dialogue. This displays the Intellisync Field Mapping dialogue.

Use the Section drop-down list box to specify the section for which you want to display field mapping.

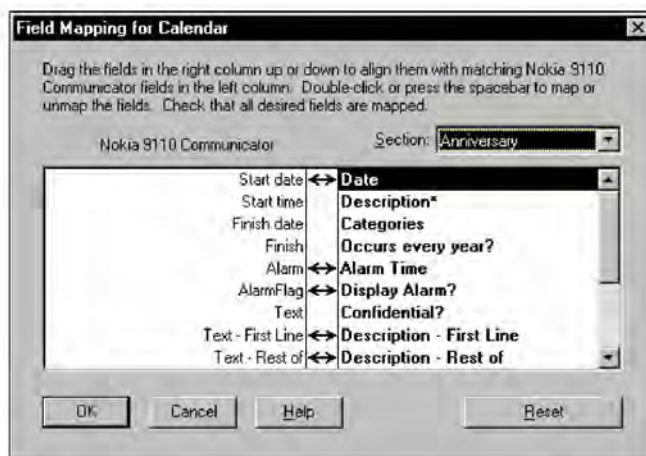

The Field Mapping dialogue lists communicator fields on the left, and PC application fields on the right. Bi-directional arrows appear between fields that are “mapped,” or linked, for synchronisation.

- ▶ **To un-map mapped fields:** Click on the arrow (or highlight the PC field name and double click or press the Spacebar).
- ▶ **To map adjacent fields:** Click between the fields (or highlight the PC application field name and double click or press the Spacebar). An arrow appears to indicate that the fields are mapped.
- ▶ **To map non-adjacent fields:** Drag the field in the right-hand column and drop it next to the field in the left-hand column.
- ▶ **To reinstate default field mapping:** Click the **Reset** button.

Field Mapping Dialogue Buttons

The buttons at the bottom of the Field Mapping dialogue work as follows:

- **OK:** Saves changes made to field mapping and re-displays the previous Advanced Settings dialogue.
- **Cancel:** Cancels changes made to field mapping.
- **Help:** Opens the Intellisync on-line Help system.
- **Reset:** Resets field mapping to the installation default configuration.

Field Mapping Notes:

- Intellisync enforces certain field mapping rules. For example, you cannot map **date** fields to **time** fields. If you attempt to map incompatible field types, an error message is displayed.
- If you change field mapping after data has been synchronised, the subsequent synchronisation will be, in effect, a first-run synchronisation.
- Fields marked with asterisks in the Field Mapping dialogue are fields that must be mapped (or their sub-fields must be mapped) in order for a data transfer to succeed. If marked fields are not mapped, an error message is displayed when you attempt to exit the Field Mapping dialogue.
- Check the Supported Systems on-line Help topic for the PC application(s) you're using to see if any special field mapping rules apply. (For example, if your application allows for the creation of custom fields, the Help topic for that system should tell you how to map custom fields.)
- When a data string is transferred between fields in your communicator and your PC application, it may be truncated in the target field if it is too lengthy to be accommodated. It is not wise to edit truncated data. If you do, the data in the other system will be truncated after the next synchronisation. Refer to "Synchronisation and Data Truncation" under "Intellisync Special Topics" for a workaround that allows you to edit truncated text.

Field Mapping and Freeform Fields

If your freeform fields are formatted inconsistently, synchronisations and exports will result in the incorrect placement of values in your PC application.

Select the address format that most closely resembles the one you're using.

When Intellisync transfers Name and Address fields between your two systems, it assumes a particular format for your communicator's Name and Address fields.

The default Name format is as follows:

LAST, FIRST MIDDLE

The Address format is determined by the Address Format you select when you first configure an operation. (Refer to "Intellisync Address Formats" under "Intellisync Special Topics" for a description of each of the four available formats.)

If names are **not** entered into your communicator in the above format, and/or if the addresses in your communicator's Contacts application do not match any of the available formats, you may want to adjust the field mapping in the Field Mapping dialogue to direct values between the correct fields.

For example, if the third line in your addresses is formatted in this way: City, State, Postal Code, but the selected Address format is Postal Code, City, State, the following field mapping scheme would transfer values correctly between your communicator and PC:

<u>Communicator</u>		<u>PC Application</u>
City	↔	Postal code
State	↔	City
Postal Code	↔	State

Intellisync Special Topics

This section is devoted to explaining in detail some aspects of Intellisync that have only been touched upon in previous sections of this chapter.

Topics include:

- ◆ Synchronisation and History Files
- ◆ Intellisync Terms
- ◆ Intellisync Address Formats
- ◆ Importing and Exporting Data
- ◆ Synchronisation and Truncated Data
- ◆ Full Re-Synchronisation
- ◆ The Same Record Changed and Deleted Dialogue
- ◆ Sync Log Files
- ◆ Remote Synchronisation

Synchronisation and History Files

An understanding of history files and how synchronisation works is not mandatory. However, you may find this information helpful.

See “The Conflict Resolution Tab” under “Intellisync Advanced Settings Dialogues” for details on Conflict Resolution.

For additional information about history files, refer to the Intellisync on-line Help system.

During a synchronisation, Intellisync compares records in your communicator application to records in your PC application, and makes whatever changes are necessary in each system to ensure that both contain the same information.

If a record has been added to one system and not the other, that record is added to the incomplete system. If a record has been deleted from one system and not the other, Intellisync deletes the record from the other system. If there are discrepancies between records in the two systems, Intellisync uses the most current data. It knows which is the most current because it uses a “**history file**” when comparing the records.

The first time a particular set of data is synchronised, there is no history file. Data from the two applications are simply merged, and conflicts between the two systems are resolved using a “**Conflict Resolution**” setting.

However, this initial operation creates the history file that will be used for subsequent synchronisations.

How does the history file work? At the end of each synchronisation, a history file matching the two synchronised systems is created. When the systems are next synchronised, Intellisync compares the two synchronised systems to each other, and to the history file. If a record in the history file matches one system, but not the other, Intellisync knows that the “conflicting” record has been changed since the last synchronisation. It therefore applies the change to the other system and to the history file.

In cases where changes have been applied to both systems, and those changes conflict (for example, if you have added address records for the same name to each system, but the phone numbers don't match), the **Conflict Resolution** setting is used to resolve the matter.

Intellisync Address Formats

If address data in your communicator is not consistently formatted, and you have the same basic data in your PC application, you can achieve consistency by deleting the addresses from your communicator and synchronising with your PC application. This will transfer the contents of your PC application back into your communicator in the selected Address Format. Before doing this, however, it would be wise to backup your communicator data as a precaution.

In order for Intellisync to transfer data correctly between your communicator and your PC application, it must assume a particular format for freeform Name and Address fields in your communicator's Contacts application.

Intellisync assumes that Name fields are entered into your communicator as follows:

Last, First Middle

When you first configure an Intellisync operation for a particular communicator, you are prompted to select an **Address** format. Address formats can also be accessed by selecting **Contacts** on the Intellisync Options menu.

Intellisync offers five formats to choose from—Address Format 1, Address Format 2, and so on. If none of the formats match the format you are using, you can either select the closest format and adjust field mapping to account for the differences, or choose Format 5, which transfers the communicator's complete Address field to a single field in your PC application.

Refer to “Field Mapping and Freeform Fields” under “Intellisync Advanced Settings Dialogues” for additional information on freeform Name and Address fields.

Note: In order for Intellisync to successfully transfer data between your two systems, data in freeform fields must be entered in a **consistent** format. If your freeform fields have been entered inconsistently, the results of a synchronisation, import, or export will reflect that inconsistency.

Available Address Formats

Address Format 1

Address Item 1, City, State, Postal Code, Country

For example: 13 Lewis St., Moose Junction, MO, 45678, USA

Address Format 2

Address Item 1 <newline>

City, State, Postal Code, Country

For example: 1312 Lewis St.
Moose Junction, MO, 45678, USA

Address Format 3

Address Line 1 <newline>

Address Line 2 <newline>

City, State Postal Code <newline>

Country

For example: 1312 Lewis St.
Suite 34
Moose Junction, MO 45678
USA

Address Format 4

Address Line 1 <newline>

Address Line 2 <newline>

Postal Code, City, State <newline>

Country

For example: 1312 Lewis St.

Suite 34

45678, Moose Junction, MO

USA

Address Format 5

Selecting Address Format 5 is, in effect, selecting no format.

This option can be used if you have not used consistent formatting in your communicator, or if none of the other formats resemble the format you're using.

When you select Address Format 5, your communicator's multi-line Address field is transferred to a single field in your PC application, and vice versa. Check the Field Mapping dialogue to see the default mapping.

Note: Using this format during synchronisations may result in the transfer of incomplete addresses from your PC application to your communicator.

For example, when Address Format 5 is selected, Intellisync maps the communicator's Address field to the Address portion of a Schedule+ address. (A complete Schedule+ address includes Address, City, State, Postal Code, and Country.) Thus, only the Address portion of a Schedule+ address transfers to your Nokia 9110 Communicator. City, State, etc. are ignored. In order to transfer the entire Schedule+ address to your communicator, you would need to enter the entire address into the Address field.

Importing and Exporting Data

In addition to synchronising your communicator with PC applications, Intellisync can also perform imports and exports of data from one system to the other.

The same procedures that are involved in configuring and performing a synchronisation are used for importing and exporting. That is, you have to set up the Configuration and Choose Translator dialogues, and, if necessary, adjust settings in the Advanced Settings, Options, and Field Mapping dialogues. Once things are set up, the **Synchronise** button on the Intellisync opening screen initiates the operation. The only difference is in the choice of the operation in the Choose Translator dialogue.

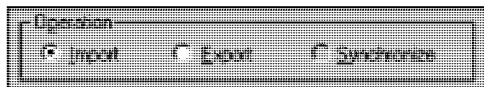

- ◆ To import data from your PC to your communicator, select **Import**.
- ◆ To export data to your PC from your communicator, select **Export**.

Notes:

- When you perform an import or export, Intellisync doesn't duplicate records that already exist in both systems. For example, if you export the contents your communicator's Contacts application to your PC, records that are already contained in both systems are not transferred to the PC file.
- In a single operation, you can perform different types of data transfers. For example, in one operation, you can import into your communicator's Contacts application, export Calendar information, and synchronise your To Do's. It's simply a matter of which operation you choose for each set of data.

Synchronisation and Data Truncation

When data is transferred between fields in your communicator and your PC application, data is truncated in the target field if the source data is too lengthy to be accommodated.

If you later **edit** the truncated data, the corresponding data in your other system is truncated after the next synchronisation. (Because Intellisync applies the detected **edit** to the data.)

If you want to edit truncated data, there is a workaround—as follows:

Any time you edit truncated data, go in and edit the corresponding record in the other system. (It can be the same change you made in the shortened record, or a trivial edit of no consequence. The important thing is that a **change** is registered in that record). Make sure the “**Notify**” Conflict Resolution setting is selected. Then, during the next synchronisation, when the Conflict Resolution dialogue box is displayed for that record, select **Ignore**. This prevents the truncated data from overwriting the data in your other system.

Note: If you select **Ignore**, as recommended, you will be prompted to resolve the conflict again the next time you run a synchronisation. If this is not acceptable, you can highlight the original (non-truncated) text in the Conflict Resolution dialogue and choose **Update**. Note, however, that this will overwrite the edit that caused the conflict in the first place.

Full Re-Synchronisation

If, for some reason, the data in either your communicator or your PC application is lost or unintentionally altered, do not synchronise the data. Doing so will transfer the problem to your other system.

For example, if all address records were accidentally deleted from your PC application, Intellisync would see that all the records were deleted since the last synchronisation and remove the address records from your communicator.

Fortunately, the confirmation prompt would warn you before such a synchronisation actually took place. In addition to warning you, it would allow you to use the **Re-Sync** button to execute a Full Re-Synchronisation.

Unlike a normal synchronisation, a **full re-synchronisation** would not delete the records in your communicator. This is because a full re-synchronisation is, in effect, a “first-run” synchronisation. That is, the history file is thrown out, and the synchronisation simply merges the contents of the two systems.

Refer to “The Confirmation Tab” under “Intellisync Advanced Settings Dialogues” for information on the confirmation prompt.

Notes:

- If the data in your communicator or PC application is not lost, but has in some other way been corrupted, you can delete the contents of the file and execute a full re-synchronisation to transfer the contents of the other system into the empty file or application. Note, however, that only mapped values can be transferred to the empty system. Unmapped values will be lost from any records you delete.
- The confirmation prompt is the **only** way to access the **Re-Sync** button. It is therefore advisable to keep active the **Confirm Record Deletions** setting in the Advanced Settings dialogue.

The Same Record Changed and Deleted Dialogue

If, during a synchronisation, Intellisync discovers that a previously synchronised record has been **changed** in one system and **deleted** in the other since the last synchronisation, a special dialogue is displayed.

This dialogue appears only when **Notify me when conflicts occur** is the selected Conflict Resolution setting. If any other setting is selected, a **change** will always override a **delete**—that is, the changed record will be added to the system from which the record was deleted.

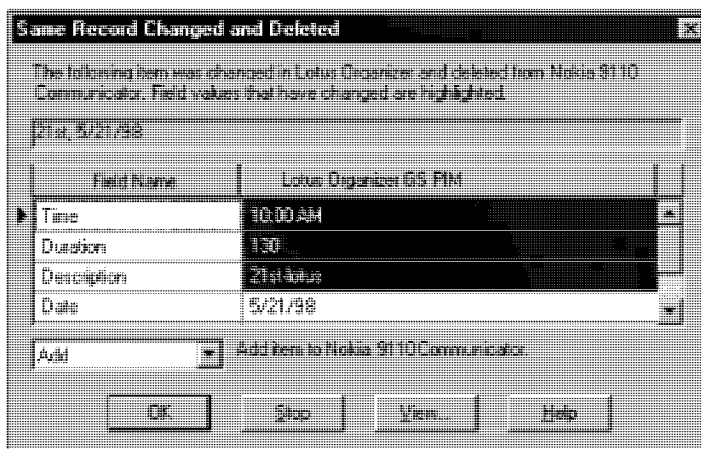

The **Same Record Changed and Deleted** dialogue alerts you to the deletion of the record in one system, and shows you the record as it has been changed in the other. A list of options allows you to decide between the following actions:

- ◆ **Add:** Adds the item back into the system from which it was deleted.
- ◆ **Delete:** Deletes the record from the other system.
- ◆ **Ignore:** Lets each system remain as it is.

A set of buttons also appear at the bottom of the dialogue.

- **OK:** Exits the dialogue and applies the selected action.
- **Stop:** Stops the synchronisation.
- **View:** Lets you see the complete value of the highlighted field when it is too long to be displayed in the grid.
- **Help:** Calls on-line Help.

The Sync Log File

The Sync Log file can be a good source of information if you call for technical assistance.

The Sync Log file is a simple text file that can be viewed using any editor.

Each time you run a synchronisation, the file is overwritten. If you want to save a particular Sync Log file, rename the file before running another synchronisation. The file is located in a sub-directory (of the installation directory) named after the communicator serial number.

Intellisync maintains a Sync Log file that is updated after each data transfer. The Sync Log file contains a detailed accounting of what occurred during the synchronisation, import, or export.

Normally, it's not necessary to read the Sync Log file after an operation. However, if errors were reported, it may be a useful source of information.

To view the Sync Log file for the last data transfer, select the **Sync Log** command on the Intellisync View menu.

The file identifies the records that were transferred from one system to the other, and indicates the exact action that was taken for each record. Field Mapping is also shown in the Sync Log file.

Reading a Sync Log File

Before any actions are taken during a data transfer, records from each system are read (looked at). You will see the term **READ** used in the log file to indicate this process.

After reading records in each of the systems, Intellisync compares the records in both systems, as indicated in a section labelled **Summary of Data Analysis**. Here you will see phrases such as: **Unchanged on Both Systems**, **Changed on First System**, and **Deleted from Second System**.

The next section of the Sync Log file lists the actions that were taken in your “First System” (Nokia 9110 Communicator) and “Second System” (PC application) during the data transfer.

Actions that may be noted in the Sync Log file are as follows:

ADD: The record was added.

DELETE: The record was deleted.

FAIL RANGE: The item was excluded from the operation. It either failed the Date Range check for Appointments or it was a “completed” **To-do list** item, and the Transfer Only Pending Items option was checked in the **To-do list** tab of the Advanced Settings dialogue.

IGNORE: The record was ignored.

SKIP: The record was skipped because the data transferred was of a different type.

UPDATE: The record was updated with a value or values from the other system.

Intellisync lets you configure and save both a local and a remote synchronisation for each Nokia 9110 Communicator you connect and “register.”

Remote Synchronisation

Intellisync allows you to configure and run “Remote” as well as “Local” synchronisations of Calendar data. A remote synchronisation is a synchronisation that you can run remotely, over a data call.

To configure a remote synchronisation, follow the “Quick Start” instructions provided at the beginning of this chapter—only click the **Remote** tab to configure the operation.

Remote vs. Local Synchronisation

When you run a synchronisation locally, you are sometimes prompted for information. For example, if the “Notify” Conflict Resolution setting is selected, you may be prompted to resolve data conflicts. If your PC application requires a password, you will be prompted to enter a password—and so forth.

Since interaction with your computer is not possible when you run a remote synchronisation, remote synchronisations are a little different from local ones.

Please note:

- ◆ When you configure a remote synchronisation, you will notice that the Conflict Resolution tab of the Advanced Settings dialogue does not contain the Ignore and Notify options. (**Add** is the default Conflict Resolution setting.)
- ◆ During a synchronisation, if Intellisync discovers that the same record has been deleted in one system and changed in the other since the last synchronisation, the change is applied instead of the delete.
- ◆ There is no Confirmation tab in the Advanced Settings dialogue because a confirmation prompt does not display during remote synchronisations.
- ◆ You cannot synchronise PC applications that require you to type a password for access during a synchronisation.

Running a Remote Synchronisation

Refer to Chapter 9, "Internet," in your Nokia 9110 Communicator manual for information on connecting your communicator to your PC via the Internet.

In order to run a remote synchronisation, you must have an Internet access point to facilitate the remote connection to your PC. In addition, PC Suite for Nokia 9110 Communicator must be up and running on your PC.

Once you have configured a remote synchronisation, follow these steps to run it from your communicator:

1. Press the **System** application button on your communicator.
2. Choose **Remote Synchronisation** and press **Select**.
3. Press **Settings** and define the destination host (the IP address of the server PC) and select your Internet access point.
4. Press **Start** to start a data call and begin synchronising.

When the synchronisation is complete, the data call ends.

Intellisync Glossary

Boldfaced text identifies additional terms defined in this section.

See “The Conflict Resolution Tab” under “Intellisync Advanced Settings Dialogues” for more information about Conflict Resolution and data conflicts.

Read this section to gain an understanding of some of the terms that are used to describe PC Suite’s Intellisync function.

Conflict Resolution

A process (controlled by a setting in the Conflict Resolution tab of the Advanced Settings dialogue) that is sometimes used by Intellisync to determine how to resolve **data conflicts** during synchronisations. See **Data Conflict**, below.

Data Conflict

A data conflict occurs when records in both systems have matching **key field** values but conflicting data in other **mapped fields**. (For example, if both systems have address records in which the First and Last Name values are identical, but the address values differ.)

The very first time a set of data is synchronised (and any time you import or export data) the Conflict Resolution setting in the Advanced Settings dialogue is used to resolve all such conflicts. Upon subsequent synchronisations of the same data (after the **history file** has been created), the Conflict Resolution setting is needed only under either of the following two conditions:

- 1) When records with the same key fields have been added to both systems since the last synchronisation, but they have conflicts in other mapped fields.
- 2) When mapped fields in previously synchronised records (with matching key fields) have been edited since the last synchronisation, but edited differently.

Fanning

The conversion of a repeating item into many individual items (“fanned” items) having unique dates. Fanning occurs when one of your systems does not support an incoming repeating item.

Field Mapping

The linkage that directs the comparison and transfer of data during an Intellisync data transfer. Field mapping is contained (and can be edited) in the Intellisync Field Mapping dialogue.

To access the Field Mapping dialogue, select the Field Mapping button in the Advanced Settings dialogue.

Filter

A statement that can be applied to a synchronisation to restrict the records that are included in an operation. See “The Filters Tab” under “Advanced Settings Dialogue” for information about using Intellisync filters.

First-Run Synchronisation

The first synchronisation of a particular set of data.

A first-run synchronisation is different from subsequent synchronisations of the same set of data because no **history file** exists. The history file is created during the first run (and the **Conflict Resolution** setting is used to settle **data conflicts** between the two systems.)

Full Re-Synchronisation

A special mode of synchronisation that merges rather than synchronises data in your two systems. (In effect, a “first-run” synchronisation.) This is used for restoring lost data and for maintaining data integrity when records have been altered. A full re-synchronisation can be performed using the Re-Sync button in the confirmation prompt that may appear before the results of a synchronisation are applied. Refer to “The Confirmation Tab” under “Intellisync Advanced Settings Dialogues” for more information.

History File

A file that is created by a “**first-run**” **synchronisation** and updated after every subsequent synchronisation. This file aids Intellisync in determining which data to use when there are discrepancies between your communicator and PC application. See “Synchronisation and History Files” under “Intellisync Special Topics” for more complete information.

Key Field

A field specially defined to detect **data conflicts** during a data transfer. During a synchronisation, Intellisync compares the values of **mapped fields** in your two systems. When “key” values match, but other mapped values differ, a data conflict exists. For example, in Contacts records, if Name (key) values match, but Phone values differ, this is a data conflict.

Mapped Fields

Fields that are linked for data transfer in the Intellisync **Field Mapping** dialogue.

Section

A type, or category, of data contained in a PC application. For example, **Addresses**, **Notepad**, and **Schedule** are sections contained in some of the PC applications supported by Intellisync.

Synchronisation

The Intellisync operation that compares the records in your communicator to the records in a PC application file, and makes whatever changes are necessary in either system to make sure that they both contain the same data.

Translator

A component of the Intellisync software that enables Intellisync to transfer data between your Nokia 9110 Communicator and a particular PC application.

Intellisync Menu Commands

FILE	
Exit	Exits PC Suite.

VIEW	
Status Bar	Toggles status bar on and off.
Sync Log	Displays the Sync Log for the last Intellisync operation.

COMPONENTS	
Contacts	Starts Contacts application component.
Intellisync	Accesses Intellisync component.
File Transfer	Accesses File Transfer component.
Backup/Restore	Accesses Backup/Restore component.
Install/Remove	Accesses Install/Remove component.
Import/Export	Accesses Import/Export component.

OPTIONS	
Contacts	Displays Contacts Address Format and File options.
Desk Stand Button Settings	Displays desk stand button options.
Registered Communicators	Lists the communicators that have been connected and named.
Preferences	Displays the Preferences dialogue.

HELP	
Contents	Displays on-line Help Contents.
Commands	Displays command information.
Using Help	Accesses Help for on-line Help.
Premier Upgrade	Displays Intellisync registration and Premier Upgrade subscription information.
About PC Suite	Displays "About PC Suite" dialogue.

Chapter 4 : File Transfer Functions

The PC Suite File Transfer functions let you move, copy, paste, rename, and delete Nokia 9110 Communicator and PC files and folders in a familiar Windows Explorer-type environment.

Topics in this chapter include:

- ◆ Using the File Transfer Functions
- ◆ File Transfer Window Panes
- ◆ Selecting Files
- ◆ Copying Files and Folders
- ◆ Moving Files and Folders
- ◆ Deleting Files and Folders
- ◆ Renaming Files and Folders
- ◆ File Properties
- ◆ File Transfer Menu Commands

Using the File Transfer Functions

The PC Suite File Transfer functions let you move, copy, paste, rename, and delete Nokia 9110 Communicator and PC files and folders in a familiar Windows Explorer-type environment.

Note: Built-in conversion utilities for some types of files allow you to transfer “incompatible” files between your communicator and your PC in a readable form. Files that are converted include: Nokia 9110 Communicator Notes files, communicator Fax files, and PC TIFF files (compressed in Group 3 (1d) Fax format).

Follow these steps to access the PC Suite File Transfer functions.

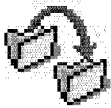

1. Start PC Suite and click the **File Transfer** icon in the opening screen.
2. Connect your communicator to your PC COM port or establish an infrared connection. If you are prompted to do so, enter a name for your communicator.

Unlike Windows Explorer, you cannot launch a program or open a file from the File Transfer screen.

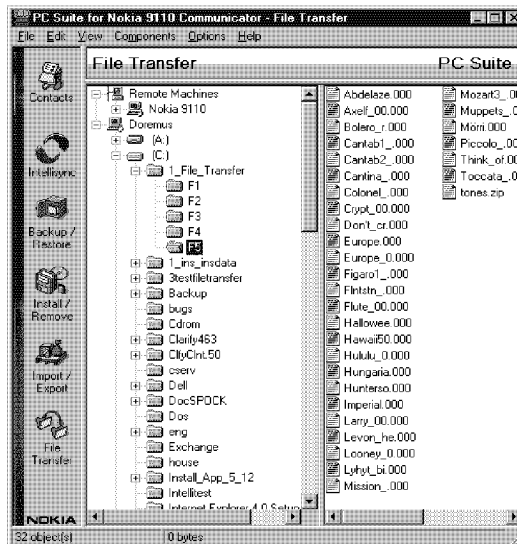

File Transfer Window Panes

The File Transfer screen looks very similar to Windows Explorer. It is divided into two panes that can be re-sized by dragging the splitter bar that separates them.

Drives and folders for both the Nokia 9110 Communicator and your PC are listed on the left, and can be expanded by clicking the + icon. The contents of the drive or folder highlighted on the left are shown on the right side of the window.

Selecting Files

Standard Windows file selection methods are used to select files or folders in the File Transfer screen. You can select an item by clicking on it with your mouse, or using the up and down arrow keys on your keyboard.

Use the Shift key in combination with the up and down arrow keys to select multiple adjacent items.

Shift-click or Ctrl-click also selects multiple files or folders.

Copying Files and Folders

Files and folders can be copied in the File Transfer window using “drag and drop” or by copying and pasting.

To Drag and Drop:

1. In the left pane, highlight the drive or folder containing the item you want to copy.
2. In either pane, select the item(s) you want to copy.
3. Hold the left mouse button down, and drag the item(s) to the new location. A + next to the cursor shows that you’re copying (and not cutting) the item.
4. Release the mouse button.

If press the **Ctrl** key while you drag the item, the item is **removed** from its original location.

To Copy and Paste:

1. In the left pane, highlight the drive or folder containing the item you want to copy.
2. In either pane, select the item(s) you want to copy.
3. Select **Copy** from the Edit menu, or click the right-mouse button choose **Copy** from the pop-up menu.
4. Highlight the left-pane drive or folder to which you want to copy the file.
5. Select **Paste** from the Edit menu, or click the right-mouse button and choose **Paste** from the pop-up menu.

Keyboard Shortcuts:

Ctrl-C = Copy

Ctrl-V = Paste

Moving Files and Folders

Files and folders can be moved in the File Transfer window using “drag and drop” or by cutting and pasting.

To Drag and Drop:

Use same drag and drop technique described previously for copying. However, you must press the **Ctrl** key while dragging. If you do not, the file or folder will not be removed from its original location.

Note that the use of the **Ctrl** key in drag and drop operations is **not** identical to its use in Microsoft Explorer.

You cannot cut read-only files or root folders from the communicator. Cut/Paste operations for these files/folders are, in effect, Copy/Paste operations.

To Cut and Paste:

1. In the left pane, highlight the drive or folder containing the item you want to cut.
2. In either pane, select the item (or items) you want to cut
3. Select **Cut** from the Edit menu, or click the right-mouse button choose **Cut** from the pop-up menu.
4. Highlight the left-pane drive or folder to which you want to move the file or folder.
5. Select **Paste** from the Edit menu, or click the right-mouse button and choose **Paste** from the pop-up menu.

Keyboard Shortcuts:

Ctrl-X = Copy

Ctrl-V = Paste

Multiple items can be deleted at once in the right pane. Only one item at a time can be deleted from the left pane.

Deleting Files and Folders

There are three ways to delete an item from the left or right pane of the File Transfer window:

Select the item you want to delete. Then:

- ◆ Press the **Del** key
- ◆ Select **Delete** from the Edit menu, or
- ◆ Press the right mouse button and choose **Delete** from the pop-up menu.

Note: You cannot delete root folders or read-only files from the communicator.

Items deleted from your PC are sent to the Windows Recycle bin.

Renaming Files and Folders

Just like in Windows Explorer, you can rename files and folders using the Rename command.

To rename a file or folder:

1. Select the file or folder you want to rename in either pane.
2. Select **Rename** from the File menu, or click the right-mouse button and choose **Rename** from the pop-up menu.
3. Type a new name and then press **Enter**.

Note: You cannot rename non-empty folders, root folders, or read-only files in the communicator.

File Properties

Like Windows Explorer, the PC Suite File Transfer function lets you display and edit a file or folder's "properties."

Follow these steps:

1. Select a file or folder in either pane.
2. Select **Properties** from the File menu, or click the right-mouse button and choose **Properties** from the pop-up menu. This displays the Properties dialogue.

When a Properties dialogue is displayed for a communicator file or folder, check boxes are disabled (greyed). You cannot change the attributes of a file or folder in the communicator.

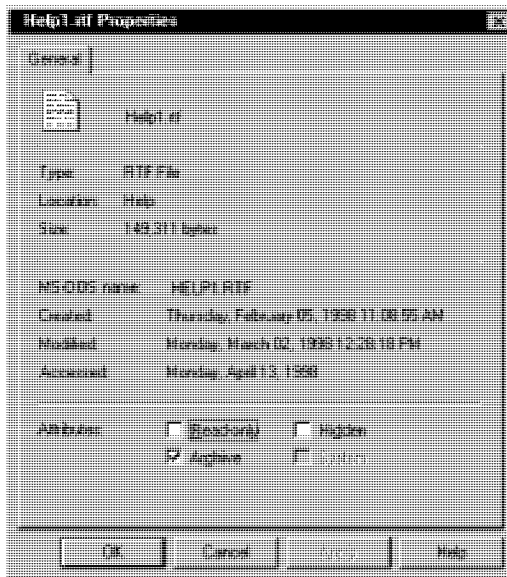

Check or un-check the check boxes in this dialogue to change a PC file or folder's attributes.

- ◆ Click **OK** to save changes and exit the dialogue.
- ◆ Click **Cancel** to exit without saving changes.
- ◆ Click **Apply** to save changes without exiting.

File Transfer Menu Commands

FILE	
Exit	Exits PC Suite.

VIEW	
Status Bar	Toggles status bar on and off.
Large Icons	Switches view to Large Icons mode.
Small Icons	Switches view to Small Icon mode.
List	Switches view to List mode.
Details	Switches view to Details mode.
Arrange Icons	Lets you arrange icons by Name, Type, Size, or Date.
Refresh	Refreshes (updates) display.

EDIT	
Cut	Cuts the selected file or folder.
Copy	Copies the selected file or folder.
Paste	Pastes the item that was cut or copied to the selected location.
Select All	Selects all the items in the open folder.
Invert Selection	Inverts the selection status of each file in the open folder.

COMPONENTS	
Contacts	Starts Contacts application component.
Intellisync	Accesses Intellisync component.
File Transfer	Accesses File Transfer component.
Backup/Restore	Accesses Backup/Restore component.
Install/Remove	Accesses Install/Remove component.
Import/Export	Accesses Import/Export component.

HELP	
Contents	Displays on-line Help Contents.
Commands	Displays command information.
Using Help	Accesses Help for on-line Help.
About PC Suite	Displays "About PC Suite" dialogue.

Chapter 5 : Backup and Restore

This chapter discusses the PC Suite Backup and Restore commands, which safeguard the data in your communicator.

Topics include:

- ◆ Backing Up Your Data
- ◆ Restoring a Backup
- ◆ Backup/Restore Menu Commands

Backing Up Your Data



Follow these steps to backup some or all of the data on your Nokia 9110 Communicator:

1. Click the **Backup/Restore** icon in the PC Suite opening screen.
2. Connect your communicator to your PC COM port or establish an infrared connection.

If prompted to do so, enter a name for your communicator.

To-do list records are included when you backup the Calendar application.

When you configure a Backup operation, your configuration is saved when you run the Backup or exit the Backup tab.

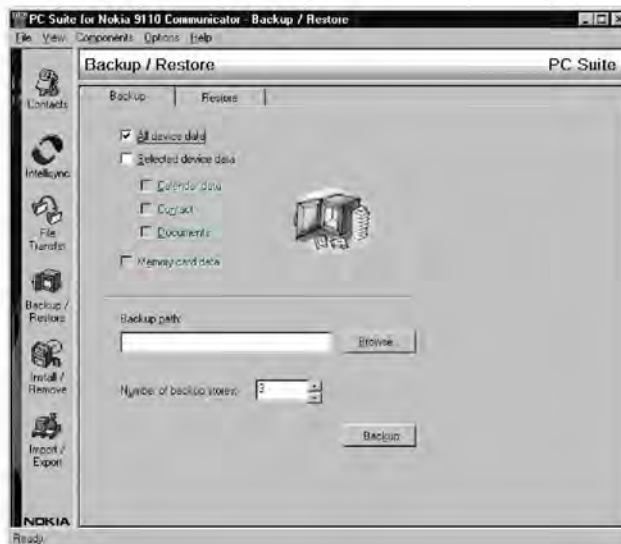

The Backup dialogue contains check boxes labelled **All device data**, **Selected device data**, and **Memory card data**.

All device data, when checked, backs up Calendar and Contact data, documents, settings, and add-on applications.

The *Selected device data* option does not backup settings and add-on applications.

Selected device data, when checked, enables three additional check boxes. You can select any or all of these options.

Calendar data: Backs up your Calendar data, including both Calendar and To do list records.

Contact: Backs up Contact records.

Documents: Backs up communicator documents.

Memory card data: Lets you include data in your Nokia 9110 Communicator Memory Card in the backup. If you do not check this option, Memory Card data is excluded from the backup.

Using the **Browse** button to specify the Backup path prevents you from making typographical errors.

3. Using the check boxes in the Backup dialogue, specify the data to backup.
4. In the box labelled **Backup Path**, specify the location (path) where you want backups stored. The backup name, **Nokia9110Backup**, is assigned automatically.

Number of Backup Stores

The PC Suite Backup command creates multiple, sequentially numbered backups—e.g., Nokia9110Backup01, Nokia9110Backup02, Nokia9110Backup03, and so on.

Nokia9110Backup01 is always the most recent backup.

The maximum number of backups stored is determined by the value entered in the box labelled **Number of backup stores**. The default value is 3. You can enter any number between 1 and 99.

Note: If you change this number before creating a new backup, existing backups will be deleted if the number you enter is less than number of existing backups. For example, if you have 10 existing backups, and you change the number to 5, the five oldest backups will be deleted when you create the new backup.

5. Enter a number between 1 and 99 in the box labelled **Number of backup stores**.
6. Click the **Backup** button to execute the Backup operation.

If you're using a desk stand with your communicator, refer to Desk Stand Button Settings, in Chapter 1, for information on how you can program your desk stand button to run the currently configured Backup operation.

Restoring a Backup



Follow these steps to restore a backup to your communicator:

1. Start PC Suite and click the **Backup/Restore** icon. Then click the **Restore** tab in the opening screen.
2. Connect your communicator to your PC COM port or establish an infrared connection.

A single Restore operation can restore an entire backup (e.g., Nokia9110Backup 01) or one backup component (e.g., Contacts).

When there is no active connection between your communicator and PC, the **Restore** button is disabled in the Restore tab.

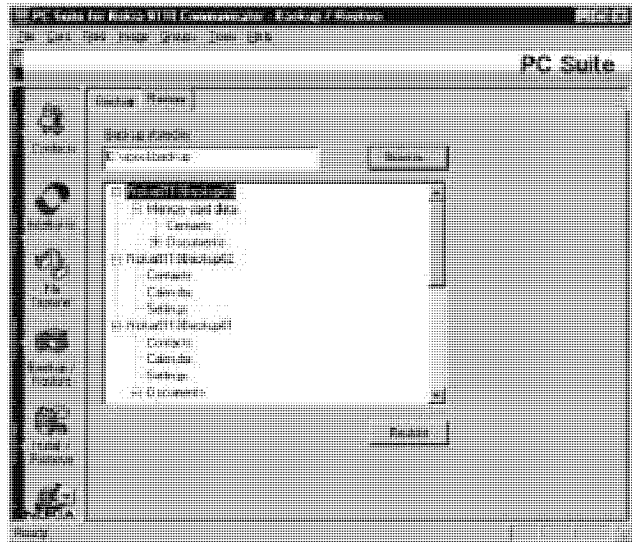

The Restore dialogue lists all the backups in the specified Backup directory. Nokia9110Backup01 is always the most recent backup in the specified location.

3. If necessary, specify the location of the backup in the text box labelled **Backup store**. (The location of the last-created backup is entered by default.)
4. In the lower portion of the dialogue, click on the data you want to restore.

You can select an entire backup (e.g., Nokia9110Backup01), or one component of a backup (e.g., Contacts). If you want to restore more than one component, but not the entire backup, you'll need to run multiple Restore operations.

5. Click **Restore** to restore the backup to your communicator and exit the Restore dialogue.

Note: If you want to delete a backup or backups, you can do so in Windows Explorer or in the PC Suite File Transfer dialogue. Refer to "File Transfer Functions" in this chapter for information about PC Suite File Transfer functions.

Backup/Restore Menu Commands

FILE	
Exit	Exits PC Suite

VIEW	
Status Bar	Toggles status bar on and off.

COMPONENTS	
Contacts	Starts Contacts application component.
Intellisync	Accesses Intellisync component.
File Transfer	Accesses File Transfer component.
Backup/Restore	Accesses Backup/Restore component.
Install/Remove	Accesses Install/Remove component.
Import/Export	Accesses Import/Export component.

OPTIONS	
Desk Stand Button Settings	Displays desk stand button options.
Registered Communicators	Lists the communicators that have been connected and named.
Preferences	Displays the Preferences dialogue.

HELP	
Contents	Displays on-line Help Contents.
Commands	Displays command information.
Using Help	Accesses Help for on-line Help.
About PC Suite	Displays "About PC Suite" dialogue.

Chapter 6 : Installing and Removing Software

PC Suite's Install/Remove Software function lets you install software to and remove software from your Nokia 9110 Communicator's main memory or memory card.

Topics include:

- ◆ Installing Software on your Communicator
- ◆ Removing Software from your Communicator
- ◆ Install/Remove Menu commands

Installing Software to your Communicator



Follow these steps to install a software package to your communicator:

1. Start PC Suite and click the **Install/Remove** icon in the opening screen.
2. Connect your communicator to your PC COM port or establish an infrared connection.
If prompted to do so, enter a name for your communicator.



3. In the **Select Path** text box, enter the path (location) of the software you want to install. Use the **Browse** button to quickly locate the software.
4. Click on the software you want to install in the box below.
5. In the Install Location box, select **Communicator's memory** or **Memory card** to specify where you want the software installed.
6. Click the **Install** button.

Removing Software from your Communicator



An icon next to each software package shows whether the software is located in your communicator's main memory or on a memory card.

The  icon represents software in your communicator's main memory.

Follow these steps to remove a software package from your communicator:

1. Start PC Suite and click the **Install/Remove** icon in the opening screen.



2. Connect your communicator to your PC COM port or establish an infrared connection.
If prompted to do so, enter a name for your communicator.
3. Click on the software you want to remove in the box below.
4. Click the **Remove** button.

Install/Remove Menu Commands

FILE	
Exit	Exits PC Suite.

VIEW	
Status Bar	Toggles status bar on and off.

COMPONENTS	
Contacts	Starts Contacts application component.
Intellisync	Accesses Intellisync component.
File Transfer	Accesses File Transfer component.
Backup/Restore	Accesses Backup/Restore component.
Install/Remove	Accesses Install/Remove component.
Import/Export	Accesses Import/Export component.

OPTIONS	
Desk Stand Button Settings	Displays desk stand button options.
Registered Communicators	Lists the communicators that have been connected and named.
Preferences	Displays the Preferences dialogue.

HELP	
Contents	Displays on-line Help Contents.
Commands	Displays command information.
Using Help	Accesses Help for on-line Help.
About PC Suite	Displays "About PC Suite" dialogue.

Chapter 7 : Importing and Exporting Calendar and Contacts Files

The PC Suite Import/Export operations can be used to transfer Calendar and Contacts files between your Nokia 9110 Communicator and your PC.

Topics in this chapter include:

- ◆ The Import/Export Commands
- ◆ Exporting a Calendar or Contacts File to your PC
- ◆ Importing a File from your PC to your Communicator
- ◆ Importing a Contacts File
- ◆ Import/Export Menu Commands

The Import/Export Commands

The File Transfer functions described in Chapter 4 cannot be used to transfer Calendar and Contacts files between your two system.

Refer to Chapter 1 for information on using the Contacts application.

The PC Suite Import/Export operations transfer Calendar and Contacts files between your communicator and your PC.

Tip: Communicator Contacts files are compatible, field-for-field, with the Contacts application that is included in PC Suite for Nokia 9110 Communicator. This Import/Export feature is useful as a means of transferring Contacts files between your Nokia 9110 Communicator and PC Contacts application.

File Import/Export vs. Intellisync Import/Export

It's important to note how the Import and Export capabilities described here are distinct from the Intellisync Import and Export capabilities described in Chapter 3's "**Importing and Exporting Data**" (Under "Intellisync Special Topics").

Intellisync Import and Export operations transfer field-level data between your communicator and PC. Source records are merged with existing records, and "conflict resolution" is applied when both systems have similar but conflicting data.

PC Suite's File Import/Export functions transfer entire files between your two systems. With one exception (see **Importing a Contacts File** later in this chapter), there is no merging of records or comparison of fields.

Exporting a Calendar or Contacts File to your PC

Before performing an export, be sure to read "Import/Export vs. Intellisync Import/Export" at the beginning of this chapter.



The PC Suite Export function exports Calendar and Contacts files from your communicator to ASCII (.txt) files on your PC.

Contacts files created by this function are compatible with the PC Suite Contacts application. Both Calendar and Contacts files can be read or edited using any text editor.

Follow these steps to export a Calendar or Contacts file from your Nokia 9110 Communicator to your PC.

1. Start PC Suite and click the **Import/Export** icon in the opening screen.
2. Connect your communicator to your PC COM port or establish an infrared connection.

If you are prompted to do so, enter a name for your communicator.

3. Click the **Export** tab.

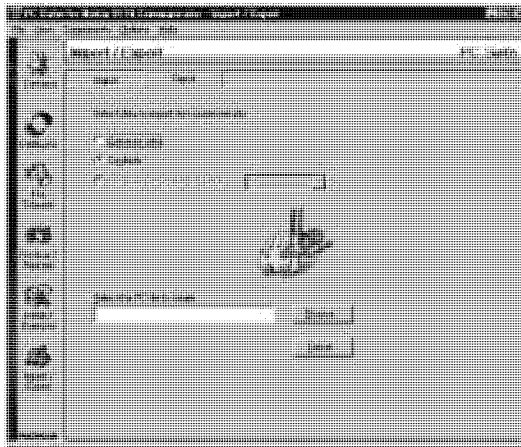

4. Choose one of three options: Calendar data; Contacts; Contacts File on Memory Card.

If you choose the last option, specify the path (location) of the Memory Card Contacts database you want to export.

To avoid making typographical errors, click the **Browse** button and use the file browser to specify file paths.

5. In the text box labelled **Select the PC file to create**, specify the name and path of the PC file you will create. (If you name an existing file, that file is overwritten when you run the Export.)
6. Click the **Export** button to start the operation.

Importing a Calendar or Contacts File from your PC to your Communicator

Follow the steps below to import a .txt file to the Calendar or Contacts application on your Nokia 9110 Communicator.

Note: Before performing an import, read “Importing a Contacts File,” which follows.



1. Start PC Suite and click the **Import/Export** icon in the opening screen to display the Import tab.
2. Connect your communicator to your PC COM port or establish an infrared connection.
If prompted to do so, enter a name for your communicator.

This function is primarily useful as a means of transferring Contacts application records to your communicator.

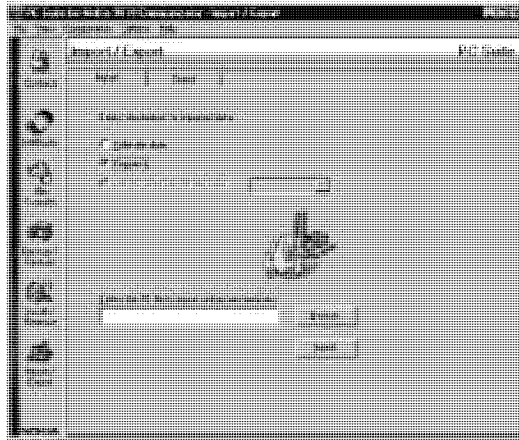

3. Choose one of three options: Calendar; Contacts; Contacts File on Memory Card.

- ◆ If you select **Calendar**, the file you specify replaces the Calendar file in your communicator's main memory.
 - ◆ If you select **Contacts**, the existing Contacts file is updated with records from your PC file.
 - ◆ If you select **Contacts File on Memory Card**, you must specify a memory card filename. If you name an existing file, the file is updated with records from your PC file.
4. Specify the PC file that you want to transfer to your communicator. To avoid making typographical errors, click the **Browse** button and use the file browser to select the file.
 5. Click the **Import** button to start the operation.

Importing a *Contacts* File

This Import function yields the same result as the Contacts application's *Update to Communicator* command.

The **Import** function, when applied to a **Contacts** file, merges records from a PC Contacts file into the existing Contacts file in your communicator.

During the merging process, records in your two systems are compared, and records that exist in your PC Contacts file that do not exist in your communicator are transferred to your communicator.

Note that if a record in your PC Contacts file is almost, but not quite identical to a record in your communicator, the record is transferred. This means, for example, that if each of your systems has a Contact card for John Johansen, but the phone numbers in the two cards are different, a duplicate card (containing a different phone number) is created in your communicator.

If you want to synchronise the Contact records in your two systems and avoid the possibility of creating "duplicate" records containing conflicting data, use the Intellisync synchronisation function described in Chapter 3.

Import/Export Menu Commands

FILE	
Exit	Exits PC Suite.

VIEW	
Status Bar	Toggles status bar on and off.

COMPONENTS	
Contacts	Starts Contacts application component.
Intellisync	Accesses Intellisync component.
File Transfer	Accesses File Transfer component.
Backup/Restore	Accesses Backup/Restore component.
Install/Remove	Accesses Install/Remove component.
Import/Export	Accesses Import/Export component.

OPTIONS	
Desk Stand Button Settings	Displays desk stand button options.
Registered Communicators	Lists the communicators that have been connected and named.
Preferences	Displays the Preferences dialogue.

HELP	
Contents	Displays on-line Help Contents.
Commands	Displays command information.
Using Help	Accesses Help for on-line Help.
About PC Suite	Displays "About PC Suite" dialogue.

Index

B

Backup Dialogue, 95
Backup/Restore Icon, 7

C

Choose Translator Dialogue
 Apply to all applications
 checkbox, 39
Communications Port
 Setting, 8
Contacts Application
 adding contact cards to, 16
 adding pictures to Contact
 cards, 20
 and updating
 communicator records,
 27
 Card menu commands, 16
 creating a card template,
 15
 creating and editing
 contact groups, 21
 editing contact card fields,
 17
 editing contact cards, 17
 finding a contact, 22
 main screen, 14
 opening a database, 15
 saving a database, 15
Contacts Icon, 7

D

Desk Stand Button Settings,
11

E

Exporting Data From Your
Communicator, 70

F

File Tab, 36
File Transfer Functions, 86
 copying files and folders,
 87
 deleting files and folders,
 89
 moving files and folders,
 88
 properties, 90
 renaming files and folders,
 89
 selecting files, 87
File Transfer Icon, 7
File Transfer Window Panes,
87
First-Run Synchronisation,
79
Full Re-Synchronisation, 80

I

Icons
 help, 5
 PC Suite, 5
 readme, 5
 uninstall, 5
Import/Export Icon, 7
Importing Data to Your
Communicator, 70
Install/Remove Icon, 7
Intellisync
 and Freeform Fields, 67

- Intellisync, 33
 - Additional Details
 - Dialogue, 49
 - address formats, 35, 67
 - Advanced Button, 39
 - Advanced Settings
 - dialogues, 42
 - and data truncation, 63, 71
 - Choose Translator
 - dialogue, 36
 - Conditions Tab, 56
 - Configuration Dialogue, 36, 38
 - Confirmation Prompt, 46, 47, 48, 72
 - Conflict Resolution tab, 50
 - Conflict Resolution, 66, 78
 - Conflict Resolution
 - Dialogue Box, 52
 - Conflict Resolution
 - Options, 52
 - data conflict, 50, 78
 - Date Range, 44
 - Date Range Tab, 43
 - Details Dialogue, 48
 - fanning of repeating items, 79
 - Field Mapping Dialogue, 61
 - Filters Tab, 55
 - First Run
 - Synchronisations, 40
 - first-run synchronisation, 79
 - Full Re-Synchronisation, 72, 80
 - glossary, 78
 - history files, 66
 - how synchronisation works, 66
 - Import and Export
 - operations, 70
 - Key Fields, 51
 - letter case in key fields, 51
 - notes on conflict resolution, 54
 - Notify Conflict Resolution
 - option, 52
 - Options dialogue, 37
 - Re-Sync Button, 72
 - Rules Tab, 57
 - Same Record Changed and Deleted Dialogue, 73
 - Sync Log File, 74
 - Taskbar Synchronisation, 40
 - To Do Range, 45
 - tutorial, 34
- Intellisync Advanced Settings
 - Dialogue
 - Confirmation tab, 46
 - Date Range tab, 43
 - Field Mapping, 61
 - Filters tab, 55
 - To-do list tab, 45
- Intellisync Buttons
 - Re-Sync, 72
- Intellisync Confirm Record
 - Deletions, 72
- Intellisync Contacts
 - synchronising memory
 - card Contacts file, 36
- Intellisync Data Conflict, 78
- Intellisync Field Mapping, 79
 - asterisks in Field Mapping dialogue, 63
 - default mapping, 62
 - Freeform Fields, 64
 - mapping non-adjacent fields, 62
- Intellisync files
 - history files, 66, 80

- sync log, 74
- Intellisync Filters
 - Add to List button, 58
 - and logical operators, 57
 - Conditions tab operators, 59
 - creating, 58
 - notes, 60
 - Update Button, 58
- Intellisync Filters Tab, 55
- Intellisync Glossary, 78
- Intellisync History Files, 40, 66, 80
- Intellisync Icon, 7
- Intellisync Settings
 - Date Range setting, 43

P

- PC Contacts Application
 - JPEG files, 41
- Preferences Dialogue, 8, 12

R

- Readme File, 5
- Remote Synchronisation
 - vs. local synchronisation, 76
- Restoring Backups, 97

S

- Sync Log File, 74
- Synchronisation
 - and data truncation, 71
 - first-run, 79
 - Same Record Changed and Deleted, 73
- System Requirements, 3

T

- Translator, 81

U

- Intellisync Field Mapping, 62