

TO: <b>Mail Stop 8</b> <b>Director of the U.S. Patent and Trademark Office</b> <b>P.O. Box 1450</b> <b>Alexandria, VA 22313-1450</b>	<b>REPORT ON THE</b> <b>FILING OR DETERMINATION OF AN</b> <b>ACTION REGARDING PATENT OR</b> <b>TRADEMARK</b>
-----------------------------------------------------------------------------------------------------------------------------------------------	-----------------------------------------------------------------------------------------------------------------------

In Compliance with 35 U.S.C. § 290 and/or 15 U.S.C. § 1116 you are hereby advised that a court action has been filed in the U.S. District Court Eastern District of Texas on the following

Trademarks or  Patents. (  the patent action involves 35 U.S.C. § 292.);

DOCKET NO.	DATE FILED	U.S. DISTRICT COURT
PLAINTIFF		DEFENDANT
Solocron Media, LLC		Verizon Communications Inc., Cellco Partnership d.b.a. Verizon Wireless, AT&T Inc., AT&T Mobility LLC, Sprint Corp., Sprint Communications Company L.P., Sprint Solutions Inc., & T-Mobile USA, Inc.
PATENT OR TRADEMARK NO.	DATE OF PATENT OR TRADEMARK	HOLDER OF PATENT OR TRADEMARK
1. US6496692	12/17/2002	Solocron Media, LLC
2. US7257395	08/14/2007	Solocron Media, LLC
3. US7295864	11/13/2007	Solocron Media, LLC
4. US7319866	01/15/2008	Solocron Media, LLC
5. US7742759	06/22/2010	Solocron Media, LLC
6. US8249572	08/21/2012	Solocron Media, LLC
7. US8594651	11/26/2013	Solocron Media, LLC

In the above—entitled case, the following patent(s)/ trademark(s) have been included:

DATE INCLUDED	INCLUDED BY
PATENT OR TRADEMARK NO.	DATE OF PATENT OR TRADEMARK
	HOLDER OF PATENT OR TRADEMARK

In the above—entitled case, the following decision has been rendered or judgement issued:

DECISION/JUDGEMENT
--------------------

CLERK	(BY) DEPUTY CLERK	DATE
-------	-------------------	------

Copy 1—Upon initiation of action, mail this copy to Director

Copy 2—Upon filing document adding patent(s), mail this copy to Director

Copy 3—Upon termination of action, mail this copy to Director

Copy 4—Case file copy



UNITED STATES PATENT AND TRADEMARK OFFICE

UNITED STATES DEPARTMENT OF COMMERCE  
United States Patent and Trademark Office  
Address: COMMISSIONER FOR PATENTS  
P.O. Box 1450  
Alexandria, Virginia 22313-1450  
www.uspto.gov

APPLICATION NUMBER	FILING OR 371(C) DATE	FIRST NAMED APPLICANT	ATTY. DOCKET NO./TITLE
10/223,200	08/16/2002	Michael E. Shanahan	MES/001CON

**CONFIRMATION NO. 8026**

**POWER OF ATTORNEY NOTICE**

39550  
KALIKO & ASSOCIATES, L.L.C.  
400-B Lake Street  
RAMSEY, NJ 07446



Date Mailed: 05/20/2011

**NOTICE REGARDING CHANGE OF POWER OF ATTORNEY**

This is in response to the Power of Attorney filed 05/11/2011.

- The Power of Attorney to you in this application has been revoked by the assignee who has intervened as provided by 37 CFR 3.71. Future correspondence will be mailed to the new address of record(37 CFR 1.33).

/mtekle michael/

Office of Data Management, Application Assistance Unit (571) 272-4000, or (571) 272-4200, or 1-888-786-0101



UNITED STATES PATENT AND TRADEMARK OFFICE

UNITED STATES DEPARTMENT OF COMMERCE  
United States Patent and Trademark Office  
Address: COMMISSIONER FOR PATENTS  
P.O. Box 1450  
Alexandria, Virginia 22313-1450  
www.uspto.gov

APPLICATION NUMBER	FILING OR 371(C) DATE	FIRST NAMED APPLICANT	ATTY. DOCKET NO./TITLE
10/223,200	08/16/2002	Michael E. Shanahan	PREMM.001A1C1

**CONFIRMATION NO. 8026**

**POA ACCEPTANCE LETTER**



20995  
KNOBBE MARTENS OLSON & BEAR LLP  
2040 MAIN STREET  
FOURTEENTH FLOOR  
IRVINE, CA 92614

Date Mailed: 05/20/2011

**NOTICE OF ACCEPTANCE OF POWER OF ATTORNEY**

This is in response to the Power of Attorney filed 05/11/2011.

The Power of Attorney in this application is accepted. Correspondence in this application will be mailed to the above address as provided by 37 CFR 1.33.

/mtekle michael/

Office of Data Management, Application Assistance Unit (571) 272-4000, or (571) 272-4200, or 1-888-786-0101

Please Direct All Correspondence to Customer Number 20,995

**CHANGE OF CORRESPONDENCE ADDRESS**

Applicant	:	Shanahan, Michael E.
App. No	:	10/223,200
Filed	:	August 16, 2002
For	:	METHODS AND APPARATUSES FOR PROGRAMMING USER-DEFINED INFORMATION INTO ELECTRONIC DEVICES
Examiner	:	Tran, CongVan
Art Unit	:	2617
Conf. No.	:	8026

**Mail Stop Post Issue**  
 Commissioner for Patents  
 P.O. Box 1450  
 Alexandria, VA 22313-1450

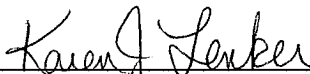
Dear Sir:

Please change the Correspondence Address for the above-identified patent application to the address associated with Customer Number: 20,995

Respectfully submitted,

KNOBBE MARTENS OLSON & BEAR LLP

Dated: May 11, 2011

  
 \_\_\_\_\_  
 Karen J. Lenker  
 Registration No. 54,618  
 Agent of Record  
 Customer No. 20,995  
 (949) 760-0404

PAT-ADDRESSCHANGE

11215640  
051011



**STATEMENT UNDER 37 CFR § 3.73(b)  
ESTABLISHMENT OF ASSIGNEE**

Applicant	:	Michael E. Shanahan
App. No.	:	10/223,200
Filed	:	August 16, 2002
For	:	METHODS AND APPARATUSES FOR PROGRAMMING USER-DEFINED INFORMATION INTO ELECTRONIC DEVICES
Examiner	:	Tran, CongVan
Group Art Unit	:	2617
Conf. No.	:	8026

Commissioner for Patents  
P.O. Box 1450  
Alexandria, VA 22313-1450

Dear Sir:

This document is being filed with a copy of a Power of Attorney signed by the Assignee. This Statement sets forth the chain of title of the above-identified application.

Premorphic Mobile LP, a Corporation, is the Assignee of the entire right, title, and interest of the above-referenced application by virtue of:

A chain of title, in reverse order, from the inventor(s) to the current Assignee as shown by the following recorded assignments:

1. Assignment from Premorphic Research, Inc. to Premorphic Mobile LP recorded in the United States Patent and Trademark Office on March 25, 2011, at Reel 026022, and Frame 0633.
2. Assignment from Twenty Year Innovations, Inc. to Premorphic Research, Inc. recorded in the United States Patent and Trademark Office on March 18, 2011, at Reel 025982, and Frame 0819.
3. Assignment from Michael E. Shanahan to Twenty Year Innovations, Inc. recorded in the United States Patent and Trademark Office on March 1, 2004, at Reel 015027, and Frame 0049.

The undersigned is an agent of Customer Number 20,995 and is authorized to act on behalf of the Assignee. Please recognize or change the correspondence address for the above-identified application to **Customer No. 20,995.**

Appl. No. : 10/223,200  
Filed : August 16, 2002

Docket No. PREMM.001A1C1  
Customer No. 20,995

Respectfully submitted,  
KNOBBE, MARTENS, OLSON & BEAR, LLP

Dated: May 11, 2011

By: Karen J. Lenker  
Karen J. Lenker  
Registration No. 54,618  
Agent of Record  
Customer No. 20,995  
(949) 760-0404

11220065

051111

**REVOCATION & GENERAL POWER OF ATTORNEY  
and  
CHANGE IN CORRESPONDENCE ADDRESS**

Commissioner for Patents  
P.O. Box 1450  
Alexandria, VA 22313-1450

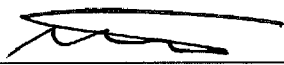
Dear Sir:

The undersigned is an empowered representative of the Assignee and hereby appoints the registrants of Knobbe, Martens, Olson & Bear, LLP, **Customer No. 20,995**, as attorneys and agents to represent the Assignee before the United States Patent and Trademark Office (USPTO) in connection with any and all patent applications assigned to the Assignee according to the USPTO assignment records or assignment documents supplied with an accompanying Statement Under 37 CFR § 3.73(b). This appointment is to be to the exclusion of the inventor(s) and his attorney(s) in accordance with the provisions of 37 CFR § 3.71.

Submission of this paper in connection with any matter of the below named assignee, together with a statement under 37 CFR 3.73(b), shall serve to revoke any previous powers of attorney in that matter.

**Attached is a Statement Under 37 CFR § 3.73(b)**, signed by a registrant of Knobbe, Martens, Olson & Bear, LLP, setting forth a full chain of title for the subject application owned by the Assignee named below.

Please recognize or change the correspondence address for the application identified in the attached Statement to **Customer No. 20,995**.

By:  Date: 5/11/11  
Name: Marcus S. Muller Title: CEO

Assignee Premorphic Mobile LP

Address: 4828 South Broadway Street  
Suite 360  
Tyler, Texas 75703

## Electronic Acknowledgement Receipt

<b>EFS ID:</b>	10071480
<b>Application Number:</b>	10223200
<b>International Application Number:</b>	
<b>Confirmation Number:</b>	8026
<b>Title of Invention:</b>	METHODS AND APPARATUSES FOR PROGRAMMING USER-DEFINED INFORMATION INTO ELECTRONIC DEVICES
<b>First Named Inventor/Applicant Name:</b>	Michael E. Shanahan
<b>Customer Number:</b>	39550
<b>Filer:</b>	Karen J. Lenker/Shirley Martinez
<b>Filer Authorized By:</b>	Karen J. Lenker
<b>Attorney Docket Number:</b>	MES/001CON
<b>Receipt Date:</b>	11-MAY-2011
<b>Filing Date:</b>	16-AUG-2002
<b>Time Stamp:</b>	19:02:55
<b>Application Type:</b>	Utility under 35 USC 111(a)

### Payment information:

Submitted with Payment	no
------------------------	----

### File Listing:

Document Number	Document Description	File Name	File Size(Bytes)/ Message Digest	Multi Part /.zip	Pages (if appl.)
1	Change of Address	PREMM_001A1C1- ChangeofAddress.pdf	30697 <small>8e2563a0618f0289416eab0e70bcd48da3b29ae4</small>	no	1

### Warnings:

### Information:

2	Assignee showing of ownership per 37 CFR 3.73(b).	PREMM_001A1C1-373.pdf	51929 58969848166c0f7b80f68e2e7778b56056de ect106	no	2
<b>Warnings:</b>					
<b>Information:</b>					
3	Power of Attorney	PREMM_000GEN-POA.PDF	350231 a4f66357a4195eda92dc67164d9ffd7bdcf2 e56	no	1
<b>Warnings:</b>					
<b>Information:</b>					
<b>Total Files Size (in bytes):</b>			432857		
<p><b>This Acknowledgement Receipt evidences receipt on the noted date by the USPTO of the indicated documents, characterized by the applicant, and including page counts, where applicable. It serves as evidence of receipt similar to a Post Card, as described in MPEP 503.</b></p> <p><b><u>New Applications Under 35 U.S.C. 111</u></b>  <b>If a new application is being filed and the application includes the necessary components for a filing date (see 37 CFR 1.53(b)-(d) and MPEP 506), a Filing Receipt (37 CFR 1.54) will be issued in due course and the date shown on this Acknowledgement Receipt will establish the filing date of the application.</b></p> <p><b><u>National Stage of an International Application under 35 U.S.C. 371</u></b>  <b>If a timely submission to enter the national stage of an international application is compliant with the conditions of 35 U.S.C. 371 and other applicable requirements a Form PCT/DO/EO/903 indicating acceptance of the application as a national stage submission under 35 U.S.C. 371 will be issued in addition to the Filing Receipt, in due course.</b></p> <p><b><u>New International Application Filed with the USPTO as a Receiving Office</u></b>  <b>If a new international application is being filed and the international application includes the necessary components for an international filing date (see PCT Article 11 and MPEP 1810), a Notification of the International Application Number and of the International Filing Date (Form PCT/RO/105) will be issued in due course, subject to prescriptions concerning national security, and the date shown on this Acknowledgement Receipt will establish the international filing date of the application.</b></p>					



**UNITED STATES PATENT AND TRADEMARK OFFICE**

UNITED STATES DEPARTMENT OF COMMERCE  
**United States Patent and Trademark Office**  
Address: COMMISSIONER FOR PATENTS  
P.O. Box 1450  
Alexandria, Virginia 22313-1450  
www.uspto.gov

APPLICATION NUMBER	PATENT NUMBER	GROUP ART UNIT	FILE WRAPPER LOCATION
10/223,200	7257395	2617	9200



**Correspondence Address/Fee Address Change**

The following fields have been set to Customer Number 39550 on 08/12/2009

- Correspondence Address
- Maintenance Fee Address
- Power of Attorney Address

The address of record for Customer Number 39550 is:

**39550  
KALIKO & ASSOCIATES, L.L.C.  
500 NORTH FRANKLIN TURNPIKE  
RAMSEY, NJ 07446**



**UNITED STATES PATENT AND TRADEMARK OFFICE**

UNITED STATES DEPARTMENT OF COMMERCE  
**United States Patent and Trademark Office**  
Address: COMMISSIONER FOR PATENTS  
P.O. Box 1450  
Alexandria, Virginia 22313-1450  
www.uspto.gov

APPLICATION NUMBER	PATENT NUMBER	GROUP ART UNIT	FILE WRAPPER LOCATION
10/223,200	7257395	2617	9200



**Correspondence Address/Fee Address Change**

The following fields have been set to Customer Number 39950 on 08/04/2009

- Correspondence Address
- Maintenance Fee Address
- Power of Attorney Address

The address of record for Customer Number 39950 is:

**39950  
JUAN CARLOS MONESTIER  
JOSE ELLAURI 1086 AP 402  
MONTEVIDEO, 11300  
URUGUAY**



**UNITED STATES PATENT AND TRADEMARK OFFICE**

UNITED STATES DEPARTMENT OF COMMERCE  
**United States Patent and Trademark Office**  
Address: COMMISSIONER FOR PATENTS  
P.O. Box 1450  
Alexandria, Virginia 22313-1450  
www.uspto.gov

APPLICATION NUMBER	PATENT NUMBER	GROUP ART UNIT	FILE WRAPPER LOCATION
10/223,200	7257395	2617	9200



**Correspondence Address/Fee Address Change**

The following fields have been set to Customer Number 27614 on 08/28/2008

- Correspondence Address
- Maintenance Fee Address
- Power of Attorney Address

The address of record for Customer Number 27614 is:

27614  
MCCARTER & ENGLISH, LLP  
FOUR GATEWAY CENTER  
100 MULBERRY STREET  
NEWARK, NJ 07102





APPLICATION NO.	ISSUE DATE	PATENT NO.	ATTORNEY DOCKET NO.	CONFIRMATION NO.
10/223,200	08/14/2007	7257395	MES/001CON	8026

39550 7590 07/25/2007  
KALIKO & YEAGER, L.L.C.  
500 NORTH FRANKLIN TURNPIKE  
RAMSEY, NJ 07446

### ISSUE NOTIFICATION

The projected patent number and issue date are specified above.

#### **Determination of Patent Term Adjustment under 35 U.S.C. 154 (b)** (application filed on or after May 29, 2000)

The Patent Term Adjustment is 323 day(s). Any patent to issue from the above-identified application will include an indication of the adjustment on the front page.

If a Continued Prosecution Application (CPA) was filed in the above-identified application, the filing date that determines Patent Term Adjustment is the filing date of the most recent CPA.

Applicant will be able to obtain more detailed information by accessing the Patent Application Information Retrieval (PAIR) WEB site (<http://pair.uspto.gov>).

Any questions regarding the Patent Term Extension or Adjustment determination should be directed to the Office of Patent Legal Administration at (571)-272-7702. Questions relating to issue and publication fee payments should be directed to the Customer Service Center of the Office of Patent Publication at (571)-272-4200.

APPLICANT(s) (Please see PAIR WEB site <http://pair.uspto.gov> for additional applicants):

Michael E. Shanahan, Nyack, NY;



**RECEIVED**  
**CENTRAL FAX CENTER**  
**JUN 26 2007**

500 North Franklin Turnpike, Ramsey, NJ 07446  
(201) 831-0575 Main Tel  
(201) 831-0519 Main Fax

**FACSIMILE TRANSMITTAL SHEET**

<b>TO:</b>  Commissioner for Patents	<b>FROM:</b> Scott H. Kaliko, Esq. <b>SENDER'S FAX NUMBER:</b> 201-831-0519 <b>SENDER'S TELEPHONE NUMBER:</b> 201-831-0575
<b>COMPANY:</b> United States Patent & Trademark Office	<b>DATE:</b> JUNE 26, 2007
<b>RECIPIENT'S FAX NUMBER:</b> 571-273-8300	<b>TOTAL NO. OF PAGES INCLUDING COVER:</b> 7
<b>RECIPIENT'S TELEPHONE NUMBER:</b>	<b>CLIENT / MATTER:</b>
<b>RE:</b> Application No. 10/223,200	<b>YOUR REFERENCE NUMBER:</b> MES/001 CON

URGENT     FOR REVIEW     PLEASE COMMENT     PLEASE REPLY     PLEASE RECYCLE

**NOTES/COMMENTS:**

Please confirm receipt of this fax and the below-identified attached parts.

1. Transmittal Form/Certificate of Transmission; and
2. Part B- Fee Transmittal; and
3. Request for Reapplication of Issue Fee; and
4. Copy of Previously Submitted Part-B Fee Transmittal; and
5. Copy of Previously Submitted check for Issue/Publication fees.

**CONFIDENTIALITY NOTICE**

The information contained in this facsimile message is privileged and confidential and is intended only for the use of the individual(s) and/or entity(ies) named above. If you are not the intended recipient, you are hereby notified that any unauthorized disclosure, copying, distribution or taking of any action in reliance on the contents of the information contained herein is strictly prohibited and review by any individual other than the intended recipient shall not constitute a waiver of the attorney-client privilege. If you have received this transmission in error, please immediately notify us by telephone. Thank you.

**JUN 26 2007**

PTO/SB/21 (09-04)

Approved for use through 07/31/2006. OMB 0651-0031  
U.S. Patent and Trademark Office; U.S. DEPARTMENT OF COMMERCE

Under the Paperwork Reduction Act of 1995, no persons are required to respond to a collection of information unless it displays a valid OMB control number.

<b>TRANSMITTAL FORM</b> <small>(to be used for all correspondence after initial filing)</small>	Application Number	10/223,200	
	Filing Date	August 18, 2002	
	First Named Inventor	Michael E. Shanahan	
	Art Unit	2817	
	Examiner Name	Congvan Tran	
Total Number of Pages in This Submission	7	Attorney Docket Number	MES/001 CON

ENCLOSURES (Check all that apply)		
<input checked="" type="checkbox"/> Fee Transmittal Form <input type="checkbox"/> Fee Attached <input type="checkbox"/> Amendment/Reply <input type="checkbox"/> After Final <input type="checkbox"/> Affidavits/declaration(s) <input type="checkbox"/> Extension of Time Request <input type="checkbox"/> Express Abandonment Request <input type="checkbox"/> Information Disclosure Statement  <input type="checkbox"/> Certified Copy of Priority Document(s) <input type="checkbox"/> Reply to Missing Parts/ Incomplete Application <input type="checkbox"/> Reply to Missing Parts under 37 CFR 1.52 or 1.53	<input type="checkbox"/> Drawing(s) <input type="checkbox"/> Licensing-related Papers <input type="checkbox"/> Petition <input type="checkbox"/> Petition to Convert to a Provisional Application <input type="checkbox"/> Power of Attorney, Revocation <input type="checkbox"/> Change of Correspondence Address <input type="checkbox"/> Terminal Disclaimer <input type="checkbox"/> Request for Refund <input type="checkbox"/> CD, Number of CD(s) _____ <input type="checkbox"/> Landscape Table on CD	<input type="checkbox"/> After Allowance Communication to TC <input type="checkbox"/> Appeal Communication to Board of Appeals and Interferences <input type="checkbox"/> Appeal Communication to TC (Appeal Notice, Brief, Reply Brief) <input type="checkbox"/> Proprietary Information <input type="checkbox"/> Status Letter <input checked="" type="checkbox"/> Other Enclosure(s) (please identify below):
Remarks 1. Request for Reapplication of Issue Fee; and 2. Copy of Previously Submitted Part-B Fee Transmittal; and 3. Copy of Previously Submitted check for Issue/Publication fees.		

SIGNATURE OF APPLICANT, ATTORNEY, OR AGENT			
Firm Name	Kaliko & Yeager, L.L.C.		
Signature			
Printed name	Scott H. Kaliko, Esq.		
Date	June 26, 2007	Reg. No.	45,786

CERTIFICATE OF TRANSMISSION/MAILING			
I hereby certify that this correspondence is being facsimile transmitted to the USPTO or deposited with the United States Postal Service with sufficient postage as first class mail in an envelope addressed to: Commissioner for Patents, P.O. Box 1450, Alexandria, VA 22313-1450 on the date shown below:			
Signature			
Typed or printed name	Scott H. Kaliko, Esq.	Date	June 26, 2007

This collection of information is required by 37 CFR 1.5. The information is required to obtain or retain a benefit by the public which is to file (and by the USPTO to process) an application. Confidentiality is governed by 35 U.S.C. 122 and 37 CFR 1.11 and 1.14. This collection is estimated to 2 hours to complete, including gathering, preparing, and submitting the completed application form to the USPTO. Time will vary depending upon the individual case. Any comments on the amount of time you require to complete this form and/or suggestions for reducing this burden, should be sent to the Chief Information Officer, U.S. Patent and Trademark Office, U.S. Department of Commerce, P.O. Box 1450, Alexandria, VA 22313-1450. DO NOT SEND FEES OR COMPLETED FORMS TO THIS ADDRESS. SEND TO: Commissioner for Patents, P.O. Box 1450, Alexandria, VA 22313-1450.

If you need assistance in completing the form, call 1-800-PTO-9199 and select option 2.

PART B - FEE(S) TRANSMITTAL

RECEIVED  
CENTRAL FAX CENTER

Complete and send this form, together with applicable fee(s), to: **Mail** Mail Stop ISSUE FEE  
Commissioner for Patents  
P.O. Box 1450  
Alexandria, Virginia 22313-1450  
or **Fax** (571)-273-2885

JUN 26 2007

INSTRUCTIONS: This form should be used for transmitting the ISSUE FEE and PUBLICATION FEE (if required). Blocks 1 through 5 should be completed where appropriate. All further correspondence including the Patent, advance orders and notification of maintenance fees will be mailed to the current correspondence address as indicated unless corrected below or directed otherwise in Block 1, by (a) specifying a new correspondence address; and/or (b) indicating a separate "FEE ADDRESS" for maintenance fee notifications.

CURRENT CORRESPONDENCE ADDRESS (Note: Use Block 1 for any change of address)

Note: A certificate of mailing can only be used for domestic mailings of the Fee(s) Transmittal. This certificate cannot be used for any other accompanying papers. Each additional paper, such as an assignment or formal drawing, must have its own certificate of mailing or transmission.

39550 7590 06/18/2007

KALIKO & YEAGER, L.L.C.  
500 NORTH FRANKLIN TURNPIKE  
RAMSEY, NJ 07446

Certificate of Mailing or Transmission  
I hereby certify that this Fee(s) Transmittal is being deposited with the United States Postal Service with sufficient postage for first class mail in an envelope addressed to the Mail Stop ISSUE FEE address above, or being facsimile transmitted to the USPTO (571) 273-2885, on the date indicated below.

Mandy Ellis (Depositor's name)  
*Mandy Ellis* (Signature)  
6/26/07 (Date)

APPLICATION NO.	FILING DATE	FIRST NAMED INVENTOR	ATTORNEY DOCKET NO.	CONFIRMATION NO.
10/223,200	08/16/2002	Michael E. Shanahan	MES/001CON	8026

TITLE OF INVENTION: METHODS AND APPARATUSES FOR PROGRAMMING USER-DEFINED INFORMATION INTO ELECTRONIC DEVICES

APPLN. TYPE	SMALL ENTITY	ISSUE FEE DUE	PUBLICATION FEE DUE	PREV. PAID ISSUE FEE	TOTAL FEE(S) DUE	DATE DUE
nonprovisional	YES	\$700	\$0	\$700	\$700	09/18/2007

EXAMINER	ART UNIT	CLASS-SUBCLASS
TRAN, CONGVAN	2617	455-418000

1. Change of correspondence address or indication of "Fee Address" (37 CFR 1.363). <input type="checkbox"/> Change of correspondence address (or Change of Correspondence Address form PTO/SB/122) attached. <input type="checkbox"/> "Fee Address" indication (or "Fee Address" Indication form PTO/SB/47; Rev 03-02 or more recent) attached. Use of a Customer Number is required.	2. For printing on the patent front page, list (1) the names of up to 3 registered patent attorneys or agents OR, alternatively, (2) the name of a single firm (having as a member a registered attorney or agent) and the names of up to 2 registered patent attorneys or agents. If no name is listed, no name will be printed.	1 Kaliko & Yeager 2 Scott H. Kaliko 3
---------------------------------------------------------------------------------------------------------------------------------------------------------------------------------------------------------------------------------------------------------------------------------------------------------------------------------------------------------------------------------------------	-----------------------------------------------------------------------------------------------------------------------------------------------------------------------------------------------------------------------------------------------------------------------------------------------------------------------------------------	---------------------------------------------

3. ASSIGNEE NAME AND RESIDENCE DATA TO BE PRINTED ON THE PATENT (print or type)  
PLEASE NOTE: Unless an assignee is identified below, no assignee data will appear on the patent. If an assignee is identified below, the document has been filed for recordation as set forth in 37 CFR 3.11. Completion of this form is NOT a substitute for filing an assignment.  
(A) NAME OF ASSIGNEE (B) RESIDENCE: (CITY and STATE OR COUNTRY)

Please check the appropriate assignee category or categories (will not be printed on the patent):  Individual  Corporation or other private group entity  Government

4a. The following fee(s) are submitted:  
 Issue Fee  
 Publication Fee (No small entity discount permitted)  
 Advance Order - # of Copies \_\_\_\_\_  
4b. Payment of Fee(s): (Please first reapply any previously paid issue fee shown above)  
 A check is enclosed.  
 Payment by credit card. Form PTO-2038 is attached.  
 The Director is hereby authorized to charge the required fee(s), any deficiency, or credit any overpayment, to Deposit Account Number \_\_\_\_\_ (enclose an extra copy of this form).

5. Change in Entity Status (from status indicated above)  
 a. Applicant claims SMALL ENTITY status. See 37 CFR 1.27.  b. Applicant is no longer claiming SMALL ENTITY status. See 37 CFR 1.27(g)(2).

NOTE: The Issue Fee and Publication Fee (if required) will not be accepted from anyone other than the applicant; a registered attorney or agent; or the assignee or other party in interest as shown by the records of the United States Patent and Trademark Office.

Authorized Signature: *Scott H. Kaliko* Date: 6/26/07  
Typed or printed name: Scott H. Kaliko Registration No. 45,786

This collection of information is required by 37 CFR 1.311. The information is required to obtain or retain a benefit by the public which is to file (and by the USPTO to process) an application. Confidentiality is governed by 35 U.S.C. 122 and 37 CFR 1.14. This collection is estimated to take 12 minutes to complete, including gathering, preparing, and submitting the completed application form to the USPTO. Time will vary depending upon the individual case. Any comments on the amount of time you require to complete this form and/or suggestions for reducing this burden, should be sent to the Chief Information Officer, U.S. Patent and Trademark Office, U.S. Department of Commerce, P.O. Box 1450, Alexandria, Virginia 22313-1450. DO NOT SEND FEES OR COMPLETED FORMS TO THIS ADDRESS. SEND TO: Commissioner for Patents, P.O. Box 1450, Alexandria, Virginia 22313-1450.

Under the Paperwork Reduction Act of 1995, no persons are required to respond to a collection of information unless it displays a valid OMB control number.

PATENT  
MES/001 CONRECEIVED  
CENTRAL FAX CENTER

JUN 26 2007

## IN THE UNITED STATES PATENT AND TRADEMARK OFFICE

Applicant : Michael E. Shanahan

Serial No. : 10/223,200 Confirmation No.: 8026

Filed : August 16, 2002

Title : METHODS AND APPARATUSES FOR PROGRAMMING  
USER-DEFINED INFORMATION INTO ELECTRONIC  
DEVICES.

Examiner : ConVan Tran

Group Art Unit : 2617

Commissioner for Patents  
P.O. Box 1450  
Alexandria, VA 22213-1450

REQUEST FOR REAPPLICATION OF ISSUE FEE

Pursuant to the Notice of Allowance mailed on January 24, 2006. A check made payable to the Commissioner for Patents in the amount of \$1000.00 was sent on February 10, 2006 for the Publication fee and the Issue fee for the above-identified patent application. I have enclosed a copy of this check along with a copy of the Fee Transmittal that was sent to the United States Patent and Trademark Office on February 10, 2006. Applicant respectfully requests that the previously paid Issue fee be reapplied to the June 18, 2007 Notice of Allowance.

PATENT  
MES/001 CON

Respectfully submitted,

6/26/07  
Date



Scott H. Kaliko  
Attorney for Applicant  
Registration No. 45,786  
KALIKO & YEAGER, L.L.C.  
500 North Franklin Turnpike  
Ramsey, NJ 07446  
Direct: 201-831-0575  
Fax: 201-831-0519

Complete and send this form, together with applicable fee(s), to: Mail

Mail Stop ISSUE FEE  
Commissioner for Patents  
P.O. Box 1450  
Alexandria, Virginia 22313-1450  
or Fax (571) 273-2885

RECEIVED  
CENTRAL FAX CENTER

JUN 26 2007

INSTRUCTIONS: This form should be used for transmitting the ISSUE FEE and PUBLICATION FEE (if required). Blocks 1 through 3 should be completed where appropriate. All further correspondence including the Patent, advance orders and notification of maintenance fees will be mailed to the current correspondence address as indicated unless corrected below or directed otherwise in Block 1, by (a) specifying a new correspondence address; and/or (b) indicating a separate "FEE ADDRESS" for maintenance fee notification.

CURRENT CORRESPONDENCE ADDRESS (Notes Use Block 1 for any change of address)

39550 7590 01/24/2006

KALIKO & YEAGER, L.L.C.  
500 NORTH FRANKLIN TURNPIKE  
RAMSBY, NJ 07446

Note: A certificate of mailing can only be used for domestic mailings of the Fee(s) Transmittal. This certificate cannot be used for any other accompanying papers. Each additional paper, such as an assignment or formal drawing, must have its own certificate of mailing or transmittal.

Certificate of Mailing or Transmittal  
I hereby certify that this Fee(s) Transmittal is being deposited with the United States Postal Service with sufficient postage for first class mail in an envelope addressed to the Mail Stop ISSUE FEE address above, or being facsimile transmitted to the USPTO (571) 273-2885, on the date indicated below.

Elizabeth Marcus (Deponent's name)  
Elizabeth Marcus (Signature)  
February 10, 2006 (Date)

APPLICATION NO.	FILING DATE	FIRST NAMED INVENTOR	ATTORNEY-DOCKET NO.	CONFIRMATION NO.
10/23,200	08/16/2002	Michael E. Shanahan	MES/DOICON	8026

TITLE OF INVENTION: METHODS AND APPARATUS FOR PROGRAMMING USER-DEFINED INFORMATION INTO ELECTRONIC DEVICES

APPL. TYPE	SMALL ENTITY	ISSUE FEE	PUBLICATION FEE	TOTAL FEE(S) DUE	DATE DUE
nonprovisional	YES	\$700	\$300	\$1000	04/24/2006

EXAMINER	ART UNIT	CLASS-SUBCLASS
TRAN, CONGVAN	2658	455-418000

1. Change of correspondence address or indication of "Fee Address" (37 CFR 1.363).
- Change of correspondence address (or Change of Correspondence Address form PTO/SQ/122) attached.
  - "Fee Address" indication (or "Fee Address" Indication form PTO/SQ/47; Rev 03-02 or more recent) attached. Use of a Customer Number is required.
2. For printing on the patent front page, list
- (1) the names of up to 3 registered patent attorneys or agents OR, alternatively,
  - (2) the name of a single firm (having as a member a registered attorney or agent) and the names of up to 2 registered patent attorneys or agents. If no name is listed, no name will be printed.
- Kaliko & Yeager, LLC  
Scott H. Kaliko  
1

3. ASSIGNEE NAME AND RESIDENCE DATA TO BE PRINTED ON THE PATENT (print or type)  
PLEASE NOTE: Unless an assignee is identified below, no assignee data will appear on the patent. If an assignee is identified below, the document has been filed for recordation as set forth in 37 CFR 3.11. Completion of this form is NOT a substitute for filing an assignment.

(A) NAME OF ASSIGNEE

(B) RESIDENCE: (CITY and STATE OR COUNTRY)

Please check the appropriate assignee category or categories (will not be printed on the patent):  Individual  Corporation or other private group entity  Government

4a. The following fee(s) are enclosed:

- Issue Fee
- Publication Fee (No small entity discount permitted)
- Advance Order - # of Copies \_\_\_\_\_

4b. Payment of Fee(s):

- A check in the amount of the fee(s) is enclosed.
- Payment by credit card. Form PTO-2038 is attached.
- The Director is hereby authorized by charge the required fee(s), or credit any overpayment, to Deposit Account Number \_\_\_\_\_ (enclose an extra copy of this form).

5. Change in Entity Status (from status indicated above)

- a. Applicant claims SMALL ENTITY status. See 37 CFR 1.27.
- b. Applicant is no longer claiming SMALL ENTITY status. See 37 CFR 1.27(g)(2).

The Director of the USPTO is requested to apply the Issue Fee and Publication Fee (if any) or to re-apply any previously paid issue fee to the application identified above.  
NOTE: The Issue Fee and Publication Fee (if required) will not be accepted from anyone other than the applicant, a registered attorney or agent, or the assignee or other party in interest as shown by the records of the United States Patent and Trademark Office.

Authorized Signature

Date February 10, 2006

Typed or printed name

Scott H. Kaliko

Registration No. 45,786

This collection of information is required by 37 CFR 1.111. The information is required to obtain or retain a benefit by the public which is to file (and by the USPTO to process) an application. Confidentiality is governed by 35 U.S.C. 122 and 37 CFR 1.14. This collection is estimated to take 12 minutes to complete, including gathering, preparing, and submitting the completed application form to the USPTO. Time will vary depending upon the individual case. Any comments on the amount of time you require to complete this form and/or suggestions for reducing this burden, should be sent to the Chief Information Officer, U.S. Patent and Trademark Office, U.S. Department of Commerce, P.O. Box 1450, Alexandria, Virginia 22313-1450. DO NOT SEND FEES OR COMPLETED FORMS TO THIS ADDRESS. SEND TO: Commissioner for Patents, P.O. Box 1450, Alexandria, Virginia 22313-1450.

Under the Paperwork Reduction Act of 1993, no persons are required to respond to a collection of information unless it displays a valid OMB control number.



NOTICE OF ALLOWANCE AND FEE(S) DUE

39550 7590 06/18/2007

KALIKO & YEAGER, L.L.C.
500 NORTH FRANKLIN TURNPIKE
RAMSEY, NJ 07446

EXAMINER
TRAN, CONGVAN
ART UNIT PAPER NUMBER

2617

DATE MAILED: 06/18/2007

Table with 5 columns: APPLICATION NO., FILING DATE, FIRST NAMED INVENTOR, ATTORNEY DOCKET NO., CONFIRMATION NO.

10/223,200 08/16/2002 Michael E. Shanahan MES/001CON 8026

TITLE OF INVENTION: METHODS AND APPARATUSES FOR PROGRAMMING USER-DEFINED INFORMATION INTO ELECTRONIC DEVICES

Table with 7 columns: APPLN. TYPE, SMALL ENTITY, ISSUE FEE DUE, PUBLICATION FEE DUE, PREV. PAID ISSUE FEE, TOTAL FEE(S) DUE, DATE DUE

nonprovisional YES \$700 \$0 \$700 \$700 09/18/2007

THE APPLICATION IDENTIFIED ABOVE HAS BEEN EXAMINED AND IS ALLOWED FOR ISSUANCE AS A PATENT. PROSECUTION ON THE MERITS IS CLOSED. THIS NOTICE OF ALLOWANCE IS NOT A GRANT OF PATENT RIGHTS. THIS APPLICATION IS SUBJECT TO WITHDRAWAL FROM ISSUE AT THE INITIATIVE OF THE OFFICE OR UPON PETITION BY THE APPLICANT. SEE 37 CFR 1.313 AND MPEP 1308.

THE ISSUE FEE AND PUBLICATION FEE (IF REQUIRED) MUST BE PAID WITHIN THREE MONTHS FROM THE MAILING DATE OF THIS NOTICE OR THIS APPLICATION SHALL BE REGARDED AS ABANDONED. THIS STATUTORY PERIOD CANNOT BE EXTENDED. SEE 35 U.S.C. 151. THE ISSUE FEE DUE INDICATED ABOVE DOES NOT REFLECT A CREDIT FOR ANY PREVIOUSLY PAID ISSUE FEE IN THIS APPLICATION. IF AN ISSUE FEE HAS PREVIOUSLY BEEN PAID IN THIS APPLICATION (AS SHOWN ABOVE), THE RETURN OF PART B OF THIS FORM WILL BE CONSIDERED A REQUEST TO REAPPLY THE PREVIOUSLY PAID ISSUE FEE TOWARD THE ISSUE FEE NOW DUE.

HOW TO REPLY TO THIS NOTICE:

I. Review the SMALL ENTITY status shown above.

If the SMALL ENTITY is shown as YES, verify your current SMALL ENTITY status:

- A. If the status is the same, pay the TOTAL FEE(S) DUE shown above.
B. If the status above is to be removed, check box 5b on Part B - Fee(s) Transmittal and pay the PUBLICATION FEE (if required) and twice the amount of the ISSUE FEE shown above, or

If the SMALL ENTITY is shown as NO:

- A. Pay TOTAL FEE(S) DUE shown above, or
B. If applicant claimed SMALL ENTITY status before, or is now claiming SMALL ENTITY status, check box 5a on Part B - Fee(s) Transmittal and pay the PUBLICATION FEE (if required) and 1/2 the ISSUE FEE shown above.

II. PART B - FEE(S) TRANSMITTAL, or its equivalent, must be completed and returned to the United States Patent and Trademark Office (USPTO) with your ISSUE FEE and PUBLICATION FEE (if required). If you are charging the fee(s) to your deposit account, section "4b" of Part B - Fee(s) Transmittal should be completed and an extra copy of the form should be submitted. If an equivalent of Part B is filed, a request to reapply a previously paid issue fee must be clearly made, and delays in processing may occur due to the difficulty in recognizing the paper as an equivalent of Part B.

III. All communications regarding this application must give the application number. Please direct all communications prior to issuance to Mail Stop ISSUE FEE unless advised to the contrary.

IMPORTANT REMINDER: Utility patents issuing on applications filed on or after Dec. 12, 1980 may require payment of maintenance fees. It is patentee's responsibility to ensure timely payment of maintenance fees when due.



**PART B - FEE(S) TRANSMITTAL**

Complete and send this form, together with applicable fee(s), to: **Mail** Mail Stop ISSUE FEE  
**Commissioner for Patents**  
**P.O. Box 1450**  
**Alexandria, Virginia 22313-1450**  
 or **Fax** (571)-273-2885

**INSTRUCTIONS:** This form should be used for transmitting the ISSUE FEE and PUBLICATION FEE (if required). Blocks 1 through 5 should be completed where appropriate. All further correspondence including the Patent, advance orders and notification of maintenance fees will be mailed to the current correspondence address as indicated unless corrected below or directed otherwise in Block 1, by (a) specifying a new correspondence address; and/or (b) indicating a separate "FEE ADDRESS" for maintenance fee notifications.

CURRENT CORRESPONDENCE ADDRESS (Note: Use Block 1 for any change of address)

Note: A certificate of mailing can only be used for domestic mailings of the Fee(s) Transmittal. This certificate cannot be used for any other accompanying papers. Each additional paper, such as an assignment or formal drawing, must have its own certificate of mailing or transmission.

**Certificate of Mailing or Transmission**

I hereby certify that this Fee(s) Transmittal is being deposited with the United States Postal Service with sufficient postage for first class mail in an envelope addressed to the Mail Stop ISSUE FEE address above, or being facsimile transmitted to the USPTO (571) 273-2885, on the date indicated below.

39550                      7590                      06/18/2007  
**KALIKO & YEAGER, L.L.C.**  
**500 NORTH FRANKLIN TURNPIKE**  
**RAMSEY, NJ 07446**

(Depositor's name)
(Signature)
(Date)

APPLICATION NO.	FILING DATE	FIRST NAMED INVENTOR	ATTORNEY DOCKET NO.	CONFIRMATION NO.
-----------------	-------------	----------------------	---------------------	------------------

10/223,200                      08/16/2002                      Michael E. Shanahan                      MES/001CON                      8026

**TITLE OF INVENTION: METHODS AND APPARATUSES FOR PROGRAMMING USER-DEFINED INFORMATION INTO ELECTRONIC DEVICES**

APPLN. TYPE	SMALL ENTITY	ISSUE FEE DUE	PUBLICATION FEE DUE	PREV. PAID ISSUE FEE	TOTAL FEE(S) DUE	DATE DUE
-------------	--------------	---------------	---------------------	----------------------	------------------	----------

nonprovisional                      YES                      \$700                      \$0                      \$700                      \$700                      09/18/2007

EXAMINER	ART UNIT	CLASS-SUBCLASS
----------	----------	----------------

TRAN, CONGVAN                      2617                      455-418000

<p>1. Change of correspondence address or indication of "Fee Address" (37 CFR 1.363).</p> <p><input type="checkbox"/> Change of correspondence address (or Change of Correspondence Address form PTO/SB/122) attached.</p> <p><input type="checkbox"/> "Fee Address" indication (or "Fee Address" Indication form PTO/SB/47; Rev 03-02 or more recent) attached. Use of a Customer Number is required.</p>	<p>2. For printing on the patent front page, list</p> <p>(1) the names of up to 3 registered patent attorneys or agents OR, alternatively, _____ 1</p> <p>(2) the name of a single firm (having as a member a registered attorney or agent) and the names of up to 2 registered patent attorneys or agents. If no name is listed, no name will be printed. _____ 2</p> <p>_____ 3</p>
------------------------------------------------------------------------------------------------------------------------------------------------------------------------------------------------------------------------------------------------------------------------------------------------------------------------------------------------------------------------------------------------------------	---------------------------------------------------------------------------------------------------------------------------------------------------------------------------------------------------------------------------------------------------------------------------------------------------------------------------------------------------------------------------------------

3. ASSIGNEE NAME AND RESIDENCE DATA TO BE PRINTED ON THE PATENT (print or type)

PLEASE NOTE: Unless an assignee is identified below, no assignee data will appear on the patent. If an assignee is identified below, the document has been filed for recordation as set forth in 37 CFR 3.11. Completion of this form is NOT a substitute for filing an assignment.

(A) NAME OF ASSIGNEE \_\_\_\_\_ (B) RESIDENCE: (CITY and STATE OR COUNTRY) \_\_\_\_\_

Please check the appropriate assignee category or categories (will not be printed on the patent) :     Individual     Corporation or other private group entity     Government

<p>4a. The following fee(s) are submitted:</p> <p><input type="checkbox"/> Issue Fee</p> <p><input type="checkbox"/> Publication Fee (No small entity discount permitted)</p> <p><input type="checkbox"/> Advance Order - # of Copies _____</p>	<p>4b. Payment of Fee(s): (Please first reapply any previously paid issue fee shown above)</p> <p><input type="checkbox"/> A check is enclosed.</p> <p><input type="checkbox"/> Payment by credit card. Form PTO-2038 is attached.</p> <p><input type="checkbox"/> The Director is hereby authorized to charge the required fee(s), any deficiency, or credit any overpayment, to Deposit Account Number _____ (enclose an extra copy of this form).</p>
-------------------------------------------------------------------------------------------------------------------------------------------------------------------------------------------------------------------------------------------------	----------------------------------------------------------------------------------------------------------------------------------------------------------------------------------------------------------------------------------------------------------------------------------------------------------------------------------------------------------------------------------------------------------------------------------------------------------

5. Change in Entity Status (from status indicated above)

a. Applicant claims SMALL ENTITY status. See 37 CFR 1.27.     b. Applicant is no longer claiming SMALL ENTITY status. See 37 CFR 1.27(g)(2).

NOTE: The Issue Fee and Publication Fee (if required) will not be accepted from anyone other than the applicant; a registered attorney or agent; or the assignee or other party in interest as shown by the records of the United States Patent and Trademark Office.

Authorized Signature \_\_\_\_\_ Date \_\_\_\_\_

Typed or printed name \_\_\_\_\_ Registration No. \_\_\_\_\_

This collection of information is required by 37 CFR 1.311. The information is required to obtain or retain a benefit by the public which is to file (and by the USPTO to process) an application. Confidentiality is governed by 35 U.S.C. 122 and 37 CFR 1.14. This collection is estimated to take 12 minutes to complete, including gathering, preparing, and submitting the completed application form to the USPTO. Time will vary depending upon the individual case. Any comments on the amount of time you require to complete this form and/or suggestions for reducing this burden, should be sent to the Chief Information Officer, U.S. Patent and Trademark Office, U.S. Department of Commerce, P.O. Box 1450, Alexandria, Virginia 22313-1450. DO NOT SEND FEES OR COMPLETED FORMS TO THIS ADDRESS. SEND TO: Commissioner for Patents, P.O. Box 1450, Alexandria, Virginia 22313-1450.

Under the Paperwork Reduction Act of 1995, no persons are required to respond to a collection of information unless it displays a valid OMB control number.



UNITED STATES PATENT AND TRADEMARK OFFICE

UNITED STATES DEPARTMENT OF COMMERCE
United States Patent and Trademark Office
Address: COMMISSIONER FOR PATENTS
P.O. Box 1450
Alexandria, Virginia 22313-1450
www.uspto.gov

Table with columns: APPLICATION NO., FILING DATE, FIRST NAMED INVENTOR, ATTORNEY DOCKET NO., CONFIRMATION NO.
10/223,200 08/16/2002 Michael E. Shanahan MES/001 CON 8026
39550 7590 06/18/2007
KALIKO & YEAGER, L.L.C.
500 NORTH FRANKLIN TURNPIKE
RAMSEY, NJ 07446
EXAMINER
TRAN, CONGVAN
ART UNIT 2617 PAPER NUMBER
DATE MAILED: 06/18/2007

Determination of Patent Term Adjustment under 35 U.S.C. 154 (b)
(application filed on or after May 29, 2000)

The Patent Term Adjustment to date is 323 day(s). If the issue fee is paid on the date that is three months after the mailing date of this notice and the patent issues on the Tuesday before the date that is 28 weeks (six and a half months) after the mailing date of this notice, the Patent Term Adjustment will be 323 day(s).

If a Continued Prosecution Application (CPA) was filed in the above-identified application, the filing date that determines Patent Term Adjustment is the filing date of the most recent CPA.

Applicant will be able to obtain more detailed information by accessing the Patent Application Information Retrieval (PAIR) WEB site (http://pair.uspto.gov).

Any questions regarding the Patent Term Extension or Adjustment determination should be directed to the Office of Patent Legal Administration at (571)-272-7702. Questions relating to issue and publication fee payments should be directed to the Customer Service Center of the Office of Patent Publication at 1-(888)-786-0101 or (571)-272-4200.

**Notice of Allowability**

<b>Application No.</b> 10/223,200	<b>Applicant(s)</b> SHANAHAN, MICHAEL E.	
<b>Examiner</b> CongVan Tran	<b>Art Unit</b> 2617	

-- The MAILING DATE of this communication appears on the cover sheet with the correspondence address--

All claims being allowable, PROSECUTION ON THE MERITS IS (OR REMAINS) CLOSED in this application. If not included herewith (or previously mailed), a Notice of Allowance (PTOL-85) or other appropriate communication will be mailed in due course. **THIS NOTICE OF ALLOWABILITY IS NOT A GRANT OF PATENT RIGHTS.** This application is subject to withdrawal from issue at the initiative of the Office or upon petition by the applicant. See 37 CFR 1.313 and MPEP 1308.

- 1.  This communication is responsive to 3/19/07.
- 2.  The allowed claim(s) is/are 33-49, 68-71, and 74-98 have been renumbered to 1-9, 14-21, 10-13, 22-26, 30-33, 27-29, 34-46 respectively.
- 3.  Acknowledgment is made of a claim for foreign priority under 35 U.S.C. § 119(a)-(d) or (f).
  - a)  All    b)  Some\*    c)  None    of the:
    - 1.  Certified copies of the priority documents have been received.
    - 2.  Certified copies of the priority documents have been received in Application No. \_\_\_\_\_.
    - 3.  Copies of the certified copies of the priority documents have been received in this national stage application from the International Bureau (PCT Rule 17.2(a)).
  - \* Certified copies not received: \_\_\_\_\_.

Applicant has THREE MONTHS FROM THE "MAILING DATE" of this communication to file a reply complying with the requirements noted below. Failure to timely comply will result in ABANDONMENT of this application. **THIS THREE-MONTH PERIOD IS NOT EXTENDABLE.**

- 4.  A SUBSTITUTE OATH OR DECLARATION must be submitted. Note the attached EXAMINER'S AMENDMENT or NOTICE OF INFORMAL PATENT APPLICATION (PTO-152) which gives reason(s) why the oath or declaration is deficient.
  - 5.  CORRECTED DRAWINGS ( as "replacement sheets") must be submitted.
    - (a)  including changes required by the Notice of Draftsperson's Patent Drawing Review ( PTO-948) attached
      - 1)  hereto or 2)  to Paper No./Mail Date \_\_\_\_\_.
    - (b)  including changes required by the attached Examiner's Amendment / Comment or in the Office action of Paper No./Mail Date \_\_\_\_\_.
- Identifying indicia such as the application number (see 37 CFR 1.84(c)) should be written on the drawings in the front (not the back) of each sheet. Replacement sheet(s) should be labeled as such in the header according to 37 CFR 1.121(d).
- 6.  DEPOSIT OF and/or INFORMATION about the deposit of BIOLOGICAL MATERIAL must be submitted. Note the attached Examiner's comment regarding REQUIREMENT FOR THE DEPOSIT OF BIOLOGICAL MATERIAL.

**Attachment(s)**

- 1.  Notice of References Cited (PTO-892)
- 2.  Notice of Draftsperson's Patent Drawing Review (PTO-948)
- 3.  Information Disclosure Statements (PTO/SB/08),  
Paper No./Mail Date \_\_\_\_\_
- 4.  Examiner's Comment Regarding Requirement for Deposit of Biological Material
- 5.  Notice of Informal Patent Application
- 6.  Interview Summary (PTO-413),  
Paper No./Mail Date \_\_\_\_\_
- 7.  Examiner's Amendment/Comment
- 8.  Examiner's Statement of Reasons for Allowance
- 9.  Other \_\_\_\_\_

**CONGVAN TRAN**  
**PRIMARY EXAMINER**

CongVan Tran  
Primary Examiner  
Art Unit: 2617

MAR 19 2007

PTO/SS/08A (08-08)

Approved for use through 03/31/2007. OMB 0851-0031

U.S. Patent and Trademark Office: U.S. DEPARTMENT OF COMMERCE

Under the Paperwork Reduction Act of 1995, no persons are required to respond to a collection of information unless it contains a valid OMB control number.

Substitute for form 1448/PTO  <b>INFORMATION DISCLOSURE STATEMENT BY APPLICANT</b> <i>(Use as many sheets as necessary)</i>	<b>Complete if Known</b>	
	Application Number	10/223,200
	Filing Date	August 16, 2002
	First Named Inventor	Michael E. Shanahan
	Art Unit	2817
Examiner Name	Congvan Tran	
Attorney Docket Number	MES/001 CON	
Sheet 1 of 1		

U. S. PATENT DOCUMENTS					
Examiner Initials*	Cite No. <sup>1</sup>	Document Number	Publication Date MM-DD-YYYY	Name of Patentee or Applicant of Cited Document	Pages, Columns, Lines, Where Relevant Passages or Relevant Figures Appear
		Number-Kind Code <sup>2</sup> (if known)			
/CTA		US- 7,088,990	08-08-2008	Isomursu, et al	
		US-			
		US-			
		US-			
		US-			
		US-			
		US-			
		US-			
		US-			
		US-			
		US-			
		US-			
		US-			
		US-			
		US-			
		US-			
		US-			
		US-			
		US-			
		US-			
		US-			
		US-			

FOREIGN PATENT DOCUMENTS						
Examiner Initials*	Cite No.	Foreign Patent Document	Publication Date MM-DD-YYYY	Name of Patentee or Applicant of Cited Document	Pages, Columns, Lines, Where Relevant Passages Or Relevant Figures Appear	7 <sup>o</sup>
		Country Code <sup>1</sup> Number <sup>1</sup> Kind Code <sup>1</sup> (if known)				

Examiner Signature	CongVan Tran 	Date Considered	06/11/2007
--------------------	--------------------------------------------------------------------------------------------------	-----------------	------------

\*EXAMINER: Initial if reference considered, whether or not citation is in conformance with MPEP 608. Draw line through citation if not in conformance and not considered. Include copy of this form with next communication to applicant. <sup>1</sup> Applicant's unique citation designation number (optional). <sup>2</sup> See Kind Code of USPTO Patent Documents at [www.uspto.gov](http://www.uspto.gov) or MPEP 901.04. <sup>3</sup> Enter Office that issued the document, by the two-letter code (WIPO Standard ST.3). <sup>4</sup> For Japanese patent documents, the indication of the year of the reign of the Emperor must precede the serial number of the patent document. <sup>5</sup> Kind of document by the appropriate symbols as indicated on the document under WIPO Standard ST.16 if possible. <sup>6</sup> Applicant is to place a check mark here if English language translation is attached.

This collection of information is required by 37 CFR 1.97 and 1.98. The information is required to obtain or retain a benefit by the public which is to file (and by the USPTO to process) an application. Confidentiality is governed by 35 U.S.C. 122 and 37 CFR 1.14. This collection is estimated to take 2 hours to complete, including gathering, preparing, and submitting the completed application form to the USPTO. Time will vary depending upon the individual case. Any comments on the amount of time you require to complete this form and/or suggestions for reducing this burden, should be sent to the Chief Information Officer, U.S. Patent and Trademark Office, P.O. Box 1450, Alexandria, VA 22313-1450. DO NOT SEND FEES OR COMPLETED FORMS TO THIS ADDRESS. SEND TO: Commissioner for Patents, P.O. Box 1450, Alexandria, VA 22313-1450.

If you need assistance in completing the form, call 1-800-PTO-9198 (1-800-786-9199) and select option 2.

RECEIVED  
CENTRAL FAX CENTER

OCT 05 2006

PTO/SB/08A (07-05)

Approved for use through 07/31/2008. OMB 0661-0031

U.S. Patent and Trademark Office: U.S. DEPARTMENT OF COMMERCE

Under the Paperwork Reduction Act of 1995, no persons are required to respond to a collection of information unless it contains a valid OMB control number.

Substitute for form 1449/PTO		<b>Complete if Known</b>	
<b>INFORMATION DISCLOSURE STATEMENT BY APPLICANT</b> <i>(Use as many sheets as necessary)</i>		Application Number	10/223,200
		Filing Date	August 16, 2002
		First Named Inventor	Michael E. Shanahan
		Art Unit	2617
		Examiner Name	Congvan Tran
		Attorney Docket Number	MES/001 CON
Sheet 1	of 1		

U. S. PATENT DOCUMENTS					
Examiner Initials*	Cite No. <sup>1</sup>	Document Number	Publication Date MM-DD-YYYY	Name of Patentee or Applicant of Cited Document	Pages, Columns, Lines, Where Relevant Passages or Relevant Figures Appear
		Number-Kind Code <sup>2</sup> if known			
/CT/		US- 5,577,190	11-19-1996	Peters	
		US-			
		US-			
		US-			
		US-			
		US-			
		US-			
		US-			
		US-			
		US-			
		US-			
		US-			
		US-			
		US-			
		US-			
		US-			
		US-			
		US-			
		US-			
		US-			
		US-			
		US-			
		US-			

FOREIGN PATENT DOCUMENTS						
Examiner Initials*	Cite No. <sup>1</sup>	Foreign Patent Document	Publication Date MM-DD-YYYY	Name of Patentee or Applicant of Cited Document	Pages, Columns, Lines, Where Relevant Passages Or Relevant Figures Appear	T <sup>n</sup>
		Country Code <sup>2</sup> Number <sup>3</sup> Kind Code <sup>4</sup> (if known)				
/CT/		CA Office Action Copy Included	09-19-2006			

Examiner Signature	CongVan Tran 	Date Considered	06/11/2007
--------------------	--------------------------------------------------------------------------------------------------	-----------------	------------

\*EXAMINER: initial if reference considered, whether or not citation is in conformance with MPEP 609. Draw line through citation if not in conformance and not considered. Include copy of this form with next communication to applicant. <sup>1</sup> Applicant's unique citation designation number (optional). <sup>2</sup> See Kinds Codes of USPTO Patent Documents at [www.uspto.gov](http://www.uspto.gov) or MPEP 901.04. <sup>3</sup> Enter Office that issued the document, by the two-letter code (WIPO Standard ST.3). <sup>4</sup> For Japanese patent documents, the indication of the year of the reign of the Emperor must precede the serial number of the patent document. <sup>5</sup> Kind of document by the appropriate symbols as indicated on the document under WIPO Standard ST.16 if possible. <sup>6</sup> Applicant is to place a check mark here if English language translation is attached.

This collection of information is required by 37 CFR 1.97 and 1.98. The information is required to obtain or retain a benefit by the public which is to file (and by the USPTO to process) an application. Confidentiality is governed by 35 U.S.C. 122 and 37 CFR 1.14. This collection is estimated to take 2 hours to complete, including gathering, preparing, and submitting the completed application form to the USPTO. Time will vary depending upon the individual case. Any comments on the amount of time you require to complete this form and/or suggestions for reducing this burden, should be sent to the Chief Information Officer, U.S. Patent and Trademark Office, P.O. Box 1450, Alexandria, VA 22313-1450. DO NOT SEND FEES OR COMPLETED FORMS TO THIS ADDRESS. SEND TO: Commissioner for Patents, P.O. Box 1450, Alexandria, VA 22313-1450.

If you need assistance in completing the form, call 1-800-PTO-9199 (1-800-786-9199) and select option 2.

JUL 20 2006

PTO/SB/08A (07-05)

Approved for use through 07/31/2008. OMB 0891-0031

U.S. Patent and Trademark Office: U.S. DEPARTMENT OF COMMERCE

Under the Paperwork Reduction Act of 1995, no person is required to respond to a collection of information unless it contains a valid OMB control number.

Substitute for form 1448/PTO  <b>INFORMATION DISCLOSURE STATEMENT BY APPLICANT</b> (Use as many sheets as necessary)	<b>Complete if Known</b>	
	Application Number	10/223,200
	Filing Date	August 16, 2002
	First Named Inventor	Michael E. Shanahan
	Art Unit	2617
	Examiner Name	CongVan Tran
Attorney Docket Number	Mes/001 CON	
Sheet 1 of 1		

U. S. PATENT DOCUMENTS					
Examiner Initials*	Cite No. <sup>1</sup>	Document Number Number-Kind Code <sup>2, 7</sup> (if known)	Publication Date MM-DD-YYYY	Name of Patentee or Applicant of Cited Document	Pages, Columns, Lines, Where Relevant Passages or Relevant Figures Appear
/CT/	US-	6,198,941	03-06-2001	Aho et al.	
/CT/	US-	2005/0054379	03-10-2005	Cao et al.	
	US-				
	US-				
	US-				
	US-				
	US-				
	US-				
	US-				
	US-				
	US-				
	US-				
	US-				
	US-				
	US-				
	US-				
	US-				
	US-				
	US-				
	US-				


FOREIGN PATENT DOCUMENTS						
Examiner Initials*	Cite No. <sup>1</sup>	Foreign Patent Document Country Code <sup>2</sup> Number <sup>3</sup> Kind Code <sup>4</sup> (if known)	Publication Date MM-DD-YYYY	Name of Patentee or Applicant of Cited Document	Pages, Columns, Lines, Where Relevant Passages Or Relevant Figures Appear	†

Examiner Signature CongVan Tran	Date Considered 06/11/2007
------------------------------------	-------------------------------

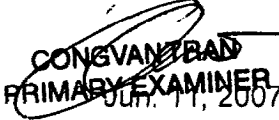
\*EXAMINER: Initial of reference cited, whether or not citation is in conformance with MPEP 809. Draw line through citation if not in conformance and not considered. Include copy of this form with next communication to applicant. † Applicant's unique citation designation number (optional). ‡ See Kinds Codes of USPTO Patent Documents at [www.uspto.gov](http://www.uspto.gov) or MPEP 901.04. ‡ Enter Office that issued the document, by the two-letter code (WIPO Standard ST.3). † For Japanese patent documents, the indication of the year of the reign of the Emperor must precede the serial number of the patent document. ‡ Kind of document by the appropriate symbols as indicated on the document under WIPO Standard ST.16 if possible. † Applicant is to place a check mark here if English language translation is attached.

This collection of information is required by 37 CFR 1.97 and 1.98. The information is required to obtain or retain a benefit by the public which is to file (and by the USPTO to process) an application. Confidentiality is governed by 35 U.S.C. 122 and 37 CFR 1.14. This collection is estimated to take 2 hours to complete, including gathering, preparing, and submitting this completed application form to the USPTO. Time will vary depending upon the individual case. Any comments on the amount of time you require to complete this form and/or suggestions for reducing this burden, should be sent to the Chief Information Officer, U.S. Patent and Trademark Office, P.O. Box 1450, Alexandria, VA 22313-1450. **DO NOT SEND FEES OR COMPLETED FORMS TO THIS ADDRESS. SEND TO: Commissioner for Patents, P.O. Box 1450, Alexandria, VA 22313-1450.**

If you need assistance in completing the form, call 1-800-PTO-9199 (1-800-786-9199) and select option 2.

<b>Issue Classification</b> 	Application/Control No.	Applicant(s)/Patent under Reexamination	
	10/223,200	SHANAHAN, MICHAEL E.	
	Examiner	Art Unit	
	CongVan Tran	2617	

ISSUE CLASSIFICATION										
ORIGINAL					CROSS REFERENCE(S)					
CLASS		SUBCLASS			CLASS	SUBCLASS (ONE SUBCLASS PER BLOCK)				
455		418			455	412.1	414.1			
INTERNATIONAL CLASSIFICATION										
H	0	4	M	3/00						
				/						
				/						
				/						
				/						

(Assistant Examiner) (Date)	 <b>CONGVAN TRAN</b> <b>PRIMARY EXAMINER</b> JUN 11, 2007	Total Claims Allowed: 46				
(Legal Instruments Examiner) (Date)	(Primary Examiner) (Date)	<table border="1" style="width: 100%;"> <tr> <td>O.G. Print Claim(s)</td> <td>O.G. Print Fig.</td> </tr> <tr> <td style="text-align: center;">1</td> <td style="text-align: center;">4A</td> </tr> </table>	O.G. Print Claim(s)	O.G. Print Fig.	1	4A
O.G. Print Claim(s)	O.G. Print Fig.					
1	4A					

<input type="checkbox"/> Claims renumbered in the same order as presented by applicant										<input type="checkbox"/> CPA		<input type="checkbox"/> T.D.		<input type="checkbox"/> R.1.47	
Final	Original	Final	Original	Final	Original	Final	Original	Final	Original	Final	Original	Final	Original	Final	Original
	1		31		61	39	91		121		151		181		211
	2		32		62	40	92		122		152		182		212
	3	1	33		63	41	93		123		153		183		213
	4	2	34		64	42	94		124		154		184		214
	5	3	35		65	43	95		125		155		185		215
	6	4	36		66	44	96		126		156		186		216
	7	5	37		67	45	97		127		157		187		217
	8	6	38	10	68	46	98		128		158		188		218
	9	7	39	11	69		99		129		159		189		219
	10	8	40	12	70		100		130		160		190		220
	11	9	41	13	71		101		131		161		191		221
	12	14	42		72		102		132		162		192		222
	13	15	43		73		103		133		163		193		223
	14	16	44	22	74		104		134		164		194		224
	15	17	45	23	75		105		135		165		195		225
	16	18	46	24	76		106		136		166		196		226
	17	19	47	25	77		107		137		167		197		227
	18	20	48	26	78		108		138		168		198		228
	19	21	49	30	79		109		139		169		199		229
	20		50	31	80		110		140		170		200		230
	21		51	32	81		111		141		171		201		231
	22		52	33	82		112		142		172		202		232
	23		53	27	83		113		143		173		203		233
	24		54	28	84		114		144		174		204		234
	25		55	29	85		115		145		175		205		235
	26		56	34	86		116		146		176		206		236
	27		57	35	87		117		147		177		207		237
	28		58	36	88		118		148		178		208		238
	29		59	37	89		119		149		179		209		239
	30		60	38	90		120		150		180		210		240



UNITED STATES PATENT AND TRADEMARK OFFICE

UNITED STATES DEPARTMENT OF COMMERCE  
 United States Patent and Trademark Office  
 Address: COMMISSIONER FOR PATENTS  
 P.O. Box 1450  
 Alexandria, Virginia 22313-1450  
 www.uspto.gov



Bib Data Sheet

CONFIRMATION NO. 8026

<b>SERIAL NUMBER</b> 10/223,200	<b>FILING OR 371(c) DATE</b> 08/16/2002 <b>RULE</b>	<b>CLASS</b> 455	<b>GROUP ART UNIT</b> 2683	<b>ATTORNEY DOCKET NO.</b> MES/001CON
------------------------------------	-----------------------------------------------------------	---------------------	-------------------------------	------------------------------------------

**APPLICANTS**  
 Michael E. Shanahan, Nyack, NY;

**\*\* CONTINUING DATA \*\*** *Yes*  
 This application is a CON of 09/518,712 03/03/2000 PAT 6,496,692 which claims benefit of 60/169,158 12/06/1999

**\*\* FOREIGN APPLICATIONS \*\*** *None*

**IF REQUIRED, FOREIGN FILING LICENSE GRANTED.. SMALL ENTITY \*\***  
**\*\* 09/23/2002**

Foreign Priority claimed 35 USC 119 (a-d) conditions met	<input type="checkbox"/> yes <input checked="" type="checkbox"/> no <input type="checkbox"/> yes <input checked="" type="checkbox"/> no <input type="checkbox"/> Met after Allowance	<b>STATE OR COUNTRY</b> NY	<b>SHEETS DRAWING</b> 13	<b>TOTAL CLAIMS</b> 15	<b>INDEPENDENT CLAIMS</b> 3
Verified and Acknowledged	Examiner's Signature <i>[Signature]</i> Initials <i>a</i>				

**ADDRESS**  
 32850

**TITLE**  
 Methods and apparatuses for programming user-defined information into electronic devices

<b>FILING FEE RECEIVED</b> 1309	FEES: Authority has been given in Paper No. _____ to charge/credit DEPOSIT ACCOUNT No. _____ for following:	<input type="checkbox"/> All Fees
		<input type="checkbox"/> 1.16 Fees ( Filing )
		<input type="checkbox"/> 1.17 Fees ( Processing Ext. of time )
		<input type="checkbox"/> 1.18 Fees ( Issue )
		<input type="checkbox"/> Other _____
		<input type="checkbox"/> Credit



**Index of Claims**



Application/Control No.

10/223,200

Examiner

CongVan Tran

Applicant(s)/Patent under Reexamination

SHANAHAN, MICHAEL E.

Art Unit

2617

√	Rejected
=	Allowed

-	(Through numeral) Cancelled
+	Restricted

N	Non-Elected
I	Interference

A	Appeal
O	Objected

Claim		Date			
Final	Original	6/11/07			
	1				
	2				
	3				
	4				
	5				
	6				
	7				
	8				
	9				
	10				
	11				
	12				
	13				
	14				
	15				
	16				
	17				
	18				
	19				
	20				
	21				
	22				
	23				
	24				
	25				
	26				
	27				
	28				
	29				
	30				
	31				
	32				
	33 =				
	34 =				
	35 =				
	36 =				
	37 =				
	38 =				
	39 =				
	40 =				
	41 =				
	42 =				
	43 =				
	44 =				
	45 =				
	46 =				
	47 =				
	48 =				
	49 =				
	50				

Claim		Date			
Final	Original				
	51				
	52				
	53				
	54				
	55				
	56				
	57				
	58				
	59				
	60				
	61				
	62				
	63				
	64				
	65				
	66				
	67				
	68 =				
	69 =				
	70 =				
	71 =				
	72				
	73				
	74 =				
	75 =				
	76 =				
	77 =				
	78 =				
	79 =				
	80 =				
	81 =				
	82 =				
	83 =				
	84 =				
	85 =				
	86 =				
	87 =				
	88 =				
	89 =				
	90 =				
	91 =				
	92 =				
	93 =				
	94 =				
	95 =				
	96 =				
	97 =				
	98 =				
	99				
	100				

Claim		Date			
Final	Original				
	101				
	102				
	103				
	104				
	105				
	106				
	107				
	108				
	109				
	110				
	111				
	112				
	113				
	114				
	115				
	116				
	117				
	118				
	119				
	120				
	121				
	122				
	123				
	124				
	125				
	126				
	127				
	128				
	129				
	130				
	131				
	132				
	133				
	134				
	135				
	136				
	137				
	138				
	139				
	140				
	141				
	142				
	143				
	144				
	145				
	146				
	147				
	148				
	149				
	150				

**Search Notes**



**Application/Control No.**

10/223,200

**Examiner**

CongVan Tran

**Applicant(s)/Patent under Reexamination**

SHANAHAN, MICHAEL E.

**Art Unit**

2617

**SEARCHED**

Class	Subclass	Date	Examiner
455	412.1	6/11/2007	CT
	414.1		
	418		
	419		
	420		
	424		
379	67.1	6/11/2007	CT
	68		

**INTERFERENCE SEARCHED**

Class	Subclass	Date	Examiner
455	412.1	6/11/2007	CT
	414.1	6/11/2007	CT

**SEARCH NOTES  
(INCLUDING SEARCH STRATEGY)**

	DATE	EXMR
Search Updated	6/11/2007	CT



**RECEIVED**  
**CENTRAL FAX CENTER**  
**MAR 19 2007**

500 North Franklin Turnpike, Ramsey, NJ 07446  
(201) 831-0575 Main Tel  
(201) 831-0519 Main Fax

**FACSIMILE TRANSMITTAL SHEET**

<b>TO:</b> Commissioner for Patents	<b>FROM:</b> Scott H. Kaliko, Esq. SENDER'S FAX NUMBER: 201-831-0519 SENDER'S TELEPHONE NUMBER: 201-831-0575
<b>COMPANY:</b> United States Patent & Trademark Office	<b>DATE:</b> MARCH 19, 2007
<b>RECIPIENT'S FAX NUMBER:</b> 571-273-8300	<b>TOTAL NO. OF PAGES INCLUDING COVER:</b> 3
<b>RECIPIENT'S TELEPHONE NUMBER:</b>	<b>CLIENT / MATTER:</b>
<b>RE:</b> Application No. 10/223,200	<b>YOUR REFERENCE NUMBER:</b> MES/001 CON

URGENT     FOR REVIEW     PLEASE COMMENT     PLEASE REPLY     PLEASE RECYCLE

NOTES/COMMENTS:

Please confirm receipt of this fax and the below-identified attached parts.

1. Transmittal Form/Certificate of Transmission; and
2. PTO Form 1449 Information Disclosure Statement.

CONFIDENTIALITY NOTICE

The information contained in this facsimile message is privileged and confidential and is intended only for the use of the individual(s) and/or entity(ies) named above. If you are not the intended recipient, you are hereby notified that any unauthorized disclosure, copying, distribution or taking of any action in reliance on the contents of the information contained herein is strictly prohibited and review by any individual other than the intended recipient shall not constitute a waiver of the attorney-client privilege. If you have received this transmission in error, please immediately notify us by telephone. Thank you.

RECEIVED  
CENTRAL FAX CENTER

MAR 19 2007

PTO/SB/21 (09-04)

Approved for use through 07/31/2008. OMB 0651-0031

U.S. Patent and Trademark Office; U.S. DEPARTMENT OF COMMERCE

Under the Paperwork Reduction Act of 1995, no person is required to respond to a collection of information unless it displays a valid OMB control number.

<b>TRANSMITTAL FORM</b>  <i>(to be used for all correspondence after initial filing)</i>	Application Number	10/223,200
	Filing Date	August 18, 2002
	First Named Inventor	Michael E. Shangan
	Art Unit	2817
	Examiner Name	Congvan Tran
	Attorney Docket Number	ME6/001 CON
Total Number of Pages in This Submission		3

ENCLOSURES <i>(Check all that apply)</i>		
<input type="checkbox"/> Fee Transmittal Form <input type="checkbox"/> Fee Attached <input type="checkbox"/> Amendment/Reply <input type="checkbox"/> After Final <input type="checkbox"/> Affidavits/declaration(s) <input type="checkbox"/> Extension of Time Request <input type="checkbox"/> Express Abandonment Request <input checked="" type="checkbox"/> Information Disclosure Statement <input type="checkbox"/> Certified Copy of Priority Document(s) <input type="checkbox"/> Reply to Missing Parts/ Incomplete Application <input type="checkbox"/> Reply to Missing Parts under 37 CFR 1.52 or 1.53	<input type="checkbox"/> Drawing(s) <input type="checkbox"/> Licensing-related Papers <input type="checkbox"/> Petition <input type="checkbox"/> Petition to Convert to a Provisional Application <input type="checkbox"/> Power of Attorney, Revocation <input type="checkbox"/> Change of Correspondence Address <input type="checkbox"/> Terminal Disclaimer <input type="checkbox"/> Request for Refund <input type="checkbox"/> CD, Number of CD(s) _____ <input type="checkbox"/> Landscape Table on CD	<input type="checkbox"/> After Allowance Communication to TC <input type="checkbox"/> Appeal Communication to Board of Appeals and Interferences <input type="checkbox"/> Appeal Communication to TC (Appeal Notice, Brief, Reply Brief) <input type="checkbox"/> Proprietary Information <input type="checkbox"/> Status Letter <input type="checkbox"/> Other Enclosure(s) (please identify below):
Remarks		

SIGNATURE OF APPLICANT, ATTORNEY, OR AGENT			
Firm Name	Kaliko & Yeager, J.L.C.		
Signature			
Printed name	Scott H. Kaliko, Esq.		
Date	March 19, 2007	Reg. No.	45,786

CERTIFICATE OF TRANSMISSION/MAILING			
I hereby certify that this correspondence is being facsimile transmitted to the USPTO or deposited with the United States Postal Service with sufficient postage as first class mail in an envelope addressed to: Commissioner for Patents, P.O. Box 1450, Alexandria, VA 22313-1450 on the date shown below:			
Signature			
Typed or printed name	Scott H. Kaliko, Esq.	Date	March 19, 2007

This collection of information is required by 37 CFR 1.5. The information is required to obtain or retain a benefit by the public which is to file (and by the USPTO to process) an application. Confidentiality is governed by 35 U.S.C. 122 and 37 CFR 1.11 and 1.14. This collection is estimated to 2 hours to complete, including gathering, preparing, and submitting the completed application form to the USPTO. Time will vary depending upon the individual case. Any comments on the amount of time you require to complete this form and/or suggestions for reducing this burden, should be sent to the Chief Information Officer, U.S. Patent and Trademark Office, U.S. Department of Commerce, P.O. Box 1450, Alexandria, VA 22313-1450. DO NOT SEND FEES OR COMPLETED FORMS TO THIS ADDRESS. SEND TO: Commissioner for Patents, P.O. Box 1450, Alexandria, VA 22313-1450.

If you need assistance in completing the form, call 1-800-PTO-9199 and select option 2.

MAR 19 2007

PTO/SB/08A (08-08)

Approved for use through 03/31/2007. OMB 0651-0031  
U.S. Patent and Trademark Office; U.S. DEPARTMENT OF COMMERCE

Under the Paperwork Reduction Act of 1995, no persons are required to respond to a collection of information unless it contains a valid OMB control number.

Substitute for form 1449/PTO

**INFORMATION DISCLOSURE  
STATEMENT BY APPLICANT**  
*(Use as many sheets as necessary)*

**Complete if Known**

Application Number	10/223,200
Filing Date	August 16, 2002
First Named Inventor	Michael E. Shanahan
Art Unit	2817
Examiner Name	Congvan Tran
Attorney Docket Number	MES/001 CON

Sheet 1 of 1

U. S. PATENT DOCUMENTS					
Examiner Initials*	Cite No. <sup>1</sup>	Document Number	Publication Date MM-DD-YYYY	Name of Patentee or Applicant of Cited Document	Pages, Columns, Lines, Where Relevant Passages or Relevant Figures Appear
		Number-Kind Code <sup>2</sup> (if known)			
		US- 7,088,990	08-08-2006	Isomursu, et al	
		US-			
		US-			
		US-			
		US-			
		US-			
		US-			
		US-			
		US-			
		US-			
		US-			
		US-			
		US-			
		US-			
		US-			
		US-			
		US-			
		US-			
		US-			
		US-			
		US-			

FOREIGN PATENT DOCUMENTS						
Examiner Initials*	Cite No. <sup>1</sup>	Foreign Patent Document	Publication Date MM-DD-YYYY	Name of Patentee or Applicant of Cited Document	Pages, Columns, Lines, Where Relevant Passages Or Relevant Figures Appear	T <sup>o</sup>
		Country Code <sup>3</sup> Number <sup>4</sup> Kind Code <sup>5</sup> (if known)				

Examiner Signature	Date Considered
--------------------	-----------------

\*EXAMINER: initial if reference considered, whether or not citation is in conformance with MPEP 809. Draw line through citation if not in conformance and not considered. Include copy of this form with next communication to applicant. <sup>1</sup> Applicant's unique citation designation number (optional). <sup>2</sup> See Kind Codes of USPTO Patent Documents at [www.uspto.gov](http://www.uspto.gov) or MPEP 901.04. <sup>3</sup> Enter Office that issued the document, by the two-letter code (WIPO Standard ST.3). <sup>4</sup> For Japanese patent documents, the indication of the year of the reign of the Emperor must precede the serial number of the patent document. <sup>5</sup> Kind of document by the appropriate symbols as indicated on the document under WIPO Standard ST.16 if possible. <sup>6</sup> Applicant is to place a check mark here if English language Translation is attached.

This collection of information is required by 37 CFR 1.97 and 1.98. The information is required to obtain or retain a benefit by the public which is to file (and by the USPTO to process) an application. Confidentiality is governed by 35 U.S.C. 122 and 37 CFR 1.14. This collection is estimated to take 2 hours to complete, including gathering, preparing, and submitting the completed application form to the USPTO. Time will vary depending upon the individual case. Any comments on the amount of time you require to complete this form and/or suggestions for reducing this burden, should be sent to the Chief Information Officer, U.S. Patent and Trademark Office, P.O. Box 1450, Alexandria, VA 22313-1450. DO NOT SEND FEES OR COMPLETED FORMS TO THIS ADDRESS. SEND TO: Commissioner for Patents, P.O. Box 1450, Alexandria, VA 22313-1450.

If you need assistance in completing the form, call 1-800-PTO-9199 (1-800-786-9199) and select option 2.

MAR 19 2007

MES/001 CON

IN THE UNITED STATES PATENT AND TRADEMARK OFFICE

Applicant : Michael E. Shanahan  
 Application No. : 10/223,200 Confirmation No.: 8026  
 Filed : August 16, 2002  
 Title : METHODS AND APPARATUSES FOR PROGRAMMING  
 USER-DEFINED INFORMATION INTO  
 ELECTRONIC DEVICES  
 Examiner : CongVan Tran  
 Group Art Unit : 2617

March 18, 2007

Mail Stop Amendment  
 Commissioner for Patents  
 P.O. Box 1450  
 Alexandria, VA 22313-1450

REPLY TO OFFICE ACTION

Sir:

In response to the Office Action dated September 18, 2006:

**A listing of claims** which begins on page 2 of this paper.

**Remarks** begin on page 22 of this paper.

Listing of Claims

1-15. (Cancelled)

16. (Withdrawn) A method of customizing a wireless telephone by programming an audio file into the wireless telephone for use as an indicia of an incoming communication, the method comprising:

connecting to a remote database that includes a plurality of lists of audio files;

allowing a user of the wireless telephone to browse at least one of the lists of audio files;

allowing the user of the wireless telephone to select at least one of the audio files from the browsed list;

optionally reviewing the selected audio file before downloading the selected audio into the wireless telephone; and

allowing the user to optionally download the selected audio file for use as an indicia of an incoming communication.

17. (Withdrawn) The method of claim 16 wherein the format of the selected audio file is from the group comprising: MIDI, MPEG, MP3, WAV, PCM, Windows Media Audio code (WMA), or Adaptive Transform Acoustic Coding (ATRAC).

18. (Withdrawn) The method of claim 16 further comprising allowing the user to search the remote database for a certain desired audio file using title or description information to aid in locating the desired audio file.

19. (Withdrawn) The method of claim 18 wherein the searching further comprises searching the Internet or other remote databases for the desired audio file.

20. (Withdrawn) The method of claim 16 wherein the browsing of audio files is accomplished at least in part using a Wireless Application Protocol (WAP) compliant system.

21. (Withdrawn) The method of claim 16 further comprising providing a visual indication on a display screen of the wireless telephone to confirm the selected audio file has been successfully downloaded.

22. (Withdrawn) The method of claim 16 further comprising:

downloading a selected audio file into the wireless telephone; and

associating the downloaded audio file with a characteristic indicative of a caller such that the associated audio file plays when the indicative characteristic is received by the wireless telephone.

23. (Withdrawn) The method of claim 1 wherein the characteristic indicative of the caller is the caller's telephone number.

24. (Withdrawn) A method of customizing a wireless telephone by programming an audio file into the wireless telephone for use as an indicia of an incoming communication, the method comprising:



connecting to a remote database that includes a plurality of audio files; the remote database operating substantially independently of a communications network that provides wireless telephone service to the wireless telephone;

allowing the user of the wireless telephone to browse and select at least one of the audio files;

allowing the user to optionally download the selected audio file into a programmable memory for use as an indicia of an incoming communication.

25. (Withdrawn) The method of claim 24 further comprising allowing the user to optionally review the selected audio file before downloading the selected audio file into the wireless telephone.

26. (Withdrawn) The method of claim 24 wherein the format of the selected audio file is from the group comprising: MIDI, MPEG, MP3, WAV, PCM, Windows Media Audio code (WMA), or Adaptive Transform Acoustic Coding (ATRAC).

27. (Withdrawn) The method of claim 24 further comprising allowing the user to search the remote database for a certain desired audio file using title or description information to aid in locating the desired audio file.

28. (Withdrawn) The method of claim 24 wherein the searching further comprises searching the Internet or other remote databases for the desired audio file.

29. (Withdrawn) The method of claim 24 wherein the browsing of audio files is accomplished at least in part using a Wireless Application Protocol (WAP) compliant system.

30. (Withdrawn) The method of claim 24 further comprising providing a visual indication on a display screen of the wireless telephone to confirm the selected audio file has been successfully downloaded.

31. (Withdrawn) The method of claim 24 further comprising:

downloading a selected audio file into the wireless telephone; and

associating the downloaded audio file with a characteristic indicative of a caller such that the associated audio file plays when the indicative characteristic is received by the wireless telephone.

32. (Withdrawn) The method of claim 24 wherein the characteristic indicative of the caller is the caller's telephone number.

33. (Currently amended) A wireless telephone that may be customized by programming ~~an~~ a digital audio file into the wireless telephone for use as an indicia of an incoming communication, the telephone comprising:

a communications link capable of connecting substantially directly to a remote database that includes a plurality of lists of digital audio files;

a display screen and a mobile browsing application that allows a user of the wireless telephone to browse at least one of the plurality of lists of digital audio files and view selectable digital audio files present in the browsed list;

a speaker and processing circuitry configured to allow the user to optionally review a selected digital audio file with the mobile browsing application before downloading the selected digital audio file into the wireless telephone; and

a programmable memory circuit for allowing the user to optionally store the selected digital audio file for use as an indicia of an incoming communication.

34. (Currently amended) The wireless telephone of claim 33 wherein the programmable memory circuit is configured to store digital audio files in a format selected from the group comprising: MIDI, MPEG, MP3, WAV, PCM, Windows Media Audio code (WMA), or Adaptive Transform Acoustic Coding (ATRAC).

35. (Currently amended) The wireless telephone of claim 33 wherein the speaker and processing circuitry is configured to play digital audio files in a format selected from the group comprising: MIDI, MPEG, MP3, WAV, PCM, Windows Media Audio code (WMA), or Adaptive Transform Acoustic Coding (ATRAC).

36. (Currently amended) The wireless telephone of claim 33 wherein the wireless telephone is configured to allow the user to search the remote database for a certain desired digital audio file using title or description information to aid in locating the desired digital audio file.

37. (Currently amended) The wireless telephone of claim 36 wherein the wireless telephone is configured to search the Internet or other remote databases for the desired digital audio file.

38. (Currently amended) The wireless telephone of claim 33 wherein the ~~wireless telephone~~ mobile browsing

application includes a Wireless Application Protocol (WAP) compliant ~~Internet~~ browser.

39. (Currently amended) The wireless telephone of claim 33 configured to provide a visual indication on the display screen to confirm the selected digital audio file has been successfully downloaded.

40. (Currently amended) The wireless telephone of claim 33 configured to allow the user to associate a downloaded digital audio file with a characteristic indicative of a caller such that the associated digital audio file plays when the indicative characteristic is received by the wireless telephone.

41. (Currently amended) The wireless telephone of claim 40 wherein the characteristic indicative of the caller is the caller's telephone number.

42. (Currently amended) A wireless telephone that may be customized by programming an a digital audio file into the wireless telephone for use as an indicia of an incoming communication, the telephone comprising:

a communications link capable of connecting substantially directly to a remote database that includes a plurality of lists of digital audio files; ~~the remote database operating substantially independently of a communications network that provides wireless telephone service to the wireless telephone;~~

a display screen and a mobile browsing application that allows a user of the wireless telephone to browse at least one of the plurality of lists of digital audio files and view selectable digital audio files present in the browsed list;

processing circuitry configured to receive a selected digital audio file from the communications link; and a programmable memory circuit for allowing the user to optionally store the selected audio file for use as an indicia of an incoming communication.

43. (Currently amended) The wireless telephone of claim 42 further comprising a speaker that operates in conjunction with the processing circuitry to allow the user to optionally review a selected digital audio file before downloading the selected audio file into the wireless telephone.

44. (Currently amended) The wireless telephone of claim 42 wherein the programmable memory circuit is configured to store digital audio files in a format selected from the group comprising: MIDI, MPEG, MP3, WAV, PCM, Windows Media Audio code (WMA), or Adaptive Transform Acoustic Coding (ATRAC).

45. (Currently amended) The wireless telephone of claim 42 wherein the speaker and processing circuitry is configured to play digital audio files in a format selected from the group comprising: MIDI, MPEG, MP3, WAV, PCM, Windows Media Audio code (WMA), or Adaptive Transform Acoustic Coding (ATRAC).

46. (Currently amended) The wireless telephone of claim 42 wherein the wireless telephone is configured to allow the user to search the remote database for a certain desired digital audio file using title or description information to aid in locating the desired audio file.

47. (Currently amended) The wireless telephone of claim 42 wherein the ~~wireless telephone~~ mobile browsing

application includes a Wireless Application Protocol (WAP) compliant ~~Internet~~ browser.

48. (Currently amended) The wireless telephone of claim 22 42 configured to provide a visual indication on the display screen to confirm the selected digital audio file has been successfully downloaded.

49. (Previously presented) The wireless telephone of claim 42 configured to allow the user to associate a downloaded digital audio file with a characteristic indicative of a caller such that the associated digital audio file plays when the indicative characteristic is received by the wireless telephone.

50. (Withdrawn) A wireless telephone that may be customized by programming an audio file into the wireless telephone for use as an indicia of an incoming communication, the telephone comprising:

means for connecting to a remote database that includes a plurality of lists of audio files;

means for browsing at least one of the lists of audio files;

means for selecting at least one of the audio files from the browsed list;

means for optionally reviewing the selected audio file before downloading the selected audio into the wireless telephone; and

means for downloading the selected audio file for use as an indicia of an incoming communication.

51. (Withdrawn) The wireless telephone of claim 50 further comprising means for searching the remote database for a certain desired audio file using title or description information to aid in locating the desired audio file.

52. (Withdrawn) The wireless telephone of claim 51 wherein the searching further comprises means for searching the Internet or other remote databases for the desired audio file.

53. (Withdrawn) The wireless telephone of claim 50 further comprising means for providing a visual indication on a display screen of the wireless telephone to confirm the selected audio file has been successfully downloaded.

54. (Withdrawn) The wireless telephone of claim 50 further comprising means for associating a downloaded audio file with a characteristic indicative of a caller such that the associated audio file plays when the indicative characteristic is received by the wireless telephone.

55. (Withdrawn) A wireless telephone that may be customized by programming an audio file into the wireless telephone for use as an indicia of an incoming communication, the telephone comprising:

means for connecting to a remote database that includes a plurality of audio files; the remote database operating substantially independently of a communications network that provides wireless telephone service to the wireless telephone;

means for browsing and selecting at least one of the audio files;

means for optionally downloading the selected audio file into a programmable memory for use as an indicia of an incoming communication.

56. (Withdrawn) The wireless telephone of claim 55 further comprising means for optionally reviewing the selected audio file before downloading the selected audio file into the wireless telephone.

57. (Withdrawn) The wireless telephone of claim 56 further comprising means for searching the remote database for a certain desired audio file using title or description information to aid in locating the desired audio file.

58. (Withdrawn) The wireless telephone of claim 55 wherein the searching further comprises means for searching the Internet or other remote databases for the desired audio file.

59. (Withdrawn) The wireless telephone of claim 55 wherein the browsing of audio files is accomplished at least in part using a Wireless Application Protocol (WAP) compliant system.

60. (Withdrawn) The wireless telephone of claim 55 further comprising providing a visual indication on a display screen of the wireless telephone to confirm the selected audio file has been successfully downloaded.

61. (Withdrawn) The wireless telephone of claim 55 further comprising means for associating a downloaded audio file with a characteristic indicative of a caller such that the associated audio file plays when the indicative characteristic is received by the wireless telephone.



62. (Withdrawn) The method of claim 16 further comprising preventing the unauthorized distribution of a downloaded audio file.

63. (Withdrawn) The method of claim 16 further comprising playing the selected audio file through an enhanced performance speaker capable of providing a substantially full range of audio sounds from MIDI, MP3, MPEG, WAV, PCM, Windows Media Audio Code (WMA), or Adaptive Transform Acoustic Coding (ATRAC) files.

64. (Withdrawn) The method of claim 16 characterized by the use of a personal computer to perform the browsing step.

65. (Withdrawn) The method of claim 16 further comprising providing the user with an opportunity to edit the selected audio file.

66. (Withdrawn) The method of claim 16 further comprising providing an indication that a memory capacity of the wireless telephone has been exceeded if the size of the audio file to be downloaded is larger than available memory space in the wireless telephone.

67. (Withdrawn) The method of claim 66 further comprising providing the user of the wireless telephone with the opportunity to cancel or modify a download request associated with an audio file download operation if the size of the audio file to be downloaded is larger than available memory space in the wireless telephone.

68. (Currently amended) The wireless telephone of claim ~~33~~ 33 wherein the wireless telephone is configured to prevent the unauthorized distribution of an digital audio file stored in the programmable memory circuit.

69. (Previously presented) The wireless telephone of claim 33 wherein the speaker is an enhanced performance speaker capable of providing a substantially full range of audio sounds from MIDI, MP3, MPEG, WAV, PCM, Windows Media Audio Code (WMA), or Adaptive Transform Acoustic Coding (ATRAC) files.

70. (Currently amended) The wireless telephone of claim 33 configured to provide an indication that a memory capacity of the wireless telephone has been exceeded if the size of the digital audio file to be downloaded is larger than available memory space in the wireless telephone.

71. (Currently amended) The wireless telephone of claim 70 configured to provide the user of the wireless telephone with the opportunity to cancel or modify a download request associated with an digital audio file download operation if the size of the digital audio file to be downloaded is larger than the available memory space in the wireless telephone.

72. (Withdrawn) A wireless telephone that may be customized by programming an audio file into the wireless telephone for use as an indicia of an incoming communication, the telephone comprising:

means for connecting to a remote database that includes a plurality of audio files;

means for selecting at least one of the audio files from the database;

means for downloading and storing the selected audio file for use as an indicia of an incoming communication; and

means for preventing the unauthorized distribution of a selected audio file stored in the wireless telephone.

73. (Withdrawn) The wireless telephone of claim 72 further comprising means for indicating that a memory capacity of the wireless telephone has been exceeded if the size of the audio file to be downloaded is larger than available memory space in the wireless telephone.

74. (Previously presented) A wireless telephone that may be customized by searching for and selecting an audio file from a remote computer and programming the selected audio file into the wireless telephone for use as an indicia of an incoming communication, the telephone comprising:

a communications link capable of connecting to a database in the remote computer that includes a plurality of lists of audio files in MPEG, or WAV, or MP3 format or a combination thereof;

a display screen and a mobile Internet browser that allows a user of the wireless telephone to browse at least one of the lists of lists of audio files and view selectable audio files present in the browsed list;

processing circuitry configured to receive a selected one of the audio files from the communications link;

a programmable memory circuit for allowing the user to optionally store the selected audio file for use as an indicia of an incoming communication; and

an enhanced performance speaker capable of providing a substantially full range of audio sounds when one of the selected audio files is played as an indicia of an incoming communication.

75. (Previously presented) The wireless telephone of claim 74 configured to provide an indication that a memory capacity of the wireless telephone has been exceeded if the size of the audio file to be downloaded is larger than the available memory space in the wireless telephone.

76. (Currently amended) The wireless telephone of claim 74 wherein the enhanced performance speaker operates in conjunction with the processing circuitry to allow the user to optionally review a the selected audio file before downloading the selected audio file into the wireless telephone.

77. (Previously presented) The wireless telephone of claim 74 configured to allow the user to search the database for a certain desired audio file using title or description information to aid in locating a desired audio file.

78. (Previously presented) The wireless telephone of claim 74 configured to prevent the unauthorized distribution of a audio file stored in the programmable memory circuit.

79. (Previously presented) A wireless telephone that may be customized by searching for and selecting an audio file from a remote computer and programming the selected audio file into the wireless telephone for ~~use at a time specified by the user, the telephone~~ as an indicia of an incoming communication, the telephone comprising:

a communications link capable of connecting to a database in the remote computer that includes a plurality of polyphonic audio files;

a display screen and a browsing application program that allows a user of the wireless telephone to browse the polyphonic audio files and select at least one polyphonic audio file therefrom;

processing circuitry configured to supervise receipt of a selected polyphonic audio file from the communications link;

a programmable memory circuit for allowing the user to optionally store the selected polyphonic audio file for use as an indicia of an incoming communication; and

an enhanced performance speaker capable of providing a substantially full range of audio sounds from the selected polyphonic audio file when the selected polyphonic audio file is played.

80. (Previously presented) The wireless telephone of claim 79 wherein the polyphonic audio file is selected from the group comprising MP3, MPEG, or WAV files.

81. (Previously presented) The wireless telephone of claim 79 wherein the enhanced performance speaker operates in conjunction with the processing circuitry to allow the user to optionally review the selected polyphonic audio file before downloading the selected polyphonic audio file into the programmable memory circuit of the wireless telephone.

82. (Previously presented) The wireless telephone of claim 79 configured to prevent the unauthorized distribution of the selected polyphonic audio file stored in the programmable memory circuit.

83. (Previously presented) The wireless telephone of claim 74 wherein the group of polyphonic audio files includes audio files in polyphonic MIDI format.

84. (Previously presented) The wireless telephone of claim 76 configured to provide the user of the wireless telephone with the option of downloading the selected polyphonic audio file into a programmable memory in the wireless telephone after reviewing the selected polyphonic audio file.

85. (Previously presented) The wireless telephone of claim 84 configured to provide the user of the wireless telephone with the option of modifying the selected polyphonic audio file before programming the selected polyphonic audio file into the programmable memory in the wireless telephone.

86. (Previously presented) The wireless telephone of claim 80 wherein the wireless telephone is configured to operate in conjunction with copyright protection software to prevent the unauthorized distribution of the selected polyphonic audio file stored in the programmable memory circuit.

87. (Previously presented) The wireless telephone of claim 79 wherein the selected polyphonic audio files is in polyphonic MIDI format.

88. (Previously presented) The wireless telephone of claim ~~79~~ 81 ~~configured to provide the user of the wireless telephone with the option of downloading the selected polyphonic~~

~~audio file into a programmable memory in the wireless telephone after reviewing the selected polyphonic audio file wherein the browsing application program is a Wireless Application Protocol (WAP) compliant browsing program.~~

89. (Previously presented) The wireless telephone of claim 88 configured to provide the user of the wireless telephone with the option of modifying the selected polyphonic audio file before programming the selected polyphonic audio file into the programmable memory in the wireless telephone.

90. (Previously presented) The wireless telephone of claim 82 wherein the wireless telephone is configured to operate in conjunction with copyright protection software to prevent the unauthorized distribution of the selected polyphonic audio file stored in the programmable memory circuit.

91. (Previously presented) A wireless telephone that may be customized by searching for and selecting an audio file from a remote computer and programming the selected audio file into the wireless telephone for use as an indicia of an incoming communication, the telephone comprising:

a communications link capable of connecting to a database in the remote computer that includes a plurality of polyphonic audio files;

a display screen and a browsing application program that allows a user of the wireless telephone to browse the polyphonic audio files and select at least one polyphonic audio file therefrom;

processing circuitry configured to supervise receipt of a selected polyphonic audio file from the communications link;

a programmable memory circuit for allowing the user to optionally store the selected polyphonic audio file for use as an indicia of an incoming communication; and

an enhanced performance speaker capable of providing a substantially full range of audio sounds from the selected polyphonic audio file when the selected polyphonic audio file is played.

92. (Previously presented) The wireless telephone of claim 91 wherein the polyphonic audio file is selected from the group comprising MP3, MPEG, or WAV files.

93. (Previously presented) The wireless telephone of claim 91 wherein the enhanced performance speaker operates in conjunction with the processing circuitry to allow the user to optionally review the selected polyphonic audio file before downloading the selected polyphonic audio file into the programmable memory circuit of the wireless telephone.

94. (Previously presented) The wireless telephone of claim 91 configured to prevent the unauthorized distribution of the selected polyphonic audio file stored in the programmable memory circuit.

95. (Previously presented) The wireless telephone of claim 91 wherein the polyphonic audio files includes audio files in polyphonic MIDI format.



96. (Previously presented) The wireless telephone of claim 93 configured to provide the user of the wireless telephone with the option of downloading the selected polyphonic audio file into a programmable memory in the wireless telephone after reviewing the selected polyphonic audio file.

97. (Previously presented) The wireless telephone of claim 93 configured to provide the user of the wireless telephone with the option of modifying the selected polyphonic audio file before programming the selected polyphonic audio file into the programmable memory in the wireless telephone.

98. (Previously presented) The wireless telephone of claim 91 wherein the wireless telephone is configured to operate in conjunction with copyright protection software to prevent the unauthorized distribution of the selected polyphonic audio file stored in the programmable memory circuit.

99. (Withdrawn) A wireless telephone that may be customized by programming an audio file into the wireless telephone for use at a time specified by a user of the wireless telephone, the telephone comprising:

means for connecting to a remote database that includes a plurality of lists of polyphonic audio files;

means for browsing at least one of the lists of polyphonic audio files;

means for selecting at least one of the polyphonic audio files from the browsed list;

means for optionally reviewing the selected polyphonic audio file before downloading the selected polyphonic audio into a memory circuit in the wireless telephone; and

means for downloading the selected polyphonic audio file for use at the time specified by the user of the wireless telephone.

100. (Withdrawn) The wireless telephone of claim 99 further comprising means for searching the remote database for a certain desired polyphonic audio file using title or description information to aid in locating the desired polyphonic audio file.

101. (Withdrawn) The wireless telephone of claim 100 wherein the searching further comprises means for searching the Internet or other remote databases for the desired polyphonic audio file.

102. (Withdrawn) The wireless telephone of claim 99 further comprising means for providing a visual indication on a display screen of the wireless telephone to confirm the selected polyphonic audio file has been successfully downloaded.

103. (Withdrawn) The wireless telephone of claim 99 wherein the browsing of polyphonic audio files is accomplished at least in part using a Wireless Application Protocol (WAP) compliant system.

104. (Withdrawn) The wireless telephone of claim 99 further comprising means for preventing unauthorized distribution of the selected polyphonic audio file stored in the programmable memory circuit.

**REMARKS****I. Petition Under 37 C.F.R. § 1.136(a)**

Pursuant to 37 C.F.R. § 1.136(a), applicant hereby petitions for a three-month extension of the shortened statutory period set for reply to the Office Action dated September 18, 2006. A credit card authorization form in the amount of \$510.00 in payment of the fee set forth in 37 C.F.R. § 1.17(a)(3) is transmitted herewith.

**II. Introduction**

Claims 1-15 are cancelled without prejudice.

Claims 33-49, 68-71, 74-98 are pending in the application.

Claims 16-32, 50-67, 72-73 and 99-104 are withdrawn from consideration.

Claims 48 and 68 are rejected under 35 U.S.C. § 112 as being indefinite.

Claims 33, 36, 39-43, 46, 48-49, 70 and 71 are rejected under 35 U.S.C. § 102(e) as being anticipated by Valentine et al., U.S. patent 6,018,654 (hereinafter "Valentine").

Claims 34-35, 37-38, 44-45, 47 and 74-98 are rejected under 35 U.S.C. § 103(a) as being unpatentable over Farris et al., U.S. patent 6,151,491 (hereinafter "Farris") in view of Valentine.

Claims 33-49, 68, 70-71, 76, 79 and 88 have been amended to more particularly point out and specify the present inventions. No new matter has been added as a result of these amendments.

Consideration and allowance of this application in light of the following remarks is respectfully requested.

III. Applicant's Reply to the Rejection Under 35 U.S.C. § 112

Claims 48 and 68 are rejected under 35 U.S.C. § 112 as being indefinite for depending on a canceled base claim. Applicant has amended claims 48 and 68 to depend from currently pending claims (42 and 33 respectively) and thus respectfully requests that this rejection be withdrawn.

IV. Applicant's Reply to the Rejection Under 35 U.S.C. § 102(e)

Claims 33, 36, 39-43, 46, 48-49, 70 and 71 are rejected under 35 U.S.C. § 102(e) as being anticipated by Valentine. Applicant respectfully traverses this rejection in view of the amendments above and the remarks below.

One aspect of applicant's claimed invention is concerned with a wireless telephone that may be customized by programming an audio file into the wireless telephone for use as an indicia of an incoming communication. This may be thought of as a wireless telephone that allows a user to customize the wireless telephone

by selecting and programming a ringtone into the wireless telephone which plays when an incoming telephone call (or other communication) is received.

One benefit of such a wireless telephone is that it allows the user the freedom and flexibility to choose and/or change to a particular ringtone that is pleasing to the user rather than be constrained by a single ringtone or limited group of ringtones, which may have been, for example, preprogrammed by a manufacturer.

The claimed wireless telephone has the ability to connect to a remote database(s) of digital ringtones and allow the user to browse lists of ringtones in the remote database(s), select a particular ringtone and optionally review (e.g., listen to) the selected digital ringtone by downloading the ringtone to the telephone for playback and subsequent potential downloading into a programmable memory in the wireless telephone for subsequent use.

Furthermore, the claimed wireless telephone provides various other novel features as compared to conventional telephone systems. For example, the claimed telephone allows the user to download high quality or high fidelity ringtones such as polyphonic ringtones (sometimes referred to now as "real tones", "true tones", "master tones" etc.) that may be actual MP3 (or

other high quality digital representations of) songs or other audio. The claimed enhanced performance speaker allows such high quality audio clips to accurately reproduce the high fidelity sound achievable with such clips, thus greatly improving the user's experience and satisfaction. In addition, embodiments of the present invention allow the wireless telephone to directly download digital audio data from a remote database without the use of slow or cumbersome messaging services.

Claims 33 and 42

In contrast, Valentine fails to show or suggest these features. For example, claim 33, as amended, is directed toward a wireless telephone with a preview feature that allows digital audio data for a ringtone preview to be downloaded to the telephone using a substantially direct connection to an audio database. Accordingly, with applicant's claimed invention, audio previews may be quickly and efficiently downloaded to the user's telephone, allowing the user to quickly evaluate the ringtone and make a selection.

Valentine, on the other hand, fails to show or suggest this feature anywhere. Rather, the system of Valentine requires the use of SMS or USSD text messages or other message services to receive digital information from a remote database (See Valentine,

FIGS. 1-3 and associated description). Valentine explains that this messaging process requires communicating with a specialized message center, retrieving requested information, encapsulating the information into an SMS message format, transmitting and then extracting data at the destination. (See Valentine columns 2-4 and FIGS 1-3). Thus, the telephone of Valentine must engage in transmission and receipt of multiple SMS text messages to navigate between various menu options. Further SMS messages are required to make selections from the menu, and additional SMS messages still are required to receive any selected digital tone information. This results in a slow and cumbersome experience for the telephone user and occupies network messaging resources.

Applicant's claimed invention, however, does not require the use of SMS or USSD messages to navigate and select digital ringtones. Rather, an end user may navigate, search and receive digital ringtones over a communication link that connects to a ringtone database substantially directly (i.e., without relying on various intermediate messaging services), obviating the need to send and receive multiple time consuming SMS messages and thereby improving the user's experience and reducing network messaging traffic. Moreover, SMS and USSD messages are intended for use as short text messages, and are very limited in capacity (less than 80 characters for SMS and less than 180 for USSD) and thus are not

suitable for providing high quality audio previews which are typically larger in size.

Accordingly applicant respectfully submits that amended claim 33, and claims 33-41 and 68-71 that depend therefrom are allowable over Valentine. Moreover, claim 42, as amended, and claims 42-49 which depend therefrom are also allowable over Valentine for at least the same reasons. Based on the foregoing, applicant respectfully requests the rejection pursuant to 35 U.S.C. § 102(e) be withdrawn.

V. Applicant's Reply to the Rejection Under 35 U.S.C. § 103(a)

Claims 34-35, 37-38, 44-45, 47, and 71 74-98 are rejected under 35 U.S.C. § 103(a) as obvious by Valentine in view of Farris. Applicant respectfully traverses this rejection.

Applicant respectfully submits that the rejection of claims 34-35, 37-38, 44-45, 47, and 71 are moot in view of the discussion above and that those claims are allowable over Farris and Valentine for at least the same reasons they are allowable over Valentine.

Claims 74, 79 and 91

Moreover, applicant's invention, as specified in claims 74, 79 and 91 include various additional novel features over the prior



art of record including a mobile Internet browsing application that allows user to browse and select audio files for use as ringtones on a remote computer, an enhanced performance speaker capable of providing a substantially full range of audio sounds for playing high quality ringtones, the browsing and selecting and playing of polyphonic ringtones as an indicia of an incoming communication, etc.

Farris fails to show or suggest these features. Rather, Farris merely relates to a system that broadcasts voicemail and email messages to remote users (see Abstract and Summary, columns 9-10). Farris explains that the Mobile Audio Programming Device (MAPOD) described in FIG. 1 is a processing unit with a cellular telephone link for receiving broadcast information relating to user email and voicemail. A user may interface with the MAPOD by connecting it to a telephone handset or video output device such as TV (See Farris, column 20, lines 41-55, FIG. 2 item 42). The MAPOD unit is typically installed in an automobile or strapped to the user's waist and may be periodically consulted to retrieve voicemail or email (see Farris, column 9, lines 40-46, column 12, lines 15-66 and FIG. 1). Similar MAPOD's are shown in FIGS. 4-7. Farris mentions that the data transmission network may include an

improved secure backend of vBNS components useful for Internet communication (Farris, column 30, lines 35-61).

However, applicant respectfully points out that nowhere in Farris is any mention made of a ringtone (polyphonic, WAV, MP3, MIDI or otherwise) phone customization, an enhanced performance speaker capable of producing a substantially full range of audio sounds when playing a ringtone or a mobile browsing application for connecting to remote database of audio files suitable for use as a ringtone. The described MAPOD does not include any of these features nor does the backbone of the Internet network mentioned by Farris have anything to do with the mobile browsing application specified in applicant's claims. Thus, applicant respectfully submits the Farris, either alone or in combination with Valentine fails to show or suggest the patentable features of applicant's claims discussed above.

Moreover, applicant submits it is not obvious to combine the references as the Examiner proposes. As mentioned above, the purpose of Farris is to provide a remote messaging platform for retrieving broadcast SNMP based email and audio voicemail messages, whereas the system of Valentine requires the use short messaging services such as SMS and USSD, teaching away from one another, and thus discouraging the combination proposed by the Examiner. Moreover the device of Farris is a messaging platform

an not a mobile telephone necessitating substantial modification of each of the devices further discouraging such a combination. No teaching is provided in any reference describing how to accomplish such modifications and there is no suggestion or motivation provided within the references themselves that such a combination would be beneficial or even desirable. For example, completely absent from Farris is any teaching or suggestion of audio that may be stored and played as an indicia of an incoming communication. Farris even fails to recognize that such customization features or the use of high quality audio or Internet browsing would be desirable or suggest the circumstances under which they would be useful or desirable. Thus, there is no motivation to combine Farris with Valentine.

In addition, even if such a combination were made, it would still not produce applicant's claimed invention (i.e., the combination would merely produce a device suffering from all the shortcomings of Farris and Valentine pointed out above).

Accordingly, based on the above applicant respectfully requests that the rejections under 35 U.S.C. § 103(a) be withdrawn.

Other Patentable Distinctions

In addition to the reasons above, applicant respectfully submits that at least several other patentable distinctions exist in pending claims over the prior art of record. For example, other features patentable over the prior art include a wireless telephone configured to prevent the unauthorized distribution of the downloaded audio files used as an indicia of an incoming communication (claims 78 and 82), the use of copyright protection measures (claims 86 and 98), optionally modifying selected audio files before programming into the wireless telephone (claims 85 and 97), the use of polyphonic audio files including the various formats specified (claims 69 and 79-98), a wireless telephone (not a messaging device) that includes an enhanced performance speaker for providing a substantially full range of audio sounds (claims 74-98) and that allows a user to browse and select audio files for use as an indicia of an incoming communication, a WAP compliant browser (claims 38, 47 and 88) as well as other patentable features set forth in the claims that are not deemed necessary to discuss here.

VI. Conclusion

For at least the above reasons, claims 33, 42, 74, 79 and 91 are patentable over the references of record. Claims 24-41, 43-49, 75-78, 80-90 and 92-98 which depend therefrom are therefore also patentable over the references of record.

For all of the above reasons, applicant respectfully requests that the Examiner withdraw the rejections and allow the pending claims. To expedite prosecution of this application to allowance, the examiner is invited to call the applicant's undersigned representative to discuss any issues relating to this application.

Respectfully submitted,

Dated: 3/18/07



\_\_\_\_\_  
Scott H. Kaliko  
Attorney for Applicant  
Registration No. 45,786  
KALIKO & YEAGER, L.L.C.  
500 North Franklin Turnpike  
Ramsey, NJ 07446  
Direct: 201-831-0575  
Fax: 201-831-0519

RECEIVED  
CENTRAL FAX CENTER

MAR 19 2007



500 North Franklin Turnpike, Ramsey, NJ 07446  
(201) 831-0575 Main Tel  
(201) 831-0519 Main Fax

FACSIMILE TRANSMITTAL SHEET

TO:  Commissioner for Patents	FROM: Scott H. Kaliko, Esq. SENDER'S FAX NUMBER: 201-831-0519 SENDER'S TELEPHONE NUMBER: 201-831-0575
COMPANY: United States Patent & Trademark Office	DATE: MARCH 19, 2007
RECIPIENT'S FAX NUMBER: 571-273-8300	TOTAL NO. OF PAGES INCLUDING COVER: 37
RECIPIENT'S TELEPHONE NUMBER:	CLIENT / MATTER:
RE: Application No. 10/223,200	YOUR REFERENCE NUMBER: MES/001 CON

URGENT     FOR REVIEW     PLEASE COMMENT     PLEASE REPLY     PLEASE RECYCLE

NOTES/COMMENTS:

Please confirm receipt of this fax and the below-identified attached parts.

1. Transmittal Form/Certificate of Transmission; and
2. Fee Transmittal (2 Copies); and
3. Credit Card Payment Form; and
4. Response to Office Action dated September 19, 2006

CONFIDENTIALITY NOTICE

The information contained in this facsimile message is privileged and confidential and is intended only for the use of the individual(s) and/or entity(ies) named above. If you are not the intended recipient, you are hereby notified that any unauthorized disclosure, copying, distribution or taking of any action in reliance on the contents of the information contained herein is strictly prohibited and review by any individual other than the intended recipient shall not constitute a waiver of the attorney-client privilege. If you have received this transmission in error, please immediately notify us by telephone. Thank you.

MAR 19 2007

PTO/SB/21 (09-04)

Approved for use through 07/31/2006. OMB 0651-0031  
U.S. Patent and Trademark Office; U.S. DEPARTMENT OF COMMERCE

Under the Paperwork Reduction Act of 1995, no persons are required to respond to a collection of information unless it displays a valid OMB control number.

<b>TRANSMITTAL FORM</b>  <i>(to be used for all correspondence after initial filing)</i>	Application Number	10/223,200	
	Filing Date	August 16, 2002	
	First Named Inventor	Michael E. Shanahan	
	Art Unit	2617	
	Examiner Name	Congvan Tran	
Total Number of Pages in This Submission	36	Attorney Docket Number	MES/001 CON

ENCLOSURES (Check all that apply)		
<input checked="" type="checkbox"/> Fee Transmittal Form <input checked="" type="checkbox"/> Fee Attached <input checked="" type="checkbox"/> Amendment/Reply <input type="checkbox"/> After Final <input type="checkbox"/> Affidavits/declaration(s) <input type="checkbox"/> Extension of Time Request <input type="checkbox"/> Express Abandonment Request <input type="checkbox"/> Information Disclosure Statement <input type="checkbox"/> Certified Copy of Priority Document(s) <input type="checkbox"/> Reply to Missing Parts/ Incomplete Application <input type="checkbox"/> Reply to Missing Parts under 37 CFR 1.52 or 1.53	<input type="checkbox"/> Drawing(s) <input type="checkbox"/> Licensing-related Papers <input type="checkbox"/> Petition <input type="checkbox"/> Petition to Convert to a Provisional Application <input type="checkbox"/> Power of Attorney, Revocation <input type="checkbox"/> Change of Correspondence Address <input type="checkbox"/> Terminal Disclaimer <input type="checkbox"/> Request for Refund <input type="checkbox"/> CD, Number of CD(s) _____ <input type="checkbox"/> Landscape Table on CD	<input type="checkbox"/> After Allowance Communication to TC <input type="checkbox"/> Appeal Communication to Board of Appeals and Interferences <input type="checkbox"/> Appeal Communication to TC (Appeal Notice, Brief, Reply Brief) <input type="checkbox"/> Proprietary Information <input type="checkbox"/> Status Letter <input type="checkbox"/> Other Enclosure(s) (please identify below):
Remarks		

SIGNATURE OF APPLICANT, ATTORNEY, OR AGENT			
Firm Name	Kaliko & Yeager, L.L.C.		
Signature			
Printed name	Scott H. Kaliko, Esq.		
Date	March 19, 2007	Reg. No.	45,786

CERTIFICATE OF TRANSMISSION/MAILING			
I hereby certify that this correspondence is being facsimile transmitted to the USPTO or deposited with the United States Postal Service with sufficient postage as first class mail in an envelope addressed to: Commissioner for Patents, P.O. Box 1450, Alexandria, VA 22313-1450 on the date shown below:			
Signature			
Typed or printed name	Scott H. Kaliko, Esq.	Date	March 19, 2007

This collection of information is required by 37 CFR 1.5. The information is required to obtain or retain a benefit by the public which is to file (and by the USPTO to process) an application. Confidentiality is governed by 35 U.S.C. 122 and 37 CFR 1.11 and 1.14. This collection is estimated to 2 hours to complete, including gathering, preparing, and submitting the completed application form to the USPTO. Time will vary depending upon the individual case. Any comments on the amount of time you require to complete this form and/or suggestions for reducing this burden, should be sent to the Chief Information Officer, U.S. Patent and Trademark Office, U.S. Department of Commerce, P.O. Box 1450, Alexandria, VA 22313-1450. DO NOT SEND FEES OR COMPLETED FORMS TO THIS ADDRESS. SEND TO: Commissioner for Patents, P.O. Box 1450, Alexandria, VA 22313-1450.

If you need assistance in completing the form, call 1-800-PTO-9199 and select option 2.

MAR 1 9 2007

PTO/SB/17 (01-06)

Approved for use through 07/31/2008. OMB 0651-0032  
U.S. Patent and Trademark Office: U.S. DEPARTMENT OF COMMERCE

Under the Paperwork Reduction Act of 1995, no persons are required to respond to a collection of information unless it displays a valid OMB control number.

<b>FEE TRANSMITTAL</b> <b>For FY 2006</b>	<b>Complete if Known</b>	
	Application Number	10/223,200
<input checked="" type="checkbox"/> Applicant claims small entity status. See 37 CFR 1.27	Filing Date	August 16, 2002
	First Named Inventor	Michael E. Shanahan
	Examiner Name	Congvan Tran
	Art Unit	2817
	Attorney Docket No.	MES/001 CON
<b>TOTAL AMOUNT OF PAYMENT</b>	(\$)	510.00

**METHOD OF PAYMENT (check all that apply)**

Check  Credit Card  Money Order  None  Other (please identify): \_\_\_\_\_  
 Deposit Account Deposit Account Number: \_\_\_\_\_ Deposit Account Name: \_\_\_\_\_  
 For the above-identified deposit account, the Director is hereby authorized to: (check all that apply)  
 Charge fee(s) indicated below  Charge fee(s) indicated below, except for the filing fee  
 Charge any additional fee(s) or underpayments of fee(s) under 37 CFR 1.16 and 1.17  Credit any overpayments

**WARNING:** Information on this form may become public. Credit card information should not be included on this form. Provide credit card information and authorization on PTO-2038.

**FEE CALCULATION (All the fees below are due upon filing or may be subject to a surcharge.)**

**1. BASIC FILING, SEARCH, AND EXAMINATION FEES**

Application Type	FILING FEES		SEARCH FEES		EXAMINATION FEES		Fees Paid (\$)
	Fee (\$)	Small Entity Fee (\$)	Fee (\$)	Small Entity Fee (\$)	Fee (\$)	Small Entity Fee (\$)	
Utility	300	150	500	250	200	100	_____
Design	200	100	100	50	130	65	_____
Plant	200	100	300	150	160	80	_____
Reissue	300	150	500	250	600	300	_____
Provisional	200	100	0	0	0	0	_____

**2. EXCESS CLAIM FEES**

Fee Description	Fee (\$)	Small Entity Fee (\$)
Each claim over 20 (including Reissues)	50	25
Each independent claim over 3 (including Reissues)	200	100
Multiple dependent claims	360	180

**Total Claims** - 20 or HP = \_\_\_\_\_ x \_\_\_\_\_ = \_\_\_\_\_  
 HP = highest number of total claims paid for, if greater than 20.  
**Indep. Claims** - 3 or HP = \_\_\_\_\_ x \_\_\_\_\_ = \_\_\_\_\_  
 HP = highest number of independent claims paid for, if greater than 3.

**3. APPLICATION SIZE FEE**

If the specification and drawings exceed 100 sheets of paper (excluding electronically filed sequence or computer listings under 37 CFR 1.52(e)), the application size fee due is \$250 (\$125 for small entity) for each additional 50 sheets or fraction thereof. See 35 U.S.C. 41(a)(1)(G) and 37 CFR 1.16(s).

Total Sheets	Extra Sheets	Number of each additional 50 or fraction thereof	Fee (\$)	Fee Paid (\$)
_____	_____	_____	_____	_____

**4. OTHER FEE(S)**

Description	Fee (\$)	Fees Paid (\$)
Non-English Specification, \$130 fee (no small entity discount)	_____	_____
Other (e.g., late filing surcharge): 37 CFR 1.17(a)(3) Extension for Response within Third Month	_____	\$510.00

**SUBMITTED BY**

Signature	Registration No. 45,786	Telephone 201-831-0575
Name (Print/Type) Scott H. Kaliko, Esq.	(Attorney/Agent)	Date March 19, 2007

This collection of information is required by 37 CFR 1.138. The information is required to obtain or retain a benefit by the public which is to file (and by the USPTO to process) an application. Confidentiality is governed by 35 U.S.C. 122 and 37 CFR 1.14. This collection is estimated to take 30 minutes to complete, including gathering, preparing, and submitting the completed application form to the USPTO. Time will vary depending upon the individual case. Any comments on the amount of time you require to complete this form and/or suggestions for reducing this burden, should be sent to the Chief Information Officer, U.S. Patent and Trademark Office, U.S. Department of Commerce, P.O. Box 1450, Alexandria, VA 22313-1450. **DO NOT SEND FEES OR COMPLETED FORMS TO THIS ADDRESS. SEND TO: Commissioner for Patents, P.O. Box 1450, Alexandria, VA 22313-1450.**

If you need assistance in completing the form, call 1-800-PTO-9199 and select option 2.

03/20/2007 WABDELRL 00000006 10223200  
 510.00 DP  
 01 FC:2253



MAR 19 2007

PTO/SB/17 (01-08)  
Approved for use through 07/31/2006. OMB 065-1-0032  
U.S. Patent and Trademark Office: U.S. DEPARTMENT OF COMMERCE

Under the Paperwork Reduction Act of 1995 no persons are required to respond to a collection of information unless it displays a valid OMB control number

Fees pursuant to the Consolidated Appropriations Act, 2005 (H.R. 4818). <b>FEE TRANSMITTAL</b> <b>For FY 2006</b>	<b>Complete if Known</b>	
	Application Number	10/223,200
<input checked="" type="checkbox"/> Applicant claims small entity status. See 37 CFR 1.27	Filing Date	August 16, 2002
<b>TOTAL AMOUNT OF PAYMENT</b> (\$) 510.00	First Named Inventor	Michael E. Shanahan
	Examiner Name	Congvan Tran
	Attorney Docket No.	MES/001 CON

**METHOD OF PAYMENT (check all that apply)**

Check  Credit Card  Money Order  None  Other (please identify): \_\_\_\_\_  
 Deposit Account Deposit Account Number: \_\_\_\_\_ Deposit Account Name: \_\_\_\_\_  
 For the above-identified deposit account, the Director is hereby authorized to: (check all that apply)  
 Charge fee(s) indicated below  Charge fee(s) indicated below, except for the filing fee  
 Charge any additional fee(s) or underpayments of fee(s) under 37 CFR 1.16 and 1.17  Credit any overpayments

**WARNING: Information on this form may become public. Credit card information should not be included on this form. Provide credit card information and authorization on PTO-2038.**

**FEE CALCULATION (All the fees below are due upon filing or may be subject to a surcharge.)**

**1. BASIC FILING, SEARCH, AND EXAMINATION FEES**

Application Type	FILING FEES		SEARCH FEES		EXAMINATION FEES		Fees Paid (\$)
	Fee (\$)	Small Entity Fee (\$)	Fee (\$)	Small Entity Fee (\$)	Fee (\$)	Small Entity Fee (\$)	
Utility	300	150	500	250	200	100	_____
Design	200	100	100	50	130	65	_____
Plant	200	100	300	150	160	80	_____
Reissue	300	150	500	250	600	300	_____
Provisional	200	100	0	0	0	0	_____

**2. EXCESS CLAIM FEES**

Fee Description	Fee (\$)	Small Entity Fee (\$)
Each claim over 20 (including Reissues)	50	25
Each independent claim over 3 (including Reissues)	200	100
Multiple dependent claims	360	180

**Total Claims** - 20 or HP = \_\_\_\_\_ x \_\_\_\_\_ = \_\_\_\_\_  
 HP = highest number of total claims paid for, if greater than 20.  
**Indep. Claims** - 3 or HP = \_\_\_\_\_ x \_\_\_\_\_ = \_\_\_\_\_  
 HP = highest number of independent claims paid for, if greater than 3.

**3. APPLICATION SIZE FEE**  
 If the specification and drawings exceed 100 sheets of paper (excluding electronically filed sequence or computer listings under 37 CFR 1.52(e)), the application size fee due is \$250 (\$125 for small entity) for each additional 50 sheets or fraction thereof. See 35 U.S.C. 41(a)(1)(G) and 37 CFR 1.16(s).

Total Sheets	Extra Sheets	Number of each additional 50 or fraction thereof	Fee (\$)	Fees Paid (\$)
_____	_____	_____	_____	_____

**4. OTHER FEE(S)**

Description	Fee (\$)	Fees Paid (\$)
Non-English Specification, \$130 fee (no small entity discount)	_____	_____
Other (e.g., late filing surcharge): 37 CFR 1.17(a)(3) Extension for Response within Third Month	_____	\$510.00

**SUBMITTED BY**

Signature	Registration No. (Attorney/Agent) 45,786	Telephone 201-831-0575
Name (Print/Type) Scott H. Kaliko, Esq.		Date March 19, 2007

This collection of information is required by 37 CFR 1.136. The information is required to obtain or retain a benefit by the public which is to file (and by the USPTO to process) an application. Confidentiality is governed by 35 U.S.C. 122 and 37 CFR 1.14. This collection is estimated to take 30 minutes to complete, including gathering, preparing, and submitting the completed application form to the USPTO. Time will vary depending upon the individual case. Any comments on the amount of time you require to complete this form and/or suggestions for reducing this burden, should be sent to the Chief Information Officer, U.S. Patent and Trademark Office, U.S. Department of Commerce, P.O. Box 1450, Alexandria, VA 22313-1450. DO NOT SEND FEES OR COMPLETED FORMS TO THIS ADDRESS. SEND TO: Commissioner for Patents, P.O. Box 1450, Alexandria, VA 22313-1450.

If you need assistance in completing the form, call 1-800-PTO-9189 and select option 2.

Under the Paperwork Reduction Act of 1995, no persons are required to respond to a collection of information unless it displays a valid OMB control number.

<b>PATENT APPLICATION FEE DETERMINATION RECORD</b> Substitute for Form PTO-875	Application or Docket Number <b>10/223,200</b>	Filing Date <b>08/16/2002</b>	<input type="checkbox"/> To be Mailed
-----------------------------------------------------------------------------------	---------------------------------------------------	----------------------------------	---------------------------------------

APPLICATION AS FILED – PART I			OTHER THAN SMALL ENTITY				
	(Column 1)	(Column 2)	SMALL ENTITY <input checked="" type="checkbox"/>	OR			
FOR	NUMBER FILED	NUMBER EXTRA	RATE (\$)	FEE (\$)	OR	RATE (\$)	FEE (\$)
<input type="checkbox"/> BASIC FEE <small>(37 CFR 1.16(a), (b), or (c))</small>	N/A	N/A	N/A			N/A	
<input type="checkbox"/> SEARCH FEE <small>(37 CFR 1.16(k), (l), or (m))</small>	N/A	N/A	N/A			N/A	
<input type="checkbox"/> EXAMINATION FEE <small>(37 CFR 1.16(o), (p), or (q))</small>	N/A	N/A	N/A			N/A	
TOTAL CLAIMS <small>(37 CFR 1.16(j))</small>	minus 20 =	*	X \$ =		OR	X \$ =	
INDEPENDENT CLAIMS <small>(37 CFR 1.16(h))</small>	minus 3 =	*	X \$ =			X \$ =	
<input type="checkbox"/> APPLICATION SIZE FEE <small>(37 CFR 1.16(s))</small>	If the specification and drawings exceed 100 sheets of paper, the application size fee due is \$250 (\$125 for small entity) for each additional 50 sheets or fraction thereof. See 35 U.S.C. 41(a)(1)(G) and 37 CFR 1.16(s).						
<input type="checkbox"/> MULTIPLE DEPENDENT CLAIM PRESENT <small>(37 CFR 1.16(j))</small>							
* If the difference in column 1 is less than zero, enter "0" in column 2.			TOTAL			TOTAL	

APPLICATION AS AMENDED – PART II					OTHER THAN SMALL ENTITY				
	(Column 1)	(Column 2)	(Column 3)		SMALL ENTITY	OR			
AMENDMENT	<b>03/19/2007</b>	CLAIMS REMAINING AFTER AMENDMENT	HIGHEST NUMBER PREVIOUSLY PAID FOR	PRESENT EXTRA	RATE (\$)	ADDITIONAL FEE (\$)	OR	RATE (\$)	ADDITIONAL FEE (\$)
	Total (37 CFR 1.16(i))	* 89	Minus	** 89	= 0	X \$25 =	0	OR	X \$ =
	Independent (37 CFR 1.16(h))	* 11	Minus	*** 11	= 0	X \$100 =	0	OR	X \$ =
	<input type="checkbox"/> Application Size Fee (37 CFR 1.16(s))								
	<input type="checkbox"/> FIRST PRESENTATION OF MULTIPLE DEPENDENT CLAIM (37 CFR 1.16(j))						OR		
					TOTAL ADD'L FEE	0	OR	TOTAL ADD'L FEE	

	(Column 1)	(Column 2)	(Column 3)		SMALL ENTITY	OR			
AMENDMENT		CLAIMS REMAINING AFTER AMENDMENT	HIGHEST NUMBER PREVIOUSLY PAID FOR	PRESENT EXTRA	RATE (\$)	ADDITIONAL FEE (\$)	OR	RATE (\$)	ADDITIONAL FEE (\$)
	Total (37 CFR 1.16(i))	*	Minus	**	=	X \$ =	OR	X \$ =	
	Independent (37 CFR 1.16(h))	*	Minus	***	=	X \$ =	OR	X \$ =	
	<input type="checkbox"/> Application Size Fee (37 CFR 1.16(s))								
	<input type="checkbox"/> FIRST PRESENTATION OF MULTIPLE DEPENDENT CLAIM (37 CFR 1.16(j))						OR		
					TOTAL ADD'L FEE		OR	TOTAL ADD'L FEE	

\* If the entry in column 1 is less than the entry in column 2, write "0" in column 3.  
 \*\* If the "Highest Number Previously Paid For" IN THIS SPACE is less than 20, enter "20".  
 \*\*\* If the "Highest Number Previously Paid For" IN THIS SPACE is less than 3, enter "3".  
 The "Highest Number Previously Paid For" (Total or Independent) is the highest number found in the appropriate box in column 1.

Legal Instrument Examiner:  
Rosalind Ball

This collection of information is required by 37 CFR 1.16. The information is required to obtain or retain a benefit by the public which is to file (and by the USPTO to process) an application. Confidentiality is governed by 35 U.S.C. 122 and 37 CFR 1.14. This collection is estimated to take 12 minutes to complete, including gathering, preparing, and submitting the completed application form to the USPTO. Time will vary depending upon the individual case. Any comments on the amount of time you require to complete this form and/or suggestions for reducing this burden, should be sent to the Chief Information Officer, U.S. Patent and Trademark Office, U.S. Department of Commerce, P.O. Box 1450, Alexandria, VA 22313-1450. DO NOT SEND FEES OR COMPLETED FORMS TO THIS ADDRESS. **SEND TO: Commissioner for Patents, P.O. Box 1450, Alexandria, VA 22313-1450.**  
 If you need assistance in completing the form, call 1-800-PTO-9199 and select option 2.

RECEIVED  
CENTRAL FAX CENTER

OCT 05 2006



500 North Franklin Turnpike, Ramsey, NJ 07446  
(201) 831-0575 Main Tel  
(201) 831-0519 Main Fax

FACSIMILE TRANSMITTAL SHEET

TO:  Commissioner for Patents	FROM: Scott H. Kaliko, Esq.
	SENDER'S FAX NUMBER: 201-831-0519
	SENDER'S TELEPHONE NUMBER: 201-831-0575
COMPANY: United States Patent & Trademark Office	DATE: OCTOBER 5, 2006
RECIPIENT'S FAX NUMBER: 571-273-8300	TOTAL NO. OF PAGES INCLUDING COVER: 8 Pages
RECIPIENT'S TELEPHONE NUMBER:	CLIENT / MATTER:
RE: Application No. 10/223,200	YOUR REFERENCE NUMBER: MES/001 CON

URGENT     FOR REVIEW     PLEASE COMMENT     PLEASE REPLY     PLEASE RECYCLE

NOTES/COMMENTS:

Please confirm receipt of this fax and the below-identified attached parts.

1. Transmittal Form/Certificate of Transmission; and
2. Information Disclosure Statement; and
3. PTO Form 1449; and
4. Copy of Canadian Office Action

CONFIDENTIALITY NOTICE

The information contained in this facsimile message is privileged and confidential and is intended only for the use of the individual(s) and/or entity(ies) named above. If you are not the intended recipient, you are hereby notified that any unauthorized disclosure, copying, distribution or taking of any action in reliance on the contents of the information contained herein is strictly prohibited and review by any individual other than the intended recipient shall not constitute a waiver of the attorney-client privilege. If you have received this transmission in error, please immediately notify us by telephone. Thank you.

**OCT 05 2006**

PTO/SB/21 (09-04)

Approved for use through 07/31/2006. OMB 0851-0031

U.S. Patent and Trademark Office, U.S. DEPARTMENT OF COMMERCE

Under the Paperwork Reduction Act of 1995, no person is required to respond to a collection of information unless it displays a valid OMB control number.

<b>TRANSMITTAL FORM</b> <small>(to be used for all correspondence after initial filing)</small>	Application Number	10/223,200
	Filing Date	August 18, 2002
	First Named Inventor	Michael E. Shanahan
	Art Unit	2617
	Examiner Name	Congvan Tran
	Attorney Docket Number	MES/001 CON
Total Number of Pages in This Submission		<b>7</b>

ENCLOSURES (Check all that apply)		
<input type="checkbox"/> Fee Transmittal Form <input type="checkbox"/> Fee Attached <input type="checkbox"/> Amendment/Reply <input type="checkbox"/> After Final <input type="checkbox"/> Affidavits/declaration(s) <input type="checkbox"/> Extension of Time Request <input type="checkbox"/> Express Abandonment Request <input checked="" type="checkbox"/> Information Disclosure Statement <input type="checkbox"/> Certified Copy of Priority Document(s) <input type="checkbox"/> Reply to Missing Parts/ Incomplete Application <input type="checkbox"/> Reply to Missing Parts under 37 CFR 1.52 or 1.53	<input type="checkbox"/> Drawing(s) <input type="checkbox"/> Licensing-related Papers <input type="checkbox"/> Petition <input type="checkbox"/> Petition to Convert to a Provisional Application <input type="checkbox"/> Power of Attorney, Revocation <input type="checkbox"/> Change of Correspondence Address <input type="checkbox"/> Terminal Disclaimer <input type="checkbox"/> Request for Refund <input type="checkbox"/> CD, Number of CD(s) _____ <input type="checkbox"/> Landscape Table on CD	<input type="checkbox"/> After Allowance Communication to TC <input type="checkbox"/> Appeal Communication to Board of Appeals and Interferences <input type="checkbox"/> Appeal Communication to TC (Appeal Notice, Brief, Reply Brief) <input type="checkbox"/> Proprietary Information <input type="checkbox"/> Status Letter <input checked="" type="checkbox"/> Other Enclosure(s) (please identify below):
Remarks 1. PTO Form 1449; and 2. Copy of Canadian Office Action		

SIGNATURE OF APPLICANT, ATTORNEY, OR AGENT			
Firm Name	Kaliko & Yeager		
Signature			
Printed name	Scott H. Kaliko, Esq.		
Date	October 5, 2006	Reg. No.	45,786

CERTIFICATE OF TRANSMISSION/MAILING			
I hereby certify that this correspondence is being facsimile transmitted to the USPTO or deposited with the United States Postal Service with sufficient postage as first class mail in an envelope addressed to: Commissioner for Patents, P.O. Box 1450, Alexandria, VA 22313-1450 on the date shown below:			
Signature			
Typed or printed name	Scott H. Kaliko, Esq.	Date	October 5, 2006

This collection of information is required by 37 CFR 1.5. The information is required to obtain or retain a benefit by the public which is to file (and by the USPTO to process) an application. Confidentiality is governed by 35 U.S.C. 122 and 37 CFR 1.11 and 1.14. This collection is estimated to 2 hours to complete, including gathering, preparing, and submitting the completed application form to the USPTO. Time will vary depending upon the individual case. Any comments on the amount of time you require to complete this form and/or suggestions for reducing this burden, should be sent to the Chief Information Officer, U.S. Patent and Trademark Office, U.S. Department of Commerce, P.O. Box 1450, Alexandria, VA 22313-1450. DO NOT SEND FEES OR COMPLETED FORMS TO THIS ADDRESS. SEND TO: Commissioner for Patents, P.O. Box 1450, Alexandria, VA 22313-1450.

If you need assistance in completing the form, call 1-800-PTO-9189 and select option 2.

PATENT  
MES/001 CON

**RECEIVED  
CENTRAL FAX CENTER**

OCT 05 2006

**IN THE UNITED STATES PATENT AND TRADEMARK OFFICE**

Applicant : Michael E. Shanahan

Serial No. : 10/223,200 Confirmation No.: 8026

Filed : August 16, 2002

Title : METHODS AND APPARATUSES FOR PROGRAMMING  
USER-DEFINED INFORMATION INTO ELECTRONIC  
DEVICES.

Examiner : Congvan Tran

Group Art Unit : 2617

Commissioner for Patents  
P.O. Box 1450  
Alexandria, VA 22213-1450

**INFORMATION DISCLOSURE STATEMENT**

Sir:

Pursuant to 37 C.F.R. §§ 1.56, 1.97 and 1.98, applicant hereby makes the documents listed below of record in the above-identified application.

**U.S. Patents**

Peters Patent No. 5,577,190 November 19, 1996

RECEIVED  
CENTRAL FAX CENTER

OCT 05 2006

PTO/SB/08A (07-05)

Approved for use through 07/31/2008. OMB 0651-0031  
U.S. Patent and Trademark Office: U.S. DEPARTMENT OF COMMERCE

Under the Paperwork Reduction Act of 1995, no persons are required to respond to a collection of information unless it contains a valid OMB control number.

Substitute for form 1449/PTO	<b>Complete If Known</b>	
	Application Number	10/223,200
<b>INFORMATION DISCLOSURE STATEMENT BY APPLICANT</b> <i>(Use as many sheets as necessary)</i>	Filing Date	August 16, 2002
	First Named Inventor	Michael E. Shanahan
	Art Unit	2617
	Examiner Name	Congvan Tran
	Attorney Docket Number	MES/001 CON
Sheet 1 of 1		

U. S. PATENT DOCUMENTS					
Examiner Initials*	Cite No. <sup>1</sup>	Document Number	Publication Date	Name of Patentee or Applicant of Cited Document	Pages, Columns, Lines, Where Relevant Passages or Relevant Figures Appear
		Number-Kind Code <sup>2</sup> (if known)	MM-DD-YYYY		
		US- 5,577,190	11-19-1996	Peters	
		US-			
		US-			
		US-			
		US-			
		US-			
		US-			
		US-			
		US-			
		US-			
		US-			
		US-			
		US-			
		US-			
		US-			
		US-			
		US-			
		US-			
		US-			
		US-			
		US-			
		US-			
		US-			
		US-			
		US-			
		US-			

FOREIGN PATENT DOCUMENTS						
Examiner Initials*	Cite No. <sup>1</sup>	Foreign Patent Document	Publication Date	Name of Patentee or Applicant of Cited Document	Pages, Columns, Lines, Where Relevant Passages Or Relevant Figures Appear	T <sup>6</sup>
		Country Code <sup>3</sup> -Number <sup>4</sup> -Kind Code <sup>5</sup> (if known)	MM-DD-YYYY			
		CA Office Action Copy Included	09-19-2006			

Examiner Signature	Date Considered
-----------------------	--------------------

\*EXAMINER: Initial if reference considered, whether or not citation is in conformance with MPEP 609. Draw line through citation if not in conformance and not considered. Include copy of this form with next communication to applicant. <sup>1</sup> Applicant's unique citation designation number (optional). <sup>2</sup> See Kinds Codes of USPTO Patent Documents at [www.uspto.gov](http://www.uspto.gov) or MPEP 901.04. <sup>3</sup> Enter Office that issued the document, by the two-letter code (WIPO Standard ST.3). <sup>4</sup> For Japanese patent documents, the indication of the year of the reign of the Emperor must precede the serial number of the patent document. <sup>5</sup> Kind of document by the appropriate symbols as indicated on the document under WIPO Standard ST.15 if possible. <sup>6</sup> Applicant is to place a check mark here if English language translation is attached.

This collection of information is required by 37 CFR 1.97 and 1.98. The information is required to obtain or retain a benefit by the public which is to file (and by the USPTO to process) an application. Confidentiality is governed by 35 U.S.C. 122 and 37 CFR 1.14. This collection is estimated to take 2 hours to complete, including gathering, preparing, and submitting the completed application form to the USPTO. Time will vary depending upon the individual case. Any comments on the amount of time you require to complete this form and/or suggestions for reducing this burden, should be sent to the Chief Information Officer, U.S. Patent and Trademark Office, P.O. Box 1450, Alexandria, VA 22313-1450. DO NOT SEND FEES OR COMPLETED FORMS TO THIS ADDRESS. SEND TO: Commissioner for Patents, P.O. Box 1450, Alexandria, VA 22313-1450.

If you need assistance in completing the form, call 1-800-PTO-9199 (1-800-786-9199) and select option 2.

PATENT  
MES/001 CON**Foreign Office Action**

Canadian Office Action dated September 19, 2006 copy included


It is respectfully requested the Examiner fully consider these and any associated documents during the examination of this application, make them of record, and indicate his or her consideration of the documents by initialing the enclosed Citation List adjacent the citation of each document, and print them on any patent that may issue on this application. It is requested that a copy of the initialed Citation form be returned to applicant's undersigned Attorney. Citing of references herein shall not be deemed an admission that such references are prior art. Copies of the cited references are transmitted herewith.

Pursuant to 37 C.F.R. § 1.97 (e) (1) each item of information contained in this Information Disclosure Statement was first cited in a communication from a foreign patent office in a counterpart foreign application not more than three months prior to the filing of this statement. Accordingly, it is believed no fees are due in connection with the filing of this Information Disclosure Statement.

PATENT  
MES/001 CON

Respectfully submitted,

10/5/06  
Date

  
\_\_\_\_\_  
Scott H. Kaliko  
Attorney for Applicant  
Registration No. 45,786  
KALIKO & YEAGER  
500 North Franklin Turnpike  
Ramsey, NJ 07446  
Direct: 201-831-0575  
Fax: 201-831-0519





Office de la propriété  
intellectuelle  
du Canada

Un organisme  
d'Industrie Canada  
www.opic.gc.ca

Canadian  
Intellectual Property  
Office

An Agency of  
Industry Canada  
www.cipo.gc.ca

RECEIVED

September 19, 2006

**SMART & BIGGAR**  
P.O. Box 2999  
Station D  
OTTAWA Ontario  
K1P 5Y6

2006 SEP 21 A 3:24  
55 METCALFE ST.

Application No. : **2,436,872**

Owner : TWENTY YEAR INNOVATIONS, INC.

Title : **METHODS AND APPARATUSES FOR PROGRAMMING  
USER-DEFINED INFORMATION INTO ELECTRONIC DEVICES**

Classification : H04M 1/247 (2006.01)

Your File No. : **50320-TS1170-16**

Examiner : S.Chhim

**YOU ARE HEREBY NOTIFIED OF :**

- A REQUISITION BY THE EXAMINER IN ACCORDANCE WITH SUBSECTION 30(2) OF THE *PATENT RULES*;
- A REQUISITION BY THE EXAMINER IN ACCORDANCE WITH SECTION 29 OF THE *PATENT RULES*.

IN ORDER TO AVOID MULTIPLE ABANDONMENTS UNDER PARAGRAPH 73(1)(A) OF THE *PATENT ACT*, A WRITTEN REPLY TO EACH REQUISITION MUST BE RECEIVED WITHIN 6 MONTHS AFTER THE ABOVE DATE.

This application has been examined taking into account applicant's correspondence received in this office on January 22, 2004.

The number of claims in this application is 171.

The examiner has identified the following defects in the application:

The search of the prior art has revealed the following:

Reference Applied:

United States Patent  
5,577,190

November 19, 1996 GOF-3/23

Peters



2,436,872

- 2 -

Peters discloses a media editing system.

Claims 10, 51, 94 and 130 do not comply with section 28.3 of the *Patent Act*. The subject matter of these claims would have been obvious on the claim date to a person skilled in the art or science to which they pertain having regard to Peters.

Claims 10, 51, 94 and 130 are obvious, because Peters teaches a media editing system for editing source material, which comprises a digitizing apparatus for receiving and digitizing video and audio source material, the video source material including a sequence of images, each spanning both the horizontal and vertical display axes of the video source material; computing apparatus including compression apparatus responsive to the digitizing apparatus, the compression apparatus being for compressing the images from the video source material; mass storage responsive to the computing apparatus to receive the compressed video source material, the audio source material, and the information regarding each adjustment; and output apparatus communicating with the computing apparatus for displaying the manipulated source material. Features of claims 10, 51, 94 and 130 are similar to those defined in the specifications of Peters's reference.

Therefore, claims 10, 51, 94 and 130 do not comply with Section 28.3 of the *Patent Act*.

In view of the foregoing defects, the applicant is requisitioned, under subsection 30(2) of the *Patent Rules*, to amend the application in order to comply with the *Patent Act* and the *Patent Rules* or to provide arguments as to why the application does comply.

***Section 29 of the Patent Rules requisition***

Under section 29 of the *Patent Rules*, the applicant is requisitioned to provide:

- identification of any prior art cited in respect of the European Patent Office application describing the same invention on behalf of the applicant or on behalf of any other person claiming under an inventor named in the present application, and the patent number, if granted, subsequent to the International Search Report under paragraph 29(1)(a) of the *Patent Rules*.

To satisfy this requisition, applicant should provide all the preceding information or documents, or provide in accordance with subsection 29(3) of the *Patent Rules* a statement of reasons why any information or document is not available or known.

S.Chhim  
Patent Examiner  
(819) 997-2238



UNITED STATES PATENT AND TRADEMARK OFFICE

UNITED STATES DEPARTMENT OF COMMERCE  
United States Patent and Trademark Office  
Address: COMMISSIONER FOR PATENTS  
P.O. Box 1450  
Alexandria, Virginia 22313-1450  
www.uspto.gov

APPLICATION NO.	FILING DATE	FIRST NAMED INVENTOR	ATTORNEY DOCKET NO.	CONFIRMATION NO.
10/223,200	08/16/2002	Michael E. Shanahan	MES/001CON	8026

39550                      7590                      09/18/2006

KALIKO & YEAGER, L.L.C.  
500 NORTH FRANKLIN TURNPIKE  
RAMSEY, NJ 07446

EXAMINER

TRAN, CONGVAN

ART UNIT                      PAPER NUMBER

2617

DATE MAILED: 09/18/2006

Please find below and/or attached an Office communication concerning this application or proceeding.

<b>Office Action Summary</b>	<b>Application No.</b> 10/223,200	<b>Applicant(s)</b> SHANAHAN, MICHAEL E.	
	<b>Examiner</b> CongVan Tran	<b>Art Unit</b> 2617	

-- The MAILING DATE of this communication appears on the cover sheet with the correspondence address --

**Period for Reply**

A SHORTENED STATUTORY PERIOD FOR REPLY IS SET TO EXPIRE 3 MONTH(S) OR THIRTY (30) DAYS, WHICHEVER IS LONGER, FROM THE MAILING DATE OF THIS COMMUNICATION.

- Extensions of time may be available under the provisions of 37 CFR 1.136(a). In no event, however, may a reply be timely filed after SIX (6) MONTHS from the mailing date of this communication.
- If NO period for reply is specified above, the maximum statutory period will apply and will expire SIX (6) MONTHS from the mailing date of this communication.
- Failure to reply within the set or extended period for reply will, by statute, cause the application to become ABANDONED (35 U.S.C. § 133). Any reply received by the Office later than three months after the mailing date of this communication, even if timely filed, may reduce any earned patent term adjustment. See 37 CFR 1.704(b).

**Status**

- 1)  Responsive to communication(s) filed on 10 July 2006.
- 2a)  This action is **FINAL**.
- 2b)  This action is non-final.
- 3)  Since this application is in condition for allowance except for formal matters, prosecution as to the merits is closed in accordance with the practice under *Ex parte Quayle*, 1935 C.D. 11, 453 O.G. 213.

**Disposition of Claims**

- 4)  Claim(s) 1-104 is/are pending in the application.
  - 4a) Of the above claim(s) 1-32,50-67,72,73 and 99-104 is/are withdrawn from consideration.
- 5)  Claim(s) \_\_\_\_\_ is/are allowed.
- 6)  Claim(s) 33-49,68-71 and 74-98 is/are rejected.
- 7)  Claim(s) \_\_\_\_\_ is/are objected to.
- 8)  Claim(s) \_\_\_\_\_ are subject to restriction and/or election requirement.

**Application Papers**

- 9)  The specification is objected to by the Examiner.
- 10)  The drawing(s) filed on \_\_\_\_\_ is/are: a)  accepted or b)  objected to by the Examiner.
  - Applicant may not request that any objection to the drawing(s) be held in abeyance. See 37 CFR 1.85(a).
  - Replacement drawing sheet(s) including the correction is required if the drawing(s) is objected to. See 37 CFR 1.121(d).
- 11)  The oath or declaration is objected to by the Examiner. Note the attached Office Action or form PTO-152.

**Priority under 35 U.S.C. § 119**

- 12)  Acknowledgment is made of a claim for foreign priority under 35 U.S.C. § 119(a)-(d) or (f).
    - a)  All    b)  Some \*    c)  None of:
      - 1.  Certified copies of the priority documents have been received.
      - 2.  Certified copies of the priority documents have been received in Application No. \_\_\_\_\_.
      - 3.  Copies of the certified copies of the priority documents have been received in this National Stage application from the International Bureau (PCT Rule 17.2(a)).
- \* See the attached detailed Office action for a list of the certified copies not received.

**Attachment(s)**

- |                                                                                                                       |                                                                                         |
|-----------------------------------------------------------------------------------------------------------------------|-----------------------------------------------------------------------------------------|
| 1) <input checked="" type="checkbox"/> Notice of References Cited (PTO-892)                                           | 4) <input type="checkbox"/> Interview Summary (PTO-413)<br>Paper No(s)/Mail Date. _____ |
| 2) <input type="checkbox"/> Notice of Draftsperson's Patent Drawing Review (PTO-948)                                  | 5) <input type="checkbox"/> Notice of Informal Patent Application                       |
| 3) <input checked="" type="checkbox"/> Information Disclosure Statement(s) (PTO/SB/08)<br>Paper No(s)/Mail Date _____ | 6) <input type="checkbox"/> Other: _____                                                |

**DETAILED ACTION**

***Claim Rejections - 35 USC § 112***

1. The following is a quotation of the second paragraph of 35 U.S.C. 112:

The specification shall conclude with one or more claims particularly pointing out and distinctly claiming the subject matter which the applicant regards as his invention.

2. Claims 48 and 68 are rejected under 35 U.S.C. 112, second paragraph, as being indefinite for failing to particularly point out and distinctly claim the subject matter which applicant regards as the invention.

3. Claims 48 and 68 are rejected under 35 U.S.C. 112, second paragraph, as being incomplete for omitting essential structural cooperative relationships of elements, such omission amounting to a gap between the necessary structural connections. See MPEP § 2172.01. The omitted structural cooperative relationships are: Claim 48 depends on claim 22. However, claim 22 has been canceled. The same as in claim 68.

***Claim Rejections - 35 USC § 102***

4. The following is a quotation of the appropriate paragraphs of 35 U.S.C. 102 that form the basis for the rejections under this section made in this Office action:

A person shall be entitled to a patent unless –

(e) the invention was described in (1) an application for patent, published under section 122(b), by another filed in the United States before the invention by the applicant for patent or (2) a patent granted on an application for patent by another filed in the United States before the invention by the applicant for patent, except that an international application filed under the treaty defined in section 351(a) shall have the effects for purposes of this subsection of an application filed in the United States only if the international application designated the United States and was published under Article 21(2) of such treaty in the English language.

5. Claims 33, 36, 39-43, 46, 48-49, 70-71 are rejected under 35 U.S.C. 102(e) as being anticipated by Valentine et al. (6,018, 654).

Regarding claims 33, 36, 39-43, 46, 48-49, 70-71, Valentine discloses a method and apparatus for downloading tones to mobile terminal, comprising:

a communications link capable of connecting to a remote database in the remoter computer that includes a plurality of lists of audio files (fig.3, elements 100, 50, 20 and its description);

a display screen that allows a user of the wireless telephone to browse at least one of the lists of audio files and view selectable audio files present in the browsed list (see fig.4, element 260, and its description);

a speaker and processing circuitry configured to allow the user to optionally review a selected audio file before downloading the selected audio file into the wireless telephone (see fig.4, element 270 and its description); and

a programmable memory circuit for allowing the user to optionally store the selected audio file for use as an indicia of an incoming communication (see fig.4, element 280 and its description).

***Claim Rejections - 35 USC § 103***

6. The following is a quotation of 35 U.S.C. 103(a) which forms the basis for all obviousness rejections set forth in this Office action:

(a) A patent may not be obtained though the invention is not identically disclosed or described as set forth in section 102 of this title, if the differences between the subject matter sought to be patented and the prior art are such that the subject matter as a whole would have been obvious at the time the invention was made to a person having ordinary skill in the art to which said subject matter pertains. Patentability shall not be negated by the manner in which the invention was made.

7. Claims 34-35, 37, 38, 44-45, 47, and 74-98, are rejected under 35 U.S.C. 103(a) as being unpatentable over Valentine et al. (6,018, 654) in view of Farris et al.

(6,151,491). 33-49, 69-71, 74-81, and 91-98

Regarding claims 74--79, 81-91, and 93-98, Valentine discloses a method and apparatus for downloading tones to mobile terminal, comprising:

a communications link capable of connecting to a remote database that includes a plurality of lists of audio files (fig.3, elements 100, 50, 20 and its description);

a display screen that allows a user of the wireless telephone to browse at least one of the lists of audio files and view selectable audio files present in the browsed list (see fig.4, element 260, and its description);

processing circuitry configured to receive a selected one of the audio files from the communications link (see fig.4, element 270 and its description); and

a programmable memory circuit for allowing the user to optionally store the selected audio file for use as an indicia of an incoming communication (see fig.4, element 280 and its description), except for mobile internet browse and enhanced performance speaker. However, Farris discloses a mobile voice message system comprises mobile Internet browse and enhanced performance speaker (see fig.1, element 2, 18 and its description). Thus, it would have been obvious to one having ordinary skill in the art at the time the invention was made to use the Farris's mobile Internet browser system in Valentine's in order to enhance the use of the mobile telecommunication device.

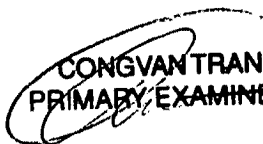
Regarding claims 34-35, 44-45, 69, 80, and 92, Farris further discloses wherein the memory circuit is configured to store audio files in a format selected from MPEG (see col. 14).

Regarding claims 37, 38, and 47, Farris further discloses wherein the wireless phone is configured to search the Internet (see fig.18 and its description).

Any inquiry concerning this communication or earlier communications from the examiner should be directed to CongVan Tran whose telephone number is 571-272-7871. The examiner can normally be reached on Monday-Thursday.

If attempts to reach the examiner by telephone are unsuccessful, the examiner's supervisor, Nick Corsaro can be reached on 571-272-7876. The fax phone number for the organization where this application or proceeding is assigned is 571-273-8300.

Information regarding the status of an application may be obtained from the Patent Application Information Retrieval (PAIR) system. Status information for published applications may be obtained from either Private PAIR or Public PAIR. Status information for unpublished applications is available through Private PAIR only. For more information about the PAIR system, see <http://pair-direct.uspto.gov>. Should you have questions on access to the Private PAIR system, contact the Electronic Business Center (EBC) at 866-217-9197 (toll-free). If you would like assistance from a USPTO Customer Service Representative or access to the automated information system, call 800-786-9199 (IN USA OR CANADA) or 571-272-1000.

  
CONGVANTRAN  
PRIMARY EXAMINER

CongVan Tran  
Primary Examiner  
Art Unit 2617

Sept. 11, 2006.



AUG 15 2006

PTC/38/08A (07-05)

Approved for use through 07/31/2006. OMB 0651-0031

U.S. Patent and Trademark Office; U.S. DEPARTMENT OF COMMERCE

Under the Paperwork Reduction Act of 1995, no persons are required to respond to a collection of information unless it contains a valid OMB control number.

Substitute for form 1449/PTO

**INFORMATION DISCLOSURE STATEMENT BY APPLICANT**  
*(Use as many sheets as necessary)*

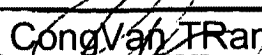
**Complete if Known**

Application Number	10/223,200
Filing Date	August 16, 2002
First Named Inventor	Michael E. Shanahan
Art Unit	2617
Examiner Name	Congvan Tran
Attorney Docket Number	MES/001 CON

Sheet 1 of 1

U. S. PATENT DOCUMENTS					
Examiner Initials <sup>1</sup>	Cite No. <sup>1</sup>	Document Number	Publication Date	Name of Patentee or Applicant of Cited Document	Pages, Columns, Lines, Where Relevant Passage or Relevant Figures Appear
		Number-Kind Code <sup>2</sup> (if known)	MM-DD-YYYY		
CT		US- 6,845,398	01-18-2005	Galsensky et al.	
CT		US- 6,829,618	12-07-2004	Abraham et al.	
		US-			
		US-			
		US-			
		US-			
		US-			
		US-			
		US-			
		US-			
		US-			
		US-			
		US-			
		US-			
		US-			
		US-			
		US-			
		US-			
		US-			
		US-			

FOREIGN PATENT DOCUMENTS						
Examiner Initials <sup>1</sup>	Cite No. <sup>1</sup>	Foreign Patent Document	Publication Date	Name of Patentee or Applicant of Cited Document	Pages, Columns, Lines, Where Relevant Passage or Relevant Figures Appear	T <sup>4</sup>
		Country Code <sup>3</sup> Number <sup>1</sup> Kind Code <sup>2</sup> (if known)	MM-DD-YYYY			

<b>Examiner Signature</b>	 <b>Cong Van Tran</b>	<b>Date Considered</b>	<b>Sept. 08, 2006</b>
---------------------------	-------------------------------------------------------------------------------------------------------------	------------------------	-----------------------

Digitally signed by Cong Van Tran  
DN: cn=Cong Van Tran, o=US, ou=2817,  
email=Congvan.tran@uspto.gov,  
date=2006.09.11.10:41:17.000Z

<sup>1</sup>EXAMINER: Initial reference considered, whether or not citation is in conformance with MPEP 609. Draw line through citation if not in conformance and not considered. Include copy of this form with next communication to applicant. <sup>2</sup>Applicant's unique citation designation number (optional). <sup>3</sup>See Kind Codes of USPTO Patent Documents at [www.uspto.gov](http://www.uspto.gov) or MPEP 901.04. <sup>4</sup>Enter Office that issued the document, by the two-letter code (WIPO Standard ST.3). <sup>5</sup>For Japanese patent documents, the indication of the year of the reign of the Emperor must precede the serial number of the patent document. <sup>6</sup>Kind of document by the appropriate symbols as indicated on the document under WIPO Standard ST.18 if possible. <sup>7</sup>Applicant is to place a check mark here if English language Translation is attached.

This collection of information is required by 37 CFR 1.97 and 1.98. The information is required to obtain or retain a benefit by the public which is to file (and by the USPTO to process) an application. Confidentiality is governed by 35 U.S.C. 122 and 37 CFR 1.14. This collection is estimated to take 2 hours to complete, including gathering, preparing, and submitting the completed application form to the USPTO. Time will vary depending upon the individual case. Any comments on the amount of time you require to complete this form and/or suggestions for reducing this burden, should be sent to the Chief Information Officer, U.S. Patent and Trademark Office, P.O. Box 1450, Alexandria, VA 22313-1450. DO NOT SEND FEES OR COMPLETED FORMS TO THIS ADDRESS. SEND TO: Commissioner for Patents, P.O. Box 1450, Alexandria, VA 22313-1450.

*If you need assistance in completing the form, call 1-800-PTO-9199 (1-800-786-9199) and select option 2.*

JUL 20 2006

PTO/SB/08A (07-05)

Approved for use through 07/31/2008. OMB 0651-0031

U.S. Patent and Trademark Office, U.S. DEPARTMENT OF COMMERCE

Under the Paperwork Reduction Act of 1995, no persons are required to respond to a collection of information unless it contains a valid OMB control number.

Substitute for form 1449/PTO  <b>INFORMATION DISCLOSURE STATEMENT BY APPLICANT</b> <i>(Use as many sheets as necessary)</i>	<i>Complete if Known</i>	
	Application Number	10/223,200
	Filing Date	August 16, 2002
	First Named Inventor	Michael E. Shanahan
	Art Unit	2617
	Examiner Name	CongVan Tran
Sheet 1 of 1	Attorney Docket Number	Mes/001 CON

Examiner Initials*	Cite No. <sup>1</sup>	Document Number	Publication Date MM-DD-YYYY	Name of Patentee or Applicant of Cited Document	Pages, Columns, Lines, Where Relevant Passages or Relevant Figures Appear
		Number-Kind Code <sup>2, 7</sup> (if known)			
CT	US-	6,928,468	08-09-2005	Leermakers	
CT	US-	6,198,941	03-06-2001	Aho et al.	
CT	US-	2005/0054379	03-10-2005	Cao et al.	
	US-				
	US-				
	US-				
	US-				
	US-				
	US-				
	US-				
	US-				
	US-				
	US-				
	US-				
	US-				
	US-				
	US-				
	US-				

Examiner Initials*	Cite No. <sup>1</sup>	Foreign Patent Document	Publication Date MM-DD-YYYY	Name of Patentee or Applicant of Cited Document	Pages, Columns, Lines, Where Relevant Passages or Relevant Figures Appear	T*
		Country Code <sup>2</sup> Number <sup>4</sup> Kind Code <sup>3</sup> (if known)				

Examiner Signature <b>CongVan Tran</b>	<small>Digitally signed by CongVan Tran DN: cn=CongVan Tran, o=US, email=congvan@uspto.gov Date: 2006.09.11 10:45:27 -0500</small>	Date Considered	Sept 08, 2006
-------------------------------------------	--------------------------------------------------------------------------------------------------------------------------------------------	-----------------	---------------

\*EXAMINER: Initials if reference considered, whether or not citation is in conformance with MPEP 608. Draw line through citation if not in conformance and not considered. Include copy of this form with next communication to applicant. <sup>1</sup> Applicant's unique citation designation number (optional). <sup>2</sup> See Kinda Codes of USPTO Patent Documents at [www.uspto.gov](http://www.uspto.gov) or MPEP 901.04. <sup>3</sup> Enter Office that issued the document, by the two-letter code (WIPO Standard ST.3). <sup>4</sup> For Japanese patent documents, the indication of the year of the reign of the Emperor must precede the serial number of the patent document. <sup>5</sup> Kind of document by the appropriate symbols as indicated on the document under WIPO Standard ST.16 if possible. <sup>6</sup> Applicant is to place a check mark here if English language translation is attached.

This collection of information is required by 37 CFR 1.97 and 1.98. The information is required to obtain or retain a benefit by the public which is to file (and by the USPTO to process) an application. Confidentiality is governed by 35 U.S.C. 122 and 37 CFR 1.14. This collection is estimated to take 2 hours to complete, including gathering, preparing, and submitting the completed application form to the USPTO. Time will vary depending upon the individual case. Any comments on the amount of time you require to complete this form and/or suggestions for reducing this burden, should be sent to the Chief Information Officer, U.S. Patent and Trademark Office, P.O. Box 1450, Alexandria, VA 22313-1450. DO NOT SEND FEES OR COMPLETED FORMS TO THIS ADDRESS. SEND TO: Commissioner for Patents, P.O. Box 1450, Alexandria, VA 22313-1450.

If you need assistance in completing the form, call 1-800-PTO-9199 (1-800-786-9199) and select option 2.

<b>Notice of References Cited</b>	Application/Control No. 10/223,200	Applicant(s)/Patent Under Reexamination SHANAHAN, MICHAEL E.	
	Examiner CongVan Tran	Art Unit 2617	Page 1 of 1

**U.S. PATENT DOCUMENTS**

*	Document Number Country Code-Number-Kind Code	Date MM-YYYY	Name	Classification
*	A US-6,018,654 A	01-2000	Valentine et al.	455/414.4
*	B US-6,151,491 A	11-2000	Farris et al.	455/412.2
	C US-			
	D US-			
	E US-			
	F US-			
	G US-			
	H US-			
	I US-			
	J US-			
	K US-			
	L US-			
	M US-			

**FOREIGN PATENT DOCUMENTS**

*	Document Number Country Code-Number-Kind Code	Date MM-YYYY	Country	Name	Classification
	N				
	O				
	P				
	Q				
	R				
	S				
	T				

**NON-PATENT DOCUMENTS**

*	Include as applicable: Author, Title Date, Publisher, Edition or Volume, Pertinent Pages)
	U
	V
	W
	X

\*A copy of this reference is not being furnished with this Office action. (See MPEP § 707.05(a).)  
Dates in MM-YYYY format are publication dates. Classifications may be US or foreign.

**Index of Claims**



**Application/Control No.**

10/223,200

**Examiner**

CongVan Tran

**Applicant(s)/Patent under Reexamination**

SHANAHAN, MICHAEL E.

**Art Unit**

2617

✓	Rejected
=	Allowed

-	(Through numeral) Cancelled
+	Restricted

N	Non-Elected
I	Interference

A	Appeal
O	Objected

Claim		Date	
Final	Original	6/11/06	
1			
2			
3			
4			
5			
6			
7			
8			
9			
10			
11			
12			
13			
14			
15			
16			
17			
18			
19			
20			
21			
22			
23			
24			
25			
26			
27			
28			
29			
30			
31			
32			
33	✓		
34			
35			
36			
37			
38			
39			
40			
41			
42			
43			
44			
45			
46			
47			
48			
49	✓		
50			

Claim		Date	
Final	Original	6/11/06	
51			
52			
53			
54			
55			
56			
57			
58			
59			
60			
61			
62			
63			
64			
65			
66			
67			
68	✓		
69	✓		
70	✓		
71	✓		
72			
73			
74	✓		
75			
76			
77			
78			
79			
80			
81			
82			
83			
84			
85			
86			
87			
88			
89			
90			
91			
92			
93			
94			
95			
96			
97			
98	✓		
99			
100			

Claim		Date	
Final	Original	6/11/06	
101			
102			
103			
104			
105			
106			
107			
108			
109			
110			
111			
112			
113			
114			
115			
116			
117			
118			
119			
120			
121			
122			
123			
124			
125			
126			
127			
128			
129			
130			
131			
132			
133			
134			
135			
136			
137			
138			
139			
140			
141			
142			
143			
144			
145			
146			
147			
148			
149			
150			

**Search Notes**



Application/Control No.

10/223,200

Examiner

CongVan Tran

Applicant(s)/Patent under Reexamination

SHANAHAN, MICHAEL E.

Art Unit

2617

**SEARCHED**

Class	Subclass	Date	Examiner

**INTERFERENCE SEARCHED**

Class	Subclass	Date	Examiner

**SEARCH NOTES (INCLUDING SEARCH STRATEGY)**

	DATE	EXMR
Search Updated	9/8/2006	CT



RECEIVED  
CENTRAL FAX CENTER  
AUG 15 2006

500 North Franklin Turnpike, Ramsey, NJ 07446  
(201) 831-0575 Main Tel  
(201) 831-0519 Main Fax

**FACSIMILE TRANSMITTAL SHEET**

TO:	FROM:
Commissioner for Patents	Scott H. Kaliko, Esq.
	SENDER'S FAX NUMBER:
	201-831-0519
	SENDER'S TELEPHONE NUMBER:
	201-831-0575
COMPANY:	DATE:
United States Patent & Trademark Office	AUGUST 15, 2006
RECIPIENT'S FAX NUMBER:	TOTAL NO. OF PAGES INCLUDING COVER:
571-273-8300	54
RECIPIENT'S TELEPHONE NUMBER:	CLIENT / MATTER:
RE:	YOUR REFERENCE NUMBER:
Application No. 10/223,200	MTS/001 CON

URGENT     FOR REVIEW     PLEASE COMMENT     PLEASE REPLY     PLEASE RECYCLE

NOTES/COMMENTS:

- Please confirm receipt of this fax and the below-identified attached parts.
1. Transmittal Form/Certificate of Transmission; and
  2. Fee Transmittal (2 Copies); and
  3. Credit Card Payment Form; and
  4. Information Disclosure Statement; and
  5. PTO Form 1449; and
  6. Copies of References.

CONFIDENTIALITY NOTICE

The information contained in this facsimile message is privileged and confidential and is intended only for the use of the individual(s) and/or entity(ies) named above. If you are not the intended recipient, you are hereby notified that any unauthorized disclosure, copying, distribution or taking of any action in reliance on the contents of the information contained herein is strictly prohibited and review by any individual other than the intended recipient shall not constitute a waiver of the attorney-client privilege. If you have received this transmission in error, please immediately notify us by telephone. Thank you.

**AUG 15 2006**

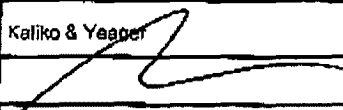
PTO/SB/21 (09-04)

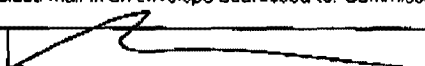
Approved for use through 07/31/2008. OMB 0651-0031  
U.S. Patent and Trademark Office, U.S. DEPARTMENT OF COMMERCE

Under the Paperwork Reduction Act of 1995, no persons are required to respond to a collection of information unless it displays a valid OMB control number.

<b>TRANSMITTAL FORM</b>  <small>(to be used for all correspondence after initial filing)</small>	Application Number	10/223,200	
	Filing Date	August 16, 2002	
	First Named Inventor	Michael E. Shanahan	
	Art Unit	2817	
	Examiner Name	Congvan Tran	
Total Number of Pages in This Submission	53	Attorney Docket Number	MES/001 CON

ENCLOSURES (Check all that apply)		
<input checked="" type="checkbox"/> Fee Transmittal Form	<input type="checkbox"/> Drawing(s)	<input type="checkbox"/> After Allowance Communication to TC
<input checked="" type="checkbox"/> Fee Attached	<input type="checkbox"/> Licensing-related Papers	<input type="checkbox"/> Appeal Communication to Board of Appeals and Interferences
<input type="checkbox"/> Amendment/Reply	<input type="checkbox"/> Petition	<input type="checkbox"/> Appeal Communication to TC (Appeal Notice, Brief, Reply Brief)
<input type="checkbox"/> After Final	<input type="checkbox"/> Petition to Convert to a Provisional Application	<input type="checkbox"/> Proprietary Information
<input type="checkbox"/> Affidavits/declaration(s)	<input type="checkbox"/> Power of Attorney, Revocation	<input type="checkbox"/> Status Letter
<input type="checkbox"/> Extension of Time Request	<input type="checkbox"/> Change of Correspondence Address	<input checked="" type="checkbox"/> Other Enclosure(s) (please identify below):
<input type="checkbox"/> Express Abandonment Request	<input type="checkbox"/> Terminal Disclaimer	
<input checked="" type="checkbox"/> Information Disclosure Statement	<input type="checkbox"/> Request for Refund	
<input type="checkbox"/> Certified Copy of Priority Document(s)	<input type="checkbox"/> CD, Number of CD(s) _____	
<input type="checkbox"/> Reply to Missing Parts/ Incomplete Application	<input type="checkbox"/> Landscape Table on CD	
<input type="checkbox"/> Reply to Missing Parts under 37 CFR 1.52 or 1.53	<b>Remarks</b>	
	1. Supplemental IDS; and 2. PTO Form 1449; and 3. Credit Card Payment Form; and 4. Copies of References.	

SIGNATURE OF APPLICANT, ATTORNEY, OR AGENT			
Firm Name	Kaliko & Yeager		
Signature			
Printed name	Scott H. Kaliko, Esq.		
Date	August 15, 2006	Reg. No.	45,786

CERTIFICATE OF TRANSMISSION/MAILING			
I hereby certify that this correspondence is being facsimile transmitted to the USPTO or deposited with the United States Postal Service with sufficient postage as first class mail in an envelope addressed to: Commissioner for Patents, P.O. Box 1450, Alexandria, VA 22313-1450 on the date shown below:			
Signature			
Typed or printed name	Scott H. Kaliko, Esq.	Date	August 15, 2006

This collection of information is required by 37 CFR 1.5. The information is required to obtain or retain a benefit by the public which is to file (and by the USPTO to process) an application. Confidentiality is governed by 35 U.S.C. 122 and 37 CFR 1.11 and 1.14. This collection is estimated to 2 hours to complete, including gathering, preparing, and submitting the completed application form to the USPTO. Time will vary depending upon the individual case. Any comments on the amount of time you require to complete this form and/or suggestions for reducing this burden, should be sent to the Chief Information Officer, U.S. Patent and Trademark Office, U.S. Department of Commerce, P.O. Box 1450, Alexandria, VA 22313-1450. DO NOT SEND FEES OR COMPLETED FORMS TO THIS ADDRESS. SEND TO: Commissioner for Patents, P.O. Box 1450, Alexandria, VA 22313-1450.

If you need assistance in completing the form, call 1-800-PTO-9199 and select option 2.

AUG 15 2006

PTO/SB/17 (01-08)  
Approved for use through 07/31/2006. OMB 0651-0032  
U.S. Patent and Trademark Office: U.S. DEPARTMENT OF COMMERCE

Under the Paperwork Reduction Act of 1995 no persons are required to respond to a collection of information unless it displays a valid OMB control number

<b>FEE TRANSMITTAL</b> <b>For FY 2006</b>		<b>Complete If Known</b>	
		Application Number	10/223.200
<input checked="" type="checkbox"/> Applicant claims small entity status. See 37 CFR 1.27		Filing Date	August 16, 2002
TOTAL AMOUNT OF PAYMENT (\$) 180.00		First Named Inventor	Michael E. Shanahan
		Examiner Name	Congvan Tran
		Art Unit	2617
		Attorney Docket No.	MES/001 CON

**METHOD OF PAYMENT** (check all that apply)

Check 
  Credit Card 
  Money Order 
  None 
  Other (please identify): \_\_\_\_\_

Deposit Account Deposit Account Number: \_\_\_\_\_ Deposit Account Name: \_\_\_\_\_

For the above-identified deposit account, the Director is hereby authorized to: (check all that apply)

Charge fee(s) indicated below 
  Charge fee(s) indicated below, except for the filing fee

Charge any additional fee(s) or underpayments of fee(s) under 37 CFR 1.16 and 1.17 
  Credit any overpayments

**WARNING:** Information on this form may become public. Credit card information should not be included on this form. Provide credit card information and authorization on PTO-2039.

**FEE CALCULATION** (All the fees below are due upon filing or may be subject to a surcharge.)

**1. BASIC FILING, SEARCH, AND EXAMINATION FEES**

Application Type	FILING FEES		SEARCH FEES		EXAMINATION FEES		Fees Paid (\$)
	Fee (\$)	Small Entity Fee (\$)	Fee (\$)	Small Entity Fee (\$)	Fee (\$)	Small Entity Fee (\$)	
Utility	300	150	500	250	200	100	_____
Design	200	100	100	50	130	65	_____
Plant	200	100	300	150	160	80	_____
Reissue	300	150	500	250	600	300	_____
Provisional	200	100	0	0	0	0	_____

**2. EXCESS CLAIM FEES**

Fee Description	Fee (\$)	Small Entity Fee (\$)
Each claim over 20 (including Reissues)	50	25
Each independent claim over 3 (including Reissues)	200	100
Multiple dependent claims	360	180

**Total Claims** - 20 or HP = \_\_\_\_\_ x \_\_\_\_\_ = \_\_\_\_\_  
 HP = highest number of total claims paid for, if greater than 20.

**Indep. Claims** - 3 or HP = \_\_\_\_\_ x \_\_\_\_\_ = \_\_\_\_\_  
 HP = highest number of independent claims paid for, if greater than 3.

**3. APPLICATION SIZE FEE**

If the specification and drawings exceed 100 sheets of paper (excluding electronically filed sequence or computer listings under 37 CFR 1.52(e)), the application size fee due is \$250 (\$125 for small entity) for each additional 50 sheets or fraction thereof. See 35 U.S.C. 41(a)(1)(G) and 37 CFR 1.16(s).

Total Sheets	Extra Sheets	Number of each additional 50 or fraction thereof	Fee (\$)	Fee Paid (\$)
_____	_____	_____	_____	_____

**4. OTHER FEE(S)**

Description	Fee (\$)	Fees Paid (\$)
Non-English Specification, \$130 fee (no small entity discount)	_____	_____
Other (e.g., late filing surcharge): IDS fee 37 CFR 1.17 (P)	_____	180.00

<b>SUBMITTED BY</b>		
Signature		Registration No. (Attorney/Agent) 45,786
Name (Print/Type)	Scott H. Kaliko, Esq.	Telephone 201-831-0575
		Date August 15, 2006

This collection of information is required by 37 CFR 1.136. The information is required to obtain or retain a benefit by the public which is to file (and by the USPTO to process) an application. Confidentiality is governed by 35 U.S.C. 122 and 37 CFR 1.14. This collection is estimated to take 30 minutes to complete, including gathering, preparing, and submitting the completed application form to the USPTO. Time will vary depending upon the individual case. Any comments on the amount of time you require to complete this form and/or suggestions for reducing this burden, should be sent to the Chief Information Officer, U.S. Patent and Trademark Office, U.S. Department of Commerce, P.O. Box 1450, Alexandria, VA 22313-1450. DO NOT SEND FEES OR COMPLETED FORMS TO THIS ADDRESS. SEND TO: Commissioner for Patents, P.O. Box 1450, Alexandria, VA 22313-1450.

If you need assistance in completing the form, call 1-800-PTO-9199 and select option 2.



AUG 15 2006

Approved for use through 07/31/2006. OMB 0661-0032  
U.S. Patent and Trademark Office; U.S. DEPARTMENT OF COMMERCE

Under the Paperwork Reduction Act of 1995 no persons are required to respond to a collection of information unless it displays a valid OMB control number

Fees pursuant to the Consolidated Appropriations Act, 2005 (H.R. 4618). <b>FEE TRANSMITTAL</b> <b>For FY 2006</b>		<b>Completes If Known</b>	
<input checked="" type="checkbox"/> Applicant claims small entity status. See 37 CFR 1.27		Application Number	10/223,200
<b>TOTAL AMOUNT OF PAYMENT</b> (\$) 180.00		Filing Date	August 16, 2002
		First Named Inventor	Michael E. Shanahan
		Examiner Name	Congvan Tran
		Art Unit	2617
		Attorney Docket No.	MES/001 CON

**METHOD OF PAYMENT** (check all that apply)

Check  Credit Card  Money Order  None  Other (please identify): \_\_\_\_\_

Deposit Account Deposit Account Number: \_\_\_\_\_ Deposit Account Name: \_\_\_\_\_

For the above-identified deposit account, the Director is hereby authorized to: (check all that apply)

Charge fee(s) indicated below  Charge fee(s) indicated below, except for the filing fee  
 Charge any additional fee(s) or underpayments of fee(s) under 37 CFR 1.16 and 1.17  Credit any overpayments

**WARNING:** Information on this form may become public. Credit card information should not be included on this form. Provide credit card information and authorization on PTO-2038.

**FEE CALCULATION** (All the fees below are due upon filing or may be subject to a surcharge.)

**1. BASIC FILING, SEARCH, AND EXAMINATION FEES**

Application Type	FILING FEES		SEARCH FEES		EXAMINATION FEES		Fees Paid (\$)
	Fee (\$)	Small Entity Fee (\$)	Fee (\$)	Small Entity Fee (\$)	Fee (\$)	Small Entity Fee (\$)	
Utility	300	150	500	250	200	100	_____
Design	200	100	100	50	130	65	_____
Plant	200	100	300	150	160	80	_____
Reissue	300	150	500	250	600	300	_____
Provisional	200	100	0	0	0	0	_____

**2. EXCESS CLAIM FEES**

Fee Description	Fee (\$)	Small Entity Fee (\$)
Each claim over 20 (including Reissues)	50	25
Each independent claim over 3 (including Reissues)	200	100
Multiple dependent claims	360	180

**Total Claims** - 20 or HP = \_\_\_\_\_ x \_\_\_\_\_ = \_\_\_\_\_  
 HP = highest number of total claims paid for, if greater than 20.

**Indep. Claims** - 3 or HP = \_\_\_\_\_ x \_\_\_\_\_ = \_\_\_\_\_  
 HP = highest number of independent claims paid for, if greater than 3.

**3. APPLICATION SIZE FEE**

If the specification and drawings exceed 100 sheets of paper (excluding electronically filed sequence or computer listings under 37 CFR 1.52(e)), the application size fee due is \$250 (\$125 for small entity) for each additional 50 sheets or fraction thereof. See 35 U.S.C. 41(a)(1)(G) and 37 CFR 1.16(g).

Total Sheets	Extra Sheets	Number of each additional 50 or fraction thereof	Fee (\$)	Fee Paid (\$)
_____	_____	_____ / 50 = _____ (round up to a whole number)	_____ x _____ = _____	_____

**4. OTHER FEE(S)**

Description	Fee (\$)	Fees Paid (\$)
Non-English Specification, \$130 fee (no small entity discount)	_____	_____
Other (e.g., late filing surcharge): JDS fee 37 CFR 1.17 (P)	_____	180.00

**SUBMITTED BY**

Signature		Registration No. (Attorney/Agent)	45,786	Telephone	201-831-0575
Name (Print/Type)	Scott H. Kaliko, Esq.	Date	August 15, 2006		

This collection of information is required by 37 CFR 1.136. The information is required to obtain or retain a benefit by the public which is to file (and by the USPTO to process) an application. Confidentiality is governed by 35 U.S.C. 122 and 37 CFR 1.14. This collection is estimated to take 30 minutes to complete, including gathering, preparing, and submitting the completed application form to the USPTO. Time will vary depending upon the individual case. Any comments on the amount of time you require to complete this form and/or suggestions for reducing this burden, should be sent to the Chief Information Officer, U.S. Patent and Trademark Office, U.S. Department of Commerce, P.O. Box 1450, Alexandria, VA 22313-1450. DO NOT SEND FEES OR COMPLETED FORMS TO THIS ADDRESS. SEND TO: Commissioner for Patents, P.O. Box 1450, Alexandria, VA 22313-1450.

If you need assistance in completing the form, call 1-800-PTO-9199 and select option 2.

RECEIVED  
CENTRAL FAX CENTER  
AUG 15 2006

PATENT  
MES/001 CON

IN THE UNITED STATES PATENT AND TRADEMARK OFFICE

Applicant : Michael E. Shanahan

Serial No. : 10/223,200 Confirmation No.: 8026

Filed : August 16, 2002

Title : METHODS AND APPARATUSES FOR PROGRAMMING  
USER-DEFINED INFORMATION INTO ELECTRONIC  
DEVICES.

Examiner : Congvan Tran

Group Art Unit : 2617

Commissioner for Patents  
P.O. Box 1450  
Alexandria, VA 22213-1450

INFORMATION DISCLOSURE STATEMENT

Sir:

Pursuant to 37 C.F.R. §§ 1.56, 1.97 and 1.98, applicant hereby makes the documents listed below of record in the above-identified application.

U.S. Patents

Abraham et al.	Patent No. 6,829,618	December, 2004
Galensky et al.	Patent No. 6,845,398	January, 2005

08/16/2006 MBINAS 00000006 10223200

01 FC:1006

100.00 OP

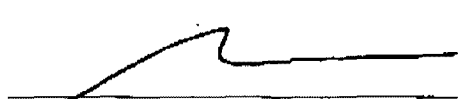
PATENT  
MES/001 CON

It is respectfully requested the Examiner fully consider these and any associated documents during the examination of this application, make them of record, and indicate his or her consideration of the documents by initialing the enclosed Citation List adjacent the citation of each document, and print them on any patent that may issue on this application. It is requested that a copy of the initialed Citation form be returned to applicant's undersigned Attorney. Citing of references herein shall not be deemed an admission that such references are prior art. Copies of the cited references are transmitted herewith.

Included is a USPTO Credit Card payment form which authorizes charges for \$180.00 in payment of IDS fee pursuant to 37 C.F.R. § 1.17 (p) and § 1.97(c) (2).

Respectfully submitted,

8/15/06  
Date

  
\_\_\_\_\_  
Scott H. Kaliko  
Attorney for Applicant  
Registration No. 45,786  
KALIKO & YEAGER, L.L.C.  
500 North Franklin Turnpike  
Ramsey, NJ 07446  
Direct: 201-831-0575  
Fax: 201-831-0519





**RECEIVED**  
**CENTRAL FAX CENTER**  
**JUL 20 2006**

500 North Franklin Turnpike, Ramsey, NJ 07446  
(201) 831-0575 Main Tel  
(201) 831-0519 Main Fax

**FACSIMILE TRANSMITTAL SHEET**

TO:	FROM:
Commissioner for Patents	Scott H. Kaliko, Esq.
	SENDER'S FAX NUMBER:
	201-831-0519
	SENDER'S TELEPHONE NUMBER:
	201-831-0575
COMPANY:	DATE:
United States Patent and Trademark Office	JULY 20, 2006
RECIPIENT'S FAX NUMBER:	TOTAL NO. OF PAGES INCLUDING COVER:
571-273-8300	39
RECIPIENT'S TELEPHONE NUMBER:	CLIENT / MATTER:
RE:	YOUR REFERENCE NUMBER:
Application No. 10/223,200	MES/001 CON

URGENT     FOR REVIEW     PLEASE COMMENT     PLEASE REPLY     PLEASE RECYCLE

NOTES/COMMENTS:

Please confirm receipt of this fax and the below-identified attached parts.

1. Transmittal Form; and
2. Fee Transmittal Form; and
3. Credit Card Payment Form; and
4. Information Disclosure Statement; and
5. PTO Form 1449; and
6. Copies of References.

**CONFIDENTIALITY NOTICE**

The information contained in this facsimile message is privileged and confidential and is intended only for the use of the individual(s) and/or entity(ies) named above. If you are not the intended recipient, you are hereby notified that any unauthorized disclosure, copying, distribution or taking of any action in reliance on the contents of the information contained herein is strictly prohibited and review by any individual other than the intended recipient shall not constitute a waiver of the attorney-client privilege. If you have received this transmission in error, please immediately notify us by telephone. Thank you.

*Pg 8-39 are US patent and are Recycled*

JUL 20 2006

PTO/SB/21 (09-04)

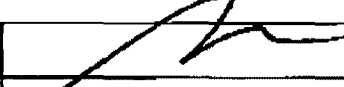
Approved for use through 07/31/2006. OMB 0851-0031  
U.S. Patent and Trademark Office, U.S. DEPARTMENT OF COMMERCE

Under the Paperwork Reduction Act of 1995, no persons are required to respond to a collection of information unless it displays a valid OMB control number.

<b>TRANSMITTAL FORM</b>  <small>(to be used for all correspondence after initial filing)</small>	Application Number	10/223,200	
	Filing Date	August 16, 2002	
	First Named Inventor	Michael E. Shanahan	
	Art Unit	2617	
	Examiner Name	Cong Van Tran	
Total Number of Pages in This Submission	<b>38</b>	Attorney Docket Number	MES/001 CON

ENCLOSURES <small>(Check all that apply)</small>		
<input checked="" type="checkbox"/> Fee Transmittal Form	<input type="checkbox"/> Drawing(s)	<input type="checkbox"/> After Allowance Communication to TC
<input checked="" type="checkbox"/> Fee Attached	<input type="checkbox"/> Licensing-related Papers	<input type="checkbox"/> Appeal Communication to Board of Appeals and Interferences
<input type="checkbox"/> Amendment/Reply	<input type="checkbox"/> Petition	<input type="checkbox"/> Appeal Communication to TC (Appeal Notice, Brief, Reply Brief)
<input type="checkbox"/> After Final	<input type="checkbox"/> Petition to Convert to a Provisional Application	<input type="checkbox"/> Proprietary Information
<input type="checkbox"/> Affidavits/declaration(s)	<input type="checkbox"/> Power of Attorney, Revocation	<input type="checkbox"/> Status Letter
<input type="checkbox"/> Extension of Time Request	<input type="checkbox"/> Change of Correspondence Address	<input checked="" type="checkbox"/> Other Enclosure(s) (please identify below):
<input type="checkbox"/> Express Abandonment Request	<input type="checkbox"/> Terminal Disclaimer	
<input checked="" type="checkbox"/> Information Disclosure Statement	<input type="checkbox"/> Request for Refund	
<input type="checkbox"/> Certified Copy of Priority Document(s)	<input type="checkbox"/> CD, Number of CD(s) _____	
<input type="checkbox"/> Reply to Missing Parts/Incomplete Application	<input type="checkbox"/> Landscape Table on CD	
<input type="checkbox"/> Reply to Missing Parts under 37 CFR 1.52 or 1.53	<b>Remarks</b>	
	1. Supplemental IDS; and 2. Information Disclosure Statement; and 3. Credit Card Payment Form; and 4. Copies of References.	

SIGNATURE OF APPLICANT, ATTORNEY, OR AGENT			
Firm Name	Kaliko & Yeager, L.L.C		
Signature			
Printed name	Scott H. Kaliko, Esq.		
Date	July 20, 2006	Reg. No.	45,786

CERTIFICATE OF TRANSMISSION/MAILING	
I hereby certify that this correspondence is being facsimile transmitted to the USPTO or deposited with the United States Postal Service with sufficient postage as first class mail in an envelope addressed to: Commissioner for Patents, P.O. Box 1450, Alexandria, VA 22313-1450 on the date shown below.	
Signature	
Typed or printed name	Scott H. Kaliko, Esq.
Date	July 20, 2006

This collection of information is required by 37 CFR 1.5. The information is required to obtain or retain a benefit by the public which it is to file (and by the USPTO to process) an application. Confidentiality is governed by 35 U.S.C. 122 and 37 CFR 1.11 and 1.14. This collection is estimated to 2 hours to complete, including gathering, preparing, and submitting the completed application form to the USPTO. Time will vary depending upon the individual case. Any comments on the amount of time you require to complete this form and/or suggestions for reducing this burden, should be sent to the Chief Information Officer, U.S. Patent and Trademark Office, U.S. Department of Commerce, P.O. Box 1450, Alexandria, VA 22313-1450. DO NOT SEND FEES OR COMPLETED FORMS TO THIS ADDRESS. SEND TO: Commissioner for Patents, P.O. Box 1450, Alexandria, VA 22313-1450.

If you need assistance in completing the form, call 1-800-PTO-9199 and select option 2.

PTO/SB/17 (01-08)

Approved for use through 07/31/2008. OMB 0651-0032

U.S. Patent and Trademark Office; U.S. DEPARTMENT OF COMMERCE

Under the Paperwork Reduction Act of 1995 no persons are required to respond to a collection of information unless it displays a valid OMB control number

<b>FEE TRANSMITTAL</b> <b>For FY 2006</b>		<i>Complete if Known</i>	
		Application Number	10/223,200
<input checked="" type="checkbox"/> Applicant claims small entity status. See 37 CFR 1.27		Filing Date	August 16, 2002
TOTAL AMOUNT OF PAYMENT (\$) 180.00		First Named Inventor	Michael E. Shanahan
		Examiner Name	CongVan Tran
		Art Unit	2617
		Attorney Docket No.	MES/001 CON

**RECEIVED**  
**CENTRAL FAX CENTER**  
**JUL 20 2006**

**METHOD OF PAYMENT (check all that apply)**

Check  Credit Card  Money Order  None  Other (please identify): \_\_\_\_\_  
 Deposit Account Deposit Account Number: \_\_\_\_\_ Deposit Account Name: \_\_\_\_\_  
 For the above-identified deposit account, the Director is hereby authorized to: (check all that apply)  
 Charge fee(s) indicated below  Charge fee(s) indicated below, except for the filing fee  
 Charge any additional fee(s) or underpayments of fee(s) under 37 CFR 1.16 and 1.17  Credit any overpayments

**WARNING:** Information on this form may become public. Credit card information should not be included on this form. Provide credit card information and authorization on PTO-2038.

**FEE CALCULATION (All the fees below are due upon filing or may be subject to a surcharge.)**

**1. BASIC FILING, SEARCH, AND EXAMINATION FEES**

Application Type	FILING FEES		SEARCH FEES		EXAMINATION FEES		Fees Paid (\$)
	Fee (\$)	Small Entity Fee (\$)	Fee (\$)	Small Entity Fee (\$)	Fee (\$)	Small Entity Fee (\$)	
Utility	300	150	500	250	200	100	_____
Design	200	100	100	50	130	65	_____
Plant	200	100	300	150	160	80	_____
Reissue	300	150	500	250	600	300	_____
Provisional	200	100	0	0	0	0	_____

**2. EXCESS CLAIM FEES**

Fee Description	Fee (\$)	Small Entity Fee (\$)
Each claim over 20 (including Reissues)	50	25
Each independent claim over 3 (including Reissues)	200	100
Multiple dependent claims	360	180

Total Claims - 20 or HP = \_\_\_\_\_ x \_\_\_\_\_ = \_\_\_\_\_  
 HP = highest number of total claims paid for, if greater than 20.  
Indep. Claims - 3 or HP = \_\_\_\_\_ x \_\_\_\_\_ = \_\_\_\_\_  
 HP = highest number of independent claims paid for, if greater than 3.

**3. APPLICATION SIZE FEE**

If the specification and drawings exceed 100 sheets of paper (excluding electronically filed sequence or computer listings under 37 CFR 1.52(e)), the application size fee due is \$250 (\$125 for small entity) for each additional 50 sheets or fraction thereof. See 35 U.S.C. 41(a)(1)(G) and 37 CFR 1.16(s).

Total Sheets	Extra Sheets	Number of each additional 50 or fraction thereof	Fee (\$)	Fee Paid (\$)
_____	_____	_____ / 50 = _____ (round up to a whole number)	_____ x _____	_____

**4. OTHER FEE(S)**

Description	Fees Paid (\$)
Non-English Specification, \$130 fee (no small entity discount)	_____
Other (e.g., late filing surcharge): IDS fee 37 CFR 1.17 (P)	180.00

**SUBMITTED BY**

Signature	Registration No. (Attorney/Agent) 45,786	Telephone 201-831-0575
Name (Print/Type) Scott H. Kaliko, Esq.		Date July 20, 2006

This collection of information is required by 37 CFR 1.136. The information is required to obtain or retain a benefit by the public which is to file (and by the USPTO to process) an application. Confidentiality is governed by 35 U.S.C. 122 and 37 CFR 1.14. This collection is estimated to take 30 minutes to complete, including gathering, preparing, and submitting the completed application form to the USPTO. Time will vary depending upon the individual case. Any comments on the amount of time you require to complete this form and/or suggestions for reducing this burden, should be sent to the Chief Information Officer, U.S. Patent and Trademark Office, U.S. Department of Commerce, P.O. Box 1450, Alexandria, VA 22313-1450. DO NOT SEND FEES OR COMPLETED FORMS TO THIS ADDRESS. SEND TO: Commissioner for Patents, P.O. Box 1450, Alexandria, VA 22313-1450.

*If you need assistance in completing the form, call 1-800-PTO-9199 and select option 2.*

PATENT  
MES/001 CON

RECEIVED  
CENTRAL FAX CENTER

JUL 20 2006

IN THE UNITED STATES PATENT AND TRADEMARK OFFICE

Applicant : Michael E. Shanahan

Serial No. : 10/223,200 Confirmation No.: 8026

Filed : August 16, 2002

Title : METHODS AND APPARATUSES FOR PROGRAMMING  
USER-DEFINED INFORMATION INTO ELECTRONIC  
DEVICES

Examiner : CongVan Tran

Group Art Unit : 2617

Commissioner for Patents  
P.O. Box 1450  
Alexandria, VA 22213-1450

INFORMATION DISCLOSURE STATEMENT

Sir:

Pursuant to 37 C.F.R. §§ 1.56, 1.97 and 1.98, applicant hereby makes the documents listed below of record in the above-identified application.

U.S. Patents

Leermakers	Patent No. 6,928,468 B2	August, 2005
Aho et al.	Patent No. 6,198,941 B1	March, 2001

07/21/2006 MBINAS 00000005 10223200

01 FC:1806

100.00 OP



PATENT  
MES/001 CON

U.S. Patent Applications

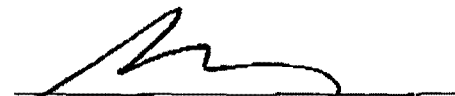
Cao et al. US-2005/0054379 A1 March, 2005

It is respectfully requested the Examiner fully consider these and any associated documents during the examination of this application, make them of record, and indicate his or her consideration of the documents by initialing the enclosed Citation List adjacent the citation of each document, and print them on any patent that may issue on this application. It is requested that a copy of the initialed Citation form be returned to applicant's undersigned Attorney. Citing of references herein shall not be deemed an admission that such references are prior art. Copies of the cited references are transmitted herewith.

Included is a USPTO Credit Card payment form which authorizes charges for \$180.00 in payment of IDS fee pursuant to 37 C.F.R. § 1.17 (p) and § 1.97(c) (2).

Respectfully submitted,

7/20/06  
Date

  
\_\_\_\_\_  
Scott H. Kaliko  
Attorney for Applicant  
Registration No. 45,786  
KALIKO & YEAGER, L.L.C.  
500 North Franklin Turnpike  
Ramsey, NJ 07446  
Direct: 201-831-0575  
Fax: 201-831-0519

JUL 20 2006

PTO/SB/06A (07-05)

Approved for use through 07/31/2006. OMB 0651-0031

U.S. Patent and Trademark Office: U.S. DEPARTMENT OF COMMERCE

Under the Paperwork Reduction Act of 1995, no persons are required to respond to a collection of information unless it contains a valid OMB control number.

Substitute for form 1449/PFO		<b>Complete if Known</b>	
<b>INFORMATION DISCLOSURE STATEMENT BY APPLICANT</b> <i>(Use as many sheets as necessary)</i>		Application Number	10/223,200
		Filing Date	August 16, 2002
		First Named Inventor	Michael E. Shanahan
		Art Unit	2617
		Examiner Name	CongVan Tran
		Attorney Docket Number	Mes/001 CON
Sheet 1	of 1		

U. S. PATENT DOCUMENTS					
Examiner Initials*	Cite No. <sup>1</sup>	Document Number	Publication Date MM-DD-YYYY	Name of Patentee or Applicant of Cited Document	Pages, Columns, Lines, Where Relevant Passages or Relevant Figures Appear
		Number-Kind Code <sup>2</sup> (if known)			
		US- 6,928,468	08-09-2005	Leersmakers	
		US- 6,198,941	03-06-2001	Aho et al.	
		US- 2005/0054379	03-10-2005	Cao et al.	
		US-			
		US-			
		US-			
		US-			
		US-			
		US-			
		US-			
		US-			
		US-			
		US-			
		US-			
		US-			
		US-			
		US-			
		US-			
		US-			
		US-			
		US-			
		US-			
		US-			

FOREIGN PATENT DOCUMENTS						
Examiner Initials*	Cite No. <sup>1</sup>	Foreign Patent Document	Publication Date MM-DD-YYYY	Name of Patentee or Applicant of Cited Document	Pages, Columns, Lines, Where Relevant Passages Or Relevant Figures Appear	T <sup>6</sup>
		Country Code <sup>3</sup> Number <sup>4</sup> Kind Code <sup>5</sup> (if known)				

Examiner Signature	Date Considered
--------------------	-----------------

\*EXAMINER: Initial if reference considered, whether or not citation is in conformance with MPEP 609. Draw line through citation if not in conformance and not considered. Include copy of this form with next communication to applicant. <sup>1</sup> Applicant's unique citation designation number (optional). <sup>2</sup> See Kinds Codes of USPTO Patent Documents at [www.uspto.gov](http://www.uspto.gov) or MPEP 901.04. <sup>3</sup> Enter Office that issued the document, by the two-letter code (WIPO Standard ST.3). <sup>4</sup> For Japanese patent documents, the indication of the year of the reign of the Emperor must precede the serial number of the patent document. <sup>5</sup> Kind of document by the appropriate symbols as indicated on the document under WIPO Standard ST.18 if possible. <sup>6</sup> Applicant is to place a check mark here if English language translation is attached.

This collection of information is required by 37 CFR 1.97 and 1.98. The information is required to obtain or retain a benefit by the public which is to file (and by the USPTO to process) an application. Confidentiality is governed by 35 U.S.C. 122 and 37 CFR 1.14. This collection is estimated to take 2 hours to complete, including gathering, preparing, and submitting the completed application form to the USPTO. Time will vary depending upon the individual case. Any comments on the amount of time you require to complete this form and/or suggestions for reducing this burden, should be sent to the Chief Information Officer, U.S. Patent and Trademark Office, P.O. Box 1450, Alexandria, VA 22313-1450. DO NOT SEND FEES OR COMPLETED FORMS TO THIS ADDRESS. SEND TO: Commissioner for Patents, P.O. Box 1450, Alexandria, VA 22313-1450.

If you need assistance in completing the form, call 1-800-PTO-9199 (1-800-786-9199) and select option 2.



**RECEIVED**  
**CENTRAL FAX CENTER**  
**JUL 10 2006**

500 North Franklin Turnpike, Ramsey, NJ 07446  
(201) 831-0575 Main Tel  
(201) 831-0519 Main Fax

**FACSIMILE TRANSMITTAL SHEET**

<b>TO:</b>  Commissioner for Patents	<b>FROM:</b> Scott H. Kaliko, Esq. <b>SENDER'S FAX NUMBER:</b> 201-831-0519 <b>SENDER'S TELEPHONE NUMBER:</b> 201-831-0575
<b>COMPANY:</b> United States Patent & Trademark Office	<b>DATE:</b> JULY 10, 2006
<b>RECIPIENT'S FAX NUMBER:</b> 571-273-8300	<b>TOTAL NO. OF PAGES INCLUDING COVER:</b> 35
<b>RECIPIENT'S TELEPHONE NUMBER:</b>	<b>CLIENT / MATTER:</b>
<b>RE:</b> Application No. 10/223,200	<b>YOUR REFERENCE NUMBER:</b> MES/001 CON

URGENT     FOR REVIEW     PLEASE COMMENT     PLEASE REPLY     PLEASE RECYCLE

**NOTES/COMMENTS:**

Please confirm receipt of this fax and the below-identified attached parts.

1. Transmittal Form/Certificate of Transmission;
2. Reply to Office Action (31 Pages).

**CONFIDENTIALITY NOTICE**

The information contained in this facsimile message is privileged and confidential and is intended only for the use of the individual(s) and/or entity(ies) named above. If you are not the intended recipient, you are hereby notified that any unauthorized disclosure, copying, distribution or taking of any action in reliance on the contents of the information contained herein is strictly prohibited and review by any individual other than the intended recipient shall not constitute a waiver of the attorney-client privilege. If you have received this transmission in error, please immediately notify us by telephone. Thank you.

RECEIVED  
CENTRAL FAX CENTER

JUL 10 2006

Scott H. Kaliko ◀  
New York, New Jersey  
Joe P. Yeager  
New Jersey, Pennsylvania  
Andy Martin ◀  
Massachusetts



Admitted to practice before  
the United States  
Patent and Trademark Office ◀

July 10, 2006

VIA FACSIMILE

United States Patent and Trademark Office  
P.O. Box 1450  
Alexandria, VA 22313-1450  
Attn: Terri Williams  
Telephone: (571) 272-2991

RE: Reply to Office Action/Fax error for Application No. 10/223,200

Dear Ms. Williams:

As per our conversation on July 10, 2006 our Reply to the USPTO Office Action for the above-identified patent application was disrupted during facsimile transmission. Enclosed please find the USPTO Auto-Reply Facsimile Transmission sheet which was received on June 29, 2006. Pursuant to our conversation today it is already agreed that the USPTO will accept 6/29/06 as the responsive date for this Office Action.

Should you have any questions, please feel free to contact me.

Sincerely,  
Kaliko & Yeager, L.L.C

Scott H. Kaliko  
For the Firm

Enclosure

SHK/mce

USPTO 6/29/2006 4:25 PM PAGE 1/001 Fax Server  
TO:Auto-reply fax to 2018310519 COMPANY:

### Auto-Reply Facsimile Transmission



TO: Fax Sender at 2018310519

Fax Information  
Date Received: 6/29/2006 4:17:13 PM [Eastern Daylight Time]  
Total Pages: 31 (including cover page)

**ADVISORY:** This is an automatically generated return receipt confirmation of the facsimile transmission received by the Office. Please check to make sure that the number of pages listed as received in Total Pages above matches what was intended to be sent. Applicants are advised to retain this receipt in the unlikely event that proof of this facsimile transmission is necessary. Applicants are also advised to use the certificate of facsimile transmission procedures set forth in 37 CFR 1.8(a) and (b), 37 CFR 1.6(f). Trademark Applicants, also see the Trademark Manual of Examining Procedure (TMEP) section 306 et seq.

Received  
Cover  
Page



07/10/2006 15:15 2018310519 KALIKO & YEAGER PAGE 01/31

**KALIKO & YEAGER**  
ATTORNEYS AT LAW  
LABORATORY CONSULTANTS

301 North Franklin Turnpike, Fayette, MO 65455  
2018310519 Main Fax  
2018310519 Main Fax

---

FACSIMILE TRANSMISSION SHEET

TO: Commissioner for Patents	FROM: Scott H. Kaliko, Esq. 301 N. FRANKLIN TURNPIKE 201-831-0519 301 N. FRANKLIN TURNPIKE 201-831-0515
ORGANIZATION: United States Patent & Trademark Office ELECTRONIC MAIL NUMBER: 571-273-8300	DATE: JUNE 29, 2006 CITY: WASHINGTON, DC STATE: DC
TRANSMISSION NUMBER: 31	REPLY TO: MTS/001

PRIORITY    MAIL RETURN    RELEASE COMMENT    PLEASE REPLY    RETURN RECEIPT

ATTENTION:

Please confirm receipt of this fax and the below-identified attached parts.

1. Transmittal Form/Certificate of Transmittal.
2. Reply to Office Action (32 Pages).

**ADMINISTRATIVE NOTICE**

This information contained in this facsimile message is privileged and confidential and is intended only for the use of the individual(s) and/or organization(s) named above. If you are not the intended recipient, you are hereby notified that any dissemination, copying, distribution or taking of any action in reliance on the contents of the information contained herein is strictly prohibited and review by any individual other than the intended recipient shall constitute a violation of the confidentiality privilege. If you have received this communication in error, please immediately notify us by e-mail. Thank you.

PAGE 001 \* RCVD AT 07/10/2006 4:17:13 PM [Eastern Daylight Time] \* SVR:USPTO-EFAX-08 \* DNIS:2738300 \* CSID:2018310519 \* DURATION (mm-ss):08-34

**JUL 10 2006**

PTO/SS/21 (09-04)

Approved for use through 07/31/2006. OMB 0691-0031

U.S. Patent and Trademark Office; U.S. DEPARTMENT OF COMMERCE

Under the Paperwork Reduction Act of 1995, no persons are required to respond to a collection of information unless it displays a valid OMB control number.

<b>TRANSMITTAL FORM</b> <small>(to be used for all correspondence after initial filing)</small>	Application Number	10/223,200
	Filing Date	August 10, 2002
	First Named Inventor	MICHAEL E. SHANAHAN
	Art Unit	2817
	Examiner Name	CongVan Tran
Total Number of Pages in This Submission	Attorney Docket Number	MES/001 CON

ENCLOSURES (Check all that apply)		
<input type="checkbox"/> Fee Transmittal Form <input type="checkbox"/> Fee Attached <input checked="" type="checkbox"/> Amendment/Reply <input type="checkbox"/> After Final <input type="checkbox"/> Affidavits/declaration(s) <input type="checkbox"/> Extension of Time Request <input type="checkbox"/> Express Abandonment Request <input type="checkbox"/> Information Disclosure Statement  <input type="checkbox"/> Certified Copy of Priority Document(s) <input type="checkbox"/> Reply to Missing Parts/Incomplete Application <input type="checkbox"/> Reply to Missing Parts under 37 CFR 1.52 or 1.53	<input type="checkbox"/> Drawing(s) <input type="checkbox"/> Licensing-related Papers <input type="checkbox"/> Petition <input type="checkbox"/> Petition to Convert to a Provisional Application <input type="checkbox"/> Power of Attorney, Revocation <input type="checkbox"/> Change of Correspondence Address <input type="checkbox"/> Terminal Disclaimer <input type="checkbox"/> Request for Refund <input type="checkbox"/> CD, Number of CD(s) _____ <input type="checkbox"/> Landscape Table on CD	<input type="checkbox"/> After Allowance Communication to TC <input type="checkbox"/> Appeal Communication to Board of Appeals and Interferences <input type="checkbox"/> Appeal Communication to TC (Appeal Notice, Brief, Reply Brief) <input type="checkbox"/> Proprietary Information <input type="checkbox"/> Status Letter <input checked="" type="checkbox"/> Other Enclosure(s) (please identify below):
Remarks 1. Reply to Office Action (31 Pages)		

SIGNATURE OF APPLICANT, ATTORNEY, OR AGENT			
Firm Name	KALIKO & YEAGER, LLC		
Signature			
Printed name	SCOTT H. KALIKO, ESQ.		
Date	JUNE 29, 2006	Reg. No.	45,786

CERTIFICATE OF TRANSMISSION/MAILING	
I hereby certify that this correspondence is being facsimile transmitted to the USPTO or deposited with the United States Postal Service with sufficient postage as first class mail in an envelope addressed to: Commissioner for Patents, P.O. Box 1450, Alexandria, VA 22313-1450 on the date shown below:	
Signature	
Typed or printed name	SCOTT H. KALIKO, ESQ.
Date	JUNE 29, 2006

This collection of information is required by 37 CFR 1.5. The information is required to obtain or maintain a benefit by the public which is to file (and by the USPTO to process) an application. Confidentiality is governed by 35 U.S.C. 122 and 37 CFR 1.11 and 1.14. This collection is estimated to 2 hours to complete, including gathering, preparing, and submitting the completed application form to the USPTO. Time will vary depending upon the individual case. Any comments on the amount of time you require to complete this form and/or suggestions for reducing this burden, should be sent to the Chief Information Officer, U.S. Patent and Trademark Office, U.S. Department of Commerce, P.O. Box 1450, Alexandria, VA 22313-1450. DO NOT SEND FEES OR COMPLETED FORMS TO THIS ADDRESS. SEND TO: Commissioner for Patents, P.O. Box 1450, Alexandria, VA 22313-1450.

If you need assistance in completing the form, call 1-800-PTO-9199 and select option 2.

RECEIVED  
CENTRAL FAX CENTER

JUL 10 2006

MES/001 CON

IN THE UNITED STATES PATENT AND TRADEMARK OFFICE

Applicant : Michael E. Shanahan  
 Application No. : 10/223,200 Confirmation No.: 8026  
 Filed : August 16, 2002  
 Title : METHODS AND APPARATUSES FOR PROGRAMMING  
 USER-DEFINED INFORMATION INTO  
 ELECTRONIC DEVICES  
 Examiner : CongVan Tran  
 Group Art Unit : 2617

June 29, 2006

Mail Stop Amendment  
 Commissioner for Patents  
 P.O. Box 1450  
 Alexandria, VA 22313-1450

REPLY TO OFFICE ACTION

Sir:

In response to the Office Action dated April 20, 2006:

**A listing of claims** which begins on page 2 of this paper.

**Remarks** begin on page 22 of this paper.

Listing of Claims

1-15. (Cancelled)

16. (Withdrawn) A method of customizing a wireless telephone by programming an audio file into the wireless telephone for use as an indicia of an incoming communication, the method comprising:

connecting to a remote database that includes a plurality of lists of audio files;

allowing a user of the wireless telephone to browse at least one of the lists of audio files;

allowing the user of the wireless telephone to select at least one of the audio files from the browsed list;

optionally reviewing the selected audio file before downloading the selected audio into the wireless telephone; and

allowing the user to optionally download the selected audio file for use as an indicia of an incoming communication.

17. (Withdrawn) The method of claim 16 wherein the format of the selected audio file is from the group comprising: MIDI, MPEG, MP3, WAV, PCM, Windows Media Audio code (WMA), or Adaptive Transform Acoustic Coding (ATRAC).

18. (Withdrawn) The method of claim 16 further comprising allowing the user to search the remote database for a certain desired audio file using title or description information to aid in locating the desired audio file.



19. (Withdrawn) The method of claim 18 wherein the searching further comprises searching the Internet or other remote databases for the desired audio file.

20. (Withdrawn) The method of claim 16 wherein the browsing of audio files is accomplished at least in part using a Wireless Application Protocol (WAP) compliant system.

21. (Withdrawn) The method of claim 16 further comprising providing a visual indication on a display screen of the wireless telephone to confirm the selected audio file has been successfully downloaded.

22. (Withdrawn) The method of claim 16 further comprising:

downloading a selected audio file into the wireless telephone; and

associating the downloaded audio file with a characteristic indicative of a caller such that the associated audio file plays when the indicative characteristic is received by the wireless telephone.

23. (Withdrawn) The method of claim 1 wherein the characteristic indicative of the caller is the caller's telephone number.

24. (Withdrawn) A method of customizing a wireless telephone by programming an audio file into the wireless telephone for use as an indicia of an incoming communication, the method comprising:

connecting to a remote database that includes a plurality of audio files; the remote database operating substantially independently of a communications network that provides wireless telephone service to the wireless telephone;

allowing the user of the wireless telephone to browse and select at least one of the audio files;

allowing the user to optionally download the selected audio file into a programmable memory for use as an indicia of an incoming communication.

25. (Withdrawn) The method of claim 24 further comprising allowing the user to optionally review the selected audio file before downloading the selected audio file into the wireless telephone.

26. (Withdrawn) The method of claim 24 wherein the format of the selected audio file is from the group comprising: MIDI, MPEG, MP3, WAV, PCM, Windows Media Audio code (WMA), or Adaptive Transform Acoustic Coding (ATRAC).

27. (Withdrawn) The method of claim 24 further comprising allowing the user to search the remote database for a certain desired audio file using title or description information to aid in locating the desired audio file.

28. (Withdrawn) The method of claim 24 wherein the searching further comprises searching the Internet or other remote databases for the desired audio file.

29. (Withdrawn) The method of claim 24 wherein the browsing of audio files is accomplished at least in part using a Wireless Application Protocol (WAP) compliant system.

30. (Withdrawn) The method of claim 24 further comprising providing a visual indication on a display screen of the wireless telephone to confirm the selected audio file has been successfully downloaded.

31. (Withdrawn) The method of claim 24 further comprising:

downloading a selected audio file into the wireless telephone; and

associating the downloaded audio file with a characteristic indicative of a caller such that the associated audio file plays when the indicative characteristic is received by the wireless telephone.

32. (Withdrawn) The method of claim 24 wherein the characteristic indicative of the caller is the caller's telephone number.

33. (Previously presented) A wireless telephone that may be customized by programming an audio file into the wireless telephone for use as an indicia of an incoming communication, the telephone comprising:

a communications link capable of connecting to a remote database that includes a plurality of lists of audio files;

a display screen that allows a user of the wireless telephone to browse at least one of the plurality of lists of audio files and view selectable audio files present in the browsed list;

a speaker and processing circuitry configured to allow the user to optionally review a selected audio file before downloading the selected audio file into the wireless telephone; and

a programmable memory circuit for allowing the user to optionally store the selected audio file for use as an indicia of an incoming communication.

34. (Previously presented) The wireless telephone of claim 33 wherein the programmable memory circuit is configured to store audio files in a format selected from the group comprising: MIDI, MPEG, MP3, WAV, PCM, Windows Media Audio code (WMA), or Adaptive Transform Acoustic Coding (ATRAC).

35. (Previously presented) The wireless telephone of claim 33 wherein the speaker and processing circuitry is configured to play audio files in a format selected from the group comprising: MIDI, MPEG, MP3, WAV, PCM, Windows Media Audio code (WMA), or Adaptive Transform Acoustic Coding (ATRAC).

36. (Previously presented) The wireless telephone of claim 33 wherein the wireless telephone is configured to allow the user to search the remote database for a certain desired audio file using title or description information to aid in locating the desired audio file.

37. (Previously presented) The wireless telephone of claim 36 wherein the wireless telephone is configured to search the Internet or other remote databases for the desired audio file.

38. (Previously presented) The wireless telephone of claim 33 wherein the wireless telephone includes a Wireless Application Protocol (WAP) compliant Internet browser.

39. (Previously presented) The wireless telephone of claim 33 configured to provide a visual indication on the display screen to confirm the selected audio file has been successfully downloaded.

40. (Previously presented) The wireless telephone of claim 33 configured to allow the user to associate a downloaded audio file with a characteristic indicative of a caller such that the associated audio file plays when the indicative characteristic is received by the wireless telephone.

41. (Previously presented) The wireless telephone of claim 40 wherein the characteristic indicative of the caller is the caller's telephone number.

42. (Previously presented) A wireless telephone that may be customized by programming an audio file into the wireless telephone for use as an indicia of an incoming communication, the telephone comprising:

a communications link capable of connecting to a remote database that includes a plurality of lists of audio files; the remote database operating substantially independently of a communications network that provides wireless telephone service to the wireless telephone;

a display screen that allows a user of the wireless telephone to browse at least one of the plurality of lists of audio files and view selectable audio files present in the browsed list;

processing circuitry configured to receive a selected audio file from the communications link; and

a programmable memory circuit for allowing the user to optionally store the selected audio file for use as an indicia of an incoming communication.

43. (Previously presented) The wireless telephone of claim 42 further comprising a speaker that operates in conjunction with the processing circuitry to allow the user to optionally review a selected audio file before downloading the selected audio file into the wireless telephone.

44. (Previously presented) The wireless telephone of claim 42 wherein the programmable memory circuit is configured to store audio files in a format selected from the group comprising: MIDI, MPEG, MP3, WAV, PCM, Windows Media Audio code (WMA), or Adaptive Transform Acoustic Coding (ATRAC).

45. (Previously presented) The wireless telephone of claim 42 wherein the speaker and processing circuitry is configured to play audio files in a format selected from the group comprising: MIDI, MPEG, MP3, WAV, PCM, Windows Media Audio code (WMA), or Adaptive Transform Acoustic Coding (ATRAC).

46. (Previously presented) The wireless telephone of claim 42 wherein the wireless telephone is configured to allow the user to search the remote database for a certain desired audio file using title or description information to aid in locating the desired audio file.

47. (Previously presented) The wireless telephone of claim 42 wherein the wireless telephone includes a Wireless Application Protocol (WAP) compliant Internet browser.

48. (Previously presented) The wireless telephone of claim 22 configured to provide a visual indication on the display screen to confirm the selected audio file has been successfully downloaded.

49. (Previously presented) The wireless telephone of claim 42 configured to allow the user to associate a downloaded audio file with a characteristic indicative of a caller such that the associated audio file plays when the indicative characteristic is received by the wireless telephone.

50. (Withdrawn) A wireless telephone that may be customized by programming an audio file into the wireless telephone for use as an indicia of an incoming communication, the telephone comprising:

means for connecting to a remote database that includes a plurality of lists of audio files;

means for browsing at least one of the lists of audio files;

means for selecting at least one of the audio files from the browsed list;

means for optionally reviewing the selected audio file before downloading the selected audio into the wireless telephone; and

means for downloading the selected audio file for use as an indicia of an incoming communication.

51. (Withdrawn) The wireless telephone of claim 50 further comprising means for searching the remote database for a

certain desired audio file using title or description information to aid in locating the desired audio file.

52. (Withdrawn) The wireless telephone of claim 51 wherein the searching further comprises means for searching the Internet or other remote databases for the desired audio file.

53. (Withdrawn) The wireless telephone of claim 50 further comprising means for providing a visual indication on a display screen of the wireless telephone to confirm the selected audio file has been successfully downloaded.

54. (Withdrawn) The wireless telephone of claim 50 further comprising means for associating a downloaded audio file with a characteristic indicative of a caller such that the associated audio file plays when the indicative characteristic is received by the wireless telephone.

55. (Withdrawn) A wireless telephone that may be customized by programming an audio file into the wireless telephone for use as an indicia of an incoming communication, the telephone comprising:

means for connecting to a remote database that includes a plurality of audio files; the remote database operating substantially independently of a communications network that provides wireless telephone service to the wireless telephone;

means for browsing and selecting at least one of the audio files;



means for optionally downloading the selected audio file into a programmable memory for use as an indicia of an incoming communication.

56. (Withdrawn) The wireless telephone of claim 55 further comprising means for optionally reviewing the selected audio file before downloading the selected audio file into the wireless telephone.

57. (Withdrawn) The wireless telephone of claim 56 further comprising means for searching the remote database for a certain desired audio file using title or description information to aid in locating the desired audio file.

58. (Withdrawn) The wireless telephone of claim 55 wherein the searching further comprises means for searching the Internet or other remote databases for the desired audio file.

59. (Withdrawn) The wireless telephone of claim 55 wherein the browsing of audio files is accomplished at least in part using a Wireless Application Protocol (WAP) compliant system.

60. (Withdrawn) The wireless telephone of claim 55 further comprising providing a visual indication on a display screen of the wireless telephone to confirm the selected audio file has been successfully downloaded.

61. (Withdrawn) The wireless telephone of claim 55 further comprising means for associating a downloaded audio file with a characteristic indicative of a caller such that the associated audio file plays when the indicative characteristic is received by the wireless telephone.

62. (Withdrawn) The method of claim 16 further comprising preventing the unauthorized distribution of a downloaded audio file.

63. (Withdrawn) The method of claim 16 further comprising playing the selected audio file through an enhanced performance speaker capable of providing a substantially full range of audio sounds from MIDI, MP3, MPEG, WAV, PCM, Windows Media Audio Code (WMA), or Adaptive Transform Acoustic Coding (ATRAC) files.

64. (Withdrawn) The method of claim 16 characterized by the use of a personal computer to perform the browsing step.

65. (Withdrawn) The method of claim 16 further comprising providing the user with an opportunity to edit the selected audio file.

66. (Withdrawn) The method of claim 16 further comprising providing an indication that a memory capacity of the wireless telephone has been exceeded if the size of the audio file to be downloaded is larger than available memory space in the wireless telephone.

67. (Withdrawn) The method of claim 66 further comprising providing the user of the wireless telephone with the opportunity to cancel or modify a download request associated with an audio file download operation if the size of the audio file to be downloaded is larger than available memory space in the wireless telephone.

68. (Previously presented) The wireless telephone of claim 33 wherein the wireless telephone is configured to prevent the unauthorized distribution of an audio file stored in the programmable memory circuit.

69. (Previously presented) The wireless telephone of claim 33 wherein the speaker is an enhanced performance speaker capable of providing a substantially full range of audio sounds from MIDI, MP3, MPEG, WAV, PCM, Windows Media Audio Code (WMA), or Adaptive Transform Acoustic Coding (ATRAC) files.

70. (Previously presented) The wireless telephone of claim 33 configured to provide an indication that a memory capacity of the wireless telephone has been exceeded if the size of the audio file to be downloaded is larger than available memory space in the wireless telephone.

71. (Previously presented) The wireless telephone of claim 70 configured to provide the user of the wireless telephone with the opportunity to cancel or modify a download request associated with an audio file download operation if the size of the audio file to be downloaded is larger than the available memory space in the wireless telephone.

72. (Withdrawn) A wireless telephone that may be customized by programming an audio file into the wireless telephone for use as an indicia of an incoming communication, the telephone comprising:

means for connecting to a remote database that includes a plurality of audio files;

means for selecting at least one of the audio files from the database;

means for downloading and storing the selected audio file for use as an indicia of an incoming communication; and

means for preventing the unauthorized distribution of a selected audio file stored in the wireless telephone.

73. (Withdrawn) The wireless telephone of claim 72 further comprising means for indicating that a memory capacity of the wireless telephone has been exceeded if the size of the audio file to be downloaded is larger than available memory space in the wireless telephone.

74. (Previously presented) A wireless telephone that may be customized by searching for and selecting an audio file from a remote computer and programming the selected audio file into the wireless telephone for use as an indicia of an incoming communication, the telephone comprising:

a communications link capable of connecting to a database in the remote computer that includes a plurality of lists of audio files in MPEG, or WAV, or MP3 format or a combination thereof;

a display screen and a mobile Internet browser that allows a user of the wireless telephone to browse at least one of the lists of lists of audio files and view selectable audio files present in the browsed list;

processing circuitry configured to receive a selected one of the audio files from the communications link;

a programmable memory circuit for allowing the user to optionally store the selected audio file for use as an indicia of an incoming communication; and

an enhanced performance speaker capable of providing a substantially full range of audio sounds when one of the selected audio files is played as an indicia of an incoming communication.

75. (Previously presented) The wireless telephone of claim 74 configured to provide an indication that a memory capacity of the wireless telephone has been exceeded if the size of the audio file to be downloaded is larger than the available memory space in the wireless telephone.

76. (Previously presented) The wireless telephone of claim 74 wherein the enhanced performance speaker operates in conjunction with the processing circuitry to allow the user to optionally review a the selected audio file before downloading the selected audio file into the wireless telephone.

77. (Previously presented) The wireless telephone of claim 74 configured to allow the user to search the database for a certain desired audio file using title or description information to aid in locating a desired audio file.

78. (Previously presented) The wireless telephone of claim 74 configured to prevent the unauthorized distribution of a audio file stored in the programmable memory circuit.

79. (Previously presented) A wireless telephone that may be customized by searching for and selecting an audio file from a remote computer and programming the selected audio file into the wireless telephone for use at a time specified by the user, the telephone comprising:

a communications link capable of connecting to a database in the remote computer that includes a plurality of polyphonic audio files;

a display screen and a browsing application program that allows a user of the wireless telephone to browse the polyphonic audio files and select at least one polyphonic audio file therefrom;

processing circuitry configured to supervise receipt of a selected polyphonic audio file from the communications link;

a programmable memory circuit for allowing the user to optionally store the selected polyphonic audio file for use as an indicia of an incoming communication; and

an enhanced performance speaker capable of providing a substantially full range of audio sounds from the selected polyphonic audio file when the selected polyphonic audio file is played.

80. (Previously presented) The wireless telephone of claim 79 wherein the polyphonic audio file is selected from the group comprising MP3, MPEG, or WAV files.

81. (Previously presented) The wireless telephone of claim 79 wherein the enhanced performance speaker operates in conjunction with the processing circuitry to allow the user to optionally review the selected polyphonic audio file before downloading the selected polyphonic audio file into the programmable memory circuit of the wireless telephone.

82. (Previously presented) The wireless telephone of claim 79 configured to prevent the unauthorized distribution of the selected polyphonic audio file stored in the programmable memory circuit.

83. (Previously presented) The wireless telephone of claim 74 wherein the group of polyphonic audio files includes audio files in polyphonic MIDI format.

84. (Previously presented) The wireless telephone of claim 76 configured to provide the user of the wireless telephone with the option of downloading the selected polyphonic audio file into a programmable memory in the wireless telephone after reviewing the selected polyphonic audio file.

85. (Previously presented) The wireless telephone of claim 84 configured to provide the user of the wireless telephone with the option of modifying the selected polyphonic audio file before programming the selected polyphonic audio file into the programmable memory in the wireless telephone.

86. (Previously presented) The wireless telephone of claim 80 wherein the wireless telephone is configured to operate in conjunction with copyright protection software to prevent the unauthorized distribution of the selected polyphonic audio file stored in the programmable memory circuit.

87. (Previously presented) The wireless telephone of claim 79 wherein the selected polyphonic audio files is in polyphonic MIDI format.

88. (Previously presented) The wireless telephone of claim 81 configured to provide the user of the wireless telephone with the option of downloading the selected polyphonic

audio file into a programmable memory in the wireless telephone after reviewing the selected polyphonic audio file.

89. (Previously presented) The wireless telephone of claim 88 configured to provide the user of the wireless telephone with the option of modifying the selected polyphonic audio file before programming the selected polyphonic audio file into the programmable memory in the wireless telephone.

90. (Previously presented) The wireless telephone of claim 82 wherein the wireless telephone is configured to operate in conjunction with copyright protection software to prevent the unauthorized distribution of the selected polyphonic audio file stored in the programmable memory circuit.

91. (Previously presented) A wireless telephone that may be customized by searching for and selecting an audio file from a remote computer and programming the selected audio file into the wireless telephone for use as an indicia of an incoming communication, the telephone comprising:

a communications link capable of connecting to a database in the remote computer that includes a plurality of polyphonic audio files;

a display screen and a browsing application program that allows a user of the wireless telephone to browse the polyphonic audio files and select at least one polyphonic audio file therefrom;

processing circuitry configured to supervise receipt of a selected polyphonic audio file from the communications link;



a programmable memory circuit for allowing the user to optionally store the selected polyphonic audio file for use as an indicia of an incoming communication; and

an enhanced performance speaker capable of providing a substantially full range of audio sounds from the selected polyphonic audio file when the selected polyphonic audio file is played.

92. (Previously presented) The wireless telephone of claim 91 wherein the polyphonic audio file is selected from the group comprising MP3, MPEG, or WAV files.

93. (Previously presented) The wireless telephone of claim 91 wherein the enhanced performance speaker operates in conjunction with the processing circuitry to allow the user to optionally review the selected polyphonic audio file before downloading the selected polyphonic audio file into the programmable memory circuit of the wireless telephone.

94. (Previously presented) The wireless telephone of claim 91 configured to prevent the unauthorized distribution of the selected polyphonic audio file stored in the programmable memory circuit.

95. (Previously presented) The wireless telephone of claim 91 wherein the polyphonic audio files includes audio files in polyphonic MIDI format.

96. (Previously presented) The wireless telephone of claim 93 configured to provide the user of the wireless telephone with the option of downloading the selected polyphonic audio file into a programmable memory in the wireless telephone after reviewing the selected polyphonic audio file.

97. (Previously presented) The wireless telephone of claim 93 configured to provide the user of the wireless telephone with the option of modifying the selected polyphonic audio file before programming the selected polyphonic audio file into the programmable memory in the wireless telephone.

98. (Previously presented) The wireless telephone of claim 91 wherein the wireless telephone is configured to operate in conjunction with copyright protection software to prevent the unauthorized distribution of the selected polyphonic audio file stored in the programmable memory circuit.

99. (Withdrawn) A wireless telephone that may be customized by programming an audio file into the wireless telephone for use at a time specified by a user of the wireless telephone, the telephone comprising:

means for connecting to a remote database that includes a plurality of lists of polyphonic audio files;

means for browsing at least one of the lists of polyphonic audio files;

means for selecting at least one of the polyphonic audio files from the browsed list;

means for optionally reviewing the selected polyphonic audio file before downloading the selected polyphonic audio into a memory circuit in the wireless telephone; and

means for downloading the selected polyphonic audio file for use at the time specified by the user of the wireless telephone.

100. (Withdrawn) The wireless telephone of claim 99 further comprising means for searching the remote database for a certain desired polyphonic audio file using title or description information to aid in locating the desired polyphonic audio file.

101. (Withdrawn) The wireless telephone of claim 100 wherein the searching further comprises means for searching the Internet or other remote databases for the desired polyphonic audio file.

102. (Withdrawn) The wireless telephone of claim 99 further comprising means for providing a visual indication on a display screen of the wireless telephone to confirm the selected polyphonic audio file has been successfully downloaded.

103. (Withdrawn) The wireless telephone of claim 99 wherein the browsing of polyphonic audio files is accomplished at least in part using a Wireless Application Protocol (WAP) compliant system.

104. (Withdrawn) The wireless telephone of claim 99 further comprising means for preventing unauthorized distribution of the selected polyphonic audio file stored in the programmable memory circuit.

**REMARKS****I. Introduction**

Claims 1-15 are cancelled without prejudice.

Claims 33-49, 68-71, 74-98 are pending in the application.

Claims 16-32, 50-67, 72-73 and 99-104 are withdrawn from consideration.

Claims 33, 36-37, 38-41 and 47 are rejected under 35 U.S.C. § 102(e) as being anticipated by Bottum, U.S. patent 6,014,569 (hereinafter "Bottum").

Claims 42-43, 46, 48-49, and 68 are rejected under 35 U.S.C. § 103(a) as being unpatentable over Goodman, U.S. patent 5,694,455 (hereinafter "Goodman") in view of Bottum.

Claims 34-35, 44-45, 69-71, and 74-98 are rejected under 35 U.S.C. § 103(a) as being unpatentable over Bottum in view of Goodman and further in view of Mills et al. U.S. patent 6,599,147 (hereinafter "Mills").

Consideration and allowance of this application in light of the following remarks is respectfully requested.

II. Applicant's Reply to the Rejection Under 35 U.S.C. § 102(e)

Claims 33, 36-37, 38-41 and 47 are rejected under 35 U.S.C. § 102(e) as being anticipated by Bottum. Applicant respectfully traverses this rejection in view of the remarks below.

One aspect of applicant's claimed invention is concerned with a wireless telephone that may be customized by programming an audio file into the wireless telephone for use as an indicia of an incoming communication. This may be thought of as a wireless telephone that allows a user to customize the wireless telephone by selecting and programming a ringtone into the wireless telephone which plays when an incoming telephone call (or other communication) is received.

One benefit of such a wireless telephone is that it allows the user the freedom and flexibility to choose and/or change to a particular ringtone that is pleasing to the user rather than be constrained by a single ringtone or limited group of ringtones, which may have been, for example, preprogrammed by a manufacturer.

The claimed wireless telephone has the ability to connect to a remote database(s) of ringtones and allow the user to browse lists of ringtones in the remote database(s), select a

particular ringtone and optionally review (e.g., listen to) the selected ringtone using a speaker and processing circuitry prior to downloading the ringtone into a programmable memory in the wireless telephone (e.g., a preview feature). This allows the user to confirm the selected ringtone is correct and/or acceptable or meets expectations, etc. Thus, one aspect of applicant's claimed invention is concerned with a customization of wireless telephone by allowing the review and selection of a ringtone that *is played subsequently when receiving an incoming call.*

In contrast, Bottum fails to show or suggest these features anywhere. Rather, Bottum is purportedly concerned with a specialized mobile radio for use with a subscription audio service that employs an asynchronous data transmission technique in place of a continuous dedicated data link that was used in the prior art (e.g., see Bottum, Column 1, line 61 to column 2, line 10, FIG. 2 and its associated description). Bottum explains that dedicated communication paths are inefficient because the transmission of data generally occurs in short bursts over short periods of time and, thus, a dedicated communication link is occupied for a far longer period of time than necessary to transmit the data, resulting in unnecessary costs (Bottum, column 1, lines 14-21). The purpose of the system described in Bottum is to provide audio data over an asynchronous communications link such as a Cellular

Digital Packet Data link ("CDPD") to a subscription radio in order to conserve transmission resources and improve overall efficiency as compared to systems that rely on dedicated communication links. See, for example, Bottum, Column 2, line 11 to column 3, line 10.

Bottum also mentions that the radio may include an interface that allows a subscriber to select certain types of audio programming based category such as news, sports and music data. See Bottum, column 3, line 54 to column 4, line 12.

However, completely absent from Bottum is any teaching or suggestion that an audio file may be stored in a wireless telephone and played as an *indicia of an incoming communication* as specified in applicant's claims. For example, the device described in Bottum is merely a subscription radio receiving device (described as a "MIR" or mobile interactive radio) that retrieves requested information for "on-demand" retrieval and/or consumption by the user (See Bottum, column 5, lines 55-58, also see column 5, lines 24-33). Thus, the device described in Bottum is a merely a device which can select and receive the selected subscription radio/audio transmissions (this may be thought of as having a functionality similar to that of an XM satellite radio receiver).

Because Bottum provides content for consumption on an "on-demand" basis, it does not and cannot play that content as an

indicia of an incoming communication as specified in applicant's claims (i.e., the content is played as received). Moreover, applicant points out that because in the system of Bottum the user receives or has access to content substantially immediately after it is requested, there is no need (or purpose) for an indicia of an incoming communication (such as a ringtone) because the user receives the information in response to his or her request and knows when to expect to receive or access the requested information (as opposed to a telephone, with which a user cannot predict incoming communications initiated by others, such as an incoming telephone call, and thus must be alerted with an indicia such as a ringtone).

Accordingly, applicant respectfully submits that the subscription radio of Bottum does not show or suggest the use of an indicia of an incoming communication and fails to recognize that such a customization feature would be desirable or suggest or recognize the circumstances under which such features would be useful or desirable. Accordingly, Bottum fails to show or suggest browsing, downloading and playing an audio file as an indicia of an incoming communication as specified in applicant's claims.

Furthermore, Bottum fails to show or suggest reviewing a selected audio file prior to download as specified in applicant's



claims. In particular, the Examiner relies on Bottum, column 4, lines 1-16 as disclosing this feature (reproduced below).

Preferably, radio 150 includes user interface 170. Interface 170 provides information to and receives instructions from a user. For example, interface 170 may provide a menu to a user visually on display screen 172 or acoustically on acoustic system 174. Of course, acoustic systems 158 and 174 may be one in the same. Also, interface 170 may act to receive instructions from the user. For example, user instructions may be received by radio 150 via a touch sensitive display screen, a voice recognition device or at least one menu navigation key. If menu navigation key 176 is used by a user to designate an audio offering (as shown in FIG. 2), radio 150 may also include selection button 178 for selecting the designated audio offering. Furthermore, radio 150 may include memory unit 180 for storing menu information previously transmitted by wireless system 120 or downloaded via a cable.

However, applicant respectfully points out that this paragraph merely relates to the operation and function of a basic user interface for a subscription radio and does not show or suggest reviewing (e.g., listening to) a selected audio file prior to downloading or use of the audio file as an indicia of an incoming communication as specified in applicant's claims. Nor does it relate to the storing audio content.

In addition, although Bottum does mention that audio data may be transmitted over the Internet (for example, see column 1, lines 22-40) no mention is made of a resident Internet browser

or a WAP compliant Internet browser as specified in applicant's claims.

Accordingly, applicant respectfully submits that independent claims 33, 36-37, 38-41, and 47, and the claims that depend therefrom are allowable over Bottum for at least these reasons.

Other Patentable Distinctions

In addition to the reasons above, applicant respectfully submits that at least several other patentable distinctions exist in pending claims over the prior art of record. For example, other features patentable over the prior art include a wireless telephone configured to prevent the unauthorized distribution of the downloaded audio files used as an indicia of an incoming communication (claims 78 and 82), the use of copyright protection measures (claims 86 and 98), optionally modifying selected audio files before programming into the wireless telephone (claims 85 and 97), the use of polyphonic audio files including the various formats specified (claims 69 and 79-98), a *wireless telephone* (not a radio) that includes an enhanced performance speaker for providing a substantially full range of audio sounds (claims 74-98) and that allows a user to browse and select audio files for use an

indicia as well as other patentable features set forth in the claims that are not deemed necessary to discuss here.

Accordingly, based on the above, applicant respectfully requests that the rejections under 35 U.S.C. § 102(e) be withdrawn.

III. Applicant's Reply to the Rejection Under 35 U.S.C. § 103(a)

Claims 42-43, 46, 48-49 and 68 are rejected under 35 U.S.C. § 103(a) as being unpatentable over by Bottum in view of Goodman.

Claims 34-35, 44-45, 69-71, and 74-98 are rejected under 35 U.S.C. § 103(a) as being unpatentable over Bottum in view of Goodman and further in view of Mills.

Applicant respectfully submits that these rejections are moot in view of the discussion above and that the instant claims are allowable over Goodman, Mills and Bottum for at least the same reasons they are allowable over Bottum.

Moreover, applicant submits it is not obvious to combine the references as the Examiner proposes. As mentioned above, the purpose of Bottum is to provide a subscription radio that uses an efficient asynchronous data transmission technique rather than a continuous dedicated data link, whereas the system of Goodman requires the use of such an inefficient dedicated data link (e.g.,

see Goodman, column 7, lines 41-55). Thus, the references teach away from one another, discouraging the combination proposed by the Examiner. Moreover, the radio of Bottum relies on external processing capabilities of a personal computer for certain sophisticated signal processing functions (e.g., see Bottum column 3, lines 15-32) further discouraging combination with the lightweight mobile device described in Goodman. Furthermore, substantial modification of each of the devices described in Bottum, Goodman and Mills would be required in order to effect the proposed combination further discouraging such a combination. No teaching is provided by any reference describing how to accomplish such modifications and there is no suggestion or motivation provided within the references themselves that such a combination would be beneficial or even desirable.

In addition, even if such a combination were made, it would still not produce applicant's claimed invention (i.e., the combination would merely produce a device suffering from all the shortcomings of Bottum pointed out above). Moreover, although Mills mentions that MP3 files may be stored in the expansion module, no mention is made of MIDI, WAV, PCM, WMA or ATRAC audio files.

Accordingly, based on the above applicant respectfully requests that the rejections under 35 U.S.C. § 103(a) be withdrawn.

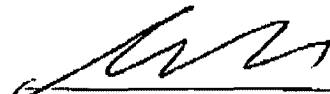
VI. Conclusion

For at least the above reasons, claims 33, 42, 74, 79 and 91 are patentable over the references of record. Claims 24-41, 43-49, 75-78, 80-90 and 92-98 which depend therefrom are therefore also patentable over the references of record.

For all of the above reasons, applicant respectfully requests that the Examiner withdraw the rejections and allow the pending claims. To expedite prosecution of this application to allowance, the examiner is invited to call the applicant's undersigned representative to discuss any issues relating to this application.

Respectfully submitted,

Dated: 6/29/06



\_\_\_\_\_  
Scott H. Kaliko  
Attorney for Applicant  
Registration No. 45,786  
KALIKO & YEAGER, L.L.C.  
500 North Franklin Turnpike  
Ramsey, NJ 07446  
Direct: 201-831-0575  
Fax: 201-831-0519



UNITED STATES PATENT AND TRADEMARK OFFICE

UNITED STATES DEPARTMENT OF COMMERCE  
United States Patent and Trademark Office  
Address: COMMISSIONER FOR PATENTS  
P.O. Box 1450  
Alexandria, Virginia 22313-1450  
www.uspto.gov

APPLICATION NO.	FILING DATE	FIRST NAMED INVENTOR	ATTORNEY DOCKET NO.	CONFIRMATION NO.
10/223,200	08/16/2002	Michael E. Shanahan	MES/001CON	8026

39550                      7590                      07/07/2006

KALIKO & YEAGER, L.L.C.  
500 NORTH FRANKLIN TURNPIKE  
RAMSEY, NJ 07446

EXAMINER

TRAN, CONGVAN

ART UNIT	PAPER NUMBER
2617	

DATE MAILED: 07/07/2006

Please find below and/or attached an Office communication concerning this application or proceeding.

<b>Notice of Non-Compliant Amendment (37 CFR 1.121)</b>	Application No. 10223200	Applicant(s)	
	Examiner	Art Unit	

-- The MAILING DATE of this communication appears on the cover sheet with the correspondence address --

The amendment document filed on 29 June 2006 is considered non-compliant because it has failed to meet the requirements of 37 CFR 1.121 or 1.4. In order for the amendment document to be compliant, correction of the following item(s) is required.

THE FOLLOWING MARKED (X) ITEM(S) CAUSE THE AMENDMENT DOCUMENT TO BE NON-COMPLIANT:

- 1. Amendments to the specification:
  - A. Amended paragraph(s) do not include markings.
  - B. New paragraph(s) should not be underlined.
  - C. Other \_\_\_\_\_.
- 2. Abstract:
  - A. Not presented on a separate sheet. 37 CFR 1.72.
  - B. Other \_\_\_\_\_.
- 3. Amendments to the drawings:
  - A. The drawings are not properly identified in the top margin as "Replacement Sheet," "New Sheet," or "Annotated Sheet" as required by 37 CFR 1.121(d).
  - B. The practice of submitting proposed drawing correction has been eliminated. Replacement drawings showing amended figures, without markings, in compliance with 37 CFR 1.84 are required.
  - C. Other \_\_\_\_\_.
- 4. Amendments to the claims:
  - A. A complete listing of all of the claims is not present.
  - B. The listing of claims does not include the text of all pending claims (including withdrawn claims)
  - C. Each claim has not been provided with the proper status identifier, and as such, the individual status of each claim cannot be identified. Note: the status of every claim must be indicated after its claim number by using one of the following status identifiers: (Original), (Currently amended), (Canceled), (Previously presented), (New), (Not entered), (Withdrawn) and (Withdrawn-currently amended).
  - D. The claims of this amendment paper have not been presented in ascending numerical order.
  - E. Other: There are pages missing from the claim section of the faxed amendment.
- 5. Other (e.g., the amendment is unsigned or not signed in accordance with 37 CFR 1.4):  
\_\_\_\_\_

For further explanation of the amendment format required by 37 CFR 1.121, see MPEP § 714.

TIME PERIODS FOR FILING A REPLY TO THIS NOTICE:

1. Applicant is given **no new time period** if the non-compliant amendment is an after-final amendment, an amendment filed after allowance, or a drawing submission (only). If applicant wishes to resubmit the non-compliant after-final amendment with corrections, the **entire corrected amendment** must be resubmitted.
2. Applicant is given **one month**, or thirty (30) days, whichever is longer, from the mail date of this notice to supply the correction, if the non-compliant amendment is one of the following: a preliminary amendment, a non-final amendment (including a submission for a request for continued examination (RCE) under 37 CFR 1.114), a supplemental amendment filed within a suspension period under 37 CFR 1.103(a) or (c), and an amendment filed in response to a *Quayle* action. If any of above boxes 1. to 4. are checked, the correction required is only the **corrected section** of the non-compliant amendment in compliance with 37 CFR 1.121.

**Extensions of time** are available under 37 CFR 1.136(a) only if the non-compliant amendment is a non-final amendment or an amendment filed in response to a *Quayle* action.

**Failure to timely respond** to this notice will result in:

**Abandonment** of the application if the non-compliant amendment is a non-final amendment or an amendment filed in response to a *Quayle* action; or

**Non-entry** of the amendment if the non-compliant amendment is a preliminary amendment or supplemental amendment.

Terri Williams J. Williams  
Legal Instruments Examiner (LIE), if applicable

(571)272-2991  
Telephone No.

RECEIVED  
CENTRAL FAX CENTER

JUN 29 2006



500 North Franklin Turnpike, Ramsey, NJ 07446  
(201) 831-0575 Main Tel  
(201) 831-0519 Main Fax

FACSIMILE TRANSMITTAL SHEET

TO: Commissioner for Patents	FROM: Scott H. Kaliko, Esq.
	SENDER'S FAX NUMBER: 201-831-0519
	SENDER'S TELEPHONE NUMBER: 201-831-0575
COMPANY: United States Patent & Trademark Office	DATE: JUNE 29, 2006
RECIPIENT'S FAX NUMBER: 571-273-8300	TOTAL NO. OF PAGES INCLUDING COVER: 32
RECIPIENT'S TELEPHONE NUMBER:	CLIENT / MATTER:
RE: Application No. 10/223,200	YOUR REFERENCE NUMBER: MFS/001 CON

URGENT     FOR REVIEW     PLEASE COMMENT     PLEASE REPLY     PLEASE RECYCLE

NOTES/COMMENTS:

Please confirm receipt of this fax and the below-identified attached parts.

1. Transmittal Form/Certificate of Transmission;
2. Reply to Office Action (32 Pages).

CONFIDENTIALITY NOTICE

The information contained in this facsimile message is privileged and confidential and is intended only for the use of the individual(s) and/or entity(ies) named above. If you are not the intended recipient, you are hereby notified that any unauthorized disclosure, copying, distribution or taking of any action in reliance on the contents of the information contained herein is strictly prohibited and review by any individual other than the intended recipient shall not constitute a waiver of the attorney-client privilege. If you have received this transmission in error, please immediately notify us by telephone. Thank you.



JUN 29 2006

PTO/SB/21 (09-04)  
Approved for use through 07/31/2006, OMB 0851-0031  
U.S. Patent and Trademark Office: U.S. DEPARTMENT OF COMMERCE

Under the Paperwork Reduction Act of 1995, no persons are required to respond to a collection of information unless it displays a valid OMB control number.

<b>TRANSMITTAL FORM</b> <small>(to be used for all correspondence after initial filing)</small>	Application Number	10/223.200
	Filing Date	August 18, 2002
	First Named Inventor	MICHAEL E. SHANAHAN
	Art Unit	2817
	Examiner Name	CongVan Tran
	Attorney Docket Number	MES/001 CON
Total Number of Pages In This Submission		

ENCLOSURES (Check all that apply)		
<input type="checkbox"/> Fee Transmittal Form <input type="checkbox"/> Fee Attached <input checked="" type="checkbox"/> Amendment/Reply <input type="checkbox"/> After Final <input type="checkbox"/> Affidavits/declaration(s) <input type="checkbox"/> Extension of Time Request <input type="checkbox"/> Express Abandonment Request <input type="checkbox"/> Information Disclosure Statement <input type="checkbox"/> Certified Copy of Priority Document(s) <input type="checkbox"/> Reply to Missing Parts/ Incomplete Application <input type="checkbox"/> Reply to Missing Parts under 37 CFR 1.52 or 1.53	<input type="checkbox"/> Drawing(s) <input type="checkbox"/> Licensing-related Papers <input type="checkbox"/> Petition <input type="checkbox"/> Petition to Convert to a Provisional Application <input type="checkbox"/> Power of Attorney, Revocation <input type="checkbox"/> Change of Correspondence Address <input type="checkbox"/> Terminal Disclaimer <input type="checkbox"/> Request for Refund <input type="checkbox"/> CD, Number of CD(s) _____ <input type="checkbox"/> Landscape Table on CD	<input type="checkbox"/> After Allowance Communication to TC <input type="checkbox"/> Appeal Communication to Board of Appeals and Interferences <input type="checkbox"/> Appeal Communication to TC (Appeal Notice, Brief, Reply Brief) <input type="checkbox"/> Proprietary Information <input type="checkbox"/> Status Letter <input checked="" type="checkbox"/> Other Enclosure(s) (please identify below):
Remarks 1. Reply to Office Action (3 Pages)		

SIGNATURE OF APPLICANT, ATTORNEY, OR AGENT			
Firm Name	KALIKO & YEAGER, LLC		
Signature			
Printed name	SCOTT H. KALIKO, ESQ.		
Date	JUNE 29, 2006	Reg. No.	45,786

CERTIFICATE OF TRANSMISSION/MAILING	
I hereby certify that this correspondence is being facsimile transmitted to the USPTO or deposited with the United States Postal Service with sufficient postage as first class mail in an envelope addressed to: Commissioner for Patents, P.O. Box 1450, Alexandria, VA 22313-1450 on the date shown below:	
Signature	
Typed or printed name	SCOTT H. KALIKO, ESQ.
Date	JUNE 29, 2006

This collection of information is required by 37 CFR 1.5. The information is required to obtain or retain a benefit by the public which is to file (and by the USPTO to process) an application. Confidentiality is governed by 35 U.S.C. 122 and 37 CFR 1.11 and 1.14. This collection is estimated to 2 hours to complete, including gathering, preparing, and submitting the completed application form to the USPTO. Time will vary depending upon the individual case. Any comments on the amount of time you require to complete this form and/or suggestions for reducing this burden, should be sent to the Chief Information Officer, U.S. Patent and Trademark Office, U.S. Department of Commerce, P.O. Box 1450, Alexandria, VA 22313-1450. DO NOT SEND FEES OR COMPLETED FORMS TO THIS ADDRESS. SEND TO: Commissioner for Patents, P.O. Box 1450, Alexandria, VA 22313-1450.

If you need assistance in completing the form, call 1-800-PTO-9199 and select option 2.

RECEIVED  
CENTRAL FAX CENTER

JUN 29 2006

MES/001 CON

IN THE UNITED STATES PATENT AND TRADEMARK OFFICE

Applicant : Michael E. Shanahan  
 Application No. : 10/223,200 Confirmation No.: 8026  
 Filed : August 16, 2002  
 Title : METHODS AND APPARATUSES FOR PROGRAMMING  
 USER-DEFINED INFORMATION INTO  
 ELECTRONIC DEVICES  
 Examiner : CongVan Tran  
 Group Art Unit : 2617

June 29, 2006

Mail Stop Amendment  
 Commissioner for Patents  
 P.O. Box 1450  
 Alexandria, VA 22313-1450

REPLY TO OFFICE ACTION

Sir:

In response to the Office Action dated April 20, 2006:

**A listing of claims** which begins on page 2 of this paper.

**Remarks** begin on page 22 of this paper.

connecting to a remote database that includes a plurality of audio files; the remote database operating substantially independently of a communications network that provides wireless telephone service to the wireless telephone;

allowing the user of the wireless telephone to browse and select at least one of the audio files;

allowing the user to optionally download the selected audio file into a programmable memory for use as an indicia of an incoming communication.

25. (Withdrawn) The method of claim 24 further comprising allowing the user to optionally review the selected audio file before downloading the selected audio file into the wireless telephone.

26. (Withdrawn) The method of claim 24 wherein the format of the selected audio file is from the group comprising: MIDI, MPEG, MP3, WAV, PCM, Windows Media Audio code (WMA), or Adaptive Transform Acoustic Coding (ATRAC).

27. (Withdrawn) The method of claim 24 further comprising allowing the user to search the remote database for a certain desired audio file using title or description information to aid in locating the desired audio file.

28. (Withdrawn) The method of claim 24 wherein the searching further comprises searching the Internet or other remote databases for the desired audio file.

29. (Withdrawn) The method of claim 24 wherein the browsing of audio files is accomplished at least in part using a Wireless Application Protocol (WAP) compliant system.

30. (Withdrawn) The method of claim 24 further comprising providing a visual indication on a display screen of the wireless telephone to confirm the selected audio file has been successfully downloaded.

31. (Withdrawn) The method of claim 24 further comprising:

downloading a selected audio file into the wireless telephone; and

associating the downloaded audio file with a characteristic indicative of a caller such that the associated audio file plays when the indicative characteristic is received by the wireless telephone.

32. (Withdrawn) The method of claim 24 wherein the characteristic indicative of the caller is the caller's telephone number.

33. (Previously presented) A wireless telephone that may be customized by programming an audio file into the wireless telephone for use as an indicia of an incoming communication, the telephone comprising:

a communications link capable of connecting to a remote database that includes a plurality of lists of audio files;

a display screen that allows a user of the wireless telephone to browse at least one of the plurality of lists of audio files and view selectable audio files present in the browsed list;

a speaker and processing circuitry configured to allow the user to optionally review a selected audio file before downloading the selected audio file into the wireless telephone; and

a programmable memory circuit for allowing the user to optionally store the selected audio file for use as an indicia of an incoming communication.

34. (Previously presented) The wireless telephone of claim 33 wherein the programmable memory circuit is configured to store audio files in a format selected from the group comprising: MIDI, MPEG, MP3, WAV, PCM, Windows Media Audio code (WMA), or Adaptive Transform Acoustic Coding (ATRAC).

35. (Previously presented) The wireless telephone of claim 33 wherein the speaker and processing circuitry is configured to play audio files in a format selected from the group comprising: MIDI, MPEG, MP3, WAV, PCM, Windows Media Audio code (WMA), or Adaptive Transform Acoustic Coding (ATRAC).

36. (Previously presented) The wireless telephone of claim 33 wherein the wireless telephone is configured to allow the user to search the remote database for a certain desired audio file using title or description information to aid in locating the desired audio file.

37. (Previously presented) The wireless telephone of claim 36 wherein the wireless telephone is configured to search the Internet or other remote databases for the desired audio file.

38. (Previously presented) The wireless telephone of claim 33 wherein the wireless telephone includes a Wireless Application Protocol (WAP) compliant Internet browser.

39. (Previously presented) The wireless telephone of claim 33 configured to provide a visual indication on the display screen to confirm the selected audio file has been successfully downloaded.

40. (Previously presented) The wireless telephone of claim 33 configured to allow the user to associate a downloaded audio file with a characteristic indicative of a caller such that the associated audio file plays when the indicative characteristic is received by the wireless telephone.

41. (Previously presented) The wireless telephone of claim 40 wherein the characteristic indicative of the caller is the caller's telephone number.

42. (Previously presented) A wireless telephone that may be customized by programming an audio file into the wireless telephone for use as an indicia of an incoming communication, the telephone comprising:

a communications link capable of connecting to a remote database that includes a plurality of lists of audio files; the remote database operating substantially independently of a communications network that provides wireless telephone service to the wireless telephone;

a display screen that allows a user of the wireless telephone to browse at least one of the plurality of lists of audio files and view selectable audio files present in the browsed list;

processing circuitry configured to receive a selected audio file from the communications link; and

a programmable memory circuit for allowing the user to optionally store the selected audio file for use as an indicia of an incoming communication.

43. (Previously presented) The wireless telephone of claim 42 further comprising a speaker that operates in conjunction with the processing circuitry to allow the user to optionally review a selected audio file before downloading the selected audio file into the wireless telephone.

44. (Previously presented) The wireless telephone of claim 42 wherein the programmable memory circuit is configured to store audio files in a format selected from the group comprising: MIDI, MPEG, MP3, WAV, PCM, Windows Media Audio code (WMA), or Adaptive Transform Acoustic Coding (ATRAC).

45. (Previously presented) The wireless telephone of claim 42 wherein the speaker and processing circuitry is configured to play audio files in a format selected from the group comprising: MIDI, MPEG, MP3, WAV, PCM, Windows Media Audio code (WMA), or Adaptive Transform Acoustic Coding (ATRAC).

46. (Previously presented) The wireless telephone of claim 42 wherein the wireless telephone is configured to allow the user to search the remote database for a certain desired audio file using title or description information to aid in locating the desired audio file.

47. (Previously presented) The wireless telephone of claim 42 wherein the wireless telephone includes a Wireless Application Protocol (WAP) compliant Internet browser.

48. (Previously presented) The wireless telephone of claim 22 configured to provide a visual indication on the display screen to confirm the selected audio file has been successfully downloaded.

49. (Previously presented) The wireless telephone of claim 42 configured to allow the user to associate a downloaded audio file with a characteristic indicative of a caller such that the associated audio file plays when the indicative characteristic is received by the wireless telephone.

50. (Withdrawn) A wireless telephone that may be customized by programming an audio file into the wireless telephone for use as an indicia of an incoming communication, the telephone comprising:

means for connecting to a remote database that includes a plurality of lists of audio files;

means for browsing at least one of the lists of audio files;

means for selecting at least one of the audio files from the browsed list;

means for optionally reviewing the selected audio file before downloading the selected audio into the wireless telephone; and

means for downloading the selected audio file for use as an indicia of an incoming communication.

51. (Withdrawn) The wireless telephone of claim 50 further comprising means for searching the remote database for a



certain desired audio file using title or description information to aid in locating the desired audio file.

52. (Withdrawn) The wireless telephone of claim 51 wherein the searching further comprises means for searching the Internet or other remote databases for the desired audio file.

53. (Withdrawn) The wireless telephone of claim 50 further comprising means for providing a visual indication on a display screen of the wireless telephone to confirm the selected audio file has been successfully downloaded.

54. (Withdrawn) The wireless telephone of claim 50 further comprising means for associating a downloaded audio file with a characteristic indicative of a caller such that the associated audio file plays when the indicative characteristic is received by the wireless telephone.

55. (Withdrawn) A wireless telephone that may be customized by programming an audio file into the wireless telephone for use as an indicia of an incoming communication, the telephone comprising:

means for connecting to a remote database that includes a plurality of audio files; the remote database operating substantially independently of a communications network that provides wireless telephone service to the wireless telephone;

means for browsing and selecting at least one of the audio files;

means for optionally downloading the selected audio file into a programmable memory for use as an indicia of an incoming communication.

56. (Withdrawn) The wireless telephone of claim 55 further comprising means for optionally reviewing the selected audio file before downloading the selected audio file into the wireless telephone.

57. (Withdrawn) The wireless telephone of claim 56 further comprising means for searching the remote database for a certain desired audio file using title or description information to aid in locating the desired audio file.

58. (Withdrawn) The wireless telephone of claim 55 wherein the searching further comprises means for searching the Internet or other remote databases for the desired audio file.

59. (Withdrawn) The wireless telephone of claim 55 wherein the browsing of audio files is accomplished at least in part using a Wireless Application Protocol (WAP) compliant system.

60. (Withdrawn) The wireless telephone of claim 55 further comprising providing a visual indication on a display screen of the wireless telephone to confirm the selected audio file has been successfully downloaded.

61. (Withdrawn) The wireless telephone of claim 55 further comprising means for associating a downloaded audio file with a characteristic indicative of a caller such that the associated audio file plays when the indicative characteristic is received by the wireless telephone.

62. (Withdrawn) The method of claim 16 further comprising preventing the unauthorized distribution of a downloaded audio file.

63. (Withdrawn) The method of claim 16 further comprising playing the selected audio file through an enhanced performance speaker capable of providing a substantially full range of audio sounds from MIDI, MP3, MPEG, WAV, PCM, Windows Media Audio Code (WMA), or Adaptive Transform Acoustic Coding (ATRAC) files.

64. (Withdrawn) The method of claim 16 characterized by the use of a personal computer to perform the browsing step.

65. (Withdrawn) The method of claim 16 further comprising providing the user with an opportunity to edit the selected audio file.

66. (Withdrawn) The method of claim 16 further comprising providing an indication that a memory capacity of the wireless telephone has been exceeded if the size of the audio file to be downloaded is larger than available memory space in the wireless telephone.

67. (Withdrawn) The method of claim 66 further comprising providing the user of the wireless telephone with the opportunity to cancel or modify a download request associated with an audio file download operation if the size of the audio file to be downloaded is larger than available memory space in the wireless telephone.

68. (Previously presented) The wireless telephone of claim 33 wherein the wireless telephone is configured to prevent the unauthorized distribution of an audio file stored in the programmable memory circuit.

69. (Previously presented) The wireless telephone of claim 33 wherein the speaker is an enhanced performance speaker capable of providing a substantially full range of audio sounds from MIDI, MP3, MPEG, WAV, PCM, Windows Media Audio Code (WMA), or Adaptive Transform Acoustic Coding (ATRAC) files.

70. (Previously presented) The wireless telephone of claim 33 configured to provide an indication that a memory capacity of the wireless telephone has been exceeded if the size of the audio file to be downloaded is larger than available memory space in the wireless telephone.

71. (Previously presented) The wireless telephone of claim 70 configured to provide the user of the wireless telephone with the opportunity to cancel or modify a download request associated with an audio file download operation if the size of the audio file to be downloaded is larger than the available memory space in the wireless telephone.

72. (Withdrawn) A wireless telephone that may be customized by programming an audio file into the wireless telephone for use as an indicia of an incoming communication, the telephone comprising:

means for connecting to a remote database that includes a plurality of audio files;

means for selecting at least one of the audio files from the database;

means for downloading and storing the selected audio file for use as an indicia of an incoming communication; and

means for preventing the unauthorized distribution of a selected audio file stored in the wireless telephone.

73. (Withdrawn) The wireless telephone of claim 72 further comprising means for indicating that a memory capacity of the wireless telephone has been exceeded if the size of the audio file to be downloaded is larger than available memory space in the wireless telephone.

74. (Previously presented) A wireless telephone that may be customized by searching for and selecting an audio file from a remote computer and programming the selected audio file into the wireless telephone for use as an indicia of an incoming communication, the telephone comprising:

a communications link capable of connecting to a database in the remote computer that includes a plurality of lists of audio files in MPEG, or WAV, or MP3 format or a combination thereof;

a display screen and a mobile Internet browser that allows a user of the wireless telephone to browse at least one of the lists of lists of audio files and view selectable audio files present in the browsed list;

processing circuitry configured to receive a selected one of the audio files from the communications link;

a programmable memory circuit for allowing the user to optionally store the selected audio file for use as an indicia of an incoming communication; and

an enhanced performance speaker capable of providing a substantially full range of audio sounds when one of the selected audio files is played as an indicia of an incoming communication.

75. (Previously presented) The wireless telephone of claim 74 configured to provide an indication that a memory capacity of the wireless telephone has been exceeded if the size of the audio file to be downloaded is larger than the available memory space in the wireless telephone.

76. (Previously presented) The wireless telephone of claim 74 wherein the enhanced performance speaker operates in conjunction with the processing circuitry to allow the user to optionally review a the selected audio file before downloading the selected audio file into the wireless telephone.

77. (Previously presented) The wireless telephone of claim 74 configured to allow the user to search the database for a certain desired audio file using title or description information to aid in locating a desired audio file.

78. (Previously presented) The wireless telephone of claim 74 configured to prevent the unauthorized distribution of a audio file stored in the programmable memory circuit.

79. (Previously presented) A wireless telephone that may be customized by searching for and selecting an audio file from a remote computer and programming the selected audio file into the wireless telephone for use at a time specified by the user, the telephone comprising:

a communications link capable of connecting to a database in the remote computer that includes a plurality of polyphonic audio files;

a display screen and a browsing application program that allows a user of the wireless telephone to browse the polyphonic audio files and select at least one polyphonic audio file therefrom;

processing circuitry configured to supervise receipt of a selected polyphonic audio file from the communications link;

a programmable memory circuit for allowing the user to optionally store the selected polyphonic audio file for use as an indicia of an incoming communication; and

an enhanced performance speaker capable of providing a substantially full range of audio sounds from the selected polyphonic audio file when the selected polyphonic audio file is played.

80. (Previously presented) The wireless telephone of claim 79 wherein the polyphonic audio file is selected from the group comprising MP3, MPEG, or WAV files.

81. (Previously presented) The wireless telephone of claim 79 wherein the enhanced performance speaker operates in conjunction with the processing circuitry to allow the user to optionally review the selected polyphonic audio file before downloading the selected polyphonic audio file into the programmable memory circuit of the wireless telephone.

82. (Previously presented) The wireless telephone of claim 79 configured to prevent the unauthorized distribution of the selected polyphonic audio file stored in the programmable memory circuit.

83. (Previously presented) The wireless telephone of claim 74 wherein the group of polyphonic audio files includes audio files in polyphonic MIDI format.

84. (Previously presented) The wireless telephone of claim 76 configured to provide the user of the wireless telephone with the option of downloading the selected polyphonic audio file into a programmable memory in the wireless telephone after reviewing the selected polyphonic audio file.

85. (Previously presented) The wireless telephone of claim 84 configured to provide the user of the wireless telephone with the option of modifying the selected polyphonic audio file before programming the selected polyphonic audio file into the programmable memory in the wireless telephone.

86. (Previously presented) The wireless telephone of claim 80 wherein the wireless telephone is configured to operate in conjunction with copyright protection software to prevent the unauthorized distribution of the selected polyphonic audio file stored in the programmable memory circuit.

87. (Previously presented) The wireless telephone of claim 79 wherein the selected polyphonic audio files is in polyphonic MIDI format.

88. (Previously presented) The wireless telephone of claim 81 configured to provide the user of the wireless telephone with the option of downloading the selected polyphonic



audio file into a programmable memory in the wireless telephone after reviewing the selected polyphonic audio file.

89. (Previously presented) The wireless telephone of claim 88 configured to provide the user of the wireless telephone with the option of modifying the selected polyphonic audio file before programming the selected polyphonic audio file into the programmable memory in the wireless telephone.

90. (Previously presented) The wireless telephone of claim 82 wherein the wireless telephone is configured to operate in conjunction with copyright protection software to prevent the unauthorized distribution of the selected polyphonic audio file stored in the programmable memory circuit.

91. (Previously presented) A wireless telephone that may be customized by searching for and selecting an audio file from a remote computer and programming the selected audio file into the wireless telephone for use as an indicia of an incoming communication, the telephone comprising:

a communications link capable of connecting to a database in the remote computer that includes a plurality of polyphonic audio files;

a display screen and a browsing application program that allows a user of the wireless telephone to browse the polyphonic audio files and select at least one polyphonic audio file therefrom;

processing circuitry configured to supervise receipt of a selected polyphonic audio file from the communications link;

a programmable memory circuit for allowing the user to optionally store the selected polyphonic audio file for use as an indicia of an incoming communication; and

an enhanced performance speaker capable of providing a substantially full range of audio sounds from the selected polyphonic audio file when the selected polyphonic audio file is played.

92. (Previously presented) The wireless telephone of claim 91 wherein the polyphonic audio file is selected from the group comprising MP3, MPEG, or WAV files.

93. (Previously presented) The wireless telephone of claim 91 wherein the enhanced performance speaker operates in conjunction with the processing circuitry to allow the user to optionally review the selected polyphonic audio file before downloading the selected polyphonic audio file into the programmable memory circuit of the wireless telephone.

94. (Previously presented) The wireless telephone of claim 91 configured to prevent the unauthorized distribution of the selected polyphonic audio file stored in the programmable memory circuit.

95. (Previously presented) The wireless telephone of claim 91 wherein the polyphonic audio files includes audio files in polyphonic MIDI format.

96. (Previously presented) The wireless telephone of claim 93 configured to provide the user of the wireless telephone with the option of downloading the selected polyphonic audio file into a programmable memory in the wireless telephone after reviewing the selected polyphonic audio file.

97. (Previously presented) The wireless telephone of claim 93 configured to provide the user of the wireless telephone with the option of modifying the selected polyphonic audio file before programming the selected polyphonic audio file into the programmable memory in the wireless telephone.

98. (Previously presented) The wireless telephone of claim 91 wherein the wireless telephone is configured to operate in conjunction with copyright protection software to prevent the unauthorized distribution of the selected polyphonic audio file stored in the programmable memory circuit.

99. (Withdrawn) A wireless telephone that may be customized by programming an audio file into the wireless telephone for use at a time specified by a user of the wireless telephone, the telephone comprising:

means for connecting to a remote database that includes a plurality of lists of polyphonic audio files;

means for browsing at least one of the lists of polyphonic audio files;

means for selecting at least one of the polyphonic audio files from the browsed list;

means for optionally reviewing the selected polyphonic audio file before downloading the selected polyphonic audio into a memory circuit in the wireless telephone; and

means for downloading the selected polyphonic audio file for use at the time specified by the user of the wireless telephone.

100. (Withdrawn) The wireless telephone of claim 99 further comprising means for searching the remote database for a certain desired polyphonic audio file using title or description information to aid in locating the desired polyphonic audio file.

101. (Withdrawn) The wireless telephone of claim 100 wherein the searching further comprises means for searching the Internet or other remote databases for the desired polyphonic audio file.

102. (Withdrawn) The wireless telephone of claim 99 further comprising means for providing a visual indication on a display screen of the wireless telephone to confirm the selected polyphonic audio file has been successfully downloaded.

103. (Withdrawn) The wireless telephone of claim 99 wherein the browsing of polyphonic audio files is accomplished at least in part using a Wireless Application Protocol (WAP) compliant system.

104. (Withdrawn) The wireless telephone of claim 99 further comprising means for preventing unauthorized distribution of the selected polyphonic audio file stored in the programmable memory circuit.

**REMARKS****I. Introduction**

Claims 1-15 are cancelled without prejudice.

Claims 33-49, 68-71, 74-98 are pending in the application.

Claims 16-32, 50-67, 72-73 and 99-104 are withdrawn from consideration.

Claims 33, 36-37, 38-41 and 47 are rejected under 35 U.S.C. § 102(e) as being anticipated by Bottum, U.S. patent 6,014,569 (hereinafter "Bottum").

Claims 42-43, 46, 48-49, and 68 are rejected under 35 U.S.C. § 103(a) as being unpatentable over Goodman, U.S. patent 5,694,455 (hereinafter "Goodman") in view of Bottum.

Claims 34-35, 44-45, 69-71, and 74-98 are rejected under 35 U.S.C. § 103(a) as being unpatentable over Bottum in view of Goodman and further in view of Mills et al. U.S. patent 6,599,147 (hereinafter "Mills").

Consideration and allowance of this application in light of the following remarks is respectfully requested.

II. Applicant's Reply to the Rejection Under 35 U.S.C. § 102(e)

Claims 33, 36-37, 38-41 and 47 are rejected under 35 U.S.C. § 102(e) as being anticipated by Bottum. Applicant respectfully traverses this rejection in view of the remarks below.

One aspect of applicant's claimed invention is concerned with a wireless telephone that may be customized by programming an audio file into the wireless telephone for use as an indicia of an incoming communication. This may be thought of as a wireless telephone that allows a user to customize the wireless telephone by selecting and programming a ringtone into the wireless telephone which plays when an incoming telephone call (or other communication) is received.

One benefit of such a wireless telephone is that it allows the user the freedom and flexibility to choose and/or change to a particular ringtone that is pleasing to the user rather than be constrained by a single ringtone or limited group of ringtones, which may have been, for example, preprogrammed by a manufacturer.

The claimed wireless telephone has the ability to connect to a remote database(s) of ringtones and allow the user to browse lists of ringtones in the remote database(s), select a

particular ringtone and optionally review (e.g., listen to) the selected ringtone using a speaker and processing circuitry prior to downloading the ringtone into a programmable memory in the wireless telephone (e.g., a preview feature). This allows the user to confirm the selected ringtone is correct and/or acceptable or meets expectations, etc. Thus, one aspect of applicant's claimed invention is concerned with a customization of wireless telephone by allowing the review and selection of a ringtone that is played subsequently when receiving an incoming call.

In contrast, Bottum fails to show or suggest these features anywhere. Rather, Bottum is purportedly concerned with a specialized mobile radio for use with a subscription audio service that employs an asynchronous data transmission technique in place of a continuous dedicated data link that was used in the prior art (e.g., see Bottum, Column 1, line 61 to column 2, line 10, FIG. 2 and its associated description). Bottum explains that dedicated communication paths are inefficient because the transmission of data generally occurs in short bursts over short periods of time and, thus, a dedicated communication link is occupied for a far longer period of time than necessary to transmit the data, resulting in unnecessary costs (Bottum, column 1, lines 14-21). The purpose of the system described in Bottum is to provide audio data over an asynchronous communications link such as a Cellular

Digital Packet Data link ("CDPD") to a subscription radio in order to conserve transmission resources and improve overall efficiency as compared to systems that rely on dedicated communication links. See, for example, Bottum, Column 2, line 11 to column 3, line 10.

Bottum also mentions that the radio may include an interface that allows a subscriber to select certain types of audio programming based category such as news, sports and music data. See Bottum, column 3, line 54 to column 4, line 12.

However, completely absent from Bottum is any teaching or suggestion that an audio file may be stored in a wireless telephone and played as an *indicia of an incoming communication* as specified in applicant's claims. For example, the device described in Bottum is merely a subscription radio receiving device (described as a "MIR" or mobile interactive radio) that retrieves requested information for "on-demand" retrieval and/or consumption by the user (See Bottum, column 5, lines 55-58, also see column 5, lines 24-33). Thus, the device described in Bottum is a merely a device which can select and receive the selected subscription radio/audio transmissions (this may be thought of as having a functionality similar to that of an XM satellite radio receiver).

Because Bottum provides content for consumption on an "on-demand" basis, it does not and cannot play that content as an



indicia of an incoming communication as specified in applicant's claims (i.e., the content is played as received). Moreover, applicant points out that because in the system of Bottum the user receives or has access to content substantially immediately after it is requested, there is no need (or purpose) for an indicia of an incoming communication (such as a ringtone) because the user receives the information in response to his or her request and knows when to expect to receive or access the requested information (as opposed to a telephone, with which a user cannot predict incoming communications initiated by others, such as an incoming telephone call, and thus must be alerted with an indicia such as a ringtone).

Accordingly, applicant respectfully submits that the subscription radio of Bottum does not show or suggest the use of an indicia of an incoming communication and fails to recognize that such a customization feature would be desirable or suggest or recognize the circumstances under which such features would be useful or desirable. Accordingly, Bottum fails to show or suggest browsing, downloading and playing an audio file as an indicia of an incoming communication as specified in applicant's claims.

Furthermore, Bottum fails to show or suggest reviewing a selected audio file prior to download as specified in applicant's

claims. In particular, the Examiner relies on Bottum, column 4, lines 1-16 as disclosing this feature (reproduced below).

Preferably, radio 150 includes user interface 170. Interface 170 provides information to and receives instructions from a user. For example, interface 170 may provide a menu to a user visually on display screen 172 or acoustically on acoustic system 174. Of course, acoustic systems 158 and 174 may be one in the same. Also, interface 170 may act to receive instructions from the user. For example, user instructions may be received by radio 150 via a touch sensitive display screen, a voice recognition device or at least one menu navigation key. If menu navigation key 176 is used by a user to designate an audio offering (as shown in FIG. 2), radio 150 may also include selection button 178 for selecting the designated audio offering. Furthermore, radio 150 may include memory unit 180 for storing menu information previously transmitted by wireless system 120 or downloaded via a cable.

However, applicant respectfully points out that this paragraph merely relates to the operation and function of a basic user interface for a subscription radio and does not show or suggest reviewing (e.g., listening to) a selected audio file prior to downloading or use of the audio file as an indicia of an incoming communication as specified in applicant's claims. Nor does it relate to the storing audio content.

In addition, although Bottum does mention that audio data may be transmitted over the Internet (for example, see column 1, lines 22-40) no mention is made of a resident Internet browser

or a WAP compliant Internet browser as specified in applicant's claims.

Accordingly, applicant respectfully submits that independent claims 33, 36-37, 38-41, and 47, and the claims that depend therefrom are allowable over Bottum for at least these reasons.

Other Patentable Distinctions

In addition to the reasons above, applicant respectfully submits that at least several other patentable distinctions exist in pending claims over the prior art of record. For example, other features patentable over the prior art include a wireless telephone configured to prevent the unauthorized distribution of the downloaded audio files used as an indicia of an incoming communication (claims 78 and 82), the use of copyright protection measures (claims 86 and 98), optionally modifying selected audio files before programming into the wireless telephone (claims 85 and 97), the use of polyphonic audio files including the various formats specified (claims 69 and 79-98), a wireless telephone (not a radio) that includes an enhanced performance speaker for providing a substantially full range of audio sounds (claims 74-98) and that allows a user to browse and select audio files for use an

indicia as well as other patentable features set forth in the claims that are not deemed necessary to discuss here.

Accordingly, based on the above, applicant respectfully requests that the rejections under 35 U.S.C. § 102(e) be withdrawn.

III. Applicant's Reply to the Rejection Under 35 U.S.C. § 103(a)

Claims 42-43, 46, 48-49 and 68 are rejected under 35 U.S.C. § 103(a) as being unpatentable over by Bottum in view of Goodman.

Claims 34-35, 44-45, 69-71, and 74-98 are rejected under 35 U.S.C. § 103(a) as being unpatentable over Bottum in view of Goodman and further in view of Mills.

Applicant respectfully submits that these rejections are moot in view of the discussion above and that the instant claims are allowable over Goodman, Mills and Bottum for at least the same reasons they are allowable over Bottum.

Moreover, applicant submits it is not obvious to combine the references as the Examiner proposes. As mentioned above, the purpose of Bottum is to provide a subscription radio that uses an efficient asynchronous data transmission technique rather than a continuous dedicated data link, whereas the system of Goodman requires the use of such an inefficient dedicated data link (e.g.,

see Goodman, column 7, lines 41-55). Thus, the references teach away from one another, discouraging the combination proposed by the Examiner. Moreover, the radio of Bottum relies on external processing capabilities of a personal computer for certain sophisticated signal processing functions (e.g., see Bottum column 3, lines 15-32) further discouraging combination with the lightweight mobile device described in Goodman. Furthermore, substantial modification of each of the devices described in Bottum, Goodman and Mills would be required in order to effect the proposed combination further discouraging such a combination. No teaching is provided by any reference describing how to accomplish such modifications and there is no suggestion or motivation provided within the references themselves that such a combination would be beneficial or even desirable.

In addition, even if such a combination were made, it would still not produce applicant's claimed invention (i.e., the combination would merely produce a device suffering from all the shortcomings of Bottum pointed out above). Moreover, although Mills mentions that MP3 files may be stored in the expansion module, no mention is made of MIDI, WAV, PCM, WMA or ATRAC audio files.

Accordingly, based on the above applicant respectfully requests that the rejections under 35 U.S.C. § 103(a) be withdrawn.

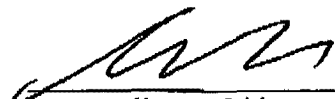
VI. Conclusion

For at least the above reasons, claims 33, 42, 74, 79 and 91 are patentable over the references of record. Claims 24-41, 43-49, 75-78, 80-90 and 92-98 which depend therefrom are therefore also patentable over the references of record.

For all of the above reasons, applicant respectfully requests that the Examiner withdraw the rejections and allow the pending claims. To expedite prosecution of this application to allowance, the examiner is invited to call the applicant's undersigned representative to discuss any issues relating to this application.

Respectfully submitted,

Dated: 6/29/06



Scott H. Kaliko  
Attorney for Applicant  
Registration No. 45,786  
KALIKO & YEAGER, L.L.C.  
500 North Franklin Turnpike  
Ramsey, NJ 07446  
Direct: 201-831-0575  
Fax: 201-831-0519

BEST AVAILABLE COPY

Under the Paperwork Reduction Act of 1995, no persons are required to respond to a collection of information unless it displays a valid OMB control number.

**PATENT APPLICATION FEE DETERMINATION RECORD**  
 Substitute for Form PTO-875

Application or Docket Number  
**10773700**

**APPLICATION AS FILED - PART I**

(Column 1)		(Column 2)	SMALL ENTITY		OR	OTHER THAN SMALL ENTITY	
FOR	NUMBER FILED	NUMBER EXTRA	RATE (\$)	FEE (\$)		RATE (\$)	FEE (\$)
BASIC FEES (37 CFR 1.18(a), (b), or (c))							
SEARCH FEE (37 CFR 1.1800, (l), or (m))							
EXAMINATION FEE (37 CFR 1.18(e), (p), or (q))							
TOTAL CLAIMS (37 CFR 1.18(f))		minus 20 =	X	=	OR	X	=
INDEPENDENT CLAIMS (37 CFR 1.18(h))		minus 3 =	X	=		X	=
APPLICATION SIZE FEE (37 CFR 1.16(s))	If the specification and drawings exceed 100 sheets of paper, the application size fee due is \$250 (\$125 for small entity) for each additional 50 sheets or fraction thereof. See 35 U.S.C. 41(a)(1)(G) and 37 CFR 1.16(s).						
MULTIPLE DEPENDENT CLAIM PRESENT (37 CFR 1.16(i))							
* If the difference in column 1 is less than zero, enter "0" in column 2.			TOTAL			TOTAL	

**APPLICATION AS AMENDED - PART II**

AMENDMENT A	(Column 1)	(Column 2)	(Column 3)	SMALL ENTITY		OR	OTHER THAN SMALL ENTITY	
	CLAIMS REMAINING AFTER AMENDMENT	HIGHEST NUMBER PREVIOUSLY PAID FOR	PRESENT EXTRA	RATE (\$)	ADDITIONAL FEE (\$)		RATE (\$)	ADDITIONAL FEE (\$)
Total (37 CFR 1.160)	89	Minus 66	= 23	X	=	OR	X 50	= 1150
Independent (37 CFR 1.160)	11	Minus 8	= 3	X	=	OR	X 20	= 600
Application Size Fee (37 CFR 1.16(s))								
FIRST PRESENTATION OF MULTIPLE DEPENDENT CLAIM (37 CFR 1.16(i))								
				TOTAL ADD'L FEE		OR	TOTAL ADD'L FEE	1750

**AMENDMENT B**

AMENDMENT B	(Column 1)	(Column 2)	(Column 3)	SMALL ENTITY		OR	OTHER THAN SMALL ENTITY	
	CLAIMS REMAINING AFTER AMENDMENT	HIGHEST NUMBER PREVIOUSLY PAID FOR	PRESENT EXTRA	RATE (\$)	ADDITIONAL FEE (\$)		RATE (\$)	ADDITIONAL FEE (\$)
Total (37 CFR 1.160)	80	Minus 89	= 0	X	=	OR	X	=
Independent (37 CFR 1.160)	0	Minus 11	= 0	X	=	OR	X	=
Application Size Fee (37 CFR 1.16(s))								
FIRST PRESENTATION OF MULTIPLE DEPENDENT CLAIM (37 CFR 1.16(i))								
				TOTAL ADD'L FEE		OR	TOTAL ADD'L FEE	

\* If the entry in column 1 is less than the entry in column 2, write "0" in column 3.  
 \*\* If the "Highest Number Previously Paid For" IN THIS SPACE is less than 20, enter "20".  
 \*\*\* If the "Highest Number Previously Paid For" IN THIS SPACE is less than 3, enter "3".  
 The "Highest Number Previously Paid For" (Total or Independent) is the highest number found in the appropriate box in column 1.

This collection of information is required by 37 CFR 1.16. The information is required to obtain or retain a benefit by the public which is to file (and by the USPTO to process) an application. Confidentiality is governed by 35 U.S.C. 122 and 37 CFR 1.14. This collection is estimated to take 12 minutes to complete, including gathering, preparing, and submitting the completed application form to the USPTO. Time will vary depending upon the individual case. Any comments on the amount of time you require to complete this form and/or suggestions for reducing this burden, should be sent to the Chief Information Officer, U.S. Patent and Trademark Office, U.S. Department of Commerce, P.O. Box 1450, Alexandria, VA 22313-1450. DO NOT SEND FEES OR COMPLETED FORMS TO THIS ADDRESS. SEND TO: Commissioner for Patents, P.O. Box 1450, Alexandria, VA 22313-1450.

If you need assistance in completing the form, call 1-800-PTO-9189 and select option 2.



UNITED STATES PATENT AND TRADEMARK OFFICE

UNITED STATES DEPARTMENT OF COMMERCE  
United States Patent and Trademark Office  
Address: COMMISSIONER FOR PATENTS  
P.O. Box 1450  
Alexandria, Virginia 22313-1450  
www.uspto.gov

APPLICATION NO.	FILING DATE	FIRST NAMED INVENTOR	ATTORNEY DOCKET NO.	CONFIRMATION NO.
10/223,200	08/16/2002	Michael E. Shanahan	MES/001CON	8026
39550	7590	04/20/2006	EXAMINER	
KALIKO & YEAGER, L.L.C. 500 NORTH FRANKLIN TURNPIKE RAMSEY, NJ 07446			TRAN, CONGVAN	
			ART UNIT	PAPER NUMBER
			2617	
DATE MAILED: 04/20/2006				

Please find below and/or attached an Office communication concerning this application or proceeding.



<b>Office Action Summary</b>	Application No. 10/223,200	Applicant(s) SHANAHAN, MICHAEL E.	
	Examiner CongVan Tran	Art Unit 2617	

-- The MAILING DATE of this communication appears on the cover sheet with the correspondence address --

**Period for Reply**

A SHORTENED STATUTORY PERIOD FOR REPLY IS SET TO EXPIRE 3 MONTH(S) OR THIRTY (30) DAYS, WHICHEVER IS LONGER, FROM THE MAILING DATE OF THIS COMMUNICATION.

- Extensions of time may be available under the provisions of 37 CFR 1.136(a). In no event, however, may a reply be timely filed after SIX (6) MONTHS from the mailing date of this communication.
- If NO period for reply is specified above, the maximum statutory period will apply and will expire SIX (6) MONTHS from the mailing date of this communication.
- Failure to reply within the set or extended period for reply will, by statute, cause the application to become ABANDONED (35 U.S.C. § 133). Any reply received by the Office later than three months after the mailing date of this communication, even if timely filed, may reduce any earned patent term adjustment. See 37 CFR 1.704(b).

**Status**

- 1)  Responsive to communication(s) filed on 15 March 2006.
- 2a)  This action is FINAL.
- 2b)  This action is non-final.
- 3)  Since this application is in condition for allowance except for formal matters, prosecution as to the merits is closed in accordance with the practice under *Ex parte Quayle*, 1935 C.D. 11, 453 O.G. 213.

**Disposition of Claims**

- 4)  Claim(s) 1-104 is/are pending in the application.
  - 4a) Of the above claim(s) 1-32, 50-67, 72, 73 and 99-104 is/are withdrawn from consideration.
- 5)  Claim(s) \_\_\_\_\_ is/are allowed.
- 6)  Claim(s) 33-49, 68-71 and 74-98 is/are rejected.
- 7)  Claim(s) \_\_\_\_\_ is/are objected to.
- 8)  Claim(s) \_\_\_\_\_ are subject to restriction and/or election requirement.

**Application Papers**

- 9)  The specification is objected to by the Examiner.
- 10)  The drawing(s) filed on \_\_\_\_\_ is/are: a)  accepted or b)  objected to by the Examiner.  
Applicant may not request that any objection to the drawing(s) be held in abeyance. See 37 CFR 1.85(a).  
Replacement drawing sheet(s) including the correction is required if the drawing(s) is objected to. See 37 CFR 1.121(d).
- 11)  The oath or declaration is objected to by the Examiner. Note the attached Office Action or form PTO-152.

**Priority under 35 U.S.C. § 119**

- 12)  Acknowledgment is made of a claim for foreign priority under 35 U.S.C. § 119(a)-(d) or (f).
    - a)  All    b)  Some \*    c)  None of:
      - 1.  Certified copies of the priority documents have been received.
      - 2.  Certified copies of the priority documents have been received in Application No. \_\_\_\_\_.
      - 3.  Copies of the certified copies of the priority documents have been received in this National Stage application from the International Bureau (PCT Rule 17.2(a)).
- \* See the attached detailed Office action for a list of the certified copies not received.

**Attachment(s)**

- |                                                                                                                                   |                                                                                         |
|-----------------------------------------------------------------------------------------------------------------------------------|-----------------------------------------------------------------------------------------|
| 1) <input checked="" type="checkbox"/> Notice of References Cited (PTO-892)                                                       | 4) <input type="checkbox"/> Interview Summary (PTO-413)<br>Paper No(s)/Mail Date. _____ |
| 2) <input type="checkbox"/> Notice of Draftsperson's Patent Drawing Review (PTO-948)                                              | 5) <input type="checkbox"/> Notice of Informal Patent Application (PTO-152)             |
| 3) <input checked="" type="checkbox"/> Information Disclosure Statement(s) (PTO-1449 or PTO/SB/08)<br>Paper No(s)/Mail Date _____ | 6) <input type="checkbox"/> Other: _____                                                |

## DETAILED ACTION

### ***Continued Examination Under 37 CFR 1.114***

1. A request for continued examination under 37 CFR 1.114, including the fee set forth in 37 CFR 1.17(e), was filed in this application after allowance or after an Office action under *Ex Parte Quayle*, 25 USPQ 74, 453 O.G. 213 (Comm'r Pat. 1935). Since this application is eligible for continued examination under 37 CFR 1.114, and the fee set forth in 37 CFR 1.17(e) has been timely paid, prosecution in this application has been reopened pursuant to 37 CFR 1.114. Applicant's submission filed on March 15, 2006 has been entered.

### ***Claim Rejections - 35 USC § 102***

2. The following is a quotation of the appropriate paragraphs of 35 U.S.C. 102 that form the basis for the rejections under this section made in this Office action:

A person shall be entitled to a patent unless –

(e) the invention was described in (1) an application for patent, published under section 122(b), by another filed in the United States before the invention by the applicant for patent or (2) a patent granted on an application for patent by another filed in the United States before the invention by the applicant for patent, except that an international application filed under the treaty defined in section 351(a) shall have the effects for purposes of this subsection of an application filed in the United States only if the international application designated the United States and was published under Article 21(2) of such treaty in the English language.

3. Claims 33, 36-37, 38-41, and 47 are rejected under 35 U.S.C. 102(e) as being anticipated by Bottum (6,014,569).

Regarding claims 33, 36-37, 39-41, Bottum discloses a mobile interactive radio, comprising:

a communications link capable of connecting to a remote database that includes a plurality of lists of audio files (fig.1, elements 150, 120, 110, 102, 104 and its description);

a display screen that allows a user of the wireless telephone to browse at least one of the lists of audio files and view selectable audio files present in the browsed list (see fig.1, elements 158, 172, and its description);

a speaker and processing circuitry configured to allow the user to optionally review a selected audio file before downloading the selected audio file into the wireless telephone (see fig.1, elements 158, 174, col.4, lines 1-16 and its description); and

a programmable memory circuit for allowing the user to optionally store the selected audio file for use as an indicia of an incoming communication (see fig.1, elements 180 col.4, lines 13-16 and its description).

Regarding claim 38, 47, Bottum further discloses compliant Internet browser (see col.1, lines 22-40).

***Claim Rejections - 35 USC § 103***

4. The following is a quotation of 35 U.S.C. 103(a) which forms the basis for all obviousness rejections set forth in this Office action:

(a) A patent may not be obtained though the invention is not identically disclosed or described as set forth in section 102 of this title, if the differences between the subject matter sought to be patented and the prior art are such that the subject matter as a whole would have been obvious at the time the invention was made to a person having ordinary skill in the art to which said subject matter pertains. Patentability shall not be negated by the manner in which the invention was made.

5. Claims 42-43, 46, 48-49, and 68 are rejected under 35 U.S.C. 103(a) as being unpatentable over Bottum (6,014,569) in view of Goodman (5,694,455).

Regarding claims 42, 46, 48-49, 68, Bottum discloses a mobile interactive radio,, comprising:

a communications link capable of connecting to a remote database that includes a plurality of lists of audio files (fig.1, elements 150, 120, 110, 102, 104 and its description);

the remote database operating substantially independently of a communication network that provides wireless service to the mobile radio device (fig.1, elements 120, 102, 104 and its description);

a display screen that allows a user of the wireless telephone to browse at least one of the plurality of lists of audio files and view selectable audio files present in the browsed list (see fig.1, elements 158, 172, and its description);

processing circuitry configured to receive a selected audio file from communication link (see fig.1, elements 158, 174, col.4, lines 1-16 and its description); and

a programmable memory circuit for allowing the user to optionally store the selected audio file for use as an indicia of an incoming communication (see fig.1, elements 180 col.4, lines 13-16 and its description), except for mobile radio device is telephone. However, Goodman discloses a mobile audio program selection system for receiving audio programming to subscribers over a Public Switched Telephone Network (PSTN), and more particularly to an audio program selection system architecture for selecting and receiving audio programming from an information providers using a mobile or cellular telephone or transceiver system (see col.10-16). Thus, it would have

been obvious to one having ordinary skill in the art at the time the invention was made to use the Bottum's invention system in Goodman's cellular telephone in order to improve the use of cellular systems.

Regarding claim 43, Bottum further discloses a speaker that operate in conjunction with the processing circuitry configured to allow the user to optionally review a selected audio file before downloading the selected audio file into the wireless telephone (see fig.1, elements 158, 174, col.4, lines 1-16 and its description).

6. Claims 34-35, 44-45, 69-71, 74-98 are rejected under 35 U.S.C. 103(a) as being unpatentable over Bottum (6,014,569) in view of Goodman (5,694,455) in further view of Mills et al. (6,599,147).

Regarding claims 34-35, 44-45, 69-71, 74-98, Bottum and Goodman disclose all the subject matters as described in rejected claim 33, except programmable memory circuit is configured to store audio files in a format selected from the group comprising: MIDI, MPEG/ MP3. However, Mills discloses a removable expansion memory, comprising: MIDI, MPEG/ MP3 (see col.13, lines 35-43). Thus, it would have been obvious to one having ordinary skill in the art at the time the invention was made to use the Mills' removable expansion memory in Bottum and Goodman in order to increase parallelism and functionality of the device.

Any inquiry concerning this communication or earlier communications from the examiner should be directed to CongVan Tran whose telephone number is 571-272-7871. The examiner can normally be reached on Monday-Thursday.

If attempts to reach the examiner by telephone are unsuccessful, the examiner's supervisor, Marsha Harold-Bank can be reached on 571-272-7905. The fax phone number for the organization where this application or proceeding is assigned is 571-273-8300.

Information regarding the status of an application may be obtained from the Patent Application Information Retrieval (PAIR) system. Status information for published applications may be obtained from either Private PAIR or Public PAIR. Status information for unpublished applications is available through Private PAIR only. For more information about the PAIR system, see <http://pair-direct.uspto.gov>. Should you have questions on access to the Private PAIR system, contact the Electronic Business Center (EBC) at 866-217-9197 (toll-free).

  
CONGVAN TRAN  
PRIMARY EXAMINER

CongVan Tran  
Primary Examiner  
Art Unit 2617

Apr. 13, 2006.



<b>Notice of References Cited</b>	Application/Control No. 10/223,200	Applicant(s)/Patent Under Reexamination SHANAHAN, MICHAEL E.	
	Examiner CongVan Tran	Art Unit 2617	Page 1 of 1

**U.S. PATENT DOCUMENTS**

*		Document Number Country Code-Number-Kind Code	Date MM-YYYY	Name	Classification
*	A	US-6,014,569 A	01-2000	Bottum, Joshua	455/466
*	B	US-5,694,455	12-1997	Goodman, William	455/413
*	C	US-6,477,580	11-2002	Bowman-Amuah, Michel K.	709/231
	D	US-			
	E	US-			
	F	US-			
	G	US-			
	H	US-			
	I	US-			
	J	US-			
	K	US-			
	L	US-			
	M	US-			

**FOREIGN PATENT DOCUMENTS**

*		Document Number Country Code-Number-Kind Code	Date MM-YYYY	Country	Name	Classification
	N					
	O					
	P					
	Q					
	R					
	S					
	T					

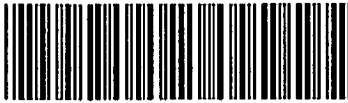
**NON-PATENT DOCUMENTS**

*		Include as applicable: Author, Title Date, Publisher, Edition or Volume, Pertinent Pages)
	U	
	V	
	W	
	X	

\*A copy of this reference is not being furnished with this Office action. (See MPEP § 707.05(a).)  
Dates in MM-YYYY format are publication dates. Classifications may be US or foreign.



**Index of Claims**



Application/Control No.

10/223,200

Examiner

CongVan Tran

Applicant(s)/Patent under Reexamination

SHANAHAN, MICHAEL E.

Art Unit

2617

√	Rejected
=	Allowed

-	(Through numeral) Cancelled
+	Restricted

N	Non-Elected
I	Interference

A	Appeal
O	Objected

Claim		Date
Final	Original	
	4/13/06	
1		
2		
3		
4		
5		
6		
7		
8		
9		
10		
11		
12		
13		
14		
15		
16		
17		
18		
19		
20		
21		
22		
23		
24		
25		
26		
27		
28		
29		
30		
31		
32		
33	√	
34		
35		
36		
37		
38		
39		
40		
41		
42		
43		
44		
45		
46		
47		
48		
49	√	
50		

Claim		Date
Final	Original	
	4/13/06	
51		
52		
53		
54		
55		
56		
57		
58		
59		
60		
61		
62		
63		
64		
65		
66		
67		
68	√	
69		
70		
71	√	
72		
73		
74	√	
75		
76		
77		
78		
79		
80		
81		
82		
83		
84		
85		
86		
87		
88		
89		
90		
91		
92		
93		
94		
95		
96		
97		
98	√	
99		
100		

Claim		Date
Final	Original	
101		
102		
103		
104		
105		
106		
107		
108		
109		
110		
111		
112		
113		
114		
115		
116		
117		
118		
119		
120		
121		
122		
123		
124		
125		
126		
127		
128		
129		
130		
131		
132		
133		
134		
135		
136		
137		
138		
139		
140		
141		
142		
143		
144		
145		
146		
147		
148		
149		
150		



UNITED STATES PATENT AND TRADEMARK OFFICE

Commissioner for Patents  
United States Patent and Trademark Office  
P.O. Box 1450  
Alexandria, VA 22313-1450  
www.uspto.gov

KALIKO & YEAGER LLC  
500 NORTH FRANKLIN TURNPIKE  
RAMSEY, NJ 07446

COPY MAILED

MAR 15 2006

OFFICE OF PETITIONS

In re Application of :  
Michael E. Shanahan :  
Application No. 10/223,200 : DECISION GRANTING PETITION  
Filed: August 16, 2002 : UNDER 37 CFR 1.313(c)(2)  
Attorney Docket No. MES/001CON :

This is a decision on the petition, filed March 14, 2006, under 37 CFR 1.313(c)(2) to withdraw the above-identified application from issue after payment of the issue fee.

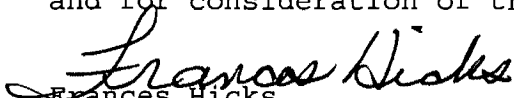
The petition is GRANTED.

The above-identified application is withdrawn from issue for consideration of a submission under 37 CFR 1.114 (request for continued examination). See 37 CFR 1.313(c)(2).

*Petitioner is advised that the issue fee paid on February 10, 2006 in the above-identified application cannot be refunded. If, however, the above-identified application is again allowed, petitioner may request that it be applied towards the issue fee required by the new Notice of Allowance.<sup>1</sup>*

Telephone inquiries should be directed to the undersigned at (571) 272-3218.

This matter is being referred to Technology Center AU 2688 for processing of the request for continued examination under 37 CFR 1.114 and for consideration of the Information Disclosure Statement.

  
Frances Hicks  
Petitions Examiner  
Office of Petitions

C:\Documents and Settings\FHicks\My Documents\470\Mar9\223200.wpd

<sup>1</sup> The request to apply the issue fee to the new Notice may be satisfied by completing and returning the new Part B – Fee(s) Transmittal Form (along with any balance due at the time of submission), which includes the following language thereon: “The Director of the USPTO is requested to apply the Issue Fee and Publication Fee (if any) or to re-apply any previously paid issue fee in the application identified above. **Petitioner is advised that, whether a fee is indicated as being due or not, the Issue Fee Transmittal Form must be completed and timely submitted to avoid abandonment. Note the language in bold text on the first page of the Notice of Allowance and Fee(s) Due (PTOL-85).**”

PATENT  
MES/001 CON  
**FAX RECEIVED**

**IN THE UNITED STATES PATENT AND TRADEMARK OFFICE**

MAR 14 2006

**OFFICE OF PETITIONS**

Applicant : Michael E. Shanahan  
 Serial No. : 10/223,200 Confirmation No.: 8026  
 Filed : August 16, 2002  
 Title : METHODS AND APPARATUSES FOR PROGRAMMING  
 USER-DEFINED INFORMATION INTO ELECTRONIC  
 DEVICES  
 Examiner : CongVan Tran  
 Group Art Unit : 2683

**BY FAX TO THE OFFICE OF PETITIONS**

Commissioner for Patents  
P.O. Box 1450  
Alexandria, VA 22313-1450

**PETITION UNDER 37 C.F.R. § 1.313(c) (2)**

Applicant respectfully petitions for withdrawal of the above-captioned application from issue, pursuant to 37 C.F.R. § 1.313(c) (2), in favor of a continuing application. A Request for Continued Examination in compliance with 37 C.F.R § 1.114, including an Information Disclosure Statement, is attached hereto as a part of this Petition.

The issue fee for this application was paid on February 10, 2006.

This Petition is filed together with a USPTO Credit Card Payment form including \$130.00 in payment of the fee required under 37 C.F.R. § 1.17(h).

03/15/2006 CKHLQK 00000005 10223200

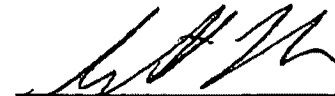
01 FC:1464

130.00 OP

PATENT  
MES/001 CON

Respectfully submitted,

3/14/06  
Date

  
\_\_\_\_\_  
Scott H. Kaliko  
Attorney for Applicant  
Registration No. 45,786  
KALIKO & YEAGER, L.L.C.  
500 North Franklin Turnpike  
Ramsey, NJ 07446  
Direct: 201-831-0575  
Fax: 201-831-0519

FAX RECEIVED

MAR 14 2006

OFFICE OF PETITIONS



500 North Franklin Turnpike, Ramsey, NJ 07446  
 (201) 831-0575 Main Tel  
 (201) 831-0519 Main Fax

FACSIMILE TRANSMITTAL SHEET

TO: Mail Stop Petition Commissioner for Patents	FROM: Scott H. Kaliko, Esq. SENDER'S FAX NUMBER: 201-831-0519 SENDER'S TELEPHONE NUMBER: 201-831-0575
COMPANY: United States Patent & Trademark Office	DATE: MARCH 14, 2006
RECIPIENT'S FAX NUMBER: 571-273-0025	TOTAL NO. OF PAGES INCLUDING COVER: 19
RECIPIENT'S TELEPHONE NUMBER: 571-272-3282	CLIENT / MATTER:
RE: Application No. 10/223,200	YOUR REFERENCE NUMBER:

URGENT   
  FOR REVIEW   
  PLEASE COMMENT   
  PLEASE REPLY   
  PLEASE RECYCLE

NOTES/COMMENTS:

CONFIDENTIALITY NOTICE

The information contained in this facsimile message is privileged and confidential and is intended only for the use of the individual(s) and/or entity(ies) named above. If you are not the intended recipient, you are hereby notified that any unauthorized disclosure, copying, distribution or taking of any action in reliance on the contents of the information contained herein is strictly prohibited and review by any individual other than the intended recipient shall not constitute a waiver of the attorney-client privilege. If you have received this transmission in error, please immediately notify us by telephone. Thank you.

PTO/SB/30 (04-05)

Approved for use through 07/31/2006. OMB 0851-0031

U.S. Patent and Trademark Office; U.S. DEPARTMENT OF COMMERCE

Under the Paperwork Reduction Act of 1995, no persons are required to respond to a collection of information unless it contains a valid OMB control number.

### Request for Continued Examination (RCE) Transmittal

Address to:  
Mail Stop RCE  
Commissioner for Patents  
P.O. Box 1450  
Alexandria, VA 22313-1450

Application Number	10/223,200
Filing Date	August 16, 2002
First Named Inventor	Shanahan
Art Unit	2688
Examiner Name	CongVan Tran
Attorney Docket Number	MES/001 Con

**FAX RECEIVED**

**MAR 14 2006**

**OFFICE OF PETITIONS**

**This is a Request for Continued Examination (RCE) under 37 CFR 1.114 of the above-identified application.**  
Request for Continued Examination (RCE) practice under 37 CFR 1.114 does not apply to any utility or plant application filed prior to June 8, 1995, or to any design application. See Instruction Sheet for RCEs (not to be submitted to the USPTO) on page 2.

1. **Submission required under 37 CFR 1.114** Note: If the RCE is proper, any previously filed unentered amendments and amendments enclosed with the RCE will be entered in the order in which they were filed unless applicant instructs otherwise. If applicant does not wish to have any previously filed unentered amendment(s) entered, applicant must request non-entry of such amendment(s).

- a.  Previously submitted. If a final Office action is outstanding, any amendments filed after the final Office action may be considered as a submission even if this box is not checked.
  - i.  Consider the arguments in the Appeal Brief or Reply Brief previously filed on \_\_\_\_\_
  - ii.  Other \_\_\_\_\_
- b.  Enclosed
  - i.  Amendment/Reply
  - ii.  Affidavit(s)/ Declaration(s)
  - iii.  Information Disclosure Statement (IDS)
  - iv.  Other \_\_\_\_\_

#### 2. Miscellaneous

- a.  Suspension of action on the above-identified application is requested under 37 CFR 1.103(c) for a period of \_\_\_\_\_ months. (Period of suspension shall not exceed 3 months; Fee under 37 CFR 1.17(l) required)
- b.  Other \_\_\_\_\_

#### 3. Fees

- The RCE fee under 37 CFR 1.17(e) is required by 37 CFR 1.114 when the RCE is filed. The Director is hereby authorized to charge the following fees, any underpayment of fees, or credit any overpayments, to Deposit Account No. \_\_\_\_\_ . I have enclosed a duplicate copy of this sheet.
- a. 
    - i.  RCE fee required under 37 CFR 1.17(e)      03/15/2006 CKHLOK    00000005 10223200
    - ii.  Extension of time fee (37 CFR 1.136 and 1.17)      02 FC:2601      395.00 DP
    - iii.  Other Payment under 37 C.F.R. 1.17(h) for withdrawal from issue (\$130.00)
  - b.  Check in the amount of \$ \_\_\_\_\_ enclosed
  - c.  Payment by credit card (Form PTO-2038 enclosed)

**WARNING: Information on this form may become public. Credit card information should not be included on this form. Provide credit card information and authorization on PTO-2038.**

#### SIGNATURE OF APPLICANT, ATTORNEY, OR AGENT REQUIRED

Signature		Date	3/14/06
Name (Print/Type)	Scott Kaliko	Registration No.	45,788

#### CERTIFICATE OF MAILING OR TRANSMISSION

I hereby certify that this correspondence is being deposited with the United States Postal Service with sufficient postage as first class mail in an envelope addressed to: Mail Stop RCE, Commissioner for Patents, P. O. Box 1450, Alexandria, VA 22313-1450 or facsimile transmitted to the U.S. Patent and Trademark Office on the date shown below.

Signature		Date	
Name (Print/Type)		Date	

This collection of information is required by 37 CFR 1.114. The information is required to obtain or retain a benefit by the public which is to file (and by the USPTO to process) an application. Confidentiality is governed by 35 U.S.C. 122 and 37 CFR 1.11 and 1.14. This collection is estimated to take 12 minutes to complete, including gathering, preparing, and submitting the completed application form to the USPTO. Time will vary depending upon the individual case. Any comments on the amount of time you require to complete this form and/or suggestions for reducing this burden, should be sent to the Chief Information Officer, U.S. Patent and Trademark Office, U.S. Department of Commerce, P.O. Box 1450, Alexandria, VA 22313-1450. DO NOT SEND FEES OR COMPLETED FORMS TO THIS ADDRESS. SEND TO: Mail Stop RCE, Commissioner for Patents, P.O. Box 1450, Alexandria, VA 22313-1450.

If you need assistance in completing the form, call 1-800-PTO-9199 and select option 2.

PATENT  
MES/001 CON

**FAX RECEIVED**

**IN THE UNITED STATES PATENT AND TRADEMARK OFFICE**

**MAR 14 2006**

Applicant : Michael E. Shanahan

**OFFICE OF PETITIONS**

Serial No. : 10/223,200 Confirmation No.: 8026

Filed : August 16, 2002

Title : METHODS AND APPARATUSES FOR PROGRAMMING  
USER-DEFINED INFORMATION INTO ELECTRONIC  
DEVICES

Examiner : CongVan Tran

Group Art Unit : 2688

Commissioner for Patents  
P.O. Box 1450  
Alexandria, VA 22213-1450

**INFORMATION DISCLOSURE STATEMENT**

Sir:

Pursuant to 37 C.F.R. §§ 1.56, 1.97 and 1.98, applicant hereby makes the documents listed below of record in the above-identified application.

**U.S. Patents**

Kobayashi Patent No. 5,963,877 October 5, 1999

Gerszberg et al. Patent No. 6,385,305 May 7, 2002

PATENT  
MES/001 CON**Foreign Office Actions**

Canadian Office Action dated April 21, 2004 (copy included)  
Canadian Office Action dated December 29, 2004 (copy included)  
Canadian Office Action dated March 31, 2005 (copy included)  
Canadian Office Action dated September 28, 2005 (copy included)

**Related Cases**

Applicant draws the Examiner's attention to the following related cases that share a common specification with this case.

U.S. Patent No. 6,496,692  
U.S. Patent application No. 09/518,846 (abandoned)  
U.S. Patent application No. 10/603,285  
U.S. Patent application No. 10/600,975  
U.S. Patent application No. 10/603,271  
U.S. Patent application No. 10/915,862  
U.S. Patent application No. 10/915,866

It is respectfully requested the Examiner fully consider these and any associated documents during the examination of this application, make them of record, and indicate his or her consideration of the documents by initialing the enclosed Citation List adjacent the citation of each document, and print them on any patent that may issue on this application. It is requested that a copy of the initialed Citation form be returned to applicant's undersigned Attorney.



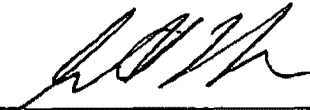
PATENT  
MES/001 CON

As this application was filed after June 30, 2003 copies of cited U.S. patents and applications are not required, and are therefore not included.

Included is a USPTO Credit Card payment form which authorizes charges for \$395.00 in payment of RCE fee pursuant to 37 C.F.R. § 1.17 (e) and \$130.00 in payment of petition fee pursuant to 37 C.F.R. § 1.313(c)(2) and 37 C.F.R. § 1.17 (h) (total of \$525.00).

Respectfully submitted,

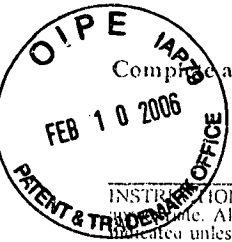
3/14/06.  
Date

  
\_\_\_\_\_  
Scott H. Kaliko  
Attorney for Applicant  
Registration No. 45,786  
KALIKO & YEAGER, L.L.C.  
500 North Franklin Turnpike  
Ramsey, NJ 07446  
Direct: 201-831-0575  
Fax: 201-831-0519



02-13-06

PART B - FEE(S) TRANSMITTAL



Complete and send this form, together with applicable fee(s), to: Mail

Mail Stop ISSUE FEE  
Commissioner for Patents  
P.O. Box 1450  
Alexandria, Virginia 22313-1450  
or Fax (571) 273-2885

INSTRUCTIONS: This form should be used for transmitting the ISSUE FEE and PUBLICATION FEE (if required). Blocks 1 through 5 should be completed where applicable. All further correspondence including the Patent, advance orders and notification of maintenance fees will be mailed to the current correspondence address as indicated unless corrected below or directed otherwise in Block 1, by (a) specifying a new correspondence address; and/or (b) indicating a separate "FEE ADDRESS" for maintenance fee notifications.

CURRENT CORRESPONDENCE ADDRESS (Note: Use Block 1 for any change of address)

39550 7590 01/24/2006

KALIKO & YEAGER, L.L.C.  
500 NORTH FRANKLIN TURNPIKE  
RAMSEY, NJ 07446

Note: A certificate of mailing can only be used for domestic mailings of the Fee(s) Transmittal. This certificate cannot be used for any other accompanying papers. Each additional paper, such as an assignment or formal drawing, must have its own certificate of mailing or transmission.

Certificate of Mailing or Transmission

I hereby certify that this Fee(s) Transmittal is being deposited with the United States Postal Service with sufficient postage for first class mail in an envelope addressed to the Mail Stop ISSUE FEE address above, or being facsimile transmitted to the USPTO (571) 273-2885, on the date indicated below.

02/14/2006 WABDELR3 00000004 10223200

01 FC:2501 700.00 DP  
02 FC:1504 300.00 DP

Elizabeth Marcus (Depositor's name)  
Elizabeth Marcus (Signature)  
February 10, 2006 (Date)

APPLICATION NO.	FILING DATE	FIRST NAMED INVENTOR	ATTORNEY DOCKET NO.	CONFIRMATION NO.
10/223,200	08/16/2002	Michael E. Shanahan	MES/001CON	8026

TITLE OF INVENTION: METHODS AND APPARATUSES FOR PROGRAMMING USER-DEFINED INFORMATION INTO ELECTRONIC DEVICES

APPLN. TYPE	SMALL ENTITY	ISSUE FEE	PUBLICATION FEE	TOTAL FEE(S) DUE	DATE DUE
nonprovisional	YES	\$700	\$300	\$1000	04/24/2006

EXAMINER	ART UNIT	CLASS-SUBCLASS
TRAN, CONGVAN	2688	455-418000

1. Change of correspondence address or indication of "Fee Address" (37 CFR 1.363).  
 Change of correspondence address (or Change of Correspondence Address form PTO/SB/122) attached.  
 "Fee Address" indication (or "Fee Address" Indication form PTO/SB/47; Rev 03-02 or more recent) attached. Use of a Customer Number is required.
2. For printing on the patent front page, list  
 (1) the names of up to 3 registered patent attorneys or agents OR, alternatively,  
 (2) the name of a single firm (having as a member a registered attorney or agent) and the names of up to 2 registered patent attorneys or agents. If no name is listed, no name will be printed.
- 1 Kaliko & Yeager, LLC  
 2 Scott H. Kaliko  
 3 \_\_\_\_\_

3. ASSIGNEE NAME AND RESIDENCE DATA TO BE PRINTED ON THE PATENT (print or type)  
PLEASE NOTE: Unless an assignee is identified below, no assignee data will appear on the patent. If an assignee is identified below, the document has been filed for recordation as set forth in 37 CFR 3.11. Completion of this form is NOT a substitute for filing an assignment.

(A) NAME OF ASSIGNEE (B) RESIDENCE: (CITY and STATE OR COUNTRY)

Please check the appropriate assignee category or categories (will not be printed on the patent):  Individual  Corporation or other private group entity  Government

- 4a. The following fee(s) are enclosed:  
 Issue Fee  
 Publication Fee (No small entity discount permitted)  
 Advance Order - # of Copies \_\_\_\_\_
- 4b. Payment of Fee(s):  
 A check in the amount of the fee(s) is enclosed.  
 Payment by credit card. Form PTO-2038 is attached.  
 The Director is hereby authorized by charge the required fee(s), or credit any overpayment, to Deposit Account Number \_\_\_\_\_ (enclose an extra copy of this form).

5. Change in Entity Status (from status indicated above)  
 a. Applicant claims SMALL ENTITY status. See 37 CFR 1.27.  b. Applicant is no longer claiming SMALL ENTITY status. See 37 CFR 1.27(g)(2).

The Director of the USPTO is requested to apply the Issue Fee and Publication Fee (if any) or to re-apply any previously paid issue fee to the application identified above. NOTE: The Issue Fee and Publication Fee (if required) will not be accepted from anyone other than the applicant; a registered attorney or agent, or the assignee or other party in interest as shown by the records of the United States Patent and Trademark Office.

Authorized Signature Scott H. Kaliko Date February 10, 2006  
Typed or printed name Scott H. Kaliko Registration No. 45,786

This collection of information is required by 37 CFR 1.311. The information is required to obtain or retain a benefit by the public which is to file (and by the USPTO to process) an application. Confidentiality is governed by 35 U.S.C. 122 and 37 CFR 1.14. This collection is estimated to take 12 minutes to complete, including gathering, preparing, and submitting the completed application form to the USPTO. Time will vary depending upon the individual case. Any comments on the amount of time you require to complete this form and/or suggestions for reducing this burden, should be sent to the Chief Information Officer, U.S. Patent and Trademark Office, U.S. Department of Commerce, P.O. Box 1450, Alexandria, Virginia 22313-1450. DO NOT SEND FEES OR COMPLETED FORMS TO THIS ADDRESS. SEND TO: Commissioner for Patents, P.O. Box 1450, Alexandria, Virginia 22313-1450.

Under the Paperwork Reduction Act of 1995, no persons are required to respond to a collection of information unless it displays a valid OMB control number.

BEST AVAILABLE COPY



UNITED STATES PATENT AND TRADEMARK OFFICE

UNITED STATES DEPARTMENT OF COMMERCE
United States Patent and Trademark Office
Address: COMMISSIONER FOR PATENTS
P.O. Box 1450
Alexandria, Virginia 22313-1450
www.uspto.gov

NOTICE OF ALLOWANCE AND FEE(S) DUE

39550 7590 01/24/2006
KALI KO & YEAGER, L.L.C.
500 NORTH FRANKLIN TURNPIKE
RAMSEY, NJ 07446

EXAMINER
TRAN, CONGVAN

ART UNIT PAPER NUMBER
2688

DATE MAILED: 01/24/2006

Table with 5 columns: APPLICATION NO., FILING DATE, FIRST NAMED INVENTOR, ATTORNEY DOCKET NO., CONFIRMATION NO.
10/223,200 08/16/2002 Michael E. Shanahan MES/001 CON 8026

TITLE OF INVENTION: METHODS AND APPARATUSES FOR PROGRAMMING USER-DEFINED INFORMATION INTO ELECTRONIC DEVICES

Table with 6 columns: APPLN. TYPE, SMALL ENTITY, ISSUE FEE, PUBLICATION FEE, TOTAL FEE(S) DUE, DATE DUE
nonprovisional YES \$700 \$300 \$1000 04/24/2006

THE APPLICATION IDENTIFIED ABOVE HAS BEEN EXAMINED AND IS ALLOWED FOR ISSUANCE AS A PATENT. PROSECUTION ON THE MERITS IS CLOSED. THIS NOTICE OF ALLOWANCE IS NOT A GRANT OF PATENT RIGHTS. THIS APPLICATION IS SUBJECT TO WITHDRAWAL FROM ISSUE AT THE INITIATIVE OF THE OFFICE OR UPON PETITION BY THE APPLICANT. SEE 37 CFR 1.313 AND MPEP 1308.

THE ISSUE FEE AND PUBLICATION FEE (IF REQUIRED) MUST BE PAID WITHIN THREE MONTHS FROM THE MAILING DATE OF THIS NOTICE OR THIS APPLICATION SHALL BE REGARDED AS ABANDONED. THIS STATUTORY PERIOD CANNOT BE EXTENDED. SEE 35 U.S.C. 151. THE ISSUE FEE DUE INDICATED ABOVE REFLECTS A CREDIT FOR ANY PREVIOUSLY PAID ISSUE FEE APPLIED IN THIS APPLICATION. THE PTOL-85B (OR AN EQUIVALENT) MUST BE RETURNED WITHIN THIS PERIOD EVEN IF NO FEE IS DUE OR THE APPLICATION WILL BE REGARDED AS ABANDONED.

HOW TO REPLY TO THIS NOTICE:

I. Review the SMALL ENTITY status shown above.

If the SMALL ENTITY is shown as YES, verify your current SMALL ENTITY status:

- A. If the status is the same, pay the TOTAL FEE(S) DUE shown above.
B. If the status above is to be removed, check box 5b on Part B - Fee(s) Transmittal and pay the PUBLICATION FEE (if required) and twice the amount of the ISSUE FEE shown above, or

If the SMALL ENTITY is shown as NO:

- A. Pay TOTAL FEE(S) DUE shown above, or
B. If applicant claimed SMALL ENTITY status before, or is now claiming SMALL ENTITY status, check box 5a on Part B - Fee(s) Transmittal and pay the PUBLICATION FEE (if required) and 1/2 the ISSUE FEE shown above.

II. PART B - FEE(S) TRANSMITTAL should be completed and returned to the United States Patent and Trademark Office (USPTO) with your ISSUE FEE and PUBLICATION FEE (if required). Even if the fee(s) have already been paid, Part B - Fee(s) Transmittal should be completed and returned. If you are charging the fee(s) to your deposit account, section "4b" of Part B - Fee(s) Transmittal should be completed and an extra copy of the form should be submitted.

III. All communications regarding this application must give the application number. Please direct all communications prior to issuance to Mail Stop ISSUE FEE unless advised to the contrary.

IMPORTANT REMINDER: Utility patents issuing on applications filed on or after Dec. 12, 1980 may require payment of maintenance fees. It is patentee's responsibility to ensure timely payment of maintenance fees when due.

**PART B - FEE(S) TRANSMITTAL**

Complete and send this form, together with applicable fee(s), to: Mail

**Mail Stop ISSUE FEE  
Commissioner for Patents  
P.O. Box 1450  
Alexandria, Virginia 22313-1450  
or Fax (571) 273-2885**

**INSTRUCTIONS:** This form should be used for transmitting the ISSUE FEE and PUBLICATION FEE (if required). Blocks 1 through 5 should be completed where appropriate. All further correspondence including the Patent, advance orders and notification of maintenance fees will be mailed to the current correspondence address as indicated unless corrected below or directed otherwise in Block 1, by (a) specifying a new correspondence address; and/or (b) indicating a separate "FEE ADDRESS" for maintenance fee notifications.

CURRENT CORRESPONDENCE ADDRESS (Note: Use Block 1 for any change of address)

39550                      7590                      01/24/2006

**KALIKO & YEAGER, L.L.C.  
500 NORTH FRANKLIN TURNPIKE  
RAMSEY, NJ 07446**

Note: A certificate of mailing can only be used for domestic mailings of the Fee(s) Transmittal. This certificate cannot be used for any other accompanying papers. Each additional paper, such as an assignment or formal drawing, must have its own certificate of mailing or transmission.

**Certificate of Mailing or Transmission**

I hereby certify that this Fee(s) Transmittal is being deposited with the United States Postal Service with sufficient postage for first class mail in an envelope addressed to the Mail Stop ISSUE FEE address above, or being facsimile transmitted to the USPTO (571) 273-2885, on the date indicated below.

_____ (Depositor's name)
_____ (Signature)
_____ (Date)

APPLICATION NO.	FILING DATE	FIRST NAMED INVENTOR	ATTORNEY DOCKET NO.	CONFIRMATION NO.
10/223,200	08/16/2002	Michael E. Shanahan	MES/001CON	8026

TITLE OF INVENTION: METHODS AND APPARATUSES FOR PROGRAMMING USER-DEFINED INFORMATION INTO ELECTRONIC DEVICES

APPLN. TYPE	SMALL ENTITY	ISSUE FEE	PUBLICATION FEE	TOTAL FEE(S) DUE	DATE DUE
nonprovisional	YES	\$700	\$300	\$1000	04/24/2006

EXAMINER	ART UNIT	CLASS-SUBCLASS
TRAN, CONGVAN	2688	455-418000

1. Change of correspondence address or indication of "Fee Address" (37 CFR 1.363).

- Change of correspondence address (or Change of Correspondence Address form PTO/SB/122) attached.
- "Fee Address" indication (or "Fee Address" Indication form PTO/SB/47; Rev 03-02 or more recent) attached. Use of a Customer Number is required.

2. For printing on the patent front page, list

- (1) the names of up to 3 registered patent attorneys or agents OR, alternatively, \_\_\_\_\_ 1
- (2) the name of a single firm (having as a member a registered attorney or agent) and the names of up to 2 registered patent attorneys or agents. If no name is listed, no name will be printed. \_\_\_\_\_ 2
- \_\_\_\_\_ 3

3. ASSIGNEE NAME AND RESIDENCE DATA TO BE PRINTED ON THE PATENT (print or type)

PLEASE NOTE: Unless an assignee is identified below, no assignee data will appear on the patent. If an assignee is identified below, the document has been filed for recordation as set forth in 37 CFR 3.11. Completion of this form is NOT a substitute for filing an assignment.

(A) NAME OF ASSIGNEE \_\_\_\_\_ (B) RESIDENCE: (CITY and STATE OR COUNTRY) \_\_\_\_\_

Please check the appropriate assignee category or categories (will not be printed on the patent) :  Individual  Corporation or other private group entity  Government

4a. The following fee(s) are enclosed:

- Issue Fee
- Publication Fee (No small entity discount permitted)
- Advance Order - # of Copies \_\_\_\_\_

4b. Payment of Fee(s):

- A check in the amount of the fee(s) is enclosed.
- Payment by credit card. Form PTO-2038 is attached.
- The Director is hereby authorized by charge the required fee(s), or credit any overpayment, to Deposit Account Number \_\_\_\_\_ (enclose an extra copy of this form).

5. Change in Entity Status (from status indicated above)

- a. Applicant claims SMALL ENTITY status. See 37 CFR 1.27.  b. Applicant is no longer claiming SMALL ENTITY status. See 37 CFR 1.27(g)(2).

The Director of the USPTO is requested to apply the Issue Fee and Publication Fee (if any) or to re-apply any previously paid issue fee to the application identified above. NOTE: The Issue Fee and Publication Fee (if required) will not be accepted from anyone other than the applicant; a registered attorney or agent; or the assignee or other party in interest as shown by the records of the United States Patent and Trademark Office.

Authorized Signature \_\_\_\_\_

Date \_\_\_\_\_

Typed or printed name \_\_\_\_\_

Registration No. \_\_\_\_\_

This collection of information is required by 37 CFR 1.311. The information is required to obtain or retain a benefit by the public which is to file (and by the USPTO to process) an application. Confidentiality is governed by 35 U.S.C. 122 and 37 CFR 1.14. This collection is estimated to take 12 minutes to complete, including gathering, preparing, and submitting the completed application form to the USPTO. Time will vary depending upon the individual case. Any comments on the amount of time you require to complete this form and/or suggestions for reducing this burden, should be sent to the Chief Information Officer, U.S. Patent and Trademark Office, U.S. Department of Commerce, P.O. Box 1450, Alexandria, Virginia 22313-1450. DO NOT SEND FEES OR COMPLETED FORMS TO THIS ADDRESS. SEND TO: Commissioner for Patents, P.O. Box 1450, Alexandria, Virginia 22313-1450.

Under the Paperwork Reduction Act of 1995, no persons are required to respond to a collection of information unless it displays a valid OMB control number.



UNITED STATES PATENT AND TRADEMARK OFFICE

UNITED STATES DEPARTMENT OF COMMERCE
United States Patent and Trademark Office
Address: COMMISSIONER FOR PATENTS
P.O. Box 1450
Alexandria, Virginia 22313-1450
www.uspto.gov

Table with columns: APPLICATION NO., FILING DATE, FIRST NAMED INVENTOR, ATTORNEY DOCKET NO., CONFIRMATION NO.
10/223,200 08/16/2002 Michael E. Shanahan MES/001CON 8026
39550 7590 01/24/2006
KALIKO & YEAGER, L.L.C.
500 NORTH FRANKLIN TURNPIKE
RAMSEY, NJ 07446
EXAMINER
TRAN, CONGVAN
ART UNIT 2688 PAPER NUMBER
DATE MAILED: 01/24/2006

Determination of Patent Term Adjustment under 35 U.S.C. 154 (b)
(application filed on or after May 29, 2000)

The Patent Term Adjustment to date is 461 day(s). If the issue fee is paid on the date that is three months after the mailing date of this notice and the patent issues on the Tuesday before the date that is 28 weeks (six and a half months) after the mailing date of this notice, the Patent Term Adjustment will be 461 day(s).

If a Continued Prosecution Application (CPA) was filed in the above-identified application, the filing date that determines Patent Term Adjustment is the filing date of the most recent CPA.

Applicant will be able to obtain more detailed information by accessing the Patent Application Information Retrieval (PAIR) WEB site (http://pair.uspto.gov).

Any questions regarding the Patent Term Extension or Adjustment determination should be directed to the Office of Patent Legal Administration at (571) 272-7702. Questions relating to issue and publication fee payments should be directed to the Customer Service Center of the Office of Patent Publication at (703) 305-8283.

<b>Notice of Allowability</b>	<b>Application No.</b>	<b>Applicant(s)</b>	
	10/223,200	SHANAHAN, MICHAEL E.	
	<b>Examiner</b>	<b>Art Unit</b>	
	CongVan Tran	2688	

**-- The MAILING DATE of this communication appears on the cover sheet with the correspondence address--**

All claims being allowable, PROSECUTION ON THE MERITS IS (OR REMAINS) CLOSED in this application. If not included herewith (or previously mailed), a Notice of Allowance (PTOL-85) or other appropriate communication will be mailed in due course. **THIS NOTICE OF ALLOWABILITY IS NOT A GRANT OF PATENT RIGHTS.** This application is subject to withdrawal from issue at the initiative of the Office or upon petition by the applicant. See 37 CFR 1.313 and MPEP 1308.

1.  This communication is responsive to 11/03/05.
2.  The allowed claim(s) is/are 33-49,68-71 and 74-98 have been renumbered to 1-9, 14-21, 10-13, 22-26, 30-33, 27-29, 34-46 respectively.
3.  Acknowledgment is made of a claim for foreign priority under 35 U.S.C. § 119(a)-(d) or (f).
  - a)  All    b)  Some\*    c)  None    of the:
    1.  Certified copies of the priority documents have been received.
    2.  Certified copies of the priority documents have been received in Application No. \_\_\_\_\_.
    3.  Copies of the certified copies of the priority documents have been received in this national stage application from the International Bureau (PCT Rule 17.2(a)).

\* Certified copies not received: \_\_\_\_\_.

Applicant has THREE MONTHS FROM THE "MAILING DATE" of this communication to file a reply complying with the requirements noted below. Failure to timely comply will result in ABANDONMENT of this application. **THIS THREE-MONTH PERIOD IS NOT EXTENDABLE.**

4.  A SUBSTITUTE OATH OR DECLARATION must be submitted. Note the attached EXAMINER'S AMENDMENT or NOTICE OF INFORMAL PATENT APPLICATION (PTO-152) which gives reason(s) why the oath or declaration is deficient.
  5.  CORRECTED DRAWINGS ( as "replacement sheets") must be submitted.
    - (a)  including changes required by the Notice of Draftsperson's Patent Drawing Review ( PTO-948) attached
      - 1)  hereto or 2)  to Paper No./Mail Date \_\_\_\_\_.
    - (b)  including changes required by the attached Examiner's Amendment / Comment or in the Office action of Paper No./Mail Date \_\_\_\_\_.
- Identifying indicia such as the application number (see 37 CFR 1.84(c)) should be written on the drawings in the front (not the back) of each sheet. Replacement sheet(s) should be labeled as such in the header according to 37 CFR 1.121(d).**
6.  DEPOSIT OF and/or INFORMATION about the deposit of BIOLOGICAL MATERIAL must be submitted. Note the attached Examiner's comment regarding REQUIREMENT FOR THE DEPOSIT OF BIOLOGICAL MATERIAL.

**Attachment(s)**

- |                                                                                                                                                                                                                                                                                                                                                                                                                                                                                       |                                                                                                                                                                                                                                                                                                                                                                                                                                                  |
|---------------------------------------------------------------------------------------------------------------------------------------------------------------------------------------------------------------------------------------------------------------------------------------------------------------------------------------------------------------------------------------------------------------------------------------------------------------------------------------|--------------------------------------------------------------------------------------------------------------------------------------------------------------------------------------------------------------------------------------------------------------------------------------------------------------------------------------------------------------------------------------------------------------------------------------------------|
| <ol style="list-style-type: none"> <li>1. <input checked="" type="checkbox"/> Notice of References Cited (PTO-892)</li> <li>2. <input type="checkbox"/> Notice of Draftsperson's Patent Drawing Review (PTO-948)</li> <li>3. <input checked="" type="checkbox"/> Information Disclosure Statements (PTO-1449 or PTO/SB/08),<br/>Paper No./Mail Date _____</li> <li>4. <input type="checkbox"/> Examiner's Comment Regarding Requirement for Deposit of Biological Material</li> </ol> | <ol style="list-style-type: none"> <li>5. <input type="checkbox"/> Notice of Informal Patent Application (PTO-152)</li> <li>6. <input type="checkbox"/> Interview Summary (PTO-413),<br/>Paper No./Mail Date _____.</li> <li>7. <input checked="" type="checkbox"/> Examiner's Amendment/Comment</li> <li>8. <input type="checkbox"/> Examiner's Statement of Reasons for Allowance</li> <li>9. <input type="checkbox"/> Other _____.</li> </ol> |
|---------------------------------------------------------------------------------------------------------------------------------------------------------------------------------------------------------------------------------------------------------------------------------------------------------------------------------------------------------------------------------------------------------------------------------------------------------------------------------------|--------------------------------------------------------------------------------------------------------------------------------------------------------------------------------------------------------------------------------------------------------------------------------------------------------------------------------------------------------------------------------------------------------------------------------------------------|

  
**CONGVANTRAN**  
**PRIMARY EXAMINER**  
 Art Unit: 2688

### EXAMINER'S AMENDMENT

1. An examiner's amendment to the record appears below. Should the changes and/or additions be unacceptable to applicant, an amendment may be filed as provided by 37 CFR 1.312. To ensure consideration of such an amendment, it **MUST** be submitted no later than the payment of the issue fee.

Authorization for this examiner's amendment was given in a telephone interview with Mr. Scott H. Kaliko on Jan. 17, 2005.

The application has been amended as follows:

**Claim 48**, line 2: "claim 22" have been changed to -claim 42--.

Any inquiry concerning this communication or earlier communications from the examiner should be directed to CongVan Tran whose telephone number is 571-272-7871. The examiner can normally be reached on Monday-Thursday.

If attempts to reach the examiner by telephone are unsuccessful, the examiner's supervisor, George Eng can be reached on 571-272-7495. The fax phone number for the organization where this application or proceeding is assigned is 571-273-8300.

Information regarding the status of an application may be obtained from the Patent Application Information Retrieval (PAIR) system. Status information for published applications may be obtained from either Private PAIR or Public PAIR. Status information for unpublished applications is available through Private PAIR only. For more information about the PAIR system, see <http://pair-direct.uspto.gov>. Should you have questions on access to the Private PAIR system, contact the Electronic Business Center (EBC) at 866-217-9197 (toll-free).



Application/Control Number: 10/223,200  
Art Unit: 2688

Page 3



CONGVAN TRAN  
PRIMARY EXAMINER

CongVan Tran  
Primary Examiner  
Art Unit 2688

Jan. 17, 2005.



<b>Notice of References Cited</b>	Application/Control No. 10/223,200	Applicant(s)/Patent Under Reexamination SHANAHAN, MICHAEL E.	
	Examiner CongVan Tran	Art Unit 2688	Page 1 of 1

**U.S. PATENT DOCUMENTS**

*	Document Number Country Code-Number-Kind Code	Date MM-YYYY	Name	Classification
*	A US-6,198,941 B1	03-2001	Aho et al.	455/552.1
*	B US-6,400,958 B1	06-2002	Isomursu et al.	455/466
C	US-			
D	US-			
E	US-			
F	US-			
G	US-			
H	US-			
I	US-			
J	US-			
K	US-			
L	US-			
M	US-			


**FOREIGN PATENT DOCUMENTS**

*	Document Number Country Code-Number-Kind Code	Date MM-YYYY	Country	Name	Classification
N					
O					
P					
Q					
R					
S					
T					

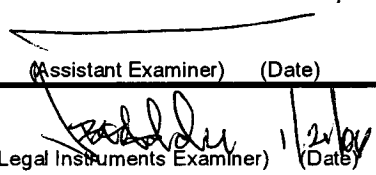
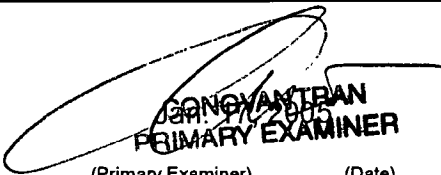
**NON-PATENT DOCUMENTS**

*	Include as applicable: Author, Title Date, Publisher, Edition or Volume, Pertinent Pages)
U	
V	
W	
X	

\*A copy of this reference is not being furnished with this Office action. (See MPEP § 707.05(a).)  
Dates in MM-YYYY format are publication dates. Classifications may be US or foreign.

<b>Issue Classification</b> 	<b>Application/Control No.</b> 10/223,200	<b>Applicant(s)/Patent under Reexamination</b> SHANAHAN, MICHAEL E.	
	<b>Examiner</b> CongVan Tran	<b>Art Unit</b> 2688	

ISSUE CLASSIFICATION										
ORIGINAL					CROSS REFERENCE(S)					
CLASS		SUBCLASS			CLASS	SUBCLASS (ONE SUBCLASS PER BLOCK)				
455		418			455	412.1	414.1			
INTERNATIONAL CLASSIFICATION					379					
H	0	4	M	3/00						
				/						
				/						
				/						
				/						

(Assistant Examiner) (Date)  (Legal Instruments Examiner) (Date)	 <b>CONGVAN TRAN</b> <b>PRIMARY EXAMINER</b> (Primary Examiner) (Date)	<b>Total Claims Allowed: 46</b>				
		<table border="1" style="width: 100%;"> <tr> <td style="width: 50%;">O.G. Print Claim(s)</td> <td style="width: 50%;">O.G. Print Fig.</td> </tr> <tr> <td style="text-align: center;">1</td> <td style="text-align: center;">4A</td> </tr> </table>	O.G. Print Claim(s)	O.G. Print Fig.	1	4A
O.G. Print Claim(s)	O.G. Print Fig.					
1	4A					

<input type="checkbox"/> Claims renumbered in the same order as presented by applicant										<input type="checkbox"/> CPA		<input type="checkbox"/> T.D.		<input type="checkbox"/> R.1.47	
Final	Original	Final	Original	Final	Original	Final	Original	Final	Original	Final	Original	Final	Original	Final	Original
	1		31		61	39	91		121		151		181		211
	2		32		62	40	92		122		152		182		212
	3	1	33		63	41	93		123		153		183		213
	4	2	34		64	42	94		124		154		184		214
	5	3	35		65	43	95		125		155		185		215
	6	4	36		66	44	96		126		156		186		216
	7	5	37		67	45	97		127		157		187		217
	8	6	38	10	68	46	98		128		158		188		218
	9	7	39	11	69		99		129		159		189		219
	10	8	40	12	70		100		130		160		190		220
	11	9	41	13	71		101		131		161		191		221
	12	14	42		72		102		132		162		192		222
	13	15	43		73		103		133		163		193		223
	14	16	44	22	74		104		134		164		194		224
	15	17	45	23	75		105		135		165		195		225
	16	18	46	24	76		106		136		166		196		226
	17	19	47	25	77		107		137		167		197		227
	18	20	48	26	78		108		138		168		198		228
	19	21	49	30	79		109		139		169		199		229
	20		50	31	80		110		140		170		200		230
	21		51	32	81		111		141		171		201		231
	22		52	33	82		112		142		172		202		232
	23		53	27	83		113		143		173		203		233
	24		54	28	84		114		144		174		204		234
	25		55	29	85		115		145		175		205		235
	26		56	34	86		116		146		176		206		236
	27		57	35	87		117		147		177		207		237
	28		58	36	88		118		148		178		208		238
	29		59	37	89		119		149		179		209		239
	30		60	38	90		120		150		180		210		240

**Index of Claims**



Application/Control No.

10/223,200

Examiner

CongVan Tran

Applicant(s)/Patent under Reexamination

SHANAHAN, MICHAEL E.

Art Unit

2688

√	Rejected
=	Allowed

-	(Through numeral) Cancelled
+	Restricted

N	Non-Elected
I	Interference

A	Appeal
O	Objected

Claim		Date	
Final	Original	1/17/05	
	1		
	2		
	3		
	4		
	5		
	6		
	7		
	8		
	9		
	10		
	11		
	12		
	13		
	14		
	15		
	16		
	17		
	18		
	19		
	20		
	21		
	22		
	23		
	24		
	25		
	26		
	27		
	28		
	29		
	30		
	31		
	32		
	33	=	
	34	=	
	35		
	36		
	37		
	38		
	39		
	40		
	41		
	42		
	43		
	44		
	45		
	46		
	47		
	48		
	49	=	
	50		

Claim		Date	
Final	Original	1/17/05	
	51		
	52		
	53		
	54		
	55		
	56		
	57		
	58		
	59		
	60		
	61		
	62		
	63		
	64		
	65		
	66		
	67		
	68	=	
	69	=	
	70	=	
	71	=	
	72		
	73		
	74	=	
	75		
	76		
	77		
	78		
	79		
	80		
	81		
	82		
	83		
	84		
	85		
	86		
	87		
	88		
	89		
	90		
	91		
	92		
	93		
	94		
	95		
	96		
	97		
	98		
	99		
	100		

Claim		Date	
Final	Original	1/17/05	
	101		
	102		
	103		
	104		
	105		
	106		
	107		
	108		
	109		
	110		
	111		
	112		
	113		
	114		
	115		
	116		
	117		
	118		
	119		
	120		
	121		
	122		
	123		
	124		
	125		
	126		
	127		
	128		
	129		
	130		
	131		
	132		
	133		
	134		
	135		
	136		
	137		
	138		
	139		
	140		
	141		
	142		
	143		
	144		
	145		
	146		
	147		
	148		
	149		
	150		



MES/001 CON

IN THE UNITED STATES PATENT AND TRADEMARK OFFICE

Applicant : Michael E. Shanahan  
Application No. : 10/223,200 Confirmation No.: 8026  
Filed : August 16, 2002  
Title : METHODS AND APPARATUSES FOR PROGRAMMING  
USER-DEFINED INFORMATION INTO  
ELECTRONIC DEVICES  
Examiner : CongVan Tran  
Group Art Unit : 2683

October 18, 2005

Mail Stop Amendment  
Commissioner for Patents  
P.O. Box 1450  
Alexandria, VA 22313-1450

**AMENDMENT AND REPLY TO OFFICE ACTION**

Sir:

In response to the Office Action dated May 18, 2005:

**Amendments to the Claims** are reflected in the listing of claims which begins on page 2 of this paper.

**Remarks** begin on page 22 of this paper.

**Listing of Claims**

1-15. (Cancelled)

16. (Withdrawn) A method of customizing a wireless telephone by programming an audio file into the wireless telephone for use as an indicia of an incoming communication, the method comprising:

connecting to a remote database that includes a plurality of lists of audio files;

allowing a user of the wireless telephone to browse at least one of the lists of audio files;

allowing the user of the wireless telephone to select at least one of the audio files from the browsed list;

optionally reviewing the selected audio file before downloading the selected audio into the wireless telephone; and

allowing the user to optionally download the selected audio file for use as an indicia of an incoming communication.

17. (Withdrawn) The method of claim 16 wherein the format of the selected audio file is from the group comprising: MIDI, MPEG, MP3, WAV, PCM, Windows Media Audio code (WMA), or Adaptive Transform Acoustic Coding (ATRAC).

18. (Withdrawn) The method of claim 16 further comprising allowing the user to search the remote database for a certain desired audio file using title or description information to aid in locating the desired audio file.

19. (Withdrawn) The method of claim 18 wherein the searching further comprises searching the Internet or other remote databases for the desired audio file.

20. (Withdrawn) The method of claim 16 wherein the browsing of audio files is accomplished at least in part using a Wireless Application Protocol (WAP) compliant system.

21. (Withdrawn) The method of claim 16 further comprising providing a visual indication on a display screen of the wireless telephone to confirm the selected audio file has been successfully downloaded.

22. (Withdrawn) The method of claim 16 further comprising:

downloading a selected audio file into the wireless telephone; and

associating the downloaded audio file with a characteristic indicative of a caller such that the associated audio file plays when the indicative characteristic is received by the wireless telephone.

23. (Withdrawn) The method of claim 1 wherein the characteristic indicative of the caller is the caller's telephone number.

24. (Withdrawn) A method of customizing a wireless telephone by programming an audio file into the wireless telephone for use as an indicia of an incoming communication, the method comprising:



connecting to a remote database that includes a plurality of audio files; the remote database operating substantially independently of a communications network that provides wireless telephone service to the wireless telephone;

allowing the user of the wireless telephone to browse and select at least one of the audio files;

allowing the user to optionally download the selected audio file into a programmable memory for use as an indicia of an incoming communication.

25. (Withdrawn) The method of claim 24 further comprising allowing the user to optionally review the selected audio file before downloading the selected audio file into the wireless telephone.

26. (Withdrawn) The method of claim 24 wherein the format of the selected audio file is from the group comprising: MIDI, MPEG, MP3, WAV, PCM, Windows Media Audio code (WMA), or Adaptive Transform Acoustic Coding (ATRAC).

27. (Withdrawn) The method of claim 24 further comprising allowing the user to search the remote database for a certain desired audio file using title or description information to aid in locating the desired audio file.

28. (Withdrawn) The method of claim 24 wherein the searching further comprises searching the Internet or other remote databases for the desired audio file.

29. (Withdrawn) The method of claim 24 wherein the browsing of audio files is accomplished at least in part using a Wireless Application Protocol (WAP) compliant system.

30. (Withdrawn) The method of claim 24 further comprising providing a visual indication on a display screen of the wireless telephone to confirm the selected audio file has been successfully downloaded.

31. (Withdrawn) The method of claim 24 further comprising:

downloading a selected audio file into the wireless telephone; and

associating the downloaded audio file with a characteristic indicative of a caller such that the associated audio file plays when the indicative characteristic is received by the wireless telephone.

32. (Withdrawn) The method of claim 24 wherein the characteristic indicative of the caller is the caller's telephone number.

33. (Previously presented) A wireless telephone that may be customized by programming an audio file into the wireless telephone for use as an indicia of an incoming communication, the telephone comprising:

a communications link capable of connecting to a remote database that includes a plurality of lists of audio files;

a display screen that allows a user of the wireless telephone to browse at least one of the plurality of lists of audio files and view selectable audio files present in the browsed list;

a speaker and processing circuitry configured to allow the user to optionally review a selected audio file before downloading the selected audio file into the wireless telephone; and

a programmable memory circuit for allowing the user to optionally store the selected audio file for use as an indicia of an incoming communication.

34. (Previously presented) The wireless telephone of claim 33 wherein the programmable memory circuit is configured to store audio files in a format selected from the group comprising: MIDI, MPEG, MP3, WAV, PCM, Windows Media Audio code (WMA), or Adaptive Transform Acoustic Coding (ATRAC).

35. (Previously presented) The wireless telephone of claim 33 wherein the speaker and processing circuitry is configured to play audio files in a format selected from the group comprising: MIDI, MPEG, MP3, WAV, PCM, Windows Media Audio code (WMA), or Adaptive Transform Acoustic Coding (ATRAC).

36. (Previously presented) The wireless telephone of claim 33 wherein the wireless telephone is configured to allow the user to search the remote database for a certain desired audio file using title or description information to aid in locating the desired audio file.

37. (Previously presented) The wireless telephone of claim 36 wherein the wireless telephone is configured to search the Internet or other remote databases for the desired audio file.

38. (Previously presented) The wireless telephone of claim 33 wherein the wireless telephone includes a Wireless Application Protocol (WAP) compliant Internet browser.

39. (Previously presented) The wireless telephone of claim 33 configured to provide a visual indication on the display screen to confirm the selected audio file has been successfully downloaded.

40. (Previously presented) The wireless telephone of claim 33 configured to allow the user to associate a downloaded audio file with a characteristic indicative of a caller such that the associated audio file plays when the indicative characteristic is received by the wireless telephone.

41. (Currently amended) ~~The method of claim 33~~ wireless telephone of claim 40 wherein the characteristic indicative of the caller is the caller's telephone number.

42. (Previously presented) A wireless telephone that may be customized by programming an audio file into the wireless telephone for use as an indicia of an incoming communication, the telephone comprising:

a communications link capable of connecting to a remote database that includes a plurality of lists of audio files; the remote database operating substantially independently of a communications network that provides wireless telephone service to the wireless telephone;

a display screen that allows a user of the wireless telephone to browse at least one of the plurality of lists of audio files and view selectable audio files present in the browsed list;

processing circuitry configured to receive a selected audio file from the communications link; and

a programmable memory circuit for allowing the user to optionally store the selected audio file for use as an indicia of an incoming communication.

43. (Previously presented) The wireless telephone of claim 42 further comprising a speaker that operates in conjunction with the processing circuitry to allow the user to optionally review a selected audio file before downloading the selected audio file into the wireless telephone.

44. (Previously presented) The wireless telephone of claim 42 wherein the programmable memory circuit is configured to store audio files in a format selected from the group comprising: MIDI, MPEG, MP3, WAV, PCM, Windows Media Audio code (WMA), or Adaptive Transform Acoustic Coding (ATRAC).

45. (Previously presented) The wireless telephone of claim 42 wherein the speaker and processing circuitry is configured to play audio files in a format selected from the group comprising: MIDI, MPEG, MP3, WAV, PCM, Windows Media Audio code (WMA), or Adaptive Transform Acoustic Coding (ATRAC).

46. (Previously presented) The wireless telephone of claim 42 wherein the wireless telephone is configured to allow the user to search the remote database for a certain desired audio file using title or description information to aid in locating the desired audio file.

47. (Previously presented) The wireless telephone of claim 42 wherein the wireless telephone includes a Wireless Application Protocol (WAP) compliant Internet browser.

48. (Previously presented) The wireless telephone of claim 22 configured to provide a visual indication on the display screen to confirm the selected audio file has been successfully downloaded.

49. (Previously presented) The wireless telephone of claim 42 configured to allow the user to associate a downloaded audio file with a characteristic indicative of a caller such that the associated audio file plays when the indicative characteristic is received by the wireless telephone.

50. (Withdrawn) A wireless telephone that may be customized by programming an audio file into the wireless telephone for use as an indicia of an incoming communication, the telephone comprising:

means for connecting to a remote database that includes a plurality of lists of audio files;

means for browsing at least one of the lists of audio files;

means for selecting at least one of the audio files from the browsed list;

means for optionally reviewing the selected audio file before downloading the selected audio into the wireless telephone; and

means for downloading the selected audio file for use as an indicia of an incoming communication.

51. (Withdrawn) The wireless telephone of claim 50 further comprising means for searching the remote database for a

certain desired audio file using title or description information to aid in locating the desired audio file.

52. (Withdrawn) The wireless telephone of claim 51 wherein the searching further comprises means for searching the Internet or other remote databases for the desired audio file.

53. (Withdrawn) The wireless telephone of claim 50 further comprising means for providing a visual indication on a display screen of the wireless telephone to confirm the selected audio file has been successfully downloaded.

54. (Withdrawn) The wireless telephone of claim 50 further comprising means for associating a downloaded audio file with a characteristic indicative of a caller such that the associated audio file plays when the indicative characteristic is received by the wireless telephone.

55. (Withdrawn) A wireless telephone that may be customized by programming an audio file into the wireless telephone for use as an indicia of an incoming communication, the telephone comprising:

means for connecting to a remote database that includes a plurality of audio files; the remote database operating substantially independently of a communications network that provides wireless telephone service to the wireless telephone;

means for browsing and selecting at least one of the audio files;

means for optionally downloading the selected audio file into a programmable memory for use as an indicia of an incoming communication.

56. (Withdrawn) The wireless telephone of claim 55 further comprising means for optionally reviewing the selected audio file before downloading the selected audio file into the wireless telephone.

57. (Withdrawn) The wireless telephone of claim 56 further comprising means for searching the remote database for a certain desired audio file using title or description information to aid in locating the desired audio file.

58. (Withdrawn) The wireless telephone of claim 55 wherein the searching further comprises means for searching the Internet or other remote databases for the desired audio file.

59. (Withdrawn) The wireless telephone of claim 55 wherein the browsing of audio files is accomplished at least in part using a Wireless Application Protocol (WAP) compliant system.

60. (Withdrawn) The wireless telephone of claim 55 further comprising providing a visual indication on a display screen of the wireless telephone to confirm the selected audio file has been successfully downloaded.

61. (Withdrawn) The wireless telephone of claim 55 further comprising means for associating a downloaded audio file with a characteristic indicative of a caller such that the associated audio file plays when the indicative characteristic is received by the wireless telephone.



62. (Withdrawn) The method of claim 16 further comprising preventing the unauthorized distribution of a downloaded audio file.

63. (Withdrawn) The method of claim 16 further comprising playing the selected audio file through an enhanced performance speaker capable of providing a substantially full range of audio sounds from MIDI, MP3, MPEG, WAV, PCM, Windows Media Audio Code (WMA), or Adaptive Transform Acoustic Coding (ATRAC) files.

64. (Withdrawn) The method of claim 16 characterized by the use of a personal computer to perform the browsing step.

65. (Withdrawn) The method of claim 16 further comprising providing the user with an opportunity to edit the selected audio file.

66. (Withdrawn) The method of claim 16 further comprising providing an indication that a memory capacity of the wireless telephone has been exceeded if the size of the audio file to be downloaded is larger than available memory space in the wireless telephone.

67. (Withdrawn) The method of claim 66 further comprising providing the user of the wireless telephone with the opportunity to cancel or modify a download request associated with an audio file download operation if the size of the audio file to be downloaded is larger than available memory space in the wireless telephone.

68. (Currently amended) The wireless telephone of claim ~~42~~ 33 wherein the wireless telephone is configured to prevent the unauthorized distribution of an audio file stored in the programmable memory circuit.

69. (Currently amended) The wireless telephone of claim ~~28~~ 33 wherein the speaker is an enhanced performance speaker capable of providing a substantially full range of audio sounds from MIDI, MP3, MPEG, WAV, PCM, Windows Media Audio Code (WMA), or Adaptive Transform Acoustic Coding (ATRAC) files.

70. (Currently amended) The wireless telephone of claim ~~27~~ 33 configured to provide an indication that a memory capacity of the wireless telephone has been exceeded if the size of the audio file to be downloaded is larger than available memory space in the wireless telephone.

71. (Currently amended) The wireless telephone of claim ~~56~~ 70 configured to provide the user of the wireless telephone with the opportunity to cancel or modify a download request associated with an audio file download operation if the size of the audio file to be downloaded is larger than the available memory space in the wireless telephone.

72. (Withdrawn) A wireless telephone that may be customized by programming an audio file into the wireless telephone for use as an indicia of an incoming communication, the telephone comprising:

means for connecting to a remote database that includes a plurality of audio files;

means for selecting at least one of the audio files from the database;

means for downloading and storing the selected audio file for use as an indicia of an incoming communication; and

means for preventing the unauthorized distribution of a selected audio file stored in the wireless telephone.

73. (Withdrawn) The wireless telephone of claim 72 further comprising means for indicating that a memory capacity of the wireless telephone has been exceeded if the size of the audio file to be downloaded is larger than available memory space in the wireless telephone.

74. (Currently amended) A wireless telephone that may be customized by searching for and selecting an audio file from a remote computer and programming the selected audio file into the wireless telephone for use as an indicia of an incoming communication, the telephone comprising:

a communications link capable of connecting to a database in the remote computer that includes a plurality of lists of audio files in MPEG, or WAV, or MP3 format or a combination thereof;

a display screen and a mobile Internet browser that allows a user of the wireless telephone to browse at least one of the lists of lists of audio files and view selectable audio files present in the browsed list;

processing circuitry configured to receive a selected one of the audio files from the communications link;

a programmable memory circuit for allowing the user to optionally store the selected audio file for use as an indicia of an incoming communication; and

an enhanced performance speaker capable of providing a substantially full range of audio sounds ~~from the MPEG, WAV, or MP3 files~~ when one of the ~~stored~~ selected audio files is played as an indicia of an incoming communication.

75. (Previously presented) The wireless telephone of claim 74 configured to provide an indication that a memory capacity of the wireless telephone has been exceeded if the size of the audio file to be downloaded is larger than the available memory space in the wireless telephone.

76. (Previously presented) The wireless telephone of claim 74 wherein the enhanced performance speaker operates in conjunction with the processing circuitry to allow the user to optionally review ~~a~~ the selected audio file before downloading the selected audio file into the wireless telephone.

77. (Previously presented) The wireless telephone of claim 74 configured to allow the user to search the ~~remote~~ database for a certain desired audio file using title or description information to aid in locating ~~the~~ a desired audio file.

78. (Previously presented) The wireless telephone of claim 74 configured to prevent the unauthorized distribution of ~~a~~ the audio file stored in the programmable memory circuit.

79. (Previously presented) A wireless telephone that may be customized by searching for and selecting an audio file from a remote computer and programming the selected audio file into the wireless telephone for use at a time specified by the user, the telephone comprising:

a communications link capable of connecting to a database in the remote computer that includes a plurality of polyphonic audio files;

a display screen and a browsing application program that allows a user of the wireless telephone to browse the polyphonic audio files and select at least one polyphonic audio file therefrom;

processing circuitry configured to supervise receipt of a selected polyphonic audio file from the communications link;

a programmable memory circuit for allowing the user to optionally store the selected polyphonic audio file for use as an indicia of an incoming communication; and

an enhanced performance speaker capable of providing a substantially full range of audio sounds from the selected polyphonic audio file when the selected polyphonic audio file is played.

80. (Previously presented) The wireless telephone of claim 79 wherein the polyphonic audio file is selected from the group comprising MP3, MPEG, or WAV files.

81. (Previously presented) The wireless telephone of claim 79 wherein the enhanced performance speaker operates in conjunction with the processing circuitry to allow the user to optionally review the selected polyphonic audio file before downloading the selected polyphonic audio file into the programmable memory circuit of the wireless telephone.

82. (Previously presented) The wireless telephone of claim 79 configured to prevent the unauthorized distribution of the selected polyphonic audio file stored in the programmable memory circuit.

83. (Previously presented) The wireless telephone of claim 74 wherein the group of polyphonic audio files includes audio files in polyphonic MIDI format.

84. (Previously presented) The wireless telephone of claim 76 configured to provide the user of the wireless telephone with the option of downloading the selected polyphonic audio file into a programmable memory in the wireless telephone after reviewing the selected polyphonic audio file.

85. (Currently amended) The wireless telephone of claim 84 configured to provide the user of the wireless telephone with the option of ~~editing~~ modifying the selected polyphonic audio file before programming the selected polyphonic audio file into the programmable memory in the wireless telephone.

86. (Previously presented) The wireless telephone of claim 80 wherein the wireless telephone is configured to operate in conjunction with copyright protection software to prevent the unauthorized distribution of the selected polyphonic audio file stored in the programmable memory circuit.

87. (Currently amended) The wireless telephone of claim 79 wherein the ~~group~~ selected polyphonic audio files is in polyphonic MIDI format.

88. (Previously presented) The wireless telephone of claim 81 configured to provide the user of the wireless

telephone with the option of downloading the selected polyphonic audio file into a programmable memory in the wireless telephone after reviewing the selected polyphonic audio file.

89. (Currently amended) The wireless telephone of claim 88 configured to provide the user of the wireless telephone with the option of ~~editing~~ modifying the selected polyphonic audio file before programming the selected polyphonic audio file into the programmable memory in the wireless telephone.

90. (Previously presented) The wireless telephone of claim 82 wherein the wireless telephone is configured to operate in conjunction with copyright protection software to prevent the unauthorized distribution of the selected polyphonic audio file stored in the programmable memory circuit.

91. (Previously presented) A wireless telephone that may be customized by searching for and selecting an audio file from a remote computer and programming the selected audio file into the wireless telephone for use as an indicia of an incoming communication, the telephone comprising:

a communications link capable of connecting to a database in the remote computer that includes a plurality of polyphonic audio files;

a display screen and a browsing application program that allows a user of the wireless telephone to browse the polyphonic audio files and select at least one polyphonic audio file therefrom;

processing circuitry configured to supervise receipt of a selected polyphonic audio file from the communications link;

a programmable memory circuit for allowing the user to optionally store the selected polyphonic audio file for use as an indicia of an incoming communication; and

an enhanced performance speaker capable of providing a substantially full range of audio sounds from the selected polyphonic audio file when the selected polyphonic audio file is played.

92. (Previously presented) The wireless telephone of claim 91 wherein the polyphonic audio file is selected from the group comprising MP3, MPEG, or WAV files.

93. (Previously presented) The wireless telephone of claim 91 wherein the enhanced performance speaker operates in conjunction with the processing circuitry to allow the user to optionally review the selected polyphonic audio file before downloading the selected polyphonic audio file into the programmable memory circuit of the wireless telephone.

94. (Previously presented) The wireless telephone of claim 91 configured to prevent the unauthorized distribution of the selected polyphonic audio file stored in the programmable memory circuit.

95. (Currently amended) The wireless telephone of claim ~~92~~ 91 wherein the ~~group of~~ polyphonic audio files includes audio files in polyphonic MIDI format.



96. (Previously presented) The wireless telephone of claim 93 configured to provide the user of the wireless telephone with the option of downloading the selected polyphonic audio file into a programmable memory in the wireless telephone after reviewing the selected polyphonic audio file.

97. (Currently amended) The wireless telephone of claim ~~96~~ 93 configured to provide the user of the wireless telephone with the option of ~~editing~~ modifying the selected polyphonic audio file before programming the selected polyphonic audio file into the programmable memory in the wireless telephone.

98. (Currently amended) The wireless telephone of claim ~~94~~ 91 wherein the wireless telephone is configured to operate in conjunction with copyright protection software to prevent the unauthorized distribution of the selected polyphonic audio file stored in the programmable memory circuit.

99. (Withdrawn) A wireless telephone that may be customized by programming an audio file into the wireless telephone for use at a time specified by a user of the wireless telephone, the telephone comprising:

means for connecting to a remote database that includes a plurality of lists of polyphonic audio files;

means for browsing at least one of the lists of polyphonic audio files;

means for selecting at least one of the polyphonic audio files from the browsed list;

means for optionally reviewing the selected polyphonic audio file before downloading the selected polyphonic audio into a memory circuit in the wireless telephone; and

means for downloading the selected polyphonic audio file for use at the time specified by the user of the wireless telephone.

100. (Withdrawn) The wireless telephone of claim 99 further comprising means for searching the remote database for a certain desired polyphonic audio file using title or description information to aid in locating the desired polyphonic audio file.

101. (Withdrawn) The wireless telephone of claim 100 wherein the searching further comprises means for searching the Internet or other remote databases for the desired polyphonic audio file.

102. (Withdrawn) The wireless telephone of claim 99 further comprising means for providing a visual indication on a display screen of the wireless telephone to confirm the selected polyphonic audio file has been successfully downloaded.

103. (Withdrawn) The wireless telephone of claim 99 wherein the browsing of polyphonic audio files is accomplished at least in part using a Wireless Application Protocol (WAP) compliant system.

104. (Withdrawn) The wireless telephone of claim 99 further comprising means for preventing unauthorized distribution of the selected polyphonic audio file stored in the programmable memory circuit.

## REMARKS

### I. Petition Under 37 C.F.R. § 1.136(a)

Pursuant to 37 C.F.R. § 1.136(a), applicant hereby petitions for a two-month extension of the shortened statutory period set for reply to the Office Action dated May 18, 2005. A check in the amount of \$225.00 in payment of the fee set forth in 37 C.F.R. § 1.17(a)(2) is enclosed.

### II. Election of Inventions

Applicant hereby elects the inventions of Group II (claims 33-49, 68-71 and 74-98) for prosecution. Applicant expressly reserves the right to file divisional applications to pursue the subject matter included in Group I (claims 16-32, 50-67, 72-73, 99-104).

### III. Introduction

Claims 1-15 are cancelled without prejudice.

Claims 33-49, 68-71, 74-98 are pending in the application.

Claims 16-32, 50-67, 72-73 and 99-104 are withdrawn from consideration.

Claims 33, 36-43, 46-49 and 68 are rejected under 35 U.S.C. § 102(e) as being anticipated by Helferich, U.S. patent 6,253,061 (hereinafter "Helferich").

Claims 34-35, 44-45, 69-71 and 74-98 are rejected under 35 U.S.C. § 103(a) as being unpatentable over Mills et al. U.S. patent 6,599,147 (hereinafter "Mills") in view of Helferich.

Consideration and allowance of this application in light of the amendments above and the following remarks is respectfully requested.

IV. Applicant's Reply to the Rejection Under 35 U.S.C. § 102(e)

Claims 33, 36-43, 46-49 and 68 are rejected under 35 U.S.C. § 102(e) as being anticipated by Helferich. Applicant respectfully traverses this rejection.

One aspect of applicant's claimed invention is concerned with a wireless telephone that may be customized by programming an audio file into the wireless telephone for use as an indicia of an incoming communication. This may be thought of as a wireless telephone that allows a user to customize the wireless telephone by selecting and programming a ringtone into the wireless telephone which plays when an incoming telephone call (or other communication) is received.

One benefit of such a wireless telephone is that it allows the user the freedom and flexibility to choose and/or change to a particular ringtone that is pleasing to the user rather than be constrained by a single ringtone or limited group

of ringtones, which may have been, for example, preselected or preprogrammed.

The claimed wireless telephone has the ability to connect to a remote database(s) of ringtones and allow the user to browse lists of ringtones in the remote database(s), select a particular ringtone and optionally review a selected ringtone using a speaker and processing circuitry prior to downloading the ringtone into a programmable memory in the wireless telephone (e.g., a preview feature). This allows the user to confirm the selected ringtone is correct and/or acceptable or meets expectations, etc. Thus, one aspect of applicant's claimed invention is concerned with a customization of wireless telephone by allowing the review and selection of a ringtone that is played subsequently when receiving an incoming call.

In contrast, Helferich fails to show or suggest these features anywhere. Rather, Helfrich is concerned with an efficient paging system that allows the user to selectively retrieve messages that are waiting in a remote storage and retrieval unit (See Helferich, FIG. 3, element 32 and column 6, lines 9-28)). Such messages are sent to the storage and retrieval unit over a Public Switched Telephone Network (PSTN) by a third party and correlated by subscriber listings (Helferich, FIG. 3, element 32 and its associated description). The purpose of

Helperich is to conserve message transmission time and device memory by sending a page to a remote paging device indicating that a message has been received and then allowing the user to selectively download one or more of the waiting messages at some point in the future. See, for example, Helperich, column 2, line 66 to column 3, line 41, column 14, lines 50-58 and FIGS. 3 and 5-8. Thus, with the system of Helperich, stored messages are not automatically sent to the paging device, rather, they are queued in a storage and retrieval unit and the user may selectively download certain messages at a convenient time in order to conserve transmission resources and reduce or minimize the memory and processing requirements of the paging device. See, for example, Helperich, column 14, line 59 to column 15, line 36.

Helperich mentions that the paging device 100 may be integrated into a tape player or CD player. In addition, certain messages may include music which when downloaded from the storage and retrieval unit may be played with such CD or tape player. See Helperich column 15, lines 46-55.

However, completely absent from Helperich is any teaching or suggestion that such music messages may be stored and played as an indicia of an incoming communication as specified in applicant's claims. Helperich merely mentions such messages may be retrieved and played at portable CD or tape player (i.e., a

portable "boom box" or radio with a messaging capability). This is very different from a wireless telephone with an audio file that may be stored and subsequently played to alert the user of an incoming communication. Moreover, applicant respectfully points out that Helferich fails to even recognize that such a customization feature would be desirable or suggest the circumstances under which it would be useful or desirable. Thus, Helferich fails to show or suggest browsing, downloading and playing an audio file as an indicia of an incoming communication as specified in applicant's claims.

Accordingly, applicant respectfully submits that independent claims 33, 42, 74, 79 and 91, and the claims that depend therefrom are allowable over Helferich for at least this reason.

#### Other Patentable Distinctions

In addition to the reasons above, applicant respectfully submits that at least several other patentable distinctions exist in pending claims over the prior art of record. For example, claims 74, 79, and 91 specify a browsing application on the wireless telephone that allows a user to browse and select an audio file from a database, whereas Helferich merely discloses sending a message that may contain a list of music. Thus, the system of Helferich merely allows a

user to retrieve and read a message that contains a list of music (just like any other received message) and does not employ a browsing program or provide any searching feature. The word "browse" as used in column 15, line 50, merely means the user may read (browse) the list of music in the received message. No browsing application (including an Internet or WAP or other compliant browser) is shown or suggested in Helferich.

Similarly, claims 36-37, 46-47 and 77 specify searching a remote database or the Internet for a desired audio file (some of which specify using title or description information). This feature is also not shown or suggested by Heleferich (i.e., merely receiving messages sent to a subscriber of the paging system by another is not searching a remote database). In addition to the reasons provided above (i.e., no browsing or search application suggested), the standard input/output devices described in Helferich at column 4, lines 53-64 are incapable of providing any searching functionality, rather, they simply allow the user to enter information into and receive information from the paging device, nothing more. No database searching features are provided by such input/output devices (keyboard, mouse, video display, speaker, etc.).

Other claims specify a wireless telephone that includes an enhanced performance speaker for providing a



substantially full range of audio sounds (claims 74-98). This feature is also not shown or suggested anywhere in Helferich. Applicant respectfully points out that a CD or tape player with and integrated paging transceiver (Helferich column 15, lines 46-55) is merely a CD player or tape deck with messaging capabilities (i.e., a CD player that can receive messages) and is not a customizable wireless telephone as specified in applicant's claims. No such device is shown or suggested anywhere in Helferich.

Other features patentable over the prior art include a wireless telephone configured to prevent the unauthorized distribution of the downloaded audio files used as an indicia of an incoming communication (claims 78 and 82), the use of copyright protection measures (claims 86 and 98), optionally modifying selected audio files before programming into the wireless telephone (claims 85 and 97), the use of polyphonic audio files including the various formats specified (claims 69 and 79-98) as well as other patentable features set forth in the claims that are not deemed necessary to discuss here.

Accordingly, based on the above, applicant respectfully requests that the rejections under 35 U.S.C. § 102(e) be withdrawn.

V. Applicant's Reply to the Rejection Under 35 U.S.C. § 103(a)

Claims 33-35, 44-45, 69-71, 74-98 are rejected under 35 U.S.C. § 103(a) as being unpatentable over by Helferich in view of Mills. Applicant respectfully submits that this rejection is moot in view of the discussion above and that the claims are allowable over Mills and Helferich for at least the same reasons they are allowable over Helferich.

Moreover, applicant submits it is not obvious to combine the references as the Examiner proposes. As mentioned above, the purpose of Helferich is to provide a lightweight and highly portable messaging application for selectively downloading certain paging messages. The system of Helferich is primarily concerned with minimizing the number of messages received and the amount of memory and processing power required by the paging device, thus teaching away from the addition of supplemental memory, and therefore discouraging the combination of Mills and Helferich proposed by the Examiner. Furthermore, substantial modification of the device of Helferich would be required to accommodate the expansion module of Mills further discouraging such a combination. No teaching is provided by either reference describing how to accomplish such modifications or is there any suggestion or

motivation provided within the references themselves that such a combination would be desirable.

In addition, even if such a combination were made, it would still not produce applicant's claimed invention (i.e., the combination would merely produce a device suffering from all the shortcomings of Helferich pointed out above). Moreover, although Mills mentions that MP3 files may be stored in the expansion module, no mention is made of MIDI, WAV, PCM, WMA or ATRAC audio files.

Accordingly, based on the above applicant respectfully requests that the rejections under 35 U.S.C. § 103(a) be withdrawn.

#### VI. Conclusion

For at least the above reasons, claims 33, 42, 74, 79 and 91 are patentable over the references of record. Claims 24-41, 43-49, 75-78, 80-90 and 92-98 which depend therefrom are therefore also patentable over the references of record.

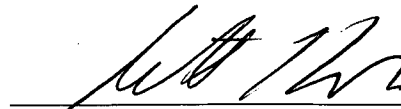
For all of the above reasons, applicant respectfully requests that the Examiner withdraw the rejections and allow the pending claims. To expedite prosecution of this application to allowance, the examiner is invited to call the applicant's

undersigned representative to discuss any issues relating to this application.

Respectfully submitted,

Dated:

10/18/2005

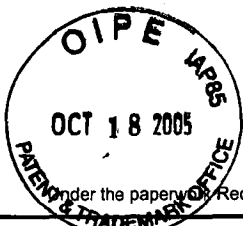


---

Scott H. Kaliko  
Attorney for Applicant  
Registration No. 45,786  
**KALIKO & YEAGER, L.L.C.**  
500 North Franklin Turnpike  
Ramsey, NJ 07446

Direct: 201-831-0575

Fax: 201-831-0519



<b>PETITION FOR EXTENSION OF TIME UNDER 37 CFR 1.136(a)</b> <b>FY 2005</b> <i>(Fees pursuant to the Consolidated Appropriations Act, 2005 (H.R. 4818).)</i>		Docket Number (Optional) <b>MES-001 CON</b>	
Application Number <b>10/223,200</b>		Filed <b>August 16, 2002</b>	
For <b>Methods and Apparatuses for programming user-defined information into electronic devices.</b>			
Art Unit <b>2683</b>		Examiner <b>Cong Van Tran</b>	
This is a request under the provisions of 37 CFR 1.136(a) to extend the period for filing a reply in the above identified application. The requested extension and fee are as follows (check time period desired and enter the appropriate fee below):			
	<u>Fee</u>	<u>Small Entity Fee</u>	
<input type="checkbox"/> One month (37 CFR 1.17(a)(1))	\$120	\$60	\$ _____
<input checked="" type="checkbox"/> Two months (37 CFR 1.17(a)(2))	\$450	\$225	\$ <u>225</u>
<input type="checkbox"/> Three months (37 CFR 1.17(a)(3))	\$1020	\$510	\$ _____
<input type="checkbox"/> Four months (37 CFR 1.17(a)(4))	\$1590	\$795	\$ _____
<input type="checkbox"/> Five months (37 CFR 1.17(a)(5))	\$2160	\$1080	\$ _____
<input checked="" type="checkbox"/> Applicant claims small entity status. See 37 CFR 1.27.			
<input checked="" type="checkbox"/> A check in the amount of the fee is enclosed.			
<input type="checkbox"/> Payment by credit card. Form PTO-2038 is attached.			
<input type="checkbox"/> The Director has already been authorized to charge fees in this application to a Deposit Account.			
<input type="checkbox"/> The Director is hereby authorized to charge any fees which may be required, or credit any overpayment, to Deposit Account Number _____ I have enclosed a duplicate copy of this sheet.			
<b>WARNING: Information on this form may become public. Credit card information should not be included on this form. Provide credit card information and authorization on PTO-2038.</b>			
I am the <input type="checkbox"/> applicant/inventor.			
<input type="checkbox"/> assignee of record of the entire interest. See 37 CFR 3.71. Statement under 37 CFR 3.73(b) is enclosed (Form PTO/SB/96).			
<input checked="" type="checkbox"/> attorney or agent of record. Registration Number <u>45,786</u> .			
<input type="checkbox"/> attorney or agent under 37 CFR 1.34. Registration number if acting under 37 CFR 1.34 _____			
_____ Signature		<u>October 18, 2005</u> Date	
<u>Scott H. Kalika</u> Typed or printed name		<u>201-831-0575</u> Telephone Number	
<input checked="" type="checkbox"/> Total of <u>1</u> forms are submitted.			

NOTE: Signatures of all the inventors or assignees of record of the entire interest or their representative(s) are required. Submit multiple forms if more than one signature is required, see below.

If you need assistance in completing the form, call 1-800-PTO-9199 and select option 2.



10-19-05

2683 \$

PATENTS  
Attorney Docket No. MES-001 CON

IN THE UNITED STATES PATENT AND TRADEMARK OFFICE

Applicant: Michael E. Shanahan  
Application No.: 10/223,200 Confirmation No.: 8026  
Title of Invention: METHODS AND APPARATUSES FOR PROGRAMMING USER-  
DEFINED INFORMATION INTO ELECTRONIC DEVICES  
Filed: AUGUST 11, 2005  
Group No.: 2683  
Examiner: CongVan Tran

**Mail Stop Amendment**  
**Commissioner for Patents**  
**P.O. Box 1450**  
**Alexandria, VA 22313-1450**

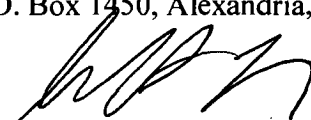
**EXPRESS MAIL CERTIFICATE**

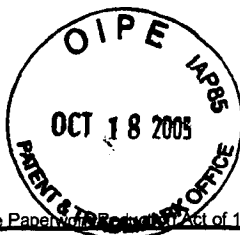
"Express Mail" label number: ED 089160859 US  
Date of Deposit : October 18, 2005

I hereby state that the following *attached* paper or fee

Transmittal Form  
Fee Transmittal Form with check in the amount of \$225.00;  
Amendment and Reply to Office Action  
Petition for Extension of Time Under 37 CFR 1.136(a); and  
Return Post Card

is being deposited with the United States Postal Service "Express Mail Post Office to Addressee" service under 37 C.F.R. § 1.10, on the date indicated above and is addressed to the Commissioner for Patents, P.O. Box 1450, Alexandria, VA 22313-1450.

  
\_\_\_\_\_  
**Signature**  
Scott H. Kaliko, Esq.



Under the Paperwork Reduction Act of 1995, no persons are required to respond to a collection of information unless it displays a valid OMB control number.

<b>TRANSMITTAL FORM</b>  <i>(to be used for all correspondence after initial filing)</i>	Application Number	10/223,200
	Filing Date	August 16, 2002
	First Named Inventor	Michael E. Shanahan
	Art Unit	2683
	Examiner Name	CongVan Tran
	Attorney Docket Number	MES-001 CON
Total Number of Pages in This Submission		

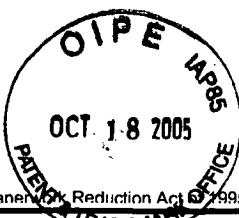
ENCLOSURES (Check all that apply)		
<input checked="" type="checkbox"/> Fee Transmittal Form	<input type="checkbox"/> Drawing(s)	<input type="checkbox"/> After Allowance Communication to TC
<input checked="" type="checkbox"/> Fee Attached	<input type="checkbox"/> Licensing-related Papers	<input type="checkbox"/> Appeal Communication to Board of Appeals and Interferences
<input checked="" type="checkbox"/> Amendment/Reply	<input type="checkbox"/> Petition	<input type="checkbox"/> Appeal Communication to TC (Appeal Notice, Brief, Reply Brief)
<input type="checkbox"/> After Final	<input type="checkbox"/> Petition to Convert to a Provisional Application	<input type="checkbox"/> Proprietary Information
<input type="checkbox"/> Affidavits/declaration(s)	<input type="checkbox"/> Power of Attorney, Revocation	<input type="checkbox"/> Status Letter
<input checked="" type="checkbox"/> Extension of Time Request	<input type="checkbox"/> Change of Correspondence Address	<input type="checkbox"/> Other Enclosure(s) (please identify below):
<input type="checkbox"/> Express Abandonment Request	<input type="checkbox"/> Terminal Disclaimer	
<input type="checkbox"/> Information Disclosure Statement	<input type="checkbox"/> Request for Refund	
<input type="checkbox"/> Certified Copy of Priority Document(s)	<input type="checkbox"/> CD, Number of CD(s) _____	
<input type="checkbox"/> Reply to Missing Parts/ Incomplete Application	<input type="checkbox"/> Landscape Table on CD	
<input type="checkbox"/> Reply to Missing Parts under 37 CFR 1.52 or 1.53	<input type="text"/> Remarks	

SIGNATURE OF APPLICANT, ATTORNEY, OR AGENT			
Firm Name	Kaliko & Yeager, LLC		
Signature			
Printed name	Scott H. Kaliko		
Date	October 18, 2005	Reg. No.	45,786

CERTIFICATE OF TRANSMISSION/MAILING			
I hereby certify that this correspondence is being facsimile transmitted to the USPTO or deposited with the United States Postal Service with sufficient postage as first class mail in an envelope addressed to: Commissioner for Patents, P.O. Box 1450, Alexandria, VA 22313-1450 on the date shown below:			
Signature			
Typed or printed name	Vimisha Dubal	Date	October 18, 2005

This collection of information is required by 37 CFR 1.5. The information is required to obtain or retain a benefit by the public which is to file (and by the USPTO to process) an application. Confidentiality is governed by 35 U.S.C. 122 and 37 CFR 1.11 and 1.14. This collection is estimated to 2 hours to complete, including gathering, preparing, and submitting the completed application form to the USPTO. Time will vary depending upon the individual case. Any comments on the amount of time you require to complete this form and/or suggestions for reducing this burden, should be sent to the Chief Information Officer, U.S. Patent and Trademark Office, U.S. Department of Commerce, P.O. Box 1450, Alexandria, VA 22313-1450. DO NOT SEND FEES OR COMPLETED FORMS TO THIS ADDRESS. SEND TO: Commissioner for Patents, P.O. Box 1450, Alexandria, VA 22313-1450.

If you need assistance in completing the form, call 1-800-PTO-9199 and select option 2.



Under the Paperwork Reduction Act of 1995, no persons are required to respond to a collection of information unless it displays a valid OMB control number.

Fees pursuant to the Consolidated Appropriations Act, 2005 (H.R. 4818).  
 Effective on 12/08/2004.

# FEE TRANSMITTAL

## For FY 2005

Applicant claims small entity status. See 37 CFR 1.27

TOTAL AMOUNT OF PAYMENT (\$) 225.00

### Complete if Known

Application Number	10/223,200
Filing Date	August 16, 2002
First Named Inventor	Michael E. Shanahan
Examiner Name	CongVan Tran
Art Unit	2683
Attorney Docket No.	MES-001 CON

### METHOD OF PAYMENT (check all that apply)

Check  Credit Card  Money Order  None  Other (please identify): \_\_\_\_\_

Deposit Account Deposit Account Number: \_\_\_\_\_ Deposit Account Name: \_\_\_\_\_

For the above-identified deposit account, the Director is hereby authorized to: (check all that apply)

Charge fee(s) indicated below  Charge fee(s) indicated below, **except for the filing fee**

Charge any additional fee(s) or underpayments of fee(s) under 37 CFR 1.16 and 1.17  Credit any overpayments

**WARNING: Information on this form may become public. Credit card information should not be included on this form. Provide credit card information and authorization on PTO-2038.**

### FEE CALCULATION

#### 1. BASIC FILING, SEARCH, AND EXAMINATION FEES

Application Type	FILING FEES		SEARCH FEES		EXAMINATION FEES		Fees Paid (\$)
	Fee (\$)	Small Entity Fee (\$)	Fee (\$)	Small Entity Fee (\$)	Fee (\$)	Small Entity Fee (\$)	
Utility	300	150	500	250	200	100	0
Design	200	100	100	50	130	65	0
Plant	200	100	300	150	160	80	0
Reissue	300	150	500	250	600	300	0
Provisional	200	100	0	0	0	0	0

#### 2. EXCESS CLAIM FEES

Fee Description	Fee (\$)	Small Entity Fee (\$)
Each claim over 20 (including Reissues)	50	25
Each independent claim over 3 (including Reissues)	200	100
Multiple dependent claims	360	180

Total Claims	Extra Claims	Fee (\$)	Fee Paid (\$)	Multiple Dependent Claims	Fee (\$)	Fee Paid (\$)
_____ - 20 or HP = _____	x _____	= _____	_____	_____	_____	_____
HP = highest number of total claims paid for, if greater than 20.						
_____ <b>Indep. Claims</b>	_____ <b>Extra Claims</b>	_____ <b>Fee (\$)</b>	_____ <b>Fee Paid (\$)</b>	_____	_____	_____
_____ - 3 or HP = _____	x _____	= _____	_____	_____	_____	_____
HP = highest number of independent claims paid for, if greater than 3.						

#### 3. APPLICATION SIZE FEE

If the specification and drawings exceed 100 sheets of paper (excluding electronically filed sequence or computer listings under 37 CFR 1.52(e)), the application size fee due is \$250 (\$125 for small entity) for each additional 50 sheets or fraction thereof. See 35 U.S.C. 41(a)(1)(G) and 37 CFR 1.16(s).

Total Sheets	Extra Sheets	Number of each additional 50 or fraction thereof	Fee (\$)	Fee Paid (\$)
_____ - 100 = _____	/ 50 = _____	(round up to a whole number) x _____	= _____	0

#### 4. OTHER FEE(S)

Non-English Specification, \$130 fee (no small entity discount) Fees Paid (\$) 0

Other (e.g., late filing surcharge): Extension of Time Request \$ 225

### SUBMITTED BY

Signature		Registration No. (Attorney/Agent) 45,786	Telephone 201-831-0575
Name (Print/Type)	Scott H. Kaliko		Date

This collection of information is required by 37 CFR 1.136. The information is required to obtain or retain a benefit by the public which is to file (and by the USPTO to process) an application. Confidentiality is governed by 35 U.S.C. 122 and 37 CFR 1.14. This collection is estimated to take 30 minutes to complete, including gathering, preparing, and submitting the completed application form to the USPTO. Time will vary depending upon the individual case. Any comments on the amount of time you require to complete this form and/or suggestions for reducing this burden, should be sent to the Chief Information Officer, U.S. Patent and Trademark Office, U.S. Department of Commerce, P.O. Box 1450, Alexandria, VA 22313-1450. DO NOT SEND FEES OR COMPLETED FORMS TO THIS ADDRESS. SEND TO: Commissioner for Patents, P.O. Box 1450, Alexandria, VA 22313-1450.

If you need assistance in completing the form, call 1-800-PTO-9199 and select option 2.



Under the Paperwork Reduction Act of 1995, no persons are required to respond to a collection of information unless it displays a valid OMB control number.

**PATENT APPLICATION FEE DETERMINATION RECORD**  
Substitute for Form PTO-875

Application or Docket Number  
**10/273200**

APPLICATION AS FILED – PART I			SMALL ENTITY		OR	OTHER THAN SMALL ENTITY	
FOR	NUMBER FILED	NUMBER EXTRA	RATE (\$)	FEE (\$)		RATE (\$)	FEE (\$)
BASIC FEE (37 CFR 1.16(a), (b), or (c))							
SEARCH FEE (37 CFR 1.16(k), (l), or (m))							
EXAMINATION FEE (37 CFR 1.16(o), (p), or (q))							
TOTAL CLAIMS (37 CFR 1.16(i))		minus 20 = *	X	=		X	=
INDEPENDENT CLAIMS (37 CFR 1.16(h))		minus 3 = *	X	=		X	=
APPLICATION SIZE FEE (37 CFR 1.16(s))	If the specification and drawings exceed 100 sheets of paper, the application size fee due is \$250 (\$125 for small entity) for each additional 50 sheets or fraction thereof. See 35 U.S.C. 41(a)(1)(G) and 37 CFR 1.16(s).						
MULTIPLE DEPENDENT CLAIM PRESENT (37 CFR 1.16(j))							
* If the difference in column 1 is less than zero, enter "0" in column 2.			TOTAL			TOTAL	

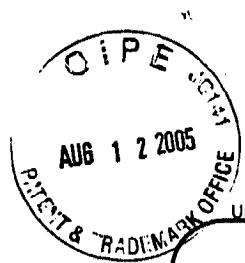
APPLICATION AS AMENDED – PART II					SMALL ENTITY		OR	OTHER THAN SMALL ENTITY			
AMENDMENT A	(Column 1)	(Column 2)	(Column 3)	(Column 4)	(Column 5)	RATE (\$)	ADDITIONAL FEE (\$)		RATE (\$)	ADDITIONAL FEE (\$)	
		CLAIMS REMAINING AFTER AMENDMENT		HIGHEST NUMBER PREVIOUSLY PAID FOR	PRESENT EXTRA						
	Total (37 CFR 1.16(i))	* 84	Minus	** 60	= 23	X	=			X 50 =	1150
Independent (37 CFR 1.16(h))	* 11	Minus	*** 8	= 3	X	=			X 20 =	600	
Application Size Fee (37 CFR 1.16(s))											
FIRST PRESENTATION OF MULTIPLE DEPENDENT CLAIM (37 CFR 1.16(j))											
					TOTAL ADD'L FEE				TOTAL ADD'L FEE 1750		

APPLICATION AS AMENDED – PART II					SMALL ENTITY		OR	OTHER THAN SMALL ENTITY			
AMENDMENT B	(Column 1)	(Column 2)	(Column 3)	(Column 4)	(Column 5)	RATE (\$)	ADDITIONAL FEE (\$)		RATE (\$)	ADDITIONAL FEE (\$)	
		CLAIMS REMAINING AFTER AMENDMENT		HIGHEST NUMBER PREVIOUSLY PAID FOR	PRESENT EXTRA						
	Total (37 CFR 1.16(i))	*	Minus	**	=	X	=			X	=
Independent (37 CFR 1.16(h))	*	Minus	***	=	X	=			X	=	
Application Size Fee (37 CFR 1.16(s))											
FIRST PRESENTATION OF MULTIPLE DEPENDENT CLAIM (37 CFR 1.16(j))											
					TOTAL ADD'L FEE				TOTAL ADD'L FEE		

\* If the entry in column 1 is less than the entry in column 2, write "0" in column 3.  
 \*\* If the "Highest Number Previously Paid For" IN THIS SPACE is less than 20, enter "20".  
 \*\*\* If the "Highest Number Previously Paid For" IN THIS SPACE is less than 3, enter "3".  
 The "Highest Number Previously Paid For" (Total or Independent) is the highest number found in the appropriate box in column 1.

This collection of information is required by 37 CFR 1.16. The information is required to obtain or retain a benefit by the public which is to file (and by the USPTO to process) an application. Confidentiality is governed by 35 U.S.C. 122 and 37 CFR 1.14. This collection is estimated to take 12 minutes to complete, including gathering, preparing, and submitting the completed application form to the USPTO. Time will vary depending upon the individual case. Any comments on the amount of time you require to complete this form and/or suggestions for reducing this burden, should be sent to the Chief Information Officer, U.S. Patent and Trademark Office, U.S. Department of Commerce, P.O. Box 1450, Alexandria, VA 22313-1450. DO NOT SEND FEES OR COMPLETED FORMS TO THIS ADDRESS. SEND TO: Commissioner for Patents, P.O. Box 1450, Alexandria, VA 22313-1450.

If you need assistance in completing the form, call 1-800-PTO-9199 and select option 2



✓ IFW

PTO/SB/123 (09-04)  
 Approved for use through 11/30/2005. OMB 0651-0035  
 U.S. Patent and Trademark Office; U.S. DEPARTMENT OF COMMERCE

Under the Paperwork Reduction Act of 1995, no persons are required to respond to a collection of information unless it displays a valid OMB control number.

<p align="center"><b>CHANGE OF CORRESPONDENCE ADDRESS</b> <i>Patent</i></p> <p>Address to:          Mail Stop Post Issue          Commissioner for Patents          P.O. Box 1450          Alexandria, VA 22313-1450</p>	Patent Number	
	Issue Date	
	Application Number	10/223,200 ✓
	Filing Date	August 16, 2002
	First Named Inventor	Michael E. Shanahan
	Attorney Docket Number	MES-001 CON

Please change the Correspondence Address for the above-identified patent to:

The address associated with Customer Number: 39550

**OR**

Firm or Individual Name

---

**Address**

<b>City</b>	<b>State</b>	<b>ZIP</b>
<b>Country</b>		
<b>Telephone</b>		<b>Fax</b>

This form cannot be used to change the data associated with a Customer Number. To change the data associated with an existing Customer Number use "Request for Customer Number Data Change" (PTO/SB/124).

This form will not affect any "fee address" provided for the above-identified patent. To change a "fee address" use the "Fee Address Indication Form" (PTO/SB/47).

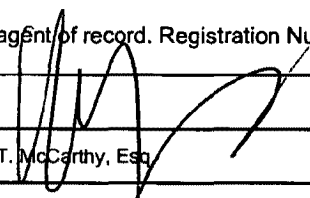
I am the:

Patentee.

Assignee of record of the entire interest. See 37 CFR 3.71. Statement under 37 CFR 3.73(b) is enclosed. (Form PTO/SB/96).

Attorney or agent of record. Registration Number \_\_\_\_\_

---

Signature 

Typed or Printed Name Kevin T. McCarthy, Esq.

---

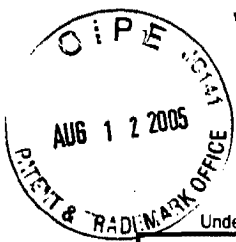
Date \_\_\_\_\_ Telephone \_\_\_\_\_

NOTE: Signatures of all the inventors or assignees of record of the entire interest or their representative(s) are required. Submit multiple forms if more than one signature is required, see below.

\*Total of 1 forms are submitted.

This collection of information is required by 37 CFR 1.33. The information is required to obtain or retain a benefit by the public which is to file (and by the USPTO to process) an application. Confidentiality is governed by 35 U.S.C. 122 and 37 CFR 1.11 and 1.14. This collection is estimated to take 3 minutes to complete, including gathering, preparing, and submitting the completed application form to the USPTO. Time will vary depending upon the individual case. Any comments on the amount of time you require to complete this form and/or suggestions for reducing this burden, should be sent to the Chief Information Officer, U.S. Patent and Trademark Office, U.S. Department of Commerce, P.O. Box 1450, Alexandria, VA 22313-1450. DO NOT SEND FEES OR COMPLETED FORMS TO THIS ADDRESS. **SEND TO: Mail Stop Post Issue, Commissioner for Patents, P.O. Box 1450, Alexandria, VA 22313-1450.**

If you need assistance in completing the form, call 1-800-PTO-9199 and select option 2.



Under the Paperwork Reduction Act of 1995, no persons are required to respond to a collection of information unless it displays a valid OMB control number.

**STATEMENT UNDER 37 CFR 3.73(b)**

Applicant/Patent Owner: Twenty Year Innovations, Inc.

Application No./Patent No.: 10/223,200 Filed/Issue Date: August 16, 2002

Entitled: METHODS AND APPARATUSES FOR PROGRAMMING USER-DEFINED INFORMATION INTO ELECTRONIC DEVICES

Twenty Year Innovations, Inc., a corporation  
(Name of Assignee) (Type of Assignee, e.g., corporation, partnership, university, government agency, etc.)

states that it is:

- 1.  the assignee of the entire right, title, and interest; or
- 2.  an assignee of less than the entire right, title and interest.  
The extent (by percentage) of its ownership interest is \_\_\_\_\_ %

in the patent application/patent identified above by virtue of either:

A.  An assignment from the inventor(s) of the patent application/patent identified above. The assignment was recorded in the United States Patent and Trademark Office at Reel 015027, Frame 0049, or for which a copy thereof is attached.

OR

B.  A chain of title from the inventor(s), of the patent application/patent identified above, to the current assignee as shown below:

1. From: \_\_\_\_\_ To: \_\_\_\_\_  
The document was recorded in the United States Patent and Trademark Office at Reel \_\_\_\_\_, Frame \_\_\_\_\_, or for which a copy thereof is attached.

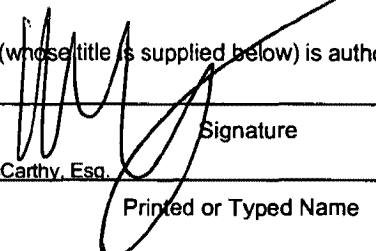
2. From: \_\_\_\_\_ To: \_\_\_\_\_  
The document was recorded in the United States Patent and Trademark Office at Reel \_\_\_\_\_, Frame \_\_\_\_\_, or for which a copy thereof is attached.

3. From: \_\_\_\_\_ To: \_\_\_\_\_  
The document was recorded in the United States Patent and Trademark Office at Reel \_\_\_\_\_, Frame \_\_\_\_\_, or for which a copy thereof is attached.

Additional documents in the chain of title are listed on a supplemental sheet.

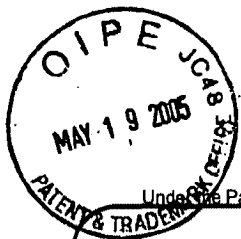
Copies of assignments or other documents in the chain of title are attached.  
[NOTE: A separate copy (i.e., a true copy of the original assignment document(s)) must be submitted to Assignment Division in accordance with 37 CFR Part 3, if the assignment is to be recorded in the records of the USPTO. See MPEP 302.08]

The undersigned (whose title is supplied below) is authorized to act on behalf of the assignee.

  
 \_\_\_\_\_  
 Signature  
 \_\_\_\_\_  
 Date  
 \_\_\_\_\_  
 Kevin T. McCarthy, Esq.  
 \_\_\_\_\_  
 Printed or Typed Name  
 \_\_\_\_\_  
 Telephone Number  
 \_\_\_\_\_  
 Chief Executive Officer  
 \_\_\_\_\_  
 Title

This collection of information is required by 37 CFR 3.73(b). The information is required to obtain or retain a benefit by the public which is to file (and by the USPTO to process) an application. Confidentiality is governed by 35 U.S.C. 122 and 37 CFR 1.11 and 1.14. This collection is estimated to take 12 minutes to complete, including gathering, preparing, and submitting the completed application form to the USPTO. Time will vary depending upon the individual case. Any comments on the amount of time you require to complete this form and/or suggestions for reducing this burden, should be sent to the Chief Information Officer, U.S. Patent and Trademark Office, U.S. Department of Commerce, P.O. Box 1450, Alexandria, VA 22313-1450. DO NOT SEND FEES OR COMPLETED FORMS TO THIS ADDRESS. SEND TO: Commissioner for Patents, P.O. Box 1450, Alexandria, VA 22313-1450.

If you need assistance in completing the form, call 1-800-PTO-9199 and select option 2.



2683  
JTW

PTO/SB/21 (09-04)  
Approved for use through 07/31/2006. OMB 0651-0031  
U.S. Patent and Trademark Office; U.S. DEPARTMENT OF COMMERCE  
Under the Paperwork Reduction Act of 1995, no persons are required to respond to a collection of information unless it displays a valid OMB control number.

<b>TRANSMITTAL FORM</b>  <i>(to be used for all correspondence after initial filing)</i>	Application Number	10/223,200
	Filing Date	August 16, 2002
	First Named Inventor	Michael E. Shanahan
	Art Unit	2683
	Examiner Name	CongVan Tran
	Attorney Docket Number	MES-001-con
Total Number of Pages in This Submission	45	

ENCLOSURES (Check all that apply)		
<input type="checkbox"/> Fee Transmittal Form	<input type="checkbox"/> Drawing(s)	<input type="checkbox"/> After Allowance Communication to TC
<input type="checkbox"/> Fee Attached	<input type="checkbox"/> Licensing-related Papers	<input type="checkbox"/> Appeal Communication to Board of Appeals and Interferences
<input type="checkbox"/> Amendment/Reply	<input type="checkbox"/> Petition	<input type="checkbox"/> Appeal Communication to TC (Appeal Notice, Brief, Reply Brief)
<input type="checkbox"/> After Final	<input type="checkbox"/> Petition to Convert to a Provisional Application	<input type="checkbox"/> Proprietary Information
<input type="checkbox"/> Affidavits/declaration(s)	<input type="checkbox"/> Power of Attorney, Revocation	<input type="checkbox"/> Status Letter
<input type="checkbox"/> Extension of Time Request	<input type="checkbox"/> Change of Correspondence Address	<input checked="" type="checkbox"/> Other Enclosure(s) (please identify below):
<input type="checkbox"/> Express Abandonment Request	<input type="checkbox"/> Terminal Disclaimer	Statement Pursuant to 37 C.F.R. Section 1.97(e)(1); Copy of foreign patent document
<input checked="" type="checkbox"/> Information Disclosure Statement	<input type="checkbox"/> Request for Refund	
<input type="checkbox"/> Certified Copy of Priority Document(s)	<input type="checkbox"/> CD, Number of CD(s) _____	
<input type="checkbox"/> Reply to Missing Parts/Incomplete Application	<input type="checkbox"/> Landscape Table on CD	
<input type="checkbox"/> Reply to Missing Parts under 37 CFR 1.52 or 1.53	<input type="text"/> Remarks	

SIGNATURE OF APPLICANT, ATTORNEY, OR AGENT			
Firm Name	Kaliko & Yeager, L.L.C.		
Signature			
Printed name	Todd W. Evans		
Date	May 17, 2005	Reg. No.	44,101

CERTIFICATE OF TRANSMISSION/MAILING			
I hereby certify that this correspondence is being facsimile transmitted to the USPTO or deposited with the United States Postal Service with sufficient postage as first class mail in an envelope addressed to: Commissioner for Patents, P.O. Box 1450, Alexandria, VA 22313-1450 on the date shown below:			
Signature			
Typed or printed name	Todd W. Evans	Date	May 17, 2005

This collection of information is required by 37 CFR 1.5. The information is required to obtain or retain a benefit by the public which is to file (and by the USPTO to process) an application. Confidentiality is governed by 35 U.S.C. 122 and 37 CFR 1.11 and 1.14. This collection is estimated to 2 hours to complete, including gathering, preparing, and submitting the completed application form to the USPTO. Time will vary depending upon the individual case. Any comments on the amount of time you require to complete this form and/or suggestions for reducing this burden, should be sent to the Chief Information Officer, U.S. Patent and Trademark Office, U.S. Department of Commerce, P.O. Box 1450, Alexandria, VA 22313-1450. DO NOT SEND FEES OR COMPLETED FORMS TO THIS ADDRESS. SEND TO: **Commissioner for Patents, P.O. Box 1450, Alexandria, VA 22313-1450.**

If you need assistance in completing the form, call 1-800-PTO-9199 and select option 2.



PATENTS  
Attorney Docket No. MES-001-con

IN THE UNITED STATES PATENT AND TRADEMARK OFFICE

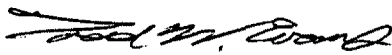
Applicant: Michael E. Shanahan  
Application No.: 10/223,200  
Title of Invention: Methods and Apparatuses for Programming User-Defined Information into Electronic Devices  
Filed: August 16, 2002  
Art Unit: 2683  
Examiner: CongVan Tran

Commissioner for Patents  
P.O. Box 1450  
Alexandria, VA 22313-1450

STATEMENT PURSUANT TO 37 C.F.R. § 1.97 (e)(1)

Each item of information contained in the attached information disclosure statement was first cited in a communication from a foreign patent office in a counterpart foreign application not more than three months prior to the date that this statement and the attached information disclosure statement are being filed. Since there has been no final action, notice of allowance, or other action that closes prosecution of the present application mailed as of the date that these document are being filed, there is no fee due at this time, pursuant to 37 C.F.R. § 1.97 (c).

Dated: 5/17/05

  
\_\_\_\_\_  
Todd W. Evans, Esq.  
Reg. No. 44,101  
Kaliko & Yeager, L.L.C.  
Attorneys for Applicant





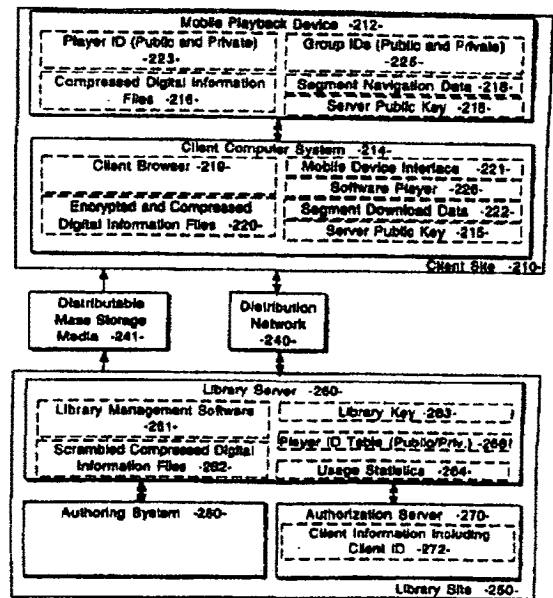
INTERNATIONAL APPLICATION PUBLISHED UNDER THE PATENT COOPERATION TREATY (PCT)

<p>(51) International Patent Classification <sup>6</sup> : <b>G06F 13/00, H04M 11/00</b></p>	<p><b>A1</b></p>	<p>(11) International Publication Number: <b>WO 98/11487</b> (43) International Publication Date: 19 March 1998 (19.03.98)</p>
<p>(21) International Application Number: PCT/US97/16184 (22) International Filing Date: 12 September 1997 (12.09.97) (30) Priority Data: 08/710,114 12 September 1996 (12.09.96) US (71) Applicant: AUDIBLE, INC. [US/US]; 65 Willowbrook Boulevard, Wayne, NJ 07470 (US). (72) Inventors: KATZ, Donald, R.; 4 Russell Terrace, Montclair, NJ 07042 (US). LAU, Edwin, J.; 1266 Shasta Avenue, San Jose, CA 95126 (US). MOTT, Timothy; 110 Old Mill Road, P.O. Box 6289, Ketchum, ID 83340 (US). BRENNEMAN, Scott, A.; 299 Waverly Street, Menlo Park, CA 94025 (US). CHE-MING JUN, Benjamin; 1081-B Tanland Drive, Palo Alto, CA 94303 (US). HONG-YEN PAI, Samuel; 340 Marmona Drive, Menlo Park, CA 94025 (US). (74) Agents: SALTER, James, H. et al.; Blakely, Sokoloff, Taylor &amp; Zafman LLP, 7th floor, 12400 Wilshire Boulevard, Los Angeles, CA 90025 (US).</p>		<p>(81) Designated States: AL, AM, AT, AT (Utility model), AU (Petty patent), AZ, BA, BB, BG, BR, BY, CA, CH, CN, CU, CZ, CZ (Utility model), DE, DE (Utility model), DK, DK (Utility model), EE, EE (Utility model), ES, FI, FI (Utility model), GB, GE, GH, HU, ID, IL, IS, JP, KE, KG, KP, KR, KZ, LC, LK, LR, LS, LT, LU, LV, MD, MG, MK, MN, MW, MX, NO, NZ, PL, PT, RO, RU, SD, SE, SG, SI, SK, SK (Utility model), SL, TJ, TM, TR, TT, UA, UG, UZ, VN, YU, ZW, ARIPO patent (GH, KE, LS, MW, SD, SZ, UG, ZW), Eurasian patent (AM, AZ, BY, KG, KZ, MD, RU, TJ, TM), European patent (AT, BE, CH, DE, DK, ES, FI, FR, GB, GR, IE, IT, LU, MC, NL, PT, SE), OAPI patent (BF, BJ, CF, CG, CI, CM, GA, GN, ML, MR, NE, SN, TD, TG).</p> <p><b>Published</b> <i>With international search report.</i> <i>Before the expiration of the time limit for amending the claims and to be republished in the event of the receipt of amendments.</i></p>

(54) Title: A DIGITAL INFORMATION LIBRARY AND DELIVERY SYSTEM

(57) Abstract

A computer network based digital information library system employing authentication and encryption protocols for the secure transfer of digital information library programs to a client computer system (214) and a mobile digital information playback device (212) removably connectable to the client computer system. The present invention is a computer network based library and information delivery system for accessing and obtaining selected digital information files. The library and information delivery system comprises: 1) a library server (260) having a plurality of digital information files; 2) a client computer system (214) coupled to the library server (260) over a network (240); and 3) a mobile device (212) removably connectable to the client computer system (214), the client computer system (214) including logic for requesting a download of a selected one or more of the digital information files from the library server (260), the client computer system (214) further including logic for downloading the selected one or more of the digital information files to the mobile device (212).



1  
**A DIGITAL INFORMATION LIBRARY  
AND DELIVERY SYSTEM**

**FIELD OF THE INVENTION**

The present invention relates generally to a digital information transmission, receiving, and playback system. Specifically, the present invention pertains to a computer network based digital information library providing interactive client computer access.

**DESCRIPTION OF RELATED ART**

Recent technological advances in the compression of digital data and the expansion of storage capacities of computer systems together with the increased bandwidth of computer network infrastructures have created new possibilities for personalized access to and usage of large amounts of digital information. One form of this type of digital information is audio information delivered across a computer network as digitized information.

In the field of interactive digital information transmission, receiving, and playback systems, several patents are known to the present applicants. U.S. Patent No. 5,132,992, issued July 21, 1992 to Yurt et al. (Yurt), describes a system of distributing video and/or audio information employing digital signal processing to achieve high rates of data compression. The Yurt patent describes a transmission system including a conversion means for placing the items from a source material library into a predetermined format as formatted data. Audio data is compressed by an audio compressor by application of an adaptive differential pulse code modulation (ADPCM) process to the audio data. Stored items are accessed in the compressed data library through the use of a unique address code assigned to each item during storage encoding. The unique address code is used for requesting and accessing information and items throughout the Yurt transmission and receiving process. The Yurt transmission system includes means by which a user enters a customer identifier (ID) code by which the system accesses the users account, and indicates to the system that the user is a subscriber of the system. If a subscriber is in good standing, the Yurt system delivers selected titles using the described techniques.

One significant problem with the audio transmission and receiving system described in Yurt is the lack of an effective means for ensuring the security of the digital information library and of the items downloaded to a user from the digital information library. Although Yurt describes the use of a unique identification code assigned to items in the library and a customer ID code assigned to particular users, no authentication protocols or encryption techniques are described to prevent the unauthorized creation of clone libraries or the unauthorized download or copying of library items. Secondly, Yurt and related prior art does not describe an authentication or encryption means providing secure transactions between a server based digital information



library supporting a client computer system having an interface to a mobile playback device. Thirdly, the prior art does not describe a mechanism for selecting a digital information passage to be previewed. Prior art systems also do not describe a system whereby only part of a program gets downloaded from a client computer system to a mobile playback device depending on how much storage space is available in the mobile playback device. Prior art systems also do not describe a mechanism for specifying multiple programs to be downloaded from a digital information library into a mobile playback device. Prior art systems also do not detail the processes required in the authoring system to generate content for the digital information library. Finally, prior art systems do not describe an accounting system whereby library content providers can perform real-time queries on usage information related to the access of library items.

**SUMMARY OF THE INVENTION**

The preferred embodiment of the present invention is a computer network based digital information library system employing authentication, targeting, and encryption protocols for the secure transfer of digital information library programs to a client computer system and a mobile digital information playback device removably connectable to the client computer system. The present invention is a computer network based library and information delivery system for accessing and obtaining selected digital information files. The library and information delivery system comprises: 1) a library server having a plurality of digital information files; 2) a client computer system coupled to the library server over a network; and 3) a mobile device removably connectable to the client computer system, the client computer system including logic for requesting a download of a selected one or more of the digital information files from the library server, the client computer system further including logic for downloading the selected one or more of the digital information files to the mobile device.

**BRIEF DESCRIPTION OF THE DRAWINGS**

The accompanying drawings, which are included as part of the present specification, illustrate the presently preferred embodiment of the present invention and together with the general description given above and the detailed description of the preferred embodiment given below serve to explain and teach the principles of the present invention.

Figure 1 illustrates a typical computer platform on which the present invention may be implemented.

Figure 2 illustrates a high level block diagram of the computer network based digital information library system of the present invention.

Figure 3 illustrates a high level block diagram of the authoring system of the present invention.

Figure 4 illustrates an alternative embodiment having a plurality of library servers.

Figure 5 illustrates an alternative embodiment having a plurality of library server processes.

Figure 6 illustrates an alternative embodiment having a single authoring/authorization server.

Figure 7 illustrates an alternative embodiment wherein client computer systems have a local library.

Figure 8 illustrates an alternative embodiment wherein mobile playback devices have a direct network interface in lieu of a client computer system.

Figure 9 illustrates an alternative embodiment wherein a kiosk is used to retain and distribute selected programming.

Figure 10 illustrates an alternative embodiment wherein all system components are connected through a common network.

**DETAILED DESCRIPTION OF  
THE PREFERRED EMBODIMENT**

The preferred embodiment of the present invention is a computer network based digital information library system employing authentication, targeting, and encryption protocols for the secure transfer of digital information library programs to a client computer system and a mobile digital information playback device removably connectable to the client computer system. In the following detailed description, numerous specific details are set forth in order to provide a thorough understanding of the present invention. However, it will be apparent to one of ordinary skill in the art that these specific details need not be used to practice the present invention. In other instances, well known structures, interfaces, and processes have not been shown in detail in order not to unnecessarily obscure the present invention.

Figure 1 illustrates a typical data processing system upon which one embodiment of the present invention is implemented. It will be apparent to those of ordinary skill in the art, however that other alternative systems of various system architectures may also be used. The data processing system illustrated in Figure 1 includes a bus or other internal communication means 101 for communicating information, and a processor 102 coupled to the bus 101 for processing information. The system further comprises a random access memory (RAM) or other volatile storage device 104 (referred to as main memory), coupled to bus 101 for storing information and instructions to be executed by processor 102. Main memory 104 also may be used for storing temporary variables or other intermediate information during execution of instructions by processor 102. The system also comprises a read only memory (ROM) and/or static storage device 106 coupled to bus 101 for storing static information and instructions for processor 102, and a mass storage device 107 such as a magnetic disk drive or optical disk drive. Mass storage device 107 is coupled to bus 101 and is typically used with a computer readable mass storage medium 108, such as a magnetic or optical disk, for storage of information and instructions. The system may further be coupled to a display device 121, such as a cathode ray tube (CRT) or a liquid crystal display (LCD) coupled to bus 101 through bus 103 for displaying information to a computer user. An alphanumeric input device 122, including alphanumeric and other keys, may also be coupled to bus 101 through bus 103 for communicating information and command selections to processor 102. An additional user input device is cursor control 123, such as a mouse, a trackball, stylus, or cursor direction keys coupled to bus 101 through bus 103 for communicating direction information and command selections to processor 102, and for controlling cursor movement on display device 121. Another device which may optionally be coupled to bus 101 through bus 103 is a hard copy device 124 which may be used for printing instructions, data, or other information on a medium such as paper, film, or similar types of media. In the preferred embodiment, a communication device 125 is coupled to bus 101 through

bus 103 for use in accessing other nodes of a network computer system or other computer peripherals. This communication device 125 may include any of a number of commercially available networking peripheral devices such as those used for coupling to an Ethernet, token ring, Internet, or wide area network. It may also include any number of commercially available peripheral devices designed to communicate with remote computer peripherals such as scanners, terminals, specialized printers, or audio input/output devices. Communication device 125 may also include an RS232 or other conventional serial port, a conventional parallel port, a small computer system interface (SCSI) port or other data communication means. Communications device 125 may use a wireless means of data transfer devices such as the infrared IRDA protocol, spread-spectrum, or wireless LAN. In addition, communication device 125 is used in the preferred embodiment to couple the mobile playback device 212 to the client computer system 214 as described in more detail below. One other device used in the preferred embodiment is sound circuitry 130 either with attached speakers or headphones 132, or with analog audio outputs suitable for input into audio reproduction equipment such as external amplifiers and speakers, cassette adapters, etc. Sound circuitry 130 is well known in the art for playing audio files. Alternatively, sound circuitry may be a radio transmitter which transmits audio data on a predefined frequency for reception and playback by a radio receiver. Other wireless methods are possible.

Note that any or all of the components of the system illustrated in Figure 1 and associated hardware may be used in various embodiments of the present invention; however, it will be appreciated by those of ordinary skill in the art that any configuration of the system may be used for various purposes according to the particular implementation. In one embodiment of the present invention, the data processing system illustrated in Figure 1 is an IBM® compatible personal computer (PC), an Apple Macintosh® personal computer, or a SUN® SPARC Workstation. Processor 102 may be one of the 80X86 compatible microprocessors such as the 80486 or PENTIUM® brand microprocessors manufactured by INTEL® Corporation of Santa Clara, California.

The software implementing the present invention can be stored in main memory 104, mass storage device 107, or other storage medium accessible to processor 102. It will be apparent to those of ordinary skill in the art that the methods and processes described herein can be implemented as software stored in main memory 104 or read only memory 106 and executed by processor 102. This software may also be resident on an article of manufacture comprising a computer usable mass storage medium 108 having computer readable program code embodied therein and being readable by the mass storage device 107 and for causing the processor 102 to perform digital information library transactions and protocols in accordance with the teachings herein.

### Digital Information Library System

Figure 2 illustrates the computer network architecture used in the preferred embodiment of the present invention. In general, the network architecture of the present invention includes a library site 250 coupled to a client site 210 via a conventional distribution network infrastructure 240. This conventional distribution network infrastructure 240 can be implemented as a standard telephone connection provided between the library site 250 and client site 210 through an Internet provider to enable data communication on the Internet over a conventional telephone network. This use of the Internet as a distribution network is well known to those of ordinary skill in the art. In an alternative embodiment having cable modem capability, communication over a conventional cable network is possible in lieu of communication over the telephone network. The cable network is typically much faster (i.e. provides a much greater bandwidth) than the standard telephone network; however, cable modems are typically more expensive than standard POTS (plain old telephone system) modems. In another alternative embodiment having conventional Integrated Services Digital Network (ISDN) capability, the distribution network 240 is accessed using an ISDN modem. Again, the ISDN network is typically faster than the POTS network; however, access to an ISDN network is generally more expensive. Cable modems and ISDN implementations are alternative communications media to the POTS implementation.

In addition, it will be apparent to those of ordinary skill in the art that other forms of networking may equivalently be supported by the present invention. For example, a wireless transmission means such as infrared or radio links may also provide the distribution network 240 described in the present application. As an alternative to the Internet, a proprietary network/bulletin board such as AMERICA-ON-LINE (AOL), or COMPUSERVE may be used.

Each of the servers at library site 250 and the client computer system 214 at client site 210 can be implemented as a computer system such as the one described above in connection with Figure 1. It will be apparent to one of ordinary skill in the art that the library server 260, authoring system 280, and authorization server 270 can be remotely located yet networked together as a distributed system using the techniques described above. In addition, the present invention allows for multiple library servers, authoring systems and authorization servers. Conversely, the servers may be implemented as separate functions of a single machine. These alternative embodiments are illustrated in Figures 4-8 and are described in more detail below.

The mobile playback device 212 is a minimally configured, low-cost, standalone mobile unit for receiving and storing digital information files or programs as downloaded by library server 260 and client computer system 214 and for playing back the digital information files or programs for a user of the mobile playback device 212. The mobile playback device 212 is temporarily removably coupled to the client computer system 214 while the download takes place.

Once downloaded, the mobile playback device 212 may be detached from the client computer system 214 and used as a standalone digital information playback device. A co-pending U.S. Patent Application titled, "Interactive Audio Transmission, Receiving and Playback System", assigned Serial No. 08/490,537, and assigned to the Audible Words Corporation of Montclair, NJ describes the details of mobile playback device 212.

In its basic form, the preferred embodiment of the present invention is a digital information library system providing selection of digital information programming on demand over a computer network. In an alternative embodiment, the digital information programming is selected via the computer network but delivered using mass storage media 241. This alternative embodiment is described in more detail below.

The digital information library is an indexed collection of digital information programming, drawing content from digital information sources such as books, daily news and entertainment feeds, conferences and educational sources, other computer systems, the host on the World Wide Web (WWW) of the Internet, and customized audio or visual image programming. Other sources of the digital information content include, but are not limited to, conference or seminar proceedings, lecture or speech materials, language lessons, readings, comedy, customized spoken digests and related, "need-to-know" business information, computer software, local sound studio material, text to speech conversion of machine readable files, pre-recorded material from magnetic tape, CD-ROM, digital audio tape, or analog cassette tape. This digital information content is input as raw digital information content to authoring system 280 shown in Figure 2. In an alternative embodiment, a raw digital information digitizer 307 is included for receiving raw input and converting the input to a digital form which can be manipulated as a digital information file.

In an alternative embodiment, the digital information comprises digitized image or graphics data used to produce visual images on a display screen or projection screen. These images may be included in the digital information retained and maintained by the library server 260.

### Authoring System

Authoring system 280 is used to edit, index, compress, scramble, segment, and catalog digital information content into digital information programs in digital information files, which are stored on mass storage media 241 or on library server 260 as scrambled and compressed digital information files 262. The digital information programs are initially categorized according to traditional criteria (e.g. genre, modern fiction, mystery, adventure, romance, non-fiction, classics, self-help, science fiction, westerns, etc.). Categories associated with specific authors or publishers are also provided. Both unabridged and abridged titles are provided. In some circumstances, it may be necessary to digitize digital information content from an undigitized form. The raw information digitizer 307 is provided for this purpose. Authoring system 280 also

partitions digital information content into segments, which can be identified, searched, and skipped over if desired. All of these functions are performed by authoring system 280.

Figure 3 illustrates the authoring system 280 of the preferred embodiment. Authoring system 280 receives digital information content from a variety of conventional sources as raw digitized data. This digital information data is fed to three components of the authoring system 280 of the preferred embodiment. The digital information compressor 314 receives the raw digital data and compresses the digitized data. There are a variety of conventional techniques in existence for compressing digital data. These techniques can be optimized depending upon the type of digital data being processed. Thus, the present invention provides several compression methods and a means for the authoring system operator 305 to select between these methods based upon the category of digital information content 310 being input to the digital information compressor 314. Alternatively, the selection of compression method may be performed automatically by interpretation of the digital information content 310 itself. A compressed digital information file is output by digital information compressor 314 to scrambler 318.

The raw digital information content 310 is also fed to template header generator 312. Each digital information file maintained by the library server 260 includes other descriptive information used to identify the file's content and to provide information used to process the digital information within the file. Each digital information file includes a template header, a descrambling map, selected preview clips, and the digital information programming itself. In the preferred embodiment, the template header comprises a number of attributes corresponding to the digital information in the file. For example, the digital information may be audio information generated from the content of a book or other published work. In this example, the audio file template header contains attributes including: 1) the title of a book, volume, or medium from which the digital information content originated, 2) the legal copyright associated with the digital information content, 3) audible title(s) of the content, 4) a table of contents of the content, and 5) playback settings for appropriately playing or rendering the digital information. The table of contents contains content navigation information including but not limited to: the number of chapters, the length of the program, and information indicative of the relevant content sections. The table of contents is generated with input from authoring system operator 305 or automatically by analysis of digital information content 310. The descrambling map 322 is used to interpret the digital information after the digital information has been scrambled by scrambler 318 as described below. The preview clips 324 comprise short pre-generated portions of digital information content used to give a consumer a sense of the content of a particular digital information file. In the preferred embodiment, these previews are generated as conventional formatted files which can be directly played by sound generation circuitry 130 or rendered by other means. A digital information file can have several preview clips associated with it. The preview clips 324 are not compressed or



scrambled in the preferred embodiment. The template header 312 remains with the digital information file as it is transferred to the network 240 or mass storage media 241. The other descriptive information related to a digital information file is typically stored with digital information file, but is not required to be so stored.

Referring again to Figure 3, template header generator 312 generates the template header given information from a particular portion of digital information content 310. Input from Authoring System Operator 305 and Digital Information Compressor 314 may be solicited during the header generation process. The template header is provided to library server 260. Other portions of the digital information file header are provided by scrambler 318 and preview generator 323. These portions of the digital information file header are assembled into the header for a particular digital information file by library server 260. The remainder of the digital information file is filled with compressed, scrambled, and segmented digital information content.

After digital information compressor 314 has compressed the raw digital information using a selected compression method suitable for the category of digital information, the scrambler 318 scrambles the digital information. The digital information is scrambled to prevent an unauthorized consumer from using the digital information. In the preferred embodiment, scrambler 318 uses a conventional encryption method to render the data unusable. A corresponding descrambling map 322 is generated to provide a means for descrambling the scrambled digital information file. A scrambling map 316 is used by scrambler 318 to scramble the digital information file. The scrambler 318 can encrypt the entire digital information file or selected critical subsets of the digital information file. The level of scrambling can be selected depending upon the capabilities of the authoring system 280, the mobile playback device 212 and/or the anticipated software player 226 on client computer system 214. In an alternative embodiment, a proprietary digital information format is used in lieu of scrambler 318.

The scrambled digital information content is output by scrambler 318 to segmentation logic 326. Segmentation logic 326 partitions the digital information content into blocks for efficient storage in and transfer to a mobile playback device 212 or software player 226 and for efficient navigation during playback. Transport integrity data is generated and appended to the segmented digital information. In an alternate embodiment, portions of the segmentation process may take place before or after digital information compressor 314 and scrambler 318. Segmentation information may also be used in the header generation process by template header generator 312. The compressed, scrambled, and segmented digital information blocks are provided to the library server 260 by authoring system 280. Library server 260 assembles the segmented digital information blocks, the descrambling map 322, the preview clip(s) 324, and the template header 312 for a particular item of digital information content into a digital information program file or files, which are stored in a digital information program file storage area 262. Other raw digital

information content is converted into digital information files using the authoring system 280 in a similar manner.

### Library Server

Referring again to Figure 2, the library server 260 is responsible for maintaining the digital information program files 262 created by the authoring system 280. In addition, the library server 260 receives requests for access to the digital information program files 262 from client computer systems 214 over network 240 and manages purchase and delivery of the selected digital information files and/or delivery of selected preview clips 324. The library server 260 includes library management software 261 for performing these library server functions and a library key 263 used for the authentication protocol described below. Library management software 261 includes processing logic for receiving and responding to client computer system 214 requests for access and/or purchase of a digital information program file 262. Upon receiving such a client request, library server 260 uses authorization server 270 to authenticate the request with client information 272 generated and maintained by library server 260 or authorization server 270. The client information 272 includes client identifiers which are used to target content for playback on individual mobile playback devices 212 or software players 226. Client information 272 may also contain client personal information, user content preferences, client billing history, player usage history, and player group lists. In an alternative embodiment, portions of client information 272 may instead be stored in server 260. Using the authorization protocol described in more detail below, the library server 260 determines if the client request can be serviced. If approved, the library server 260 accesses the digital information program file(s) or preview clip(s) requested by the client computer system 214, delivers the selected preview clip(s) or builds encrypted, targeted, and digitally signed digital information files using the authentication protocol described in more detail below, and transfers the encrypted and compressed digital information file(s) to the requesting client computer system 214 via network 240. Distributable mass storage media 241 may also be used as a delivery medium for the transfer of information to client system 214. The client computer system 214 may then independently download the selected digital information files (or a subset thereof) into the mobile playback device 212 for subsequent playback. The library server 260 also collects usage statistics on the access history of the digital information files 262 and stores this usage data into usage statistic storage area 264. The library server 260 also stores operating code segments (firmware) for the client browser 219, software player 226, and for mobile playback device 212. This operating code can be downloaded to the client computer system 214 in the same manner as digital information files are transferred. Player configuration data for playback device 212 and software player 226 is stored on the library server 260 and can be customized or updated in the same manner as digital information files and firmware are

transferred. Configuration data includes, but is not limited to, audio prompts, user interface options, group ID information, and information playback parameters. Player configuration data is transferred to client computer system 214, software player 226, or mobile playback device 212 as required according to client information 272.

The library server 260 interfaces with a client application program or client browser 219 executing on client computer system 214. The client browser 219 is used to make requests of library server 260 for various types of service including, but not limited to, searching the digital information files 262 for a desired program, previewing a selected preview clip associated with a digital information file 262, purchasing a selected program, requesting operating code segments or player configuration data, and downloading the purchased program or other material to the requesting client computer system 214.

The library server 260 interface with the authorization server 270 and client computer system 214 uses the unique authentication protocol and encryption protocol of the preferred embodiment of the present invention. The preferred embodiment of these protocols is described in the sections below.

#### Client Computer System

Referring again to Figure 2, the client computer system 214 represents a consumer or end user computer system, typically a personal computer, such as the sample system illustrated in Figure 1, with which a consumer may browse, preview, select, purchase, and take delivery of digital information content from digital information library server 260 across distribution network 240. Client computer system 214 comprises client browser software 219, a mobile device interface 221, storage for encrypted and compressed digital information files 220 downloaded from the network 240, software player 226, and segment download data 222 derived from digital information files 220 for defining the storage segments in mobile playback device 212 and for assisting in the downloading of digital information files 220 from client computer system 214 to mobile playback device 212. Client computer system 214 also includes a server public key 215 used for authenticating digital information and software files received from server 260. Client browser software 219 provides the control logic with which the client or consumer accesses and purchases titles from the digital information library 262 of library server 260. Client browser software 219 also provides control logic which requests and downloads configuration information or operating code from server 260. The client browser software 219 can be configured to perform these operations without direct human intervention. The mobile device interface 221 is a software interface used to control the transfer of control information, operating code, and digital information files from client computer system 214 to mobile playback device 212. Encrypted and compressed digital information files 220 are received by client computer system 214 from library

server 260 over network 240. In an alternate embodiment, distributable mass storage media 241 is used instead of network 240 to transfer information to client computer system 214. The software player 226 is a software module used to emulate the operation of mobile playback device 212 and for playing digital information files through the sound circuitry 130 and audio output device 132 of client computer system 214. Operating code and configuration information for the software player 226 can be downloaded or updated from the server 260 in the same manner as the mobile playback device 212 can be downloaded or updated. The software player 226 functionality is the equivalent of the functionality and operation of the mobile playback device 212. Thus, the use of the term "player" throughout this document generally applies to both the mobile playback device 212 and software player 226. Software players 226 are assigned unique player IDs and can be assigned group IDs that function similarly to IDs assigned to mobile playback devices 212.

#### Mobile Playback Device

The mobile playback device 212 converts a digital information file into sound or displayable imagery which is played through audio output means or displayed on a display device. In the preferred embodiment, the mobile playback device 212 is a minimal capability, low-cost device primarily dedicated to playing audio files or displaying visual images or text on a display device. The mobile playback device 212 is minimally configured to retain its light-weight, low cost, and readily mobile features. The preferred embodiment does not therefore include the use of a portable personal computer or laptop computer as the mobile playback device 212; because, such general purpose computing devices typically do not meet the light-weight and low cost constraints of the preferred mobile playback device 212. Such general purpose computing devices typically have unnecessary functionality, more complicated interfaces, and may suffer cost and performance penalties in comparison to the special purpose mobile playback device 212. In the preferred embodiment, the mobile playback device 212 includes a processor, memory, and an interface to client computer system 214 over which compressed digital information files 216 are received. As described in more detail below, mobile playback device 212 also includes a player ID 223, group IDs 225, and server public key 215 used for authenticating digital information and software files received from server 260 via client computer system 214. The user controls the mobile playback device 212 using buttons and knobs provided on the device. These controls are used to navigate through digital information files 216, adjust configuration data and playback parameters, or perform other functions as directed by firmware stored in playback device 212. When coupled to the player, client computer system 214 or other electronic devices can solicit user input from these controls. In an alternative embodiment, a set of additional user controls is provided on a remote control unit that is coupled to the player via a wired or wireless connection. Digital information output may be provided via a headphone jack, on board speaker, or wireless transmitter to a

separate wireless receiver with speakers or headphones. Audio level can be adjusted with a volume knob. A wireless transmitter may contain an adjustment knob to adjust the transmission frequency or other transmission parameters. Visual information output is provided via LCD display, LED display, or outputs to a standard visual display device. The mobile playback device 212 contains a limited quantity of non-volatile memory, RAM, and ROM. Digital information content, configuration data, and operating code are stored in the memory space of the mobile playback device 212. Configuration data includes but is not limited to: public and private IDs, content playback parameters, and user interface parameters. The use of non-volatile memory allows portions of the digital information content, configuration data, and firmware to be updated via download. Both digital information content and firmware (operating software) is stored in this memory device. Portions of the firmware and configuration information are stored permanently in a read only memory (ROM). An internal memory allocation method is used to track the content of mobile playback device 212 memory. This allocation method, in conjunction with segment navigation data 218, also provides the means for locating desired digital information, program, configuration data, or header data resident in the mobile playback device 212 memory. The mobile playback device 212 includes an interface to the client computer system 214 through which the mobile playback device 212 receives compressed digital information files 216, software updates, and configuration changes from client computer system 214.

#### Downloading Digital Information Content, Software Updates, or Configuration Information From the Library Server to the Client Computer System

The client browser software 219 of client computer system 214 operates in cooperation with library management software 261 of library server 260 and the firmware resident on the mobile playback device 212 to provide a means by which a consumer may browse, preview, select, purchase, and take delivery of selected digital information content from digital information library server 260 across distribution network 240. The digital information content is typically downloaded to the client computer system 214 at the time of purchase, but it is possible to download digital information content either, 1) sometime after the purchase, or 2) multiple times after an initial purchase. The client browser 219 can be configured to download content to client computer system 214 without user intervention. In addition, portions of the client computer system 214 software itself or mobile playback device 212 resident software/firmware may be downloaded or updated from library server 260. The mobile playback device 212 resident software/firmware is downloaded through client computer system 214. If library server 260 has an updated or more recent copy of client computer system 214 software or mobile playback device 212 software/firmware, the library server copy is downloaded to replace the outdated version of the corresponding client computer system 214 software or mobile playback device software 212.

The software is encrypted, scrambled, and digitally signed in a manner similar to the scrambling and delivery of the digital information files. Changes to the ID list, audio prompts, and other configuration data for playback device 212 can be downloaded in a manner similar to the downloading of software updates from library server 260.

The preferred embodiment utilizes three authentication processes to protect the transfer of information from server 260 to client system 214 and playback device 212. First, a point-to-point authentication protocol is performed whereby the library server 260 must verify that the requesting client computer system 214 is an authorized client and the client computer system 214 must verify that the library server 260 is an authorized provider. Secondly, a targeting protocol is performed whereby the library server 260 utilizes a set of identifiers (i.e. player IDs) for mobile playback devices 212 authorized to receive the selected download data from library server 260. The mobile playback device identifiers are provided by client computer system 214 or are referenced from user profiles stored on library server 260. In the targeting process, library server 260 formats and downloads data that can only be read by mobile devices 212 with these identifiers. Thirdly, a library server digital signature is appended to the downloaded data for use by the mobile playback device 212 to verify that the downloaded data was originated by an authorized library server. These three authentication processes of the present invention are described in detail in the following sections.

#### Point-to-Point Authentication Protocol

The library server 260, client computer system 214, and mobile playback devices 212 each have a unique verification sequence which is used to verify the authenticity of another system. In communications between library server 260 and client system 214, both systems alternately act to (1) request verification of the other system and (2) provide an authenticating response to a verification request. Communication between mobile devices 212 and client computer system 214 use a similar authentication protocol, as well as real-time communication between mobile devices 212 and library server 260 via client system 214. This verification sequence comprises a pre-defined set of bit streams or data structures which are sent by the requesting system (i.e. the system requesting verification) to the receiving system being authenticated (i.e. the respondent) in a point-to-point transmission. The receiving system must respond to the verification sequence in a pre-defined manner by sending particular response bit streams or data structures to the requesting system. If the appropriate response data from the respondent is received by the requesting system, the system being verified is considered an authorized system. Conversely, the system being verified is considered unauthorized if the appropriate response data is not received by the requesting system prior to a pre-defined time-out period. Both systems begin communication by acting as requesters and respondents in separate verification cycles. Upon completion of these

point-to-point authentication cycles, further client/server processing only continues if both systems deem each other to be authorized systems.

In an alternate embodiment, point-to-point authentication is used in a subset of the communications among library server 260, client computer system 214, and mobile playback devices 212. In another embodiment, point-to-point authentication is not used and system security rests on the use of targeting and/or digital signature authentication.

#### Targeting Protocol

The targeting protocol of the present invention is a means and method for limiting the playback of digital information content, the adjustment of player configuration data, and the download of player operating code to a specified player 212/226 or a specified set of mobile playback devices 212. Each player 212/226 contains a unique player ID 223. The player ID 223 comprises a public player ID and a private player ID. The public player ID is a unique identifier and serves as a serial number for player identification. The private player ID is used to target data for individual mobile playback devices 212. Private player IDs are never sent through any communications link or network path, except during installation. In the preferred embodiment, private player IDs should be sufficiently diverse, but need not be unique.

Mobile playback devices 212 may be logically grouped together using a Group ID. Digital information content, software, or configuration data changes may be targeted to a group of mobile playback devices 212 defined by a group ID. Each player 212/226 includes memory space for storage of one or more group IDs 225 of which the particular player 212/226 is a member. Each group ID includes a public portion and a private portion, each of which is equivalent to the public and private player IDs, respectively. Each group is identified by a uniquely valued public ID that is not shared with other player or group IDs. Digital information content, software, or configuration data can be targeted to a particular group ID in the same way as it would be targeted for a specific player ID. Mobile playback devices 212 in the same group share the same Group ID. A particular Group ID is pre-defined as the global group to which all mobile playback devices 212 are a member. Mobile playback devices 212 may be members of more than one group. A particular player 212/226 is added to a new group by appending the new group ID to the set of group IDs 225 maintained in the particular player 212/226. The new group ID is appended after the server 260 provides a public group ID and a group key to the player 212/226 via client computer system 214. The player 212/226 generates a private group ID from the combination of the group key and the mobile playback device's 212 private player ID. As with the private player ID, the private group ID is never sent through any communications link or network path, except during installation. In an alternative embodiment, players receive the group private ID directly or by combining the group key with the players public ID or other known numeric value. In another

alternative embodiment, the private group ID is not used in the targeting process and is not transferred to the player. The group assignment process may be restricted to using real-time communications between server 260 and the player via client system 214, or it may take place sometime after group assignments have been downloaded to client system 214. Having described the player IDs and group IDs defined in the present invention, the use of these IDs in the targeting protocol is described next.

Library server 260 includes a player ID table 266 as shown in Figure 2. Player ID table 266 includes a storage area for private IDs and public IDs. The private IDs are pre-loaded into player table 266 when a new mobile playback device is installed into the system or when a new group is established. In another embodiment, ID table 266 is a mathematical function which converts group or player public IDs. Public player and group IDs are sent by a client computer system 214 to the server 260 when the client computer system 214 desires to target a particular player 212/226 or set of mobile playback devices 212 to a particular specified digital information, software content, or configuration data selection. Digital information selection is made from the files 262 stored on library server 260. Software or configuration data selection is made from files stored on server 260 or from data generated upon request by server 260. Software content and configuration data is prepared and scrambled in a manner similar to the authoring process for digital information content. Once an association is made by client computer system 214 between a set of targeted public IDs and the associated data to be transferred from server 260, library server 260 creates a targeted header for the selected files. The library management software 261 consults the public ID to private ID table 266 to locate the corresponding targeted private ID(s). The targeted header comprises a combination of the descrambling map 322 from the selected files with the private player IDs corresponding to the targeted mobile playback devices 212. The descrambling map 322 is thereby encrypted using the secret IDs of the targeted mobile playback device(s) 212. This targeted header is linked with the corresponding digital information or software content of the selected file in a network transport ready data block. A digital signature is applied to the data block as described below in connection with the data signature protocol. Transport integrity data (such as the use of checksums or cyclic redundancy check) is applied to the data block and the data block is sent to the client computer system 214 via network 240. Because the data block can only be unscrambled using the corresponding descrambling block 322 in its header and because the descrambling block 322 was combined (i.e. encrypted) with a private ID known only by the targeted mobile playback device(s) 212, only the targeted mobile playback device(s) 212 will be able to unscramble and read the data block. The selected digital information, software content, and configuration data is thereby targeted to a particular set of mobile playback devices 212.

For small groups of mobile playback devices 212, each targeted header of a digital



information file may contain a plurality of descrambling maps, each associated with a different player 212/226. In this manner, multiple mobile playback devices 212 can read a single file 220 stored on the client computer system 214.

A person of ordinary skill in the art will note that alternative methods of targeting exist. In an alternative embodiment, library server 260 uses the targeted recipient's private player 212/226 identifier or the targeted group's private group identifier to generate scrambling map 316. Descrambling map 322 is not stored with the file as it is already known by the recipient player or group. This method targets content to a single player 212/226 or group and achieves the identical result of preventing unauthorized playback of content.

In another alternative embodiment, library server 260 does not scramble the digital information content or uses a known key to scramble the digital information content. In this embodiment, descrambling map 322 is unnecessary and is not stored with the file. Either the public or private player 212/226 identifier can be stored in the header for targeting identification purposes. Upon receipt of data from library server 260, the player 212/226 checks if its player 212/226 identifier or group identifier is included in the header. This method assumes unmodified mobile playback devices 212 and achieves the identical result of preventing unauthorized playback of content.

In another alternative embodiment, the player IDs for the targeted mobile playback devices 212 are sent to the library server 260 by the client computer system 214 when the user registers with the library server 260 to obtain the user's client ID. In this alternative embodiment, these player IDs are stored on the library server 260 in a user profile. In this embodiment, the library server 260 manages the player IDs for the targeted mobile playback devices 212.

#### Digital Signature Protocol

The third authentication protocol used in the present invention is the digital signature protocol. For selected data blocks generated by library server 260 and downloaded to a client computer system 214, library server 260 uses its private library key 263 to apply a digital signature to the data block. The digital signature comprises a known bit string or data pattern which is combined with the data in data blocks that are downloaded from library server 260 to client computer system 214. The library server 260 may perform this operation on all the data blocks or a selected subset of the data blocks. After a data block is downloaded to a player 212/226 through a client computer system 214, the player 212/226 can retrieve the digital signature applied by the library server 260 using a public server key known to the player 212/226. The player 212/226 can thereby verify that the data block originated with an authorized library server 260. The public server key is also known to client computer system 214, which can perform the identical operation to verify that the data block originated with an authorized library

server 260. In this embodiment, library server 260 performs signatures on the content. A person of ordinary skill in the art would realize that the signatures may also be performed on the digital information by authoring system 280. The signatures may also be performed in a multiple step process shared by authoring system 280 and library server 260.

In an alternate embodiment, digital signatures are applied to downloaded material by a trusted client computer system 214. In another alternate embodiment, digital signatures are not applied to downloaded material and system security rests on the use of targeting and/or point-to-point authentication.

#### Downloading Digital Information Content, Software Updates, or Configuration Information From the Client Computer System to the Mobile Playback Device

In a first step, the client computer system 214 and the mobile device use the point-to-point authentication protocol described above to verify that an authorized mobile playback device 212 is communicating with an authorized client computer system 214. If this is the case, the mobile playback device 212 transmits its memory map to the client computer system 214 via the mobile device interface 221. A table of contents defining the available digital information files 220 and player configuration profiles resident in client computer system 214 is displayed along with the mobile playback device 212 memory map for a user of client computer system 214. The user selects which files 220 of client computer system 214 should replace portions or segments of specified mobile playback device 212 memory as defined by the mobile playback device 212 memory map. Alternately, client browser 219 can be configured to automatically perform this selection process. In either case, the user is prevented from selecting digital information content larger than the available memory of playback device 212. In addition, control software and/or configuration data for playback device 212 may be automatically updated by client computer 214. The specified digital information files 220, associated headers, operating code, or configuration data are thereafter downloaded into mobile playback device 212 memory. The mobile playback device 212 uses checksums to verify the integrity of the download. The mobile playback device 212 uses the server public key 215, the header, and the digital signature to authenticate the download as described above. The header descrambling map is used by targeted mobile playback devices 212 to unscramble the downloaded data. In other embodiments, mobile playback device 212 may unscramble the downloaded data and/or decompress the downloaded data before authenticating the signature. Each segment of the digital information content may be independently authenticated and validated using any of the techniques described above. Digital information prompts on the mobile playback device 212 guide the user to the desired portion of the

downloaded digital information content as specified by the table of contents residing in the header of the downloaded data. The user may preview selected portions of the digital information content by selecting a preview option. The preview option plays a predetermined portion of a selected digital information program. Upon selection of a particular digital information program, the selected digital information program is played for the user after the mobile playback device 212 converts the digital information content into sound or displayable imagery which is played through an audio output means or displayed on a display device.

The software player 226 of client computer system 214 may also receive digital information content in approximately the same form as the digital information content downloaded to the mobile playback device 212; however, the digital information content for the software player 226 does not need to be downloaded to the software player 226. The software player 226 has direct access to the digital information content; because, it shares memory and/or disk storage space with the client computer system 214. Therefore, there are no downloading or memory map concerns. In the same manner as the mobile playback device 212, the software player 226 performs digital signature verification, verification of checksums, and receiving targeted information. In an alternative embodiment, software player 226 may use a communication protocol similar to that of mobile playback device 212 when receiving digital information content, configuration information, and dynamically downloaded software.

Figure 4 illustrates an alternative embodiment of the present invention. As shown in Figure 4, authoring system 280 can support a plurality of library servers 260. Each library server can be configured to support a specific type of digital information content. In the same manner described above, the client computer systems 214 access network 240 and obtain digital information content from any of the library servers 260 after performing the authentication process described above. Authorization server 270 is provided for this purpose. The configuration illustrated in Figure 4 provides a more distributed architecture thereby dispersing the load across several server platforms. A site with many client computer systems 214 may have its own library server 260 to reduce demand on network 240. This architecture scales well as the number of client computer systems 214 grows and the content provided by the library server 260 grows.

Figure 5 illustrates another embodiment of the present invention except the library server 461 has been implemented as a plurality of separate processes or tasks 460 running concurrently on a single library server platform 461. Each library server process 460 services requests for access to its corresponding portion of the digital information content. This content is created using authoring system 280 in the manner described above. The authorization server 270 is used to validate the links between the client computer systems 214 and the library server processes 460. The configuration illustrated in Figure 5 is advantageous in that the convenience of a single server is maintained while the scalability of multiple libraries is also supported.

This concept can also be used for the authoring and authorization servers 280 and 270, respectively. As shown in Figure 6, the authoring system 280 and the authorization server 270 is implemented on a single platform 685 as authoring process 680 and authorization process 670. These processes perform the same functions as described above, except the implementation provides the convenience of a single server and the scalability of multiple processes for the authoring and authorization tasks.

Figure 7 illustrates yet another alternative embodiment wherein the client computer systems 214 include a local library 710. The local library 710 provides a local storage area and library access control functionality which provides access to a subset of the archived digital information from library server 260. In the manner described above, the user of a client computer system 214 identifies the titles or items of digital information in library server 260 that the user wishes to access. In the preferred embodiment, these content selections are transferred to a client storage area 220 (as shown in Figure 2) for subsequent downloading to mobile playback device 212. The embodiment shown in Figure 7 expands upon the client storage area 220 and creates a local library 710. The local library 710 is used for storage of selected content; but also for searching, sorting, categorizing, and abstracting the locally stored content. The local library 710 allows a client computer system 214 to maintain a small subset of the full library which may be used to create custom collections of content in a variety of user selected configurations. Client systems 214 may be permitted to access the contents of local libraries 710 on other client systems 214. In a related alternate embodiment, library server processes 460 may also reside on selected client systems 214. This embodiment allows client systems 214 to browse and purchase content that is scrambled, targeted, and delivered from library server process 460 executing on a locally positioned client system 214. By maintaining the library locally, a portion of the network access and transfer overhead is eliminated.

Figure 8 illustrates another alternative embodiment of the present invention wherein the client computer system 214 is eliminated and the mobile playback device 212 is connected directly to the network 240 through network interface 810. In the preferred embodiment, the mobile playback device 212 is a **minimal capability device primarily dedicated to playing audio files or displaying visual images or text on a display device**. The mobile playback device 212 is minimally configured to retain its **light-weight, low cost, and readily mobile features**. The preferred embodiment does not therefore include the use of a portable personal computer or laptop computer, because, such devices typically do not meet the light-weight and low cost constraints of the preferred mobile playback device 212. However, the minimal mobile playback device 212 may be augmented to add network interface 810 which comprises a conventional hardware connector, hardware buffers and controllers, and firmware support for a particular conventional network protocol. For example, the mobile playback device 212 may be augmented with an **integrated**

modem that includes a telephone jack with which the playback device may be connected to a telephone network. It will be apparent to those of ordinary skill in the art that network interface 810 may be implemented in a low cost and light-weight device such as mobile playback device 212. Because the client system browser 219 would not be available in the alternative embodiment shown in Figure 8, a simplified user interface may be provided in firmware or other non-volatile memory of mobile playback device 212 with which the user may select items of digital information for download and playback from library server 260. As described above, the authentication process to validate the link between the mobile playback device 212 and the library server 260 must also be performed prior to user access to the library server 260 content. Alternatively, a client system 814 coupled to network 240 may be provided to support client browser 219 and thereby enable selection of items of digital information for download and playback from library server 260 directly to any of the mobile playback devices 212. Client systems 814 may support local storage of digital information, software, and configuration data in a form similar to storage space 220 or local library 710. In addition, a more simplified implementation of network interface 810 may be designed to communicate via network 240 to client system 814 instead of library server 260.

In another alternative embodiment of the present invention, digital information programming selections are made using the client computer system 214 and library server 260 as described above; however, the selections are delivered on mass storage medium 241. Mass storage medium 241 represents any of a variety of conventional mass storage technologies including CD-ROM, PCMCIA cards, DVDs, floppy disks, removable hard drives, digital magnetic tape, optical cards, flash memory or other optical, magnetic, electronic, or semiconductor memory devices. Upon selection by a user of a client computer system 214, selected programming is targeted and scrambled as described above and transferred to a selected mass storage medium 241 and mailed, hand-delivered, or held for pickup by the user. Once the user takes physical possession of the selected mass storage media 241, the selected programming may be read from the mass storage medium 241 by the client browser 219 and thereafter transferred to the mobile playback device 212 as described above. Figure 9 illustrates another embodiment of the system that does not include the use of client computer 214 to transfer data to mobile playback device 212. Kiosk 910 consists of a computer system such as the one described above in Figure 1. Kiosk 910 is a publicly accessible unit that can perform browse, content purchase, and download functions in a manner equivalent to a client computer system 214. The kiosk 910 is special because it contains its own library server for fast local access and download of content. Kiosk 910 contains a mobile device interface 221, a special version of client browser 219, and local library server process 460. Kiosk library server process 460 has local storage of scrambled and compressed digital information files 262. These compressed information files 262 originate from remote authoring system 280 and may be delivered via physical transport of mass

storage media 241 or via distribution network 240. A customer operates client browser 219 to browse, select, and purchase digital information files that are delivered to the customer's mobile playback device 212. Authentication, targeting, and download processes are performed within the kiosk by library server process 460 that is connected to remote authorization server 270 over network 240. In a related embodiment, figure 7 shows a client system 214 with local library 710 that can be converted into a kiosk with functionality similar to kiosk 910. In this system, a special version of client browser 219 provides the same user functionality as the previous kiosk embodiment.

An alternate embodiment of the system uses a common communication network to connect all system components. In Figure 10, network 240 is directly coupled to client system 214 and 814, network interface(s) 810, library server(s) 260, authorization server 270, and authoring system(s) 280. One of ordinary skill in the art will realize that network 240 can also be segmented into a number of independent networks or communication links without changing the functionality of the system.

Thus, a method and apparatus for implementing a computer network based digital information library system employing authentication and encryption protocols for the secure transfer of digital information library programs, software, and configuration data to a client computer system and a mobile digital information playback device removably connectable to the client computer system is disclosed. Although the present invention has been described with respect to specific examples and subsystems, it will be apparent to those of ordinary skill in the art that the invention is not limited to these specific examples or subsystems but extends to other embodiments as well. The present invention includes all of these other embodiments as specified in the claims that follow.

**CLAIMS**

We claim:

1. A computer based library and information delivery system for accessing and obtaining selected digital information files, said library and information delivery system comprising:

a library server having a plurality of digital information files;

a client computer system coupled to said library server over a network; and

a mobile device removably connectable to said client computer system, said client computer system including logic for requesting a download of a selected one or more of said digital information files from said library server, said client computer system further including logic for downloading said selected one or more of said digital information files to said mobile device.

2. The library and information delivery system as claimed in Claim 1 further including an authoring system coupled to said library server for generating or modifying said plurality of digital information files.

3. The library and information delivery system as claimed in Claim 1 wherein said plurality of digital information files includes audio files, spoken audio files, visual image files, text files, video files, multimedia files, operating code files, or configuration information files.

4. The library and information delivery system as claimed in Claim 1 wherein said library server further includes library management software for interfacing with said client computer system and said plurality of digital information files.

5. The library and information delivery system as claimed in Claim 1 wherein said client computer system further includes a client browser for interfacing with said library server and for making selections of one or more of said digital information files from said library server.

6. The library and information delivery system as claimed in Claim 1 wherein said client computer system further includes a player for tangibly playing said selected one or more of said digital information files on said client computer system.

7. The library and information delivery system as claimed in Claim 1 wherein said mobile device further includes a means for tangibly playing said selected one or more of said digital information files downloaded from said client computer system.

8. The library and information delivery system as claimed in Claim 1 further including an authorization server coupled to said library server for authorizing access to said plurality of digital information files by said client computer system.

9. The library and information delivery system as claimed in Claim 1 wherein said library server is a software process running on several computer systems.

10. The library and information delivery system as claimed in Claim 2 wherein said library server and said authoring system run on different computer systems.

11. The library and information delivery system as claimed in Claim 8 wherein said library server and said authorization server run on different computer systems.

12. The library and information delivery system as claimed in Claim 1 further including an authoring system coupled to said library server for generating or modifying said plurality of digital information files, said library and information delivery system further including an authorization server coupled to said library server for authorizing access to said plurality of digital information files by said client computer system, said library and information delivery system running on a single computer system.



13. The library and information delivery system as claimed in Claim 1 further including an authoring system coupled to said library server for generating or modifying said plurality of digital information files, said library and information delivery system further including an authorization server coupled to said library server for authorizing access to said plurality of digital information files by said client computer system, said authoring system and said authorization server running on a different computer system than said library server.

14. The library and information delivery system as claimed in Claim 1 wherein said client computer system further includes a local library for local storage of a selected portion of said plurality of digital information files.

15. The library and information delivery system as claimed in Claim 1 wherein said mobile device further includes a network interface for direct communication with a network without the aid of a client computer system.

16. The library and information delivery system as claimed in Claim 1 wherein said logic for downloading further includes logic for limiting said download based on available memory of said mobile device.

17. The library and information delivery system as claimed in Claim 1 wherein said logic for downloading further includes logic for performing authentication on each segment of said digital information files downloaded to said mobile device.

18. The library and information delivery system as claimed in Claim 1 wherein said client computer system further includes logic for previewing said digital information files prior to being downloaded to said mobile device.

19. The library and information delivery system as claimed in Claim 1 further including authentication logic for authenticating access to said library, said authentication logic including a means for performing a point-to-point authentication protocol.

20. The library and information delivery system as claimed in Claim 1 further including authentication logic for authenticating access to said library, said authentication logic including a means for performing a targeting authentication protocol.

21. The library and information delivery system as claimed in Claim 1 further including authentication logic for authenticating access to said library, said authentication logic including a means for performing a digital signature authentication protocol.

22. In a computer based library and information delivery system, said library and information delivery system including a library server having a plurality of digital information files, a client computer system coupled to said library server over a network, and a mobile device removably connectable to said client computer system, a method for accessing and obtaining selected digital information files comprising the steps of:

requesting a download of a selected one or more of said digital information files from said library server; and

downloading said selected one or more of said digital information files to said mobile device.

23. The method as claimed in Claim 22 further including a step of generating or modifying said plurality of digital information files.

24. The method as claimed in Claim 22 wherein said plurality of digital information files includes audio files, spoken audio files, visual image files, text files, video files, multimedia files, operating code files, or configuration information files.

25. The method as claimed in Claim 22 further including a step of activating library management software for interfacing with said client computer system and said plurality of digital information files.

26. The method as claimed in Claim 22 further including a step of interfacing with said library server and for making selections of one or more of said digital information files from said library server.

27. The method as claimed in Claim 22 further including a step of tangibly playing said selected one or more of said digital information files on said client computer system.

28. The method as claimed in Claim 22 further including a step of tangibly playing said selected one or more of said digital information files downloaded from said client computer system.

29. The method as claimed in Claim 22 further including a step of authorizing access to said plurality of digital information files by said client computer system.

30. The method as claimed in Claim 22 further including the steps of generating or modifying said plurality of digital information files, and authorizing access to said plurality of digital information files by said client computer system, said library and information delivery system running on a single computer system.

31. The method as claimed in Claim 22 further including a step of locally storing a selected portion of said plurality of digital information files.

29

32. The method as claimed in Claim 22 further including a step of directly communicating with a network without the aid of a client computer system.

33. The method as claimed in Claim 22 further including a step of limiting said download based on available memory of said mobile device.

34. The method as claimed in Claim 22 further including a step of performing authentication on each segment of said digital information files downloaded to said mobile device.

35. The method as claimed in Claim 22 further including a step of previewing said digital information files prior to being downloaded to said mobile device.

36. The method as claimed in Claim 22 further including a step of performing a point-to-point authentication protocol.

37. The method as claimed in Claim 22 further including a step of performing a targeting authentication protocol.

38. The method as claimed in Claim 22 further including a step of performing a digital signature authentication protocol.

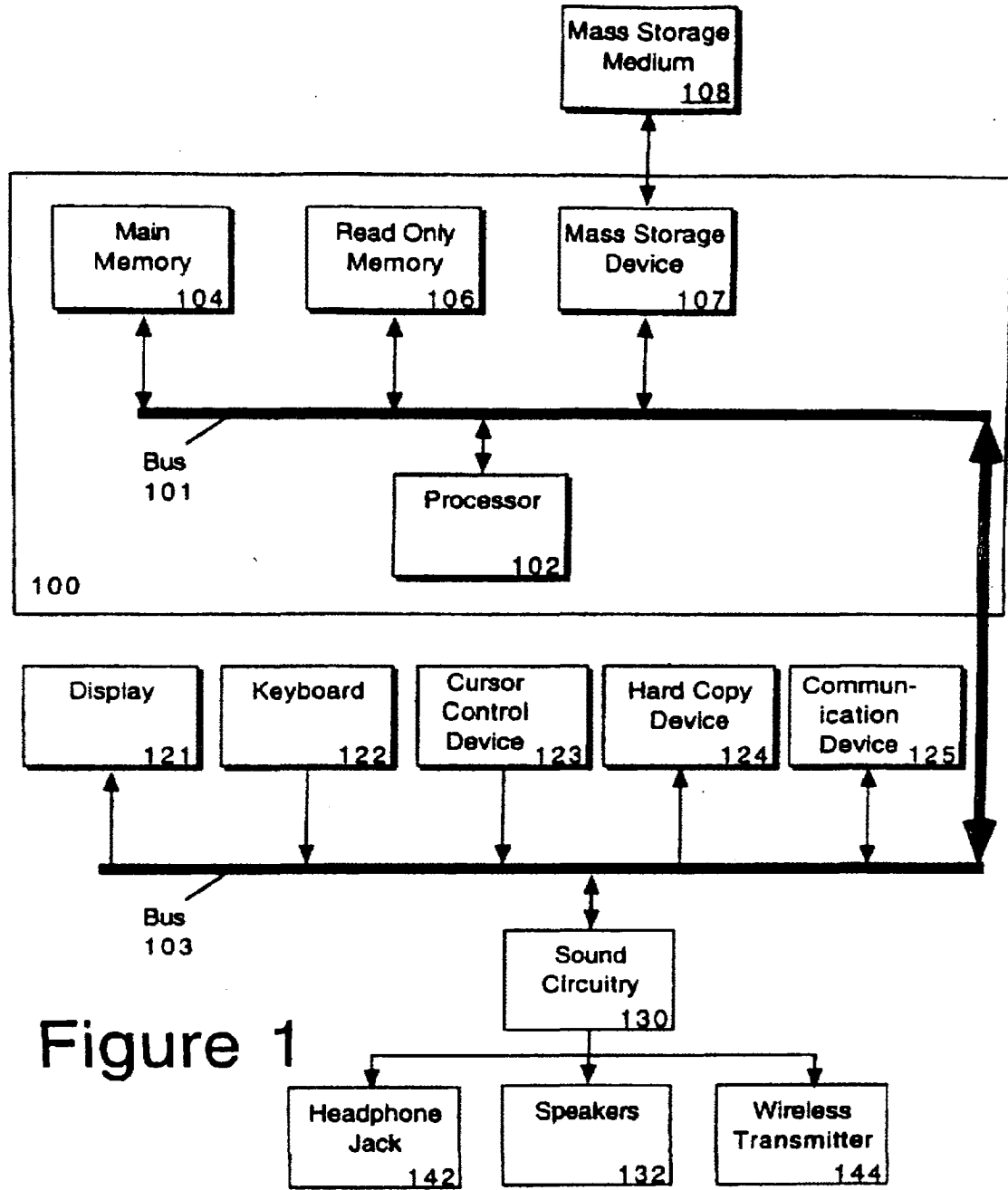


Figure 1

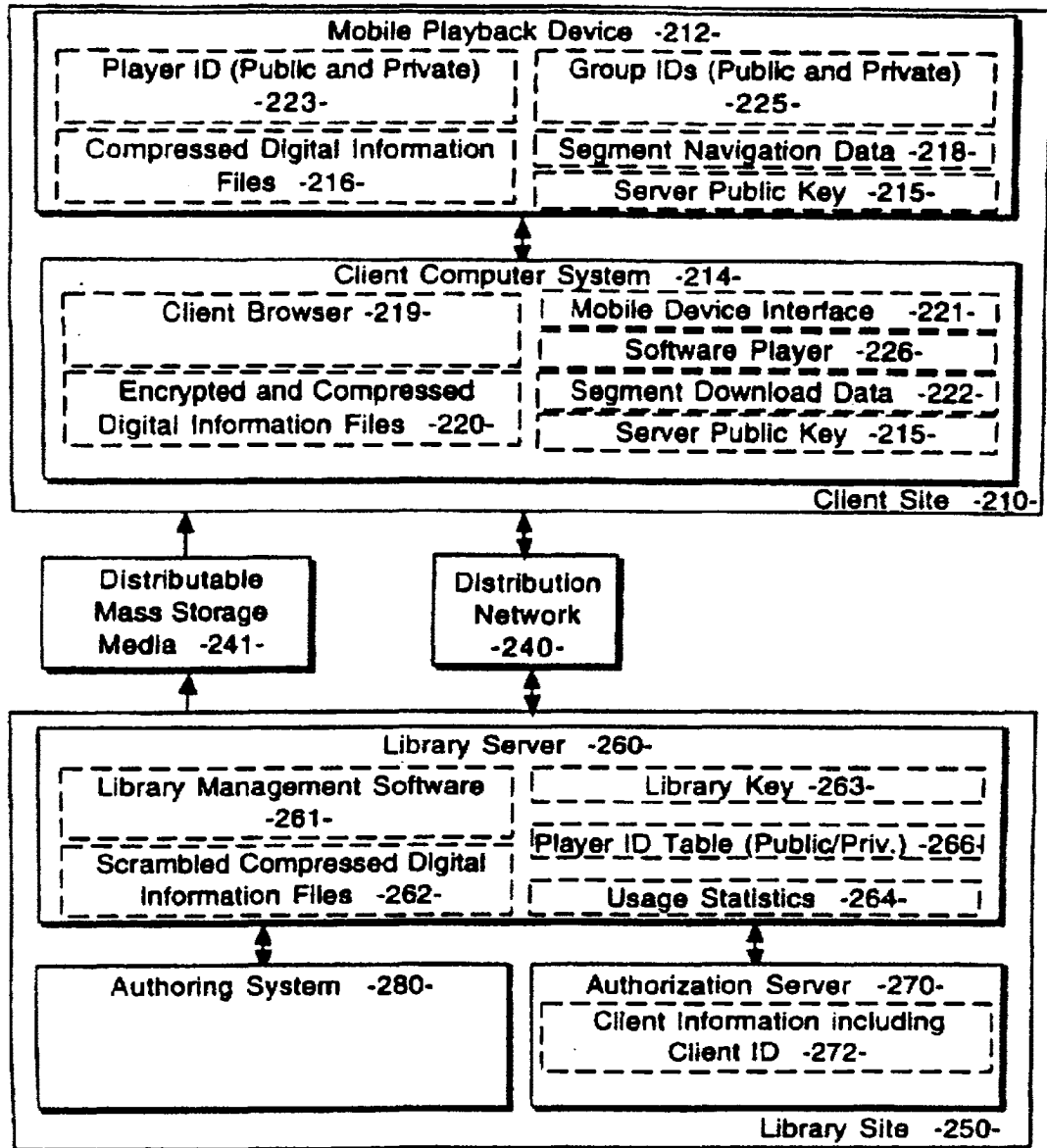


Figure 2

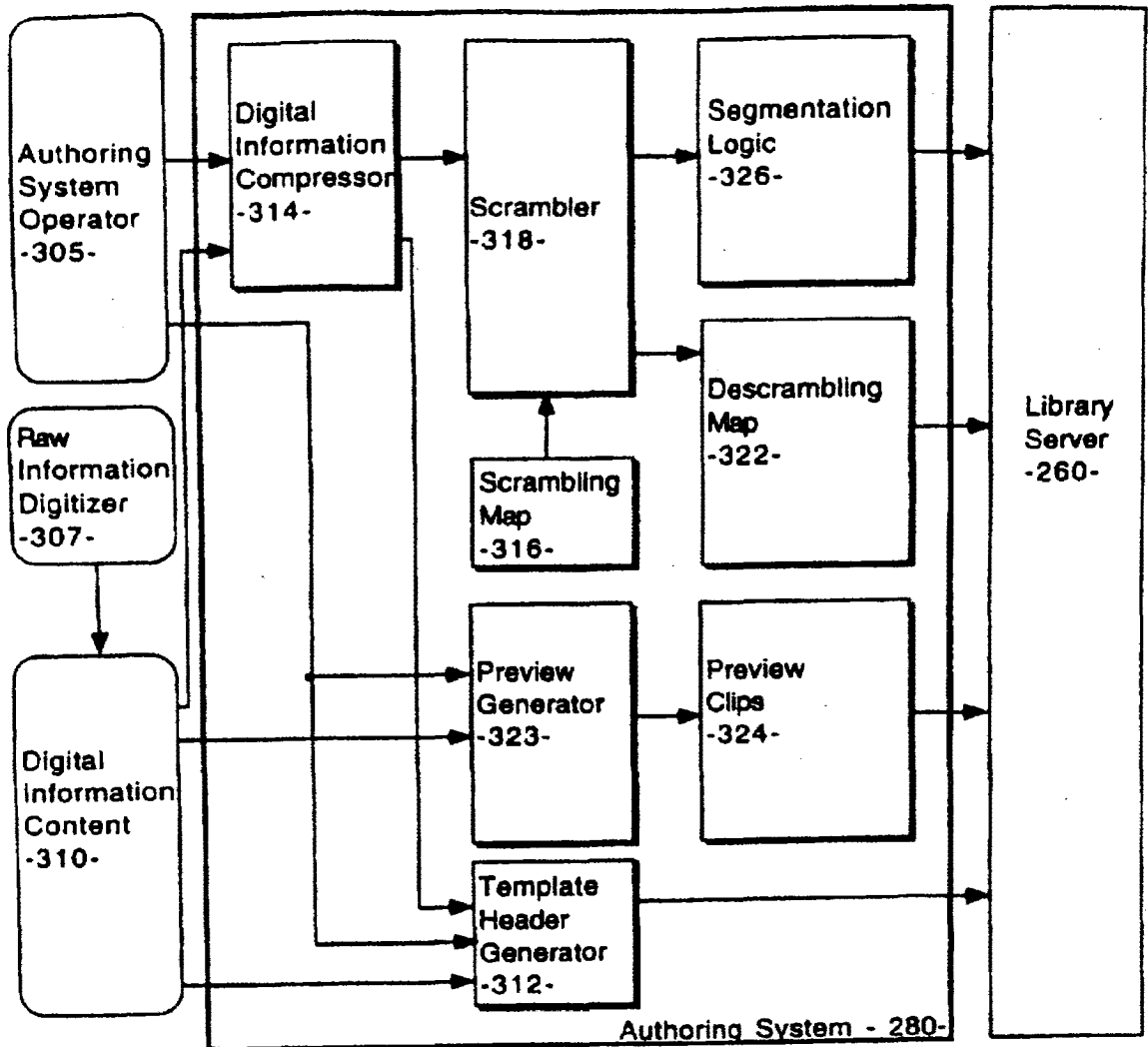


Figure 3

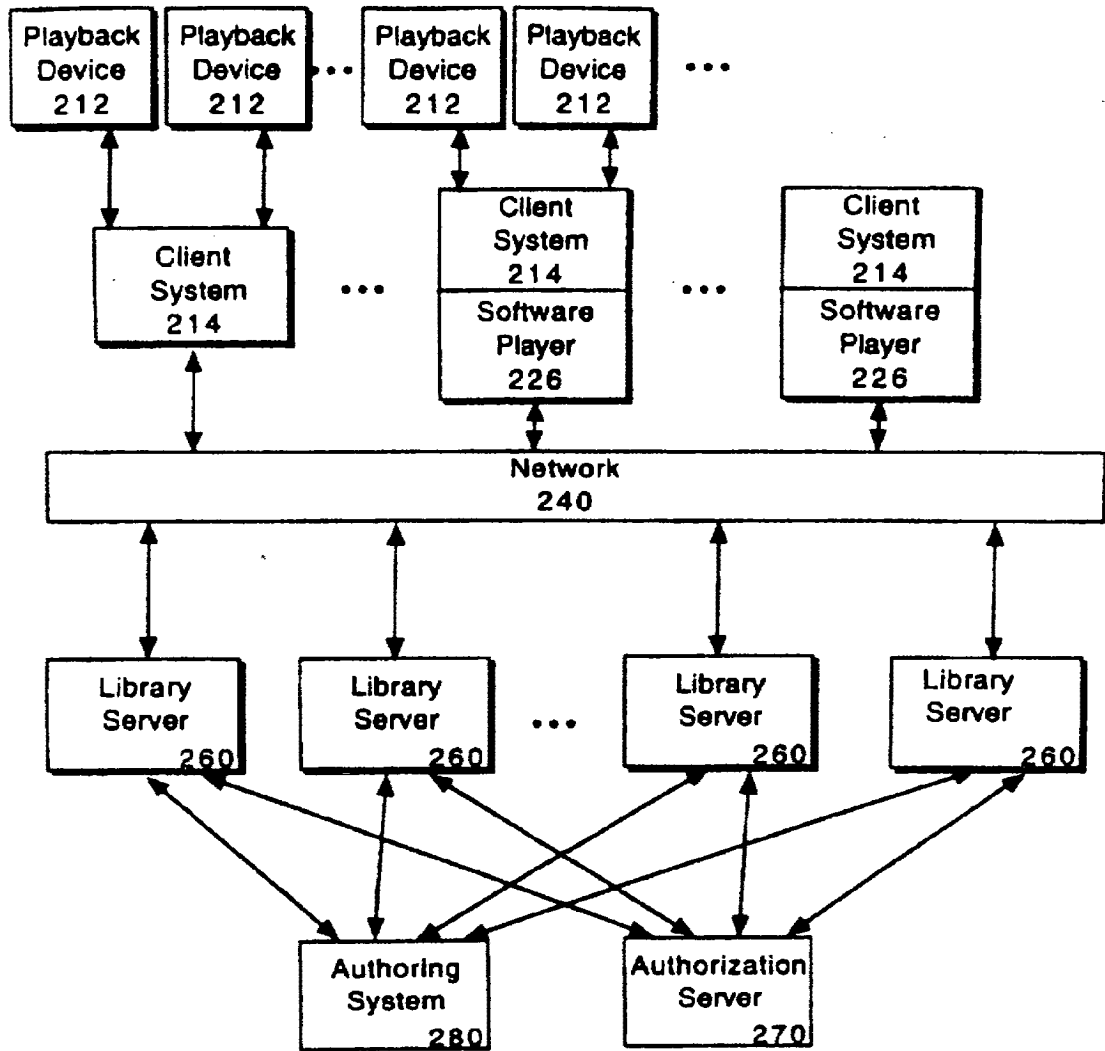


Figure 4



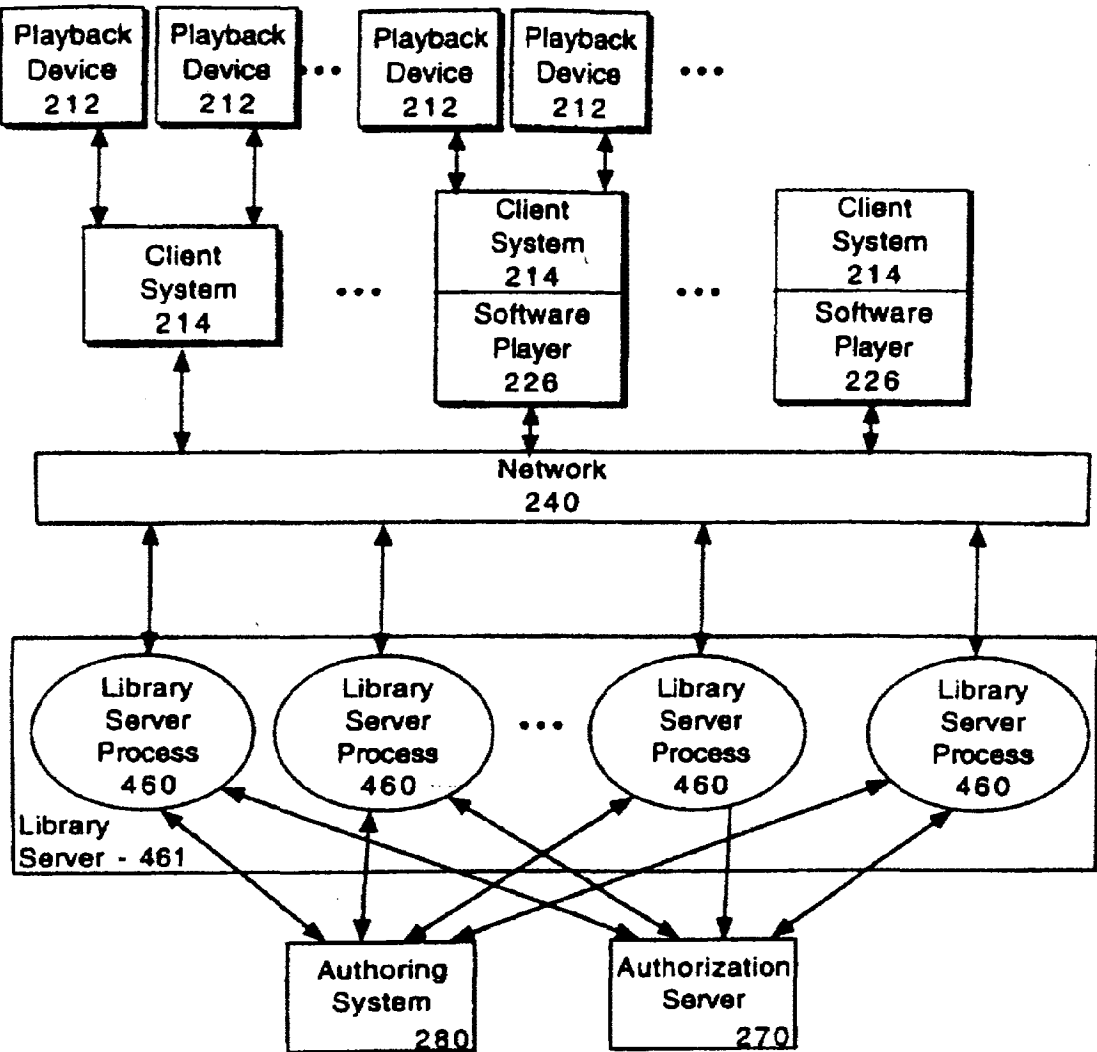


Figure 5

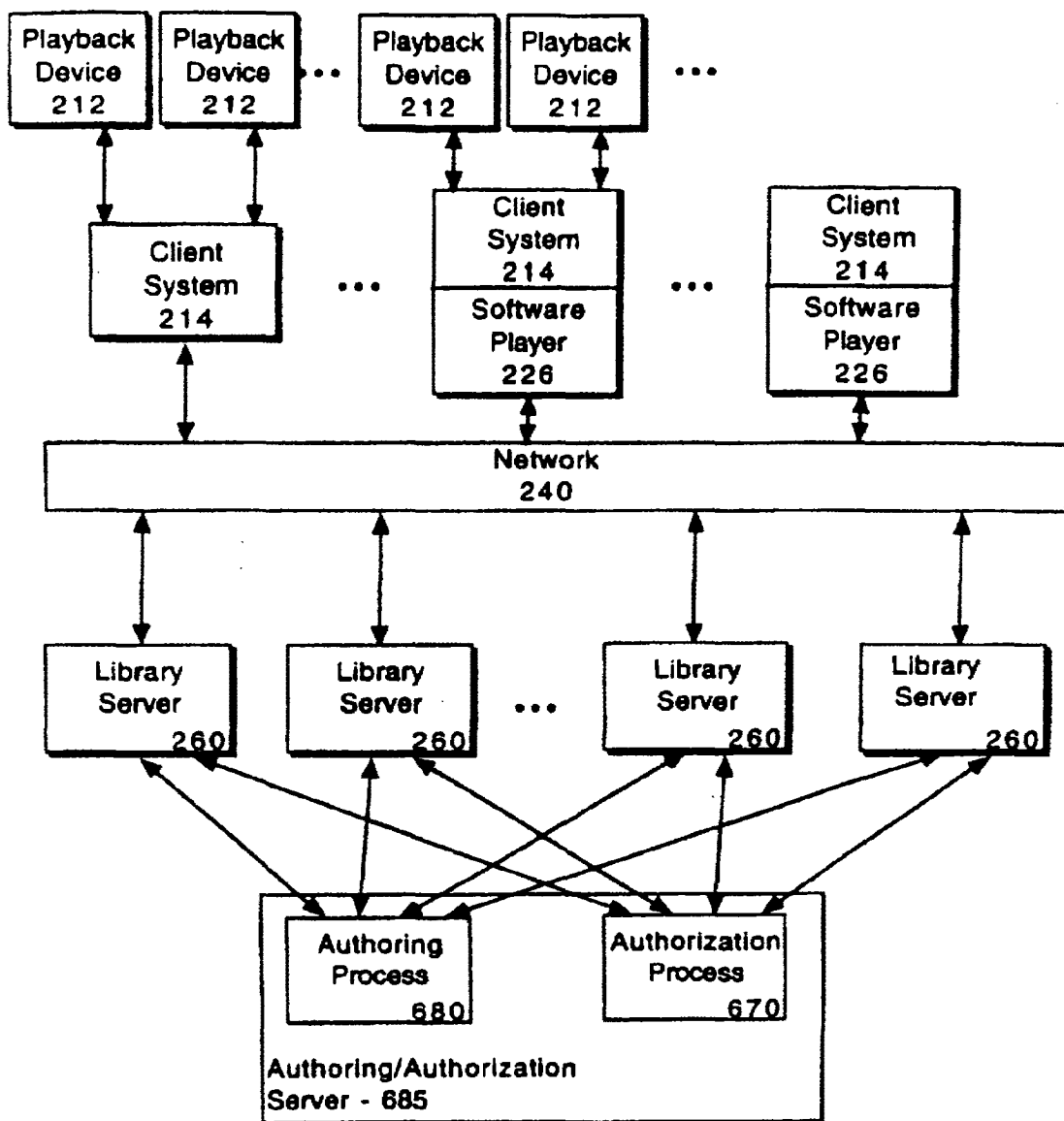


Figure 6

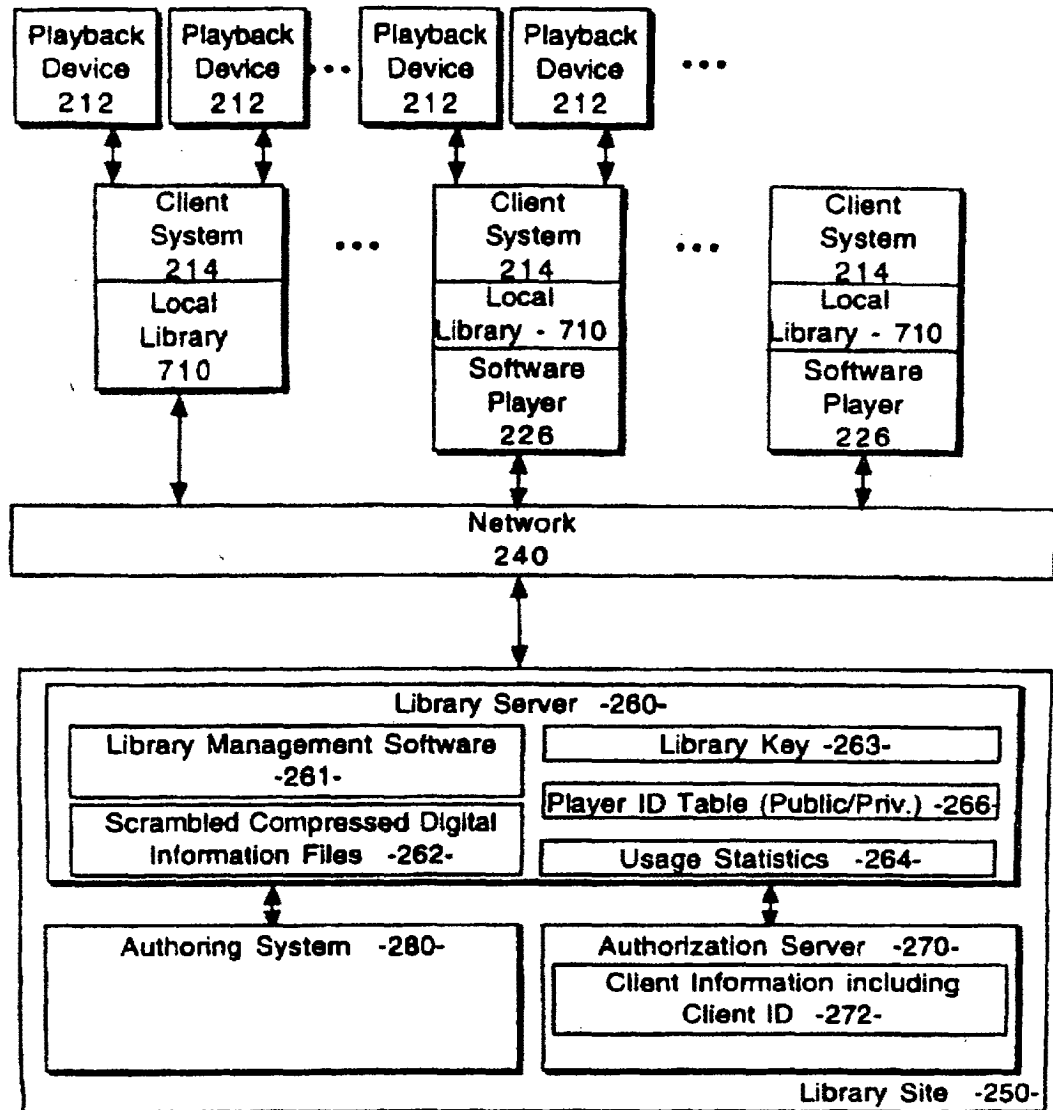


Figure 7

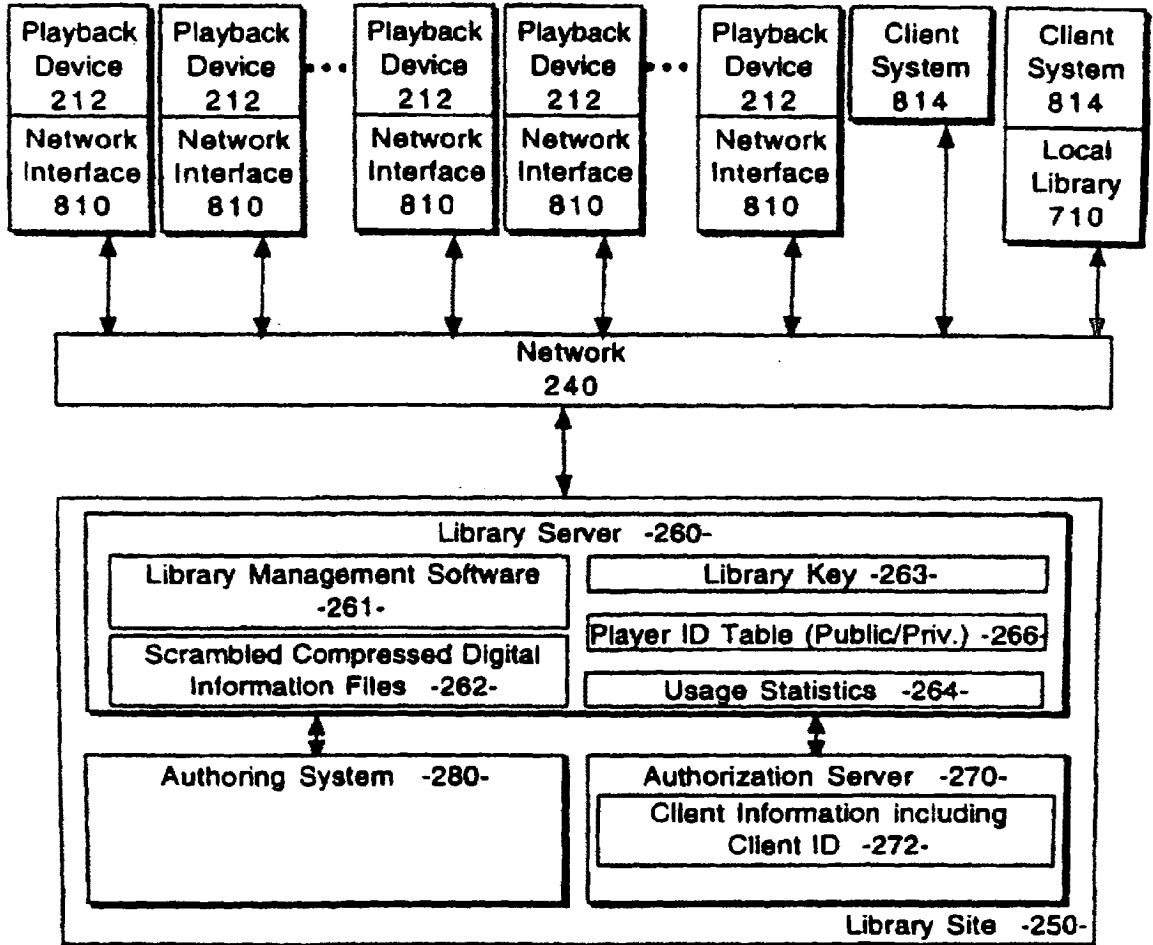


Figure 8

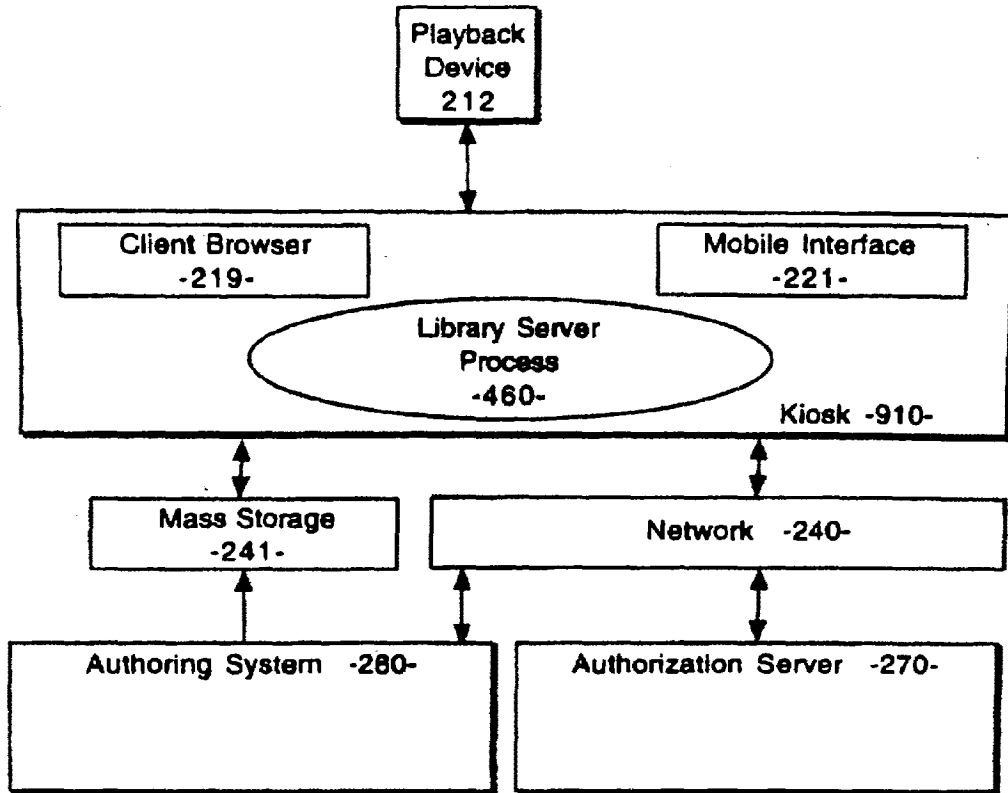


Figure 9

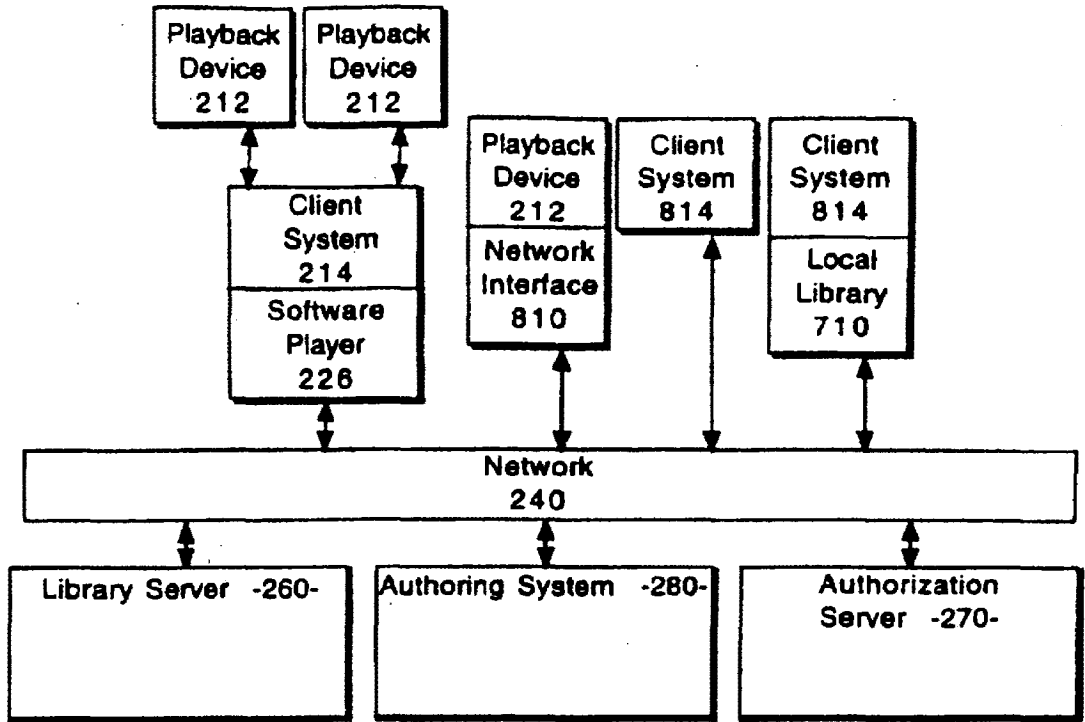


Figure 10

INTERNATIONAL SEARCH REPORT

International application No.  
PCT/US97/16184

**A. CLASSIFICATION OF SUBJECT MATTER**  
 IPC(6) :G06F 13/00; H04M 11/00  
 US CL : 395/200.47, 200.49; 705/26  
 According to International Patent Classification (IPC) or to both national classification and IPC

**B. FIELDS SEARCHED**  
 Minimum documentation searched (classification system followed by classification symbols)  
 U.S. : 395/200.31, 200.32, 200.47, 200.48, 200.49; 345/327, 156, 169; 705/26, 27

Documentation searched other than minimum documentation to the extent that such documents are included in the fields searched

Electronic data base consulted during the international search (name of data base and, where practicable, search terms used)  
 Please See Extra Sheet.

**C. DOCUMENTS CONSIDERED TO BE RELEVANT**

Category*	Citation of document, with indication, where appropriate, of the relevant passages	Relevant to claim No.
Y	US 5,440,336 A (BUHRO et al.) 08 August 1995, col.4 lines 49-60.	1-38
Y,P	US 5,634,080 A (KIKINIS et al.) 27 May 1997, fig.47, 48	1, 22
Y,P	US 5,579,471 A (BARBER et al) 26 November 1996. col.3 lines 39-68.	5-9 18, 25-28
A	RAMANATHAN ET AL. "Architectures for personalized multimedia", IEEE Multimedia, 1994, all	1-38
Y	DESMEDT ET AL. "Multi-receivier / Multi-sender network security", INFOCOM '92, p.2045-2054	19-21, 35-38

Further documents are listed in the continuation of Box C.  See patent family annex.

* Special categories of cited documents:	*T* later document published after the international filing date or priority date and not in conflict with the application but cited to understand the principle or theory underlying the invention
*A* document defining the general state of the art which is not considered to be of particular relevance	*X* document of particular relevance; the claimed invention cannot be considered novel or cannot be considered to involve an inventive step when the document is taken alone
*B* earlier document published on or after the international filing date	*Y* document of particular relevance; the claimed invention cannot be considered to involve an inventive step when the document is combined with one or more other such documents, such combination being obvious to a person skilled in the art
*L* document which may throw doubts on priority claim(s) or which is cited to establish the publication date of another citation or other special reason (as specified)	*A* document member of the same patent family
*O* document referring to an oral disclosure, use, exhibition or other means	
*P* document published prior to the international filing date but later than the priority date claimed	

Date of the actual completion of the international search 25 NOVEMBER 1997	Date of mailing of the international search report 30 JAN 1998
Name and mailing address of the ISA/US Commissioner of Patents and Trademarks Box PCT Washington, D.C. 20231 Facsimile No. (703) 305-3230	Authorized Officer DUNG DINH Telephone No. (703) 305-9600

INTERNATIONAL SEARCH REPORT

International application No.  
PCT/US97/16184

**B. FIELDS SEARCHED**

Electronic data bases consulted (Name of data base and where practicable terms used):

APS

(online or library or demand) and (mobile or portable) and server and client and authoriz?

Proquest IEEE Publications OnDisc

authentication

digital signature





UNITED STATES PATENT AND TRADEMARK OFFICE

UNITED STATES DEPARTMENT OF COMMERCE  
United States Patent and Trademark Office  
Address: COMMISSIONER FOR PATENTS  
P.O. Box 1450  
Alexandria, Virginia 22313-1450  
www.uspto.gov

FW

APPLICATION NO.	FILING DATE	FIRST NAMED INVENTOR	ATTORNEY DOCKET NO.	CONFIRMATION NO.
10/223,200	08/16/2002	Michael E. Shanahan	MES/001CON	8026
32850	7590	05/18/2005	EXAMINER	
MICHAEL E SHANAHAN P.O. BOX 381 NYACK, NY 10960			TRAN, CONGVAN	
			ART UNIT	PAPER NUMBER
			2683	

DATE MAILED: 05/18/2005

Please find below and/or attached an Office communication concerning this application or proceeding.

<b>Office Action Summary</b>	<b>Application No.</b> 10/223,200	<b>Applicant(s)</b> SHANAHAN, MICHAEL E.	
	<b>Examiner</b> CongVan Tran	<b>Art Unit</b> 2683	

-- The MAILING DATE of this communication appears on the cover sheet with the correspondence address --

**Period for Reply**

A SHORTENED STATUTORY PERIOD FOR REPLY IS SET TO EXPIRE 3 MONTH(S) FROM THE MAILING DATE OF THIS COMMUNICATION.

- Extensions of time may be available under the provisions of 37 CFR 1.136(a). In no event, however, may a reply be timely filed after SIX (6) MONTHS from the mailing date of this communication.
- If the period for reply specified above is less than thirty (30) days, a reply within the statutory minimum of thirty (30) days will be considered timely.
- If NO period for reply is specified above, the maximum statutory period will apply and will expire SIX (6) MONTHS from the mailing date of this communication.
- Failure to reply within the set or extended period for reply will, by statute, cause the application to become ABANDONED (35 U.S.C. § 133). Any reply received by the Office later than three months after the mailing date of this communication, even if timely filed, may reduce any earned patent term adjustment. See 37 CFR 1.704(b).

**Status**

- 1)  Responsive to communication(s) filed on \_\_\_\_.
- 2a)  This action is **FINAL**.                      2b)  This action is non-final.
- 3)  Since this application is in condition for allowance except for formal matters, prosecution as to the merits is closed in accordance with the practice under *Ex parte Quayle*, 1935 C.D. 11, 453 O.G. 213.

**Disposition of Claims**

- 4)  Claim(s) 1-104 is/are pending in the application.  
    4a) Of the above claim(s) 1-32,50-67,72,73 and 99-104 is/are withdrawn from consideration.
- 5)  Claim(s) \_\_\_\_ is/are allowed.
- 6)  Claim(s) 33-49,68-71 and 74-98 is/are rejected.
- 7)  Claim(s) \_\_\_\_ is/are objected to.
- 8)  Claim(s) \_\_\_\_ are subject to restriction and/or election requirement.

**Application Papers**

- 9)  The specification is objected to by the Examiner.
- 10)  The drawing(s) filed on \_\_\_\_ is/are: a)  accepted or b)  objected to by the Examiner.  
    Applicant may not request that any objection to the drawing(s) be held in abeyance. See 37 CFR 1.85(a).  
    Replacement drawing sheet(s) including the correction is required if the drawing(s) is objected to. See 37 CFR 1.121(d).
- 11)  The oath or declaration is objected to by the Examiner. Note the attached Office Action or form PTO-152.

**Priority under 35 U.S.C. § 119**

- 12)  Acknowledgment is made of a claim for foreign priority under 35 U.S.C. § 119(a)-(d) or (f).  
    a)  All    b)  Some \*    c)  None of:
1.  Certified copies of the priority documents have been received.
2.  Certified copies of the priority documents have been received in Application No. \_\_\_\_.
3.  Copies of the certified copies of the priority documents have been received in this National Stage application from the International Bureau (PCT Rule 17.2(a)).
- \* See the attached detailed Office action for a list of the certified copies not received.

**Attachment(s)**

- |                                                                                                                                   |                                                                                         |
|-----------------------------------------------------------------------------------------------------------------------------------|-----------------------------------------------------------------------------------------|
| 1) <input checked="" type="checkbox"/> Notice of References Cited (PTO-892)                                                       | 4) <input type="checkbox"/> Interview Summary (PTO-413)<br>Paper No(s)/Mail Date. ____. |
| 2) <input type="checkbox"/> Notice of Draftsperson's Patent Drawing Review (PTO-948)                                              | 5) <input type="checkbox"/> Notice of Informal Patent Application (PTO-152)             |
| 3) <input checked="" type="checkbox"/> Information Disclosure Statement(s) (PTO-1449 or PTO/SB/08)<br>Paper No(s)/Mail Date ____. | 6) <input type="checkbox"/> Other: ____.                                                |

### DETAILED ACTION

1. During a telephone conversation with Mr. Scott Kaliko on Wed. 27, 2005 a provisional election was made without traverse to prosecute the invention of group II, claims 33-49, 68-71, and 74-98. Affirmation of this election must be made by applicant in replying to this Office action. Claims 16-32, 50-67, 72-73, and 99-104 withdrawn from further consideration by the examiner, 37 CFR 1.142(b), as being drawn to a non-elected invention.
2. Claims 1-15 have been canceled.

#### ***Claim Rejections - 35 USC § 102***

3. The following is a quotation of the appropriate paragraphs of 35 U.S.C. 102 that form the basis for the rejections under this section made in this Office action:

A person shall be entitled to a patent unless –

(e) the invention was described in (1) an application for patent, published under section 122(b), by another filed in the United States before the invention by the applicant for patent or (2) a patent granted on an application for patent by another filed in the United States before the invention by the applicant for patent, except that an international application filed under the treaty defined in section 351(a) shall have the effects for purposes of this subsection of an application filed in the United States only if the international application designated the United States and was published under Article 21(2) of such treaty in the English language.

4. Claims 33, 36-43, 46-49, and 68 are rejected under 35 U.S.C. 102(e) as being anticipated by Helferich (6,253,061).

Regarding claims 33, 36-37, 39-41, Helferich discloses a systems and methods for delivering information to a transmitting and receiving device, comprising:

a communications link capable of connecting to a remote database that includes a plurality of lists of audio files (fig.2, element 1, 100, fig.3, elements 30, 34, 100, fig.10 and its description);

a display screen that allows a user of the wireless telephone to browse at least one of the lists of audio files and view selectable audio files present in the browsed list (see fig. 3, element 2, col.4, lines 53-64, col.15, lines 46-55);

a speaker and processing circuitry configured to allow the user to optionally review a selected audio file before downloading the selected audio file into the wireless telephone (see fig. 3, element 2, col.15, lines 46-55); and

a programmable memory circuit for allowing the user to optionally store the selected audio file for use as an indicia of an incoming communication (see fig.2, element 5, col.15, lines 46-55 and its description).

Regarding claim 38, 47 Helferich further discloses compliant Internet browser (see col.16, lines 21-30)

Regarding claims 42, 46, 48-49, 68, Helferich discloses a systems and methods for delivering information to a transmitting and receiving device, comprising:

a communications link capable of connecting to a remote database that includes a plurality of lists of audio files (fig.2, element 1, 100, fig.3, elements 30, 34, 100, fig.10 and its description); the remote database operating substantially independently of a communication network that provides wireless telephone service to the telephone (see fig.3, element 32 and its description);

a display screen that allows a user of the wireless telephone to browse at least one of the plurality of lists of audio files and view selectable audio files present in the browsed list (see fig. 3, element 2, col.4, lines 53-64, col.15, lines 46-55);

processing circuitry configured to receive a selected audio file from communication link (see fig.2, element 27 and its description); and

a programmable memory circuit for allowing the user to optionally store the selected audio file for use as an indicia of an incoming communication (see fig.2, element 5, col.15, lines 46-55 and its description).

Regarding claim 43, Helferich further discloses a speaker that operate in conjunction with the processing circuitry configured to allow the user to optionally review a selected audio file before downloading tie selected audio file into the wireless telephone (see fig. 3, element 2, col.15, lines 46-55).

### ***Claim Rejections - 35 USC § 103***

5. The following is a quotation of 35 U.S.C. 103(a) which forms the basis for all obviousness rejections set forth in this Office action:

(a) A patent may not be obtained though the invention is not identically disclosed or described as set forth in section 102 of this title, if the differences between the subject matter sought to be patented and the prior art are such that the subject matter as a whole would have been obvious at the time the invention was made to a person having ordinary skill in the art to which said subject matter pertains. Patentability shall not be negatived by the manner in which the invention was made.

6. Claims 34-35, 44-45, 69-71, 74-98 are rejected under 35 U.S.C. 103(a) as being unpatentable over Helferich (6,253,061) in view of Mills et al. (6,599,147).

Regarding claims 34-35, 44-45, 69-71, Helferich discloses all the subject matters as described in rejected claim 33, except programmable memory circuit is configured to

Art Unit: 2683

store audio files in a format selected from the group comprising: MIDI, MPEG/ MP3. However, Mills discloses a removable expansion memory, comprising: MIDI, MPEG/ MP3 (see col.13, lines 35-43). Thus, it would have been obvious to one having ordinary skill in the art at the time the invention was made to use the Mills' removable expansion memory in Helferich's invention in order to increase parallelism and functionality of the device.

Regarding claims 74-76, 79-81, 91-92, Helferich discloses a systems and methods for delivering information to a transmitting and receiving device, comprising:

a communications link capable of connecting to a database in the remote computer that includes a plurality of lists of audio files (fig.2, element 1, 100, fig.3, elements 30, 34, 100, fig.10 and its description);

a display screen and a mobile Internet browser that allows a user of the wireless telephone to browse at least one of the plurality of lists of audio files and view selectable audio files present in the browsed list (see fig. 3, element 2, col.4, lines 53-64, col.15, lines 46-55);

processing circuitry configured to receive a selected one of the audio files from the communications link (see fig.2, element 27 and its description);

a programmable memory circuit for allowing the user to optionally store the selected audio file for use as an indicia of an incoming communication (see fig.2, element 5, col.15, lines 46-55 and its description); and

an enhanced performance speaker (see fig. 3, element 2, col.15, lines 46-55),, except for capable of providing a substantially full range of audio sounds from MP3 files

Art Unit: 2683

when one of the stored audio files is played as an indicia of an incoming complication. However, Mills discloses a removable expansion memory, comprising: MIDI, MPEG/MP3 (see col.13, lines 35-43). Thus, it would have been obvious to one having ordinary skill in the art at the time the invention was made to use the Mills' removable expansion memory in Helferich's invention in order to increase parallelism and functionality of the device.

Regarding claims 77-78, 82-90, 93-98 Helferich further discloses configured to allow the user to search the remote database for a certain desired audio file using title or description information to aid in locating the desired audio file (see col.4, lines 53-64, col.15, lines 46-55).

Any inquiry concerning this communication or earlier communications from the examiner should be directed to CongVan Tran whose telephone number is 571-272-7871. The examiner can normally be reached on Monday-Thursday.

If attempts to reach the examiner by telephone are unsuccessful, the examiner's supervisor, William Trost can be reached on 571-272-7872. The fax phone number for the organization where this application or proceeding is assigned is 703-872-9306.

Information regarding the status of an application may be obtained from the Patent Application Information Retrieval (PAIR) system. Status information for published applications may be obtained from either Private PAIR or Public PAIR. Status information for unpublished applications is available through Private PAIR only. For more information about the PAIR system, see <http://pair-direct.uspto.gov>. Should you have questions on access to the Private PAIR system, contact the Electronic Business Center (EBC) at 866-217-9197 (toll-free).

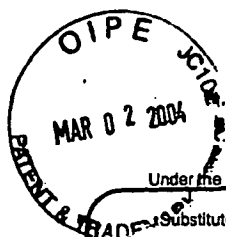


**CONGVAN TRAN**  
**PRIMARY EXAMINER**

CongVan Tran  
Primary Examiner  
Art Unit 2683

May 16, 2005.





PTO/SB/08A (08-03)

Approved for use through 07/31/2006. OMB 0651-0031  
U.S. Patent and Trademark Office; U.S. DEPARTMENT OF COMMERCE

Under the Paperwork Reduction Act of 1995, no persons are required to respond to a collection of information unless it contains a valid OMB control number.

<b>INFORMATION DISCLOSURE STATEMENT BY APPLICANT</b> (Use as many sheets as necessary)		<b>Complete if Known</b>	
		Application Number	10/223,200
Substitute for form 1449/PTO		Filing Date	AUGUST 16, 2003
		First Named Inventor	Michael E. Shanahan
		Art Unit	2681
		Examiner Name	
Sheet 1 of 3		Attorney Docket Number	MES/001 CON

U. S. PATENT DOCUMENTS					
Examiner Initials*	Cite No. <sup>1</sup>	Document Number	Publication Date MM-DD-YYYY	Name of Patentee or Applicant of Cited Document	Pages, Columns, Lines, Where Relevant Passages or Relevant Figures Appear
		Number-Kind Code <sup>2</sup> (if known)			
		US- 5,220,420	06-15-1993	Hoarty, et al.	
		US- 5,247,347	09-21-1993	Litter, et al.	
		US- 5,253,275	10-12-1993	Yurt, et al.	
		US- 5,262,275	11-16-1993	Mincer, et al.	
		US- 5,341,474	08-23-1994	Gelman, et al	
		US- 5,428,606	06-27-1995	Moskowitz	
		US- 5,440,336	08-08-1995	Buhro, et al.	
		US- 5,442,749	08-15-1995	Northcutt, et al.	
		US- 5,508,733	04-16-1996	Kassatly	
		US- 5,524,141	06-04-1996	Braun, et al.	
		US- 5,528,281	06-18-1996	Grady, et al.	
		US- 5,541,917	06-30-1996	Farris	
		US- 5,550,557	08-27-1996	Verbiest, et al.	
		US- 5,550,578	08-27-1996	Hoarty, et al.	
		US- 5,550,863	08-27-1996	Yurt, et al.	
		US- 5,553,311	09-03-1996	McLaughlin, et al.	
		US- 5,557,675	09-17-1996	Schupak	
		US- 5,561,688	10-01-1996	Jones, Jr.	
		US- 5,563,649	10-08-1996	Gould, et al.	

RECEIVED  
MAR 04 2004

Technology Center 2600

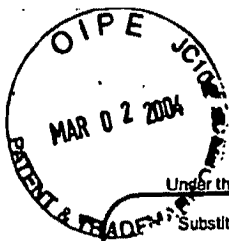
FOREIGN PATENT DOCUMENTS						
Examiner Initials*	Cite No. <sup>1</sup>	Foreign Patent Document	Publication Date MM-DD-YYYY	Name of Patentee or Applicant of Cited Document	Pages, Columns, Lines, Where Relevant Passages Or Relevant Figures Appear	T <sup>6</sup>
		Country Code <sup>2</sup> -Number <sup>3</sup> -Kind Code <sup>4</sup> (if known)				

Examiner Signature		Date Considered	5/14/05
--------------------	--	-----------------	---------

\*EXAMINER: Initial if reference considered, whether or not citation is in conformance with MPEP 609. Draw line through citation if not in conformance and not considered. Include copy of this form with next communication to applicant. <sup>1</sup> Applicant's unique citation designation number (optional). <sup>2</sup> See Kinds Codes of USPTO Patent Documents at [www.uspto.gov](http://www.uspto.gov) or MPEP 901.04. <sup>3</sup> Enter Office that issued the document, by the two-letter code (WIPO Standard ST.3). <sup>4</sup> For Japanese patent documents, the indication of the year of the reign of the Emperor must precede the serial number of the patent document. <sup>5</sup> Kind of document by the appropriate symbols as indicated on the document under WIPO Standard ST.16 if possible. <sup>6</sup> Applicant is to place a check mark here if English language translation is attached.

This collection of information is required by 37 CFR 1.97 and 1.98. The information is required to obtain or retain a benefit by the public which is to file (and by the USPTO to process) an application. Confidentiality is governed by 35 U.S.C. 122 and 37 CFR 1.14. This collection is estimated to take 2 hours to complete, including gathering, preparing, and submitting the completed application form to the USPTO. Time will vary depending upon the individual case. Any comments on the amount of time you require to complete this form and/or suggestions for reducing this burden, should be sent to the Chief Information Officer, U.S. Patent and Trademark Office, P.O. Box 1450, Alexandria, VA 22313-1450. DO NOT SEND FEES OR COMPLETED FORMS TO THIS ADDRESS. SEND TO: Commissioner for Patents, P.O. Box 1450, Alexandria, VA 22313-1450.

If you need assistance in completing the form, call 1-800-PTO-9199 (1-800-786-9199) and select option 2.



PTO/SB/08A (08-03)  
 Approved for use through 07/31/2008. OMB 0651-0031  
 U.S. Patent and Trademark Office; U.S. DEPARTMENT OF COMMERCE

Under the Paperwork Reduction Act of 1995, no persons are required to respond to a collection of information unless it contains a valid OMB control number.

Substitute for form 1449/PTO

## INFORMATION DISCLOSURE STATEMENT BY APPLICANT

(Use as many sheets as necessary)

Sheet 2 of 3

Complete if Known	
Application Number	10/223,200
Filing Date	August 16, 2003
First Named Inventor	Michael E. Shanahan
Art Unit	2681
Examiner Name	
Attorney Docket Number	MES/001/CON

U. S. PATENT DOCUMENTS					
Examiner Initials*	Cite No. <sup>1</sup>	Document Number	Publication Date MM-DD-YYYY	Name of Patentee or Applicant of Cited Document	Pages, Columns, Lines, Where Relevant Passages or Relevant Figures Appear
		Number-Kind Code <sup>2</sup> (if known)			
a		US- 5,566,353	10-15-1996	Cho, et al.	
		US- 5,568,181	10-22-1996	Greenwood, et al.	
		US- 5,570,126	10-29-1996	Blahut, et al.	
		US- 5,613,190	03-18-1997	Hylton, et al.	<b>RECEIVED</b>
		US- 5,613,191	03-18-1997	Hylton, et al.	
		US- 5,619,247	04-08-1997	Russo	<b>MAR 04 2004</b>
		US- 5,625,404	04-29-1997	Grady, et al.	
		US- 5,625,405	04-29-1997	DuLac, et al.	<b>Technology Center 2600</b>
		US- 5,644,354	07-01-1997	Thompson, et al.	
		US- 5,675,738	10-07-1997	Suzuki, et al.	
		US- 5,677,905	10-14-1997	Bigham, et al.	
		US- 5,680,325	10-21-1997	Rohner	
		US- 5,790,423	08-04-1998	Lau, et al.	
		US- 5,793,413	08-11-1998	Hylton, et al.	
		US- 5,793,980	08-11-1998	Glaser, et al.	
		US- 5,880,770	03-09-1999	Ilcisin, et al.	
		US- 5,926,624	07-20-1999	Katz, et al.	
		US- 5,943,046	08-24-1999	Cave, et al.	
a		US- 5,983,069	11-09-1999	Cho, et al.	

FOREIGN PATENT DOCUMENTS						
Examiner Initials*	Cite No. <sup>1</sup>	Foreign Patent Document	Publication Date MM-DD-YYYY	Name of Patentee or Applicant of Cited Document	Pages, Columns, Lines, Where Relevant Passages Or Relevant Figures Appear	T <sup>6</sup>
		Country Code <sup>3</sup> Number <sup>4</sup> Kind Code <sup>5</sup> (if known)				

Examiner Signature	Date Considered	5/14/05
--------------------	-----------------	---------

\*EXAMINER: Initial if reference considered, whether or not citation is in conformance with MPEP 609. Draw line through citation if not in conformance and not considered. Include copy of this form with next communication to applicant. <sup>1</sup> Applicant's unique citation designation number (optional). <sup>2</sup> See Kinds Codes of USPTO Patent Documents at [www.uspto.gov](http://www.uspto.gov) or MPEP 901.04. <sup>3</sup> Enter Office that issued the document, by the two-letter code (WIPO Standard ST.3). <sup>4</sup> For Japanese patent documents, the indication of the year of the reign of the Emperor must precede the serial number of the patent document. <sup>5</sup> Kind of document by the appropriate symbols as indicated on the document under WIPO Standard ST.16 if possible. <sup>6</sup> Applicant is to place a check mark here if English language Translation is attached.

This collection of information is required by 37 CFR 1.97 and 1.98. The information is required to obtain or retain a benefit by the public which is to file (and by the USPTO to process) an application. Confidentiality is governed by 35 U.S.C. 122 and 37 CFR 1.14. This collection is estimated to take 2 hours to complete, including gathering, preparing, and submitting the completed application form to the USPTO. Time will vary depending upon the individual case. Any comments on the amount of time you require to complete this form and/or suggestions for reducing this burden, should be sent to the Chief Information Officer, U.S. Patent and Trademark Office, P.O. Box 1450, Alexandria, VA 22313-1450. DO NOT SEND FEES OR COMPLETED FORMS TO THIS ADDRESS. SEND TO: Commissioner for Patents, P.O. Box 1450, Alexandria, VA 22313-1450.

*If you need assistance in completing the form, call 1-800-PTO-9199 (1-800-786-9199) and select option 2.*





FORM PTO-1449

U.S. DEPARTMENT OF COMMERCE  
PATENT AND TRADEMARK OFFICE

ATTY. DOCKET NO.  
MES/001 Con

SERIAL NO.  
10/223,200

APPLICANT  
Michael E. Shanahan

FILING DATE  
August 16, 2002

GROUP  
2681

INFORMATION DISCLOSURE  
STATEMENT BY APPLICANT



U.S. PATENT DOCUMENTS

EXAMINER INITIAL	DOCUMENT NUMBER	DATE	NAME	CLASS	SUBCLASS	FILING DATE IF APPROPRIATE	
<i>a</i>	4,866,766	09/89	Mitzlaff	379	374		
	4,868,561	09/89	Davis	340	825.44		
	5,452,354	09/95	Kyronlahti et al.	379	375		
	5,600,712	02/97	Hanson et al.	379	142.06		
	5,724,411	03/98	Eisdorfer et al.	379	93.23		
	5,870,683	02/99	Wells et al.	455	566		
	5,907,604	05/99	Hsu	379	142.06		
	5,987,323	11/99	Huotari	455	433		
	6,138,006	10/00	Foti	455	414		
	<i>a</i>	6,389,124	05/02	Schnarel et al.	379	142.01	
		6,483,531	11/02	Ryu	348	14.01	

RECEIVED  
FEB 03 2003  
Technology Center 2800

OTHER DOCUMENTS (Including Author, Title, Date, Pertinent Pages, Etc.)

EXAMINER INITIAL	

EXAMINER

DATE CONSIDERED

*5/14/05*


EXAMINER: Initial if citation considered, whether or not citation is in conformance with MPEP 609; Draw line through citation if not conformance and not considered. Include copy of this form with next communication to applicant.

FORM PTO-1449	U.S. DEPARTMENT OF COMMERCE PATENT AND TRADEMARK OFFICE	ATTY. DOCKET NO. MES/001CON	SERIAL NO. 09/518,712
INFORMATION DISCLOSURE STATEMENT BY APPLICANT		APPLICANT Michael E. Shanahan	
		FILING DATE March 3, 2000	GROUP 2683

1017 U.S. PTO  
 10/223200  
 08/16/02

U.S. PATENT DOCUMENTS

EXAMINER INITIAL	DOCUMENT NUMBER	DATE	NAME	CLASS	SUBCLASS	FILING DATE IF APPROPRIATE
<i>a</i>	5,414,444	05/09/95	Britz	345	156	
	5,461,666	10/24/95	McMahan et al.	379	67	
	5,479,510	12/26/95	Olsen et al.	380	24	
	5,481,599	01/02/96	MacAllister et al.	379	101	
	5,483,580	01/09/96	Brandman et al.	379	88	
	5,483,581	01/09/96	Hird et al.	379	132	
	5,485,370	01/16/96	Moss et al.	364	408	
	5,486,686	01/23/96	Zdybel, Jr. et al.	235	375	
	5,487,671	01/30/96	Shapiro et al.	434	185	
	5,490,210	02/06/96	Sasso	379	100	
	5,490,251	02/06/96	Clark et al.	395	200.2	
	5,499,288	03/12/96	Hunt et al.	379	88	
	5,510,777	04/23/96	Pilc et al.	340	825.310	
	5,513,272	04/30/96	Bogosian, Jr.	382	116	
	5,517,605	05/14/96	Wolf	395	155	
	5,526,620	06/18/96	Hallsten	52	246	
	5,530,852	06/25/96	Meske, Jr. et al.	395	600	
	5,533,115	07/02/96	Hollenbach et al.	379	220	
	5,534,855	07/09/96	Shockley et al.	340	825.300	
	5,537,586	07/16/96	Amram et al.	395	600	
	5,542,046	07/30/96	Carlson et al.	395	186	
	5,544,255	08/06/96	Smithies et al.	382	119	
	5,544,322	08/06/96	Cheng et al.	395	200.12	
	5,548,726	08/20/96	Pettus	395	200.09	
	5,550,976	08/27/96	Henderson et al.	395	200.06	
	5,551,021	08/27/96	Harada et al.	395	600	
	5,572,571	11/06/96	Shirai	379	58	
	5,598,461	01/28/97	Greenberg	379	67	
<i>a</i>	5,606,597	02/25/97	Newland	379	61	

EXAMINER 

DATE CONSIDERED 5/14/07

EXAMINER: Initial if citation considered, whether or not citation is in conformance with MPEP 609; Draw line through citation if not conformance and not considered. Include copy of this form with next communication to applicant.

EV133107427US

FORM PTO-1449

U.S. DEPARTMENT OF COMMERCE  
PATENT AND TRADEMARK OFFICE

ATTY. DOCKET NO.  
MES/001CON

SERIAL NO.  
09/518,712

INFORMATION DISCLOSURE  
STATEMENT BY APPLICANT

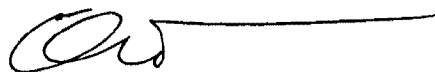
APPLICANT  
Michael E. Shanahan

FILING DATE  
March 3, 2000

GROUP  
2683

	5,608,786	03/04/97	Gordon	379	100	
	5,612,682	03/18/97	DeLuca et al.	340	825.34	
	5,613,012	03/18/97	Hoffman et al	382	115	
	5,623,531	04/22/97	Nilssen	379	56	
	5,661,802	08/26/97	Nilssen	380	20	
	5,687,227	11/11/97	Cohrs et al.	379	374	
	5,689,825	11/18/97	Averbuch et al.	455	89	
	5,727,047	03/10/98	Bentley et al.	379	93	
	5,796,728	08/18/98	Rondeau et al.	370	338	
	5,828,956	10/27/98	Shirai	455	411	
	5,842,124	11/24/98	Kenagy et al.	455	418	
	5,884,262	03/16/99	Wise et al.	704	270	
	5,915,001	06/22/99	Uppaluru	379	88.22	
	5,926,756	07/20/99	Piosenka et al.	455	418	
	5,930,703	07/27/99	Cairns	455	418	
	5,940,752	08/17/99	Henrick	455	419	
	5,940,775	08/17/99	Kim	455	567	
	5,953,638	09/14/99	Flood et al.	455	31.2	
	5,999,094	12/07/99	Nilssen	340	507	
	5,999,599	12/07/99	Schaffer et al.	379	93.23	
	6,002,761	12/14/99	Sremac	379	374	
	6,018,654	01/25/00	Valentine et al.	455	414	
	6,018,656	01/25/00	Shirai	455	422	
	6,035,018	03/07/00	Kaufman	379	88.17	
	6,035,189	03/07/00	Ali-Vehmas et al.	455	414	
	6,058,161	05/02/00	Anderson et al.	379	27	
	6,073,003	06/06/00	Nilsenn	455	402	
	6,088,730	07/11/00	Kato et al.	709	227	
	6,094,587	07/25/00	Armanto et al.	455	567	
	6,122,526	09/19/00	Parluski et al.	455	556	
	6,137,525	10/24/00	Lee et al.	348	14	
	6,144,722	11/07/00	Anderson et al.	379	27	
	6,167,130	12/26/00	Rosen	379	355	

EXAMINER



DATE CONSIDERED

8/14/97

EXAMINER: Initial if citation considered, whether or not citation is in conformance with MPEP 609; Draw line through citation if not conformance and not considered. Include copy of this form with next communication to applicant.

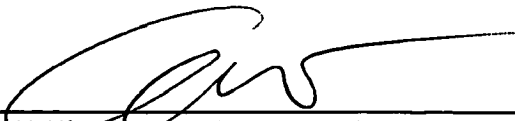
FORM PTO-1449 U.S. DEPARTMENT OF COMMERCE PATENT AND TRADEMARK OFFICE  INFORMATION DISCLOSURE STATEMENT BY APPLICANT	ATTY. DOCKET NO. MES/001CON	SERIAL NO. 09/518,712
	APPLICANT Michael E. Shanahan	
	FILING DATE March 3, 2000	GROUP 2683

<i>a</i>	6,167,278	12/26/00	Nilssen	455	462	
<i>f</i>	6,179,682	01/30/01	Plain et al.	446	141	
<i>f</i>	6,256,378	07/03/01	Iggulden et al.	379	102.03	
<i>a</i>	6,366,791	04/02/02	Lin et al.	455	567	

FOREIGN PATENT DOCUMENTS

EXAMINER INITIAL	DOCUMENT NUMBER	DATE	COUNTRY	CLASS	SUBCLASS	TRANSLATION
<i>a</i>	EP 0 851 649 A2	12/16/97	Europe			
<i>f</i>	WO 9928897	12/04/97				
<i>f</i>	WO 0038340	12/22/98				
<i>f</i>	WO 9943136	02/18/98				
<i>a</i>	JP 09205471	08/05/97	Japan			

EXAMINER



DATE CONSIDERED

*5/19/05*

EXAMINER: Initial if citation considered, whether or not citation is in conformance with MPEP 609; Draw line through citation if not conformance and not considered. Include copy of this form with next communication to applicant.



<b>Notice of References Cited</b>	Application/Control No. 10/223,200	Applicant(s)/Patent Under Reexamination SHANAHAN, MICHAEL E.	
	Examiner CongVan Tran	Art Unit 2683	Page 1 of 1

**U.S. PATENT DOCUMENTS**

*	Document Number Country Code-Number-Kind Code	Date MM-YYYY	Name	Classification
A	US-6,392,640	05-2002	Will, Craig Alexander	345/184
B	US-6,599,147	07-2003	Mills et al.	439/377
C	US-6,754,509	06-2004	Khan et al.	455/556.1
D	US-6,253,061	06-2001	Helferich, Richard J.	340/7.22
E	US-6,564,056	05-2003	Fitzgerald, Christopher A.	455/435.1
F	US-			
G	US-			
H	US-			
I	US-			
J	US-			
K	US-			
L	US-			
M	US-			

**FOREIGN PATENT DOCUMENTS**

*	Document Number Country Code-Number-Kind Code	Date MM-YYYY	Country	Name	Classification
N					
O					
P					
Q					
R					
S					
T					

**NON-PATENT DOCUMENTS**

*	Include as applicable: Author, Title Date, Publisher, Edition or Volume, Pertinent Pages)
U	
V	
W	
X	

\*A copy of this reference is not being furnished with this Office action. (See MPEP § 707.05(a).)  
Dates in MM-YYYY format are publication dates. Classifications may be US or foreign.



**Index of Claims**



Application No.

10/223,200

Examiner

CongVan Tran

Applicant(s)

SHANAHAN, MICHAEL E.

Art Unit

2683

√	Rejected
=	Allowed

-	(Through numeral) Cancelled
÷	Restricted

N	Non-Elected
I	Interference

A	Appeal
O	Objected

Claim		Date
Final	Original	
	5/16/05	
	<del>1</del>	
	<del>2</del>	
	<del>3</del>	
	<del>4</del>	
	<del>5</del>	
	<del>6</del>	
	<del>7</del>	
	<del>8</del>	
	<del>9</del>	
	10	
	11	
	12	
	13	
	14	
	15	
	16	
	17	
	18	
	19	
	20	
	21	
	22	
	23	
	24	
	25	
	26	
	27	
	28	
	29	
	30	
	31	
	32	
	33	
	34	
	35	
	36	
	37	
	38	
	39	
	40	
	41	
	42	
	43	
	44	
	45	
	46	
	47	
	48	
	49	
	<del>50</del>	

Claim		Date
Final	Original	
	5/16/05	
	<del>51</del>	
	<del>52</del>	
	<del>53</del>	
	<del>54</del>	
	<del>55</del>	
	<del>56</del>	
	<del>57</del>	
	<del>58</del>	
	<del>59</del>	
	60	
	61	
	62	
	63	
	64	
	65	
	66	
	67	
	68	
	69	
	70	
	71	
	72	
	73	
	74	
	75	
	76	
	77	
	78	
	79	
	80	
	81	
	82	
	83	
	84	
	85	
	86	
	87	
	88	
	89	
	90	
	91	
	92	
	93	
	94	
	95	
	96	
	97	
	98	
	99	
	100	

Claim		Date
Final	Original	
	5/16/05	
	<del>101</del>	
	<del>102</del>	
	<del>103</del>	
	<del>104</del>	
	105	
	106	
	107	
	108	
	109	
	110	
	111	
	112	
	113	
	114	
	115	
	116	
	117	
	118	
	119	
	120	
	121	
	122	
	123	
	124	
	125	
	126	
	127	
	128	
	129	
	130	
	131	
	132	
	133	
	134	
	135	
	136	
	137	
	138	
	139	
	140	
	141	
	142	
	143	
	144	
	145	
	146	
	147	
	148	
	149	
	150	



UNITED STATES PATENT AND TRADEMARK OFFICE

UNITED STATES DEPARTMENT OF COMMERCE  
United States Patent and Trademark Office  
Address: COMMISSIONER FOR PATENTS  
P.O. Box 1450  
Alexandria, Virginia 22313-1450  
www.uspto.gov

APPLICATION NO.	FILING DATE	FIRST NAMED INVENTOR	ATTORNEY DOCKET NO.	CONFIRMATION NO.
10/223,200	08/16/2002	Michael E. Shanahan	MES/001CON	8026
32850	7590	03/21/2005	EXAMINER TRAN, CONGVAN	
MICHAEL E SHANAHAN P.O. BOX 381 NYACK, NY 10960			ART UNIT	PAPER NUMBER
			2683	
DATE MAILED: 03/21/2005				

Please find below and/or attached an Office communication concerning this application or proceeding.

<b>Office Action Summary</b>	<b>Application No.</b> 10/223,200	<b>Applicant(s)</b> SHANAHAN, MICHAEL E.	
	<b>Examiner</b> CongVan Tran	<b>Art Unit</b> 2683	

-- The MAILING DATE of this communication appears on the cover sheet with the correspondence address --

**Period for Reply**

A SHORTENED STATUTORY PERIOD FOR REPLY IS SET TO EXPIRE 1 MONTH(S) FROM THE MAILING DATE OF THIS COMMUNICATION.

- Extensions of time may be available under the provisions of 37 CFR 1.136(a). In no event, however, may a reply be timely filed after SIX (6) MONTHS from the mailing date of this communication.
- If the period for reply specified above is less than thirty (30) days, a reply within the statutory minimum of thirty (30) days will be considered timely.
- If NO period for reply is specified above, the maximum statutory period will apply and will expire SIX (6) MONTHS from the mailing date of this communication.
- Failure to reply within the set or extended period for reply will, by statute, cause the application to become ABANDONED (35 U.S.C. § 133). Any reply received by the Office later than three months after the mailing date of this communication, even if timely filed, may reduce any earned patent term adjustment. See 37 CFR 1.704(b).

**Status**

- 1)  Responsive to communication(s) filed on 16 August 2002.
- 2a)  This action is **FINAL**.                      2b)  This action is non-final.
- 3)  Since this application is in condition for allowance except for formal matters, prosecution as to the merits is closed in accordance with the practice under *Ex parte Quayle*, 1935 C.D. 11, 453 O.G. 213.

**Disposition of Claims**

- 4)  Claim(s) 1-104 is/are pending in the application.  
    4a) Of the above claim(s) 1-15 is/are withdrawn from consideration.
- 5)  Claim(s) \_\_\_\_\_ is/are allowed.
- 6)  Claim(s) \_\_\_\_\_ is/are rejected.
- 7)  Claim(s) \_\_\_\_\_ is/are objected to.
- 8)  Claim(s) 16-104 are subject to restriction and/or election requirement.

**Application Papers**

- 9)  The specification is objected to by the Examiner.
- 10)  The drawing(s) filed on \_\_\_\_\_ is/are: a)  accepted or b)  objected to by the Examiner.  
    Applicant may not request that any objection to the drawing(s) be held in abeyance. See 37 CFR 1.85(a).  
    Replacement drawing sheet(s) including the correction is required if the drawing(s) is objected to. See 37 CFR 1.121(d).
- 11)  The oath or declaration is objected to by the Examiner. Note the attached Office Action or form PTO-152.

**Priority under 35 U.S.C. § 119**

- 12)  Acknowledgment is made of a claim for foreign priority under 35 U.S.C. § 119(a)-(d) or (f).  
    a)  All    b)  Some \*    c)  None of:
1.  Certified copies of the priority documents have been received.
2.  Certified copies of the priority documents have been received in Application No. \_\_\_\_\_.
3.  Copies of the certified copies of the priority documents have been received in this National Stage application from the International Bureau (PCT Rule 17.2(a)).
- \* See the attached detailed Office action for a list of the certified copies not received.

**Attachment(s)**

- |                                                                                                                        |                                                                                         |
|------------------------------------------------------------------------------------------------------------------------|-----------------------------------------------------------------------------------------|
| 1) <input type="checkbox"/> Notice of References Cited (PTO-892)                                                       | 4) <input type="checkbox"/> Interview Summary (PTO-413)<br>Paper No(s)/Mail Date. _____ |
| 2) <input type="checkbox"/> Notice of Draftsperson's Patent Drawing Review (PTO-948)                                   | 5) <input type="checkbox"/> Notice of Informal Patent Application (PTO-152)             |
| 3) <input type="checkbox"/> Information Disclosure Statement(s) (PTO-1449 or PTO/SB/08)<br>Paper No(s)/Mail Date _____ | 6) <input type="checkbox"/> Other: _____                                                |

## DETAILED ACTION

### *Election/Restrictions*

1. Restriction to one of the following inventions is required under 35 U.S.C. 121:
  - I. Claims 16-32, 50-67, 72-73, and 99-104 drawn to a wireless telephone by programming an audio file, classified in class 455, subclass 418.
  - II. Claims 33-49, 68-71 and 74-98, drawn to radiotelephone equipment detail, classified in class 455, subclass 550.1.

The inventions are distinct, each from the other because of the following reasons:

2. Inventions I and II are related as combination and subcombination. Inventions in this relationship are distinct if it can be shown that (1) the combination as claimed does not require the particulars of the subcombination as claimed for patentability, and (2) that the subcombination has utility by itself or in other combinations (MPEP § 806.05(c)). In the instant case, the combination as claimed does not require the particulars of the subcombination as claimed because first group relates to programming an audio file and second group relates to detail of radiotelephone. The subcombination has separate utility such as programming an audio file in radiotelephone.
3. Because these inventions are distinct for the reasons given above and have acquired a separate status in the art as shown by their different classification, restriction for examination purposes as indicated is proper.


Art Unit: 2683

4. Applicant is advised that the reply to this requirement to be complete must include an election of the invention to be examined even though the requirement be traversed (37 CFR 1.143).

5. Any inquiry concerning this communication or earlier communications from the examiner should be directed to CongVan Tran whose telephone number is 703-305-4024. The examiner can normally be reached on Monday-Thursday.

If attempts to reach the examiner by telephone are unsuccessful, the examiner's supervisor, William Trost can be reached on 703-308-5318. The fax phone number for the organization where this application or proceeding is assigned is 703-872-9306.

Information regarding the status of an application may be obtained from the Patent Application Information Retrieval (PAIR) system. Status information for published applications may be obtained from either Private PAIR or Public PAIR. Status information for unpublished applications is available through Private PAIR only. For more information about the PAIR system, see <http://pair-direct.uspto.gov>. Should you have questions on access to the Private PAIR system, contact the Electronic Business Center (EBC) at 866-217-9197 (toll-free).

  
CONGVAN TRAN  
PRIMARY EXAMINER

CongVan Tran  
Examiner  
Art Unit 2683

March 17, 2005.

**Index of Claims**



Application No.

10/223,200

Examiner

CongVan Tran

Applicant(s)

SHANAHAN, MICHAEL E.

Art Unit

2683

√	Rejected
=	Allowed

-	(Through numeral) Cancelled
+	Restricted

N	Non-Elected
I	Interference

A	Appeal
O	Objected

Claim		Date			
Final	Original	3/17/05			
-0	1	-			
-0	2	-			
-0	3	-			
-0	4	-			
-0	5	-			
-0	6	-			
-0	7	-			
-0	8	-			
-0	9	-			
-0	10	-			
-0	11	-			
-0	12	-			
-0	13	-			
-0	14	-			
-0	15	-			
	16	+			
	17				
	18				
	19				
	20				
	21				
	22				
	23				
	24				
	25				
	26				
	27				
	28				
	29				
	30				
	31				
	32				
	33				
	34				
	35				
	36				
	37				
	38				
	39				
	40				
	41				
	42				
	43				
	44				
	45				
	46				
	47				
	48				
	49				
	50				

Claim		Date			
Final	Original	3/17/05			
	51	+			
	52				
	53				
	54				
	55				
	56				
	57				
	58				
	59				
	60				
	61				
	62				
	63				
	64				
	65				
	66				
	67				
	68				
	69				
	70				
	71				
	72				
	73				
	74				
	75				
	76				
	77				
	78				
	79				
	80				
	81				
	82				
	83				
	84				
	85				
	86				
	87				
	88				
	89				
	90				
	91				
	92				
	93				
	94				
	95				
	96				
	97				
	98				
	99				
	100				

Claim		Date			
Final	Original	3/17/05			
	101	+			
	102				
	103				
	104	+			
	105				
	106				
	107				
	108				
	109				
	110				
	111				
	112				
	113				
	114				
	115				
	116				
	117				
	118				
	119				
	120				
	121				
	122				
	123				
	124				
	125				
	126				
	127				
	128				
	129				
	130				
	131				
	132				
	133				
	134				
	135				
	136				
	137				
	138				
	139				
	140				
	141				
	142				
	143				
	144				
	145				
	146				
	147				
	148				
	149				
	150				





RECEIVED  
MAR 04 2004

2681

PTO/SB/21 (02-04)

Approved for use through 07/31/2006. OMB 0651-0031  
U.S. Patent and Trademark Office; U.S. DEPARTMENT OF COMMERCE

Under the Paperwork Reduction Act of 1995, no persons are required to respond to a collection of information unless it displays a valid OMB control number.

TC 2600

#14  
fd  
4/20/04

<b>TRANSMITTAL FORM</b> <i>(to be used for all correspondence after initial filing)</i>	Application Number	10/223,200	<b>RECEIVED</b> <b>MAR 04 2004</b> <b>Technology Center 2600</b>
	Filing Date	August 16, 2003	
	First Named Inventor	Michael E. Shanahan	
	Art Unit	2681	
	Examiner Name	Not Yet Assigned	
Total Number of Pages in This Submission	4	Attorney Docket Number	MES/001 CON

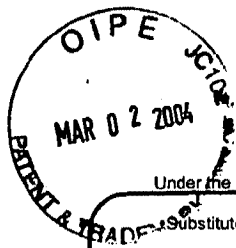
ENCLOSURES <i>(Check all that apply)</i>		
<input checked="" type="checkbox"/> Fee Transmittal Form	<input type="checkbox"/> Drawing(s)	<input type="checkbox"/> After Allowance communication to Technology Center (TC)
<input type="checkbox"/> Fee Attached	<input type="checkbox"/> Licensing-related Papers	<input type="checkbox"/> Appeal Communication to Board of Appeals and Interferences
<input type="checkbox"/> Amendment/Reply	<input type="checkbox"/> Petition	<input type="checkbox"/> Appeal Communication to TC (Appeal Notice, Brief, Reply Brief)
<input type="checkbox"/> After Final	<input type="checkbox"/> Petition to Convert to a Provisional Application	<input type="checkbox"/> Proprietary Information
<input type="checkbox"/> Affidavits/declaration(s)	<input type="checkbox"/> Power of Attorney, Revocation Change of Correspondence Address	<input type="checkbox"/> Status Letter
<input type="checkbox"/> Extension of Time Request	<input type="checkbox"/> Terminal Disclaimer	<input type="checkbox"/> Other Enclosure(s) (please identify below):
<input type="checkbox"/> Express Abandonment Request	<input type="checkbox"/> Request for Refund	
<input checked="" type="checkbox"/> Information Disclosure Statement	<input type="checkbox"/> CD, Number of CD(s) _____	
<input type="checkbox"/> Certified Copy of Priority Document(s)	Remarks	
<input type="checkbox"/> Response to Missing Parts/ Incomplete Application	Submitted in accordance with 37 C.F.R. Section 1.97(B)(8).	
<input type="checkbox"/> Response to Missing Parts under 37 CFR 1.52 or 1.53		

SIGNATURE OF APPLICANT, ATTORNEY, OR AGENT	
Firm or Individual name	Law Offices of Scott H. Kaliko, L.L.C. Scott H. Kaliko, Esq. Reg No. 45,786
Signature	
Date	2/26/04

CERTIFICATE OF TRANSMISSION/MAILING		
I hereby certify that this correspondence is being facsimile transmitted to the USPTO or deposited with the United States Postal Service with sufficient postage as first class mail in an envelope addressed to: Commissioner for Patents, P.O. Box 1450, Alexandria, VA 22313-1450 on the date shown below.		
Typed or printed name	Scott H. Kaliko	
Signature		Date
		2/27/04

This collection of information is required by 37 CFR 1.5. The information is required to obtain or retain a benefit by the public which is to file (and by the USPTO to process) an application. Confidentiality is governed by 35 U.S.C. 122 and 37 CFR 1.14. This collection is estimated to 2 hours to complete, including gathering, preparing, and submitting the completed application form to the USPTO. Time will vary depending upon the individual case. Any comments on the amount of time you require to complete this form and/or suggestions for reducing this burden, should be sent to the Chief Information Officer, U.S. Patent and Trademark Office, U.S. Department of Commerce, P.O. Box 1450, Alexandria, VA 22313-1450. DO NOT SEND FEES OR COMPLETED FORMS TO THIS ADDRESS. SEND TO: Commissioner for Patents, P.O. Box 1450, Alexandria, VA 22313-1450.

If you need assistance in completing the form, call 1-800-PTO-9199 and select option 2.



Under the Paperwork Reduction Act of 1995, no persons are required to respond to a collection of information unless it contains a valid OMB control number.

<b>INFORMATION DISCLOSURE STATEMENT BY APPLICANT</b> <i>(Use as many sheets as necessary)</i>	Substitute for form 1449/PTO		<b>Complete if Known</b>	
	Application Number	10/223,200		
	Filing Date	August 16, 2003		
	First Named Inventor	Michael E. Shanahan		
	Art Unit	2681		
	Examiner Name	MES/001 CON		
Attorney Docket Number	MES/001 CON			
Sheet	1	of	3	

U. S. PATENT DOCUMENTS					
Examiner Initials*	Cite No. <sup>1</sup>	Document Number	Publication Date MM-DD-YYYY	Name of Patentee or Applicant of Cited Document	Pages, Columns, Lines, Where Relevant Passages or Relevant Figures Appear
		Number-Kind Code <sup>2</sup> (if known)			
		US- 5,220,420	06-15-1993	Hoarty, et al.	
		US- 5,247,347	09-21-1993	Litter, et al.	
		US- 5,253,275	10-12-1993	Yurt, et al.	
		US- 5,262,275	11-16-1993	Mincer, et al.	
		US- 5,341,474	08-23-1994	Gelman, et al	
		US- 5,428,606	06-27-1995	Moskowitz	
		US- 5,440,336	08-08-1995	Buhro, et al.	
		US- 5,442,749	08-15-1995	Northcutt, et al.	
		US- 5,508,733	04-16-1996	Kassatly	
		US- 5,524,141	06-04-1996	Braun, et al.	
		US- 5,528,281	06-18-1996	Grady, et al.	
		US- 5,541,917	06-30-1996	Farris	
		US- 5,550,557	08-27-1996	Verbiest, et al.	
		US- 5,550,578	08-27-1996	Hoarty, et al.	
		US- 5,550,863	08-27-1996	Yurt, et al.	
		US- 5,553,311	09-03-1996	McLaughlin, et al.	
		US- 5,557,675	09-17-1996	Schupak	
		US- 5,561,688	10-01-1996	Jones, Jr.	
		US- 5,563,649	10-08-1996	Gould, et al.	

RECEIVED  
MAR 04 2004  
Technology Center 2600

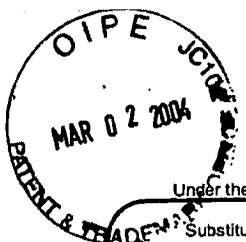
FOREIGN PATENT DOCUMENTS						
Examiner Initials*	Cite No. <sup>1</sup>	Foreign Patent Document	Publication Date MM-DD-YYYY	Name of Patentee or Applicant of Cited Document	Pages, Columns, Lines, Where Relevant Passages Or Relevant Figures Appear	T <sup>d</sup>
		Country Code <sup>3</sup> Number <sup>4</sup> Kind Code <sup>5</sup> (if known)				

Examiner Signature	Date Considered
--------------------	-----------------

\*EXAMINER: Initial if reference considered, whether or not citation is in conformance with MPEP 609. Draw line through citation if not in conformance and not considered. Include copy of this form with next communication to applicant. <sup>1</sup> Applicant's unique citation designation number (optional). <sup>2</sup> See Kinds Codes of USPTO Patent Documents at [www.uspto.gov](http://www.uspto.gov) or MPEP 901.04. <sup>3</sup> Enter Office that issued the document, by the two-letter code (WIPO Standard ST.3). <sup>4</sup> For Japanese patent documents, the indication of the year of the reign of the Emperor must precede the serial number of the patent document. <sup>5</sup> Kind of document by the appropriate symbols as indicated on the document under WIPO Standard ST.16 if possible. <sup>d</sup> Applicant is to place a check mark here if English language Translation is attached.

This collection of information is required by 37 CFR 1.97 and 1.98. The information is required to obtain or retain a benefit by the public which is to file (and by the USPTO to process) an application. Confidentiality is governed by 35 U.S.C. 122 and 37 CFR 1.14. This collection is estimated to take 2 hours to complete, including gathering, preparing, and submitting the completed application form to the USPTO. Time will vary depending upon the individual case. Any comments on the amount of time you require to complete this form and/or suggestions for reducing this burden, should be sent to the Chief Information Officer, U.S. Patent and Trademark Office, P.O. Box 1450, Alexandria, VA 22313-1450. DO NOT SEND FEES OR COMPLETED FORMS TO THIS ADDRESS. SEND TO: Commissioner for Patents, P.O. Box 1450, Alexandria, VA 22313-1450.

If you need assistance in completing the form, call 1-800-PTO-9199 (1-800-786-9199) and select option 2.



Under the Paperwork Reduction Act of 1995, no persons are required to respond to a collection of information unless it contains a valid OMB control number.

<p><b>INFORMATION DISCLOSURE STATEMENT BY APPLICANT</b> (Use as many sheets as necessary)</p>	<p><b>Complete if Known</b></p> <table border="1" style="width:100%; border-collapse: collapse;"> <tr> <td>Application Number</td> <td>10/223,200</td> </tr> <tr> <td>Filing Date</td> <td>August 16, 2003</td> </tr> <tr> <td>First Named Inventor</td> <td>Michael E. SHANAHAN</td> </tr> <tr> <td>Art Unit</td> <td>2681</td> </tr> <tr> <td>Examiner Name</td> <td></td> </tr> <tr> <td>Attorney Docket Number</td> <td>MES 1001 CON</td> </tr> </table>	Application Number	10/223,200	Filing Date	August 16, 2003	First Named Inventor	Michael E. SHANAHAN	Art Unit	2681	Examiner Name		Attorney Docket Number	MES 1001 CON
Application Number	10/223,200												
Filing Date	August 16, 2003												
First Named Inventor	Michael E. SHANAHAN												
Art Unit	2681												
Examiner Name													
Attorney Docket Number	MES 1001 CON												
<p>Substitute for form 1449/PTO</p>													
<p>Sheet <u>2</u> of <u>3</u></p>													

U. S. PATENT DOCUMENTS					
Examiner Initials*	Cite No. <sup>1</sup>	Document Number	Publication Date MM-DD-YYYY	Name of Patentee or Applicant of Cited Document	Pages, Columns, Lines, Where Relevant Passages or Relevant Figures Appear
		Number-Kind Code <sup>2</sup> (if known)			
		US- 5,566,353	10-15-1996	Cho, et al.	
		US- 5,568,181	10-22-1996	Greenwood, et al.	
		US- 5,570,126	10-29-1996	Blahut, et al.	
		US- 5,613,190	03-18-1997	Hylton, et al.	<b>RECEIVED</b>
		US- 5,613,191	03-18-1997	Hylton, et al.	
		US- 5,619,247	04-08-1997	Russo	<b>MAR 04 2004</b>
		US- 5,625,404	04-29-1997	Grady, et al.	
		US- 5,625,405	04-29-1997	DuLac, et al.	<b>Technology Center 2600</b>
		US- 5,644,354	07-01-1997	Thompson, et al.	
		US- 5,675,738	10-07-1997	Suzuki, et al.	
		US- 5,677,905	10-14-1997	Bigham, et al.	
		US- 5,680,325	10-21-1997	Rohner	
		US- 5,790,423	08-04-1998	Lau, et al.	
		US- 5,793,413	08-11-1998	Hylton, et al.	
		US- 5,793,980	08-11-1998	Glaser, et al.	
		US- 5,880,770	03-09-1999	Ilcisin, et al.	
		US- 5,926,624	07-20-1999	Katz, et al.	
		US- 5,943,046	08-24-1999	Cave, et al.	
		US- 5,983,069	11-09-1999	Cho, et al.	

FOREIGN PATENT DOCUMENTS						
Examiner Initials*	Cite No. <sup>1</sup>	Foreign Patent Document	Publication Date MM-DD-YYYY	Name of Patentee or Applicant of Cited Document	Pages, Columns, Lines, Where Relevant Passages Or Relevant Figures Appear	T <sup>6</sup>
		Country Code <sup>3</sup> Number <sup>4</sup> Kind Code <sup>5</sup> (if known)				

Examiner Signature	Date Considered	
--------------------	-----------------	--

\*EXAMINER: Initial if reference considered, whether or not citation is in conformance with MPEP 609. Draw line through citation if not in conformance and not considered. Include copy of this form with next communication to applicant. <sup>1</sup> Applicant's unique citation designation number (optional). <sup>2</sup> See Kinds Codes of USPTO Patent Documents at [www.uspto.gov](http://www.uspto.gov) or MPEP 901.04. <sup>3</sup> Enter Office that issued the document, by the two-letter code (WIPO Standard ST.3). <sup>4</sup> For Japanese patent documents, the indication of the year of the reign of the Emperor must precede the serial number of the patent document. <sup>5</sup> Kind of document by the appropriate symbols as indicated on the document under WIPO Standard ST.16 if possible. <sup>6</sup> Applicant is to place a check mark here if English language Translation is attached.

This collection of information is required by 37 CFR 1.97 and 1.98. The information is required to obtain or retain a benefit by the public which is to file (and by the USPTO to process) an application. Confidentiality is governed by 35 U.S.C. 122 and 37 CFR 1.14. This collection is estimated to take 2 hours to complete, including gathering, preparing, and submitting the completed application form to the USPTO. Time will vary depending upon the individual case. Any comments on the amount of time you require to complete this form and/or suggestions for reducing this burden, should be sent to the Chief Information Officer, U.S. Patent and Trademark Office, P.O. Box 1450, Alexandria, VA 22313-1450. DO NOT SEND FEES OR COMPLETED FORMS TO THIS ADDRESS. SEND TO: Commissioner for Patents, P.O. Box 1450, Alexandria, VA 22313-1450.

If you need assistance in completing the form, call 1-800-PTO-9199 (1-800-786-9199) and select option 2.



RECEIVED  
CENTRAL FAX CENTER

JAN 12 2004

MES/001 CON

# 12/F  
PAC  
B.D.  
OFFICIAL  
12-04

IN THE UNITED STATES PATENT AND TRADEMARK OFFICE

Applicant : Michael E. Shanahan  
Serial No. : 10/223,200 Confirmation No.: 8026  
Filed: : August 16, 2002  
For : METHODS AND APPARATUSES FOR PROGRAMMING  
USER-DEFINED INFORMATION INTO ELECTRONIC  
DEVICES  
Group Art Unit : 2681  
Examiner : Not Yet Assigned

October 14, 2003

Hon. Commissioner  
for Patents  
P.O. box 1450,  
Alexandria VA 22313-1450

PRELIMINARY AMENDMENT IV

Sir:

Before examining this patent application, please  
amend the application as follows:

Priority Data

Applicant notes this case is listed as a  
continuation-in-part (CIP) on the filing receipt dated  
September 23, 2002. This is an error. The specification and  
accompanying declaration, as originally filed, indicate the  
case is a continuation, and not a CIP of United States Patent  
Application 09/518,846 now United States Patent 6,496,692.  
Appropriate correction is respectfully requested.

In the Claims

---

Claims 1-15 (canceled).

16. (Previously presented) A method of customizing a wireless telephone by programming an audio file into the wireless telephone for use as an indicia of an incoming communication, the method comprising:

connecting to a remote database that includes a plurality of lists of audio files;

allowing a user of the wireless telephone to browse at least one of the lists of audio files;

allowing the user of the wireless telephone to select at least one of the audio files from the browsed list;

optionally reviewing the selected audio file before downloading the selected audio into the wireless telephone;

and

allowing the user to optionally download the selected audio file for use as an indicia of an incoming communication.

17. (Previously presented) The method of claim 16 wherein the format of the selected audio file is from the group comprising: MIDI, MPEG, MP3, WAV, PCM, Windows Media Audio code (WMA), or Adaptative Transform Acoustic Coding (ATRAC).

18. (Previously presented) The method of claim 16 further comprising allowing the user to search the remote

database for a certain desired audio file using title or description information to aid in locating the desired audio file.

19. (Previously presented) The method of claim 18 wherein the searching further comprises searching the Internet or other remote databases for the desired audio file.

20. (Previously presented) The method of claim 16 wherein the browsing of audio files is accomplished at least in part using a Wireless Application Protocol (WAP) compliant system.

21. (Currently amended) The method of claim 16 further comprising providing a visual indication on a display screen of the wireless telephone to confirm [an] the selected audio file has been successfully downloaded.

22. (Previously presented) The method of claim 16 further comprising:

downloading a selected audio file into the wireless telephone; and

associating the downloaded audio file with a characteristic indicative of a caller such that the associated audio file plays when the indicative characteristic is received by the wireless telephone.

23. (Previously presented) The method of claim 16 wherein the characteristic indicative of the caller is the caller's telephone number.

24. (Currently amended) A method of customizing a wireless telephone by programming an audio file into the wireless telephone for use as an indicia of an incoming communication, the method comprising:

connecting to a remote database that includes a plurality of audio files; the remote database operating substantially independently of a communications network that provides wireless telephone service to the wireless telephone;

allowing the user of the wireless telephone to browse and select at least one of the audio files;

allowing the user to optionally download the selected audio file into a programmable memory for use as an indicia of an incoming communication.

25. (Previously presented) The method of claim 24 further comprising allowing the user to optionally review the selected audio file before downloading the selected audio file into the wireless telephone.

26. (Previously presented) The method of claim 24 wherein the format of the selected audio file is from the group comprising: MIDI, MPEG, MP3, WAV, PCM, Windows Media



Audio code (WMA), or Adaptative Transform Acoustic Coding (ATRAC).

27. (Previously presented) The method of claim 24 further comprising allowing the user to search the remote database for a certain desired audio file using title or description information to aid in locating the desired audio file.

F1  
cont  
28. (Previously presented) The method of claim 27 wherein the searching further comprises searching the Internet or other remote databases for the desired audio file.

29. (Previously presented) The method of claim 24 wherein the browsing of audio files is accomplished at least in part using a Wireless Application Protocol (WAP) compliant system.

30. (Currently amended) The method of claim 24 further comprising providing a visual indication on a display screen of the wireless telephone to confirm [an] the selected audio file has been successfully downloaded.

31. (Currently amended) The method of claim 24 further comprising:

downloading a selected audio file into the wireless telephone; and

associating the downloaded audio file with a characteristic ~~indictative~~ indicative of a caller such that the associated audio file plays when the indicative characteristic is received by the wireless telephone.

32. (Previously presented) The method of claim 24 wherein the characteristic indicative of the caller is the caller's telephone number.

F1  
Cont

33. (Previously presented) A wireless telephone that may be customized by programming an audio file into the wireless telephone for use as an indicia of an incoming communication, the telephone comprising:

a communications link capable of connecting to a remote database that includes a plurality of lists of audio files;

a display screen that allows a user of the wireless telephone to browse at least one of the lists of audio files and view selectable audio files present in the browsed list;

a speaker and processing circuitry configured to allow the user to optionally review a selected audio file before downloading the selected audio file into the wireless telephone; and

a programmable memory circuit for allowing the user to optionally store the selected audio file for use as an indicia of an incoming communication.

34. (Previously presented) The wireless telephone of claim 33 wherein the programmable memory circuit is configured to store audio files in a format selected from the group comprising: MIDI, MPEG, MP3, WAV, PCM, Windows Media Audio code (WMA), or Adaptative Transform Acoustic Coding (ATRAC).

FI  
cont

35. (Previously presented) The wireless telephone of claim 33 wherein the speaker and processing circuitry is configured to play audio files in a format selected from the group comprising: MIDI, MPEG, MP3, WAV, PCM, Windows Media Audio code (WMA), or Adaptative Transform Acoustic Coding (ATRAC).

36. (Previously presented) The wireless telephone of claim 33 wherein the wireless telephone is configured to allow the user to search the remote database for a certain desired audio file using title or description information to aid in locating the desired audio file.

37. (Previously presented) The wireless telephone of claim 36 wherein the wireless telephone is configured to search the Internet or other remote databases for the desired audio file.

38. (Previously presented) The wireless telephone of claim 33 wherein the wireless telephone includes a Wireless Application Protocol (WAP) compliant Internet browser.

39. (Currently amended) The wireless telephone of claim 33 configured to provide a visual indication on the display screen of the wireless to confirm [an] the selected audio file has been successfully downloaded.

F1  
Cont

40. (Previously presented) The wireless telephone of claim 33 configured to allow the user to associate a downloaded audio file with a characteristic indicative of a caller such that the associated audio file plays when the indicative characteristic is received by the wireless telephone.

41. (Previously presented) The method of claim 33 wherein the characteristic indicative of the caller is the caller's telephone number.

42. (Currently amended) A wireless telephone that may be customized by programming an audio file into the wireless telephone for use as an indicia of an incoming communication, the telephone comprising:

a communications link capable of connecting to a remote database that includes a plurality of lists of audio files; the remote database operating substantially

independently of a communications network that provides wireless telephone service to the wireless telephone;

a display screen that allows a user of the wireless telephone to browse at least one of the plurality of lists of audio files and view selectable audio files present in the browsed list;

processing circuitry configured to receive a selected audio file from the communications link; and

a programmable memory circuit for allowing the user to optionally store the selected audio file for use as an indicia of an incoming communication.

F1  
Cont

43. (Previously presented) The wireless telephone of claim 42 further comprising a speaker that operates in conjunction with the processing circuitry to allow the user to optionally review a selected audio file before downloading the selected audio file into the wireless telephone.

44. (Previously presented) The wireless telephone of claim 42 wherein the programmable memory circuit is configured to store audio files in a format selected from the group comprising: MIDI, MPEG, MP3, WAV, PCM, Windows Media Audio code (WMA), or Adaptive Transform Acoustic Coding (ATRAC).

45. (Previously presented) The wireless telephone of claim 42 wherein the speaker and processing circuitry is

configured to play audio files in a format selected from the group comprising: MIDI, MPEG, MP3, WAV, PCM, Windows Media Audio code (WMA), or Adaptative Transform Acoustic Coding (ATRAC).

46. (Previously presented) The wireless telephone of claim 42 wherein the wireless telephone is configured to allow the user to search the remote database for a certain desired audio file using title or description information to aid in locating the desired audio file.

F1  
cont

47. (Previously presented) The wireless telephone of claim 42 wherein the wireless telephone includes a Wireless Application Protocol (WAP) compliant Internet browser.

48. (Currently amended) The wireless telephone of claim 42 configured to provide a visual indication on the display screen to confirm [an] the selected audio file has been successfully downloaded.

49. (Previously presented) The wireless telephone of claim 42 configured to allow the user to associate a

downloaded audio file with a characteristic indicative of a caller such that the associated audio file plays when the indicative characteristic is received by the wireless telephone.

50. (Currently amended) A wireless telephone that may be customized by programming an audio file into the wireless telephone for use as an indicia of an incoming communication, the telephone comprising:

means for connecting to a remote database that includes a plurality of lists of audio files;

means for browsing at least one of the lists of audio files;

means for ~~select~~ selecting at least one of the audio files from the browsed list;

means for optionally reviewing the selected audio file before downloading the selected audio into the wireless telephone; and

means for downloading the selected audio file for use as an indicia of an incoming communication.

51. (Previously presented) The wireless telephone of claim 50 further comprising means for searching the remote database for a certain desired audio file using title or description information to aid in locating the desired audio file.

52. (Previously presented) The wireless telephone of claim 51 wherein the searching further comprises means for searching the Internet or other remote databases for the desired audio file.

53. (Currently amended) The wireless telephone of claim 50 further comprising means for providing a visual indication on a display screen of the wireless telephone to confirm (an) the selected audio file has been successfully downloaded.

54. (Currently amended) The wireless telephone of claim 50 further comprising means for associating a downloaded audio file with a characteristic ~~indictative~~ indicative of a caller such that the associated audio file plays when the indicative characteristic is received by the wireless telephone.

55. (Previously presented) A wireless telephone that may be customized by programming an audio file into the wireless telephone for use as an indicia of an incoming communication, the telephone comprising:

means for connecting to a remote database that includes a plurality of audio files; the remote database operating independently of a communications network that provides wireless telephone service to the wireless telephone;



means for browsing and selecting at least one of the audio files;

means for optionally downloading the selected audio file into a programmable memory for use as an indicia of an incoming communication.

56. (Previously presented) The wireless telephone of claim 55 further comprising means for optionally reviewing the selected audio file before downloading the selected audio file into the wireless telephone.

57. (Previously presented) The wireless telephone of claim 56 further comprising means for searching the remote database for a certain desired audio file using title or description information to aid in locating the desired audio file.

58. (Previously presented) The wireless telephone of claim 55 wherein the searching further comprises means for searching the Internet or other remote databases for the desired audio file.

59. (Previously presented) The wireless telephone of claim 55 wherein the browsing of audio files is accomplished at least in part using a Wireless Application Protocol (WAP) compliant system.

60. (Currently amended) The wireless telephone of claim 55 further comprising providing a visual indication on a display screen of the wireless telephone to confirm [an] the selected audio file has been successfully downloaded.

61. (Previously presented) The wireless telephone of claim 55 further comprising means for associating a downloaded audio file with a characteristic indicative of a caller such that the associated audio file plays when the indicative characteristic is received by the wireless telephone.

62. (Previously presented) The method of claim 16 further comprising preventing the unauthorized distribution of a downloaded audio file.

63. (Previously presented) The method of claim 16 further comprising playing the selected audio file through an enhanced performance speaker capable of providing a substantially full range of audio sounds from MIDI, MP3, MPEG, WAV, PCM, Windows Media Audio Code (WMA), or Adaptive Transform Acoustic Coding (ATRAC) files.

64. (Previously presented) The method of claim 16 characterized by the use of a personal computer to perform the browsing step.

65. (Previously presented) The method of claim 16 further comprising providing the user with an opportunity to edit the selected audio file.

66. (Previously presented) The method of claim 16 further comprising providing an indication that a memory capacity of the wireless telephone has been exceeded if the size of the audio file to be downloaded is larger than available memory space in the wireless telephone.

F!  
Cont

67. (Previously presented) The method of claim 66 further comprising providing the user of the wireless telephone with the opportunity to cancel or modify a download request associated with an audio file download operation if the size of the audio file to be downloaded is larger than available memory space in the wireless telephone.

68. (Previously presented) The wireless telephone of claim 42 wherein the wireless telephone is configured to prevent the unauthorized distribution of an audio file stored in the programmable memory circuit.

69. (Previously presented) The wireless telephone of claim 43 wherein the speaker is an enhanced performance speaker capable of providing a substantially full range of audio sounds from MIDI, MP3, MPEG, WAV, PCM, Windows Media

Audio Code (WMA), or Adaptive Transform Acoustic Coding (ATRAC) files.

70. (Previously presented) The wireless telephone of claim 42 configured to provide an indication that a memory capacity of the wireless telephone has been exceeded if the size of the audio file to be downloaded is larger than available memory space in the wireless telephone.

F1  
Cont

71. (Previously presented) The wireless telephone of claim 70 configured to provide the user of the wireless telephone with the opportunity to cancel or modify a download request associated with an audio file download operation if the size of the audio file to be downloaded is larger than the available memory space in the wireless telephone.

72. (Currently amended) A wireless telephone that may be customized by programming an audio file into the wireless telephone for use as an indicia of an incoming communication, the telephone comprising:

means for connecting to a remote database that includes a plurality of [of] audio files;

means for selecting at least one of the audio files from the database;

means for downloading and storing the selected audio file for use as an indicia of an incoming communication; and

means for preventing the unauthorized distribution of a selected audio file stored in the wireless telephone.

73. (Previously presented) The wireless telephone of claim 72 further comprising means for indicating that a memory capacity of the wireless telephone has been exceeded if the size of the audio file to be downloaded is larger than available memory space in the wireless telephone.

F1  
cont

74. (Currently amended) A wireless telephone that may be customized by searching for and selecting an audio file from a remote computer and programming the selected audio file into the wireless telephone for use as an indicia of an incoming communication, the telephone comprising:

a communications link capable of connecting to a database in the remote computer that includes a plurality of lists of audio files in MIDI, MPEG, WAV, or MP3 format or a combination thereof;

a display screen and a mobile Internet browser that allows a user of the wireless telephone to browse at least one of the plurality of lists of audio files and view selectable audio files present in the browsed list;

processing circuitry configured to receive a selected one of the audio files from the communications link;

a programmable memory circuit for allowing the user to optionally store the selected audio file for use as an indicia of an incoming communication; and

an enhanced performance speaker capable of providing a substantially full range of audio sounds from ~~MIDI~~ MPEG, WAV, or MP3 files when one of the stored audio files is played as an indicia of an [incomming] incoming communication.

75. (Previously presented) The wireless telephone of claim 74 configured to provide an indication that a memory capacity of the wireless telephone has been exceeded if the size of the audio file to be downloaded is larger than available memory space in the wireless telephone.

76. (Previously presented) The wireless telephone of claim 74 wherein the enhanced performance speaker operates in conjunction with the processing circuitry to allow the user to optionally review a selected audio file before downloading the selected audio file into the wireless telephone.

77. (Previously presented) The wireless telephone of claim 74 configured to allow the user to search the remote database for a certain desired audio file using title or description information to aid in locating the desired audio file.

78. (Previously presented) The wireless telephone of claim 74 configured to prevent the unauthorized distribution of an audio file stored in the programmable memory circuit.

79. (Currently amended) A wireless telephone that may be customized by searching for and selecting an audio file from a remote computer and programming the selected audio file into the wireless telephone for use as an indicia of an incoming communication, the telephone comprising:

a communications link capable of connecting to a database in the remote computer that includes a plurality of [of] polyphonic audio files;

a display screen and a browsing application program that allows a user of the wireless telephone to browse the polyphonic audio files and select at least one polyphonic audio file therefrom;

processing circuitry configured to supervise receipt of a selected polyphonic audio file from the communications link;

a programmable memory circuit for allowing the user to optionally store the selected polyphonic audio file for use as an indicia of an incoming communication; and

an enhanced performance speaker capable of providing a substantially full range of audio sounds from the selected polyphonic audio file when the selected polyphonic audio file is played as an indicia of an ~~incoming~~ incoming communication.

80. (Currently amended) The wireless telephone of claim 79 wherein the polyphonic audio file is selected from the group comprising ~~MIDI~~, MP3, MPEG, or WAV files.

81. (Currently amended) The wireless telephone of claim 79 wherein the enhanced performance speaker operates in conjunction with the processing circuitry to allow the user to optionally review the selected polyphonic audio file before downloading the selected polyphonic audio file into the programmable ~~memory~~ memory circuit of the wireless telephone.

82. (Previously presented) The wireless telephone of claim 79 configured to prevent the unauthorized distribution of the selected polyphonic audio file stored in the programmable memory circuit.

83. (New) The wireless telephone of claim 74 wherein the communications link is capable of connecting to a database in the remote computer that includes a plurality of lists of audio files in polyphonic MIDI format.

84. (New) The wireless telephone of claim 76 configured to provide the user of the wireless telephone with the option of downloading the selected polyphonic audio file into a programmable memory in the wireless telephone after reviewing the selected polyphonic audio file.



85. (New) The wireless telephone of claim 84 configured to provide the user of the wireless telephone with the option of editing the selected polyphonic audio file before programming the selected polyphonic audio file into the programmable memory in the wireless telephone.

86. (New) The wireless telephone of claim 78 wherein the wireless telephone is configured to operate in conjunction with copyright protection software to prevent the unauthorized distribution of the selected polyphonic audio file stored in the programmable memory circuit.

87. (New) The wireless telephone of claim 79 wherein the group of polyphonic audio files include audio files in polyphonic MIDI format.

88. (New) The wireless telephone of claim 81 configured to provide the user of the wireless telephone with the option of downloading the selected polyphonic audio file into a programmable memory in the wireless telephone after reviewing the selected polyphonic audio file.

89. (New) The wireless telephone of claim 88 configured to provide the user of the wireless telephone with the option of editing the selected polyphonic audio file before programming the selected polyphonic audio file into the programmable memory in the wireless telephone.

90. (New) The wireless telephone of claim 82 wherein the wireless telephone is configured to operate with copyright protection software to prevent the unauthorized distribution of the selected polyphonic audio file stored in the programmable memory circuit.

91. (New) A wireless telephone that may be customized by searching for and selecting an audio file from a remote computer and programming the selected audio file into the wireless telephone for use at a time specified by the user, the telephone comprising:

*F1*  
*cont*

- a communications link capable of connecting to a database in the remote computer that includes a plurality of polyphonic audio files;

- a display screen and a browsing application program that allows a user of the wireless telephone to browse the polyphonic audio files and select at least one polyphonic audio file therefrom;

- processing circuitry configured to supervise receipt of a selected polyphonic audio file from the communications link;

- a programmable memory circuit for allowing the user to optionally store the selected polyphonic audio file for use as an indicia of an incoming communication; and

- an enhanced performance speaker capable of providing a substantially full range of audio sounds from the selected

polyphonic audio file when the selected polyphonic audio file is played.

92. (New) The wireless telephone of claim 91 wherein the polyphonic audio file is selected from the group comprising MP3, MPEG, or WAV files.

F1  
Cont

93. (New) The wireless telephone of claim 91 wherein the enhanced performance speaker operates in conjunction with the processing circuitry to allow the user to optionally review the selected polyphonic audio file before downloading the selected polyphonic audio file into the programmable memory circuit of the wireless telephone.

94. (New) The wireless telephone of claim 91 configured to prevent the unauthorized distribution of the selected polyphonic audio file stored in the programmable memory circuit.

95. (New) The wireless telephone of claim 92 wherein the group of polyphonic audio files includes audio files in polyphonic MIDI format.

96. (New) The wireless telephone of claim 93 configured to provide the user of the wireless telephone with the option of downloading the selected polyphonic audio file

into a programmable memory in the wireless telephone after reviewing the selected polyphonic audio file.

97. (New) The wireless telephone of claim 96 configured to provide the user of the wireless telephone with the option of editing the selected polyphonic audio file before programming the selected polyphonic audio file into the programmable memory in the wireless telephone.

*FI*  
*Cont*

98. (New) The wireless telephone of claim 94 wherein the wireless telephone is configured to operate in conjunction with copyright protection software to prevent the unauthorized distribution of the selected polyphonic audio file stored in the programmable memory circuit.

99. (New) A wireless telephone that may be customized by programming an audio file into the wireless telephone for use at a time specified by a user of the wireless telephone, the telephone comprising:

means for connecting to a remote database that includes a plurality of lists of polyphonic audio files;

means for browsing at least one of the lists of polyphonic audio files;

means for selecting at least one of the polyphonic audio files from the browsed list;

means for optionally reviewing the selected polyphonic audio file before downloading the selected

polyphonic audio into a memory circuit in the wireless telephone; and

means for downloading the selected polyphonic audio file for use at the time specified by the user of the wireless telephone.

100. (New) The wireless telephone of claim 99 further comprising means for searching the remote database for a certain desired polyphonic audio file using title or description information to aid in locating the desired polyphonic audio file.

101. (New) The wireless telephone of claim 100 wherein the searching further comprises means for searching the Internet or other remote databases for the desired polyphonic audio file.

102. (New) The wireless telephone of claim 99 further comprising means for providing a visual indication on a display screen of the wireless telephone to confirm the selected polyphonic audio file has been successfully downloaded.


103. (New) The wireless telephone of claim 99 wherein the browsing of polyphonic audio files is accomplished at least in part using a Wireless Application Protocol (WAP) compliant system.

104. (New) The wireless telephone of claim 99  
further comprising means for preventing unauthorized  
distribution of the selected polyphonic audio file stored in  
the programmable memory circuit.

REMARKS

These amendments more particularly point out and define the invention. An early and favorable action on this patent application is requested.

Respectfully submitted,



---

Michael E. Shanahan  
Applicant  
Customer No. 32850  
P.O. Box 381  
Nyack, N.Y. 10960

(703) 872-9306

1/12/04

28 pages including  
Cover.

To: Bobbie Davenport  
Crystal Park 2  
Rm 8W18

RECEIVED  
CENTRAL FAX CENTER

JAN 12 2004

OFFICIAL

Re: Application 10/223,200

MR. DAVENPORT,

In response to your notice  
of non-compliance mailed 12/31/03  
I enclose a compliant amendment  
in response to your communication.



**PATENT APPLICATION FEE DETERMINATION RECORD**  
Effective October 1, 2001

Application or Docket Number

ME S 1001 COM  
10/22/03

**CLAIMS AS FILED - PART I**

	(Column 1)	(Column 2)
TOTAL CLAIMS	15	
FOR	NUMBER FILED	NUMBER EXTRA
TOTAL CHARGEABLE CLAIMS	15 minus 20 = *	0
INDEPENDENT CLAIMS	3 minus 3 = *	0
MULTIPLE DEPENDENT CLAIM PRESENT <input type="checkbox"/>		

\* If the difference in column 1 is less than zero, enter "0" in column 2

**SMALL ENTITY TYPE**  OR **OTHER THAN SMALL ENTITY**

RATE	FEE		RATE	FEE
BASIC FEE	370.00	OR	BASIC FEE	740.00
X\$ 9=		OR	X\$18=	
X42=		OR	X84=	
+140=		OR	+280=	
TOTAL	270	OR	TOTAL	

**CLAIMS AS AMENDED - PART II**

	(Column 1)	(Column 2)	(Column 3)
AMENDMENT A	CLAIMS REMAINING AFTER AMENDMENT	HIGHEST NUMBER PREVIOUSLY PAID FOR	PRESENT EXTRA
Total	* 47	Minus ** 20	= 27
Independent	* 5	Minus *** 3	= 2
FIRST PRESENTATION OF MULTIPLE DEPENDENT CLAIM <input type="checkbox"/>			

**SMALL ENTITY** OR **OTHER THAN SMALL ENTITY**

RATE	ADDITIONAL FEE		RATE	ADDITIONAL FEE
X\$ 9=	243.00	OR	X\$18=	
X42=	84.00	OR	X84=	
+140=		OR	+280=	
TOTAL ADDIT. FEE		OR	TOTAL ADDIT. FEE	

6/27/03

	(Column 1)	(Column 2)	(Column 3)
AMENDMENT B	CLAIMS REMAINING AFTER AMENDMENT	HIGHEST NUMBER PREVIOUSLY PAID FOR	PRESENT EXTRA
Total	* 62	Minus ** 47	= 15
Independent	* 7	Minus *** 5	= 2
FIRST PRESENTATION OF MULTIPLE DEPENDENT CLAIM <input type="checkbox"/>			

RATE	ADDITIONAL FEE		RATE	ADDITIONAL FEE
X\$ 9=	135.00	OR	X\$18=	
X42=	42.00	OR	X84=	
+140=		OR	+280=	
TOTAL ADDIT. FEE		OR	TOTAL ADDIT. FEE	

7-11-03

	(Column 1)	(Column 2)	(Column 3)
AMENDMENT C	CLAIMS REMAINING AFTER AMENDMENT	HIGHEST NUMBER PREVIOUSLY PAID FOR	PRESENT EXTRA
Total	* 65	Minus ** 62	= 3
Independent	* 8	Minus *** 7	= 1
FIRST PRESENTATION OF MULTIPLE DEPENDENT CLAIM <input type="checkbox"/>			

RATE	ADDITIONAL FEE		RATE	ADDITIONAL FEE
X\$ 9=	315.00	OR	X\$18=	
X42=	42.00	OR	X84=	
+140=		OR	+280=	
TOTAL ADDIT. FEE		OR	TOTAL ADDIT. FEE	

\* If the entry in column 1 is less than the entry in column 2, write "0" in column 3.  
 \*\* If the "Highest Number Previously Paid For" IN THIS SPACE is less than 20, enter "20."  
 \*\*\* If the "Highest Number Previously Paid For" IN THIS SPACE is less than 3, enter "3."  
 The "Highest Number Previously Paid For" (Total or Independent) is the highest number found in the appropriate box in column 1.

Best Available Copy

Under the Paperwork Reduction Act of 1995, no persons are required to respond to a collection of information unless it displays a valid OMB control number.

**PATENT APPLICATION FEE DETERMINATION RECORD**  
 Substitute for Form PTO-875

Application or Docket Number  
101223200

**CLAIMS AS FILED - PART I**

(Column 1)		(Column 2)	SMALL ENTITY		OR	OTHER THAN SMALL ENTITY	
FOR	NUMBER FILED	NUMBER EXTRA	RATE	FFF		RATE	FEE
BASIC FEE (37 CFR 1.16(a))				\$ _____	OR		\$ _____
TOTAL CLAIMS (37 CFR 1.16(c))	minus 20 = *		X \$ _____ =		OR	X \$ _____ =	
INDEPENDENT CLAIMS (37 CFR 1.16(b))	minus 3 = *		X \$ _____ =		OR	X \$ _____ =	
MULTIPLE DEPENDENT CLAIM PRESENT (37 CFR 1.16(d))			+ \$ _____ =		OR	+ \$ _____ =	
			TOTAL		OR	TOTAL	

\* If the difference in column 1 is less than zero, enter "0" in column 2.

**CLAIMS AS AMENDED - PART II**

10/14/03

(Column 1)		(Column 2)	(Column 3)	SMALL ENTITY		OR	OTHER THAN SMALL ENTITY	
AMENDMENT	CLAIMS REMAINING AFTER AMENDMENT	HIGHEST NUMBER PREVIOUSLY PAID FOR	PRESENT EXTRA	RATE	ADDITIONAL FEE		RATE	ADDITIONAL FEE
D						OR		
Total (37 CFR 1.16(c))	89	Minus ** 66	= 23	X \$ 9 =	207	OR	X \$ _____ =	
Independent (37 CFR 1.16(b))	11	Minus *** 8	= 3	X \$ 42 =	126	OR	X \$ _____ =	
FIRST PRESENTATION OF MULTIPLE DEPENDENT CLAIM (37 CFR 1.16(d))				+ \$ _____ =		OR	+ \$ _____ =	
				TOTAL ADD'L FEE		OR	TOTAL ADD'L FEE	

12/30/03

(Column 1)		(Column 2)	(Column 3)	SMALL ENTITY		OR	OTHER THAN SMALL ENTITY	
AMENDMENT	CLAIMS REMAINING AFTER AMENDMENT	HIGHEST NUMBER PREVIOUSLY PAID FOR	PRESENT EXTRA	RATE	ADDITIONAL FEE		RATE	ADDITIONAL FEE
E						OR		
Total (37 CFR 1.16(c))	47	Minus ** 89	= 0	X \$ _____ =		OR	X \$ _____ =	
Independent (37 CFR 1.16(b))	5	Minus *** 11	= 0	X \$ _____ =		OR	X \$ _____ =	
FIRST PRESENTATION OF MULTIPLE DEPENDENT CLAIM (37 CFR 1.16(d))				+ \$ _____ =		OR	+ \$ _____ =	
				TOTAL ADD'L FEE		OR	TOTAL ADD'L FEE	

1/12/04

(Column 1)		(Column 2)	(Column 3)	SMALL ENTITY		OR	OTHER THAN SMALL ENTITY	
AMENDMENT	CLAIMS REMAINING AFTER AMENDMENT	HIGHEST NUMBER PREVIOUSLY PAID FOR	PRESENT EXTRA	RATE	ADDITIONAL FEE		RATE	ADDITIONAL FEE
F						OR		
Total (37 CFR 1.16(c))	89	Minus ** 89	= 0	X \$ _____ =		OR	X \$ _____ =	
Independent (37 CFR 1.16(b))	11	Minus *** 11	= 0	X \$ _____ =		OR	X \$ _____ =	
FIRST PRESENTATION OF MULTIPLE DEPENDENT CLAIM (37 CFR 1.16(d))				+ \$ _____ =		OR	+ \$ _____ =	
				TOTAL ADD'L FEE		OR	TOTAL ADD'L FEE	

\* If the entry in column 1 is less than the entry in column 2, write "0" in column 3.  
 \*\* If the "Highest Number Previously Paid For" IN THIS SPACE is less than 20, enter "20".  
 \*\*\* If the "Highest Number Previously Paid For" IN THIS SPACE is less than 3, enter "3".  
 The "Highest Number Previously Paid For" (Total or Independent) is the highest number found in the appropriate box in column 1.

This collection of information is required by 37 CFR 1.16. The information is required to obtain or retain a benefit by the public which is to file (and by the USPTO to process) an application. Confidentiality is governed by 35 U.S.C. 122 and 37 CFR 1.14. This collection is estimated to take 12 minutes to complete, including gathering, preparing, and submitting the completed application form to the USPTO. Time will vary depending upon the individual case. Any comments on the amount of time you require to complete this form and/or suggestions for reducing this burden, should be sent to the Chief Information Officer, U.S. Patent and Trademark Office, U.S. Department of Commerce, P.O. Box 1450, Alexandria, VA 22313-1450. DO NOT SEND FEES OR COMPLETED FORMS TO THIS ADDRESS. SEND TO: Commissioner for Patents, P.O. Box 1450, Alexandria, VA 22313-1450.

If you need assistance in completing the form, call 1-800-PTO-9199 and select option 2.



UNITED STATES PATENT AND TRADEMARK OFFICE

UNITED STATES DEPARTMENT OF COMMERCE  
United States Patent and Trademark Office  
Address: COMMISSIONER FOR PATENTS  
P.O. Box 1450  
Alexandria, Virginia 22313-1450  
www.uspto.gov

APPLICATION NO.	FILING DATE	FIRST NAMED INVENTOR	ATTORNEY DOCKET NO.	CONFIRMATION NO.
10/223,200	08/16/2002	Michael E. Shanahan	MES/001CON	8026

32850                      7590                      12/31/2003

MICHAEL E SHANAHAN  
P.O. BOX 381  
NYACK, NY 10960

EXAMINER

TRAN, CONGVAN

ART UNIT                      PAPER NUMBER

2683

DATE MAILED: 12/31/2003

10

Please find below and/or attached an Office communication concerning this application or proceeding.



Paper No.

**Notice of Non-Compliant Amendment (37 CFR 1.121)**

The amendment document filed on 10-14-03 is considered non-compliant because it has failed to meet the requirements of 37 CFR 1.121, as amended on June 30, 2003 (see 68 Fed. Reg. 38611, Jun. 30, 2003). In order for the amendment document to be compliant, correction of the following item(s) is required. **Only the corrected section of the non-compliant amendment document must be resubmitted (in its entirety), e.g., the entire "Amendments to the claims" section of applicant's amendment document must be re-submitted.** 37 CFR 1.121(h).

**THE FOLLOWING CHECKED (X) ITEM(S) CAUSE THE AMENDMENT DOCUMENT TO BE NON-COMPLIANT:**

- 1. Amendments to the specification:
  - A. Amended paragraph(s) do not include markings.
  - B. New paragraph(s) should not be underlined.
  - C. Other \_\_\_\_\_
  
- 2. Abstract:
  - A. Not presented on a separate sheet. 37 CFR 1.72.
  - B. Other \_\_\_\_\_
  
- 3. Amendments to the drawings: \_\_\_\_\_
  
- 4. Amendments to the claims:
  - A. A complete listing of all of the claims is not present.
  - B. The listing of claims does not include the text of all claims (including withdrawn claims)
  - C. Each claim has not been provided with the proper status identifier, and as such, the individual status of each claim cannot be identified.
  - D. The claims of this amendment paper have not been presented in ascending numerical order.
  - E. Other: SEE ATTACHED.

For further explanation of the amendment format required by 37 CFR 1.121, see MPEP Sec. 714 and the USPTO website at <http://www.uspto.gov/web/offices/pac/dapp/opla/preognotice/officeflyer.pdf>.

If the non-compliant amendment is a **PRELIMINARY AMENDMENT**, applicant is given **ONE MONTH** from the mail date of this letter to supply the corrected section which complies with 37 CFR 1.121. Failure to comply with 37 CFR 1.121 will result in non-entry of the preliminary amendment and examination on the merits will commence without consideration of the proposed changes in the preliminary amendment(s). This notice is not an action under 35 U.S.C. 132, and **this ONE MONTH time limit is not extendable.**

If the non-compliant amendment is a reply to a **NON-FINAL OFFICE ACTION (including a submission for an RCE)**, and since the amendment appears to be a *bona fide* attempt to be a reply (37 CFR 1.135(c)), applicant is given a **TIME PERIOD** of **ONE MONTH** from the mailing of this notice within which to re-submit the corrected section which complies with 37 CFR 1.121 in order to avoid abandonment. **EXTENSIONS OF THIS TIME PERIOD ARE AVAILABLE UNDER 37 CFR 1.136(a).**

If the amendment is a reply to a **FINAL REJECTION**, this form may be an attachment to an Advisory Action. The period for response to a final rejection continues to run from the date set in the final rejection, and is not affected by the non-compliant status of the amendment.

Bobbie Davenport \_\_\_\_\_ 703-305-9630 \_\_\_\_\_  
Legal Instruments Examiner (LIE) Telephone No.

10223200

Serial Number

- Canceled claims cannot show text of claim.
- "Amended" is not a proper status identifier.
- Amendments to the Specifications should begin on a separate page.
- Amendment to the Claims should begin on a separate page.
- "Remarks" should begin on a separate sheet.
- The "Cover Sheet", amendments to the "Specifications", amendments to the "Claims", and "Remarks" should each begin on a separate sheet.
- Only "Currently Amended" and "Withdrawn" claims can show markings.
- Drawings should each have "Replacement Sheet(s)" or "Annotated Sheet(s)" as a heading.
- "Previously Added" is not a proper status identifier.
- "Previously Amended" is not a proper status identifier.
- A Clean copy and A Marked Up copy of the Claims is a Non-Compliant amendment Format.
- "Re-Presented" is an improper status identifier.
- "Claims \_\_\_\_\_ have been cancelled" is an improper status identifier.
- "Currently Amended claims must show markings.

\_\_\_\_\_ **A Clean copy and a Marked Up copy of Substitute Specification is needed.**

\_\_\_\_\_ **Amendments to the Specifications must be by marked-up replacement paragraphs or sections only; (no clean or replacement paragraph or section is required; No replacements sheets permitted.**

**X** **The Status Identifier of Claim 83 should be "Previously Presented".**

\_\_\_\_\_

\_\_\_\_\_

RECEIVED  
CENTRAL FAX CENTER

DEC 30 2003

OFFICIAL

MES/001 CON

IN THE UNITED STATES PATENT AND TRADEMARK OFFICE

Applicant : Michael E. Shanahan  
Serial No. : 10/223,200 Confirmation No. : 8026  
Filed: : August 16, 2002  
For : METHODS AND APPARATUSES FOR PROGRAMMING  
USER-DEFINED INFORMATION INTO ELECTRONIC  
DEVIVES  
Group Art Unit : 2681  
Examiner : Not Yet Assigned

Hon. Commissioner  
for Patents  
P.O. box 1450,  
Alexandria VA 22313-1450

6/20/03

PRELIMINARY AMENDMENT

Sir:

Before examining this patent application, please  
amend the application as follows:

In the Specification

On page 1, line 7, after March 3, 2000 please insert  
"now U.S. Patent 6,496,692, issued December 17, 2002".

In the Claims

Please cancel, without prejudice, claims 1-15.

Please add the following new claims 16-61.

16. (New) A method of customizing a wireless telephone by programming an audio file into the wireless telephone for use as an indicia of an incoming communication, the method comprising:

connecting to a remote database that includes a plurality of lists of audio files;

allowing a user of the wireless telephone to browse at least one of the lists of audio files;

allowing the user of the wireless telephone to select at least one of the audio files from the browsed list;

optionally reviewing the selected audio file before downloading the selected audio into the wireless telephone;

and

allowing the user to optionally download the selected audio file for use as an indicia of an incoming communication.

17. (New) The method of claim 16 wherein the format of the selected audio file is from the group comprising: MIDI, MPEG, MP3, WAV, PCM, Windows Media Audio code (WMA), or Adaptive Transform Acoustic Coding (ATRAC).

18. (New) The method of claim 16 further comprising allowing the user to search the remote database for a certain desired audio file using title or description information to aid in locating the desired audio file.



19. (New) The method of claim 18 wherein the searching further comprises searching the Internet or other remote databases for the desired audio file.

20. (New) The method of claim 16 wherein the browsing of audio files is accomplished at least in part using a Wireless Application Protocol (WAP) compliant system.

21. (New) The method of claim 16 further comprising providing a visual indication on a display screen of the wireless telephone to confirm an audio file has been successfully downloaded.

22. (New) The method of claim 16 further comprising: downloading a selected audio file into the wireless telephone; and

associating the downloaded audio file with a characteristic indicative of a caller such that the associated audio file plays when the indicative characteristic is received by the wireless telephone.

23. (New) The method of claim 16 wherein the characteristic indicative of the caller is the caller's telephone number.

24. (New) A method of customizing a wireless telephone by programming an audio file into the wireless telephone for use as an indicia of an incoming communication, the method comprising:

connecting to a remote database that includes a plurality of audio files; the remote database operating independently of a communications network that provides wireless telephone service to the wireless telephone;

allowing the user of the wireless telephone to browse and select at least one of the audio files;

allowing the user to optionally download the selected audio file into a programmable memory for use as an indicia of an incoming communication.

25. (New) The method of claim 24 further comprising allowing the user to optionally review the selected audio file before downloading the selected audio file into the wireless telephone.

26. (New) The method of claim 24 wherein the format of the selected audio file is from the group comprising: MIDI, MPEG, MP3, WAV, PCM, Windows Media Audio code (WMA), or Adaptative Transform Acoustic Coding (ATRAC).

27. (New) The method of claim 24 further comprising allowing the user to search the remote database for a certain desired audio file using title or description information to aid in locating the desired audio file.

28. (New) The method of claim 27 wherein the searching further comprises searching the Internet or other remote databases for the desired audio file.

29. (New) The method of claim 24 wherein the browsing of audio files is accomplished at least in part using a Wireless Application Protocol (WAP) compliant system.

30. (New) The method of claim 24 further comprising providing a visual indication on a display screen of the wireless telephone to confirm an audio file has been successfully downloaded.

31. (New) The method of claim 24 further comprising: downloading a selected audio file into the wireless telephone; and

associating the downloaded audio file with a characteristic indicative of a caller such that the associated audio file plays when the indicative characteristic is received by the wireless telephone.

32. (New) The method of claim 24 wherein the characteristic indicative of the caller is the caller's telephone number.

33. (New) A wireless telephone that may be customized by programming an audio file into the wireless telephone for use as an indicia of an incoming communication, the telephone comprising:

a communications link capable of connecting to a remote database that includes a plurality of lists of audio files;

a display screen that allows a user of the wireless telephone to browse at least one of the lists of audio files and view selectable audio files present in the browsed list;

<sup>Enhanced Performance</sup> a speaker and processing circuitry configured to allow the user to optionally review a selected audio file before downloading the selected audio file into the wireless telephone; and

a programmable memory circuit for allowing the user to optionally store the selected audio file for use as an indicia of an incoming communication.

34. (New) The wireless telephone of claim 33 wherein the programmable memory circuit is configured to store audio files in a format selected from the group comprising:

MIDI, MPEG, MP3, WAV, PCM, Windows Media Audio code (WMA), or  
Adaptative Transform Acoustic Coding (ATRAC).

35. (New) The wireless telephone of claim 33  
wherein the <sup>speaker</sup> speaker and processing circuitry is configured to  
play audio files in a format selected from the group  
comprising: MIDI, MPEG, MP3, WAV, PCM, Windows Media Audio  
code (WMA), or Adaptative Transform Acoustic Coding (ATRAC).

36. (New) The wireless telephone of claim 33  
wherein the wireless telephone is configured to allow the user  
to search the remote database for a certain desired audio file  
using title or description information to aid in locating the  
desired audio file.

37. (New) The wireless telephone of claim 36 wherein  
the wireless telephone is configured to search the Internet or  
other remote databases for the desired audio file.

38. (New) The wireless telephone of claim 33 wherein  
the wireless telephone includes a Wireless Application  
Protocol (WAP) compliant Internet browser.

39. (New) The wireless telephone of claim 33  
configured to provide a visual indication on the display  
screen of the wireless to confirm an audio file has been  
successfully downloaded. TELEPHONE

40. (New) The wireless telephone of claim 33 configured to allow the user to associate a downloaded audio file with a characteristic indicative of a caller such that the associated audio file plays when the indicative characteristic is received by the wireless telephone.

41. (New) The method of claim 33 wherein the characteristic indicative of the caller is the caller's telephone number.

42. (New) A wireless telephone that may be customized by programming an audio file into the wireless telephone for use as an indicia of an incoming communication, the telephone comprising:

a communications link capable of connecting to a remote database that includes a plurality of lists of audio files; the remote database operating independently of a communications network that provides wireless telephone service to the wireless telephone;

a display screen that allows a user of the wireless telephone to browse at least one of the plurality of lists of audio files and view selectable audio files present in the browsed list;

processing circuitry configured to receive a selected audio file from the communications link; and

a programmable memory circuit for allowing the user to optionally store the selected audio file for use as an indicia of an incoming communication.

43. (New) The wireless telephone of claim 42 further comprising a speaker that operates in conjunction with the processing circuitry to allow the user to optionally review a selected audio file before downloading the selected audio file into the wireless telephone.

44. (New) The wireless telephone of claim 42 wherein the programmable memory circuit is configured to store audio files in a format selected from the group comprising: MIDI, MPEG, MP3, WAV, PCM, Windows Media Audio code (WMA), or Adaptive Transform Acoustic Coding (ATRAC).

45. (New) The wireless telephone of claim 42 wherein the speaker and processing circuitry is configured to play audio files in a format selected from the group comprising: MIDI, MPEG, MP3, WAV, PCM, Windows Media Audio code (WMA), or Adaptive Transform Acoustic Coding (ATRAC).

46. (New) The wireless telephone of claim 42 wherein the wireless telephone is configured to allow the user to search the remote database for a certain desired audio file using title or description information to aid in locating the desired audio file.

46. (New) The wireless telephone of claim 45 wherein the wireless telephone is configured to search the Internet or other remote databases for the desired audio file.

47. (New) The wireless telephone of claim 42 wherein the wireless telephone includes a Wireless Application Protocol (WAP) compliant Internet browser.

48. (New) The wireless telephone of claim 42 configured to provide a visual indication on the display screen to confirm an audio file has been successfully downloaded.

49. (New) The wireless telephone of claim 42 configured to allow the user to associate a downloaded audio file with a characteristic indicative of a caller such that the associated audio file plays when the indicative characteristic is received by the wireless telephone.

50. (New) A wireless telephone that may be customized by programming an audio file into the wireless telephone for use as an indicia of an incoming communication, the telephone comprising:

means for connecting to a remote database that includes a plurality of lists of audio files;



means for browsing at least one of the lists of audio files;

means for select<sup>ing</sup> at least one of the audio files from the browsed list;

means for optionally reviewing the selected audio file before downloading the selected audio into the wireless telephone; and

means for downloading the selected audio file for use as an indicia of an incoming communication.

51. (New) The wireless telephone of claim 50 further comprising means for searching the remote database for a certain desired audio file using title or description information to aid in locating the desired audio file.

52. (New) The wireless telephone of claim 51 wherein the searching further comprises means for searching the Internet or other remote databases for the desired audio file.

53. (New) The wireless telephone of claim 50 further comprising means for providing a visual indication on a display screen of the wireless telephone to confirm an audio file has been successfully downloaded.

54. (New) The wireless telephone of claim 50 further comprising means for associating a downloaded audio file with a characteristic indicative of a caller such that the

associated audio file plays when the indicative characteristic is received by the wireless telephone.

55. (New) A wireless telephone that may be customized by programming an audio file into the wireless telephone for use as an indicia of an incoming communication, the telephone comprising:

means for connecting to a remote database that includes a plurality of audio files; the remote database operating independently of a communications network that provides wireless telephone service to the wireless telephone;

means for browsing and selecting at least one of the audio files;

means for optionally downloading the selected audio file into a programmable memory for use as an indicia of an incoming communication.

56. (New) The wireless telephone of claim 55 further comprising means for optionally reviewing the selected audio file before downloading the selected audio file into the wireless telephone.

57. (New) The wireless telephone of claim 56 further comprising means for searching the remote database for a certain desired audio file using title or description information to aid in locating the desired audio file.

58. (New) The wireless telephone of claim 55 wherein the searching further comprises means for searching the Internet or other remote databases for the desired audio file.

59. (New) The wireless telephone of claim 55 wherein the browsing of audio files is accomplished at least in part using a Wireless Application Protocol (WAP) compliant system.

60. (New) The wireless telephone of claim 55 further comprising providing a visual indication on a display screen of the wireless telephone to confirm an audio file has been successfully downloaded.

61. (New) The wireless telephone of claim 55 further comprising means for associating a downloaded audio file with a characteristic indicative of a caller such that the associated audio file plays when the indicative characteristic is received by the wireless telephone.

REMARKS

These amendments more particularly point out and define the invention. An early and favorable action on this patent application is requested.

Respectfully submitted,



Michael E. Shanahan  
Applicant  
Customer No. 32850  
P.O. Box 381  
Nyack, N.Y. 10960

ReFAXed 12/30/03 12:50 pm

(703) 872-9306

To: Bobbie Davenport

Crystal Park Z

Rm 8W18

# 11/E

pages 19  
plus last  
page twice

OK (N.F.)  
J. J.

RECEIVED  
CENTRAL FAX CENTER  
DEC 30 2003

2004

OFFICIAL

Re: Application

10/223,200

Mr. Davenport,

Here are the pages missing from  
file regarding the preliminary amendment of  
6/20/2003. As you can see from return postcard  
this preliminary amendment was received by the P.T.O.  
and apparently inadvertently misplaced

REV. 01/03  
Small Entity

Docket No. MES/001 CON

IN THE UNITED STATES PATENT AND TRADEMARK OFFICE  
PATENT APPLICATION

Applicant : Michael E. Shanahan  
Application No. : 10/223,200 Confirmation No. 8026  
Filed : August 16, 2002  
For : METHODS AND APPARATUSES FOR PROGRAMMING USER-  
DEFINED INFORMATION INTO ELECTRONIC DEVICES  
Group Art Unit : 2681  
Examiner : Not Yet Assigned

Hon. Commissioner  
for Patents  
P.O. Box 1450  
Alexandria VA 22313-1450

TRANSMITTAL LETTER

Sir:

Transmitted herewith:  a Preliminary Amendment;  
 a Declaration;  a Supplemental Information Disclosure  
Statement;  substitute specification;  an Associate Power  
of Attorney;  formal drawings; to be filed in the above-  
identified patent application.

FEE FOR ADDITIONAL CLAIMS

- A fee for additional claims is not required.  
 A fee for additional claims is required.

DOCKET No. MES/001CON  
CONFIRMATION No. 8026

APPLICANT Michael E. Shanahan  
APPLICATION No. 10/223,200 FILED August 16, 2002

RECEIPT IS HEREBY ACKNOWLEDGED OF THE  
Transmittal Letter (in duplicate); Preliminary Amendment.  
*CHECK FOR \$360.00*



DATED June 20, 2003

FILED IN CONNECTION WITH THE ABOVE CASE.

COMMISSIONER FOR PATENTS

The additional fee has been calculated as shown below:

	CLAIMS REMAINING AFTER AMENDMENT	HIGHEST NUMBER PREVIOUSLY PAID FOR	PRESENT EXTRA	RATE	EXTRA FEES
TOTAL CLAIMS	46	20	* = 26	X \$9 = \$	234.00
INDEPENDENT CLAIMS	6	3	** = 3	X \$42 = \$	126.00
FIRST PRESENTATION OF A MULTIPLE DEPENDENT CLAIM				+ \$140 =	\$ .00

\* If less than 20, insert 20. TOTAL \$ 360.00  
 \*\* If less than 3, insert 3.

[X] A check in the amount of \$ 360.00 is transmitted herewith.

EXTENSION FEE

[ ] The following extension is applicable to the Response filed herewith; [ ] \$55.00 extension fee for response within first month pursuant to 37 C.F.R. § 1.17(a)(1); [X] \$205.00 extension fee for response within second month pursuant to 37 C.F.R. § 1.17(a)(2); [ ] \$465.00 extension fee for response within third month pursuant to 37 C.F.R. § 1.17(a)(3); [ ] \$725.00 extension fee for response within fourth month pursuant to 37 C.F.R. § 1.17(a)(4).

[ ] A check in the amount of [ ] \$55.00; [ ] \$205.00; [ ] \$465.00; [ ] \$725.00; in payment of the extension fee is transmitted herewith. A duplicate copy of this transmittal letter is transmitted herewith.



SUPPLEMENTAL IDS FEE

[ ] A check in the amount of \$ 0.00 is transmitted herewith in payment of the Supplemental IDS fee pursuant to 37 C.F.R. § 1.17 (p).



Michael E. Shanahan  
Applicant  
Customer No. 32850  
P.O. Box 381  
Nyack, N.Y., 10960

RECEIVED #4/a  
CENTRAL FAX CENTER

DEC 16 2003

OFFICIAL P.D.

MES/001 CON

IN THE UNITED STATES PATENT AND TRADEMARK OFFICE

Applicant : Michael E. Shanahan

Serial No. : 10/223,200 Confirmation No.: 8028

Filed: : August 16, 2002

For : METHODS AND APPARATUSES FOR PROGRAMMING  
USER-DEFINED INFORMATION INTO ELECTRONIC  
DEVICES

Group Art Unit : 2681

Examiner : Not Yet Assigned

12-27-03

Hon. Commissioner  
for Patents  
P.O. box 1450,  
Alexandria VA 22313-1450

6/20/03

PRELIMINARY AMENDMENT

Sir:

Before examining this patent application, please  
amend the application as follows:

In the Specification

On page 1, line 7, after March 3, 2000 please insert

"now U.S. Patent 6,496,692, issued December 17, 2002".

In the Claims

Please cancel, without prejudice, claims 1-15.

Please add the following new claims 16-61.

16. (New) A method of customizing a wireless telephone by programming an audio file into the wireless telephone for use as an indicia of an incoming communication, the method comprising:

connecting to a remote database that includes a plurality of lists of audio files;

allowing a user of the wireless telephone to browse at least one of the lists of audio files;

allowing the user of the wireless telephone to select at least one of the audio files from the browsed list;

optionally reviewing the selected audio file before downloading the selected audio into the wireless telephone;

and

allowing the user to optionally download the selected audio file for use as an indicia of an incoming communication.

17. (New) The method of claim 16 wherein the format of the selected audio file is from the group comprising: MIDI, MPEG, MP3, WAV, PCM, Windows Media Audio code (WMA), or Adaptive Transform Acoustic Coding (ATRAC).

18. (New) The method of claim 16 further comprising allowing the user to search the remote database for a certain desired audio file using title or description information to aid in locating the desired audio file.

19. (New) The method of claim 18 wherein the searching further comprises searching the Internet or other remote databases for the desired audio file.

20. (New) The method of claim 16 wherein the browsing of audio files is accomplished at least in part using a Wireless Application Protocol (WAP) compliant system.

21. (New) The method of claim 16 further comprising providing a visual indication on a display screen of the wireless telephone to confirm an audio file has been successfully downloaded.

22. (New) The method of claim 16 further comprising: downloading a selected audio file into the wireless telephone; and

associating the downloaded audio file with a characteristic indicative of a caller such that the associated audio file plays when the indicative characteristic is received by the wireless telephone.

23. (New) The method of claim 16 wherein the characteristic indicative of the caller is the caller's telephone number.

24. (New) A method of customizing a wireless telephone by programming an audio file into the wireless telephone for use as an indicia of an incoming communication, the method comprising:

connecting to a remote database that includes a plurality of audio files; the remote database operating independently of a communications network that provides wireless telephone service to the wireless telephone;

allowing the user of the wireless telephone to browse and select at least one of the audio files;

allowing the user to optionally download the selected audio file into a programmable memory for use as an indicia of an incoming communication.

25. (New) The method of claim 24 further comprising allowing the user to optionally review the selected audio file before downloading the selected audio file into the wireless telephone.

26. (New) The method of claim 24 wherein the format of the selected audio file is from the group comprising: MIDI, MPEG, MP3, WAV, PCM, Windows Media Audio code (WMA), or Adaptive Transform Acoustic Coding (ATRAC).

27. (New) The method of claim 24 further comprising allowing the user to search the remote database for a certain desired audio file using title or description information to aid in locating the desired audio file.

28. (New) The method of claim 27 wherein the searching further comprises searching the Internet or other remote databases for the desired audio file.

29. (New) The method of claim 24 wherein the browsing of audio files is accomplished at least in part using a Wireless Application Protocol (WAP) compliant system.

30. (New) The method of claim 24 further comprising providing a visual indication on a display screen of the wireless telephone to confirm an audio file has been successfully downloaded.

31. (New) The method of claim 24 further comprising: downloading a selected audio file into the wireless telephone; and

associating the downloaded audio file with a characteristic indicative of a caller such that the associated audio file plays when the indicative characteristic is received by the wireless telephone.

32. (New) The method of claim 24 wherein the characteristic indicative of the caller is the caller's telephone number.

33. (New) A wireless telephone that may be customized by programming an audio file into the wireless telephone for use as an indicia of an incoming communication, the telephone comprising:

a communications link capable of connecting to a remote database that includes a plurality of lists of audio files;

a display screen that allows a user of the wireless telephone to browse at least one of the lists of audio files and view selectable audio files present in the browsed list; <sup>ENHANCED PERFORMANCE</sup> a speaker and processing circuitry configured to allow the user to optionally review a selected audio file before downloading the selected audio file into the wireless telephone; and

a programmable memory circuit for allowing the user to optionally store the selected audio file for use as an indicia of an incoming communication.

34. (New) The wireless telephone of claim 33 wherein the programmable memory circuit is configured to store audio files in a format selected from the group comprising:

MIDI, MPEG, MP3, WAV, PCM, Windows Media Audio code (WMA), or Adaptive Transform Acoustic Coding (ATRAC).

35. (New) The wireless telephone of claim 33 wherein the <sup>speaker</sup> ~~speaker~~ and processing circuitry is configured to play audio files in a format selected from the group comprising: MIDI, MPEG, MP3, WAV, PCM, Windows Media Audio code (WMA), or Adaptive Transform Acoustic Coding (ATRAC).

36. (New) The wireless telephone of claim 33 wherein the wireless telephone is configured to allow the user to search the remote database for a certain desired audio file using title or description information to aid in locating the desired audio file.

37. (New) The wireless telephone of claim 36 wherein the wireless telephone is configured to search the Internet or other remote databases for the desired audio file.

38. (New) The wireless telephone of claim 33 wherein the wireless telephone includes a Wireless Application Protocol (WAP) compliant Internet browser.

39. (New) The wireless telephone of claim 33 configured to provide a visual indication on the display screen of the wireless to confirm an audio file has been successfully downloaded. <sup>Telephone</sup>



40. (New) The wireless telephone of claim 33 configured to allow the user to associate a downloaded audio file with a characteristic indicative of a caller such that the associated audio file plays when the indicative characteristic is received by the wireless telephone.

41. (New) The method of claim 33 wherein the characteristic indicative of the caller is the caller's telephone number.

42. (New) A wireless telephone that may be customized by programming an audio file into the wireless telephone for use as an indicia of an incoming communication, the telephone comprising:

a communications link capable of connecting to a remote database that includes a plurality of lists of audio files; the remote database operating independently of a communications network that provides wireless telephone service to the wireless telephone;

a display screen that allows a user of the wireless telephone to browse at least one of the plurality of lists of audio files and view selectable audio files present in the browsed list;

processing circuitry configured to receive a selected audio file from the communications link; and

a programmable memory circuit for allowing the user to optionally store the selected audio file for use as an indicia of an incoming communication.

43. (New) The wireless telephone of claim 42 further comprising a speaker that operates in conjunction with the processing circuitry to allow the user to optionally review a selected audio file before downloading the selected audio file into the wireless telephone.

44. (New) The wireless telephone of claim 42 wherein the programmable memory circuit is configured to store audio files in a format selected from the group comprising: MIDI, MPEG, MP3, WAV, PCM, Windows Media Audio code (WMA), or Adaptive Transform Acoustic Coding (ATRAC).

45. (New) The wireless telephone of claim 42 wherein the speaker and processing circuitry is configured to play audio files in a format selected from the group comprising: MIDI, MPEG, MP3, WAV, PCM, Windows Media Audio code (WMA), or Adaptive Transform Acoustic Coding (ATRAC).

46. (New) The wireless telephone of claim 42 wherein the wireless telephone is configured to allow the user to search the remote database for a certain desired audio file using title or description information to aid in locating the desired audio file.

Rule 1.126

47

46. (New) The wireless telephone of claim 45 wherein the wireless telephone is configured to search the Internet or other remote databases for the desired audio file.

48

47. (New) The wireless telephone of claim 42 wherein the wireless telephone includes a Wireless Application Protocol (WAP) compliant Internet browser.

49

48. (New) The wireless telephone of claim 42 configured to provide a visual indication on the display screen to confirm an audio file has been successfully downloaded.

50

49. (New) The wireless telephone of claim 42 configured to allow the user to associate a downloaded audio file with a characteristic indicative of a caller such that the associated audio file plays when the indicative characteristic is received by the wireless telephone.

51

50. (New) A wireless telephone that may be customized by programming an audio file into the wireless telephone for use as an indicia of an incoming communication, the telephone comprising:

means for connecting to a remote database that includes a plurality of lists of audio files;

a2  
cont

means for browsing at least one of the lists of audio files;

means for select <sup>204</sup> at least one of the audio files from the browsed list;

means for optionally reviewing the selected audio file before downloading the selected audio into the wireless telephone; and

means for downloading the selected audio file for use as an indicia of an incoming communication.

*a2*  
*cont*  
*52*  
51. (New) The wireless telephone of claim 50 further comprising means for searching the remote database for a certain desired audio file using title or description information to aid in locating the desired audio file.

*53*  
52. (New) The wireless telephone of claim 51 wherein the searching further comprises means for searching the Internet or other remote databases for the desired audio file.

*54*  
53. (New) The wireless telephone of claim 50 further comprising means for providing a visual indication on a display screen of the wireless telephone to confirm an audio file has been successfully downloaded.

*55*  
54. (New) The wireless telephone of claim 50 further comprising means for associating a downloaded audio file with a characteristic indicative of a caller such that the

associated audio file plays when the indicative characteristic is received by the wireless telephone.

*56*  
55. (New) A wireless telephone that may be customized by programming an audio file into the wireless telephone for use as an indicia of an incoming communication, the telephone comprising:

means for connecting to a remote database that includes a plurality of audio files; the remote database operating independently of a communications network that provides wireless telephone service to the wireless telephone;

means for browsing and selecting at least one of the audio files;

means for optionally downloading the selected audio file into a programmable memory for use as an indicia of an incoming communication.

*57*  
56. (New) The wireless telephone of claim 55 further comprising means for optionally reviewing the selected audio file before downloading the selected audio file into the wireless telephone.

*58*  
57. (New) The wireless telephone of claim 56 further comprising means for searching the remote database for a certain desired audio file using title or description information to aid in locating the desired audio file.

59

58. (New) The wireless telephone of claim 55 wherein the searching further comprises means for searching the Internet or other remote databases for the desired audio file.

60

59. (New) The wireless telephone of claim 55 wherein the browsing of audio files is accomplished at least in part using a Wireless Application Protocol (WAP) compliant system.

61

60. (New) The wireless telephone of claim 55 further comprising providing a visual indication on a display screen of the wireless telephone to confirm an audio file has been successfully downloaded.

62


61. (New) The wireless telephone of claim 55 further comprising means for associating a downloaded audio file with a characteristic indicative of a caller such that the associated audio file plays when the indicative characteristic is received by the wireless telephone.

a2  
cont

REMARKS

These amendments more particularly point out and define the invention. An early and favorable action on this patent application is requested.

Respectfully submitted,



Michael E. Shanahan  
Applicant  
Customer No. 32850  
P.O. Box 381  
Nyack, N.Y. 10960

pages 19

(703) 872 - 9306  
TO: Bobbie Davenport  
Crystal Park Z  
Rm 8W18

RECEIVED  
CENTRAL FAX CENTER

DEC 16 2003

OFFICIAL

Re: Application 10/223,200

Mr. Davenport,

Here are the pages missing from  
file regarding the preliminary amendment of  
6/20/2003. As you can see from return postcard  
this preliminary amendment was received by the P.T.O.  
on and apparently inadvertently misplaced



REV. 01/03  
Small Entity

Docket No. MES/001 CON

IN THE UNITED STATES PATENT AND TRADEMARK OFFICE  
PATENT APPLICATION

Applicant : Michael E. Shanahan  
Application No. : 10/223,200 Confirmation No. 8026  
Filed : August 16, 2002  
For : METHODS AND APPARATUSES FOR PROGRAMMING USER-  
DEFINED INFORMATION INTO ELECTRONIC DEVICES  
Group Art Unit : 2681  
Examiner : Not Yet Assigned

Hon. Commissioner  
for Patents  
P.O. Box 1450  
Alexandria VA 22313-1450

TRANSMITTAL LETTER

Sir:

Transmitted herewith:  a Preliminary Amendment;  
 a Declaration;  a Supplemental Information Disclosure  
Statement;  substitute specification;  an Associate Power  
of Attorney;  formal drawings; to be filed in the above-  
identified patent application.

FEE FOR ADDITIONAL CLAIMS

- A fee for additional claims is not required.  
 A fee for additional claims is required.

The additional fee has been calculated as shown below:

	CLAIMS REMAINING AFTER AMENDMENT	HIGHEST NUMBER PREVIOUSLY PAID FOR	PRESENT EXTRA	RATE	EXTRA FEES
TOTAL CLAIMS	46	20	* = 26	X \$9 = \$	234.00
INDEPENDENT CLAIMS	6	3	** = 3	X \$42 = \$	126.00
FIRST PRESENTATION OF A MULTIPLE DEPENDENT CLAIM				+ \$140 =	\$ .00

\* If less than 20, insert 20.  
 \*\* If less than 3, insert 3.

TOTAL \$ 360.00

[X] A check in the amount of \$ 360.00 is transmitted herewith.

EXTENSION FEE

[ ] The following extension is applicable to the Response filed herewith; [ ] \$55.00 extension fee for response within first month pursuant to 37 C.F.R. § 1.17(a)(1); [X] \$205.00 extension fee for response within second month pursuant to 37 C.F.R. § 1.17(a)(2); [ ] \$465.00 extension fee for response within third month pursuant to 37 C.F.R. § 1.17(a)(3); [ ] \$725.00 extension fee for response within fourth month pursuant to 37 C.F.R. § 1.17(a)(4).

[ ] A check in the amount of [ ] \$55.00; [ ] \$205.00; [ ] \$465.00; [ ] \$725.00; in payment of the extension fee is transmitted herewith. A duplicate copy of this transmittal letter is transmitted herewith.

SUPPLEMENTAL IDS FEE

[ ] A check in the amount of \$ 0.00 is transmitted herewith in payment of the Supplemental IDS fee pursuant to 37 C.F.R. § 1.17 (p).



Michael E. Shanahan  
Applicant  
Customer No. 32850  
P.O. Box 381  
Nyack, N.Y., 10960

DOCKET NO. MES/001CON  
CONFIRMATION NO. 8026

APPLICANT Michael E. Shanahan  
APPLICATION NO. 10/223,200 FILED August 16, 2002

RECEIPT IS HEREBY ACKNOWLEDGED OF THE  
Transmittal Letter (in duplicate); Preliminary Amendment.  
*CHECK FOR \$360.00*



DATED June 20, 2003

FILED IN CONNECTION WITH THE ABOVE CASE.

COMMISSIONER FOR PATENTS

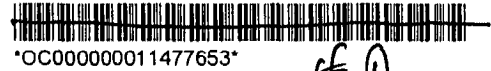

**UNITED STATES PATENT AND TRADEMARK OFFICE**

UNITED STATES DEPARTMENT OF COMMERCE  
 United States Patent and Trademark Office  
 Address: COMMISSIONER FOR PATENTS  
 P.O. Box 1450  
 Alexandria, Virginia 22313-1450  
 www.uspto.gov

APPL NO.	FILING OR 371 (c) DATE	ART UNIT	FIL FEE REC'D	ATTY DOCKET NO	DRAWINGS	TOT CLMS	IND CLMS
10/223,200	08/16/2002	2683	1309	MES/001CON	13	15	3

32850  
 MICHAEL E SHANAHAN  
 P.O. BOX 381  
 NYACK, NY 10960

**CONFIRMATION NO. 8026**  
**CORRECTED FILING RECEIPT**



\*OC000000011477653\*

*ffp*

Date Mailed: 12/12/2003

Receipt is acknowledged of this regular Patent Application. It will be considered in its order and you will be notified as to the results of the examination. Be sure to provide the U.S. APPLICATION NUMBER, FILING DATE, NAME OF APPLICANT, and TITLE OF INVENTION when inquiring about this application. Fees transmitted by check or draft are subject to collection. Please verify the accuracy of the data presented on this receipt. If an error is noted on this Filing Receipt, please write to the Office of Initial Patent Examination's Filing Receipt Corrections, facsimile number 703-746-9195. Please provide a copy of this Filing Receipt with the changes noted thereon. If you received a "Notice to File Missing Parts" for this application, please submit any corrections to this Filing Receipt with your reply to the Notice. When the USPTO processes the reply to the Notice, the USPTO will generate another Filing Receipt incorporating the requested corrections (if appropriate).

**Applicant(s)**

Michael E. Shanahan, Nyack, NY;

**Domestic Priority data as claimed by applicant**

This application is a CON of 09/518,712 03/03/2000 PAT 6,496,692  
 which claims benefit of 60/169,158 12/06/1999

**Foreign Applications**

If Required, Foreign Filing License Granted: 09/23/2002

Projected Publication Date: Not Applicable

Non-Publication Request: No

Early Publication Request: No

\*\* SMALL ENTITY \*\*

**Title**

Methods and apparatuses for programming user-defined information into electronic devices

**Preliminary Class**

---

**LICENSE FOR FOREIGN FILING UNDER  
Title 35, United States Code, Section 184  
Title 37, Code of Federal Regulations, 5.11 & 5.15**

**GRANTED**

The applicant has been granted a license under 35 U.S.C. 184, if the phrase "IF REQUIRED, FOREIGN FILING LICENSE GRANTED" followed by a date appears on this form. Such licenses are issued in all applications where the conditions for issuance of a license have been met, regardless of whether or not a license may be required as set forth in 37 CFR 5.15. The scope and limitations of this license are set forth in 37 CFR 5.15(a) unless an earlier license has been issued under 37 CFR 5.15(b). The license is subject to revocation upon written notification. The date indicated is the effective date of the license, unless an earlier license of similar scope has been granted under 37 CFR 5.13 or 5.14.

This license is to be retained by the licensee and may be used at any time on or after the effective date thereof unless it is revoked. This license is automatically transferred to any related applications(s) filed under 37 CFR 1.53(d). This license is not retroactive.

The grant of a license does not in any way lessen the responsibility of a licensee for the security of the subject matter as imposed by any Government contract or the provisions of existing laws relating to espionage and the national security or the export of technical data. Licensees should apprise themselves of current regulations especially with respect to certain countries, of other agencies, particularly the Office of Defense Trade Controls, Department of State (with respect to Arms, Munitions and Implements of War (22 CFR 121-128)); the Office of Export Administration, Department of Commerce (15 CFR 370.10 (j)); the Office of Foreign Assets Control, Department of Treasury (31 CFR Parts 500+) and the Department of Energy.

**NOT GRANTED**

No license under 35 U.S.C. 184 has been granted at this time, if the phrase "IF REQUIRED, FOREIGN FILING LICENSE GRANTED" DOES NOT appear on this form. Applicant may still petition for a license under 37 CFR 5.12, if a license is desired before the expiration of 6 months from the filing date of the application. If 6 months has lapsed from the filing date of this application and the licensee has not received any indication of a secrecy order under 35 U.S.C. 181, the licensee may foreign file the application pursuant to 37 CFR 5.15(b).



UNITED STATES PATENT AND TRADEMARK OFFICE

UNITED STATES DEPARTMENT OF COMMERCE  
United States Patent and Trademark Office  
Address: COMMISSIONER FOR PATENTS  
P.O. Box 1450  
Alexandria, Virginia 22313-1450  
www.uspto.gov

APPLICATION NO.	FILING DATE	FIRST NAMED INVENTOR	ATTORNEY DOCKET NO.	CONFIRMATION NO.
10/223,200	08/16/2002	Michael E. Shanahan	MES/001CON	8026

32850 7590 12/01/2003

MICHAEL E SHANAHAN  
P.O. BOX 381  
NYACK, NY 10960

EXAMINER

TRAN, CONGVAN

ART UNIT PAPER NUMBER

2683

DATE MAILED: 12/01/2003

7

Please find below and/or attached an Office communication concerning this application or proceeding.



Paper No. 7

Notice of Non-Compliant Amendment (37 CFR 1.121)

The amendment document filed on 10-14-03 is considered non-compliant because it has failed to meet the requirements of 37 CFR 1.121, as amended on June 30, 2003 (see 68 Fed. Reg. 38611, Jun. 30, 2003). In order for the amendment document to be compliant, correction of the following item(s) is required. Only the corrected section of the non-compliant amendment document must be resubmitted (in its entirety), e.g., the entire "Amendments to the claims" section of applicant's amendment document must be re-submitted. 37 CFR 1.121(h).

THE FOLLOWING CHECKED (X) ITEM(S) CAUSE THE AMENDMENT DOCUMENT TO BE NON-COMPLIANT:

- 1. Amendments to the specification:
  - A. Amended paragraph(s) do not include markings.
  - B. New paragraph(s) should not be underlined.
  - C. Other \_\_\_\_\_
- 2. Abstract:
  - A. Not presented on a separate sheet. 37 CFR 1.72.
  - B. Other \_\_\_\_\_
- 3. Amendments to the drawings: \_\_\_\_\_
- 4. Amendments to the claims:
  - A. A complete listing of all of the claims is not present.
  - B. The listing of claims does not include the text of all claims (including withdrawn claims)
  - C. Each claim has not been provided with the proper status identifier, and as such, the individual status of each claim cannot be identified.
  - D. The claims of this amendment paper have not been presented in ascending numerical order.
  - E. Other: \_\_\_\_\_

For further explanation of the amendment format required by 37 CFR 1.121, see MPEP Sec. 714 and the USPTO website at <http://www.uspto.gov/web/offices/pac/dapp/opla/preognotice/officelflyer.pdf>.

If the non-compliant amendment is a **PRELIMINARY AMENDMENT**, applicant is given ONE MONTH from the mail date of this letter to supply the corrected section which complies with 37 CFR 1.121. Failure to comply with 37 CFR 1.121 will result in non-entry of the preliminary amendment and examination on the merits will commence without consideration of the proposed changes in the preliminary amendment(s). This notice is not an action under 35 U.S.C. 132, and **this ONE MONTH time limit is not extendable.**

If the non-compliant amendment is a reply to a **NON-FINAL OFFICE ACTION (including a submission for an RCE)**, and since the amendment appears to be a *bona fide* attempt to be a reply (37 CFR 1.135(c)), applicant is given a **TIME PERIOD** of ONE MONTH from the mailing of this notice within which to re-submit the corrected section which complies with 37 CFR 1.121 in order to avoid abandonment. **EXTENSIONS OF THIS TIME PERIOD ARE AVAILABLE UNDER 37 CFR 1.136(a).**

If the amendment is a reply to a **FINAL REJECTION**, this form may be an attachment to an Advisory Action. The period for response to a final rejection continues to run from the date set in the final rejection, and is not affected by the non-compliant status of the amendment.

Bobbie Davenport 703-305-9630  
Legal Instruments Examiner (LIE) Telephone No.



10 223 200

Serial Number

- \_\_\_ Canceled claims cannot show text of claim.
- \_\_\_ "Amended" is not a proper status identifier.
- \_\_\_ Amendments to the Specifications should begin on a separate page.
- \_\_\_ Amendment to the Claims should begin on a separate page.
- \_\_\_ "Remarks" should begin on a separate sheet.
- \_\_\_ The "Cover Sheet", amendments to the "Specifications", amendments to the "Claims", and "Remarks" should each begin on a separate sheet.
- \_\_\_ Only "Currently Amended" and "Withdrawn" claims can show markings.
- \_\_\_ Drawings should each have "Replacement Sheet(s)" or "Annotated Sheet(s)" as a heading.
- \_\_\_ "Previously Added" is not a proper status identifier.
- \_\_\_ "Previously Amended" is not a proper status identifier.
- \_\_\_ A Clean copy and A Marked Up copy of the Claims is a Non-Compliant amendment Format.
- \_\_\_ "Re-Presented" is an improper status identifier.
- \_\_\_ "Claims \_\_\_\_\_ have been cancelled" is an improper status identifier.
- \_\_\_ "Currently Amended claims must show markings.

A Clean copy and a Marked Up copy of Substitute Specification is needed.

Amendments to the Specifications must be by marked-up replacement paragraphs or sections only; (no clean or replacement paragraph or section is required; No replacements sheets permitted.

X The claims amendment of 6/24/03 was renumbered as claims 16-32, since the  
original claims were 1-15. The Amendment of 7/8/03 claims were renumbered as 33  
-36. The Status Identifiers of claims 37-82 were not labelled as "New", so they are  
therefore, improper.

*62-78*

*79-82*

*amdt. of 10-14-03*



#6 D.J. 11-30-03  
Pre amend (N.E.)  
MES/001 CON

IN THE UNITED STATES PATENT AND TRADEMARK OFFICE

Applicant : Michael E. Shanahan  
Serial No. : 10/223,200 Confirmation No.: 8026  
Filed: : August 16, 2002  
For : METHODS AND APPARATUSES FOR PROGRAMMING  
USER-DEFINED INFORMATION INTO ELECTRONIC  
DEVIVES  
Group Art Unit : 2681  
Examiner : Not Yet Assigned

ENTERED  
P.J.  
12/24/03

RECEIVED  
OCT 23 2003  
Technology Center 2600

October 14, 2003

Hon. Commissioner  
for Patents  
P.O. box 1450,  
Alexandria VA 22313-1450

PRELIMINARY AMENDMENT IV

Sir:

Before examining this patent application, please  
amend the application as follows:

Priority Data

Applicant notes this case is listed as a  
continuation-in-part (CIP) on the filing receipt dated  
September 23, 2002. This is an error. The specification and  
accompanying declaration, as originally filed, indicate the  
case is a continuation, and not a CIP of United States Patent  
Application 09/518,846 now United States Patent 6,496,692.  
Appropriate correction is respectfully requested.

10/21/2003 ZJUHA1 00000046 10223200  
01 FC:2202 189.00 OP  
02 FC:2201 86.00 OP

EV132192548US

In the Claims

Claims 1-15 (canceled).

16. (Previously presented) A method of customizing a wireless telephone by programming an audio file into the wireless telephone for use as an indicia of an incoming communication, the method comprising:

connecting to a remote database that includes a plurality of lists of audio files;

allowing a user of the wireless telephone to browse at least one of the lists of audio files;

allowing the user of the wireless telephone to select at least one of the audio files from the browsed list;

optionally reviewing the selected audio file before downloading the selected audio into the wireless telephone;

and

allowing the user to optionally download the selected audio file for use as an indicia of an incoming communication.

17. (Previously presented) The method of claim 16 wherein the format of the selected audio file is from the group comprising: MIDI, MPEG, MP3, WAV, PCM, Windows Media Audio code (WMA), or Adaptive Transform Acoustic Coding (ATRAC).

18. (Previously presented) The method of claim 16 further comprising allowing the user to search the remote

database for a certain desired audio file using title or description information to aid in locating the desired audio file.

19. (Previously presented) The method of claim 18 wherein the searching further comprises searching the Internet or other remote databases for the desired audio file.

20. (Previously presented) The method of claim 16 wherein the browsing of audio files is accomplished at least in part using a Wireless Application Protocol (WAP) compliant system.

21. (Currently amended) The method of claim 16 further comprising providing a visual indication on a display screen of the wireless telephone to confirm [an] the selected audio file has been successfully downloaded.

22. (Previously presented) The method of claim 16 further comprising:

downloading a selected audio file into the wireless telephone; and

associating the downloaded audio file with a characteristic indicative of a caller such that the associated audio file plays when the indicative characteristic is received by the wireless telephone.

23. (Previously presented) The method of claim 16 wherein the characteristic indicative of the caller is the caller's telephone number.

24. (Currently amended) A method of customizing a wireless telephone by programming an audio file into the wireless telephone for use as an indicia of an incoming communication, the method comprising:

connecting to a remote database that includes a plurality of audio files; the remote database operating substantially independently of a communications network that provides wireless telephone service to the wireless telephone;

allowing the user of the wireless telephone to browse and select at least one of the audio files;

allowing the user to optionally download the selected audio file into a programmable memory for use as an indicia of an incoming communication.

25. (Previously presented) The method of claim 24 further comprising allowing the user to optionally review the selected audio file before downloading the selected audio file into the wireless telephone.

26. (Previously presented) The method of claim 24 wherein the format of the selected audio file is from the group comprising: MIDI, MPEG, MP3, WAV, PCM, Windows Media

C1  
Cont

Audio code (WMA), or Adaptive Transform Acoustic Coding (ATRAC).

27. (Previously presented) The method of claim 24 further comprising allowing the user to search the remote database for a certain desired audio file using title or description information to aid in locating the desired audio file.

28. (Previously presented) The method of claim 27 wherein the searching further comprises searching the Internet or other remote databases for the desired audio file.

29. (Previously presented) The method of claim 24 wherein the browsing of audio files is accomplished at least in part using a Wireless Application Protocol (WAP) compliant system.

30. (Currently amended) The method of claim 24 further comprising providing a visual indication on a display screen of the wireless telephone to confirm [an] the selected audio file has been successfully downloaded.

31. (Currently amended) The method of claim 24 further comprising:

downloading a selected audio file into the wireless telephone; and

associating the downloaded audio file with a characteristic ~~indictative~~ indicative of a caller such that the associated audio file plays when the indicative characteristic is received by the wireless telephone.

32. (Previously presented) The method of claim 24 wherein the characteristic indicative of the caller is the caller's telephone number.

33. (Previously presented) A wireless telephone that may be customized by programming an audio file into the wireless telephone for use as an indicia of an incoming communication, the telephone comprising:

a communications link capable of connecting to a remote database that includes a plurality of lists of audio files;

a display screen that allows a user of the wireless telephone to browse at least one of the lists of audio files and view selectable audio files present in the browsed list;

a speaker and processing circuitry configured to allow the user to optionally review a selected audio file before downloading the selected audio file into the wireless telephone; and

a programmable memory circuit for allowing the user to optionally store the selected audio file for use as an indicia of an incoming communication.



34. (Previously presented) The wireless telephone of claim 33 wherein the programmable memory circuit is configured to store audio files in a format selected from the group comprising: MIDI, MPEG, MP3, WAV, PCM, Windows Media Audio code (WMA), or Adaptative Transform Acoustic Coding (ATRAC).

C1  
Cont

35. (Previously presented) The wireless telephone of claim 33 wherein the speaker and processing circuitry is configured to play audio files in a format selected from the group comprising: MIDI, MPEG, MP3, WAV, PCM, Windows Media Audio code (WMA), or Adaptative Transform Acoustic Coding (ATRAC).

36. (Previously presented) The wireless telephone of claim 33 wherein the wireless telephone is configured to allow the user to search the remote database for a certain desired audio file using title or description information to aid in locating the desired audio file.

37. (Previously presented) The wireless telephone of claim 36 wherein the wireless telephone is configured to search the Internet or other remote databases for the desired audio file.

38. (Previously presented) The wireless telephone of claim 33 wherein the wireless telephone includes a Wireless Application Protocol (WAP) compliant Internet browser.

39. (Currently amended) The wireless telephone of claim 33 configured to provide a visual indication on the display screen of the wireless to confirm [an] the selected audio file has been successfully downloaded.

C1  
Cont

40. (Previously presented) The wireless telephone of claim 33 configured to allow the user to associate a downloaded audio file with a characteristic indicative of a caller such that the associated audio file plays when the indicative characteristic is received by the wireless telephone.

41. (Previously presented) The method of claim 33 wherein the characteristic indicative of the caller is the caller's telephone number.

42. (Currently amended) A wireless telephone that may be customized by programming an audio file into the wireless telephone for use as an indicia of an incoming communication, the telephone comprising:

a communications link capable of connecting to a remote database that includes a plurality of lists of audio files; the remote database operating substantially

independently of a communications network that provides wireless telephone service to the wireless telephone;

a display screen that allows a user of the wireless telephone to browse at least one of the plurality of lists of audio files and view selectable audio files present in the browsed list;

processing circuitry configured to receive a selected audio file from the communications link; and

a programmable memory circuit for allowing the user to optionally store the selected audio file for use as an indicia of an incoming communication.

*C1*  
*Cont*

43. (Previously presented) The wireless telephone of claim 42 further comprising a speaker that operates in conjunction with the processing circuitry to allow the user to optionally review a selected audio file before downloading the selected audio file into the wireless telephone.

44. (Previously presented) The wireless telephone of claim 42 wherein the programmable memory circuit is configured to store audio files in a format selected from the group comprising: MIDI, MPEG, MP3, WAV, PCM, Windows Media Audio code (WMA), or Adaptative Transform Acoustic Coding (ATRAC).

45. (Previously presented) The wireless telephone of claim 42 wherein the speaker and processing circuitry is

configured to play audio files in a format selected from the group comprising: MIDI, MPEG, MP3, WAV, PCM, Windows Media Audio code (WMA), or Adaptive Transform Acoustic Coding (ATRAC).

46. (Previously presented) The wireless telephone of claim 42 wherein the wireless telephone is configured to allow the user to search the remote database for a certain desired audio file using title or description information to aid in locating the desired audio file.

*cl*  
*cont*  
46. (Previously presented) The wireless telephone of claim 45 wherein the wireless telephone is configured to search the Internet or other remote databases for the desired audio file.

47. (Previously presented) The wireless telephone of claim 42 wherein the wireless telephone includes a Wireless Application Protocol (WAP) compliant Internet browser.

48. (Currently amended) The wireless telephone of claim 42 configured to provide a visual indication on the display screen to confirm [an] the selected audio file has been successfully downloaded.

49. (Previously presented) The wireless telephone of claim 42 configured to allow the user to associate a

downloaded audio file with a characteristic indicative of a caller such that the associated audio file plays when the indicative characteristic is received by the wireless telephone.

50. (Currently amended) A wireless telephone that may be customized by programming an audio file into the wireless telephone for use as an indicia of an incoming communication, the telephone comprising:

means for connecting to a remote database that includes a plurality of lists of audio files;

means for browsing at least one of the lists of audio files;

means for ~~select~~ selecting at least one of the audio files from the browsed list;

means for optionally reviewing the selected audio file before downloading the selected audio into the wireless telephone; and

means for downloading the selected audio file for use as an indicia of an incoming communication.

51. (Previously presented) The wireless telephone of claim 50 further comprising means for searching the remote database for a certain desired audio file using title or description information to aid in locating the desired audio file.

52. (Previously presented) The wireless telephone of claim 51 wherein the searching further comprises means for searching the Internet or other remote databases for the desired audio file.

53. (Currently amended) The wireless telephone of claim 50 further comprising means for providing a visual indication on a display screen of the wireless telephone to confirm [an] the selected audio file has been successfully downloaded.

C1  
Cost

54. (Currently amended) The wireless telephone of claim 50 further comprising means for associating a downloaded audio file with a characteristic ~~indictative~~ indicative of a caller such that the associated audio file plays when the indicative characteristic is received by the wireless telephone.

55. (Previously presented) A wireless telephone that may be customized by programming an audio file into the wireless telephone for use as an indicia of an incoming communication, the telephone comprising:

means for connecting to a remote database that includes a plurality of audio files; the remote database operating independently of a communications network that provides wireless telephone service to the wireless telephone;

means for browsing and selecting at least one of the audio files;

means for optionally downloading the selected audio file into a programmable memory for use as an indicia of an incoming communication.

56. (Previously presented) The wireless telephone of claim 55 further comprising means for optionally reviewing the selected audio file before downloading the selected audio file into the wireless telephone.

*C!*  
*Cont*  
57. (Previously presented) The wireless telephone of claim 56 further comprising means for searching the remote database for a certain desired audio file using title or description information to aid in locating the desired audio file.

58. (Previously presented) The wireless telephone of claim 55 wherein the searching further comprises means for searching the Internet or other remote databases for the desired audio file.

59. (Previously presented) The wireless telephone of claim 55 wherein the browsing of audio files is accomplished at least in part using a Wireless Application Protocol (WAP) compliant system.

60. (Currently amended) The wireless telephone of claim 55 further comprising providing a visual indication on a display screen of the wireless telephone to confirm [an] the selected audio file has been successfully downloaded.

61. (Previously presented) The wireless telephone of claim 55 further comprising means for associating a downloaded audio file with a characteristic indicative of a caller such that the associated audio file plays when the indicative characteristic is received by the wireless telephone.

*C/ Cont*  
62. (Previously presented) The method of claim 16 further comprising preventing the unauthorized distribution of a downloaded audio file.

63. (Previously presented) The method of claim 16 further comprising playing the selected audio file through an enhanced performance speaker capable of providing a substantially full range of audio sounds from MIDI, MP3, MPEG, WAV, PCM, Windows Media Audio Code (WMA), or Adaptive Transform Acoustic Coding (ATRAC) files.

64. (Previously presented) The method of claim 16 characterized by the use of a personal computer to perform the browsing step.



65. (Previously presented) The method of claim 16 further comprising providing the user with an opportunity to edit the selected audio file.

66. (Previously presented) The method of claim 16 further comprising providing an indication that a memory capacity of the wireless telephone has been exceeded if the size of the audio file to be downloaded is larger than available memory space in the wireless telephone.

*C1*  
*Cont*

67. (Previously presented) The method of claim 66 further comprising providing the user of the wireless telephone with the opportunity to cancel or modify a download request associated with an audio file download operation if the size of the audio file to be downloaded is larger than available memory space in the wireless telephone.

68. (Previously presented) The wireless telephone of claim 42 wherein the wireless telephone is configured to prevent the unauthorized distribution of an audio file stored in the programmable memory circuit.

69. (Previously presented) The wireless telephone of claim 43 wherein the speaker is an enhanced performance speaker capable of providing a substantially full range of audio sounds from MIDI, MP3, MPEG, WAV, PCM, Windows Media

Audio Code (WMA), or Adaptive Transform Acoustic Coding (ATRAC) files.

70. (Previously presented) The wireless telephone of claim 42 configured to provide an indication that a memory capacity of the wireless telephone has been exceeded if the size of the audio file to be downloaded is larger than available memory space in the wireless telephone.

C1  
Cont

71. (Previously presented) The wireless telephone of claim 70 configured to provide the user of the wireless telephone with the opportunity to cancel or modify a download request associated with an audio file download operation if the size of the audio file to be downloaded is larger than the available memory space in the wireless telephone.

~~72.~~ (Currently amended) A wireless telephone that may be customized by programming an audio file into the wireless telephone for use as an indicia of an incoming communication, the telephone comprising:

means for connecting to a remote database that includes a plurality of [of] audio files;

means for selecting at least one of the audio files from the database;

means for downloading and storing the selected audio file for use as an indicia of an incoming communication; and

means for preventing the unauthorized distribution of a selected audio file stored in the wireless telephone.

73. (Previously presented) The wireless telephone of claim 72 further comprising means for indicating that a memory capacity of the wireless telephone has been exceeded if the size of the audio file to be downloaded is larger than available memory space in the wireless telephone.

74. (Currently amended) A wireless telephone that may be customized by searching for and selecting an audio file from a remote computer and programming the selected audio file into the wireless telephone for use as an indicia of an incoming communication, the telephone comprising:

a communications link capable of connecting to a database in the remote computer that includes a plurality of lists of audio files in ~~MIDI~~ MPEG, WAV, or MP3 format ~~or a combination thereof~~;

a display screen and a mobile Internet browser that allows a user of the wireless telephone to browse at least one of the plurality of lists of audio files and view selectable audio files present in the browsed list;

processing circuitry configured to receive a selected one of the audio files from the communications link;

a programmable memory circuit for allowing the user to optionally store the selected audio file for use as an indicia of an incoming communication; and

an enhanced performance speaker capable of providing a substantially full range of audio sounds from MIDI MPEG, WAV, or MP3 files when one of the stored audio files is played as an indicia of an [incomming] incoming communication.

75. (Previously presented) The wireless telephone of claim 74 configured to provide an indication that a memory capacity of the wireless telephone has been exceeded if the size of the audio file to be downloaded is larger than available memory space in the wireless telephone.

C1  
Cont  
76. (Previously presented) The wireless telephone of claim 74 wherein the enhanced performance speaker operates in conjunction with the processing circuitry to allow the user to optionally review a selected audio file before downloading the selected audio file into the wireless telephone.

77. (Previously presented) The wireless telephone of claim 74 configured to allow the user to search the remote database for a certain desired audio file using title or description information to aid in locating the desired audio file.

78. (Previously presented) The wireless telephone of claim 74 configured to prevent the unauthorized distribution of an audio file stored in the programmable memory circuit.

79. (Currently amended) A wireless telephone that may be customized by searching for and selecting an audio file from a remote computer and programming the selected audio file into the wireless telephone for use as an indicia of an incoming communication, the telephone comprising:

a communications link capable of connecting to a database in the remote computer that includes a plurality of [of] polyphonic audio files;

a display screen and a browsing application program that allows a user of the wireless telephone to browse the polyphonic audio files and select at least one polyphonic audio file therefrom;

processing circuitry configured to supervise receipt of a selected polyphonic audio file from the communications link;

a programmable memory circuit for allowing the user to optionally store the selected polyphonic audio file for use as an indicia of an incoming communication; and

an enhanced performance speaker capable of providing a substantially full range of audio sounds from the selected polyphonic audio file when the selected polyphonic audio file is played as an indicia of an ~~incomming~~ incoming communication.

80. (Currently amended) The wireless telephone of claim 79 wherein the polyphonic audio file is selected from the group comprising MIDI, MP3, MPEG, or WAV files.

81. (Currently amended) The wireless telephone of claim 79 wherein the enhanced performance speaker operates in conjunction with the processing circuitry to allow the user to optionally review the selected polyphonic audio file before downloading the selected polyphonic audio file into the programmable ~~memory~~ memory circuit of the wireless telephone.

Cl  
Cont  
82. (Previously presented) The wireless telephone of claim 79 configured to prevent the unauthorized distribution of the selected polyphonic audio file stored in the programmable memory circuit.

*PREVIOUSLY PRESENTED*  
83. (New) The wireless telephone of claim 74 wherein the communications link is capable of connecting to a database in the remote computer that includes a plurality of lists of audio files in polyphonic MIDI format.

84. (New) The wireless telephone of claim 76 configured to provide the user of the wireless telephone with the option of downloading the selected polyphonic audio file into a programmable memory in the wireless telephone after reviewing the selected polyphonic audio file.

85. (New) The wireless telephone of claim 84 configured to provide the user of the wireless telephone with the option of editing the selected polyphonic audio file before programming the selected polyphonic audio file into the programmable memory in the wireless telephone.

86. (New) The wireless telephone of claim 78 wherein the wireless telephone is configured to operate in conjunction with copyright protection software to prevent the unauthorized distribution of the selected polyphonic audio file stored in the programmable memory circuit.

*C1*  
*Cont*  
87. (New) The wireless telephone of claim 79 wherein the group of polyphonic audio files include audio files in polyphonic MIDI format.

88. (New) The wireless telephone of claim 81 configured to provide the user of the wireless telephone with the option of downloading the selected polyphonic audio file into a programmable memory in the wireless telephone after reviewing the selected polyphonic audio file.

89. (New) The wireless telephone of claim 88 configured to provide the user of the wireless telephone with the option of editing the selected polyphonic audio file before programming the selected polyphonic audio file into the programmable memory in the wireless telephone.

90. (New) The wireless telephone of claim 82 wherein the wireless telephone is configured to operate with copyright protection software to prevent the unauthorized distribution of the selected polyphonic audio file stored in the programmable memory circuit.

91. (New) A wireless telephone that may be customized by searching for and selecting an audio file from a remote computer and programming the selected audio file into the wireless telephone for use at a time specified by the user, the telephone comprising:

*C1*  
*Cont*  
a communications link capable of connecting to a database in the remote computer that includes a plurality of polyphonic audio files;

a display screen and a browsing application program that allows a user of the wireless telephone to browse the polyphonic audio files and select at least one polyphonic audio file therefrom;

processing circuitry configured to supervise receipt of a selected polyphonic audio file from the communications link;

a programmable memory circuit for allowing the user to optionally store the selected polyphonic audio file for use as an indicia of an incoming communication; and

an enhanced performance speaker capable of providing a substantially full range of audio sounds from the selected



polyphonic audio file when the selected polyphonic audio file is played.

92. (New) The wireless telephone of claim 91 wherein the polyphonic audio file is selected from the group comprising MP3, MPEG, or WAV files.

93. (New) The wireless telephone of claim 91 wherein the enhanced performance speaker operates in conjunction with the processing circuitry to allow the user to optionally review the selected polyphonic audio file before downloading the selected polyphonic audio file into the programmable memory circuit of the wireless telephone.

94. (New) The wireless telephone of claim 91 configured to prevent the unauthorized distribution of the selected polyphonic audio file stored in the programmable memory circuit.

95. (New) The wireless telephone of claim 92 wherein the group of polyphonic audio files includes audio files in polyphonic MIDI format.

96. (New) The wireless telephone of claim 93 configured to provide the user of the wireless telephone with the option of downloading the selected polyphonic audio file

into a programmable memory in the wireless telephone after reviewing the selected polyphonic audio file.

97. (New) The wireless telephone of claim 96 configured to provide the user of the wireless telephone with the option of editing the selected polyphonic audio file before programming the selected polyphonic audio file into the programmable memory in the wireless telephone.

98. (New) The wireless telephone of claim 94 wherein the wireless telephone is configured to operate in conjunction with copyright protection software to prevent the unauthorized distribution of the selected polyphonic audio file stored in the programmable memory circuit.

99. (New) A wireless telephone that may be customized by programming an audio file into the wireless telephone for use at a time specified by a user of the wireless telephone, the telephone comprising:

means for connecting to a remote database that includes a plurality of lists of polyphonic audio files;

means for browsing at least one of the lists of polyphonic audio files;

means for selecting at least one of the polyphonic audio files from the browsed list;

means for optionally reviewing the selected polyphonic audio file before downloading the selected

C1  
Cont

polyphonic audio into a memory circuit in the wireless telephone; and

means for downloading the selected polyphonic audio file for use at the time specified by the user of the wireless telephone.

100. (New) The wireless telephone of claim 99 further comprising means for searching the remote database for a certain desired polyphonic audio file using title or description information to aid in locating the desired polyphonic audio file.

*C1*  
*Cont*  
101. (New) The wireless telephone of claim 100 wherein the searching further comprises means for searching the Internet or other remote databases for the desired polyphonic audio file.

102. (New) The wireless telephone of claim 99 further comprising means for providing a visual indication on a display screen of the wireless telephone to confirm the selected polyphonic audio file has been successfully downloaded.

103. (New) The wireless telephone of claim 99 wherein the browsing of polyphonic audio files is accomplished at least in part using a Wireless Application Protocol (WAP) compliant system.

C1  
Cont

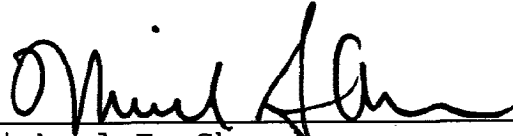
104. (New) The wireless telephone of claim 99 further comprising means for preventing unauthorized distribution of the selected polyphonic audio file stored in the programmable memory circuit.

---

REMARKS

These amendments more particularly point out and define the invention. An early and favorable action on this patent application is requested.

Respectfully submitted,



---

Michael E. Shanahan  
Applicant  
Customer No. 32850  
P.O. Box 381  
Nyack, N.Y. 10960



10-16-03

26818

Attorney Docket No. MES/001 CON

IN THE UNITED STATES PATENT AND TRADEMARK OFFICE

RECEIVED

OCT 23 2003

Technology Center 2600

PATENT APPLICATION

Applicant : Michael E. Shanahan

Application No. : 10/223,200 Confirmation No. 8026

Filing Date : August 16, 2002

For : METHODS AND APPARATUSES FOR PROGRAMMING USER-DEFINED INFORMATION INTO ELECTRONIC DEVICES

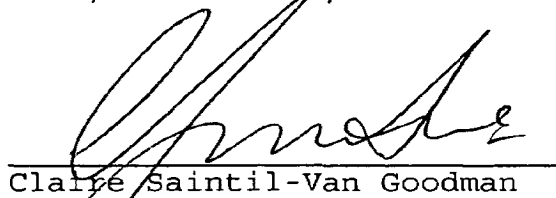
Group Art Unit : 2681

Examiner : Not Yet Assigned

"EXPRESS MAIL" mailing label number EV132192548US.

Date of Deposit: October 14, 2003

I hereby certify that this papers and listed hereon are being deposited with the United States Postal Service "EXPRESS MAIL POST OFFICE TO ADDRESSEE" service under 37 C.F.R. 1.10 on the date indicated above and is addressed to the Hon. Commissioner for Patents, P.O. Box 1450, Alexandria, VA 22313-1450.

  
\_\_\_\_\_  
Claire Saintil-Van Goodman

- Enc.
- Preliminary Amendment 4
- Check for \$ 275.00



REV. 10/03  
Small Entity

Docket No. MES/001 CON

IN THE UNITED STATES PATENT AND TRADEMARK OFFICE

**RECEIVED**

OCT 23 2003

PATENT APPLICATION

Technology Center 2600

Applicant : Michael E. Shanahan

Application No. : 10/223,200 Confirmation No.: 8026

Filed : August 16, 2002

For : METHODS AND APPARATUSES FOR PROGRAMMING USER-  
DEFINED INFORMATION INTO ELECTRONIC DEVICES

Group Art Unit : 2681

Examiner : Not Yet Assigned

Hon. Commissioner  
for Patents  
P.O. Box 1450  
Alexandria VA 22313-1450

TRANSMITTAL LETTER

Sir:

Transmitted herewith:  a Preliminary Amendment;  
 a Declaration;  a Supplemental Information Disclosure  
Statement;  substitute specification;  an Associate Power  
of Attorney;  formal drawings; to be filed in the above-  
identified patent application.

FEE FOR ADDITIONAL CLAIMS

- A fee for additional claims is not required.
- A fee for additional claims is required.

EV132192548US

The additional fee has been calculated as shown below:

	CLAIMS REMAINING AFTER AMENDMENT		HIGHEST NUMBER PREVIOUSLY PAID FOR		PRESENT EXTRA		RATE		EXTRA FEES
TOTAL CLAIMS	87	-	66	*	=	21	X \$9	=	\$ 189.00
INDEPENDENT CLAIMS	11	-	9	**	=	2	X \$43	=	\$ 86.00
FIRST PRESENTATION OF A MULTIPLE DEPENDENT CLAIM							+ \$145	=	\$ 0.00

\* If less than 20, insert 20. TOTAL \$ 275.00  
 \*\* If less than 3, insert 3.

[X] A check in the amount of \$ 275.00 is transmitted herewith.

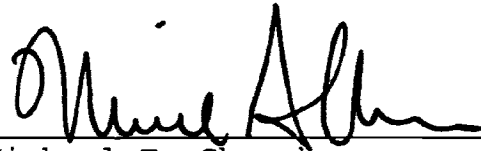
EXTENSION FEE

[ ] The following extension is applicable to the Response filed herewith; [ ] \$55.00 extension fee for response within first month pursuant to 37 C.F.R. § 1.17(a)(1); [ ] \$210.00 extension fee for response within second month pursuant to 37 C.F.R. § 1.17(a)(2); [ ] \$475.00 extension fee for response within third month pursuant to 37 C.F.R. § 1.17(a)(3); [ ] \$740.00 extension fee for response within fourth month pursuant to 37 C.F.R. § 1.17(a)(4).

[ ] A check in the amount of [ ] \$55.00; [ ] \$210.00; [ ] \$475.00; [ ] \$740.00; in payment of the extension fee is transmitted herewith. A duplicate copy of this transmittal letter is transmitted herewith.

SUPPLEMENTAL IDS FEE

[ ] A check in the amount of \$0.00 is transmitted herewith in payment of the Supplemental IDS fee pursuant to 37 C.F.R. § 1.17 (p).



---

Michael E. Shanahan  
Applicant  
Customer No. 32850  
P.O. Box 381  
Nyack, N.Y., 10960



2681



Docket No. MES/001 CON

IN THE UNITED STATES PATENT AND TRADEMARK OFFICE

Applicant : Michael E. Shanahan  
 Application No.: 10/223,200 Conf. No.: 8026  
 Filed : August 16, 2002  
 For : METHODS AND APPARATUSES FOR PROGRAMMING  
 USER-DEFINED INFORMATION IN ELECTRONIC  
 DEVICES  
 Group Art Unit : 2681

RECEIVED

SEP 05 2003

Technology Center 2600

New York, New York  
August 28, 2003

Hon. Commissioner  
for Patents  
P.O. Box 1450,  
Alexandria VA 22313-1450

THIRD SUPPLEMENTAL INFORMATION DISCLOSURE STATEMENT

Sir:

In accordance with 37 C.F.R. §§ 1.56 and 1.97,  
 applicants wish to call the attention of the Examiner to the  
 documents cited in the Supplemental Information Disclosure  
 Statement (IDS) filed herewith. Because these references are  
 being cited in this case before the mailing date of the Office  
 Action on the merits, pursuant to 37 C.F.R. § 1.97(b)(3),  
 applicant believes no fee is due in connection with this  
 Supplemental IDS.



U.S. Patents

Yamada	5,414,751	May, 1995
Blanvillain et al.	5,953,408	September, 1999
Morishima	6,075,998	June, 2000
Kohler	6,140,568	October, 2000
Yoshino	6,308,086	October, 2001

RECEIVED

SEP 05 2003

Foreign Patents

Vazvan	WO 00/36857	June 2000
--------	-------------	-----------

Technology Center 2600


Other Documents

SGS Thompson Microelectronics ST 5092 Data Sheet pp. 1-29

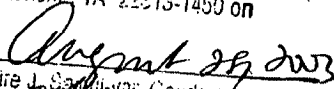
Copies of the aforementioned patents and publications, which are listed on the accompanying Form PTO-1449 (submitted in duplicate), are enclosed herewith.

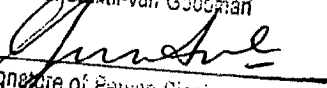
It is respectfully requested that these patents and publications be (1) fully considered by the Patent and Trademark Office during examination of this application; and (2) printed on any patent which may issue on this application. Applicant requests that a copy of Form PTO-1449, as considered and initialed by the Examiner, be returned with the next communication

Respectfully submitted,

  
 \_\_\_\_\_  
 Michael E. Shanahan  
 Applicant  
 Customer No. 32850  
 P.O. Box 381  
 Nyack, NY 10960

I hereby certify that this  
 Correspondence is being  
 deposited with the U.S.  
 Postal Service in First  
 Class mail in an envelope  
 Addressed to:  
 Commissioner for Patents  
 P.O. Box 1450  
 Alexandria, VA 22313-1450 on

  
 Claire J. Sarkis-van Goodman

  
 \_\_\_\_\_  
 Signature of Person Signing



This Page Is Inserted by IFW Operations  
and is not a part of the Official Record

## **BEST AVAILABLE IMAGES**

Defective images within this document are accurate representations of the original documents submitted by the applicant.

Defects in the images may include (but are not limited to):

- BLACK BORDERS
- TEXT CUT OFF AT TOP, BOTTOM OR SIDES
- FADED TEXT
- ILLEGIBLE TEXT
- SKEWED/SLANTED IMAGES
- COLORED PHOTOS
- BLACK OR VERY BLACK AND WHITE DARK PHOTOS
- GRAY SCALE DOCUMENTS

**IMAGES ARE BEST AVAILABLE COPY.**

**As rescanning documents *will not* correct images,  
please do not report the images to the  
Image Problems Mailbox.**



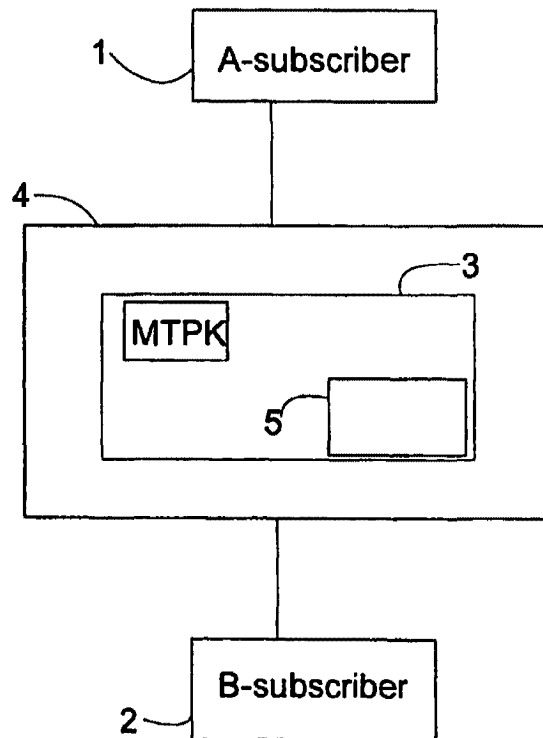
INTERNATIONAL APPLICATION PUBLISHED UNDER THE PATENT COOPERATION TREATY (PCT)

<p>(51) International Patent Classification <sup>7</sup> : <b>H04Q 7/22</b></p>	<p><b>A2</b></p>	<p>(11) International Publication Number: <b>WO 00/36857</b> (43) International Publication Date: <b>22 June 2000 (22.06.00)</b></p>
<p>(21) International Application Number: <b>PCT/FI99/01042</b> (22) International Filing Date: <b>15 December 1999 (15.12.99)</b> (30) Priority Data: <b>982714</b>                      <b>15 December 1998 (15.12.98)</b>      <b>FI</b> (71) Applicant: <b>OY RADIOLINJA AB [FI/FI]; P.O. Box 500, FIN-00181 Helsinki (FI).</b> (72) Inventor: <b>VAZVAN, Behruz; Viulutie 7 B 25, FIN-00420 Helsinki (FI).</b> (74) Agent: <b>SEPPO LAINE OY; Itämerenkatu 3 B, FIN-00180 Helsinki (FI).</b></p>	<p>(81) Designated States: <b>EE, LT, LV, NO, European patent (AT, BE, CH, CY, DE, DK, ES, FI, FR, GB, GR, IE, IT, LU, MC, NL, PT, SE).</b>  <b>Published</b> <i>In English translation (filed in Finnish). Without international search report and to be republished upon receipt of that report.</i></p>	

(54) Title: **METHOD FOR IMPLEMENTING A SOUND MESSAGE SEND/RECEIVE SERVICE IN A TELECOMMUNICATION NETWORK**

(57) Abstract

The present invention concerns a method for sending a sound or musical tune message from a service user terminal device (1) or, alternatively, on the service user's request, to the terminal device (2) of another subscriber in short-message format. The method is adapted implementable by means of a mobile phone and/or a PC connected to a telecom network (3). According to the invention, the subscriber wishing to send a musical tune message selects the desired musical tune from the information displayed on his terminal device (1) and then selects the directory number or connection code of the recipient, whereupon said message is sent to the recipient's terminal device (2). In conjunction with the receipt of said musical tune message at the recipient(s) terminal (2), the sender's name and/or directory number, together with a possible text message, are displayed to the recipient. Hereupon, the recipient may activate said musical tune message and hear it and, if so desired, store the same in his terminal device (2) or, optionally, send the same to the terminal device of a third party.



**Method for implementing a sound message send/receive service in a telecommunication network**

The invention relates to a method according to the preamble of claim 1.

5

The invention also relates to a mobile phone, a service center and a terminal device suitable for implementing the method according to the invention.

10

It is an object of the invention to provide a method for sending a sound message (a tune) from a subscriber terminal device 1 or, alternatively, on a request sent therefrom, in a short-message format to a terminal device 2 owned by another subscriber. It is a further object of the invention to provide a technique for storing said sound message in a subscriber terminal device as the alarm signal of the terminal device's alarm clock.

15

In the art are known a method and system in which the connection data associated with a service provider or a service, such as the name, connection code, etc., are selected and activated in the subscriber's terminal device and, subsequently, are sent to the system switching center or to the recipient's terminal device or account. Also a method and system are known featuring the possibility of delivering messages comprised of successive tones or a text (such as short messages) to a subscriber terminal device or, vice versa, from the terminal device. Such embodiments are described, e.g., in FI patent applications no. FI 945,075, FI 962,553 and FI 962,961. On the basis of cited method, also systems have been developed in which the system switching center (server) has ring tones (e.g., popular music samples) stored therein so that a mobile phone subscriber can retrieve said ring tones into his mobile phone through the steps of reading a code (e.g., BVAZSAEP), e.g., from the service provider's www pages, by entering the code into his own terminal device and then sending said code as a short message to the short-message server/center, where the subscriber is identified and, based on said code, the ring tone ordered by the subscriber is sent to his mobile telephone. Next, the subscriber can play the delivered

30

ring tone and store it in his mobile phone's selection of ring tones, whereupon it can be used only as a ring tone. The implementation of this embodiment is possible in, e.g., mobile phone types Nokia 6110, 6150, 8810, 8110i and 9000i, however, without the possibility of retransmitting the received ring tone to another subscriber or using  
5 the same as the alarm signal of the mobile phone's alarm clock. Such a service provider can be found by contacting, e.g., Radiolinja's Jukebox service at <http://jukehoksi.radiolinja.fi> or Sonera's Doris service at <http://www.sonera.fi/nmt-gsm/doris/aanivalitsin.html>.

10 The basic concept of these ring tone services is that a subscriber can order a desired ring tone from a service provider, whereby the ring tone data is sent only to his personal mobile phone, wherein it can be used as a ring tone for incoming calls.

For some time, the service centers of telecom operators have also offered voice mail  
15 systems in which a subscriber can leave a voice message to the voice mail center, whereupon the destination party known as B-subscriber has been provided with the possibility of hearing said message by calling the voice mail center. Systems based on this concept operate so that, after receiving a voice mail message, the voice mail center sends the destination subscriber a message informing that one voice mail  
20 message has been received at the voice mail center. Then, the destination subscriber calls the voice mail center, receives instructions and enters his password, whereupon he is authorized to listen to the voice-mail messages addressed to him.

A shortcoming of this arrangement is that no musical tune messages or melodic ring  
25 tones can be transmitted to another subscriber from the ordering pages of the service provider's www site or from the subscriber's personal terminal device. A further shortcoming is that the sending subscriber cannot *a priori* know whether the other subscriber has a terminal device suitable for receiving a melodic voice mail message.

30 It is an object of the invention to provide a feature service allowing a subscriber to send by means of his terminal device a musical tune message (MT) to another

subscriber's terminal, by means of which device the musical tune message can be listened to, stored and/or retransmitted to the terminal device of a third party.

5 A further shortcoming of conventional techniques is that the alarm clock signal of a terminal device has been controllable only by the owner of the terminal device, whereby alarm signal information defined by others than the terminal device owner has been impossible to emit via the alarm clock device or in the same fashion as by an alarm clock.

10 The goal of the invention is achieved by providing a telecom network with a facility to deliver ring tones and the like particularly as a musical tune message to the terminal device of another subscriber. The invention is particularly characterized in that the sending party (e.g., the A-subscriber) is offered the possibility of sending a musical tune message (MT) to the terminal device of the another party later called  
15 the B-subscriber. A preferred embodiment of the invention is also characterized in that the message received by a subscriber terminal device may also be used as the alarm signal of the terminal device's alarm clock.

20 Particularly advantageously, the musical tune message is played to the subscriber either from the alarm signal device at the loudness of the terminal device's alarm clock or from the earphone of a hands-free set at a sound pressure above the normal setting.

25 More specifically, the method according to the invention is characterized by the specifications disclosed in the characterizing part of claim 1.

The mobile phone according to the invention is characterized by what is stated in the characterizing part of claim 15.

30 The service center according to the invention is characterized by what is stated in the characterizing part of claim 16.



The terminal device according to the invention is characterized by what is stated in the characterizing part of claim 17.

5 The invention has significant benefits. Instead of a mere voice mail message or text message, the user of the invention can send another subscriber of a short-message service a musical tune message (MT), whereby an unexpected type of novel feature service is offered to mobile phone users and service providers.

10 In the following, the invention is described in more detail with reference to appended drawings in which

Fig. 1 is a block diagram illustrating the equipment and system associated with the service; and

15

Figs. 2A and 2B show a flow diagram illustrating the send/receive arrangements of a musical tune message in two alternative embodiments.

Referring to the block diagram of Fig. 1, the invention described herein relates to a  
20 method for sending a voice mail message or musical tune message (MT) with the help of a subscriber terminal device 1 to the terminal device 2 of another subscriber. The method is applicable in a telecom network 4, part of which is formed by a musical tune message center 3, wherefrom the user by means of his terminal device can select a desired musical piece 5, then submit the directory number of the recipient's  
25 terminal device 2 and thus send the musical piece to the recipient's terminal device 2, whose display subsequently indicates the greetings or other message received from the sender. Next, the recipient can after storage and/or activation of the received musical or voice-mail message listen to the same, store the same in his terminal device 2 and use the same as a ring tone, the alarm signal of the alarm clock of the  
30 terminal device or retransmit the same to a third party.

As shown in Fig. 1 and Fig. 2A, the process according to the invention begins from block 10, followed by block 11 in which the A-subscriber opens with the help of his terminal device 1 the www page of a musical tune message center MTPK 3 maintained by a service provider such as a telecom operator, where the stored musical pieces are selectable by certain codes/names and are so arranged that the A-subscriber 1 can enter in a certain field the mobile phone directory number (e.g., 050-5066728) of the recipient's (B-subscriber) terminal device 2. After the A-subscriber has entered the directory number of the B-subscriber 2 and selected his favourite musical piece, he can give the "send" command (by a certain keystroke or icon, etc.) that in block 12 sends the musical tune message to the B-subscriber's mobile phone 2 over the telecom network 4. The B-subscriber's terminal device 2 indicates the greeting/message associated with the musical tune message as a short message (e.g., as text "*With love from me*") on the display of the terminal device 2. The B-subscriber can store and/or activate the musical tune message, as well as listen to or store the same in his terminal device as is known from the listening and storing technique of ring tones. Before the desired musical tune message (MT) is sent to the B-subscriber's terminal device 2, MTPK 3 checks in block 13 the compatibility of B-subscriber's terminal device 2. If the check result is "YES", MTPK 3 sends in block 15 the musical tune message (MT) to the B-subscriber's terminal device 2. If the result is "NO", MTPK 3 reports in block 14 the situation to the A-subscriber via his terminal device 1. Next, the B-subscriber's terminal device in block 16 indicates the message transmitted along with the received MT. At his will, the B-subscriber can activate the MT in block 17 and hear it.

Fig. 2B illustrates an alternative process in which the A-subscriber enters, after the start block 18, into his own mobile phone 1 the code of the desired musical piece stored in the musical tune message service center 3 and/or the name thereof (e.g., "BVAZSAEP" and/or "Holy night") and in block 19 the mobile phone directory number of the B-subscriber, and sends the information as a short message to the service provider's service center 3, where the message is checked in block 20 and, when necessary, checks in block 21 whether the B-subscriber has a compatible

terminal device and, subsequently, the ordered musical tune message is sent in block 23 to the B-subscriber's terminal device 2. If MTPK cannot retrieve sufficient data on the type of the B-subscriber's terminal device (e.g., because the B-subscriber may be a client of another network and therefore data on his terminal device is not available in the network, or some other reason prevents access to the needed data), MTPK sends a report on such a shortcoming to the A-subscriber and gives in block 22 the A-subscriber a choice whether or not to send the ordered musical tune message MT to the B-subscriber. Then, A-subscriber can decide whether to send the ordered MT to the B-subscriber although no firm information has been obtained on the existence of a compatible terminal device on the B-subscriber side. This choice can save the A-subscriber from unnecessary costs. Nevertheless, the A-subscriber can order the musical tune message MT to be sent to his own mobile phone 1 and then retransmit the message to the B-subscriber's terminal device 2 by dialing the B-subscriber's directory number. The user's terminal device (1, 2) contains all the necessary means for retransmitting the musical tune message to another subscriber or for storing the musical tune message into the alarm signal selection of the alarm clock of his terminal device.

MTPK may include a short-message center, an intelligent network or a portion of these facilities or, alternatively, comprise a www server or the like equipment.

Instead of a musical tune message, also a synthesized sound message may be used as the ordered message. Hence, the scope and spirit of the invention also covers synthesized sound sequences that cannot be categorized as music or speech in a strict sense.

A sound message is typically played from the alarm signal device of the terminal at a sound pressure approximately equal to that of the alarm signal proper.

Accordingly, at least the following alternatives are possible according to the invention:

The B-subscriber may be provided with a facility allowing the musical tune message, which is sent by the A-subscriber or, respectively, ordered by the A-subscriber to be sent, to be stored in his terminal device 2 or the smart card thereof (such as the SIM card) and use the content of the message as the ring tone of his terminal device 2, alarm signal of his terminal device alarm clock or retransmit the message to a third party.

Service billing can be arranged according to the invention so that the A-subscriber is billed by the service center 3 or a billing facility (such as a billing center) operating therewith for a musical tune message sent to the B-subscriber or, alternatively, a sufficient payment (e-cash) must be sent from the A-subscriber's terminal device in conjunction with the sending of the musical tune message to the account of the service center and/or the due party to receive the payment such as the service provider.

It is also possible to complement the billing of the musical tune message service by allowing the service center 3 or the billing center operating therewith to cater to the artists' royalty payments so that the latter will be paid in conjunction with the musical tune message transmission or thereafter to the artists' royalty payment account.

The invention also concerns a mobile phone 1, 2 to be used in conjunction with the use of the method according to the invention, said mobile phone including means for reception, storage and playing as well as retransmission of said sound message to the terminal device of a third party.

Furthermore, the invention concerns a service center comprising means for storage, reception and sending of musical tune messages, as well as means for receiving and/or storing the (B-subscriber) directory number of the recipient of the musical tune message, whereby said service center 3 also includes means for receiving the code/name of the musical tune message and the destination B-subscriber directory number submitted from the A-subscriber's terminal device 1 so that said service

center is capable of sending the musical tune message selected by the A-subscriber 1 to the terminal device 2 of the B-subscriber.

5 While the invention has been described above by making reference to one of its preferred embodiment, those skilled in the art will find a plurality of modifications possible within the inventive spirit and scope of the appended claims.

What is claimed is:

1. Method for sending a message to the terminal device (2) of a mobile phone subscriber in a telecom network (4), said network incorporating a service center (3) wherein the subscriber identity is verified if necessary, characterized in that the sending party (e.g., the A-subscriber) is provided with a facility to send another terminal device (2) (e.g., the B-subscriber) a sound message (such as a musical tune message, MT) that can be listened to at least essentially at the same loudness as the normal alarm signal emitted by said terminal device (2).  
5
2. Method according to claim 1, characterized in that the message to be sent comprises a preselectable musical piece.  
10
3. Method according to claim 1, characterized in that the message to be sent comprises a preselectable sampled or synthesized sound message.  
15
4. Method according to any of claims 1-3, characterized in that the identity of the client (1) ordering the service and/or the recipient of the message or his terminal device (2) is verified if necessary from a service code and/or directory number and/or name/code.  
20
5. Method according to claim 1, characterized in that the sending client is provided with a facility to select a desired sound message and enter the directory number of the B-subscriber on a www service page furnished by said service center (3) so that said www service page is displayed on the sending client's terminal device (1).  
25
6. Method according to claim 1, characterized in that the client (1) is provided with a facility to send the code and/or name of said desired musical tune message, together with the B-subscriber directory number, to said musical tune message service center (3), wherein the data of the B-subscriber and the compatibili-  
30

ty of the B-subscriber's terminal device are verified if necessary, after which the musical tune message ordered by said client is sent to the B-subscriber (2), the B-subscriber's terminal device (2) indicates the receipt of the musical tune message by displaying a text telling that said musical tune message has been received and, if so arranged, displays the sending party's text message (e.g., "With love"), and finally the B-subscriber can hear said musical tune message by activating/storing the same and, when so desired, retransmit the same to the terminal device of a third mobile phone user.

10 7. Method according to claim 1, characterized in that sending said musical tune message (MT) may be allowed from both the service client's terminal device (1) as well as from said service center (3) to the terminal device (2) of the B-subscriber in a short-message format.

15 8. Method according to any of foregoing claims, characterized in that the mobile phone (1 or 2) used in the method is allowed to receive, store, play and re-transmit a musical tune message sent thereto.

20 9. Method according to any of foregoing claims, characterized in that the recipient's terminal (2) is allowed to receive and play the musical tune message sent thereto immediately after the receipt thereof without any action from the user's side.

25 10. Method according to any of foregoing claims for sending and/or receiving musical tune messages via such a telecom network that incorporates a service center (3) or a data base (5) associated therewith, said data base containing therein in a stored format a plurality of music or sound messages or musical tune samples, together with their codes, names and the like data, characterized in that said service center and/or said data base (3) is arranged so that the names and codes of the musical tune messages are sent to the service user's terminal device (1) and are displayed thereon, together with a field serving for the entry of the recipient's directory number therein, 30 whereby the service user can submit the recipient's directory number in the field and

select the desired musical tune message and send the same directly from the service center to the B-subscriber's terminal device (2).

5 11. Method according to any of foregoing claims, c h a r a c t e r i z e d in that the A-subscriber is provided with a facility of entering the code and/or name of a musical tune message, together with the B-subscriber's mobile phone directory number, to send said data to said service center (3), wherein the necessary operations are carried out to send said desired musical tune message to said B-subscriber.

10 12. Method according to any of foregoing claims, c h a r a c t e r i z e d in that the B-subscriber is provided with a facility allowing the musical tune message, which is sent by the A-subscriber (1) or, respectively, ordered by the A-subscriber to be sent, to be stored in his terminal device (2) or the smart card thereof (such the SIM card) and, subsequently, use the content of the message as the ring tone of his terminal  
15 device (2).

13. Method according to any of foregoing claims, c h a r a c t e r i z e d in that the A-subscriber is billed by the service center (3) or a billing facility (such as a billing center) operating therewith for a music sample message or a musical tune message  
20 sent to the B-subscriber or, alternatively, a sufficient payment (e-cash) is required to be sent from the A-subscriber's terminal device in conjunction with the sending of said music sample message or said musical tune message to the account of the service center (3) and/or the due party to receive the payment such as the service  
25 provider.

14. Method according to any of foregoing claims, c h a r a c t e r i z e d in that the billing of the musical tune message service performed in conjunction with the sending of said message at said service center (3) or said billing center operating therewith takes into account the artists' royalty payments so that the latter will be  
30 paid in conjunction with the musical tune message transmission or thereafter to the artists' royalty payment account.



15. Mobile phone (1, 2) suitable for use in the method according to any of foregoing claims, characterized in that said mobile phone (1, 2) includes means for reception, storage and playing as well as retransmission of said sound message to the  
5 terminal device (2) of another subscriber.

16. Service center (3) suitable for use in the method according to any of foregoing claims, characterized in that said service center comprises means for storage, reception and sending of musical tune messages, as well as means for receiving  
10 and/or storing the (B-subscriber) directory number of the recipient of the musical tune message, whereby said service center (3) also includes means for receiving the code/name of the musical tune message and the destination B-subscriber directory number submitted from the A-subscriber's terminal device (1) so that said service center is capable of sending the musical tune message selected by the A-subscriber  
15 (1) to the terminal device (2) of the B-subscriber.

17. Terminal device suitable for use in the method according to any of foregoing claims, characterized in that said terminal device (1 or 2) includes means facilitating the service user to store the received musical tune message into a format  
20 serving as the alarm signal of terminal device's alarm clock and to select and/or change said tune to serve as the alarm signal of the alarm clock.

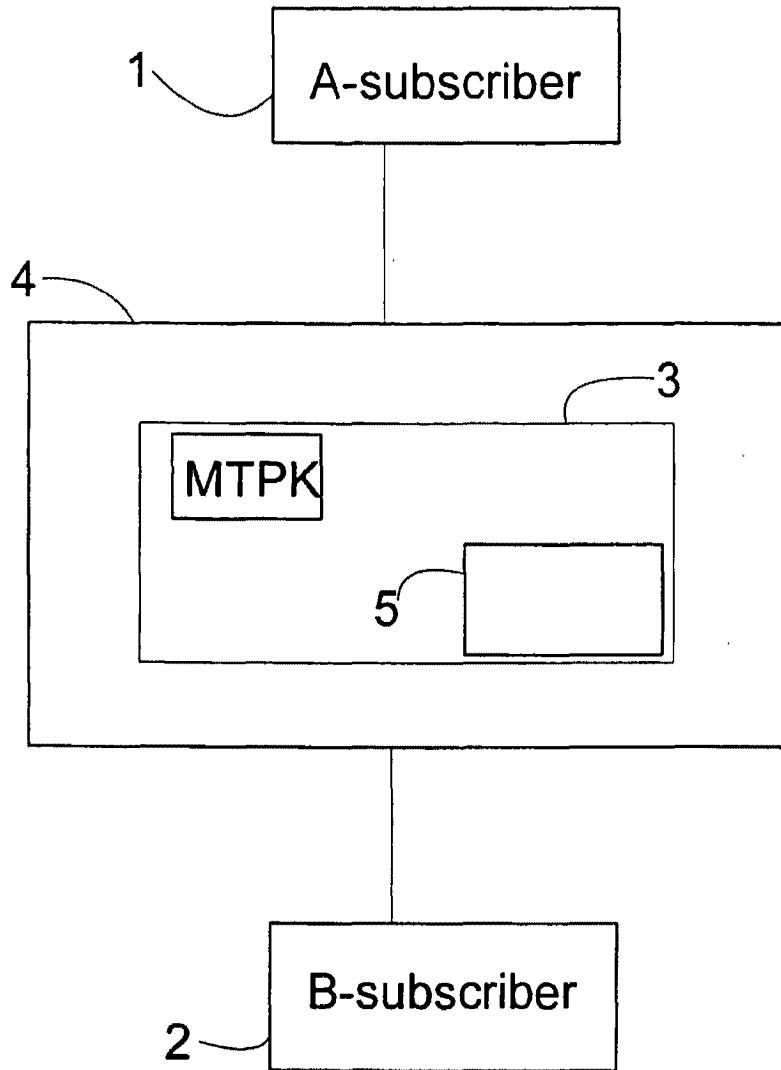


Fig. 1

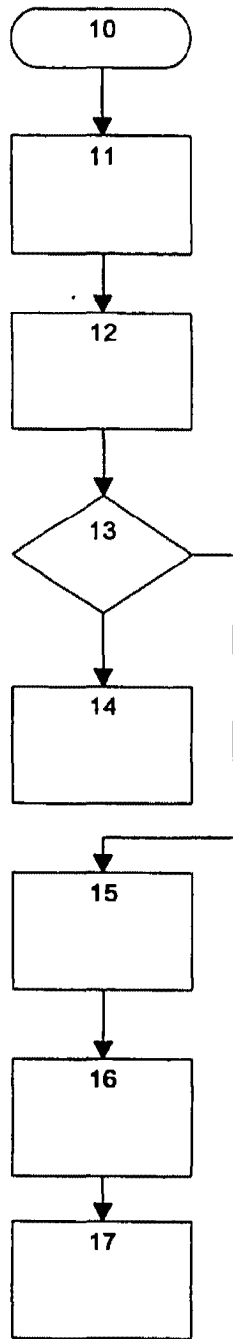


Fig. 2A

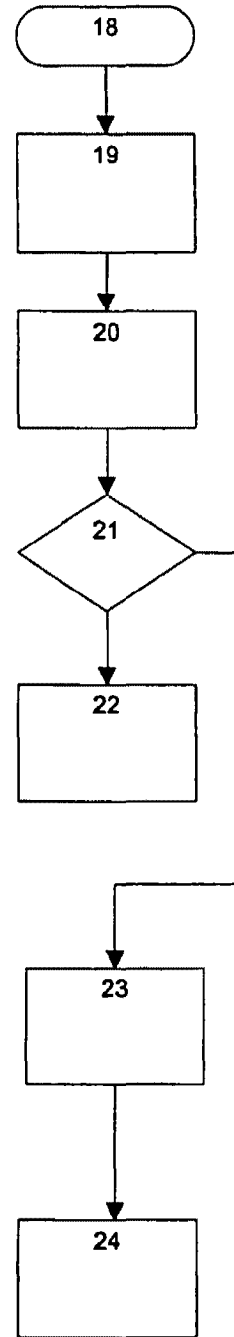
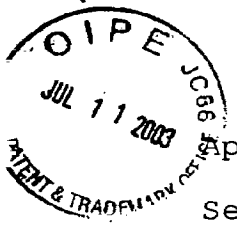


Fig. 2B

#50

MES/001 CON



IN THE UNITED STATES PATENT AND TRADEMARK OFFICE

Applicant : Michael E. Shanahan  
 Serial No. : 10/223,200 Confirmation No.: 8026  
 Filed: : August 16, 2002  
 For : METHODS AND APPARATUSES FOR PROGRAMMING  
 USER-DEFINED INFORMATION INTO ELECTRONIC  
 DEVIVES  
 Group Art Unit : 2681  
 Examiner : Not Yet Assigned

Hon. Commissioner  
 for Patents  
 P.O. box 1450,  
 Alexandria VA 22313-1450

July 8, 2003

**RECEIVED**  
 JUL 15 2003  
 Technology Center 2600

PRELIMINARY AMENDMENT III

Sir:

Before examining this patent application, please  
 amend the application as follows:

In the Claims

Please add claims 79-82 as indicated below.

Rule 1.120

80  
79

(New) A wireless telephone that may be  
 customized by searching for and selecting an audio file from a  
 remote computer and programming the selected audio file into  
 the wireless telephone for use as an indicia of an incoming  
 communication, the telephone comprising:

CA

07/14/2003 AOSMAN1 00000004 10223200

01 FC:2201  
02 FC:2202

42.00 OP  
36.00 OP

a communications link capable of connecting to a database in the remote computer that includes a plurality of polyphonic audio files;

a display screen and a browsing application program that allows a user of the wireless telephone to browse the polyphonic audio files and select at least one polyphonic audio file therefrom;

processing circuitry configured to supervise receipt of a selected polyphonic audio file from the communications link;

CA. a programmable memory circuit for allowing the user to optionally store the selected polyphonic audio file for use as an indicia of an incoming communication; and

an enhanced performance speaker capable of providing a substantially full range of audio sounds from the selected polyphonic audio file when the selected polyphonic audio file is played as an indicia of an incoming communication.

<sup>80</sup>~~80~~ (New) The wireless telephone of claim 79 wherein the polyphonic audio file is selected from the group comprising MIDI, MP3, MPEG, or WAV files.

<sup>82</sup>~~81~~ (New) The wireless telephone of claim 79 wherein the enhanced performance speaker operates in conjunction with the processing circuitry to allow the user to optionally review the selected polyphonic audio file before downloading

the selected polyphonic audio file into the programmable  
memory circuit of the wireless telephone.

<sup>83</sup>  
82. (New) The wireless telephone of claim 79  
configured to prevent the unauthorized distribution of the  
selected polyphonic audio file stored in the programmable  
memory circuit.

REMARKS

These amendments more particularly point out and  
define the invention. Support for these claims can be found  
in the specification. In particular, support for the  
polyphonic feature may be found on page 6, lines 31-35 and  
page 8, lines 19-21 as MP3, WAV, MPEG, and many MIDI files are  
polyphonic audio files. An early and favorable action on this  
patent application is requested.

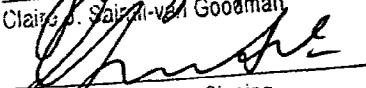
Respectfully submitted,



Michael E. Shanahan  
Applicant  
Customer No. 32850  
P.O. Box 381  
Nyack, N.Y. 10960

I hereby certify that this  
Correspondence is being  
deposited with the U.S.  
Postal Service as First  
Class Mail in an envelope  
Addressed to:  
Commissioner for Patents  
P.O. Box 1450  
Alexandria, VA 22313-1450 on

July 8, 2003  
Claire J. Saito-van Goodman

  
Signature of Person Signing



2681

REV. 01/03  
Small Entity

Docket No. MES/001 CON

IN THE UNITED STATES PATENT AND TRADEMARK OFFICE  
PATENT APPLICATION

Applicant : Michael E. Shanahan  
Application No. : 10/223,200 Confirmation No. 8026  
Filed : August 16, 2002  
For : METHODS AND APPARATUSES FOR PROGRAMMING USER-  
DEFINED INFORMATION INTO ELECTRONIC DEVICES  
Group Art Unit : 2681  
Examiner : Not Yet Assigned

RECEIVED

July 8, 2003

JUL 15 2003

Technology Center 2600

Hon. Commissioner  
for Patents  
P.O. Box 1450  
Alexandria VA 22313-1450

TRANSMITTAL LETTER

Sir:

Transmitted herewith:  a Preliminary Amendment;  
 a Declaration;  a Supplemental Information Disclosure  
Statement;  substitute specification;  an Associate Power  
of Attorney;  formal drawings; to be filed in the above-  
identified patent application.

FEE FOR ADDITIONAL CLAIMS

A fee for additional claims is not required.

A fee for additional claims is required.

The additional fee has been calculated as shown below:

CLAIMS REMAINING AFTER AMENDMENT	HIGHEST NUMBER PREVIOUSLY PAID FOR	PRESENT EXTRA	RATE	EXTRA FEES
TOTAL CLAIMS	66 - 62	* = 4	X \$9 = \$	36.00
INDEPENDENT CLAIMS	9 - 8	** = 1	X \$42 = \$	42.00
FIRST PRESENTATION OF A MULTIPLE DEPENDENT CLAIM			+ \$140 =	\$ 0.00

\* If less than 20, insert 20. TOTAL \$ 78.00

\*\* If less than 3, insert 3.

[X] A check in the amount of \$ 78.00 is transmitted herewith.

EXTENSION FEE

[ ] The following extension is applicable to the Response filed herewith; [ ] \$55.00 extension fee for response within first month pursuant to 37 C.F.R. § 1.17(a)(1); [ ] \$205.00 extension fee for response within second month pursuant to 37 C.F.R. § 1.17(a)(2); [ ] \$465.00 extension fee for response within third month pursuant to 37 C.F.R. § 1.17(a)(3); [ ] \$725.00 extension fee for response within fourth month pursuant to 37 C.F.R. § 1.17(a)(4).

[ ] A check in the amount of [ ] \$55.00; [ ] \$205.00; [ ] \$465.00; [ ] \$725.00; in payment of the extension fee is transmitted herewith. A duplicate copy of this transmittal letter is transmitted herewith.

RECEIVED  
JUL 15 2003  
Technology Center 2600  
2



SUPPLEMENTAL IDS FEE

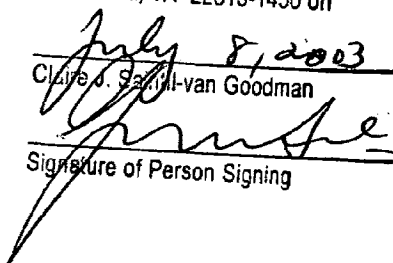
[ ] A check in the amount of \$ 0.00 is transmitted herewith in payment of the Supplemental IDS fee pursuant to 37 C.F.R. § 1.17 (p).



Michael E. Shanahan  
Applicant  
Customer No. 32850  
P.O. Box 381  
Nyack, N.Y., 10960

I hereby certify that this  
Correspondence is being  
deposited with the U.S.  
Postal Service as First  
Class Mail in an envelope  
Addressed to:  
Commissioner for Patents  
P.O. Box 1450  
Alexandria, VA 22313-1450 on

July 8, 2003  
Clive J. Samoil-van Goodman

  
Signature of Person Signing

RECEIVED  
JUL 15 2003  
Technology Center 2600

NOTICE OF FEE DUE

DATE: 6-30-03

TO: 2581

FROM: Office of Initial Patent Examination

SUBJECT: Fee Due

APPLICATION NUMBER: 10223 200

A fee is due for the attached document submitted to the U. S. Patent and Trademark Office for the following reason. Please check the application for the appropriate authorization to charge a deposit account. If an authorization is present, please charge the appropriate fee. If an authorization is not present, notify the applicant of the fee deficiency.

- Insufficient fee by check
- Insufficient funds in deposit account
- Declined credit card
- Non authorization for charge to deposit account
- No fee submitted per requirement

The correct fee code:	<u>2202x1</u>	amount	\$ <u>42</u>
The suspended fee code:	<u>1999</u> <del>1997</del>	amount	-\$ <u>40</u>
Fee Due		amount	=\$ <u>2</u>

If you have any questions, please contact Cynthia Streater at 703-306-5430 or Eleanor Kurtz at 703-308-3642.

Terminal Operator Yamaday



RECEIVED

JUL 02 2003

Technology Center 2600

MES/001 CON

5/B  
OK  
7/8

IN THE UNITED STATES PATENT AND TRADEMARK OFFICE

Applicant : Michael E. Shanahan

Serial No. : 10/223,200 Confirmation No.: 8026

Filed: : August 16, 2002

For : METHODS AND APPARATUSES FOR PROGRAMMING  
USER-DEFINED INFORMATION INTO ELECTRONIC  
DEVICES

Group Art Unit : 2681

Examiner : Not Yet Assigned

June 24, 2003

Hon. Commissioner  
for Patents  
P.O. box 1450,  
Alexandria VA 22313-1450

PRELIMINARY AMENDMENT

Sir:

Before examining this patent application, please  
amend the application as follows:

In the Claims

[Please add the following new claims 62-77]

*Rel'n 1.124*  
*B1*  
*cont*

63  
-62. (New) The method of claim 16 further comprising  
preventing the unauthorized distribution of a downloaded audio  
file.

06/30/2003 YPOLITE1 00000102 10223200

01 FC:2202	144.00 OP
02 FC:2201	42.00 OP
03 FC:1999	40.00 OP

<sup>64</sup>  
~~63~~. (New) The method of claim 16 further comprising playing the selected audio file through an enhanced performance speaker capable of providing a substantially full range of audio sounds from MIDI, MP3, MPEG, WAV, PCM, Windows Media Audio Code (WMA), or Adaptive Transform Acoustic Coding (ATRAC) files.

<sup>65</sup>  
~~64~~. (New) The method of claim 16 characterized by the use of a personal computer to perform the browsing step.

<sup>66</sup>  
~~65~~. (New) The method of claim 16 further comprising providing the user with an opportunity to edit the selected audio file.

<sup>67</sup>  
~~66~~. (New) The method of claim 16 further comprising providing an indication that a memory capacity of the wireless telephone has been exceeded if the size of the audio file to be downloaded is larger than available memory space in the wireless telephone.

<sup>68</sup>  
~~67~~. (New) The method of claim 66 further comprising providing the user of the wireless telephone with the opportunity to cancel or modify a download request associated with an audio file download operation if the size of the audio file to be downloaded is larger than available memory space in the wireless telephone.

~~69~~  
~~68.~~

(New) The wireless telephone of claim 42 wherein the wireless telephone is configured to prevent the unauthorized distribution of an audio file stored in the programmable memory circuit.

~~70~~  
~~69.~~

(New) The wireless telephone of claim 43 wherein the speaker is an enhanced performance speaker capable of providing a substantially full range of audio sounds from MIDI, MP3, MPEG, WAV, PCM, Windows Media Audio Code (WMA), or Adaptive Transform Acoustic Coding (ATRAC) files.

~~71~~  
~~70.~~

(New) The wireless telephone of claim 42 configured to provide an indication that a memory capacity of the wireless telephone has been exceeded if the size of the audio file to be downloaded is larger than available memory space in the wireless telephone.

~~72~~  
~~71.~~

(New) The wireless telephone of claim 70 configured to provide the user of the wireless telephone with the opportunity to cancel or modify a download request associated with an audio file download operation if the size of the audio file to be downloaded is larger than the available memory space in the wireless telephone.

B  
CMA

73

~~72.~~

(New) A wireless telephone that may be customized by programming an audio file into the wireless telephone for use as an indicia of an incoming communication, the telephone comprising:

means for connecting to a remote database that includes a plurality of of audio files;

means for selecting at least one of the audio files from the database;

means for downloading and storing the selected audio file for use as an indicia of an incoming communication; and

means for preventing the unauthorized distribution of a selected audio file stored in the wireless telephone.

74

~~73.~~

(New) The wireless telephone of claim 72 further comprising means for indicating that a memory capacity of the wireless telephone has been exceeded if the size of the audio file to be downloaded is larger than available memory space in the wireless telephone.

75

~~74.~~

(New) A wireless telephone that may be customized by searching for and selecting an audio file from a remote computer and programming the selected audio file into the wireless telephone for use as an indicia of an incoming communication, the telephone comprising:

a communications link capable of connecting to a database in the remote computer that includes a plurality of

lists of audio files in MIDI, WAV, or MP3 format or a combination thereof;

a display screen and a mobile Internet browser that allows a user of the wireless telephone to browse at least one of the plurality of lists of audio files and view selectable audio files present in the browsed list;

processing circuitry configured to receive a selected one of the audio files from the communications link;

a programmable memory circuit for allowing the user to optionally store the selected audio file for use as an indicia of an incoming communication; and

an enhanced performance speaker capable of providing a substantially full range of audio sounds from MIDI, WAV, or MP3 files when one of the stored audio files is played as an indicia of an incoming communication.

76

75

(New) The wireless telephone of claim 74 configured to provide an indication that a memory capacity of the wireless telephone has been exceeded if the size of the audio file to be downloaded is larger than available memory space in the wireless telephone.

77

76

(New) The wireless telephone of claim 74 wherein the enhanced performance speaker operates in conjunction with the processing circuitry to allow the user to optionally review a selected audio file before downloading the selected audio file into the wireless telephone.

78

~~77~~

(New) The wireless telephone of claim 74 configured to allow the user to search the remote database for a certain desired audio file using title or description information to aid in locating the desired audio file.

79

~~78~~

(New) The wireless telephone of claim 74 configured to prevent the unauthorized distribution of an audio file stored in the programmable memory circuit.

*B  
G  
G  
G*

REMARKS


These amendments more particularly point out and define the invention. An early and favorable action on this patent application is requested.

Respectfully submitted,



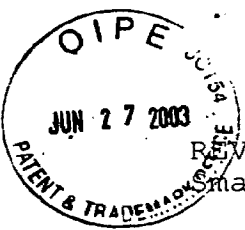
Michael E. Shanahan  
Applicant  
Customer No. 32850  
P.O. Box 381  
Nyack, N.Y. 10960

I hereby certify that this  
Correspondence is being  
deposited with the U.S.  
Postal Service as First  
Class Mail in an envelope  
Addressed to:  
Commissioner for Patents  
P.O. Box 1450  
Alexandria, VA 22313-1450 on

June 24, 2003  
Lillian Garcia  
  
Signature of Person Signing



2531  
\$



Rev. 01/03  
Small Entity

Docket No. MES/001 CON

IN THE UNITED STATES PATENT AND TRADEMARK OFFICE

RECEIVED

JUL 02 2003

PATENT APPLICATION

Technology Center 2600

Applicant : Michael E. Shanahan

Application No. : 10/223,200 Confirmation No. 8026

Filed : August 16, 2002

For : METHODS AND APPARATUSES FOR PROGRAMMING USER-DEFINED INFORMATION INTO ELECTRONIC DEVICES

Group Art Unit : 2681

Examiner : Not Yet Assigned

June 24, 2003

Hon. Commissioner  
for Patents  
P.O. Box 1450  
Alexandria VA 22313-1450

TRANSMITTAL LETTER

Sir:

Transmitted herewith:  a Preliminary Amendment;  
 a Declaration;  a Supplemental Information Disclosure Statement;  
 substitute specification;  an Associate Power of Attorney;  
 formal drawings; to be filed in the above-identified patent application.

FEE FOR ADDITIONAL CLAIMS

- A fee for additional claims is not required.
- A fee for additional claims is required.

The additional fee has been calculated as shown below:

	CLAIMS REMAINING AFTER AMENDMENT		HIGHEST NUMBER PREVIOUSLY PAID FOR		PRESENT EXTRA		RATE		EXTRA FEES
TOTAL CLAIMS	62	-	46	*	=	16	X	\$9 = \$	144.00
INDEPENDENT CLAIMS	8	-	6	**	=	2	X	\$42 = \$	82.00
FIRST PRESENTATION OF A MULTIPLE DEPENDENT CLAIM								+ \$140 =	\$ .00

\* If less than 20, insert 20. TOTAL \$ 226.00  
 \*\* If less than 3, insert 3.

[X] A check in the amount of \$ 226.00 is transmitted herewith.

EXTENSION FEE

[ ] The following extension is applicable to the Response filed herewith; [ ] \$55.00 extension fee for response within first month pursuant to 37 C.F.R. § 1.17(a)(1); [ ] \$205.00 extension fee for response within second month pursuant to 37 C.F.R. § 1.17(a)(2); [ ] \$465.00 extension fee for response within third month pursuant to 37 C.F.R. § 1.17(a)(3); [ ] \$725.00 extension fee for response within fourth month pursuant to 37 C.F.R. § 1.17(a)(4).

[ ] A check in the amount of [ ] \$55.00; [ ] \$205.00; [ ] \$465.00; [ ] \$725.00; in payment of the extension fee is transmitted herewith. A duplicate copy of this transmittal letter is transmitted herewith.

SUPPLEMENTAL IDS FEE

[ ] A check in the amount of \$ 0.00 is transmitted herewith in payment of the Supplemental IDS fee pursuant to 37 C.F.R. § 1.17 (p).



---

Michael E. Shanahan  
Applicant  
Customer No. 32850  
P.O. Box 381  
Nyack, N.Y., 10960

I hereby certify that this  
Correspondence is being  
deposited with the U.S.  
Postal Service as First  
Class Mail in an envelope  
Addressed to:  
Commissioner for Patents  
P.O. Box 1450  
Alexandria, VA 22313-1450 on

June 24, 2003

Lillian Garcia



Signature of Person Signing



2681  
#3  
EN

Attorney Docket No. MES/001 Con 2-11-03

Applicant : Michael E. Shanahan

Title : METHODS AND APPARATUSES FOR  
PROGRAMMING USER-DEFINED INFORMATION  
INTO ELECTRONIC DEVICES

Application No.: 10/223,200 Conf. No.: 8026

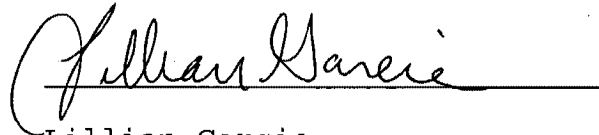
Filing Date : August 16, 2002

Group Art Unit : 2681

**RECEIVED**  
FEB 03 2003  
Technology Center 2600

Date of Deposit: January 28, 2003

I hereby certify that the papers listed hereon are being deposited with the United States Postal Service "FIRST CLASS MAIL TO ADDRESSEE" service under 37 C.F.R. 1.8 on the date indicated above and is addressed to the Hon. Commissioner for Patents, P.O. Box 2327, Arlington, VA 22202.

  
Lillian Garcia

Enc.

- Supplemental IDS
- Form PTO 1449 (in duplicate)
- Copies of cited references

Docket No. MES/001 Con

IN THE UNITED STATES PATENT AND TRADEMARK OFFICE

Applicant : Michael E. Shanahan  
Application No.: 10/223,200 Conf. No.: 8026  
Filed : August 16, 2002  
For : METHODS AND APPARATUSES FOR PROGRAMMING  
USER-DEFINED INFORMATION INTO ELECTRONIC  
DEVICES  
Group Art Unit : 2681

New York, New York  
January 28, 2003

Hon. Commissioner  
for Patents  
Washington, D.C. 20231

SUPPLEMENTAL INFORMATION DISCLOSURE STATEMENT

Sir:

In accordance with 37 C.F.R. §§ 1.56 and 1.97, applicants wish to call the attention of the Examiner to the documents cited in the Supplemental Information Disclosure Statement (IDS) filed herewith. Because these references are being cited in this case before the mailing date of the Office Action on the merits, pursuant to 37 C.F.R. § 1.97(b)(3), applicant believes no fee is due in connection with this Supplemental IDS.

U.S. Patents

Mitzlaff	4,866,766	September, 1989
Davis	4,868,561	September, 1989
Kyronlahti et al.	5,452,354	September, 1995
Hanson et al.	5,600,712	February, 1997
Eisdorfer et al.	5,724,411	March, 1998
Wells et al.	5,870,683	February, 1999
Hsu	5,907,604	May, 1999
Houtari	5,987,323	November, 1999
Foti	6,138,006	October, 2000
Schnarel et al.	6,389,124	May, 2002
Ryu	6,483,531	November, 2002

Copies of the aforementioned patents and publications, which are listed on the accompanying Form PTO-1449 (submitted in duplicate), are enclosed herewith.

It is respectfully requested that these patents and publications be (1) fully considered by the Patent and Trademark Office during examination of this application; and (2) printed on any patent which may issue on this application. Applicant requests that a copy of Form PTO-1449, as considered and initialed by the Examiner, be returned with the next communication

Respectfully submitted,



Michael E. Shanahan  
Applicant  
Customer No. 32850  
P.O. Box 381  
Nyack, NY 10960



08/16/02  
j0961 U.S. PTO

08-20-02 10223200 .081602 A

Rev. 06/02

PATENTS

Modified PTO 1082  
For A Small Entity

11017 U.S. PTO  
10/223200  
08/16/02

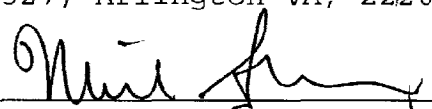
Attorney Docket No. MES/001 Con

Applicant : Michael E. Shanahan  
For : METHODS AND APPARATUSES FOR PROGRAMMING  
USER-DEFINED INFORMATION INTO ELECTRONIC  
DEVICES

EXPRESS MAIL CERTIFICATION

"Express Mail" mailing label number EV133107427US  
Date of Deposit August 16, 2002

I hereby certify that this transmittal letter and the other papers and fees identified in this transmittal letter as being transmitted herewith are being deposited with the United States Postal Service "Express Mail Post Office to Addressee" service under 37 C.F.R. § 1.10 on the date indicated above and are addressed to the Hon. Assistant Commissioner for Patents, P.O. Box 2327, Arlington VA, 22202.

  
MICHAEL SHANAHAN

Hon. Assistant Commissioner  
for Patents  
Washington, D.C. 20231

TRANSMITTAL LETTER FOR  
CONTINUATION PATENT APPLICATION

Sir:

Transmitted herewith for filing are the  
[X] specification; [X] claims; [X] abstract; [X] declaration;  
[X] a verified statement claiming small entity status; [X] an  
information disclosure statement; for the above-identified  
patent application.




Also transmitted herewith are:

- 13 sheets of:
  - Formal drawings.
  - Informal drawings. Formal drawings will be filed during the pendency of this application.
- An assignment of the invention to:
  - A check in the amount of \$40.00 to cover the recording fee.
  - An associate power of attorney.
- A certified copy of the priority document, \_\_\_\_\_ application, No. \_\_\_\_\_, filed \_\_\_\_\_

The filing fee has been calculated as shown below:

FOR	NUMBER FILED	NUMBER EXTRA	RATE	FEE
BASIC FEE				\$370.00
TOTAL CLAIMS	15 - 20 = 12		x \$ 9 = \$	0.00
INDEPENDENT CLAIMS	3 - 3 = 0		x \$ 42 = \$	0.00
<input type="checkbox"/> A MULTIPLE DEPENDENT CLAIM			+ \$ 130 = \$	0.00
TOTAL				\$370.00

- A check in the amount of \$ 370.00 in payment of the filing fee is transmitted herewith.



Michael E. Shanahan  
 Applicant  
 Customer No. 32850  
 P.O. Box 381  
 Nyack, N.Y., 10960  
 Tel.: (914) 261-1160

INVENTOR INFORMATION

102222200 031202

Inventor One Given Name:: Michael E  
Family Name:: Shanahan  
Postal Address Line One:: P.O. Box 381  
City:: Nyack  
State or Province:: New York  
Country:: U.S.A.  
Postal or Zip Code:: 10960  
Citizenship Country:: U.S.A.

CORRESPONDENCE INFORMATION

Correspondence Customer Number:: 32850  
Fax One:: 646-728-2623  
Electronic Mail One:: mshanahan@fishneave.com

APPLICATION INFORMATION

Title Line One:: METHODS AND APPARATUSES FOR PROGRAMMING  
Title Line Two:: USER-DEFINED INFORMATION INTO ELECTRONIC  
Title Line Three:: DEVICES  
Total Drawing Sheets:: 13  
Formal Drawings?:: Yes  
Application Type:: Utility  
Docket Number:: MES/001CON  
Secrecy Order in Parent Appl.?:: No

CONTINUITY INFORMATION

This application is a:: CONTINUATION IN PART OF  
> Application One:: 09/518712  
Filing Date:: 03-03-2000

Source:: PrintEFS Version 1.0.1

MES/001 Con.

5                   METHODS AND APPARATUSES FOR PROGRAMMING  
                  USER-DEFINED INFORMATION INTO ELECTRONIC DEVICES

                  This application is a continuation of United  
States Patent Application 09/518,712 filed March 3, 2000  
which claims priority from United States Provisional  
Application 60/169,158 filed December 6, 1999.

10

Background of the Invention

                  This application relates to electronic devices,  
and more particularly to a programming apparatus that  
allows users to program user-defined information into  
15                   their electronic device.

                  There are many types of electronic devices  
available to consumers today that have the ability to  
produce both audio sounds and video displays. Many of  
these devices provide users with the ability to select  
20                   and play a particular piece of audio or video. A  
television viewer, for example, may tune to a TV channel  
and watch a particular program, or connect a VCR or DVD  
player to the television in order to view a specific  
program not currently being broadcast. Similarly, an

audio system user may, tune a receiver to a particular  
radio station to hear a certain genre of music, or  
connect a CD or tape player to the system in order to  
hear specific pieces of music. In both cases, the audio  
5 and video is user-selectable.

Currently, however, there are many electronic  
products that offer an audio/video playing capability  
that are not fully user-programmable. Users of such  
devices (e.g., wireless or cordless telephones, pagers,  
10 personal digital assistants (PDAs), hand-held computers  
and the like) have to choose from a limited selection of  
pre-programmed information (e.g., audio clips, video  
clips or frames, etc.) placed there by the manufacturer.  
This severely limits the user's ability to customize the  
15 device to suit his or her particular taste. Furthermore,  
most pre-programmed audio tends to be rather generic and  
can be confusing when a device of a nearby user generates  
a sound similar to or the same as that of another user's  
device. Although a programmable memory within many such  
20 electronic devices could support user-defined audio,  
currently, no system exists for programming such  
information into an electronic device.

The same is true for user-defined video. For  
example, certain types of user-defined video information,  
25 such as video clips, frames, and other digital or analog  
images could be programmed into an electronic device  
(e.g., PDA, wireless phone, or any portable display  
device) and displayed at a time of the user choosing.  
Although a programmable memory within such a device could  
30 support user-defined video, currently, no system exists  
for programming such information into the device.

#### Summary Of The Invention

It is therefore an object of the present  
invention to provide an apparatus that allows a user to

program user-defined audio information into a programmable electronic device.

It is a further object of the present invention to provide an apparatus that allows a user to program user-defined video information into a programmable electronic device.

These and other objects of the present invention are accomplished by providing methods apparatuses that allow a user to program user-defined information into his or her electronic device. In one embodiment of the present invention, the programming apparatus includes processing circuitry and first and second communications links. In operation, a user selects a piece of information from a source such as a computer disk drive, the Internet, or a remote database using the first communications link. The programming apparatus may download this information and compare its format with that required by the programmable device to determine format compatibility. If the two formats are compatible, the programming apparatus may download the selected information into the programmable device. If the formats are not compatible, the programming apparatus may convert the downloaded file to a format compatible with that required by the programmable electronic device. The programming apparatus may also provide the user with an opportunity to edit the converted file. Once editing is complete, the resulting file may then be programmed into the programmable device for subsequent use.

In another aspect of the invention, a user may send customized information such as an audio or video file called a "signature" when placing a telephone call. This feature allows a user to select and send a signature file to the person receiving the telephone call such that the person receiving the call is alerted by that file.

Brief Description Of The Drawings

The above and other objects and advantages of the present invention will be apparent upon consideration of the following detailed description, taken in  
5 conjunction with the accompanying drawings, in which like reference characters refer to like parts throughout, and in which:

FIG. 1 is a generalized block diagram of a system for programming user-defined information into an  
10 electronic device in accordance with one embodiment of the present invention.

FIG. 2 is a schematic diagram of a programmer constructed in accordance with one possible embodiment of the present invention.

15 FIG. 3 shows a computer based implementation of a programmer constructed in accordance with one embodiment of the present invention.

FIG. 4a shows an alternate embodiment of a computer based implementation of a programmer constructed  
20 in accordance with the principles of the present invention.

FIG. 4b shows an alternate network embodiment of the computer based implementation in shown in FIG. 4a.

25 FIG. 5 illustrates an imbedded implementation of the programmer shown in FIG. 2.

FIG. 6 shows yet another embodiment of a computer based implementation the programmer in shown in FIG. 4b.

30 FIG. 7 is a schematic diagram of one possible embodiment of a wireless telephone that can receive and play user-defined audio in accordance with one aspect of the present invention.

FIGS. 8-9 show a flow chart illustrating some of the steps involved in programming user-defined

information into an electronic device in accordance with one embodiment of the present invention.

FIGS. 10-12 show a flow chart illustrating some of the steps involved in sending and receiving signature information in accordance with one embodiment of the present invention.

#### Detailed Description of the Invention

FIG. 1 shows a block diagram of a system 10 for programming user-defined information (e.g., audio, video, or Internet access information, etc.) into an electronic device in accordance with one embodiment of the present invention. As shown in FIG. 1, system 10 generally includes a programmable electronic device 20, a device programmer 30, and a source 50. Programmer 30 is connected to source 50 via link 31, and to device 20 via link 32.

Programmable device 20 may be any portable electronic device (e.g., a wireless telephone, a pager, a handheld computer, personal digital assistant (PDA), etc.). Device 20 may also be any device which integrates some or all of the functions of such devices into one device. For example, device 20 may be a PDA capable of making wireless telephone calls, a PDA with paging functions, a wireless telephone with some PDA or paging functions, a handheld or notebook computer with some or all of the functions of a PDA, a pager, and a telephone, etc.

In FIG. 1, links 31 and 32 may be, for example, communications links (e.g., serial ports, parallel ports, universal serial buses (USB), RS232, GPIB, etc.), modems (e.g., any suitable analog or digital modems, cellular modems, or cable modems), a network interface link (e.g., Ethernet links, token ring links, etc.), wireless communications links (e.g., cellular telephone links,

wireless Internet links, infrared links, etc.), or any other suitable hard-wired or wireless Internet or communications links.

5 Source 50 may be any device or combination of devices suitable for providing user-defined information to programmer 30 (e.g., the Internet, an optical disc player (CD, DVD), a cassette player, a VCR, a digital camera, or any suitable storage device containing computer programs or files, etc.).

10 In operation, a user may choose certain information, such as Internet configuration information, an audio sample of a popular song, a video clip or frame, etc., that is available from source 50 and transfer it to programmer 30. Programmer 30 may then process this  
15 information into a suitable format (or may simply route the information if no format conversion is required), and program it into a programmable memory within device 20 (not shown). Device 20 may then retrieve this information when a certain event occurs (e.g., when  
20 receiving an incoming telephone call, browsing the Internet, or when programmed to do so by a user, etc.).

Programmer 30 may also coordinate or perform certain functions related to the routing and storing of information within device 20. For example, programmer 30  
25 may communicate with (or simply search) device 20 to find available memory locations in which to store the user-defined information. Programmer 30 may also communicate with device 20 to determine which format the incoming information should be converted to so that the  
30 information is compatible with the downloading requirements of device 20. For audio files, this may include, but is not limited to, converting to or from any of the following format types: analog; MIDI; MPEG; PCM; Windows Media Audio Code (WMA); WAV; or Adaptive  
35 Transform Acoustic Coding (ATRAC), or to or from any



other suitable audio format, etc. For video files, this may include, but is not limited to, converting to or from any of the following format types: analog; JPEG; MPEG; GIF; AVI, or to or from any other suitable video format, etc. Text files may include, for example, HTML files, Wireless Markup Language (WML) files, WordPerfect™ files, Microsoft Office™ files, or any other suitable text files.

If multiple blocks of information are being programmed into device 20, programmer 30 may "tag" the different blocks so that device 20 and/or a user may distinguish among the different blocks stored therein. After the information has been provided, programmer 30 may communicate with device 20 to confirm that the information has been correctly received.

A more detailed diagram of one possible embodiment of programmer 30 is illustrated in FIG. 2. As illustrated, programmer 30 may include a transducer 25, a processor 34, a programmable memory 36, an analog-to-digital (A/D) converter 38, signal processing circuitry (SPC) 40, an output buffer 42, and an input buffer 44. Generally speaking, processor 40 controls the operation of programmer 30. Programmer 30 may be configured to receive and process both analog and digital signals. It may also acquire acoustic signals via transducer 25 (if installed).

In operation, programmer 30 may download certain user-selected information from source 50 via link 31. This information, such as audio or video files, in the form of electronic signals, may be received from link 31 and directed to input buffer 44. As mentioned above, these signals may need to be processed in order to be compatible with the format required by programmable device 20. For example, if analog input signals are received at input buffer 44 and device 20 requires a

digital format, the analog signals may be routed to A/D converter 38 for conversion into a suitable digital form (e.g., into PCM, PAM, etc.). Further processing into another digital format (e.g., MP3, ATRAC, WMA, etc.) may  
5 be accomplished by routing the converted signals to SPC 40 or processor 34 (discussed in more detail below). On the other hand, if digital input signals are received at input buffer 44 and device 20 requires analog signals, the digital signals may be routed to SPC 40 or to a  
10 dedicated digital-to-analog (D/A) converter (not shown) for conversion to the analog domain.

Processor 34 may route incoming signals from source 50 to memory 36, SPC 40, or directly to output buffer 42 depending on the circumstances. For example,  
15 some or all of the input signals received from source 50 may require further processing to meet the downloading specifications of device 20. In this case, the incoming signals that require processing may be routed to SPC 40 for such processing. For example, incoming MP3 or WMA  
20 signals may be routed to SPC 40 and converted to ATRAC format (or vice-versa). Once this conversion is complete, the resulting information may be stored in memory 36, or routed to output buffer 42 for programming in device 20. Input signals that do not require a format  
25 change may be routed directly from input buffer 44 to memory 36, or output buffer 42. Although not shown in FIG. 2, programmer 30 preferably has a display screen and a data input device, such as a keyboard associated with it so that a user may, among other things, browse and  
30 select files, monitor file transfers, and ensure that device 20 has properly received the selected files.

In one embodiment of the present invention, SPC 40 may be programmable so that the conversion and processing protocols contained therein may be periodically updated.

Furthermore, in some embodiments, processor 34 may be programmed via software routines in programmable memory 36 to perform some or all of the functions of SPC 40. In this case, an SPC of reduced processing capacity may be used or SPC 40 may be removed altogether from programmer 30.

Audio signals may also be acquired and processed by programmer 30. Transducer 25 may acquire an acoustic signal from a stereo or other audio source and convert it to an electrical signal. This electrical signal may then be processed in a way similar to the way the above-described analog signal was processed. That is, the electrical signal may be routed to A/D converter 38 and/or SPC 40 and then stored in memory 36 or output buffer 42, for example.

It will be understood that the generalized system shown in FIG. 1 may be implemented in many ways. For example, as shown in FIG. 3, system 100 may be implemented using a computer-based architecture. In this case, some or all of programmer 30 may be installed in or connected to a computer, such as a personal computer. For example, in FIG. 3, programmer 30 may be installed in an expansion slot and connected to an interface bus such as an ISA or PCI bus (not shown) in computer 60. In this configuration, programmer 30 may receive user-defined information via the interface bus in computer 60 and operate as described above with the interface bus acting as part of link 31. Some or all of programmer 30 may also be external to computer 60 and connected to it via a link similar to link 31 (not shown). Furthermore, in certain embodiments, some of the functions of programmer 30 may be distributed between computer 60 and programmer 30. For example, programmer 30 may be constructed such that it partially or fully relies on the processing capability of computer 60. In this type of

embodiment, programmer 30 may be constructed without processor 34 or with a processor of reduced capacity. Programmer 30 may also be constructed such that it partially or fully relies on the memory capacity of computer 60. Moreover, signal processing functions such as those performed by SPC 40 could also be fully or partially carried out by circuitry or software resident within computer 60.

As shown in FIG. 3, computer 60 may be connected to Internet 80 through link 70. Link 70 may be, for example, a modem (e.g., any suitable analog or digital modem, cellular modem, or cable modem), a network interface link (e.g., an Ethernet link, token ring link, etc.), a wireless communications link (e.g., a wireless telephone link, a wireless Internet link, an infrared link, etc.), or any other suitable hard-wired or wireless communications link. With this configuration, a user may download information from Internet 80 (e.g., using electronic distribution (ED) services) and/or from a disc drive or other devices (not shown) connected to computer 60 and program that information into device 20 (via programmer 30 and link 32).

It will be understood, of course, that computer 60, with a suitable communications link, such as link 32, may be programmed with software to function as programmer 30. In this way, a user may take advantage of the fact that many of the components of programmer 30 are resident within computer 60. For example, computer 60 may contain a processor, such as processor 34 and programmable memory circuitry such as memory 36. Computer 60 may also include signal processing circuitry such as SPC 40, or software that instructs processor 34 to perform the necessary format conversions. Computer 60 may include circuitry similar to input buffer 44 and output buffer 42. Such circuitry may include random

access memory (RAM) or cache memory in computer 60. Computer 60 also may include internal or external A/D conversion circuitry, such as A/D converter 38, and an internal or external transducer 25.

5           As shown in FIG. 4a, computer 60, programmed to function as programmer 30, may be connected to Internet 80 through link 70 and to device 20 through link 32. This arrangement allows a user to select information from Internet 80 or from a storage device  
10           connected to computer 30 (not shown) for programming into device 20.

          Using the generalized system shown in FIG. 4a, user-defined information may be programmed into device 20 in many ways. For example, computer 60 may be part of a  
15           communications network 95, such as a telephone network, that provides Internet and/or telephone access to programmable device 20 (shown in FIG 4b). Communications network 95 may be provide hard-wired or wireless telephone or Internet access (or combination of the two).  
20           This arrangement is generally illustrated in FIG. 4b as architecture 200, in which computer 90, for the sake of clarity, represents computer 60, configured at least in part, to function as programmer 30.

          With this configuration, a user of device 20 may  
25           access Internet 80 and select information for downloading into device 20. It will be understood, however, that in this implementation, at least a portion of computer 90 is configured to function as programmer 30, and that computer 90 may continue to perform other functions such  
30           as communicating with network computers 82, communicating with Internet 80, interfacing with external telephone network 84, and coordinating wireless Internet and telephone access etc., in addition to performing some or all of the above-described programming functions.

In operation, computer 90 may communicate with device 20 to determine its format requirements and perform any conversions necessary to make user-selected information compatible with those requirements. This  
5 allows a user to select information, such as audio and/or video, that is available on the Internet or on a remote network computer, and program that information into device 20. This may be accomplished via communications link 33 (which may be any type of link previously  
10 described as suitable for link 32). For example, a user may wish to download video images from an Internet site to a hand-held computer, such as a PDA, or to a wireless telephone. The user may communicate with computer 90 via a wireless link 33 and select information from  
15 Internet 80 using an Internet browser installed in device 20. Such a browser may be a Wireless Application Protocol (WAP) compliant browser for supporting wireless Internet services. Computer 90 ensures format compatibility of the information, transmits the  
20 information to device 20, and may communicate with device 20 to confirm that the selected information has been properly received. Device 20 may provide a visual, audio, or tactile output to indicate the requested information has been successfully received.

25 Computer 90 may also coordinate information downloading with respect to the memory capacity of device 20. For example, if the user-selected information exceeds the available memory of device 20, computer 90 may inform the user, via link 33, that the selected  
30 information is larger than the available memory. In such an event, the user may be prompted to cancel or modify the information request. In certain instances, however, the user may instruct computer 90 to provide the information in a "scrolling" fashion (*i.e.*, provide it in  
35 portions) so that all the requested information may be

reviewed, albeit in sections. This may be particularly desirable in instances where large files, such as video files, are requested.

In some embodiments of the present invention,  
5 computer 90 may simply contact a remote computer or Internet site to fulfill requests for audio or video information in a particular format. Such web sites or remote computers may act as virtual "jukeboxes" of video and audio information, containing extensive lists of such  
10 information in a variety of formats available for downloading. Using this approach, a user may select a particular piece of information in a certain format from a list displayed on a screen of programmable device 20. Computer 90 may receive this as a request via link 33 and  
15 handle the information transfer to device 20. In some embodiments, format selection may be transparent to the user. That is, the user may simply request a piece of information and computer 90 may determine and then request information in a format appropriate for the  
20 requesting device.

In another embodiment, a remote computer or Internet site may perform a format conversion of information requested by computer 90 or device 20. For example, a user may access an Internet site or remote  
25 computer using communications network 95 and enter a title or description of the desired audio or video information along with format requirements. The remote computer or Internet site may then search the Internet or other databases to find a file that matches the user's  
30 description. Once this file is found, the Internet site or remote computer may convert that file to the requested format, (using a system similar to the described above) and provide it to device 20 via computer 90 and/or link 33. It will be understood, of course, that

embodiments such as these are within the scope of the present invention.

If desired, a user may also employ the systems shown in FIGS. 4a and 4b to download remotely stored information such as Internet access information to device 20. For example, a user may have customized bookmarks or web page addresses stored in a remote personal computer or on Internet 80. The user may employ wireless link 32 or 33 to contact that remote computer or Internet site and then download the Internet access information for use in device 20. This feature is desirable because it relieves the user of the burden of having to type in complicated Internet access information from the small keyboard of a wireless telephone or handheld computer. It also spares the user from having to re-enter customized Internet information that is already present in another location, into their electronic device. Moreover, such a feature is convenient when a user wishes to access information on a remote computer that is not currently available in device 20. For example, a user may wish to view spreadsheet information stored on a remote computer with device 20. Rather than having to download this information from a hard-wired access point, a user may simply employ wireless link 33 (e.g., a wireless modem or Internet connection) to access that remote computer or Internet site and download that information to device 20.

Another feature which may be implemented using the embodiments shown in FIGS. 4a and 4b is a "signature" feature. This allows device 20 to send user-defined information, which may be indicative of the user's personal taste or identity, along with other information when performing certain functions. For example, if a user is placing a wireless telephone call or paging someone with device 20, he or she may select the



signature feature in order to send user-defined audio or video along with, or prior to, that call. A user may accomplish this by browsing through a menu on device 20 that displays available signature options, and by  
5 choosing a particular file (not shown). If the user chooses an audio file, for example, device 20 may send that selected audio file when a call or page is placed (or a period of time before the call or page is placed). This audio file may temporarily replace the "ring  
10 sequence" of the device receiving the incoming call so that the person receiving the incoming call will be alerted by hearing the audio file sent by the caller. The person receiving the call may be able to discern the identity of the caller or other information from the  
15 audio file. After the call is complete, the ring sequence of the receiving device may be returned to its former configuration (either by computer 60 or by the receiving device).

In another embodiment, a user may program certain  
20 audio or video files into device 20 that are activated when a certain person calls. For example, a user may program device 20 so that certain signature files are played in response to receiving a characteristic indicative of the caller, such as the caller's telephone  
25 number. In this way, a user will be able to identify the caller by the sound and/or display generated by device 20. Users may also program signatures in device 20 to be played at predetermined times. For  
30 example, a user (or caller) may program "Happy Birthday" or "Jingle Bells" into device 20 to play on a certain day, or may program device 20 to play a certain signature file at specified time (e.g., as an alarm).

In yet another embodiment, a user, when placing a  
35 call, may invoke a menu on device 20, which displays a list of signature files available for the person being

called. This list may be defined by the person receiving the call. For example, the person receiving the call may create a signature file list by selecting certain audio and/or video files and placing them in a database of a remote computer such as computer 90 by using, for  
5 example, a personal computer connected to the Internet. In some embodiments, signature files may also be stored in a device 20 of the person receiving the call. In this implementation, a list of signature file names may be  
10 stored in computer 90 so that a caller may browse the names of signature files stored in the device of the person receiving the call. Signature files may also be stored in a combination of both computer 90 and device 20.

15 In some embodiments, the signature information may not necessarily be user-defined. For example, a list of pre-selected signature files may stored on computer 90 or a remote computer from which a user of device 20 may choose. Such a list may be created by a wireless service  
20 provider, an Internet provider, an Internet site, or a manufacturer of the wireless telephone.

With these implementations, the caller may simply select a signature file from the displayed list. The selected file is then sent along with the call by  
25 computer 90 (if the selected signature file is stored in computer 90) or associated with the incoming call at device 20 (if the selected signature file is stored in device 20). In some embodiments, the caller may be able to preview signatures before sending them. For example,  
30 computer 90 may send the selected signature file to the caller for his or her review.

In systems that have a video capability, a video file containing a video clip or frame may be sent instead of or in addition to the audio sample. This may be  
35 accomplished by selecting a video option from a signature

menu and choosing a video file. In this case, the person receiving the call is alerted by seeing or hearing the video clip and/or associated audio. It will be appreciated that a video clip may have its own audio portion associated with it so that the video clip (or frame) by itself would be sufficient to alert the person receiving the incoming call.

The above-described signature feature may be implemented in many ways. In some embodiments, for example, the audio or video signatures may be stored in (the caller's) device 20 and sent along with the outgoing call or page via link 33 and computer 90. In other embodiments, however, the signature information may be stored in computer 90 and associated with the outgoing call when it is processed by computer 90. This type of embodiment may be implemented when it is desired to conserve memory space within device 20. In still other embodiments, signature information may be stored in both device 20 and computer 90. In any case, computer 90 may determine the format requirements of the device receiving the incoming call or page and convert the accompanying signature information into a suitable format.

Another implementation of a system in accordance with this invention may use an architecture 300, which is shown in FIG. 5. Using this arrangement, programmer 30 (or similar circuitry) may be embedded within programmable device 20. User-defined information may be provided to device 20 from source 50 via link 32. Such information may be routed to programmer 30, which may perform some or all of the above-described functions.

If source 50 is an acoustic source, however, link 32 may not be needed. For example, if a user desires to program an acoustic sound into device 20, the user may place a transducer 25, (e.g., a speaker/microphone existing within or external to device 20) near

the acoustic signal source, place device 20 into an "acquisition mode," and record an audio sample. In this case, transducer 25 converts the acoustic signal into an electrical signal, which is provided to programmer 30 for processing and possibly storage within device 20. A visual, audio, or tactile output may be provided by device 20 to indicate a sample has been successfully loaded. A user may employ transducer 25 to acquire and record, for example, a verbal message or sound effect (e.g., laughter, crying, sneezing, etc.) for use as a signature file.

Other embodiments of the present invention may use the embedded architecture of system 400 as shown in FIG. 6. Using this arrangement, user-defined information may be requested by device 20 via link 32 and computer 60. With this approach, a user may select information from Internet 80 or a remote computer and perform any necessary format conversion within device 20.

In addition to selecting user-defined information with programmer 30, a user may customize that information by performing various editing procedures. For example, a user may find an audio track or video clip that suits his or her taste. It may be desired, however, to utilize only a portion of that track or clip. In this case, a user may edit or "sample" a portion of the information to obtain the desired segment. For example, a user may wish to sample a few bars of a popular song and send it along as signature information when making a wireless telephone call. Such editing may be accomplished, for example, by using an application program with programmer 30 or by using known software with computer 60. Furthermore, once the user has edited a particular piece of information, he or she may be given the option to review the piece to ensure it is acceptable. When a user is satisfied with an edited segment, he or she may save it and be given an

opportunity to "name" that segment, so that it may be readily identified later by a user of device 20.

It will be appreciated that various other types of editing procedures are also possible. For example, a user may combine and/or further edit the content of segments of information. This may be accomplished using "cut and paste" routines in an application program. Other types of revisions may include modifying the color or content of a portion of video clip or frame, as well as editing the audio track that accompanies a video clip or frame. It may also include revising or combining audio segments or creating customized audio segments to accompany video clips or frames.

In some instances, a user may wish to download large portions of copyrighted audio or video. To prevent improper usage of such material, programmer 30 may include copyright protection software such as software that conforms with the Secure Digital Music Initiative (SDMI). Generally speaking, this may allow an owner of such material to "check out" a finite number of copies so that unauthorized distribution is prevented.

A schematic diagram of a portion of a wireless telephone 500 that can receive and play user-defined audio and/or video is shown in FIG. 7. As illustrated in FIG. 7, telephone 500 may include antenna 510, receiver/transmitter (R/T) circuit 520, processor 530, communications interface 532, speaker/transducer 540, alerting circuit 550, and optionally, programmer 30 (or similar circuitry).

A user may program information into telephone 500 in several ways. For example, a user may connect telephone 500 to an external programmer 30 (not shown in FIG. 7) via link 32 to program user-defined audio or video in telephone 500 as described above. Processor 530 may route this information to alerting circuit 550 for

storage and subsequent use. Afterwards, the user may configure telephone 500 to play a certain user-defined audio file stored in alerting circuit 550 when receiving an incoming call. Thus, when a call is received, processor 530 may instruct alerting circuit 550 to play the selected file through speaker 540. If a video file is chosen, processor 530 may instruct alerting circuit 550 to play the user-selected video file through a display screen on the telephone (not shown). Alerting circuit 550 may include programmable memory circuitry for storing user-defined information and driver circuitry (not shown) for driving speaker 540 and/or a display screen on telephone 500.

Telephone 500 may also receive user-defined information from communications network 95 via link 33 and antenna 510. With this implementation, user defined information, such as a signature file, may be received by antenna 510 and demodulated with R/T circuit 520. Processor 530 may then route the demodulated signals to an appropriate location. In the case of a signature file, for example, processor 530 may check the format of the incoming file to ensure it is compatible with the format required by alerting circuit 550. If the format is compatible, the incoming file may be routed to alerting 550 for storage and subsequent use or to speaker 540 for immediate playing. If the format is not compatible, the incoming file may be routed to programmer 30 for conversion. After conversion is complete, processor 530 may instruct programmer 30 to route the converted file to speaker 540 or alerting circuit 550. If a video file was sent as a signature file, processor 530 may instruct alerting circuit 550 to play the user-selected video file through a display in telephone 500 (not shown). In some embodiments,

speaker 540 may be an enhanced performance speaker (as compared to those currently installed in telephones) with a capacity for generating a full range of audio sounds. Moreover, it will be understood that circuitry similar to that shown in FIG. 7 may be installed for use in other communication devices such as PDA's, pagers, notebook computers, etc.

Some of the steps involved in programming user-defined information into programmable device 20 as described herein are illustrated in the flow chart of FIGS. 8-9. It will be understood that although programmer 30 is used in the following description, computer/programmer 90 may also perform some or all of these (or similar) steps.

At step 100 in FIG. 8, programmer 30 allows the user to browse information for potential programming into device 20. As mentioned above, this may include browsing audio/video information on the Internet, or on a hard, floppy, or optical disc drive of a computer. At step 102, the user may choose certain files for programming into device 20. Next, at step 104, programmer 30 may determine the format requirements of device 20 and compare the format of the selected files to that specified by device 20. This may be accomplished, for example, by electronically polling device 20. At step 105, if the formats are compatible, programmer 30 may go directly to step 108. If the formats are not compatible, at step 106, programmer 30 may convert the selected files to a format compatible with device 20. In some embodiments, the user may be prompted to confirm that the conversion should be performed. In addition, programmer 30 may also prompt the user to supply a name for the converted file. Moreover, if the selected file cannot be converted, programmer 30 may so inform the user.

Next, programmer 30 provides the user with an option of editing the contents of the resulting files at step 108. If desired, the user may first review the converted file to determine if editing is warranted. At  
5 step 109, if the user chooses not to edit the file, programmer 30 may go directly to step 112 (shown in FIG. 9). If the user decides to edit the file, he or she may do so at step 110. When finished editing, the user may be given the option of reviewing the file at  
10 step 111 by returning to step 108 to determine whether the file is acceptable or requires further revision. Programmer 30 may alternate between steps 108-110 until the user is satisfied with the resulting file. When editing is complete, programmer 30 provides the user with  
15 the option of programming the file into device 20 at step 112. At this point, (step 113) the user may exit the program at step 114 or return to step 100 to browse more information.

It will be understood that these steps are merely  
20 illustrative, and are not meant to be comprehensive or necessarily performed in the order shown. For example, it may be desired to edit a file already stored in device 20. In this case, a user may bypass steps 100-106 and go directly to step 108. In some embodiments,  
25 selected files may be revised before converting them to format compatible with device 20. This may be desirable when the file's original format facilitates the editing process. In addition, programmer 30 may determine the format requirements of device 20 at any time before the  
30 conversion occurs. A user may also name or revise the name of a selected file at any time.

Some of the steps involved in sending signature files to programmable device 20 as described herein are illustrated in the flow chart of FIGS. 10-12.



At step 150 in FIG. 10, device 20 allows the user to browse signature files for potential transmission to device 20 of the person receiving the call (hereinafter the "receiver"). At step 150, the user may be provided with option of creating a new signature file if a suitable signature file not found on the list. At step 154 the user may select a signature file. Once a signature file is selected, computer 90, at step 156, may determine the location of the selected signature file. Such locations may include, but are not limited to, the caller's device 20, the receiver's device 20, or computer 90.

If computer 90 determines that the signature file is located in the user's device 20 (*i.e.*, the caller's device 20) computer 90 may retrieve that file from the user's device 20 at step 158. Next, computer 90 may compare the format requirements of the receiver's device 20 with the format of the retrieved file to determine if they are compatible at step 160. If the formats are compatible, computer 90 may go directly to step 164. If the formats are not compatible, computer 90 may convert the signature file to an acceptable format at step 162. At step 164, the signature file may be sent along with, or somewhat before, the outgoing call. At step 166, the receiver's device 20 may replace its ring sequence with the signature file and play the signature file. At step 167, the receiver's ring sequence may be returned to its original setting and the program may exit.

If, however, the signature file is located in computer 90 (step 156), computer 90 may retrieve that file at step 168 (FIG. 11). Next, computer 90 may compare the format requirements of the receiver's device 20 with the format of the retrieved file to determine if they are compatible at step 170. If the

formats are compatible, computer 90 may go directly to step 174. If the formats are not compatible, computer 90 may convert the signature file to an acceptable format at step 172. At step 174, the signature file may be sent  
5 along with, or somewhat before, the outgoing call. At step 176, the receiver's device 20 may replace its ring sequence with the signature file and play the signature file. At step 177 the receiver's ring sequence may return to its original setting and the program may exit.

10 On the other hand, if computer 90 determines at step 156 that the signature file is located in the receiver's device 20, computer 90 may transmit an indicia indicative of the selected file to the receiver's device 20 along with the outgoing call at step 178

15 (FIG. 12). Next, the receiver's device 20 may associate a signature file that corresponds to the indicia, replace its ring sequence with that signature file, and play that signature file at step 180. At step 182, the receiver's ring sequence may be returned to its original setting and  
20 the program may exit. It is assumed for the purposes of this illustration that signatures files stored in the receiver's device 20 are already in a suitable format. However, if this is not the case, a conversion step may be added between step 178 and step 180 (not shown).

25 It will be understood that these steps are merely illustrative, and are not meant to be comprehensive or necessarily performed in the order shown. For example, computer 90 may determine the format requirements of device 20 at any time before the conversion occurs.

30 Thus, it is seen that a device for programming user-defined information into an electronic device is provided. The programmer allows a user to program customized information, such as audio, video, or Internet access information into his or programmable device. This  
35 allows a user to, among other things, customize his or

her device to suit the user's particular taste. It will be understood that the foregoing is only illustrative of the principles of the invention, and that various modifications can be made by those skilled in the art without departing from the scope and spirit of the invention. For example, it is not necessary that programmable memory within device be a fixed programmable memory. That is, a removable memory module may be programmed externally from a given programmable device and subsequently installed in that device. Furthermore, the many aspects of the invention are suitable for use with hard-wired, cordless, or wireless communications devices. For example, user-defined audio and video and signature files may be used with hard-wired or cordless telephone systems. Accordingly, such embodiments will be recognized as within the scope of the present invention.

Persons skilled in the art will appreciate that the present invention can be practiced by other than the described embodiments, which are presented for purposes of illustration rather than of limitation, and the present invention is limited only by the claims which follow.

I Claim:

1. A system for programming an audio file into a device capable of making person to person telephone calls comprising:

an electronic means for locating the audio file, the audio file being external to the device and the electronic locating means; and

means for enabling a user of the device to program at least a portion of the audio file into the device wherein the audio file is used as an indicia of an incoming communication.

2. The system of claim 1 wherein the means for allowing the user to locate further comprises means for locating the audio file on the Internet.

3. The system of claim 1 wherein the means for allowing the user to locate further comprises means for allowing the user to search a plurality of locations on the Internet that contain audio files.

4. The system of claim 1 wherein the means for allowing the user to locate further comprises means for searching a plurality of audio files and wherein the system further comprises means for allowing the user of the device to select at least one of the audio files to program into the device.

5. The system of claim 1 wherein the means for allowing the user to locate further comprises means for locating the audio file on an optical disc drive of a computer.

6. The system of claim 1 further comprising means for modifying the audio file.

7. The system of claim 1 wherein the means for enabling further comprises:

- means for determining a format of the audio file;
- means for determining an audio file format required by the device; and
- means for comparing the format of the audio file with the audio file format required by the device.

8. The system of claim 7 further comprising means for converting the audio file to the file format required by the device.

9. The system of claim 7 wherein the means for enabling further comprises means for retrieving the audio file from the Internet.

10. The system of claim 7 wherein the means for enabling further comprises means for transmitting the audio file across a wireless network.

11. The system of claim 1 wherein the device includes a programmable memory means that is a removable, wherein the audio file is programmed into the removable memory means.

12. An apparatus for programming an audio file into a telephone having a telephone memory comprising:  
a data input device that allows a user to search a plurality of locations that include audio files;  
and  
means for programming a selected one of the plurality of audio files into the telephone memory

wherein the audio file is used as an indication of an incoming telephone call.

13. A method for customizing an electronic device capable of making person to person calls by programming an audio file into the device, the method comprising:

allowing a user to search a plurality of locations that contain audio files;

allowing the user to browse a group of predefined audio files at a selected one of the plurality of locations;

allowing the user to choose an audio file from the predefined group; and

enabling the user of the device to program the modified audio file into the device for use as an indicia of an incoming communication.

14. The method of claim 13 characterized by the use of a wireless phone as the electronic device.

15. The method of claim 13 characterized by the use of a PDA as the electronic device.

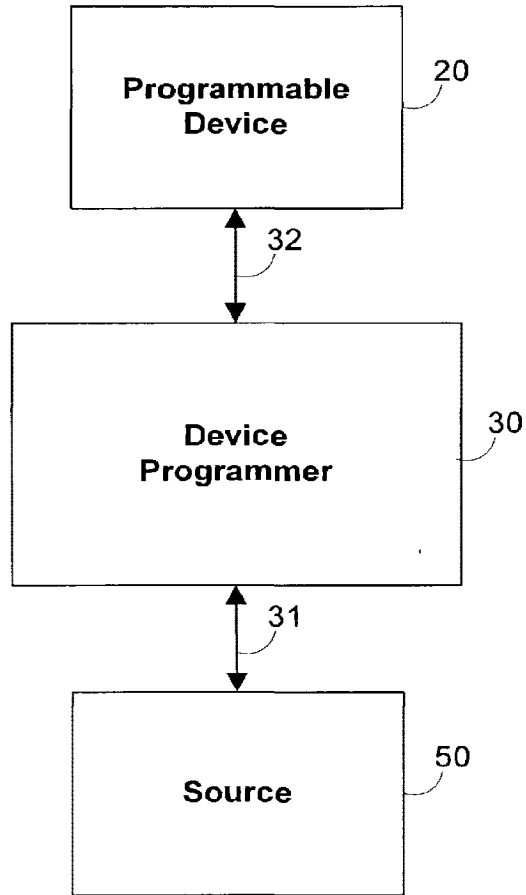
MES/001 Con.

METHODS AND APPARATUS FOR PROGRAMMING  
USER-DEFINED INFORMATION INTO ELECTRONIC DEVICES

Abstract of the Invention

5 A device for programming user-defined information  
into an electronic device is provided. The programmer  
allows a user to program customized information, such as  
user-selected audio, video, or Internet access  
information into his or her programmable device. Such  
10 electronic devices include wireless telephones, pagers,  
and personal digital assistants. The programmer allows a  
user to, among other things, customize the device to suit  
his or her particular taste.

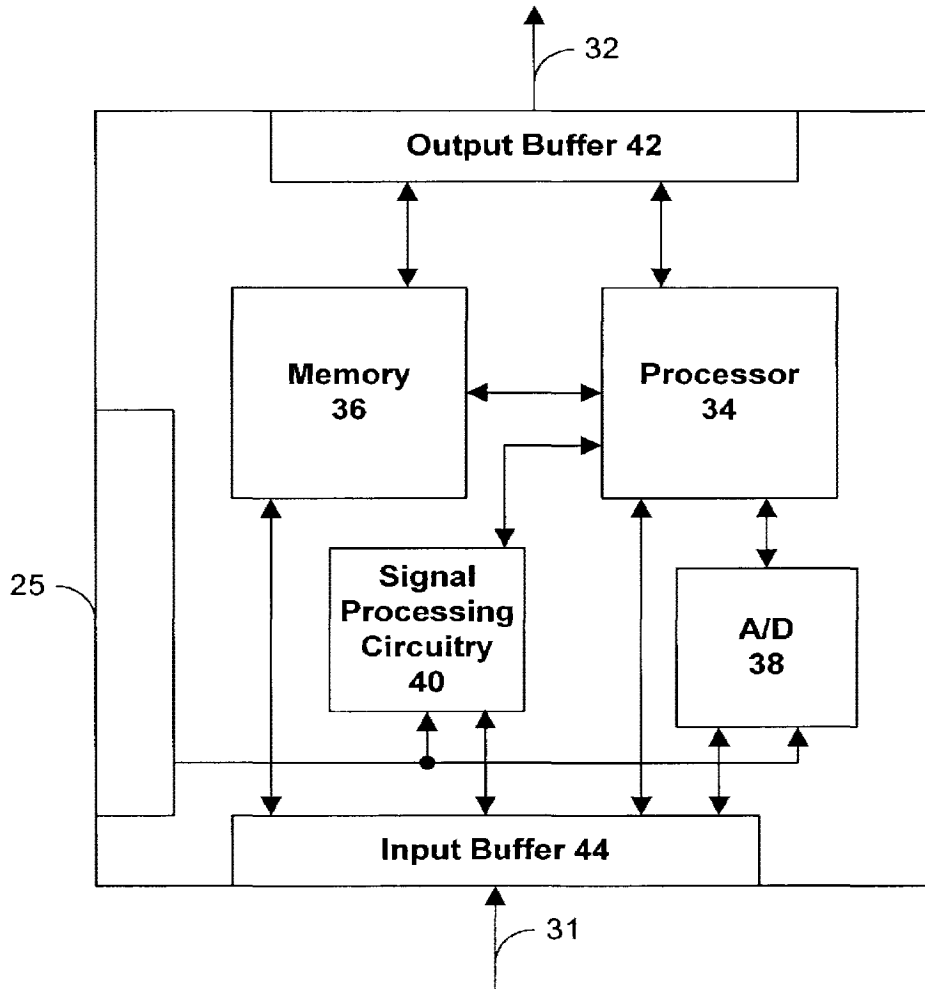
**10**



**FIG. 1**

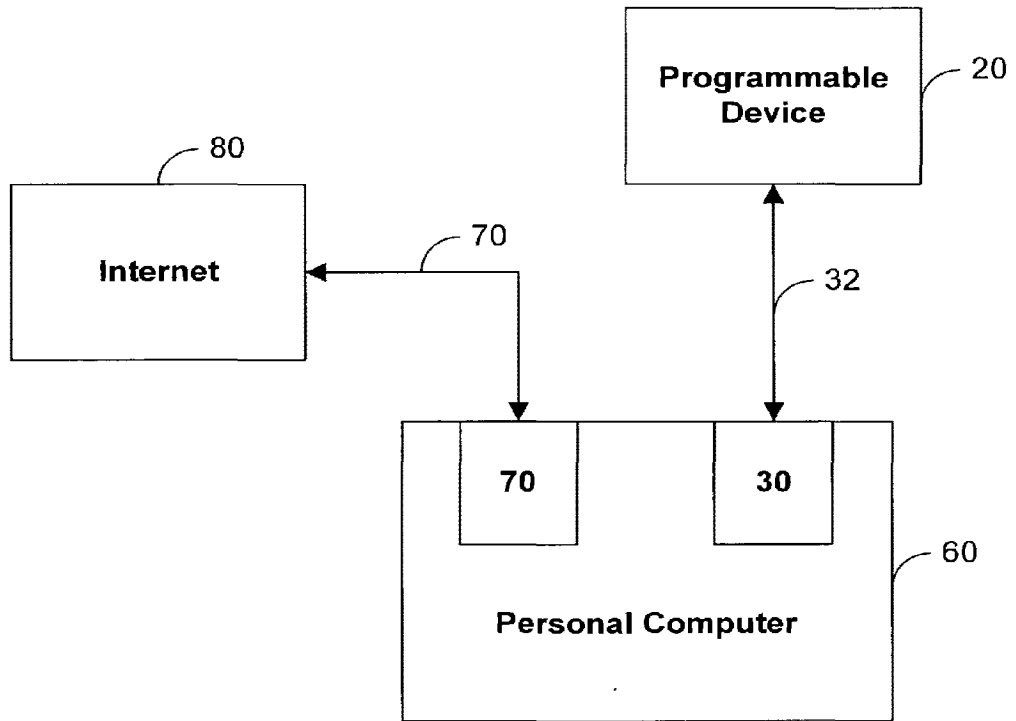


30

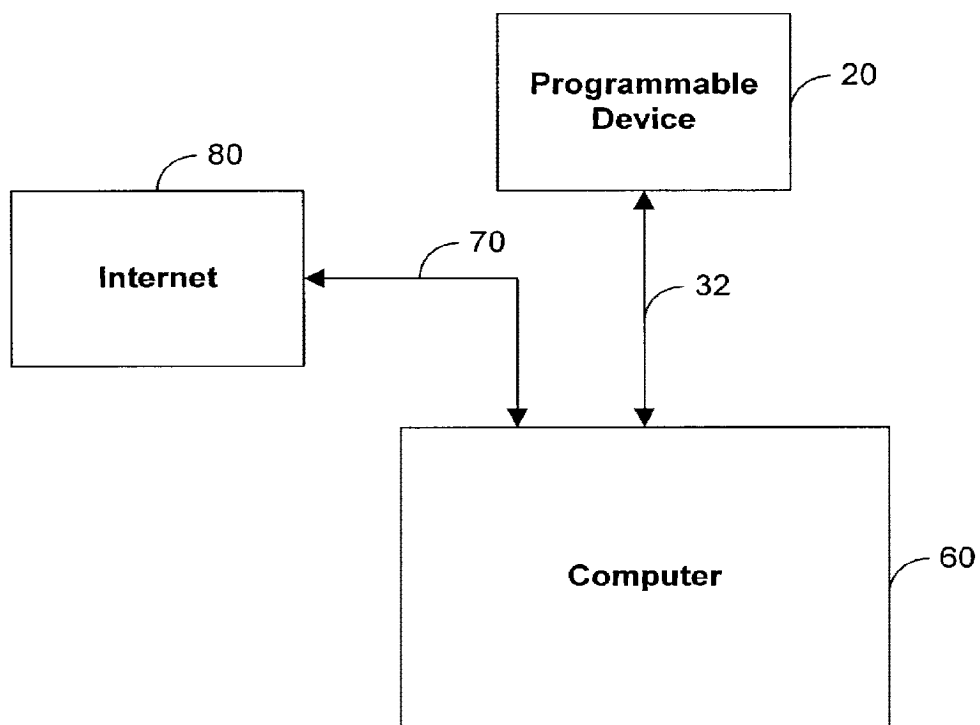


**FIG. 2**

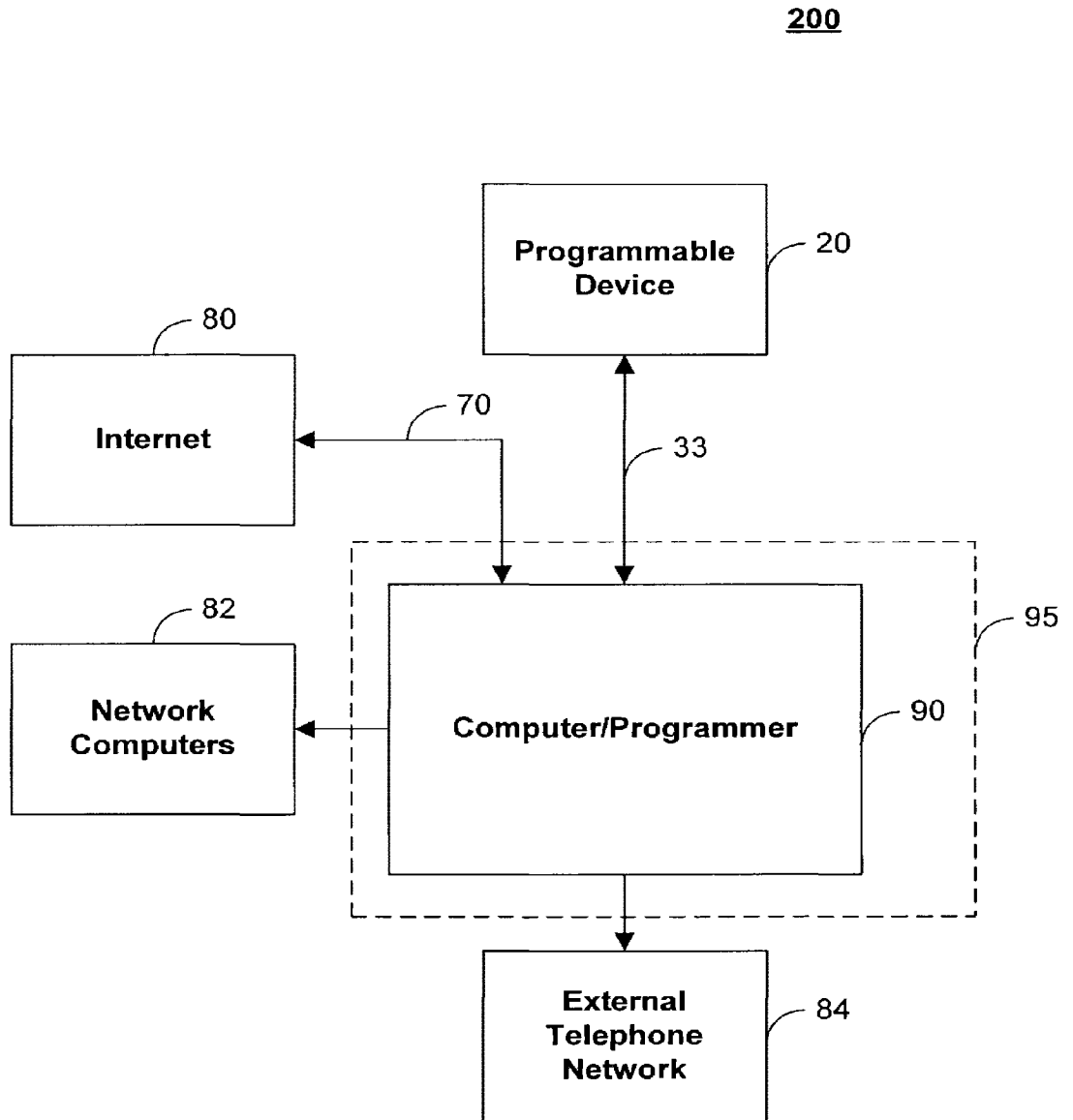
100



**FIG. 3**

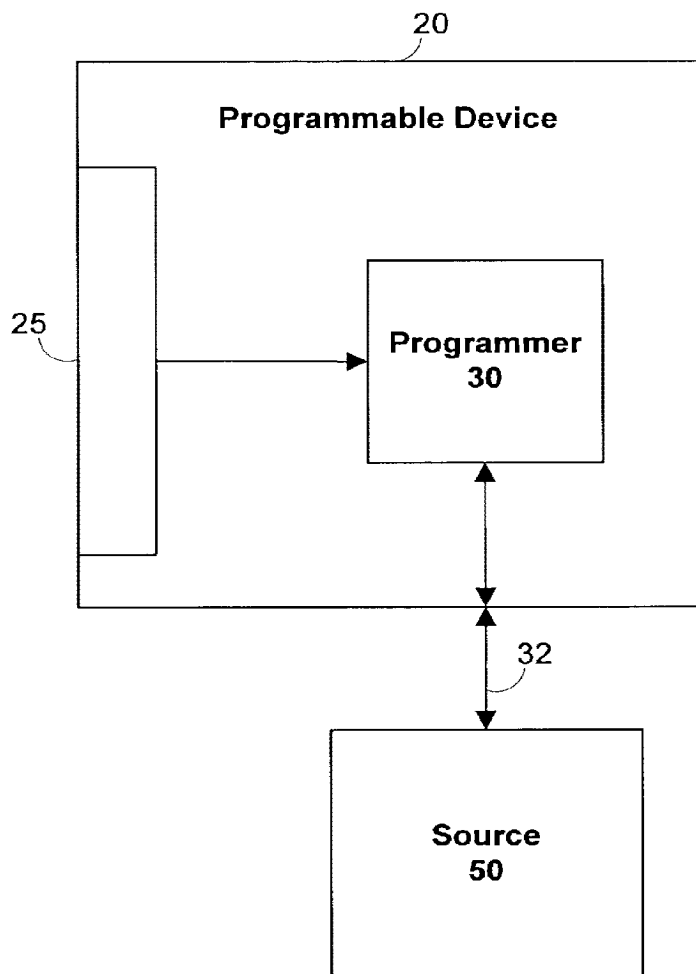


**FIG. 4A**

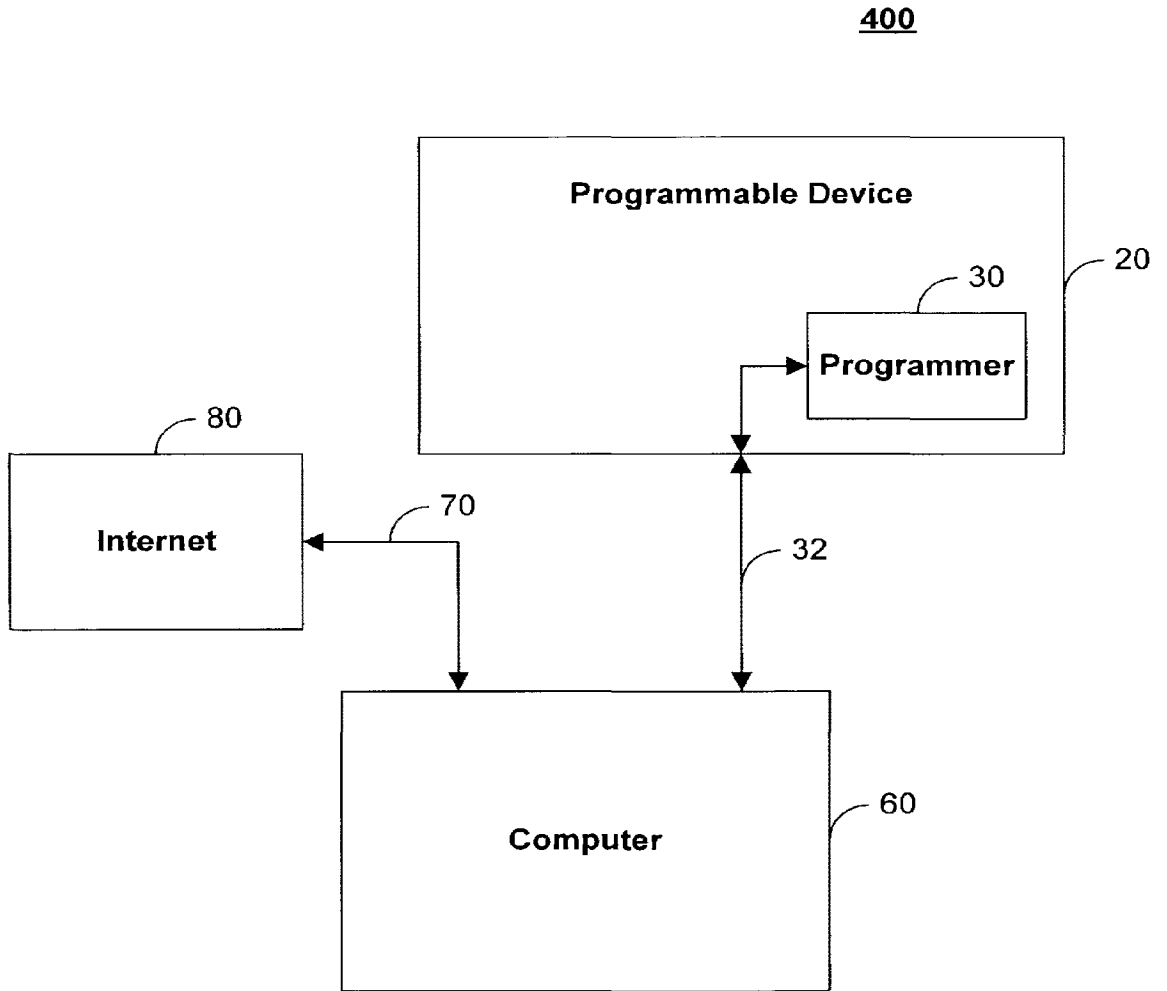


**FIG. 4B**

300



**FIG. 5**



**FIG. 6**

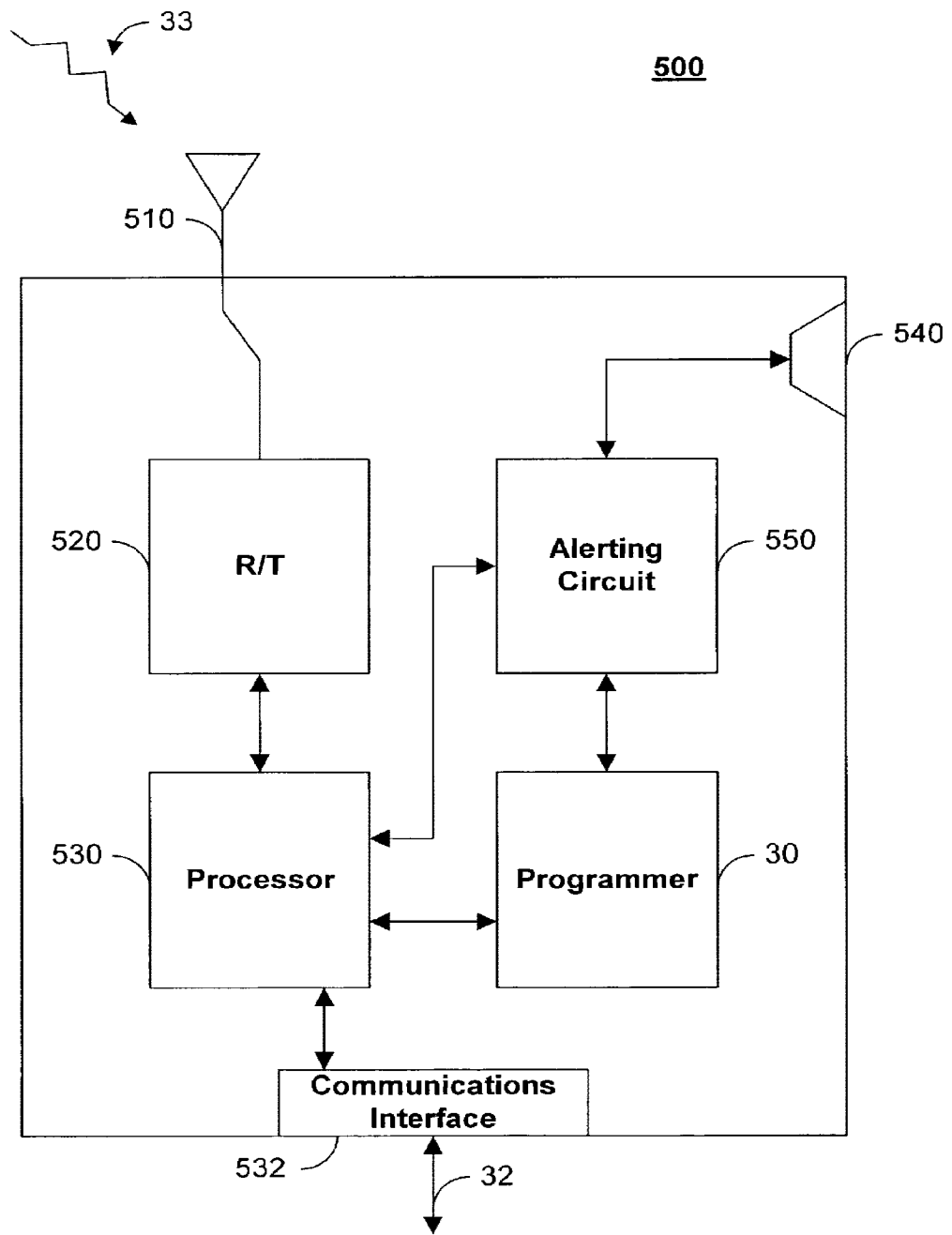


FIG. 7

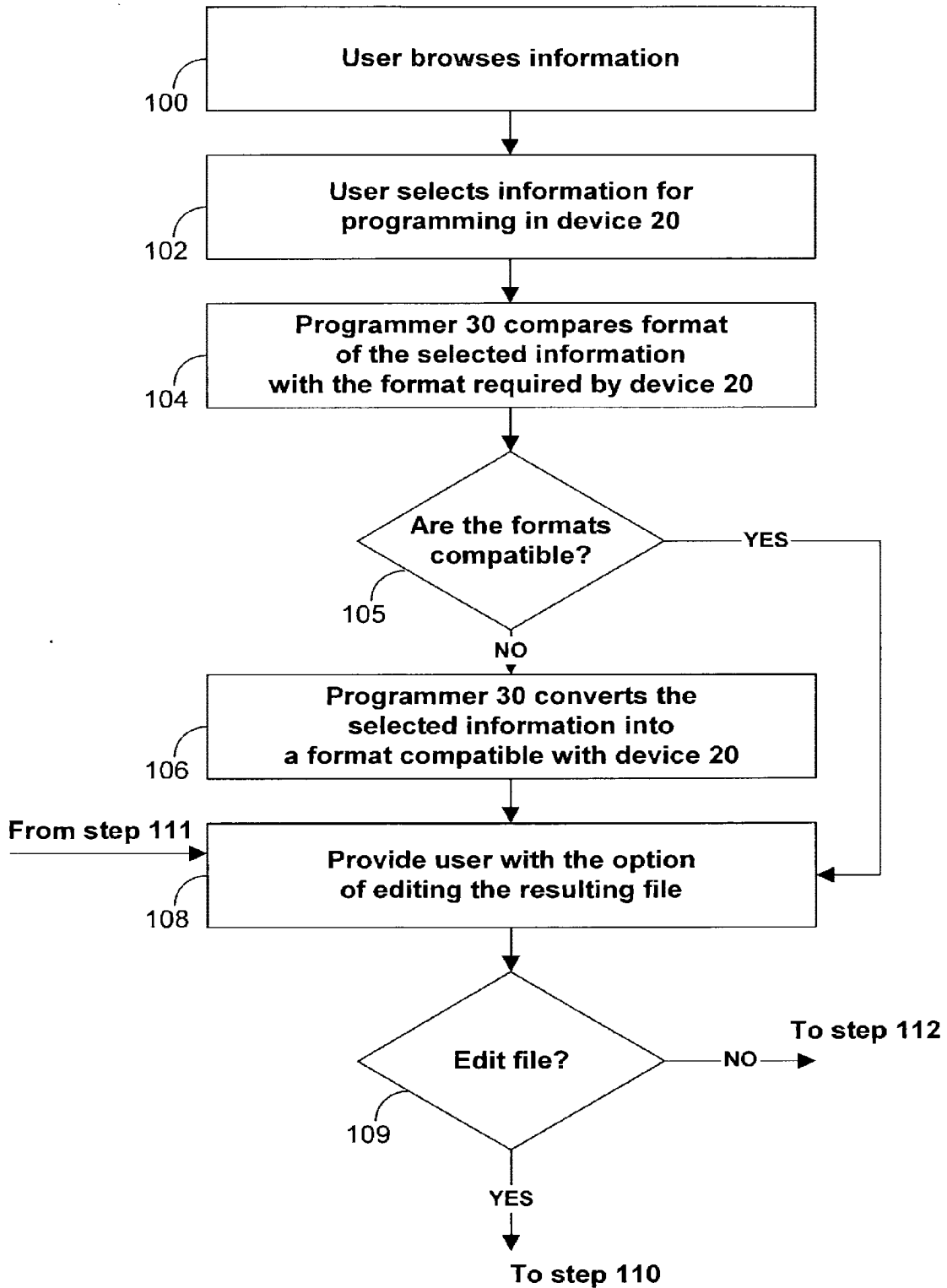


FIG. 8



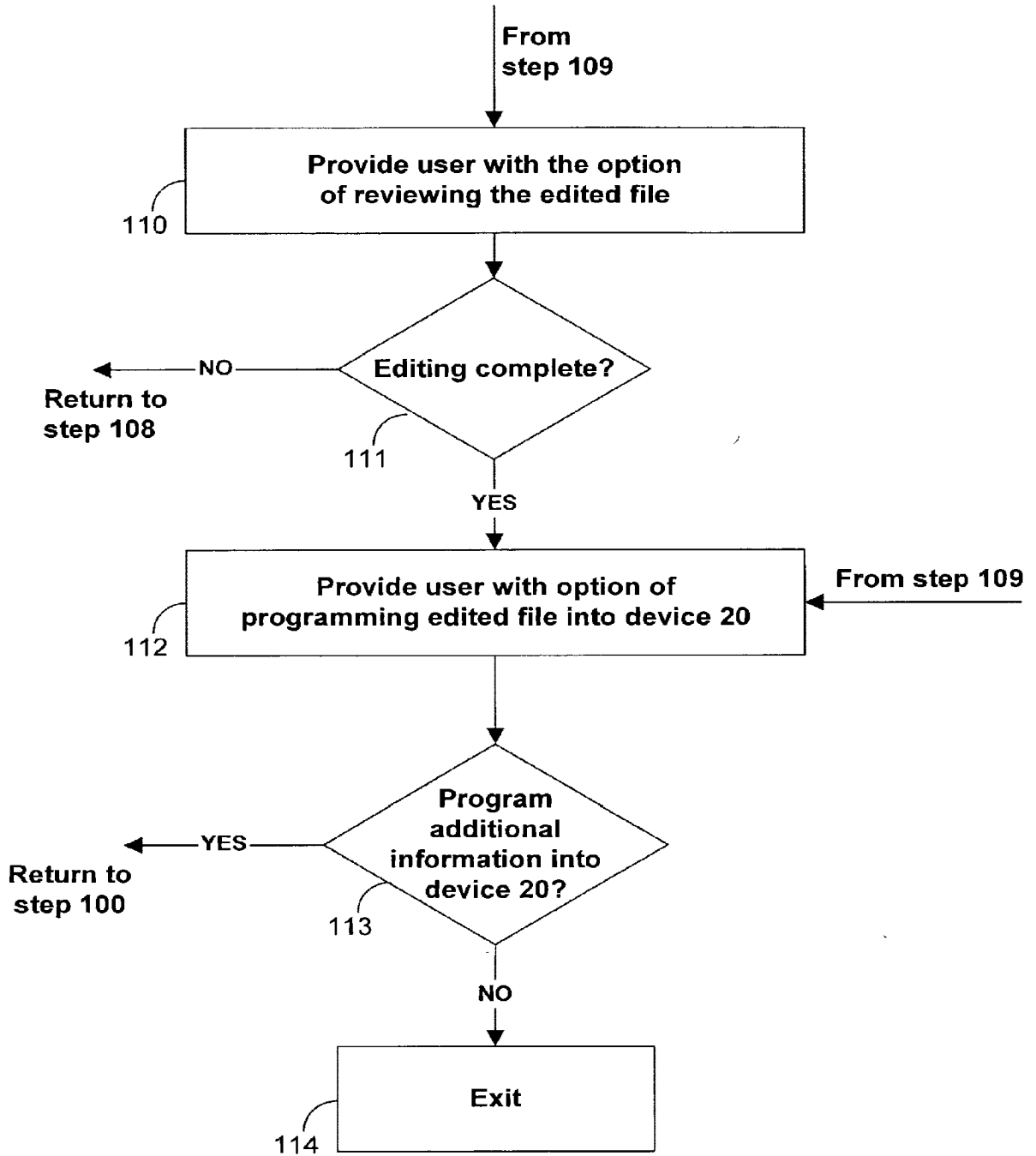


FIG. 9

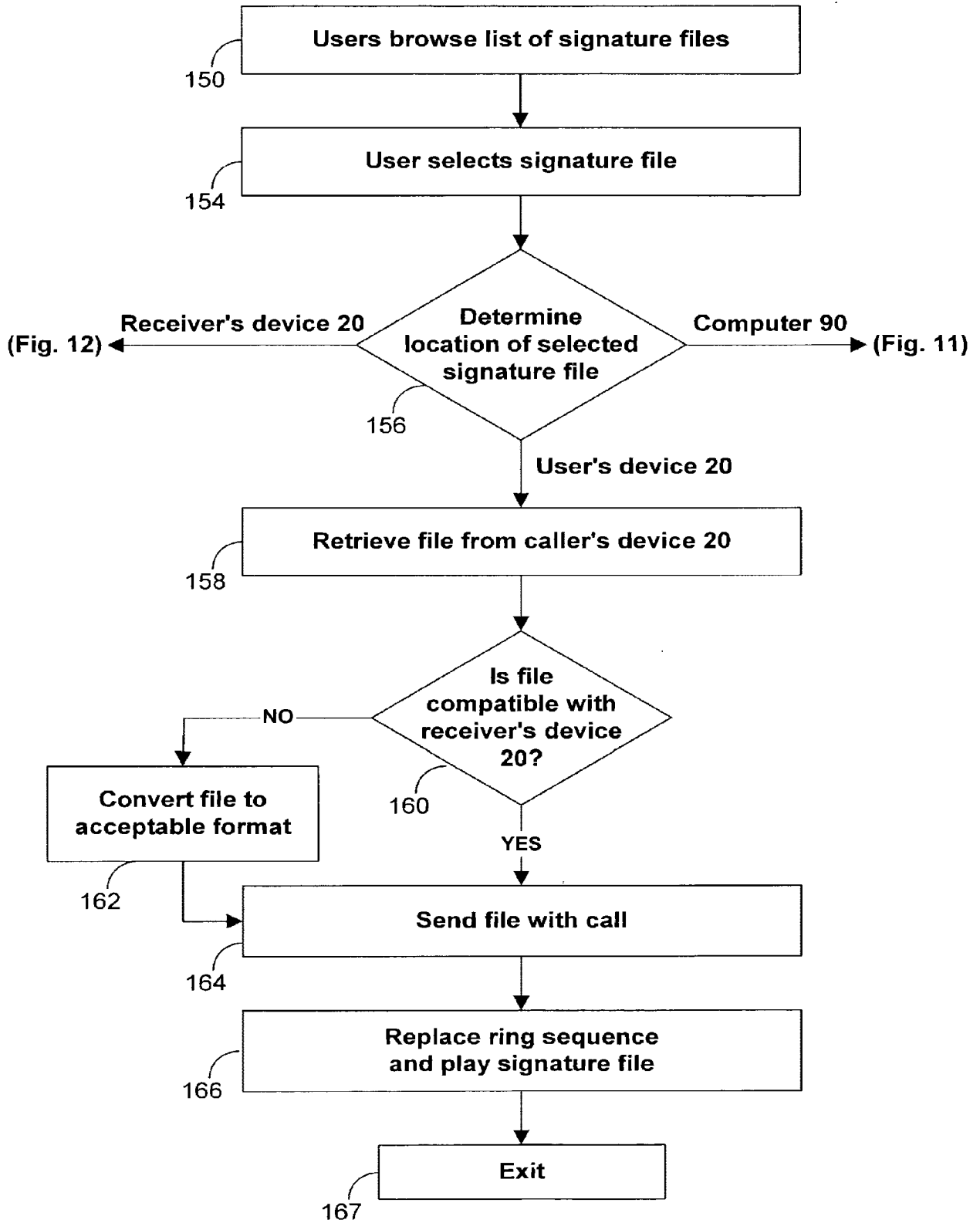


FIG. 10

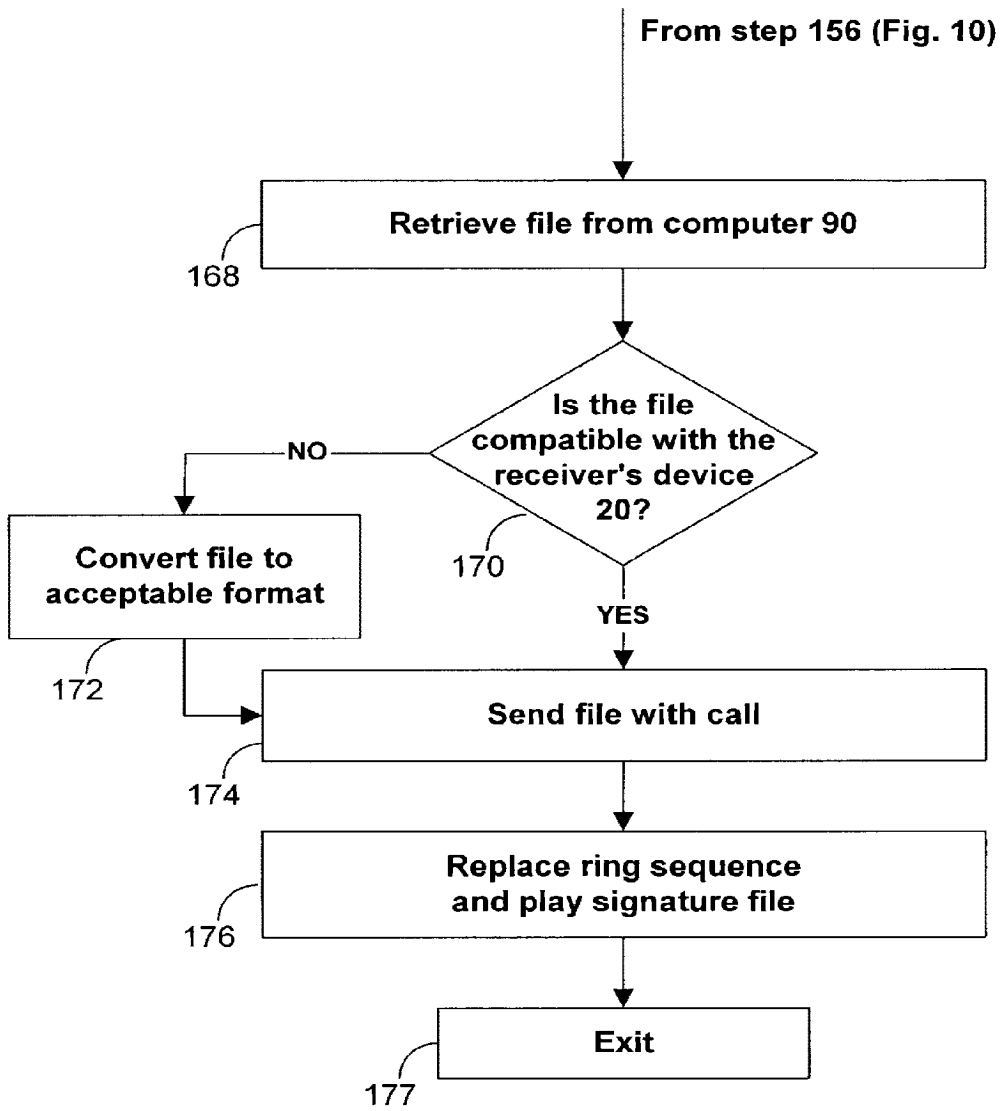
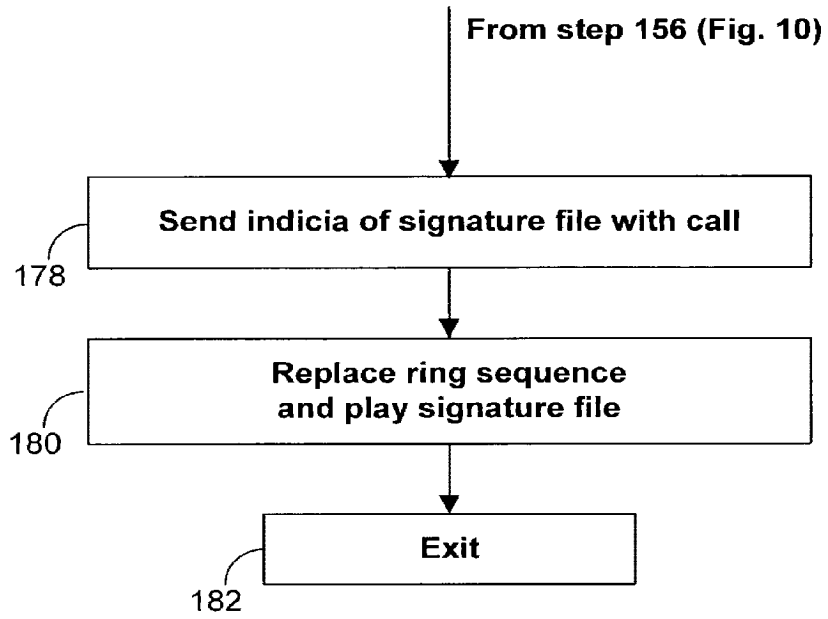


FIG. 11



**FIG. 12**

DECLARATION AND POWER OF ATTORNEY

As a below named inventor, I hereby declare that: my residence, post office address and citizenship are as stated below next to my name;

I believe I am an original, first and sole inventor of the subject matter which is claimed and for which a patent is sought on the invention entitled:

METHODS AND APPARATUSES FOR PROGRAMMING  
USER-DEFINED INFORMATION INTO ELECTRONIC DEVICES

the specification of which

is attached hereto

was filed on \_\_\_\_\_ as  
Application Serial No. \_\_\_\_\_.

I hereby state that I have reviewed and understand the contents of the above-identified specification, including the claims.

I do not know and do not believe that the invention was ever patented or described in any printed publication in any country before my or our invention thereof or more than one year prior to this application.

I do not know and do not believe that the invention was in public use or on sale in the United States of America more than one year prior to this application.

I acknowledge the duty to disclose to the United States Patent and Trademark Office all information known by me to be material to patentability as defined in Title 37, Code of Federal Regulations, § 1.56.

I hereby claim foreign priority benefits under Title 35, United States Code, § 119(a)-(d) of any foreign application(s) for patent or inventor's certificate listed below and have also identified below any foreign application for patent or inventor's certificate having a filing date before that of the application on which priority is claimed:

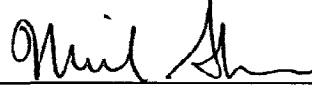
Prior Foreign Application(s)

Priority  
Claimed

			[ ]	[ ]
(Number)	(Country)	(Filing Date)	Yes	No



Full name of first inventor Michael E. Shanahan

First inventor's signature  8/16/02  
Date

Residence 783 Route 9W South  
Nyack, New York, 10960

Citizenship United States

Post Office Address P.O. Box 381 Nyack N.Y., 10960

EXPRESS MAIL LABEL NO. -- EV133107427US

Applicant or Patentee: Michael E. Shanahan Attorney's  
Serial or Patent No.: \_\_\_\_\_ Docket No.: MES/001 Con  
Filed or Issued: Herewith  
For: METHODS AND APPARATUSES FOR PROGRAMMING USER-DEFINED INFORMATION INTO ELECTRONIC DEVICES

VERIFIED STATEMENT (DECLARATION) CLAIMING SMALL ENTITY STATUS (37 C.F.R. 1.9(f) AND 1.27(b)) - INDEPENDENT INVENTOR

As a below named inventor, I hereby declare that I qualify as an independent inventor as defined in 37 C.F.R. 1.9 (c) for purposes of paying reduced fees under Section 41(a) and (b) of Title 35, United States Code, to the Patent and Trademark Office with regard to the invention entitled METHODS AND APPARATUSES FOR PROGRAMMING USER-DEFINED INFORMATION INTO ELECTRONIC DEVICES described in:

- The specification filed herewith
- Application Serial No. \_\_\_\_\_, filed \_\_\_\_\_
- Patent No. \_\_\_\_\_, issued \_\_\_\_\_

I have not assigned, granted, conveyed or licensed and am under no obligation under contract or law to assign, grant, convey or license, any rights in the invention to any person who could not be classified as an independent inventor under 37 C.F.R. 1.9(c) if that person had made the invention, or to any concern which would not qualify as a small business concern under 37 C.F.R. 1.9(d) or a nonprofit organization under 37 C.F.R. 1.9(e).

Each person, concern or organization to which I have assigned, granted, conveyed, or licensed or am under an obligation under contract or law to assign, grant, convey, or license any rights in the invention is listed below:

- No such person, concern, or organization
- Persons, concerns or organizations listed below\*

\*NOTE: Separate verified statements are required from each named person, concern or organization having rights to the invention averring to their status as small entities. (37 C.F.R. 1.27)

FULL NAME \_\_\_\_\_

ADDRESS \_\_\_\_\_

- INDIVIDUAL     SMALL BUSINESS CONCERN     NONPROFIT ORGANIZATION

FULL NAME \_\_\_\_\_



ADDRESS \_\_\_\_\_

INDIVIDUAL     SMALL BUSINESS CONCERN     NONPROFIT ORGANIZATION

FULL NAME \_\_\_\_\_


ADDRESS \_\_\_\_\_

INDIVIDUAL     SMALL BUSINESS CONCERN     NONPROFIT ORGANIZATION

I acknowledge the duty to file, in this application or patent, notification of any change in status resulting in loss of entitlement to small entity status prior to paying, or at the time of paying, the earliest of the issue fee or any maintenance fee due after the date on which status as a small entity is no longer appropriate. (37 C.F.R. 1.28(b))

I hereby declare that all statements made herein of my own knowledge are true and that all statements made on information and belief are believed to be true; and further that these statements were made with the knowledge that willful false statements and the like so made are punishable by fine or imprisonment, or both, under Section 1001 of Title 18 of the United States Code, and that such willful false statements may jeopardize the validity of the application, any patent issuing thereon, or any patent to which this verified statement is directed.

NAME OF INVENTOR	NAME OF INVENTOR	NAME OF INVENTOR
Michael E. Shanahan		

Signature of Inventor Inventor August 16, 2002 <del>March 3, 2000</del>	Signature of Inventor 	Signature of
Date	Date	Date

Address of Inventor -- P.O. Box 381, Nyack, NY 10960 \_\_\_\_\_



UNITED STATES PATENT AND TRADEMARK OFFICE

UNITED STATES DEPARTMENT OF COMMERCE  
 United States Patent and Trademark Office  
 Address: COMMISSIONER FOR PATENTS  
 P.O. Box 1450  
 Alexandria, Virginia 22313-1450  
 www.uspto.gov



Bib Data Sheet

CONFIRMATION NO. 8026

<b>SERIAL NUMBER</b> 10/223,200	<b>FILING OR 371(c) DATE</b> 08/16/2002 <b>RULE</b>	<b>CLASS</b> 455	<b>GROUP ART UNIT</b> 2683	<b>ATTORNEY DOCKET NO.</b> MES/001CON
------------------------------------	-----------------------------------------------------------	---------------------	-------------------------------	------------------------------------------

**APPLICANTS**  
 Michael E. Shanahan, Nyack, NY;

**\*\* CONTINUING DATA \*\*\*\*\***  
 This application is a CON of 09/518,712 03/03/2000 PAT 6,496,692 which claims benefit of 60/169,158 12/06/1999

**\*\* FOREIGN APPLICATIONS \*\*\*\*\***

**IF REQUIRED, FOREIGN FILING LICENSE GRANTED\*\* SMALL ENTITY \*\***  
 \*\* 09/23/2002

Foreign Priority claimed <input type="checkbox"/> yes <input type="checkbox"/> no	<b>STATE OR COUNTRY</b> NY	<b>SHEETS DRAWING</b> 13	<b>TOTAL CLAIMS</b> 15	<b>INDEPENDENT CLAIMS</b> 3
35 USC 119 (a-d) conditions met <input type="checkbox"/> yes <input type="checkbox"/> no <input type="checkbox"/> Met after Allowance				
Verified and Acknowledged	Examiner's Signature _____	Initials _____		

**ADDRESS**  
 32850

**TITLE**  
 Methods and apparatuses for programming user-defined information into electronic devices

<b>FILING FEE RECEIVED</b> 1309	FEES: Authority has been given in Paper No. _____ to charge/credit DEPOSIT ACCOUNT No. _____ for following:	<input type="checkbox"/> All Fees
		<input type="checkbox"/> 1.16 Fees ( Filing )
		<input type="checkbox"/> 1.17 Fees ( Processing Ext. of time )
		<input type="checkbox"/> 1.18 Fees ( Issue )
		<input type="checkbox"/> Other _____
		<input type="checkbox"/> Credit

PATENT APPLICATION SERIAL NO. \_\_\_\_\_

U.S. DEPARTMENT OF COMMERCE  
PATENT AND TRADEMARK OFFICE  
FEE RECORD SHEET

08/21/2002 DLY111 00000048 10223200

01 FC:201 370.00 OP

PTO-1556  
(5/87)

**PATENT APPLICATION FEE DETERMINATION RECORD**

Effective October 1, 2001

Application or Docket Number

ME S / 001 COM

**CLAIMS AS FILED - PART I**

	(Column 1)	(Column 2)
TOTAL CLAIMS	15	
FOR	NUMBER FILED	NUMBER EXTRA
TOTAL CHARGEABLE CLAIMS	15 minus 20= *	0
INDEPENDENT CLAIMS	3 minus 3= *	0
MULTIPLE DEPENDENT CLAIM PRESENT <input type="checkbox"/>		

SMALL ENTITY TYPE

OR OTHER THAN SMALL ENTITY

RATE	FEE
BASIC FEE	370.00
X\$ 9=	
X42=	
+140=	
TOTAL	370

RATE	FEE
BASIC FEE	740.00
X\$18=	
X84=	
+280=	
TOTAL	

\* If the difference in column 1 is less than zero, enter "0" in column 2

**CLAIMS AS AMENDED - PART II**

	(Column 1)	(Column 2)	(Column 3)
AMENDMENT A	CLAIMS REMAINING AFTER AMENDMENT	HIGHEST NUMBER PREVIOUSLY PAID FOR	PRESENT EXTRA
	Total *	Minus **	=
	Independent *	Minus ***	=
FIRST PRESENTATION OF MULTIPLE DEPENDENT CLAIM <input type="checkbox"/>			

SMALL ENTITY

OR OTHER THAN SMALL ENTITY

RATE	ADDITIONAL FEE
X\$ 9=	
X42=	
+140=	
TOTAL ADDIT. FEE	

RATE	ADDITIONAL FEE
X\$18=	
X84=	
+280=	
TOTAL ADDIT. FEE	

	(Column 1)	(Column 2)	(Column 3)
AMENDMENT B	CLAIMS REMAINING AFTER AMENDMENT	HIGHEST NUMBER PREVIOUSLY PAID FOR	PRESENT EXTRA
	Total *	Minus **	=
	Independent *	Minus ***	=
FIRST PRESENTATION OF MULTIPLE DEPENDENT CLAIM <input type="checkbox"/>			

RATE	ADDITIONAL FEE
X\$ 9=	
X42=	
+140=	
TOTAL ADDIT. FEE	

RATE	ADDITIONAL FEE
X\$18=	
X84=	
+280=	
TOTAL ADDIT. FEE	

	(Column 1)	(Column 2)	(Column 3)
AMENDMENT C	CLAIMS REMAINING AFTER AMENDMENT	HIGHEST NUMBER PREVIOUSLY PAID FOR	PRESENT EXTRA
	Total *	Minus **	=
	Independent *	Minus ***	=
FIRST PRESENTATION OF MULTIPLE DEPENDENT CLAIM <input type="checkbox"/>			

RATE	ADDITIONAL FEE
X\$ 9=	
X42=	
+140=	
TOTAL ADDIT. FEE	

RATE	ADDITIONAL FEE
X\$18=	
X84=	
+280=	
TOTAL ADDIT. FEE	

\* If the entry in column 1 is less than the entry in column 2, write "0" in column 3.

\*\* If the "Highest Number Previously Paid For" IN THIS SPACE is less than 20, enter "20."

\*\*\*If the "Highest Number Previously Paid For" IN THIS SPACE is less than 3, enter "3."

The "Highest Number Previously Paid For" (Total or Independent) is the highest number found in the appropriate box in column 1.

Best Available Copy

**PATENT APPLICATION FEE DETERMINATION RECORD**

Effective October 1, 2000

Application or Docket Number

**CLAIMS AS FILED - PART I**

(Column 1) (Column 2)

TOTAL CLAIMS		
FOR	NUMBER FILED	NUMBER EXTRA
TOTAL CHARGEABLE CLAIMS	minus 20=	*
INDEPENDENT CLAIMS	minus 3=	*
MULTIPLE DEPENDENT CLAIM PRESENT <input type="checkbox"/>		

**SMALL ENTITY TYPE**  OR

**OTHER THAN SMALL ENTITY**

RATE	FEE
BASIC FEE	355.00
X\$ 9=	
X40=	
+135=	
TOTAL	

RATE	FEE
BASIC FEE	710.00
X\$18=	
X80=	
+270=	
TOTAL	

\* If the difference in column 1 is less than zero, enter "0" in column 2

**CLAIMS AS AMENDED - PART II**

(Column 1) (Column 2) (Column 3)

AMENDMENT A	CLAIMS REMAINING AFTER AMENDMENT		HIGHEST NUMBER PREVIOUSLY PAID FOR	PRESENT EXTRA
	Total	* 89	Minus ** 87	= 2
	Independent	* 11	Minus *** 10	= 1
	FIRST PRESENTATION OF MULTIPLE DEPENDENT CLAIM <input type="checkbox"/>			

**SMALL ENTITY** OR

**OTHER THAN SMALL ENTITY**

RATE	ADDITIONAL FEE
X\$ 9=	18
X40=	43
+135=	0
TOTAL ADDIT. FEE	61

RATE	ADDITIONAL FEE
X\$18=	
X80=	
+270=	
TOTAL ADDIT. FEE	

(Column 1) (Column 2) (Column 3)

AMENDMENT B	CLAIMS REMAINING AFTER AMENDMENT		HIGHEST NUMBER PREVIOUSLY PAID FOR	PRESENT EXTRA
	Total	*	Minus **	=
	Independent	*	Minus ***	=
	FIRST PRESENTATION OF MULTIPLE DEPENDENT CLAIM <input type="checkbox"/>			

RATE	ADDITIONAL FEE
X\$ 9=	
X40=	
+135=	
TOTAL ADDIT. FEE	

RATE	ADDITIONAL FEE
X\$18=	
X80=	
+270=	
TOTAL ADDIT. FEE	

(Column 1) (Column 2) (Column 3)

AMENDMENT C	CLAIMS REMAINING AFTER AMENDMENT		HIGHEST NUMBER PREVIOUSLY PAID FOR	PRESENT EXTRA
	Total	* 89	Minus ** 87	= 2
	Independent	* 11	Minus *** 10	= 1
	FIRST PRESENTATION OF MULTIPLE DEPENDENT CLAIM <input type="checkbox"/>			

RATE	ADDITIONAL FEE
X\$ 9=	18
X40=	43
+135=	0
TOTAL ADDIT. FEE	61

RATE	ADDITIONAL FEE
X\$18=	
X80=	
+270=	
TOTAL ADDIT. FEE	

\* If the entry in column 1 is less than the entry in column 2, write "0" in column 3.  
 \*\* If the "Highest Number Previously Paid For" IN THIS SPACE is less than 20, enter "20."  
 \*\*\* If the "Highest Number Previously Paid For" IN THIS SPACE is less than 3, enter "3."  
 The "Highest Number Previously Paid For" (Total or Independent) is the highest number found in the appropriate box in column 1.

Best Available Copy

**MULTIPLE DEPENDENT CLAIM  
FEE CALCULATION SHEET  
(FOR USE WITH FORM PTO-875)**

SERIAL NO. 10/203209 FILING DATE

APPLICANT(S)

**CLAIMS**

	AS FILED		AFTER 1st AMENDMENT		AFTER 2nd AMENDMENT			*		*		*	
	IND.	DEP.	IND.	DEP.	IND.	DEP.		IND.	DEP.	IND.	DEP.	IND.	DEP.
1	1						51						
2							52						
3							53						
4							54						
5							55						
6							56						
7							57						
8							58						
9							59						
10							60						
11							61						
12	1						62						
13							63						
14							64						
15							65						
16							66						
17							67						
18							68						
19							69						
20							70						
21							71						
22							72						
23							73						
24							74						
25							75						
26							76						
27							77						
28							78						
29							79						
30							80						
31							81						
32							82						
33							83						
34							84						
35							85						
36							86						
37							87						
38							88						
39							89						
40							90						
41							91						
42							92						
43							93						
44							94						
45							95						
46							96						
47							97						
48							98						
49							99						
50							100						
TOTAL IND.	3						TOTAL IND.						
TOTAL DEP.	12						TOTAL DEP.						
TOTAL CLAIMS	15						TOTAL CLAIMS						

PTO-1360 (3-78)

\*MAY BE USED FOR ADDITIONAL CLAIMS OR AMENDMENTS

U.S. DEPARTMENT OF COMMERCE  
Patent and Trademark Office

*Handwritten signature*

PATENTS  
MES/001 Con

IN THE UNITED STATES PATENT AND TRADEMARK OFFICE

PATENT APPLICATION

Applicant : Michael E. Shanahan

Serial No. : not yet assigned

Filed: : August 16, 2002

For : METHODS AND APPARATUSES FOR PROGRAMMING  
USER-DEFINED INFORMATION INTO  
ELECTRONIC DEVICES

Group Art Unit : not yet assigned

11017 U.S. PTO  
10/223200  
08/16/02



Hon. Assistant Commissioner  
for Patents  
Washington, D.C. 20231

INFORMATION DISCLOSURE STATEMENT

Sir:

Pursuant to 37 C.F.R. §§ 1.56 and 1.97,  
applicants hereby make the documents listed below of record  
in the above-identified application.

Britz	5,414,444	May 9, 1995
McMahan et al.	5,461,666	October 24, 1995
Olsen et al.	5,479,510	December 26, 1995
MacAllister et al.	5,481,599	January 2, 1996
Brandman et al.	5,483,580	January 9, 1996
Hird et al.	5,483,581	January 9, 1996
Moss et al.	5,485,370	January 16, 1996
Zdybel, Jr. et al.	5,486,686	January 23, 1996
Shapiro et al.	5,487,671	January 30, 1996
Sasso	5,490,210	February 6, 1996
Clark et al.	5,490,251	February 6, 1996
Hunt et al.	5,499,288	March 12, 1996
Pilc et al.	5,510,777	April 23, 1996
Bogosian, Jr.	5,513,272	April 30, 1996
Wolf	5,517,605	May 14, 1996
Hallsten	5,526,620	June 18, 1996
Meske, Jr. et al.	5,530,852	June 25, 1996

EV133107427US

Hollenbach et al.	5,533,115	July 2, 1996
Shockley et al.	5,534,855	July 9, 1996
Amram et al.	5,537,586	July 16, 1996
Carlson et al.	5,542,046	July 30, 1996
Smithies et al.	5,544,255	August 6, 1996
Cheng et al.	5,544,322	August 6, 1996
Pettus	5,548,726	August 20, 1996
Henderson et al.	5,550,976	August 27, 1996
Harada et al.	5,551,021	August 27, 1996
Shirai	5,572,571	November 6, 1996
Greenberg	5,598,461	January 28, 1997
Newland	5,606,597	February 25, 1997
Gordon	5,608,786	March 4, 1997
DeLuca et al.	5,612,682	March 18, 1997
Hoffman et al.	5,613,012	March 18, 1997
Nilssen	5,623,531	April 22, 1997
Nilssen	5,661,802	August 26, 1997
Cohrs et al.	5,687,227	November 11, 1997
Averbuch et al.	5,689,825	November 18, 1997
Bentley et al.	5,727,047	March 10, 1998
Rondeau et al.	5,796,728	August 18, 1998
Shirai	5,828,956	October 27, 1998
Kenagy et al.	5,842,124	November 24, 1998
Wise et al.	5,884,262	March 16, 1999
Uppaluru	5,915,001	June 22, 1999
Piosenka et al.	5,926,756	July 20, 1999
Cairns	5,930,703	July 27, 1999
Henrick	5,940,752	August 17, 1999
Kim	5,940,775	August 17, 1999
Flood et al.	5,953,638	September 14, 1999
Nilssen	5,999,094	December 7, 1999
Shaffer et al.	5,999,599	December 7, 1999
Sremac	6,002,761	December 14, 1999
Valentine et al.	6,018,654	January 25, 2000
Shirai	6,018,656	January 25, 2000
Kaufman	6,035,018	March 7, 2000
Ali-Vehmas et al.	6,035,189	March 7, 2000
Anderson et al.	6,058,161	May 2, 2000
Nilssen	6,073,003	June 6, 2000
Kato et al.	6,088,730	July 11, 2000
Armanto et al.	6,094,587	July 25, 2000
Parluski et al.	6,122,526	September 19, 2000
Lee et al.	6,137,525	October 24, 2000
Anderson et al.	6,144,722	November 7, 2000
Rosen	6,167,130	December 26, 2000
Nilssen	6,167,278	December 26, 2000
Plain et al.	6,179,682	January 30, 2001
Iggulden et al.	6,256,378	July 3, 2001
Lin et al.	6,366,791	April 2, 2002



Foreign Patents

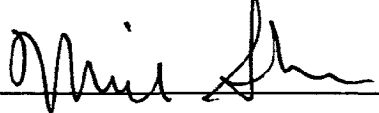
Armanto et al.	EP 0 851 649 A2	December 16, 1997
Divon et al.	WO 9928897	December 4, 1997
Kim	WO 0038340	December 22, 1998
Rydbeck et al.	WO 9943136	February 18, 1998
Hideo	JP 09205471	August 5, 1997

Because this is a continuation application, copies of these documents are not enclosed herewith. It is respectfully requested that these documents be: (1) fully considered by the Patent and Trademark Office during the examination of this application; and (2) printed on any patent which may issue on this application. Applicant requests that a copy of Form PTO-1449 (submitted in duplicate herewith), as considered and initialed by the Examiner, be returned with the next communication.

Applicant believes that no fee is due at this time. A duplicate copy of this Information Disclosure Statement is enclosed herewith.

An early and favorable action is respectfully requested.

Respectfully submitted,



---

Michael E. Shanahan  
Applicant  
P.O. Box 381  
Nyack, N.Y., 10960

FORM PTO-1449 U.S. DEPARTMENT OF COMMERCE  
PATENT AND TRADEMARK OFFICE

ATTY. DOCKET NO.  
MES/001CON

SERIAL NO.  
09/518,712

INFORMATION DISCLOSURE  
STATEMENT BY APPLICANT

APPLICANT  
Michael E. Shanahan

FILING DATE  
March 3, 2000

GROUP  
2683

1017 U.S. PTO  
10/223200



U.S. PATENT DOCUMENTS

EXAMINER INITIAL	DOCUMENT NUMBER	DATE	NAME	CLASS	SUBCLASS	FILING DATE IF APPROPRIATE
	5,414,444	05/09/95	Britz	345	156	
	5,461,666	10/24/95	McMahan et al.	379	67	
	5,479,510	12/26/95	Olsen et al.	380	24	
	5,481,599	01/02/96	MacAllister et al.	379	101	
	5,483,580	01/09/96	Brandman et al.	379	88	
	5,483,581	01/09/96	Hird et al.	379	132	
	5,485,370	01/16/96	Moss et al.	364	408	
	5,486,686	01/23/96	Zdybel, Jr. et al.	235	375	
	5,487,671	01/30/96	Shapiro et al.	434	185	
	5,490,210	02/06/96	Sasso	379	100	
	5,490,251	02/06/96	Clark et al.	395	200.2	
	5,499,288	03/12/96	Hunt et al.	379	88	
	5,510,777	04/23/96	Pilc et al.	340	825.310	
	5,513,272	04/30/96	Bogosian, Jr.	382	116	
	5,517,605	05/14/96	Wolf	395	155	
	5,526,620	06/18/96	Hallsten	52	246	
	5,530,852	06/25/96	Meske, Jr. et al.	395	600	
	5,533,115	07/02/96	Hollenbach et al.	379	220	
	5,534,855	07/09/96	Shockley et al.	340	825.300	
	5,537,586	07/16/96	Amram et al.	395	600	
	5,542,046	07/30/96	Carlson et al.	395	186	
	5,544,255	08/06/96	Smithies et al.	382	119	
	5,544,322	08/06/96	Cheng et al.	395	200.12	
	5,548,726	08/20/96	Pettus	395	200.09	
	5,550,976	08/27/96	Henderson et al.	395	200.06	
	5,551,021	08/27/96	Harada et al.	395	600	
	5,572,571	11/06/96	Shirai	379	58	
	5,598,461	01/28/97	Greenberg	379	67	
	5,606,597	02/25/97	Newland	379	61	

EXAMINER

DATE CONSIDERED

EXAMINER: Initial if citation considered, whether or not citation is in conformance with MPEP 609; Draw line through citation if not conformance and not considered. Include copy of this form with next communication to applicant.

EV133107427US

FORM PTO-1449

U.S. DEPARTMENT OF COMMERCE  
PATENT AND TRADEMARK OFFICEATTY. DOCKET NO.  
MES/001CONSERIAL NO.  
09/518,712INFORMATION DISCLOSURE  
STATEMENT BY APPLICANTAPPLICANT  
Michael E. ShanahanFILING DATE  
March 3, 2000GROUP  
2683

	5,608,786	03/04/97	Gordon	379	100	
	5,612,682	03/18/97	DeLuca et al.	340	825.34	
	5,613,012	03/18/97	Hoffman et al	382	115	
	5,623,531	04/22/97	Nilssen	379	56	
	5,661,802	08/26/97	Nilssen	380	20	
	5,687,227	11/11/97	Cohrs et al.	379	374	
	5,689,825	11/18/97	Averbuch et al.	455	89	
	5,727,047	03/10/98	Bentley et al.	379	93	
	5,796,728	08/18/98	Rondeau et al.	370	338	
	5,828,956	10/27/98	Shirai	455	411	
	5,842,124	11/24/98	Kenagy et al.	455	418	
	5,884,262	03/16/99	Wise et al.	704	270	
	5,915,001	06/22/99	Uppaluru	379	88.22	
	5,926,756	07/20/99	Piosenka et al.	455	418	
	5,930,703	07/27/99	Cairns	455	418	
	5,940,752	08/17/99	Henrick	455	419	
	5,940,775	08/17/99	Kim	455	567	
	5,953,638	09/14/99	Flood et al.	455	31.2	
	5,999,094	12/07/99	Nilssen	340	507	
	5,999,599	12/07/99	Schaffer et al.	379	93.23	
	6,002,761	12/14/99	Sremac	379	374	
	6,018,654	01/25/00	Valentine et al.	455	414	
	6,018,656	01/25/00	Shirai	455	422	
	6,035,018	03/07/00	Kaufman	379	88.17	
	6,035,189	03/07/00	Ali-Vehmas et al.	455	414	
	6,058,161	05/02/00	Anderson et al.	379	27	
	6,073,003	06/06/00	Nilsenn	455	402	
	6,088,730	07/11/00	Kato et al.	709	227	
	6,094,587	07/25/00	Armanto et al.	455	567	
	6,122,526	09/19/00	Parluski et al.	455	556	
	6,137,525	10/24/00	Lee et al.	348	14	
	6,144,722	11/07/00	Anderson et al.	379	27	
	6,167,130	12/26/00	Rosen	379	355	

EXAMINER

DATE CONSIDERED

EXAMINER: Initial if citation considered, whether or not citation is in conformance with MPEP 609; Draw line through citation if not conformance and not considered. Include copy of this form with next communication to applicant.

FORM PTO-1449 U.S. DEPARTMENT OF COMMERCE PATENT AND TRADEMARK OFFICE  INFORMATION DISCLOSURE STATEMENT BY APPLICANT	ATTY. DOCKET NO. MES/001CON	SERIAL NO. 09/518,712
	APPLICANT Michael E. Shanahan	
	FILING DATE March 3, 2000	GROUP 2683

	6,167,278	12/26/00	Nilssen	455	462	
	6,179,682	01/30/01	Plain et al.	446	141	
	6,256,378	07/03/01	Iggulden et al.	379	102.03	
	6,366,791	04/02/02	Lin et al.	455	567	

FOREIGN PATENT DOCUMENTS

EXAMINER INITIAL	DOCUMENT NUMBER	DATE	COUNTRY	CLASS	SUBCLASS	TRANSLATION
	EP 0 851 649 A2	12/16/97	Europe			
	WO 9928897	12/04/97				
	WO 0038340	12/22/98				
	WO 9943136	02/18/98				
	JP 09205471	08/05/97	Japan			

EXAMINER

DATE CONSIDERED

EXAMINER: Initial if citation considered, whether or not citation is in conformance with MPEP 609; Draw line through citation if not conformance and not considered. Include copy of this form with next communication to applicant.