

INTERNATIONAL  
STANDARD

**ISO/IEC**  
**11172-3**

First edition  
1993-08-01

---

---

**Information technology — Coding of  
moving pictures and associated audio for  
digital storage media at up to about  
1,5 Mbit/s —**

**Part 3:**  
Audio

*Technologies de l'information — Codage de l'image animée et du son  
associé pour les supports de stockage numérique jusqu'à environ  
1,5 Mbit/s —*

*Partie 3: Audio*



Licensed to JOHN SCHAUZ  
ISO Store order #: 669832/Downloaded: 2005-05-17  
Single user licence only, copying and networking prohibited

Reference number  
ISO/IEC 11172-3:1993(E)

<b>Contents</b>	<b>Page</b>
Introduction.....	v
Section 1: General.....	1
1.1 Scope.....	1
1.2 Normative references.....	1
Section 2: Technical elements.....	2
2.1 Definitions.....	2
2.2 Symbols and abbreviations.....	10
2.3 Method of describing bitstream syntax.....	12
2.4 Requirements.....	14
<b>Annexes</b>	
A Diagrams.....	38
B Tables.....	45
C The encoding process.....	66
D Psychoacoustic models.....	109
E Bit sensitivity to errors.....	140

© ISO/IEC 1993

All rights reserved. No part of this publication may be reproduced or utilized in any form or by any means, electronic or mechanical, including photocopying and microfilm, without permission in writing from the publisher.

ISO/IEC Copyright Office • Case Postale 56 • CH1211 Genève 20 • Switzerland

Printed in Switzerland.

F Error concealment.....142

G Joint stereo coding.....143

H List of patent holders.....147

## Foreword

ISO (the International Organization for Standardization) and IEC (the International Electrotechnical Commission) form the specialized system for worldwide standardization. National bodies that are members of ISO or IEC participate in the development of International Standards through technical committees established by the respective organization to deal with particular fields of technical activity. ISO and IEC technical committees collaborate in fields of mutual interest. Other international organizations, governmental and non-governmental, in liaison with ISO and IEC, also take part in the work.

In the field of information technology, ISO and IEC have established a joint technical committee, ISO/IEC JTC 1. Draft International Standards adopted by the joint technical committee are circulated to national bodies for voting. Publication as an International Standard requires approval by at least 75 % of the national bodies casting a vote.

International Standard ISO/IEC 11172-3 was prepared by Joint Technical Committee ISO/IEC JTC 1, *Information technology, Sub-Committee SC 29, Coded representation of audio, picture, multimedia and hypermedia information*.

ISO/IEC 11172 consists of the following parts, under the general title *Information technology — Coding of moving pictures and associated audio for digital storage media at up to about 1,5 Mbit/s*:

- Part 1: *Systems*
- Part 2: *Video*
- Part 3: *Audio*
- Part 4: *Compliance testing*

Annexes A and B form an integral part of this part of ISO/IEC 11172. Annexes C, D, E, F, G and H are for information only.

## Introduction

Note: Readers interested in an overview of MPEG Audio should read this Introduction and then proceed to annex A (Diagrams) and annex C (The encoding process) before reading the normative clauses 1 and 2.

To aid in the understanding of the specification of the stored compressed bitstream and its decoding, a sequence of encoding, storage and decoding is described.

### 0.1 Encoding

The encoder processes the digital audio signal and produces the compressed bitstream for storage. The encoder algorithm is not standardized, and may use various means for encoding such as estimation of the auditory masking threshold, quantization, and scaling. However, the encoder output must be such that a decoder conforming to the specifications of clause 2.4 will produce audio suitable for the intended application.

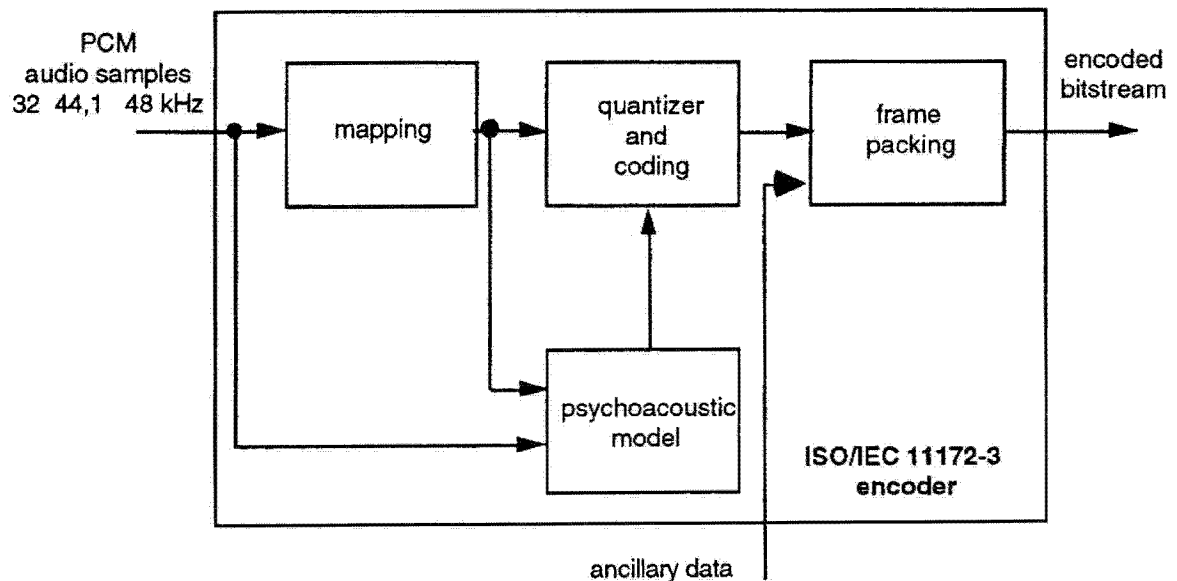

Figure 1 -- Sketch of the basic structure of an encoder

Figure 1 illustrates the basic structure of a audio encoder. Input audio samples are fed into the encoder. The mapping creates a filtered and subsampled representation of the input audio stream. The mapped samples may be called either subband samples (as in Layer I or II, see below) or transformed subband samples (as in Layer III). A psychoacoustic model creates a set of data to control the quantizer and coding. These data are different depending on the actual coder implementation. One possibility is to use an estimation of the masking threshold to do this quantizer control. The quantizer and coding block creates a set of coding symbols from the mapped input samples. Again, this block can depend on the encoding system. The block 'frame packing' assembles the actual bitstream from the output data of the other blocks, and adds other information (e.g. error correction) if necessary.

There are four different modes possible, single channel, dual channel (two independent audio signals coded within one bitstream), stereo (left and right signals of a stereo pair coded within one bitstream), and Joint Stereo (left and right signals of a stereo pair coded within one bitstream with the stereo irrelevancy and redundancy exploited).

## 0.2 Layers

Depending on the application, different layers of the coding system with increasing encoder complexity and performance can be used. An ISO/IEC 11172-3 Audio Layer N decoder is able to decode bitstream data which has been encoded in Layer N and all layers below N.

### Layer I

This layer contains the basic mapping of the digital audio input into 32 subbands, fixed segmentation to format the data into blocks, a psychoacoustic model to determine the adaptive bit allocation, and quantization using block companding and formatting. The theoretical minimum encoding/decoding delay for Layer I is about 19 ms.

### Layer II

This layer provides additional coding of bit allocation, scalefactors and samples. Different framing is used. The theoretical minimum encoding/decoding delay for Layer II is about 35 ms.

### Layer III

This layer introduces increased frequency resolution based on a hybrid filterbank. It adds a different (nonuniform) quantizer, adaptive segmentation and entropy coding of the quantized values. The theoretical minimum encoding/decoding delay for Layer III is about 59 ms.

Joint Stereo coding can be added as an additional feature to any of the layers.

## 0.3 Storage

Various streams of encoded video, encoded audio, synchronization data, systems data and auxiliary data may be stored together on a storage medium. Editing of the audio will be easier if the edit point is constrained to coincide with an addressable point.

Access to storage may involve remote access over a communication system. Access is assumed to be controlled by a functional unit other than the audio decoder itself. This control unit accepts user commands, reads and interprets data base structure information, reads the stored information from the media, demultiplexes non-audio information and passes the stored audio bitstream to the audio decoder at the required rate.

## 0.4 Decoding

The decoder accepts the compressed audio bitstream in the syntax defined in 2.4.1, decodes the data elements according to 2.4.2, and uses the information to produce digital audio output according to 2.4.3.

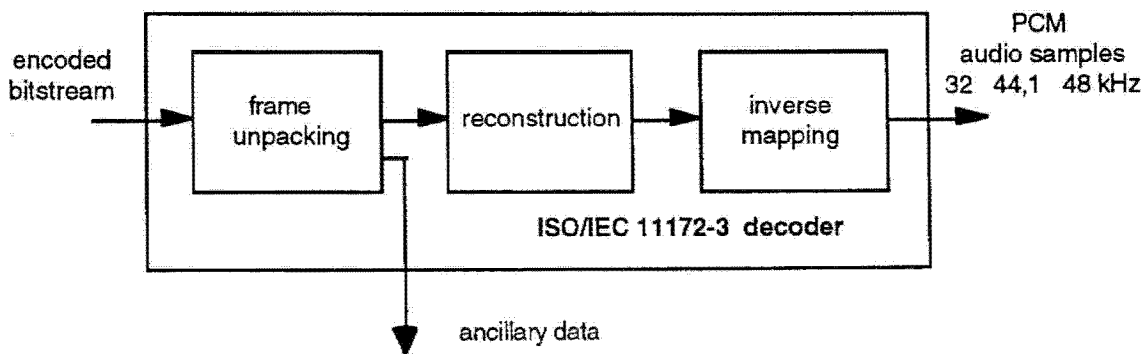

Figure 2 -- Sketch of the basic structure of a decoder

Figure 2 illustrates the basic structure of an audio decoder. Bitstream data is fed into the decoder. The bitstream unpacking and decoding block does error detection if error-check is applied in the encoder (see 2.4.2.4). The bitstream data are unpacked to recover the various pieces of information. The reconstruction block reconstructs the quantized version of the set of mapped samples. The inverse mapping transforms these mapped samples back into uniform PCM.

# Information technology — Coding of moving pictures and associated audio for digital storage media at up to about 1,5 Mbit/s —

## Part 3: Audio

### Section 1: General

#### 1.1 Scope

This part of ISO/IEC 11172 specifies the coded representation of high quality audio for storage media and the method for decoding of high quality audio signals. The input of the encoder and the output of the decoder are compatible with existing PCM standards such as standard Compact Disc and Digital Audio Tape.

This part of the ISO/IEC 11172 is intended for application to digital storage media providing a total continuous transfer rate of about 1,5 Mbits/sec for both audio and video bitstreams, such as CD, DAT and magnetic hard disc. The storage media may either be connected directly to the decoder, or via other means such as communication lines and the ISO/IEC 11172 multiplexed stream defined in ISO/IEC 11172-1. This part of ISO/IEC 11172 is intended for sampling rates of 32 kHz, 44,1 kHz, and 48 kHz.

#### 1.2 Normative references

The following International Standards contain provisions which, through reference in this text, constitute provisions of this part of ISO/IEC 11172. At the time of publication, the editions indicated were valid. All standards are subject to revision, and parties to agreements based on this part of ISO/IEC 11172 are encouraged to investigate the possibility of applying the most recent editions of the standards indicated below. Members of IEC and ISO maintain registers of currently valid International Standards.

ISO/IEC 11172-1:1993 *Information technology - Coding of moving pictures and associated audio for digital storage media at up to about 1,5 Mbit/s - Part 1 Systems.*

ISO/IEC 11172-2:1993 *Information technology - Coding of moving pictures and associated audio for digital storage media at up to about 1,5 Mbit/s - Part 2: Video.*

CCIR Recommendation 601-2 *Encoding parameters of digital television for studios.*

CCIR Report 624-4 *Characteristics of systems for monochrome and colour television.*

CCIR Recommendation 648 *Recording of audio signals.*

CCIR Report 955-2 *Sound broadcasting by satellite for portable and mobile receivers, including Annex IV Summary description of Advanced Digital System II.*

CCITT Recommendation J.17 *Pre-emphasis used on Sound-Programme Circuits.*

IEEE Draft Standard P1180/D2 1990 *Specification for the implementation of 8x 8 inverse discrete cosine transform".*

IEC publication 908:1987 *CD Digital Audio System.*

## Section 2: Technical elements

### 2.1 Definitions

For the purposes of ISO/IEC 11172, the following definitions apply. If specific to a part, this is noted in square brackets.

**2.1.1 ac coefficient [video]:** Any DCT coefficient for which the frequency in one or both dimensions is non-zero.

**2.1.2 access unit [system]:** In the case of compressed audio an access unit is an audio access unit. In the case of compressed video an access unit is the coded representation of a picture.

**2.1.3 adaptive segmentation [audio]:** A subdivision of the digital representation of an audio signal in variable segments of time.

**2.1.4 adaptive bit allocation [audio]:** The assignment of bits to subbands in a time and frequency varying fashion according to a psychoacoustic model.

**2.1.5 adaptive noise allocation [audio]:** The assignment of coding noise to frequency bands in a time and frequency varying fashion according to a psychoacoustic model.

**2.1.6 alias [audio]:** Mirrored signal component resulting from sub-Nyquist sampling.

**2.1.7 analysis filterbank [audio]:** Filterbank in the encoder that transforms a broadband PCM audio signal into a set of subsampled subband samples.

**2.1.8 audio access unit [audio]:** For Layers I and II an audio access unit is defined as the smallest part of the encoded bitstream which can be decoded by itself, where decoded means "fully reconstructed sound". For Layer III an audio access unit is part of the bitstream that is decodable with the use of previously acquired main information.

**2.1.9 audio buffer [audio]:** A buffer in the system target decoder for storage of compressed audio data.

**2.1.10 audio sequence [audio]:** A non-interrupted series of audio frames in which the following parameters are not changed:

- ID
- Layer
- Sampling Frequency
- For Layer I and II: Bitrate index

**2.1.11 backward motion vector [video]:** A motion vector that is used for motion compensation from a reference picture at a later time in display order.

**2.1.12 Bark [audio]:** Unit of critical band rate. The Bark scale is a non-linear mapping of the frequency scale over the audio range closely corresponding with the frequency selectivity of the human ear across the band.

**2.1.13 bidirectionally predictive-coded picture; B-picture [video]:** A picture that is coded using motion compensated prediction from a past and/or future reference picture.

**2.1.14 bitrate:** The rate at which the compressed bitstream is delivered from the storage medium to the input of a decoder.

**2.1.15 block companding [audio]:** Normalizing of the digital representation of an audio signal within a certain time period.

**2.1.16 block [video]:** An 8-row by 8-column orthogonal block of pels.

**2.1.17 bound [audio]:** The lowest subband in which intensity stereo coding is used.



- 2.1.18 byte aligned:** A bit in a coded bitstream is byte-aligned if its position is a multiple of 8-bits from the first bit in the stream.
- 2.1.19 byte:** Sequence of 8-bits.
- 2.1.20 channel:** A digital medium that stores or transports an ISO/IEC 11172 stream.
- 2.1.21 channel [audio]:** The left and right channels of a stereo signal
- 2.1.22 chrominance (component) [video]:** A matrix, block or single pel representing one of the two colour difference signals related to the primary colours in the manner defined in CCIR Rec 601. The symbols used for the colour difference signals are Cr and Cb.
- 2.1.23 coded audio bitstream [audio]:** A coded representation of an audio signal as specified in this part of ISO/IEC 11172.
- 2.1.24 coded video bitstream [video]:** A coded representation of a series of one or more pictures as specified in ISO/IEC 11172-2.
- 2.1.25 coded order [video]:** The order in which the pictures are stored and decoded. This order is not necessarily the same as the display order.
- 2.1.26 coded representation:** A data element as represented in its encoded form.
- 2.1.27 coding parameters [video]:** The set of user-definable parameters that characterize a coded video bitstream. Bitstreams are characterised by coding parameters. Decoders are characterised by the bitstreams that they are capable of decoding.
- 2.1.28 component [video]:** A matrix, block or single pel from one of the three matrices (luminance and two chrominance) that make up a picture.
- 2.1.29 compression:** Reduction in the number of bits used to represent an item of data.
- 2.1.30 constant bitrate coded video [video]:** A compressed video bitstream with a constant average bitrate.
- 2.1.31 constant bitrate:** Operation where the bitrate is constant from start to finish of the compressed bitstream.
- 2.1.32 constrained parameters [video]:** The values of the set of coding parameters defined in 2.4.3.2 of ISO/IEC 11172-2.
- 2.1.33 constrained system parameter stream (CSPS) [system]:** An ISO/IEC 11172 multiplexed stream for which the constraints defined in 2.4.6 of ISO/IEC 11172-1 apply.
- 2.1.34 CRC:** Cyclic redundancy code.
- 2.1.35 critical band rate [audio]:** Psychoacoustic function of frequency. At a given audible frequency it is proportional to the number of critical bands below that frequency. The units of the critical band rate scale are Barks.
- 2.1.36 critical band [audio]:** Psychoacoustic measure in the spectral domain which corresponds to the frequency selectivity of the human ear. This selectivity is expressed in Bark.
- 2.1.37 data element:** An item of data as represented before encoding and after decoding.
- 2.1.38 dc-coefficient [video]:** The DCT coefficient for which the frequency is zero in both dimensions.

- 2.1.39 dc-coded picture; D-picture [video]:** A picture that is coded using only information from itself. Of the DCT coefficients in the coded representation, only the dc-coefficients are present.
- 2.1.40 DCT coefficient:** The amplitude of a specific cosine basis function.
- 2.1.41 decoded stream:** The decoded reconstruction of a compressed bitstream.
- 2.1.42 decoder input buffer [video]:** The first-in first-out (FIFO) buffer specified in the video buffering verifier.
- 2.1.43 decoder input rate [video]:** The data rate specified in the video buffering verifier and encoded in the coded video bitstream.
- 2.1.44 decoder:** An embodiment of a decoding process.
- 2.1.45 decoding (process):** The process defined in ISO/IEC 11172 that reads an input coded bitstream and produces decoded pictures or audio samples.
- 2.1.46 decoding time-stamp; DTS [system]:** A field that may be present in a packet header that indicates the time that an access unit is decoded in the system target decoder.
- 2.1.47 de-emphasis [audio]:** Filtering applied to an audio signal after storage or transmission to undo a linear distortion due to emphasis.
- 2.1.48 dequantization [video]:** The process of rescaling the quantized DCT coefficients after their representation in the bitstream has been decoded and before they are presented to the inverse DCT.
- 2.1.49 digital storage media; DSM:** A digital storage or transmission device or system.
- 2.1.50 discrete cosine transform; DCT [video]:** Either the forward discrete cosine transform or the inverse discrete cosine transform. The DCT is an invertible, discrete orthogonal transformation. The inverse DCT is defined in annex A of ISO/IEC 11172-2.
- 2.1.51 display order [video]:** The order in which the decoded pictures should be displayed. Normally this is the same order in which they were presented at the input of the encoder.
- 2.1.52 dual channel mode [audio]:** A mode, where two audio channels with independent programme contents (e.g. bilingual) are encoded within one bitstream. The coding process is the same as for the stereo mode.
- 2.1.53 editing:** The process by which one or more compressed bitstreams are manipulated to produce a new compressed bitstream. Conforming edited bitstreams must meet the requirements defined in this ISO/IEC 11172.
- 2.1.54 elementary stream [system]:** A generic term for one of the coded video, coded audio or other coded bitstreams.
- 2.1.55 emphasis [audio]:** Filtering applied to an audio signal before storage or transmission to improve the signal-to-noise ratio at high frequencies.
- 2.1.56 encoder:** An embodiment of an encoding process.
- 2.1.57 encoding (process):** A process, not specified in ISO/IEC 11172, that reads a stream of input pictures or audio samples and produces a valid coded bitstream as defined in ISO/IEC 11172.
- 2.1.58 entropy coding:** Variable length lossless coding of the digital representation of a signal to reduce redundancy.
- 2.1.59 fast forward playback [video]:** The process of displaying a sequence, or parts of a sequence, of pictures in display-order faster than real-time.

**2.1.60 FFT:** Fast Fourier Transformation. A fast algorithm for performing a discrete Fourier transform (an orthogonal transform).

**2.1.61 filterbank [audio]:** A set of band-pass filters covering the entire audio frequency range.

**2.1.62 fixed segmentation [audio]:** A subdivision of the digital representation of an audio signal into fixed segments of time.

**2.1.63 forbidden:** The term "forbidden" when used in the clauses defining the coded bitstream indicates that the value shall never be used. This is usually to avoid emulation of start codes.

**2.1.64 forced updating [video]:** The process by which macroblocks are intra-coded from time-to-time to ensure that mismatch errors between the inverse DCT processes in encoders and decoders cannot build up excessively.

**2.1.65 forward motion vector [video]:** A motion vector that is used for motion compensation from a reference picture at an earlier time in display order.

**2.1.66 frame [audio]:** A part of the audio signal that corresponds to audio PCM samples from an Audio Access Unit.

**2.1.67 free format [audio]:** Any bitrate other than the defined bitrates that is less than the maximum valid bitrate for each layer.

**2.1.68 future reference picture [video]:** The future reference picture is the reference picture that occurs at a later time than the current picture in display order.

**2.1.69 granules [Layer II] [audio]:** The set of 3 consecutive subband samples from all 32 subbands that are considered together before quantization. They correspond to 96 PCM samples.

**2.1.70 granules [Layer III] [audio]:** 576 frequency lines that carry their own side information.

**2.1.71 group of pictures [video]:** A series of one or more coded pictures intended to assist random access. The group of pictures is one of the layers in the coding syntax defined in ISO/IEC 11172-2.

**2.1.72 Hann window [audio]:** A time function applied sample-by-sample to a block of audio samples before Fourier transformation.

**2.1.73 Huffman coding:** A specific method for entropy coding.

**2.1.74 hybrid filterbank [audio]:** A serial combination of subband filterbank and MDCT.

**2.1.75 IMDCT [audio]:** Inverse Modified Discrete Cosine Transform.

**2.1.76 intensity stereo [audio]:** A method of exploiting stereo irrelevance or redundancy in stereophonic audio programmes based on retaining at high frequencies only the energy envelope of the right and left channels.

**2.1.77 interlace [video]:** The property of conventional television pictures where alternating lines of the picture represent different instances in time.

**2.1.78 intra coding [video]:** Coding of a macroblock or picture that uses information only from that macroblock or picture.

**2.1.79 intra-coded picture; I-picture [video]:** A picture coded using information only from itself.

**2.1.80 ISO/IEC 11172 (multiplexed) stream [system]:** A bitstream composed of zero or more elementary streams combined in the manner defined in ISO/IEC 11172-1.

- 2.1.81 joint stereo coding [audio]:** Any method that exploits stereophonic irrelevance or stereophonic redundancy.
- 2.1.82 joint stereo mode [audio]:** A mode of the audio coding algorithm using joint stereo coding.
- 2.1.83 layer [audio]:** One of the levels in the coding hierarchy of the audio system defined in this part of ISO/IEC 11172.
- 2.1.84 layer [video and systems]:** One of the levels in the data hierarchy of the video and system specifications defined in ISO/IEC 11172-1 and ISO/IEC 11172-2.
- 2.1.85 luminance (component) [video]:** A matrix, block or single pel representing a monochrome representation of the signal and related to the primary colours in the manner defined in CCIR Rec 601. The symbol used for luminance is Y.
- 2.1.86 macroblock [video]:** The four 8 by 8 blocks of luminance data and the two corresponding 8 by 8 blocks of chrominance data coming from a 16 by 16 section of the luminance component of the picture. Macroblock is sometimes used to refer to the pel data and sometimes to the coded representation of the pel values and other data elements defined in the macroblock layer of the syntax defined in ISO/IEC 11172-2. The usage is clear from the context.
- 2.1.87 mapping [audio]:** Conversion of an audio signal from time to frequency domain by subband filtering and/or by MDCT.
- 2.1.88 masking [audio]:** A property of the human auditory system by which an audio signal cannot be perceived in the presence of another audio signal.
- 2.1.89 masking threshold [audio]:** A function in frequency and time below which an audio signal cannot be perceived by the human auditory system.
- 2.1.90 MDCT [audio]:** Modified Discrete Cosine Transform.
- 2.1.91 motion compensation [video]:** The use of motion vectors to improve the efficiency of the prediction of pel values. The prediction uses motion vectors to provide offsets into the past and/or future reference pictures containing previously decoded pel values that are used to form the prediction error signal.
- 2.1.92 motion estimation [video]:** The process of estimating motion vectors during the encoding process.
- 2.1.93 motion vector [video]:** A two-dimensional vector used for motion compensation that provides an offset from the coordinate position in the current picture to the coordinates in a reference picture.
- 2.1.94 MS stereo [audio]:** A method of exploiting stereo irrelevance or redundancy in stereophonic audio programmes based on coding the sum and difference signal instead of the left and right channels.
- 2.1.95 non-intra coding [video]:** Coding of a macroblock or picture that uses information both from itself and from macroblocks and pictures occurring at other times.
- 2.1.96 non-tonal component [audio]:** A noise-like component of an audio signal.
- 2.1.97 Nyquist sampling:** Sampling at or above twice the maximum bandwidth of a signal.
- 2.1.98 pack [system]:** A pack consists of a pack header followed by one or more packets. It is a layer in the system coding syntax described in ISO/IEC 11172-1.
- 2.1.99 packet data [system]:** Contiguous bytes of data from an elementary stream present in a packet.
- 2.1.100 packet header [system]:** The data structure used to convey information about the elementary stream data contained in the packet data.

- 2.1.101 packet [system]:** A packet consists of a header followed by a number of contiguous bytes from an elementary data stream. It is a layer in the system coding syntax described in ISO/IEC 11172-1.
- 2.1.102 padding [audio]:** A method to adjust the average length in time of an audio frame to the duration of the corresponding PCM samples, by conditionally adding a slot to the audio frame.
- 2.1.103 past reference picture [video]:** The past reference picture is the reference picture that occurs at an earlier time than the current picture in display order.
- 2.1.104 pel aspect ratio [video]:** The ratio of the nominal vertical height of pel on the display to its nominal horizontal width.
- 2.1.105 pel [video]:** Picture element.
- 2.1.106 picture period [video]:** The reciprocal of the picture rate.
- 2.1.107 picture rate [video]:** The nominal rate at which pictures should be output from the decoding process.
- 2.1.108 picture [video]:** Source, coded or reconstructed image data. A source or reconstructed picture consists of three rectangular matrices of 8-bit numbers representing the luminance and two chrominance signals. The Picture layer is one of the layers in the coding syntax defined in ISO/IEC 11172-2. Note that the term "picture" is always used in ISO/IEC 11172 in preference to the terms field or frame.
- 2.1.109 polyphase filterbank [audio]:** A set of equal bandwidth filters with special phase interrelationships, allowing for an efficient implementation of the filterbank.
- 2.1.110 prediction [video]:** The use of a predictor to provide an estimate of the pel value or data element currently being decoded.
- 2.1.111 predictive-coded picture; P-picture [video]:** A picture that is coded using motion compensated prediction from the past reference picture.
- 2.1.112 prediction error [video]:** The difference between the actual value of a pel or data element and its predictor.
- 2.1.113 predictor [video]:** A linear combination of previously decoded pel values or data elements.
- 2.1.114 presentation time-stamp; PTS [system]:** A field that may be present in a packet header that indicates the time that a presentation unit is presented in the system target decoder.
- 2.1.115 presentation unit; PU [system]:** A decoded audio access unit or a decoded picture.
- 2.1.116 psychoacoustic model [audio]:** A mathematical model of the masking behaviour of the human auditory system.
- 2.1.117 quantization matrix [video]:** A set of sixty-four 8-bit values used by the dequantizer.
- 2.1.118 quantized DCT coefficients [video]:** DCT coefficients before dequantization. A variable length coded representation of quantized DCT coefficients is stored as part of the compressed video bitstream.
- 2.1.119 quantizer scalefactor [video]:** A data element represented in the bitstream and used by the decoding process to scale the dequantization.
- 2.1.120 random access:** The process of beginning to read and decode the coded bitstream at an arbitrary point.

- 2.1.121 reference picture [video]:** Reference pictures are the nearest adjacent I- or P-pictures to the current picture in display order.
- 2.1.122 reorder buffer [video]:** A buffer in the system target decoder for storage of a reconstructed I-picture or a reconstructed P-picture.
- 2.1.123 requantization [audio]:** Decoding of coded subband samples in order to recover the original quantized values.
- 2.1.124 reserved:** The term "reserved" when used in the clauses defining the coded bitstream indicates that the value may be used in the future for ISO/IEC defined extensions.
- 2.1.125 reverse playback [video]:** The process of displaying the picture sequence in the reverse of display order.
- 2.1.126 scalefactor band [audio]:** A set of frequency lines in Layer III which are scaled by one scalefactor.
- 2.1.127 scalefactor index [audio]:** A numerical code for a scalefactor.
- 2.1.128 scalefactor [audio]:** Factor by which a set of values is scaled before quantization.
- 2.1.129 sequence header [video]:** A block of data in the coded bitstream containing the coded representation of a number of data elements.
- 2.1.130 side information:** Information in the bitstream necessary for controlling the decoder.
- 2.1.131 skipped macroblock [video]:** A macroblock for which no data are stored.
- 2.1.132 slice [video]:** A series of macroblocks. It is one of the layers of the coding syntax defined in ISO/IEC 11172-2.
- 2.1.133 slot [audio]:** A slot is an elementary part in the bitstream. In Layer I a slot equals four bytes, in Layers II and III one byte.
- 2.1.134 source stream:** A single non-multiplexed stream of samples before compression coding.
- 2.1.135 spreading function [audio]:** A function that describes the frequency spread of masking.
- 2.1.136 start codes [system and video]:** 32-bit codes embedded in that coded bitstream that are unique. They are used for several purposes including identifying some of the layers in the coding syntax.
- 2.1.137 STD input buffer [system]:** A first-in first-out buffer at the input of the system target decoder for storage of compressed data from elementary streams before decoding.
- 2.1.138 stereo mode [audio]:** Mode, where two audio channels which form a stereo pair (left and right) are encoded within one bitstream. The coding process is the same as for the dual channel mode.
- 2.1.139 stuffing (bits); stuffing (bytes) :** Code-words that may be inserted into the compressed bitstream that are discarded in the decoding process. Their purpose is to increase the bitrate of the stream.
- 2.1.140 subband [audio]:** Subdivision of the audio frequency band.
- 2.1.141 subband filterbank [audio]:** A set of band filters covering the entire audio frequency range. In this part of ISO/IEC 11172 the subband filterbank is a polyphase filterbank.
- 2.1.142 subband samples [audio]:** The subband filterbank within the audio encoder creates a filtered and subsampled representation of the input audio stream. The filtered samples are called subband samples.

From 384 time-consecutive input audio samples, 12 time-consecutive subband samples are generated within each of the 32 subbands.

**2.1.143 syncword [audio]:** A 12-bit code embedded in the audio bitstream that identifies the start of a frame.

**2.1.144 synthesis filterbank [audio]:** Filterbank in the decoder that reconstructs a PCM audio signal from subband samples.

**2.1.145 system header [system]:** The system header is a data structure defined in ISO/IEC 11172-1 that carries information summarising the system characteristics of the ISO/IEC 11172 multiplexed stream.

**2.1.146 system target decoder; STD [system]:** A hypothetical reference model of a decoding process used to describe the semantics of an ISO/IEC 11172 multiplexed bitstream.

**2.1.147 time-stamp [system]:** A term that indicates the time of an event.

**2.1.148 triplet [audio]:** A set of 3 consecutive subband samples from one subband. A triplet from each of the 32 subbands forms a granule.

**2.1.149 tonal component [audio]:** A sinusoid-like component of an audio signal.

**2.1.150 variable bitrate:** Operation where the bitrate varies with time during the decoding of a compressed bitstream.

**2.1.151 variable length coding; VLC:** A reversible procedure for coding that assigns shorter code-words to frequent events and longer code-words to less frequent events.

**2.1.152 video buffering verifier; VBV [video]:** A hypothetical decoder that is conceptually connected to the output of the encoder. Its purpose is to provide a constraint on the variability of the data rate that an encoder or editing process may produce.

**2.1.153 video sequence [video]:** A series of one or more groups of pictures. It is one of the layers of the coding syntax defined in ISO/IEC 11172-2.

**2.1.154 zig-zag scanning order [video]:** A specific sequential ordering of the DCT coefficients from (approximately) the lowest spatial frequency to the highest.

## 2.2 Symbols and abbreviations

The mathematical operators used to describe this International Standard are similar to those used in the C programming language. However, integer division with truncation and rounding are specifically defined. The bitwise operators are defined assuming twos-complement representation of integers. Numbering and counting loops generally begin from zero.

### 2.2.1 Arithmetic operators

+	Addition.						
-	Subtraction (as a binary operator) or negation (as a unary operator).						
++	Increment.						
--	Decrement.						
*	Multiplication.						
^	Power.						
/	Integer division with truncation of the result toward zero. For example, $7/4$ and $-7/-4$ are truncated to 1 and $-7/4$ and $7/-4$ are truncated to -1.						
//	Integer division with rounding to the nearest integer. Half-integer values are rounded away from zero unless otherwise specified. For example $3//2$ is rounded to 2, and $-3//2$ is rounded to -2.						
DIV	Integer division with truncation of the result towards $-\infty$ .						
x	Absolute value. <table style="margin-left: 2em;"> <tr> <td><math> x  = x</math></td> <td>when <math>x &gt; 0</math></td> </tr> <tr> <td><math> x  = 0</math></td> <td>when <math>x == 0</math></td> </tr> <tr> <td><math> x  = -x</math></td> <td>when <math>x &lt; 0</math></td> </tr> </table>	$ x  = x$	when $x > 0$	$ x  = 0$	when $x == 0$	$ x  = -x$	when $x < 0$
$ x  = x$	when $x > 0$						
$ x  = 0$	when $x == 0$						
$ x  = -x$	when $x < 0$						
%	Modulus operator. Defined only for positive numbers.						
Sign( )	Sign(x) = <table style="margin-left: 2em;"> <tr> <td>1</td> <td><math>x &gt; 0</math></td> </tr> <tr> <td>0</td> <td><math>x == 0</math></td> </tr> <tr> <td>-1</td> <td><math>x &lt; 0</math></td> </tr> </table>	1	$x > 0$	0	$x == 0$	-1	$x < 0$
1	$x > 0$						
0	$x == 0$						
-1	$x < 0$						
NINT( )	Nearest integer operator. Returns the nearest integer value to the real-valued argument. Half-integer values are rounded away from zero.						
sin	Sine.						
cos	Cosine.						
exp	Exponential.						
√	Square root.						
log <sub>10</sub>	Logarithm to base ten.						
log <sub>e</sub>	Logarithm to base e.						
log <sub>2</sub>	Logarithm to base 2.						

### 2.2.2 Logical operators

	Logical OR.
&&	Logical AND.

Licensed to JOHN SCHAUB.  
 ISO Store order #: 669832/Downloaded: 2005-05-17  
 Single user license-only, copying and networking prohibited



! Logical NOT

### 2.2.3 Relational operators

> Greater than.

>= Greater than or equal to.

< Less than.

<= Less than or equal to.

= Equal to.

!= Not equal to.

max [.....] the maximum value in the argument list.

min [.....] the minimum value in the argument list.

### 2.2.4 Bitwise operators

A two's complement number representation is assumed where the bitwise operators are used.

& AND

| OR

>> Shift right with sign extension.

<< Shift left with zero fill.

### 2.2.5 Assignment

= Assignment operator.

### 2.2.6 Mnemonics

The following mnemonics are defined to describe the different data types used in the coded bit-stream.

bslbf	Bit string, left bit first, where "left" is the order in which bit strings are written in ISO/IEC 11172. Bit strings are written as a string of 1s and 0s within single quote marks, e.g. '1000 0001'. Blanks within a bit string are for ease of reading and have no significance.
ch	Channel. If ch has the value 0, the left channel of a stereo signal or the first of two independent signals is indicated. (Audio)
nch	Number of channels; equal to 1 for single_channel mode, 2 in other modes. (Audio)
gr	Granule of 3 * 32 subband samples in audio Layer II, 18 * 32 sub-band samples in audio Layer III. (Audio)
main_data	The main_data portion of the bitstream contains the scalefactors, Huffman encoded data, and ancillary information. (Audio)
main_data_beg	The location in the bitstream of the beginning of the main_data for the frame. The location is equal to the ending location of the previous frame's main_data plus one bit. It is calculated from the main_data_end value of the previous frame. (Audio)
part2_length	The number of main_data bits used for scalefactors. (Audio)

rpchof	Remainder polynomial coefficients, highest order first. (Audio)
sb	Subband. (Audio)
sblimit	The number of the lowest sub-band for which no bits are allocated. (Audio)
scfsi	Scalefactor selection information. (Audio)
switch_point_l	Number of scalefactor band (long block scalefactor band) from which point on window switching is used. (Audio)
switch_point_s	Number of scalefactor band (short block scalefactor band) from which point on window switching is used. (Audio)
uimsbf	Unsigned integer, most significant bit first.
vlclbf	Variable length code, left bit first, where "left" refers to the order in which the VLC codes are written.
window	Number of the actual time slot in case of block_type==2, $0 \leq \text{window} \leq 2$ . (Audio)

The byte order of multi-byte words is most significant byte first.

### 2.2.7 Constants

$\pi$	3,14159265358...
e	2,71828182845...

## 2.3 Method of describing bitstream syntax

The bitstream retrieved by the decoder is described in 2.4.1. Each data item in the bitstream is in bold type. It is described by its name, its length in bits, and a mnemonic for its type and order of transmission.

The action caused by a decoded data element in a bitstream depends on the value of that data element and on data elements previously decoded. The decoding of the data elements and definition of the state variables used in their decoding are described in 2.4.2. The following constructs are used to express the conditions when data elements are present, and are in normal type:

Note this syntax uses the 'C'-code convention that a variable or expression evaluating to a non-zero value is equivalent to a condition that is true.

<b>while ( condition ) {</b> <b>data_element</b> . . . }	If the condition is true, then the group of data elements occurs next in the data stream. This repeats until the condition is not true.
<b>do {</b> <b>data_element</b> . . . } while ( condition )	The data element always occurs at least once. The data element is repeated until the condition is not true.
<b>if ( condition ) {</b> <b>data_element</b> . . . }	If the condition is true, then the first group of data elements occurs next in the data stream.
<b>else {</b> <b>data_element</b> . . . }	If the condition is not true, then the second group of data elements occurs next in the data stream.

for (expr1; expr2; expr3) { expr1 is an expression specifying the initialization of the loop. Normally it specifies the initial state of the counter. expr2 is a condition specifying a test made before each iteration of the loop. The loop terminates when the condition is not true. expr3 is an expression that is performed at the end of each iteration of the loop, normally it increments a counter.  
**data\_element** . . .  
 }

Note that the most common usage of this construct is as follows:

for ( i = 0; i < n; i++) { The group of data elements occurs n times. Conditional constructs within the group of data elements may depend on the value of the loop control variable i, which is set to zero for the first occurrence, incremented to one for the second occurrence, and so forth.  
**data\_element** . . .  
 }

As noted, the group of data elements may contain nested conditional constructs. For compactness, the {} may be omitted when only one data element follows.

**data\_element []** data\_element [] is an array of data. The number of data elements is indicated by the context.

**data\_element [n]** data\_element [n] is the n+1th element of an array of data.

**data\_element [m][n]** data\_element [m][n] is the m+1,n+1 th element of a two-dimensional array of data.

**data\_element [l][m][n]** data\_element [l][m][n] is the l+1,m+1,n+1 th element of a three-dimensional array of data.

**data\_element [m..n]** is the inclusive range of bits between bit m and bit n in the data\_element.

While the syntax is expressed in procedural terms, it should not be assumed that 2.4.3 implements a satisfactory decoding procedure. In particular, it defines a correct and error-free input bitstream. Actual decoders must include a means to look for start codes in order to begin decoding correctly.

**Definition of bytealigned function**

The function bytealigned () returns 1 if the current position is on a byte boundary, that is the next bit in the bitstream is the first bit in a byte. Otherwise it returns 0.

**Definition of nextbits function**

The function nextbits () permits comparison of a bit string with the next bits to be decoded in the bitstream.

**Definition of next\_start\_code function**

The next\_start\_code function removes any zero bit and zero byte stuffing and locates the next start code.

Syntax	No. of bits	Mnemonic
next_start_code() { while ( !bytealigned() ) <b>zero_bit</b> while ( nextbits() != '0000 0000 0000 0000 0000 0001' ) <b>zero_byte</b> }	1    8	'0'    '00000000'

This function checks whether the current position is bytealigned. If it is not, zero stuffing bits are present. After that any number of zero bytes may be present before the start-code. Therefore start-codes are always bytealigned and may be preceded by any number of zero stuffing bits.

## 2.4 Requirements

### 2.4.1 Specification of the coded audio bitstream syntax

#### 2.4.1.1 Audio sequence

Syntax	No. of bits	Mnemonic
<pre>audio sequence() {     while (nextbits()==syncword) {         frame()     } }</pre>		

#### 2.4.1.2 Audio frame

Syntax	No. of bits	Mnemonic
<pre>frame() {     header()     error_check()     audio_data()     ancillary_data() }</pre>		

#### 2.4.1.3 Header

Syntax	No. of bits	Mnemonic
<pre>header() {     syncword     ID     layer     protection_bit     bitrate_index     sampling_frequency     padding_bit     private_bit     mode     mode_extension     copyright     original/copy     emphasis }</pre>	<p>12</p> <p>1</p> <p>2</p> <p>1</p> <p>4</p> <p>2</p> <p>1</p> <p>1</p> <p>2</p> <p>2</p> <p>1</p> <p>1</p> <p>2</p>	<p>bslbf</p> <p>bslbf</p> <p>bslbf</p> <p>bslbf</p> <p>bslbf</p> <p>bslbf</p> <p>bslbf</p> <p>bslbf</p> <p>bslbf</p> <p>bslbf</p> <p>bslbf</p> <p>bslbf</p> <p>bslbf</p>

#### 2.4.1.4 Error check

Syntax	No. of bits	Mnemonic
<pre>error_check() {     if (protection_bit==0)         crc_check }</pre>	<p>16</p>	<p>rpchof</p>

## 2.4.1.5 Audio data, Layer I

Syntax	No. of bits	Mnemonic
audio_data() {		
for (sb=0; sb<bound; sb++)		
for (ch=0; ch<nch; ch++)		
<b>allocation[ch][sb]</b>	4	<b>uimsbf</b>
for (sb=bound; sb<32; sb++) {		
<b>allocation[0][sb]</b>	4	<b>uimsbf</b>
allocation[1][sb]=allocation[0][sb]		
}		
for (sb=0; sb<32; sb++)		
for (ch=0; ch<nch; ch++)		
if (allocation[ch][sb]!=0)		
<b>scalefactor[ch][sb]</b>	6	<b>uimsbf</b>
for (s=0; s<12; s++) {		
for (sb=0; sb<bound; sb++)		
for (ch=0; ch<nch; ch++)		
if (allocation[ch][sb]!=0)		
<b>sample[ch][sb][s]</b>	2..15	<b>uimsbf</b>
for (sb=bound; sb<32; sb++)		
if (allocation[0][sb]!=0)		
<b>sample[0][sb][s]</b>	2..15	<b>uimsbf</b>
}		
}		

2.4.1.6 Audio data, Layer II

Syntax	No. of bits	Mnemonic
audio_data()		
{		
for (sb=0; sb<bound; sb++)		
for (ch=0; ch<nch; ch++)		
<b>allocation[ch][sb]</b>	<b>2..4</b>	<b>uimsbf</b>
for (sb=bound; sb<sblimit; sb++) {		
<b>allocation[0][sb]</b>	<b>2..4</b>	<b>uimsbf</b>
allocation[1][sb]=allocation[0][sb]		
}		
for (sb=0; sb<sblimit; sb++)		
for (ch=0; ch<nch; ch++)		
if (allocation[ch][sb]!=0)		
<b>scfsi[ch][sb]</b>	<b>2</b>	<b>bslbf</b>
for (sb=0; sb<sblimit; sb++)		
for (ch=0; ch<nch; ch++)		
if (allocation[ch][sb]!=0) {		
if (scfsi[ch][sb]==0) {		
<b>scalefactor[ch][sb][0]</b>	<b>6</b>	<b>uimsbf</b>
<b>scalefactor[ch][sb][1]</b>	<b>6</b>	<b>uimsbf</b>
<b>scalefactor[ch][sb][2]</b>	<b>6</b>	<b>uimsbf</b>
}		
if ((scfsi[ch][sb]==1)    (scfsi[ch][sb]==3)) {		
<b>scalefactor[ch][sb][0]</b>	<b>6</b>	<b>uimsbf</b>
<b>scalefactor[ch][sb][2]</b>	<b>6</b>	<b>uimsbf</b>
}		
if (scfsi[ch][sb]==2)		
<b>scalefactor[ch][sb][0]</b>	<b>6</b>	<b>uimsbf</b>
}		
for (gr=0; gr<12; gr++) {		
for (sb=0; sb<bound; sb++)		
for (ch=0; ch<nch; ch++)		
if (allocation[ch][sb]!=0) {		
if (grouping[ch][sb])		
<b>samplecode[ch][sb][gr]</b>	<b>5..10</b>	<b>uimsbf</b>
else		
for (s=0; s<3; s++)		
<b>sample[ch][sb][3*gr+s]</b>	<b>3..16</b>	<b>uimsbf</b>
}		
for (sb=bound; sb<sblimit; sb++)		
if (allocation[0][sb]!=0) {		
if (grouping[0][sb])		
<b>samplecode[0][sb][gr]</b>	<b>5..10</b>	<b>uimsbf</b>
else		
for (s=0; s<3; s++)		
<b>sample[0][sb][3*gr+s]</b>	<b>3..16</b>	<b>uimsbf</b>
}		
}		
}		

## 2.4.1.7 Audio data, Layer III

Syntax	No. of bits	Mnemonic
<code>audio_data()</code>		
{		
<b>main_data_begin</b>	9	<b>uimsbf</b>
if (mode==single_channel)		
<b>private_bits</b>	5	<b>bslbf</b>
else		
<b>private_bits</b>	3	<b>bslbf</b>
for (ch=0; ch<nch; ch++)		
for (scfsi_band=0; scfsi_band<4; scfsi_band++)		
scfsi[ch][scfsi_band]	1	<b>bslbf</b>
for (gr=0; gr<2; gr++)		
for (ch=0; ch<nch; ch++) {		
<b>part2_3_length</b> [gr][ch]	12	<b>uimsbf</b>
<b>big_values</b> [gr][ch]	9	<b>uimsbf</b>
<b>global_gain</b> [gr][ch]	8	<b>uimsbf</b>
<b>scalefac_compress</b> [gr][ch]	4	<b>bslbf</b>
<b>window_switching_flag</b> [gr][ch]	1	<b>bslbf</b>
if (window_switching_flag[gr][ch]) {		
<b>block_type</b> [gr][ch]	2	<b>bslbf</b>
<b>mixed_block_flag</b> [gr][ch]	1	<b>uimsbf</b>
for (region=0; region<2; region++)		
<b>table_select</b> [gr][ch][region]	5	<b>bslbf</b>
for (window=0; window<3; window++)		
<b>subblock_gain</b> [gr][ch][window]	3	<b>uimsbf</b>
}		
else {		
for (region=0; region<3; region++)		
<b>table_select</b> [gr][ch][region]	5	<b>bslbf</b>
<b>region0_count</b> [gr][ch]	4	<b>bslbf</b>
<b>region1_count</b> [gr][ch]	3	<b>bslbf</b>
}		
<b>preflag</b> [gr][ch]	1	<b>bslbf</b>
<b>scalefac_scale</b> [gr][ch]	1	<b>bslbf</b>
<b>count1table_select</b> [gr][ch]	1	<b>bslbf</b>
}		
<b>main_data()</b>		
}		

The main data bitstream is defined below. The `main_data` field in the `audio_data()` syntax contains bytes from the main data bitstream. However, because of the variable nature of Huffman coding used in Layer III, the main data for a frame does not generally follow the header and side information for that frame. The `main_data` for a frame starts at a location in the bitstream preceding the header of the frame at a negative offset given by the value of `main_data_begin`. (See definition of `main_data_begin` and figure A.7.a).

Syntax	No. of bits	Mnemonic
<pre> main_data() {   for (gr=0; gr&lt;2; gr++) {     for (ch=0; ch&lt;nch; ch++) {       if ((window_switching_flag[gr][ch]==1)           &amp;&amp; (block_type[gr][ch]==2)) {         if (mixed_block_flag[gr][ch]) {           for (sfb=0; sfb&lt;8; sfb++)             scalefac_l[gr][ch][sfb]           for (sfb=3; sfb&lt;12; sfb++)             for (window=0; window&lt;3; window++)               scalefac_s[gr][ch][sfb][window]         }         else {           for (sfb=0; sfb&lt;12; sfb++)             for (window=0; window&lt;3; window++)               scalefac_s[gr][ch][sfb][window]         }       }       else {         if ((scfsi[ch][0]==0)    (gr == 0))           for (sfb=0; sfb&lt;6; sfb++)             scalefac_l[gr][ch][sfb]         if ((scfsi[ch][1]==0)    (gr == 0))           for (sfb=6; sfb&lt;11; sfb++)             scalefac_l[gr][ch][sfb]         if ((scfsi[ch][2]==0)    (gr == 0))           for (sfb=11; sfb&lt;16; sfb++)             scalefac_l[gr][ch][sfb]         if ((scfsi[ch][3]==0)    (gr == 0))           for (sfb=16; sfb&lt;21; sfb++)             scalefac_l[gr][ch][sfb]       }       Huffmancodebits()     }   }   for (b=0; b&lt;no_of_ancillary_bits; b++)     ancillary_bit } </pre>	<p>0..4</p> <p>0..4</p> <p>0..4</p> <p>0..4</p> <p>0..4</p> <p>0..4</p> <p>0..4</p> <p>0..3</p> <p>0..3</p> <p>1</p>	<p><b>uimsbf</b></p> <p><b>uimsbf</b></p> <p><b>uimsbf</b></p> <p><b>uimsbf</b></p> <p><b>uimsbf</b></p> <p><b>uimsbf</b></p> <p><b>uimsbf</b></p> <p><b>uimsbf</b></p> <p><b>uimsbf</b></p> <p><b>bslbf</b></p>



Syntax	No. of bits	Mnemonic
Huffmancodebits() {		
for (l=0; l<big_values*2; l+=2) {		
hcod[lx][ly]	0..19	bslbf
if (lx==15 && linbits>0)		
linbitsx	1..13	uimsbf
if (x != 0)		
signx	1	bslbf
if (ly==15 && linbits>0)		
linbitsy	1..13	uimsbf
if (y != 0)		
signy	1	bslbf
is[l] = x		
is[l+1] = y		
}		
for (; l<big_values*2+count1*4; l+=4) {		
hcod[lv][lw][lx][ly]	1..6	bslbf
if (v!=0)		
signv	1	bslbf
if (w!=0)		
signw	1	bslbf
if (x!=0)		
signx	1	bslbf
if (y!=0)		
signy	1	bslbf
is[l] = v		
is[l+1] = w		
is[l+2] = x		
is[l+3] = y		
}		
for (; l<576; l++)		
is[l] = 0		
}		

#### 2.4.1.8 Ancillary data

Syntax	No. of bits	Mnemonic
ancillary_data() {		
if ((layer == 1)    (layer == 2))		
for (b=0; b<no_of_ancillary_bits; b++)		
ancillary_bit	1	bslbf
}		

## 2.4.2 Semantics for the audio bitstream syntax

### 2.4.2.1 Audio sequence general

**frame** -- Layer I and Layer II: Part of the bitstream that is decodable by itself. In Layer I it contains information for 384 samples and in Layer II for 1 152 samples. It starts with a syncword, and ends just before the next syncword. It consists of an integer number of slots (four bytes in Layer I, one byte in Layer II).

-- Layer III: Part of the bitstream that is decodable with the use of previously acquired main information. In Layer III it contains information for 1 152 samples. Although the distance between the start of consecutive syncwords is an integer number of slots (one byte in Layer III), the audio information belonging to one frame is generally not contained between two successive syncwords.

### 2.4.2.2 Audio frame

**header** -- Part of the bitstream containing synchronization and state information.

**error\_check** -- Part of the bitstream containing information for error detection.

**audio\_data** -- Part of the bitstream containing information on the audio samples.

**ancillary\_data** -- Part of the bitstream that may be used for ancillary data.

### 2.4.2.3 Header

The first 32 bits (four bytes) are header information which is common to all layers.

**syncword** -- The bit string '1111 1111 1111'.

**ID** -- One bit to indicate the ID of the algorithm. Equals '1' for ISO/IEC 11172-3 audio, '0' is reserved.

**Layer** -- 2 bits to indicate which layer is used, according to the following.

Layer	
'11'	Layer I
'10'	Layer II
'01'	Layer III
'00'	reserved

To change the layer, a reset of the audio decoder may be required.

**protection\_bit** -- One bit to indicate whether redundancy has been added in the audio bitstream to facilitate error detection and concealment. Equals '1' if no redundancy has been added, '0' if redundancy has been added.

**bitrate\_index** -- Indicates the bitrate. The all zero value indicates the 'free format' condition, in which a fixed bitrate which does not need to be in the list can be used. Fixed means that a frame contains either N or N+1 slots, depending on the value of the padding bit. The **bitrate\_index** is an index to a table, which is different for the different layers.

The **bitrate\_index** indicates the total bitrate irrespective of the mode (stereo, joint\_stereo, dual\_channel, single\_channel).

bitrate_index	bitrate specified (kbits/s)		
	Layer I	Layer II	Layer III
'0000'	free	free	free
'0001'	32	32	32
'0010'	64	48	40
'0011'	96	56	48
'0100'	128	64	56
'0101'	160	80	64
'0110'	192	96	80
'0111'	224	112	96
'1000'	256	128	112
'1001'	288	160	128
'1010'	320	192	160
'1011'	352	224	192
'1100'	384	256	224
'1101'	416	320	256
'1110'	448	384	320
'1111'	forbidden	forbidden	forbidden

In order to provide the smallest possible delay and complexity, the decoder is not required to support a continuously variable bitrate when in Layer I or II. Layer III supports variable bitrate by switching the bitrate\_index. The switching of the bitrate\_index can be used either to optimize storage requirements on DSM or to interpolate any mean data rate by switching between nearby values in the bitrate table. However, in free format, fixed bitrate is required. The decoder is also not required to support bitrates higher than 448 kbits/s, 384 kbits/s, 320 kbits/s in respect to Layer I, II and III when in free format mode.

For Layer II, not all combinations of total bitrate and mode are allowed. See the following table.

bit rate (kbits/s)	Allowed modes
free format	all modes
32	single_channel
48	single_channel
56	single_channel
64	all modes
80	single_channel
96	all modes
112	all modes
128	all modes
160	all modes
192	all modes
224	stereo, intensity stereo, dual channel
256	stereo, intensity stereo, dual channel
320	stereo, intensity stereo, dual channel
384	stereo, intensity stereo, dual channel

sampling\_frequency -- Indicates the sampling frequency, according to the following table.

sampling_frequency	frequency specified (kHz)
'00'	44,1
'01'	48
'10'	32
'11'	reserved

A reset of the audio decoder may be required to change the sampling rate.

padding\_bit -- If this bit equals '1', the frame contains an additional slot to adjust the mean bitrate to the sampling frequency, otherwise this bit will be '0'. Padding is necessary with a sampling frequency of 44,1 kHz. Padding may also be required in free format.

The padding should be applied to the bitstream such that the accumulated length of the coded frames, after a certain number of audio frames does not deviate more than (+0, -1 slot) from the following computed value:

$$\text{accumulated frame length} = \sum_{\text{first frame}}^{\text{current frame}} (\text{frame\_size} * \text{bitrate} / \text{sampling frequency})$$

where :frame\_size = 384 for Layer I,  
1 152 for Layer II or III.

The following method can be used to determine whether or not to use padding:

```

for 1st audio frame:
    rest = 0;
    padding = no;

for each subsequent audio frame:
    if (Layer == 1) dif = (12 * bitrate) % sampling_frequency;
    else dif = (144 * bitrate) % sampling_frequency;
    rest = rest - dif;
    if (rest < 0) {
        padding = yes;
        rest = rest + sampling_frequency;
    }
    else padding = no;
    
```

**private\_bit** -- Bit for private use. This bit will not be used in the future by ISO/IEC.

**mode** -- Indicates the mode according to the following table. In Layer I and II the joint\_stereo mode is intensity\_stereo. in Layer III it is intensity\_stereo and/or ms\_stereo.

mode	mode specified
'00'	stereo
'01'	joint_stereo (intensity_stereo and/or ms_stereo)
'10'	dual_channel
'11'	single_channel

In Layer I, in all modes except joint stereo, the value of bound equals 32. In layer II, in all modes except joint\_stereo, the value of bound equals sblimit. In joint\_stereo mode the bound is determined by the mode\_extension.

**mode\_extension** -- These bits are used in joint\_stereo mode. In Layer I and II they indicate which subbands are in intensity\_stereo. All other subbands are coded in stereo.

mode_extension	
'00'	subbands 4-31 in intensity_stereo, bound=4
'01'	subbands 8-31 in intensity_stereo, bound=8
'10'	subbands 12-31 in intensity_stereo, bound=12
'11'	subbands 16-31 in intensity_stereo, bound=16

In Layer III they indicate which type of joint stereo coding method is applied. The frequency ranges over which the intensity\_stereo and ms\_stereo modes are applied are implicit in the algorithm. For more information see 2.4.3.4.

mode_extension	intensity_stereo	ms_stereo
'00'	off	off
'01'	on	off
'10'	off	on
'11'	on	on

Note that the mode "stereo" is used if the mode bits specify stereo or equivalently if the mode bits specify joint stereo and the mode\_extension specifies intensity\_stereo "off" and ms\_stereo "off".

**copyright** -- If this bit equals '0', there is no copyright on the ISO/IEC 11172-3 bitstream, '1' means copyright protected.

**original/copy** -- This bit equals '0' if the bitstream is a copy, '1' if it is an original.

**emphasis** -- Indicates the type of de-emphasis that shall be used.

emphasis	emphasis specified
'00'	none
'01'	50/15 microseconds
'10'	reserved
'11'	CCITT J.17

#### 2.4.2.4 Error check

**crc\_check** -- A 16 bit parity-check word is used for optional error detection within the encoded bitstream.

#### 2.4.2.5 Audio data, Layer I

**allocation[ch][sb]** -- Indicates the number of bits used to code the samples in subband sb of channel ch. For subbands in intensity\_stereo mode the bitstream contains only one allocation data element per subband.

allocation[ch][sb]	bits per sample
0	0
1	2
2	3
3	4
4	5
5	6
6	7
7	8
8	9
9	10
10	11
11	12
12	13
13	14
14	15
15	forbidden

Note: For code '0000' no samples are transferred.

**scalefactor[ch][sb]** -- Indicates the factor of subband sb of channel ch by which the requantized samples of subband sb in channel ch shall be multiplied. The six bits constitute an unsigned integer, index to table B.1 "Layer I, II scalefactors".

**sample[ch][sb][s]** -- Coded representation of the s-th sample in subband sb of channel ch. For subbands in intensity\_stereo mode the coded representation of the sample is valid for both channels.

#### 2.4.2.6 Audio data, Layer II

**allocation[ch][sb]** -- Contains information concerning the quantizers used for the samples in subband sb in channel ch, whether the information on three consecutive samples has been grouped to one code, and on the number of bits used to code the samples. The meaning and length of this field depends on the number of the subband, the bitrate, and the sampling frequency. The bits in this field form an unsigned integer used as an index to the relevant table in table B.2 "Layer II bit allocation tables", which gives the number of levels used for quantization. For subbands in intensity\_stereo mode the bitstream contains only one allocation data element per subband.

**scfsi[ch][sb]** -- Scalefactor selection information. This gives information on the number of scalefactors transferred for subband sb in channel ch and for which parts of the signal in this frame they are valid. The frame is divided into three equal parts of 12 subband samples each per subband.

scfsi[sb]	
'00'	three scalefactors transmitted, for parts 0,1,2 respectively.
'01'	two scalefactors transmitted, first one valid for parts 0 and 1, second one for part 2.
'10'	one scalefactor transmitted, valid for all three parts.
'11'	two scalefactors transmitted, first one valid for part 0, the second one for parts 1 and 2.

**scalefactor[ch][sb][p]** -- Indicates the factor by which the requantized samples of subband sb in channel ch and of part p of the frame should be multiplied. The six bits constitute an unsigned integer, index to table B.1 "Layer I, II scalefactors".

**grouping[ch][sb]** -- Is a function that determines, whether grouping is in effect for coding of samples in subband sb of channel ch. Grouping means, that three consecutive samples (a triplet) of the current subband sb in channel ch in the current granule gr are coded and transmitted using one common codeword and not using three separate codewords. Grouping[ch][sb] is true, if in the Bit Allocation table currently in use (see B.2) the value found under the sb (row) and the allocation[sb] (column) is either 3, 5, or 9. Otherwise it is false. For subbands in intensity\_stereo mode the grouping is valid for both channels.

**samplecode[ch][sb][gr]** -- Coded representation of the three consecutive samples in the granule gr in subband sb of channel ch. For subbands in intensity\_stereo mode the coded representation of the samplecode is valid for both channels.

**sample[ch][sb][s]** -- Coded representation of the s-th sample in subband sb of channel ch. For subbands in intensity\_stereo mode the coded representation of the sample is valid for both channels.

**2.4.2.7 Audio data, Layer III**

**main\_data\_begin** -- The value of main\_data\_begin is used to determine the location of the first bit of main data of a frame. The main\_data\_begin value specifies the location as a negative offset in bytes from the first byte of the audio sync word. The number of bytes belonging to the header and side information is not taken into account. For example, if main\_data\_begin == 0, then main data starts after the side information. Examples are given in figure A.7.a and figure A.7.b.

**private\_bits** -- Bits for private use. These bits will not be used in the future by ISO/IEC. The number of private\_bits depends on the number of channels. The number of bits allocated for private\_bits is determined to equalize the total number of bits used for side-information.

**scfsi[ch][scfsi\_band]** -- In Layer III, the scalefactor selection information works similarly to audio Layer II. The main difference is the use of the variable scfsi\_band to apply scfsi to groups of scalefactors instead of single scalefactors. The application of scalefactors to granules is controlled by scfsi.

scfsi[scfsi_band]	
'0'	scalefactors are transmitted for each granule
'1'	scalefactors transmitted for granule 0 are also valid for granule 1

If short windows are switched on, i.e. block\_type==2 for one of the granules, then scfsi is always 0 for this frame.

scfsi\_band controls the use of the scalefactor selection information for groups of scalefactors (scfsi\_bands).

scfsi_band	scalefactor bands (see table B.8)
0	0,1,2,3,4,5,
1	6,7,8,9,10,
2	11 ... 15
3	16 ... 20

part2\_3\_length[gr][ch] -- This value contains the number of main\_data bits used for scalefactors and Huffman code data. Because the length of the side information is always the same, this value can be used to calculate the beginning of the main information for the next granule or the position of the ancillary information (if used). Note that single channel audio frames contain 17 bytes of side information and dual channel audio frames contain 32 bytes of side information (see 2.4.1.7 Audio Data, Layer III - syntax for audio\_data()).

big\_values[gr][ch] -- The spectral values of each granule are coded with different Huffman code tables. The full frequency range from zero to the Nyquist frequency is divided into several regions, which then are coded using different tables. Partitioning is done according to the maximum quantized values. This is done with the assumption that values at higher frequencies are expected to have lower amplitudes or do not need to be coded at all. Starting at high frequencies, the pairs of quantized values equal to zero are counted. This number is named "rzero". Then, quadruples of quantized values with absolute value not exceeding 1 (i.e. only 3 possible quantization levels) are counted. This number is named "count1". Again an even number of values remain. Finally, the number of pairs of values in the region of the spectrum which extends down to zero is named "big\_values". The maximum absolute value in this range is constrained to 8191. The following figure shows the partitioning:

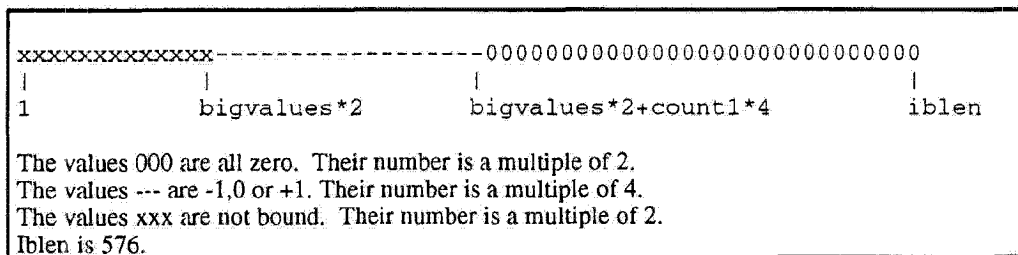

global\_gain[gr][ch] -- The quantizer step size information is transmitted in the side information variable global\_gain. It is logarithmically quantized. For the application of global\_gain, refer to the formula in 2.4.3.4, "Formula for requantization and all scaling".

scalefac\_compress[gr][ch] -- Selects the number of bits used for the transmission of the scalefactors according to the following table:

- if block\_type is 0, 1, or 3:
  - slen1: length of scalefactors for the scalefactor bands 0 to 10
  - slen2: length of scalefactors for the scalefactor bands 11 to 20
- if block\_type is 2 and mixed\_block\_flag is 0:
  - slen1: length of scalefactors for the scalefactor bands 0 to 5
  - slen2: length of scalefactors for the scalefactor bands 6 to 11
- if block\_type is 2 and mixed\_block\_flag is 1:
  - slen1: length of scalefactors for the scalefactor bands 0 to 7 (long window scalefactor band) and 3 to 5 (short window scalefactor band) Note: Scalefactor bands 0-7 are from the "long window

scalefactor band" table, and scalefactor bands 3 to 11 from the "short window scalefactor band" table. This combination of partitions is contiguous and spans the entire frequency spectrum.  
 slen2: length of scalefactors for the scalefactor bands 6 to 11

scalefac_compress[gr]	slen1	slen2
0	0	0
1	0	1
2	0	2
3	0	3
4	3	0
5	1	1
6	1	2
7	1	3
8	2	1
9	2	2
10	2	3
11	3	1
12	3	2
13	3	3
14	4	2
15	4	3

**window\_switching\_flag[gr][ch]** -- Signals that the block uses an other than normal (type 0) window.

If **window\_switching\_flag** is set, several other variables are set by default:

**region0\_count** = 7 (in case of **block\_type**==1 or **block\_type**==3  
 or **block\_type**==2 and **mixed\_block\_flag**)  
**region0\_count** = 8 (in case of **block\_type**==2 and not **mixed\_block\_flag**)  
**region1\_count** = 36 Thus all remaining values in the big\_value region are contained in region 1.

If **window\_switching\_flag** is not set, then the value of **block\_type** is zero.

**block\_type[gr][ch]** -- Indicates the window type for the granule (see description of the filterbank, Layer III).

block_type[gr]	
0	reserved
1	start block
2	3 short windows
3	end block

**Block\_type** and **mixed\_block\_flag** give the information about assembling of values in the block and about length and count of the transforms (see figure A.4 for a schematic, annex C for an analytic description). If **window\_switching\_flag**==1, then the **mixed\_block\_flag** indicates whether lower frequency polyphase filter subbands are coded using normal window type. The polyphase filterbank is described in 2.4.3.

In the case of long blocks (**block\_type** not equal to 2 or in the lower subbands of **block\_type** 2 if the **mixed\_block\_flag** is set) the IMDCT generates an output of 36 values every 18 input values. The output is windowed depending on the **block\_type** and the first half is overlapped with the second half of the block before. The resulting vector is the input of the synthesis part of the polyphase filterbank of one band.

In the case of short blocks (in the upper subbands of a type 2 block if the **mixed\_block\_flag** is set, or in all subbands of a type 2 block if **mixed\_block\_flag** is not set), three transforms are performed producing 12 output values each. The three vectors are windowed and overlapped each. Concatenating 6 zeros on both ends of the resulting vector gives a vector of length 36, which is processed like the output of a long transform.



**mixed\_block\_flag[gr][ch]** -- Indicates that lower frequencies are transformed with a window type that is different than that which is used at higher frequencies. If **mixed\_block\_flag** is zero, then all blocks are transformed as indicated by **block\_type[gr][ch]**. If **mixed\_block\_flag** is one, then the frequency lines corresponding to the two lowest frequency polyphase subbands are transformed with normal window (**block\_type**=0), while the remaining 30 subbands are transformed as **block\_type[gr][ch]**.

**table\_select[gr][ch][region]** -- Different Huffman code tables are used depending on the maximum quantized value and the local statistics of the signal. There are a total of 32 possible tables given in table B.7.

**subblock\_gain[gr][ch][window]** -- Indicates the gain offset (quantization: factor 4) from the global gain for one subblock. Used only with block type 2 (short windows). The values of the subblock have to be divided by  $4^{(\text{subblock\_gain}[\text{window}])}$  in the decoder. See 2.4.3.4 - Formula for requantization and all scaling.

**region0\_count[gr][ch]** -- A further partitioning of the spectrum is used to enhance the performance of the Huffman coder. It is a subdivision of the region which is described by **big\_values**. The purpose of this subdivision is to get better error robustness and better coding efficiency. Three regions are used, they are named: region 0, 1 and 2. Each region is coded using a different Huffman code table depending on the maximum quantized value and the local signal statistics.

The values **region0\_count** and **region1\_count** are used to indicate the boundaries of the regions. The region boundaries are aligned with the partitioning of the spectrum into scale factor bands.

The field **region0\_count** contains one less than the number of scalefactor bands in region 0. In the case of short blocks, each scale factor band is counted three times, once for each short window, so that a **region0\_count** value of 8 indicates that **region1** begins at scalefactor band number 3.

If **block\_type**=2 and **mixed\_block\_flag**=0, the total amount of scalefactor bands for the granule in this case is  $12 \times 3 = 36$ . If **block\_type**=2 and **mixed\_block\_flag**=1, the amount of scalefactor bands is  $8 + 9 \times 3 = 35$ . If **block\_type**!=2, the amount of scalefactor bands is 21.

**region1\_count[gr][ch]** -- **region1\_count** counts one less than the number of scalefactor bands in region 1. Again, if **block\_type**=2 the scalefactor bands representing different time slots are counted separately.

**preflag[gr][ch]** -- This is a shortcut for additional high frequency amplification of the quantized values. If **preflag** is set, the values of a table are added to the scalefactors (see table B.6). This is equivalent to multiplication of the requantized scalefactors with table values. If **block\_type**=2 (short blocks) **preflag** is never used.

**scalefac\_scale[gr][ch]** -- The scalefactors are logarithmically quantized with a step size of 2 or ( $\sqrt{2}$ ) depending on **scalefac\_scale**. The following table indicates the scale factor multiplier used in the requantization equation for each stepsize.

scalefac_scale[gr]	scalefac_multiplier
0	0,5
1	1

**count1table\_select[gr][ch]** -- This flag selects one of two possible Huffman code tables for the region of quadruples of quantized values with magnitude not exceeding 1.

count1table_select[gr]	
0	Table B.7 - A
1	Table B.7 - B

**scalefac\_l[gr][ch][sfb]**, **scalefac\_s[gr][ch][sfb][window]**, **is\_pos[sfb]** -- The scalefactors are used to colour the quantization noise. If the quantization noise is coloured with the right shape, it is masked completely. Unlike Layers I and II, the Layer III scalefactors say nothing about the local maximum of the quantized signal. In Layer III, scalefactors are used in the decoder to get division factors for groups of values. In the case of Layer III, the groups stretch over several frequency lines. These groups are called scalefactor bands and are selected to resemble critical bands as closely as possible.

The `scalefac_compress` table shows that the scalefactors 0...10 have a range of 0 to 15 (maximum length 4 bits) and the scalefactors 11...21 have a range of 0 to 7 (maximum length 3 bits).

If `intensity_stereo` is enabled (`modebit_extension`) the scalefactors of the "zero\_part" of the difference (right) channel are used as `intensity_stereo` positions, `is_pos[sfb]` (see 2.4.3.4, MS\_stereo mode). `is_pos[sfb]` is the intensity stereo position for scalefactor band `sfb`.

The subdivision of the spectrum into scalefactor bands is fixed for every block length and sampling frequency and stored in tables in the coder and decoder (see table B.8). The scale factor for frequency lines above the highest line in the tables is zero, which means that the actual multiplication factor is 1,0.

The scalefactors are logarithmically quantized. The quantization step is set with `scalefac_scale`.

**huffmancodebits()** -- Huffman encoded data.

The syntax for `huffmancodebits()` shows how quantized values are encoded. Within the `big_values` partition, pairs of quantized values with an absolute value less than 15 are directly coded using a Huffman code. The codes are selected from Huffman tables 0 through 31 in table B.7. Always pairs of values (x,y) are coded. If quantized values of magnitude greater than or equal to 15 are coded, the values are coded with a separate field following the Huffman code. If one or both values of a pair is not zero, one or two sign bits are appended to the code word.

The Huffman tables for the `big_values` partition are comprised of three parameters:

<code>hcod[x][y]</code>	is the Huffman code table entry for values x,y.
<code>hlen[x][y]</code>	is the Huffman length table entry for values x,y.
<code>linbits</code>	is the length of <code>linbitsx</code> or <code>linbitsy</code> when they are coded.

The syntax for `huffmancodebits` contains the following fields and parameters:

<code>signv</code>	is the sign of v (0 if positive, 1 if negative).
<code>signw</code>	is the sign of w (0 if positive, 1 if negative).
<code>signx</code>	is the sign of x (0 if positive, 1 if negative).
<code>signy</code>	is the sign of y (0 if positive, 1 if negative).
<code>linbitsx</code>	is used to encode the value of x if the magnitude of x is greater or equal to 15. This field is coded only if <code> x </code> in <code>hcod</code> is equal to 15. If <code>linbits</code> is zero, so that no bits are actually coded when <code> x =15</code> , then the value <code>linbitsx</code> is defined to be zero.
<code>linbitsy</code>	is the same as <code>linbitsx</code> but for y.
<code>is[l]</code>	is the quantized value for frequency line number l.

The `linbitsx` or `linbitsy` fields are only used if a value greater or equal to 15 needs to be encoded. These fields are interpreted as unsigned integers and added to 15 to obtain the encoded value. The `linbitsx` and `linbitsy` fields are never used if the selected table is one for blocks with a maximum quantized value less than 15. Note that a value of 15 can still be encoded with a Huffman table for which `linbits` is zero. In this case, the `linbitsx` or `linbitsy` fields are not actually coded, since `linbits` is zero.

Within the `count1` partition, quadruples of values with magnitude less than or equal to one are coded. Again magnitude values are coded using a Huffman code from tables A or B in table B.7. Again, for each non-zero value, a sign bit is appended after the Huffman code symbol.

The Huffman tables for the `count1` partition are comprised of the following parameters:

<code>hcod[v][w][x][y]</code>	is the Huffman code table entry for values v,w,x,y.
<code>hlen[v][w][x][y]</code>	is the Huffman length table entry for values v,w,x,y.

Huffman code table B is not really a 4-dimensional code because it is constructed from the trivial code: 0 is coded with a 1, and 1 is coded with a 0.

Quantized values above the `count1` partition are zero, so they are not encoded.

For clarity, the parameter "count1" is used in this document to indicate the number of Huffman codes in the `count1` region. However, unlike the `bigvalues` partition, the number of values in the `count1` partition is not

explicitly coded by a field in the syntax. The end of the count1 partition is known only when all bits for the granule (as specified by part2\_3\_length), have been exhausted, and the value of count1 is known implicitly after decoding the count1 region.

The order of the Huffman data depends on the block\_type of the granule. If block\_type is 0, 1 or 3 the Huffman encoded data is ordered in terms of increasing frequency.

If block\_type=2 (short blocks) the Huffman encoded data is ordered in the same order as the scalefactor values for that granule. The Huffman encoded data is given for successive scalefactor bands, beginning with scalefactor band 0. Within each scalefactor band, the data is given for successive time windows, beginning with window 0 and ending with window 2. Within each window, the quantized values are then arranged in order of increasing frequency.

#### 2.4.2.8 Ancillary data

**Ancillary\_bit** -- User definable.

The number of ancillary bits (no\_of\_ancillary\_bits) equals the available number of bits in an audio frame minus the number of bits actually used for header, error check and audio data. In Layer I and II the no\_of\_ancillary\_bits corresponds to the distance between the end of the audio data and the beginning of the next header. In Layer III the no\_of\_ancillary\_bits corresponds to the distance between the end of the Huffman\_code\_bits and the location in the bitstream where the next frame's main\_data\_begin pointer points to.

### 2.4.3 The audio decoding process

#### 2.4.3.1 General

The first action is synchronization of the decoder to the incoming bitstream. Just after startup this may be done by searching in the bitstream for the 12 bit syncword. In some applications the ID, layer, and protection status are already known to the decoder, and thus the first 16 bits of the header should be regarded as a 16 bit syncword, thereby allowing a more reliable synchronization. The position of consecutive syncwords can be calculated from the information provided by the seven bits after the protection\_bit: the bitstream is subdivided in slots. The distance between the start of two consecutive syncwords is equal to "N" or "N+1" slots. The value of "N" depends on the layer.

For Layer I the following equation is valid:

$$N = 12 * \frac{\text{bitrate}}{\text{sampling\_frequency}}$$

For Layers II and III the equation becomes:

$$N = 144 * \frac{\text{bitrate}}{\text{sampling\_frequency}}$$

If this calculation does not give an integer number the result is truncated and 'padding' is required. In this case the number of slots in a frame will vary between N and N+1. The padding bit is set to '0' if the number of slots equals N, and to '1' otherwise. This knowledge of the position of consecutive syncwords greatly facilitates synchronization.

If the bitrate index equals '0000', the exact bitrate is not indicated. N can be determined from the distance between consecutive syncwords and the value of the padding bit.

The mode bits in the bitstream shall be read and if their value is '01' the mode\_extension bits shall also be read. The mode\_extension bits set the 'bound' as shown in 2.4.2.3 and thus indicate which subbands are coded in joint\_stereo mode.

If the protection bit in the header equals '0', a CRC-check word has been inserted in the bitstream just after the header. The error detection method used is 'CRC-16' whose generator polynomial is:

$$G(X) = X^{16} + X^{15} + X^2 + 1$$

The bits included into the CRC-check are given by table B.5.

The method is depicted in figure A.9 "CRC-check diagram". The initial state of the shift register is '1111 1111 1111 1111'. Then all the bits included into the CRC-check are input to the circuit shown in figure A.9 "CRC-check diagram". After each bit is input the shift register is shifted by one bit. After the last shift operation, the outputs  $b_{15} \dots b_0$  constitute a word to be compared with the CRC-check word in the bitstream. If the words are not identical, a transmission error has occurred in the protected field of the bitstream. To avoid annoying distortions, application of a concealment technique, such as muting of the actual frame or repetition of the previous frame, is recommended.

#### 2.4.3.2 Layer I

After the part of the decoding which is common to all layers (see 2.4.3.1) the bit allocation information has to be read for all subbands, and the scalefactors read for all subbands with a nonzero bit allocation. The decoder flowchart is given in figure A.1 "Layer I and II decoder flow chart".

##### 2.4.3.2.1 Requantization of subband samples

From the bit allocation the number of bits  $n_b$  that has to be read for the samples in each subband is known. The order of the samples is given in 2.4.1.5 for each mode. After the bits for one sample have been gathered from the bitstream, the first bit has to be inverted. The resulting number can be considered as a two's

complement fractional number, where the MSB represents the value -1. The requantized value can be obtained by applying a linear formula :

$$s'' = \frac{2^{nb}}{2^{nb} - 1} * (s''' + 2^{-nb+1})$$

where

$s'''$  is the fractional number;  
 $s''$  is the requantized value;  
 $nb$  is the number of bits allocated to samples in the subband.

Samples in subbands which are in intensity\_stereo mode must be copied to both channels. The requantized value has to be rescaled. The multiplication factor can be found in the table B.1 "Layer I, II scalefactors". The rescaled value  $s'$  is calculated as :

$$s' = \text{factor} * s''$$

#### 2.4.3.2.2 Synthesis subband filter

If a subband has no bits allocated to it, the samples in that subband are set to zero. Each time the subband samples for all 32 subbands of one channel have been calculated, they can be applied to the synthesis subband filter and 32 consecutive audio samples can be calculated. The actions in flow diagram figure A.2 "Synthesis subband filter flow chart" show the reconstruction operation. The coefficients  $N_{ik}$  for the matrixing operation are given by

$$N_{ik} = \cos \left[ (16 + i) (2k+1) \frac{\pi}{64} \right] \quad 0 \leq i \leq 63, 0 \leq k \leq 31$$

The coefficients  $D_i$  for the windowing operation can be found in table B.3 "Coefficients  $D_i$  of the synthesis window". The coefficients have been derived by numerical optimization. One frame contains  $12 * 32 = 384$  subband samples, which result, after filtering, in 384 audio samples.

#### 2.4.3.3 Layer II

Layer II is a more efficient but more complex coding scheme than Layer I. The flowchart in figure A.1 "Layer I and II decoder flow chart" applies to both Layers I and II. The first step is to perform the decoding which is common to all three layers (see 2.4.3.1).

##### 2.4.3.3.1 Bit allocation decoding

For different combinations of bitrate and sampling frequency different bit allocation tables exist (table B.2 "Layer II bit allocation tables"). Note that the bitrates given in the table headers are per channel. If the mode is not single\_channel, the bitrate should be divided by two to obtain the bitrate per channel. The decoding of the bit allocation table is done in a three-step approach. The first step consists of reading 'nbal' (2,3, or 4) bits of information for one subband from the bitstream. The value of 'nbal' is given in the second column of the relevant table B.2 "Layer II bit allocation tables". These bits shall be interpreted as an unsigned integer number. The second step uses this number and the number of the subband as indices to point to a value in the table. This value represents the number of levels 'nlevels' used to quantize the samples in the subband. As a third step, using table B.4 "Layer II classes of quantization", the number of bits used to code the quantized samples, the requantization coefficients, and whether the codes for three consecutive subband samples have been grouped to one code can be determined. It can be seen from the bit allocation tables that some of the highest subbands will never have bits allocated. The number of the lowest subband that will not have bits allocated to it is assigned to the identifier 'sblimit'.

##### 2.4.3.3.2 Scalefactor selection information decoding

The 36 samples in one subband within a frame are divided in three equal parts of 12 subband samples. Each part can have its own scalefactor. The number of scalefactors that has to be read from the bitstream depends on scfsi[sb]. The scalefactor selection information scfsi[sb] is read from the bitstream for the subbands that have a nonzero bit allocation. If scfsi[sb] equals '00' three scalefactors are transmitted, for parts 0,1,2 respectively. If scfsi[sb] equals '01' two scalefactors are transmitted, the first one valid for parts 0 and 1, the

second one for part 2. If  $scfsi[sb]$  equals '10' one scalefactor is transmitted, valid for all three parts. If  $scfsi[sb]$  equals '11' two scalefactors are transmitted, the first one valid for part 0, the second one for parts 1 and 2.

#### 2.4.3.3.3 Scalefactor decoding

For every subband with a nonzero bit allocation the coded scalefactors for that subband are read from the bitstream. The number of coded scalefactors and the part of the subband samples they refer to is defined by  $scfsi[sb]$ . The 6 bits of a coded scalefactor should be interpreted as an unsigned integer index to table B.1 "Layer I, II scalefactors". This table gives the scalefactor by which the relevant subband samples should be multiplied after requantization.

#### 2.4.3.3.4 Requantization of subband samples

Next the coded samples are read. As can be seen from 2.4.1.6, the coded samples appear as triplets, the code contains three consecutive samples at a time. From table B.4 "Layer II classes of quantization" it is known how many bits have to be read for one triplet from the bitstream for each subband. Also from table B.4 "Layer II classes of quantization", it is known whether this code consists of three consecutive separable codes for each sample or of one combined code for the three samples (grouping). In the last case degrouping must be performed. The combined code has to be regarded as an unsigned integer, called 'c'. The following algorithm will supply the three separate codes  $s[0]$ ,  $s[1]$ ,  $s[2]$ .

```
for (i=0; i<3; i++) {
    s[i]= c % nlevels
    c = c DIV nlevels
}
```

where  $nlevels$  is the number of steps as shown in table B.2 "Layer II bit allocation table".

The first bit of each of the three codes has to be inverted, and the resulting numbers should be regarded as two's complement fractional numbers, where the MSB represents the value -1. The requantized values can be obtained by applying a linear formula :

$$s'' = C * (s''' + D)$$

where

$s'''$  is the fractional number;  
 $s''$  is the requantized value.

The values of the constants C and D are given in table B.4 "Layer II classes of quantization". The requantized values have to be rescaled. The multiplication factors can be found in the table B.1 "Layer I, II scalefactors", as described above. The rescaled value  $s'$  is calculated as :

$$s' = \text{factor} * s''$$

#### 2.4.3.3.5 Synthesis subband filter

If a subband has no bits allocated to it, the samples in that subband are set to zero. Each time the subband samples for all 32 subbands of one channel have been calculated, they can be applied to the synthesis subband filter and 32 consecutive audio samples can be calculated. For that purpose, the actions in the flow diagram of figure A.2 "Synthesis subband filter flow chart" have to be carried out. The coefficients  $N_{ik}$  for the matrixing operation are given by

$$N_{ik} = \cos \left[ (16 + i) (2k+1) \frac{\pi}{64} \right] \quad 0 \leq i \leq 63, 0 \leq k \leq 31$$

The coefficients  $D_i$  for the windowing operation can be found in table B.3 "Coefficients  $D_i$  of the synthesis window". One frame contains  $36 * 32 = 1152$  subband samples, which result after filtering in 1152 audio samples.

### 2.4.3.4 Layer III

Additional frequency resolution is provided by the use of a hybrid filterbank. Every band is split into 18 frequency lines by use of an MDCT. The window length of the MDCT is 36. Adaptive window switching is used to control time artifacts (pre-echoes), see the description in annex C. The frequency above which shorter blocks (better time resolution) are used can be selected. Parts of the signal below a frequency depending on "mixed\_block\_flag" are coded with better frequency resolution, parts of the signal above are coded with better time resolution.

The frequency components are quantized using a nonuniform quantizer and coded using a Huffman encoder. The Huffman coder uses one of 18 different tables (see table B.7). A buffer is used to help enhance the coding efficiency of the Huffman coder and to help in the case of pre-echo conditions (see the description in annex C). The size of the input buffer is the size of one frame at the bitrate of 160 kbits/s per channel for Layer III. The short term buffer technique used is called "bit reservoir" because it uses short-term variable bitrate with a maximum integral offset from the mean bitrate.

Each frame holds the data from 2 granules. The audio data in a frame is allocated in the following way:

- main\_data\_begin pointer
- side info for both granules (scfsi)
- side info granule 1
- side info granule 2

The header and this part of the audio data constitute the side information stream.

- scalefactors and Huffman code data granule 1
- scalefactors and Huffman code data granule 2
- ancillary data

These data constitute the main data stream. The main\_data\_begin pointer specifies a negative offset from the position of the first byte of the header.

#### 2.4.3.4.1 Decoding

The first action is the synchronization of the decoder to the incoming bitstream. This is done as in the other layers. The header information (first 32 bits including syncword) is read in just as in the other layers. The information about sampling frequency is used to select the scalefactor\_band table (see annex B.8).

#### 2.4.3.4.2 Side information

The side information must be extracted from the bitstream and stored for use during the decoding of the associated frame. The table select information is used to select the Huffman decoder table and the number of ESC-bits (linbits), according to table B.7.

#### 2.4.3.4.3 Start of main\_data

The main\_data (scalefactors, Huffman coded data and ancillary information) are not necessarily located adjacent to the side information. This is described in figure A.7.a and figure A.7.b. The beginning of the main data part is located by using the main\_data\_begin pointer of the current frame. The allocation of the main data is done in a way that all main data are resident in the input buffer when the header of the next frame is arriving in the input buffer. The decoder has to skip Header and side information when decoding the main data. It knows their positions from the bitrate\_index and padding\_bit. The length of the Header is always 4 bytes, the length of the side information is 17 bytes in mode single\_channel and 32 bytes in the other modes. Main data can span more than one block of header and side information (see figure A.7.b).

#### 2.4.3.4.4 Buffer considerations

The following rule can be used to calculate the maximum number of bits used for one granule:

The buffer length is 7 680 bits. This value is used as the maximum buffer at every bitrate. At the highest possible bitrate of Layer III (320 kbits/s per stereo signal) and sampling frequency 48 kHz the mean frame length is  $(320\ 000/48\ 000)*1\ 152 = 7\ 680$  bits. Therefore the frames must be of constant length at this bitrate and sampling frequency. At 64 kbits/s (128 kbits/s stereo) the mean granule length is

$(64\ 000/48\ 000) \cdot 576 = 768$  bit at 48 kHz sampling frequency. This means that there is a maximum deviation (short time buffer) of  $7\ 680 - 4 \cdot 768 = 4\ 608$  bits is allowed at 64 kbits/s. The actual deviation is equal to the number of bytes denoted by the `main_data_begin` offset pointer. The actual maximum deviation is  $2 \cdot 9 \cdot 8 \text{ bit} = 4\ 096$  bits. For intermediate bitrates the delay and buffer length can be calculated accordingly. The exchange of buffer between the left and right channel in a stereo bitstream is allowed without restrictions. Because of the constraint on the buffer size `main_data_begin` is always set to 0 in the case of `bitrate_index==14`, i.e. data rate 320 kbits/s per stereo signal. In this case all data are allocated between adjacent header words.

At sampling frequencies lower than 48 kHz the buffer should be constrained such that the same physical buffer size is sufficient as the one calculated for the 48 kHz case above.

#### 2.4.3.4.5 Scalefactors

The scalefactors are decoded according to the `slen1` and `slen2` which themselves are determined from the values of `scalefac_compress`. The decoded values can be used as entries into a table or used to calculate the factors for each scalefactor band directly. When decoding the second granule, the `scfsi` has to be considered. For the bands in which the corresponding `scfsi` is set to 1, the scalefactors of the first granule are also used for the second granule, therefore they are not transmitted for the second granule.

The number of bits used to encode scalefactors is called `part2_length`, and is calculated as follows.

For `block_type == 0, 1, or 3` (long blocks):

$$\text{part2\_length} = 11 \cdot \text{slen1} + 10 \cdot \text{slen2}.$$

For `block_type==2` (short blocks) and `mixed_block_flag == 0`:

$$\text{part2\_length} = 18 \cdot \text{slen1} + 18 \cdot \text{slen2}.$$

For `block_type==2` (short blocks) and `mixed_block_flag == 1`:

$$\text{part2\_length} = 17 \cdot \text{slen1} + 18 \cdot \text{slen2}.$$

These formulas are valid if `gr==0` or if `gr==1` and `scfsi[ch][scfsi_band]==0` for all `scfsi_bands`, i.e. scalefactor selection information is not used.

#### 2.4.3.4.6 Huffman decoding

All necessary information including the table which realizes the Huffman code tree can be generated from the tables in table B.7. First the `big_values` data are decoded, using the tables with the number `table_select[gr][ch][region]`. The frequency lines in region 0, region 1 and region 2 are Huffman decoded in pairs until `big_values` number of line-pairs have been decoded. The remaining Huffman code bits are decoded using the table according to `count1table_select[gr][ch]`. Decoding is done until all Huffman code bits have been decoded or until quantized values representing 576 frequency lines have been decoded, whichever comes first. If there are more Huffman code bits than necessary to decode 576 values they are regarded as stuffing bits and discarded. The variable `count1` is implicitly derived as the number of quadruples of decoded values using `count1table_select`.

#### 2.4.3.4.7 Requantizer

The nonuniform quantizer uses a power law. For each output value, "is", from the Huffman decoder, "`is4/3`" is calculated. This can be done either by table lookup or by explicit calculation.

##### 2.4.3.4.7.1 Formula for requantization and all scaling

One complete formula describes all the processing from the Huffman decoded values to the input of the synthesis filterbank. All necessary scaling factors are contained within this formula. The output data are reconstructed from requantized samples. Global gain and subblock gain values affect all values within one time window (in the case of `block_type==2`). Scalefactors and preflag further adjust the gain within each scalefactor band. An illustration can be found in figure A.8.



The following is the requantization equation for short windows. The Huffman decoded value at buffer index  $i$  is called  $is_i$ , the input to the synthesis filterbank at index  $i$  is called  $xr_i$ :

$$xr_i = \text{sign}(is_i) * |is_i| \left| \frac{4}{3} * 2^{\frac{1}{4}} (\text{global\_gain}[gr] - 210 - 8 * \text{subblock\_gain}[\text{window}][gr]) \right. \\ \left. * 2^{-(\text{scalefac\_multiplier} * \text{scalefac\_s}[gr][ch][\text{sfb}][\text{window}])} \right.$$

For long blocks, the formula is:

$$xr_i = \text{sign}(is_i) * |is_i| \left| \frac{4}{3} * 2^{\frac{1}{4}} (\text{global\_gain}[gr] - 210) \right. \\ \left. * 2^{-(\text{scalefac\_multiplier} * (\text{scalefac\_l}[\text{sfb}][ch][gr] + \text{preflag}[gr] * \text{pretab}[\text{sfb}]))} \right.$$

$\text{Pretab}[\text{sfb}]$  is a value given in the preemphasis table B.6. The constant 210 in this formula is needed to scale the output appropriately. It is a system constant. The synthesis filterbank is assumed to be implemented according to the formulas below. The range of the output values of the decoder (PCM samples) is between -1,0 and +1,0.

#### 2.4.3.4.8 Reordering

If short blocks are used ( $\text{block\_type}=2$ ), the rescaled data  $xr[\text{sfc\_band}][\text{window}][\text{freq\_line}]$  (as described in  $\text{huffmancodebits}()$  in 2.4.1.7) shall be reordered in subband order,  $xr[\text{subband}[\text{window}][\text{freq\_line}]$ , prior to the IMDCT operation.

#### 2.4.3.4.9 Stereo Processing

After requantization, the reconstructed values are processed for MS or intensity stereo modes or both, before going to the synthesis filterbank. In MS\_stereo mode, both channels of a granule must have the same  $\text{block\_type}$ .

##### 2.4.3.4.9.1 MS\_stereo mode

This mode switch (found in the header:  $\text{mode\_extension}$ ) allows switching from "independent stereo" to MS\_stereo. If MS\_stereo is enabled but intensity stereo is not enabled the entire spectrum is decoded in MS\_stereo. If both MS\_stereo and intensity stereo are enabled, the upper bound of the scalefactor bands decoded in MS\_stereo is derived from the "zero\_part" of the difference (right) channel. In this case the scalefactor band in which the last non-zero (right channel) frequency line occurs is the last scalefactor band to which the MS\_stereo equations apply. Above this bound intensity stereo may be applied if enabled in the header. The "zero\_part" of the difference channel is the part of the spectrum from " $\text{bigvalues} * 2 + \text{count1} * 4$ " (see 2.4.2.7) to the Nyquist rate.

##### 2.4.3.4.9.2 MS matrix

In MS stereo mode the values of the normalized middle/side channels  $M_i/S_i$  are transmitted instead of the left/right channel values  $L_i/R_i$ . Thus  $L_i/R_i$  are reconstructed using

$$L_i = \frac{M_i + S_i}{\sqrt{2}} \quad \text{and} \quad R_i = \frac{M_i - S_i}{\sqrt{2}}$$

The values  $M_i$  are transmitted in the left, values  $S_i$  are transmitted in the right channel.

If window switching occurs, then the M and S channels must switch synchronously.

##### 2.4.3.4.9.3 Intensity stereo mode

This mode switch (found in the header:  $\text{mode\_extension}$ ) allows switching from 'normal stereo' to intensity stereo. In Layer III, intensity stereo is not done using a pair of scalefactor  $s$  as in Layers I and II, but by specifying the magnitude (via the scalefactors of the right channel as normal) and a stereo position  $is\_pos_{sb}[\text{sfb}]$ .  $is\_pos_{sb}[\text{sfb}]$  is transmitted instead of scalefactors for the right channels. The stereo position is used to derive the left and right channel signals according to the formulas below. The lower bound of the scalefactor bands decoded in intensity stereo is derived from the "zero\_part" of the right

channel. Above this bound decoding of intensity stereo is applied using the scalefactors of the right channel as intensity stereo positions. An intensity stereo position of 7 in one scalefactor band indicates that this scalefactor band is not decoded as intensity stereo.

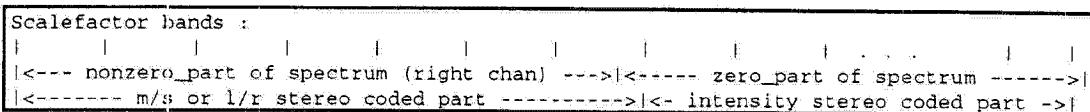

For each scalefactor band (sb) coded in intensity stereo, the following steps are executed:

- 1) the intensity stereo position  $is\_pos_{sb}$  is read from the scalefactor of the right channel.
- 2) if ( $is\_pos_{sb} == 7$ ) do not perform the following steps (illegal  $is\_pos$ ).
- 3)  $is\_ratio = \tan\left(is\_pos_{sb} * \frac{\pi}{12}\right)$ .
- 4)  $L_i := L_i * \frac{is\_ratio}{1 + is\_ratio}$  for all indices  $i$  within the actual scalefactor band sb.
- 5)  $R_i := L_i * \frac{1}{1 + is\_ratio}$  for all indices  $i$  within the actual scalefactor band sb.

**2.4.3.4.10 Synthesis filterbank**

Figure A.4. shows a block diagram including the synthesis filterbank. The frequency lines are preprocessed by the "alias reduction" scheme (see the block diagrams in in figure A.5 and in table B.9. for the coefficients) and fed into the IMDCT matrix, each 18 into one transform block. The first half of the output values are added to the stored overlap values from the last block. These values are new output values and are input values for the polyphase filterbank. The second half of the output values is stored for overlap with the next data granule. For every second subband of the polyphase filterbank every second input value is multiplied by -1 to correct for the frequency inversion of the polyphase filterbank.

**2.4.3.4.10.1 Alias reduction**

For long block\_type granules (block\_type != 2) the input to the synthesis filterbank is processed for alias reduction before processing by the IMDCT. The following pseudo code describes the alias reduction computation:

```

for (sb=1; sb<32; sb++)
  for (i=0; i<8; i++) {
    xr[18*sb-1-i] = xr[18*sb-1-i]Cs[i] - xr[18*sb+i]Ca[i]
    xr[18*sb+i] = xr[18*sb+i]Cs[i] + xr[18*sb-1-i]Ca[i]
  }

```

The indices of arrays  $xar[]$  and  $xr[]$  label the frequency lines in a granule, arranged in order of lowest frequency to highest frequency, with zero being the index of the lowest frequency line, and 575 being the index of the highest. The coefficients:  $Cs[i]$  and  $Ca[i]$  can be found in table B.9. Figures A.5 and A.6 illustrate the alias reduction computation.

Alias reduction is not applied for granules with  $block\_type == 2$  (short block).

**2.4.3.4.10.2 IMDCT**

In the following,  $n$  is the number of windowed samples (for short blocks  $n$  is 12, for long blocks  $n$  is 36). In the case of a block of type "short", each of the three short blocks is transformed separately.  $n/2$  values  $X_k$  are transformed to  $n$  values  $x_i$ . The analytical expression of the IMDCT is:

$$x_i = \sum_{k=0}^{\frac{n}{2}-1} X_k \cos\left(\frac{\pi}{2n} \left(2i + 1 + \frac{n}{2}\right)(2k + 1)\right) \text{ for } i = 0 \text{ to } n - 1$$

### 2.4.3.4.10.3 Windowing

Depending on the block\_type different shapes of windows are used.

a) *block\_type=0 (normal window)*

$$z_i = x_i \sin\left(\frac{\pi}{36}\left(i + \frac{1}{2}\right)\right) \quad \text{for } i = 0 \text{ to } 35$$

b) *block\_type=1 (start block)*

$$z_i = \begin{cases} x_i \sin\left(\frac{\pi}{36}\left(i + \frac{1}{2}\right)\right) & \text{for } i = 0 \text{ to } 17 \\ x_i & \text{for } i = 18 \text{ to } 23 \\ x_i \sin\left(\frac{\pi}{12}\left(i - 18 + \frac{1}{2}\right)\right) & \text{for } i = 24 \text{ to } 29 \\ 0 & \text{for } i = 30 \text{ to } 35 \end{cases}$$

c) *block\_type=3 (stop block)*

$$z_i = \begin{cases} 0 & \text{for } i = 0 \text{ to } 5 \\ x_i \sin\left(\frac{\pi}{12}\left(i - 6 + \frac{1}{2}\right)\right) & \text{for } i = 6 \text{ to } 11 \\ x_i & \text{for } i = 12 \text{ to } 17 \\ x_i \sin\left(\frac{\pi}{36}\left(i + \frac{1}{2}\right)\right) & \text{for } i = 18 \text{ to } 35 \end{cases}$$

d) *block\_type=2 (short block)*

Each of the three short blocks is windowed separately.

$$y_i^{(j)} = x_i^{(j)} \sin\left(\frac{\pi}{12}\left(i + \frac{1}{2}\right)\right) \quad \text{for } i = 0 \text{ to } 11, j = 0 \text{ to } 2$$

The windowed short blocks must be overlapped and concatenated.

$$z_i = \begin{cases} 0 & \text{for } i = 0 \text{ to } 5 \\ y_{i-6}^{(1)} & \text{for } i = 6 \text{ to } 11 \\ y_{i-6}^{(1)} + y_{i-12}^{(2)} & \text{for } i = 12 \text{ to } 17 \\ y_{i-12}^{(2)} + y_{i-18}^{(3)} & \text{for } i = 18 \text{ to } 23 \\ y_{i-18}^{(3)} & \text{for } i = 24 \text{ to } 29 \\ 0 & \text{for } i = 30 \text{ to } 35 \end{cases}$$

### 2.4.3.4.10.4 Overlapping and adding with previous block

The first half of the block of 36 values is overlapped with the second half of the previous block. The second half of the actual block is stored to be used in the next block:

$$\begin{aligned} \text{result}_i &= z_i + s_i & \text{for } i = 0 \text{ to } 17 \\ s_i &= z_{i+18} & \text{for } i = 0 \text{ to } 17 \end{aligned}$$

### 2.4.3.4.10.5 Compensation for frequency inversion of polyphase filterbank

The output of the overlap add consists of 18 time samples for each of the 32 polyphase subbands. If the time samples are labeled 0 through 17, with 0 being the earliest time sample, and subbands are labeled 0 through 31, with 0 being the lowest subband, then every odd time sample of every odd subband is multiplied by  $-1$  before processing by the polyphase filter bank.

**Annex A**  
(normative)  
**Diagrams**

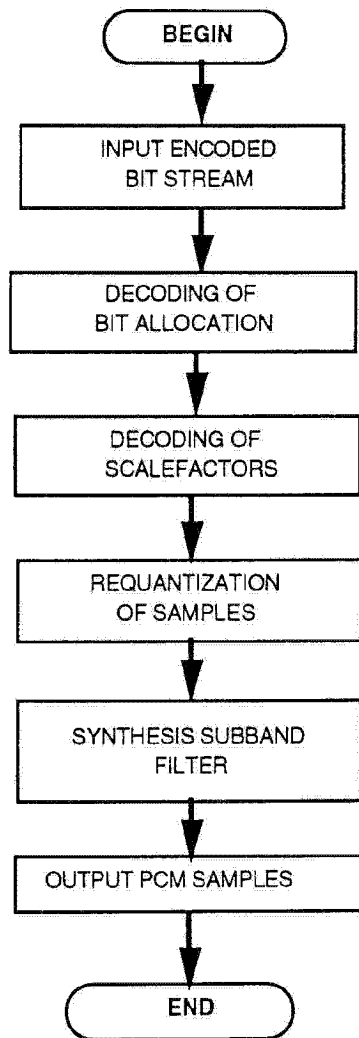

Figure A.1 -- Layer I and II decoder flow chart

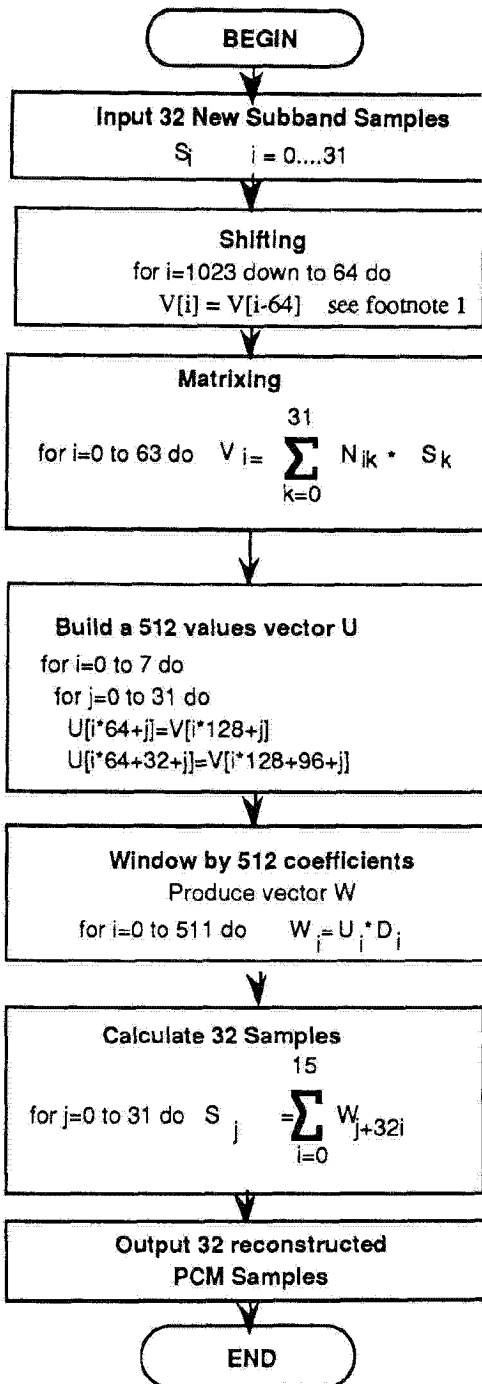

Figure A.2 -- Synthesis subband filter flow chart

<sup>1</sup> V to be initialized with zeroes during startup.

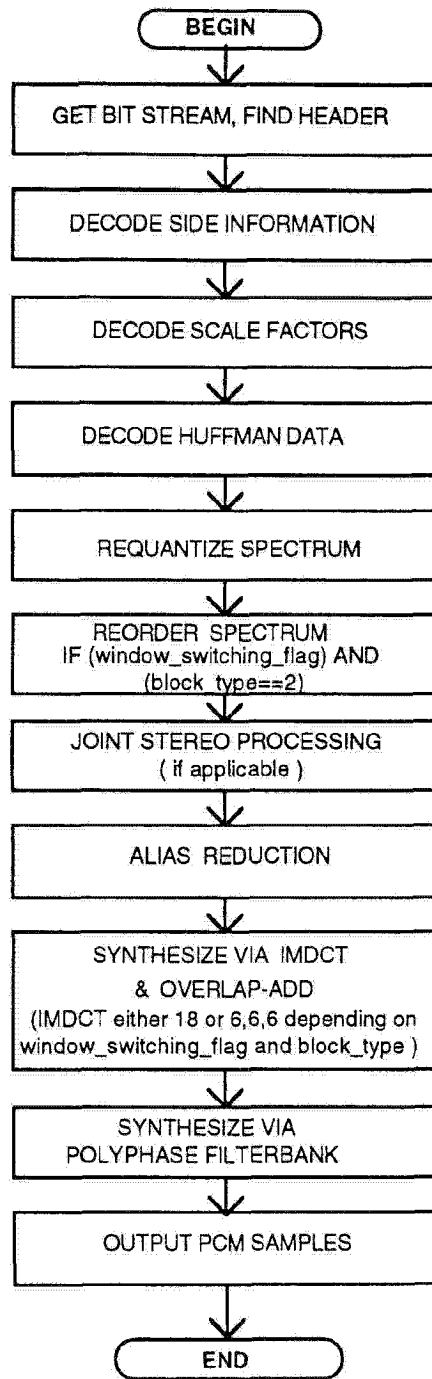
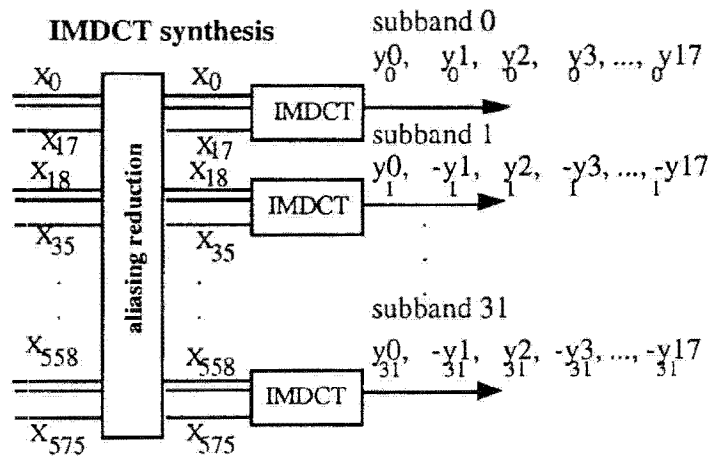
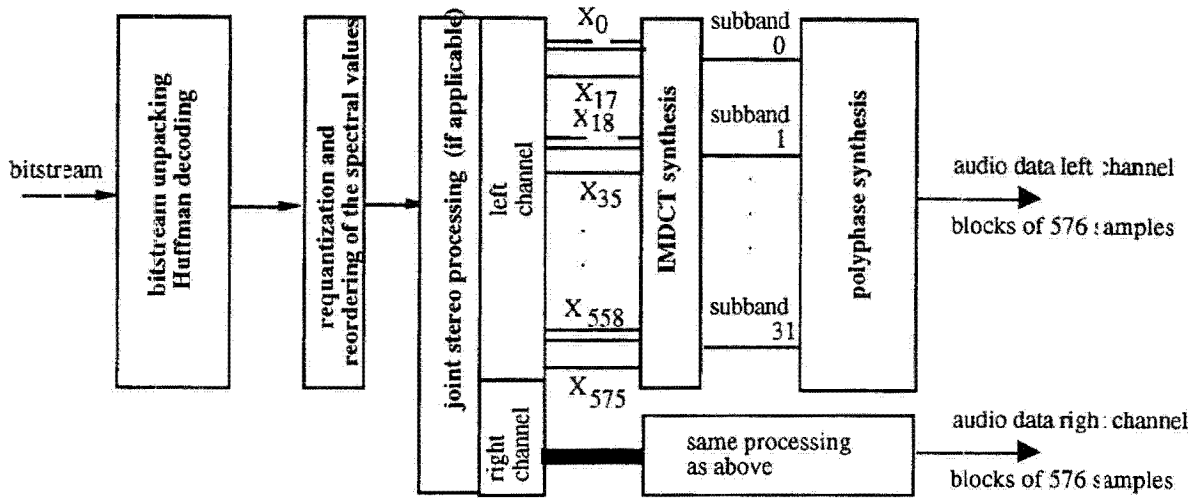

Figure A.3 -- Layer III decoder flow chart



Each IMDCT module calculates 18 output values  $y_0..y_{17}$  out of 18 input spectra values. For every other subband every other output sample should be multiplied by -1, as shown in the diagram.

Figure A.4 -- Layer III decoder diagram

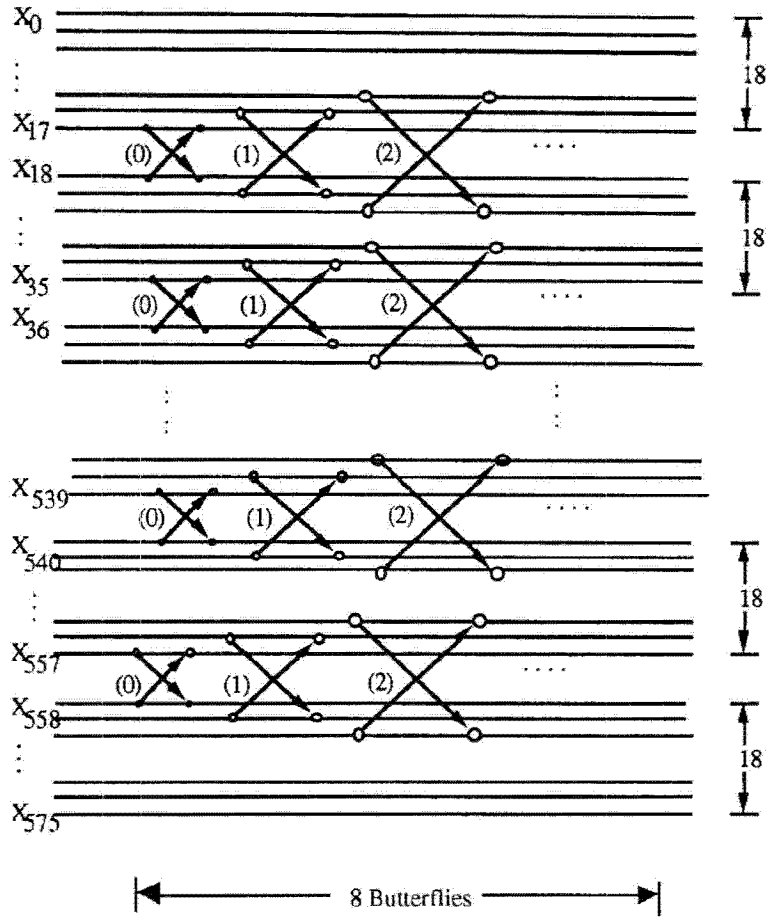

Figure A.5 -- Layer III aliasing reduction decoder diagram

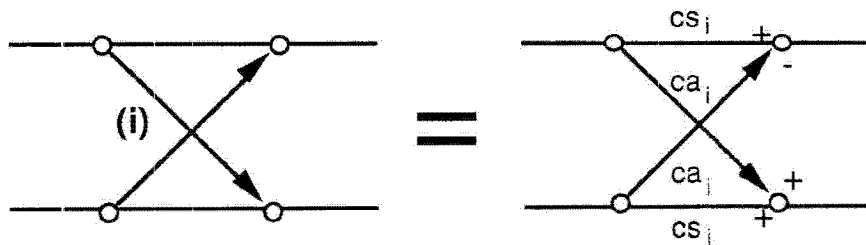

Figure A.6 -- Layer III aliasing-butterfly, decoder



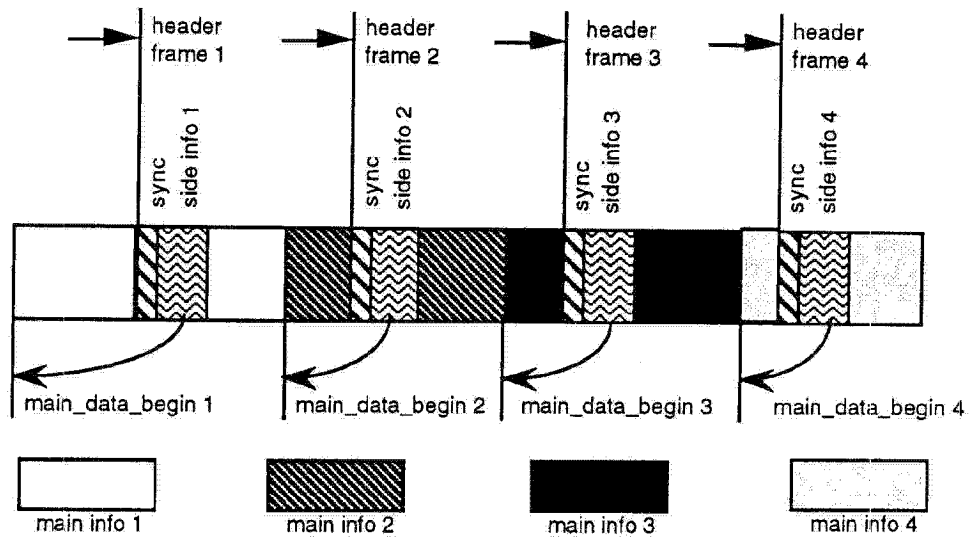
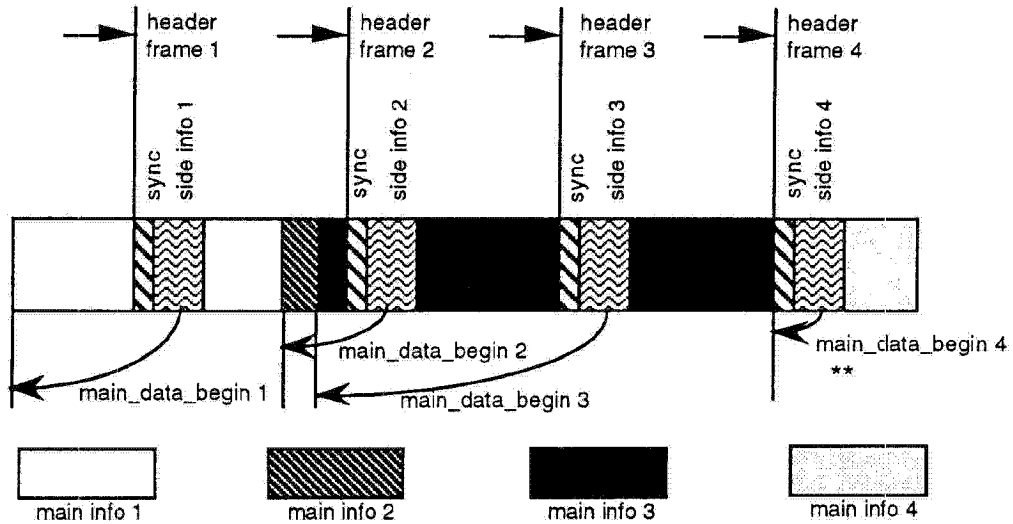

Figure A.7.a -- Layer III bitstream organization



\*\*) main\_data\_begin 4 == 0 : This signifies that main data starts directly after the side information for frame 4. This is the lower limit for main\_data\_begin; main\_data cannot start later than this point. Note that data bytes used by "sync" and "side info" are not counted by the main\_data\_begin pointer.

**Note:** 'info' means information

Figure A.7.b -- Layer III bitstream organization with peak demand at main info 3 and a small demand at main info 2.

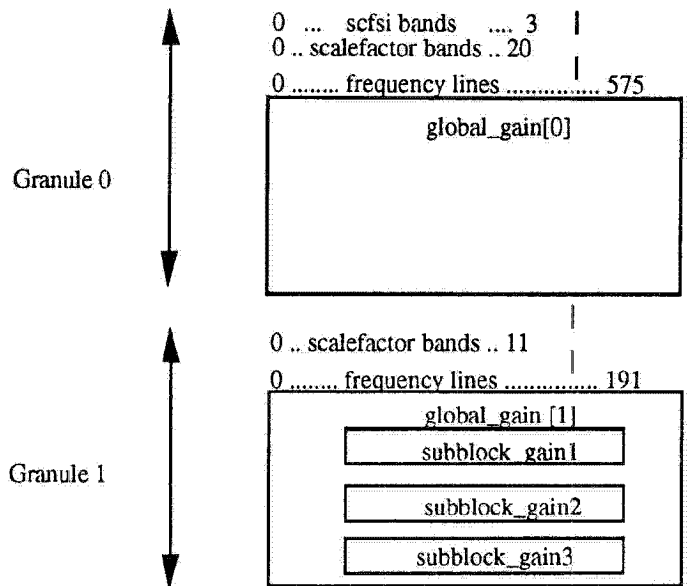

Figure A.8 -- Layer III illustration of granules for frame with block\_type == 0 in first granule and block\_type == 2 in second granule.

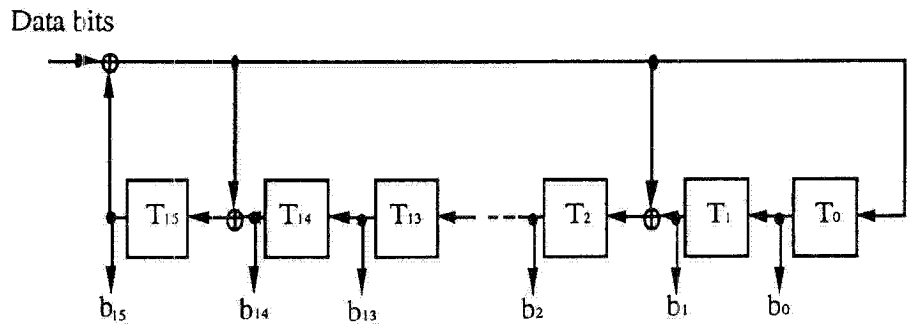

Figure A.9 -- CRC-check diagram

**Annex B**

(normative)

**Tables****Table B.1 -- Layer I,II scalefactors**

index	scalefactor	index	scalefactor
0	2,00000000000000	32	0,00123039165029
1	1,58740105196820	33	0,00097656250000
2	1,25992104989487	34	0,00077509816991
3	1,00000000000000	35	0,00061519582514
4	0,79370052598410	36	0,00048828125000
5	0,62996052494744	37	0,00038754908495
6	0,50000000000000	38	0,00030759791257
7	0,39685026299205	39	0,00024414062500
8	0,31498026247372	40	0,00019377454248
9	0,25000000000000	41	0,00015379895629
10	0,19842513149602	42	0,00012207031250
11	0,15749013123686	43	0,00009688727124
12	0,12500000000000	44	0,00007689947814
13	0,09921256574801	45	0,00006103515625
14	0,07874506561843	46	0,00004844363562
15	0,06250000000000	47	0,00003844973907
16	0,04960628287401	48	0,00003051757813
17	0,03937253280921	49	0,00002422181781
18	0,03125000000000	50	0,00001922486954
19	0,02480314143700	51	0,00001525878906
20	0,01968626640461	52	0,00001211090890
21	0,01562500000000	53	0,00000961243477
22	0,01240157071850	54	0,00000762939453
23	0,00984313320230	55	0,00000605545445
24	0,00781250000000	56	0,00000480621738
25	0,00620078535925	57	0,00000381469727
26	0,00492156660115	58	0,00000302772723
27	0,00390625000000	59	0,00000240310869
28	0,00310039267963	60	0,00000190734863
29	0,00246078330058	61	0,00000151386361
30	0,00195312500000	62	0,00000120155435
31	0,00155019633981		

**Table B.2 -- Layer II bit allocation tables**

**Table B.2a -- Possible quantization per subband**

Fs = 48 kHz Bit rates per channel = 56, 64, 80, 96, 112, 128, 160, 192 kbits/s, and free format.  
 Fs = 44,1 kHz Bit rates per channel = 56, 64, 80 kbits/s.  
 Fs = 32 kHz Bit rates per channel = 56, 64, 80 kbits/s.

sb	nbal	index															
		0	1	2	3	4	5	6	7	8	9	10	11	12	13	14	15
0	4	-	3	7	15	31	63	127	255	511	1023	2047	4095	8191	16383	32767	65535
1	4	-	3	7	15	31	63	127	255	511	1023	2047	4095	8191	16383	32767	65535
2	4	-	3	7	15	31	63	127	255	511	1023	2047	4095	8191	16383	32767	65535
3	4	-	3	5	7	9	15	31	63	127	255	511	1023	2047	4095	8191	65535
4	4	-	3	5	7	9	15	31	63	127	255	511	1023	2047	4095	8191	65535
5	4	-	3	5	7	9	15	31	63	127	255	511	1023	2047	4095	8191	65535
6	4	-	3	5	7	9	15	31	63	127	255	511	1023	2047	4095	8191	65535
7	4	-	3	5	7	9	15	31	63	127	255	511	1023	2047	4095	8191	65535
8	4	-	3	5	7	9	15	31	63	127	255	511	1023	2047	4095	8191	65535
9	4	-	3	5	7	9	15	31	63	127	255	511	1023	2047	4095	8191	65535
10	4	-	3	5	7	9	15	31	63	127	255	511	1023	2047	4095	8191	65535
11	3	-	3	5	7	9	15	31	65535								
12	3	-	3	5	7	9	15	31	65535								
13	3	-	3	5	7	9	15	31	65535								
14	3	-	3	5	7	9	15	31	65535								
15	3	-	3	5	7	9	15	31	65535								
16	3	-	3	5	7	9	15	31	65535								
17	3	-	3	5	7	9	15	31	65535								
18	3	-	3	5	7	9	15	31	65535								
19	3	-	3	5	7	9	15	31	65535								
20	3	-	3	5	7	9	15	31	65535								
21	3	-	3	5	7	9	15	31	65535								
22	3	-	3	5	7	9	15	31	65535								
23	2	-	3	5	65535												
24	2	-	3	5	65535												
25	2	-	3	5	65535												
26	2	-	3	5	65535												
27	0	-															
28	0	-															
29	0	-															
30	0	-															
31	0	-															

sblimit = 27  
 Sum of nbal = 88

Table B.2b -- Possible quantization per subband

F<sub>s</sub> = 48 kHz ----- not relevant -----  
 F<sub>s</sub> = 44,1 kHz Bitrates per channel = 96, 112, 128, 160, 192 kbits/s and free format  
 F<sub>s</sub> = 32 kHz Bitrates per channel = 96, 112, 128, 160, 192 kbits/s and free format

sb	nbal	index															
		0	1	2	3	4	5	6	7	8	9	10	11	12	13	14	15
0	4	-	3	7	15	31	63	127	255	511	1023	2047	4095	8191	16383	32767	65535
1	4	-	3	7	15	31	63	127	255	511	1023	2047	4095	8191	16383	32767	65535
2	4	-	3	7	15	31	63	127	255	511	1023	2047	4095	8191	16383	32767	65535
3	4	-	3	5	7	9	15	31	63	127	255	511	1023	2047	4095	8191	65535
4	4	-	3	5	7	9	15	31	63	127	255	511	1023	2047	4095	8191	65535
5	4	-	3	5	7	9	15	31	63	127	255	511	1023	2047	4095	8191	65535
6	4	-	3	5	7	9	15	31	63	127	255	511	1023	2047	4095	8191	65535
7	4	-	3	5	7	9	15	31	63	127	255	511	1023	2047	4095	8191	65535
8	4	-	3	5	7	9	15	31	63	127	255	511	1023	2047	4095	8191	65535
9	4	-	3	5	7	9	15	31	63	127	255	511	1023	2047	4095	8191	65535
10	4	-	3	5	7	9	15	31	63	127	255	511	1023	2047	4095	8191	65535
11	3	-	3	5	7	9	15	31	65535								
12	3	-	3	5	7	9	15	31	65535								
13	3	-	3	5	7	9	15	31	65535								
14	3	-	3	5	7	9	15	31	65535								
15	3	-	3	5	7	9	15	31	65535								
16	3	-	3	5	7	9	15	31	65535								
17	3	-	3	5	7	9	15	31	65535								
18	3	-	3	5	7	9	15	31	65535								
19	3	-	3	5	7	9	15	31	65535								
20	3	-	3	5	7	9	15	31	65535								
21	3	-	3	5	7	9	15	31	65535								
22	3	-	3	5	7	9	15	31	65535								
23	2	-	3	5	65535												
24	2	-	3	5	65535												
25	2	-	3	5	65535												
26	2	-	3	5	65535												
27	2	-	3	5	65535												
28	2	-	3	5	65535												
29	2	-	3	5	65535												
30	0	-															
31	0	-															

sblim.it = 30  
 Sum of nbal = 94

Table B.2c -- Possible quantization per subband

Fs = 48 kHz      Bitrates per channel = 32, 48 kbits/s  
 Fs = 44,1 kHz    Bitrates per channel = 32, 48 kbits/s  
 Fs = 32 kHz      ----- not relevant -----

sb	nbal	index															
		0	1	2	3	4	5	6	7	8	9	10	11	12	13	14	15
0	4	-	3	5	9	15	31	63	127	255	511	1023	2047	4095	8191	16383	32767
1	4	-	3	5	9	15	31	63	127	255	511	1023	2047	4095	8191	16383	32767
2	3	-	3	5	9	15	31	63	127								
3	3	-	3	5	9	15	31	63	127								
4	3	-	3	5	9	15	31	63	127								
5	3	-	3	5	9	15	31	63	127								
6	3	-	3	5	9	15	31	63	127								
7	3	-	3	5	9	15	31	63	127								
8	0	-															
9	0	-															
10	0	-															
11	0	-															
12	0	-															
13	0	-															
14	0	-															
15	0	-															
16	0	-															
17	0	-															
18	0	-															
19	0	-															
20	0	-															
21	0	-															
22	0	-															
23	0	-															
24	0	-															
25	0	-															
26	0	-															
27	0	-															
28	0	-															
29	0	-															
30	0	-															
31	0	-															

sblimit = 8  
 Sum of nbal = 26

**Table B.2d. -- Possible quantization per subband**

Fs = 48 kHz ----- not relevant -----  
 Fs = 44,1kHz ----- not relevant -----  
 Fs = 32 kHz Bitrates per channel = 32, 48 kbits/s.

sb	nbal	index															
		0	1	2	3	4	5	6	7	8	9	10	11	12	13	14	15
0	4	-	3	5	9	15	31	63	127	255	511	1023	2047	4095	8191	16383	32767
1	4	-	3	5	9	15	31	63	127	255	511	1023	2047	4095	8191	16383	32767
2	3	-	3	5	9	15	31	63	127								
3	3	-	3	5	9	15	31	63	127								
4	3	-	3	5	9	15	31	63	127								
5	3	-	3	5	9	15	31	63	127								
6	3	-	3	5	9	15	31	63	127								
7	3	-	3	5	9	15	31	63	127								
8	3	-	3	5	9	15	31	63	127								
9	3	-	3	5	9	15	31	63	127								
10	3	-	3	5	9	15	31	63	127								
11	3	-	3	5	9	15	31	63	127								
12	0	-															
13	0	-															
14	0	-															
15	0	-															
16	0	-															
17	0	-															
18	0	-															
19	0	-															
20	0	-															
21	0	-															
22	0	-															
23	0	-															
24	0	-															
25	0	-															
26	0	-															
27	0	-															
28	0	-															
29	0	-															
30	0	-															
31	0	-															

sblimit = 12  
 Sum of nbal = 38

Table B.3 -- Coefficients  $D_j$  of the synthesis window

D[ 0]= 0,000000000	D[ 1]=-0,000015259	D[ 2]=-0,000015259	D[ 3]=-0,000015259
D[ 4]=-0,000015259	D[ 5]=-0,000015259	D[ 6]=-0,000015259	D[ 7]=-0,000030518
D[ 8]=-0,000030518	D[ 9]=-0,000030518	D[10]=-0,000030518	D[11]=-0,000045776
D[12]=-0,000045776	D[13]=-0,000061035	D[14]=-0,000061035	D[15]=-0,000076294
D[16]=-0,000076294	D[17]=-0,000091553	D[18]=-0,000106812	D[19]=-0,000106812
D[20]=-0,000122070	D[21]=-0,000137329	D[22]=-0,000152588	D[23]=-0,000167847
D[24]=-0,000198364	D[25]=-0,000213623	D[26]=-0,000244141	D[27]=-0,000259399
D[28]=-0,000289917	D[29]=-0,000320435	D[30]=-0,000366211	D[31]=-0,000396729
D[32]=-0,000442505	D[33]=-0,000473022	D[34]=-0,000534058	D[35]=-0,000579834
D[36]=-0,000625610	D[37]=-0,000686646	D[38]=-0,000747681	D[39]=-0,000808716
D[40]=-0,000885010	D[41]=-0,000961304	D[42]=-0,001037598	D[43]=-0,001113892
D[44]=-0,001205444	D[45]=-0,001296997	D[46]=-0,001388550	D[47]=-0,001480103
D[48]=-0,001586914	D[49]=-0,001693726	D[50]=-0,001785278	D[51]=-0,001907349
D[52]=-0,002014160	D[53]=-0,002120972	D[54]=-0,002243042	D[55]=-0,002349854
D[56]=-0,002456665	D[57]=-0,002578735	D[58]=-0,002685547	D[59]=-0,002792358
D[60]=-0,002899170	D[61]=-0,002990723	D[62]=-0,003082275	D[63]=-0,003173828
D[64]= 0,003250122	D[65]= 0,003326416	D[66]= 0,003387451	D[67]= 0,003433228
D[68]= 0,003463745	D[69]= 0,003479004	D[70]= 0,003479004	D[71]= 0,003463745
D[72]= 0,003417969	D[73]= 0,003372192	D[74]= 0,003280640	D[75]= 0,003173828
D[76]= 0,003051758	D[77]= 0,002883911	D[78]= 0,002700806	D[79]= 0,002487183
D[80]= 0,002227783	D[81]= 0,001937866	D[82]= 0,001617432	D[83]= 0,001266479
D[84]= 0,000869751	D[85]= 0,000442505	D[86]=-0,000030518	D[87]=-0,000549316
D[88]=-0,001098633	D[89]=-0,001693726	D[90]=-0,002334595	D[91]=-0,003005981
D[92]=-0,003723145	D[93]=-0,004486084	D[94]=-0,005294800	D[95]=-0,006118774
D[96]=-0,007003784	D[97]=-0,007919312	D[98]=-0,008865356	D[99]=-0,009841919
D[100]=-0,010848999	D[101]=-0,011886597	D[102]=-0,012939453	D[103]=-0,014022827
D[104]=-0,015121460	D[105]=-0,016235352	D[106]=-0,017349243	D[107]=-0,018463135
D[108]=-0,019577026	D[109]=-0,020690918	D[110]=-0,021789551	D[111]=-0,022857666
D[112]=-0,023910522	D[113]=-0,024932861	D[114]=-0,025909424	D[115]=-0,026840210
D[116]=-0,027725220	D[117]=-0,028533936	D[118]=-0,029281616	D[119]=-0,029937744
D[120]=-0,030532837	D[121]=-0,031005859	D[122]=-0,031387329	D[123]=-0,031661987
D[124]=-0,031814575	D[125]=-0,031845093	D[126]=-0,031738281	D[127]=-0,031478882
D[128]= 0,031082153	D[129]= 0,030517578	D[130]= 0,029785156	D[131]= 0,028884888
D[132]= 0,027801514	D[133]= 0,026535034	D[134]= 0,025085449	D[135]= 0,023422241
D[136]= 0,021575928	D[137]= 0,019531250	D[138]= 0,017257690	D[139]= 0,014801025
D[140]= 0,012115479	D[141]= 0,009231567	D[142]= 0,006134033	D[143]= 0,002822876
D[144]=-0,000686646	D[145]=-0,004394531	D[146]=-0,008316040	D[147]=-0,012420654
D[148]=-0,016708374	D[149]=-0,021179199	D[150]=-0,025817871	D[151]=-0,030609131
D[152]=-0,035552979	D[153]=-0,040634155	D[154]=-0,045837402	D[155]=-0,051132202
D[156]=-0,056533813	D[157]=-0,061996460	D[158]=-0,067520142	D[159]=-0,073059082
D[160]=-0,078628540	D[161]=-0,084182739	D[162]=-0,089706421	D[163]=-0,095169067
D[164]=-0,100540161	D[165]=-0,105819702	D[166]=-0,110946655	D[167]=-0,115921021
D[168]=-0,120697021	D[169]=-0,125259399	D[170]=-0,129562378	D[171]=-0,133590698
D[172]=-0,137298584	D[173]=-0,140670776	D[174]=-0,143676758	D[175]=-0,146255493
D[176]=-0,148422241	D[177]=-0,150115967	D[178]=-0,151306152	D[179]=-0,151962280
D[180]=-0,152069092	D[181]=-0,151596069	D[182]=-0,150497437	D[183]=-0,148773193
D[184]=-0,146362305	D[185]=-0,143264771	D[186]=-0,139450073	D[187]=-0,134887695
D[188]=-0,129577637	D[189]=-0,123474121	D[190]=-0,116577148	D[191]=-0,108856201
D[192]= 0,100311279	D[193]= 0,090927124	D[194]= 0,080688477	D[195]= 0,069595337
D[196]= 0,087617187	D[197]= 0,044784546	D[198]= 0,031082153	D[199]= 0,016510010
D[200]= 0,001068115	D[201]=-0,015228271	D[202]=-0,032379150	D[203]=-0,050354004
D[204]=-0,069168091	D[205]=-0,088775635	D[206]=-0,109161377	D[207]=-0,130310059
D[208]=-0,152206421	D[209]=-0,174789429	D[210]=-0,198059082	D[211]=-0,221984863
D[212]=-0,246505737	D[213]=-0,271591187	D[214]=-0,297210693	D[215]=-0,323318481
D[216]=-0,349868774	D[217]=-0,376800537	D[218]=-0,404083252	D[219]=-0,431655884
D[220]=-0,459472656	D[221]=-0,487472534	D[222]=-0,515609741	D[223]=-0,543823242

Licensed to JOHN SCHAUB  
 ISO Store order #: 669832/Downloaded: 2005-05-17  
 Single user licence only, copying and networking prohibited



D[224]= -0,572036743	D[225]= -0,600219727	D[226]= -0,628295898	D[227]= -0,656219482
D[228]= -0,683914185	D[229]= -0,711318970	D[230]= -0,738372803	D[231]= -0,765029907
D[232]= -0,791213989	D[233]= -0,816864014	D[234]= -0,841949463	D[235]= -0,866363525
D[236]= -0,890090942	D[237]= -0,913055420	D[238]= -0,935195923	D[239]= -0,956481934
D[240]= -0,976852417	D[241]= -0,996246338	D[242]= -1,014617920	D[243]= -1,031936646
D[244]= -1,048156738	D[245]= -1,063217163	D[246]= -1,077117920	D[247]= -1,089782715
D[248]= -1,101211548	D[249]= -1,111373901	D[250]= -1,120223999	D[251]= -1,127746582
D[252]= -1,133926392	D[253]= -1,138763428	D[254]= -1,142211914	D[255]= -1,144287109
D[256]= 1,144989014	D[257]= 1,144287109	D[258]= 1,142211914	D[259]= 1,138763428
D[260]= 1,133926392	D[261]= 1,127746582	D[262]= 1,120223999	D[263]= 1,111373901
D[264]= 1,101211548	D[265]= 1,089782715	D[266]= 1,077117920	D[267]= 1,063217163
D[268]= 1,048156738	D[269]= 1,031936646	D[270]= 1,014617920	D[271]= 0,996246338
D[272]= 0,976852417	D[273]= 0,956481934	D[274]= 0,935195923	D[275]= 0,913055420
D[276]= 0,890090942	D[277]= 0,866363525	D[278]= 0,841949463	D[279]= 0,816864014
D[280]= 0,791213989	D[281]= 0,765029907	D[282]= 0,738372803	D[283]= 0,711318970
D[284]= 0,683914185	D[285]= 0,656219482	D[286]= 0,628295898	D[287]= 0,600219727
D[288]= 0,572036743	D[289]= 0,543823242	D[290]= 0,515609741	D[291]= 0,487472534
D[292]= 0,459472656	D[293]= 0,431655884	D[294]= 0,404083252	D[295]= 0,376800537
D[296]= 0,349868774	D[297]= 0,323318481	D[298]= 0,297210693	D[299]= 0,271591187
D[300]= 0,246505737	D[301]= 0,221984863	D[302]= 0,198059082	D[303]= 0,174789429
D[304]= 0,152206421	D[305]= 0,130310059	D[306]= 0,109161377	D[307]= 0,088775635
D[308]= 0,069168091	D[309]= 0,050354004	D[310]= 0,032379150	D[311]= 0,015228271
D[312]= -0,001068115	D[313]= -0,016510010	D[314]= -0,031082153	D[315]= -0,044784546
D[316]= -0,057617187	D[317]= -0,069595337	D[318]= -0,080688477	D[319]= -0,090927124
D[320]= 0,100311279	D[321]= 0,108856201	D[322]= 0,116577148	D[323]= 0,123474121
D[324]= 0,129577637	D[325]= 0,134887695	D[326]= 0,139450073	D[327]= 0,143264771
D[328]= 0,146362305	D[329]= 0,148773193	D[330]= 0,150497437	D[331]= 0,151596069
D[332]= 0,152069092	D[333]= 0,151962280	D[334]= 0,151306152	D[335]= 0,150115967
D[336]= 0,148422241	D[337]= 0,146255493	D[338]= 0,143676758	D[339]= 0,140670776
D[340]= 0,137298584	D[341]= 0,133590698	D[342]= 0,129562378	D[343]= 0,125259399
D[344]= 0,120697021	D[345]= 0,115921021	D[346]= 0,110946655	D[347]= 0,105819702
D[348]= 0,100540161	D[349]= 0,095169067	D[350]= 0,089706421	D[351]= 0,084182739
D[352]= 0,078628540	D[353]= 0,073059082	D[354]= 0,067520142	D[355]= 0,061996460
D[356]= 0,056533813	D[357]= 0,051132202	D[358]= 0,045837402	D[359]= 0,040634155
D[360]= 0,035552979	D[361]= 0,030609131	D[362]= 0,025817871	D[363]= 0,021179199
D[364]= 0,016708374	D[365]= 0,012420654	D[366]= 0,008316040	D[367]= 0,004394531
D[368]= 0,000686646	D[369]= -0,002822876	D[370]= -0,006134033	D[371]= -0,009231567
D[372]= -0,012115479	D[373]= -0,014801025	D[374]= -0,017257690	D[375]= -0,019531250
D[376]= -0,021575928	D[377]= -0,023422241	D[378]= -0,025085449	D[379]= -0,026535034
D[380]= -0,027801514	D[381]= -0,028884888	D[382]= -0,029785156	D[383]= -0,030517578
D[384]= 0,031082153	D[385]= 0,031478882	D[386]= 0,031738281	D[387]= 0,031845093
D[388]= 0,031814575	D[389]= 0,031661987	D[390]= 0,031387329	D[391]= 0,031005859
D[392]= 0,030532837	D[393]= 0,029937744	D[394]= 0,029281616	D[395]= 0,028533936
D[396]= 0,027725220	D[397]= 0,026840210	D[398]= 0,025909424	D[399]= 0,024932861
D[400]= 0,023910522	D[401]= 0,022857666	D[402]= 0,021789551	D[403]= 0,020690918
D[404]= 0,019577026	D[405]= 0,018463135	D[406]= 0,017349243	D[407]= 0,016235352
D[408]= 0,015121460	D[409]= 0,014022827	D[410]= 0,012939453	D[411]= 0,011886597
D[412]= 0,010848999	D[413]= 0,009841919	D[414]= 0,008865356	D[415]= 0,007919312
D[416]= 0,007003784	D[417]= 0,006118774	D[418]= 0,005294800	D[419]= 0,004485084
D[420]= 0,003723145	D[421]= 0,003005981	D[422]= 0,002334595	D[423]= 0,001693726
D[424]= 0,001098633	D[425]= 0,000549316	D[426]= 0,000030518	D[427]= -0,000442505
D[428]= -0,000869751	D[429]= -0,001266479	D[430]= -0,001617432	D[431]= -0,001937866
D[432]= -0,002227783	D[433]= -0,002487183	D[434]= -0,002700806	D[435]= -0,002883911
D[436]= -0,003051758	D[437]= -0,003173828	D[438]= -0,003280640	D[439]= -0,003372192
D[440]= -0,003417969	D[441]= -0,003463745	D[442]= -0,003479004	D[443]= -0,003479004
D[444]= -0,003463745	D[445]= -0,003433228	D[446]= -0,003387451	D[447]= -0,003326416
D[448]= 0,003250122	D[449]= 0,003173828	D[450]= 0,003082275	D[451]= 0,002990723
D[452]= 0,002899170	D[453]= 0,002792358	D[454]= 0,002685547	D[455]= 0,002578735

D[456]= 0,002456665	D[457]= 0,002349854	D[458]= 0,002243042	D[459]= 0,002120972
D[460]= 0,002014160	D[461]= 0,001907349	D[462]= 0,001785278	D[463]= 0,001693726
D[464]= 0,001586914	D[465]= 0,001480103	D[466]= 0,001388550	D[467]= 0,001296997
D[468]= 0,001205444	D[469]= 0,001113892	D[470]= 0,001037598	D[471]= 0,000961304
D[472]= 0,000885010	D[473]= 0,000808716	D[474]= 0,000747681	D[475]= 0,000686646
D[476]= 0,000625610	D[477]= 0,000579834	D[478]= 0,000534058	D[479]= 0,000473022
D[480]= 0,000442505	D[481]= 0,000396729	D[482]= 0,000366211	D[483]= 0,000320435
D[484]= 0,000289917	D[485]= 0,000259399	D[486]= 0,000244141	D[487]= 0,000213623
D[488]= 0,000198364	D[489]= 0,000167847	D[490]= 0,000152588	D[491]= 0,000137329
D[492]= 0,000122070	D[493]= 0,000106812	D[494]= 0,000106812	D[495]= 0,000091553
D[496]= 0,000076294	D[497]= 0,000076294	D[498]= 0,000061035	D[499]= 0,000061035
D[500]= 0,000045776	D[501]= 0,000045776	D[502]= 0,000030518	D[503]= 0,000030518
D[504]= 0,000030518	D[505]= 0,000030518	D[506]= 0,000015259	D[507]= 0,000015259
D[508]= 0,000015259	D[509]= 0,000015259	D[510]= 0,000015259	D[511]= 0,000015259

Table B.4 -- Layer II classes of quantization

Number of steps	C	D	grouping	Samples per codeword	Bits per codeword
3	1,3333333333	0,5000000000	yes	3	5
5	1,6000000000	0,5000000000	yes	3	7
7	1,14285714286	0,2500000000	no	1	3
9	1,7777777777	0,5000000000	yes	3	10
15	1,0666666666	0,1250000000	no	1	4
31	1,03225806452	0,0625000000	no	1	5
63	1,01587301587	0,0312500000	no	1	6
127	1,00787401575	0,0156250000	no	1	7
255	1,00392156863	0,0078125000	no	1	8
511	1,00195694716	0,0039062500	no	1	9
1023	1,00097751711	0,0019531250	no	1	10
2047	1,00048851979	0,0009765625	no	1	11
4095	1,00024420024	0,00048828125	no	1	12
8191	1,00012208522	0,00024414063	no	1	13
16383	1,00006103888	0,00012207031	no	1	14
32767	1,00003051851	0,00006103516	no	1	15
65535	1,00001525902	0,00003051758	no	1	16

Table B.5 -- Number of protected audio\_data bits

Layer	Protected Fields
I	bits 16...31 of header bit allocation
II	bits 16...31 of header bit allocation scalefactor selection information
III	bits 16...31 of header side information: - bits 0...135 of audio_data in single_channel mode - bits 0...255 of audio_data in other modes

Table B.6 -- Layer III preemphasis (pretab)

scalefactor band (cb)	0	1	2	3	4	5	6	7	8	9	10	11	12	13	14	15	16	17	18	19	20
pretab[cb]	0	0	0	0	0	0	0	0	0	0	0	1	1	1	1	2	2	3	3	3	2

**Table B.7 -- Huffman codes for Layer III**

**Huffman code table for quadruples (A)**

v w x y	hlen	hcod
0000	1	1
0001	4	0101
0010	4	0100
0011	5	00101
0100	4	0110
0101	6	000101
0110	5	00100
0111	6	000100
1000	4	0111
1001	5	00011
1010	5	00110
1011	6	000000
1100	5	00111
1101	6	000010
1110	6	000011
1111	6	000001

**Huffman code table for quadruples (B)**

v w x y	hlen	hcod
0000	4	1111
0001	4	1110
0010	4	1101
0011	4	1100
0100	4	1011
0101	4	1010
0110	4	1001
0111	4	1000
1000	4	0111
1001	4	0110
1010	4	0101
1011	4	0100
1100	4	0011
1101	4	0010
1110	4	0001
1111	4	0000

**Huffman code table 0**

linbits=0

x	y	hlen
0	0	0

**Huffman code table 1**

linbits=0

x	y	hlen	hcod
0	0	1	1
0	1	3	001
1	0	2	01
1	1	3	000

**Huffman code table 2**

linbits=0

x	y	hlen	hcod
0	0	1	1
0	1	3	010
0	2	6	000001
1	0	3	011
1	1	3	001
1	2	5	00001
2	0	5	00011
2	1	5	00010
2	2	6	000000

**Huffman code table 3**

linbits=0

x	y	hlen	hcod
0	0	2	11
0	1	2	10
0	2	6	000001
1	0	3	001
1	1	2	01
1	2	5	00001
2	0	5	00011
2	1	5	00010
2	2	6	000000

**Huffman code table 4**

not used

**Huffman code table 5**

linbits=0

x	y	hlen	hcod
0	0	1	1
0	1	3	010
0	2	6	000110
0	3	7	0000101
1	0	3	011
1	1	3	001
1	2	6	000100
1	3	7	0000100
2	0	6	000111
2	1	6	000101
2	2	7	0000111
2	3	8	00000001
3	0	7	0000110
3	1	6	000001
3	2	7	0000001
3	3	8	00000000

**Huffman code table 6**

linbits=0

x	y	hlen	hcod
0	0	3	111
0	1	3	011
0	2	5	00101
0	3	7	0000001
1	0	3	110
1	1	2	10
1	2	4	0011
1	3	5	00010
2	0	4	0101
2	1	4	0100
2	2	5	00100
2	3	6	000001
3	0	6	000011
3	1	5	00011
3	2	6	000010
3	3	7	0000000

**Huffman code table 7**

linbits=0

x	y	hlen	hcod
0	0	1	1
0	1	3	010
0	2	6	001010
0	3	8	00010011
0	4	8	00010000
0	5	9	000001010
1	0	3	011
1	1	4	0011
1	2	6	000111
1	3	7	0001010
1	4	7	0000101
1	5	8	00000011
2	0	6	001011
2	1	5	00100
2	2	7	0001101
2	3	8	00010001
2	4	8	00001000
2	5	9	000000100
3	0	7	0001100
3	1	7	0001011
3	2	8	00010010
3	3	9	000001111
3	4	9	000001011
3	5	9	000000010
4	0	7	0000111
4	1	7	0000110
4	2	8	00001001
4	3	9	000001110
4	4	9	000000011
4	5	10	0000000001
5	0	8	00000110
5	1	8	00000100
5	2	9	000000101
5	3	10	0000000011
5	4	10	0000000010
5	5	10	0000000000

Huffman code table 8

Huffman code table 9

Huffman code table 10

linbits=0

linbits=0

linbits=0

x	y	hlen	hcod
0	0	2	11
0	1	3	100
0	2	6	000110
0	3	8	00010010
0	4	8	00001100
0	5	9	000000101
1	0	3	101
1	1	2	01
1	2	4	0010
1	3	8	00010000
1	4	8	00001001
1	5	8	00000011
2	0	6	000111
2	1	4	0011
2	2	6	000101
2	3	8	00001110
2	4	8	00000111
2	5	9	000000011
3	0	8	00010011
3	1	8	00010001
3	2	8	00001111
3	3	9	000001101
3	4	9	000001010
3	5	10	0000000100
4	0	8	00001101
4	1	7	0000101
4	2	8	00001000
4	3	9	000001011
4	4	10	0000000101
4	5	10	0000000001
5	0	9	000001100
5	1	8	00000100
5	2	9	000000100
5	3	9	000000001
5	4	11	00000000001
5	5	11	00000000000

x	y	hlen	hcod
0	0	3	111
0	1	3	101
0	2	5	01001
0	3	6	001110
0	4	8	00001111
0	5	9	000000111
1	0	3	110
1	1	3	100
1	2	4	0101
1	3	5	00101
1	4	6	000110
1	5	8	00000111
2	0	4	0111
2	1	4	0110
2	2	5	01000
2	3	6	001000
2	4	7	0001000
2	5	8	00000101
3	0	6	001111
3	1	5	00110
3	2	6	001001
3	3	7	0001010
3	4	7	0000101
3	5	8	00000001
4	0	7	0001011
4	1	6	000111
4	2	7	0001001
4	3	7	0000110
4	4	8	00000100
4	5	9	000000001
5	0	8	00001110
5	1	7	0000100
5	2	8	00000110
5	3	8	00000010
5	4	9	000000110
5	5	9	000000000

x	y	hlen	hcod
0	0	1	1
0	1	3	010
0	2	6	001010
0	3	8	00010111
0	4	9	000100011
0	5	9	000011110
0	6	9	000001100
0	7	10	0000010001
1	0	3	011
1	1	4	0011
1	2	6	001000
1	3	7	0001100
1	4	8	00010010
1	5	9	000010101
1	6	8	00001100
1	7	8	00000111
2	0	6	001011
2	1	6	001001
2	2	7	0001111
2	3	8	00010101
2	4	9	000100000
2	5	10	0000101000
2	6	9	000010011
2	7	9	000000110
3	0	7	0001110
3	1	7	0001101
3	2	8	00010110
3	3	9	000100010
3	4	10	0000101110
3	5	10	0000010111
3	6	9	000010010
3	7	10	0000000111
4	0	8	00010100
4	1	8	00010011
4	2	9	000100001
4	3	10	0000101111
4	4	10	0000011011
4	5	10	0000010110
4	6	10	0000001001
4	7	10	0000000011
5	0	9	000011111
5	1	9	000010110
5	2	10	0000101001
5	3	10	0000011010
5	4	11	00000010101
5	5	11	00000010100
5	6	10	0000000101
5	7	11	00000000011
6	0	8	00001110
6	1	8	00001101
6	2	9	000001010
6	3	10	0000001011
6	4	10	0000010000
6	5	10	0000000110
6	6	11	00000000101
6	7	11	00000000001
7	0	9	000001001
7	1	8	00001000
7	2	9	000000111
7	3	10	0000001000
7	4	10	0000000100
7	5	11	00000000100
7	6	11	00000000010
7	7	11	00000000000

Huffman code table 11

Huffman code table 12

Huffman code table 13

linbits=0

linbits=0

linbits=0

x	y	hlen	hcod
0	0	2	11
0	1	3	100
0	2	5	01010
0	3	7	0011000
0	4	8	00100010
0	5	9	000100001
0	6	8	00010101
0	7	9	000001111
1	0	3	101
1	1	3	011
1	2	4	0100
1	3	6	001010
1	4	8	00100000
1	5	8	00010001
1	6	7	0001011
1	7	8	00001010
2	0	5	01011
2	1	5	00111
2	2	6	0011101
2	3	7	0010010
2	4	8	00011110
2	5	9	000011111
2	6	8	00010100
2	7	8	00000101
3	0	7	0011001
3	1	6	001011
3	2	7	0010011
3	3	9	000111011
3	4	8	00011011
3	5	10	0000010010
3	6	8	00001100
3	7	9	000000101
4	0	8	00100011
4	1	8	00100001
4	2	8	00011111
4	3	9	000111010
4	4	9	000011110
4	5	10	0000010000
4	6	9	000000111
4	7	10	0000000101
5	0	8	00011100
5	1	8	00011010
5	2	9	000100000
5	3	10	0000010011
5	4	10	0000010001
5	5	11	00000001111
5	6	10	0000001000
5	7	11	00000001110
6	0	8	00001110
6	1	7	0001100
6	2	7	0001001
6	3	8	00001101
6	4	9	000001110
6	5	10	0000001001
6	6	10	0000000100
6	7	10	0000000001
7	0	8	00001011
7	1	7	0000100
7	2	8	00000110
7	3	9	0000000110
7	4	10	00000000110
7	5	10	00000000011
7	6	10	00000000010
7	7	10	00000000000

x	y	hlen	hcod
0	0	4	1001
0	1	3	110
0	2	5	10000
0	3	7	0100001
0	4	8	00101001
0	5	9	000100111
0	6	9	000100110
0	7	9	000011010
1	0	3	111
1	1	3	101
1	2	4	0110
1	3	5	01001
1	4	7	0010111
1	5	7	0010000
1	6	8	00011010
1	7	8	00001011
2	0	5	10001
2	1	4	0111
2	2	5	01011
2	3	6	001110
2	4	7	0010101
2	5	8	00011110
2	6	7	0001010
2	7	8	00000111
3	0	6	010001
3	1	5	01010
3	2	6	001111
3	3	6	001100
3	4	7	0010010
3	5	8	00011100
3	6	8	00001110
3	7	8	00000101
4	0	7	010000
4	1	6	001101
4	2	7	0010110
4	3	7	0010011
4	4	8	00010010
4	5	8	00010000
4	6	8	00001001
4	7	9	000000101
5	0	8	00101000
5	1	7	0010001
5	2	8	00011111
5	3	8	00011101
5	4	8	00010001
5	5	9	000001101
5	6	8	00000100
5	7	9	000000010
6	0	8	00011011
6	1	7	0001100
6	2	7	0001011
6	3	8	00001111
6	4	8	00001010
6	5	9	000000111
6	6	9	000000100
6	7	10	0000000001
7	0	9	000011011
7	1	8	00001100
7	2	8	00001000
7	3	9	000001100
7	4	9	000000110
7	5	9	000000011
7	6	9	000000001
7	7	10	0000000000

x	y	hlen	hcod
0	0	1	1
0	1	4	0101
0	2	6	001110
0	3	7	0010101
0	4	8	00100010
0	5	9	000110011
0	6	9	000101110
0	7	10	0001000111
0	8	9	000101010
0	9	10	0000110100
0	10	11	00001000100
0	11	11	00000110100
0	12	12	000001000011
0	13	12	0000000101100
0	14	13	00000000101011
0	15	13	00000000010011
1	0	3	011
1	1	4	0100
1	2	6	001100
1	3	7	0010011
1	4	8	00011111
1	5	8	00011010
1	6	9	000101100
1	7	9	000100001
1	8	9	000011111
1	9	9	000011000
1	10	10	0000100000
1	11	10	0000011000
1	12	11	000000011111
1	13	12	0000000100011
1	14	12	0000000010110
1	15	12	0000000001110
2	0	6	001111
2	1	6	001101
2	2	7	0010111
2	3	8	00100100
2	4	9	000111011
2	5	9	000110001
2	6	10	0001001101
2	7	10	0001000001
2	8	9	000011101
2	9	10	0000101000
2	10	10	0000011110
2	11	11	00000101000
2	12	11	000000011011
2	13	12	0000000100001
2	14	13	00000000101010
2	15	13	00000000010000
3	0	7	0010110
3	1	7	0010100
3	2	8	00100101
3	3	9	000111101
3	4	9	000111000
3	5	10	0001001111
3	6	10	0001001001
3	7	10	0001000000
3	8	10	0000101011
3	9	11	00001001100
3	10	11	00000111000
3	11	11	000001000101
3	12	11	000000011010
3	13	12	0000000011111
3	14	13	00000000011001
3	15	13	00000000001110
4	0	8	00100011
4	1	7	0010000
4	2	9	000111100
4	3	9	000111001
4	4	10	0001100001
4	5	10	0001001011
4	6	11	00001110010

Licensed to: JOHN SCHAUB  
 ISO Store order #: 669832/Downloaded: 2005-05-17  
 Single user licence only, copying and networking prohibited

4	7	11	00001011011
4	8	10	0000110110
4	9	11	00001001001
4	10	11	00000110111
4	11	12	000000101001
4	12	12	000000110000
4	13	13	0000000110101
4	14	13	0000000010111
4	15	14	0000000011000
5	0	9	000111010
5	1	8	00011011
5	2	9	000110010
5	3	10	0001100000
5	4	10	0001001100
5	5	10	0001000110
5	6	11	00001011101
5	7	11	00001010100
5	8	11	00001001101
5	9	11	00000111010
5	10	12	000001001111
5	11	11	00000011101
5	12	13	0000001001010
5	13	13	0000000110001
5	14	14	00000000101001
5	15	14	0000000010001
6	0	9	000101111
6	1	9	000101101
6	2	10	0001001110
6	3	10	0001001010
6	4	11	00001110011
6	5	11	00001011110
6	6	11	00001011010
6	7	11	00001001111
6	8	11	00001000101
6	9	12	000001010011
6	10	12	000001000111
6	11	12	000000110010
6	12	13	0000000111011
6	13	13	0000000100110
6	14	14	00000000100100
6	15	14	00000000001111
7	0	10	0001001000
7	1	9	000100010
7	2	10	0000111000
7	3	11	00001011111
7	4	11	00001011100
7	5	11	00001010101
7	6	12	000001011011
7	7	12	000001011010
7	8	12	000001010110
7	9	12	000001001001
7	10	13	0000001001101
7	11	13	0000001000001
7	12	13	0000000110011
7	13	14	00000000101100
7	14	16	000000000101011
7	15	16	0000000000101010
8	0	9	000101011
8	1	8	00010100
8	2	9	000011110
8	3	10	0000101100
8	4	10	0000110111
8	5	11	00001001110
8	6	11	00001001000
8	7	12	000001010111
8	8	12	000001001110
8	9	12	000000111101
8	10	12	000000101110
8	11	13	0000000110110
8	12	13	0000000100101
8	13	14	00000000111110
8	14	15	00000000010100
8	15	15	00000000010000
9	0	10	0000110101
9	1	9	000011001
9	2	10	0000101001
9	3	10	0000100101

9	4	11	00000101100
9	5	11	00000111011
9	6	11	00000110110
9	7	13	0000001010001
9	8	12	000001000010
9	9	13	0000001001100
9	10	13	0000000111001
9	11	14	00000000110110
9	12	14	00000000100101
9	13	14	0000000010010
9	14	16	0000000000100111
9	15	15	00000000001011
10	0	10	0000100011
10	1	10	0000100001
10	2	10	0000011111
10	3	11	00000111001
10	4	11	00000101010
10	5	12	000001010010
10	6	12	000001001000
10	7	13	0000001010000
10	8	12	000000101111
10	9	13	0000000111010
10	10	14	00000000110111
10	11	13	0000000010101
10	12	14	0000000010110
10	13	15	000000000011010
10	14	16	0000000000100110
10	15	17	00000000000010110
11	0	11	00000110101
11	1	10	0000011001
11	2	10	0000010111
11	3	11	00000100110
11	4	12	000001000110
11	5	12	000000111100
11	6	12	000000110011
11	7	12	000000100100
11	8	13	0000000110111
11	9	13	000000011010
11	10	13	0000000100010
11	11	14	0000000010111
11	12	15	000000000011011
11	13	15	0000000000001110
11	14	15	000000000001001
11	15	16	0000000000001111
12	0	11	00000100010
12	1	11	00000100000
12	2	11	00000011100
12	3	12	000000100111
12	4	12	000000110001
12	5	13	0000001001011
12	6	12	000000011110
12	7	13	0000000110100
12	8	14	00000000110000
12	9	14	00000000101000
12	10	15	000000000110100
12	11	15	000000000011100
12	12	15	000000000010010
12	13	16	0000000000010001
12	14	16	000000000001001
12	15	16	000000000000101
13	0	12	000000101101
13	1	11	00000010101
13	2	12	000000100010
13	3	13	000000100000
13	4	13	0000000111000
13	5	13	0000000110010
13	6	14	00000000110001
13	7	14	00000000101101
13	8	14	00000000011111
13	9	14	00000000010011
13	10	14	00000000001100
13	11	15	00000000001111
13	12	16	0000000000001010
13	13	15	000000000000111
13	14	16	0000000000000110
13	15	16	0000000000000011
14	0	13	0000000110000

14	1	12	000000010111
14	2	12	000000010100
14	3	13	0000000100111
14	4	13	0000000100100
14	5	13	0000000100011
14	6	15	00000000110101
14	7	14	00000000010101
14	8	14	000000000010000
14	9	17	00000000000010111
14	10	15	000000000001101
14	11	15	000000000001010
14	12	15	000000000000110
14	13	17	00000000000000001
14	14	16	0000000000000100
14	15	16	0000000000000010
15	0	12	000000010000
15	1	12	000000001111
15	2	13	0000000010001
15	3	14	00000000011011
15	4	14	00000000011001
15	5	14	00000000010100
15	6	15	000000000011010
15	7	14	00000000001011
15	8	15	000000000010001
15	9	15	000000000001100
15	10	16	0000000000010000
15	11	16	0000000000001000
15	12	19	000000000000000001
15	13	18	000000000000000001
15	14	19	000000000000000000
15	15	16	0000000000000001

Huffman code table 14

not used

Huffman code table 15

linbits=0

x	y	hlen	head
0	0	3	111
0	1	4	1100
0	2	5	10010
0	3	7	0110101
0	4	7	0101111
0	5	8	01001100
0	6	9	001111100
0	7	9	001101100
0	8	9	001011001
0	9	10	0001111011
0	10	10	0001101100
0	11	11	00001110111
0	12	11	00001101011
0	13	11	00001010001
0	14	12	000001111010
0	15	13	000000011111
1	0	4	1101
1	1	3	101
1	2	5	10000
1	3	6	011011
1	4	7	0101110
1	5	7	0100100
1	6	8	00111101
1	7	8	00110011
1	8	8	00101010
1	9	9	001000110
1	10	9	000110100
1	11	10	0001010011
1	12	10	0001000001
1	13	10	0000101001
1	14	11	00000111011
1	15	11	00000100100
2	0	5	10011

2 1 5	10001	6 14 12	000001000110	11 11 11	00000011001
2 2 5	01111	6 15 12	000000011110	11 12 12	000000011101
2 3 6	011000	7 0 9	001101101	11 13 12	000000010010
2 4 7	0101001	7 1 8	00110101	11 14 12	000000001011
2 5 7	0100010	7 2 8	00110001	11 15 13	000000001011
2 6 8	00111011	7 3 9	001011110	12 0 11	00001110110
2 7 8	00110000	7 4 9	001011000	12 1 10	0001000100
2 8 8	00101000	7 5 9	001001011	12 2 9	000011110
2 9 9	001000000	7 6 9	001000010	12 3 10	0000110111
2 10 9	000110010	7 7 10	0001111010	12 4 10	0000110010
2 11 10	0001001110	7 8 10	0001011011	12 5 10	0000101110
2 12 10	0000111110	7 9 10	0001001001	12 6 11	00001001010
2 13 11	00001010000	7 10 10	0000111000	12 7 11	00001000001
2 14 11	00000111000	7 11 10	0000101010	12 8 11	00000110001
2 15 11	00000100001	7 12 11	00001000000	12 9 11	00000100111
3 0 6	011101	7 13 11	00000101100	12 10 11	00000011000
3 1 6	011100	7 14 11	00000010101	12 11 11	00000010000
3 2 6	011001	7 15 12	000000011001	12 12 12	000000010110
3 3 7	0101011	8 0 9	001011010	12 13 12	000000001101
3 4 7	0100111	8 1 8	00101011	12 14 13	000000001110
3 5 8	00111111	8 2 8	00101001	12 15 13	0000000000111
3 6 8	00110111	8 3 9	001001101	13 0 11	00001011011
3 7 9	001011101	8 4 9	001001001	13 1 10	0000101100
3 8 9	001001100	8 5 9	000111111	13 2 10	0000100111
3 9 9	000111011	8 6 9	000111000	13 3 10	0000100110
3 10 10	0001011101	8 7 10	0001011100	13 4 10	0000100010
3 11 10	0001001000	8 8 10	0001001101	13 5 11	00000111111
3 12 10	0000110110	8 9 10	0001000010	13 6 11	00000110100
3 13 11	00001001011	8 10 10	0000101111	13 7 11	00000101101
3 14 11	00000110010	8 11 11	00001000011	13 8 11	00000011111
3 15 11	00000011101	8 12 11	00000110000	13 9 12	000000110100
4 0 7	0110100	8 13 12	000000110101	13 10 12	000000011100
4 1 6	010110	8 14 12	000000100100	13 11 12	000000010011
4 2 7	0101010	8 15 12	000000010100	13 12 12	000000001110
4 3 7	0101000	9 0 9	001000111	13 13 12	000000001000
4 4 8	01000011	9 1 8	00100010	13 14 13	000000001001
4 5 8	00111001	9 2 9	001000011	13 15 13	0000000000011
4 6 9	001011111	9 3 9	000111100	14 0 12	000001111011
4 7 9	001001111	9 4 9	000111010	14 1 11	00000111100
4 8 9	001001000	9 5 9	000110001	14 2 11	00000111010
4 9 9	000111001	9 6 10	0001011000	14 3 11	00000110101
4 10 10	0001011001	9 7 10	0001001100	14 4 11	00000101111
4 11 10	0001000101	9 8 10	0001000011	14 5 11	00000101011
4 12 10	0000110001	9 9 11	00001101010	14 6 11	00000100000
4 13 11	00001000010	9 10 11	00001000111	14 7 11	00000010110
4 14 11	00000101110	9 11 11	00000110110	14 8 12	000000100101
4 15 11	00000011011	9 12 11	00000100110	14 9 12	000000011000
5 0 8	01001101	9 13 12	000000100111	14 10 12	000000010001
5 1 7	0100101	9 14 12	000000010111	14 11 12	000000001100
5 2 7	0100011	9 15 12	000000001111	14 12 13	0000000001111
5 3 8	01000010	10 0 10	0001101101	14 13 13	0000000001010
5 4 8	00111010	10 1 9	000110101	14 14 12	000000000010
5 5 8	00110100	10 2 9	000110011	14 15 13	0000000000001
5 6 9	001011011	10 3 9	000101111	15 0 12	000001000111
5 7 9	001001010	10 4 10	0001011010	15 1 11	00000100101
5 8 9	000111110	10 5 10	0001010010	15 2 11	00000100010
5 9 9	000110000	10 6 10	0000111010	15 3 11	00000011110
5 10 10	0001001111	10 7 10	0000111001	15 4 11	00000011100
5 11 10	0000111111	10 8 10	0000110000	15 5 11	00000010100
5 12 11	00001011010	10 9 11	00001001000	15 6 11	00000010001
5 13 11	00000111110	10 10 11	00000111001	15 7 12	000000011010
5 14 11	00000101000	10 11 11	00000101001	15 8 12	000000010101
5 15 12	000000100110	10 12 11	00000010111	15 9 12	000000010000
6 0 9	001111101	10 13 12	000000011011	15 10 12	000000001010
6 1 7	0100000	10 14 13	000000011110	15 11 12	000000000110
6 2 8	00111100	10 15 12	000000001001	15 12 13	0000000001000
6 3 8	00111000	11 0 10	0001010110	15 13 13	0000000000110
6 4 8	00110010	11 1 9	000101010	15 14 13	0000000000010
6 5 9	001011100	11 2 9	000101000	15 15 13	0000000000000
6 6 9	001001110	11 3 9	000100101		
6 7 9	001000001	11 4 10	0001000110		
6 8 9	000110111	11 5 10	0001000000		
6 9 10	0001010111	11 6 10	0000110100		
6 10 10	0001000111	11 7 10	0000101011		
6 11 10	0000110011	11 8 11	00001000110		
6 12 11	00001001001	11 9 11	00000110111		
6 13 11	00000110011	11 10 11	00000101010		



**Huffman code table 16**

linbits=1

x	y	hlen	hcod
0	0	1	1
0	1	4	0101
0	2	6	001110
0	3	8	00101100
0	4	9	0010001010
0	5	9	000111111
0	6	10	0001101110
0	7	10	0001011101
0	8	11	00010101100
0	9	11	00010010101
0	10	11	00010001010
0	11	12	000011110010
0	12	12	000011100001
0	13	12	0000110000011
0	14	13	0000101111000
0	15	9	000010001
1	0	3	011
1	1	4	0100
1	2	6	001100
1	3	7	0010100
1	4	8	00100011
1	5	9	000111110
1	6	9	000110101
1	7	9	000101111
1	8	10	0001010011
1	9	10	0001001011
1	10	10	0001000100
1	11	11	00001110111
1	12	12	000011001001
1	13	11	00001101011
1	14	12	000011001111
1	15	8	00001001
2	0	6	001111
2	1	6	001101
2	2	7	0010111
2	3	8	00100110
2	4	9	001000011
2	5	9	000111010
2	6	10	0001100111
2	7	10	0001011010
2	8	11	00010100001
2	9	10	0001001000
2	10	11	00001111111
2	11	11	00001110101
2	12	11	00001101110
2	13	12	000011010001
2	14	12	000011001110
2	15	9	000010000
3	0	8	00101101
3	1	7	0010101
3	2	9	00100111
3	3	9	001000101
3	4	9	001000000
3	5	10	0001110010
3	6	10	0001100011
3	7	10	0001010111
3	8	11	00010011110
3	9	11	00010001100
3	10	12	000011111100
3	11	12	000011010100
3	12	12	000011000111
3	13	13	0000110000011
3	14	13	0000101101101
3	15	10	0000011010
4	0	9	001001011
4	1	8	00100100
4	2	9	001000100
4	3	9	001000001
4	4	10	0001110011
4	5	10	0001100101
4	6	11	00010110011
4	7	11	00010100100
4	8	11	000100001000
4	9	12	000011100010
4	10	12	0000110000101
4	11	12	00001100001011
4	12	13	000011000010111
4	13	13	00001011111110
4	14	13	00001011010110
4	15	10	00000110100
5	0	9	001000010
5	1	8	00011110
5	2	9	000111011
5	3	9	000111000
5	4	10	0001100110
5	5	11	00010111001
5	6	11	00010101101
5	7	12	000100001001
5	8	11	00010001110
5	9	12	000011111101
5	10	12	000011101000
5	11	13	0000110010000
5	12	13	0000110000100
5	13	13	0000101111010
5	14	14	00000110111101
5	15	10	0000010000
6	0	10	000110111
6	1	9	000110110
6	2	9	000110100
6	3	10	0001100100
6	4	11	00010111000
6	5	11	00010110010
6	6	11	00010100000
6	7	11	00010000101
6	8	12	000100000001
6	9	12	000011110100
6	10	12	000011100100
6	11	12	000011011001
6	12	13	0000110000001
6	13	13	0000101101110
6	14	14	00001011001011
6	15	10	0000001010
7	0	10	0001100010
7	1	9	000110000
7	2	10	0001011011
7	3	10	0001011000
7	4	11	00010100101
7	5	11	00010011101
7	6	11	00010010100
7	7	12	000100000101
7	8	12	000011111000
7	9	13	0000110010111
7	10	13	0000110001101
7	11	13	0000101110100
7	12	13	0000101111100
7	13	15	000001101111001
7	14	15	000001101110100
7	15	10	0000001000
8	0	10	0001010101
8	1	10	0001010100
8	2	10	0001010001
8	3	11	00010011111
8	4	11	00010011100
8	5	11	00010001111
8	6	12	000100000100
8	7	12	000011111001
8	8	13	0000110101011
8	9	13	0000110010001
8	10	13	0000110001000
8	11	13	0000101111111
8	12	14	00001011010111
8	13	14	00001011001001
8	14	14	00001011000100
8	15	10	0000000111
9	0	11	00010011010
9	1	10	0001001100
9	2	10	0001001001
9	3	11	00010001101
9	4	11	00010000011
9	5	12	000011100000
9	6	12	000011001011
9	7	13	0000110101010
9	8	13	0000110010110
9	9	13	0000110001010
9	10	13	0000110000000
9	11	14	00001011011111
9	12	14	000010110111111
9	13	14	000010110101110
9	14	13	0000101100001
9	15	11	0000000100
10	0	11	00010001011
10	1	11	00010000001
10	2	10	0001000011
10	3	11	00001111101
10	4	12	000011110111
10	5	12	000011101001
10	6	12	000011100101
10	7	12	000011011011
10	8	13	0000110001001
10	9	14	00001011100111
10	10	14	00001011100001
10	11	14	00001011010000
10	12	15	000001101110101
10	13	15	000001101110010
10	14	14	00000110110111
10	15	10	0000000100
11	0	12	000011110011
11	1	11	00001111000
11	2	11	00001110110
11	3	11	00001110011
11	4	12	000011100011
11	5	12	000011011111
11	6	13	0000110001100
11	7	14	00001011101010
11	8	14	00001011100110
11	9	14	00001011100000
11	10	14	00001011010001
11	11	14	00001011001000
11	12	14	00001011000010
11	13	13	0000011011111
11	14	14	00000110110100
11	15	11	0000000010
12	0	12	000011001010
12	1	12	000011100000
12	2	12	000011011110
12	3	12	000011011010
12	4	12	000011011000
12	5	13	0000110000101
12	6	13	0000110000010
12	7	13	0000101111101
12	8	13	0000101101100
12	9	15	000001101111000
12	10	14	00000110111011
12	11	14	00001011000011
12	12	14	00000110111000
12	13	14	00000110110101
12	14	16	0000011011000000
12	15	11	00000000100
13	0	14	00001011101011
13	1	12	000011010011
13	2	12	000011010010
13	3	12	000011010000
13	4	13	0000101110010
13	5	13	0000101111011
13	6	14	00001011011110
13	7	14	00001011010011
13	8	14	0000101100010
13	9	16	0000011011000111
13	10	15	000001101110011
13	11	15	000001101101101
13	12	15	000001101101100
13	13	17	00000110110000011
13	14	15	000001101100001
13	15	11	00000000010
14	0	13	0000101111001

14	1	13	0000101110001
14	2	11	00001100110
14	3	12	000010111011
14	4	14	00001011010110
14	5	14	00001011010010
14	6	13	0000101100110
14	7	14	00001011000111
14	8	14	00001011000101
14	9	15	000001101100010
14	10	16	0000011011000110
14	11	15	000001101100111
14	12	17	00000110110000010
14	13	15	000001101100110
14	14	14	00000110110010
14	15	11	00000000000
15	0	9	000001100
15	1	8	00001010
15	2	8	00000111
15	3	9	000001011
15	4	9	000001010
15	5	10	0000010001
15	6	10	000001011
15	7	10	000001001
15	8	11	00000001101
15	9	11	00000001100
15	10	11	00000001010
15	11	11	00000000111
15	12	11	00000000101
15	13	11	00000000011
15	14	11	00000000001
15	15	8	00000011

**Huffman code table 17**

same as table 16, but linbits=2

**Huffman code table 18**

same as table 16, but linbits=3

**Huffman code table 19**

same as table 16, but linbits=4

**Huffman code table 20**

same as table 16, but linbits=6

**Huffman code table 21**

same as table 16, but linbits=8

**Huffman code table 22**

same as table 16, but linbits=10

**Huffman code table 23**

same as table 16, but linbits=13

**Huffman code table 24**

linbits=4

x	y	hlen	hcod
0	0	4	1111
0	1	4	1101
0	2	6	101110
0	3	7	1010000
0	4	8	10010010
0	5	9	100000110
0	6	9	011111000
0	7	10	0110110010
0	8	10	0110101010
0	9	11	01010011101
0	10	11	01010001101
0	11	11	01010001001
0	12	11	01001101101
0	13	11	01000000101
0	14	12	010000001000
0	15	9	001011000
1	0	4	1110
1	1	4	1100
1	2	5	10101
1	3	6	100110
1	4	7	1000111
1	5	8	10000010
1	6	8	01111010
1	7	9	011011000
1	8	9	011010001
1	9	9	011000110
1	10	10	0101000111
1	11	10	0101011001
1	12	10	0100111111
1	13	10	0100101001
1	14	10	0100010111
1	15	8	00101010
2	0	6	101111
2	1	5	10110
2	2	6	101001
2	3	7	1001010
2	4	7	1000100
2	5	8	10000000
2	6	8	01111000
2	7	9	011011101
2	8	9	011001111
2	9	9	011000010
2	10	9	010110110
2	11	10	0101010100
2	12	10	0100111011
2	13	10	0100100111
2	14	11	01000011101
2	15	7	0010010
3	0	7	1010001
3	1	6	100111
3	2	7	1001011
3	3	7	1000110
3	4	8	10000110
3	5	8	01111101
3	6	8	01110100
3	7	9	011011100
3	8	9	011001100
3	9	9	010111110
3	10	9	010110010
3	11	10	0101000101
3	12	10	0100110111
3	13	10	0100100101
3	14	10	0100001111
3	15	7	0010000
4	0	8	10010011
4	1	7	1001000
4	2	7	1000101
4	3	8	10000111
4	4	8	01111111
4	5	8	01110110
4	6	8	01110000

4	7	9	011010010
4	8	9	011001000
4	9	9	010111100
4	10	10	0101100000
4	11	10	0101000011
4	12	10	0100110010
4	13	10	0100011101
4	14	11	01000011100
4	15	7	0001110
5	0	9	100000111
5	1	7	1000010
5	2	8	10000001
5	3	8	01111110
5	4	8	01110111
5	5	8	01110010
5	6	9	011010110
5	7	9	011001010
5	8	9	011000000
5	9	9	010110100
5	10	10	0101010101
5	11	10	0100111101
5	12	10	0100101101
5	13	10	0100011001
5	14	10	0100000110
5	15	7	0001100
6	0	9	011111001
6	1	8	01111011
6	2	8	01111001
6	3	8	01110101
6	4	8	01110001
6	5	9	011010111
6	6	9	011001110
6	7	9	011000011
6	8	9	010111001
6	9	10	0101011011
6	10	10	0101001010
6	11	10	0100110100
6	12	10	0100100011
6	13	10	0100010000
6	14	11	01000001000
6	15	7	0001010
7	0	10	0110110011
7	1	8	01110011
7	2	8	01101111
7	3	8	01101101
7	4	9	011010011
7	5	9	011001011
7	6	9	011000100
7	7	9	010111011
7	8	10	0101100001
7	9	10	0101001100
7	10	10	0100111001
7	11	10	0100101010
7	12	10	0100011011
7	13	11	01000010011
7	14	11	00101111101
7	15	8	00010001
8	0	10	0110101011
8	1	9	011010100
8	2	9	011010000
8	3	9	011001101
8	4	9	011001001
8	5	9	011000001
8	6	9	010111010
8	7	9	010110001
8	8	9	010101001
8	9	10	0101000000
8	10	10	0100101111
8	11	10	0100011110
8	12	10	0100001100
8	13	11	01000000010
8	14	11	00101111001
8	15	8	00010000
9	0	10	0101001111
9	1	9	011000111
9	2	9	011000101
9	3	9	010111111

9	4	9	010111101
9	5	9	010110101
9	6	9	010101110
9	7	10	0101001101
9	8	10	0101000001
9	9	10	0100110001
9	10	10	0100100001
9	11	10	0100010011
9	12	11	01000001001
9	13	11	00101111011
9	14	11	00101110011
9	15	8	00001011
10	0	11	01010011100
10	1	9	010111000
10	2	9	010110111
10	3	9	010110011
10	4	9	010101111
10	5	10	0101011000
10	6	10	0101001011
10	7	10	0100111010
10	8	10	0100110000
10	9	10	0100100010
10	10	10	0100010101
10	11	11	01000010010
10	12	11	00101111111
10	13	11	00101110101
10	14	11	00101101110
10	15	8	00001010
11	0	11	01010001100
11	1	10	0101011010
11	2	9	010101011
11	3	9	010101000
11	4	9	010100100
11	5	10	0100111110
11	6	10	0100110101
11	7	10	0100101011
11	8	10	0100011111
11	9	10	0100010100
11	10	10	0100000111
11	11	11	01000000001
11	12	11	00101110111
11	13	11	00101110000
11	14	11	00101101010
11	15	8	00000110
12	0	11	01010001000
12	1	10	0101000010
12	2	10	0100111100
12	3	10	0100111000
12	4	10	0100110011
12	5	10	0100101110
12	6	10	0100100100
12	7	10	0100011100
12	8	10	0100001101
12	9	10	0100000101
12	10	11	01000000000
12	11	11	00101111000
12	12	11	00101110010
12	13	11	00101101100
12	14	11	00101100111
12	15	8	00000100
13	0	11	01001101100
13	1	10	0100101100
13	2	10	0100101000
13	3	10	0100100110
13	4	10	0100100000
13	5	10	0100011010
13	6	10	0100010001
13	7	10	0100001010
13	8	11	01000000011
13	9	11	00101111100
13	10	11	00101110110
13	11	11	00101110001
13	12	11	00101101101
13	13	11	00101101001
13	14	11	00101100101
13	15	8	00000010
14	0	12	010000001001

14	1	10	0100011000
14	2	10	0100010110
14	3	10	0100010010
14	4	10	0100001011
14	5	10	0100001000
14	6	10	0100000011
14	7	11	00101111110
14	8	11	00101111010
14	9	11	00101110100
14	10	11	00101101111
14	11	11	00101101011
14	12	11	00101101000
14	13	11	00101100110
14	14	11	00101100100
14	15	8	00000000
15	0	8	00101011
15	1	7	0010100
15	2	7	0010011
15	3	7	0010001
15	4	7	0001111
15	5	7	0001101
15	6	7	0001011
15	7	7	0001001
15	8	7	0000111
15	9	7	0000110
15	10	7	0000100
15	11	8	00000111
15	12	8	00000101
15	13	8	00000011
15	14	8	00000001
15	15	4	0011

**Huffman code table 25**

same as table 24, but linbits=5

**Huffman code table 26**

same as table 24, but linbits=6

**Huffman code table 27**

same as table 24, but linbits=7

**Huffman code table 28**

same as table 24, but linbits=8

**Huffman code table 29**

same as table 24, but linbits=9

**Huffman code table 30**

same as table 24, but linbits=11

**Huffman code table 31**

same as table 24, but linbits=13

**Table B.8 -- Layer III scalefactor bands**

These tables list the width of each scalefactor band. There are 21 bands at each sampling frequency for long (type 0,1 or 3) windows and 12 bands each for short windows.

**Table B.8a. -- 32kHz sampling rate**

long blocks:

scale factor band	width of band	index of start	index of end
0	4	0	3
1	4	4	7
2	4	8	11
3	4	12	15
4	4	16	19
5	4	20	23
6	6	24	29
7	6	30	35
8	8	36	43
9	10	44	53
10	12	54	65
11	16	66	81
12	20	82	101
13	24	102	125
14	30	126	155
15	38	156	193
16	46	194	239
17	56	240	295
18	68	296	363
19	84	364	447
20	102	448	549

short blocks:

scale factor band	width of band	index of start	index of end
0	4	0	3
1	4	4	7
2	4	8	11
3	4	12	15
4	6	16	21
5	8	22	29
6	12	30	41
7	16	42	57
8	20	58	77
9	26	78	103
10	34	104	137
11	42	138	179

Table B.8b. -- 44,1kHz sampling rate

long blocks:

scale factor band	width of band	index of start	index of end
0	4	0	3
1	4	4	7
2	4	8	11
3	4	12	15
4	4	16	19
5	4	20	23
6	6	24	29
7	6	30	35
8	8	36	43
9	8	44	51
10	10	52	61
11	12	62	73
12	16	74	89
13	20	90	109
14	24	110	133
15	28	134	161
16	34	162	195
17	42	196	237
18	50	238	287
19	54	288	341
20	76	342	417

short blocks:

scale factor band	width of band	index of start	index of end
0	4	0	3
1	4	4	7
2	4	8	11
3	4	12	15
4	6	16	21
5	8	22	29
6	10	30	39
7	12	40	51
8	14	52	65
9	18	66	83
10	22	84	105
11	30	106	135

Table B.8c. -- 48 kHz sampling rate

long blocks:

scale factor band	width of band	index of start	index of end
0	4	0	3
1	4	4	7
2	4	8	11
3	4	12	15
4	4	16	19
5	4	20	23
6	6	24	29
7	6	30	35
8	6	36	41
9	8	42	49
10	10	50	59
11	12	60	71
12	16	72	87
13	18	88	105
14	22	106	127
15	28	128	155
16	34	156	189
17	40	190	229
18	46	230	275
19	54	276	329
20	54	330	383

short blocks:

scale factor band	width of band	index of start	index of end
0	4	0	3
1	4	4	7
2	4	8	11
3	4	12	15
4	6	16	21
5	6	22	27
6	10	28	37
7	12	38	49
8	14	50	63
9	16	64	79
10	20	80	99
11	26	100	125

**Table B.9 -- Layer III coefficients for aliasing reduction:**

(i)	$c_i$
0	-0,6
1	-0,535
2	-0,33
3	-0,185
4	-0,095
5	-0,041
6	-0,0142
7	-0,0037

The butterfly coefficients  $cs_i$  and  $ca_i$  are calculated as follows:

$$cs_i = \frac{1}{\sqrt{1+c_i^2}}, \quad ca_i = \frac{c_i}{\sqrt{1+c_i^2}}$$

## Annex C

(informative)

### The encoding process

#### C.1 Encoder

##### C.1.1 Overview

For each of the layers, an example of one suitable encoder with the corresponding flow-diagram is given in this annex. In subsequent clauses the analysis subband filter and the layer-specific encoding techniques are described. In annex D two examples of psychoacoustic models, which are common to all layers, are described. A short introduction describes the overall philosophy.

##### C.1.1.1 Introduction

The ISO/IEC 11172-3 (MPEG-Audio) algorithm is a psychoacoustic algorithm. The figure C.1 shows the primary parts of a psychoacoustic algorithm.

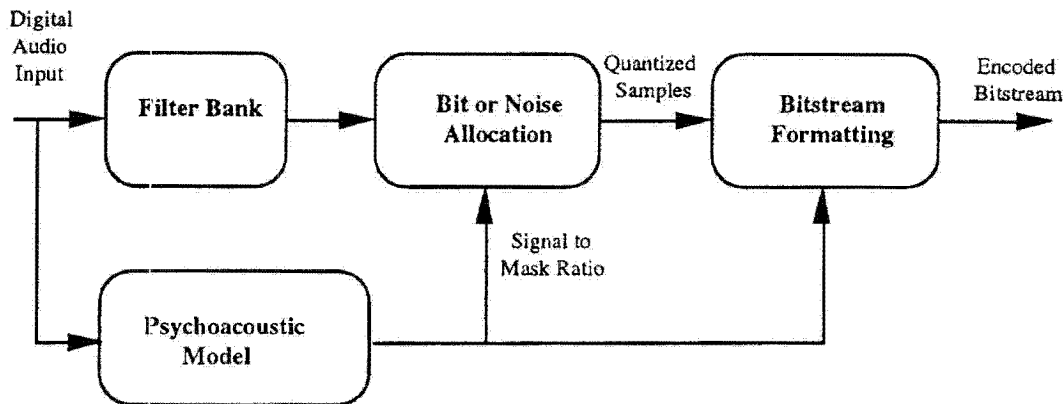

Figure C.1 -- ISO/IEC 11172-3 (MPEG-audio) encoder block diagram

The four primary parts of the psychoacoustic encoder are:

##### C.1.1.1.1 The filterbank

The filterbank does a time to frequency mapping. There are two filterbanks used in the ISO/IEC 11172-3 (MPEG-Audio) algorithm, a polyphase filterbank and a hybrid polyphase/MDCT filterbank. Each provides a specific mapping in time and frequency. These filterbanks are critically sampled (i.e. there are as many samples in the analyzed domain as there are in the time domain). These filterbanks provide the primary frequency separation for the encoder, and the reconstruction filters for the decoder. The output samples of the filterbank are quantized.

##### C.1.1.1.2 The psychoacoustic model

The psychoacoustic model calculates a just noticeable noise-level for each band in the filterbank. This noise level is used in the bit or noise allocation to determine the actual quantizers and quantizer levels. There are two psychoacoustic models presented in annex D. While they can both be applied to any layer of the ISO/IEC 11172-3 (MPEG-Audio) algorithm, in practice Model 1 has been used for Layers I and II, and Model 2 for Layer III. In both psychoacoustic models, the final output of the model is a signal-to-mask ratio (SMR) for each band (Layers I and II) or group of bands (Layer III).



### C.1.1.1.3 Bit or noise Allocation

The allocator looks at both the output samples from the filterbank and the SMR's from the psychoacoustic model, and adjusts the bit allocation (Layers I and II) or noise allocation (Layer III) in order simultaneously to meet both the bitrate requirements and the masking requirements. At low bitrates, these methods attempt to spend bits in a fashion that is psychoacoustically inoffensive when they cannot meet the psychoacoustic demand at the required bitrate.

### C.1.1.1.4 The bitstream formatter

The bitstream formatter takes the quantized filterbank outputs, together with the bit allocation (Layers I and II) or noise allocation (Layer III) and other required side information, and encodes and formats that information in an efficient fashion. In the case of Layer III, the Huffman codes are also inserted at this point.

### C.1.1.2 The filterbank

In Layers I and II, a filterbank with 32 subbands is used. In each subband, 12 or 36 samples are grouped for processing. In Layer III, the filterbank has a signal-dependent resolution, where there are either 6x32 or 18x32 frequency bands. In the case where there are 6x32 frequency samples, the 3 sets of each frequency are quantized separately.

### C.1.1.3 Bit or noise allocation method

There are two different bitrate control methods explained in this annex. In Layers I and II this method is a bit allocation process, i.e. a number of bits is assigned to each sample (or group of samples) in each subband. The method for Layer III is a noise-allocation loop, where the quantizers are varied in an organized fashion, and the variable to be controlled is actually the injected noise. In either case, the result is a set of quantization parameters and quantized output samples that are given to the bitstream formatter.

### C.1.1.4 Bitstream formatting

The bitstream formatter varies from layer to layer. In Layers I and II, a fixed PCM code is used for each subband sample, with the exception that in Layer II quantized samples may be grouped. In Layer III, Huffman codes are used to represent the quantized frequency samples. These Huffman codes are variable-length codes that allow for more efficient bitstream representation of the quantized samples at the cost of additional complexity.

### C.1.2 Input high-pass filter

The encoding algorithms provide a frequency response down to d.c. However, in applications where this is not a requirement, it is recommended that a high-pass filter be included at the input of the encoder. The cut-off frequency should be in the range of 2 to 10 Hz.

The application of such a high-pass filter avoids an unnecessarily high bitrate requirement for the lowest subband and increases the overall audio quality.

### C.1.3 Analysis subband filter

An analysis subband filterbank is used to split the broadband signal with sampling frequency  $f_s$  into 32 equally spaced subbands with sampling frequencies  $f_s/32$ . The flow chart of this process with the appropriate formulas is given in figure C.4 "Analysis Subband Filter Flow Chart". The analysis subband filtering includes the following steps:

- Input 32 audio samples.
- Build an input sample vector  $X$  of 512 elements. The 32 audio samples are shifted in at positions 0 to 31, the most recent one at position 0, and the 32 oldest elements are shifted out.
- Window vector  $X$  by vector  $C$ . The coefficients are to be found in table C.1.
- Calculate the 64 values  $Y_i$  according to the formula given in the flow chart.
- Calculate the 32 subband samples  $S_i$  by matrixing. The coefficients for the matrix can be calculated by the following formula:

$$M_{ik} = \cos [(2i + 1)(k - 16)\pi/64], \quad \text{for } i = 0 \text{ to } 31, \text{ and } k = 0 \text{ to } 63.$$

Table C.1 -- Coefficients  $C_i$  of the Analysis Window

C[ 0] = 0,000000000	C[ 1] = -0,000000477	C[ 2] = -0,000000477	C[ 3] = -0,000000477
C[ 4] = -0,000000477	C[ 5] = -0,000000477	C[ 6] = -0,000000477	C[ 7] = -0,000000954
C[ 8] = -0,000000954	C[ 9] = -0,000000954	C[ 10] = -0,000000954	C[ 11] = -0,000001431
C[ 12] = -0,000001431	C[ 13] = -0,000001907	C[ 14] = -0,000001907	C[ 15] = -0,000002384
C[ 16] = -0,000002384	C[ 17] = -0,000002861	C[ 18] = -0,000003338	C[ 19] = -0,000003338
C[ 20] = -0,000003815	C[ 21] = -0,000004292	C[ 22] = -0,000004768	C[ 23] = -0,000005245
C[ 24] = -0,000005199	C[ 25] = -0,000006676	C[ 26] = -0,000007629	C[ 27] = -0,000008106
C[ 28] = -0,000009060	C[ 29] = -0,000010014	C[ 30] = -0,000011444	C[ 31] = -0,000012398
C[ 32] = -0,000013828	C[ 33] = -0,000014782	C[ 34] = -0,000016689	C[ 35] = -0,000018120
C[ 36] = -0,000019550	C[ 37] = -0,000021458	C[ 38] = -0,000023365	C[ 39] = -0,000025272
C[ 40] = -0,000027657	C[ 41] = -0,000030041	C[ 42] = -0,000032425	C[ 43] = -0,000034809
C[ 44] = -0,000037670	C[ 45] = -0,000040531	C[ 46] = -0,000043392	C[ 47] = -0,000046253
C[ 48] = -0,000049591	C[ 49] = -0,000052929	C[ 50] = -0,000055790	C[ 51] = -0,000059605
C[ 52] = -0,000062943	C[ 53] = -0,000066280	C[ 54] = -0,000070095	C[ 55] = -0,000073433
C[ 56] = -0,000076771	C[ 57] = -0,000080585	C[ 58] = -0,000083923	C[ 59] = -0,000087261
C[ 60] = -0,000090599	C[ 61] = -0,000093460	C[ 62] = -0,000096321	C[ 63] = -0,000099182
C[ 64] = 0,000101566	C[ 65] = 0,000103951	C[ 66] = 0,000105858	C[ 67] = 0,000107288
C[ 68] = 0,000108242	C[ 69] = 0,000108719	C[ 70] = 0,000108719	C[ 71] = 0,000108242
C[ 72] = 0,000106812	C[ 73] = 0,000105381	C[ 74] = 0,000102520	C[ 75] = 0,000099182
C[ 76] = 0,000095367	C[ 77] = 0,000090122	C[ 78] = 0,000084400	C[ 79] = 0,000077724
C[ 80] = 0,000069618	C[ 81] = 0,000060558	C[ 82] = 0,000050545	C[ 83] = 0,000039577
C[ 84] = 0,000027180	C[ 85] = 0,000013828	C[ 86] = -0,000000954	C[ 87] = -0,000017166
C[ 88] = -0,000034332	C[ 89] = -0,000052929	C[ 90] = -0,000072956	C[ 91] = -0,000093937
C[ 92] = -0,000116348	C[ 93] = -0,000140190	C[ 94] = -0,000165462	C[ 95] = -0,000191212
C[ 96] = -0,000218868	C[ 97] = -0,000247478	C[ 98] = -0,000277042	C[ 99] = -0,000307560
C[100] = -0,000339031	C[101] = -0,000371456	C[102] = -0,000404358	C[103] = -0,000438213
C[104] = -0,000472546	C[105] = -0,000507355	C[106] = -0,000542164	C[107] = -0,000576973
C[108] = -0,000611782	C[109] = -0,000646591	C[110] = -0,000680923	C[111] = -0,000714302
C[112] = -0,000747204	C[113] = -0,000779152	C[114] = -0,000809669	C[115] = -0,000838757
C[116] = -0,000866413	C[117] = -0,000891685	C[118] = -0,000915051	C[119] = -0,000935555
C[120] = -0,000954151	C[121] = -0,000968933	C[122] = -0,000980854	C[123] = -0,000989437
C[124] = -0,000994205	C[125] = -0,000995159	C[126] = -0,000991821	C[127] = -0,000983715
C[128] = 0,000971317	C[129] = 0,000953674	C[130] = 0,000930786	C[131] = 0,000902653
C[132] = 0,000868797	C[133] = 0,000829220	C[134] = 0,000783920	C[135] = 0,000731945
C[136] = 0,000674248	C[137] = 0,000610352	C[138] = 0,000539303	C[139] = 0,000462532
C[140] = 0,000378609	C[141] = 0,000288486	C[142] = 0,000191689	C[143] = 0,000088215
C[144] = -0,000021458	C[145] = -0,000137329	C[146] = -0,000259876	C[147] = -0,000388145
C[148] = -0,000522137	C[149] = -0,000661850	C[150] = -0,000806808	C[151] = -0,000956535
C[152] = -0,001111031	C[153] = -0,001269817	C[154] = -0,001432419	C[155] = -0,001597681
C[156] = -0,001766682	C[157] = -0,001937389	C[158] = -0,002110004	C[159] = -0,002283096
C[160] = -0,002457142	C[161] = -0,002630711	C[162] = -0,002803326	C[163] = -0,002974033
C[164] = -0,003141880	C[165] = -0,003306866	C[166] = -0,003467083	C[167] = -0,003622532
C[168] = -0,003771782	C[169] = -0,003914356	C[170] = -0,004048824	C[171] = -0,004174709
C[172] = -0,004290581	C[173] = -0,004395962	C[174] = -0,004489899	C[175] = -0,004570484
C[176] = -0,004638195	C[177] = -0,004691124	C[178] = -0,004728317	C[179] = -0,004748821
C[180] = -0,004752159	C[181] = -0,004737377	C[182] = -0,004703045	C[183] = -0,004649162
C[184] = -0,004573822	C[185] = -0,004477024	C[186] = -0,004357815	C[187] = -0,004215240
C[188] = -0,004049301	C[189] = -0,003858566	C[190] = -0,003643036	C[191] = -0,003401756
C[192] = 0,003134727	C[193] = 0,002841473	C[194] = 0,002521515	C[195] = 0,002174854
C[196] = 0,001800537	C[197] = 0,001399517	C[198] = 0,000971317	C[199] = 0,000515938
C[200] = 0,000033379	C[201] = -0,000475883	C[202] = -0,001011848	C[203] = -0,001573563
C[204] = -0,002161503	C[205] = -0,002774239	C[206] = -0,003411293	C[207] = -0,004072189
C[208] = -0,004756451	C[209] = -0,005462170	C[210] = -0,006189346	C[211] = -0,006937027
C[212] = -0,007703304	C[213] = -0,008487225	C[214] = -0,009287834	C[215] = -0,010103703
C[216] = -0,010933399	C[217] = -0,011775017	C[218] = -0,012627602	C[219] = -0,013489246
C[220] = -0,014358521	C[221] = -0,015233517	C[222] = -0,016112804	C[223] = -0,016994476
C[224] = -0,017876148	C[225] = -0,018756866	C[226] = -0,019634247	C[227] = -0,020506859
C[228] = -0,021372318	C[229] = -0,022228718	C[230] = -0,023074150	C[231] = -0,023907185
C[232] = -0,024725437	C[233] = -0,025527000	C[234] = -0,026310921	C[235] = -0,027073860
C[236] = -0,027815342	C[237] = -0,028532982	C[238] = -0,029224873	C[239] = -0,029890060
C[240] = -0,030526638	C[241] = -0,031132698	C[242] = -0,031706810	C[243] = -0,032248020
C[244] = -0,032754898	C[245] = -0,033225536	C[246] = -0,033659935	C[247] = -0,034055710
C[248] = -0,034412861	C[249] = -0,034730434	C[250] = -0,035007000	C[251] = -0,035242081
C[252] = -0,035435200	C[253] = -0,035586357	C[254] = -0,035694122	C[255] = -0,035758972
C[256] = 0,035780907	C[257] = 0,035758972	C[258] = 0,035694122	C[259] = 0,035586357
C[260] = 0,035435200	C[261] = 0,035242081	C[262] = 0,035007000	C[263] = 0,034730434
C[264] = 0,034412861	C[265] = 0,034055710	C[266] = 0,033659935	C[267] = 0,033225536
C[268] = 0,032754898	C[269] = 0,032248020	C[270] = 0,031706810	C[271] = 0,031132698
C[272] = 0,030526638	C[273] = 0,029890060	C[274] = 0,029224873	C[275] = 0,028532982
C[276] = 0,027815342	C[277] = 0,027073860	C[278] = 0,026310921	C[279] = 0,025527000
C[280] = 0,024725437	C[281] = 0,023907185	C[282] = 0,023074150	C[283] = 0,022228718
C[284] = 0,021372318	C[285] = 0,020506859	C[286] = 0,019634247	C[287] = 0,018756866
C[288] = 0,017876148	C[289] = 0,016994476	C[290] = 0,016112804	C[291] = 0,015233517

C[292]= 0,014358521	C[293]= 0,013489246	C[294]= 0,012627602	C[295]= 0,011775017
C[296]= 0,010933399	C[297]= 0,010103703	C[298]= 0,009287834	C[299]= 0,008487225
C[300]= 0,007703304	C[301]= 0,006937027	C[302]= 0,006189346	C[303]= 0,005462170
C[304]= 0,004756451	C[305]= 0,004072189	C[306]= 0,003411293	C[307]= 0,002774239
C[308]= 0,002161503	C[309]= 0,001573563	C[310]= 0,001011848	C[311]= 0,000475883
C[312]=-0,000033379	C[313]=-0,000515938	C[314]=-0,000971317	C[315]=-0,001399517
C[316]=-0,001800537	C[317]=-0,002174854	C[318]=-0,002521515	C[319]=-0,002841473
C[320]= 0,003134727	C[321]= 0,003401756	C[322]= 0,003643036	C[323]= 0,003858566
C[324]= 0,004049301	C[325]= 0,004215240	C[326]= 0,004357815	C[327]= 0,004477024
C[328]= 0,004573822	C[329]= 0,004649162	C[330]= 0,004703045	C[331]= 0,004737377
C[332]= 0,004752159	C[333]= 0,004748821	C[334]= 0,004728317	C[335]= 0,004691124
C[336]= 0,004638195	C[337]= 0,004570484	C[338]= 0,004489899	C[339]= 0,004395962
C[340]= 0,004290581	C[341]= 0,004174709	C[342]= 0,004048824	C[343]= 0,003914356
C[344]= 0,003771782	C[345]= 0,003622532	C[346]= 0,003467083	C[347]= 0,003306866
C[348]= 0,003141880	C[349]= 0,002974033	C[350]= 0,002803326	C[351]= 0,002630711
C[352]= 0,002457142	C[353]= 0,002283096	C[354]= 0,002110004	C[355]= 0,001937389
C[356]= 0,001766682	C[357]= 0,001597881	C[358]= 0,001432419	C[359]= 0,001269817
C[360]= 0,001111031	C[361]= 0,000956535	C[362]= 0,000806808	C[363]= 0,000661850
C[364]= 0,000522137	C[365]= 0,000388145	C[366]= 0,000259876	C[367]= 0,000137329
C[368]= 0,000021458	C[369]=-0,000088215	C[370]=-0,000191689	C[371]=-0,000288486
C[372]=-0,000378609	C[373]=-0,000462532	C[374]=-0,000539303	C[375]=-0,000610352
C[376]=-0,000674248	C[377]=-0,000731945	C[378]=-0,000783920	C[379]=-0,000829220
C[380]=-0,000868797	C[381]=-0,000902653	C[382]=-0,000930786	C[383]=-0,000953674
C[384]= 0,000971317	C[385]= 0,000983715	C[386]= 0,000991821	C[387]= 0,000995159
C[388]= 0,000994205	C[389]= 0,000989437	C[390]= 0,000980854	C[391]= 0,000968933
C[392]= 0,000954151	C[393]= 0,000935555	C[394]= 0,000915051	C[395]= 0,000891685
C[396]= 0,000866413	C[397]= 0,000838757	C[398]= 0,000809669	C[399]= 0,000779152
C[400]= 0,000747204	C[401]= 0,000714302	C[402]= 0,000680923	C[403]= 0,000646591
C[404]= 0,000611782	C[405]= 0,000576973	C[406]= 0,000542164	C[407]= 0,000507355
C[408]= 0,000472546	C[409]= 0,000438213	C[410]= 0,000404358	C[411]= 0,000371456
C[412]= 0,000339031	C[413]= 0,000307560	C[414]= 0,000277042	C[415]= 0,000247478
C[416]= 0,000218868	C[417]= 0,000191212	C[418]= 0,000165462	C[419]= 0,000140190
C[420]= 0,000116348	C[421]= 0,000093937	C[422]= 0,000072956	C[423]= 0,000052929
C[424]= 0,000034332	C[425]= 0,000017166	C[426]= 0,000000954	C[427]=-0,000013828
C[428]=-0,000027180	C[429]=-0,000039577	C[430]=-0,000050545	C[431]=-0,000060558
C[432]=-0,000069618	C[433]=-0,000077724	C[434]=-0,000084400	C[435]=-0,000090122
C[436]=-0,000095367	C[437]=-0,000099182	C[438]=-0,000102520	C[439]=-0,000105381
C[440]=-0,000106812	C[441]=-0,000108242	C[442]=-0,000108719	C[443]=-0,000108719
C[444]=-0,000108242	C[445]=-0,000107288	C[446]=-0,000105858	C[447]=-0,000103951
C[448]= 0,000101566	C[449]= 0,000099182	C[450]= 0,000096321	C[451]= 0,000093460
C[452]= 0,000090599	C[453]= 0,000087261	C[454]= 0,000083923	C[455]= 0,000080585
C[456]= 0,000076771	C[457]= 0,000073433	C[458]= 0,000070095	C[459]= 0,000066280
C[460]= 0,000062943	C[461]= 0,000059605	C[462]= 0,000055790	C[463]= 0,000052929
C[464]= 0,000049591	C[465]= 0,000046253	C[466]= 0,000043392	C[467]= 0,000040531
C[468]= 0,000037670	C[469]= 0,000034809	C[470]= 0,000032425	C[471]= 0,000030041
C[472]= 0,000027657	C[473]= 0,000025272	C[474]= 0,000023365	C[475]= 0,000021458
C[476]= 0,000019550	C[477]= 0,000018120	C[478]= 0,000016689	C[479]= 0,000014782
C[480]= 0,000013828	C[481]= 0,000012398	C[482]= 0,000011444	C[483]= 0,000010014
C[484]= 0,000009060	C[485]= 0,000008106	C[486]= 0,000007629	C[487]= 0,000006676
C[488]= 0,000006199	C[489]= 0,000005245	C[490]= 0,000004768	C[491]= 0,000004292
C[492]= 0,000003815	C[493]= 0,000003338	C[494]= 0,000003338	C[495]= 0,000002861
C[496]= 0,000002384	C[497]= 0,000002384	C[498]= 0,000001907	C[499]= 0,000001907
C[500]= 0,000001431	C[501]= 0,000001431	C[502]= 0,000000954	C[503]= 0,000000954
C[504]= 0,000000954	C[505]= 0,000000954	C[506]= 0,000000477	C[507]= 0,000000477
C[508]= 0,000000477	C[509]= 0,000000477	C[510]= 0,000000477	C[511]= 0,000000477

### C.1.4 Psychoacoustic models

Two examples of psychoacoustic models are presented in annex D, "Psychoacoustic models".

### C.1.5 Encoding

#### C.1.5.1 Layer I encoding

##### C.1.5.1.1 Introduction

This clause describes a possible Layer I encoding method. The description is made with reference to figure C.5, "Layer I, II Encoder Flow Chart".

##### C.1.5.1.2 Psychoacoustic model

The calculation of the psychoacoustic parameters can be done either with Psychoacoustic Model 1 described in clause D.1, or with Psychoacoustic Model 2 as described in D.2. The FFT shiftlength equals 384 samples. Either model provides the signal-to-mask ratio for every subband.

##### C.1.5.1.3 Analysis subband filtering

The subband analysis is described in the clause C.1.3, "Analysis subband filter".

##### C.1.5.1.4 Scalefactor calculation

The calculation of the scalefactor for each subband is performed every 12 subband samples. The maximum of the absolute value of these 12 samples is determined. The lowest value in table B.1, "Layer I, II Scalefactors", which is larger than this maximum is used as the scalefactor.

##### C.1.5.1.5 Coding of scalefactors

The index in the table B.1, "Layer I, II Scalefactors" is represented by 6 bits, MSB first. The scalefactor is transmitted only if a non-zero number of bits has been allocated to the subband.

##### C.1.5.1.6 Bit allocation

Before adjustment to a fixed bitrate, the number of bits that are available for coding the samples and the scalefactors must be determined. This number can be obtained by subtracting from the total number of bits available "cb", the number of bits needed for the header "bhdr" (32 bits), the CRC checkword "bcrc" if used (16 bits), the bit allocation "bbal", and the number of bits required for ancillary data "banc":

$$adb = cb - (bhdr + bcrc + bbal + banc)$$

The resulting number of bits can be used to code the subband samples and the scalefactors. The principle used in the allocation procedure is minimization of the total noise-to-mask ratio over the frame with the constraint that the number of bits used does not exceed the number of bits available for that frame. The possible number of bits allocated to one sample can be found in the table in 2.4.2.5 of the main part of the audio standard (Audio data, Layer I); the range is 0...15 bits, excluding an allocation of 1 bit.

The allocation procedure is an iterative procedure, where in each iteration step the number of levels of the subband samples of greatest benefit is increased.

First the mask-to-noise ratio "MNR" for each subband is calculated by subtracting from the signal-to-noise-ratio "SNR" the signal-to-mask-ratio "SMR":

$$MNR = SNR - SMR$$

The signal-to-noise-ratio can be found in the table C.2, "Layer I Signal-to-Noise Ratio". The signal-to-mask-ratio is the output of the psychoacoustic model.

Then zero bits are allocated to the samples and the scalefactors. The number of bits for the samples "bspl" and the number of bits for the scalefactors "bscf" are set to zero. Next an iterative procedure is started. Each iteration loop contains the following steps :

- Determination of the minimal MNR of all subbands.
- The accuracy of the quantization of the subband with the minimal MNR is increased by using the next higher number of bits.
- The new MNR of this subband is calculated.
- bspl is updated according to the additional number of bits required. If a non-zero number of bits is assigned to a subband for the first time, bscf has to be incremented by 6 bits. Then adb is calculated again using the formula:

$$adb = cb - (bhdr + bcrs + bbal + bscf + bspl + banc)$$

The iterative procedure is repeated as long as adb is not less than any possible increase of bspl and bscf within one loop.

#### C.1.5.1.7 Quantization and encoding of subband samples

A linear quantizer with a symmetric zero representation is used to quantize the subband samples. This representation prevents small value changes around zero from quantizing to different levels. Each of the subband samples is normalized by dividing its value by the scalefactor to obtain X, and quantized using the following formula :

- Calculate AX+B
- Take the N most significant bits.
- Invert the MSB.

A and B can be found in table C.3, "Layer I Quantization Coefficients". N represents the necessary number of bits to encode the number of steps. The inversion of the most significant bit (MSB) is done in order to avoid the all '1' representation of the code, because the all '1' code is used for the synchronization word.

#### C.1.5.1.8 Coding of bit allocation

The 4-bit code for the allocation is given in 2.4.2.5, "Audio data Layer I", of the main part of the audio standard.

#### C.1.5.1.9 Ancillary data

The Audio standard provides a number of bits for the inclusion and transmission of variable length ancillary data with the audio bitstream. The ancillary data will reduce the number of bits available for audio, which may result in a degradation of audio quality.

The presence of a bit pattern in the ancillary data matching the syncword may hamper synchronization. This problem is more likely to occur when the free format is used.

#### C.1.5.1.10 Formatting

The encoded subband information is transferred in frames (See also 2.4.1.2, 2.4.1.3, 2.4.1.5 and 2.4.1.8). The number of slots in a frame varies with the sample frequency (Fs) and bitrate. Each frame contains information on 384 samples of the original input signal, so the frame rate is Fs/384.

Fs (kHz)	Frame size (ms)
48	8
44,1	8,7074...
32	12

A frame may carry audio information from one or two channels.

The length of a slot in Layer I is 32 bits. The number of slots in a frame can be computed by this formula:

$$\text{Number of slots/frame (N)} = \frac{\text{bitrate}}{F_s} * 12$$

If this does not give an integer number the result is truncated and 'padding' is required. This means that the number of slots may vary between N and N + 1.

An overview of the Layer I format is given in figure C.2:

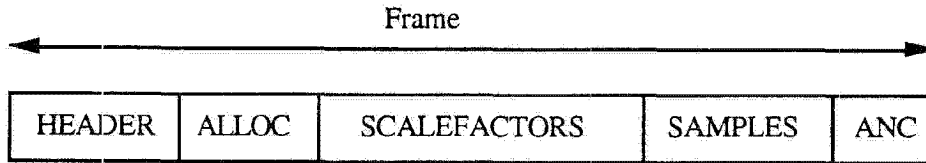

Figure C.2 -- Layer I Format

Table C.2 -- Layer I Signal-to-Noise Ratios

No. of steps	SNR (dB)
0	0,00
3	7,00
7	16,00
15	25,28
31	31,59
63	37,75
127	43,84
255	49,89
511	55,93
1 023	61,96
2 047	67,98
4 095	74,01
8 191	80,03
16 383	86,05
32 767	92,01

Table -- C.3 Layer I Quantization Coefficients

No. of steps	A	B
3	0,750000000	-0,250000000
7	0,875000000	-0,125000000
15	0,937500000	-0,062500000
31	0,968750000	-0,031250000
63	0,984375000	-0,015625000
127	0,992187500	-0,007812500
255	0,996093750	-0,003906250
511	0,998046875	-0,001953125
1 023	0,999023438	-0,000976563
2 047	0,999511719	-0,000488281
4 095	0,999755859	-0,000244141
8 191	0,999877930	-0,000122070
16 383	0,999938965	-0,000061035
32 767	0,999969482	-0,000030518

### C.1.5.2 Layer II encoding

#### C.1.5.2.1 Introduction

This clause describes a possible Layer II encoding method. The description is made according to figure C.5, "Layer I, II encoder flow chart".

#### C.1.5.2.2 Psychoacoustic model

The calculation of the psychoacoustic parameters can be done either with Psychoacoustic Model 1 described in clause D.1. or with Psychoacoustic Model 2 described in clause D.2. If Psychoacoustic Model 1 is used to calculate the psychoacoustic parameters, the FFT shiftlength is 1152 samples. If Psychoacoustic Model 2 is used, the calculation is performed twice with a shiftlength of 576 samples and the largest of each pair of signal to mask ratios is used. Either model provides the signal-to-mask ratio for every subband.

#### C.1.5.2.3 Analysis subband filter

The analysis subband filter is described in clause C.1.3, "Analysis subband filter".

#### C.1.5.2.4 Scalefactor calculation

The calculation of the scalefactor for each subband is performed every 12 subband samples. The maximum of the absolute value of these 12 samples is determined. The lowest value in table B.1, "Layer I, II Scalefactors", which is larger than this maximum is used as the scalefactor.

#### C.1.5.2.5 Coding of scalefactors

A frame corresponds to 36 subband samples and therefore contains three scalefactors per subband. Define 'scf' as the index in table B.1, "Layer I, II Scalefactors". First, the two differences  $dscf_1$  and  $dscf_2$  of the successive scalefactor indices  $scf_1$ ,  $scf_2$  and  $scf_3$  are calculated:

$$\begin{aligned}dscf_1 &= scf_1 - scf_2 \\dscf_2 &= scf_2 - scf_3\end{aligned}$$

The class of each of the differences is determined as follows:

class.	dscf
1	$dscf \leq -3$
2	$-3 < dscf < 0$
3	$dscf = 0$
4	$0 < dscf < 3$
5	$dscf \geq 3$

The pair of classes of differences indicate the entry point in table C.4, "Layer II Scalefactors Transmission Patterns". The column labelled "scalefactor used in encoder" gives the three scalefactors which are actually used. "1", "2" and "3" mean respectively the first, second and third scalefactor within a frame, "4" means the maximum of the three scalefactors. If, after this adjusting of scalefactors two or three are the same, not all scalefactors need to be transmitted for a certain subband within one frame. Only the scalefactors indicated in the "transmission pattern" column are transmitted. The information describing the number and the position of the scalefactors in each subband is called "scalefactor selection information".

#### C.1.5.2.6 Coding of scalefactor selection information

The "scalefactor selection information" (scfsi) is coded by a two bit word, which is also to be found in table C.4, "Layer II scalefactor transmission patterns". Only the scfsi for the subbands which will get a nonzero bit allocation are transmitted.

#### C.1.5.2.7 Bit allocation

Before adjustment to a fixed bitrate, the number of bits, "adb", that are available for coding the samples and the scalefactors must be determined. This number can be obtained by subtracting from the total number of

available bits "cb", the number of bits needed for the header "bhdr" (32 bits), the CRC checkword "bcrc" if used (16 bits), the bit allocation "bbal", and the number of bits "banc" required for ancillary data:

$$adb = cb - (bhdr + bcrc + bbal + banc)$$

The resulting number can be used to code the subband samples and the scalefactors. The principle used in the allocation procedure is minimization of the total noise-to-mask ratio over the frame with the constraint that the number of bits used does not exceed the number of bits available for that frame. Use is made of table B.2, "Layer II Possible Quantization per subband" that indicates for every subband the number of steps that may be used to quantize the samples. The number of bits required to represent these quantized samples can be derived from table B.4, "Layer II Classes of Quantization".

The allocation procedure is an iterative procedure where, in each iteration step the number of levels of the subband that has the greatest benefit is increased.

First the mask-to-noise ratio "MNR" for each subband is calculated by subtracting from the signal-to-noise-ratio "SNR" the signal-to-mask-ratio "SMR":

$$MNR = SNR - SMR$$

The signal-to-noise-ratio can be found in table C.5 "Layer II Signal-to-Noise Ratios". The signal-to-mask-ratio is the output of the psychoacoustic model.

Then zero bits are allocated to the samples and the scalefactors. The number of bits for the samples "bspl" and the number of bits for the scalefactors "bscf" are set to zero. Next an iterative procedure is started. Each iteration loop contains the following steps :

- Determination of the minimal MNR of all subbands.
- The accuracy of the quantization of the subband with the minimal MNR is increased by using the next higher entry in the relevant table B.2, "Layer II Possible Quantization per Subband".
- The new MNR of this subband is calculated.
- bspl is updated according to the additional number of bits required. If a non-zero number of bits is assigned to a subband for the first time, bsel has to be updated, and bscf has to be updated according to the number of scalefactors required for this subband. Then adb is calculated again using the formula :

$$adb = cb - (bhdr + bcrc + bbal + bsel + bscf + bspl + banc)$$

The iterative procedure is repeated as long as adb is not less than any possible increase of bspl, bsel and bscf within one loop.

#### C.1.5.2.8 Quantization and encoding of subband samples

Each of the 12 subband samples is normalized by dividing its value by the scalefactor to obtain X and quantized using the following formula:

- Calculate  $A * X + B$
- Take the N most significant bits.
- Invert the MSB

A and B can be found in the table C.6, "Layer II Quantization Coefficients". N represents the necessary number of bits to encode the number of steps. The inversion of the MSB is done in order to avoid the all '1' code that is used for the synchronization word.

Given the number of steps that the samples will be quantized to, table B.4, "Layer II Classes of Quantization" shows whether grouping will be used. If grouping is not required, the three samples are coded with individual codewords.

If grouping is required, three consecutive samples are coded as one codeword. Only one value  $v_m$ , MSB first, is transmitted for this triplet. The relationships between the coded value  $v_m$  ( $m=3,5,9$ ) and the three consecutive subband samples x, y, z are:



$$\begin{aligned} v_3 &= 9z + 3y + x & (v_3 \text{ in } 0 \dots 26) \\ v_5 &= 25z + 5y + x & (v_5 \text{ in } 0 \dots 124) \\ v_9 &= 81z + 9y + x & (v_9 \text{ in } 0 \dots 728) \end{aligned}$$

#### C.1.5.2.9 Coding of bit allocation

For the purpose of a more efficient coding, only a limited number of possible quantizations, which may be different for each subband, are allowed. Only the index with wordlength "nbal" in the relevant table B.2, "Layer II Possible Quantizations per Subband" is transmitted, MSB first.

#### C.1.5.2.10 Ancillary data

The Audio standard provides a number of bits for the inclusion and transmission of variable length ancillary data with the audio bitstream. The ancillary data will reduce the number of bits available for audio, which may result in a degradation of audio quality.

The presence of a bit pattern in the ancillary data matching the syncword may hamper synchronization. This problem is more likely to occur when the free format is used.

#### C.1.5.2.11 Formatting

An overview of the Layer II format can be seen in figure C.3.

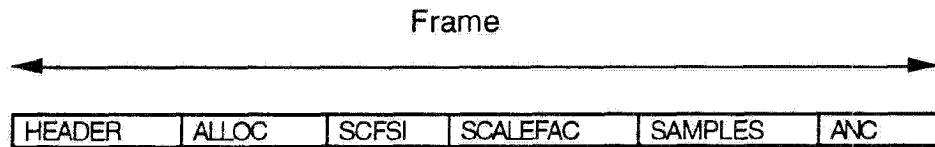

Figure C.3 -- Layer II Format

The differences compared to the Layer I format are:

- The length of a slot equals 8 bits.
- A new block scfsi containing the scalefactor selection information has been introduced.
- The bit allocation information, scalefactors and samples have been subject to further coding (see the related).

The details can be found in 2.4.1.

Table C.4 -- Layer II scalefactor transmission patterns

Class <sub>1</sub>	Class <sub>2</sub>	Scalefactors used in encoder	Transmission pattern	Selection Information
1	1	1 2 3	1 2 3	0
1	2	1 2 2	1 2	3
1	3	1 2 2	1 2	3
1	4	1 3 3	1 3	3
1	5	1 2 3	1 2 3	0
2	1	1 1 3	1 3	1
2	2	1 1 1	1	2
2	3	1 1 1	1	2
2	4	4 4 4	4	2
2	5	1 1 3	1 3	1
3	1	1 1 1	1	2
3	2	1 1 1	1	2
3	3	1 1 1	1	2
3	4	3 3 3	3	2
3	5	1 1 3	1 3	1
4	1	2 2 2	2	2
4	2	2 2 2	2	2
4	3	2 2 2	2	2
4	4	3 3 3	3	2
4	5	1 2 3	1 2 3	0
5	1	1 2 3	1 2 3	0
5	2	1 2 2	1 2	3
5	3	1 2 2	1 2	3
5	4	1 3 3	1 3	3
5	5	1 2 3	1 2 3	0

Table C.5 -- Layer II Signal-to-Noise Ratios

No. of steps	SNR (dB)
0	0,00
3	7,00
5	11,00
7	16,00
9	20,84
15	25,28
31	31,59
63	37,75
127	43,84
255	49,89
511	55,93
1 023	61,96
2 047	67,98
4 095	74,01
8 191	80,03
16 383	86,05
32 767	92,01
65 535	98,01

Table C.6 -- Layer II quantization coefficients

No. of steps	A	B
3	0,75000000	-0,25000000
5	0,62500000	-0,37500000
7	0,87500000	-0,12500000
9	0,56250000	-0,43750000
15	0,93750000	-0,06250000
31	0,96875000	-0,03125000
63	0,98437500	-0,01562500
127	0,99218750	-0,00781250
255	0,99609375	-0,00390625
511	0,998046875	-0,001953125
1 023	0,999023438	-0,000976563
2 047	0,999511719	-0,000488281
4 095	0,999755859	-0,000244141
8 191	0,999877930	-0,000122070
16 383	0,999938965	-0,000061035
32 767	0,999969482	-0,000030518
65 535	0,999984741	-0,000015259

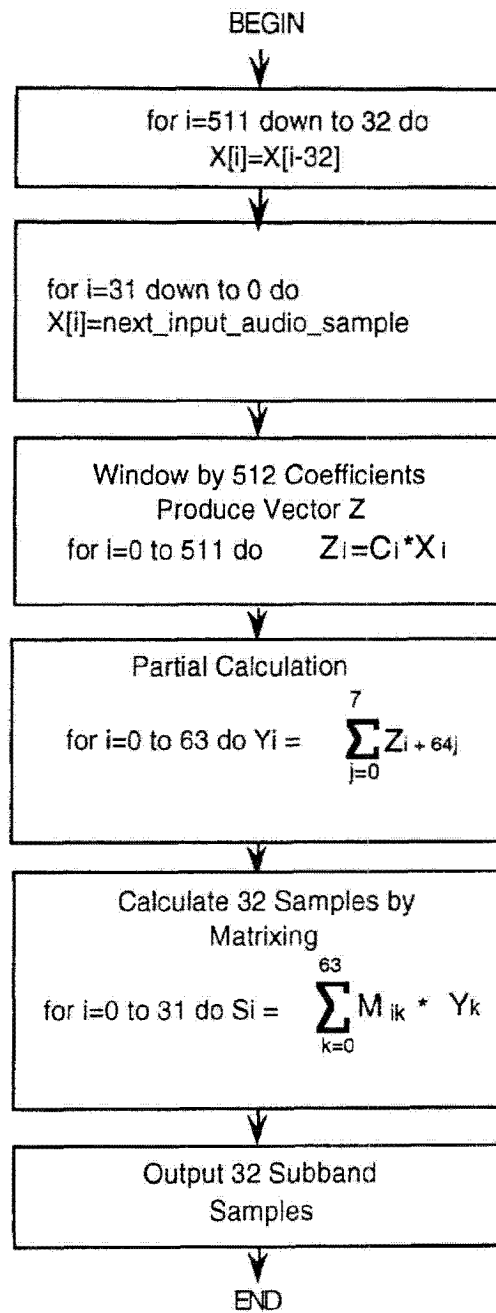

Figure C.4 -- Analysis subband filter flow chart

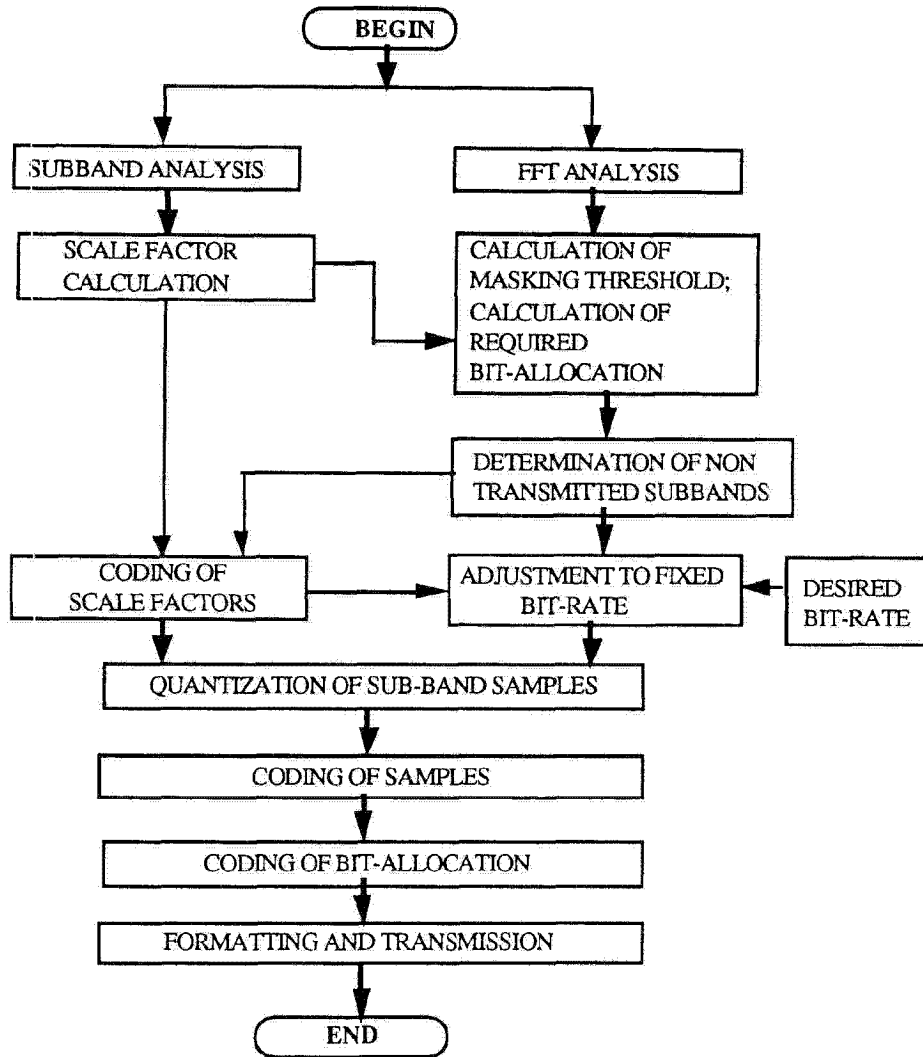

Figure C.5 -- Layer I, II Encoder flow chart

### C.1.5.3 Layer III encoding

#### C.1.5.3.1 Introduction

This clause describes a possible Layer III encoding method. The basic data flow is described by the general psychoacoustic coder block diagram. The basic blocks are described in more detail and below.

#### C.1.5.3.2 Psychoacoustic model

The calculation of the psychoacoustic parameters can be done either with Psychoacoustic Model I described in clause D.1. or with Psychoacoustic Model 2 described in clause D.2. A description of modifications to Psychoacoustic Model 2 for use with Layer III can be found below. The model is run twice per block, using a shift length of 576 samples. A signal-to-mask-ratio is provided for every scalefactor band.

##### C.1.5.3.2.1 Adaptation of psychoacoustic model II for Layer III

Psychoacoustic Model 2 (clause D.2) is modified as described below for the use with Layer III encoding.

##### General considerations:

The model is calculated twice in parallel. One computation is done with a shift length *iblen* of 192 samples (to be used with short blocks), the other is done with a shift length of 576 samples. For the shift length of 192 samples the block length of the FFT is changed to 256, and the parameters changed accordingly.

Change to unpredictability calculation:

The calculation of the unpredictability metric in Psychoacoustic Model 2 is changed.

##### - Calculation of the unpredictability:

The unpredictability *cw* is calculated for the first 206 spectral lines. For the other spectral lines, the unpredictability is set to 0,4.

The unpredictability for the first 6 lines is calculated from the long FFT (window length = 1024, *shifflen* = 576). For the spectral lines 6 up to 205, the unpredictability is calculated from the short FFT (window length 256, *shifflen* = 192):

$$cw(w) = \begin{cases} cw_l(w) & \text{for } 0 \leq w < 6 \\ cw_s((w+2)DIV4) & \text{for } 6 \leq w < 206 \\ 0,4 & \text{for } w \geq 206 \end{cases}$$

*cw\_l* is the unpredictability calculated from the long FFT, *cw\_s* is the unpredictability calculated from the second short block out of three short blocks within one granule.

##### - The spreading function has been replaced:

$$\begin{array}{ll} \text{If } j \geq i & \text{unpy} = 3,0 (j - i) \\ \text{else} & \text{unpy} = 1,5(j - i) \text{ is used.} \end{array}$$

Only values of the spreading function greater than  $10^{-6}$  are used. All other values are set to zero.

##### - For converting the unpredictability the parameters

$$\begin{array}{l} \text{conv1} = -0,299 \\ \text{conv2} = -0,43 \end{array}$$

are used.

##### - The parameter NMT (noise masking tone) is set to 6,0 dB for all threshold calculation partions. The parameter TMN (tone masking noise) is set to 29,0 dB for all partions. For *minval* see table "threshold calculation partions" (table C.7).

- The psychoacoustic entropy is estimated from the ratio  $\text{thr}/\text{eb}$ , where  $\text{thr}$  is the threshold and  $\text{eb}$  is the energy:

$$pe = - \sum (\text{cbwidth}_k \cdot \log(\text{thr}_k/(\text{eb}_k+1.)))$$

where  $k$  indexes the threshold calculation partitions and  $\text{cbwidth}$  is the width of the threshold calculation partition (see tables).

- pre-echo control

The following constants are used for the control of pre-echo's (see block diagram):

$$\begin{aligned} \text{rpelev} &= 2 \\ \text{rpelev2} &= 16 \end{aligned}$$

- The threshold is not spread over the FFT lines. The threshold calculation partitions are converted directly to scalefactor bands. The first partition which is added to the scalefactor band is weighted with  $w1$ , the last with  $w2$  (see table C.8 "Converting Threshold Calculation Partitions to Scalefactor Bands"). The table contains also the number of partitions ( $\text{cbw}$ ) converted to one scalefactor band (excluding the first and the last partition).

The parameters  $\text{bo}$  and  $\text{bu}$  are shown in table C.8. They are used for converting threshold calculation partitions to scalefactor bands.

- For short blocks a simplified version of the threshold calculation (constant signal to noise ratio) is used. The constants can be found in the columns labelled "SNR (dB)" in table C.7(def) below.

Table C.7 -- Threshold calculation partitions with following parameters width, minval, threshold in quiet, norm and bval:

Table C.7.a -- Sampling\_frequency = 48 kHz long blocks

no.	FFT-lines	minval	qthr	norm	bval
0	1	24,5	4,532	0,970	0,000
1	1	24,5	4,532	0,755	0,469
2	1	24,5	4,532	0,738	0,937
3	1	24,5	0,904	0,730	1,406
4	1	24,5	0,904	0,724	1,875
5	1	20	0,090	0,723	2,344
6	1	20	0,090	0,723	2,812
7	1	20	0,029	0,723	3,281
8	1	20	0,029	0,718	3,750
9	1	20	0,009	0,690	4,199
10	1	20	0,009	0,660	4,625
11	1	18	0,009	0,641	5,047
12	1	18	0,009	0,600	5,437
13	1	18	0,009	0,584	5,828
14	1	12	0,009	0,531	6,187
15	1	12	0,009	0,537	6,522
16	2	6	0,018	0,857	7,174
17	2	6	0,018	0,858	7,800
18	2	3	0,018	0,853	8,402
19	2	3	0,018	0,824	8,966
20	2	3	0,018	0,778	9,483
21	2	3	0,018	0,740	9,966
22	2	0	0,018	0,709	10,426
23	2	0	0,018	0,676	10,866
24	2	0	0,018	0,632	11,279
25	2	0	0,018	0,592	11,669
26	2	0	0,018	0,553	12,042
27	2	0	0,018	0,510	12,386
28	2	0	0,018	0,513	12,721
29	3	0	0,027	0,608	13,115
30	3	0	0,027	0,673	13,561
31	3	0	0,027	0,636	13,983
32	3	0	0,027	0,586	14,371
33	3	0	0,027	0,571	14,741
34	4	0	0,036	0,616	15,140
35	4	0	0,036	0,640	15,562
36	4	0	0,036	0,597	15,962
37	4	0	0,036	0,538	16,324
38	4	0	0,036	0,512	16,665
39	5	0	0,045	0,528	17,020
40	5	0	0,045	0,516	17,373
41	5	0	0,045	0,493	17,708
42	6	0	0,054	0,499	18,045
43	7	0	0,063	0,525	18,398
44	7	0	0,063	0,541	18,762
45	8	0	0,072	0,528	19,120
46	8	0	0,072	0,510	19,466
47	8	0	0,072	0,506	19,807
48	10	0	0,180	0,525	20,159
49	10	0	0,180	0,536	20,522
50	10	0	0,180	0,518	20,873
51	13	0	0,372	0,501	21,214
52	13	0	0,372	0,496	21,553
53	14	0	0,400	0,497	21,892
54	18	0	1,628	0,495	22,231
55	18	0	1,628	0,494	22,569
56	20	0	1,808	0,497	22,909
57	25	0	22,607	0,494	23,248
58	25	0	22,607	0,487	23,583
59	35	0	31,650	0,483	23,915
60	67	0	605,867	0,482	24,246
61	67	0	605,867	0,524	24,576



Table C.7.b Sampling frequency = 44,1 kHz long blocks

no.	FFT-lines	minval	qthr	norm	bval
0	1	24,5	4,532	0,951	0,000
1	1	24,5	4,532	0,700	0,431
2	1	24,5	4,532	0,681	0,861
3	1	24,5	0,904	0,675	1,292
4	1	24,5	0,904	0,667	1,723
5	1	20	0,090	0,665	2,153
6	1	20	0,090	0,664	2,584
7	1	20	0,029	0,664	3,015
8	1	20	0,029	0,664	3,445
9	1	20	0,029	0,655	3,876
10	1	20	0,009	0,616	4,279
11	1	20	0,009	0,597	4,670
12	1	18	0,009	0,578	5,057
13	1	18	0,009	0,541	5,415
14	1	18	0,009	0,575	5,774
15	2	12	0,018	0,856	6,422
16	2	6	0,018	0,846	7,026
17	2	6	0,018	0,840	7,609
18	2	3	0,018	0,822	8,168
19	2	3	0,018	0,800	8,710
20	2	3	0,018	0,753	9,207
21	2	3	0,018	0,704	9,662
22	2	0	0,018	0,674	10,099
23	2	0	0,018	0,640	10,515
24	2	0	0,018	0,609	10,917
25	2	0	0,018	0,566	11,293
26	2	0	0,018	0,535	11,652
27	2	0	0,018	0,531	11,997
28	3	0	0,027	0,615	12,394
29	3	0	0,027	0,686	12,850
30	3	0	0,027	0,650	13,277
31	3	0	0,027	0,611	13,681
32	3	0	0,027	0,567	14,062
33	3	0	0,027	0,520	14,411
34	3	0	0,027	0,513	14,751
35	4	0	0,036	0,557	15,119
36	4	0	0,036	0,584	15,508
37	4	0	0,036	0,570	15,883
38	5	0	0,045	0,579	16,263
39	5	0	0,045	0,585	16,654
40	5	0	0,045	0,548	17,020
41	6	0	0,054	0,536	17,374
42	6	0	0,054	0,550	17,744
43	7	0	0,063	0,532	18,104
44	7	0	0,063	0,504	18,447
45	7	0	0,063	0,496	18,781
46	9	0	0,081	0,516	19,130
47	9	0	0,081	0,527	19,487
48	9	0	0,081	0,516	19,838
49	10	0	0,180	0,497	20,179
50	10	0	0,180	0,489	20,510
51	11	0	0,198	0,502	20,852
52	14	0	0,400	0,502	21,196
53	14	0	0,400	0,491	21,531
54	15	0	0,429	0,497	21,870
55	20	0	1,808	0,504	22,214
56	20	0	1,808	0,504	22,558
57	21	0	1,899	0,495	22,898
58	27	0	24,415	0,486	23,232
59	27	0	24,415	0,484	23,564
60	36	0	32,554	0,483	23,897
61	73	0	660,124	0,475	24,229
62	18	0	162,770	0,515	24,542

Table C.7.c -- Sampling\_frequency = 32 kHz long blocks

no.	FFT-lines	minval	gthr	norm	bval
0	2	24,5	9,064	0,997	0,312
1	2	24,5	9,064	0,893	0,937
2	2	24,5	1,808	0,881	1,562
3	2	20	0,181	0,873	2,187
4	2	20	0,181	0,872	2,812
5	2	20	0,057	0,871	3,437
6	2	20	0,018	0,860	4,045
7	2	20	0,018	0,839	4,625
8	2	18	0,018	0,812	5,173
9	2	18	0,018	0,784	5,698
10	2	12	0,018	0,741	6,184
11	2	12	0,018	0,697	6,634
12	2	6	0,018	0,674	7,070
13	2	6	0,018	0,651	7,492
14	2	6	0,018	0,633	7,905
15	2	3	0,018	0,611	8,305
16	2	3	0,018	0,589	8,695
17	2	3	0,018	0,575	9,064
18	3	3	0,027	0,654	9,483
19	3	3	0,027	0,724	9,966
20	3	0	0,027	0,701	10,425
21	3	0	0,027	0,673	10,866
22	3	0	0,027	0,631	11,279
23	3	0	0,027	0,592	11,669
24	3	0	0,027	0,553	12,042
25	3	0	0,027	0,510	12,386
26	3	0	0,027	0,505	12,721
27	4	0	0,036	0,562	13,091
28	4	0	0,036	0,598	13,488
29	4	0	0,036	0,589	13,873
30	5	0	0,045	0,607	14,268
31	5	0	0,045	0,620	14,679
32	5	0	0,045	0,580	15,067
33	5	0	0,045	0,532	15,424
34	5	0	0,045	0,517	15,771
35	6	0	0,054	0,517	16,120
36	6	0	0,054	0,509	16,466
37	6	0	0,054	0,506	16,807
38	8	0	0,072	0,522	17,158
39	8	0	0,072	0,531	17,518
40	8	0	0,072	0,519	17,869
41	10	0	0,090	0,512	18,215
42	10	0	0,090	0,509	18,562
43	10	0	0,090	0,497	18,902
44	12	0	0,108	0,494	19,239
45	12	0	0,108	0,501	19,579
46	13	0	0,117	0,507	19,925
47	14	0	0,252	0,502	20,269
48	14	0	0,252	0,493	20,606
49	16	0	0,289	0,497	20,944
50	20	0	0,572	0,506	21,288
51	20	0	0,572	0,510	21,635
52	23	0	0,658	0,504	21,979
53	27	0	2,441	0,496	22,319
54	27	0	2,441	0,493	22,656
55	32	0	2,894	0,490	22,993
56	37	0	33,458	0,483	23,326
57	37	0	33,458	0,458	23,656
58	12	0	10,851	0,500	23,937

Licensed to JOHN SCHAUB  
 ISO Store order #: 659832/Downloaded: 2005-05-17  
 Single user licence only, copying and networking prohibited

Table C.7.d -- Sampling\_frequency = 48 kHz short blocks

no.	FFT-lines	qthr	norm	SNR (db)	bval
0	1	4,532	0,970	-8,240	0,000
1	1	0,904	0,755	-8,240	1,875
2	1	0,029	0,738	-8,240	3,750
3	1	0,009	0,730	-8,240	5,437
4	1	0,009	0,724	-8,240	6,857
5	1	0,009	0,723	-8,240	8,109
6	1	0,009	0,723	-8,240	9,237
7	1	0,009	0,723	-8,240	10,202
8	1	0,009	0,718	-8,240	11,083
9	1	0,009	0,690	-8,240	11,864
10	1	0,009	0,660	-7,447	12,553
11	1	0,009	0,641	-7,447	13,195
12	1	0,009	0,600	-7,447	13,781
13	1	0,009	0,584	-7,447	14,309
14	1	0,009	0,532	-7,447	14,803
15	1	0,009	0,537	-7,447	15,250
16	1	0,009	0,857	-7,447	15,667
17	1	0,009	0,858	-7,447	16,068
18	1	0,009	0,853	-7,447	16,409
19	2	0,018	0,824	-7,447	17,044
20	2	0,018	0,778	-6,990	17,607
21	2	0,018	0,740	-6,990	18,097
22	2	0,018	0,709	-6,990	18,528
23	2	0,018	0,676	-6,990	18,930
24	2	0,018	0,632	-6,990	19,295
25	2	0,018	0,592	-6,990	19,636
26	3	0,054	0,553	-6,990	20,038
27	3	0,054	0,510	-6,990	20,486
28	3	0,054	0,513	-6,990	20,900
29	4	0,114	0,608	-6,990	21,305
30	4	0,114	0,673	-6,020	21,722
31	5	0,452	0,637	-6,020	22,128
32	5	0,452	0,586	-6,020	22,512
33	5	0,452	0,571	-6,020	22,877
34	7	6,330	0,616	-5,229	23,241
35	7	6,330	0,640	-5,229	23,616
36	11	9,947	0,597	-5,229	23,974
37	17	153,727	0,538	-5,229	24,312

Table C.7.e -- Sampling\_frequency = 44,1 kHz short blocks

no.	FFT-lines	qthr	norm	SNR (db)	bval
0	1	4,532	0,952	-8,240	0,000
1	1	0,904	0,700	-8,240	1,723
2	1	0,029	0,681	-8,240	3,445
3	1	0,009	0,675	-8,240	5,057
4	1	0,009	0,667	-8,240	6,422
5	1	0,009	0,665	-8,240	7,609
6	1	0,009	0,664	-8,240	8,710
7	1	0,009	0,664	-8,240	9,662
8	1	0,009	0,664	-8,240	10,515
9	1	0,009	0,655	-8,240	11,293
10	1	0,009	0,616	-7,447	12,009
11	1	0,009	0,597	-7,447	12,625
12	1	0,009	0,578	-7,447	13,210
13	1	0,009	0,541	-7,447	13,748
14	1	0,009	0,575	-7,447	14,241
15	1	0,009	0,856	-7,447	14,695
16	1	0,009	0,846	-7,447	15,125
17	1	0,009	0,840	-7,447	15,508
18	1	0,009	0,822	-7,447	15,891
19	2	0,018	0,800	-7,447	16,537
20	2	0,018	0,753	-6,990	17,112
21	2	0,018	0,704	-6,990	17,620
22	2	0,018	0,674	-6,990	18,073
23	2	0,018	0,640	-6,990	18,470
24	2	0,018	0,609	-6,990	18,849
25	3	0,027	0,566	-6,990	19,271
26	3	0,027	0,535	-6,990	19,741
27	3	0,054	0,531	-6,990	20,177
28	3	0,054	0,615	-6,990	20,576
29	3	0,054	0,686	-6,990	20,950
30	4	0,114	0,650	-6,020	21,316
31	4	0,114	0,612	-6,020	21,699
32	5	0,452	0,567	-6,020	22,078
33	5	0,452	0,520	-6,020	22,438
34	5	0,452	0,513	-5,229	22,782
35	7	6,330	0,557	-5,229	23,133
36	7	6,330	0,584	-5,229	23,484
37	7	6,330	0,570	-5,229	23,828
38	19	171,813	0,578	-4,559	24,173

Table C.7.f -- Sampling\_frequency = 32 kHz short blocks

no.	FFT-lines	qthr	norm	SNR (db)	bval
0	1	4,532	0,997	-8,240	0,000
1	1	0,904	0,893	-8,240	1,250
2	1	0,090	0,881	-8,240	2,500
3	1	0,029	0,873	-8,240	3,750
4	1	0,009	0,872	-8,240	4,909
5	1	0,009	0,871	-8,240	5,958
6	1	0,009	0,860	-8,240	6,857
7	1	0,009	0,839	-8,240	7,700
8	1	0,009	0,812	-8,240	8,500
9	1	0,009	0,784	-8,240	9,237
10	1	0,009	0,741	-7,447	9,895
11	1	0,009	0,697	-7,447	10,500
12	1	0,009	0,674	-7,447	11,083
13	1	0,009	0,651	-7,447	11,604
14	1	0,009	0,633	-7,447	12,107
15	1	0,009	0,611	-7,447	12,554
16	1	0,009	0,589	-7,447	13,000
17	1	0,009	0,575	-7,447	13,391
18	1	0,009	0,654	-7,447	13,781
19	2	0,018	0,724	-7,447	14,474
20	2	0,018	0,701	-6,990	15,096
21	2	0,018	0,673	-6,990	15,667
22	2	0,018	0,631	-6,990	16,177
23	2	0,018	0,592	-6,990	16,636
24	2	0,018	0,553	-6,990	17,057
25	2	0,018	0,510	-6,990	17,429
26	2	0,018	0,506	-6,990	17,786
27	3	0,027	0,562	-6,990	18,177
28	3	0,027	0,598	-6,990	18,597
29	3	0,027	0,589	-6,990	18,994
30	3	0,027	0,607	-6,020	19,352
31	3	0,027	0,620	-6,020	19,693
32	4	0,072	0,580	-6,020	20,066
33	4	0,072	0,532	-6,020	20,461
34	4	0,072	0,517	-5,229	20,841
35	5	0,143	0,517	-5,229	21,201
36	5	0,143	0,509	-5,229	21,549
37	6	0,172	0,506	-5,229	21,911
38	7	0,633	0,522	-4,559	22,275
39	7	0,633	0,531	-4,559	22,625
40	8	0,723	0,519	-3,980	22,971
41	10	9,043	0,512	-3,980	23,321

Table C.8 -- Tables for converting threshold calculation partitions to scalefactor bands

Table C.8.a -- Sampling\_frequency = 48 kHz long blocks

no.	sb	cbw	bu	bo	w1	w2
0		3	0	4	1,000	0,056
1		3	4	7	0,944	0,611
2		4	7	11	0,389	0,167
3		3	11	14	0,833	0,722
4		3	14	17	0,278	0,639
5		2	17	19	0,361	0,417
6		3	19	22	0,583	0,083
7		2	22	24	0,917	0,750
8		3	24	27	0,250	0,417
9		3	27	30	0,583	0,648
10		3	30	33	0,352	0,611
11		3	33	36	0,389	0,625
12		4	36	40	0,375	0,144
13		3	40	43	0,856	0,389
14		3	43	46	0,611	0,160
15		3	46	49	0,840	0,217
16		3	49	52	0,783	0,184
17		2	52	54	0,816	0,886
18		3	54	57	0,114	0,313
19		2	57	59	0,687	0,452
20		1	59	60	0,548	0,908

Table C.8.b -- Sampling\_frequency = 44,1 kHz long blocks

no.	sb	cbw	bu	bo	w1	w2
0		3	0	4	1,000	0,056
1		3	4	7	0,944	0,611
2		4	7	11	0,389	0,167
3		3	11	14	0,833	0,722
4		3	14	17	0,278	0,139
5		1	17	18	0,861	0,917
6		3	18	21	0,083	0,583
7		3	21	24	0,417	0,250
8		3	24	27	0,750	0,805
9		3	27	30	0,194	0,574
10		3	30	33	0,426	0,537
11		3	33	36	0,463	0,819
12		4	36	40	0,180	0,100
13		3	40	43	0,900	0,468
14		3	43	46	0,532	0,623
15		3	46	49	0,376	0,450
16		3	49	52	0,550	0,552
17		3	52	55	0,448	0,403
18		2	55	57	0,597	0,643
19		2	57	59	0,357	0,722
20		2	59	61	0,278	0,960

Table C.8.c -- Sampling\_frequency = 32 kHz long blocks

no. sb	cbw	bu	bo	w1	w2
0	1	0	2	1,000	0,528
1	2	2	4	0,472	0,305
2	2	4	6	0,694	0,083
3	1	6	7	0,917	0,861
4	2	7	9	0,139	0,639
5	2	9	11	0,361	0,417
6	3	11	14	0,583	0,083
7	2	14	16	0,917	0,750
8	3	16	19	0,250	0,870
9	3	19	22	0,130	0,833
10	4	22	26	0,167	0,389
11	4	26	30	0,611	0,478
12	4	30	34	0,522	0,033
13	3	34	37	0,967	0,917
14	4	37	41	0,083	0,617
15	3	41	44	0,383	0,995
16	4	44	48	0,005	0,274
17	3	48	51	0,726	0,480
18	3	51	54	0,519	0,261
19	2	54	56	0,739	0,884
20	2	56	58	0,116	1,000

Table C.8.d -- Sampling\_frequency = 48 kHz short blocks

no. sb	cbw	bu	bo	w1	w2
0	2	0	3	1,000	0,167
1	2	3	5	0,833	0,833
2	3	5	8	0,167	0,500
3	3	8	11	0,500	0,167
4	4	11	15	0,833	0,167
5	4	15	19	0,833	0,583
6	3	19	22	0,417	0,917
7	4	22	26	0,083	0,944
8	4	26	30	0,055	0,042
9	2	30	32	0,958	0,567
10	3	32	35	0,433	0,167
11	2	35	37	0,833	0,618

Table C.8.e -- Sampling\_frequency = 44,1 kHz short blocks

no.	sb	cbw	bu	bo	w1	w2
0		2	0	3	1,000	0,167
1		2	3	5	0,833	0,833
2		3	5	8	0,167	0,500
3		3	8	11	0,500	0,167
4		4	11	15	0,833	0,167
5		5	15	20	0,833	0,250
6		3	20	23	0,750	0,583
7		4	23	27	0,417	0,055
8		3	27	30	0,944	0,375
9		3	30	33	0,625	0,300
10		3	33	36	0,700	0,167
11		2	36	38	0,833	1,000

Table C.8.f -- Sampling\_frequency = 32 kHz short blocks

no.	sb	cbw	bu	bo	w1	w2
0		2	0	3	1,000	0,167
1		2	3	5	0,833	0,833
2		3	5	8	0,167	0,500
3		3	8	11	0,500	0,167
4		4	11	15	0,833	0,167
5		5	15	20	0,833	0,250
6		4	20	24	0,750	0,250
7		5	24	29	0,750	0,055
8		4	29	33	0,944	0,375
9		4	33	37	0,625	0,472
10		3	37	40	0,528	0,937
11		1	40	41	0,062	1,000



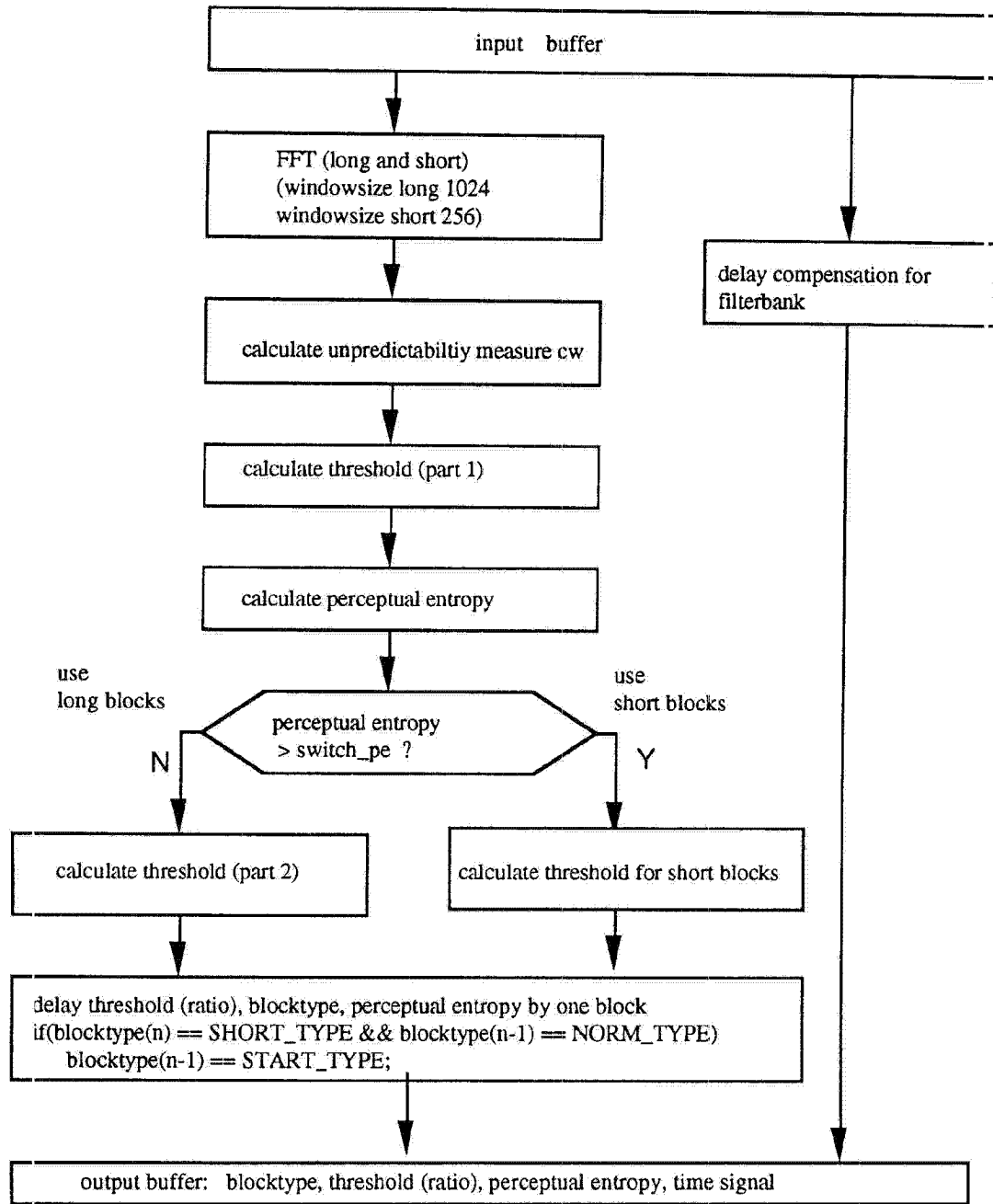

Figure C.6.a -- Block diagram psychoacoustic model 2, Layer III: calculate threshold

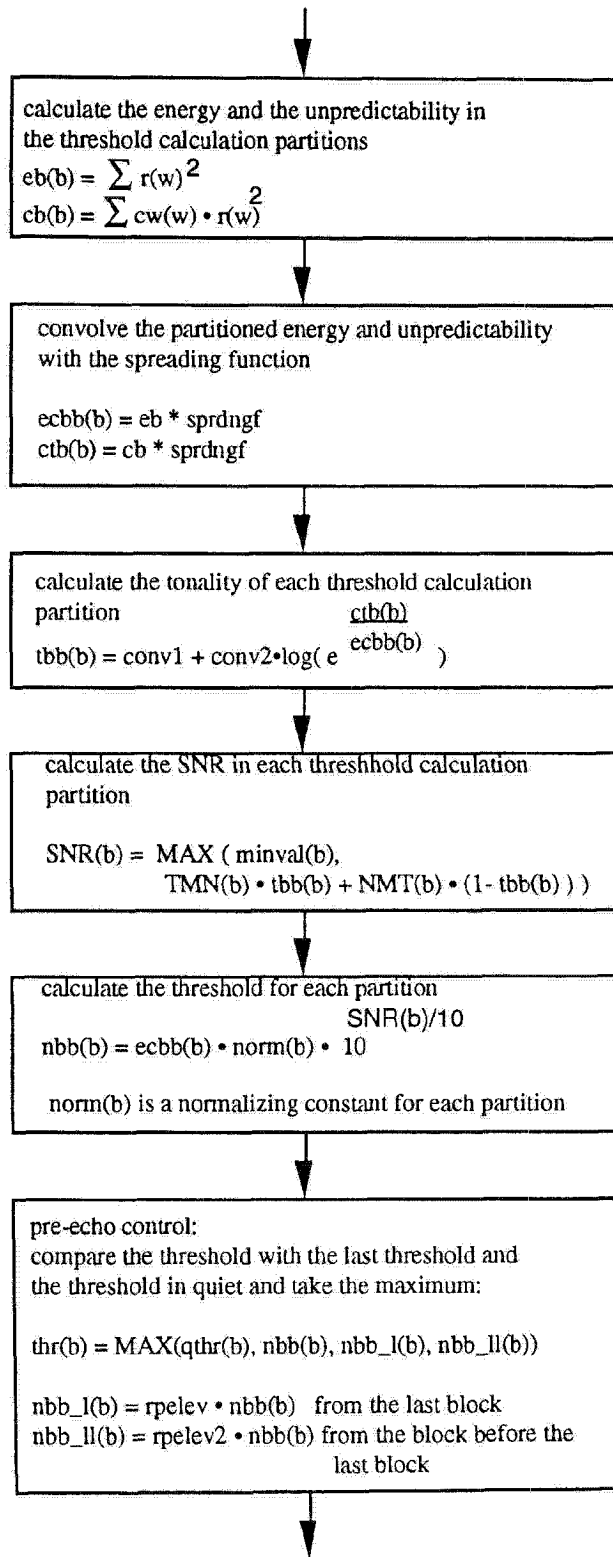

Figure C.6.b -- Block diagram psychoacoustic model 2, Layer III: calculate threshold (part 1)

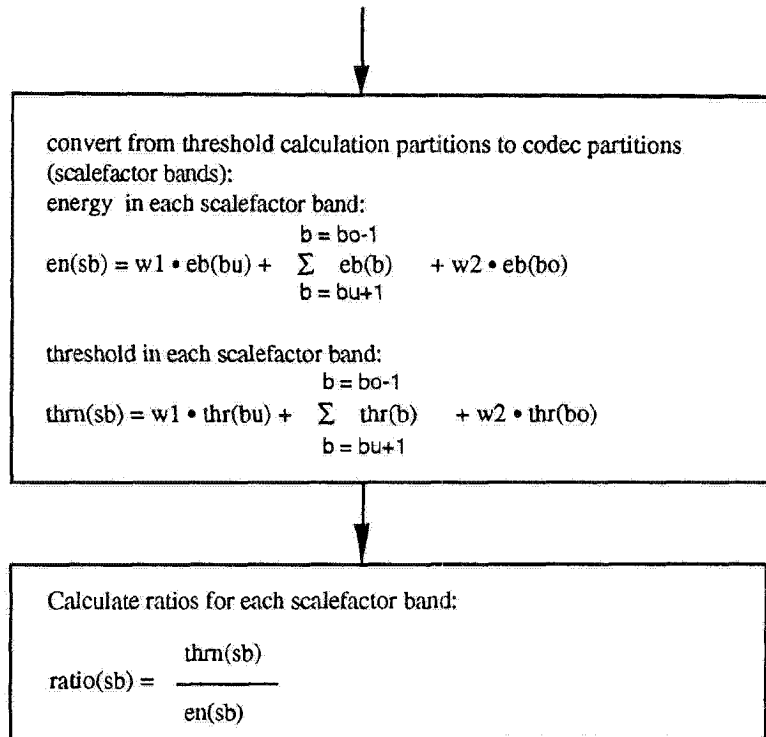

Figure C.6.c -- Block diagram psychoacoustic model 2, Layer III: calculate threshold (part 2)

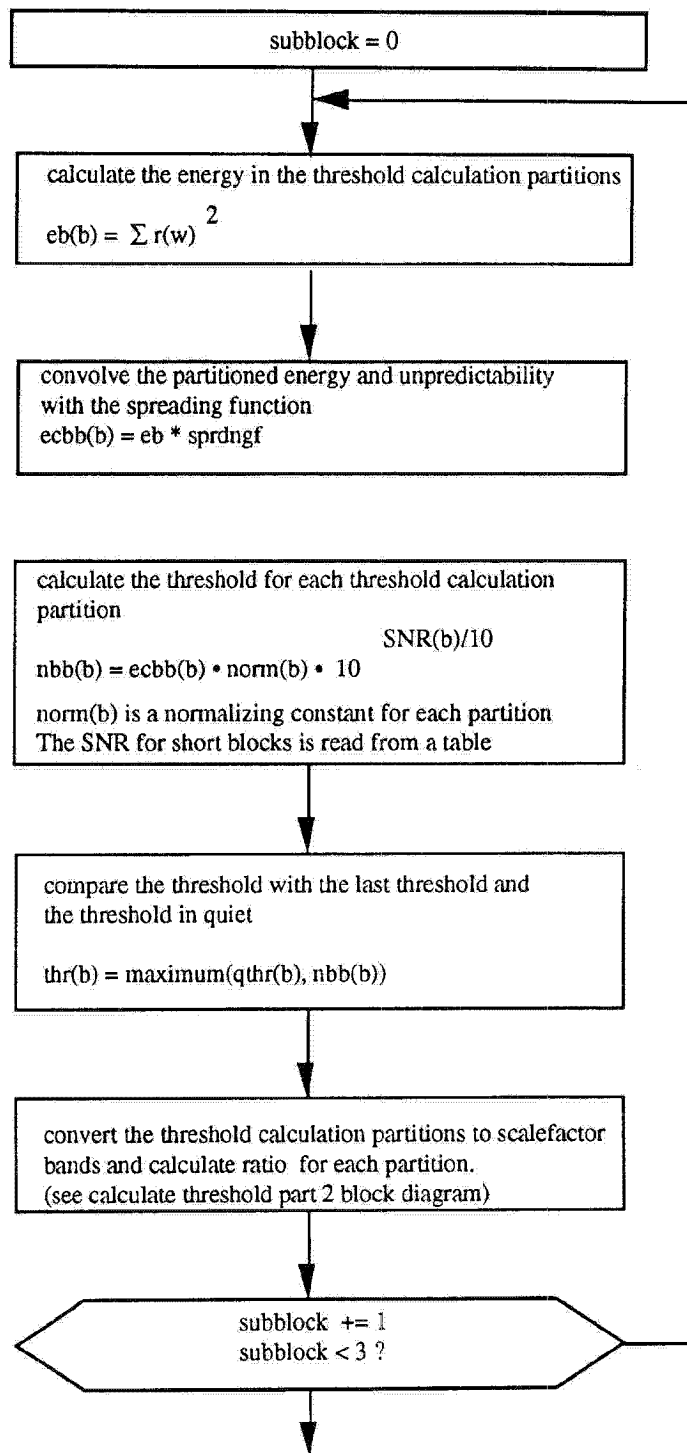

Figure C.6.d -- Block diagram psychoacoustic model 2, Layer III: calculate threshold for short blocks

**Window switching decision:**

The decision whether the filterbank should be switched to short windows is derived from the calculation of the masking threshold by calculating the estimate of the psychoacoustic entropy (PE) and switching when the PE exceeds the value 1800. If this condition is met, the sequence start (block\_type=1), short (block\_type=2), short, stop (block\_type=3) is started. Figure C.7 shows the possible state changes for the window switching logic.

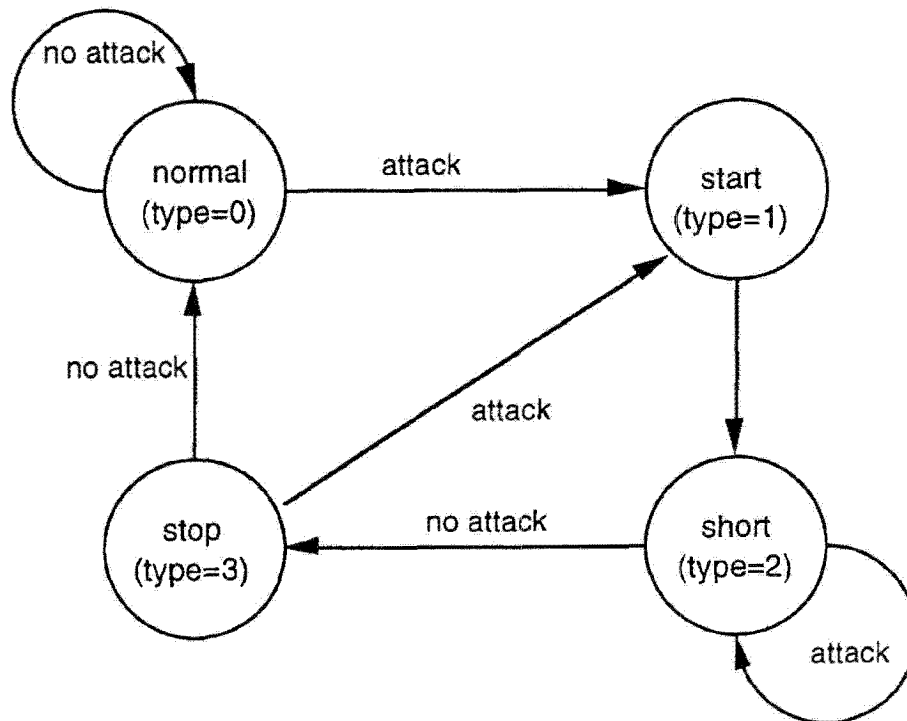

Figure C.7 -- Window Switching State Diagram

**C.1.5.3.3 Analysis part of the hybrid filterbank**

The subband analysis of the polyphase filterbank is described in clause C.1.3, "Subband analysis filter". The output of the polyphase filterbank is the input to the subdivision using the MDCT. According to the output of the psychoacoustic model (variables `blocksplit_flag` and `block_type`) the window and transform types `normal`, `start`, `short` or `stop` are used.

18 consecutive output values of one granule and 18 output values of the granule before are assembled to one block of 36 samples.

Block type "**normal**"

$$z_i = x'_i \sin\left(\frac{\pi}{36} \left(i + \frac{1}{2}\right)\right) \quad \text{for } i=0 \text{ to } 35$$

Block type "start"

$$z_i = \begin{cases} x'_i \sin\left(\frac{\pi}{36}\left(i + \frac{1}{2}\right)\right) & \text{for } i=0 \text{ to } 17 \\ x'_i & \text{for } i=18 \text{ to } 23 \\ x'_i \sin\left(\frac{\pi}{12}\left(i - 18 + \frac{1}{2}\right)\right) & \text{for } i=24 \text{ to } 29 \\ 0 & \text{for } i=30 \text{ to } 35 \end{cases}$$

Block type "stop"

$$z_i = \begin{cases} 0 & \text{for } i=0 \text{ to } 5 \\ x'_i \sin\left(\frac{\pi}{12}\left(i - 6 + \frac{1}{2}\right)\right) & \text{for } i=6 \text{ to } 11 \\ x'_i & \text{for } i=12 \text{ to } 17 \\ x'_i \sin\left(\frac{\pi}{36}\left(i + \frac{1}{2}\right)\right) & \text{for } i=18 \text{ to } 35 \end{cases}$$

Block type "short"

The block of 36 samples is divided into three overlapping blocks:

$$\begin{aligned} y_i^{(0)} &= x'_{i+6} \text{ for } i=0 \text{ to } 11 \\ y_i^{(1)} &= x'_{i+12} \text{ for } i=0 \text{ to } 11 \\ y_i^{(2)} &= x'_{i+18} \text{ for } i=0 \text{ to } 11 \end{aligned}$$

Each of the three small blocks is windowed separately:

$$z_i^{(k)} = y_i^{(k)} \sin\left(\frac{\pi}{12}\left(i + \frac{1}{2}\right)\right) \text{ for } i=0 \text{ to } 11, \text{ for } k=0 \text{ to } 2$$

**MDCT:**

In the following  $n$  is the number of windowed samples. For short blocks  $n$  is 12, for long blocks  $n$  is 36. The analytical expression of the MDCT is:

$$x_i = \sum_{k=0}^{n-1} z_k \cos\left(\frac{\pi}{2n}\left(2k+1+\frac{n}{2}\right)(2i+1)\right) \text{ for } i=0 \text{ to } \frac{n}{2} - 1$$

**Aliasing-Butterfly, Encoder:**

The calculation of aliasing reduction in the encoder is performed as in the decoder. The general procedure is shown in figure A.5. The butterfly definition to be used in the encoder is shown in figure C.8. The coefficients  $ca_j$  and  $cs_j$  can be found in table B.9.

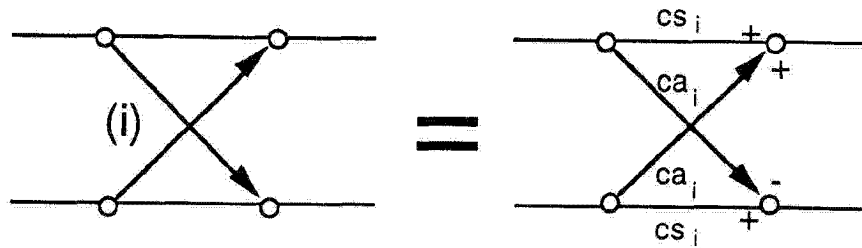

Figure C.8 -- Encoder Butterfly Definition

#### C.1.5.3.4 Calculation of average available bits

The average number of bits per granule is calculated from the frame size. The bitrate 64 kbits/s is used as an example. At bitrate 64 kbits/s at 48 000 samples per second,

$$(64\,000 * (1\,152/48\,000) \text{ bits per frame}) / (2 \text{ granules per frame}) = 768 \text{ bits per granule.}$$

As the header takes 32 bits and the side information takes 17 bytes (136 bits) in single\_channel mode, the average amount of available bits for the main\_data for a granule is given by

$$\text{mean\_bits} = 768 \text{ bits per granule} - (32+136 \text{ bits per frame}) / (2 \text{ granules per frame}) = 684 \text{ bits per granule.}$$

#### Bit reservoir:

The bit reservoir can provide additional bits which may be used for the granule. The number of bits which are provided is determined within the iteration loops.

#### C.1.5.3.5 Quantization and encoding of frequency domain samples

The frequency domain data are quantized and coded within two nested iteration loops. Subclause C.1.5.4 contains a detailed description of these iteration loops.

#### C.1.5.3.6 Ancillary data

The Audio Standard provides a number of bits for the inclusion and transmission of variable length ancillary data with the audio bitstream. The ancillary data will reduce the number of bits available for audio, which may result in a degradation of audio quality.

The presence of a bit pattern in the ancillary data matching the syncword may hamper synchronization. This problem is more likely to occur when the free format is used.

#### C.1.5.3.7 Formatting

The details about the Layer III bitstream format can be found in 2.4.4. The formatting of the Huffman code words is described below:

The Huffman code words are in sequence from low to high frequencies. In the iteration loops the following variables have been calculated and are used in encoding the Huffman code words:

is(i), i=0...575	quantized frequency domain values
table_select[region]	Huffman code table used for regions (region = 0, 1, 2)
region_adress1	defines the border between region 0 and 1
region_adress2	defines the border between region 1 and 2
max_value[region]	maximum absolute value of quantized data in regions (region = 0, 1, 2)

The data are written to the bitstream according to the Huffman code syntax described in 2.4.2.7

The actual assembly of the Huffman code for the big\_values part is described in a pseudo high level language:

```

for region number from 0 to 2
  if table_select for this region is 0
    nothing to do, all values in region are zero
  else
    if table_select for this region is > 15
      an ESC-table is used: look up linbits value connected to the table used
      for i = begin of region to end of region, count in pairs
        x = is(i), y = is(i+1)
        if x > 14
          linbitsx = x - 15, x = 15
        end if
        signx = sign(x), x = abs(x)
        if y > 14
          linbitsy = y - 15, y = 15
        end if
        signy = sign(y), y = abs(y)
        look for codeword = hcod([x][y]) in table table_select
        write hcod([x][y]), beginning with the leftmost bit, number of bits is hlen([x][y])
        if x > 14
          write linbitsx to the bitstream, number of bits is linbits
        end if
        if x != 0
          write signx to bitstream
        end if
        if y > 14
          write linbitsy to the bitstream, number of bits is linbits
        end if
        if y != 0
          write signy to bitstream
        end if
      end do
    else
      no ESC-words are used in this region:
      for i = beginning of region to end of region, count in pairs
        x = is(i), y = is(i+1)
        signx = sign(x), x = abs(x)
        signy = sign(y), y = abs(y)
        look for codeword = hcod([x][y]) in table table_select
        write hcod([x][y]), beginning with the leftmost bit, number of bits is hlen([x][y])
        if x != 0
          write signx to bitstream
        end if
        if y != 0
          write signy to bitstream
        end if
      end do
    end if
  end if
end for

```

A possible application for the private\_bits is to use them as frame counter.

### C.1.5.4 Layer III iteration loops

#### C.1.5.4.1 Introduction

The description of the Layer III loop module is subdivided into three levels. The top level is called "loops frame program". The loops frame program calls a subroutine named "outer iteration loop" which calls the subroutine "inner iteration loop". For each level a corresponding flow diagram is shown.



The loops module quantizes an input vector of spectral data in an iterative process according to several demands. The inner loop quantizes the input vector and increases the quantizer step size until the output vector can be coded with the available number of bits. After completion of the inner loop an outer loop checks the distortion of each scalefactor band and, if the allowed distortion is exceeded, amplifies the scalefactor band and calls the inner loop again.

Layer III loops module input:

- (1) vector of the magnitudes of the spectral values  $xr(0..575)$ .
- (2)  $xmin(sb)$ , the allowed distortion of the scalefactor bands.  $xmin = ratio(sb) * en(sb) / bw(sb)$ .
- (3)  $window\_switching\_flag$  which, in conjunction with  $mixed\_block\_flag$  and  $block\_type$ , determines the number of scalefactor bands.
- (4)  $mean\_bits$  (bit available for the Huffman coding and the coding of the scalefactors).
- (5)  $more\_bits$ , the number of bits in addition to the average number of bits, as demanded by the value of the psychoacoustic entropy for the granule:  
 $more\_bits = 3.1 * PE - (average\ number\ of\ bits)$

Layer III loops module output:

- (1) vector of quantized values  $ix(0..575)$ .
- (2)  $scalefac\_1(sb)$  or  $scalefac\_s(sb)$  depending on  $window\_switching\_flag$ ,  $block\_type$  and  $mixed\_block\_flag$ .
- (3)  $global\_gain$  (quantizer step size information)  
 $global\_gain = qquant + system\_constant$ .  
 $system\_constant$  includes all the scaling operations of the encoder and an offset to achieve the correct output with the decoding process described in the main part.
- (4) number of unused bits available for later use.
- (5)  $preflag$  (loops preemphasis on/off).
- (6) Huffman code related side information
  - $big\_values$  (number of pairs of Huffman coded values, excluding "count1")
  - $count1\_table\_select$  (Huffman code table of absolute values  $\leq 1$  at the upper end of the spectrum)
  - $table\_select[0..2]$  (Huffman code table of regions)
  - $region0\_count$ ,  $region1\_count$  (used to calculate boundaries between regions)
  - $part2\_3\_length$

#### C.1.5.4.2 Preparatory steps

##### C.1.5.4.2.1 Reset of all iteration variables

The scalefactors of the coder partitions,  $scalefac\_1[sb]$  or  $scalefac\_s[sb]$ , are respectively set to zero.

The counter  $qquant$  for the quantizer step size is reset to zero.

$preflag$  is reset to zero.

$scalefac\_scale$  is reset to zero.

The initial value of  $quantanf$  is set as follows:

$$quantanf = system\_const * \log_e(sfm),$$

where  $sfm$  is the spectral flatness measure and  $quantanf$  depends on the computational implementation of the encoder.

The spectral flatness measure  $sfm$  is given by

$$sfm = \frac{e^{\frac{1}{n} \left( \sum_{i=0}^{n-1} \log xr(i)^2 \right)}}{\frac{1}{n} \sum_{i=0}^{n-1} xr(i)^2}$$

The value of `system_const` is chosen so that for all signals the first iteration of the inner loop for all signals comes out with a bit sum higher than the desired bitsum. By that it is ensured that the first call of the inner loop results in the solution which uses as many of the available bits as possible. In order to spare computing time it is desirable to minimize the number of iterations by adapting the value of `quantanf` to the bitrate and the signal statistics.

#### C.1.5.4.2.2 Bit reservoir control

Bits are saved to the reservoir when fewer than the `mean_bits` are used to code one granule. If bits are saved for a frame, the value of `main_data_end` is increased accordingly. See figure A.7.a.

The number of bits which are made available for the `main_data` (called "`max_bits`") is derived from the actual estimated threshold (the PE as calculated by the psychoacoustic model), the average number of bits (`mean_bits`) and the actual content of the bit reservoir. The number of bytes in the bit reservoir is given by `main_data_end`.

The actual rules for the control of the bit reservoir are given below:

- If a number of bytes available to the inner iteration loop is not used for the Huffman encoding or other `main_data`, the number is added to the bit reservoir.
- If the bit reservoir contains more than 0,8 times the maximum allowed content of the bit reservoir, all bytes exceeding this number are made available for `main_data` (in addition to `mean_bits`).
- If `more_bits` is greater than 100 bits, then  $\max(\text{more\_bits}/8, 0,6 * \text{main\_data\_end})$  bytes are taken from the bit reservoir and made available for `main_data` (in addition to `mean_bits`).
- After the actual loops computations have been completed, the number of bytes not used for `main_data` is added to the bit reservoir.
- If after the step above the number of bytes in the bit reservoir exceeds the maximum allowed content, stuffing bits are written to the bitstream and the content of the bit reservoir is adjusted accordingly.

#### C.1.5.4.2.3 Calculation of the scalefactor selection information (scfsi)

The `scfsi` contains the information, which scalefactors (grouped in the `scfsi_bands`) of the first granule can also be used for the second granule. These scalefactors are therefore not transmitted, the bits gained can be used for the Huffman coding.

To determine the usage of the `scfsi`, the following information of each granule must be stored:

- a) The block type
- b) The total energy of the granule:

$$\text{en\_tot} = \text{int} \left\{ \log_2 \left( \sum_{i=1}^n |xr(i)|^2 \right) \right\}$$

where  $n$  is the total number of spectral values.

- c) The energy of each scalefactor band:

$$\text{en}(sb) = \text{int} \left\{ \log_2 \left( \sum_{i=\text{lbl}(sb)}^{\text{lbl}(sb)+\text{bw}(sb)-1} |xr(i)|^2 \right) \right\}$$

where  $\text{lbl}(sb)$  is the number of the first coefficient belonging to scalefactor band  $sb$  and  $\text{bw}(sb)$  is the number of coefficients within scalefactor band  $sb$ .

- d) The allowed distortion of each scalefactor band:

$$xm(sb) = \text{int} \{ \log_2 (x_{\text{min}}(i)) \}$$

$x_{\text{min}}(sb)$  is calculated by the psychoacoustic model.

The scalefactors of the first granule are always transmitted. When coding the second granule, the information of the two granules is compared. There are four criteria to determine if the scfsi can be used in general. If one of the four is not fulfilled, the scfsi is disabled (that means it is set to 0 in all scfsi\_bands). The criteria are (index 0 means first, index 1 second granule):

- a) The spectral values are not all zero  
 b) None of the granules contains short blocks  
 c)

$$|en_{\text{tot}0} - en_{\text{tot}1}| < en_{\text{tot}k_{\text{rit}}}$$

- d)

$$\sum_{\text{all scalefactor bands}} |en(sb)_0 - en(sb)_1| < en_{\text{dif}k_{\text{rit}}}$$

If the scfsi is not disabled after the tests above, there are two criteria for each scfsi\_band, which have both to be fulfilled to enable scfsi (that means to set it to 1 in this scfsi\_band):

- a)

$$\sum_{\text{all cr. bds in scfsi\_band}} |en(sb)_0 - en(sb)_1| < en(\text{scfsi\_band})_{k_{\text{rit}}}$$

- b)

$$\sum_{\text{all cr. bds in scfsi\_band}} |xm(sb)_0 - xm(sb)_1| < xm(\text{scfsi\_band})_{k_{\text{rit}}}$$

The constants (with the index *krit*) have to be chosen so, that the scfsi is only enabled in case of similar energy/distortion.

Suggested values are:

$en_{\text{tot}k_{\text{rit}}}$	=	10	
$en_{\text{dif}k_{\text{rit}}}$	=	100	
$en(\text{scfsi\_band})_{k_{\text{rit}}}$	=	10	for each scfsi_band
$xm(\text{scfsi\_band})_{k_{\text{rit}}}$	=	10	for each scfsi_band

#### C.1.5.4.3 Outer iteration loop (distortion control loop)

The outer iteration loop controls the quantization noise which is produced by the quantization of the frequency domain lines within the inner iteration loop. The colouring of the noise is done by multiplication of the lines within scalefactor bands with the actual scalefactors before doing the quantization. The following pseudo-code illustrates the multiplication.

```

do for each scalefactor band:
  do from lower index to upper index of scale factor band
     $xr(i) = xr(i) * \sqrt{(2)^{((1 + \text{scalefac\_scale}) * \text{scalefac}(sb))}}$ 
  end do
end do

```

Where scalefac is either scalefac\_1 or scalefac\_s as appropriate.

In the actual system the multiplication is done incrementally with just the increase of the scalefactors applied in each distortion control loop. This is described in C.1.5.4.3.5 below.

The distortion loop is always started with `scalefac_scale = 0`. If after some iterations the maximum length of the scalefactors would be exceeded (see `scalefac_compress` table in 2.4.2.7 and C.1.5.4.3.5 below), then `scalefac_scale` is increased to the value 1 thus increasing the possible dynamic range of the scalefactors. In this case the actual scalefactors and frequency lines have to be corrected accordingly.

#### **C.1.5.4.3.1 Saving of the scalefactors**

The scalefactors of all scalefactor bands, `scalefac_1(sb)` or `scalefac_s(sb)`, as well as the quantizer step size `qquant` are saved. If the computation of the outer loop is cancelled without having reached a proper result, this value together with the quantized spectrum give an approximation and can be transmitted.

#### **C.1.5.4.3.2 Call of inner iteration loop**

For each outer iteration loop (distortion control loop) the inner iteration loop (rate control loop) is called. The parameters are the frequency domain values (hybrid filterbank output) with the scalefactors applied to the values within the scalefactor bands and the number of bits which are available to the rate control loop. The result is the number of bits actually used and the quantized frequency lines `ix(i)`.

#### **C.1.5.4.3.3 Calculation of the distortion of the scalefactor bands**

For each scalefactor band the actual distortion is calculated according to:

$$xfsf(sb) = \sum_{l=lbl(sb)}^{i=lbl(sb)+bw(sb)-1} \frac{(|xr(i)| - ix(i))^{4/3} * \sqrt[4]{2^{qquant+quantanf}}}{bandwidth(sb)}^2$$

where `lbl(sb)` is the number of the coefficient representing the lowest frequency in a scalefactor band and `bw(sb)` is the number of coefficients within this band.

#### **C.1.5.4.3.4 Preemphasis**

The preemphasis option (switched on by setting `preflag` to a value of 1) provides the possibility to amplify the upper part of the spectrum according to the preemphasis tables, table B.6.

```
if (preflag==1) {
    ifqstep = 2 ^ (0,5*(1+scalefac_scale) )
    xmin(j) = xmin(j) *ifqstep ^ (2*prefact(j))
    for (i=lower limit of scalefactor band j; i <=upper limit of scalefactor band j; i++) {
        xr(i) = xr(i) * ifqstepprefact(j)
    }
}
```

The condition to switch on the preemphasis is up to the implementation. For example preemphasis could be switched on if in all of the upper 4 scalefactor bands the actual distortion exceeds the threshold after the first call of the inner loop.

If the second granule is being coded and `scfsi` is active in at least one `scfsi_band`, the preemphasis in the second granule is set equal to the setting in first granule.

#### **C.1.5.4.3.5 Amplification of scalefactor bands which violate the masking threshold**

All spectral values of the scalefactor bands which have a distortion that exceeds the allowed distortion are amplified by a factor of `ifqstep`. The value of `ifqstep` is transmitted by `scalefac_scale`.

```

if ( (xmin - xfsf) of scalefactor band j < 0 ) {
    xmin(j) = xmin(j) * ifqstep ^ 2
    ifq(j) = ifq(j) + 1
    for (i=lower limit of scalefactor band; i <=upper limit of scalefactor band; i++) {
        xr(i) = xr(i) * ifqstep
    }
}

```

If the second granule is being coded and scfsi is active in at least one scfsi\_band, the following steps have to be done:

- a) ifqstep has to be set similar to the first granule
- b) If it is the first iteration, the scalefactors of scalefactor bands in which scfsi is enabled have to be taken over from the first granule. The corresponding spectral values have to be amplified:

```

if ( scfsi according to scalefactor band j == 1 ) {
    ifq(j) = ifq(j)first granule
    for (i=lower limit of scalefactor band; i <=upper limit of scalefactor band; i++) {
        xr(i) = xr(i) * ifqstep ^ scalefac(j)
    }
}

```

Where scalefac is either scalefac\_1() or scalefac\_s() as appropriate.

- c) If it is not the first iteration, the amplification must be prevented for scalefactor bands in which scfsi is enabled.

#### **C.1.5.4.3.6 Conditions for the termination of the loops processing**

Normally the loops processing terminates if there is no scalefactor band with more than the allowed distortion. However this is not always possible to obtain. In this case there are other conditions to terminate the outer loop. If

- a) All scalefactor bands are already amplified, or
- b) The amplification of at least one band exceeds the upper limit which is determined by the transmission format of the scalefactors. The upper limit is a scalefactor of 15 for scalefactor bands 0 through 10 and 7 for scalefactors 11 through 20. In the case of block\_type == 2 and mixed\_block\_flag == 0, the upper limit is 15 for scalefactors 0 through 18. In the case of block\_type == 2 and mixed\_block\_flag == 1, the upper limit is 15 for scalefactors 0 through 17. The upper limit is 7 for other scalefactors.

The loop processing stops, and by restoring the saved scalefac\_1(sb) or scalefac\_s(sb) a useful output is available. For realtime implementation, there might be a third condition added which terminates the loops in case of a lack of computing time.

#### **C.1.5.4.4 Inner iteration loop (rate control loop)**

The inner iteration loop does the actual quantization of the frequency domain data and prepares the formatting. The table selection, subdivision of the big\_values range into regions and the selection of the quantizer step size takes place here.

##### **C.1.5.4.4.1 Quantization**

The quantization of the complete vector of spectral values is done according to

$$ix(i) = \text{nint} \left( \left( \frac{|xr(i)|}{\sqrt[4]{\text{quant} + \text{quantanf}}} \right)^{0,75} - 0,0946 \right)$$

**C.1.5.4.4.2 Test of the maximum of the quantized values**

The maximum allowed quantized value is limited. This limit is set to constraint the table size if a table-lookup is used to requantize the quantized frequency lines. The limit is given by the possible values of the length identifier, "linbits", of values flagged with an ESC-code. Therefore before any bit counting is done the quantizer stepsize is increased by

$$qquant = qquant + 1$$

until the maximum of the quantized values is within the range of the largest Huffman code table.

**C.1.5.4.4.3 Calculation of the run length of zeros**

The run length rzero of pairs of spectral coefficients quantized to zero on the upper end of the spectrum is counted and called "rzero".

**C.1.5.4.4.4 Calculation of the run length of values less or equal one**

The run length of quadrupels of spectral coefficients quantized to one or zero, following the rzero pairs of zeros, is calculated and called "count1".

**C.1.5.4.4.5 Counting the bits necessary to code the values less or equal one**

One Huffman code word is used to code one of the "count1" quadrupels. There are two different Huffman code books with corresponding code length tables (table A and table B in clause B.7). The number of bits to code all the count1 quadrupels is given by:

$$\text{bitsum\_count1} = \min(\text{bitsum\_table0}, \text{bitsum\_table1})$$

where count1table\_0 is used to point to table A

$$\text{bitsum\_table0} = \sum_{k=\text{firstcount1}}^{k=\text{firstcount1}+\text{count1}-1} \text{count1table\_0} (ix(4k)+2*ix(4k+1)+4*ix(4k+2)+8*ix(4k+3))$$

and count1table\_1 is used to point to table B

$$\text{bitsum\_table1} = \sum_{k=\text{firstcount1}}^{k=\text{firstcount1}+\text{count1}-1} \text{count1table\_1} (ix(4k)+2*ix(4k+1)+4*ix(4k+2)+8*ix(4k+3))$$

Count1table\_0 as well as count1table\_1 have to include the number of bits necessary to encode the sign bits.

The information which table is used is transmitted by count1table\_select, which is "0" for table A or "1" for table B, respectively.

**C.1.5.4.4.6 Call of subroutine SUBDIVIDE**

The number of pairs of quantized values not counted in "count1" or "rzero" is called bigvalues. SUBDIVIDE splits the scalefactor bands corresponding to this values into three groups. The last one, incomplete generally, counts as a complete one. The number of scalefactor bands in the first and second regions are contained in (region0\_count+1) and (region1\_count+1) respectively. The number of scalefactor bands in the third region can be calculated using bigvalues. The split strategy is up to the implementation. A very simple one for instance is to assign 1/3 of the scalefactor bands to the first and 1/4 to the last region.

Subdivide in case of blocksplit is done analogously but there are only two subregions. Region1\_count is set to a default in this case. This default is 8 in the case of split\_point=0 and 9 in the case of split\_point=1. Both these values point to the same absolute frequency.

#### C.1.5.4.4.7 Calculation of the code book for each subregion

There are 32 different Huffman code tables available for the coding of pairs of quantized values. They differ from each other in the maximum value that can be coded and in the signal statistics for which they are optimized. Only codes for values < 16 are in the table. For values  $\geq 16$  there are two tables provided, where the largest value 15 is an escape character. In this case the value 15 is coded in an additional word using a linear PCM code with a word length called linbits.

A simple way to choose a table is to use the maximum of the quantized values in a subregion. Tables which have the same size are optimized for different signal statistics. Therefore additional coding gain can be achieved for example by trying all of these tables.

#### C.1.5.4.4.8 Counting of the bits necessary to code the values in the subregions

The number of bits necessary to code the quantized values of a subregion is given by:

$$\text{bitsum}(j) = \sum_{k=0}^{k=np(j)-1} \text{bitz}(\text{tableselect}(j), \min(15, ix(2k+fe(j))), \min(15, ix(2k+fe(j)+1))) \\ + \sum_{k=0}^{k=np(j)-1} (s(ix(2k+fe(j)) - 15) + s(ix(2k+fe(j)+1) - 15)) * \text{linbits}(j)$$

np(j): number of pairs in a sub region  
 fe(j): number of the first quantized value in a sub-region  
 bitz: table with Huffman code length

s(...) step function: if  $x \geq 0$   $s(x) = 1$   
 if  $x < 0$   $s(x) = 0$

Note that the Huffman code length tables have to include the number of bits necessary to encode the sign bits.

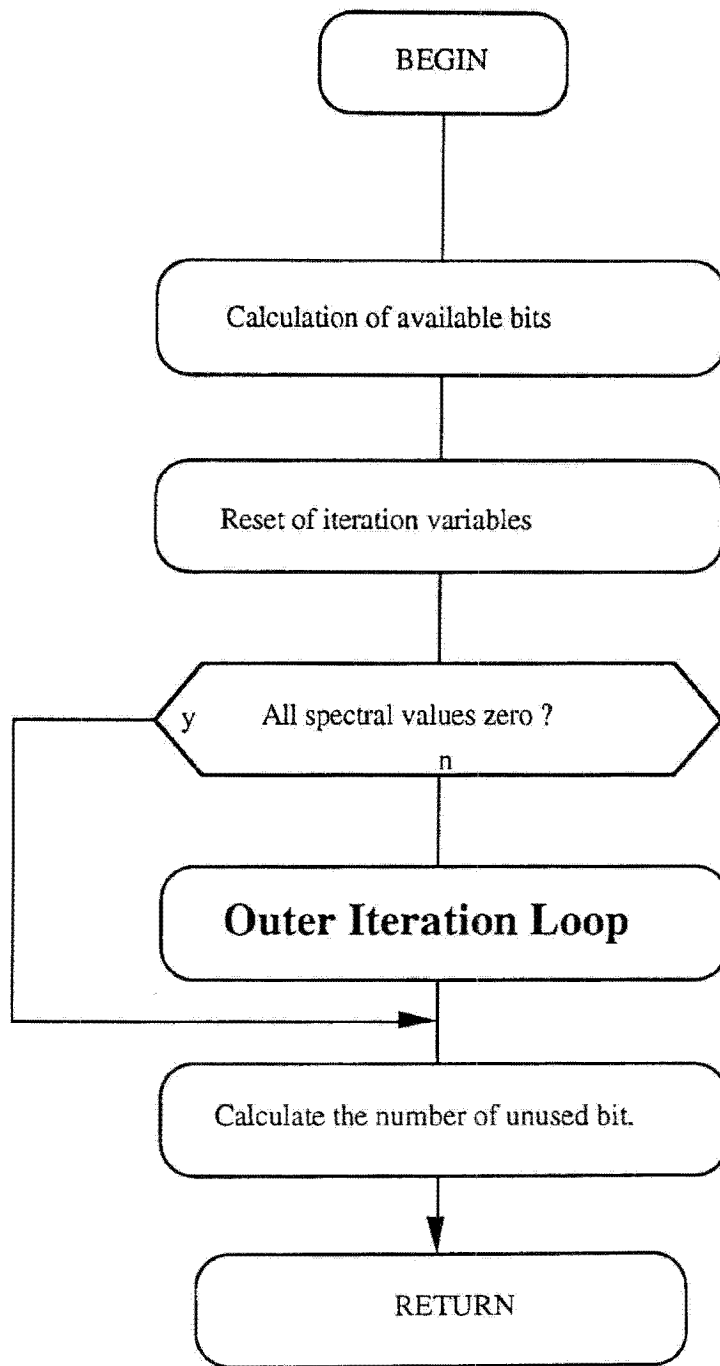

Figure C.9.a -- Layer III iteration loop



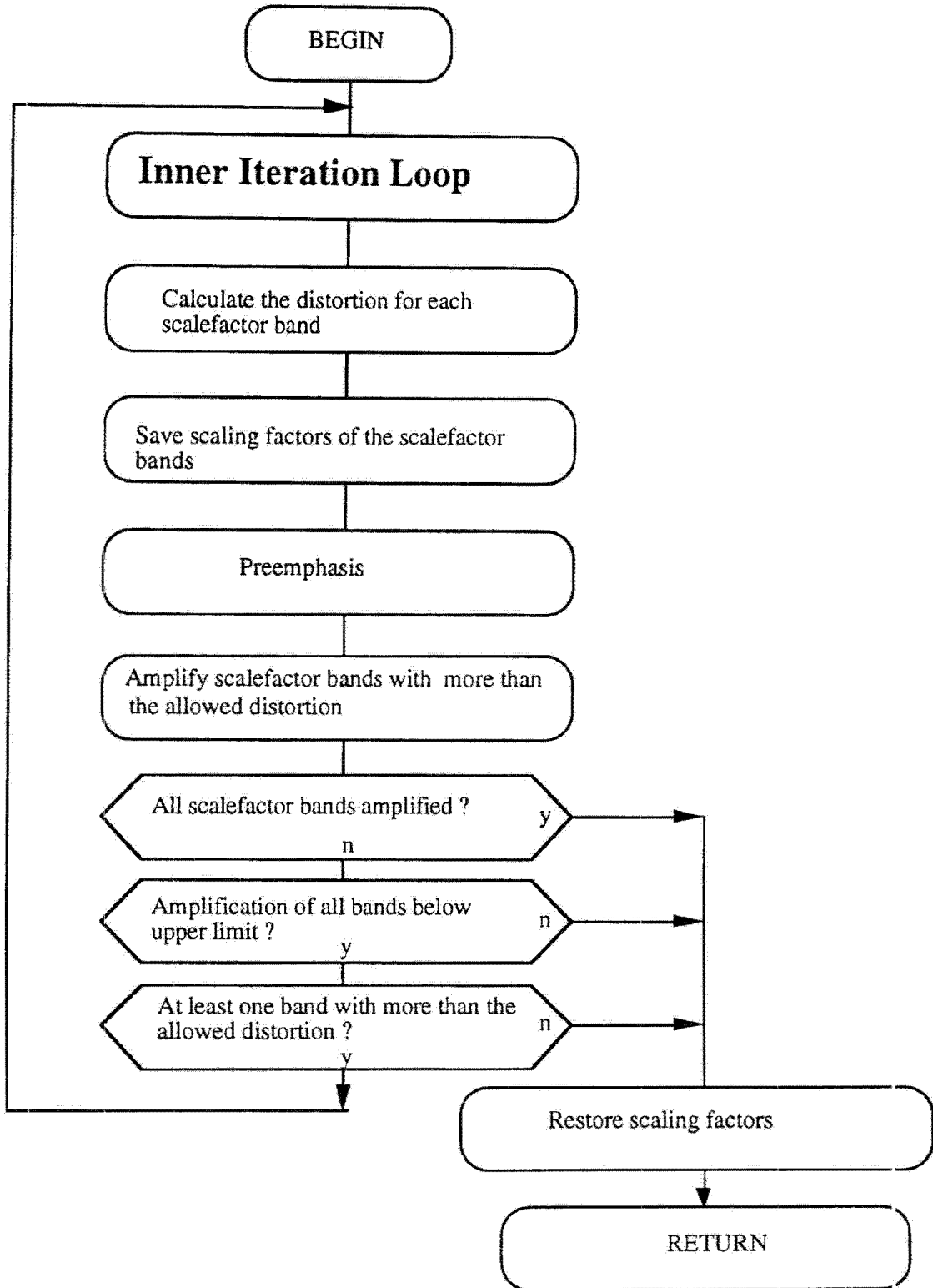

Figure C.9.b -- Layer III outer iteration loop

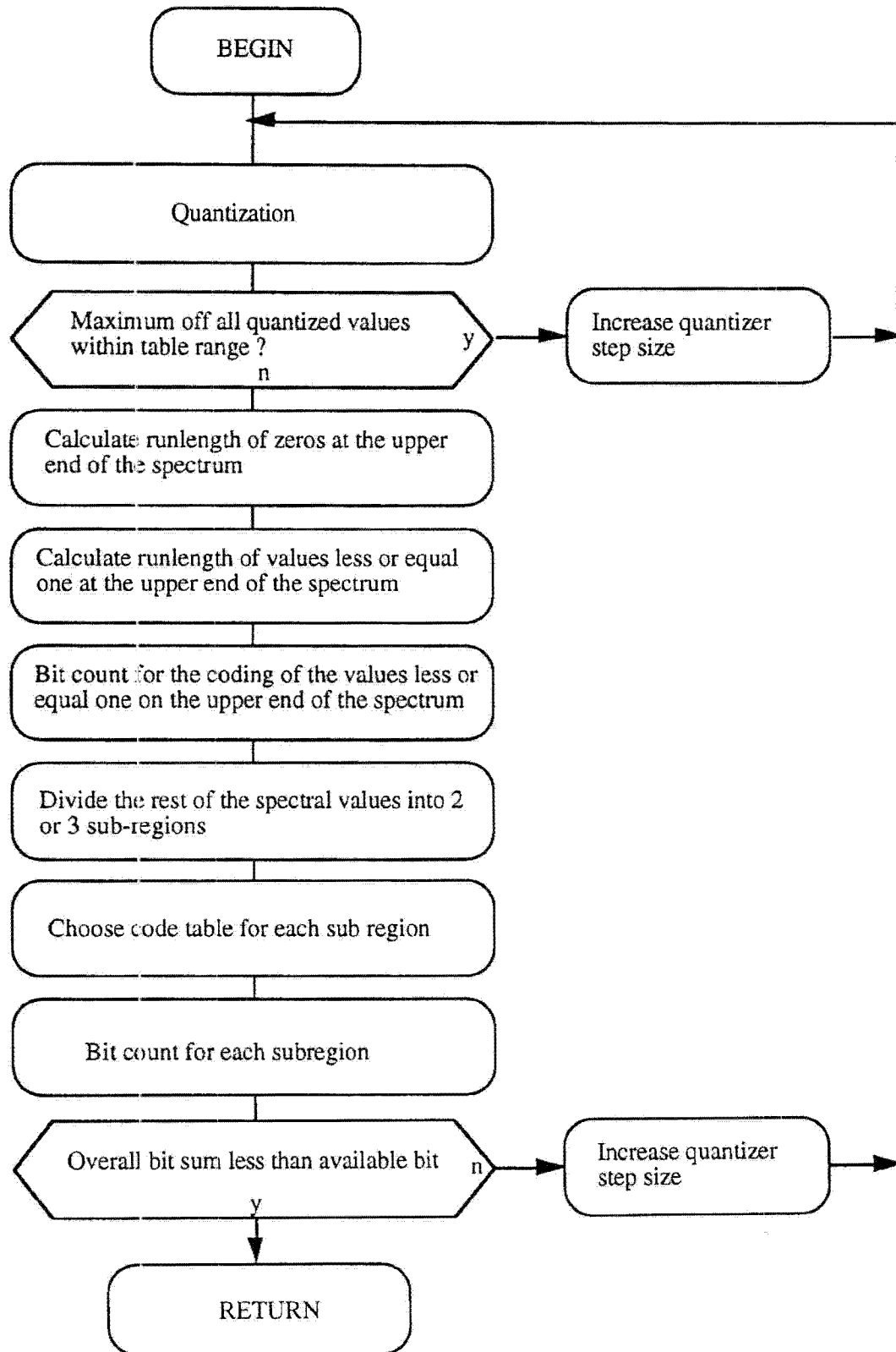

Figure C.9.c -- Layer III inner iteration loop

## Annex D

(informative)

### Psychoacoustic models

#### D.1. Psychoacoustic model 1

The calculation of the psychoacoustic model has to be adapted to the corresponding layer. This example is valid for Layers I and II. The model can be adapted to Layer III.

There is no principal difference in the application of psychoacoustic model 1 to Layer I or II.

Layer I: A new bit allocation is calculated for each block of 12 subband or 384 input PCM samples.

Layer II: A new bit allocation is calculated for three blocks totaling 36 subband samples corresponding to 3\*384 (1 152) input PCM samples.

The bit allocation of the 32 subbands is calculated on the basis of the signal-to-mask ratios of all the subbands. Therefore, it is necessary to determine for each subband, the maximum signal level and the minimum masking threshold. The minimum masking threshold is derived from an FFT of the input PCM signal, followed by a psychoacoustic model calculation.

The FFT in parallel with the subband filter compensates for the lack of spectral selectivity obtained at low frequencies by the subband filterbank. This technique provides both a sufficient time resolution for the coded audio signal (Polyphase filter with optimized window for minimal pre-echoes) and a sufficient spectral resolution for the calculation of the masking thresholds. The frequencies and levels of aliasing distortions can be calculated. This is necessary for calculating a minimum bitrate for those subbands which need some bits to cancel the aliasing components in the decoder. The additional complexity to calculate the better frequency resolution is necessary only in the encoder, and introduces no additional delay or complexity in the decoder.

The calculation of the signal-to-mask-ratio is based on the following steps:

**Step 1**

- Calculation of the FFT for time to frequency conversion.

**Step 2**

- Determination of the sound pressure level in each subband.

**Step 3**

- Determination of the threshold in quiet (absolute threshold).

**Step 4**

- Finding of the tonal (more sinusoid-like) and non-tonal (more noise-like) components of the audio signal.

**Step 5**

- Decimation of the maskers, to obtain only the relevant maskers.

**Step 6**

- Calculation of the individual masking thresholds.

**Step 7**

- Determination of the global masking threshold.

**Step 8**

- Determination of the minimum masking threshold in each subband.

**Step 9**

- Calculation of the signal-to-mask ratio in each subband.

These steps will be further discussed. A sampling frequency of 48 kHz is assumed. For the other two sampling frequencies all frequencies mentioned should be scaled accordingly.

### Step 1: FFT Analysis

The masking threshold is derived from an estimate of the power density spectrum that is calculated by a 512-point FFT for Layer I, or by a 1 024-point FFT for Layer II. The FFT is calculated directly from the input PCM signal, windowed by a Hann window.

For a coincidence in time between the bit allocation and the corresponding subband samples, the PCM-samples entering the FFT have to be delayed:

- The delay of the analysis subband filter is 256 samples, corresponding to 5,3 ms at the 48 kHz sampling rate. A window shift of 256 samples is required to compensate for the delay in the analysis subband filter.
- The Hann window must coincide with the subband samples of the frame. For Layer I this amounts to an additional window shift of 64 samples. For Layer II an additional window shift of minus 64 samples is required.

Technical data of the FFT:

	Layer I	Layer II
- transform length	512 samples	1 024 samples
- Window size if fs = 48 kHz	10,67 ms	21,3 ms
- Window size if fs = 44,1 kHz	11,6 ms	23,2 ms
- Window size if fs = 32 kHz	16 ms	32 ms
- Frequency resolution	sampling_frequency / 512	sampling_frequency / 1024
- Hann window, h(i):		
-	$h(i) = \sqrt{8/3} * 0,5 * \{1 - \cos[2 * \pi * (i)/N]\}$ $0 \leq i \leq N-1$	
- power density spectrum X(k):		

$$X(k) = 10 * \log_{10} \left| \frac{1}{N} \sum_{l=0}^{N-1} h(l) * s(l) * e^{-j * k * l * 2 * \pi / N} \right|^2 \quad \text{dB} \quad k = 0 \dots N/2,$$

where s(l) is the input signal.

A normalization to the reference level of 96 dB SPL (Sound Pressure Level) has to be done in such a way that the maximum value corresponds to 96 dB.

### Step 2: Determination of the sound pressure level

The sound pressure level  $L_{sb}$  in subband n is computed by:

$$L_{sb}(n) = \text{MAX} [ X(k), 20 * \log(\text{scf}_{\text{max}}(n) * 32 768) - 10 ] \text{ dB}$$

X(k) in subband n

where X(k) is the sound pressure level of the spectral line with index k of the FFT with the maximum amplitude in the frequency range corresponding to subband n. The expression  $\text{scf}_{\text{max}}(n)$  is in Layer I the scalefactor, and in Layer II the maximum of the three scalefactors of subband n within a frame. The "-10 dB" term corrects for the difference between peak and RMS level. The sound pressure level  $L_{sb}(n)$  is computed for every subband n.

The following alternative method of calculating  $L_{sb}(n)$  offers a potential for better encoder performance, but this technique has not been subjected to a formal audio quality test.

The alternative sound pressure level  $L_{sb}$  in subband  $n$  is computed by:

$$L_{sb}(n) = \text{MAX}[ X_{spl}(n), 20 \cdot \log(\text{scf}_{\text{max}}(n) \cdot 32\,768) - 10 ] \text{ dB}$$

with

$$X_{spl}(n) = 10 \cdot \log_{10} \left( \sum_{\substack{k \\ k \text{ in subband } n}} 10^{X(k)/10} \right) \text{ dB}$$

where  $X_{spl}(n)$  is the alternative sound pressure level corresponding to subband  $n$ .

### Step 3: Considering the threshold in quiet

The threshold in quiet  $LT_q(k)$ , also called absolute threshold, is available in the tables "Frequencies, critical band rates and absolute threshold" (tables D.1a, D.1b, D.1c for Layer I; tables D.1d, D.1e, D.1f for Layer II). These tables depend on the sampling rate of the input PCM signal. Values are available for each sample in the frequency domain where the masking threshold is calculated. An offset depending on the overall bit rate is used for the absolute threshold. This offset is -12 dB for bit rates  $\geq 96$  kbits/s and 0 dB for bit rates  $< 96$  kbits/s per channel.

### Step 4: Finding of tonal and non-tonal components

The tonality of a masking component has an influence on the masking threshold. For this reason, it is worthwhile to discriminate between tonal and non-tonal components. For calculating the global masking threshold it is necessary to derive the tonal and the non-tonal components from the FFT spectrum.

This step starts with the determination of local maxima, then extracts tonal components (sinusoids) and calculates the intensity of the non-tonal components within a bandwidth of a critical band. The boundaries of the critical bands are given in the tables "Critical band boundaries" (tables D.2a, D.2b, D.2c for Layer I; tables D.2d, D.2e, D.2f for Layer II).

The bandwidth of the critical bands varies with the center frequency with a bandwidth of about only 0,1 kHz at low frequencies and with a bandwidth of about 4 kHz at high frequencies. It is known from psychoacoustic experiments that the ear has a better frequency resolution in the lower than in the higher frequency region. To determine if a local maximum may be a tonal component, a frequency range  $df$  around the local maximum is examined. The frequency range  $df$  is given by:

Sampling rate: 32 kHz

Layer I:	$df = 125 \text{ Hz}$	$0 \text{ kHz} < f \leq 4,0 \text{ kHz}$
	$df = 187,5 \text{ Hz}$	$4,0 \text{ kHz} < f \leq 8,0 \text{ kHz}$
	$df = 375 \text{ Hz}$	$8,0 \text{ kHz} < f \leq 15,0 \text{ kHz}$

Layer II:	$df = 62,5 \text{ Hz}$	$0 \text{ kHz} < f \leq 3,0 \text{ kHz}$
	$df = 93,75 \text{ Hz}$	$3,0 \text{ kHz} < f \leq 6,0 \text{ kHz}$
	$df = 187,5 \text{ Hz}$	$6,0 \text{ kHz} < f \leq 12,0 \text{ kHz}$
	$df = 375 \text{ Hz}$	$12,0 \text{ kHz} < f \leq 24,0 \text{ kHz}$

Sampling rate: 44,1 kHz

Layer I:	$df = 172,266 \text{ Hz}$	$0 \text{ kHz} < f \leq 5,512 \text{ kHz}$
	$df = 281,25 \text{ Hz}$	$5,512 \text{ kHz} < f \leq 11,024 \text{ kHz}$
	$df = 562,50 \text{ Hz}$	$11,024 \text{ kHz} < f \leq 19,982 \text{ kHz}$

Layer II:	$df = 86,133 \text{ Hz}$	$0 \text{ kHz} < f \leq 2,756 \text{ kHz}$
	$df = 129,199 \text{ Hz}$	$2,756 \text{ kHz} < f \leq 5,512 \text{ kHz}$
	$df = 258,398 \text{ Hz}$	$5,512 \text{ kHz} < f \leq 11,024 \text{ kHz}$
	$df = 516,797 \text{ Hz}$	$11,024 \text{ kHz} < f \leq 19,982 \text{ kHz}$

Sampling rate: 48 kHz

Layer I: df = 187,5 Hz            0 kHz < f ≤ 6,0 kHz  
 df = 281,25 Hz            6,0 kHz < f ≤ 12,0 kHz  
 df = 562,50 Hz            12,0 kHz < f ≤ 24,0 kHz

Layer II: df = 93,750 Hz            0 kHz < f ≤ 3,0 kHz  
 df = 140,63 Hz            3,0 kHz < f ≤ 6,0 kHz  
 df = 281,25 Hz            6,0 kHz < f ≤ 12,0 kHz  
 df = 562,50 Hz            12,0 kHz < f ≤ 24,0 kHz

To make lists of the spectral lines  $X(k)$  that are tonal or non-tonal, the following three operations are performed:

**a) Labelling of local maxima**

A spectral line  $X(k)$  is labelled as a local maximum if

$$X(k) > X(k-1) \text{ and } X(k) \geq X(k+1)$$

**b) Listing of tonal components and calculation of the sound pressure level**

A local maximum is put in the list of tonal components if

$$X(k) - X(k+j) \geq 7 \text{ dB,}$$

where  $j$  is chosen according to

Layer I:  
 j = -2, +2                            for 2 < k < 63  
 j = -3, -2, +2, +3                for 63 ≤ k < 127  
 j = -6, ..., -2, +2, ..., +6        for 127 ≤ k ≤ 250

Layer II:  
 j = -2, +2                            for 2 < k < 63  
 j = -3, -2, +2, +3                for 63 ≤ k < 127  
 j = -6, ..., -2, +2, ..., +6        for 127 ≤ k < 255  
 j = -12, ..., -2, +2, ..., +12      for 255 ≤ k ≤ 500

If  $X(k)$  is found to be a tonal component, then the following parameters are listed:

- Index number  $k$  of the spectral line.
- Sound pressure level  $X_{tm}(k) = 10 * \log_{10} \left\{ 10 \frac{X(k-1)}{10} + 10 \frac{X(k)}{10} + 10 \frac{X(k+1)}{10} \right\}$ , in dB
- Tonal flag.

Next, all spectral lines within the examined frequency range are set to  $-\infty$  dB.

**c) Listing of non-tonal components and calculation of the power**

The non-tonal (noise) components are calculated from the remaining spectral lines. To calculate the non-tonal components from these spectral lines  $X(k)$ , the critical bands  $z(k)$  are determined using the tables, "Critical band boundaries" (tables D.2a, D.2b, D.2c for Layer I; tables D.2d, D.2e, D.2f for Layer II). In Layer I, 23 critical bands are used for the sampling rate of 32 kHz, 24 critical bands for 44,1 kHz and 25 critical bands are used for 48 kHz. In Layer II, 24 critical bands are used for 32 kHz sampling rate, and 26 critical bands are used for 44,1 kHz and 48 kHz sampling rate. Within each critical band, the power of the spectral lines (remaining after the tonal components have been zeroed) are summed to form the sound pressure level of the new non-tonal component  $X_{nm}(k)$  corresponding to that critical band.

The following parameters are listed:

- Index number  $k$  of the spectral line nearest to the geometric mean of the critical band.
- Sound pressure level  $X_{nm}(k)$  in dB.
- Non-tonal flag.

#### Step 5: Decimation of tonal and non-tonal masking components

Decimation is a procedure that is used to reduce the number of maskers which are considered for the calculation of the global masking threshold.

- a) Tonal  $X_{tm}(k)$  or non-tonal components  $X_{nm}(k)$  are considered for the calculation of the masking threshold only if:

$$X_{tm}(k) \geq LT_q(k) \quad \text{or} \quad X_{nm}(k) \geq LT_q(k)$$

In this expression,  $LT_q(k)$  is the absolute threshold (or threshold in quiet) at the frequency of index  $k$ . These values are given in tables D.1a, D.1b, D.1c for Layer I; tables D.1d, D.1e, D.1f for Layer II.

- b) Decimation of two or more tonal components within a distance of less than 0,5 Bark: Keep the component with the highest power, and remove the smaller component(s) from the list of tonal components. For this operation, a sliding window in the critical band domain is used with a width of 0,5 Bark.

In the following, the index  $j$  is used to indicate the relevant tonal or non-tonal masking components from the combined decimated list.

#### Step 6: Calculation of individual masking thresholds

Of the original  $N/2$  frequency domain samples, indexed by  $k$ , only a subset of the samples, indexed by  $i$ , are considered for the global masking threshold calculation. The samples used are shown in tables D.1a, D.1b, D.1c for Layer I; tables D.1d, D.1e, D.1f for Layer II.

##### Layer I:

For the frequency lines corresponding to the frequency region which is covered by the first six subbands no subsampling is used. For the frequency region corresponding to the next six subbands every second spectral line is considered. Finally, in the case of 44,1 kHz and 48 kHz sampling rates, in the frequency region corresponding to the remaining subbands, every fourth spectral line is considered up to 20 kHz. In the case of 32 kHz sampling rate, in the frequency region corresponding to the remaining subbands, every fourth spectral line is considered up to 15 kHz (see also tables D.1a, D.1b, D.1c for Layer I).

##### Layer II:

For the frequency lines corresponding to the frequency region which is covered by the first three subbands no subsampling is used. For the frequency region which is covered by next three subbands every second spectral line is considered. For the frequency region corresponding to the next six subbands every fourth spectral line is considered. Finally, in the case of 44,1 kHz and 48 kHz sampling rates, in the remaining subbands every eighth spectral line is considered up to 20 kHz. In the case of 32 kHz sampling rate, in the frequency region corresponding to the remaining subbands, every eighth spectral line is considered up to 15 kHz. (See also tables D.1d, D.1e, D.1f for Layer II).

The number of samples,  $n$ , in the subsampled frequency domain is different depending on the sampling rates and layers.

32 kHz sampling rate:	$n = 108$ for Layer I	and	$n = 132$ for Layer II
44,1 kHz sampling rate:	$n = 106$ for Layer I	and	$n = 130$ for Layer II
48 kHz sampling rate:	$n = 102$ for Layer I	and	$n = 126$ for Layer II

Every tonal and non-tonal component is assigned the value of the index  $i$  that most closely corresponds to the frequency of the original spectral line  $X(k)$ . This index  $i$  is given in tables D.1a, D.1b, D.1c for Layer I; tables D.1d, D.1e, D.1f for Layer II.

The individual masking thresholds of both tonal and non-tonal components are given by the following expression:

$$\begin{aligned} LT_{tm}[z(j),z(i)] &= X_{tm}[z(j)] + av_{tm}[z(j)] + vf[z(j),z(i)] \text{ dB} \\ LT_{nm}[z(j),z(i)] &= X_{nm}[z(j)] + av_{nm}[z(j)] + vf[z(j),z(i)] \text{ dB} \end{aligned}$$

In this formula,  $LT_{tm}$  and  $LT_{nm}$  are the individual masking thresholds at critical band rate  $z$  in Bark of the masking component at the critical band rate of the masker  $z_m$  in Bark. The values in dB can be either positive or negative. The term  $X_{tm}[z(j)]$  is the sound pressure level of the masking component with the index number  $j$  at the corresponding critical band rate  $z(j)$ . The term  $av$  is called the masking index and  $vf$  the masking function of the masking component  $X_{tm}[z(j)]$ . The masking index  $av$  is different for tonal and non-tonal maskers ( $av_{tm}$  and  $av_{nm}$ ).

For tonal maskers it is given by

$$av_{tm} = -1,525 - 0,275 * z(j) - 4,5 \text{ dB},$$

and for non-tonal maskers

$$av_{nm} = -1,525 - 0,175 * z(j) - 0,5 \text{ dB}.$$

The masking function  $vf$  of a masker is characterized by different lower and upper slopes, which depend on the distance in Bark  $dz = z(i) - z(j)$  to the masker. In this expression  $i$  is the index of the spectral line at which the masking function is calculated and  $j$  that of the masker. The critical band rates  $z(j)$  and  $z(i)$  can be found in tables D.1a, D.1b, D.1c for Layer I; tables D.1d, D.1e, D.1f for Layer II. The masking function, which is the same for tonal and non-tonal maskers, is given by:

$$\begin{aligned} vf &= 17 * (dz + 1) - (0,4 * X[z(j)] + 6) \text{ dB} && \text{for } -3 \leq dz < -1 \text{ Bark} \\ vf &= (0,4 * X[z(j)] + 6) * dz \text{ dB} && \text{for } -1 \leq dz < 0 \text{ Bark} \\ vf &= -17 * dz \text{ dB} && \text{for } 0 \leq dz < 1 \text{ Bark} \\ vf &= -(dz - 1) * (17 - 0,15 * X[z(j)]) - 17 \text{ dB} && \text{for } 1 \leq dz < 8 \text{ Bark} \end{aligned}$$

In these expressions  $X[z(j)]$  is the sound pressure level of the  $j$ 'th masking component in dB. For reasons of implementation complexity, the masking is no longer considered ( $LT_{tm}$  and  $LT_{nm}$  are set to  $-\infty$  dB outside this range) if  $dz < -3$  Bark, or  $dz \geq 8$  Bark.

### Step 7: Calculation of the global masking threshold $LT_g$

The global masking threshold  $LT_g(i)$  at the  $i$ 'th frequency sample is derived from the upper and lower slopes of the individual masking thresholds of each of the  $j$  tonal and non-tonal maskers and from the threshold in quiet  $LT_q(i)$ . This is also given in tables D.1a, D.1b, D.1c for Layer I; tables D.1d, D.1e, D.1f for Layer II. The global masking threshold is found by summing the powers corresponding to the individual masking thresholds and the threshold in quiet.

$$LT_g(i) = 10 \log_{10} \left( 10^{LT_q(i)/10} + \sum_{j=1}^m 10^{LT_{tm}(z(j),z(i))/10} + \sum_{j=1}^n 10^{LT_{nm}(z(j),z(i))/10} \right)$$

The total number of tonal maskers is given by  $m$ , and the total number of non-tonal maskers is given by  $n$ . For a given  $i$ , the range of  $j$  can be reduced to just encompass those masking components that are within  $-8$  to  $+3$  Bark from  $i$ . Outside of this range  $LT_{tm}$  and  $LT_{nm}$  are  $-\infty$  dB.

### Step 8: Determination of the minimum masking threshold

The minimum masking level  $LT_{min}(n)$  in subband  $n$  is determined by the following expression:

$$LT_{min}(n) = \text{MIN} \left[ LT_g(i) \right] \text{ dB} \\ \text{f(i) in subband n}$$



where  $f(i)$  is the frequency of the  $i$ 'th frequency sample. The  $f(i)$  are tabulated in tables D.1a, D.1b, D.1c for Layer I; tables D.1d, D.1e, D.1f for Layer II. A minimum masking level  $LT_{\min}(n)$  is computed for every subband.

**Step 9: Calculation of the signal-to-mask-ratio**

The signal-to-mask ratio

$$SMR_{sb}(n) = L_{sb}(n) - LT_{\min}(n) \text{ dB}$$

is computed for every subband  $n$ .

**Table D.1a. -- Frequencies, critical band rates and absolute threshold**  
 Table is valid for Layer I at a sampling rate of 32 kHz.

Index Number i	Frequency [Hz]	Crit. Band Rate [z]	Absolute Thresh. [dB]
1	62,50	0,617	33,44
2	125,00	1,232	19,20
3	187,50	1,842	13,87
4	250,00	2,445	11,01
5	312,50	3,037	9,20
6	375,00	3,618	7,94
7	437,50	4,185	7,00
8	500,00	4,736	6,28
9	562,50	5,272	5,70
10	625,00	5,789	5,21
11	687,50	6,289	4,80
12	750,00	6,770	4,45
13	812,50	7,233	4,14
14	875,00	7,677	3,86
15	937,50	8,103	3,61
16	1 000,00	8,511	3,37
17	1 062,50	8,901	3,15
18	1 125,00	9,275	2,93
19	1 187,50	9,632	2,73
20	1 250,00	9,974	2,53
21	1 312,50	10,301	2,32
22	1 375,00	10,614	2,12
23	1 437,50	10,913	1,92
24	1 500,00	11,199	1,71
25	1 562,50	11,474	1,49
26	1 625,00	11,736	1,27
27	1 687,50	11,988	1,04
28	1 750,00	12,230	0,80
29	1 812,50	12,461	0,55
30	1 875,00	12,684	0,29
31	1 937,50	12,898	0,02
32	2 000,00	13,104	-0,25
33	2 062,50	13,302	-0,54
34	2 125,00	13,493	-0,83
35	2 187,50	13,678	-1,12
36	2 250,00	13,855	-1,43
37	2 312,50	14,027	-1,73
38	2 375,00	14,193	-2,04
39	2 437,50	14,354	-2,34
40	2 500,00	14,509	-2,64
41	2 562,50	14,660	-2,93
42	2 625,00	14,807	-3,22
43	2 687,50	14,949	-3,49
44	2 750,00	15,087	-3,74
45	2 812,50	15,221	-3,98
46	2 875,00	15,351	-4,20
47	2 937,50	15,478	-4,40
48	3 000,00	15,602	-4,57
49	3 125,00	15,841	-4,82
50	3 250,00	16,069	-4,96
51	3 375,00	16,287	-4,97
52	3 500,00	16,496	-4,86
53	3 625,00	16,697	-4,63
54	3 750,00	16,891	-4,29
55	3 875,00	17,078	-3,87
56	4 000,00	17,259	-3,39
57	4 125,00	17,434	-2,86
58	4 250,00	17,605	-2,31
59	4 375,00	17,770	-1,77
60	4 500,00	17,932	-1,24
61	4 625,00	18,089	-0,74
62	4 750,00	18,242	-0,29
63	4 875,00	18,392	0,12
64	5 000,00	18,539	0,48
65	5 125,00	18,682	0,79
66	5 250,00	18,823	1,06
67	5 375,00	18,960	1,29
68	5 500,00	19,095	1,49
69	5 625,00	19,226	1,66
70	5 750,00	19,356	1,81
71	5 875,00		19,482
72	6 000,00		19,606
73	6 250,00		19,847
74	6 500,00		20,079
75	6 750,00		20,300
76	7 000,00		20,513
77	7 250,00		20,717
78	7 500,00		20,912
79	7 750,00		21,098
80	8 000,00		21,275
81	8 250,00		21,445
82	8 500,00		21,606
83	8 750,00		21,760
84	9 000,00		21,906
85	9 250,00		22,046
86	9 500,00		22,178
87	9 750,00		22,304
88	10 000,00		22,424
89	10 250,00		22,538
90	10 500,00		22,646
91	10 750,00		22,749
92	11 000,00		22,847
93	11 250,00		22,941
94	11 500,00		23,030
95	11 750,00		23,114
96	12 000,00		23,195
97	12 250,00		23,272
98	12 500,00		23,345
99	12 750,00		23,415
100	13 000,00		23,482
101	13 250,00		23,546
102	13 500,00		23,607
103	13 750,00		23,666
104	14 000,00		23,722
105	14 250,00		23,775
106	14 500,00		23,827
107	14 750,00		23,876
108	15 000,00		23,923
			51,04

Licensed to JOHN SCHAUB  
 ISO Store order #: 659832/Downloaded: 2005-05-17  
 Single user licence only, copying and networking prohibited

**Table D.1b. -- Frequencies, critical band rates and absolute threshold**  
 Table is valid for Layer I at a sampling rate of 44,1 kHz.

Index Number i	Frequency [Hz]	Crit. Band Rate [z]	Absolute Thresh. [dB]
1	86,13	0,850	25,87
2	172,27	1,694	14,85
3	258,40	2,525	10,72
4	344,53	3,337	8,50
5	430,66	4,124	7,10
6	516,80	4,882	6,11
7	602,93	5,608	5,37
8	689,06	6,301	4,79
9	775,20	6,959	4,32
10	861,33	7,581	3,92
11	947,46	8,169	3,57
12	1 033,59	8,723	3,25
13	1 119,73	9,244	2,95
14	1 205,86	9,734	2,67
15	1 291,99	10,195	2,39
16	1 378,13	10,629	2,11
17	1 464,26	11,037	1,83
18	1 550,39	11,421	1,53
19	1 636,52	11,783	1,23
20	1 722,66	12,125	0,90
21	1 808,79	12,448	0,56
22	1 894,92	12,753	0,21
23	1 981,05	13,042	-0,17
24	2 067,19	13,317	-0,56
25	2 153,32	13,578	-0,96
26	2 239,45	13,826	-1,38
27	2 325,59	14,062	-1,79
28	2 411,72	14,288	-2,21
29	2 497,85	14,504	-2,63
30	2 583,98	14,711	-3,03
31	2 670,12	14,909	-3,41
32	2 756,25	15,100	-3,77
33	2 842,38	15,284	-4,09
34	2 928,52	15,460	-4,37
35	3 014,65	15,631	-4,60
36	3 100,78	15,796	-4,78
37	3 186,91	15,955	-4,91
38	3 273,05	16,110	-4,97
39	3 359,18	16,260	-4,98
40	3 445,31	16,406	-4,92
41	3 531,45	16,547	-4,81
42	3 617,58	16,685	-4,65
43	3 703,71	16,820	-4,43
44	3 789,84	16,951	-4,17
45	3 875,98	17,079	-3,87
46	3 962,11	17,205	-3,54
47	4 048,24	17,327	-3,19
48	4 134,38	17,447	-2,82
49	4 306,64	17,680	-2,06
50	4 478,91	17,905	-1,32
51	4 651,17	18,121	-0,64
52	4 823,44	18,331	-0,04
53	4 995,70	18,534	0,47
54	5 167,97	18,731	0,89
55	5 340,23	18,922	1,23
56	5 512,50	19,108	1,51
57	5 684,77	19,289	1,74
58	5 857,03	19,464	1,93
59	6 029,30	19,635	2,11
60	6 201,56	19,801	2,28
61	6 373,83	19,963	2,46
62	6 546,09	20,120	2,63
63	6 718,36	20,273	2,82
64	6 890,63	20,421	3,03
65	7 062,89	20,565	3,25
66	7 235,16	20,705	3,49
67	7 407,42	20,840	3,74
68	7 579,69	20,972	4,02
69	7 751,95	21,099	4,32
70	7 924,22	21,222	4,64

71	8 096,48	21,342	4,98
72	8 268,75	21,457	5,35
73	8 613,28	21,677	6,15
74	8 957,81	21,882	7,07
75	9 302,34	22,074	8,10
76	9 646,88	22,253	9,25
77	9 991,41	22,420	10,54
78	10 335,94	22,576	11,97
79	10 680,47	22,721	13,56
80	11 025,00	22,857	15,31
81	11 369,53	22,984	17,23
82	11 714,06	23,102	19,34
83	12 058,59	23,213	21,64
84	12 403,13	23,317	24,15
85	12 747,66	23,415	26,88
86	13 092,19	23,506	29,84
87	13 436,72	23,592	33,05
88	13 781,25	23,673	36,52
89	14 125,78	23,749	40,25
90	14 470,31	23,821	44,27
91	14 814,84	23,888	48,59
92	15 159,38	23,952	53,22
93	15 503,91	24,013	58,18
94	15 848,44	24,070	63,49
95	16 192,97	24,125	68,00
96	16 537,50	24,176	68,00
97	16 882,03	24,225	68,00
98	17 226,56	24,271	68,00
99	17 571,09	24,316	58,00
100	17 915,63	24,358	58,00
101	18 260,16	24,398	58,00
102	18 604,69	24,436	58,00
103	18 949,22	24,473	58,00
104	19 293,75	24,508	58,00
105	19 638,28	24,542	58,00
106	19 982,81	24,574	58,00

**Table D.1c. -- Frequencies, critical band rates and absolute threshold**  
 Table is valid for Layer I at a sampling rate of 48 kHz.

Index Number i	Frequency [Hz]	Crit. Band Rate [z]	Absolute Thresh. [dB]
1	93,75	0,925	24,17
2	187,50	1,842	13,87
3	281,25	2,742	10,01
4	375,00	3,618	7,94
5	468,75	4,463	6,62
6	562,50	5,272	5,70
7	656,25	6,041	5,00
8	750,00	6,770	4,45
9	843,75	7,457	4,00
10	937,50	8,103	3,61
11	1 031,25	8,708	3,26
12	1 125,00	9,275	2,93
13	1 218,75	9,805	2,63
14	1 312,50	10,301	2,32
15	1 406,25	10,765	2,02
16	1 500,00	11,199	1,71
17	1 593,75	11,606	1,38
18	1 687,50	11,988	1,04
19	1 781,25	12,347	0,67
20	1 875,00	12,684	0,29
21	1 968,75	13,002	-0,11
22	2 062,50	13,302	-0,54
23	2 156,25	13,586	-0,97
24	2 250,00	13,855	-1,43
25	2 343,75	14,111	-1,88
26	2 437,50	14,354	-2,34
27	2 531,25	14,585	-2,79
28	2 625,00	14,807	-3,22
29	2 718,75	15,018	-3,62
30	2 812,50	15,221	-3,98
31	2 906,25	15,415	-4,30
32	3 000,00	15,602	-4,57
33	3 093,75	15,783	-4,77
34	3 187,50	15,956	-4,91
35	3 281,25	16,124	-4,98
36	3 375,00	16,287	-4,97
37	3 468,75	16,445	-4,90
38	3 562,50	16,598	-4,76
39	3 656,25	16,746	-4,55
40	3 750,00	16,891	-4,29
41	3 843,75	17,032	-3,99
42	3 937,50	17,169	-3,64
43	4 031,25	17,303	-3,26
44	4 125,00	17,434	-2,86
45	4 218,75	17,563	-2,45
46	4 312,50	17,688	-2,04
47	4 406,25	17,811	-1,63
48	4 500,00	17,932	-1,24
49	4 687,50	18,166	-0,51
50	4 875,00	18,392	0,12
51	5 062,50	18,611	0,64
52	5 250,00	18,823	1,06
53	5 437,50	19,028	1,39
54	5 625,00	19,226	1,66
55	5 812,50	19,419	1,88
56	6 000,00	19,606	2,08
57	6 187,50	19,788	2,27
58	6 375,00	19,964	2,46
59	6 562,50	20,135	2,65
60	6 750,00	20,300	2,86
61	6 937,50	20,461	3,09
62	7 125,00	20,616	3,33
63	7 312,50	20,766	3,60
64	7 500,00	20,912	3,89
65	7 687,50	21,052	4,20
66	7 875,00	21,188	4,54
67	8 062,50	21,318	4,91
68	8 250,00	21,445	5,31
69	8 437,50	21,567	5,73
70	8 625,00	21,684	6,18

71	8 812,50	21,797	6,67
72	9 000,00	21,906	7,19
73	9 375,00	22,113	8,33
74	9 750,00	22,304	9,63
75	10 125,00	22,482	11,08
76	10 500,00	22,646	12,71
77	10 875,00	22,799	14,53
78	11 250,00	22,941	16,54
79	11 625,00	23,072	18,77
80	12 000,00	23,195	21,23
81	12 375,00	23,309	23,94
82	12 750,00	23,415	26,90
83	13 125,00	23,515	30,14
84	13 500,00	23,607	33,67
85	13 875,00	23,694	37,51
86	14 250,00	23,775	41,67
87	14 625,00	23,852	46,17
88	15 000,00	23,923	51,04
89	15 375,00	23,991	56,29
90	15 750,00	24,054	61,94
91	16 125,00	24,114	68,00
92	16 500,00	24,171	68,00
93	16 875,00	24,224	68,00
94	17 250,00	24,275	68,00
95	17 625,00	24,322	68,00
96	18 000,00	24,368	68,00
97	18 375,00	24,411	68,00
98	18 750,00	24,452	68,00
99	19 125,00	24,491	68,00
100	19 500,00	24,528	68,00
101	19 875,00	24,564	68,00
102	20 250,00	24,597	68,00

Licensed to JOHN SCHAUB  
 ISO Store order #: 869832/Downloaded: 2005-05-17  
 Single user licence only, copying and networking prohibited

**Table D.Id. -- Frequencies, critical band rates and absolute threshold**  
**Table is valid for Layer II at a sampling rate of 32 kHz.**

Index Number i	Frequency [Hz]	Crit.Band Rate [z]	Absolute Thresh. [dB]
1	31,25	0,309	58,23
2	62,50	0,617	33,44
3	93,75	0,925	24,17
4	125,00	1,232	19,20
5	156,25	1,538	16,05
6	187,50	1,842	13,87
7	218,75	2,145	12,26
8	250,00	2,445	11,01
9	281,25	2,742	10,01
10	312,50	3,037	9,20
11	343,75	3,329	8,52
12	375,00	3,618	7,94
13	406,25	3,903	7,44
14	437,50	4,185	7,00
15	468,75	4,463	6,62
16	500,00	4,736	6,28
17	531,25	5,006	5,97
18	562,50	5,272	5,70
19	593,75	5,533	5,44
20	625,00	5,789	5,21
21	656,25	6,041	5,00
22	687,50	6,289	4,80
23	718,75	6,532	4,62
24	750,00	6,770	4,45
25	781,25	7,004	4,29
26	812,50	7,233	4,14
27	843,75	7,457	4,00
28	875,00	7,677	3,86
29	906,25	7,892	3,73
30	937,50	8,103	3,61
31	968,75	8,309	3,49
32	1 000,00	8,511	3,37
33	1 031,25	8,708	3,26
34	1 062,50	8,901	3,15
35	1 093,75	9,090	3,04
36	1 125,00	9,275	2,93
37	1 156,25	9,456	2,83
38	1 187,50	9,632	2,73
39	1 218,75	9,805	2,63
40	1 250,00	9,974	2,53
41	1 281,25	10,139	2,42
42	1 312,50	10,301	2,32
43	1 343,75	10,459	2,22
44	1 375,00	10,614	2,12
45	1 406,25	10,765	2,02
46	1 437,50	10,913	1,92
47	1 468,75	11,058	1,81
48	1 500,00	11,199	1,71
49	1 562,50	11,474	1,49
50	1 625,00	11,736	1,27
51	1 687,50	11,988	1,04
52	1 750,00	12,230	0,80
53	1 812,50	12,461	0,55
54	1 875,00	12,684	0,29
55	1 937,50	12,898	0,02
56	2 000,00	13,104	-0,25
57	2 062,50	13,302	-0,54
58	2 125,00	13,493	-0,83
59	2 187,50	13,678	-1,12
60	2 250,00	13,855	-1,43
61	2 312,50	14,027	-1,73
62	2 375,00	14,193	-2,04
63	2 437,50	14,354	-2,34
64	2 500,00	14,509	-2,64
65	2 562,50	14,660	-2,93
66	2 625,00	14,807	-3,22
67	2 687,50	14,949	-3,49
68	2 750,00	15,087	-3,74
69	2 812,50	15,221	-3,98
70	2 875,00	15,351	-4,20
71	2 937,50		15,478
72	3 000,00		15,602
73	3 125,00		15,841
74	3 250,00		16,069
75	3 375,00		16,287
76	3 500,00		16,496
77	3 625,00		16,697
78	3 750,00		16,891
79	3 875,00		17,078
80	4 000,00		17,259
81	4 125,00		17,434
82	4 250,00		17,605
83	4 375,00		17,770
84	4 500,00		17,932
85	4 625,00		18,089
86	4 750,00		18,242
87	4 875,00		18,392
88	5 000,00		18,539
89	5 125,00		18,682
90	5 250,00		18,823
91	5 375,00		18,960
92	5 500,00		19,095
93	5 625,00		19,226
94	5 750,00		19,356
95	5 875,00		19,482
96	6 000,00		19,606
97	6 250,00		19,847
98	6 500,00		20,079
99	6 750,00		20,300
100	7 000,00		20,513
101	7 250,00		20,717
102	7 500,00		20,912
103	7 750,00		21,098
104	8 000,00		21,275
105	8 250,00		21,445
106	8 500,00		21,606
107	8 750,00		21,760
108	9 000,00		21,906
109	9 250,00		22,046
110	9 500,00		22,178
111	9 750,00		22,304
112	10 000,00		22,424
113	10 250,00		22,538
114	10 500,00		22,646
115	10 750,00		22,749
116	11 000,00		22,847
117	11 250,00		22,941
118	11 500,00		23,030
119	11 750,00		23,114
120	12 000,00		23,195
121	12 250,00		23,272
122	12 500,00		23,345
123	12 750,00		23,415
124	13 000,00		23,482
125	13 250,00		23,546
126	13 500,00		23,607
127	13 750,00		23,666
128	14 000,00		23,722
129	14 250,00		23,775
130	14 500,00		23,827
131	14 750,00		23,876
132	15 000,00		23,923
			-4,40
			-4,57
			-4,82
			-4,96
			-4,97
			-4,86
			-4,63
			-4,29
			-3,87
			-3,39
			-2,86
			-2,31
			-1,77
			-1,24
			-0,74
			-0,29
			0,12
			0,48
			0,79
			1,06
			1,29
			1,49
			1,66
			1,81
			1,95
			2,08
			2,33
			2,59
			2,86
			3,17
			3,51
			3,89
			4,31
			4,79
			5,31
			5,88
			6,50
			7,19
			7,93
			8,75
			9,63
			10,58
			11,60
			12,71
			13,90
			15,18
			16,54
			18,01
			19,57
			21,23
			23,01
			24,90
			26,90
			29,03
			31,28
			33,67
			36,19
			38,86
			41,67
			44,63
			47,76
			51,04

**Table D.1e. -- Frequencies, Critical Band Rates and Absolute Threshold**  
 Table is valid for Layer II at a sampling rate of 44,1 kHz.

Index Number i	Frequency [Hz]	Crit.Band Rate [z]	Absolute Thresh. [dB]
1	43,07	0,425	45,05
2	86,13	0,850	25,87
3	129,20	1,273	18,70
4	172,27	1,694	14,85
5	215,33	2,112	12,41
6	258,40	2,525	10,72
7	301,46	2,934	9,47
8	344,53	3,337	8,50
9	387,60	3,733	7,73
10	430,66	4,124	7,10
11	473,73	4,507	6,56
12	516,80	4,882	6,11
13	559,86	5,249	5,72
14	602,93	5,608	5,37
15	646,00	5,959	5,07
16	689,06	6,301	4,79
17	732,13	6,634	4,55
18	775,20	6,959	4,32
19	818,26	7,274	4,11
20	861,33	7,581	3,92
21	904,39	7,879	3,74
22	947,46	8,169	3,57
23	990,53	8,450	3,40
24	1 033,59	8,723	3,25
25	1 076,66	8,987	3,10
26	1 119,73	9,244	2,95
27	1 162,79	9,493	2,81
28	1 205,86	9,734	2,67
29	1 248,93	9,968	2,53
30	1 291,99	10,195	2,39
31	1 335,06	10,416	2,25
32	1 378,13	10,629	2,11
33	1 421,19	10,836	1,97
34	1 464,26	11,037	1,83
35	1 507,32	11,232	1,68
36	1 550,39	11,421	1,53
37	1 593,46	11,605	1,38
38	1 636,52	11,783	1,23
39	1 679,59	11,957	1,07
40	1 722,66	12,125	0,90
41	1 765,72	12,289	0,74
42	1 808,79	12,448	0,56
43	1 851,86	12,603	0,39
44	1 894,92	12,753	0,21
45	1 937,99	12,900	0,02
46	1 981,05	13,042	-0,17
47	2 024,12	13,181	-0,36
48	2 067,19	13,317	-0,56
49	2 153,32	13,578	-0,96
50	2 239,45	13,826	-1,38
51	2 325,59	14,062	-1,79
52	2 411,72	14,288	-2,21
53	2 497,85	14,504	-2,63
54	2 583,98	14,711	-3,03
55	2 670,12	14,909	-3,41
56	2 756,25	15,100	-3,77
57	2 842,38	15,284	-4,09
58	2 928,52	15,460	-4,37
59	3 014,65	15,631	-4,60
60	3 100,78	15,796	-4,78
61	3 186,91	15,955	-4,91
62	3 273,05	16,110	-4,97
63	3 359,18	16,260	-4,98
64	3 445,31	16,406	-4,92
65	3 531,45	16,547	-4,81
66	3 617,58	16,685	-4,65
67	3 703,71	16,820	-4,43
68	3 789,84	16,951	-4,17
69	3 875,98	17,079	-3,87
70	3 962,11	17,205	-3,54
71	4 048,24		17,327
72	4 134,38		17,447
73	4 306,64		17,680
74	4 478,91		17,905
75	4 651,17		18,121
76	4 823,44		18,331
77	4 995,70		18,534
78	5 167,97		18,731
79	5 340,23		18,922
80	5 512,50		19,108
81	5 684,77		19,289
82	5 857,03		19,464
83	6 029,30		19,635
84	6 201,56		19,801
85	6 373,83		19,963
86	6 546,09		20,120
87	6 718,36		20,273
88	6 890,63		20,421
89	7 062,89		20,565
90	7 235,16		20,705
91	7 407,42		20,840
92	7 579,69		20,972
93	7 751,95		21,099
94	7 924,22		21,222
95	8 096,48		21,342
96	8 268,75		21,457
97	8 441,02		21,567
98	8 613,28		21,672
99	8 785,55		21,772
100	8 957,81		21,872
101	9 130,08		21,972
102	9 302,34		22,072
103	9 474,61		22,172
104	9 646,88		22,272
105	9 819,14		22,372
106	9 991,41		22,472
107	10 163,68		22,572
108	10 335,94		22,672
109	10 508,21		22,772
110	10 680,47		22,872
111	10 852,74		22,972
112	11 025,00		23,072
113	11 197,27		23,172
114	11 369,53		23,272
115	11 541,80		23,372
116	11 714,06		23,472
117	11 886,33		23,572
118	12 058,59		23,672
119	12 230,86		23,772
120	12 403,13		23,872
121	12 575,39		23,972
122	12 747,66		24,072
123	12 919,92		24,172
124	13 092,19		24,272
125	13 264,45		24,372
126	13 436,72		24,472
127	13 609,00		24,572
128	13 781,25		24,672
129	13 953,52		24,772
130	14 125,78		24,872
	14 298,05		24,972
	14 470,31		25,072
	14 642,58		25,172
	14 814,84		25,272
	14 987,11		25,372
	15 159,38		25,472
	15 331,64		25,572
	15 503,91		25,672
	15 676,18		25,772
	15 848,44		25,872
	16 020,71		25,972
	16 192,97		26,072
	16 365,24		26,172
	16 537,50		26,272
	16 709,77		26,372
	16 882,03		26,472
	17 054,30		26,572
	17 226,56		26,672
	17 398,83		26,772
	17 571,09		26,872
	17 743,36		26,972
	17 915,63		27,072
	18 087,89		27,172
	18 260,16		27,272
	18 432,43		27,372
	18 604,69		27,472
	18 776,96		27,572
	18 949,22		27,672
	19 121,49		27,772
	19 293,75		27,872
	19 466,02		27,972
	19 638,28		28,072
	19 810,55		28,172
	19 982,81		28,272

Licensed to JOHN SCHAUB  
 ISO Store order #: 669832/Downloaded: 2005-05-17  
 Single user licence only, copying and networking prohibited

Table D.1f. -- Frequencies, critical band rates and absolute threshold  
Table is valid for Layer II at a sampling rate of 48 kHz

Index Number i	Frequency [Hz]	Crit. Band Rate [z]	Absolute Thresh. [dB]				
1	46,88	0,463	42,10	71	4 406,25	17,811	-1,63
2	93,75	0,925	24,17	72	4 500,00	17,932	-1,24
3	140,63	1,385	17,47	73	4 687,50	18,166	-0,51
4	187,50	1,842	13,87	74	4 875,00	18,392	0,12
5	234,38	2,295	11,60	75	5 062,50	18,611	0,64
6	281,25	2,742	10,01	76	5 250,00	18,823	1,06
7	328,13	3,184	8,84	77	5 437,50	19,028	1,39
8	375,00	3,618	7,94	78	5 625,00	19,226	1,66
9	421,88	4,045	7,22	79	5 812,50	19,419	1,88
10	468,75	4,463	6,62	80	6 000,00	19,606	2,08
11	515,63	4,872	6,12	81	6 187,50	19,788	2,27
12	562,50	5,272	5,70	82	6 375,00	19,964	2,46
13	609,38	5,661	5,33	83	6 562,50	20,135	2,65
14	656,25	6,041	5,00	84	6 750,00	20,300	2,86
15	703,13	6,411	4,71	85	6 937,50	20,461	3,09
16	750,00	6,770	4,45	86	7 125,00	20,616	3,33
17	796,88	7,119	4,21	87	7 312,50	20,766	3,60
18	843,75	7,457	4,00	88	7 500,00	20,912	3,89
19	890,63	7,785	3,79	89	7 687,50	21,052	4,20
20	937,50	8,103	3,61	90	7 875,00	21,188	4,54
21	984,38	8,410	3,43	91	8 062,50	21,318	4,91
22	1 031,25	8,708	3,26	92	8 250,00	21,445	5,31
23	1 078,13	8,996	3,09	93	8 437,50	21,567	5,73
24	1 125,00	9,275	2,93	94	8 625,00	21,684	6,18
25	1 171,88	9,544	2,78	95	8 812,50	21,797	6,67
26	1 218,75	9,805	2,63	96	9 000,00	21,906	7,19
27	1 265,63	10,057	2,47	97	9 375,00	22,113	8,33
28	1 312,50	10,301	2,32	98	9 750,00	22,304	9,63
29	1 359,38	10,537	2,17	99	10 125,00	22,482	11,08
30	1 406,25	10,765	2,02	100	10 500,00	22,646	12,71
31	1 453,13	10,986	1,86	101	10 875,00	22,799	14,53
32	1 500,00	11,199	1,71	102	11 250,00	22,941	16,54
33	1 546,88	11,406	1,55	103	11 625,00	23,072	18,77
34	1 593,75	11,606	1,38	104	12 000,00	23,195	21,23
35	1 640,63	11,800	1,21	105	12 375,00	23,309	23,94
36	1 687,50	11,988	1,04	106	12 750,00	23,415	26,90
37	1 734,38	12,170	0,86	107	13 125,00	23,515	30,14
38	1 781,25	12,347	0,67	108	13 500,00	23,607	33,67
39	1 828,13	12,518	0,49	109	13 875,00	23,694	37,51
40	1 875,00	12,684	0,29	110	14 250,00	23,775	41,67
41	1 921,88	12,845	0,09	111	14 625,00	23,852	46,17
42	1 968,75	13,002	-0,11	112	15 000,00	23,923	51,04
43	2 015,63	13,154	-0,32	113	15 375,00	23,991	56,29
44	2 062,50	13,302	-0,54	114	15 750,00	24,054	61,94
45	2 109,38	13,446	-0,75	115	16 125,00	24,114	68,00
46	2 156,25	13,586	-0,97	116	16 500,00	24,171	74,50
47	2 203,13	13,723	-1,20	117	16 875,00	24,224	81,50
48	2 250,00	13,855	-1,43	118	17 250,00	24,275	89,00
49	2 343,75	14,111	-1,88	119	17 625,00	24,322	97,00
50	2 437,50	14,354	-2,34	120	18 000,00	24,368	105,00
51	2 531,25	14,585	-2,79	121	18 375,00	24,411	113,00
52	2 625,00	14,807	-3,22	122	18 750,00	24,452	121,00
53	2 718,75	15,018	-3,62	123	19 125,00	24,491	129,00
54	2 812,50	15,221	-3,98	124	19 500,00	24,528	137,00
55	2 906,25	15,415	-4,30	125	19 875,00	24,564	145,00
56	3 000,00	15,602	-4,57	126	20 250,00	24,597	153,00
57	3 093,75	15,783	-4,77				
58	3 187,50	15,956	-4,91				
59	3 281,25	16,124	-4,98				
60	3 375,00	16,287	-4,97				
61	3 468,75	16,445	-4,90				
62	3 562,50	16,598	-4,76				
63	3 656,25	16,746	-4,55				
64	3 750,00	16,891	-4,29				
65	3 843,75	17,032	-3,99				
66	3 937,50	17,169	-3,64				
67	4 031,25	17,303	-3,26				
68	4 125,00	17,434	-2,86				
69	4 218,75	17,563	-2,45				
70	4 312,50	17,688	-2,04				

**Table D.2a. -- Critical band boundaries**  
 This table is valid for Layer I at a sampling rate of 32 kHz.  
 The frequencies represent the top end of each critical band.

no	index of Table F&CB	frequency [Hz]	Bark [z]
0	1	62,500	0,617
1	3	187,500	1,842
2	5	312,500	3,037
3	7	437,500	4,185
4	9	562,500	5,272
5	11	687,500	6,289
6	13	812,500	7,233
7	15	937,500	8,103
8	18	1 125,000	9,275
9	21	1 312,500	10,301
10	24	1 500,000	11,199
11	27	1 687,500	11,988
12	32	2 000,000	13,104
13	37	2 312,500	14,027
14	44	2 750,000	15,087
15	50	3 250,000	16,069
16	55	3 875,000	17,078
17	61	4 625,000	18,089
18	68	5 500,000	19,095
19	74	6 500,000	20,079
20	79	7 750,000	21,098
21	85	9 250,000	22,046
22	94	11 500,000	23,030
23	108	15 000,000	23,923



**Table D.2b. -- Critical band boundaries**  
 This table is valid for Layer I at a sampling rate of 44,1 kHz.  
 The frequencies represent the top end of each critical band.

no	index of Table F&CB	frequency [Hz]	Bark [z]
0	1	86,133	0,850
1	2	172,266	1,694
2	3	258,398	2,525
3	5	430,664	4,124
4	6	516,797	4,882
5	8	689,063	6,301
6	9	775,195	6,959
7	11	947,461	8,169
8	13	1 119,727	9,244
9	15	1 291,992	10,195
10	17	1 464,258	11,037
11	20	1 722,656	12,125
12	23	1 981,055	13,042
13	27	2 325,586	14,062
14	32	2 756,250	15,100
15	37	3 186,914	15,955
16	45	3 875,977	17,079
17	50	4 478,906	17,904
18	55	5 340,234	18,922
19	61	6 373,828	19,963
20	68	7 579,688	20,971
21	75	9 302,344	22,074
22	81	11 369,531	22,984
23	93	15 503,906	24,013
24	106	19 982,813	24,573

**Table D.2c. -- Critical band boundaries**

This table is valid for Layer I at a sampling rate of 48 kHz.

The frequencies represent the top end of each critical band.

no	index of Table F&CB	frequency [Hz]	Bark [z]
0	1	93,750	0,925
1	2	187,500	1,842
2	3	281,250	2,742
3	4	375,000	3,618
4	5	468,750	4,463
5	6	562,500	5,272
6	7	656,250	6,041
7	9	843,750	7,457
8	10	937,500	8,103
9	12	1 125,000	9,275
10	14	1 312,500	10,301
11	16	1 500,000	11,199
12	19	1 781,250	12,347
13	21	1 968,750	13,002
14	25	2 343,750	14,111
15	29	2 718,750	15,018
16	35	3 281,250	16,124
17	41	3 843,750	17,032
18	49	4 687,500	18,166
19	53	5 437,500	19,028
20	58	6 375,000	19,964
21	65	7 687,500	21,052
22	73	9 375,000	22,113
23	79	11 625,000	23,072
24	89	15 375,000	23,991
25	102	20 250,000	24,597

**Table D.2d. -- Critical band boundaries**

This table is valid for Layer II at a sampling rate of 32 kHz.

The frequencies represent the top end of each critical band.

no	index of Table F & CB	frequency [Hz]	Bark [z]
0	1	31,250	0,309
1	3	93,750	0,925
2	6	187,500	1,842
3	10	312,500	3,037
4	13	406,250	3,903
5	17	531,250	5,006
6	21	656,250	6,041
7	25	781,250	7,004
8	30	937,500	8,103
9	35	1 093,750	9,090
10	41	1 281,250	10,139
11	47	1 468,750	11,058
12	51	1 687,500	11,988
13	56	2 000,000	13,104
14	61	2 312,500	14,027
15	68	2 750,000	15,087
16	74	3 250,000	16,069
17	79	3 875,000	17,078
18	85	4 625,000	18,089
19	92	5 500,000	19,095
20	98	6 500,000	20,079
21	103	7 750,000	21,098
22	109	9 250,000	22,046
23	118	11 500,000	23,030
24	132	15 000,000	23,923

**Table D.2e. -- Critical band boundaries**  
 This table is valid for Layer II at a sampling rate of 44,1 kHz.  
 The frequencies represent the top end of each critical band.

no	index of Table F&CB	frequency [Hz]	Bark [z]
0	1	43,066	0,425
1	2	86,133	0,850
2	3	129,199	1,273
3	5	215,332	2,112
4	7	301,465	2,934
5	10	430,664	4,124
6	13	559,863	5,249
7	16	689,063	6,301
8	19	818,262	7,274
9	22	947,461	8,169
10	26	1 119,727	9,244
11	30	1 291,992	10,195
12	35	1 507,324	11,232
13	40	1 722,656	12,125
14	46	1 981,055	13,042
15	51	2 325,586	14,062
16	56	2 756,250	15,100
17	62	3 273,047	16,11
18	69	3 875,977	17,079
19	74	4 478,906	17,904
20	79	5 340,234	18,922
21	85	6 373,828	19,963
22	92	7 579,688	20,971
23	99	9 302,344	22,074
24	105	11 369,531	22,984
25	117	15 503,906	24,013
26	130	19 982,813	24,573

**Table D.2f. -- Critical band boundaries**  
 This table is valid for Layer II at a sampling rate of 48 kHz.  
 The frequencies represent the top end of each critical band.

no	index of Table F&CB	frequency [Hz]	Bark [z]
0	1	46,875	0,463
1	2	93,750	0,925
2	3	140,625	1,385
3	5	234,375	2,295
4	7	328,125	3,184
5	9	421,875	4,045
6	12	562,500	5,272
7	14	656,250	6,041
8	17	796,875	7,119
9	20	937,500	8,103
10	24	1 125,000	9,275
11	27	1 265,625	10,057
12	32	1 500,000	11,199
13	37	1 734,375	12,170
14	42	1 968,750	13,002
15	49	2 343,750	14,111
16	53	2 718,750	15,018
17	59	3 281,250	16,124
18	65	3 843,750	17,032
19	73	4 687,500	18,166
20	77	5 437,500	19,028
21	82	6 375,000	19,964
22	89	7 687,500	21,052
23	97	9 375,000	22,113
24	103	11 625,000	23,072
25	113	15 375,000	23,991
26	126	20 250,000	24,597

## D.2 Psychoacoustic model 2

### D.2.1 General

Psychoacoustic Model 2 is an independent psychoacoustic model that can be adjusted and adapted to any ISO/IEC 11172-3 layer. This annex presents the general Psychoacoustic Model 2, and provides sufficient information for implementation of Model 2 with Layers I and II. The Layer III psychoacoustic model is based on this implementation, with adaptations as described in the Layer III encoder.

The threshold generation process has three inputs. They are:

- a) The shift length for the threshold calculation process,  $iblen$ , where  $384 < iblen < 640$ . This  $iblen$  must remain constant over any particular application of the threshold calculation process. If (as in Layer III), it is necessary to calculate thresholds for two different shift lengths, two processes, each running with a fixed shift length, will be necessary. In the case of  $iblen$  outside the range of 384 to 640 it may be necessary to calculate the psychoacoustic thresholds with a different window length as well as shift length. There are two ways to do this:
  - Use a different length transform, and recalculate the startup coefficients for the model, or
  - Use the same length transform, but a substantially shorter Hann window, appropriate to the data and problem at hand.

The choice of these is left to the implementation.

- b) The newest  $iblen$  samples of the signal, with the samples delayed (either in the filter bank or psychoacoustic calculation) such that the window of the psychoacoustic calculation is centered in the time-window of application.
- c) The sampling rate. There are sets of tables provided for the standard sampling rates. Sampling rate, like  $iblen$ , must necessarily remain constant over one implementation of the threshold calculation process.

There is one output from Psychoacoustic Model 2, a set of Signal-to-Masking Ratios,  $SMR_n$ , which are adapted to the layers as described below.

Before running the model initially, the array used to hold the preceding FFT source data window and the arrays used to hold  $r$  and  $f$  should be zeroed to provide a known starting point.

In Layer II, the psychoacoustic masking ratios must be calculated twice during each coder frame. The more stringent of each pair of ratios is used for bit allocation as shown in the software simulation model for Layers I and II with Psychoacoustic Model 2.

### D.2.2 Comments on notation

Throughout this threshold calculation process, three indices for data values are used. These are:

- $\omega$  - indicates that the calculation is indexed by frequency in the FFT spectral line domain. An index of 1 corresponds to the DC term and an index of 513 corresponds to the spectral line at the Nyquist frequency.
- $b$  - indicates that the calculation is indexed in the threshold calculation partition domain. In the case where the calculation includes a convolution or sum in the threshold calculation partition domain,  $bb$  will be used as the summation variable. Partition numbering starts at 1.
- $n$  - indicates that the calculation is indexed in the coder bit (or codebook) allocation domain. An index of 1 corresponds to the lowest band in the subband filter bank.

### D.2.3 The "spreading function"

Several points in the following description refer to the "spreading function". It is calculated by the following method:

$$tmpx = 1,05 (j-i),$$

Where  $i$  is the Bark value of the signal being spread,  $j$  is the Bark value of the band being spread into, and  $tmpx$  is a temporary variable.

$$x = 8 \text{ minimum } ((tmpx-0,5)^2 - 2(tmpx-0,5), 0)$$

Where  $x$  is a temporary variable, and minimum (a,b) is a function returning the more negative of a or b.

$$tmpy = 15,811389 + 7,5(tmpx+0,474) - 17,5(1,0+(tmpx+0,474)^2)^{0,5}$$

where  $tmpy$  is another temporary variable.

$$\text{if } (tmpy < -100) \text{ then } \{sprdngf(i,j) = 0\} \text{ else } \{sprdngf(i,j) = 10^{\frac{(x + tmpy)}{10}}\}$$

### D.2.4 Steps in threshold calculation

The following are the necessary steps for calculation of the  $SMR_n$  used in the coder.

- a) Reconstruct 1 024 samples of the input signal.

$iblen$  new samples are made available at every call to the threshold generator. The threshold generator must store 1 024- $iblen$  samples, and concatenate those samples to accurately reconstruct 1 024 consecutive samples of the input signal,  $s_i$ , where  $i$  represents the index,  $1 \leq i \leq 1\ 024$  of the current input stream.

- b) Calculate the complex spectrum of the input signal.

First,  $s_i$  is windowed by a 1 024 point Hann window, i.e.  $sw_i = s_i * (0,5 - 0,5 \cos(\frac{2\pi(i-0,5)}{1024}))$ .

Note that in Layer III, a shorter window may be used when window switching is active, with appropriate centering of the window, per the Layer III encoder description.

Second, a standard forward FFT of  $sw_i$  is calculated.

Third, the polar representation of the transform is calculated.  $r_\omega$  and  $f_\omega$  represent the magnitude and phase components of the transformed  $sw_i$ , respectively.

- c) Calculate a predicted  $r$  and  $f$ .

A predicted magnitude,  $\hat{r}_\omega$ , and phase,  $\hat{f}_\omega$  are calculated from the preceding two threshold calculation blocks'  $r$  and  $f$ :

$$\hat{r}_\omega = 2,0 r_\omega(t-1) - r_\omega(t-2)$$

$$\hat{f}_\omega = 2,0 f_\omega(t-1) - f_\omega(t-2)$$

where  $t$  represents the current block number,  $t-1$  indexes the previous block's data, and  $t-2$  indexes the data from the threshold calculation block before that.

- d) Calculate the unpredictability measure  $c_\omega$   
 $c_\omega$ , the unpredictability measure, is:

$$c_{\omega} = \frac{((r_{\omega} \cos f_{\omega} - \hat{r}_{\omega} \cos \hat{f}_{\omega})^2 + (r_{\omega} \sin f_{\omega} - \hat{r}_{\omega} \sin \hat{f}_{\omega})^2)^{0,5}}{r_{\omega} + \text{abs}(\hat{r}_{\omega})}$$

By sacrificing performance, this measure can be calculated on only a lower portion of the frequency lines. Calculations should be done from DC to at least 3 kHz and preferably to 7kHz. An upper limit of less than 5,5kHz may considerably reduce performance from that obtained during the subjective testing of the audio algorithm. The  $c_{\omega}$  values above this limit should be set to 0,3. Best results will be obtained by calculating  $c_{\omega}$  up to 20 kHz.

- e) Calculate the energy and unpredictability in the threshold calculation partitions.

The energy in each partition,  $e_b$ , is:

$$e_b = \sum_{\omega=\omega_{low_b}}^{\omega_{high_b}} r_{\omega}^2$$

and the weighted unpredictability,  $c_b$ , is:

$$c_b = \sum_{\omega=\omega_{low_b}}^{\omega_{high_b}} r_{\omega}^2 c_{\omega}$$

The threshold calculation partitions provide a resolution of approximately either one FFT line or  $\frac{1}{3}$  critical band, whichever is wider. At low frequencies, a single line of the FFT will constitute a calculation partition. At high frequencies, many lines will be combined into one calculation partition. A set of partition values is provided for each of the three sampling rates in table D.3. "Calculation partition tables". These table elements will be used in the threshold calculation process. There are several elements in each table entry:

1. The index of the calculation partition,  $b$ .
2. The lowest frequency line in the partition,  $\omega_{low_b}$ .
3. The highest frequency line in the partition,  $\omega_{high_b}$ .
4. The median bark value of the partition,  $bval_b$ .
5. A lower limit for the SNR in the partition that controls stereo unmasking effects,  $minval_b$ .
6. The value for tone masking noise (in dB) for the partition,  $TMN_b$ .

A largest value of  $b$ ,  $bmax$ , equal to the largest index, exists for each sampling rate.

- f) Convolve the partitioned energy and unpredictability with the spreading function.

$$ecb_b = \sum_{bb=1}^{bmax} e_{bb} * \text{sprdngf}(bval_{bb}, bval_b)$$

$$ct_b = \sum_{bb=1}^{bmax} c_{bb} * \text{sprdngf}(bval_{bb}, bval_b)$$

Because  $ct_b$  is weighted by the signal energy, it must be renormalized to  $cb_b$ .



$$cb_b = \frac{ct_b}{ecb_b}$$

At the same time, due to the non-normalized nature of the spreading function,  $ecb_b$  should be renormalized and the normalized energy  $en_b$ , calculated.

$$en_b = ecb_b * rnorm_b$$

The normalization coefficient,  $rnorm_b$ , is:

$$rnorm_b = \frac{1}{bmax \sum_{bb=0} sprdn_gf(bval_{bb}, bval_b)}$$

- g) Convert  $cb_b$  to  $tb_b$ , the tonality index.

$$tb_b = -0,299 - 0,43 \log_e (cb_b)$$

Each  $tb_b$  is limited to the range of  $0 < tb_b < 1$ .

- h) Calculate the required SNR in each partition.

$NMT_b = 5,5\text{dB}$  for all  $b$ .  $NMT_b$  is the value for noise masking tone (in dB) for the partition. The required signal to noise ratio,  $SNR_b$ , is:

$$SNR_b = \text{maximum}(minval_b, tb_b * TMN_b + (1-tb_b) * NMT_b)$$

Where maximum (a,b) is a function returning the least negative of a or b.

- i) Calculate the power ratio.

The power ratio,  $bc_b$ , is:

$$bc_b = 10^{-\frac{SNR_b}{10}}$$

- j) Calculation of actual energy threshold,  $nb_b$ .

$$nb_b = en_b bc_b$$

- k) Spread the threshold energy over FFT lines, yielding  $nb_\omega$ .

$$nb_\omega = \frac{nb_b}{\omega_{high_b} - \omega_{low_b} + 1}$$

- l) Include absolute thresholds, yielding the final energy threshold of audibility,  $thr_\omega$

$$thr_\omega = \text{max}(nb_\omega, absth_r_\omega)$$

The dB values of  $absth_r$  shown in tables D.4. "Absolute threshold tables" are relative to the level that a sine wave of  $\pm \frac{1}{2}$  lsb has in the FFT used for threshold calculation. The dB values must be converted into the energy domain after considering the FFT normalization actually used.

- m) Pre-echo control

For Layer III, pre-echo control occurs at this point. The actual control is described as part of the Layer III encoder specification. This step is omitted for Layers I and II.

- n) Calculate the signal-to-mask ratios,  $SMR_n$ .

Table D.5. "Layer I and II coder partition table" shows:

1. The index,  $n$ , of the coder partition.
2. The lower index  $\omega_{low_n}$ , of the coder partition.
3. The upper index,  $\omega_{high_n}$  of the coder partition.
4. The width index,  $width_n$ , where  $width_n=1$  for a psychoacoustically narrow scalefactor band, and  $width_n=0$  for a psychoacoustically wide scalefactor band. A psychoacoustically narrow scalefactor band is one whose width is less than approximately  $\frac{1}{3}$  critical band.

The energy in the scalefactor band,  $epart_n$ , is:

$$epart_n = \sum_{\omega=\omega_{low_n}}^{\omega_{high_n}} r \omega^2$$

Then, if ( $width_n = 1$ ), the noise level in the scalefactor band,  $npart_n$  is calculated as:

$$npart_n = \sum_{\omega=\omega_{low_n}}^{\omega_{high_n}} thr_{\omega}$$

else,

$$npart_n = \text{minimum}(thr_{\omega_{low_n}}, \dots, thr_{\omega_{high_n}}) * (\omega_{high_n} - \omega_{low_n} + 1)$$

Where, in this case, minimum (a,...,z) is a function returning the smallest positive argument of the arguments a...z.

The ratios to be sent to the coder,  $SMR_n$ , are calculated as:

$$SMR_n = 10 \log_{10} \left( \frac{epart_n}{npart_n} \right)$$

**Table D.3a. -- Calculation partition table**  
This table is valid at a sampling rate of 32 kHz.

Index	$\omega_{low}$	$\omega_{high}$	bval	minval	TMN
1	1	1	0,00	0,0	24,5
2	2	4	0,63	0,0	24,5
3	5	7	1,56	20,0	24,5
4	8	10	2,50	20,0	24,5
5	11	13	3,44	20,0	24,5
6	14	16	4,34	20,0	24,5
7	17	19	5,17	20,0	24,5
8	20	22	5,94	20,0	24,5
9	23	25	6,63	17,0	24,5
10	26	28	7,28	15,0	24,5
11	29	31	7,90	15,0	24,5
12	32	34	8,50	10,0	24,5
13	35	37	9,06	7,0	24,5
14	38	41	9,65	7,0	24,5
15	42	45	10,28	4,4	24,8
16	46	49	10,87	4,4	25,4
17	50	53	11,41	4,5	25,9
18	54	57	11,92	4,5	26,4
19	58	61	12,39	4,5	26,9
20	62	65	12,83	4,5	27,3
21	66	70	13,29	4,5	27,8
22	71	75	13,78	4,5	28,3
23	76	81	14,27	4,5	28,8
24	82	87	14,76	4,5	29,3
25	88	93	15,22	4,5	29,7
26	94	99	15,63	4,5	30,1
27	100	106	16,06	4,5	30,6
28	107	113	16,47	4,5	31,0
29	114	120	16,86	4,5	31,4
30	121	129	17,25	4,5	31,8
31	130	138	17,65	4,5	32,2
32	139	148	18,05	4,5	32,5
33	149	159	18,42	4,5	32,9
34	160	170	18,81	4,5	33,3
35	171	183	19,18	4,5	33,7
36	184	196	19,55	4,5	34,1
37	197	210	19,93	4,5	34,4
38	211	225	20,29	4,5	34,8
39	226	240	20,65	4,5	35,2
40	241	258	21,02	4,5	35,5
41	259	279	21,38	4,5	35,9
42	280	300	21,74	4,5	36,2
43	301	326	22,10	4,5	36,6
44	327	354	22,44	4,5	36,9
45	355	382	22,79	4,5	37,3
46	383	420	23,14	4,5	37,6
47	421	458	23,49	4,5	38,0
48	459	496	23,83	4,5	38,3
49	497	513	24,07	4,5	38,6

**Table D.3b. -- Calculation partition table**  
 This table is valid at a sampling rate of 44,1 kHz.

Index	$\omega_{low}$	$\omega_{high}$	bval	minval	TMN
1	1	1	0,00	0,0	24,5
2	2	2	0,43	0,0	24,5
3	3	3	0,86	0,0	24,5
4	4	4	1,29	20,0	24,5
5	5	5	1,72	20,0	24,5
6	6	6	2,15	20,0	24,5
7	7	7	2,58	20,0	24,5
8	8	8	3,01	20,0	24,5
9	9	9	3,45	20,0	24,5
10	10	10	3,88	20,0	24,5
11	11	11	4,28	20,0	24,5
12	12	12	4,67	20,0	24,5
13	13	13	5,06	20,0	24,5
14	14	14	5,42	20,0	24,5
15	15	15	5,77	20,0	24,5
16	16	16	6,11	17,0	24,5
17	17	19	6,73	17,0	24,5
18	20	22	7,61	15,0	24,5
19	23	25	8,44	10,0	24,5
20	26	28	9,21	7,0	24,5
21	29	31	9,88	7,0	24,5
22	32	34	10,51	4,4	25,0
23	35	37	11,11	4,5	25,6
24	38	40	11,65	4,5	26,2
25	41	44	12,24	4,5	26,7
26	45	48	12,85	4,5	27,4
27	49	52	13,41	4,5	27,9
28	53	56	13,94	4,5	28,4
29	57	60	14,42	4,5	28,9
30	61	64	14,86	4,5	29,4
31	65	69	15,32	4,5	29,8
32	70	74	15,79	4,5	30,3
33	75	80	16,26	4,5	30,8
34	81	86	16,73	4,5	31,2
35	87	93	17,19	4,5	31,7
36	94	100	17,62	4,5	32,1
37	101	108	18,05	4,5	32,5
38	109	116	18,45	4,5	32,9
39	117	124	18,83	4,5	33,3
40	125	134	19,21	4,5	33,7
41	135	144	19,60	4,5	34,1
42	145	155	20,00	4,5	34,5
43	156	166	20,38	4,5	34,9
44	167	177	20,74	4,5	35,2
45	178	192	21,12	4,5	35,6
46	193	207	21,48	4,5	36,0
47	208	222	21,84	4,5	36,3
48	223	243	22,20	4,5	36,7
49	244	264	22,56	4,5	37,1
50	265	286	22,91	4,5	37,4
51	287	314	23,26	4,5	37,8
52	315	342	23,60	4,5	38,1
53	343	371	23,95	4,5	38,4
54	372	401	24,30	4,5	38,8
55	402	431	24,65	4,5	39,1
56	432	469	25,00	4,5	39,5
57	470	513	25,33	3,5	39,8

**Table D.3c. -- Calculation partition table**  
This table is valid at a sampling rate of 48 kHz.

Index	$\omega_{low}$	$\omega_{high}$	bval	minval	TMN
1	1	1	0,00	0,0	24,5
2	2	2	0,47	0,0	24,5
3	3	3	0,94	0,0	24,5
4	4	4	1,41	20,0	24,5
5	5	5	1,88	20,0	24,5
6	6	6	2,34	20,0	24,5
7	7	7	2,81	20,0	24,5
8	8	8	3,28	20,0	24,5
9	9	9	3,75	20,0	24,5
10	10	10	4,20	20,0	24,5
11	11	11	4,63	20,0	24,5
12	12	12	5,05	20,0	24,5
13	13	13	5,44	20,0	24,5
14	14	14	5,83	20,0	24,5
15	15	15	6,19	20,0	24,5
16	16	16	6,52	17,0	24,5
17	17	17	6,86	17,0	24,5
18	18	20	7,49	15,0	24,5
19	21	23	8,40	10,0	24,5
20	24	26	9,24	7,0	24,5
21	27	29	9,97	7,0	24,5
22	30	32	10,65	4,4	25,1
23	33	35	11,28	4,5	25,8
24	36	38	11,86	4,5	26,4
25	39	41	12,39	4,5	26,9
26	42	45	12,96	4,5	27,5
27	46	49	13,56	4,5	28,1
28	50	53	14,12	4,5	28,6
29	54	57	14,62	4,5	29,1
30	58	62	15,14	4,5	29,6
31	63	67	15,67	4,5	30,2
32	68	72	16,15	4,5	30,7
33	73	77	16,58	4,5	31,1
34	78	83	17,02	4,5	31,5
35	84	89	17,44	4,5	31,9
36	90	95	17,84	4,5	32,3
37	96	103	18,24	4,5	32,7
38	104	111	18,66	4,5	33,2
39	112	120	19,07	4,5	33,6
40	121	129	19,47	4,5	34,0
41	130	138	19,85	4,5	34,3
42	139	149	20,23	4,5	34,7
43	150	160	20,63	4,5	35,1
44	161	173	21,02	4,5	35,5
45	174	187	21,40	4,5	35,9
46	188	201	21,76	4,5	36,3
47	202	219	22,12	4,5	36,6
48	220	238	22,47	4,5	37,0
49	239	257	22,83	4,5	37,3
50	258	283	23,18	4,5	37,7
51	284	309	23,53	4,5	38,0
52	310	335	23,88	4,5	38,4
53	336	363	24,23	4,5	38,7
54	364	391	24,58	4,5	39,1
55	392	423	24,93	4,5	39,4
56	424	465	25,27	4,5	39,8
57	466	507	25,61	3,5	40,1
58	508	513	25,81	3,5	40,3

**Table D.4a. -- Absolute threshold table**

This table is valid at a sampling rate of 32 kHz.

A value of 0 dB represents a level in the absolute threshold calculation of 96 dB below the energy of a sine wave of amplitude  $\pm 32\ 760$ .

index [line]		absthr [dB]	index [line]		absthr [dB]	index [line]		absthr [dB]
lower	higher		lower	higher		lower	higher	
1	1	58,23	48	48	1,71	185	188	1,95
2	2	33,44	49	50	1,49	189	192	2,08
3	3	24,17	51	52	1,27	193	200	2,33
4	4	19,20	53	54	1,04	201	208	2,59
5	5	16,05	55	56	0,80	209	216	2,86
6	6	13,87	57	57	0,55	217	224	3,17
7	7	12,26	59	60	0,29	225	232	3,51
8	8	11,01	61	62	0,02	233	240	3,89
9	9	10,01	63	64	-0,25	241	248	4,31
10	10	9,20	65	66	-0,54	249	256	4,79
11	11	8,52	67	68	-0,83	257	264	5,31
12	12	7,94	69	70	-1,12	265	272	5,88
13	13	7,44	71	72	-1,43	273	280	6,50
14	14	7,00	73	74	-1,73	281	288	7,19
15	15	6,62	75	76	-2,04	289	296	7,93
16	16	6,28	77	78	-2,34	297	304	8,75
17	17	5,97	79	80	-2,64	305	312	9,63
18	18	5,70	81	82	-2,93	313	320	10,58
19	19	5,44	83	84	-3,22	321	328	11,60
20	20	5,21	85	86	-3,49	329	336	12,71
21	21	5,00	87	88	-3,74	337	344	13,90
22	22	4,80	89	90	-3,98	345	352	15,18
23	23	4,62	91	92	-4,20	353	360	16,54
24	24	4,45	93	94	-4,40	361	368	18,01
25	25	4,29	95	96	-4,57	369	376	19,57
26	26	4,14	97	100	-4,82	377	384	21,23
27	27	4,00	101	104	-4,96	385	392	23,01
28	28	3,86	105	108	-4,97	393	400	24,90
29	29	3,73	109	112	-4,86	401	408	26,90
30	30	3,61	113	116	-4,63	409	416	29,03
31	31	3,49	117	120	-4,29	417	424	31,28
32	32	3,37	121	124	-3,87	425	432	33,67
33	33	3,26	125	128	-3,39	433	440	36,19
34	34	3,15	129	132	-2,86	441	448	38,86
35	35	3,04	133	136	-2,31	449	456	41,67
36	36	2,93	137	140	-1,77	457	464	44,63
37	37	2,83	141	144	-1,24	465	472	47,76
38	38	2,73	145	148	-0,74	473	480	51,03
39	39	2,63	149	152	-0,29			
40	40	2,53	153	156	0,12			
41	41	2,42	157	160	0,48			
42	42	2,32	161	164	0,79			
43	43	2,22	165	168	1,06			
44	44	2,12	169	172	1,29			
45	45	2,02	173	176	1,49			
46	46	1,92	177	180	1,56			
47	47	1,81	181	184	1,81			

**Table D.4b -- Absolute threshold table**  
 This table is valid at a sampling rate of 44,1kHz.

A value of 0 dB represents a level in the absolute threshold calculation of 96dB below the energy of a sine wave of amplitude  $\pm 32\ 760$ .

index [line]		absthr [dB]	index [line]		absthr [dB]	index [line]		absthr [dB]
lower	higher		lower	higher		lower	higher	
1	1	45,05	48	48	-0,56	185	188	4,98
2	2	25,87	49	50	-0,96	189	192	5,35
3	3	18,70	51	52	-1,37	193	200	6,15
4	4	14,85	53	54	-1,79	201	208	7,07
5	5	12,41	55	56	-2,21	209	216	8,10
6	6	10,72	57	58	-2,63	217	224	9,25
7	7	9,47	59	60	-3,03	225	232	10,54
8	8	8,50	61	62	-3,41	233	240	11,97
9	9	7,73	63	64	-3,77	241	248	13,56
10	10	7,10	65	66	-4,09	249	256	15,30
11	11	6,56	67	68	-4,37	257	264	17,23
12	12	6,11	69	70	-4,60	265	272	19,33
13	13	5,72	71	72	-4,78	273	280	21,64
14	14	5,37	73	74	-4,91	281	288	24,15
15	15	5,07	75	76	-4,97	289	296	26,83
16	16	4,79	77	78	-4,98	297	304	29,84
17	17	4,55	79	80	-4,92	305	312	33,04
18	18	4,32	81	82	-4,81	313	320	36,51
19	19	4,11	83	84	-4,65	321	328	40,24
20	20	3,92	85	86	-4,43	329	336	44,25
21	21	3,74	87	88	-4,17	337	344	48,53
22	22	3,57	89	90	-3,87	345	352	53,21
23	23	3,40	91	92	-3,54	353	360	58,17
24	24	3,25	93	94	-3,19	361	368	63,43
25	25	3,10	95	96	-2,82	369	376	69,13
26	26	2,95	97	100	-2,06	377	384	69,13
27	27	2,81	101	104	-1,33	385	392	69,13
28	28	2,67	105	108	-0,64	393	400	69,13
29	29	2,53	109	112	-0,04	401	408	69,13
30	30	2,39	113	116	0,47	409	416	69,13
31	31	2,25	117	120	0,89	417	424	69,13
32	32	2,11	121	124	1,23	425	432	69,13
33	33	1,97	125	128	1,51	433	440	69,13
34	34	1,83	129	132	1,74	441	448	69,13
35	35	1,68	133	136	1,93	449	456	69,13
36	36	1,53	137	140	2,11	457	464	69,13
37	37	1,38	141	144	2,28			
38	38	1,23	145	148	2,45			
39	39	1,07	149	152	2,63			
40	40	0,90	153	156	2,82			
41	41	0,74	157	160	3,03			
42	42	0,56	161	164	3,25			
43	43	0,39	165	168	3,49			
44	44	0,21	169	172	3,74			
45	45	0,02	173	176	4,02			
46	46	-0,17	177	180	4,32			
47	47	-0,36	181	184	4,64			

**Table D.4c -- Absolute threshold table**  
 This table is valid at a sampling rate of 48 kHz.

A value of 0 dB represents a level in the absolute threshold calculation of 96dB below the energy of a sine wave of amplitude +32 760.

index [line]		absthr	index [line]		absthr	index [line]		absthr
lower	higher	[dB]	lower	higher	[dB]	lower	higher	[dB]
1	1	42,10	48	48	-1,43	185	188	6,67
2	2	24,17	49	50	-1,88	189	192	7,19
3	3	17,47	51	52	-2,34	193	200	8,33
4	4	13,87	53	54	-2,79	201	208	9,63
5	5	11,60	55	56	-3,22	209	216	11,08
6	6	10,01	57	58	-3,62	217	224	12,71
7	7	8,84	59	60	-3,98	225	232	14,53
8	8	7,94	61	62	-4,30	233	240	16,54
9	9	7,22	63	64	-4,57	241	248	18,77
10	10	6,62	65	66	-4,77	249	256	21,23
11	11	6,12	67	68	-4,91	257	264	23,94
12	12	5,70	69	70	-4,98	265	272	26,90
13	13	5,33	71	72	-4,97	273	280	30,14
14	14	5,00	73	74	-4,90	281	288	33,67
15	15	4,71	75	76	-4,76	289	296	37,51
16	16	4,45	77	78	-4,55	297	304	41,67
17	17	4,21	79	80	-4,29	305	312	46,17
18	18	4,00	81	82	-3,99	313	320	51,04
19	19	3,79	83	84	-3,64	321	328	56,29
20	20	3,61	85	86	-3,26	329	332	61,94
21	21	3,43	87	88	-2,86	333	340	68,00
22	22	3,26	89	90	-2,45	341	348	68,00
23	23	3,09	91	92	-2,04	349	356	68,00
24	24	2,93	93	94	-1,63	357	364	68,00
25	25	2,78	95	96	-1,24	365	372	68,00
26	26	2,63	97	100	-0,51	373	380	68,00
27	27	2,47	101	104	0,12	381	388	68,00
28	28	2,32	105	108	0,64	389	396	68,00
29	29	2,17	109	112	1,06	397	404	68,00
30	30	2,02	113	116	1,39	405	412	68,00
31	31	1,86	117	120	1,66	413	420	68,00
32	32	1,71	121	124	1,88	421	428	68,00
33	33	1,55	125	128	2,08			
34	34	1,38	129	132	2,27			
35	35	1,21	133	136	2,46			
36	36	1,04	137	140	2,65			
37	37	0,86	141	144	2,86			
38	38	0,67	145	148	3,09			
39	39	0,49	149	152	3,33			
40	40	0,29	153	156	3,60			
41	41	0,09	157	160	3,89			
42	42	-0,11	161	164	4,20			
43	43	-0,32	165	168	4,54			
44	44	-0,54	169	172	4,91			
45	45	-0,75	173	176	5,31			
46	46	-0,97	177	180	5,73			
47	47	-1,20	181	184	6,18			



Table D.5 -- Layer I and Layer II coder partition table

Index	$\omega_{low_{n+1}}$ $\omega_{high_n}$	$width_n$
0	1	0
1	17	0
2	33	0
3	49	0
4	65	0
5	81	0
6	97	0
7	113	0
8	129	0
9	145	0
10	161	0
11	177	0
12	193	0
13	209	1
14	225	1
15	241	1
16	257	1
17	273	1
18	289	1
19	305	1
20	321	1
21	337	1
22	353	1
23	369	1
24	385	1
25	401	1
26	417	1
27	433	1
28	449	1
29	465	1
30	481	1
31	497	1
32	513	1

## Annex E

(informative)

### Bit sensitivity to errors

#### E.1. General

This annex indicates the sensitivity of individual bits to random errors if application specific error protection is needed. This sensitivity is given for each bit by a value from 0 to 5, indicating the amount of degradation resulting from one isolated error :

5	catastrophic
4	very annoying
3	annoying
2	slightly annoying
1	audible
0	insensitive

The values are not the results of precise measurements, rather they rely upon knowledge of the codec. They assume the error detection scheme is not in use.

Some fields in the bit stream do not have a fixed length. All bits in these fields are rated for error sensitivity, even if not in use.

For all layers, the header and error check information defined in 2.4.1.3 and 2.4.1.4 are considered to have the highest sensitivity.

#### E.2. Layers I and II

Parameters	#bit	sensitivity
Bit allocation	all bits	5
Scalefactors select information	all bits	5
Scalefactors	5 (msb)	4
	4	4
	3	4
	2	3
	1	2
	0 (lsb)	1
Subband samples (*)	8-16(msb)	3
	5-7	2
	3,4	1
	(lsb)0-2	0

(\*) according to the bit allocation

### E.3. Layer III

Parameters	#bit	sensitivity
scfsi	all bits	5
part2_3_length	all bits	4
big_values	all bits	3
global_gain	all bits	5
scalefac_compress	all bits	5
window_switching_flag	0	5
block_type	all bits	4
mixed_block_flag	0	4
table_select	all bits	5
region0_count	all bits	3
region1_count	all bits	3
preflag	0	2
scalefac_scale	0	2
count1table_select	0	3
Subblock_gain	2 (msb)	4
	1	3
	0 (lsb)	2
scale_fac (**)	3 (msb)	3(2)
	2	3(2)
	1	2(1)
	0 (lsb)	2(1)
Huffmancodebits () (***)	0...n-1	3 - 0

(\*\*) the scalefac length depends on scalefac\_compress.

The bit sensitivity values refer to the scalefac\_scale value 1 (if 0 the value is in parenthesis).

(\*\*\*) If n is the number of bits for Huffman coding in one block the bit sensitivity decreases linearly from 3 to 0 as the bit number varies from 0 up to n, (from low to high frequency).

Note:

Rearrangement of the Huffman coded values:

To get better implicit error robustness for the low frequency part of the spectrum the Huffman coded values can be transmitted not in their logical order, but in an interleaved fashion.

If max\_hlen is the maximum length of a Huffman codeword over the tables which are used to code the particular block and n is the number of bits used for Huffman coding of data in the block (not frame), then  $\text{int}(n/\text{max\_hlen})$  slots are filled with the first codewords, beginning from low frequencies. The remaining codewords are filled into the remaining place, again arranged from low to high frequencies.

After bit interleaving, the bit sensitivity of bit  $k+i*\text{int}(n/\text{max\_hlen})$  decreases linearly from 3 to 0 as k varies from 0 up to  $\text{int}(n/\text{max\_hlen})-1$ , where  $i=0, \dots, \text{max\_hlen}-1$ , and n is the number of bits for Huffman coding in one block.

This is the recommended practice for Layer III data for all channels where error robustness is important.

## Annex F

(informative)

### Error concealment

An optional feature of the coded bit stream is the CRC word which provides some error detection facility to the decoder. The Hamming distance of this error detection code is  $d=4$ , which allows for the detection of up to 3 single bit errors or for the detection of one error burst of up to 16 bit length. The amount and the position of the protected bits within one encoded audio frame generally depends on the layer, the mode, data rate, and sampling frequency.

This can be used to control an error concealment strategy in order to avoid severe impairments of the reconstructed signal due to errors in the most sensitive information.

Some basic techniques can be used for concealment, for instance information substitution, or muting. A simple substitution technique consists, when an erroneous frame occurs, of replacing it by the previous one (if error free).

## Annex G

(informative)

### Joint stereo coding

#### G.1. Intensity stereo coding Layer I, II

An optional joint stereo coding method used in Layers I and II is intensity stereo coding. Intensity stereo coding can be used to increase the audio quality and/or reduce the bitrate for stereophonic signals. The gain in bitrate is typically about 10 to 30 kbits/s. It requires negligible additional decoder complexity. The increase of encoder complexity is small. The encoder and decoder delay is not affected.

Psychoacoustic results indicate that at high frequencies (above about 2 kHz) the localization of the stereophonic image within a critical band is determined by the temporal envelope and not by the temporal fine structure of the audio signal.

The basic idea for intensity stereo coding is that for some subbands, instead of transmitting separate left and right subband samples, only the sum-signal is transmitted, but with scalefactors for both the left and right channels, thus preserving the stereophonic image.

Flow diagrams of a stereo encoder and decoder, including intensity stereo mode, are shown in figure G.1 "General stereo encoder flow-chart" and figure G.2 "General stereo decoder flow-chart". First, an estimation is made of the required bitrate for both left and right channel. If the required bitrate exceeds the available bitrate, the required bitrate can be decreased by setting a number of subbands to intensity stereo mode. Depending on the bitrate needed, subbands

16 to 31,  
12 to 31,  
8 to 31, or  
4 to 31

can be set to intensity stereo mode. For the quantization of such combined subbands, the higher of the bit allocations for left and right channel is used.

The left and right subband signals of the subbands in joint stereo mode are added. These new subband signals are scaled in the normal way, but the originally determined scalefactors of the left and right subband signals are transmitted according to the bitstream syntax. Quantization of common subband samples, coding of common samples, and coding of common bit allocation are performed in the same way as in independent coding.

#### G.2. MS\_Stereo and intensity stereo coding Layer III

In Layer III a combination of ms\_stereo mode (sum/difference) and intensity stereo mode can be used.

a) MS\_stereo switching

MS\_stereo mode is switched on if in joint stereo mode condition

$$\sum_{i=0}^{511} [rl_i^2 - rr_i^2] < 0.8 * \sum_{i=0}^{511} [rl_i^2 + rr_i^2]$$

is true. The values  $rl_i$  and  $rr_i$  correspond to the energies of the FFT line spectrum of the left and right channel calculated within the psychoacoustic model.

b) MS\_stereo processing

- MS matrix

In MS\_stereo mode the values of the normalized middle/side channel  $M_i/S_i$  are transmitted instead of the left/right channel values  $L_i/R_i$ :

$$M_i = \frac{R_i + L_i}{\sqrt{2}} \quad \text{and} \quad S_i = \frac{L_i - R_i}{\sqrt{2}}$$

- Limitation of  $S_i$  channel bandwidth

All  $S_i$  values above the highest scalefactor band are set to zero.

- Sparsing of  $S_i$  channel

In every scalefactor band  $sb$  all pairs of small values  $(S_i, S_{i+1})$  are set to zero:

$$\text{if } (S_i^2 + S_{i+1}^2) < s_{sb} * (L_i^2 + L_{i+1}^2 + R_i^2 + R_{i+1}^2) \{ \\ S_i = 0; \quad S_{i+1} = 0; \\ \}$$

The following difference channel threshold coefficients apply to the scalefactor bands for block type  $\neq 2$  (long MDCT transforms):

$s_b$	0	1	2	3	4	5	6	7	8	9	
$s_{sb}$	0,0	0,0	0,0	0,0	0,0	0,10	0,10	0,10	0,10	0,10	
$s_b$	10	11	12	13	14	15	16	17	18	19	20
$s_{sb}$	0,10	0,20	0,30	0,40	0,50	0,60	0,70	0,80	0,90	1,00	1,50

c) Intensity stereo processing

- Calculation of intensity stereo position

For each scalefactor band  $sb$  coded in intensity stereo the following steps are executed:

-  $is\_pos_{sb} = NINT(\frac{12}{\pi} * \arctan(\sqrt{\frac{L\_Energy_{sb}}{R\_Energy_{sb}}}))$

-  $L_i = L_i + R_i$  for all indices  $i$  within the actual scalefactor band  $sb$

-  $R_i = 0$  for all indices  $i$  within the actual scalefactor band  $sb$

- the intensity stereo position  $is\_pos_{sb}$  is transmitted instead of the scalefactor of the right channel (3 bits always, stereo positions 0..6, 7=illegal stereo position)

where  $L\_Energy_{sb}/R\_Energy_{sb}$  denote the signal energies of the left/right channel within the actual scalefactor band and  $L_i/R_i$  are the transformed values.

Scalefactor bands of the right/difference channel containing only zeros after coding which do not belong to the intensity coded part should be transmitted with the scalefactor '7' to prevent intensity stereo decoding.

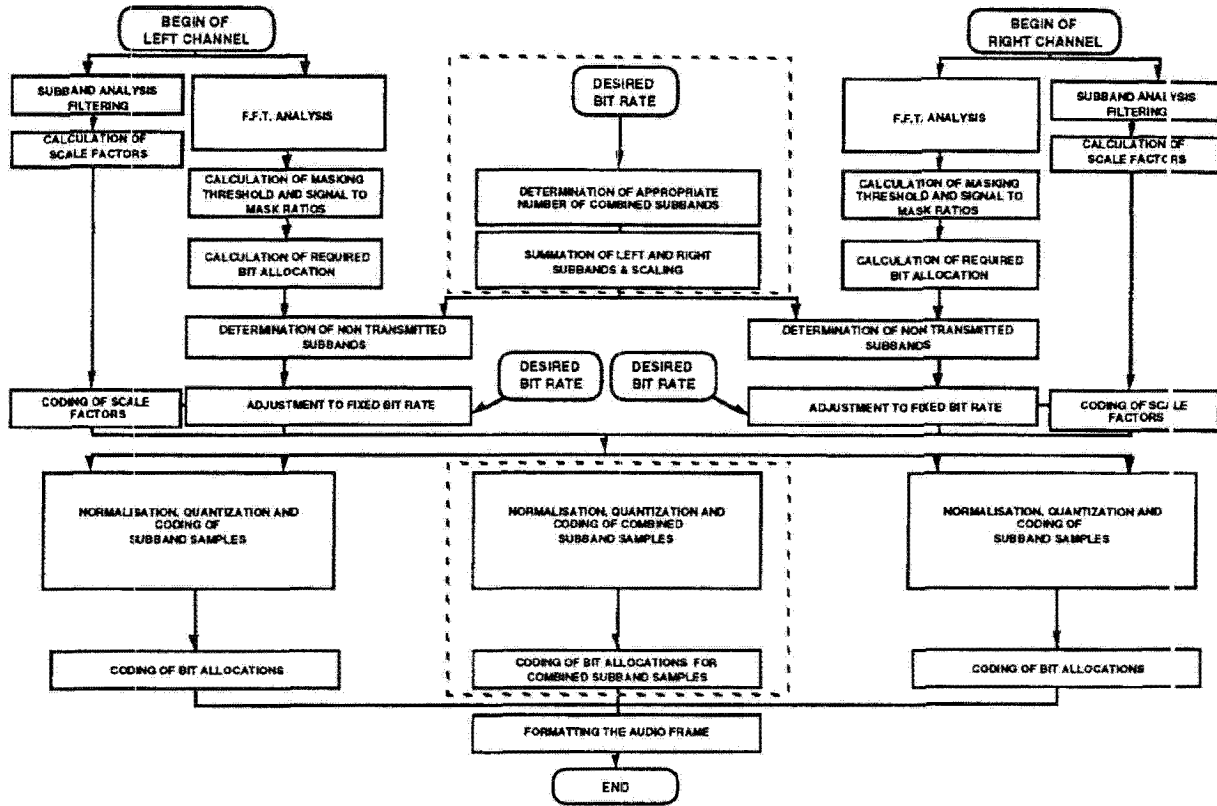

--- This part exists only in the joint stereo mode

Figure G.1 -- General stereo encoder flow chart

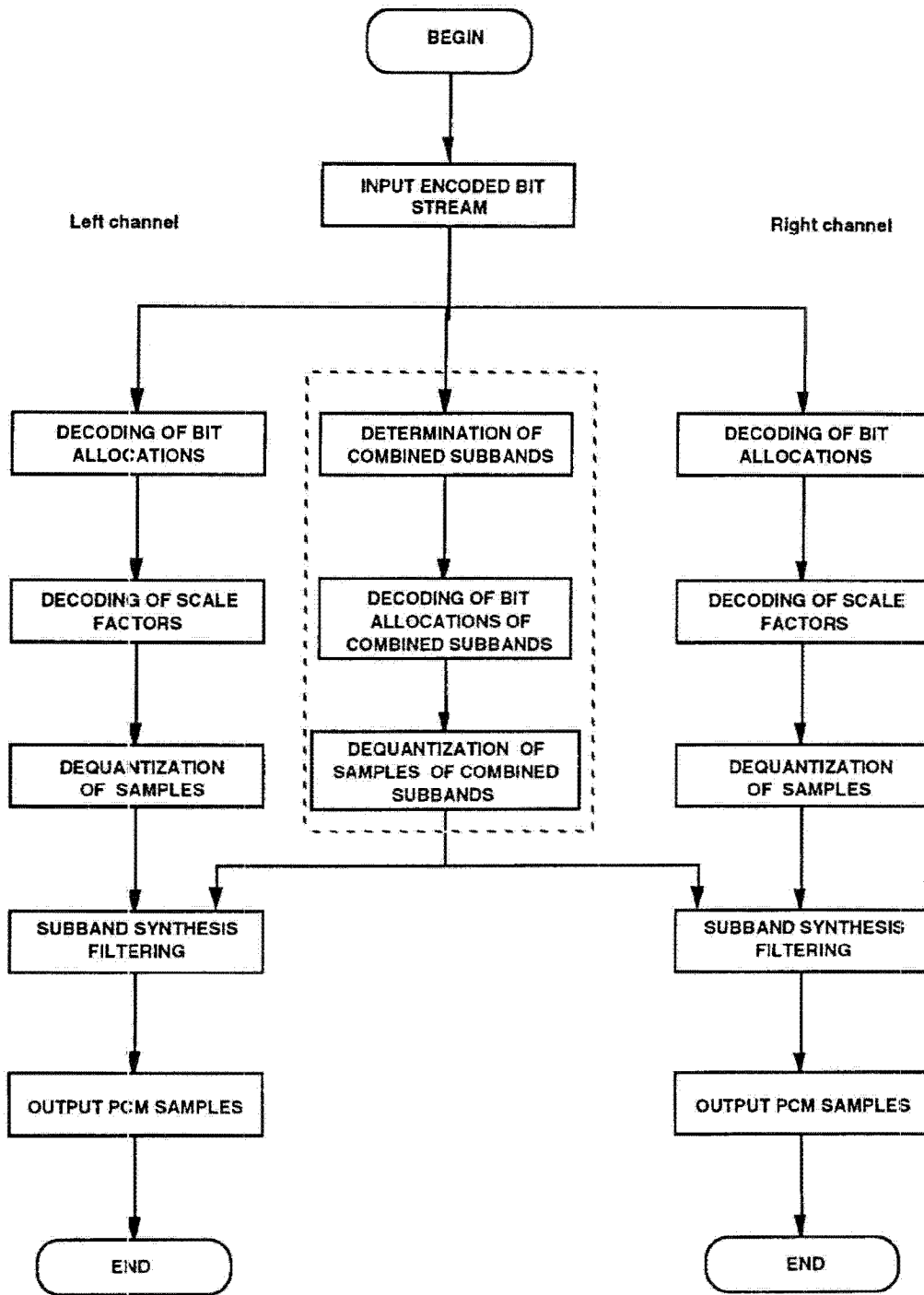

This part is used only in joint stereo mode.

Figure G.2 -- General stereo decoder flow chart



## Annex H

(informative)

### List of patent holders

The user's attention is called to the possibility that - for some of the processes specified in this part of ISO/IEC 11172 - compliance with this International Standard may require use of an invention covered by patent rights.

By publication of this part of ISO/IEC 11172, no position is taken with respect to the validity of this claim or of any patent rights in connection therewith. However, each company listed in this annex has filed with the Information Technology Task Force (ITTF) a statement of willingness to grant a license under such rights that they hold on reasonable and nondiscriminatory terms and conditions to applicants desiring to obtain such a license.

Information regarding such patents can be obtained from :

AT&T  
32 Avenue of the Americas  
New York  
NY 10013-2412  
USA

Aware  
1 Memorial Drive  
Cambridge  
02142 Massachusetts  
USA

Bellcore  
290 W Mount Pleasant Avenue  
Livingston  
NJ 07039  
USA

The British Broadcasting Corporation  
Broadcasting House  
London  
W1A 1AA  
United Kingdom

British Telecommunications plc  
Intellectual Property Unit  
13th Floor  
151 Gower Street  
London  
WC1E 6BA  
United Kingdom

CCETT  
4 Rue du Clos-Courtel  
BP 59  
F-35512  
Cesson-Sevigne Cedex  
France

CNET  
38-40 Rue du General Leclerc  
F-92131 Issy-les-Moulineaux  
France

Compression Labs, Incorporated  
2860 Junction Avenue  
San Jose  
CA 95134  
USA

CSELT  
Via G Reiss Romoli 274  
I-10148 Torino  
Italy

CompuSonics Corporation  
PO Box 61017  
Palo Alto  
CA 94306  
USA

Daimler Benz AG  
PO Box 800 230  
Epplestrasse 225  
D-7000 Stuttgart 80  
Germany

Dornier Gmbh  
An der Bundesstrasse 31  
D-7990 Friedrichshafen 1  
Germany

Fraunhofer Gesellschaft zur Foerderung der Angerwandten Forschung e.V.  
Leonrodstrasse 54  
8000 Muenchen 19  
Germany

Hitachi Ltd  
6 Kanda-Surugadai 4 chome  
Chiyoda-ku  
Tokyo 101  
Japan

Institut für Rundfunktechnik Gmbh  
Florianmühlstraße 60  
8000 München 45  
Germany

International Business Machines Corporation  
Armonk  
New York 10504  
USA

KDD Corporation  
2-3-2 Nishishinjuku  
Shinjuku-ku  
Tokyo  
Japan

Licentia Patent-Verwaltungs-GmbH  
Theodor-Stern-Kai &  
D-6000 Frankfurt 70  
Germany

Massachusetts Institute of Technology  
20 Ames Street  
Cambridge  
Massachusetts 02139  
USA

Matsushita Electric Industrial Co. Ltd  
1006 Oaza-Kadoma  
Kadoma  
Osaka 571  
Japan

Mitsubishi Electric Corporation  
2-3 Marunouchi  
2-Chome  
Chiyoda-Ku  
Tokyo  
100 Japan

NEC Corporation  
7-1 Shiba 5-Chome  
Minato-ku  
Tokyo  
Japan

Nippon Hoso Kyokai  
2-2-1 Jin-nan  
Shibuya-ku  
Tokyo 150-01  
Japan

Philips Electronics NV  
Groenewoudseweg 1  
5621 BA Eindhoven  
The Netherlands

Pioneer Electronic Corporation  
4-1 Meguro 1-Chome  
Meguro-ku  
Tokyo 153  
Japan

Ricoh Co, Ltd  
1-3-6 Nakamagome  
Ohta-ku  
Tokyo 143  
Japan

Schwartz Engineering & Design  
15 Buckland Court  
San Carlos, CA 94070  
USA

Sony Corporation  
6-7-35 Kitashinagawa  
Shinagawa-ku  
Tokyo 141  
Japan

Symbionics  
St John's Innovation Centre  
Cowley Road  
Cambridge  
CB4 4WS  
United Kingdom

Telefunken Fernseh und Rundfunk GmbH  
Göttinger Chaussee  
D-3000 Hannover 91  
Germany

Thomson Consumer Electronics  
9, Place des Vosges  
La Défense 5  
92400 Courbevoie  
France

Toppan Printing Co, Ltd  
1-5-1 Taito  
Taito-ku  
Tokyo 110  
Japan

Toshiba Corporation  
1-1 Shibusu 1-Chome  
Minato-ku  
Tokyo 105  
Japan

Victor Company of Japan Ltd  
12 Moriya-cho 3 chome  
Kanagawa-ku  
Yokohama  
Kanagawa 221  
Japan

Licensed to /JOHN SCHALB  
iSO Store order #: 669832/Downloaded: 2005-05-17  
Single user licence only, copying and networking prohibited.

---

---

**UDC 681.3.04(084.14)**

**Descriptors:** data processing, moving pictures, audio data, video recording, data storage devices, digital storage, coded representation, coding (data conversion).

Price based on 150 pages

---

---

Licensed to JOHN SCHAUB  
ISO Store order #: 669832/Downloaded: 2005-05-17  
Single user licence only, copying and networking prohibited