

1           24. A class-based system including at least one computer  
2 that processes digital information, said system including at least one  
3 element that uses at least some rights management information.

1           25. A method of operating a class-based system including at  
2 least one computer that processes digital information, said method  
3 including the step of using at least some rights management  
4 information.

1           26. A system for assigning at least one thing or person to at  
2 least one class including at least one computer that processes digital  
3 information, said system including at least one element that uses at  
4 least some rights management data in making said assignment.

1           27. A system for making and/or using at least one class-  
2 based assignment including at least one computer that processes  
3 digital information, said system including at least one element that  
4 uses at least some rights management information.

1           28. A system for clearing at least one transaction including at  
2 least one computer that processes digital information, said system  
3 including at least one element that uses at least one class defined,  
4 assigned, selected, and/or matched based at least in part on rights  
5 management information.

1           29. A method for authorizing at least one computer and/or  
2 computer user including the step of using at least one class defined,

3 assigned, selected, and/or matched based at least in part on rights  
4 management information.

1       30. A method for authorizing at least one electronic  
2 transaction including the step of using at least one class defined,  
3 assigned, selected, and/or matched based at least in part on rights  
4 management information.

1       31. A method for initiating and/or performing at least one at  
2 least in part secure electronic transaction including the step of using  
3 class related information defined, assigned, selected, and/or matched  
4 based at least in part on rights management information.

1       32. An information processing method including the steps  
2 of:  
3       securely charging a fee; and  
4       conditioning said charging step at least in part on at least one  
5 class defined, assigned, selected, and/or matched based at least in part  
6 on rights management information.

1       33. A method for securely exchanging digital information  
2 including the step of at least in part defining, assigning, selecting,  
3 and/or matching at least one class based at least in part on rights  
4 management information.

1       34. A method for performing at least one rights operating  
2 system based transaction including the step of defining, assigning,

3 selecting, and/or matching at least one class based at least in part on  
4 rights management information.

1 35. A method for performing at least one protected  
2 processing environment operation including the step of defining,  
3 assigning, selecting, and/or matching at least one class based at least  
4 in part on rights management information.

1 36. A method of pushing information including the steps of  
2 classifying recipients and/or information to be sent to said recipients  
3 based at least in part on rights management information, and selecting  
4 said information to distribute to said recipients based at least in part  
5 on said classifying.

1 37. A method of pushing information including the steps of  
2 classifying recipients and/or information to be sent to said recipients  
3 based at least in part on rights management information, and  
4 matching at least a portion of said information with at least one class  
5 of said recipients based at least in part on said classifying.

1 38. A method of pushing information as in claim 37 further  
2 including the step of creating a classification scheme and/or hierarchy  
3 using at least some rights information.

1 39. A method of pushing information as in claim 37 further  
2 including the step of assigning at least some information and/or at  
3 least one recipient to a class or category, said assignment based at  
4 least in part on rights management information.

1           40. A subject switch for matching subscribers and/or  
2 recipients desiring information in one or more classes with one or  
3 more sources of information, wherein the subject switch matches at  
4 least one subscriber and/or participant with at least one information  
5 source on a mapping based at least in part on rights management  
6 information.

1           41. A subject switch as in claim 40 wherein said information  
2 source:

3           selects at least some information, said selection based on at  
4 least one class, and wherein said assignment of said at least some  
5 information to said at least one class is based at least in part on rights  
6 management information; and

7           sends at least some said selected information to said subscriber  
8 in accordance with said subscriber's subscribing to said class of  
9 information.

1           42. A subject switch as in claim 40 wherein at least one of  
2 said subject switch, said subscriber and/or participant and said  
3 information source includes at least one computer providing a  
4 protected processing environment.

1           43. A subject switch as in claim 40 wherein at least one  
2 subscriber and/or participant uses rights management information at  
3 least in part to persistently subscribe to at least some information  
4 provided by at least one information source.

1           44. A subject switch as in claim 40 wherein the subject  
2 switch includes means for using at least one class definition for said  
3 mapping.

1           45. A subject switch as in claim 40 wherein the subject  
2 switch includes means for responding to a subscriber and/or  
3 participant request by providing information indicating information  
4 sources in at least one specified or desired class.

1           46. A subject switch as in claim 40 further including a  
2 messaging service for use by at least two of said subject switch, said  
3 subscriber and/or participant and said information source and/or  
4 participant to communicate electronically.

1           47. A subject switch as in claim 46 wherein said electronic  
2 communications uses at least one secure container.

1           48. A subject switch as in claim 40 wherein at least one of  
2 said subject switch, subscriber, or information source uses at least one  
3 control set associated with at least some information received by at  
4 least one subscriber.

1           49. A digital narrowcasting arrangement comprising:  
2 a computer; and  
3 at least one classifying element used to select content to  
4 narrowcast to recipients based at least in part on rights management  
5 information.

1           50. A digital narrowcasting arrangement as in claim 49  
2 wherein the classifying element classifies at least one of (a) a  
3 recipient, and (b) content, based at least in part on rights management  
4 information.

1           51. A digital narrowcasting arrangement as in claim 49  
2 wherein said classifying element defines at least one class using at  
3 least some rights management information.

1           52. A digital narrowcasting arrangement as in claim 49  
2 wherein the classifying element assigns at least some content to at  
3 least one class, said assignment based on at least some rights  
4 management information.

1           53. A digital narrowcasting arrangement as in claim 49  
2 wherein the classifying element defines at least one class based at  
3 least in part on content selections previously made by the recipients  
4 and/or profiles generated based at least in part on recipient input.

1           54. A digital narrowcasting arrangement as in claim 49  
2 wherein the classifying element sends a content request including  
3 classification data and destination information to at least one  
4 provider.

1           55. An information distribution system including: a  
2 computer network; and a selection arrangement that selects  
3 information for use by individual recipients using classes based at  
4 least in part on rights management information.

1           56.    An information distribution system as in claim 55  
2 wherein the system further includes a classifying element that  
3 determines at least one class of content and/or service of interest to at  
4 least one recipient.

1           57.    An information distribution system as in claim 56  
2 wherein said classifying element defines at least one class using at  
3 least some rights management information.

1           58.    An information distribution system as in claim 56  
2 wherein said classifying element assigns at least some content to at  
3 least one class, said assignment based on at least some rights  
4 management information.

1           59.    An information distribution system as in claim 55  
2 wherein the system includes means for allowing the user to choose to  
3 receive the selected information.

1           60.    An enterprise information system including a computer  
2 system for classifying employees, said system including at least one  
3 rights management component that distributes information to the  
4 employees based at least in part on employee classification.

1           61.    An enterprise information system as in claim 60 wherein  
2 the computer matches the information to employees based at least in  
3 part on the employee classification.

1           62.    An enterprise information system as in claim 60 wherein  
2 the employee classification is used to gather information for

3 employees without revealing substantial information concerning  
4 individual employees.

1           63. A method for conducting a chain of handling and/or  
2 control including the steps of allowing plural parties to contribute  
3 rules and/or consequences, and performing at least one classification  
4 based at least in part on said rules and/or consequences.

1           64. A method as in claim 63 wherein at least some of said  
2 contributed rules and/or consequences are class based.

1           65. A method as in claim 63 wherein at least one of said  
2 parties modifies at least one of said rules and/or consequences based  
3 at least in part on class.

1           66. A method as in claim 63 including the step of generating  
2 class assignments based at least in part on said rules and/or  
3 consequences, and sending said class assignments to at least one  
4 clearinghouse.

1           67. A method as in claim 63 including the step of classifying  
2 said rules and/or consequences to provide at least one class, and  
3 fulfilling at least one request by selecting based on said class.

1           68. A directory services system for classifying confidential  
2 information, the system including:  
3           a communications component that receives directory requests;  
4 and  
5           a response component that uses said classification to respond to



6 directory requests while preserving confidentiality of said  
7 confidential information.

1 69. A directory services system as in claim 68 wherein said  
2 response component uses at least one classification process to classify  
3 items in a directory, and uses results of the classification process, at  
4 least in part, to respond to directory requests.

1 70. A directory services system as in claim 68 wherein said  
2 response component sends information to destinations revealed by the  
3 results of the classification process without revealing at least some  
4 information concerning said destinations to the information source.

1 71. A microsegmented merchandising technique including  
2 the steps of performing classification based at least in part on usage  
3 data and/or lifestyle profiles, and distributing offers for products  
4 and/or services based at least in part on the classification.

1 72. A microsegmented merchandising technique as in claim  
2 71 wherein the performing step includes defining at least one class  
3 hierarchy based at least in part on rights management information.

1 73. A microsegmented merchandising technique as in claim  
2 71 further including the step of combining plural offers for different  
3 products and/or services based at least in part on said classification.

1 74. A trading network including:  
2 a communications element for communicating digital signals;  
3 and

4 means for matching value chain participants through a  
5 classification based at least in part on rights management  
6 information.

1 75. A trading network as in claim 74 further including means  
2 for defining at least one class hierarchy based at least in part on rights  
3 management information.

1 76. A trading network as in claim 74 further including means  
2 for determining class membership based at least in part on action  
3 and/or information provided by at least one value chain participant.

1 77. A trading network as in claim 74 wherein said matching  
2 means includes means for at least in part performing at least one  
3 electronic negotiation.

1 78. A securities trading method including the step of  
2 performing a classification process at least in part using at least one  
3 rights management element, and using the classification process to  
4 select securities for trade.

1 79. A securities trading method as in claim 78 wherein said  
2 classification process includes defining at least one class hierarchy  
3 based at least in part on rights management information.

1 80. A currency/debt trading system including:  
2 a currency or debt trading computer; and  
3 an arrangement coupled to said computer that performs at least

4 one classification process based at least in part on rights management  
5 information.

1 81. A currency/debt trading system as in claim 80 wherein  
2 said arrangement includes means for defining at least one class  
3 hierarchy based at least in part on rights management information.

1 82. A currency/debt trading system as in claim 80 wherein  
2 the arrangement uses classification to maximize return or minimize  
3 loss.

1 83. A financial institution selection system including a  
2 computer that classifies financial institutions based at least in part on  
3 rights management information.

1 84. A software distribution method including the steps of  
2 generating class information based at least in part on rights  
3 management information, and selecting software to be distributed  
4 and/or recipients who are to receive distributed software based at least  
5 in part on class information.

1 85. A software distribution method as in claim 84 wherein  
2 said generating step includes defining a class hierarchy using at least  
3 some rights management information.

1 86. A software distribution method as in claim 84 wherein  
2 the selecting step includes selecting software to be distributed by  
3 classifying the software based at least in part on rights management  
4 information associated with the software.

1           87. A software distribution method as in claim 80 wherein  
2 the selecting step includes selecting recipients to receive software  
3 based at least in part on usage information provided by a rights  
4 management process.

1           88. A classification technique including the step of  
2 authenticating class membership based at least in part on digital  
3 credentials and/or certificates.

1           89. A classification technique as in claim 88 wherein said  
2 digital credentials are digital certificates.

1           90. A classification technique as in claim 88 wherein said  
2 digital credentials are digital membership cards.

1           91. A classification technique as in claim 88 further  
2 including the step of deciding class membership based at least in part  
3 on rights management information.

1           92. A classification technique as in claim 88 further  
2 including the step of classifying at least one of users, nodes, devices,  
3 networks, servers, clients and services based at least in part on rights  
4 management information.

1           93. A classification technique as in claim 88 further  
2 including the step of conditioning at least one rights management  
3 process at least in part on authenticated class membership.

1           94. A computer system including:  
2           a first arrangement that generates class-based controls to  
3 participants based at least in part on class and/or class-based  
4 assignments; and  
5           a second arrangement that allows participants to interact with  
6 information and/or one another at least in part using said class-based  
7 controls.

1           95. A computer system as in claim 94 further including  
2 means for using said class-based controls to limit participants' access  
3 to information and/or services based on participants' classes.

1           96. A health care computer system including an arrangement  
2 for issuing health care workers, administrators and insurers class-  
3 based digital credentials and/or certificates, wherein the digital  
4 information sent to said health care workers and administrators  
5 includes class-based controls that condition use and/or access to  
6 information based at least in part on said class-based digital  
7 credentials and/or certificates.

1           97. A health care computer system as in claim 96 further  
2 including means for allowing said health care workers, administrators  
3 and insurers sharing a common object subject to class-based controls  
4 to have access to different portions of the object based at least in part  
5 on said class-based controls.

1           98.    A work process automation system including a matching  
2    and/or classification computer that matches tasks to resources based  
3    at least in part on assigning classifying the tasks and/or the resources  
4    to at least one class.

1           99.    A work process automation system as in claim 98  
2    wherein said matching and/or classification computer includes means  
3    for defining at least one class hierarchy based at least in part on rights  
4    management information.

1           100.   A work process automation system as in claim 98  
2    wherein said matching and/or classification computer includes means  
3    for matching based at least in part on rights management information.

1           101.   An automatic governmental and/or societal rights  
2    supporting system including a matching and/or classification  
3    computing element that assigns and/or classifies entities to at least  
4    one class based at least in part on rights management information.

1           102.   An automatic governmental and/or societal rights  
2    supporting system as in claim 101 wherein the matching and/or  
3    classification computing element includes means for defining a class  
4    hierarchy based at least in part on rights management information.

1           103.   An automatic governmental and/or societal rights  
2    supporting system as in claim 101 wherein the matching and/or  
3    classification computing element includes means for classifying  
4    entities based on at least one of the following:

5 tax status;  
6 right to receive certain information;  
7 right to engage in certain transactions; and  
8 jurisdiction.

1 104. An automatic taxing authority computer including  
2 means for issuing tax class control sets based at least in part on tax-  
3 based class definitions, and means for using said tax control sets at  
4 least in part to collect and/or enforce taxation.

1 105. A method for adaptively presenting information  
2 differently to different participants, including associating said  
3 participants with classes, and controlling presentation based at least in  
4 part on class-based control sets included within the information.

1 106. A method as in claim 105 further including using said  
2 class-based control sets to match participants with different portions  
3 of said information.

1 107. A method as in claim 105 further including using said  
2 class-based control sets to change the form in which information is  
3 presented based at least in part on said classes.

1 108. A method as in claim 105 further including the step of  
2 operating said class-based control sets based at least in part on  
3 metadata associated with different portions of said information.

1 109. A method as in claim 105 further including selecting  
2 said class-based control sets between different images for

3 presentation based at least in part on one or more classes associated  
4 with a participant.

1 110. A method as in claim 105 further including using said  
2 class-based control sets to emphasize certain portions of said  
3 information over other portions in said presentation based at least in  
4 part on one or more classes associated with a participant.

1 111. A method as in claim 105 further including using at  
2 least one computer having a protected processing environment.

1 112. A method for adaptively presenting information  
2 differently to different participants including:  
3 classifying the different participants based on capability; and  
4 using class-based control sets associated with said information  
5 to change the difficulty of the presentation based at least in part on  
6 said classification.

1 113. A method as in claim 112 wherein the different  
2 recipients are classified based on grade level.

1 114. A method as in claim 112 including the step of  
2 changing the vocabulary and/or syntactical complexity of the  
3 presentation based at least in part on said classification.

1 115. A method as in claim 112 further including the step of  
2 using said class-based control sets to ensure that in at least some  
3 cases, recipients in different classes pay different levels of  
4 compensation for said presentation.



1           116. A method for adaptively presenting information  
2 differently to different participants including:  
3           classifying different participants based on capability, and  
4           using class-based control sets associated with said information  
5 to change the language of the presentation based at least in part on  
6 said classification.

1           117. An information searching mechanism including a  
2 matching computer element that classifies information based at least  
3 in part on rights management information, said computing element  
4 including means responsive to user requests to search for information  
5 based at least in part on said classification.

1           118. An information searching mechanism as in claim 117  
2 wherein said matching computer element further includes means for  
3 assigning information to classes based at least in part on rights  
4 management information.

1           119. An information searching mechanism as in claim 117  
2 wherein said matching computer element includes means for scoring  
3 information based at least in part on user indicated parameters.

1           120. An information searching mechanism as in claim 117  
2 wherein said matching computer element includes means for  
3 responding to at least some user requests by providing Universal  
4 Resource Locator designations of where information can be found.

1           121. An information handling method including the step of  
2 using class-based controls to control support extraction and/or  
3 aggregation of information.

1           122. An information handling method as in claim 121 further  
2 including using a computing element to extract information from  
3 plural objects based at least in part on class-based criteria.

1           123. An information handling method as in claim 121 further  
2 including using a computing element to aggregate information based  
3 at least in part on class-based criteria.

1           124. An information handling method as in claim 121 further  
2 including using said class-based controls to represent nested or multi-  
3 level classifications.

1           125. An information classification method including the step  
2 of generating at least one class hierarchy from other plural  
3 classification hierarchies based at least in part on rights management  
4 information and/or class-based rights management information based  
5 at least in part on classification metadata.

1           126. An information classification method as in claim 125  
2 further including basing said other plural classification hierarchies at  
3 least in part on object metadata.

1           127. An information classification method as in claim 125  
2 further including specifying said classification object metadata

3 specified classifications based on at least one of location, name,  
4 prices, permissions, ISSN, title, author, publisher and/or date.

1 128. An information classification method as in claim 125  
2 further including generating said class-based rights management  
3 information by classifying classes.

1 129. An electronic gambling system including a computer  
2 that matches gamblers with plural gambling providers based at least  
3 in part through classifying the gambling providers using rights  
4 management information.

1 130. An electronic gambling system as in claim 129 wherein  
2 the computer includes means for classifying the gamblers based at  
3 least in part on rights management information.

1 131. An electronic gambling system as in claim 129 wherein  
2 the computer includes at least one protected processing environment.

1 132. An electronic gambling system as in claim 129 wherein  
2 the computer uses at least one control set to classify, select and/or  
3 match at least one of said gambling providers, and/or gamblers.

1 133. An electronic ticketing system including a computer  
2 that matches recipients with tickets to events through classifying said  
3 recipients, said system including a computer that matches tickets  
4 and/or said events based at least in part on rights management  
5 information.

1           134. An electronic ticketing system as in claim 133 wherein  
2 a recipient provides a request containing event and rights  
3 management criteria, and the computer matches the recipient with a  
4 provider based at least in part on said classifying process.

1           135. An electronic ticketing system as in claim 133 wherein  
2 the rights management information includes method of payment  
3 information.

1/96

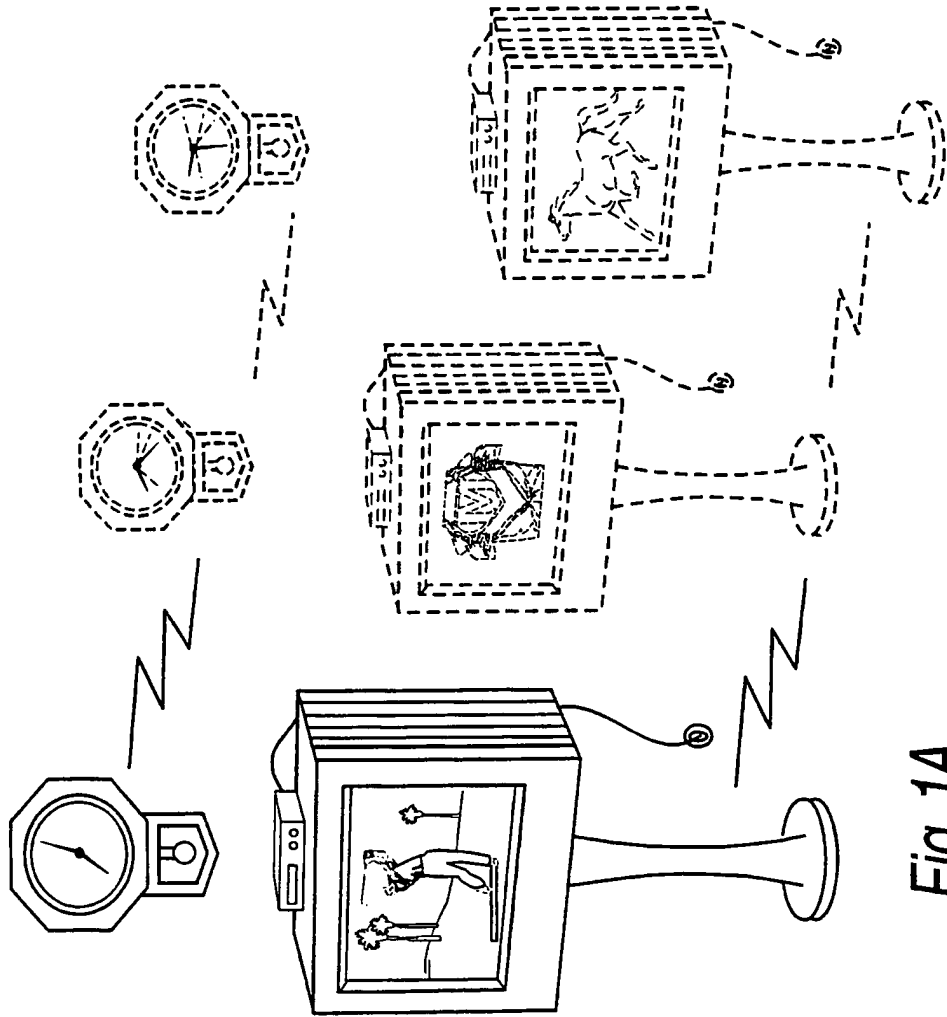
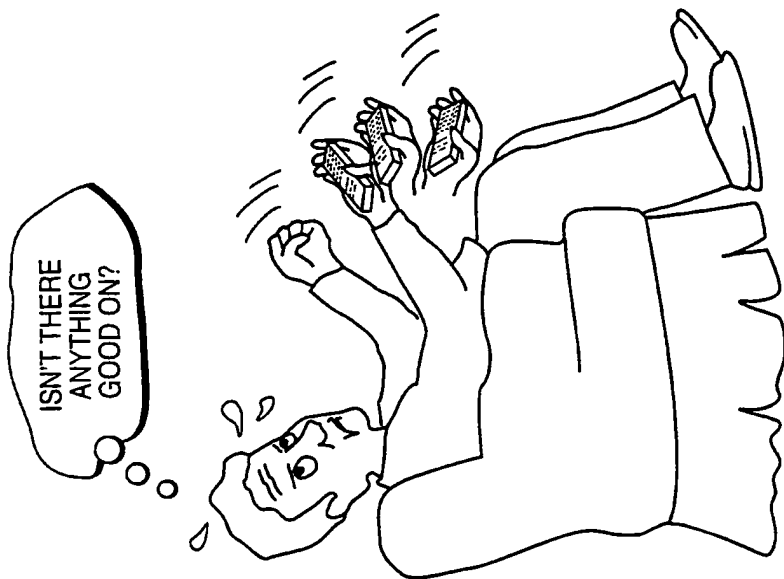
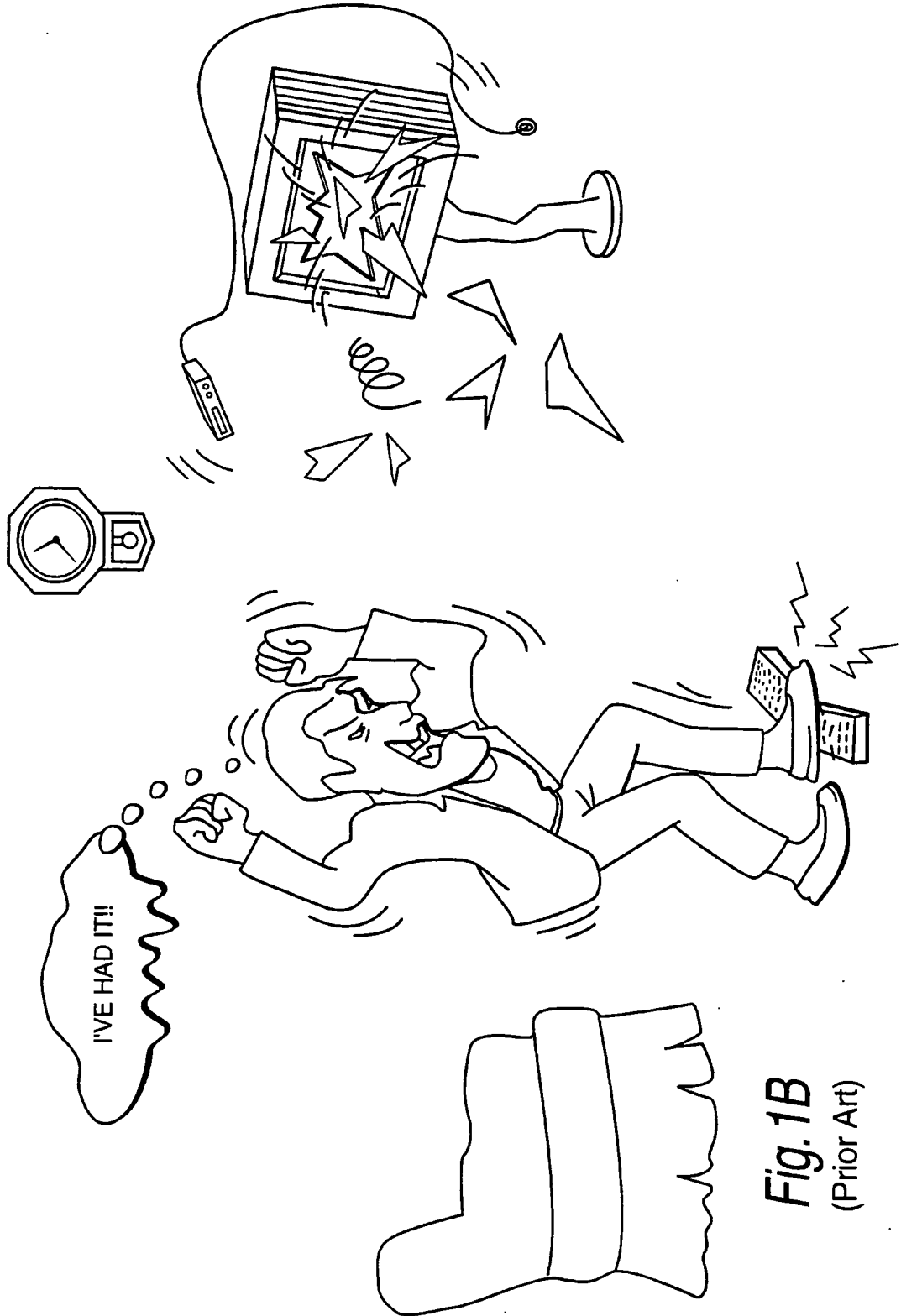

Fig. 1A  
(Prior Art)





**Fig. 1B**  
(Prior Art)

3/96



Fig. 2  
(Prior Art)

4/96

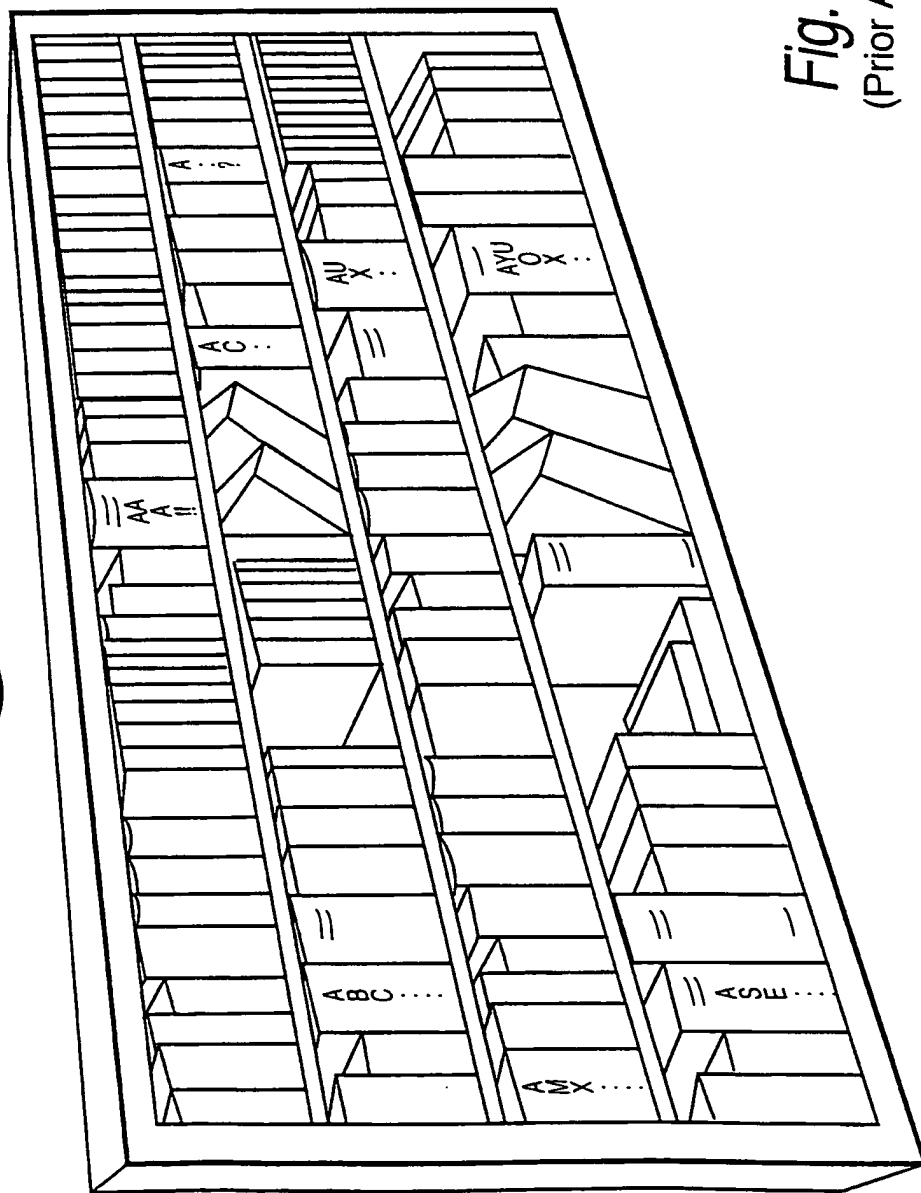

Fig. 3  
(Prior Art)



5/96

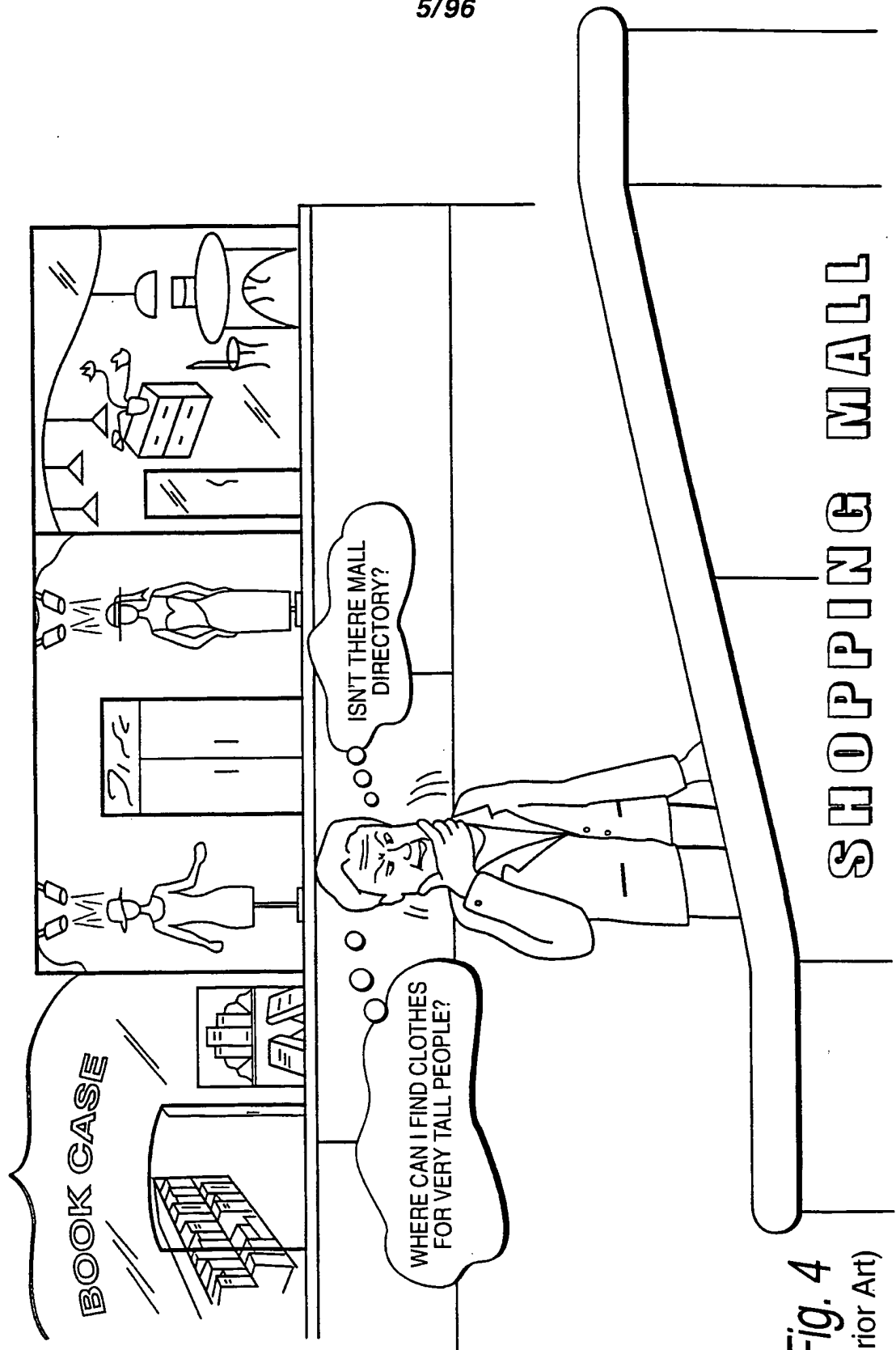

Fig. 4  
(Prior Art)

6/96

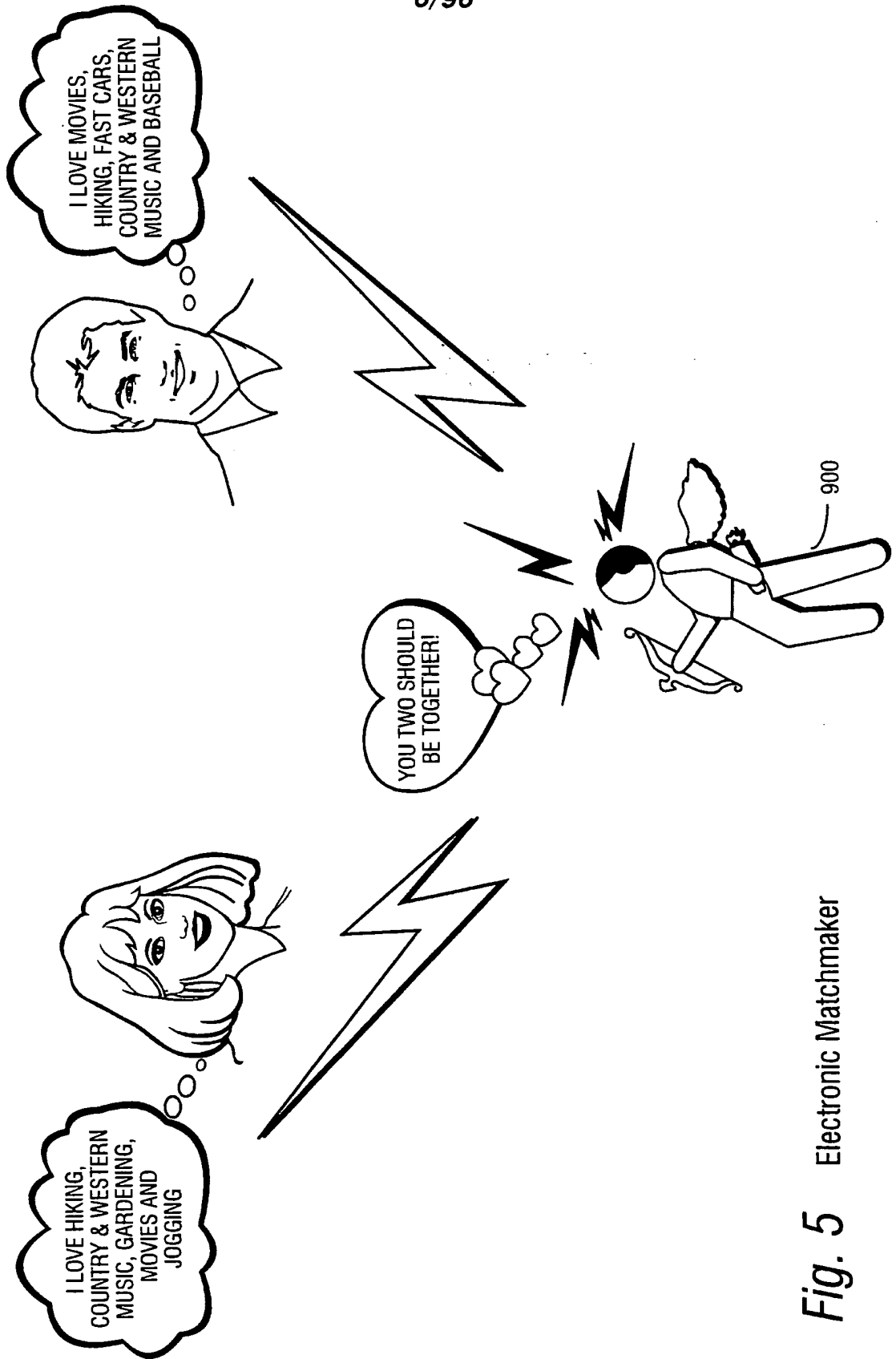
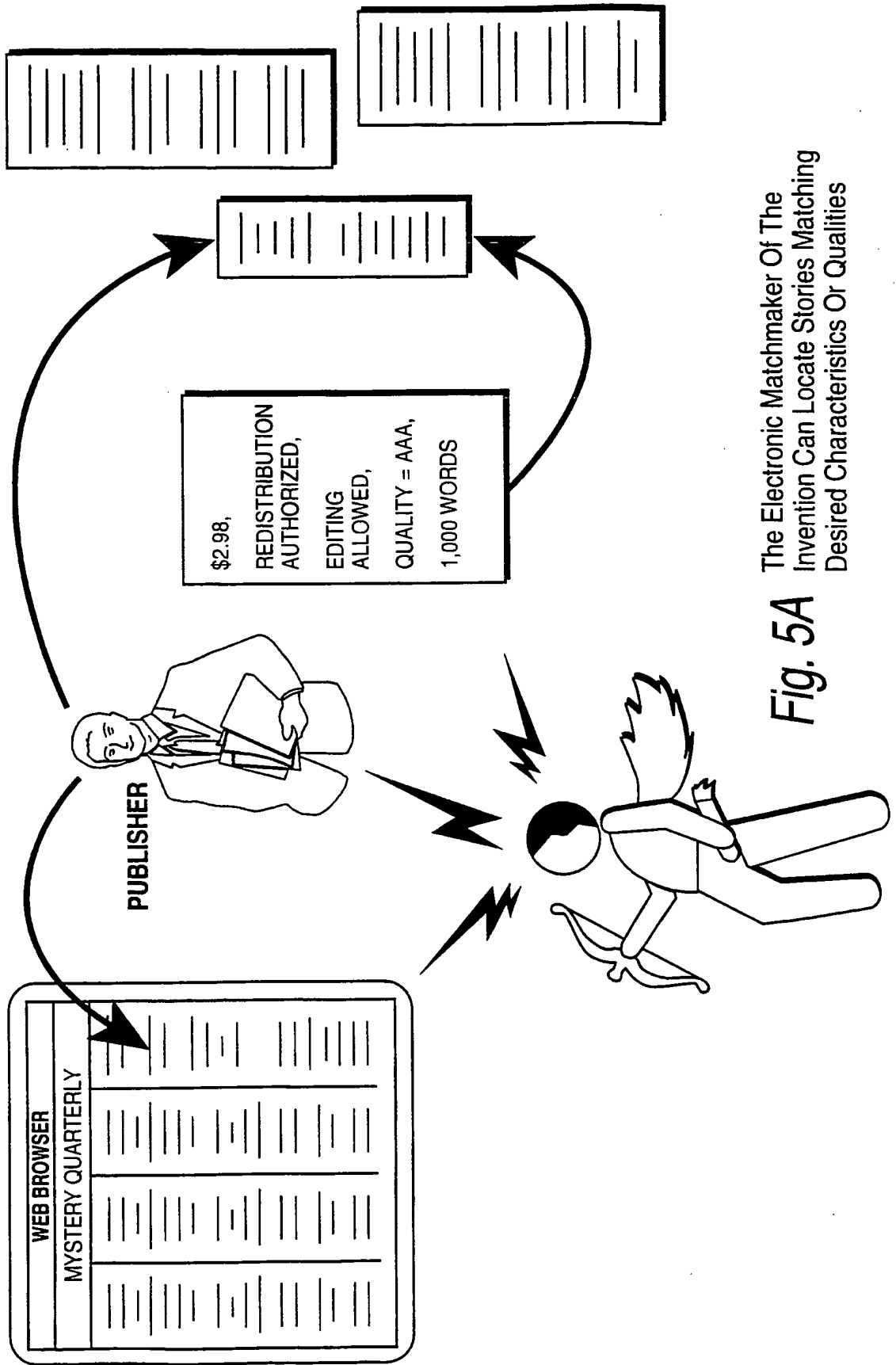

Fig. 5 Electronic Matchmaker



The Electronic Matchmaker Of The Invention Can Locate Stories Matching Desired Characteristics Or Qualities

Fig. 5A

8/96

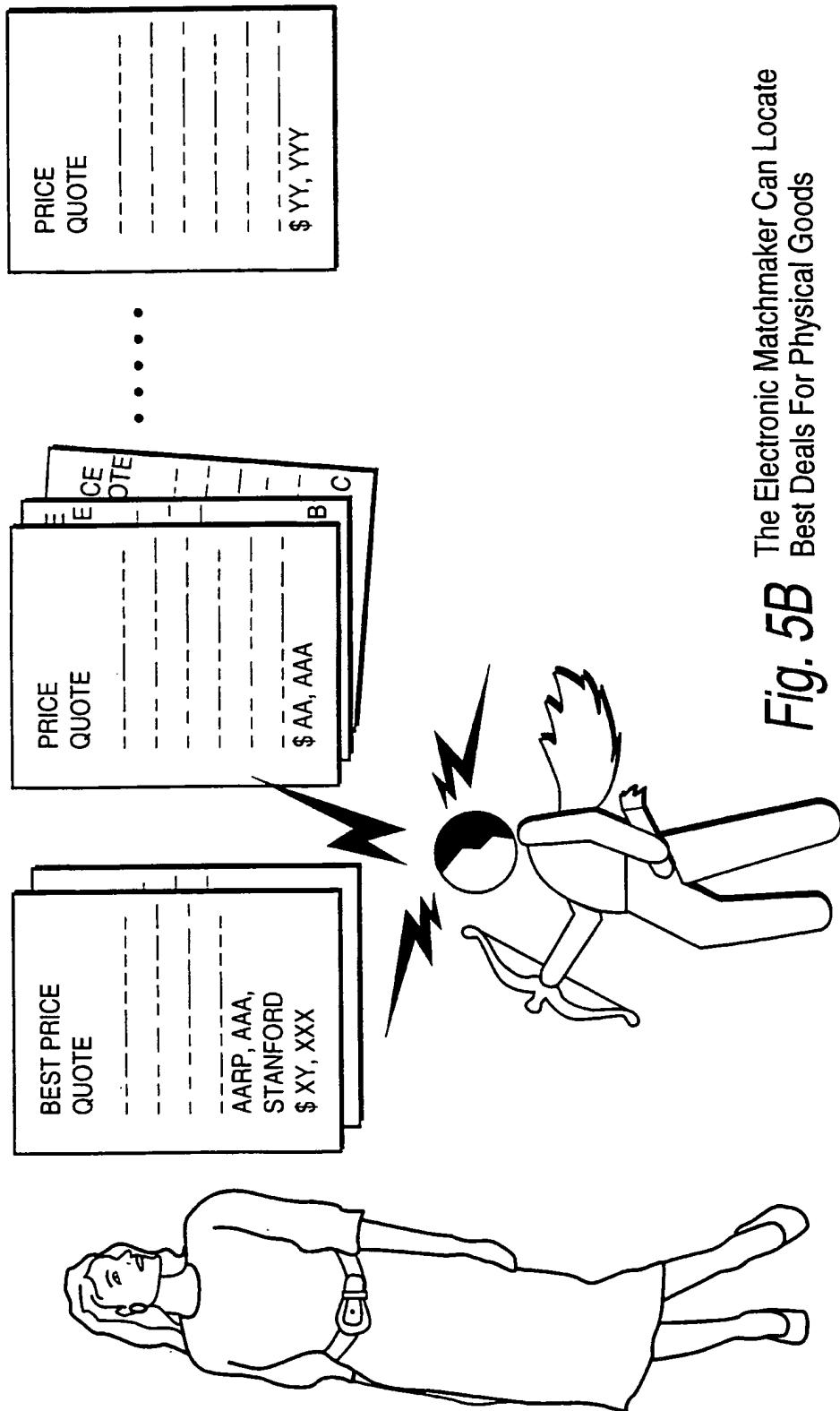
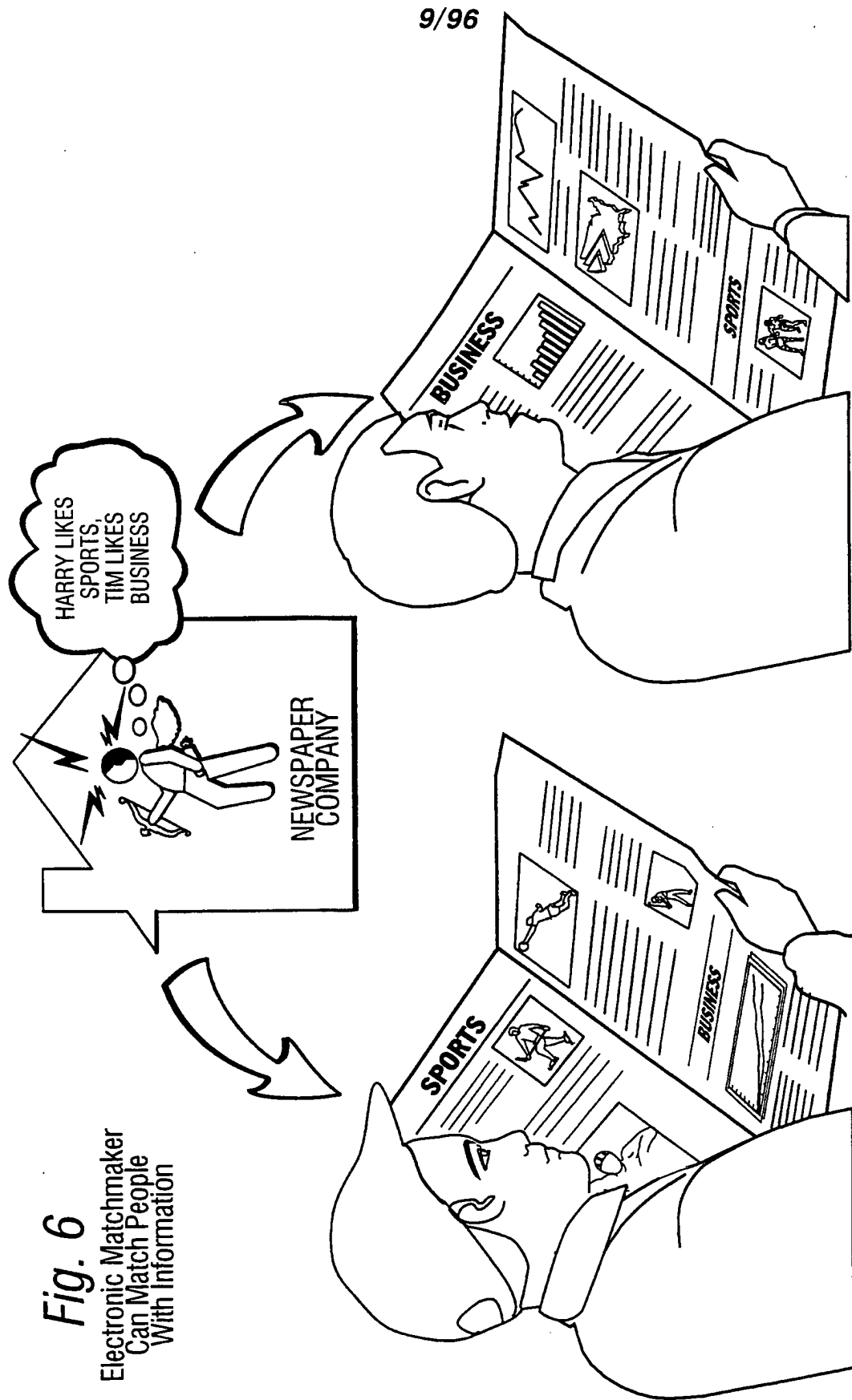

Fig. 5B The Electronic Matchmaker Can Locate Best Deals For Physical Goods



**Fig. 6**  
Electronic Matchmaker  
Can Match People  
With Information

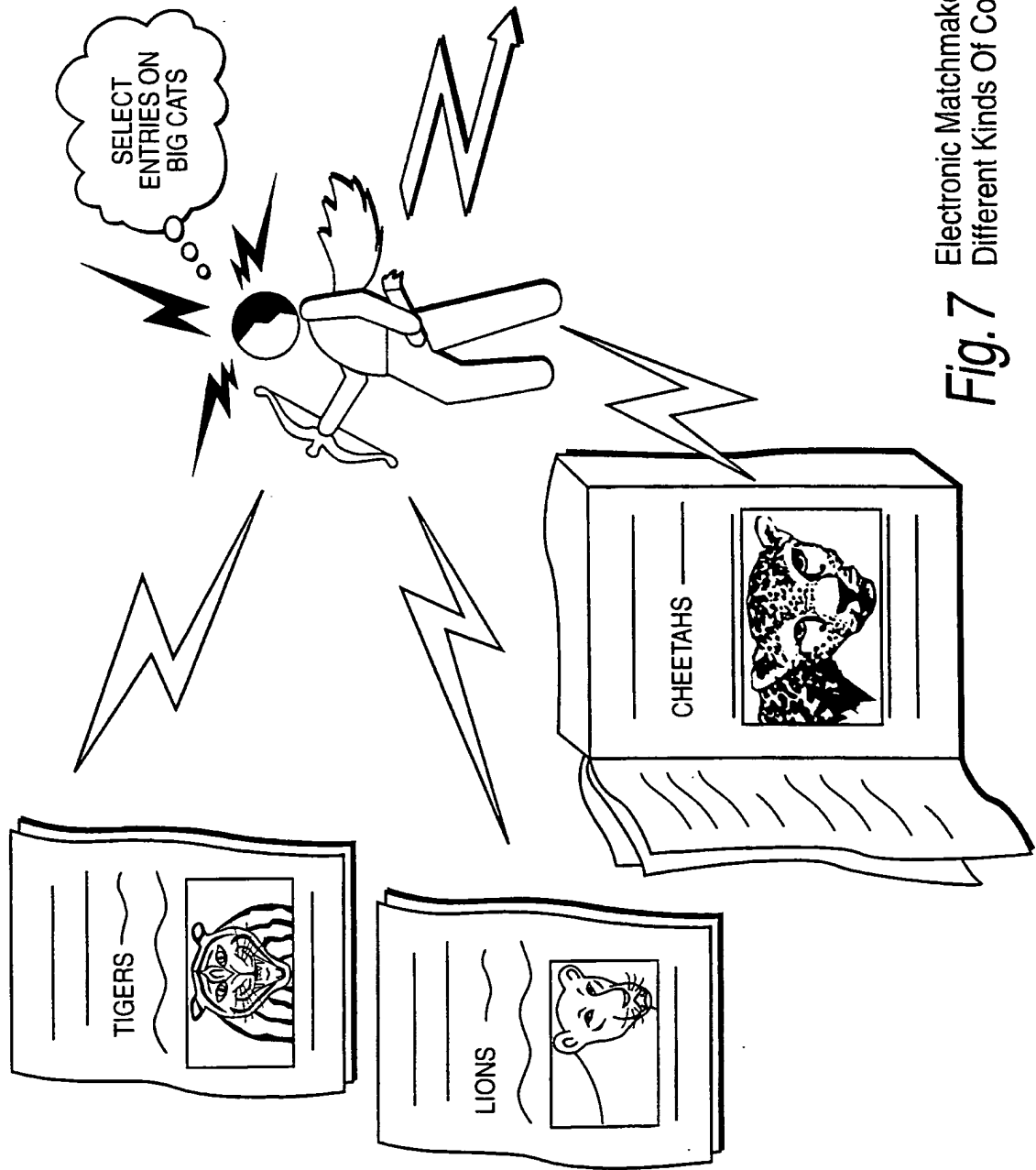
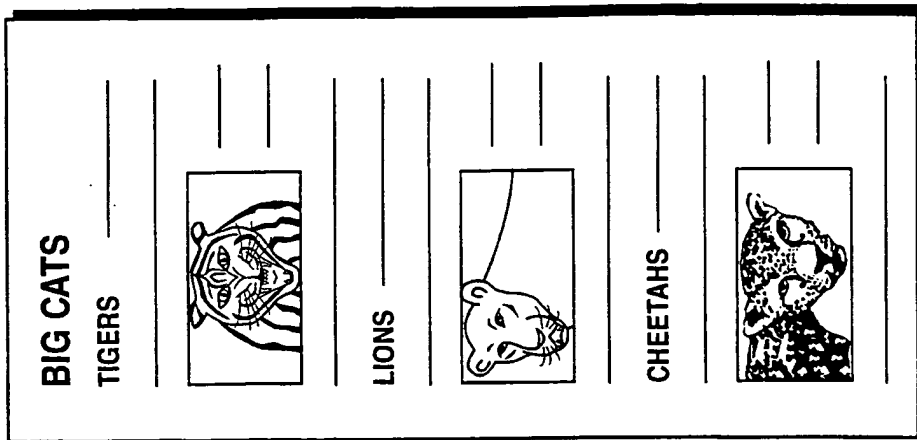
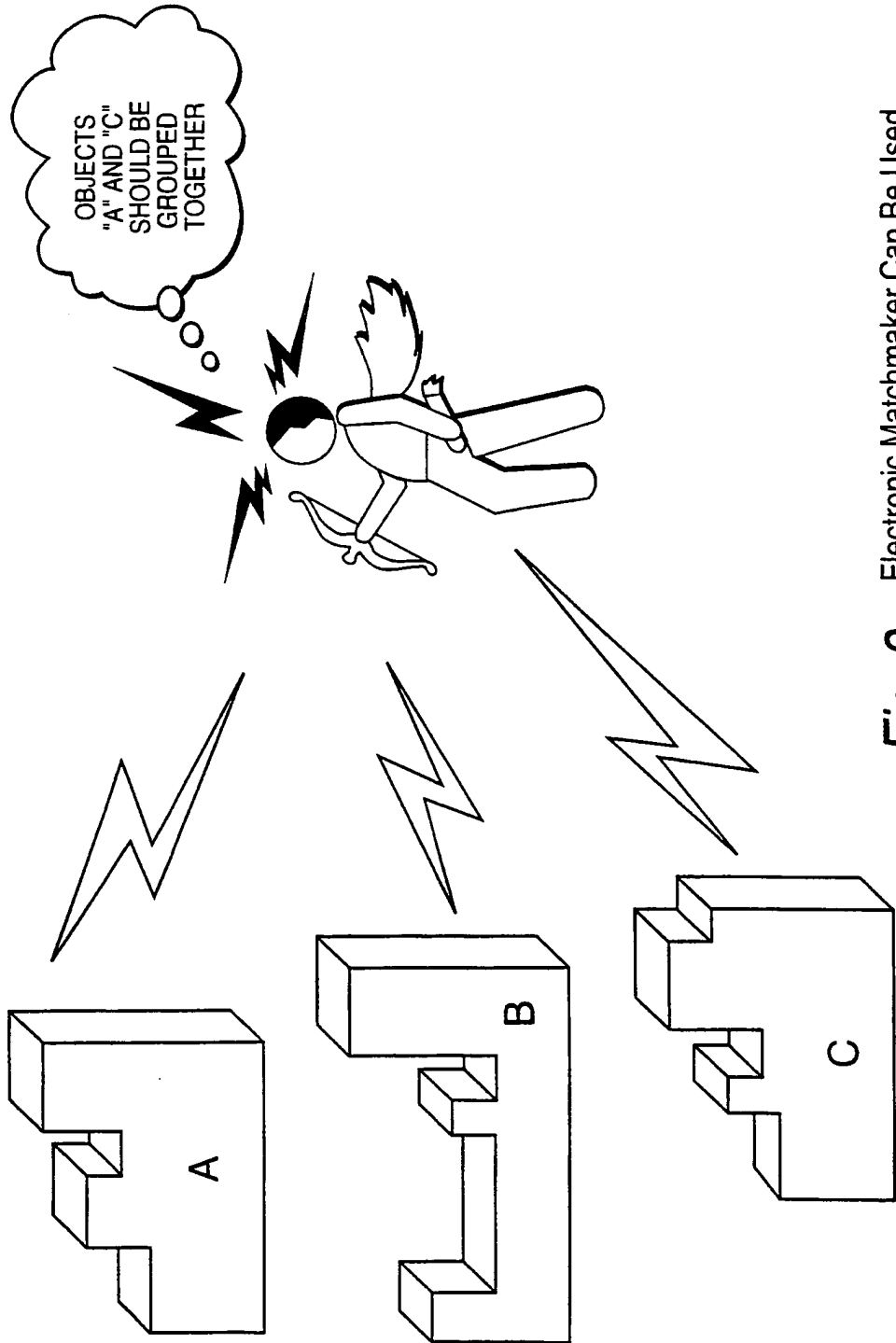

Fig. 7 Electronic Matchmaker Can Match Different Kinds Of Content

11/96



**Fig. 8** Electronic Matchmaker Can Be Used For Matching Any Kinds of Things

12/96

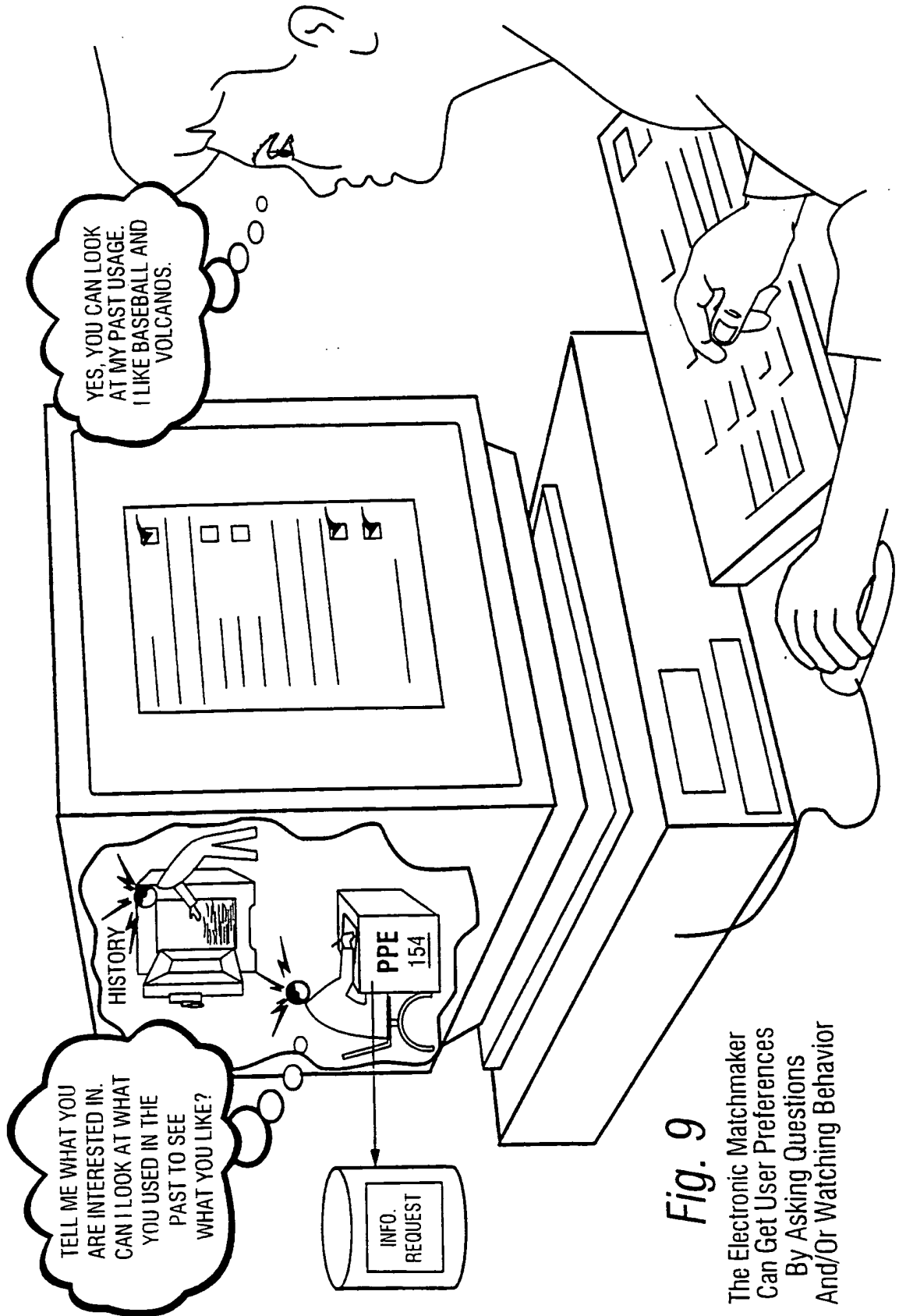

**Fig. 9**  
 The Electronic Matchmaker  
 Can Get User Preferences  
 By Asking Questions  
 And/Or Watching Behavior



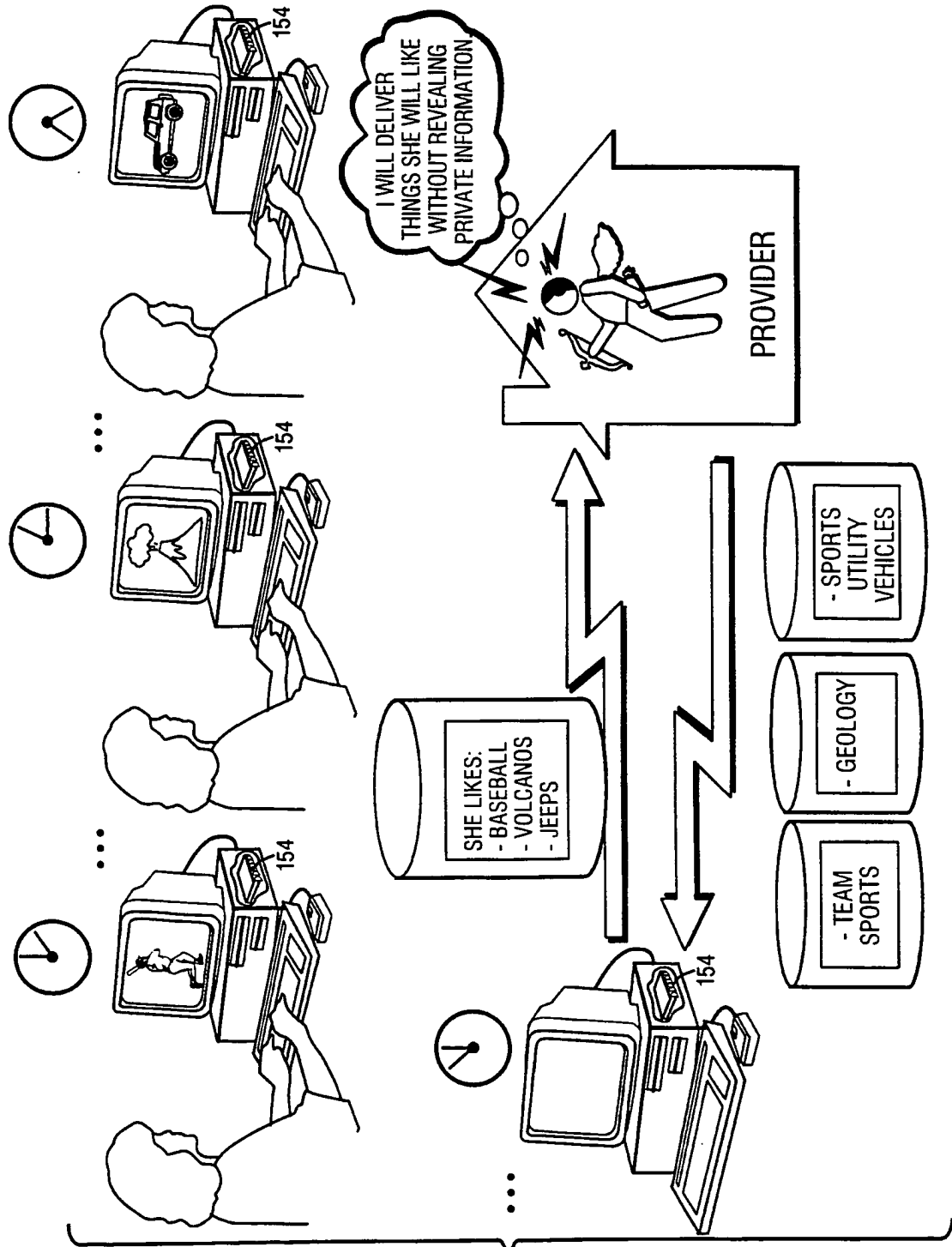

**Fig. 10**  
Example Electronic  
Matchmaking Process

**Fig. 11** Example User Rights Management Information  
By Electronic Matchmaker

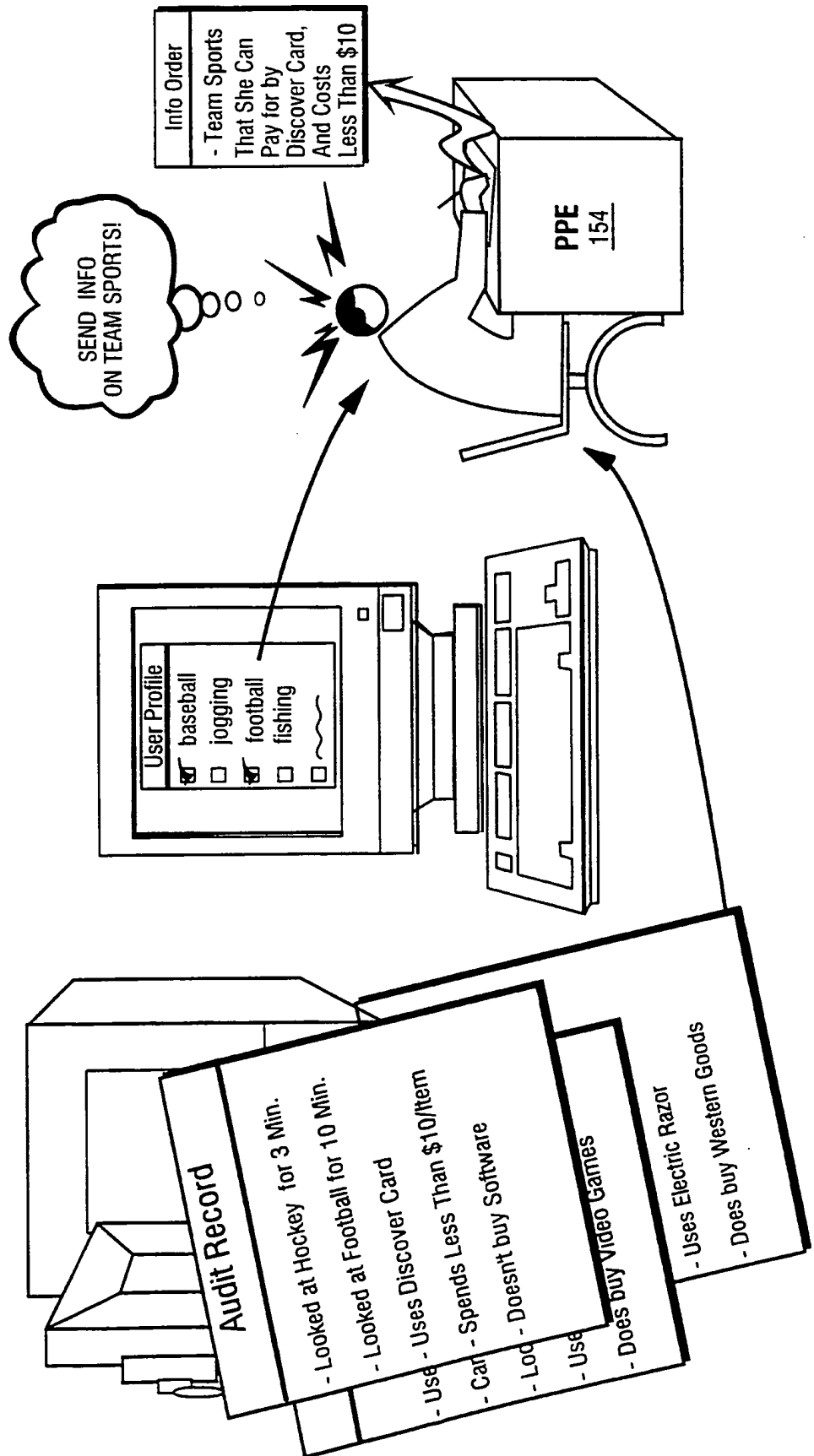

SUBSTITUTE SHEET (RULE 26)

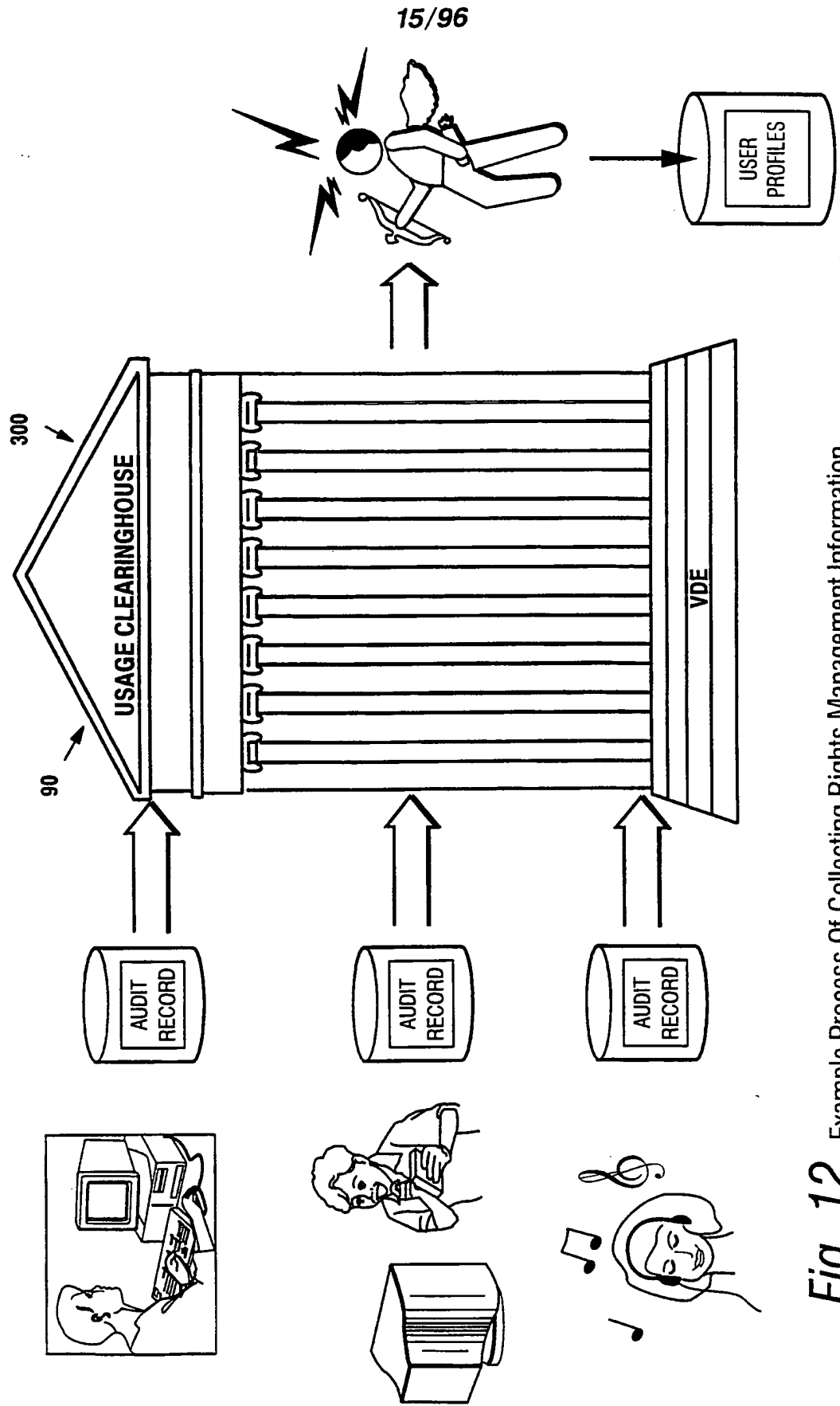

Fig. 12 Example Process Of Collecting Rights Management Information

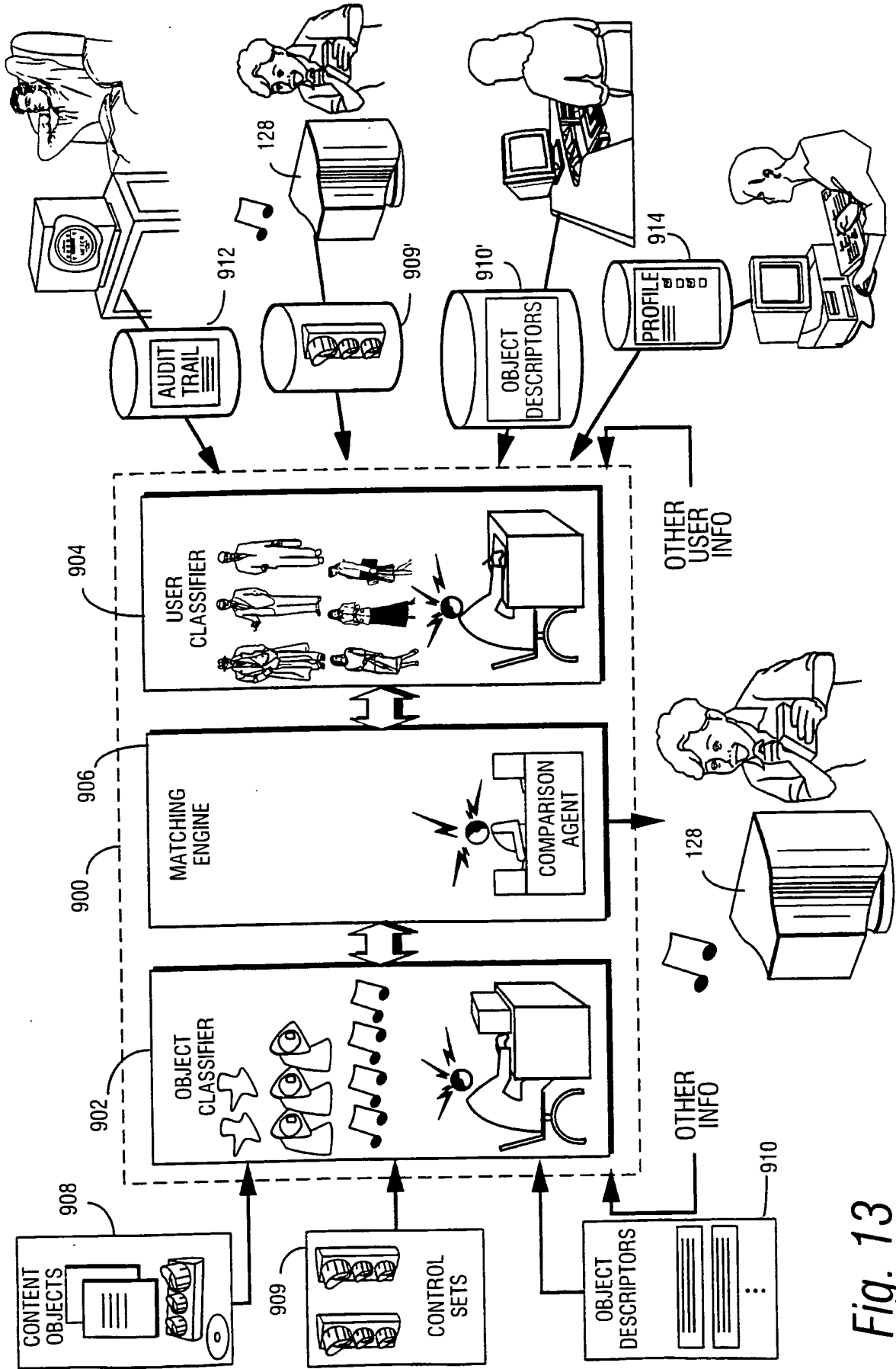

Fig. 13

SUBSTITUTE SHEET (RULE 26)

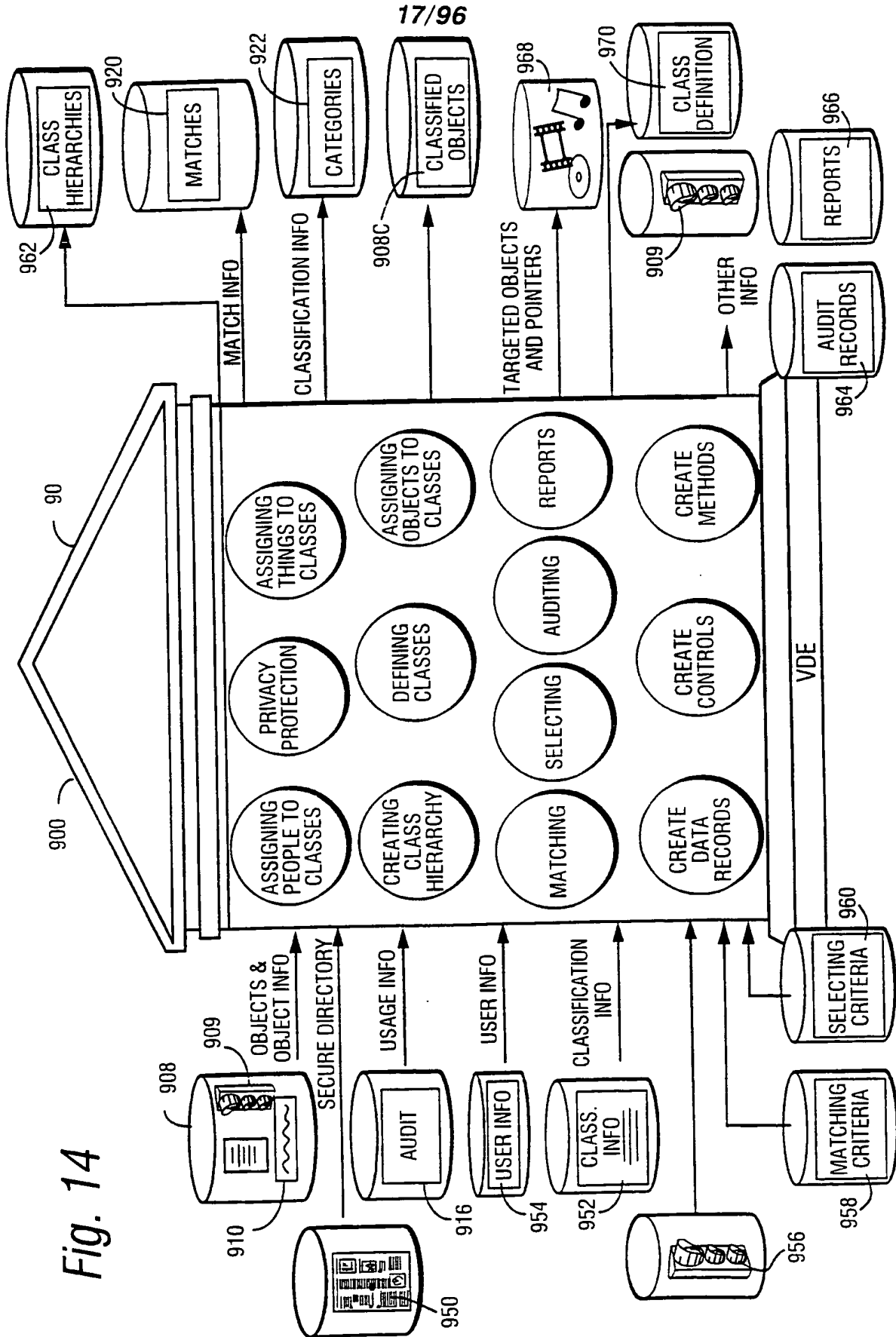
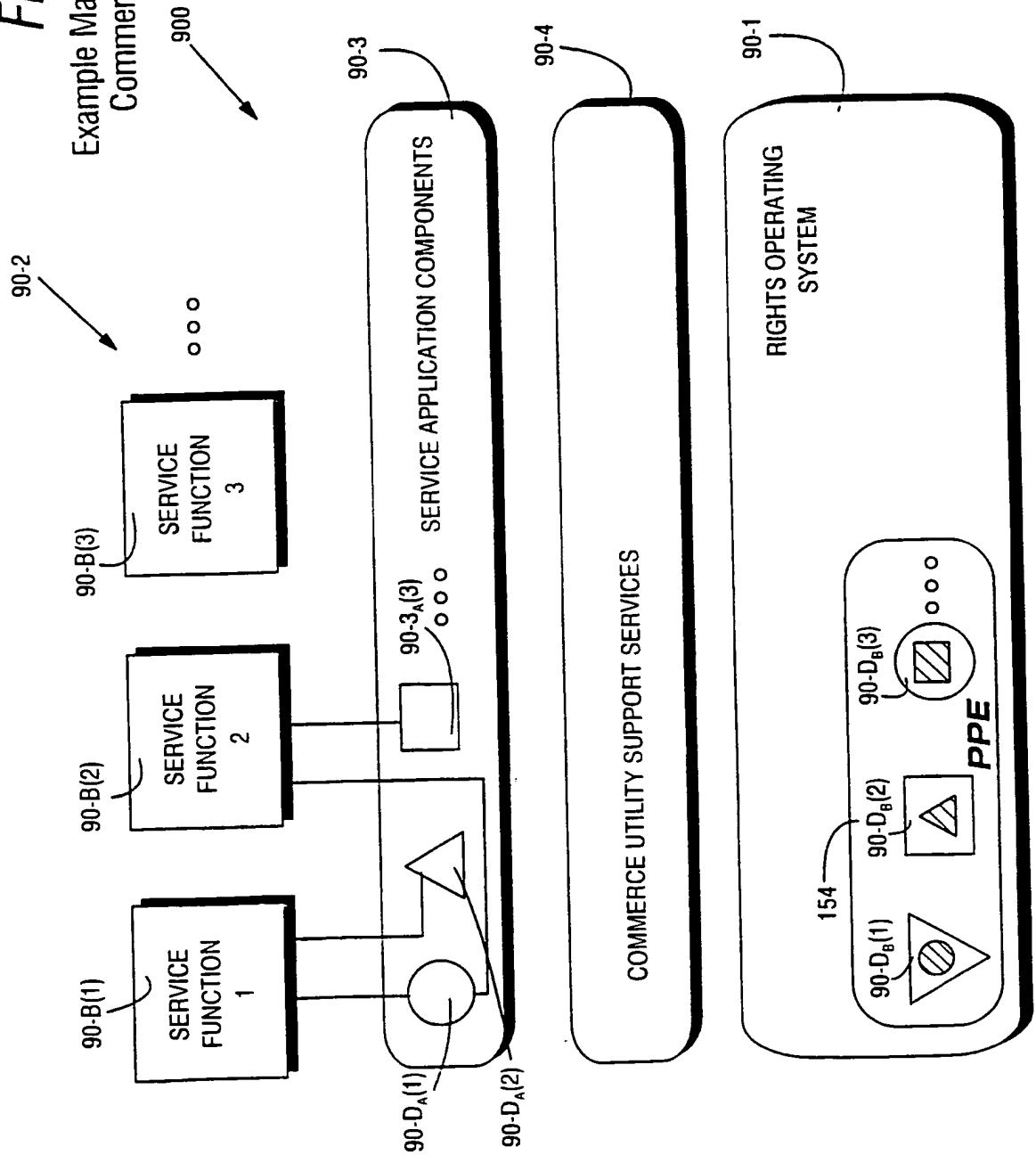

Fig. 14

Fig. 14(A)  
Example Matching and Classification  
Commerce Utility System 900



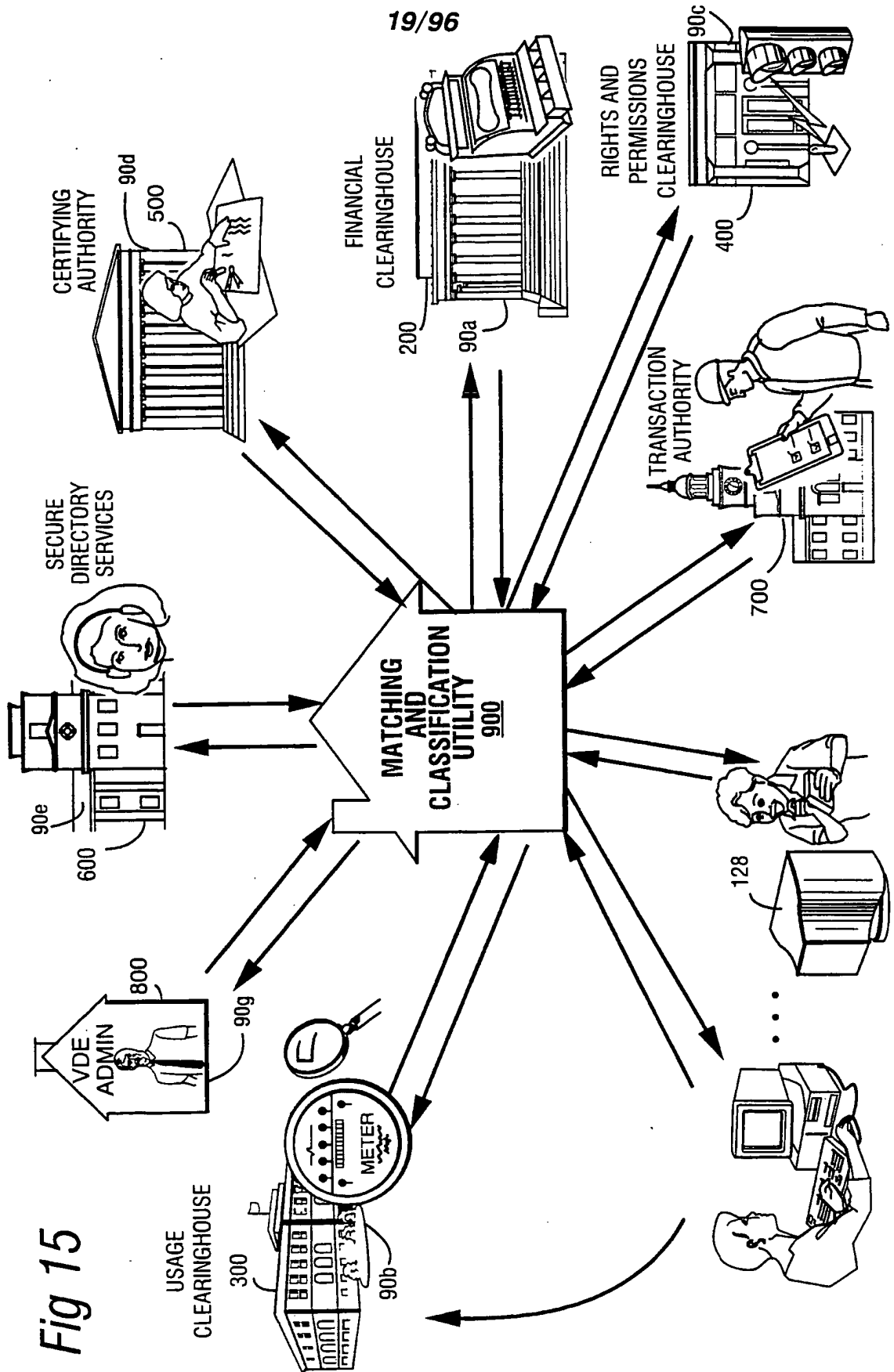

Fig 15

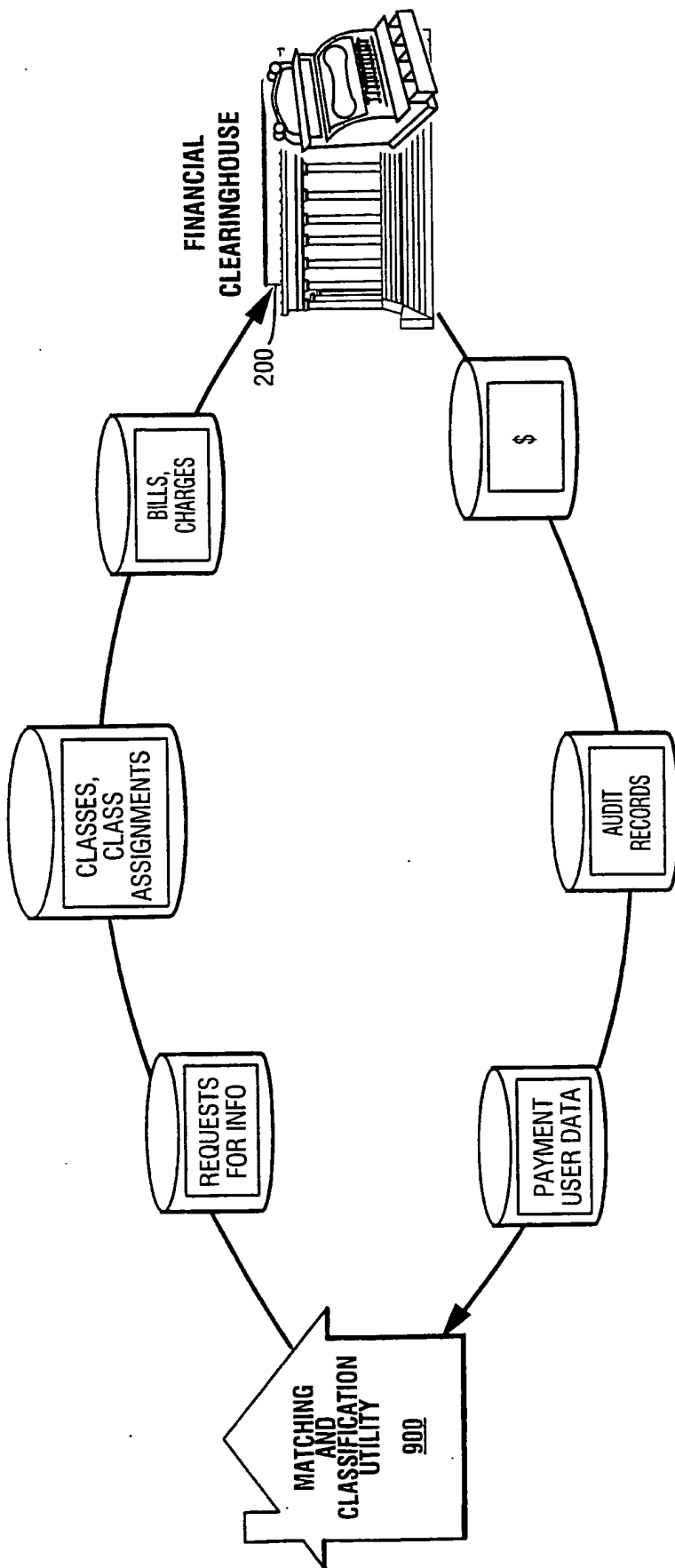
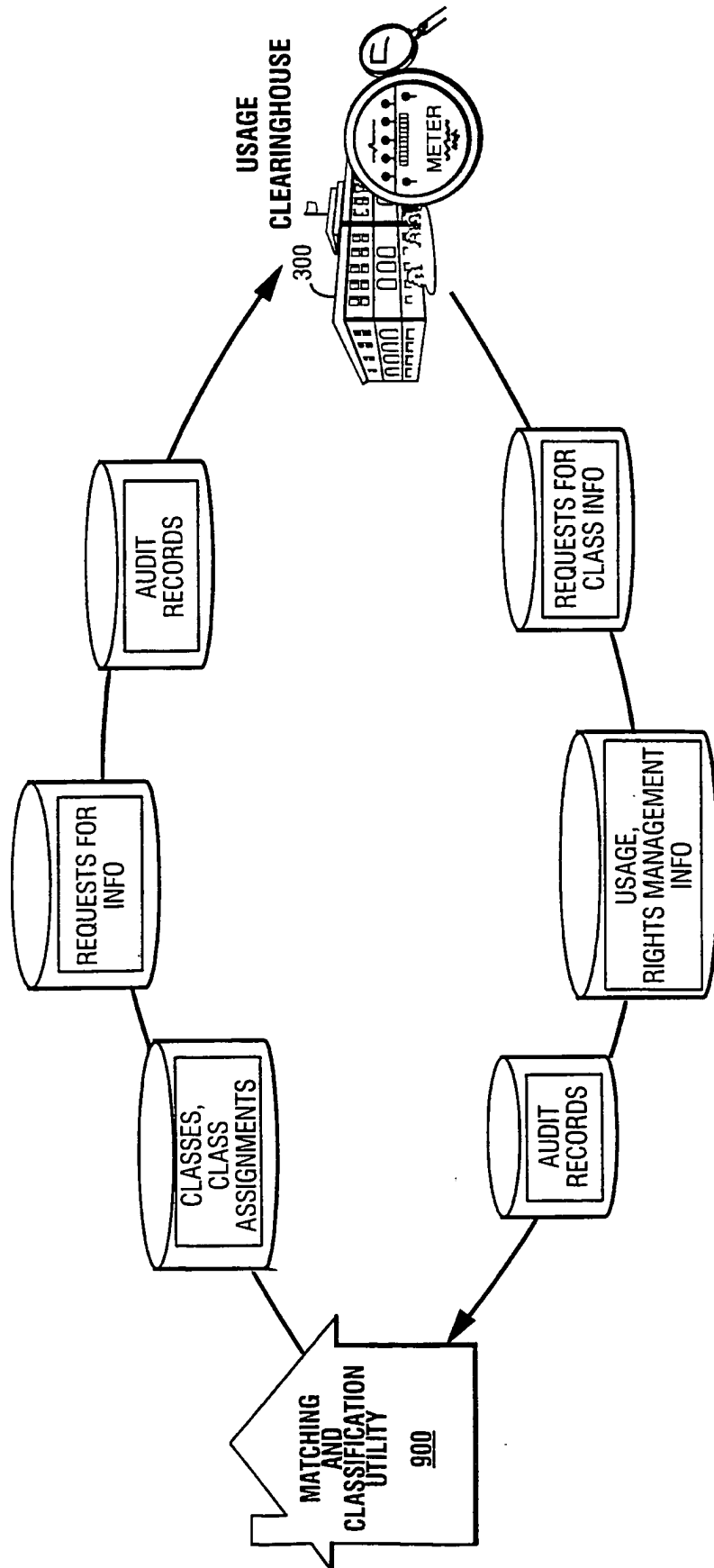

Fig. 15A



Fig. 15B



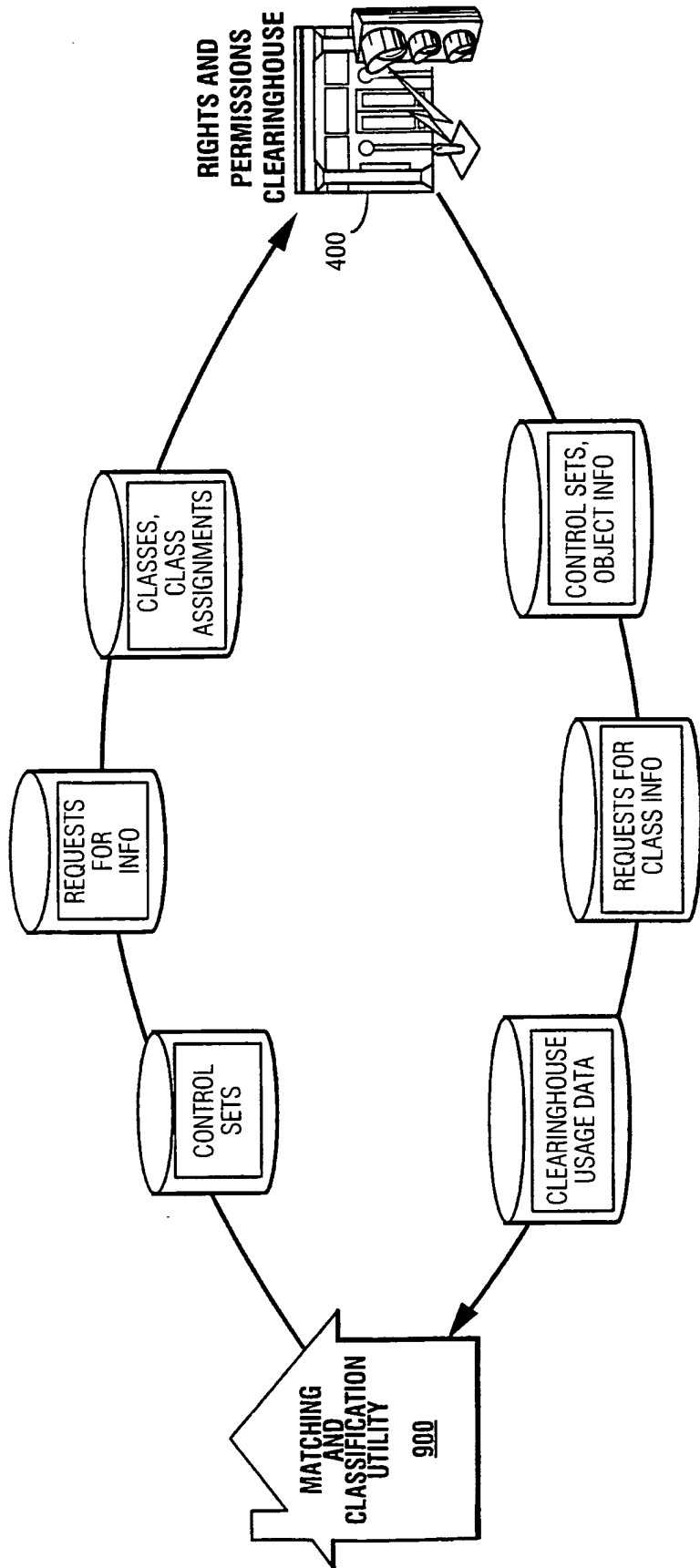
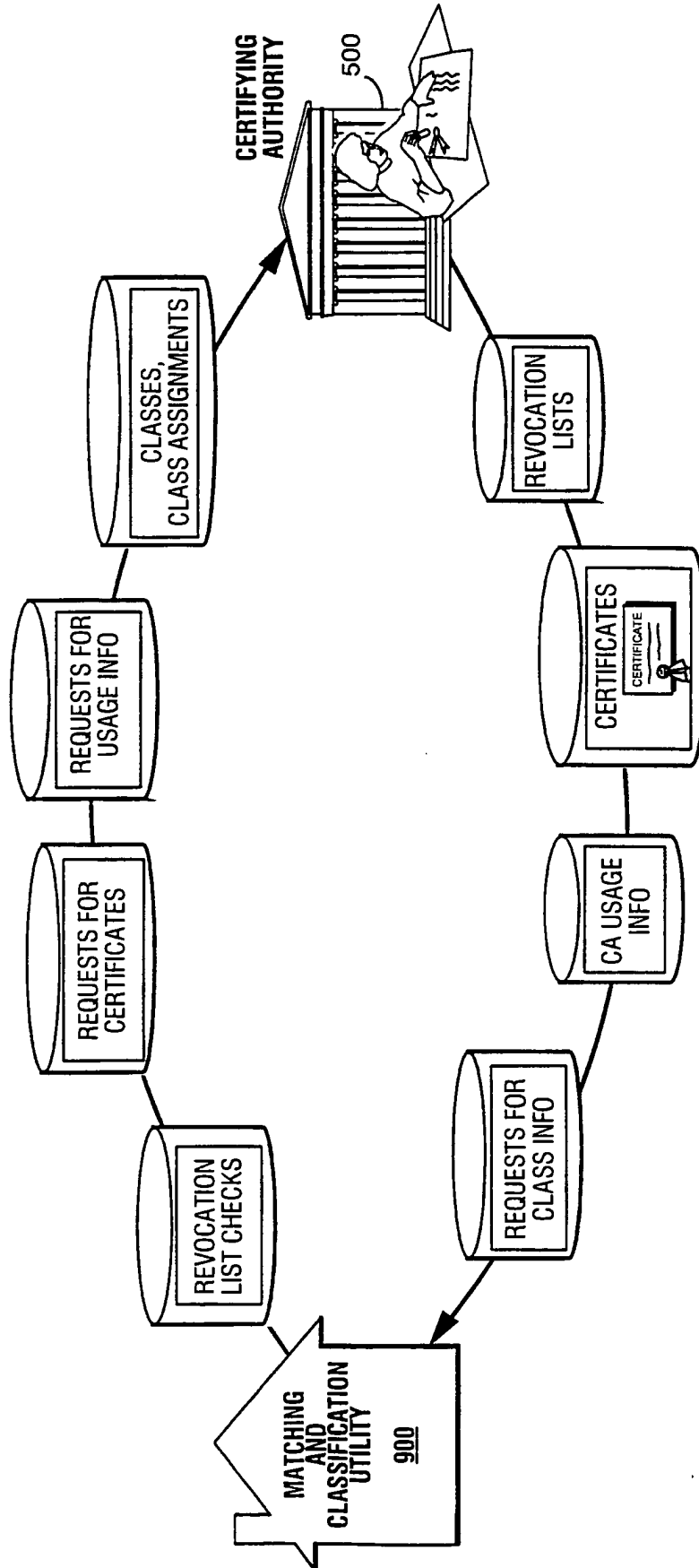

Fig. 15C

Fig. 15D



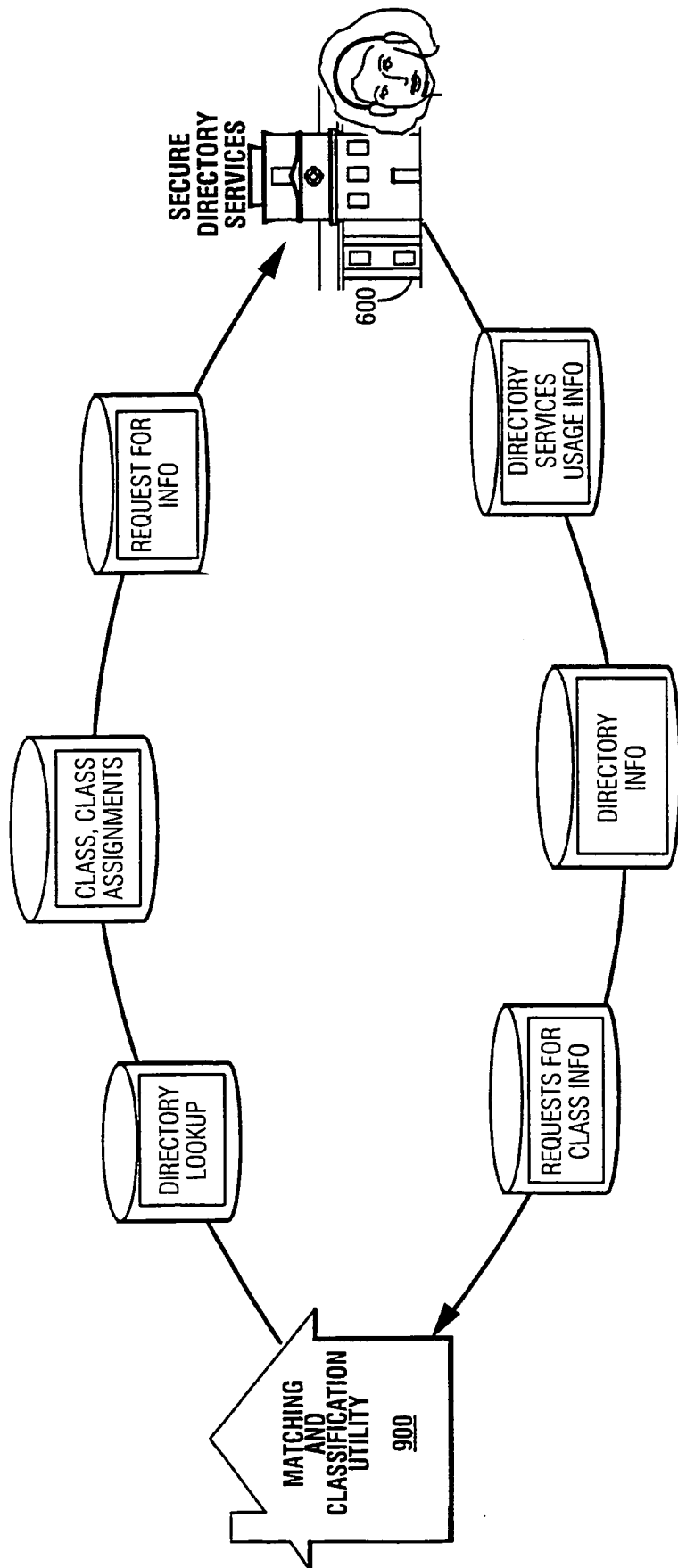
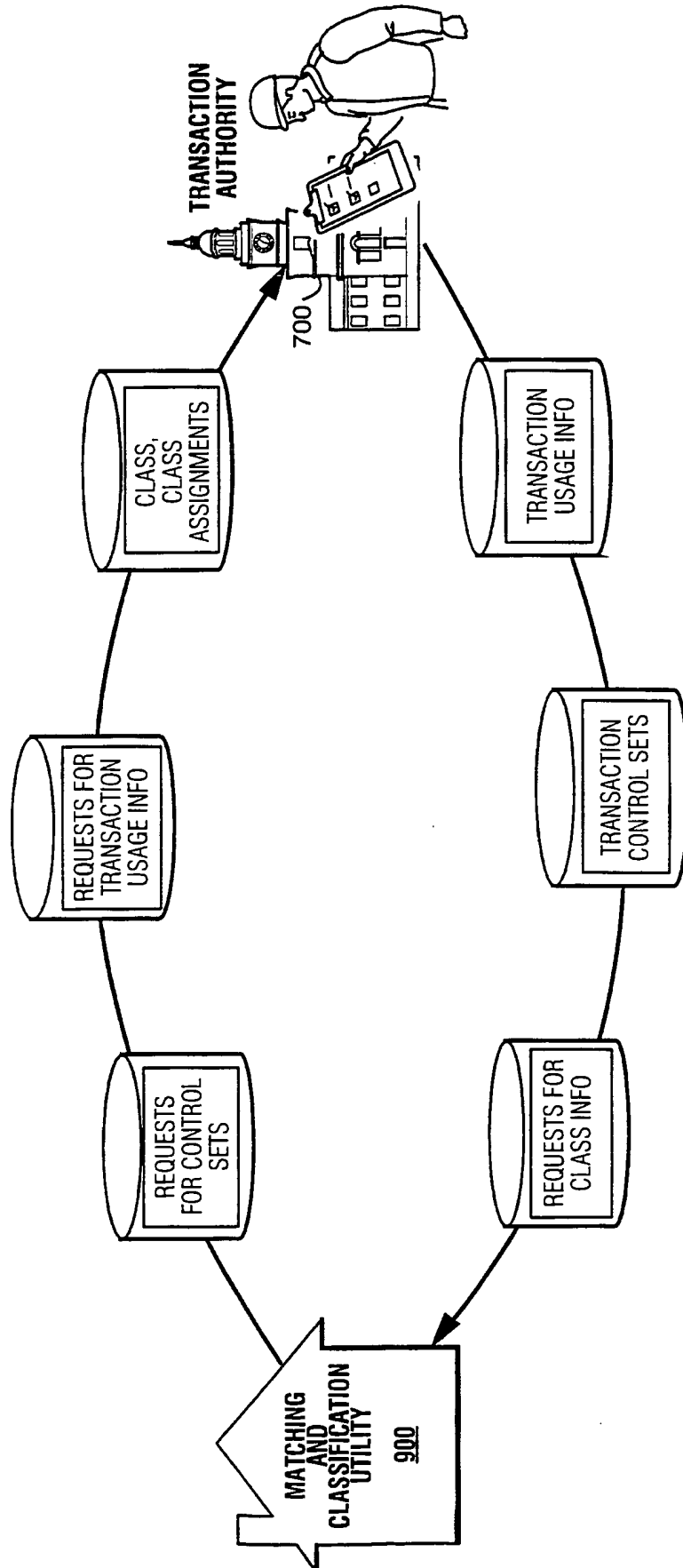

Fig. 15E

Fig. 15F



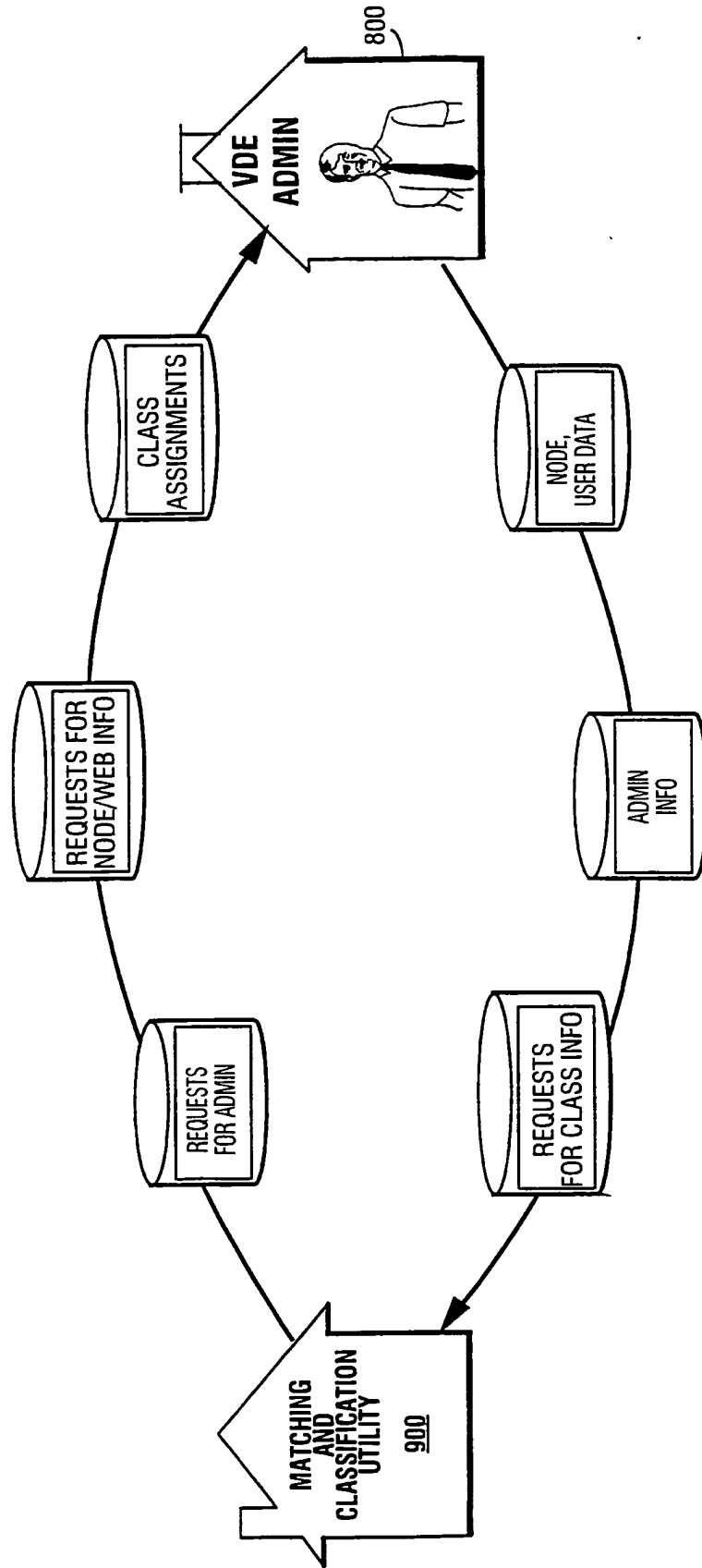

Fig. 15G

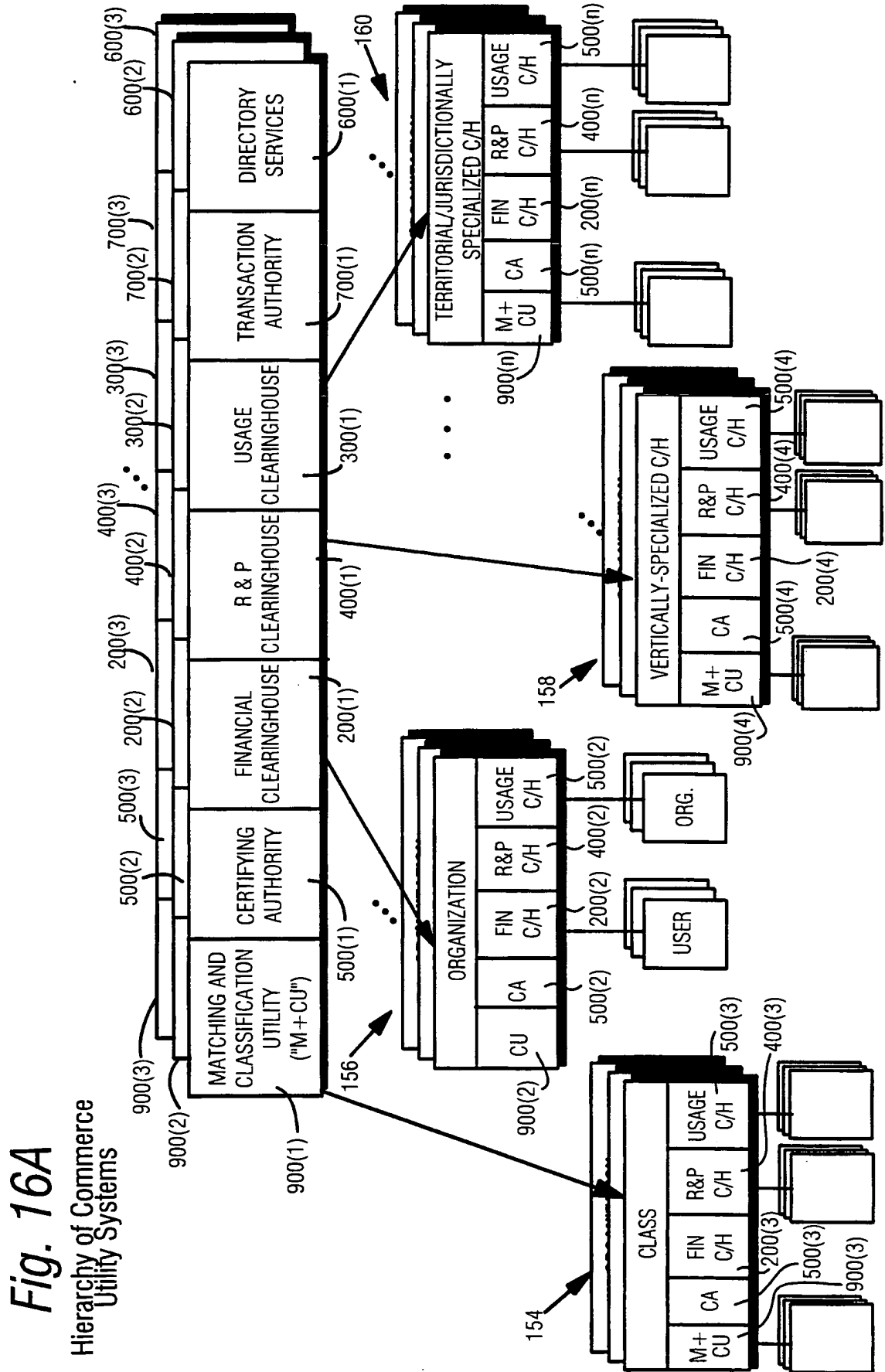
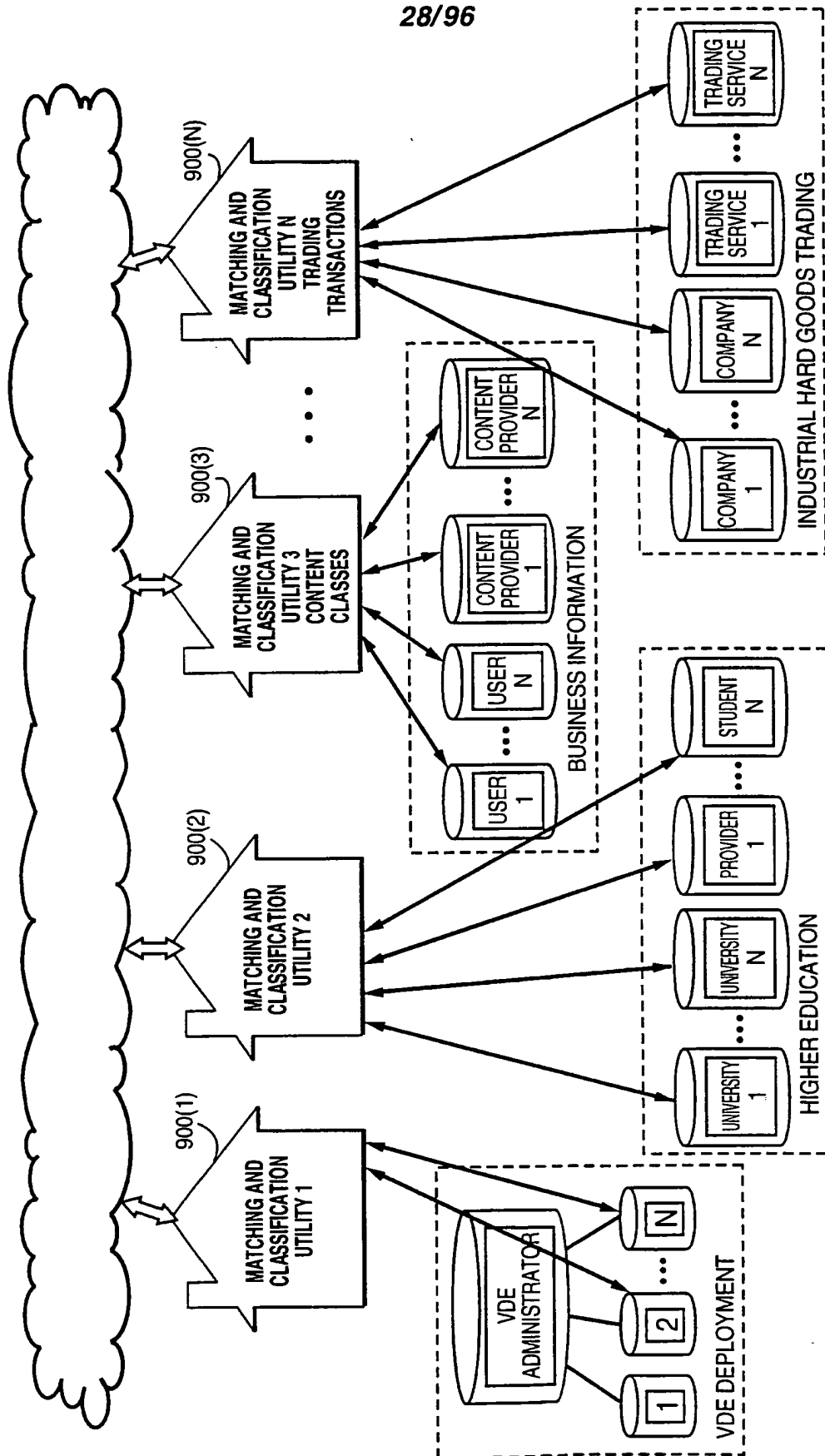

Fig. 16A  
Hierarchy of Commerce  
Utility Systems

28/96



**Fig. 16B** Matching & Classification Utilities Provide Services To Classes Of Nodes, Users, Content Services, Transaction Services.



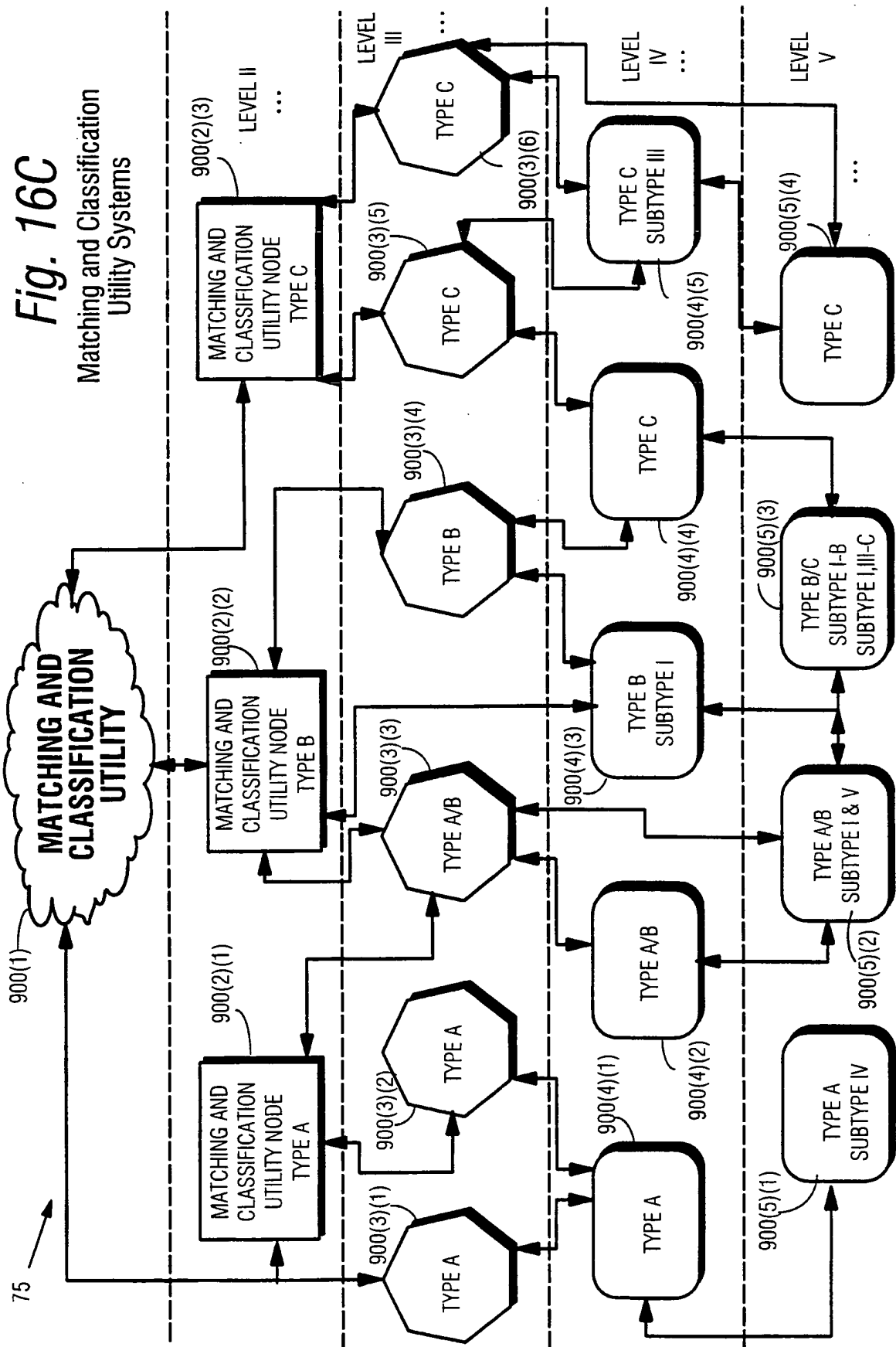

90B

Fig. 17

FINANCIAL CLEARINGHOUSE	USAGE CLEARINGHOUSE	RIGHTS & PERMISSIONS CLEARINGHOUSE	CERTIFICATE AUTHORITY	SECURE DIRECTORY SERVICES	TANGIBLES & PURCHASE & FULFILLMENT	INTANGIBLES & PURCHASE & FULFILLMENT	CONTRACT NEGOTIATIONS & EXECUTION	EDI	SECURE DOCUMENT DELIVERY	BUSINESS PROCESS INTEGRATION	ARBITRATION & MEDIATION	ELECTRONIC ORDERS	ELECTRONIC BANKING & CURRENCY MANAGEMENT	CYBERSPACE TRADING ENVIRONMENTS	CLASSIFICATION UTILITY	...
AUDIT BY CLASS		MAINTAINING RECORDS	STATUS NOTIFICATION	EVENT DATABASE MANAGEMENT	CONTROL SET DATABASE MGMT	NOTARY	OBJECT REGISTRY	CERTIFICATE CREATION	...	...	...	...	...	...	...	...
OVERSEEING PROCESS	CONFIRMATIONS	ROUTING DATABASE	GENERATE CONTROL SETS	SEAL GENERATOR	OBJECT IDENTIFIER ASSIGNMENT	REVOCATION LIST MAINTENANCE	...	...	...	...	...	...	...	...	...	...
MONITORING STATUS	UNCOMPLETED EVENTS RECORD	GENERATING REQUESTS	PROCESS CONTROL LOGIC	DIGITAL TIME STAMP	COPYRIGHT REGISTRATION	...	...	...	...	...	...	...	...	...	...	...
COMPLETE PROCESS DEFINITION	REQUIREMENTS GENERATION	REPLICATION	EVENT FLOW GENERATION	FINGERPRINT /WATERMARK	CONTROL SET REGISTRY	...	...	...	...	...	...	...	...	...	...	...
PROCESS CONTROL	REPORT GENERATION	PROPAGATION	ROUTING	OFFERS & COUNTER OFFERS	TEMPLATE REGISTRY	DIRECTOR DATABASE MANAGEMENT	...	...	...	...	...	...	...	...	...	...
INTERFACE(S) TO SETTLEMENT SERVICES	FUNDS TRANSFER	EVENT CONSEQUENCES	USAGE DATABASE MANAGEMENT	ARCHIVE	DATABASE QUERY & RESPONSE PROCESSING	...	...	...	...	...	...	...	...	...	...	...
CURRENCY CONVERSION	TAX CALCULATION & APPLICATION	ACCOUNT RECONCILIATION	BILL CREATION & PROCESSING	RIGHTS & PERMISSION DATABASE MANAGEMENT	ADVERTISING DATABASE MANAGEMENT	...	...	...	...	...	...	...	...	...	...	...
ACCOUNT CREATION & IDENTIFIER ASSIGNMENT	PAYMENT AGGREGATION	IDENTITY AUTHENTICATION	MARKET RESEARCH	TEMPLATE DATABASE MANAGEMENT	AUTOMATIC CLASS GENERATION	AUTOMATIC CLASS MATCHING	...	...	...	...	...	...	...	...	...	...
PAYMENT DISAGGREGATION	BUDGET PRE-AUTHORIZATION	ELECTRONIC CURRENCY CREATION	NEGOTIATION	COMMERCE MGMT LANGUAGE PROCESSING	AUTOMATIC CLASS ASSIGNMENT	CLASS-BASED SEARCHING	...	...	...	...	...	...	...	...	...	...
...	...	...	RIGHTS MANAGEMENT LANGUAGE PROCESSING	...	...	CLASS-BASED DIRECTORY	...	...	...	...	...	...	...	...	...	...

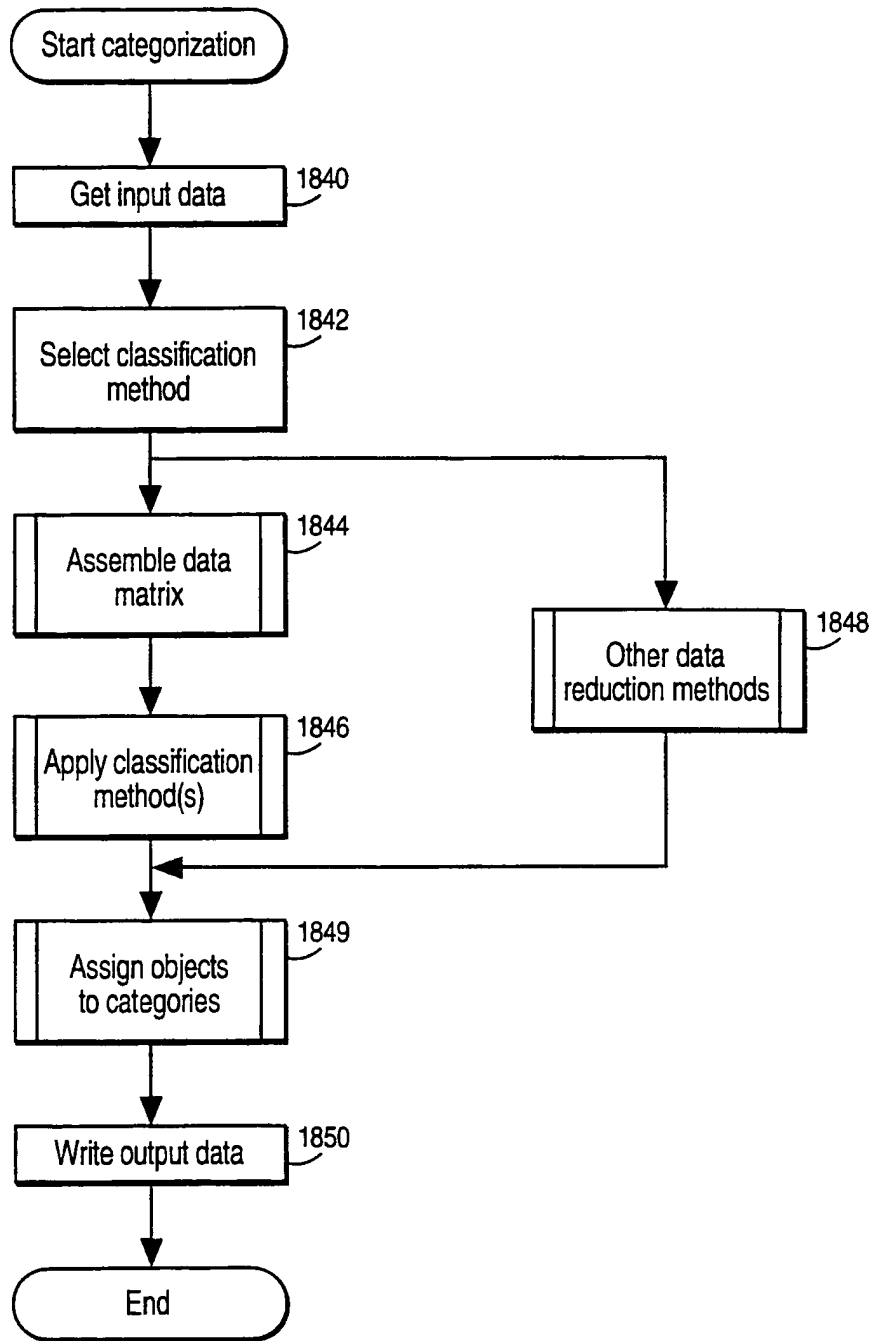

**Fig. 18**

Example Steps to Categorize Objects

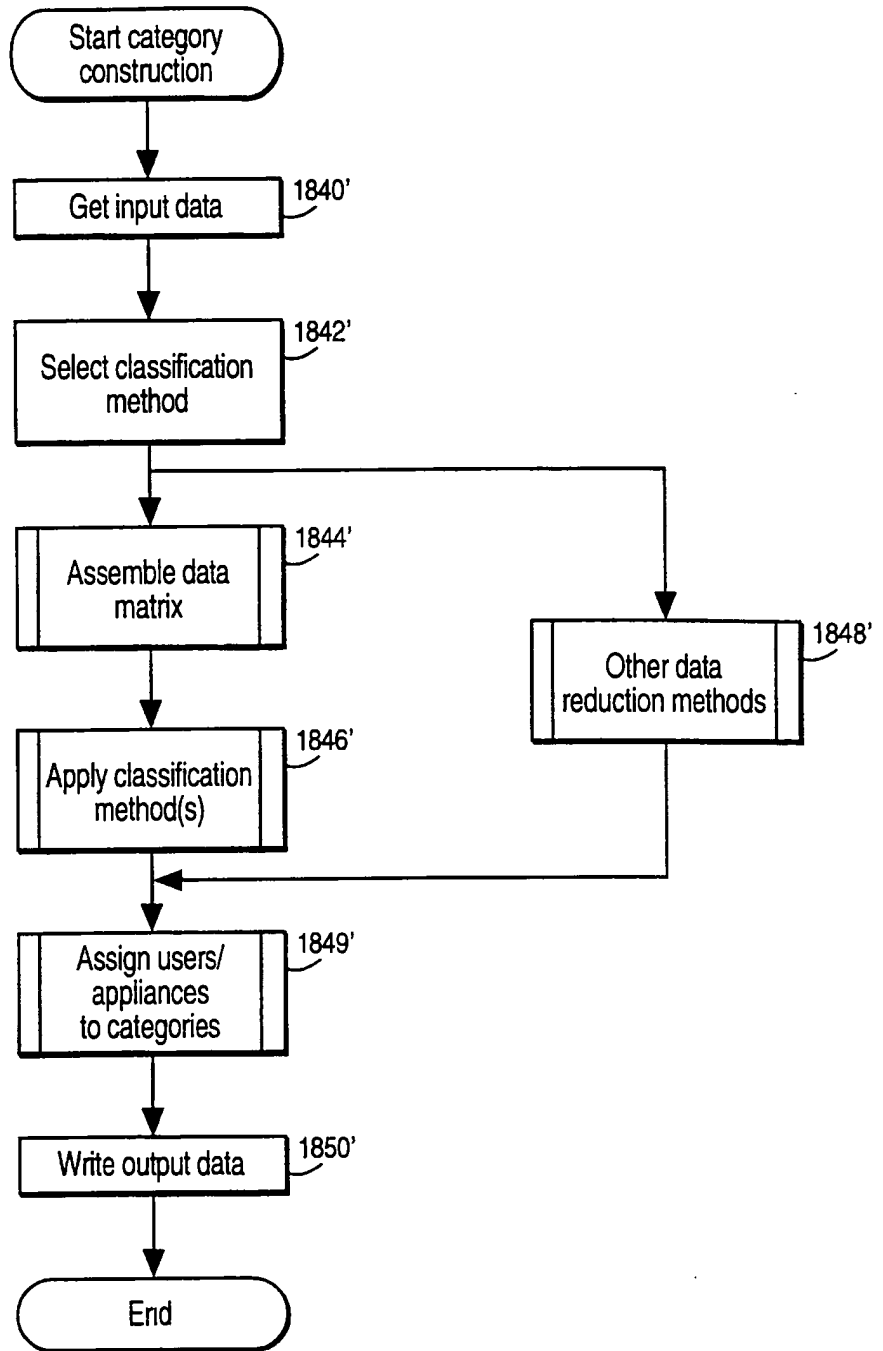

*Fig. 19*

Example Steps to Categorize Users/Appliances

Node ID	Operating system	Country	State	VDE Adm. Org.	VDE version	VDE maintenance level	User ID number	Gender	Age	Highest edu. level	Citizenship	Country of residence	City
128.1.4.132	WIN95	USA	CA	VDEADM	1.5	02	FF98C48A	Female	32	14	UK	UK	London

1852

User ID	Myers-Briggs Categories				SRI internet iVALS category
	Extroversion or introversion	Sensing or intuition	Thinking or feeling	Judging or perceiving	
FF98C48A	I	N	T	J	Worker

33/96

**Fig. 20**  
Example Composite Record-Input To Classification Process

User ID number	Object ID	Right ID	Method	Right ID	Method	Right ID	Method
CF129CD5	1227-33-1298-2	Use	Open	Meter	Each time	Budget	Simple purchase
.....	.....	.....	.....	.....	.....	.....	.....
.....	.....	.....	.....	.....	.....	.....	.....

34/96

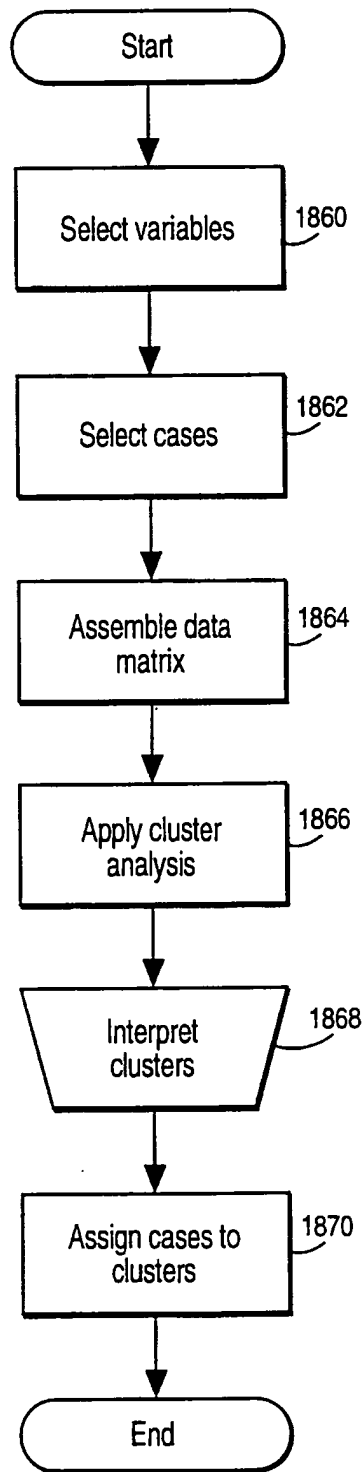

*Fig. 21*

Example Cluster Analysis Process

35/96

Variables	Typical Class 1-Profile	Typical Class 2-Profile
City	Washington, DC	Knoxville, TN
Av. price of content purchased last 30 days	\$8.79	\$1.95
Number of trips abroad in last 2 years	3	0
Type of content most frequently purchased	National and international news	Sports
2nd most frequently purchased	Business information	Religious
Third most frequently purchased	Travel information	Movies
Pay per view	No	Yes
Add new controls to content	Yes	No
Stated religious affiliation	None	Methodist
SRI internet lifestyle category	Surfer	Worker
Modification rights purchased	20% of text items	5% of text items

**Fig. 22** Example Classification Output Illustrating Different Classes Based Upon Differing Profiles

Variables	Factor 1 Loadings	Factor 2 Loadings
Region of US	.82	.11
Family income	.90	-.09
Av. price of content purchased last 30 days	.72	.15
Number of trips abroad in last 2 years	.91	.09
Percent news, business	.79	-.12
Percent entertainment	-.69	.21
Add new controls to content	.88	.19
Religiosity	-.60	-.22
Participates in sports	-.21	.87
Watches team/individual sports on TV	-.11	.62
Owens a sports utility vehicle	.12	.72
Consumes beer/wine	-.18	.83
Male/female	.21	.92
Education beyond college	.45	-.45
Buys pay per view sports events	-.25	.77
Number of TVs in house	-.11	.66

**Fig. 23** Example Classification Output Illustrating Principal Components Analysis On Parameter Data And Categories Data



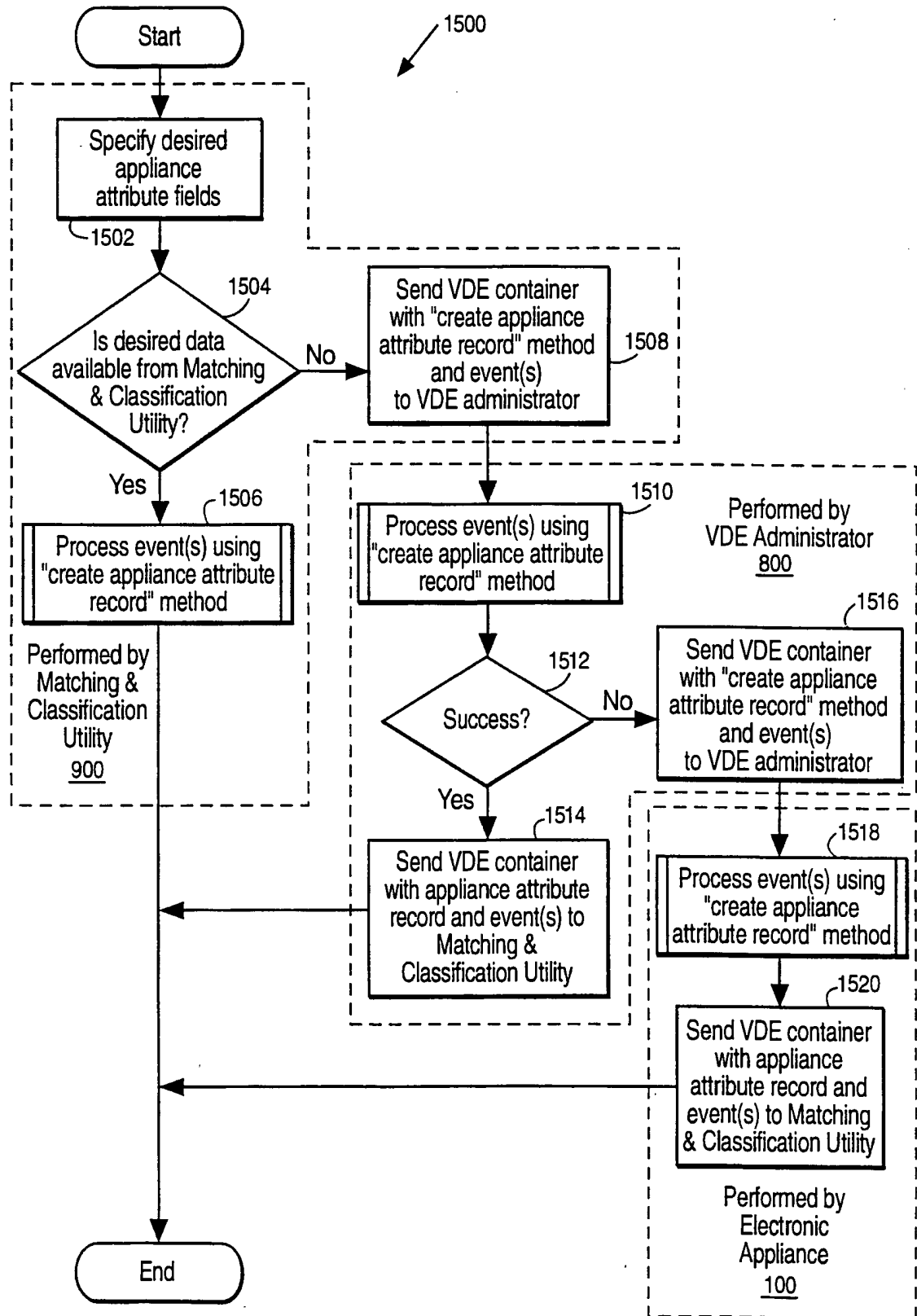

**Fig. 24**

Example Steps for Collecting Appliance Attribute Data

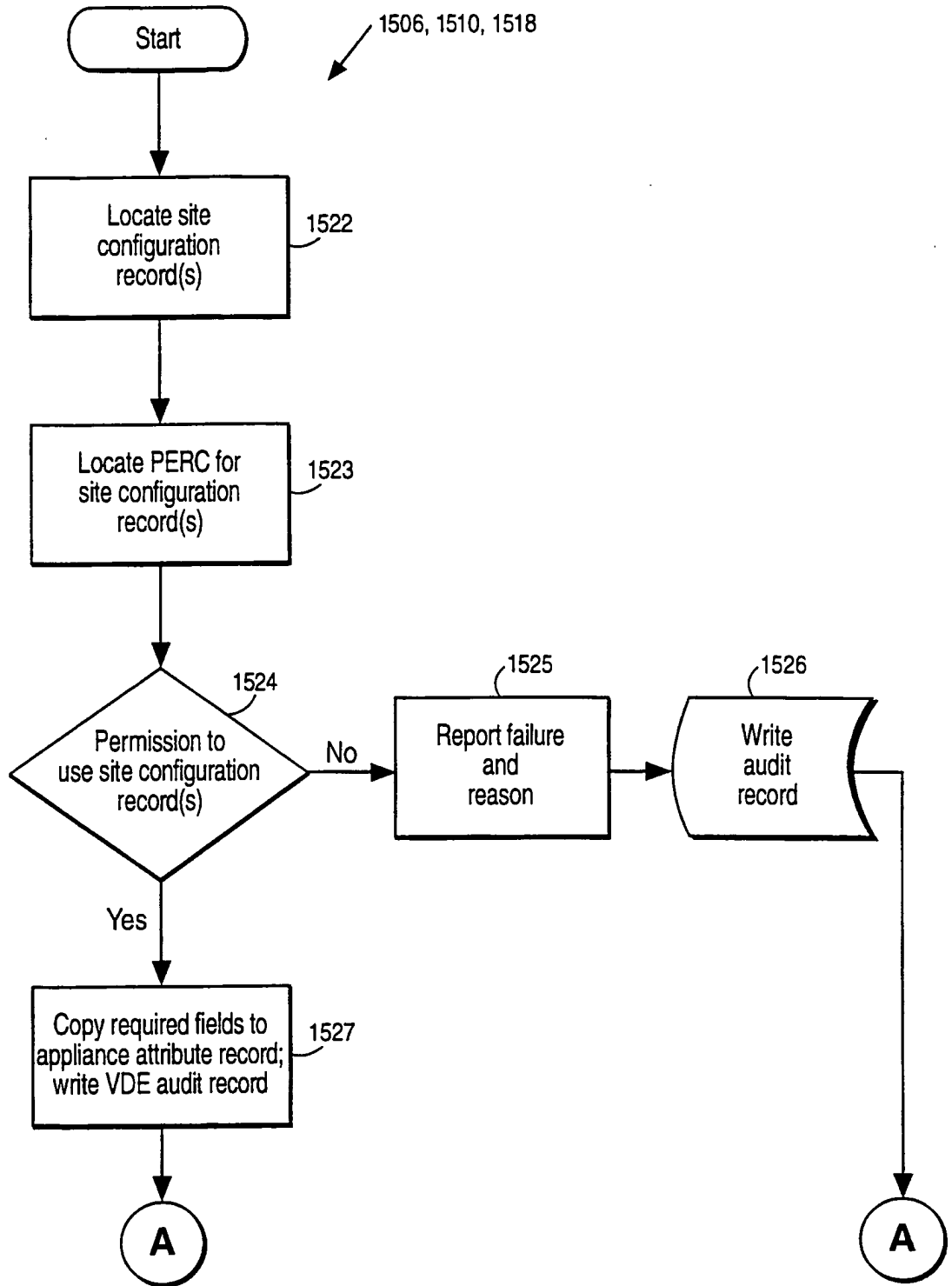
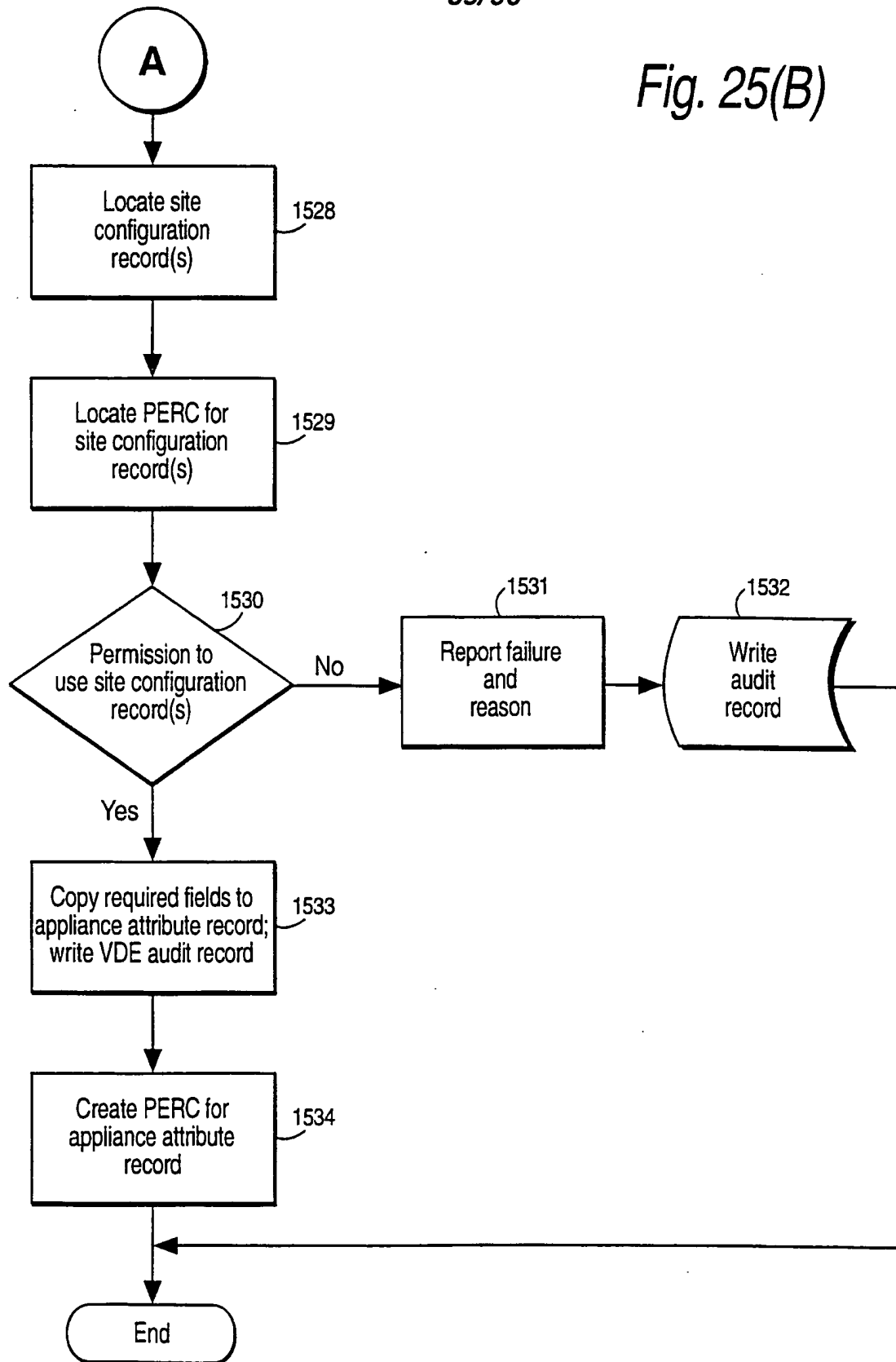

*Fig. 25(A)*

Example Create Appliance Attribute Data Method steps

39/96

Fig. 25(B)



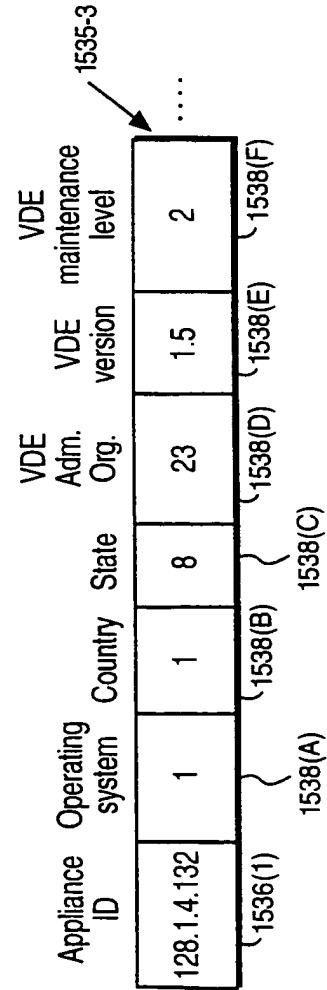
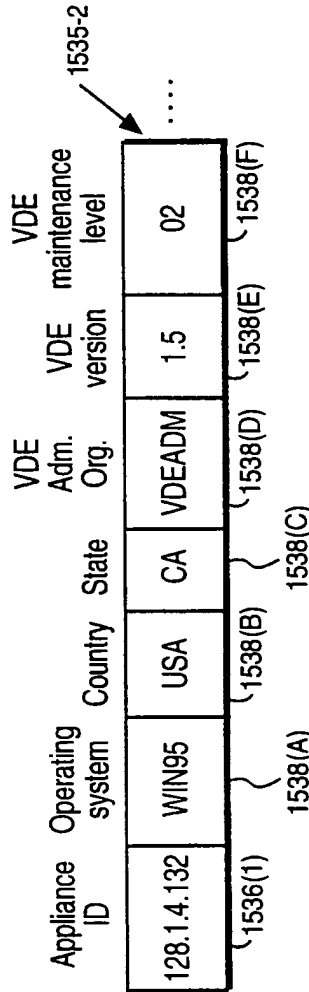
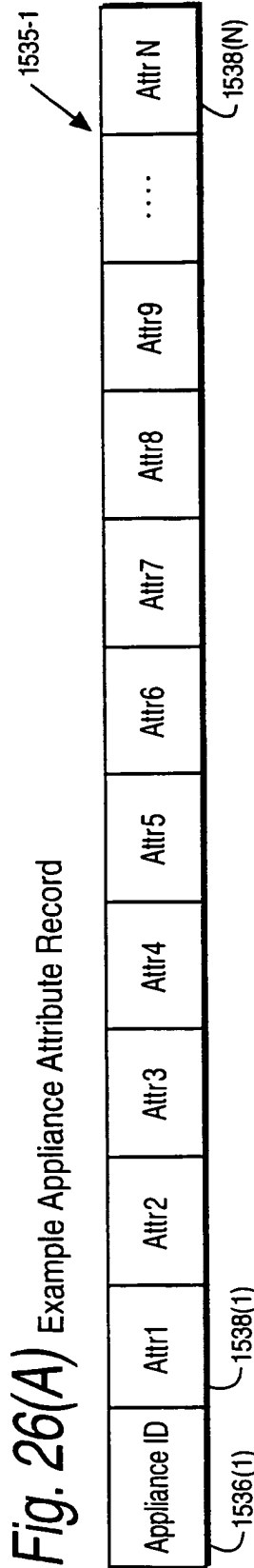

**Fig. 26(C)**  
Example Appliance Attribute Record

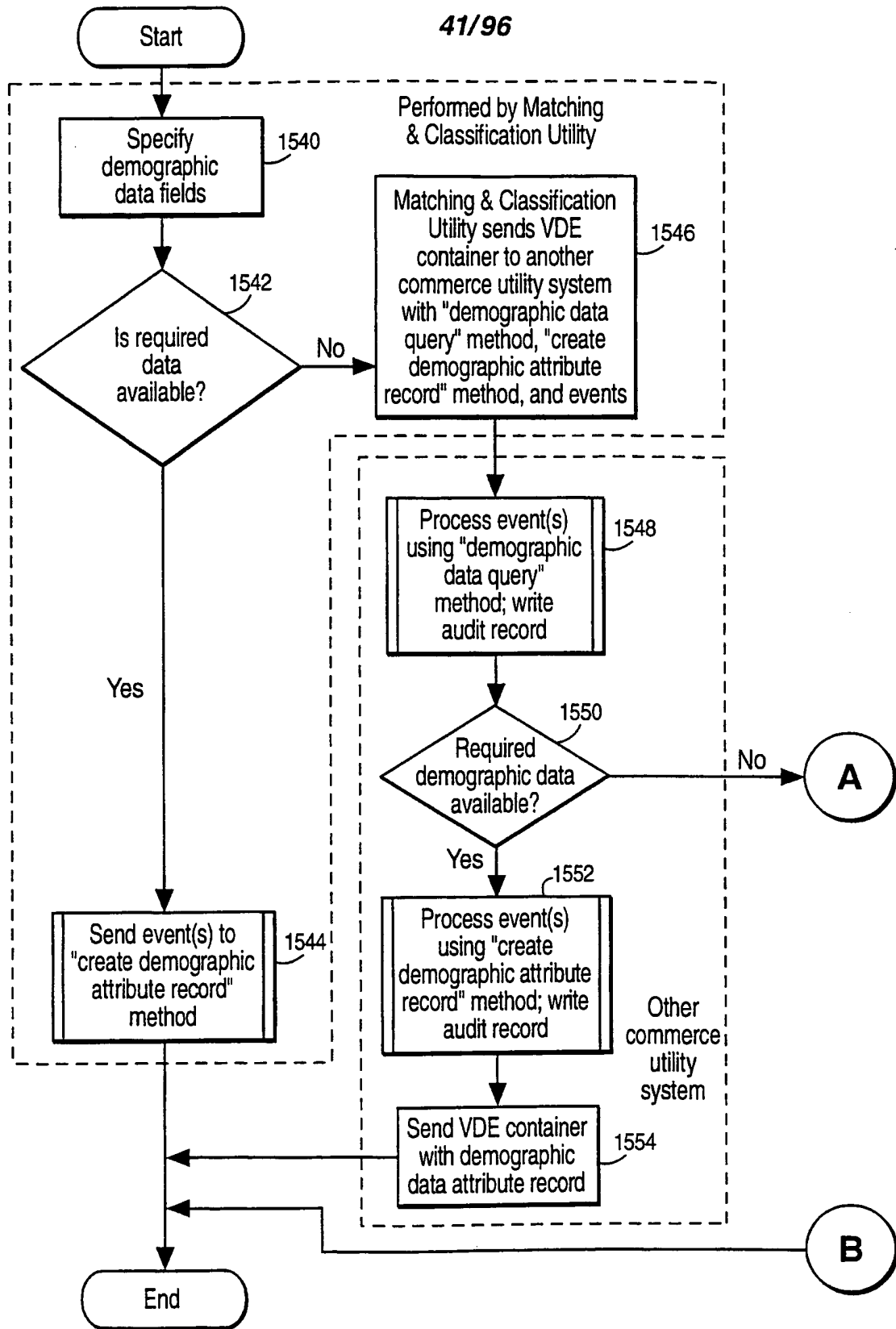

**Fig. 27(A)** Example Steps for Collecting Demographic Data

42/96

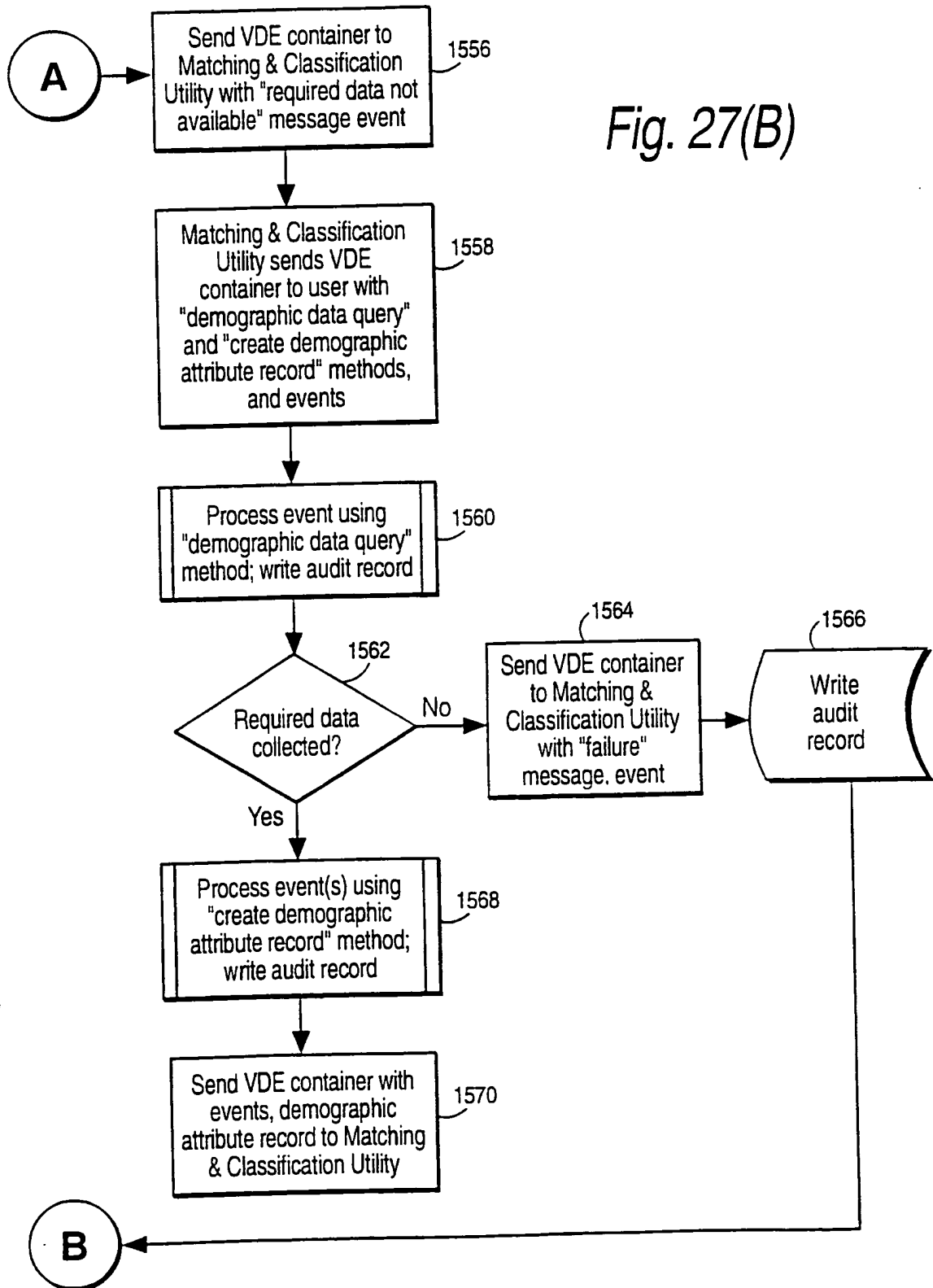

Fig. 27(B)

**Demographic Information Questionnaire**

Name: \_\_\_\_\_

Address: \_\_\_\_\_

Address: \_\_\_\_\_

City: \_\_\_\_\_ State: \_\_\_\_\_ Zip: \_\_\_\_\_ - \_\_\_\_\_

Gender (M/F) \_\_\_\_\_ Date of birth: \_\_\_\_\_ / \_\_\_\_\_ / \_\_\_\_\_

Education:

- Have not graduated high school
- High school graduate
- Some college
- College degree
- Some graduate school
- Advanced degree

All Information Will Be Treated As Confidential

**Fig. 28** Example Demographic Questionnaire "Pop-Up" Screen

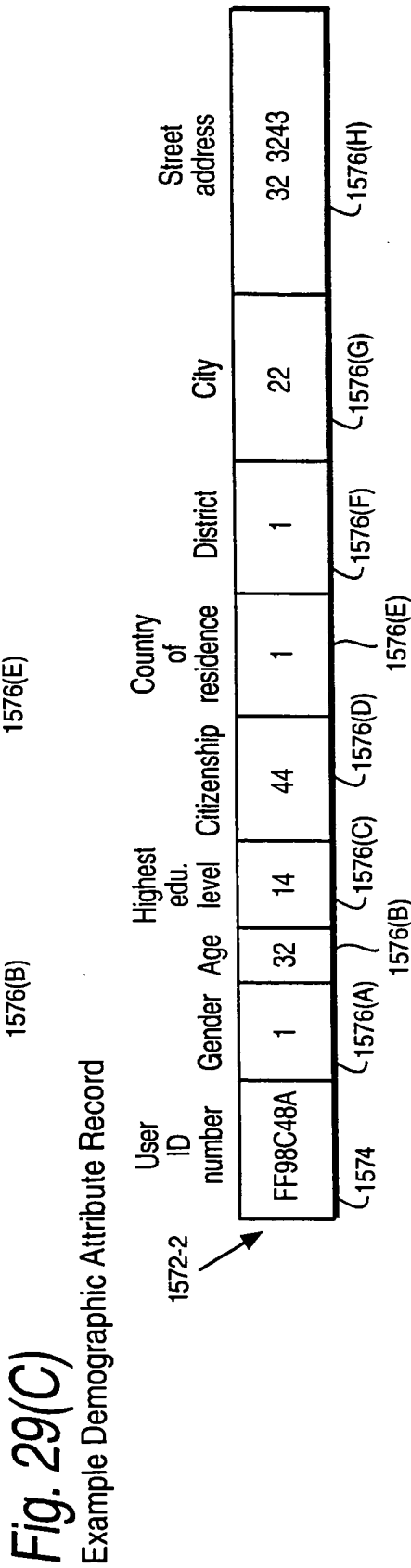
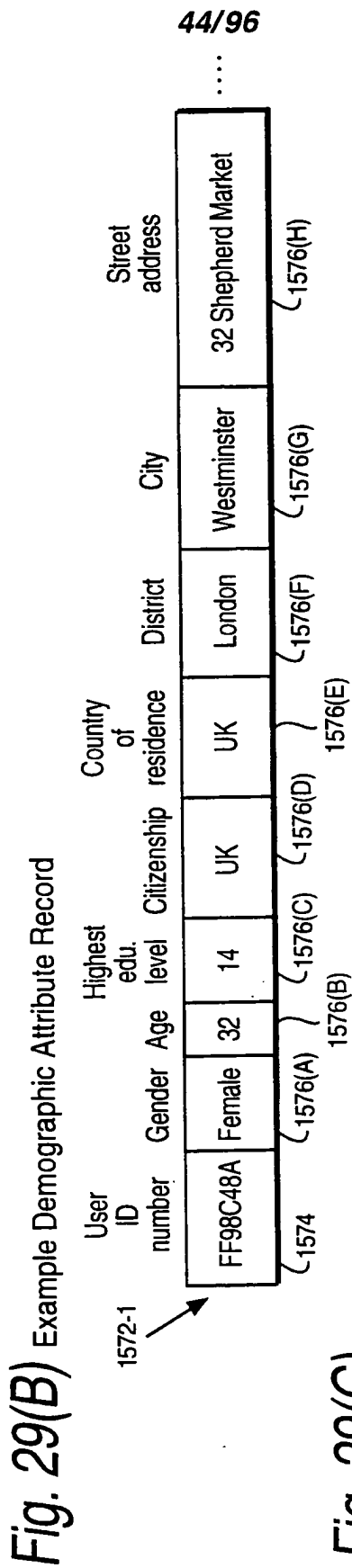
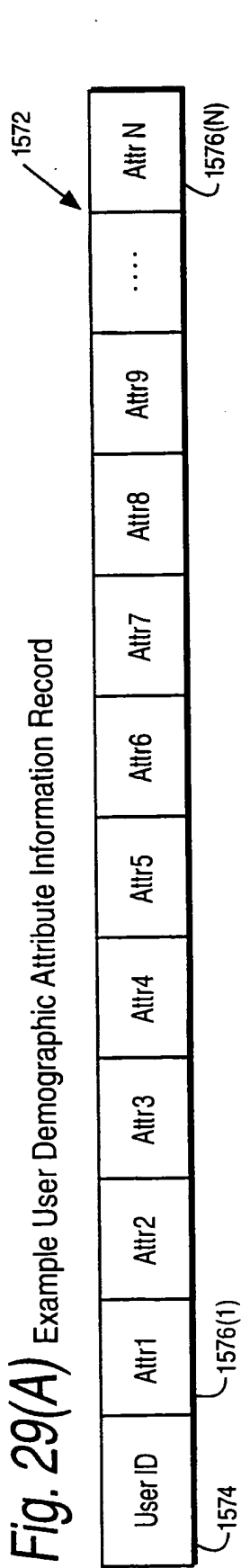



45/96

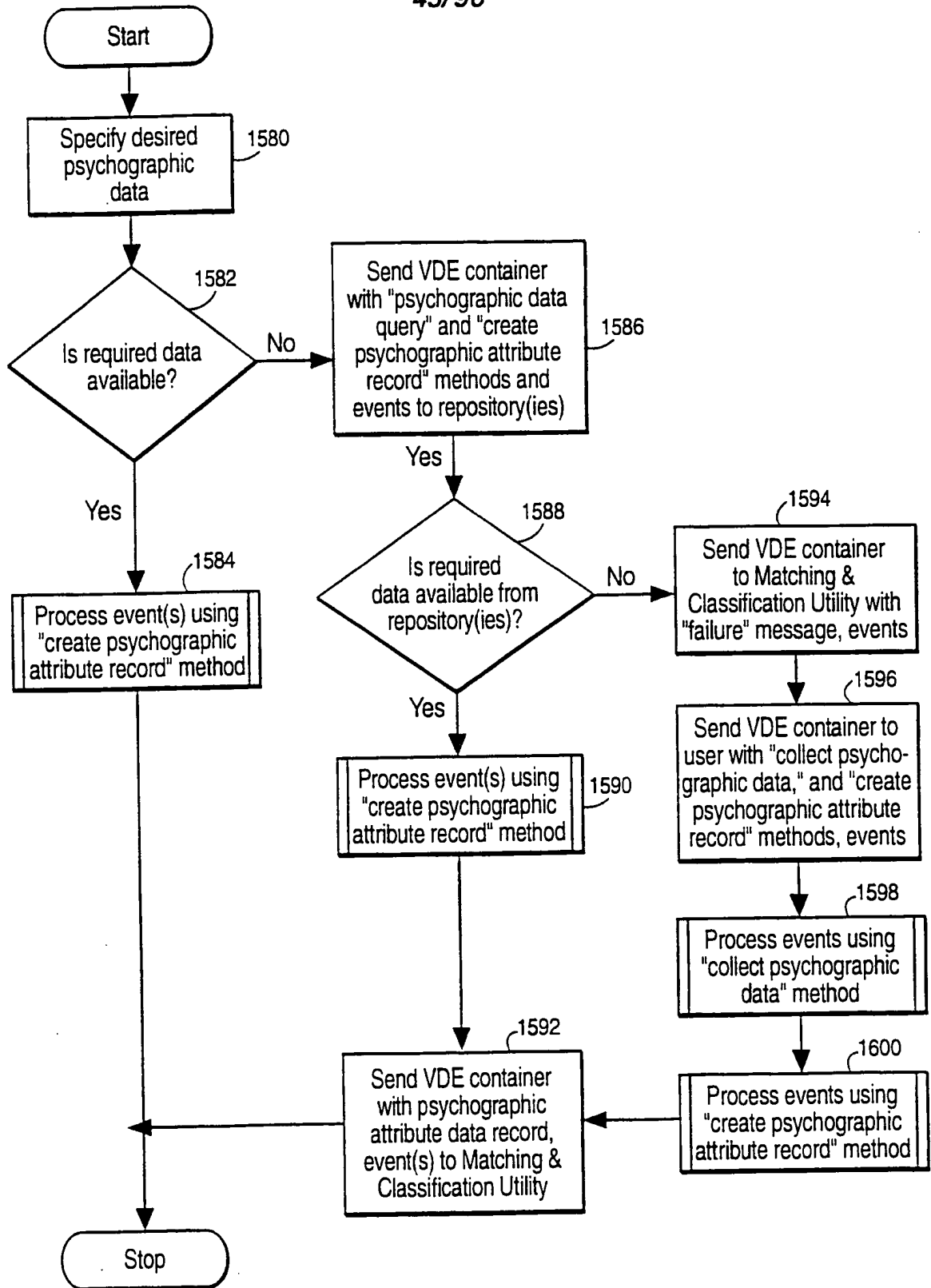

Fig. 30 Example Steps for Collecting Psychographic Data

46/96

**Today's Anonymous Questionnaire**  
**Thanks for taking the time to answer these questions**  
**We'll put \$2.00 in your VDE budget**

1. Do you feel sad, blue, unhappy or "down in the dumps"?

A. Never  
 B. Rarely  
 C. Sometimes  
 D. Very Often  
 E. Most of the time

2. Do you feel tired, having little energy, unable to concentrate?

A. Never  
 B. Rarely  
 C. Sometimes  
 D. Very Often  
 E. Most of the time

3. Do you feel uneasy, restless or irritable?

A. Never  
 B. Rarely  
 C. Sometimes  
 D. Very Often  
 E. Most of the time

4. Do you have trouble sleeping or eating (too little or too much)?

A. Never  
 B. Rarely  
 C. Sometimes  
 D. Very Often  
 E. Most of the time

Click here for more questions

All Information Will Be Treated As Confidential

**Fig. 31** Example Psychographic Questionnaire "Pop-Up" Screen

47/96

**Fig. 32(A)** Example User Psychographic Attribute Information Record

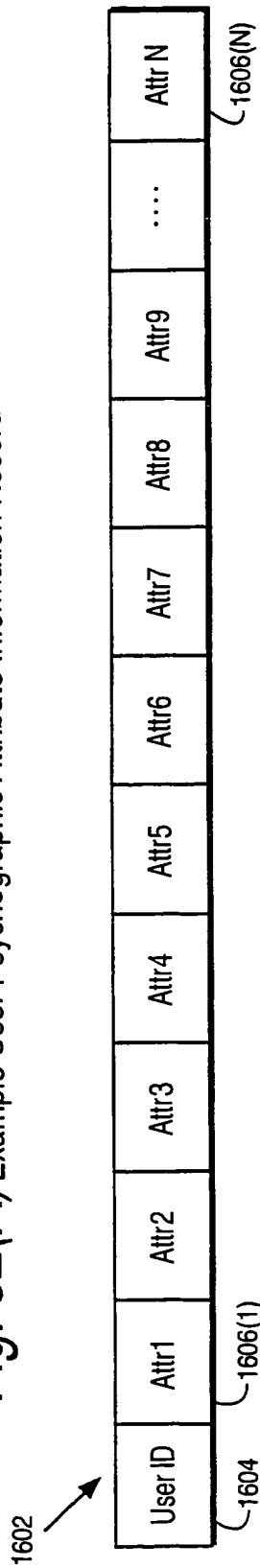

**Fig. 32(B)**  
Example User Psychographic Attribute Record

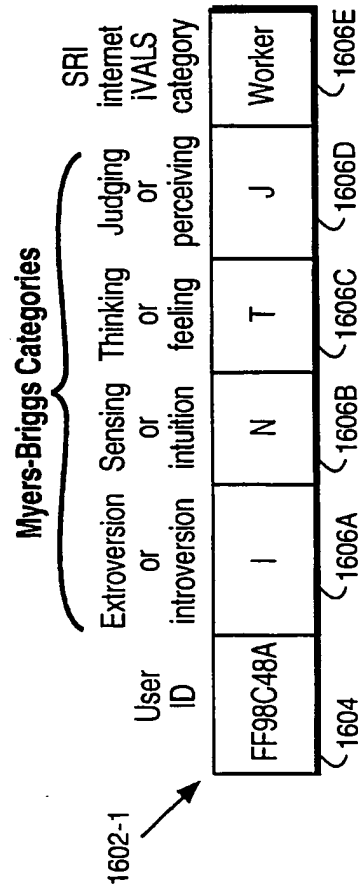

48/96

1602-2 User ID	FF98C48A	Myers-Briggs Categories				SRI Internet iVALS Categories									
		Extroversion or introversion	Sensing or intuition	Thinking or feeling	Judging or perceiving	Wizard	Pioneer	Worker	Seeker	Surfer	Immigrant	Sociable	Socialite	Up-streamer	Main-streamer
		1	0	1	1	0	0	1	0	0	0	0	0	0	0
		1606A	1606B	1606C	1606D	1606E									

Fig. 32(C) Example Psychographic Attribute Record

49/96

**Fig. 33**

Example Steps For Determining Attributes Based On Available Rules And Consequences

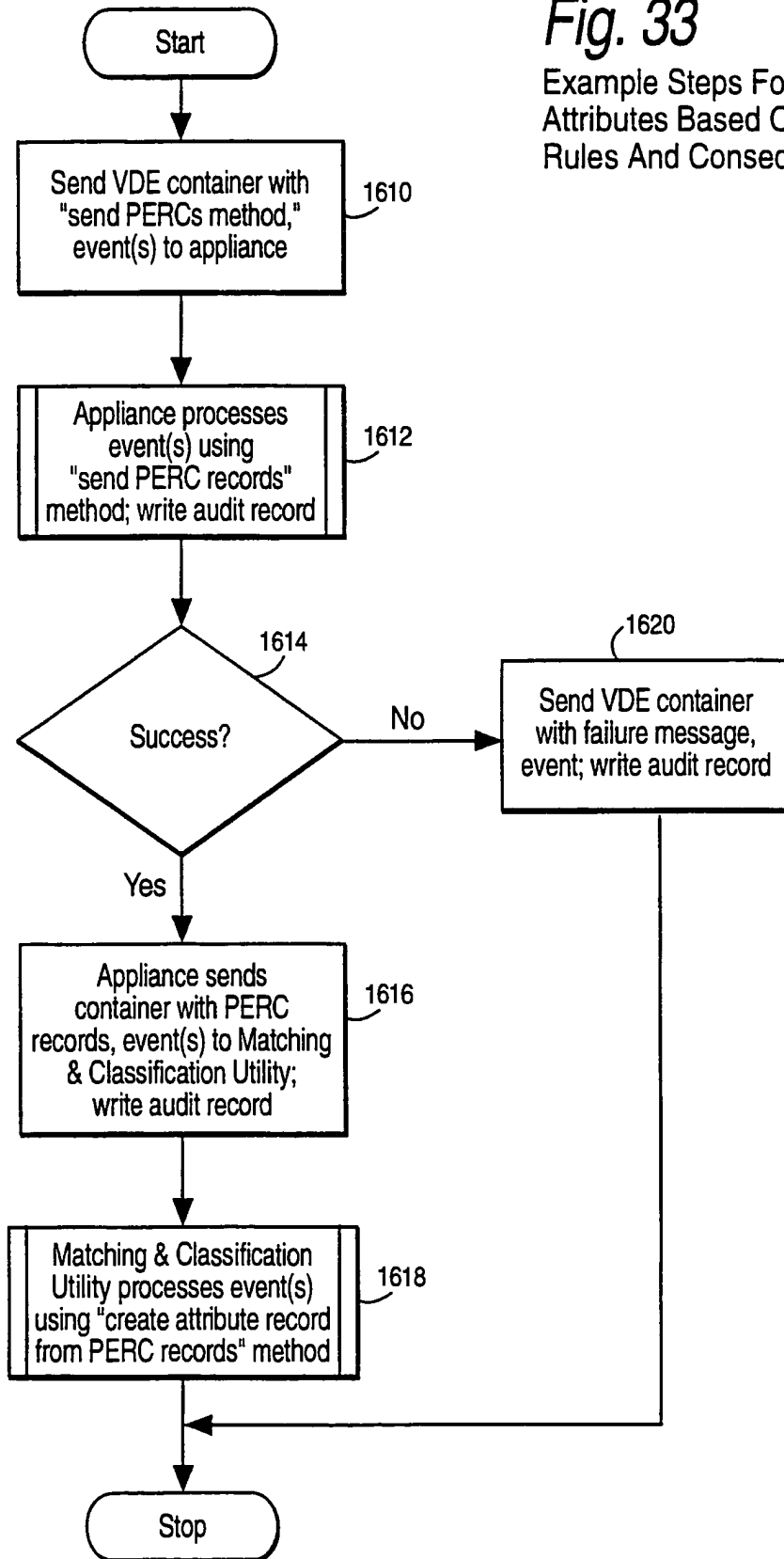

50/96

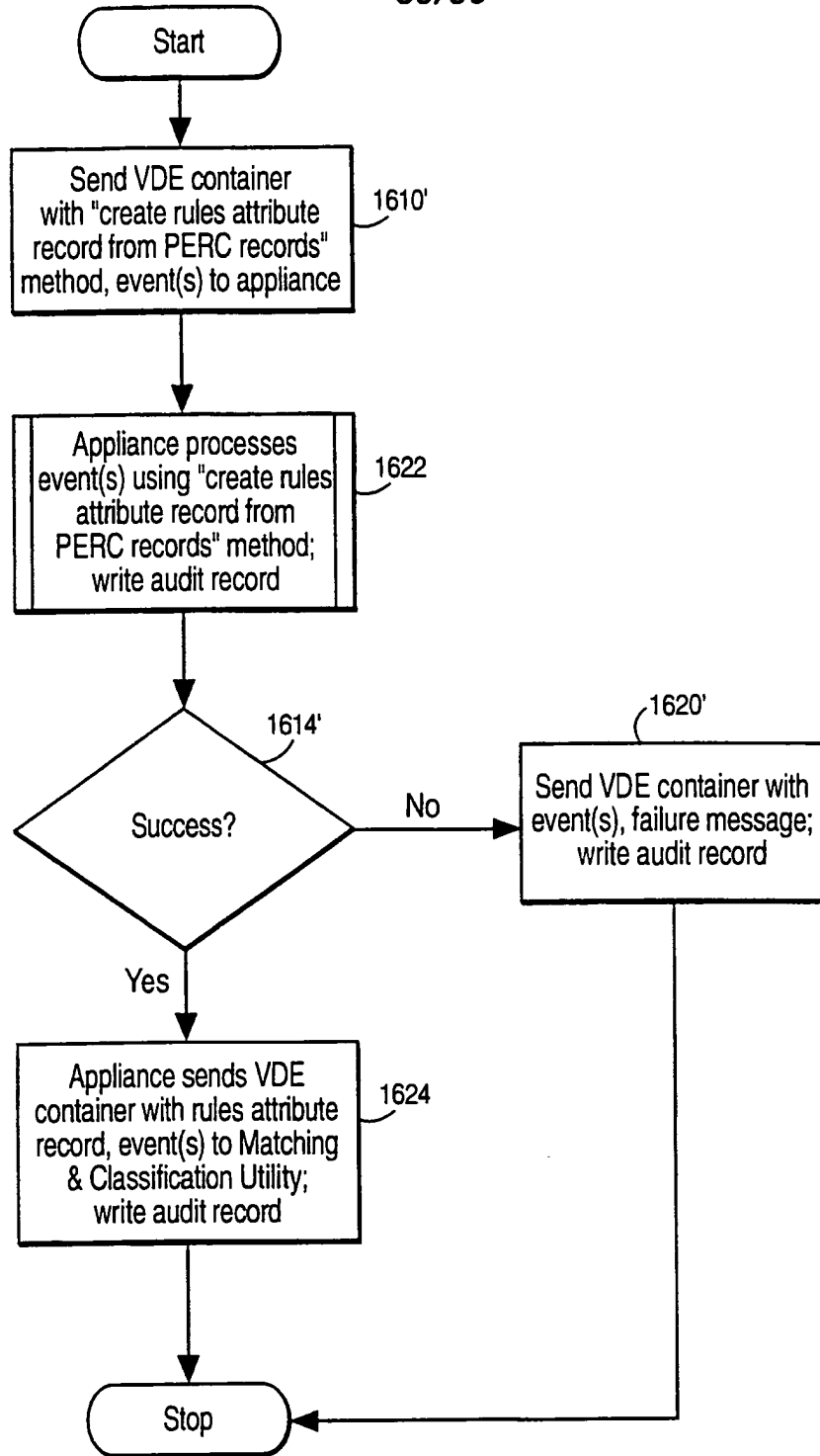

**Fig. 34**

Example Steps For Determining Attributes Based On Available Rules And Consequences

51/96

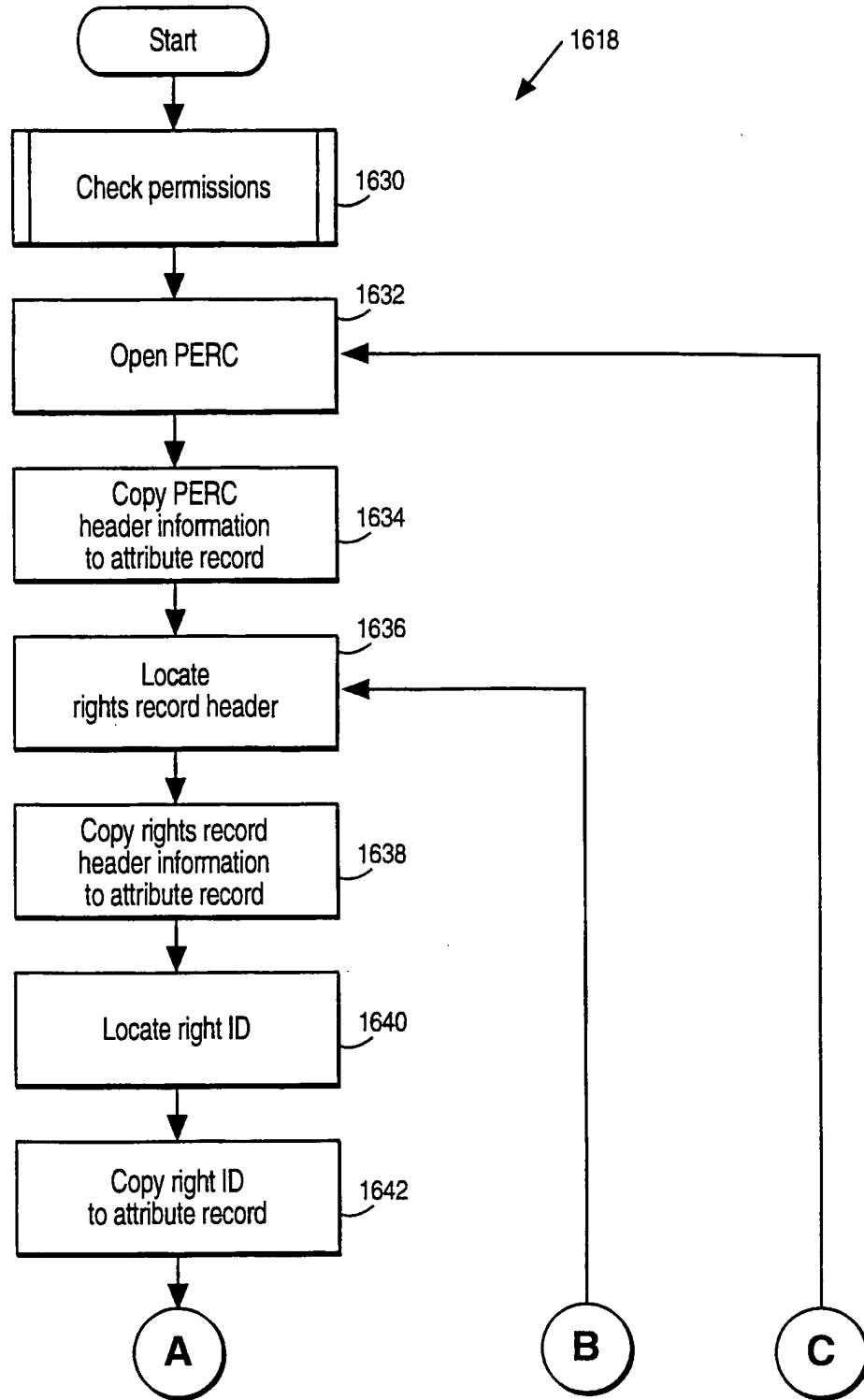

*Fig. 35(A)*

Construct Attribute Records From PERC Records Example Method

52/96

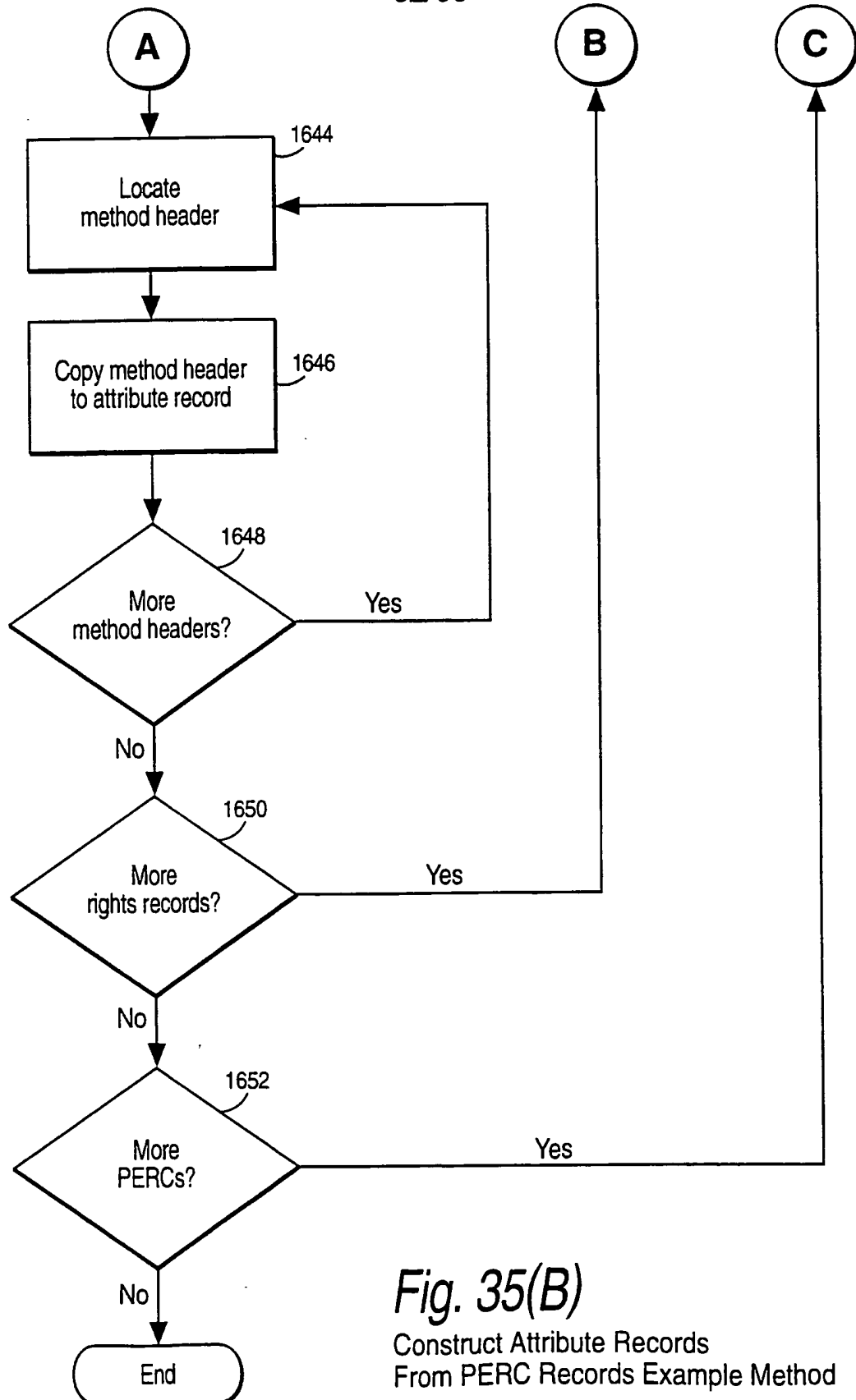

**Fig. 35(B)**  
Construct Attribute Records  
From PERC Records Example Method



53/96

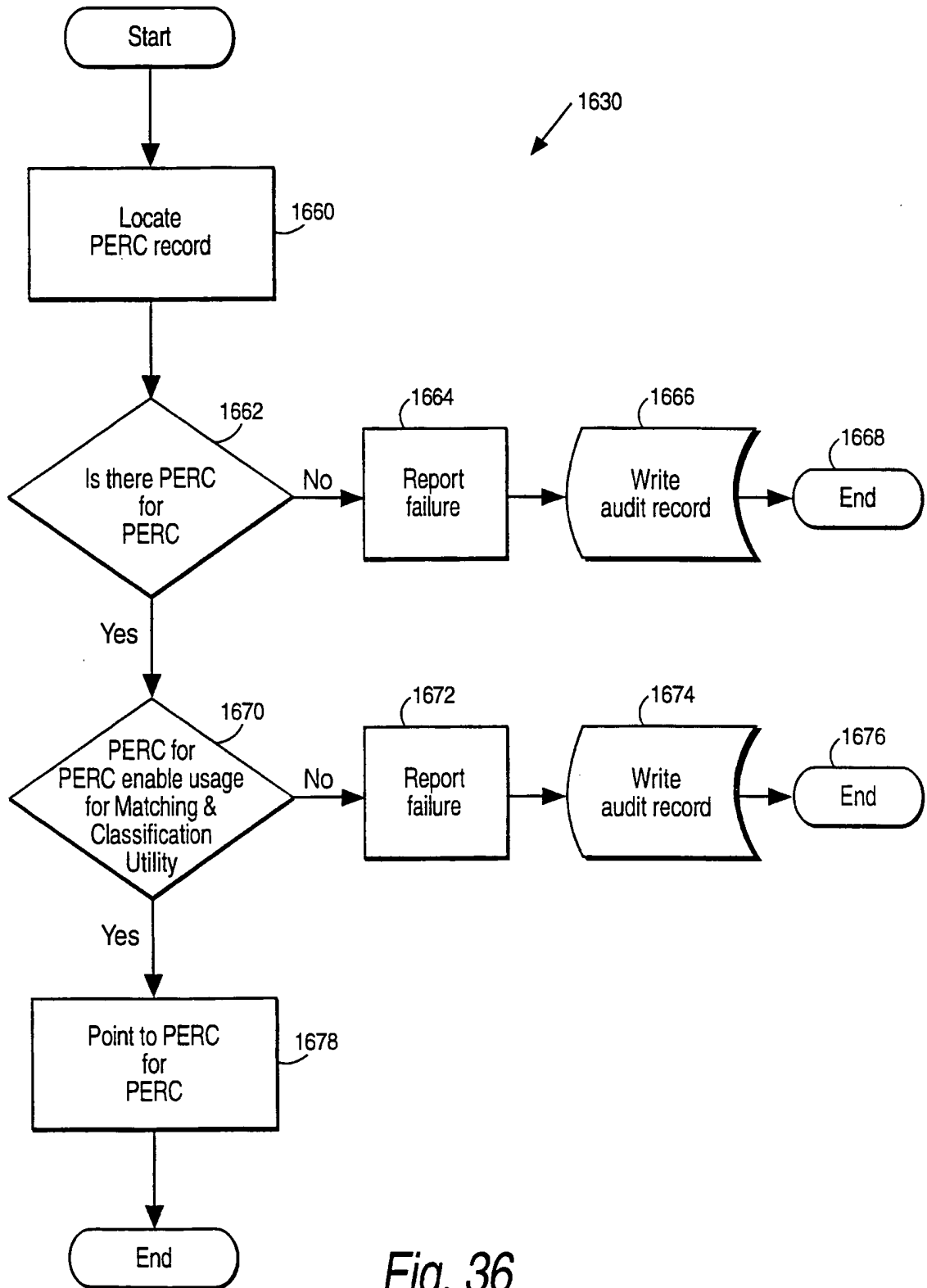

Fig. 36

Check Permissions Record Example Steps

**Fig. 37(A)** Example Rights Attribute Record From PERCs

1680-1	User ID	Object ID	Attr1	Attr2	Attr3	Attr4	Attr5	Attr6	Attr7	Attr8	Attr9	...	Attr N
	1682	1684	1686(1)										1686(N)

**Fig. 37(B)** Example Attribute Record

1680-2	User ID number	Object ID	Right ID	Method	Right ID	Method	Right ID	Method	Right ID	Method	Right ID	Method	...
	1682	1684	1686A	1686B	1686C	1686D	1686E	1686F	1686G	1686H	1686I	1686J	54/96
	CF129CD5	1227-33-1298-2	Use	Open	Meter	Each time	Budget	One time purchase	\$1.00	Bill	VISA	AMEX	

**Fig. 37(C)** Example Attribute Records From PERC Record

1680-3	User ID number	Object ID	Right ID	Method	Right ID	Method	Right ID	Method	Right ID	Method	Right ID	Method	...
	1682	1684	1686A	1686B	1686C	1686D	1686E	1686F	1686G	1686H	1686I	1686J	
	CF129CD5	1227-33-1298-2	27	239	15	546	81	423	1.00	02	666	601	

**Fig. 38**

Example Steps For Assembling Attribute Records Based On Rules and Consequences

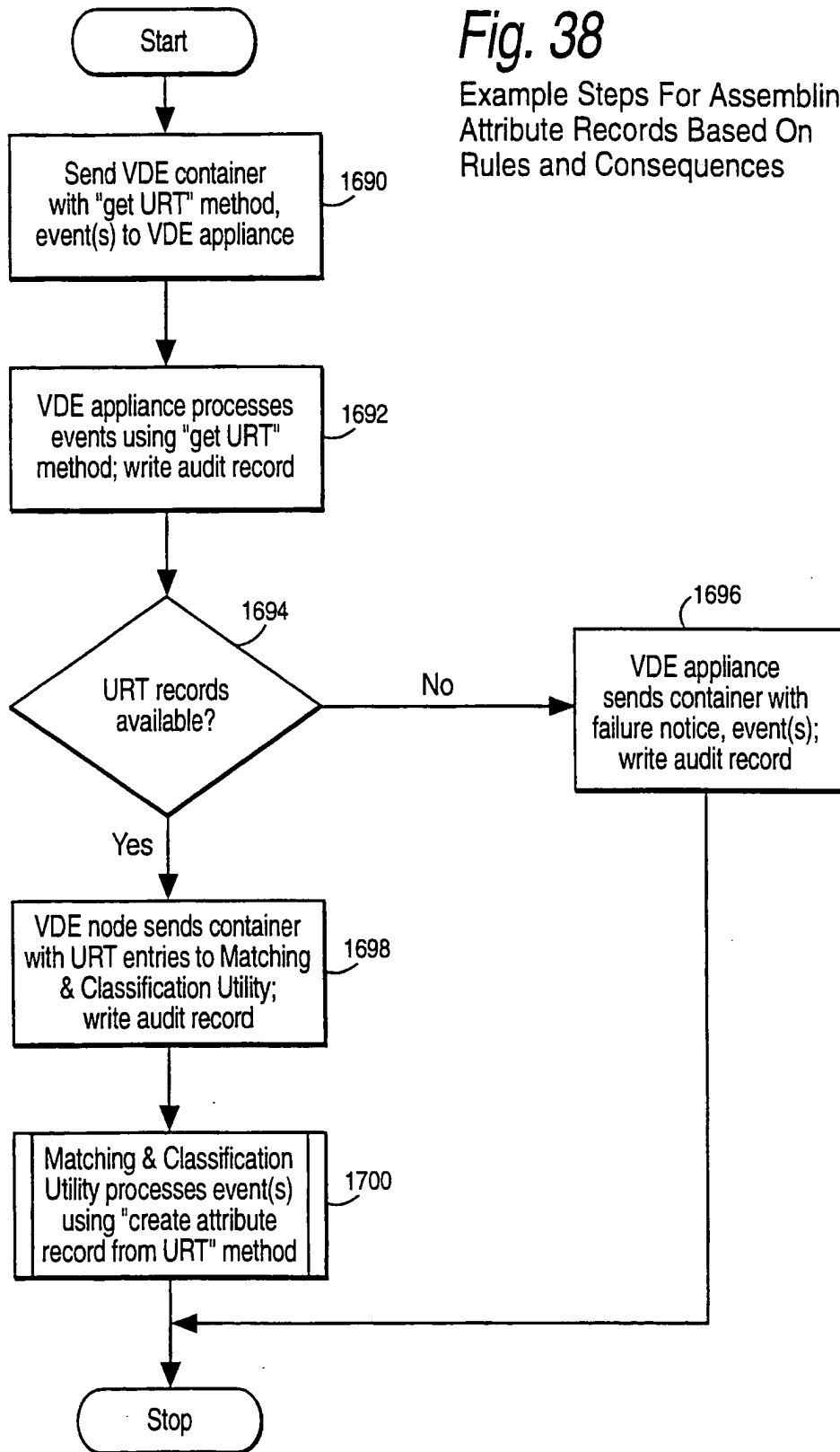

56/96

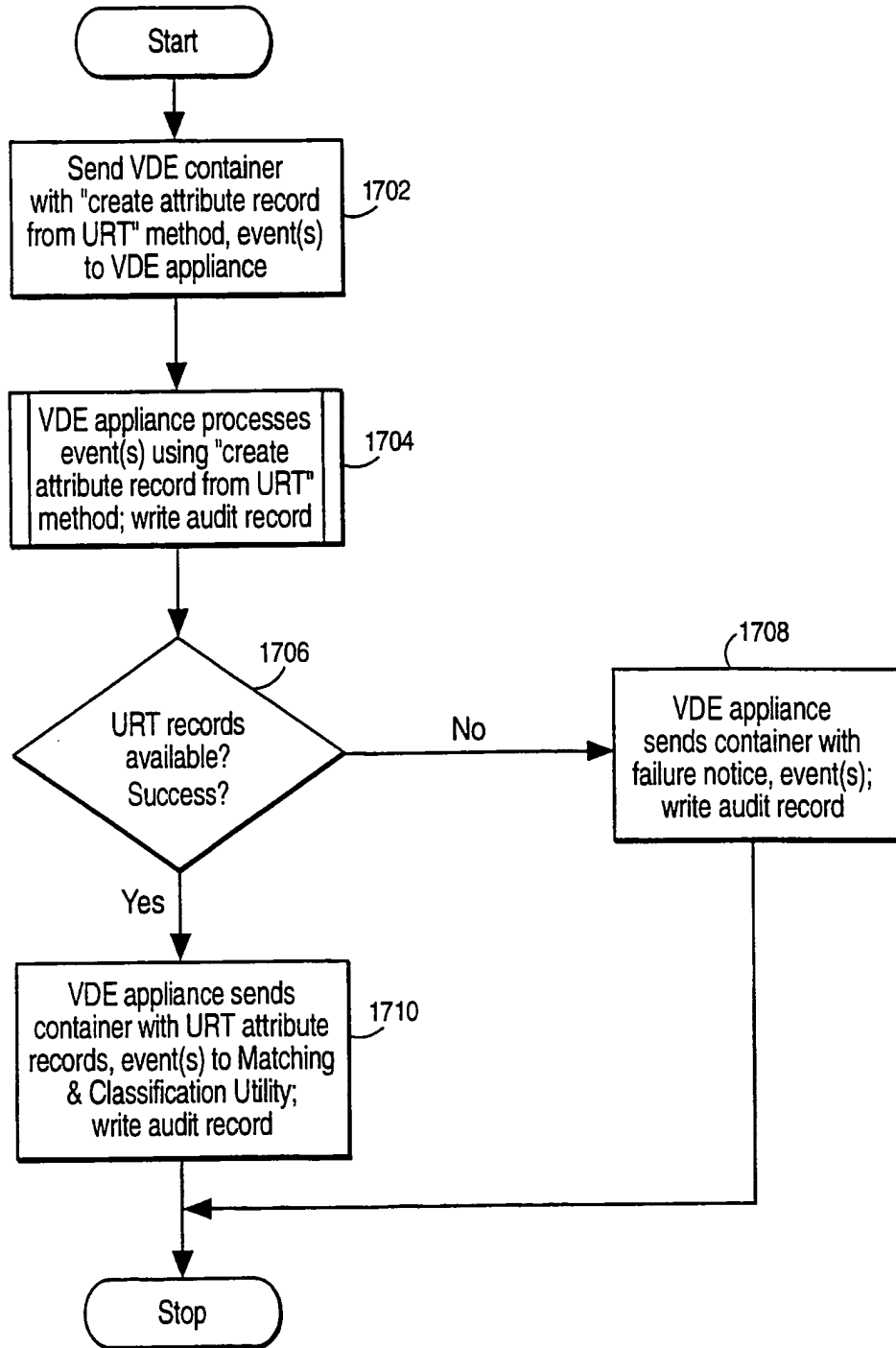

**Fig. 39**

Example Steps For Assembling Attribute Records Based On Rules and Consequences

57/96

**Fig. 40(A)**

Example Steps To Check  
On Attribute Record From  
A User Rights Table

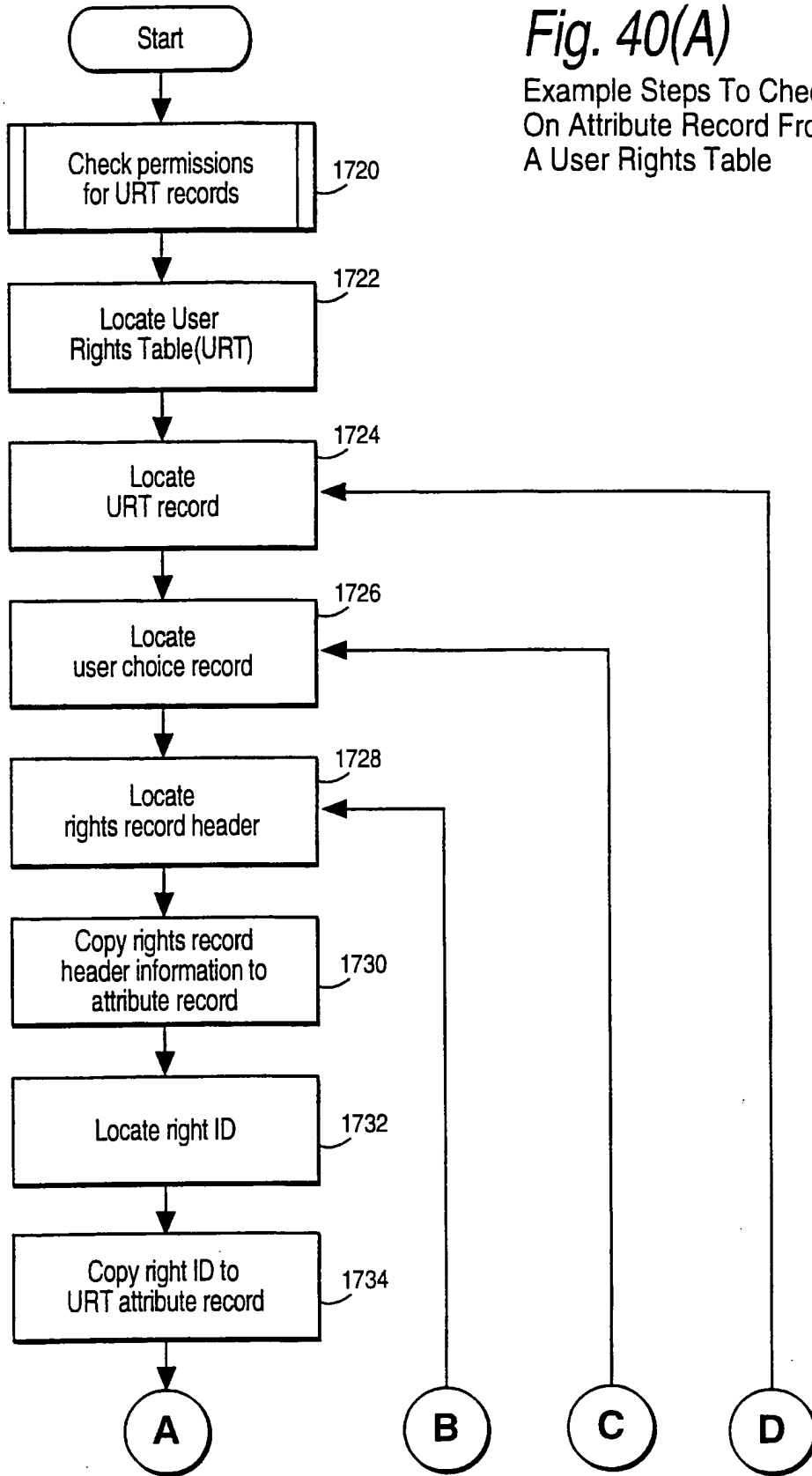

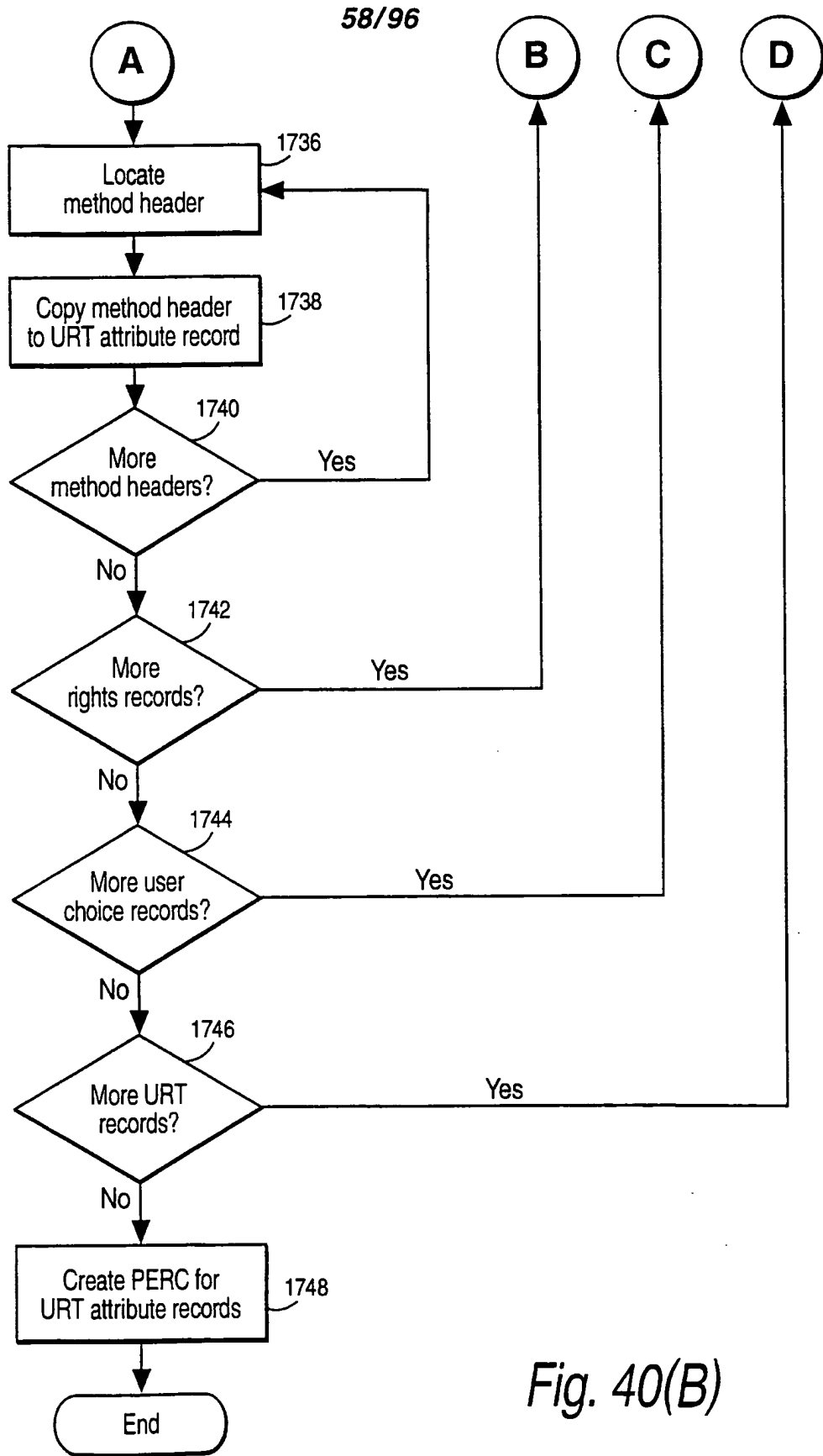
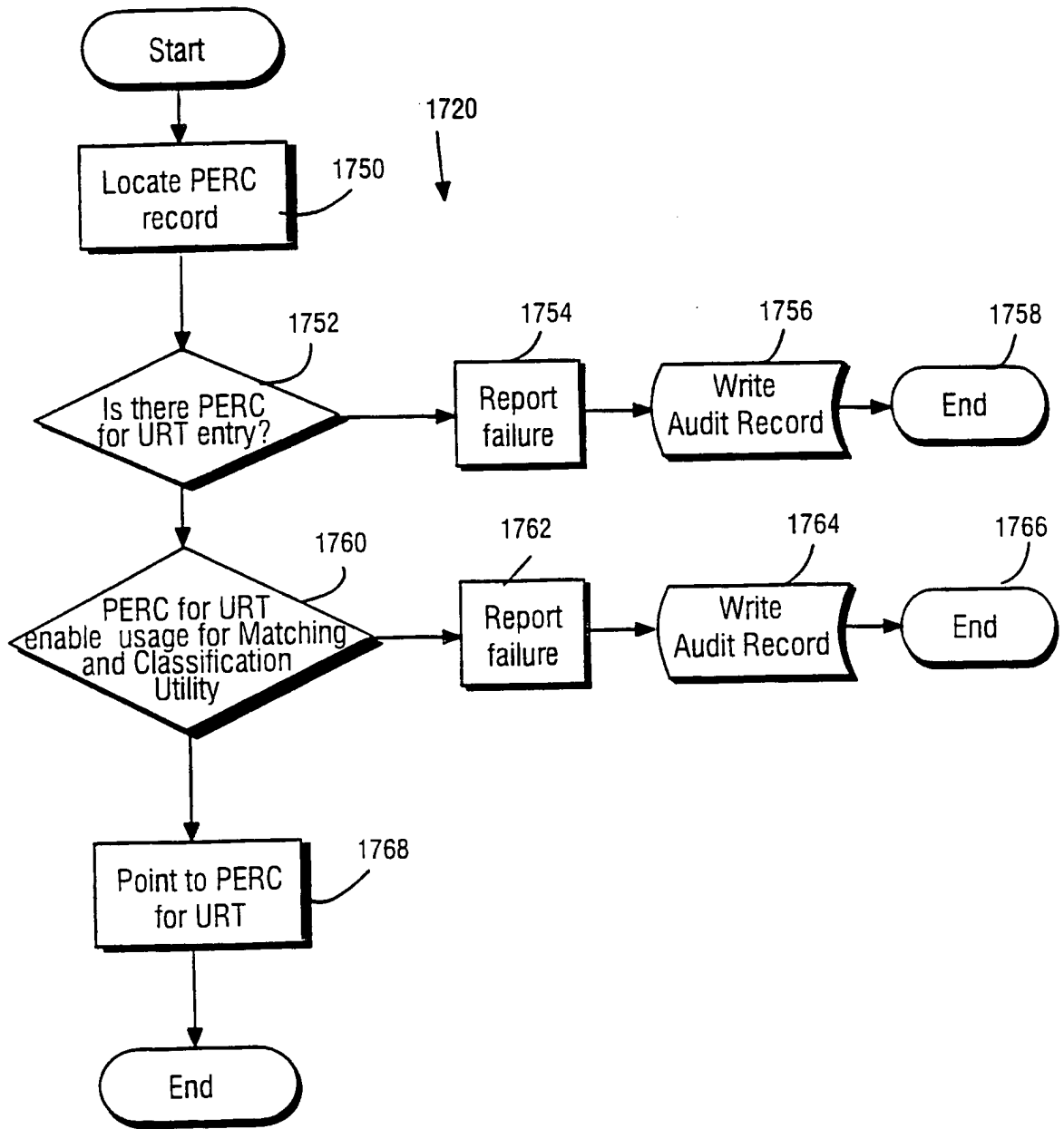

Fig. 40(B)

59/96

Fig. 41

Contract attribute records from PERC records method example



**Fig. 42(A)** Example Rights Attribute Record From URT

1770-1	1772	1774	1776(1)	Attr1	Attr2	Attr3	Attr4	Attr5	Attr6	Attr7	Attr8	Attr9	...	Attr N	1776(N)
	User ID	Object ID	Attr1	Attr2	Attr3	Attr4	Attr5	Attr6	Attr7	Attr8	Attr9	...	Attr N		

60/96

**Fig. 42(B)** Example Rights Attribute Record From URT

1770-2	1772	1774	1776A	1776B	1776C	1776D	1776E	1776F	1776G	1776H	1776I	...
	User ID number	Object ID	Right ID	Method	Right ID	Method	Right ID	Method	Right ID	Method	Right ID	Method
	CF129CD5	1227-33-1298-2	Use	Open	Meter	Each time	Budget	One time purchase	\$1.00	Bill	VISA	...

**Fig. 42(C)** Example User Choice Attribute Records (From URT)

1770-3	1772	1774	1776A	1776B	1776C	1776D	1776E	1776F	1776G	1776H	1776I	...
	User ID number	Object ID	Right ID	Method	Right ID	Method	Right ID	Method	Right ID	Method	Right ID	Method
	CF129CD5	1227-33-1298-2	27	239	15	546	81	423	1.00	02	666	...



61/96

*Fig. 43*

Example steps for assembling  
usage audit records

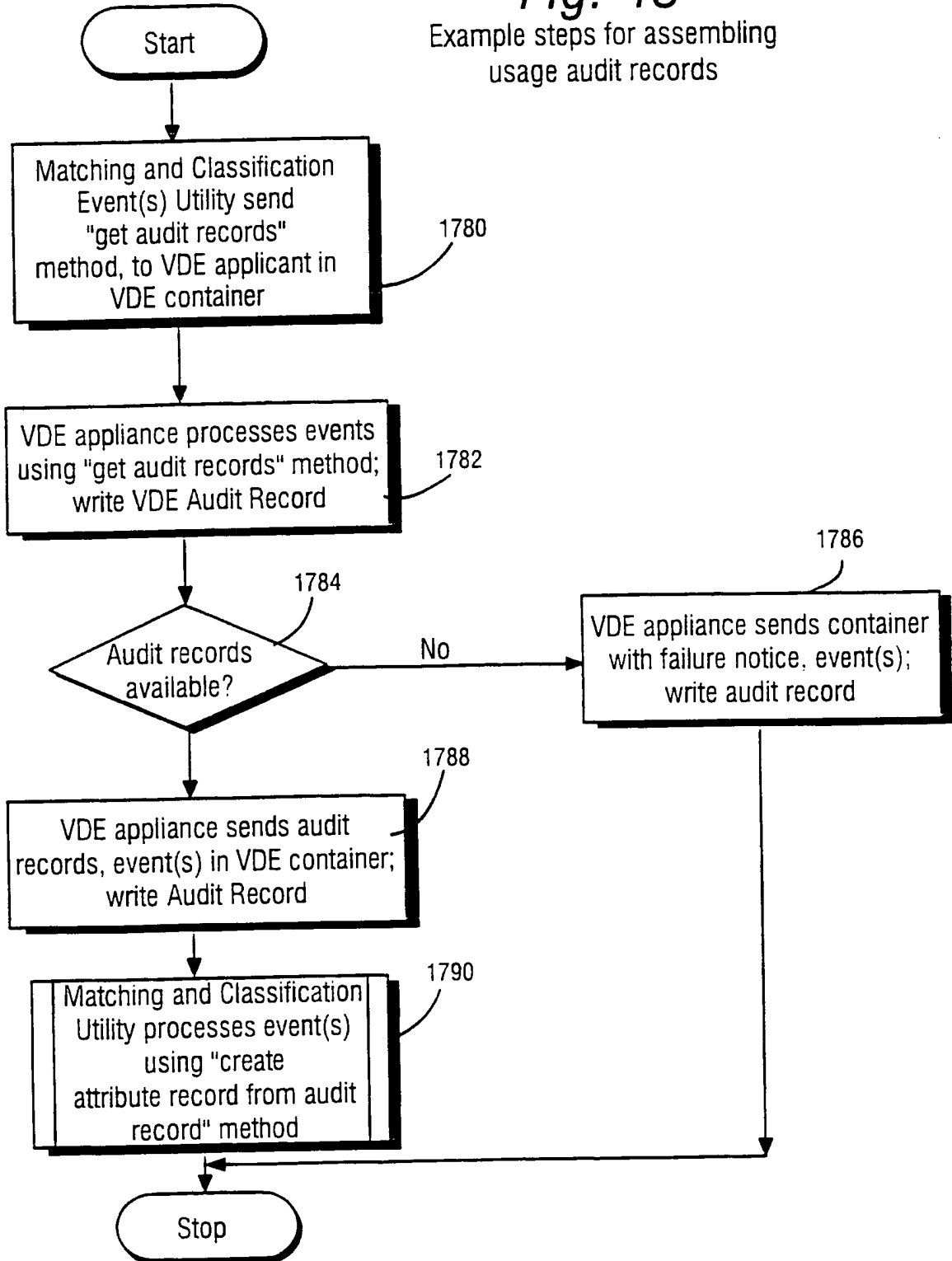

62/96

**Fig. 44**  
Example steps for assembling usage  
audit records

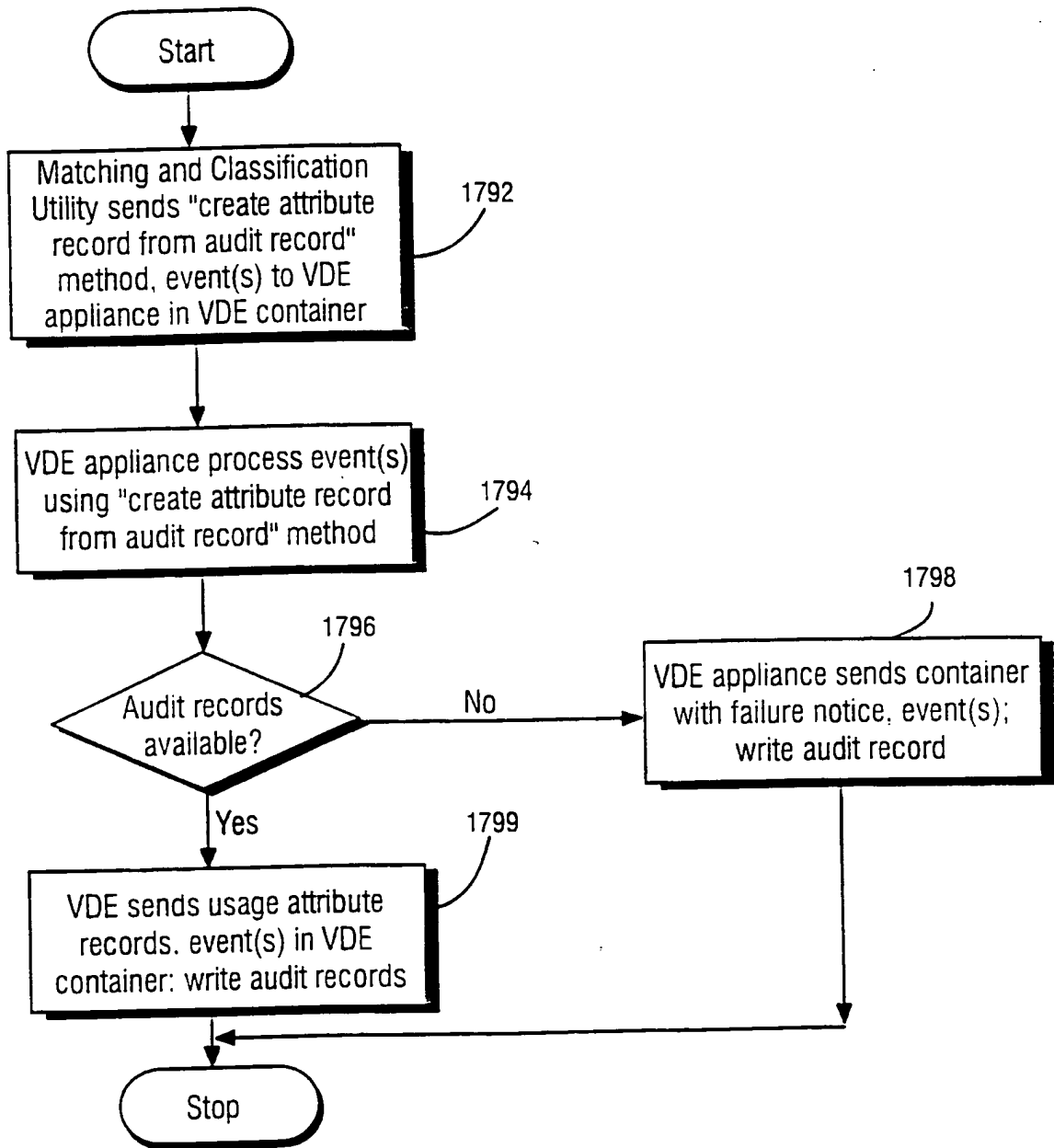

63/96

Fig. 45(A)

Example steps to create audit attribute records

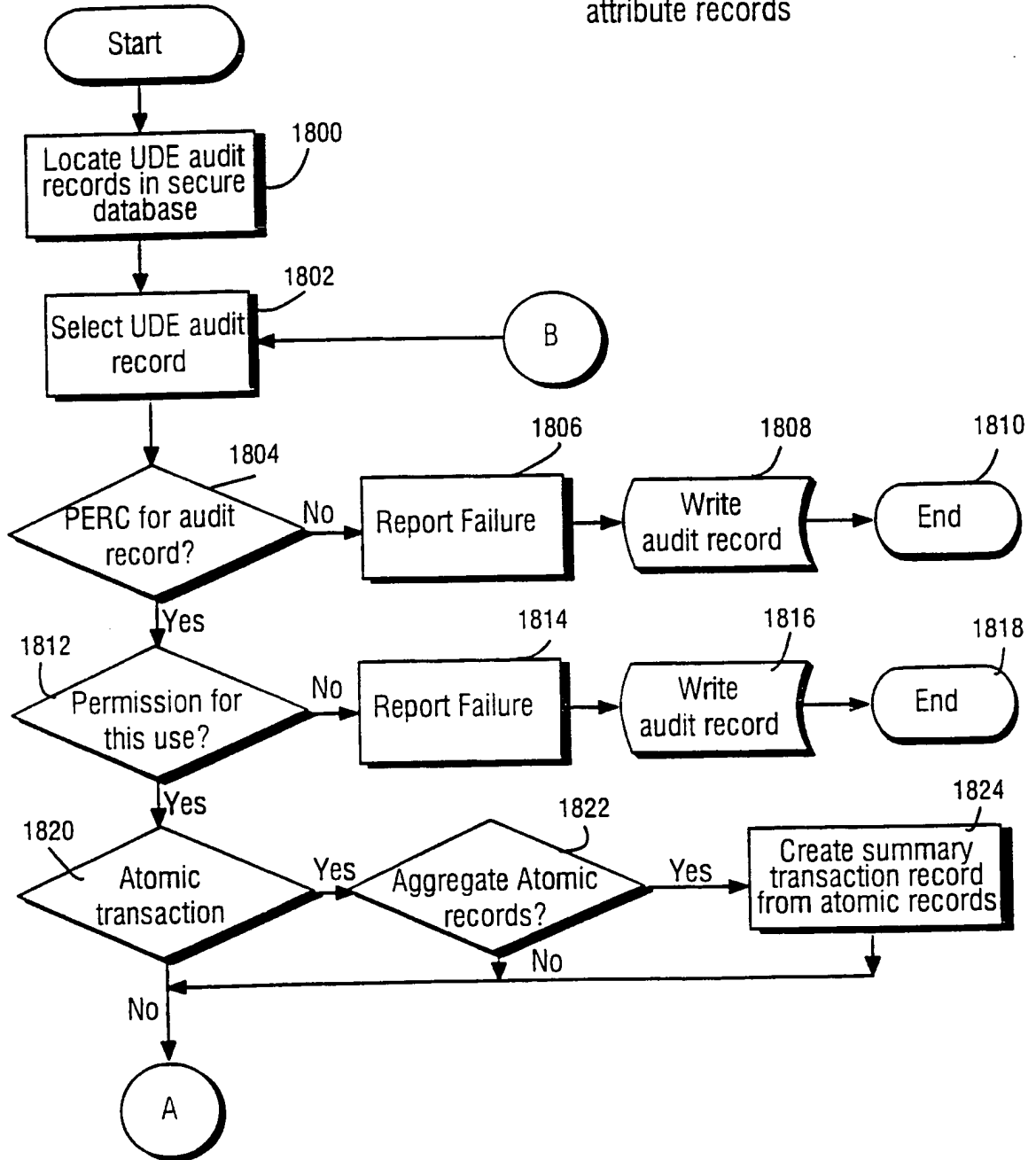

64/96

**Fig. 45(B)**  
Example steps to create audit  
attribute records

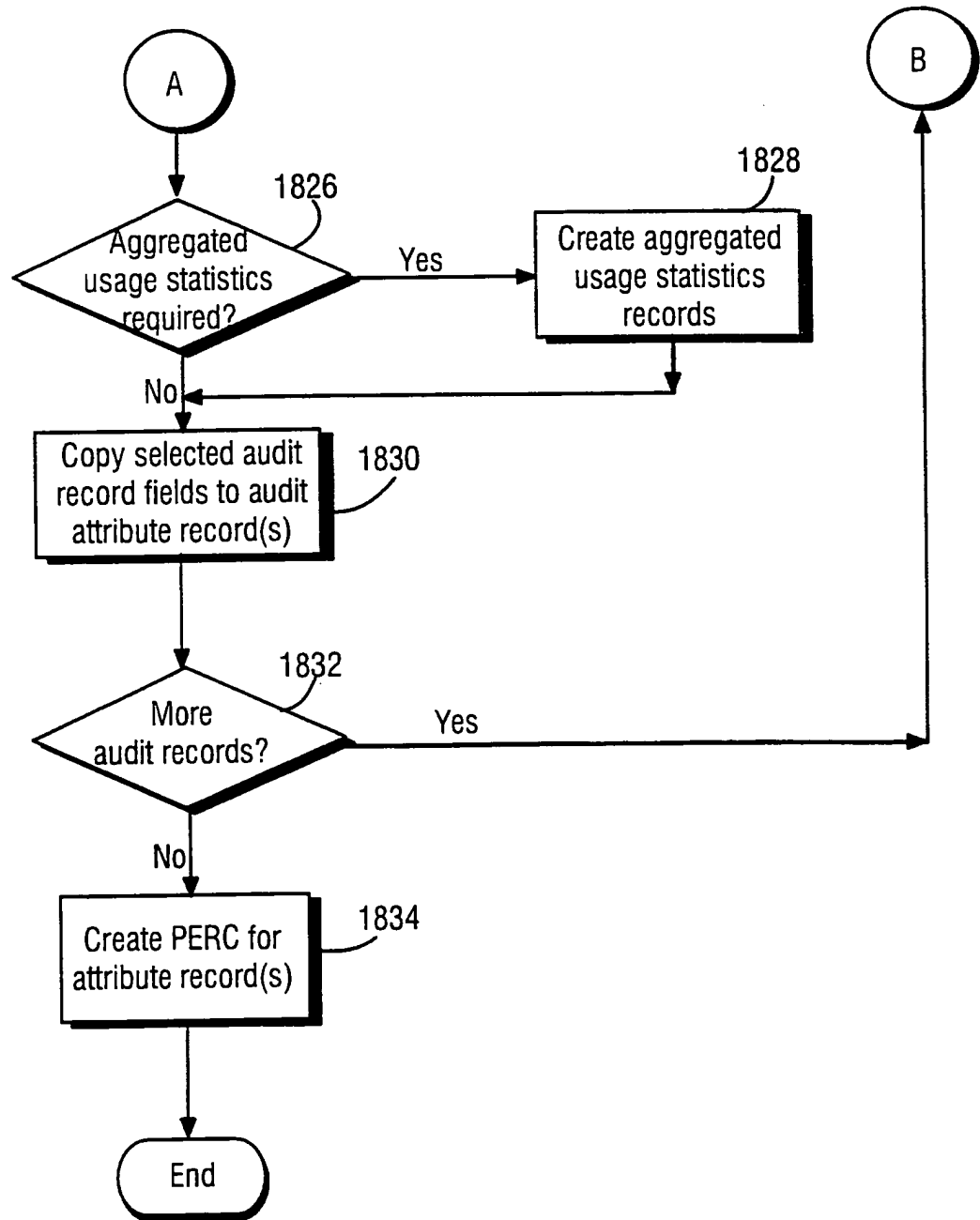

Fig. 46(A) Example Usage Attribute Record From UDE Audit Record

User ID	Object ID	Attr1	Attr2	Attr3	Attr4	Attr5	Attr6	Attr7	Attr8	Attr9	...	Attr N
1832	1834	1836(1)										1836(N)

Fig. 46(B) Example Usage Attribute/Statistics Records From UDE Audit Records

User ID number	CF129CD5	Object ID	1227-33-1298-2	Right ID	Use	Method	Open	Right ID	Meter	Method	Each time	Number opens	4	Right ID	Budget	Method	One time purchase	Right ID	Bill	Method	\$1.00	Method	VISA	...
	1832		1834		1836A		1836B		1836C		1836D		1836E		1836F		1836G		1836H		1836I		1836J	

Account number	xxxx-yyyyyyy-zzzzzzzzzzzzz	First use date	12/30/95	First use time	18:22:30 EST	Most recent use date	01/04/96	Most recent use time	20:14:01
	1836K		1836L		1836M		1836N		1836O

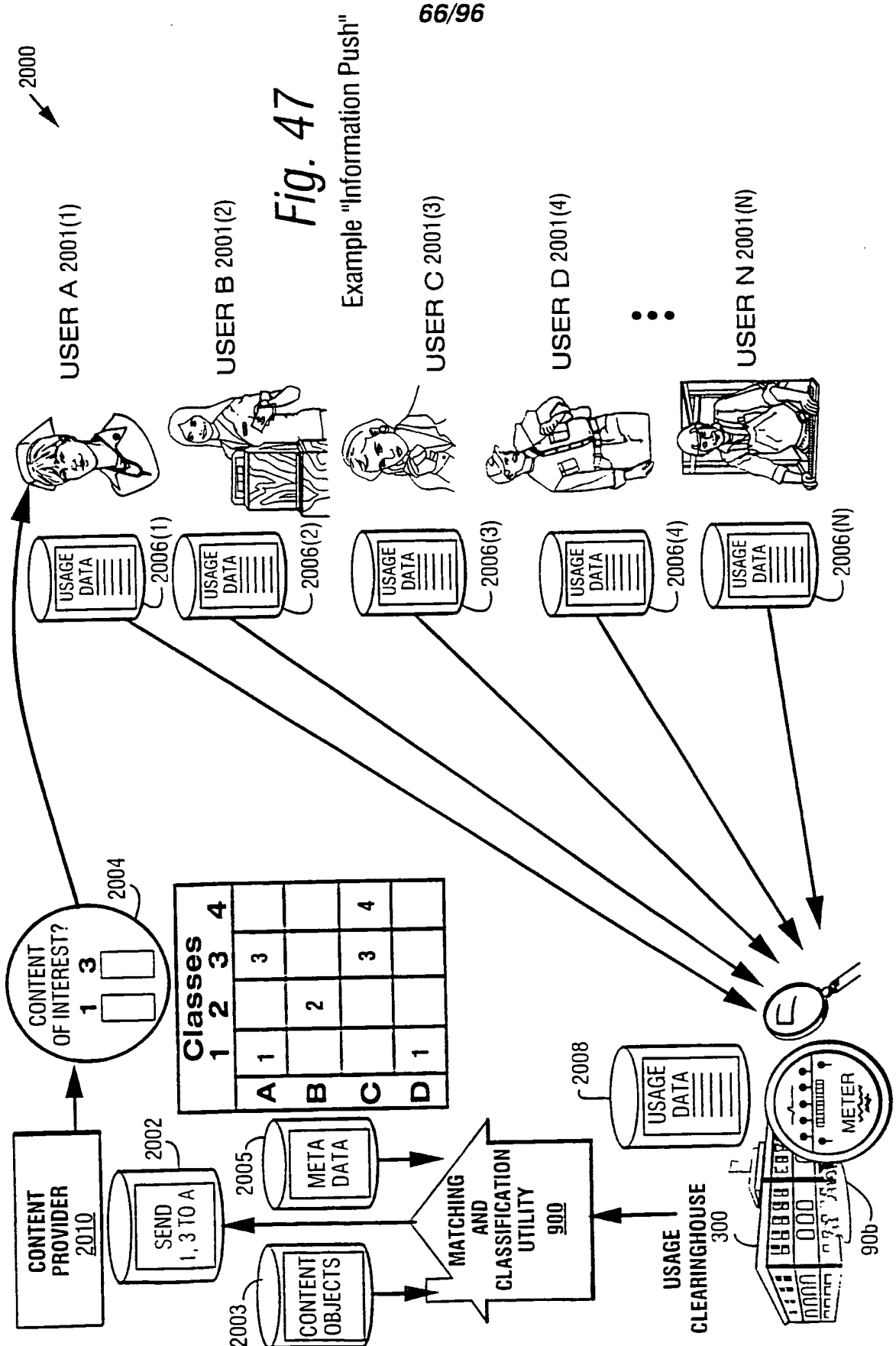

Fig. 47

Example "Information Push" 66/96

67/96

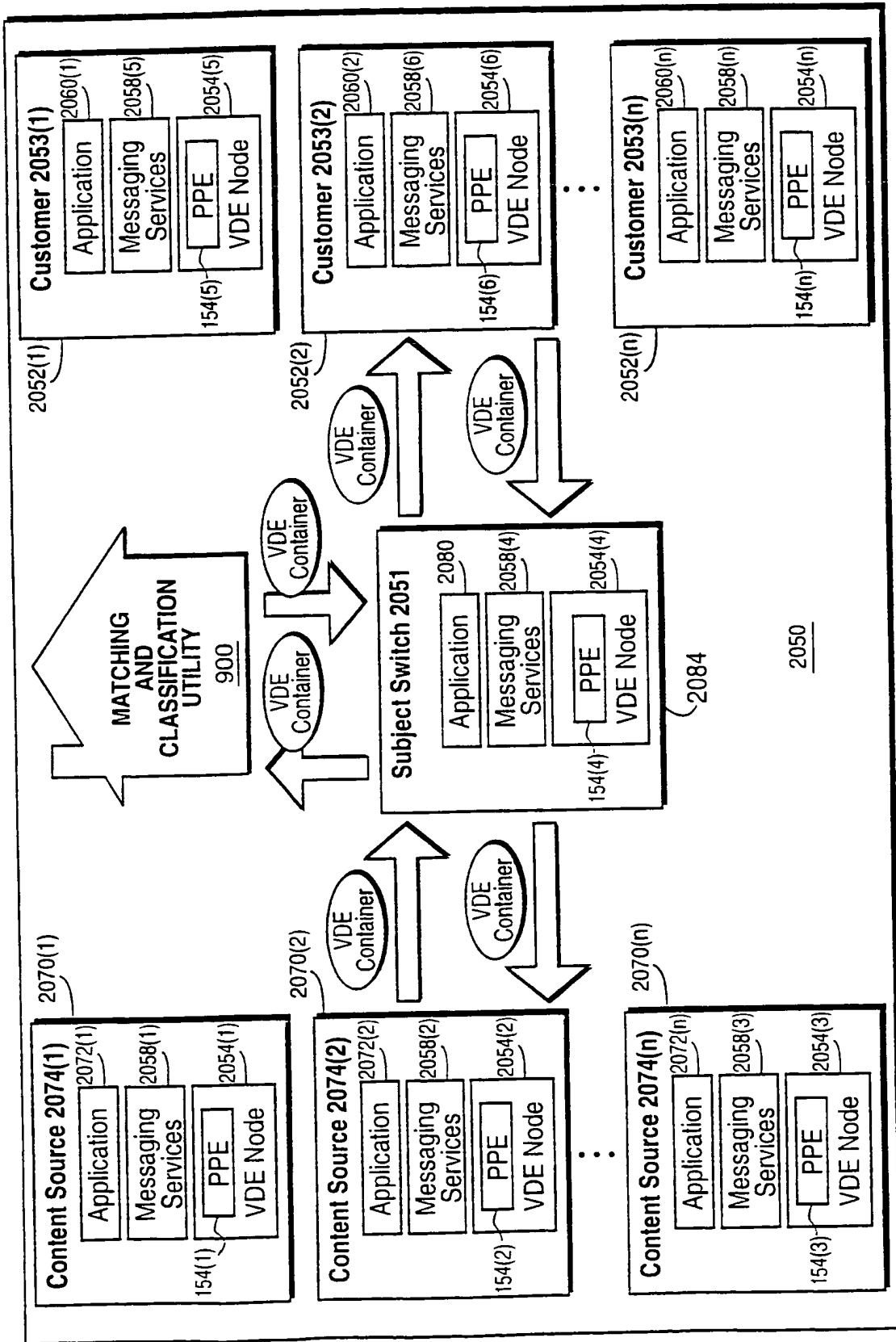

Fig. 47(A) Matching and Classification Utility 900 Supports "Push" models using Subject Switching and Messaging Services

68/96

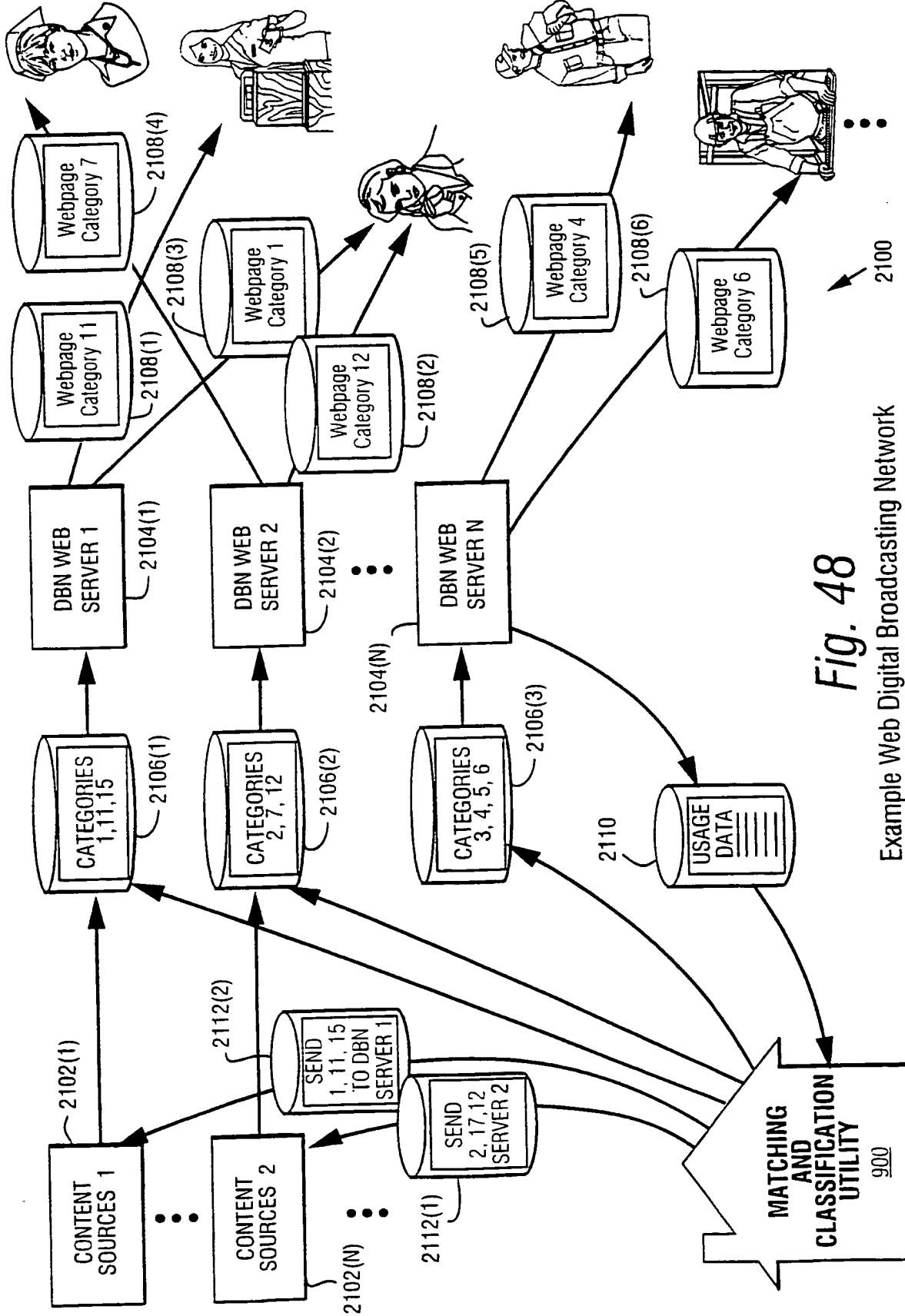

Fig. 48

Example Web Digital Broadcasting Network



69/96

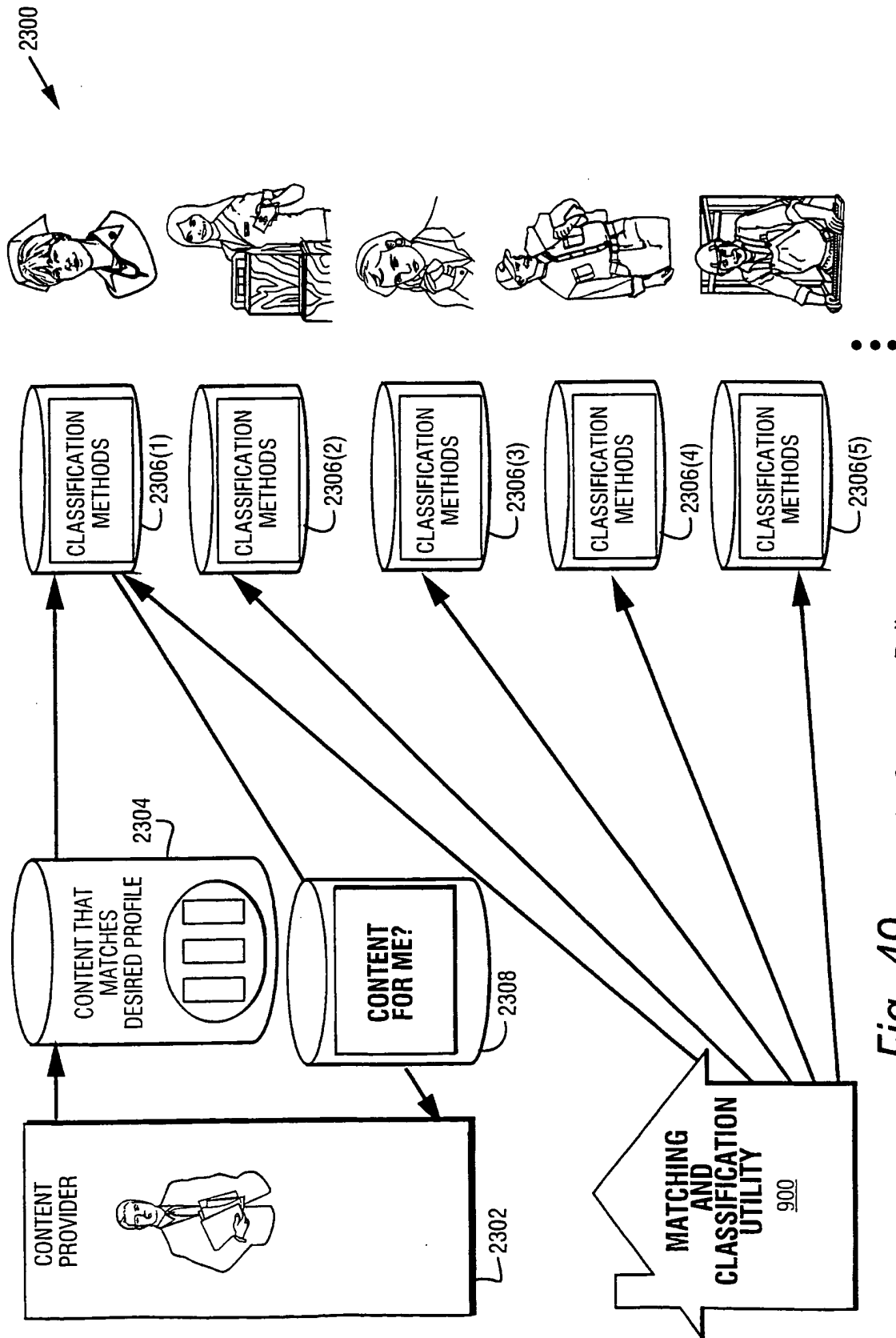
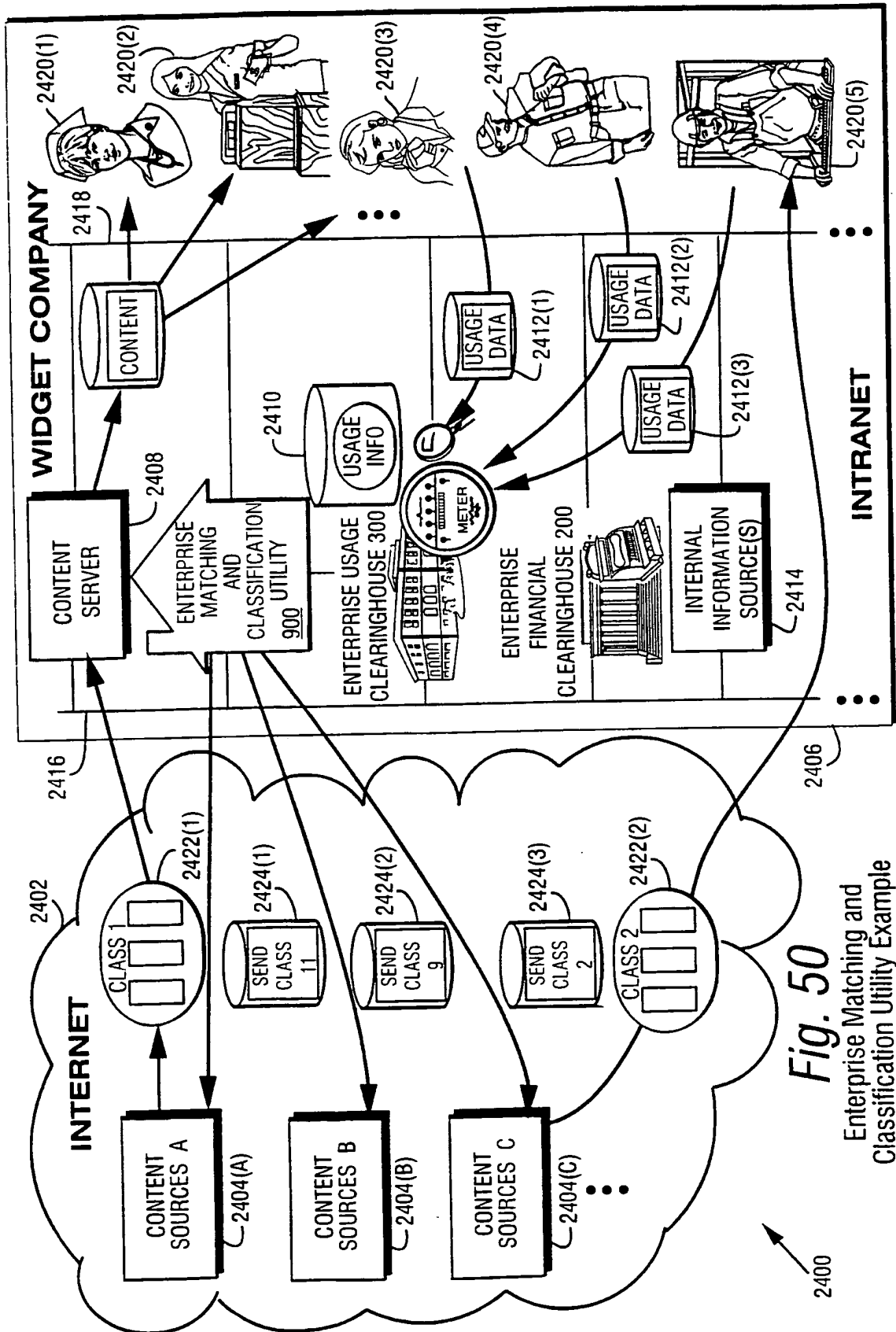
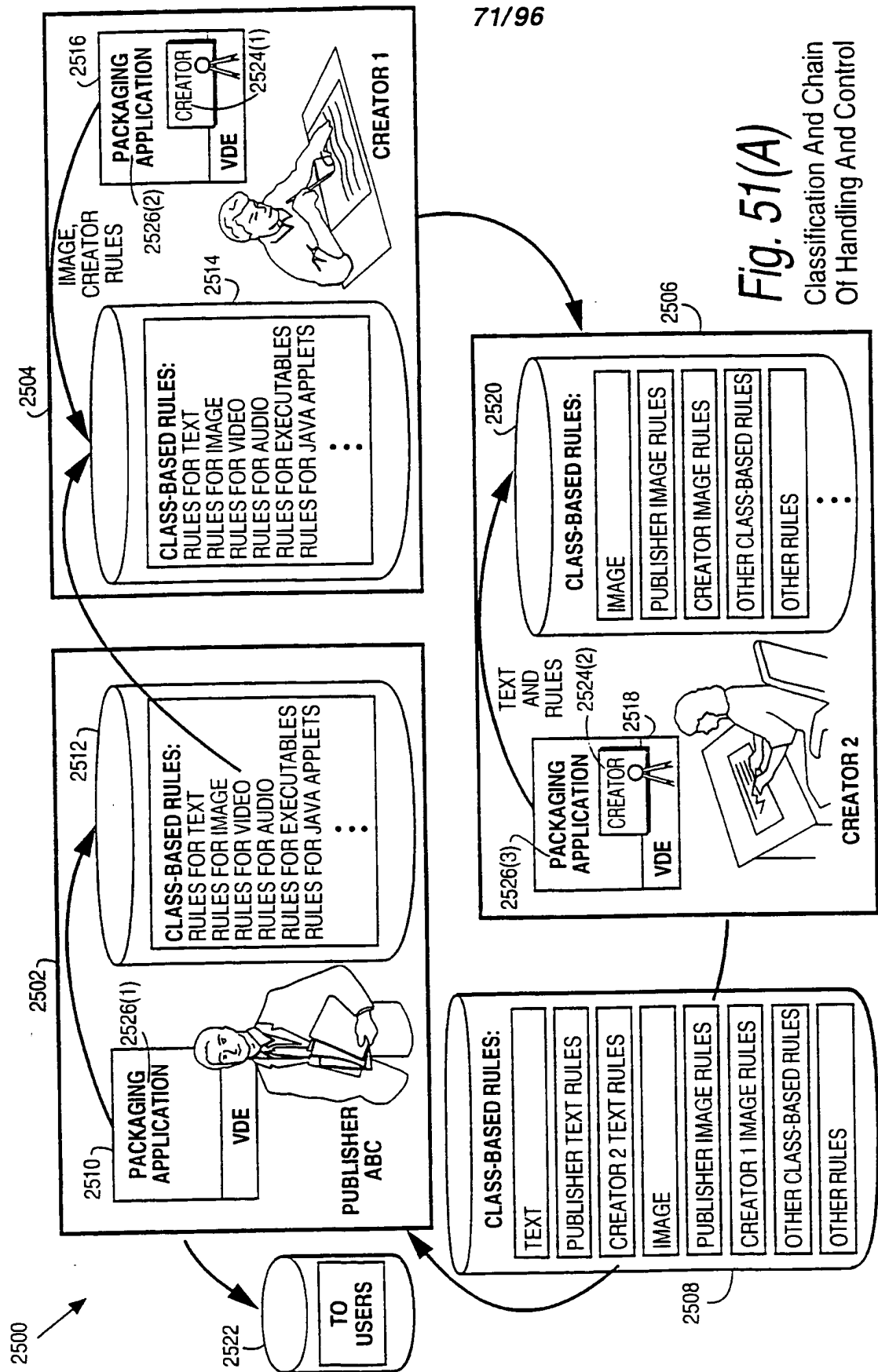

Fig. 49 Example "Consumer Pull"

70/96

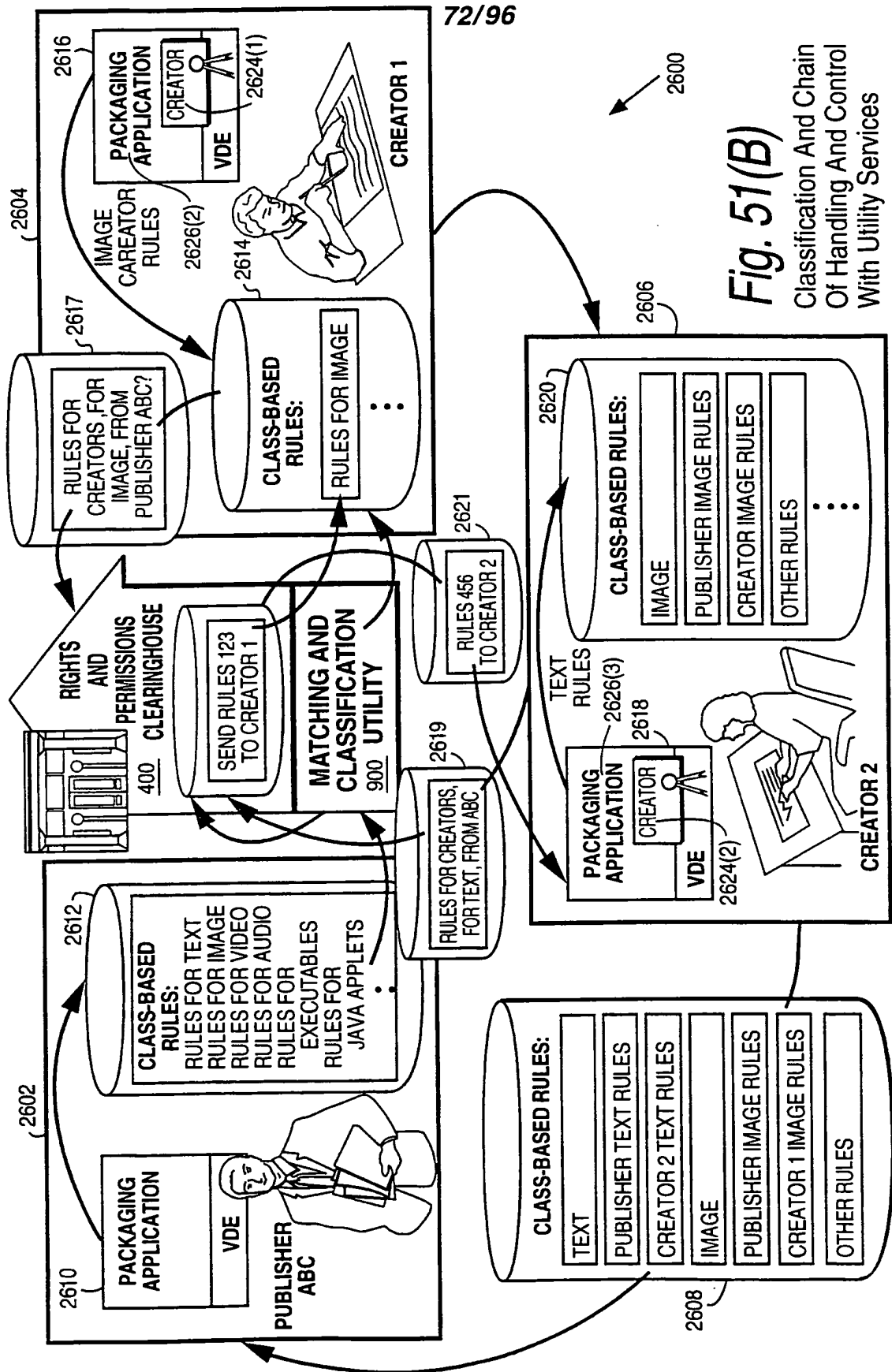

**Fig. 50**  
 Enterprise Matching and  
 Classification Utility Example



71/96

Fig. 51(A)  
Classification And Chain  
Of Handling And Control



**Fig. 51(B)**  
 Classification And Chain  
 Of Handling And Control  
 With Utility Services

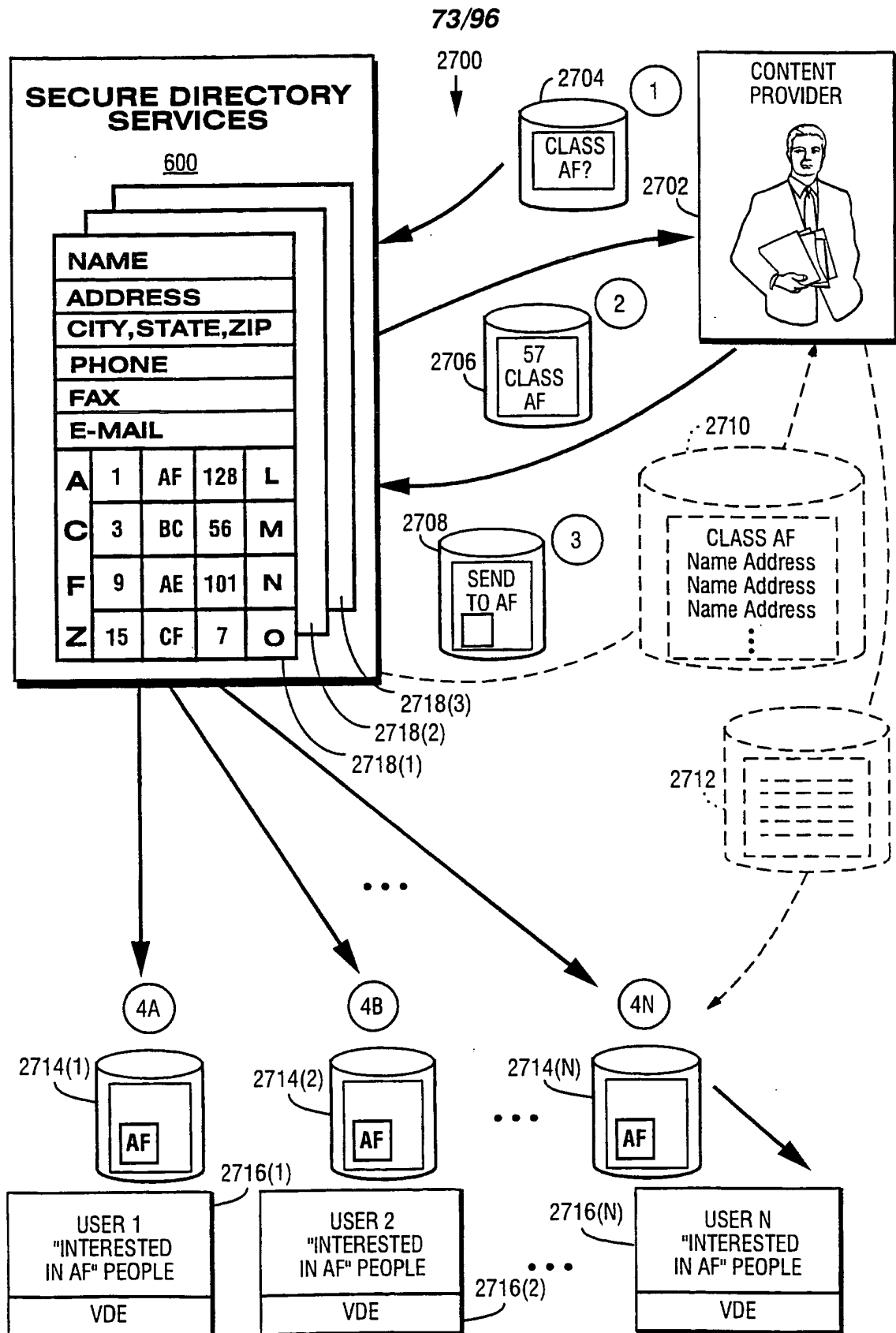

**Fig. 52** Secure Directory Services

74/96

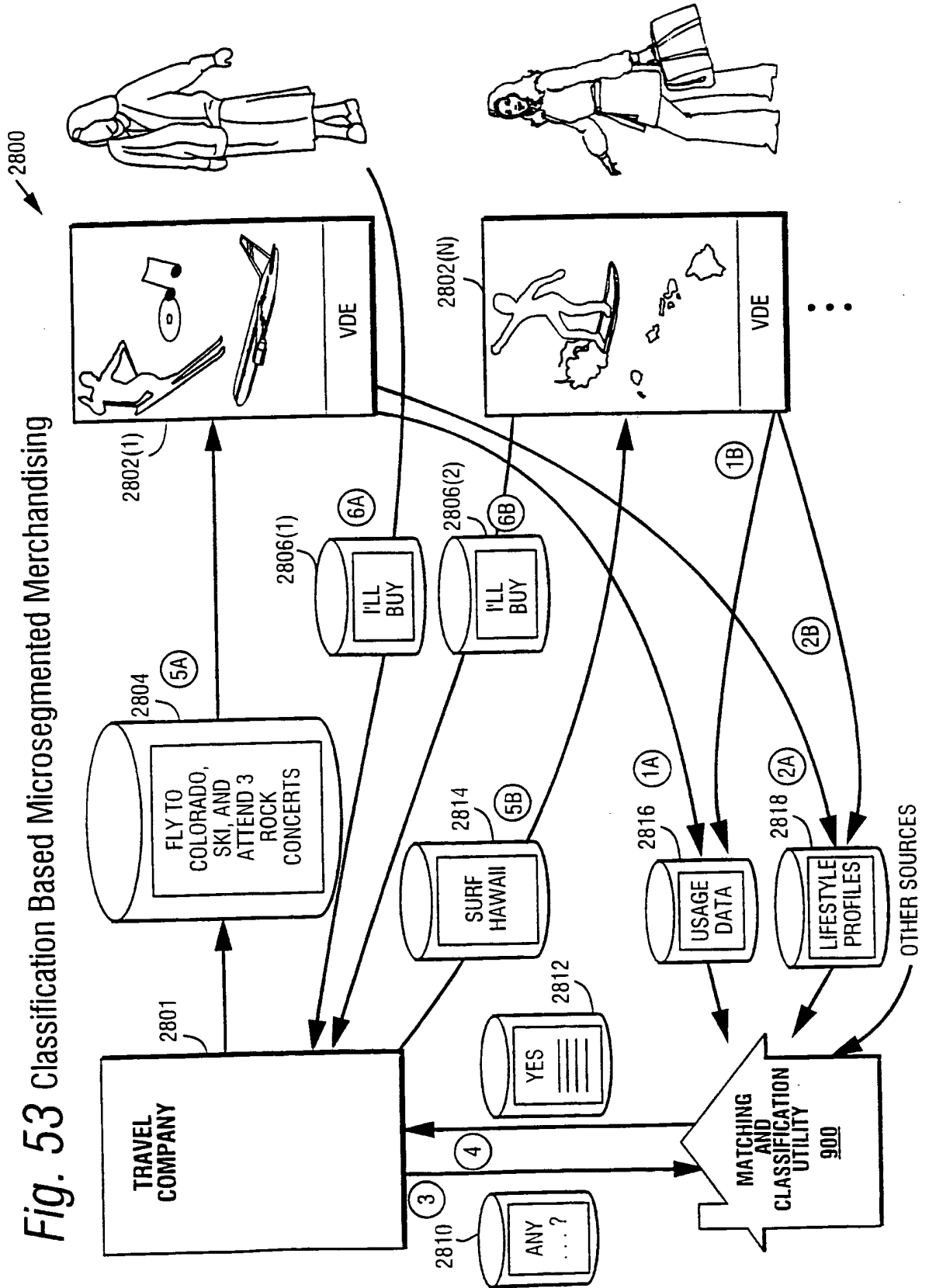

Fig. 53 Classification Based Microsegmented Merchandising

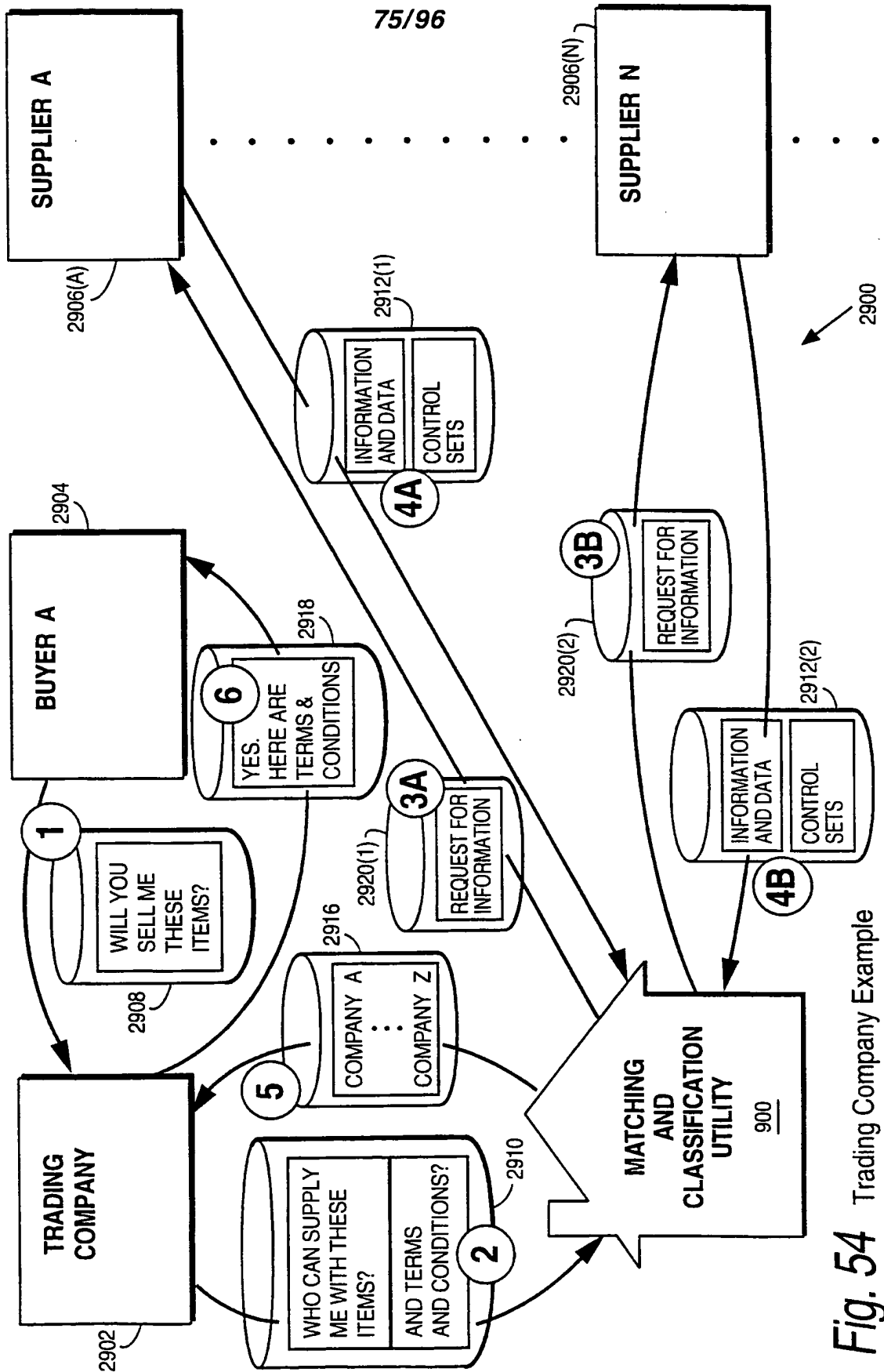

Fig. 54 Trading Company Example

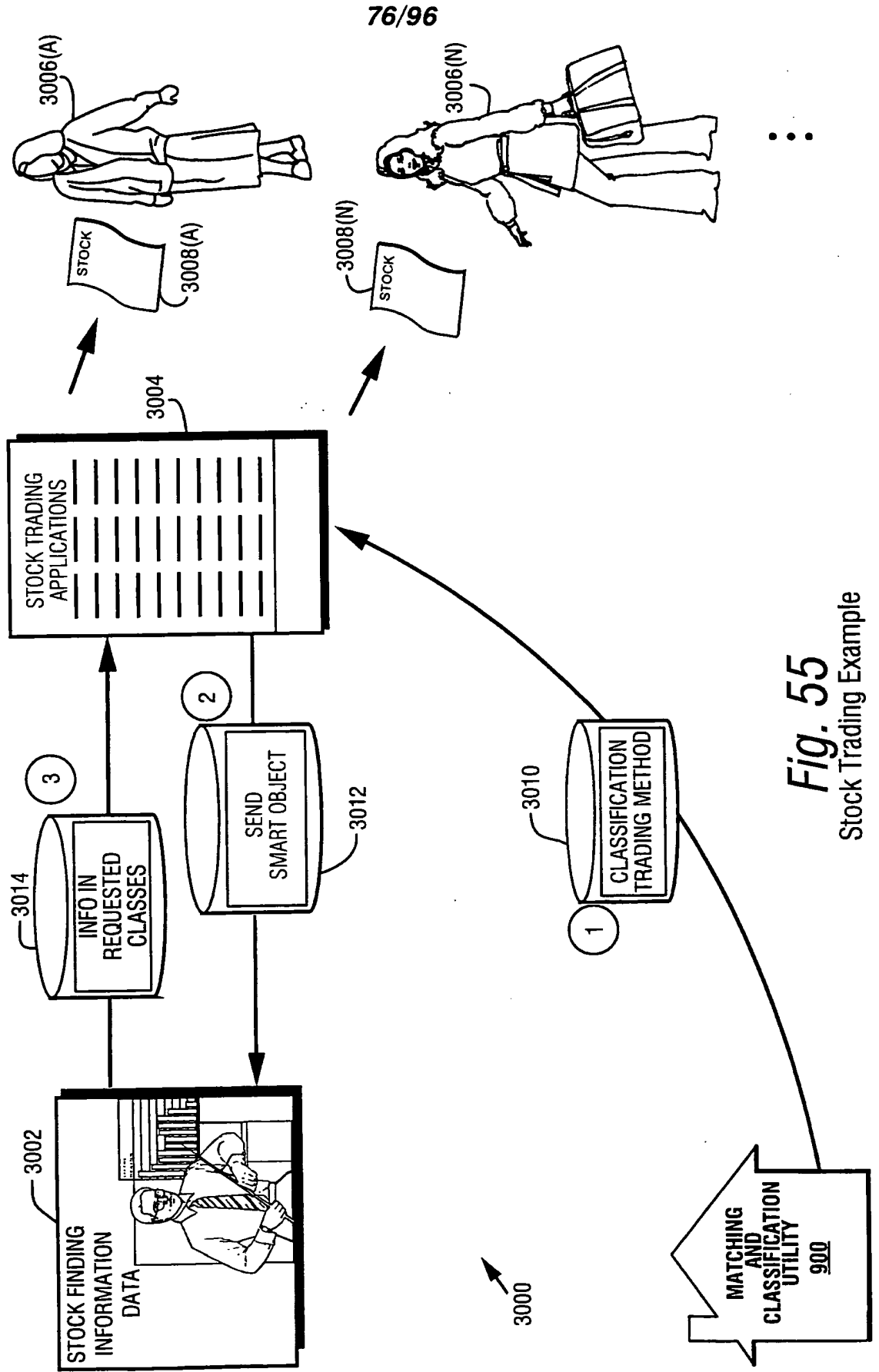

Fig. 55  
Stock Trading Example



77/96

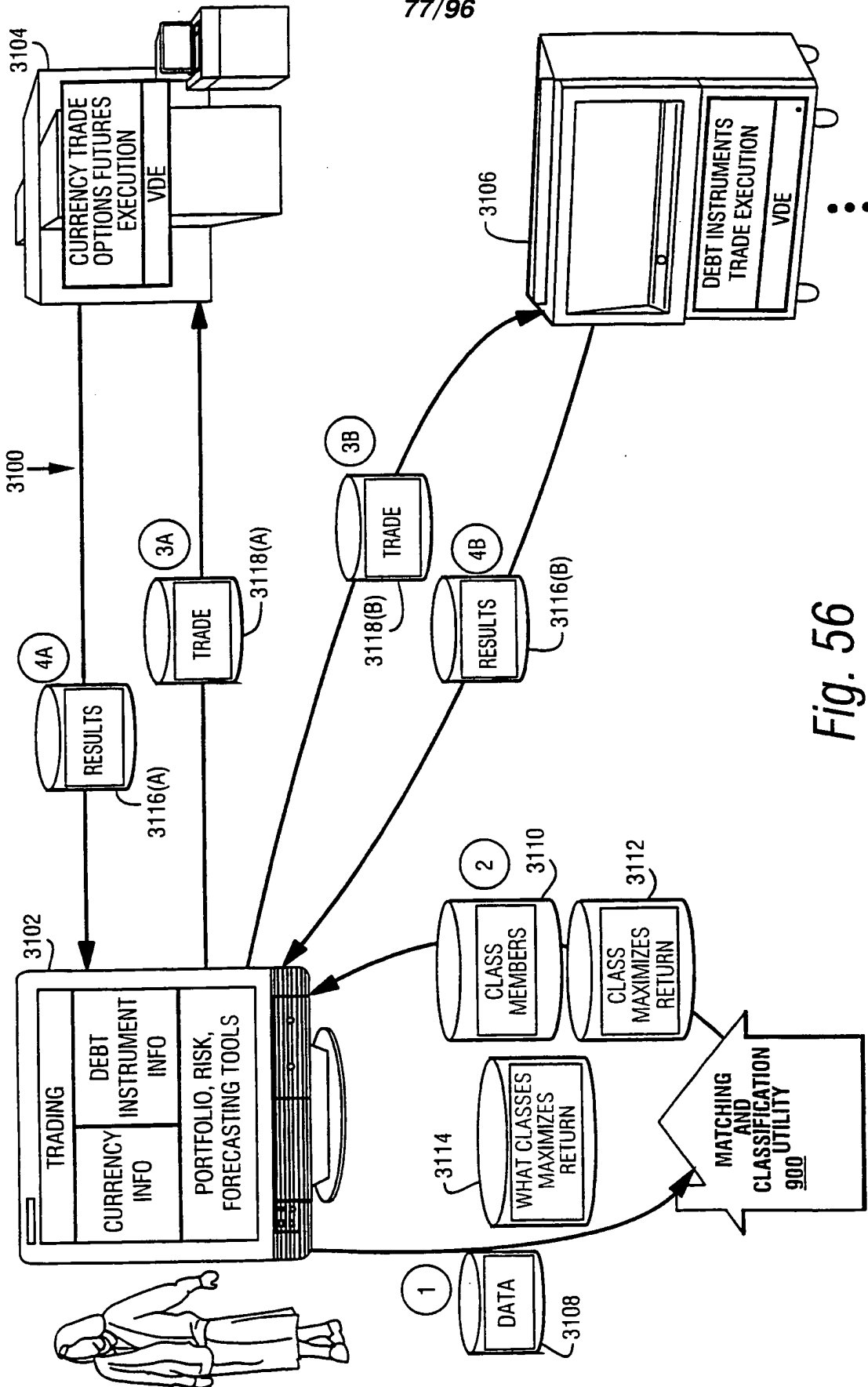
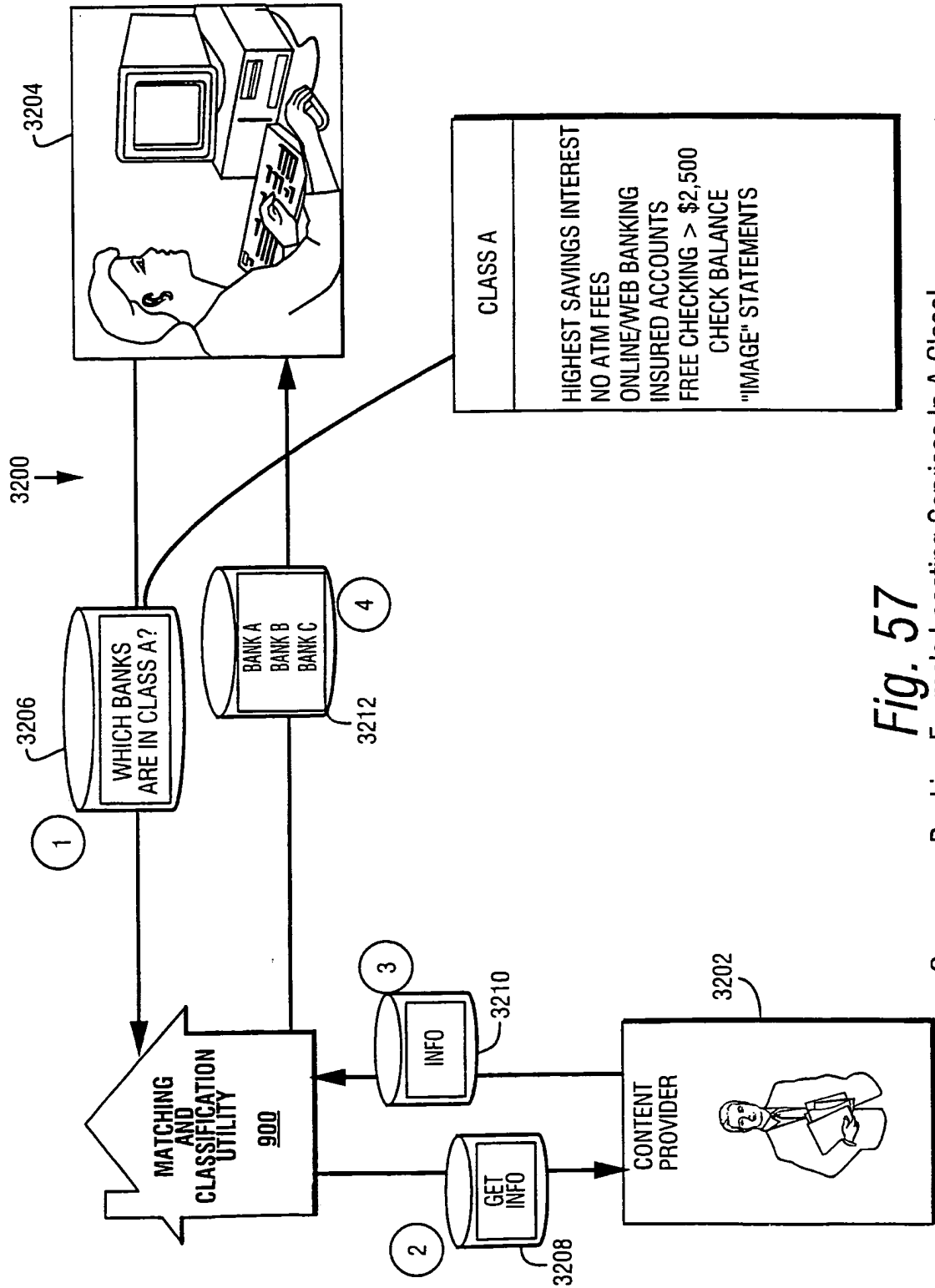

Fig. 56  
Currency Trading Example

78/96



CLASS A
HIGHEST SAVINGS INTEREST
NO ATM FEES
ONLINE/WEB BANKING
INSURED ACCOUNTS
FREE CHECKING > \$2,500
CHECK BALANCE
"IMAGE" STATEMENTS

Fig. 57

Consumer Banking Example Locating Services In A Class!

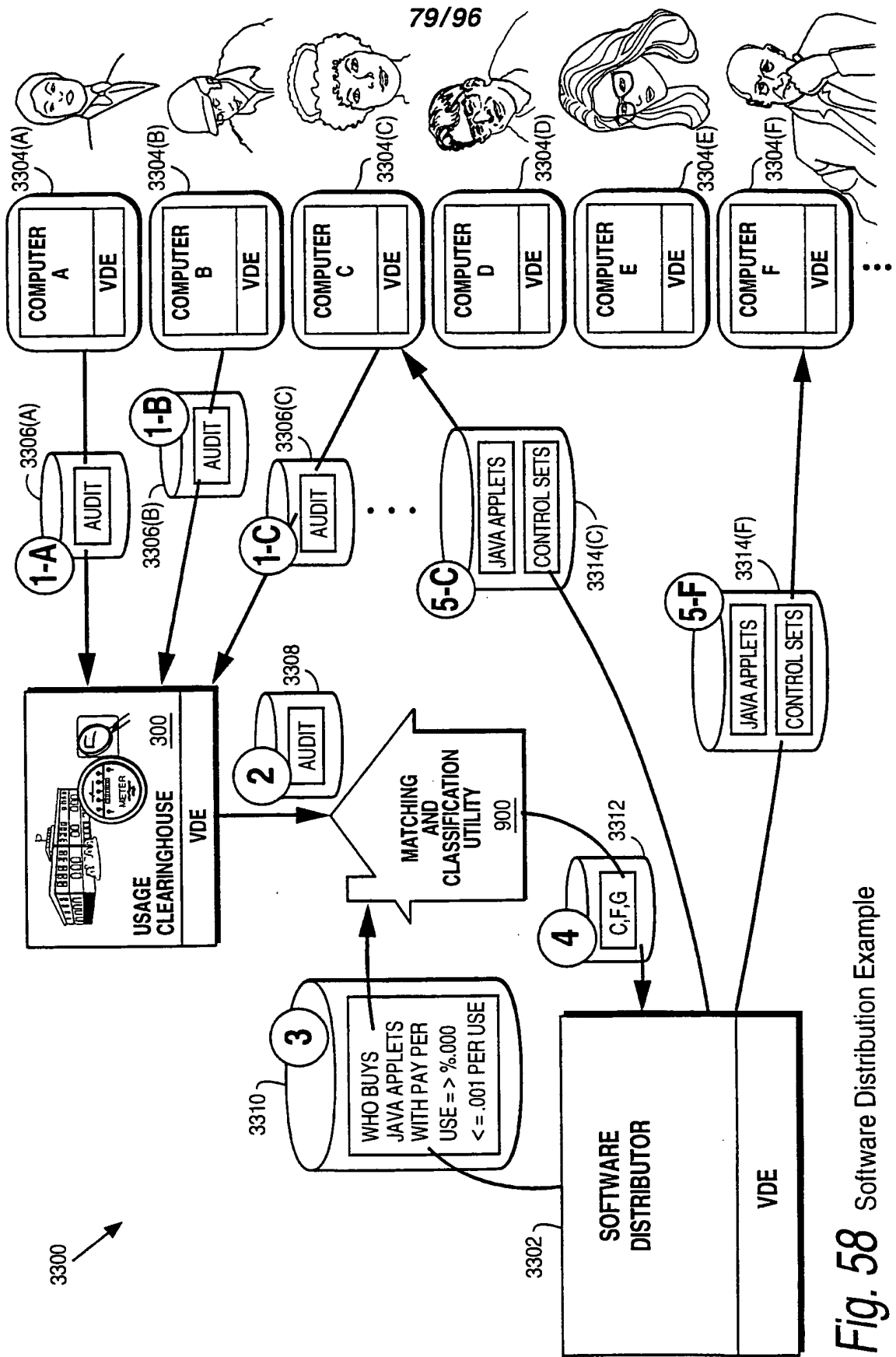

Fig. 58 Software Distribution Example

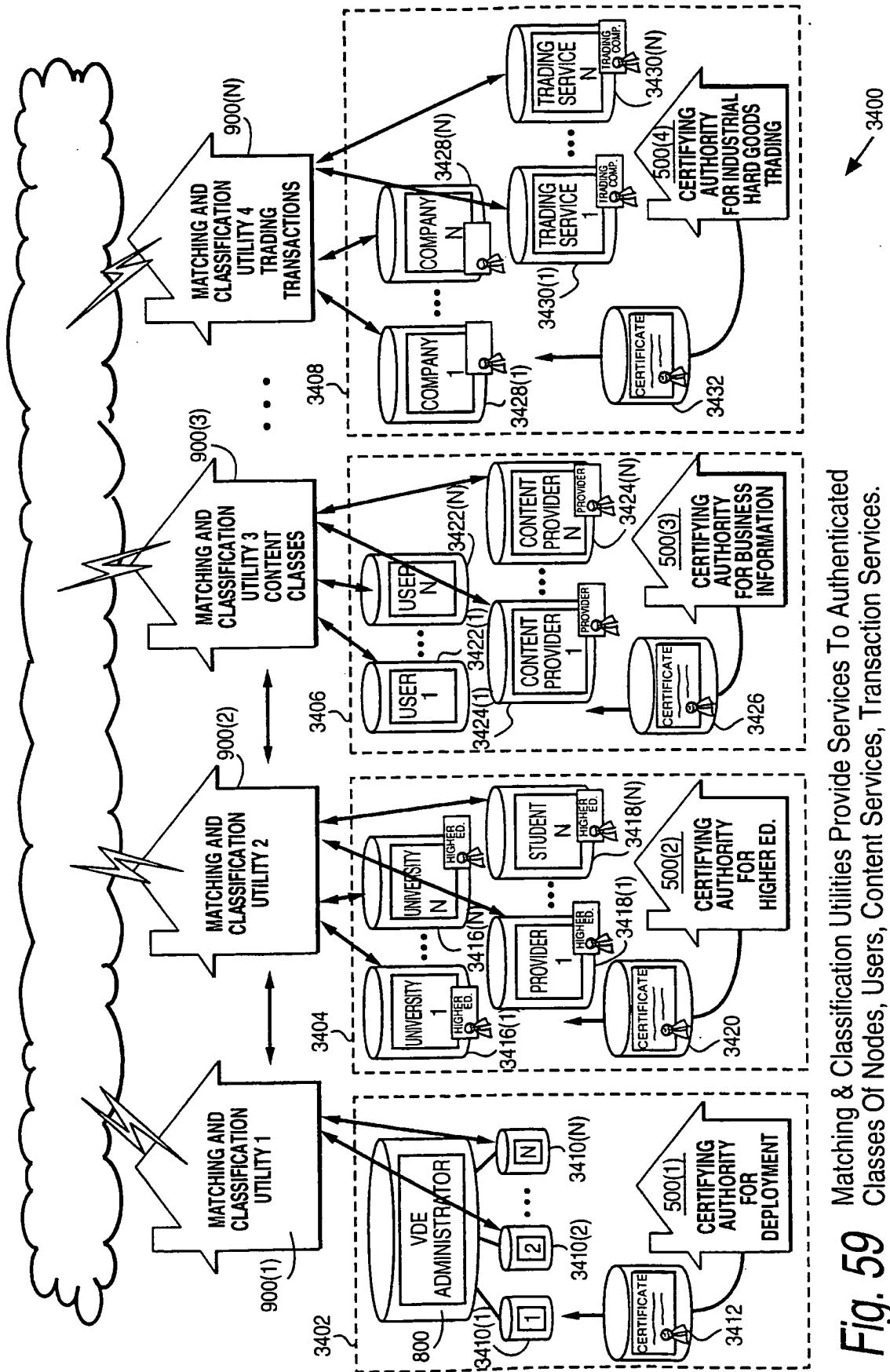
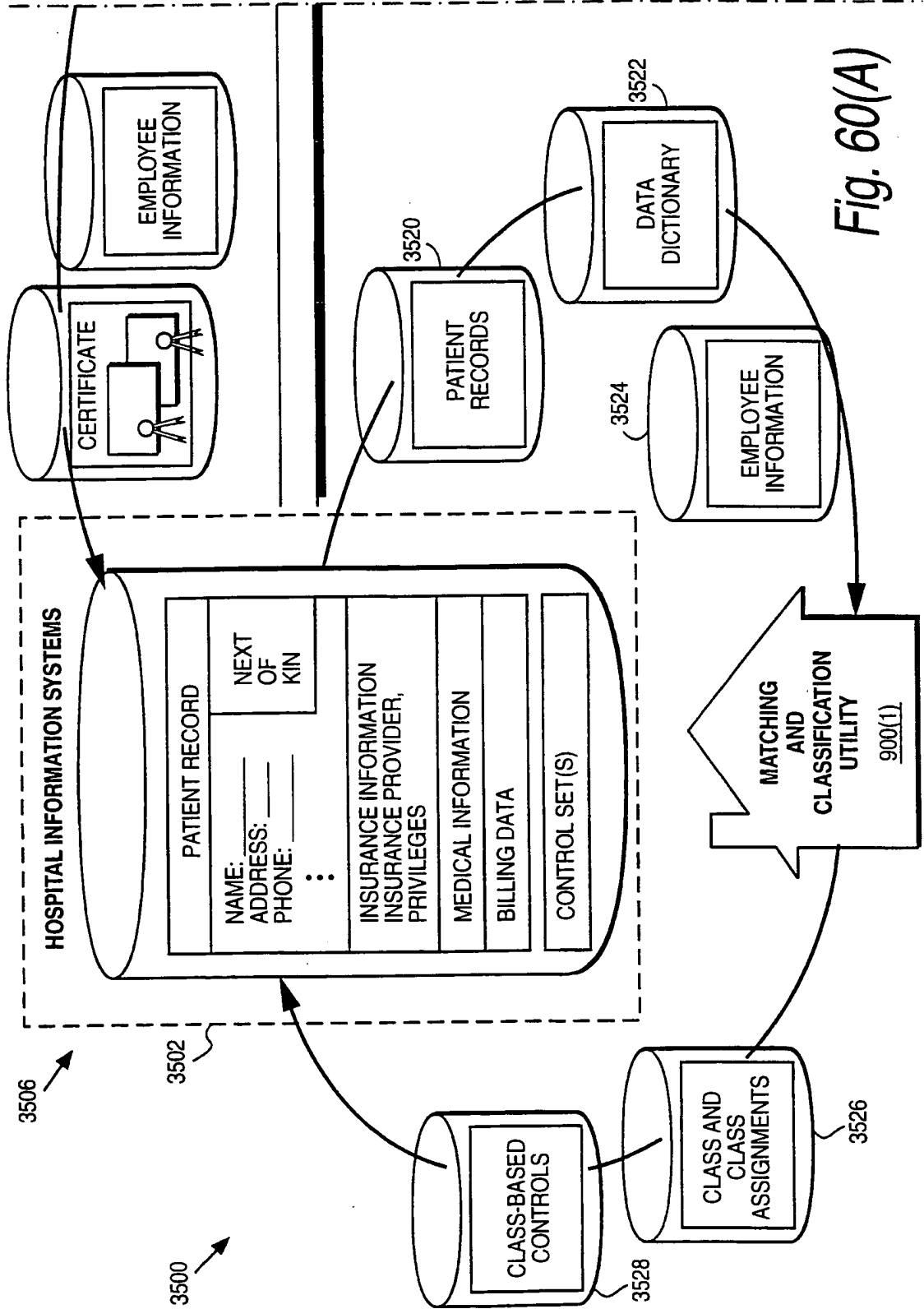

Fig. 59 Matching & Classification Utilities Provide Services To Authenticated Classes Of Nodes, Users, Content Services, Transaction Services.

81/96

TO  
FIG. 60B

TO  
FIG. 60B



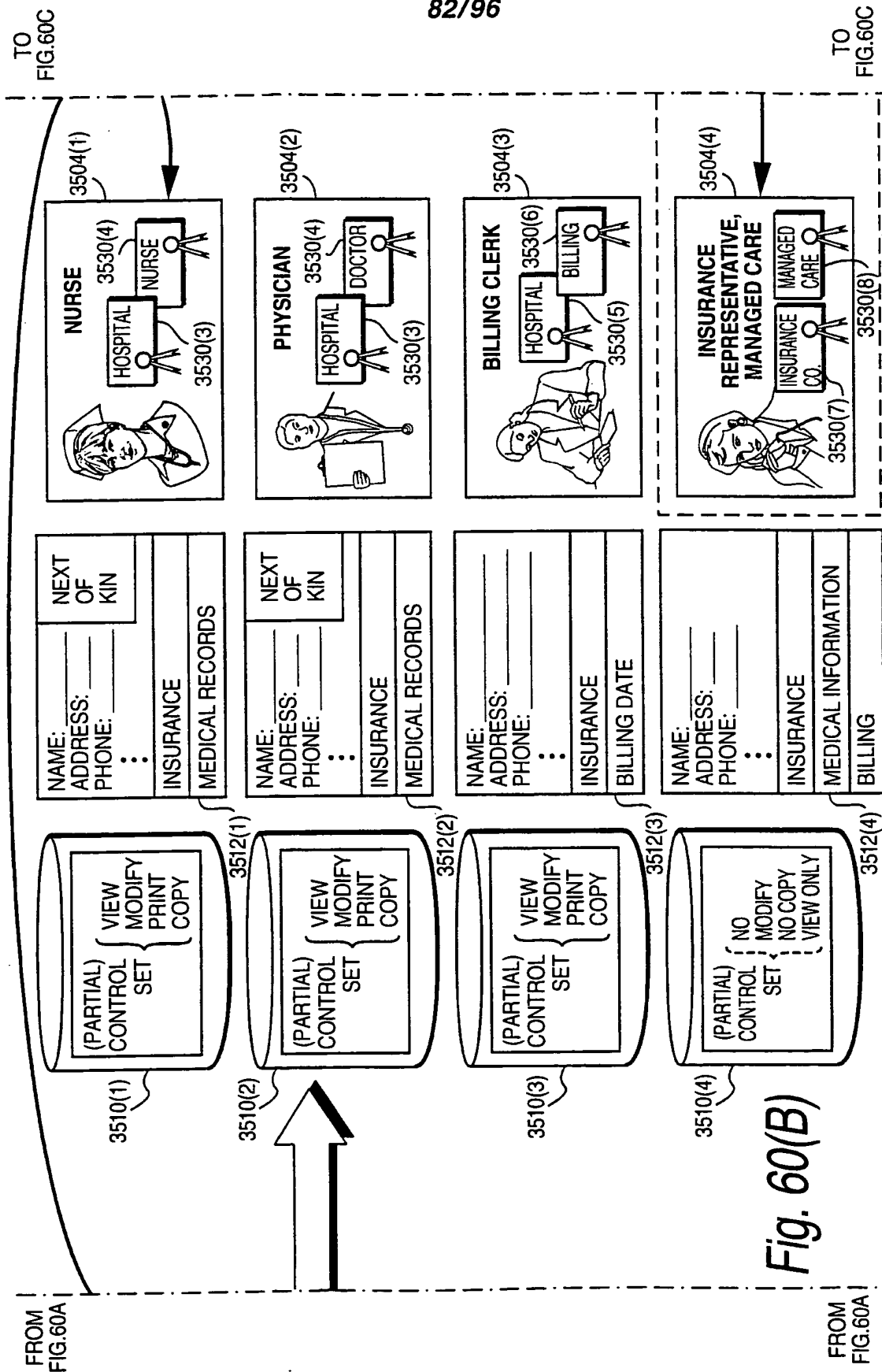

Fig. 60(B)

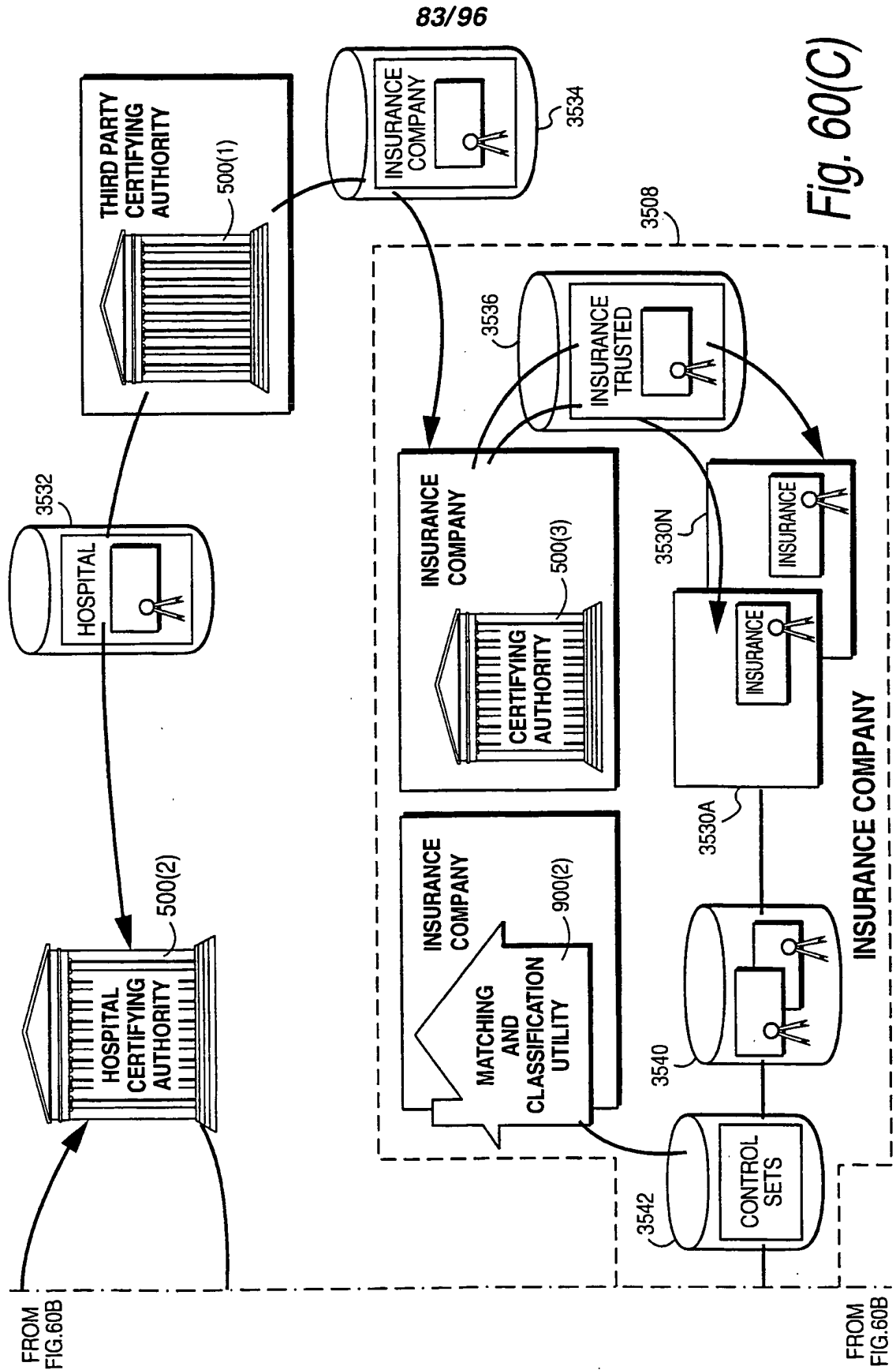

Fig. 60(C)

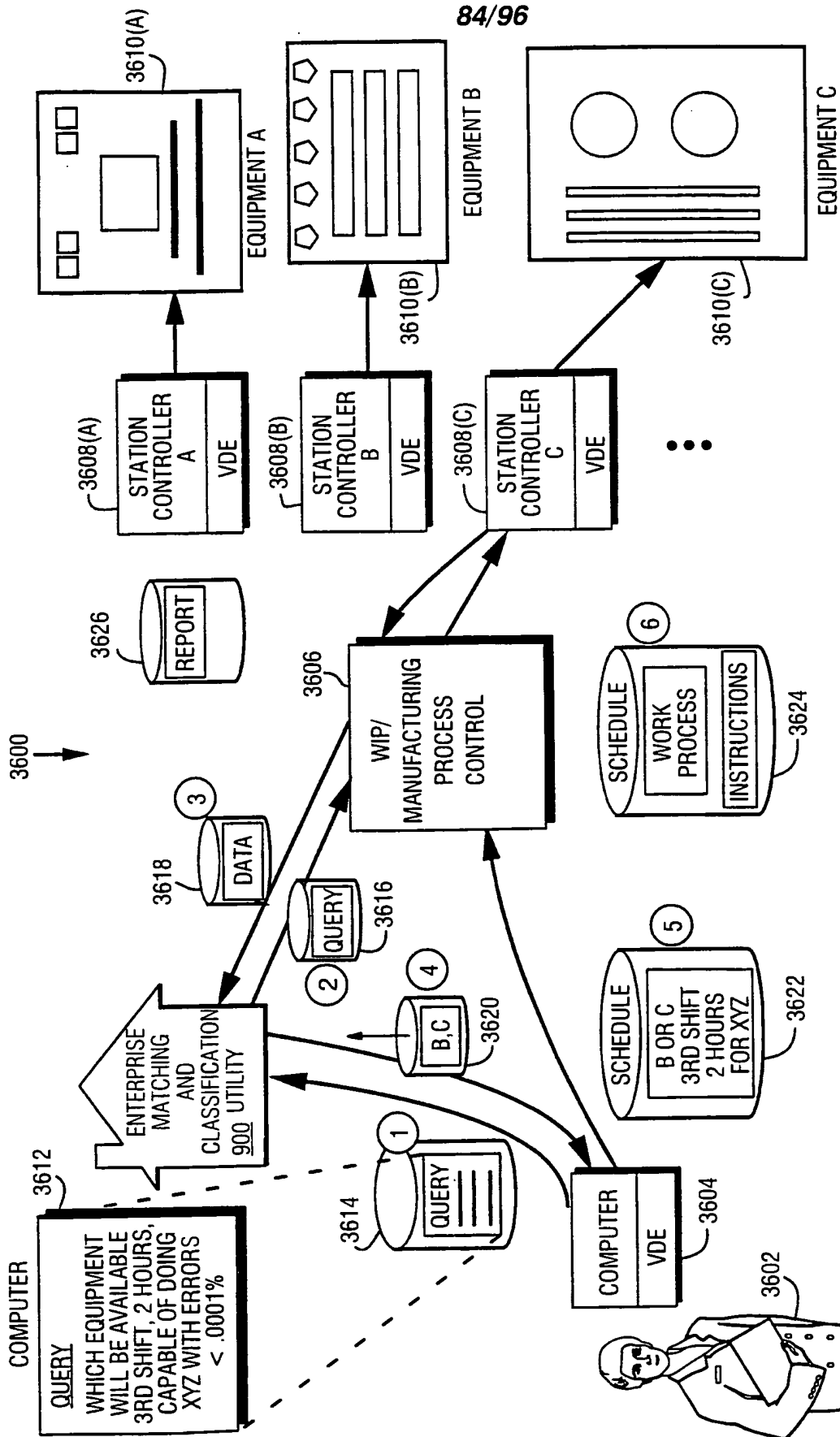
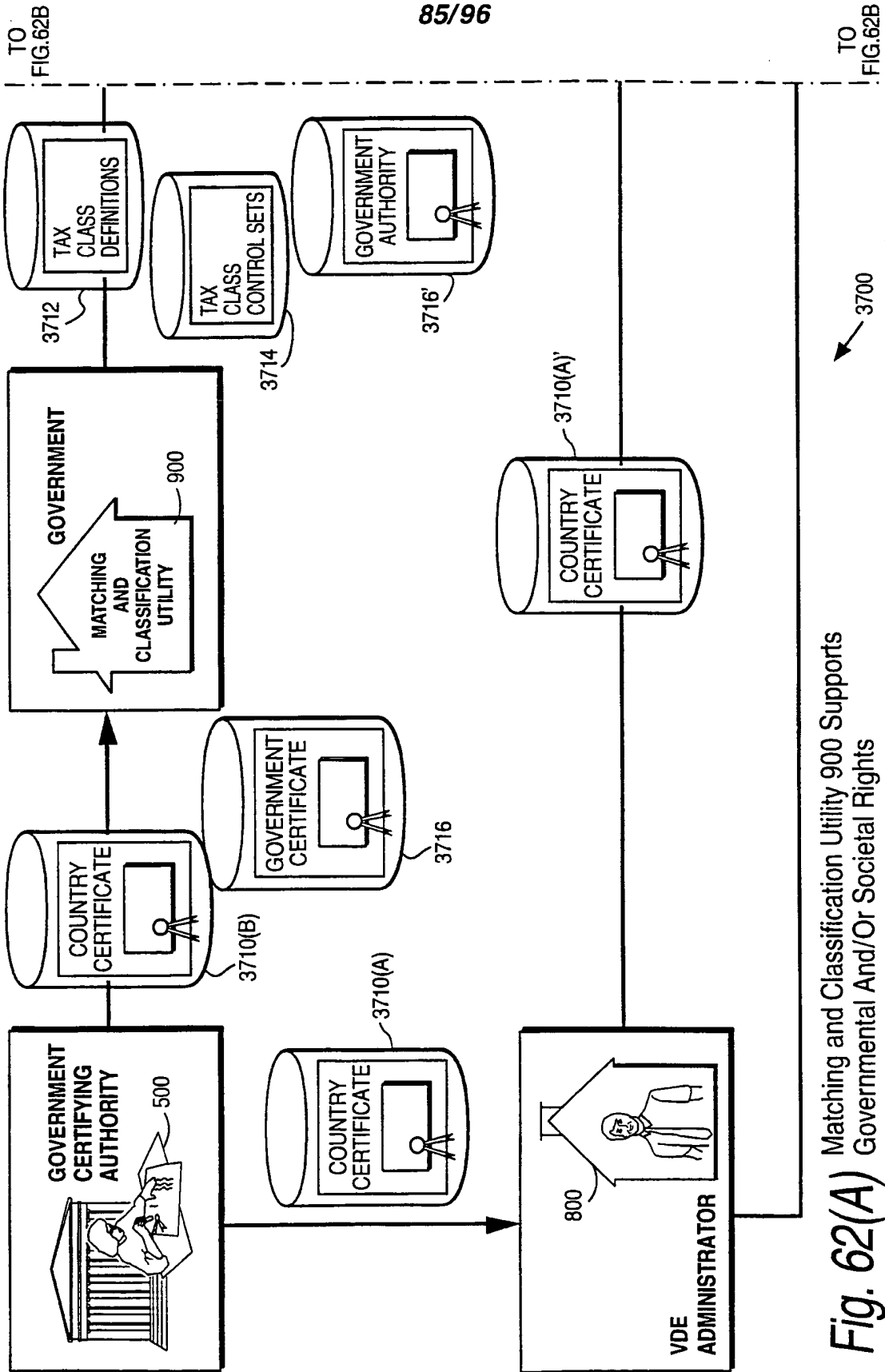

Fig. 61 Workflow Example



85/96



**Fig. 62(A)** Matching and Classification Utility 900 Supports Governmental And/Or Societal Rights

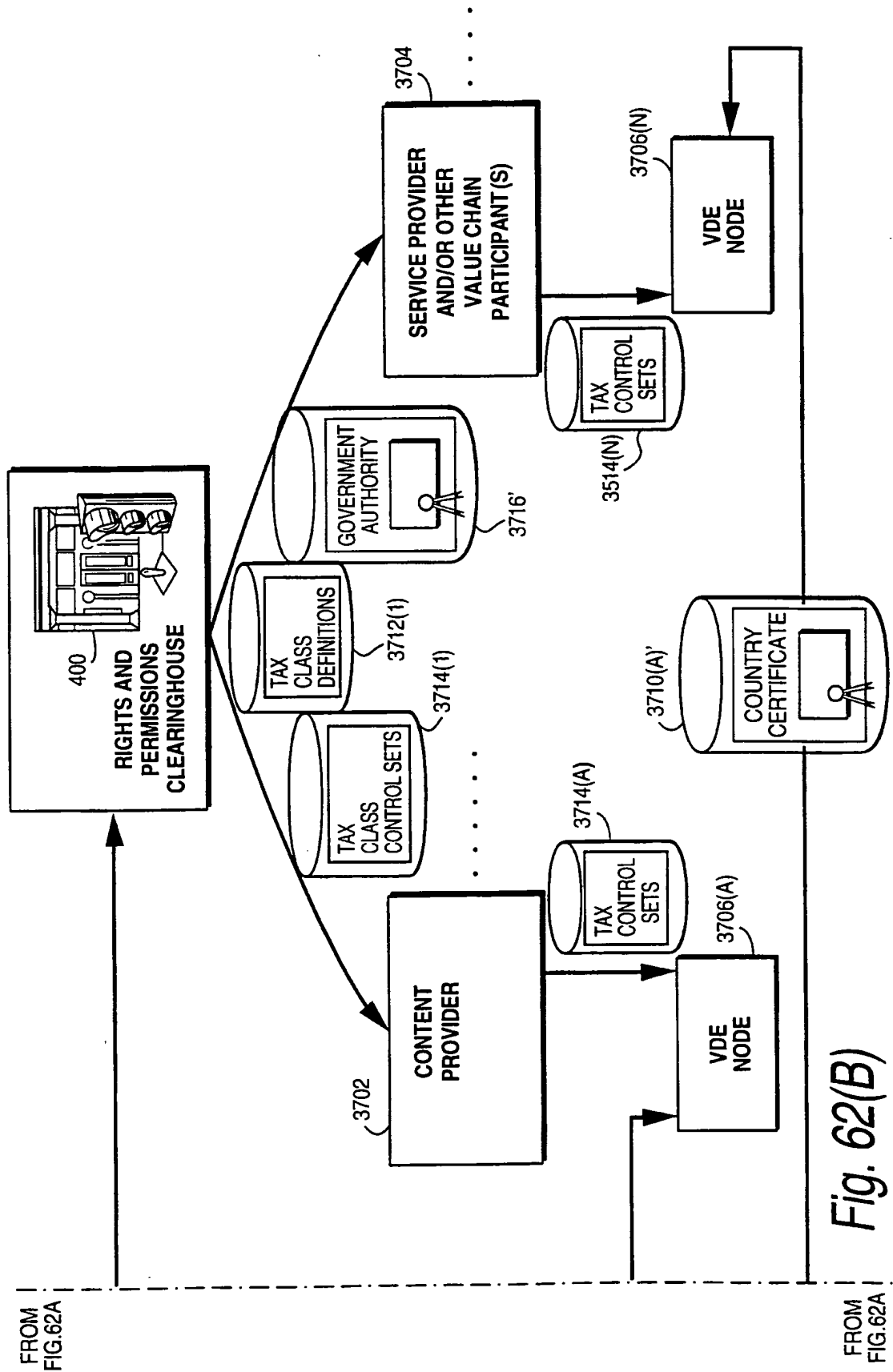

Fig. 62(B)

FROM FIG. 62A

FROM FIG. 62A

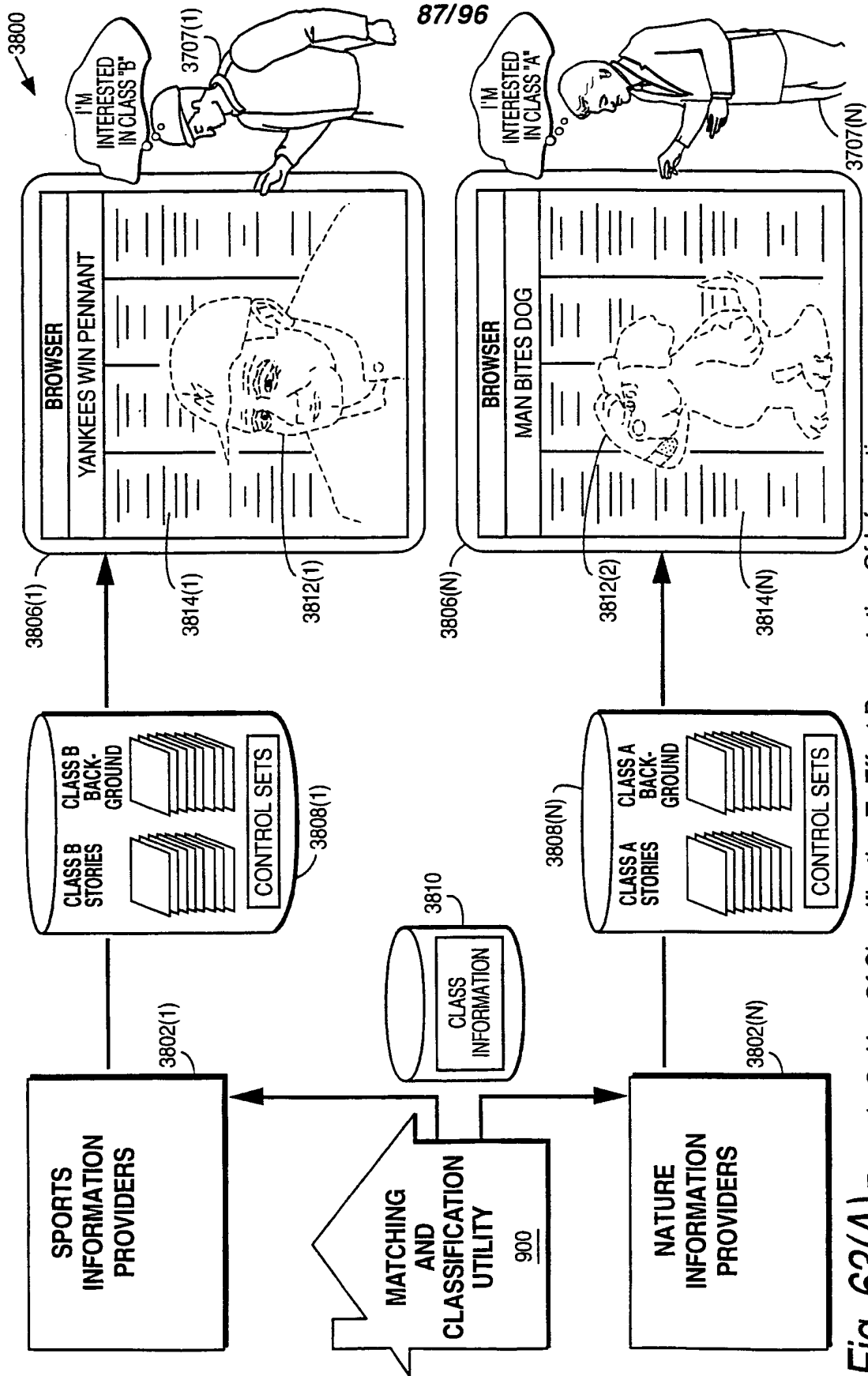
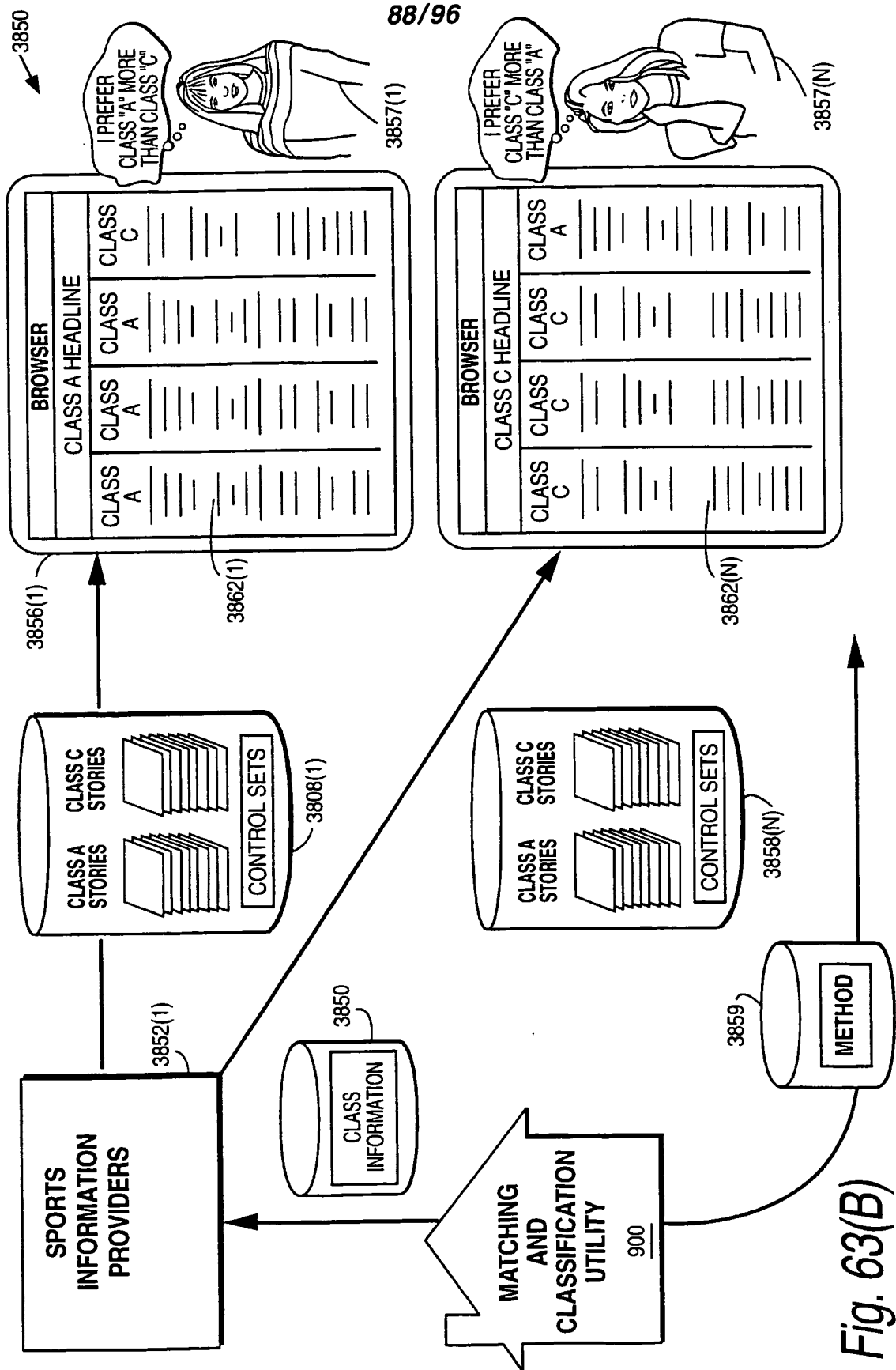

Fig. 63(A) Example Or Use Of Classification To Effect Presentation Of Information.



88/96

Fig. 63(B)

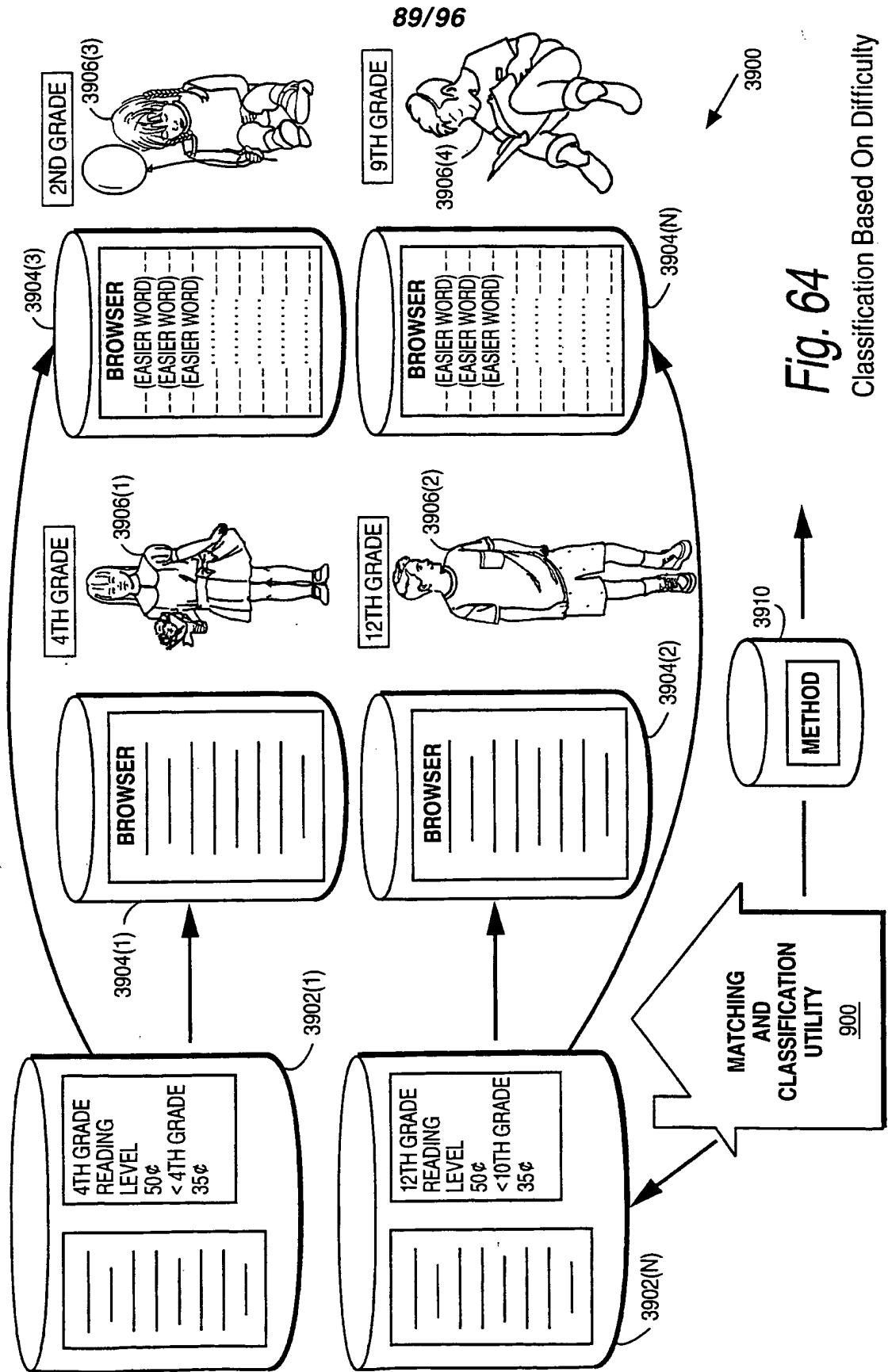

Fig. 64

Classification Based On Difficulty

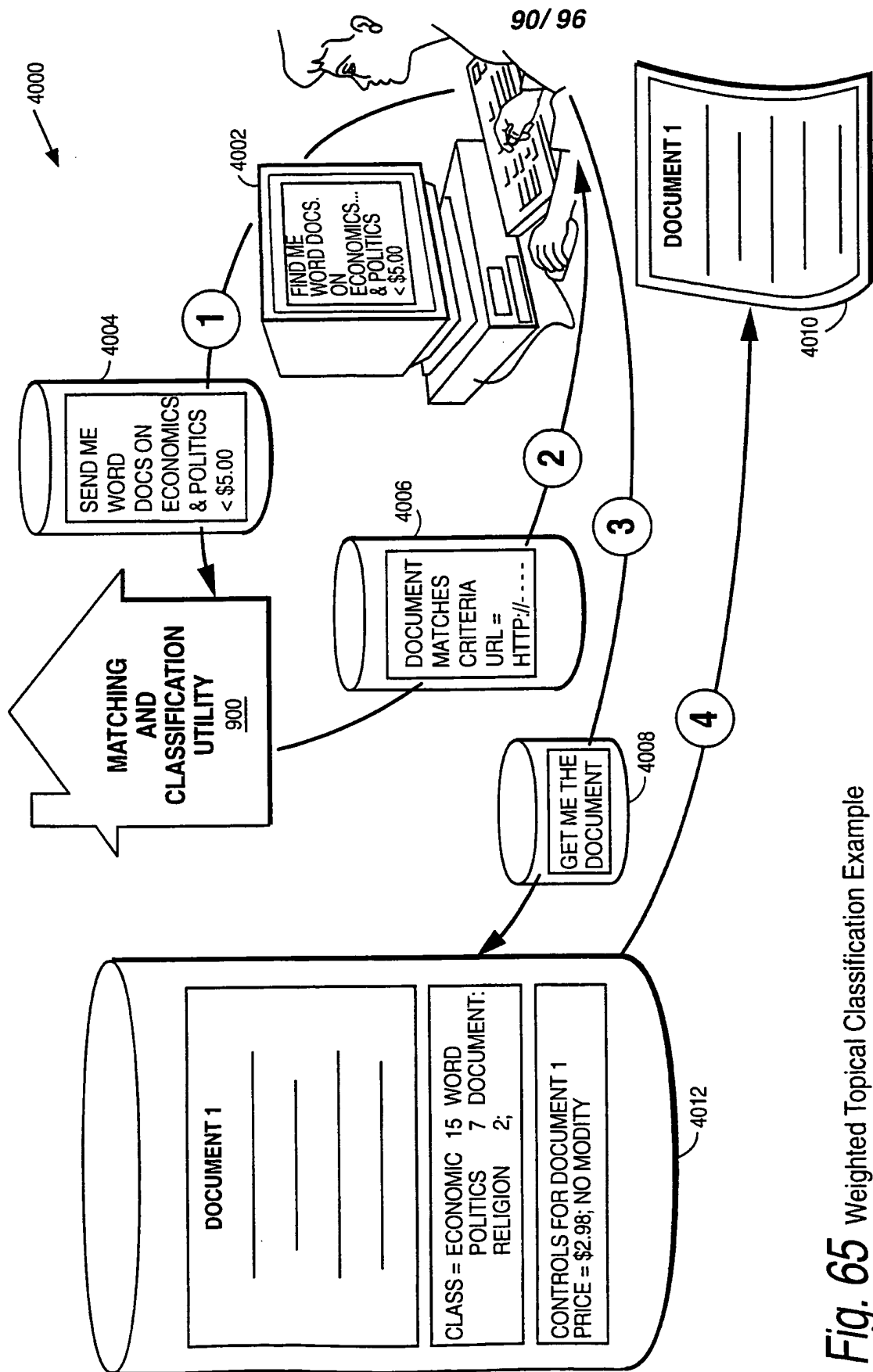

Fig. 65 Weighted Topical Classification Example

91/96

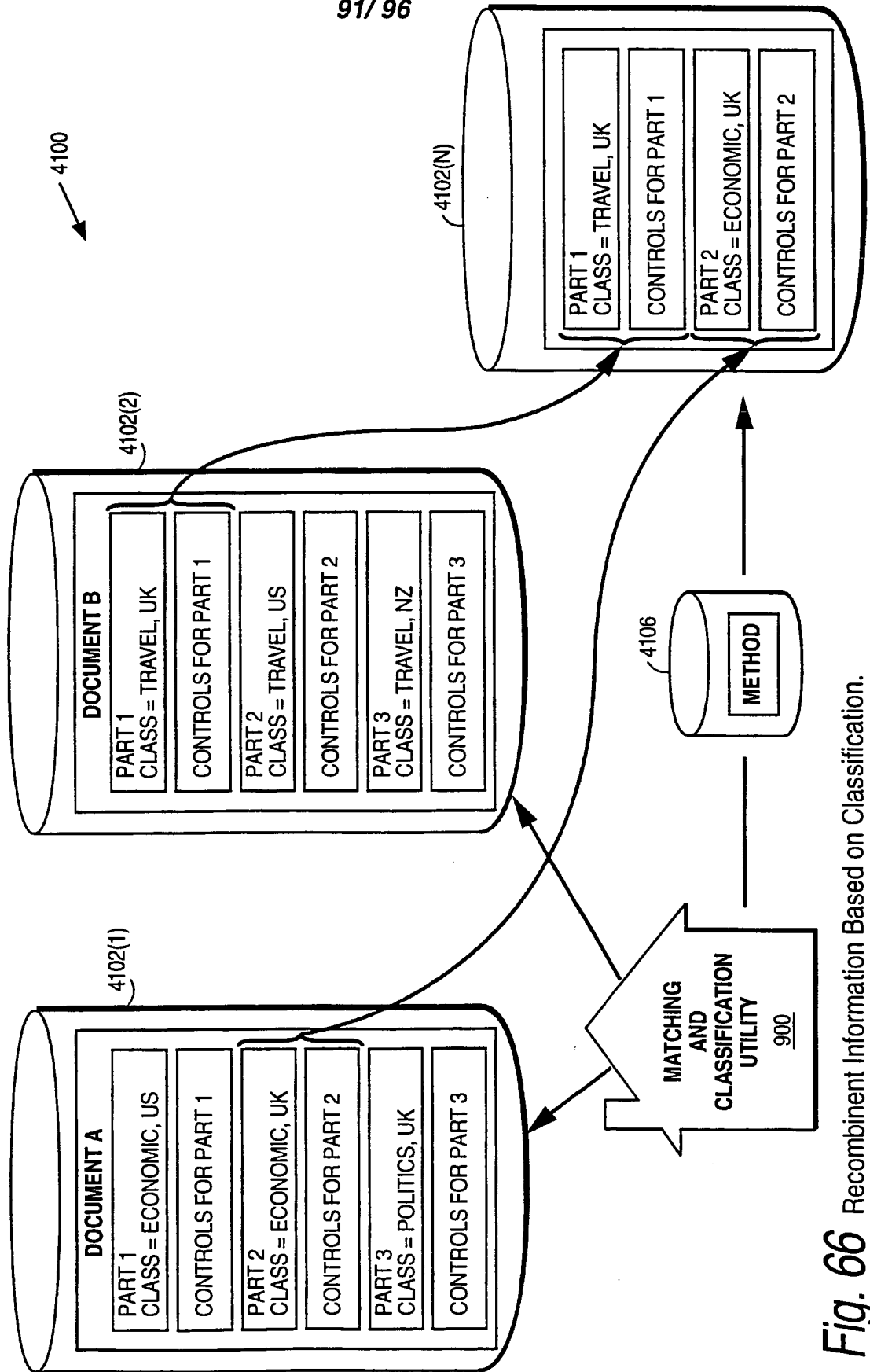

Fig. 66 Recombinant Information Based on Classification.

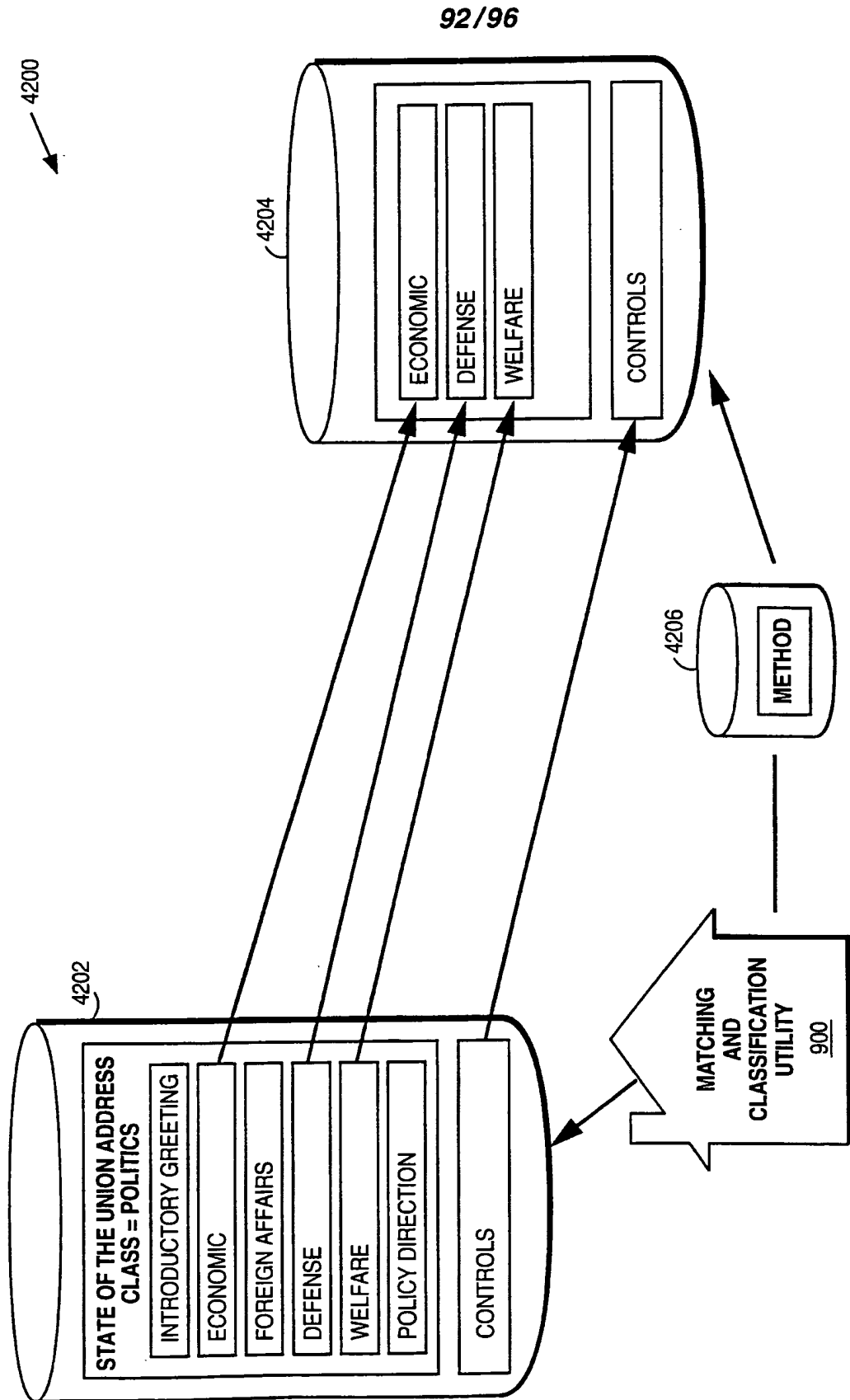
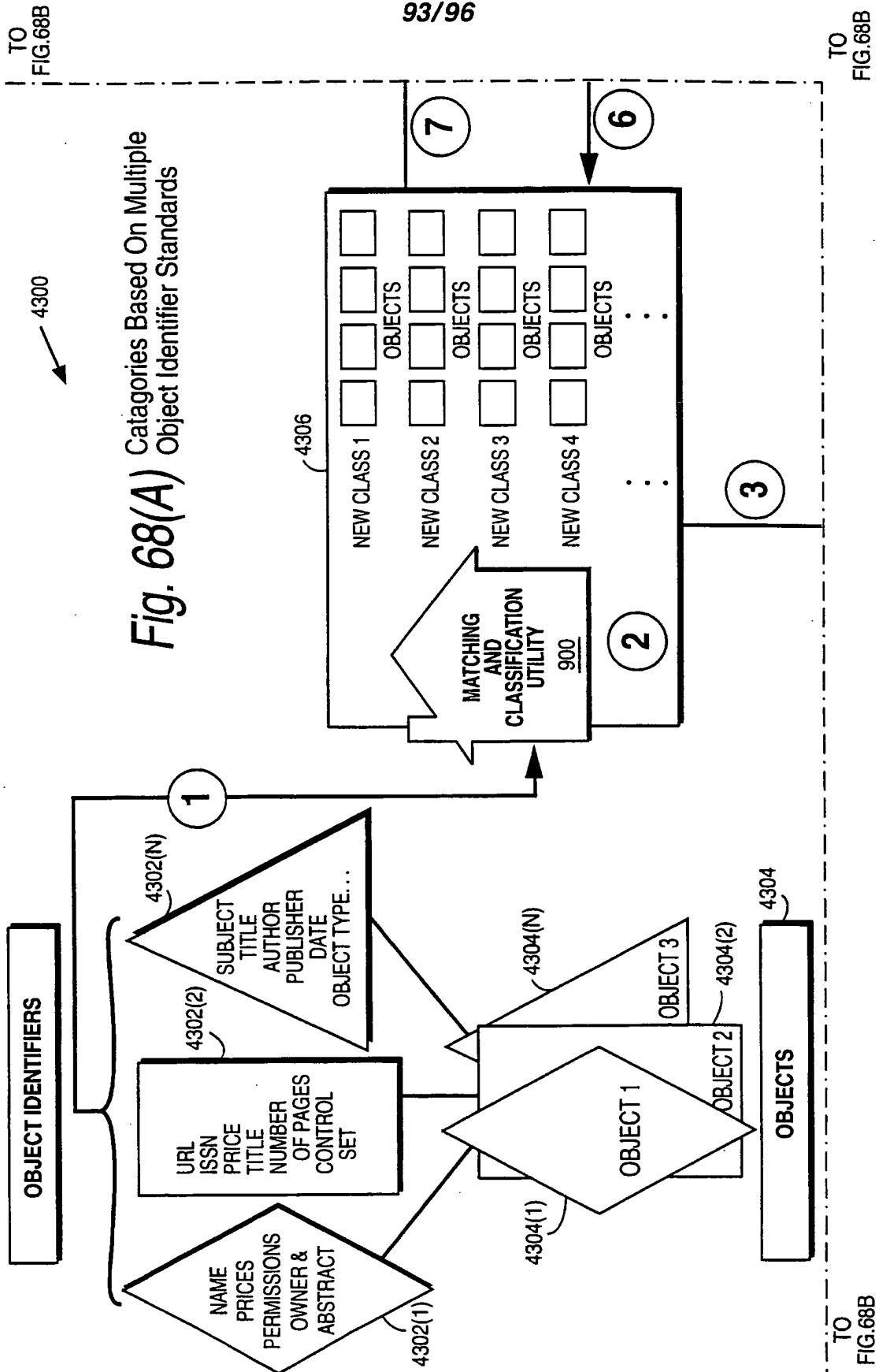

Fig. 67 Nested Classification.





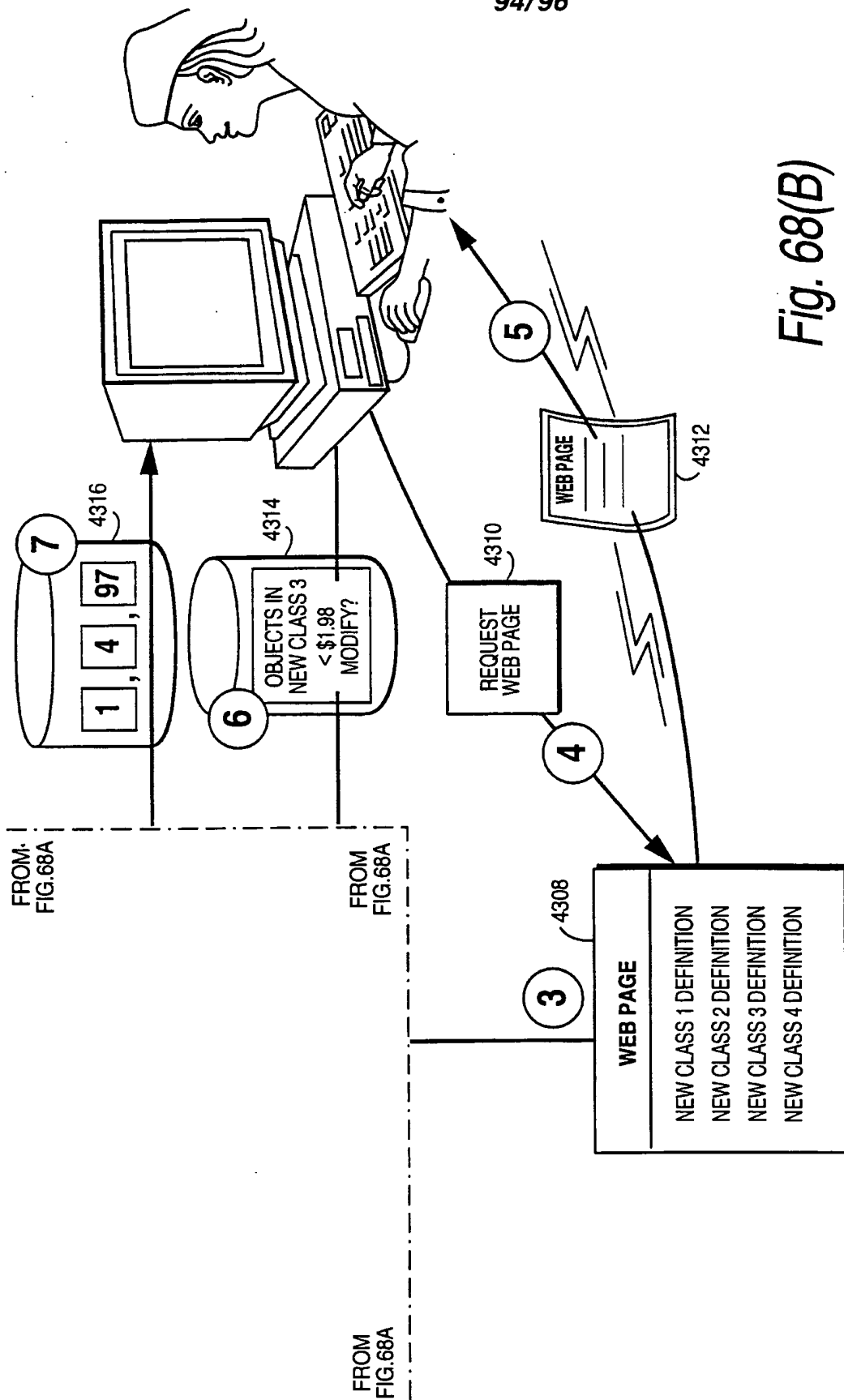

Fig. 68(B)

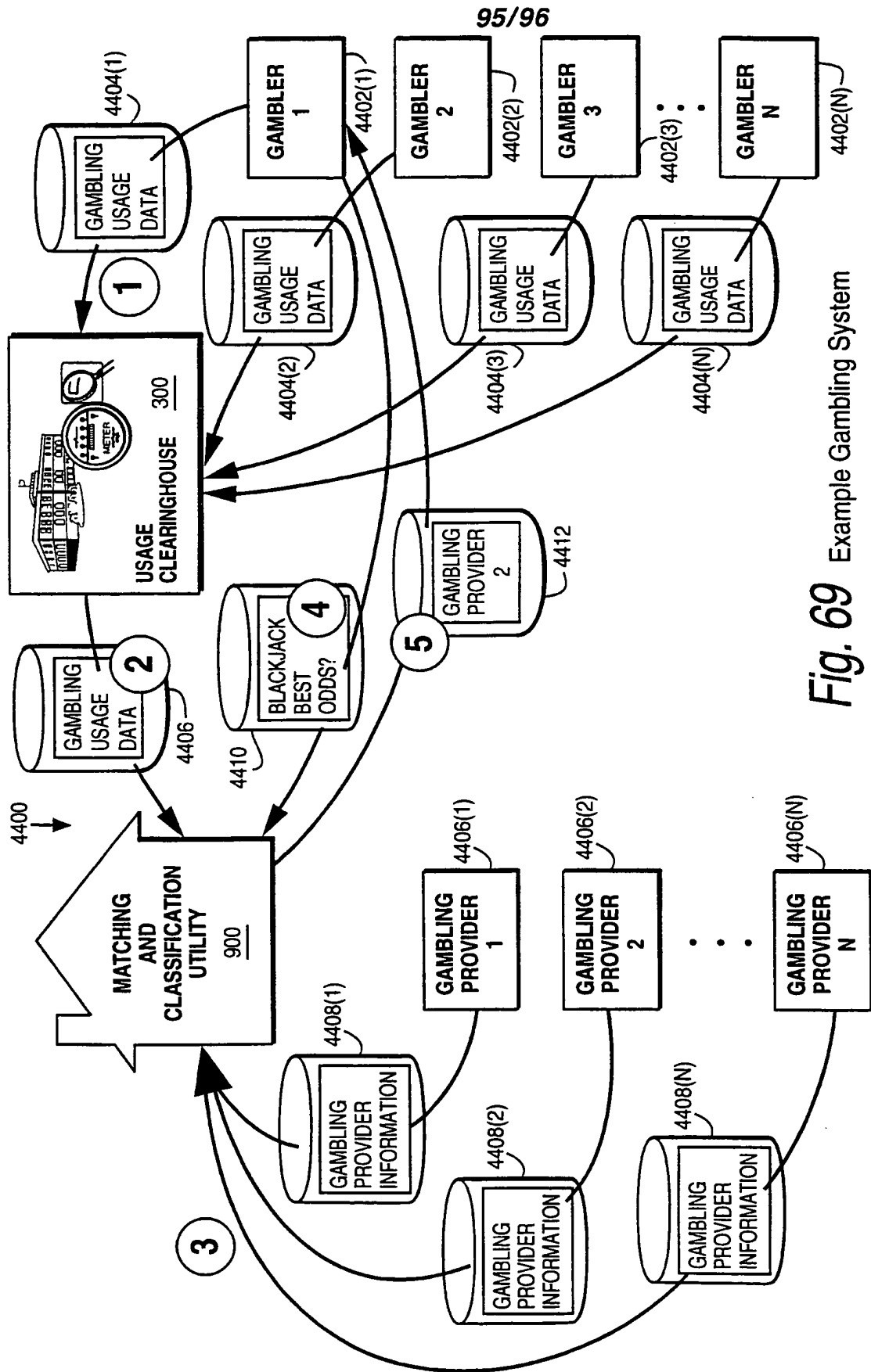

Fig. 69 Example Gambling System

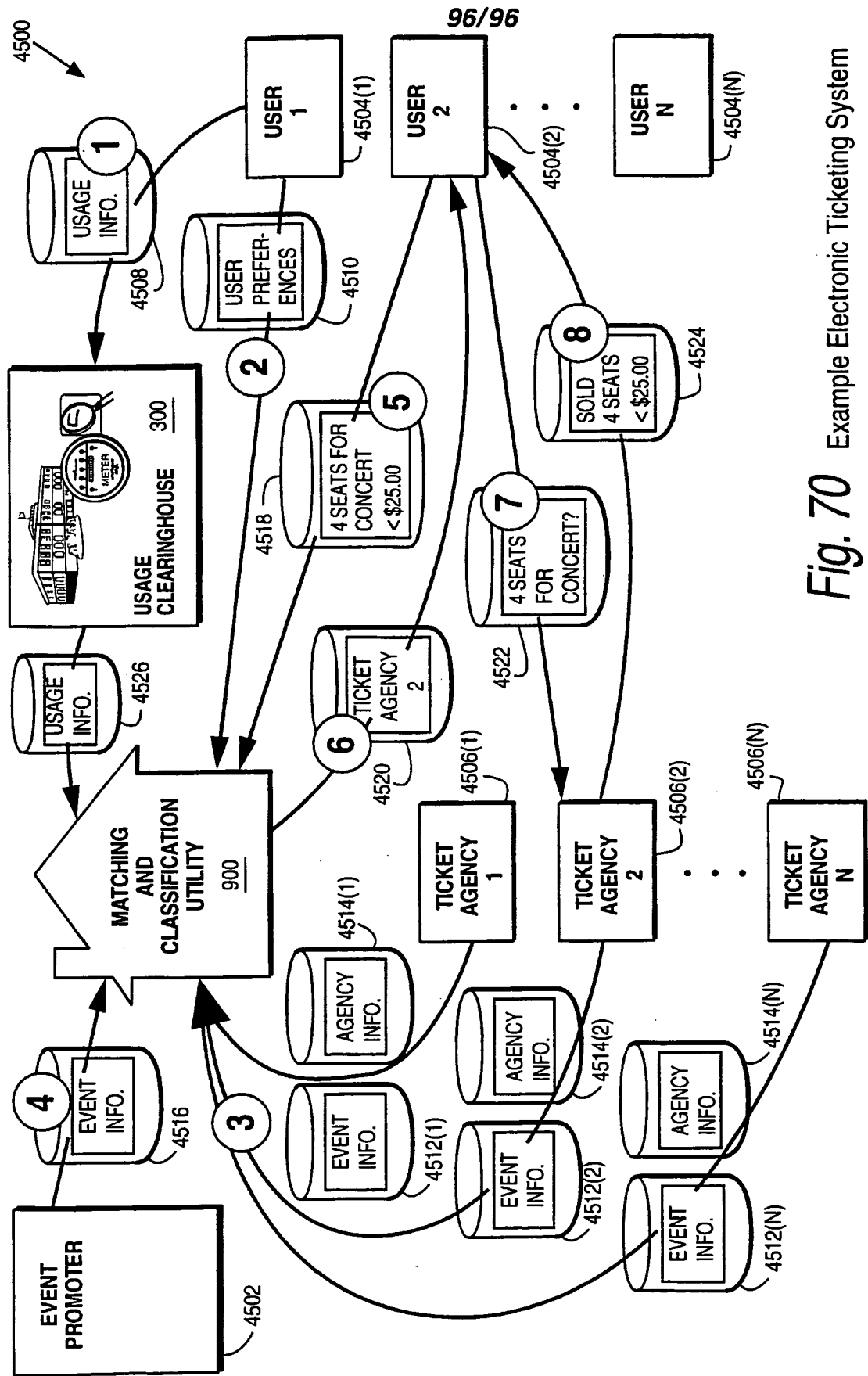



Fig. 70 Example Electronic Ticketing System

<b>Search Notes</b>  	<b>Application/Control No.</b>  10956121	<b>Applicant(s)/Patent Under Reexamination</b>  WANG ET AL.
	<b>Examiner</b>  THOMAS WEST	<b>Art Unit</b>  3621

<b>SEARCHED</b>			
<b>Class</b>	<b>Subclass</b>	<b>Date</b>	<b>Examiner</b>
705	50-79	4/3/2008	Thomas West

<b>SEARCH NOTES</b>		
<b>Search Notes</b>	<b>Date</b>	<b>Examiner</b>
EAST	4/3/2008	Thomas West

<b>INTERFERENCE SEARCH</b>			
<b>Class</b>	<b>Subclass</b>	<b>Date</b>	<b>Examiner</b>



UNITED STATES PATENT AND TRADEMARK OFFICE

UNITED STATES DEPARTMENT OF COMMERCE
United States Patent and Trademark Office
Address: COMMISSIONER FOR PATENTS
P.O. Box 1450
Alexandria, Virginia 22313-1450
www.uspto.gov

Table with 5 columns: APPLICATION NO., FILING DATE, FIRST NAMED INVENTOR, ATTORNEY DOCKET NO., CONFIRMATION NO.
10/956,121 10/04/2004 Xin Wang 111325-291300 8924

22204 7590 04/15/2008
NIXON PEABODY, LLP
401 9TH STREET, NW
SUITE 900
WASHINGTON, DC 20004-2128

EXAMINER

WEST, THOMAS C

ART UNIT PAPER NUMBER

3621

MAIL DATE DELIVERY MODE

04/15/2008

PAPER

Please find below and/or attached an Office communication concerning this application or proceeding.

The time period for reply, if any, is set in the attached communication.

<b>Office Action Summary</b>	<b>Application No.</b> 10/956,121	<b>Applicant(s)</b> WANG ET AL.	
	<b>Examiner</b> THOMAS WEST	<b>Art Unit</b> 3621	

-- The MAILING DATE of this communication appears on the cover sheet with the correspondence address --

**Period for Reply**

A SHORTENED STATUTORY PERIOD FOR REPLY IS SET TO EXPIRE 3 MONTH(S) OR THIRTY (30) DAYS, WHICHEVER IS LONGER, FROM THE MAILING DATE OF THIS COMMUNICATION.

- Extensions of time may be available under the provisions of 37 CFR 1.136(a). In no event, however, may a reply be timely filed after SIX (6) MONTHS from the mailing date of this communication.
- If NO period for reply is specified above, the maximum statutory period will apply and will expire SIX (6) MONTHS from the mailing date of this communication.
- Failure to reply within the set or extended period for reply will, by statute, cause the application to become ABANDONED (35 U.S.C. § 133). Any reply received by the Office later than three months after the mailing date of this communication, even if timely filed, may reduce any earned patent term adjustment. See 37 CFR 1.704(b).

**Status**

- 1)  Responsive to communication(s) filed on 04 October 2004.
- 2a)  This action is **FINAL**.                      2b)  This action is non-final.
- 3)  Since this application is in condition for allowance except for formal matters, prosecution as to the merits is closed in accordance with the practice under *Ex parte Quayle*, 1935 C.D. 11, 453 O.G. 213.

**Disposition of Claims**

- 4)  Claim(s) 1-36 is/are pending in the application.  
4a) Of the above claim(s) \_\_\_\_\_ is/are withdrawn from consideration.
- 5)  Claim(s) \_\_\_\_\_ is/are allowed.
- 6)  Claim(s) 1-36 is/are rejected.
- 7)  Claim(s) \_\_\_\_\_ is/are objected to.
- 8)  Claim(s) \_\_\_\_\_ are subject to restriction and/or election requirement.

**Application Papers**

- 9)  The specification is objected to by the Examiner.
- 10)  The drawing(s) filed on \_\_\_\_\_ is/are: a)  accepted or b)  objected to by the Examiner.  
Applicant may not request that any objection to the drawing(s) be held in abeyance. See 37 CFR 1.85(a).  
Replacement drawing sheet(s) including the correction is required if the drawing(s) is objected to. See 37 CFR 1.121(d).
- 11)  The oath or declaration is objected to by the Examiner. Note the attached Office Action or form PTO-152.

**Priority under 35 U.S.C. § 119**

- 12)  Acknowledgment is made of a claim for foreign priority under 35 U.S.C. § 119(a)-(d) or (f).  
a)  All    b)  Some \*    c)  None of:
1.  Certified copies of the priority documents have been received.
2.  Certified copies of the priority documents have been received in Application No. \_\_\_\_\_.
3.  Copies of the certified copies of the priority documents have been received in this National Stage application from the International Bureau (PCT Rule 17.2(a)).

\* See the attached detailed Office action for a list of the certified copies not received.

**Attachment(s)**

- |   |   |
|---|---|
| 1) <input checked="" type="checkbox"/> Notice of References Cited (PTO-892)   | 4) <input type="checkbox"/> Interview Summary (PTO-413)<br>Paper No(s)/Mail Date. _____ |
| 2) <input type="checkbox"/> Notice of Draftsperson's Patent Drawing Review (PTO-948)  | 5) <input type="checkbox"/> Notice of Informal Patent Application                       |
| 3) <input checked="" type="checkbox"/> Information Disclosure Statement(s) (PTO/SB/08)<br>Paper No(s)/Mail Date <u>1-26-05, 8-4-05, 2-19-08</u> . | 6) <input type="checkbox"/> Other: _____  |

## **DETAILED ACTION**

### ***Status of Claims***

1. This action is in reply to the US Application filed October 4, 2004.
2. Claims 1-36 are currently pending and have been examined.

### ***Information Disclosure Statement***

3. The Information Disclosure Statements filed on January 26, 2005, August 4, 2005, and February 19, 2008 have been considered. Initialed copies of Form 1449 are enclosed herewith.

### ***Double Patenting***

4. The nonstatutory double patenting rejection is based on a judicially created doctrine grounded in public policy (a policy reflected in the statute) so as to prevent the unjustified or improper timewise extension of the "right to exclude" granted by a patent and to prevent possible harassment by multiple assignees. A nonstatutory obviousness-type double patenting rejection is appropriate where the conflicting claims are not identical, but at least one examined application claim is not patentably distinct from the reference claim(s) because the examined application claim is either anticipated by, or would have been obvious over, the reference claim(s). See, e.g., *In re Berg*, 140 F.3d 1428, 46 USPQ2d 1226 (Fed. Cir. 1998); *In re Goodman*, 11 F.3d 1046, 29 USPQ2d 2010 (Fed. Cir. 1993); *In re Longi*, 759 F.2d 887, 225 USPQ 645 (Fed. Cir. 1985); *In re Van Ornum*, 686 F.2d 937, 214 USPQ 761 (CCPA 1982); *In re Vogel*, 422



F.2d 438, 164 USPQ 619 (CCPA 1970); and *In re Thorington*, 418 F.2d 528, 163 USPQ 644 (CCPA 1969).

A timely filed terminal disclaimer in compliance with 37 CFR 1.321(c) or 1.321(d) may be used to overcome an actual or provisional rejection based on a nonstatutory double patenting ground provided the conflicting application or patent either is shown to be commonly owned with this application, or claims an invention made as a result of activities undertaken within the scope of a joint research agreement.

Effective January 1, 1994, a registered attorney or agent of record may sign a terminal disclaimer. A terminal disclaimer signed by the assignee must fully comply with 37 CFR 3.73(b).

Claims 1-36 are provisionally rejected on the ground of nonstatutory double patenting over claim 6 of copending Application No. 10162701. This is a provisional double patenting rejection since the conflicting claims have not yet been patented.

The subject matter claimed in the instant application is fully disclosed in the referenced copending application and would be covered by any patent granted on that copending application since the referenced copending application and the instant application are claiming common subject matter, as follows: meta-rights, derived rights, rights transfer, generating a license.

Furthermore, there is no apparent reason why applicant would be prevented from presenting claims corresponding to those of the instant application in the other copending application. See *In re Schneller*, 397 F.2d 350, 158 USPQ 210 (CCPA 1968). See also MPEP § 804.

***Claim Rejections - 35 USC § 103***

5. The following is a quotation of 35 U.S.C. 103(a) which forms the basis for all obviousness rejections set forth in this Office action:

(a) A patent may not be obtained though the invention is not identically disclosed or described as set forth in section 102 of this title, if the differences between the subject matter sought to be patented and the prior art are such that the subject matter as a whole would have been obvious at the time the invention was made to a person having ordinary skill in the art to which said subject matter pertains. Patentability shall not be negated by the manner in which the invention was made.

6. Claims 1-36 are rejected under U.S.C. 103(a) as being unpatentable over Anand, US Patent No. 6,044,466 (Anand), in view of Workshop on Digital Rights Management, Minutes from Architecture/Infrastructure Session (Infrastructure).

**Claims 1, 12, 24:**

Anand, as shown, discloses the following limitations:

obtaining a set of rights associated with an item, the set of rights including meta-rights specifying derivable rights that can be derived from the meta-rights (see column 3, line 15-31, column 5, lines 17-23, column 5, lines 1-16)

determining whether the rights consumer is entitled to the derivable rights specified by the meta-rights (see column 5, line 14-21)

deriving at least one right from the derivable rights, if the rights consumer is entitled to the derivable rights specified by the meta-rights, wherein the derived right includes at least one state variable based on the set of rights and used for determining a state of the derived right (see column 5, line 1-16)

Anand discloses the limitations as shown above. Anand does not directly disclose a state variable (state machine), but Infrastructure does (page 8, paragraph 3)

It would have been obvious to one of ordinary skill in the art at the time of the invention to modify Anand to include the state machine of Infrastructure since this provides a dynamic structure that can express dynamic rights relationships.

**Claims 2, 13, 25:**

Anand, as shown, discloses the following limitations:

the state variable inherits a state thereof for content usage or rights transfer from the set of rights (see column 5, line 1-16)

**Claims 3, 4, 14, 15, 26, 27:**

Anand/Infrastructure discloses the limitations shown above. Anand further discloses:

the state variable shares a state thereof for content usage or rights transfer with the set of rights (see column 8, line 7-14)

the state variable inherits a remaining state for content usage or rights transfer from the set of rights (see column 5, line 14-16)

**Claims 5, 16, 28:**

Anand, as shown, discloses the following limitations:

the state variable is updated upon exercise of a right associated with the state variable (see column 7, line 5-14)

**Claims 6, 17, 29:**

Anand, as shown, discloses the following limitations:

deriving a plurality of rights from the derivable rights, wherein the state variable is shared by the derived rights (see column 7, line 1-7)

**Claims 7, 8, 18, 19, 30, 31:**

Anand discloses the limitations as shown above. Anand does not directly disclose a state variable (state machine), but Infrastructure does:

the state variable represents a collection of states (see page 8, paragraph 3)

a plurality of state variables that determine the state of the derived right (see page 8, paragraph 3)

It would have been obvious to one of ordinary skill in the art at the time of the invention to modify Anand to include the state machine of Infrastructure since this provides a dynamic structure that can express dynamic rights relationships.

**Claims 9, 20, 32:**

Anand, as shown, discloses the following limitations:

at least one state variable is unspecified in the derived right, is created during a rights transfer, and is assigned to the derived right (see column 7, line 1-14)

**Claims 10, 21, 33:**

Anand, as shown, discloses the following limitations:

the state variable is transferred from the derivable rights to the derived right (see column 7, line 15-23)

**Claims 11, 22, 34, 36:**

Anand, as shown, discloses the following limitations:

generating a license including the derived right, if the rights consumer is entitled to the derivable rights specified by the meta-rights (see column 7, line 24-29)

one or more of the means for obtaining, the means for determining, and the means for deriving are specified in a license (see column 7, line 24-29)

**Claim 35:**

Anand, as shown, discloses the following limitations:

obtaining, the means for determining, and the means for deriving comprise at least one of computer-executable instructions, and devices of a computer system (see column 4, line 51-67)

**Conclusion**

Any inquiry concerning this communication or earlier communications from the examiner should be directed to Thomas West whose telephone number is 571-270-1236. The examiner can normally be reached on M-R 7:30am - 5pm EST, ALT Fridays off.

If attempts to reach the examiner by telephone are unsuccessful, the examiner's supervisor, Andrew Fischer can be reached on 571-272-6779. The fax phone number for the organization where this application or proceeding is assigned is 571-273-8300.

Information regarding the status of an application may be obtained from the Patent Application Information Retrieval (PAIR) system. Status information for published applications may be obtained from either Private PAIR or Public PAIR. Status information for unpublished applications is available through Private PAIR only. For more information about the PAIR system, see <http://pair-direct.uspto.gov>. Should you have questions on access to the Private PAIR system, contact the Electronic Business Center (EBC) at 866-217-9197 (toll-free). If you would like assistance from a USPTO Customer Service Representative or access to the automated information system, call 800-786-9199 (IN USA OR CANADA) or 571-272-1000.

Thomas West  
Patent Examiner  
Art Unit 3621  
April 3, 2008

/Jalatee Worjloh/  
Primary Examiner, Art Unit 3621

Application/Control Number: 10/956,121  
Art Unit: 3621

Page 9

<b>Index of Claims</b>  	<b>Application/Control No.</b>  10956121	<b>Applicant(s)/Patent Under Reexamination</b>  WANG ET AL.
	<b>Examiner</b>  THOMAS WEST	<b>Art Unit</b>  3621

✓	<b>Rejected</b>
=	<b>Allowed</b>

-	<b>Cancelled</b>
÷	<b>Restricted</b>

N	<b>Non-Elected</b>
I	<b>Interference</b>

A	<b>Appeal</b>
O	<b>Objected</b>

Claims renumbered in the same order as presented by applicant
  CPA
  T.D.
  R.1.47

CLAIM		DATE							
Final	Original	04/03/2008							
	1	✓							
	2	✓							
	3	✓							
	4	✓							
	5	✓							
	6	✓							
	7	✓							
	8	✓							
	9	✓							
	10	✓							
	11	✓							
	12	✓							
	13	✓							
	14	✓							
	15	✓							
	16	✓							
	17	✓							
	18	✓							
	19	✓							
	20	✓							
	21	✓							
	22	✓							
	23	✓							
	24	✓							
	25	✓							
	26	✓							
	27	✓							
	28	✓							
	29	✓							
	30	✓							
	31	✓							
	32	✓							
	33	✓							
	34	✓							
	35	✓							
	36	✓							



<b><i>Index of Claims</i></b>  	<b>Application/Control No.</b> 10956121	<b>Applicant(s)/Patent Under Reexamination</b> WANG ET AL.
	<b>Examiner</b> THOMAS WEST	<b>Art Unit</b> 3621

✓	<b>Rejected</b>
=	<b>Allowed</b>

-	<b>Cancelled</b>
÷	<b>Restricted</b>

<b>N</b>	<b>Non-Elected</b>
<b>I</b>	<b>Interference</b>

<b>A</b>	<b>Appeal</b>
<b>O</b>	<b>Objected</b>



UNITED STATES PATENT AND TRADEMARK OFFICE

UNITED STATES DEPARTMENT OF COMMERCE  
 United States Patent and Trademark Office  
 Address: COMMISSIONER FOR PATENTS  
 P.O. Box 1450  
 Alexandria, Virginia 22313-1450  
 www.uspto.gov

BIB DATA SHEET

CONFIRMATION NO. 8924

<b>SERIAL NUMBER</b> 10/956,121	<b>FILING or 371(c) DATE</b> 10/04/2004 <b>RULE</b>	<b>CLASS</b> 713	<b>GROUP ART UNIT</b> 3621	<b>ATTORNEY DOCKET NO.</b> 111325-291300	
<b>APPLICANTS</b> Xin Wang, Torrance, CA; Thanh Ta, Huntington Beach, CA; Guillermo Lao, Torrance, CA; Eddie J. Chen, Rancho Palos Verdes, CA;					
<b>** CONTINUING DATA *****</b> This application is a CIP of 10/162,701 06/06/2002 which claims benefit of 60/331,624 11/20/2001 and claims benefit of 60/331,623 11/20/2001 and claims benefit of 60/331,621 11/20/2001 and claims benefit of 60/296,113 06/07/2001 and claims benefit of 60/296,117 06/07/2001 and claims benefit of 60/296,118 06/07/2001					
<b>** FOREIGN APPLICATIONS *****</b>					
<b>** IF REQUIRED, FOREIGN FILING LICENSE GRANTED **</b> 12/03/2004					
Foreign Priority claimed <input type="checkbox"/> Yes <input checked="" type="checkbox"/> No 35 USC 119(a-d) conditions met <input type="checkbox"/> Yes <input checked="" type="checkbox"/> No Verified and Acknowledged <u>/THOMAS C WEST/</u> Examiner's Signature	<input type="checkbox"/> Met after Allowance Initials _____	<b>STATE OR COUNTRY</b> CA	<b>SHEETS DRAWINGS</b> 14	<b>TOTAL CLAIMS</b> 36	<b>INDEPENDENT CLAIMS</b> 3
<b>ADDRESS</b> NIXON PEABODY, LLP 401 9TH STREET, NW SUITE 900 WASHINGTON, DC 20004-2128 UNITED STATES					
<b>TITLE</b> System and method for managing transfer of rights using shared state variables					
<b>FILING FEE RECEIVED</b> 1078	FEES: Authority has been given in Paper No. _____ to charge/credit DEPOSIT ACCOUNT No. _____ for following:		<input type="checkbox"/> All Fees <input type="checkbox"/> 1.16 Fees (Filing) <input type="checkbox"/> 1.17 Fees (Processing Ext. of time) <input type="checkbox"/> 1.18 Fees (Issue) <input type="checkbox"/> Other _____ <input type="checkbox"/> Credit		

## EAST Search History

Ref #	Hits	Search Query	DBs	Default Operator	Plurals	Time Stamp
S1	1	"10956121"	US-PGPUB; USPAT; USOCR; FPRS; EPO; JPO; DERWENT; IBM_TDB	OR	ON	2008/04/02 09:39
S2	264	"3263158"   "3609697"   "3790700"   "3798605"   "4159468"   "4220991"   "4278837"   "4323921"   "4442486"   "4529870"   "4558176"   "4593376"   "4614861"   "4644493"   "4658093"   "4713753"   "4796220"   "4817140"   "4827508"   "4868376"   "4891838"   "4924378"   "4932054"   "4937863"   "4949187"   "4953209"   "4961142"   "4975647"   "4977594"   "4999806"   "5010571"   "5014234"   "5023907"   "5047928"   "5050213"   "5052040"   "5058164"   "5103476"   "5113519"   "5136643"   "5138712"   "5146499"   "5148481"   "5159182"   "5183404"   "5191193"   "5204897"   "5222134"   "5235642"   "5247575"   "5255106"   "5260999"   "5263157"   "5263158"   "5276444"   "5276735"   "5291596"   "5301231"   "5311591"   "5319705"   "5337357"   "5339091"   "5341429"   "5347579"   "5381526"   "5394469"   "5410598"   "5412717"   "5428606"   "5432849"   "5438508"   "5444779"   "5453601"   "5455953"   "5457746"   "5473687"   "5473692"   "5499298"   "5502766"   "5504814"   "5504818"   "5504837"   "5509070"   "5530235"   "5532920"   "5534975"   "5539735"   "5563946"   "5568552"   "5621797"   "5629980"   "5633932"   "5634012"   "5638443"	US-PGPUB; USPAT; USOCR; FPRS; EPO; JPO; DERWENT; IBM_TDB	OR	ON	2008/04/02 09:41

		"5649013"   "5655077"   "5708717"   "5715403"   "5734823"   "5734891"   "5737413"   "5737416"   "5745569"   "5748783"   "5757907"   "5761686"   "5765152"   "5768426"   "5825892"   "5892900"   "5910987"   "5915019"   "5917912"   "5920861"   "5940504"   "5943422"   "5949876"   "5982891"   "5999949"   "6047067"   "6112181"   "6115471"   "6138119"   "6157721"   "6185683"   "6226618"   "6233684"   "6237786"   "6240185"   "6253193"   "6266618"   "6292569"   "6301660"   "6327652"   "6330670"   "6345256"   "6363488"   "6389402").PN.				
S3	979	((Derived derivation derivable derivative derive) near right)	US-PGPUB; USPAT; USOCR; FPRS; EPO; JPO; DERWENT; IBM_TDB	OR	ON	2008/04/02 10:13
S4	101	S3 and (digital near right)	US-PGPUB; USPAT; USOCR; FPRS; EPO; JPO; DERWENT; IBM_TDB	OR	ON	2008/04/02 10:15
S6	106	S3 and ((digital near rights) (rights near management))	US-PGPUB; USPAT; USOCR; FPRS; EPO; JPO; DERWENT; IBM_TDB	OR	ON	2008/04/02 10:16
S7	23	S6 and (state near variable)	US-PGPUB; USPAT; USOCR; FPRS; EPO; JPO; DERWENT; IBM_TDB	OR	ON	2008/04/02 10:18
S9	979	((Derived derivation derivable derivative derive) near right)	US-PGPUB; USPAT; USOCR; FPRS; EPO; JPO; DERWENT; IBM_TDB	OR	ON	2008/04/02 11:23

S10	106	S9 and ((digital near rights) (rights near management))	US-PGPUB; USPAT; USOCR; FPRS; EPO; JPO; DERWENT; IBM_TDB	OR	ON	2008/04/02 11:23
S11	23	S10 and (state near variable)	US-PGPUB; USPAT; USOCR; FPRS; EPO; JPO; DERWENT; IBM_TDB	OR	ON	2008/04/02 11:23
S12	0	S11 and @ad<="20010607"	US-PGPUB; USPAT; USOCR; FPRS; EPO; JPO; DERWENT; IBM_TDB	OR	ON	2008/04/02 11:23
S13	9	S10 and inherit\$4	US-PGPUB; USPAT; USOCR; FPRS; EPO; JPO; DERWENT; IBM_TDB	OR	ON	2008/04/02 11:28
S14	55	S10 and (transfer\$3 with right)	US-PGPUB; USPAT; USOCR; FPRS; EPO; JPO; DERWENT; IBM_TDB	OR	ON	2008/04/02 11:30
S15	3	S14 and @ad<="20010607"	US-PGPUB; USPAT; USOCR; FPRS; EPO; JPO; DERWENT; IBM_TDB	OR	ON	2008/04/02 11:31
S16	16426	((Derived derivation derivable derivative derive) with right)	US-PGPUB; USPAT; USOCR; FPRS; EPO; JPO; DERWENT; IBM_TDB	OR	ON	2008/04/02 11:42
S17	136	S9 and ((digital near rights) (rights near management) drm (content near right))	US-PGPUB; USPAT; USOCR; FPRS; EPO; JPO; DERWENT; IBM_TDB	OR	ON	2008/04/02 11:43
S18	11	S17 and @ad<="20010607"	US-PGPUB; USPAT; USOCR; FPRS; EPO; JPO; DERWENT; IBM_TDB	OR	ON	2008/04/02 11:44

S19	71035	((Derived derivation derivable derivative derive transfer\$4) with right)	US-PGPUB; USPAT; USOCR; FPRS; EPO; JPO; DERWENT; IBM_TDB	OR	ON	2008/04/02 11:48
S20	2	"7228426"	US-PGPUB; USPAT; USOCR; FPRS; EPO; JPO; DERWENT; IBM_TDB	OR	ON	2008/04/02 14:50
S21	2	"7130829"	US-PGPUB; USPAT; USOCR; FPRS; EPO; JPO; DERWENT; IBM_TDB	OR	ON	2008/04/02 14:56
S22	0	(rights near definition near language) and (secure near inheritance)	US-PGPUB; USPAT; USOCR; FPRS; EPO; JPO; DERWENT; IBM_TDB	OR	ON	2008/04/02 15:17
S23	0	(rights near definition near language)	US-PGPUB; USPAT; USOCR; FPRS; EPO; JPO; DERWENT; IBM_TDB	OR	ON	2008/04/02 15:18
S24	1	(secure near inheritance)	US-PGPUB; USPAT; USOCR; FPRS; EPO; JPO; DERWENT; IBM_TDB	OR	ON	2008/04/02 15:18
S25	123	rights with inheritance	US-PGPUB; USPAT; USOCR; FPRS; EPO; JPO; DERWENT; IBM_TDB	OR	ON	2008/04/02 15:19
S26	47	S25 and @ad<="20010607"	US-PGPUB; USPAT; USOCR; FPRS; EPO; JPO; DERWENT; IBM_TDB	OR	ON	2008/04/02 15:19
S27	1	digital near rights with inheritance	US-PGPUB; USPAT; USOCR; FPRS; EPO; JPO; DERWENT; IBM_TDB	OR	ON	2008/04/02 17:15

S28	290	"6226618"	US-PGPUB; USPAT; USOCR; FPRS; EPO; JPO; DERWENT; IBM_TDB	OR	ON	2008/04/02 17:18
S29	2	"6226618".pn.	US-PGPUB; USPAT; USOCR; FPRS; EPO; JPO; DERWENT; IBM_TDB	OR	ON	2008/04/02 17:19
S30	49	XML near Ticket	US-PGPUB; USPAT; USOCR; FPRS; EPO; JPO; DERWENT; IBM_TDB	OR	ON	2008/04/03 07:31
S31	12	S30 and @ad<="20010607"	US-PGPUB; USPAT; USOCR; FPRS; EPO; JPO; DERWENT; IBM_TDB	OR	ON	2008/04/03 07:31
S32	1	S31 and ((digital near rights) (rights near management) drm (content near right))	US-PGPUB; USPAT; USOCR; FPRS; EPO; JPO; DERWENT; IBM_TDB	OR	ON	2008/04/03 07:35
S33	0	S31 and inherit\$4	US-PGPUB; USPAT; USOCR; FPRS; EPO; JPO; DERWENT; IBM_TDB	OR	ON	2008/04/03 07:36
S34	0	S31 and ((Derived derivation derivable derivative derive) with right)	US-PGPUB; USPAT; USOCR; FPRS; EPO; JPO; DERWENT; IBM_TDB	OR	ON	2008/04/03 07:37
S35	2287967	(Derived derivation derivable derivative derive inherit\$4)	US-PGPUB; USPAT; USOCR; FPRS; EPO; JPO; DERWENT; IBM_TDB	OR	ON	2008/04/03 07:40
S36	4807	S35 and ((digital near rights) (rights near management) drm (content near right))	US-PGPUB; USPAT; USOCR; FPRS; EPO; JPO; DERWENT; IBM_TDB	OR	ON	2008/04/03 07:41

S37	1025	S36 and @ad<="20010607"	US-PGPUB; USPAT; USOCR; FPRS; EPO; JPO; DERWENT; IBM_TDB	OR	ON	2008/04/03 07:44
S38	20	S37 and (state near variable)	US-PGPUB; USPAT; USOCR; FPRS; EPO; JPO; DERWENT; IBM_TDB	OR	ON	2008/04/03 07:45
S39	2	"5109413".pn.	US-PGPUB; USPAT; USOCR; FPRS; EPO; JPO; DERWENT; IBM_TDB	OR	ON	2008/04/03 08:40
S40	2	"5765152".pn.	US-PGPUB; USPAT; USOCR; FPRS; EPO; JPO; DERWENT; IBM_TDB	OR	ON	2008/04/03 08:41
S41	2	"5922074".pn.	US-PGPUB; USPAT; USOCR; FPRS; EPO; JPO; DERWENT; IBM_TDB	OR	ON	2008/04/03 08:41
S42	2	"6098056".pn.	US-PGPUB; USPAT; USOCR; FPRS; EPO; JPO; DERWENT; IBM_TDB	OR	ON	2008/04/03 08:42
S43	2	"6125349".pn.	US-PGPUB; USPAT; USOCR; FPRS; EPO; JPO; DERWENT; IBM_TDB	OR	ON	2008/04/03 08:43
S44	2	"6226618".pn.	US-PGPUB; USPAT; USOCR; FPRS; EPO; JPO; DERWENT; IBM_TDB	OR	ON	2008/04/03 08:44
S45	2	"6385596".pn.	US-PGPUB; USPAT; USOCR; FPRS; EPO; JPO; DERWENT; IBM_TDB	OR	ON	2008/04/03 10:57



S46	7	(US-20050060571-\$).did. or (US-5109413-\$ or US-5765152-\$ or US-6098056-\$ or US-6125349-\$ or US-6226618-\$ or US-6385596-\$).did.	US-PGPUB; USPAT	OR	ON	2008/04/03 10:59
S47	4	S46 and (Derived derivation derivable derivative derive inherit\$4)	US-PGPUB; USPAT; USOCR; FPRS; EPO; JPO; DERWENT; IBM_TDB	OR	ON	2008/04/03 11:02
S48	3	S47 and @ad<="20010607"	US-PGPUB; USPAT; USOCR; FPRS; EPO; JPO; DERWENT; IBM_TDB	OR	ON	2008/04/03 11:03
S49	0	S48 and (state near variable)	US-PGPUB; USPAT; USOCR; FPRS; EPO; JPO; DERWENT; IBM_TDB	OR	ON	2008/04/03 11:05
S50	1	S46 and metadata	US-PGPUB; USPAT; USOCR; FPRS; EPO; JPO; DERWENT; IBM_TDB	OR	ON	2008/04/03 11:11
S51	223	(US-20050060571-\$).did. or (US-6389402-\$ or US-6363488-\$ or US-6345256-\$ or US-6330670-\$ or US-6327652-\$ or US-6301660-\$ or US-6292569-\$ or US-6266618-\$ or US-6253193-\$ or US-6240185-\$ or US-6237786-\$ or US-6233684-\$ or US-6226618-\$ or US-6185683-\$ or US-6157721-\$ or US-6138119-\$ or US-6115471-\$ or US-6112181-\$ or US-6047067-\$ or US-5999949-\$ or US-5982891-\$ or US-5949876-\$ or US-5943422-\$ or US-5940504-\$ or US-5920861-\$ or US-5917912-\$).did. or (US-5915019-\$ or US-5910987-\$ or US-5892900-\$ or US-5825892-\$ or US-5768426-\$ or US-5765152-\$ or US-5761686-\$ or US-5757907-\$ or US-5748783-\$ or US-5745569-\$ or US-5737416-\$ or US-5737413-\$ or US-	US-PGPUB; USPAT; USOCR; EPO; DERWENT	OR	ON	2008/04/03 11:12

5734891-\$ or US-5734823-\$  
or US-5715403-\$ or US-  
5708717-\$ or US-5655077-\$  
or US-5649013-\$ or US-  
5638443-\$ or US-5634012-\$  
or US-5633932-\$ or US-  
5629980-\$ or US-5621797-\$  
or US-5568552-\$ or US-  
5563946-\$ or US-5539735-\$  
or US-5534975-\$).did. or (US-  
5532920-\$ or US-5530235-\$  
or US-5509070-\$ or US-  
5504837-\$ or US-5504818-\$  
or US-5504814-\$ or US-  
5502766-\$ or US-5499298-\$  
or US-5473692-\$ or US-  
5473687-\$ or US-5457746-\$  
or US-5455953-\$ or US-  
5453601-\$ or US-5444779-\$  
or US-5438508-\$ or US-  
5432849-\$ or US-5428606-\$  
or US-5412717-\$ or US-  
5410598-\$ or US-5394469-\$  
or US-5381526-\$ or US-  
5347579-\$ or US-5341429-\$  
or US-5339091-\$ or US-  
5337357-\$ or US-5319705-\$  
or US-5311591-\$).did. or (US-  
5301231-\$ or US-5291596-\$  
or US-5276735-\$ or US-  
5276444-\$ or US-5263158-\$  
or US-5263157-\$ or US-  
5260999-\$ or US-5255106-\$  
or US-5247575-\$ or US-  
5235642-\$ or US-5222134-\$  
or US-5204897-\$ or US-  
5191193-\$ or US-5183404-\$  
or US-5159182-\$ or US-  
5148481-\$ or US-5146499-\$  
or US-5138712-\$ or US-  
5136643-\$ or US-5113519-\$  
or US-5103476-\$ or US-  
5058164-\$ or US-5052040-\$  
or US-5050213-\$ or US-  
5047928-\$ or US-5023907-\$  
or US-5014234-\$).did. or (US-  
5010571-\$ or US-4999806-\$  
or US-4977594-\$ or US-  
4975647-\$ or US-4961142-\$  
or US-4953209-\$ or US-  
4949187-\$ or US-4937863-\$  
or US-4932054-\$ or US-  
4924378-\$ or US-4891838-\$  
or US-4868376-\$ or US-  
4827508-\$ or US-4817140-\$  
or US-4796220-\$ or US-  
4713753-\$ or US-4658093-\$  
or US-4644493-\$ or US-  
4614861-\$ or US-4593376-\$  
or US-4558176-\$ or US-

4529870-\$ or US-4442486-\$  
or US-4323921-\$ or US-  
4278837-\$ or US-4220991-\$  
or US-4159468-\$).did. or (US-  
3798605-\$ or US-3790700-\$  
or US-3609697-\$ or US-  
3263158-\$ or US-6298316-\$  
or US-6135646-\$ or US-  
6161114-\$ or US-5956737-\$  
or US-5109413-\$ or US-  
6098056-\$ or US-6125349-\$  
or US-6385596-\$).did. or (US-  
3263158-\$).did. or (DE-  
4323921-\$ or DE-3609697-\$).  
did. or (EP-1308115-A-\$ or  
EP-1180798-A-\$ or JP-  
2002016565-\$ or US-  
6330670-B-\$ or US-6327652-  
B-\$ or WO-0008909-A-\$ or  
FR-2772486-A-\$ or WO-  
9924928-A-\$ or EP-895149-A-  
\$ or WO-9840969-A-\$ or EP-  
862318-A-\$ or WO-9837481-  
A-\$ or JP-10214297-\$ or US-  
5761686-\$ or EP-838785-A-\$  
or US-5737413-\$ or US-  
5734823-\$ or WO-9809209-  
A-\$ or WO-9743761-A-\$ or  
US-5655077-\$ or WO-  
9726732-A-\$ or US-5649013-  
\$ or WO-9720298-A-\$ or US-  
5633932-\$ or WO-9714087-  
A-\$ or WO-9636163-A-\$).did.  
or (WO-9633476-A-\$ or US-  
5568552-\$ or WO-9627155-  
A-\$ or US-5539735-\$ or US-  
5534975-\$ or US-5530235-\$  
or EP-715246-A-\$ or EP-  
715245-A-\$ or EP-715244-A-  
\$ or EP-715243-A-\$ or DE-  
4442486-A-\$ or US-5509070-  
\$ or US-5504814-\$ or US-  
5473692-\$ or US-5473687-\$  
or WO-9530211-A-\$ or EP-  
679980-A-\$ or EP-679978-A-  
\$ or EP-679977-A-\$ or EP-  
672991-A-\$ or US-5428606-\$  
or WO-9514289-A-\$ or CA-  
2102743-\$ or EP-649074-A-\$  
or WO-9508231-A-\$ or US-  
5394469-\$ or DE-4323921-A-  
\$).did. or (WO-9427411-A-\$  
or WO-9419884-A-\$ or US-  
5337357-\$ or JP-06181924-\$  
or EP-601500-A-\$ or US-  
5319705-\$ or JP-06095591-\$  
or EP-588243-A-\$ or EP-  
575936-A-\$ or EP-570123-A-  
\$ or EP-567800-A-\$ or WO-  
9321581-A-\$ or EP-555715-A-

		\$ or US-5235642-\$ or US-5291596-\$ or EP-542298-A-\$ or WO-9309490-A-\$ or EP-534679-A-\$ or US-5183404-\$ or WO-9301550-A-\$ or WO-9220022-A-\$ or WO-9214187-A-\$ or US-5136643-\$ or WO-9209160-A-\$ or US-5103476-\$ or EP-471939-\$ or US-5058164-\$).did. or (US-5052040-\$ or EP-447339-\$ or US-5047928-\$ or EP-442838-\$ or US-5023907-\$ or EP-425053-\$ or EP-423035-\$ or GB-2236604-\$ or EP-421409-\$ or US-4999806-\$ or EP-398494-\$ or US-4961142-\$ or US-4949187-\$ or DE-3903454-\$ or EP-367700-\$ or EP-366854-\$ or US-4924378-\$ or CA-1267443-\$ or EP-359220-\$ or WO-9002382-\$ or US-4891838-\$ or EP-332304-\$ or US-4796220-\$ or WO-8809019-\$ or EP-266748-\$ or WO-8802960-\$ or WO-8802202-\$).did. or (EP-252646-\$ or DE-3609697-\$ or US-4658093-\$ or EP-192243-\$ or US-4593376-\$ or WO-8603040-\$ or EP-174472-\$ or US-4558176-\$ or US-4529870-\$ or EP-80244-\$ or US-4368162-\$ or US-4278837-\$ or WO-8001635-\$ or DE-2849718-\$ or DE-2840980-\$ or US-3798605-\$).did.				
S52	20	S51 and metadata	US-PGPUB; USPAT; USOCR; FPRS; EPO; JPO; DERWENT; IBM_TDB	OR	ON	2008/04/03 11:12
S53	0	S52 and (state near variable)	US-PGPUB; USPAT; USOCR; FPRS; EPO; JPO; DERWENT; IBM_TDB	OR	ON	2008/04/03 11:13
S54	0	S52 and (state with variable)	US-PGPUB; USPAT; USOCR; FPRS; EPO; JPO; DERWENT; IBM_TDB	OR	ON	2008/04/03 11:13

S55	5	S51 and (state near variable)	US-PGPUB; USPAT; USOCR; FPRS; EPO; JPO; DERWENT; IBM_TDB	OR	ON	2008/04/03 11:13
S56	2287967	(Derived derivation derivable derivative derive inherit\$4)	US-PGPUB; USPAT; USOCR; FPRS; EPO; JPO; DERWENT; IBM_TDB	OR	ON	2008/04/03 12:12
S57	7539	S56 and (state near variable)	US-PGPUB; USPAT; USOCR; FPRS; EPO; JPO; DERWENT; IBM_TDB	OR	ON	2008/04/03 12:12
S58	272	S57 and metadata	US-PGPUB; USPAT; USOCR; FPRS; EPO; JPO; DERWENT; IBM_TDB	OR	ON	2008/04/03 12:13
S59	17	S58 and @ad<="20010607"	US-PGPUB; USPAT; USOCR; FPRS; EPO; JPO; DERWENT; IBM_TDB	OR	ON	2008/04/03 12:14
S60	223	(US-20050060571-\$).did. or (US-6389402-\$ or US- 6363488-\$ or US-6345256-\$ or US-6330670-\$ or US- 6327652-\$ or US-6301660-\$ or US-6292569-\$ or US- 6266618-\$ or US-6253193-\$ or US-6240185-\$ or US- 6237786-\$ or US-6233684-\$ or US-6226618-\$ or US- 6185683-\$ or US-6157721-\$ or US-6138119-\$ or US- 6115471-\$ or US-6112181-\$ or US-6047067-\$ or US- 5999949-\$ or US-5982891-\$ or US-5949876-\$ or US- 5943422-\$ or US-5940504-\$ or US-5920861-\$ or US- 5917912-\$).did. or (US- 5915019-\$ or US-5910987-\$ or US-5892900-\$ or US- 5825892-\$ or US-5768426-\$ or US-5765152-\$ or US- 5761686-\$ or US-5757907-\$ or US-5748783-\$ or US- 5745569-\$ or US-5737416-\$ or US-5737413-\$ or US-	US-PGPUB; USPAT; USOCR; EPO; DERWENT	OR	ON	2008/04/03 17:02

5734891-\$ or US-5734823-\$  
or US-5715403-\$ or US-  
5708717-\$ or US-5655077-\$  
or US-5649013-\$ or US-  
5638443-\$ or US-5634012-\$  
or US-5633932-\$ or US-  
5629980-\$ or US-5621797-\$  
or US-5568552-\$ or US-  
5563946-\$ or US-5539735-\$  
or US-5534975-\$).did. or (US-  
5532920-\$ or US-5530235-\$  
or US-5509070-\$ or US-  
5504837-\$ or US-5504818-\$  
or US-5504814-\$ or US-  
5502766-\$ or US-5499298-\$  
or US-5473692-\$ or US-  
5473687-\$ or US-5457746-\$  
or US-5455953-\$ or US-  
5453601-\$ or US-5444779-\$  
or US-5438508-\$ or US-  
5432849-\$ or US-5428606-\$  
or US-5412717-\$ or US-  
5410598-\$ or US-5394469-\$  
or US-5381526-\$ or US-  
5347579-\$ or US-5341429-\$  
or US-5339091-\$ or US-  
5337357-\$ or US-5319705-\$  
or US-5311591-\$).did. or (US-  
5301231-\$ or US-5291596-\$  
or US-5276735-\$ or US-  
5276444-\$ or US-5263158-\$  
or US-5263157-\$ or US-  
5260999-\$ or US-5255106-\$  
or US-5247575-\$ or US-  
5235642-\$ or US-5222134-\$  
or US-5204897-\$ or US-  
5191193-\$ or US-5183404-\$  
or US-5159182-\$ or US-  
5148481-\$ or US-5146499-\$  
or US-5138712-\$ or US-  
5136643-\$ or US-5113519-\$  
or US-5103476-\$ or US-  
5058164-\$ or US-5052040-\$  
or US-5050213-\$ or US-  
5047928-\$ or US-5023907-\$  
or US-5014234-\$).did. or (US-  
5010571-\$ or US-4999806-\$  
or US-4977594-\$ or US-  
4975647-\$ or US-4961142-\$  
or US-4953209-\$ or US-  
4949187-\$ or US-4937863-\$  
or US-4932054-\$ or US-  
4924378-\$ or US-4891838-\$  
or US-4868376-\$ or US-  
4827508-\$ or US-4817140-\$  
or US-4796220-\$ or US-  
4713753-\$ or US-4658093-\$  
or US-4644493-\$ or US-  
4614861-\$ or US-4593376-\$  
or US-4558176-\$ or US-

4529870-\$ or US-4442486-\$  
or US-4323921-\$ or US-  
4278837-\$ or US-4220991-\$  
or US-4159468-\$).did. or (US-  
3798605-\$ or US-3790700-\$  
or US-3609697-\$ or US-  
3263158-\$ or US-6298316-\$  
or US-6135646-\$ or US-  
6161114-\$ or US-5956737-\$  
or US-5109413-\$ or US-  
6098056-\$ or US-6125349-\$  
or US-6385596-\$).did. or (US-  
3263158-\$).did. or (DE-  
4323921-\$ or DE-3609697-\$).  
did. or (EP-1308115-A-\$ or  
EP-1180798-A-\$ or JP-  
2002016565-\$ or US-  
6330670-B-\$ or US-6327652-  
B-\$ or WO-0008909-A-\$ or  
FR-2772486-A-\$ or WO-  
9924928-A-\$ or EP-895149-A-  
\$ or WO-9840969-A-\$ or EP-  
862318-A-\$ or WO-9837481-  
A-\$ or JP-10214297-\$ or US-  
5761686-\$ or EP-838785-A-\$  
or US-5737413-\$ or US-  
5734823-\$ or WO-9809209-  
A-\$ or WO-9743761-A-\$ or  
US-5655077-\$ or WO-  
9726732-A-\$ or US-5649013-  
\$ or WO-9720298-A-\$ or US-  
5633932-\$ or WO-9714087-  
A-\$ or WO-9636163-A-\$).did.  
or (WO-9633476-A-\$ or US-  
5568552-\$ or WO-9627155-  
A-\$ or US-5539735-\$ or US-  
5534975-\$ or US-5530235-\$  
or EP-715246-A-\$ or EP-  
715245-A-\$ or EP-715244-A-  
\$ or EP-715243-A-\$ or DE-  
4442486-A-\$ or US-5509070-  
\$ or US-5504814-\$ or US-  
5473692-\$ or US-5473687-\$  
or WO-9530211-A-\$ or EP-  
679980-A-\$ or EP-679978-A-  
\$ or EP-679977-A-\$ or EP-  
672991-A-\$ or US-5428606-\$  
or WO-9514289-A-\$ or CA-  
2102743-\$ or EP-649074-A-\$  
or WO-9508231-A-\$ or US-  
5394469-\$ or DE-4323921-A-  
\$).did. or (WO-9427411-A-\$  
or WO-9419884-A-\$ or US-  
5337357-\$ or JP-06181924-\$  
or EP-601500-A-\$ or US-  
5319705-\$ or JP-06095591-\$  
or EP-588243-A-\$ or EP-  
575936-A-\$ or EP-570123-A-  
\$ or EP-567800-A-\$ or WO-  
9321581-A-\$ or EP-555715-A-

		\$ or US-5235642-\$ or US-5291596-\$ or EP-542298-A-\$ or WO-9309490-A-\$ or EP-534679-A-\$ or US-5183404-\$ or WO-9301550-A-\$ or WO-9220022-A-\$ or WO-9214187-A-\$ or US-5136643-\$ or WO-9209160-A-\$ or US-5103476-\$ or EP-471939-\$ or US-5058164-\$).did. or (US-5052040-\$ or EP-447339-\$ or US-5047928-\$ or EP-442838-\$ or US-5023907-\$ or EP-425053-\$ or EP-423035-\$ or GB-2236604-\$ or EP-421409-\$ or US-4999806-\$ or EP-398494-\$ or US-4961142-\$ or US-4949187-\$ or DE-3903454-\$ or EP-367700-\$ or EP-366854-\$ or US-4924378-\$ or CA-1267443-\$ or EP-359220-\$ or WO-9002382-\$ or US-4891838-\$ or EP-332304-\$ or US-4796220-\$ or WO-8809019-\$ or EP-266748-\$ or WO-8802960-\$ or WO-8802202-\$).did. or (EP-252646-\$ or DE-3609697-\$ or US-4658093-\$ or EP-192243-\$ or US-4593376-\$ or WO-8603040-\$ or EP-174472-\$ or US-4558176-\$ or US-4529870-\$ or EP-80244-\$ or US-4368162-\$ or US-4278837-\$ or WO-8001635-\$ or DE-2849718-\$ or DE-2840980-\$ or US-3798605-\$).did.				
S61	21	S60 and (state near (variable machine))	US-PGPUB; USPAT; USOCR; FPRS; EPO; JPO; DERWENT; IBM_TDB	OR	ON	2008/04/03 17:02
S62	1611	(state near (variable machine)) and metadata	US-PGPUB; USPAT; USOCR; FPRS; EPO; JPO; DERWENT; IBM_TDB	OR	ON	2008/04/03 17:03
S63	863	S62 and (Derived derivation derivable derivative derive inherit\$4)	US-PGPUB; USPAT; USOCR; FPRS; EPO; JPO; DERWENT; IBM_TDB	OR	ON	2008/04/03 17:04



S65	95	S63 and ((digital near rights) (rights near management) drm (content near right))	US-PGPUB; USPAT; USOCR; FPRS; EPO; JPO; DERWENT; IBM_TDB	OR	ON	2008/04/03 17:05
S66	22	S65 and @ad<="20010607"	US-PGPUB; USPAT; USOCR; FPRS; EPO; JPO; DERWENT; IBM_TDB	OR	ON	2008/04/03 17:05
S67	22	S66 and license	US-PGPUB; USPAT; USOCR; FPRS; EPO; JPO; DERWENT; IBM_TDB	OR	ON	2008/04/03 17:10
S68	1809	(state near (variable machine table)) and metadata	US-PGPUB; USPAT; USOCR; FPRS; EPO; JPO; DERWENT; IBM_TDB	OR	ON	2008/04/03 17:26
S69	958	S68 and (Derived derivation derivable derivative derive inherit\$4)	US-PGPUB; USPAT; USOCR; FPRS; EPO; JPO; DERWENT; IBM_TDB	OR	ON	2008/04/03 17:26
S70	96	S69 and ((digital near rights) (rights near management) drm (content near right))	US-PGPUB; USPAT; USOCR; FPRS; EPO; JPO; DERWENT; IBM_TDB	OR	ON	2008/04/03 17:27
S71	206	S69 and license	US-PGPUB; USPAT; USOCR; FPRS; EPO; JPO; DERWENT; IBM_TDB	OR	ON	2008/04/03 17:28
S72	35	S71 and @ad<="20010607"	US-PGPUB; USPAT; USOCR; FPRS; EPO; JPO; DERWENT; IBM_TDB	OR	ON	2008/04/03 17:28
S74	1809	(state near (variable machine table)) and metadata	US-PGPUB; USPAT; USOCR; FPRS; EPO; JPO; DERWENT; IBM_TDB	OR	ON	2008/04/04 08:11

S75	958	S74 and (Derived derivation derivable derivative derive inherit\$4)	US-PGPUB; USPAT; USOCR; FPRS; EPO; JPO; DERWENT; IBM_TDB	OR	ON	2008/04/04 08:11
S76	206	S75 and license	US-PGPUB; USPAT; USOCR; FPRS; EPO; JPO; DERWENT; IBM_TDB	OR	ON	2008/04/04 08:11
S77	35	S76 and @ad<="20010607"	US-PGPUB; USPAT; USOCR; FPRS; EPO; JPO; DERWENT; IBM_TDB	OR	ON	2008/04/04 08:11
S78	20	S77 and (right with transfer)	US-PGPUB; USPAT; USOCR; FPRS; EPO; JPO; DERWENT; IBM_TDB	OR	ON	2008/04/04 08:11
S80	20	S77 and (right with transfer \$3)	US-PGPUB; USPAT; USOCR; FPRS; EPO; JPO; DERWENT; IBM_TDB	OR	ON	2008/04/04 08:12
S81	64	(state near (variable machine table)) with metadata	US-PGPUB; USPAT; USOCR; FPRS; EPO; JPO; DERWENT; IBM_TDB	OR	ON	2008/04/04 08:39
S82	25	S81 and (Derived derivation derivable derivative derive inherit\$4)	US-PGPUB; USPAT; USOCR; FPRS; EPO; JPO; DERWENT; IBM_TDB	OR	ON	2008/04/04 08:39
S83	1	S81 and ((Derived derivation derivable derivative derive inherit\$4 transfer\$4) with right)	US-PGPUB; USPAT; USOCR; FPRS; EPO; JPO; DERWENT; IBM_TDB	OR	ON	2008/04/04 08:41
S84	0	S83 and license	US-PGPUB; USPAT; USOCR; FPRS; EPO; JPO; DERWENT; IBM_TDB	OR	ON	2008/04/04 08:41

S85	20	"09866101"	US-PGPUB; USPAT; USOCR; FPRS; EPO; JPO; DERWENT; IBM_TDB	OR	ON	2008/04/04 08:48
S86	1	"9866101"	US-PGPUB; USPAT; USOCR; FPRS; EPO; JPO; DERWENT; IBM_TDB	OR	ON	2008/04/04 08:48
S87	1	S85 and @ad<="20010607"	US-PGPUB; USPAT; USOCR; FPRS; EPO; JPO; DERWENT; IBM_TDB	OR	ON	2008/04/04 08:52
S88	2	"20030163597".pn.	US-PGPUB; USPAT; USOCR; FPRS; EPO; JPO; DERWENT; IBM_TDB	OR	ON	2008/04/04 08:54
S89	64	(state near (variable machine table)) with metadata	US-PGPUB; USPAT; USOCR; FPRS; EPO; JPO; DERWENT; IBM_TDB	OR	ON	2008/04/04 11:27
S90	25	S89 and (Derived derivation derivable derivative derive inherit\$4)	US-PGPUB; USPAT; USOCR; FPRS; EPO; JPO; DERWENT; IBM_TDB	OR	ON	2008/04/04 11:27
S91	0	S90 and @ad<="20010607"	US-PGPUB; USPAT; USOCR; FPRS; EPO; JPO; DERWENT; IBM_TDB	OR	ON	2008/04/04 11:27
S92	65	(state near (variable machine table diagram)) with metadata	US-PGPUB; USPAT; USOCR; FPRS; EPO; JPO; DERWENT; IBM_TDB	OR	ON	2008/04/04 11:30
S93	8	S92 and @ad<="20010607"	US-PGPUB; USPAT; USOCR; FPRS; EPO; JPO; DERWENT; IBM_TDB	OR	ON	2008/04/04 11:30

S94	246	(US-20050060571-\$ or US-20020165724-\$ or US-20020069324-\$ or US-20060064666-\$ or US-20030163597-\$ or US-20010054180-\$ or US-20010053996-\$ or US-20010039571-\$).did. or (US-6389402-\$ or US-6363488-\$ or US-6345256-\$ or US-6330670-\$ or US-6327652-\$ or US-6301660-\$ or US-6292569-\$ or US-6266618-\$ or US-6253193-\$ or US-6240185-\$ or US-6237786-\$ or US-6233684-\$ or US-6226618-\$ or US-6185683-\$ or US-6157721-\$ or US-6138119-\$ or US-6115471-\$ or US-6112181-\$ or US-6047067-\$ or US-5999949-\$ or US-5982891-\$ or US-5949876-\$ or US-5943422-\$ or US-5940504-\$ or US-5920861-\$ or US-5917912-\$).did. or (US-5915019-\$ or US-5910987-\$ or US-5892900-\$ or US-5825892-\$ or US-5768426-\$ or US-5765152-\$ or US-5761686-\$ or US-5757907-\$ or US-5748783-\$ or US-5745569-\$ or US-5737416-\$ or US-5737413-\$ or US-5734891-\$ or US-5734823-\$ or US-5715403-\$ or US-5708717-\$ or US-5655077-\$ or US-5649013-\$ or US-5638443-\$ or US-5634012-\$ or US-5633932-\$ or US-5629980-\$ or US-5621797-\$ or US-5568552-\$ or US-5563946-\$ or US-5539735-\$ or US-5534975-\$).did. or (US-5532920-\$ or US-5530235-\$ or US-5509070-\$ or US-5504837-\$ or US-5504818-\$ or US-5504814-\$ or US-5502766-\$ or US-5499298-\$ or US-5473692-\$ or US-5473687-\$ or US-5457746-\$ or US-5455953-\$ or US-5453601-\$ or US-5444779-\$ or US-5438508-\$ or US-5432849-\$ or US-5428606-\$ or US-5412717-\$ or US-5410598-\$ or US-5394469-\$ or US-5381526-\$ or US-5347579-\$ or US-5341429-\$ or US-5339091-\$	US-PGPUB; USPAT; USOCR; EPO; DERWENT	OR	ON	2008/04/04 11:46
-----	-----	---	--	----	----	---------------------

or US-5337357-\$ or US-5319705-\$ or US-5311591-\$).  
did. or (US-5301231-\$ or US-5291596-\$ or US-5276735-\$  
or US-5276444-\$ or US-5263158-\$ or US-5263157-\$  
or US-5260999-\$ or US-5255106-\$ or US-5247575-\$  
or US-5235642-\$ or US-5222134-\$ or US-5204897-\$  
or US-5191193-\$ or US-5183404-\$ or US-5159182-\$  
or US-5148481-\$ or US-5146499-\$ or US-5138712-\$  
or US-5136643-\$ or US-5113519-\$ or US-5103476-\$  
or US-5058164-\$ or US-5052040-\$ or US-5050213-\$  
or US-5047928-\$ or US-5023907-\$ or US-5014234-\$).  
did. or (US-5010571-\$ or US-4999806-\$ or US-4977594-\$  
or US-4975647-\$ or US-4961142-\$ or US-4953209-\$  
or US-4949187-\$ or US-4937863-\$ or US-4932054-\$  
or US-4924378-\$ or US-4891838-\$ or US-4868376-\$  
or US-4827508-\$ or US-4817140-\$ or US-4796220-\$  
or US-4713753-\$ or US-4658093-\$ or US-4644493-\$  
or US-4614861-\$ or US-4593376-\$ or US-4558176-\$  
or US-4529870-\$ or US-4442486-\$ or US-4323921-\$  
or US-4278837-\$ or US-4220991-\$ or US-4159468-\$).  
did. or (US-3798605-\$ or US-3790700-\$ or US-3609697-\$  
or US-3263158-\$ or US-6298316-\$ or US-6135646-\$  
or US-6161114-\$ or US-5956737-\$ or US-5109413-\$  
or US-6098056-\$ or US-6125349-\$ or US-6385596-\$  
or US-6366904-\$ or US-7133845-\$ or US-7120800-\$  
or US-7095854-\$ or US-7076652-\$ or US-7069451-\$  
or US-6948070-\$ or US-6427140-\$ or US-6850252-\$  
or US-7130807-\$ or US-7124101-\$ or US-6671818-\$  
or US-6606744-\$ or US-6442684-\$ or US-6158001-\$).  
did. or (US-5996073-\$).did.  
or (US-3263158-\$).did. or  
(DE-4323921-\$ or DE-3609697-\$).did. or (EP-

1308115-A-\$ or EP-1180798-A-\$ or JP-2002016565-\$ or US-6330670-B-\$ or US-6327652-B-\$ or WO-0008909-A-\$ or FR-2772486-A-\$ or WO-9924928-A-\$ or EP-895149-A-\$ or WO-9840969-A-\$ or EP-862318-A-\$ or WO-9837481-A-\$ or JP-10214297-\$ or US-5761686-\$ or EP-838785-A-\$ or US-5737413-\$ or US-5734823-\$ or WO-9809209-A-\$ or WO-9743761-A-\$ or US-5655077-\$ or WO-9726732-A-\$ or US-5649013-\$ or WO-9720298-A-\$ or US-5633932-\$ or WO-9714087-A-\$ or WO-9636163-A-\$).did. or (WO-9633476-A-\$ or US-5568552-\$ or WO-9627155-A-\$ or US-5539735-\$ or US-5534975-\$ or US-5530235-\$ or EP-715246-A-\$ or EP-715245-A-\$ or EP-715244-A-\$ or EP-715243-A-\$ or DE-4442486-A-\$ or US-5509070-\$ or US-5504814-\$ or US-5473692-\$ or US-5473687-\$ or WO-9530211-A-\$ or EP-679980-A-\$ or EP-679978-A-\$ or EP-679977-A-\$ or EP-672991-A-\$ or US-5428606-\$ or WO-9514289-A-\$ or CA-2102743-\$ or EP-649074-A-\$ or WO-9508231-A-\$ or US-5394469-\$ or DE-4323921-A-\$).did. or (WO-9427411-A-\$ or WO-9419884-A-\$ or US-5337357-\$ or JP-06181924-\$ or EP-601500-A-\$ or US-5319705-\$ or JP-06095591-\$ or EP-588243-A-\$ or EP-575936-A-\$ or EP-570123-A-\$ or EP-567800-A-\$ or WO-9321581-A-\$ or EP-555715-A-\$ or US-5235642-\$ or US-5291596-\$ or EP-542298-A-\$ or WO-9309490-A-\$ or EP-534679-A-\$ or US-5183404-\$ or WO-9301550-A-\$ or WO-9220022-A-\$ or WO-9214187-A-\$ or US-5136643-\$ or WO-9209160-A-\$ or US-5103476-\$ or EP-471939-\$ or US-5058164-\$).did. or (US-5052040-\$ or EP-447339-\$ or US-5047928-\$ or EP-442838-\$ or US-5023907-\$ or EP-425053-\$ or EP-

		423035-\$ or GB-2236604-\$ or EP-421409-\$ or US-4999806-\$ or EP-398494-\$ or US-4961142-\$ or US-4949187-\$ or DE-3903454-\$ or EP-367700-\$ or EP-366854-\$ or US-4924378-\$ or CA-1267443-\$ or EP-359220-\$ or WO-9002382-\$ or US-4891838-\$ or EP-332304-\$ or US-4796220-\$ or WO-8809019-\$ or EP-266748-\$ or WO-8802960-\$ or WO-8802202-\$.did. or (EP-252646-\$ or DE-3609697-\$ or US-4658093-\$ or EP-192243-\$ or US-4593376-\$ or WO-8603040-\$ or EP-174472-\$ or US-4558176-\$ or US-4529870-\$ or EP-80244-\$ or US-4368162-\$ or US-4278837-\$ or WO-8001635-\$ or DE-2849718-\$ or DE-2840980-\$ or US-3798605-\$.did.				
S95	7	S94 and (state near (variable machine table diagram)) with metadata	US-PGPUB; USPAT; USOCR; FPRS; EPO; JPO; DERWENT; IBM_TDB	OR	ON	2008/04/04 11:47
S96	1	S95 and (Derived derivation derivable derivative derive inherit\$4)	US-PGPUB; USPAT; USOCR; FPRS; EPO; JPO; DERWENT; IBM_TDB	OR	ON	2008/04/04 11:49
S97	0	S95 and license	US-PGPUB; USPAT; USOCR; FPRS; EPO; JPO; DERWENT; IBM_TDB	OR	ON	2008/04/04 11:51
S98	16931	(Derived derivation derivable derivative derive inherit\$4) with rights	US-PGPUB; USPAT; USOCR; FPRS; EPO; JPO; DERWENT; IBM_TDB	OR	ON	2008/04/04 11:58
S99	440	S98 and metadata	US-PGPUB; USPAT; USOCR; FPRS; EPO; JPO; DERWENT; IBM_TDB	OR	ON	2008/04/04 11:59

S100	1	S98 and (state near (variable machine table diagram)) with metadata	US-PGPUB; USPAT; USOCR; FPRS; EPO; JPO; DERWENT; IBM_TDB	OR	ON	2008/04/04 11:59
S101	2	S98 and (state near (variable machine table diagram)) same metadata	US-PGPUB; USPAT; USOCR; FPRS; EPO; JPO; DERWENT; IBM_TDB	OR	ON	2008/04/04 12:00
S102	116	S98 and (state near (variable machine table diagram)) and metadata	US-PGPUB; USPAT; USOCR; FPRS; EPO; JPO; DERWENT; IBM_TDB	OR	ON	2008/04/04 12:00
S103	97	S102 and license	US-PGPUB; USPAT; USOCR; FPRS; EPO; JPO; DERWENT; IBM_TDB	OR	ON	2008/04/04 12:01
S104	22	S103 and @ad<="20010607"	US-PGPUB; USPAT; USOCR; FPRS; EPO; JPO; DERWENT; IBM_TDB	OR	ON	2008/04/04 12:01
S105	10	S102 and drm	US-PGPUB; USPAT; USOCR; FPRS; EPO; JPO; DERWENT; IBM_TDB	OR	ON	2008/04/04 12:13
S106	0	S105 and @ad<="20010607"	US-PGPUB; USPAT; USOCR; FPRS; EPO; JPO; DERWENT; IBM_TDB	OR	ON	2008/04/04 12:13
S107	22	S104 and (Derived derivation derivable derivative derive inherit\$4) with rights	US-PGPUB; USPAT; USOCR; FPRS; EPO; JPO; DERWENT; IBM_TDB	OR	ON	2008/04/04 12:26
S108	0	S104 and (Derived derivation derivable derivative derive inherit\$4) near rights	US-PGPUB; USPAT; USOCR; FPRS; EPO; JPO; DERWENT; IBM_TDB	OR	ON	2008/04/04 12:26



S109	0	S104 and (Derived derivation derivable derivative derive inherit\$4) near (rights product)	US-PGPUB; USPAT; USOCR; FPRS; EPO; JPO; DERWENT; IBM_TDB	OR	ON	2008/04/04 12:27
S110	0	S104 and ((Derived derivation derivable derivative derive inherit\$4) near (rights product))	US-PGPUB; USPAT; USOCR; FPRS; EPO; JPO; DERWENT; IBM_TDB	OR	ON	2008/04/04 12:27
S111	37700	((Derived derivation derivable derivative derive inherit\$4) near (rights product))	US-PGPUB; USPAT; USOCR; FPRS; EPO; JPO; DERWENT; IBM_TDB	OR	ON	2008/04/04 12:27
S112	42471	((Derived derivation derivable derivative derive inherit\$4) near (rights product content))	US-PGPUB; USPAT; USOCR; FPRS; EPO; JPO; DERWENT; IBM_TDB	OR	ON	2008/04/04 12:28
S113	0	S112 and (state near (variable machine table diagram)) with metadata	US-PGPUB; USPAT; USOCR; FPRS; EPO; JPO; DERWENT; IBM_TDB	OR	ON	2008/04/04 12:28
S114	605	S112 and ((digital near rights) (rights near management) drm (content near right))	US-PGPUB; USPAT; USOCR; FPRS; EPO; JPO; DERWENT; IBM_TDB	OR	ON	2008/04/04 12:29
S115	200	S114 and metadata	US-PGPUB; USPAT; USOCR; FPRS; EPO; JPO; DERWENT; IBM_TDB	OR	ON	2008/04/04 12:30
S116	0	S115 and (state near (variable machine table diagram)) with metadata	US-PGPUB; USPAT; USOCR; FPRS; EPO; JPO; DERWENT; IBM_TDB	OR	ON	2008/04/04 12:30
S117	48	S115 and (state near (variable machine table diagram))	US-PGPUB; USPAT; USOCR; FPRS; EPO; JPO; DERWENT; IBM_TDB	OR	ON	2008/04/04 12:30

S119	21	S117 and @ad<="20010607"	US-PGPUB; USPAT; USOCR; FPRS; EPO; JPO; DERWENT; IBM_TDB	OR	ON	2008/04/04 12:31
S120	53061	"rights expression language" prep	US-PGPUB; USPAT; USOCR; FPRS; EPO; JPO; DERWENT; IBM_TDB	OR	ON	2008/04/04 12:47
S121	119	S120 and metadata	US-PGPUB; USPAT; USOCR; FPRS; EPO; JPO; DERWENT; IBM_TDB	OR	ON	2008/04/04 12:48
S122	29	S121 and (state near (variable machine table diagram))	US-PGPUB; USPAT; USOCR; FPRS; EPO; JPO; DERWENT; IBM_TDB	OR	ON	2008/04/04 12:48
S123	5	S122 and @ad<="20010607"	US-PGPUB; USPAT; USOCR; FPRS; EPO; JPO; DERWENT; IBM_TDB	OR	ON	2008/04/04 12:48
S124	163	"rights expression language"	US-PGPUB; USPAT; USOCR; FPRS; EPO; JPO; DERWENT; IBM_TDB	OR	ON	2008/04/04 12:50
S125	56	S124 and metadata	US-PGPUB; USPAT; USOCR; FPRS; EPO; JPO; DERWENT; IBM_TDB	OR	ON	2008/04/04 12:50
S126	8	S125 and (state near (variable machine table diagram))	US-PGPUB; USPAT; USOCR; FPRS; EPO; JPO; DERWENT; IBM_TDB	OR	ON	2008/04/04 12:50
S127	0	S126 and @ad<="20010607"	US-PGPUB; USPAT; USOCR; FPRS; EPO; JPO; DERWENT; IBM_TDB	OR	ON	2008/04/04 12:50

S128	225	"rights expression language" "open digital rights language" odrl	US-PGPUB; USPAT; USOCR; FPRS; EPO; JPO; DERWENT; IBM_TDB	OR	ON	2008/04/04 12:54
S129	74	S128 and metadata	US-PGPUB; USPAT; USOCR; FPRS; EPO; JPO; DERWENT; IBM_TDB	OR	ON	2008/04/04 12:54
S130	8	S129 and (state near (variable machine table diagram))	US-PGPUB; USPAT; USOCR; FPRS; EPO; JPO; DERWENT; IBM_TDB	OR	ON	2008/04/04 12:55
S131	0	S130 and @ad<="20010607"	US-PGPUB; USPAT; USOCR; FPRS; EPO; JPO; DERWENT; IBM_TDB	OR	ON	2008/04/04 12:55
S132	219	drm and ((Derived derivation derivable derivative derive inherit\$4) with rights)	US-PGPUB; USPAT; USOCR; FPRS; EPO; JPO; DERWENT; IBM_TDB	OR	ON	2008/04/04 13:03
S133	35	S132 and (state near (variable machine table diagram))	US-PGPUB; USPAT; USOCR; FPRS; EPO; JPO; DERWENT; IBM_TDB	OR	ON	2008/04/04 13:04
S134	10	S133 and metadata	US-PGPUB; USPAT; USOCR; FPRS; EPO; JPO; DERWENT; IBM_TDB	OR	ON	2008/04/04 13:04
S135	0	S134 and @ad<="20010607"	US-PGPUB; USPAT; USOCR; FPRS; EPO; JPO; DERWENT; IBM_TDB	OR	ON	2008/04/04 13:06
S136	171	S114 and @ad<="20010607"	US-PGPUB; USPAT; USOCR; FPRS; EPO; JPO; DERWENT; IBM_TDB	OR	ON	2008/04/04 13:07

S137	39	S136 and metadata	US-PGPUB; USPAT; USOCR; FPRS; EPO; JPO; DERWENT; IBM_TDB	OR	ON	2008/04/04 13:07
S138	21	S137 and (state near (variable machine table diagram))	US-PGPUB; USPAT; USOCR; FPRS; EPO; JPO; DERWENT; IBM_TDB	OR	ON	2008/04/04 13:09

4/ 4/ 2008 6:03:38 PM

C:\Documents and Settings\twest\My Documents\EAST\Workspaces\10\_9\56121 - Wang\56121 - Wang.wsp



## Workshop on Digital Rights Management for the Web

World Wide Web Consortium

22-23 January 2001

INRIA - Sophia-Antipolis, France

2004, Route des Lucioles

### WORKSHOP PROGRAM

Workshop Notes & Presentations

Workshop Summary Report

Submitted Position Papers

Participants

Mailing List

Call for Participation

Background Reference Material

### **Important dates**

*Papers submission deadline: 22 December 2000*

*Registration deadline: 12 January 2001*

### **Workshop meter**

On 20 December 2000: 62 registrations, 41 position papers received, and 69 persons on the mailing list.

---

Last update \$Date: 2001/04/26 16:55:07 \$ by \$Author: rigo \$



[\[Minutes Overview\]](#) [\[Workshop Home\]](#) [\[Previous: Publishers Requirements\]](#)  
[\[Next: Architecture: Interoperability and Standards\]](#)

## Minutes from the Architecture/Infrastructure Session

***Please refer to the position-papers and slides for authoritative answers. The following minutes are only a snapshot of Presentations and Discussions***

- [INDECS Framework Data Definitions](#)  
Godfrey Rust (Indecs Project)
- [URI's and Object Identifiers](#)  
Dan Connolly (W3C)
- [Principles for Standardization and Interoperability in Web-based Digital Rights Management](#)  
John Erickson (Hewlett-Packard)
- [Open Digital Rights Management](#)  
Renato Iannella (IPR Systems)
- [Digital Object Identifier](#)  
Norman Paskin (Int. DOI Foundation)
- [Discussion](#)

---

### Godfrey Rust (<indecs> Project), INDECS Framework Data Definitions

*See also the [\[Slides \(ppt\)\]](#) and the [<indecs> Framework](#)*

The <indecs> project ended 2000, now we are new company called <indecs> framework. Look at our online document: Principles, model, and data dictionary, June 2000.

We see DRM in terms of metadata, as a metadata problem. The description is covered in Open eBook, ONIX, and my company.

Here is the scheme:

1. people make stuff
2. people use stuff

### 3. people do deals about stuff

The scope is stuff. This can be characterized in terms of:

1. Parties
2. Creations
3. Agreements

Rust projected a diagram showing the high granularity in the <indec> model, with hierarchy of parties and agreements. He noted that you must pass along the metadata in a structured defined way to permit computational processes.

The following things are required:

- functional granularity: you must be able to identify stuff at any level of granularity
- unique id
- who says so - designated authority
- appropriate access (who can do what)

In the 1980s, there were few schemes for description, today there are many, lists ten major ones, including MPEG-7, ONIX, SMPTE, RIAA/IFPI, and several more.

Here are the <indec> principles:

- **All metadata is just a view** (example: about the work versus about the manifestation, and more, each of which may have its own rights)
  - views must not be confused; mistaken identity can be disastrous to rights management
  - views need to be interoperable
- **Almost all terms need identifiers**
  - values must be defined and identified
  - need standard vocabularies and ontologies.
  - automation need for disambiguity. There is an existing vocabulary for some things: territories, language, currency, date/time and some others. But we need dozens of others.
- **Events are key to interoperability**
  - most metadata is stuff or people based
  - events description are key to rights management

Godfrey Rust gave an example how this would work:

1. make event the first class object, e.g., Rust creating these slides
2. then all the other elements are attributes: author, date, title, etc.
3. next event, e.g., Rust showing this Slide -- it has attributes too and references the previous event, thus connecting the creative items
4. next event: Norman Paskin adapts (transforming event) these slides before he shows it at another meeting, thus creating new attributes and references to preceding events, thus connecting the creative items

This model has the same information as other metadata structures, just organized differently to serve rights management.

Here's another event that bears on rights: agreeing. What goes into the agreement is what goes into descriptive metadata, what he had, what he did. Also assertion by a trusted entity that verifies or authenticates.

Using the event structure, now have six events regarding these slide-show. See how you can use events to **integrate** descriptive and rights metadata.

But we need rights vocabularies to make this work, on a parallel with the need for vocabularies to serve descriptive metadata.

## Dan Connolly [W3C], W3C URI Design Principles

*See also the corresponding Activity within W3C and the slides*

He outlined W3C's Philosophy of Standards: Help people do the right thing.

URIs will have a relationship to a potential DRM-Activity. Connolly also suggests that DRM discussion focus on payments and rights negotiation as much as prevention of access.

All names are ultimately local. Global naming depends on social agreements and trust. HTTP is not the only protocol. For the Web, we use DNS (Domain Name System). Don't forget, HTML is not the only file type. Things can evolve, you can use proxies and thus use an old name against new protocol. But URIs are the only thing in that arena. New protocols can be used with existing names. There is no need to change names just because you change protocols. We don't need to make new URI schemes just because we have made a new data format.

There is opacity: Don't peek inside names, names (URIs) are not user interface. Don't reinvent redirection in http, it is not a service, they are not locators. DNS supports multiple A records. Lots of administrative hierarchies fit in current http and DNS, you don't need to



invent a new URI scheme.

URIs were not designed as a user interface. Don't use a URN as a brand name. To establish a new trusted brand name, trying to wedge them into DNS is a problem, you're ought to use <title>

## John Erickson (HP), Principles for Standardization and Interoperability in Web-based Digital Rights Management

*See also the [slides](#) and the [Position Paper](#).*

John Erickson started by re-inforcing what was already heard during previous sessions: When we think about DRM, we have to separate expression of rights information and policies from the enforcement of those rights. We have to think of a layered model, separate the expression of rights information from the info for discovery and from implementing and enforcing those rights.

What is the W3C's role here? We think W3C should recommend a platform. Erickson put emphasis on the development of a language and a protocol for IPR policy expression, discovery, and interpretation.

The W3C should not recommend a standard DRM system. But we should provide a basis for the interoperability of such systems. Core should be to find a reliable way to express and transfer rights information. Remember the design principles of the web, IPR work ought not violate them.

Erickson developed the following set of requirements:

- never interfere with users' ability to discover info (incl rights info) on the web, this is what I mean by universal access, so I can decide about whether to access
- always communicate the policies and technical restraints in understandable language
- policies are communicated in fair and open ways
- need for trust, need to have a basis to trust the assertions being made, need a mechanism to assure trustworthiness
- IPR information and policies must be discoverable and minimally interpretable independent of any given vendor's solution
- the languages and protocols must be designed for evolution
- web based mechanism must allow for owners to choose different tools and consumers to use different tools to discover and interpret rights info
- cool new content that comes along ought not break the DRM systems or break the languages and protocols

Here's our [HP publishing group] proposal: PREP (Policy and Rights Expression Platform, see the [Position Paper](#) for more information). It would be a framework to express and interpret the policies and info. It should complement laws and self-regulatory programs. It should be consistent with prior work, e.g., P3P.

What are the building blocks of PREP?

- semantics - policy interpretation mechanisms
- objects - rights messaging protocol
- syntax - rights expression languages

**Erickson concluded:**

1. W3C should recommend a platform for IPR policy expression, discovery, and interpretation.
2. W3C should not recommend a standardized digital rights management system.
3. Core should be reliable way to express and transfer rights information.

Renato Iannella (IPR Systems), Open Digital Rights Management

*See also the [slides](#) and the [Position Paper](#)*

We need to define DRM formally. Customary DRM definitions tend to emphasize protection, enforcement, security. We need to remove the security/locking focus of DRM. There are a lot of definitions out there. But we want DRM to be broader: describe, identity, trade, monitor, track, and manage rights holder relationships. We want to leave behind the "creation waterfall" concept of create => trade => use as a line. We want to look at a circular life cycle approach (compare Rust events). We use the same terms: create-trade-use and add reuse = recreate. Then the life cycle is more accurately seen as circular. He gave an example of transparency in presenting rights, from Adobe eBook. You are authorized to get the copy. It is OK to copy (up to 10 times each week), to print, to lend. But you cannot give or read aloud. He suggested, that it should be possible to pay for usage, not possession.

The following are building blocks for a DRM architecture:

- A better metadata framework: He would like it to be in RDF
- Trust (digital signatures)
- There are lessons to learn from P3P, CC/PP
- identification (URIs)
- XML packaging and tools

- use the <indec> model: content, parties, rights. Each one is a kind of class. Parties described would be: author, corporate, agent, publisher. The content would be classified in work, expression, manifestation, item. Rights would be classified in usages, rewards, constraints.

Renato Iannella presented the ODRL. He sees it as a starting point for a DRM Language, that could be developed within W3C.

Concludes: W3C Role could be:

- W3C Digital Rights Language Working Group to develop semantics of a digital rights language encoded in XML
- Trusted Metadata Working Group to develop architecture to support encoding and transmission of DRM and other metadata
- DRM Interest Group to discuss next steps and establish relationship with other communities

W3C can solve some part of the DRM problem, coordinate others, and empower the user community.

## Norman Paskin (Int. DOI Foundation), Digital Object Identifier (DOI)

*See also the [slides \(ppt\)](#) and the [Position Paper](#)*

Paskin was presenting the activity of the DOI Foundation. We have spent three years developing an identifier system for digital objects. We have been influenced by <indec> analysis and implementations, e.g., ONIX and by consideration of digital object infrastructure (e.g., CNRI work).

DRM must be maximally extensible. DRM is digital management of rights, not just management of digital rights. Practical rights management will require dealing with both digital and non-digital rights. Unique identification is essential for automation to work on this.

Description info and rights info are not distinguishable. Any piece of description may be needed in a rights transaction.

Creative items used to be physical, today we have both a physical and digital manifestation, so sometimes there are two identifiers, e.g., ISBN for one, URL for the other. But if we are going to automate transactions we must dis-ambiguate meanings. We need to define word like book in the spaces it may found in, the ISBN space or the <indec> space.

There will not be one model for applying identifiers, it will differ for content communities, given practical implications, e.g. ONIX, MPEG-7, etc. A work may be an original manuscript version, the work in the abstract, a draft, a copy in a publication, a digital copy not in a publication, a reprint, etc.. In each role, there will be different ids and attributes. We don't have to have complete knowledge representation. We can build on agreements over what an identifier means within a given namespace

About names and locations, he said that a name is a location in a defined namespace, thus all names are locations is trivially true.

As practical needs for DOI, Paskin identified:

- multiple instances
- persistence in face of change
- mgt of non-digital entities
- de-referencing, resolution

Who should be responsible for naming: Standards bodies, rights collectives? Examples are:

- EAN/UPC bar code system
- ISBN system
- URI system But what in the digital realm?
- URLs are a poor system for publishers

Identifier needs to be actionable. They can be the basis for rights management. But there won't be one place to go for:

- e.g., directory of parties (names of people, sort of, as for music, is developing a directory)
- e.g., ontology of scientific article

We need to involve stakeholders, what is the W3C good for here?

Paskin used an aphorism: I think what is called media convergence really is "people convergence" (with the correlative problem of communication). Formalisms are essential in their place but must be explained. What we ought to care about does not just encompass the web.

DOI system offers :

- numbering - use any identifier
- description - can use <indec> framework

- action - handles allow to link to instances
- It is persistent, granular, flexible, can wrap other identifiers

## Discussion

*Not for all questions and answers, the author was identified. In this case, you'll see only question and answer*

**Question:** is URI primarily address where you find something?

**Dan Connolly (W3C):** I don't think so.

**Danny Weitzner (W3C):** Question to Godfrey Rust and John Erickson: Is there a consensus point? John said there should be a rights management schema. How modular is the <indec> system? Does anyone who uses something that falls under the <indec> model have to use the whole model?

**Godfrey Rust (<indec>):** It is a matter of how you structure your information. If we use the event model to organize our system, this should lead to interoperability. If one wants to express things in most efficient way, an events - systems will be very powerful. Other systems/legacy info can be transformed into events model. One doesn't have to organize all data into high level of functionality. We can still use information that is fairly low grade.

**John Erickson (HP):** An event model is powerful, because it allows description of certain rights relationships that we might think of in terms of electronic contracts. If we speak about rights languages, we can imagine a lot of different types of transactions. There are things that need to be declared, between an author and a publisher. It is a dynamic activity with lots of outcomes that the event model can characterize. The event model is the basis of an ontology. We need different vocabularies for different purposes. A contract between an author and a publisher is like dynamic state machine. The event model is a powerful way to express that. Things like rights vouchers/licenses and output of individual states are dependant on dynamic events.

**Maximilian Herberger (Uni Saarland):** Events are only one side. The event model reflects the state of subjective rights within a specific contract. We also need a way to describe how things fit together or what things have in common. We need a language at a higher level about objective rights. This language should be able to express classes of contract relationships. I think the combination of the two is the solution here.

**Jonathan Schull (Digital Goods):** Suppose I'm a publisher and I want to publish a book electronically. There are a whole lot of ways to do this. Each combination will have a

different address, thus creating a different digital object. A publisher doesn't really care about the locations, he only cares about initial work. He may decide that people shouldn't print it, or that people want their money back. As a publisher, I want to have only one thing to do.

**Jonathan D. Hahn (Versaware):** In a contrarian mode I say, well, about these "events," you know publishers may think of only one event, the one that came into play when I signed on to publish this work.

**Godfrey Rust (<indec>):** A DOI is a single number for the object

**Dan Connolly (W3C):** What's the first letter of most DOIs? Names are little pieces of communication. Making up a name without thinking about communication is sort of silly. We don't decide anything by ourselves, we decide together with people we communicate with. I don't think you can invent new technology that solves all the social problems involved

**Norman Paskin (DOI):** The web is not the universal information space. There are things, which aren't on the web. We need to identify them too.

**Eric Miller (OCLC):** you can place something on the web without using DOI. I represent libraries, so if you publish, you want consumer to get access to stuff - you have to talk to your customer base to find out whether they will use access mechanism you are designing to access content. What are the things we are trying to automate here? Let's think about a scenario with implemented DRM, let's do what-if scenarios.

**Question:** Why are ontologies so important?

**Answer:** Take a look at ontologies and what publishers require and you have your problem defined

**Eric Miller (OCLC):** A question not yet resolved is, what happens in DRM if different kinds of people are accessing the same object, e.g. in the context of a library.

**Robert Bollick, (McGraw-Hill):** This is already covered. It is like every consumer/publisher interaction which is covered by the requirements. More information can be found on [publishers.org](http://publishers.org). The name of the document is publishers DRM requirements.

**Comment:** We will get a lot of input/requirements from many different constituencies, e.g. record industry, book industry etc.. We need to consider the evolution of technology - technical components should be able to move independently from one another. We have a conceptual model: Take a language and a context used by different areas and avoid using

two different terms for same requirement. We need to build a common platform. That gives you a mechanism to do extensions that are truly unique. Medicine, oil-drilling all use different terminology, but a conceptual model helps us to decide whether their need is unique and helps us develop an orthogonal system, and avoid redundancy

**Scott Foshee, (Adobe)** states agreement with the interest in fine-grained identification implied by the <indecs>/DOI ideas.

**Question:** We won't be able to define precisely what work is. We should avoid defining it. While broad categories of interactions may have been studied, do you think your publishing model is extensible to images, text, font? To Godfrey Rust: Do you think we can extend this to publishing of aggregations, e.g. written book by an author combined with paper it is printed on ?

**Godfrey Rust (<indecs>):** Take a look at indecs papers. The answer is yes, I think this is possible.

**Answer:** The same is true for ONIX - thinking about selling pieces of a work

**Danny Weitzner (W3C):** Commenting on Norman's point of the Web not being the universal information space, I think that in the discussions so far we showed lots of attention on commercial needs. The question is whether we would like common framework for discovering rights of document whether or not produced principally for trade or not? E.g., does a picture of my 3-year old fit into this framework? We risk to produce big costs if there are two classes of documents: One that fits into trading and others who don't. If we look at music, we see, that non-traditional documents are traded. I'm a bit concerned about the application of these systems only to "trade" items in the web, ignoring or disenfranchising the little objects which also have rights associated with them.

**Godfrey Rust (<indecs>):**The model we worked on are neutral as far as commerce is concerned. It can be used for picture of 3 year old. We haven't actually developed framework though. A critical piece of work is to decide what those verbs (note: for the actions) are. The model still needs a lot of detailed work. We have roughly agreed on the direction we take. Please don't overestimate what we've done.

**Norman Paskin (DOI):** <indecs>/DOI is about transactions. We mean by transaction anything, whether it's free or not. We focused on e-commerce. Our economic model is based on the barcode model. For some transactions, the financial cost will be zero.

**John Erickson (HP):** What is the methodology for rationalising to interpret new dimensions for a given problem space? There has been a lot of talk about notion of ontologies. We

have a certain way of thinking about a problem, and perhaps another way. Now we try to find ontologies to identify common points. Where does the notion of rationalizing problem spaces conflict with ontologies? I can see that it resonates in a closed room ...

**Rob Koenen, MPEG:** MPEG-7 is standard for describing content. Based on XML schema, there are principle notions like actor, people etc. Those are listed in a concepts list. There are basic concepts like shape, color etc. People can build their own ontology. MPEG has just decided to do a data dictionary for a rights language. MPEG has issued a call for requirements on 19 January 2001. Koenen invited W3C to work with MPEG on working on this problem

**Peter Schirling (IBM & MPEG):** We should try to avoid unnecessary duplication. We allow each discipline to build an ontology from a common frame, to reduce duplication of elements. Under that framework, different sectors can add their own things to a specific concepts list. Currently, we have only concept lists very specific to audio-visual content.

**Scott Foshee (Adobe):** There are two classes of objects (things): Under control and not under control. I wanted to state my agreement with Danny Weitzner, that there should only be one class. Clipart in a presentation software is an aggregation with content you created. By using a product that was licensed, everything on a harddisk is aggregated content work. DRM should be able to handle that. Take a picture of Danny Weitzner and apply a filter may result in aggregate work. The process that is applied results in another object. We need to get something that is workable, because this technology will be everywhere

Coffee Break, but not enough coffee for some

---

[\[Minutes Overview\]](#) [\[Workshop Home\]](#) [\[Previous:Publishers Requirements\]](#)  
[\[Next:Architecture: Interoperability and Standards\]](#)

Created by Rigo Wenning February 2001  
Last update \$Date: 2001/04/18 16:50:31 \$ by \$Author: rigo \$



<b>Notice of References Cited</b>	Application/Control No. 10/956,121	Applicant(s)/Patent Under Reexamination WANG ET AL.	
	Examiner THOMAS WEST	Art Unit 3621	Page 1 of 1

**U.S. PATENT DOCUMENTS**

*	Document Number Country Code-Number-Kind Code	Date MM-YYYY	Name	Classification
*	A US-6,044,466 A	03-2000	Anand et al.	726/1
B	US-			
C	US-			
D	US-			
E	US-			
F	US-			
G	US-			
H	US-			
I	US-			
J	US-			
K	US-			
L	US-			
M	US-			

**FOREIGN PATENT DOCUMENTS**

*	Document Number Country Code-Number-Kind Code	Date MM-YYYY	Country	Name	Classification
N					
O					
P					
Q					
R					
S					
T					

**NON-PATENT DOCUMENTS**

*	Document Number Country Code-Number-Kind Code	Date MM-YYYY	Country	Name	Classification
		Include as applicable: Author, Title Date, Publisher, Edition or Volume, Pertinent Pages)			
U		Workshop on Digital Rights Management for the Web, World Wide Web Consortium, Minutes from the Architecture/Infrastructure Session, January 2001			
V					
W					
X					

\*A copy of this reference is not being furnished with this Office action. (See MPEP § 707.05(a).)  
Dates in MM-YYYY format are publication dates. Classifications may be US or foreign.



FW

<b>TRANSMITTAL FORM</b> <i>(to be used for all correspondence after initial filing)</i>	Application Number	10/956,121
	Filing Date	October 4, 2004
	First Named Inventor	Mai NGUYEN, <i>et al.</i>
	Group Art Unit	2131
	Examiner Name	Not Yet Assigned
Total Number of Pages in This Submission	Attorney Docket Number	111325-291300

ENCLOSURES <i>(check all that apply)</i>		
<input type="checkbox"/> Fee Transmittal Form <input type="checkbox"/> Fee Attached <input type="checkbox"/> Amendment / Reply <input type="checkbox"/> After Final <input type="checkbox"/> Affidavits/declaration(s) <input type="checkbox"/> Extension of Time Request <input type="checkbox"/> Express Abandonment Request <input checked="" type="checkbox"/> Information Disclosure Statement <input type="checkbox"/> Certified Copy of Priority Document(s) <input type="checkbox"/> Response to Missing Parts/ Incomplete Application <input type="checkbox"/> Response to Missing Parts under 37 CFR 1.52 or 1.53	<input type="checkbox"/> Assignment Papers <i>(for an Application)</i> <input type="checkbox"/> Drawing(s) <input type="checkbox"/> Declaration and Power of Attorney <input type="checkbox"/> Licensing-related Papers <input type="checkbox"/> Petition <input type="checkbox"/> Petition to Convert to a Provisional Application <input type="checkbox"/> Power of Attorney, Revocation Change of Correspondence Address <input type="checkbox"/> Terminal Disclaimer <input type="checkbox"/> Request for Refund <input type="checkbox"/> CD, Number of CD(s) _____	<input type="checkbox"/> After Allowance Communication to Group <input type="checkbox"/> Appeal Communication to Board of Appeals and Interferences <input type="checkbox"/> Appeal Communication to Group (Appeal Notice, Brief, Reply Brief) <input type="checkbox"/> Proprietary Information <input type="checkbox"/> Status Letter <input checked="" type="checkbox"/> Application Data Sheet <input checked="" type="checkbox"/> Request for Corrected Filing Receipt with Enclosures <input type="checkbox"/> A self-addressed prepaid postcard for acknowledging receipt <input type="checkbox"/> Other Enclosure(s) <i>(please identify below):</i>
Remarks		<input checked="" type="checkbox"/> The Commissioner is hereby authorized to charge any additional fees required or credit any overpayments to Deposit Account No. 19-2380 for the above identified docket number.

SIGNATURE OF APPLICANT, ATTORNEY, OR AGENT	
Firm or Individual name	Marc S. Kaufman Registration No. 35,212 Nixon Peabody LLP 401 9 <sup>th</sup> Street, N.W., Suite 900 Washington, D.C. 20004-2128
Signature	
Date	January 26, 2005

CERTIFICATE OF MAILING OR TRANSMISSION [37 CFR 1.8(a)]	
I hereby certify that this correspondence is being:	
<input type="checkbox"/> deposited with the United States Postal Service on the date shown below with sufficient postage as first class mail in an envelope addressed to: Mail Stop _____, Commissioner for Patents, P. O. Box 1450, Alexandria, VA 22313-1450	
<input type="checkbox"/> transmitted by facsimile on the date shown below to the United States Patent and Trademark Office at (703) _____.	
Date	Signature
_____	_____
	Typed or printed name



**IN THE UNITED STATES PATENT AND TRADEMARK OFFICE**

In re Patent Application of:	)	
Mai NGUYEN, <i>et al.</i>	)	Examiner: Unassigned
Serial No. 10/956,121	)	Group Art Unit: 2131
Filed: October 4, 2004	)	
For: SYSTEM AND METHOD FOR MANAGING )		
TRANSFER OF RIGHTS USING SHARED )		
STATE VARIABLES )		

U.S. Patent and Trademark Office  
Customer Window, Mail Stop  
Randolph Building  
Alexandria, VA 22314

Sir:

**INFORMATION DISCLOSURE STATEMENT**

In accordance with the duty of disclosure as set forth in 37 C.F.R. §1.56, Applicants hereby submit the following information in conformance with 37 C.F.R. §§ 1.97 and 1.98. The references listed on the attached PTO-1449 forms have been made of record in parent application serial number 10/162,701 Filed on June 6, 2002, therefore no copies of the references cited are submitted herewith.

It is requested that the accompanying PTO-1449 be considered and made of record in the above-identified application. To assist the Examiner, the documents are listed on the attached form PTO-1449. It is respectfully requested that an Examiner initial a copy of this form be returned to the undersigned.

The Commissioner is hereby authorized to charge any fees connected with this filing which may be required now, or credit any overpayment to Deposit Account No. 19-2380 (111325-291300).

Respectfully submitted,  
**NIXON PEABODY, LLP**

By:   
\_\_\_\_\_  
Marc S. Kaufman  
Registration No. 35, 212

Date: **January 26, 2005**

Customer No. 22204  
**NIXON PEABODY LLP**  
401 9<sup>th</sup> Street, N.W., Suite 900  
Washington, DC 20004-2128  
Telephone: (202) 585-8000

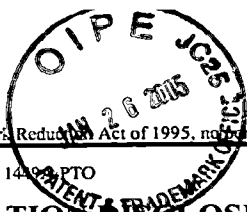

Under the Paperwork Reduction Act of 1995, no persons are required to respond to a collection of information unless it contains a valid OMB control number.

Substitute for form 1449, PTO				<b>Complete if Known</b>			
<b>INFORMATION DISCLOSURE STATEMENT BY APPLICANT</b> <i>(use as many sheets as necessary)</i>				Application Number		10/956,121	
				Filing Date		January 26, 2005	
				First Named Inventor		Mai NGUYEN, et al.	
				Art Unit		Not Yet Assigned	
				Examiner Name		Not Yet Assigned	
Sheet	1	of	10	Attorney Docket Number		111325-291300	
<b>U.S. PATENT DOCUMENTS</b>							
Examiner Initials <sup>2</sup>	Cite No. <sup>1</sup>	U.S. Patent Document		Publication Date MM-DD-YYYY	Name of Patentee or Applicant of Cited Document	Pages, Columns, Lines, Where Relevant Passages or Relevant Figures Appear	
		Number - Kind Code <sup>3</sup> (if known)					
		US-3,263,158		07/26/1966	D.W. Bargaen et al.		
		US-3,609,697		09/28/1971	Blevins et al.		
		US-3,790,700		02/05/1974	Callais et al.		
		US-3,798,605		03/19/1974	Feistel		
		US-4,159,468		06/26/1979	Barnes et al.		
		US-4,220,991		09/02/1980	Hamano et al.		
		US-4,278,837		07/14/1981	Best		
		US-4,323,921		04/06/1982	Guillou		
		US-4,442,486		04/10/1984	Mayer		
		US-4,529,870		07/16/1985	Chaum		
		US-4,558,176		12/10/1985	Arnold et al.		
		US-4,593,376		06/03/1986	Volk		
		US-4,614,861		09/30/1986	Pavlov et al.		
		US-4,644,493		02/17/1987	Chandra et al.		
		US-4,658,093		04/14/1987	Hellman		
		US-4,713,753		12/15/1987	Beobert et al.		
		US-4,796,220		01/03/1989	Wolfe		
		US-4,817,140		03/28/1989	Chandra et al.		
		US-4,827,508		05/02/1989	Shear		
		US-4,868,376		09/19/1989	Lessin et al.		
<b>FOREIGN PATENT DOCUMENTS</b>							
Examiner Initials <sup>2</sup>	Cite No. <sup>1</sup>	Foreign Patent Document		Publication Date MM-DD-YYYY	Name of Patentee or Applicant of Cited Document	Pages, Columns, Lines, Where Relevant Passages or Relevant Figures Appear	T <sup>6</sup>
		Country Code <sup>3</sup>	Number <sup>4</sup> Kind Code <sup>5</sup> (if known)				
		0 084 441	EP	07/27/1983	TABS LIMITED		
		0 180 460	EP	05/07/1986	SONY CORPORATION		
		0 332 707	EP	09/20/1989	HONDA GIKEN KOGYO KABUSHIKI KAISHA		
		0 651 554	EP	05/03/1995	EASTMAN KODAK CO.		
		0 668 695	EP	08/23/1995	VICTOR COMPANY OF JAPAN LIMITED		
		0 725 376	EP	08/07/1996	SONY CORP.		
		2 136 175	GB	09/12/1984	ATALLA CORP.		
		2 236 604	GB	04/10/1991	SUN MICROSYSTEMS INC		
		0 715 241	JP	06/05/1996	MITSUBISHI CORP.		
		04-369068	JP	12/21/1992	CHIYUUBU NIHON DENKI SOFUTOUEA KK		Abst
Examiner Signature	/Thomas West/				Date Considered	04/03/2008	

\*EXAMINER: Initial if reference considered, whether or not citation is in conformance with MPEP 609. Draw line through citation if not in conformance and not considered. Include copy of this form with next communication to applicant.

<sup>1</sup> Applicant's unique citation designation number (optional). <sup>2</sup> See Kinds Codes of USPTO Patent Documents at 222.uspto.gov or MPEP 901.04. <sup>3</sup> Enter Office that issued the document, by the two-letter code (WIPO Standard ST.3). <sup>4</sup> For Japanese patent documents, the indication of the year of the reign of the Emperor must precede the serial number of the patent document. <sup>5</sup> Kind of document by the appropriate symbols as indicated on the document under WIPO Standard ST.16 if possible. <sup>6</sup> Applicant is to place a check mark here if English language translation is attached.

Burden Hour Statement: This form is estimated to take 2.0 hours to complete. Time will vary depending upon the needs of the individual case. Any comments on the amount of time you are required to complete this form should be sent to the Chief Information Officer, U.S. Patent and Trademark Office, Washington, DC 20231. DO NOT SEND FEES OR COMPLETED FORMS TO THIS ADDRESS. SEND TO: Commissioner for Patents, Washington, DC 20231.

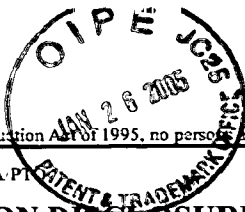

Under the Paperwork Reduction Act of 1995, no person is required to respond to a collection of information unless it contains a valid OMB control number.

Substitute for form 1449A-PT <b>INFORMATION DISCLOSURE STATEMENT BY APPLICANT</b> <i>(use as many sheets as necessary)</i>				<b>Complete if Known</b>		
				Application Number	10/956,121	
Sheet		2	of	10	Examiner Name	Not Yet Assigned
					Attorney Docket Number	111325-291300

U.S. PATENT DOCUMENTS						
Examiner Initials <sup>1</sup>	Cite No. <sup>1</sup>	U.S. Patent Document		Publication Date MM-DD-YYYY	Name of Patentee or Applicant of Cited Document	Pages, Columns, Lines, Where Relevant Passages or Relevant Figures Appear
		Number - Kind Code <sup>2</sup> (if known)				
		US-4,891,838		01/02/1990	Faber	
		US-4,924,378		05/08/1990	Hershey et al.	
		US-4,932,054		06/05/1990	Chou et al.	
		US-4,937,863		06/26/1990	Robert et al.	
		US-4,949,187		08/14/1990	Cohen	
		US-4,953,209		08/28/1990	Ryder, Sr. et al.	
		US-4,961,142		10/02/1990	Elliott et al.	
		US-4,975,647		12/04/1990	Downer et al.	
		US-4,977,594		12/11/1990	Shear	
		US-4,999,806		03/12/1991	Chernow et al.	
		US-5,010,571		04/23/1991	Katznelson	
		US-5,014,234		05/07/1991	Edwards, Jr.	
		US-5,023,907		06/11/1991	Johnson et al.	
		US-5,047,928		09/10/1991	Wiedemer	
		US-5,050,213		09/17/1991	Shear	
		US-5,052,040		09/24/1991	Preston et al.	
		US-5,058,164		10/15/1991	Elmer et al.	
		US-5,103,476		04/07/1992	Waite et al.	
		US-5,113,519		05/12/1992	Johnson et al.	
		US-5,136,643		08/04/1992	Fischer	

FOREIGN PATENT DOCUMENTS								
Examiner Initials <sup>1</sup>	Cite No. <sup>1</sup>	Foreign Patent Document			Publication Date MM-DD-YYYY	Name of Patentee or Applicant of Cited Document	Pages, Columns, Lines, Where Relevant Passages or Relevant Figures Appear	T <sup>6</sup>
		Country Code <sup>3</sup>	Number <sup>4</sup>	Kind Code <sup>2</sup> (if known)				
		05-268415	JP		10/15/1993	RICOH CO LTD		Abst
		06-175794	JP		06/24/1994	FUJI XEROX CO LTD		Abst
		06-215010	JP		08/05/1994	SONY CORP.		Abst
		07-084852	JP		03/31/1995	HITACHI LTD.		Abst
		07-200317	JP		08/04/1995	TOSHIBA CORP.		Abst
		07-244639	JP		09/19/1995	FUJITSU LTD		Abst
		62-241061	JP		10/21/1987	NEC CORP.		Abst
		64-068835	JP		03/14/1989	RYOICHI MORI		Abst
		WO 01/63528	PCT		08/30/2001	IPDN COPR.		
		WO 92/20022	PCT		11/12/1992	DIGITAL EQUIPMENT CORP.		

Examiner Signature	/Thomas West/	Date Considered	04/03/2008
--------------------	---------------	-----------------	------------

\*EXAMINER: Initial if reference considered, whether or not citation is in conformance with MPEP 609. Draw line through citation if not in conformance and not considered. Include copy of this form with next communication to applicant.

<sup>1</sup> Applicant's unique citation designation number (optional). <sup>2</sup> See Kinds Codes of USPTO Patent Documents at 222.uspto.gov or MPEP 901.04. <sup>3</sup> Enter Office that issued the document, by the two-letter code (WIPO Standard ST.3). <sup>4</sup> For Japanese patent documents, the indication of the year of the reign of the Emperor must precede the serial number of the patent document. <sup>5</sup> Kind of document by the appropriate symbols as indicated on the document under WIPO Standard ST.16 if possible. <sup>6</sup> Applicant is to place a check mark here if English language Translation is attached.

Burden Hour Statement: This form is estimated to take 2.0 hours to complete. Time will vary depending upon the needs of the individual case. Any comments on the amount of time you are required to complete this form should be sent to the Chief Information Officer, U.S. Patent and Trademark Office, Washington, DC 20231. DO NOT SEND FEES OR COMPLETED FORMS TO THIS ADDRESS. SEND TO: Commissioner for Patents, Washington, DC 20231.

Under the Paperwork Reduction Act of 1995, no persons are required to respond to a collection of information unless it contains a valid OMB control number.

Substitute for form I449A PTO				<b>Complete if Known</b>	
<b>INFORMATION DISCLOSURE STATEMENT BY APPLICANT</b> <i>(use as many sheets as necessary)</i>				Application Number	10/956,121
				Filing Date	January 26, 2005
				First Named Inventor	Mai NGUYEN, <i>et al.</i>
				Art Unit	Not Yet Assigned
				Examiner Name	Not Yet Assigned
Sheet	3	of	10	Attorney Docket Number	111325-291300

U.S. PATENT DOCUMENTS						
Examiner Initials <sup>7</sup>	Cite No. <sup>1</sup>	U.S. Patent Document		Publication Date MM-DD-YYYY	Name of Patentee or Applicant of Cited Document	Pages, Columns, Lines, Where Relevant Passages or Relevant Figures Appear
		Number - Kind Code <sup>2</sup> (if known)				
		US-5,138,712		08/11/1992	Corbin	
		US-5,146,499		09/08/1992	Geffrotin	
		US-5,148,481		09/15/1992	Abraham et al.	
		US-5,159,182		10/27/1992	Eisele	
		US-5,183,404		02/02/1993	Aldous et al.	
		US-5,191,193		03/02/1993	Le Roux	
		US-5,204,897		04/20/1993	Wyman	
		US-5,222,134		06/22/1993	Waite et al.	
		US-5,235,642		08/10/1993	Wobber et al.	
		US-5,247,575		09/21/1993	Sprague et al.	
		US-5,255,106		10/19/1993	Castro	
		US-5,260,999		11/09/1993	Wyman	
		US-5,263,157		11/16/1993	Janis	
		US-5,263,158		11/16/1993	Janis	
		US-5,276,444		01/04/1994	McNair	
		US-5,276,735		01/04/1994	Boebert et al.	
		US-5,291,596		03/01/1994	Mita	
		US-5,301,231		04/05/1994	Abraham et al.	
		US-5,311,591		05/10/1994	Fischer	
		US-5,319,705		06/07/1994	Halter et al.	

FOREIGN PATENT DOCUMENTS							
Examiner Initials <sup>7</sup>	Cite No. <sup>1</sup>	Foreign Patent Document		Publication Date MM-DD-YYYY	Name of Patentee or Applicant of Cited Document	Pages, Columns, Lines, Where Relevant Passages or Relevant Figures Appear	T <sup>6</sup>
		Country Code <sup>3</sup>	Number <sup>4</sup>				
		WO 93/01550	PCT	01/21/1993	INFOLOGIC SOFTWARE, INC		
		WO 94/01821	PCT	01/20/1994	SECURE COMPUTING CORP.		
		WO 96/24092	PCT	08/08/1996	BENSON, Greg		
		WO 97/48203	PCT	12/18/1997	INTEL CORP.		
		WO 98/11690	PCT	03/19/1998	GLOVER, John J.		
		WO 98/42098	PCT	09/24/1998	CRYPTOWORKS, INC.		
		WO 99/49615	PCT	09/30/1999	MICROTOME		
		WO 00/20950		04/13/2000			
Examiner Signature	/Thomas West/				Date Considered	04/03/2008	

\*EXAMINER: Initial if reference considered, whether or not citation is in conformance with MPEP 609. Draw line through citation if not in conformance and not considered. Include copy of this form with next communication to applicant.

<sup>1</sup> Applicant's unique citation designation number (optional). <sup>2</sup> See Kinds Codes of USPTO Patent Documents at 222.uspto.gov or MPEP 901.04. <sup>3</sup> Enter Office that issued the document, by the two-letter code (WIPO Standard ST.3). <sup>4</sup> For Japanese patent documents, the indication of the year of the reign of the Emperor must precede the serial number of the patent document. <sup>5</sup> Kind of document by the appropriate symbols as indicated on the document under WIPO Standard ST.16 if possible. <sup>6</sup> Applicant is to place a check mark here if English language Translation is attached.

Burden Hour Statement: This form is estimated to take 2.0 hours to complete. Time will vary depending upon the needs of the individual case. Any comments on the amount of time you are required to complete this form should be sent to the Chief Information Officer, U.S. Patent and Trademark Office, Washington, DC 20231. DO NOT SEND FEES OR COMPLETED FORMS TO THIS ADDRESS. SEND TO: Commissioner for Patents, Washington, DC 20231.

Under the Paperwork Reduction Act of 1995, no persons are required to respond to a collection of information unless it contains a valid OMB control number.

Substitute for form 1449A PTO <b>INFORMATION DISCLOSURE STATEMENT BY APPLICANT</b> (use as many sheets as necessary)				<b>Complete if Known</b>	
Application Number		10/956,121			
Filing Date		January 26, 2005			
First Named Inventor		Mai NGUYEN, et al.			
Art Unit		2131			
Examiner Name		Not Yet Assigned			
Attorney Docket Number		111325291300			
Sheet	4	of	10		

U.S. PATENT DOCUMENTS						
Examiner Initials <sup>2</sup>	Cite No. <sup>1</sup>	U.S. Patent Document		Publication Date MM-DD-YYYY	Name of Patentee or Applicant of Cited Document	Pages, Columns, Lines, Where Relevant Passages or Relevant Figures Appear
		Number - Kind Code <sup>3</sup>	(if known)			
		US-5,337,357		08/09/1994	Chou et al.	
		US-5,339,091		08/16/1994	Yamazaki et al.	
		US-5,341,429		08/23/1994	Stringer et al.	
		US-5,347,579		09/13/1994	Blandford	
		US-5,381,526		01/10/1995	Ellson	
		US-5,394,469		02/28/1995	Nagel et al.	
		US-5,410,598		04/25/1995	Shear	
		US-5,412,717		05/02/1995	Fischer	
		US-5,428,606		06/27/1995	Moskowitz	
		US-5,432,849		07/11/1995	Johnson et al.	
		US-5,438,508		08/01/1995	Wyman	
		US-5,444,779		08/22/1995	Daniele	
		US-5,453,601		09/26/1995	Rosen	
		US-5,455,953		10/03/1995	Russell	
		US-5,457,746		10/10/1995	Dolphin	
		US-5,473,687		12/05/1995	Lipscomb et al.	
		US-5,473,692		12/05/1995	Davis	
		US-5,499,298		03/12/1996	Narasimhalu et al.	
		US-5,502,766		03/26/1996	Boebert et al.	
		US-5,504,814		04/02/1996	Miyahara	

FOREIGN PATENT DOCUMENTS								
Examiner Initials <sup>2</sup>	Cite No. <sup>1</sup>	Foreign Patent Document			Publication Date MM-DD-YYYY	Name of Patentee or Applicant of Cited Document	Pages, Columns, Lines, Where Relevant Passages or Relevant Figures Appear	T <sup>6</sup>
		Country Code <sup>3</sup>	Number <sup>4</sup>	Kind Code <sup>5</sup> (if known)				

Examiner Signature	/Thomas West/	Date Considered	04/03/2008
--------------------	---------------	-----------------	------------

\*EXAMINER: Initial if reference considered, whether or not citation is in conformance with MPEP 609. Draw line through citation if not in conformance and not considered. Include copy of this form with next communication to applicant.

<sup>1</sup> Applicant's unique citation designation number (optional). <sup>2</sup> See Kinds Codes of USPTO Patent Documents at 222.uspto.gov or MPEP 901.04. <sup>3</sup> Enter Office that issued the document, by the two-letter code (WIPO Standard ST.3). <sup>4</sup> For Japanese patent documents, the indication of the year of the reign of the Emperor must precede the serial number of the patent document. <sup>5</sup> Kind of document by the appropriate symbols as indicated on the document under WIPO Standard ST.16 if possible. <sup>6</sup> Applicant is to place a check mark here if English language Translation is attached.

Burden Hour Statement: This form is estimated to take 2.0 hours to complete. Time will vary depending upon the needs of the individual case. Any comments on the amount of time you are required to complete this form should be sent to the Chief Information Officer, U.S. Patent and Trademark Office, Washington, DC 20231. DO NOT SEND FEES OR COMPLETED FORMS TO THIS ADDRESS. SEND TO: Commissioner for Patents, Washington, DC 20231.



Under the Paperwork Reduction Act of 1995, no persons are required to respond to a collection of information unless it contains a valid OMB control number.

Substitute for form 1449A PTO				<b>Complete if Known</b>		
<b>INFORMATION DISCLOSURE STATEMENT BY APPLICANT</b> (use as many sheets as necessary)				Application Number		10/956,121
				Filing Date		January 26, 2005
				First Named Inventor		Mai NGUYEN, et al.
				Art Unit		2131
				Examiner Name		Not Yet Assigned
Sheet	5	of	10	Attorney Docket Number		111325-191300

U.S. PATENT DOCUMENTS						
Examiner Initials <sup>2</sup>	Cite No. <sup>1</sup>	U.S. Patent Document		Publication Date MM-DD-YYYY	Name of Patentee or Applicant of Cited Document	Pages, Columns, Lines, Where Relevant Passages or Relevant Figures Appear
		Number - Kind Code <sup>3</sup>	(if known)			
		US-5,504,818		04/02/1996	Okano	
		US-5,504,837		04/02/1996	Griffeth et al.	
		US-5,509,070		04/16/1996	Schull	
		US-5,530,235		06/25/1996	Stefik et al.	
		US-5,532,920		07/02/1996	Hartrick et al.	
		US-5,534,975		07/09/1996	Stefik et al.	
		US-5,539,735		07/23/1996	Moskowitz	
		US-5,563,946		10/08/1996	Cooper et al.	
		US-5,568,552		10/22/1996	Davis	
		US-5,621,797		04/15/1997	Rosen	
		US-5,629,980		05/13/1997	Stefik et al.	
		US-5,633,932		05/27/1997	Davis et al.	
		US-5,634,012		05/27/1997	Stefik et al.	
		US-5,638,443		06/10/1997	Stefik et al.	
		US-5,649,013		07/15/1997	Stuckey et al.	
		US-5,655,077		08/05/1997	Jones et al.	
		US-5,708,717		01/13/1998	Alasia	
		US-5,734,823		03/31/1998	Saigh et al.	
		US-5,734,891		03/31/1998	Saigh	
		US-5,737,413		04/07/1998	Akiyama et al.	

FOREIGN PATENT DOCUMENTS							
Examiner Initials <sup>2</sup>	Cite No. <sup>1</sup>	Foreign Patent Document		Publication Date MM-DD-YYYY	Name of Patentee or Applicant of Cited Document	Pages, Columns, Lines, Where Relevant Passages or Relevant Figures Appear	T <sup>6</sup>
		Country Code <sup>3</sup>	Number <sup>4</sup> Kind Code <sup>5</sup> (if known)				

Examiner Signature	/Thomas West/	Date Considered	04/03/2008
--------------------	---------------	-----------------	------------

\*EXAMINER: Initial if reference considered, whether or not citation is in conformance with MPEP 609. Draw line through citation if not in conformance and not considered. Include copy of this form with next communication to applicant.

<sup>1</sup> Applicant's unique citation designation number (optional). <sup>2</sup> See Kinds Codes of USPTO Patent Documents at 222.uspto.gov or MPEP 901.04. <sup>3</sup> Enter Office that issued the document, by the two-letter code (WIPO Standard ST.3). <sup>4</sup> For Japanese patent documents, the indication of the year of the reign of the Emperor must precede the serial number of the patent document. <sup>5</sup> Kind of document by the appropriate symbols as indicated on the document under WIPO Standard ST.16 if possible. <sup>6</sup> Applicant is to place a check mark here if English language Translation is attached.

Burden Hour Statement: This form is estimated to take 2.0 hours to complete. Time will vary depending upon the needs of the individual case. Any comments on the amount of time you are required to complete this form should be sent to the Chief Information Officer, U.S. Patent and Trademark Office, Washington, DC 20231. DO NOT SEND FEES OR COMPLETED FORMS TO THIS ADDRESS. SEND TO: Commissioner for Patents, Washington, DC 20231.

Under the Paperwork Reduction Act of 1995, no persons are required to respond to a collection of information unless it contains a valid OMB control number.

Substitute for form 1449A PTO				<b>Complete if Known</b>	
<b>INFORMATION DISCLOSURE STATEMENT BY APPLICANT</b> <i>(use as many sheets as necessary)</i>				Application Number	10/956,121
				Filing Date	January 26, 2005
				First Named Inventor	Mai NGUYEN, <i>et al.</i>
				Art Unit	2131
				Examiner Name	Not Yet Assigned
Sheet	6	of	10	Attorney Docket Number	111325-291300

U.S. PATENT DOCUMENTS					
Examiner Initials <sup>5</sup>	Cite No. <sup>1</sup>	U.S. Patent Document	Publication Date MM-DD-YYYY	Name of Patentee or Applicant of Cited Document	Pages, Columns, Lines, Where Relevant Passages or Relevant Figures Appear
		Number - Kind Code <sup>2</sup> (if known)			
		US-5,737,416	04/07/1998	Cooper et al.	
		US-5,745,569	04/28/1998	Moskowitz et al.	
		US-5,748,783	05/05/1998	Rhoads	
		US-5,757,907	05/26/1998	Cooper et al.	
		US-5,761,686	06/02/1998	Bloomberg	
		US-5,765,152	06/09/1998	Erickson	
		US-5,768,426	06/16/1998	Rhoads	
		US-5,825,892	10/20/1998	Braudaway et al.	
		US-5,892,900	04/06/1999	Ginter et al.	
		US-5,910,987	06/08/1999	Ginter et al.	
		US-5,915,019	06/22/1999	Ginter et al.	
		US-5,917,912	06/29/1999	Ginter et al.	
		US-5,920,861	07/06/1999	Hall et al.	
		US-5,940,504	08/17/1999	Griswold	
		US-5,943,422	08/24/1999	Van Wie et al.	
		US-5,949,876	09/07/1999	Ginter et al.	
		US-5,982,891	11/09/1999	Ginter et al.	
		US-5,999,949	12/07/1999	Crandall	
		US-6,047,067	04/04/2000	Rosen	
		US-6,112,181	08/29/2000	Shear et al.	

FOREIGN PATENT DOCUMENTS							
Examiner Initials <sup>5</sup>	Cite No. <sup>1</sup>	Foreign Patent Document		Publication Date MM-DD-YYYY	Name of Patentee or Applicant of Cited Document	Pages, Columns, Lines, Where Relevant Passages or Relevant Figures Appear	T <sup>6</sup>
		Country Code <sup>3</sup>	Number <sup>4</sup> Kind Code <sup>2</sup> (if known)				

Examiner Signature	/Thomas West/	Date Considered	04/03/2008
--------------------	---------------	-----------------	------------

\*EXAMINER: Initial if reference considered, whether or not citation is in conformance with MPEP 609. Draw line through citation if not in conformance and not considered. Include copy of this form with next communication to applicant.

<sup>1</sup> Applicant's unique citation designation number (optional). <sup>2</sup> See Kinds Codes of USPTO Patent Documents at 222.uspto.gov or MPEP 901.04. <sup>3</sup> Enter Office that issued the document, by the two-letter code (WIPO Standard ST.3). <sup>4</sup> For Japanese patent documents, the indication of the year of the reign of the Emperor must precede the serial number of the patent document. <sup>5</sup> Kind of document by the appropriate symbols as indicated on the document under WIPO Standard ST. 16 if possible. <sup>6</sup> Applicant is to place a check mark here if English language Translation is attached.

Burden Hour Statement: This form is estimated to take 2.0 hours to complete. Time will vary depending upon the needs of the individual case. Any comments on the amount of time you are required to complete this form should be sent to the Chief Information Officer, U.S. Patent and Trademark Office, Washington, DC 20231. DO NOT SEND FEES OR COMPLETED FORMS TO THIS ADDRESS. SEND TO: Commissioner for Patents, Washington, DC 20231.

Under the Paperwork Reduction Act of 1995, no persons are required to respond to a collection of information unless it contains a valid OMB control number.

Substitute for form 1449A PTO			<b>Complete if Known</b>		
<b>INFORMATION DISCLOSURE STATEMENT BY APPLICANT</b> <i>(use as many sheets as necessary)</i>			Application Number	10/956,121	
			Filing Date	January 26, 2005	
			First Named Inventor	Mai NGUYEN, et al.	
			Art Unit	2131	
			Examiner Name	Not Yet Assigned	
Sheet	7	of	10	Attorney Docket Number	111325-291300

U.S. PATENT DOCUMENTS						
Examiner Initials*	Cite No. <sup>1</sup>	U.S. Patent Document		Publication Date MM-DD-YYYY	Name of Patentee or Applicant of Cited Document	Pages, Columns, Lines, Where Relevant Passages or Relevant Figures Appear
		Number - Kind Code <sup>2</sup>	(if known)			
		US-6,115,471		09/05/2000	Oki et al.	
		US-6,138,119		10/24/2000	Hall et al.	
		US-6,157,721		12/05/2000	Shear et al.	
		US-6,185,683		02/06/2001	Ginter et al.	
		US-6,226,618		05/01/2001	Downs et al.	
		US-6,233,684		05/15/2001	Stefik et al.	
		US-6,237,786		05/29/2001	Ginter et al.	
		US-6,240,185		05/29/2001	Van Wie et al.	
		US-6,253,193		06/26/2001	Ginter et al.	
		US-6,266,618		07/24//2001	Ye et al.	
		US-6,292,569		09/18/2001	Shear et al.	
		US-6,301,660		10/09/2001	Benson	
		US-6,327,652		12/04/2001	England et al.	
		US-6,330,670		12/11/2001	England et al.	
		US-6,345,256		02/05/2002	Milsted et al.	
		US-6,363,488		03/26/2002	Ginter et al.	
		US-6,389,402		05/14/2002	Ginter et al.	

FOREIGN PATENT DOCUMENTS							
Examiner Initials*	Cite No. <sup>1</sup>	Foreign Patent Document		Publication Date MM-DD-YYYY	Name of Patentee or Applicant of Cited Document	Pages, Columns, Lines, Where Relevant Passages or Relevant Figures Appear	T <sup>6</sup>
		Country Code <sup>3</sup>	Number <sup>4</sup>				

Examiner Signature	/Thomas West/	Date Considered	04/03/2008
--------------------	---------------	-----------------	------------

\*EXAMINER: Initial if reference considered, whether or not citation is in conformance with MPEP 609. Draw line through citation if not in conformance and not considered. Include copy of this form with next communication to applicant.

<sup>1</sup> Applicant's unique citation designation number (optional). <sup>2</sup> See Kinds Codes of USPTO Patent Documents at 222.uspto.gov or MPEP 901.04. <sup>3</sup> Enter Office that issued the document, by the two-letter code (WIPO Standard ST.3). <sup>4</sup> For Japanese patent documents, the indication of the year of the reign of the Emperor must precede the serial number of the patent document. <sup>5</sup> Kind of document by the appropriate symbols as indicated on the document under WIPO Standard ST.16 if possible. <sup>6</sup> Applicant is to place a check mark here if English language Translation is attached.

Burden Hour Statement: This form is estimated to take 2.0 hours to complete. Time will vary depending upon the needs of the individual case. Any comments on the amount of time you are required to complete this form should be sent to the Chief Information Officer, U.S. Patent and Trademark Office, Washington, DC 20231. DO NOT SEND FEES OR COMPLETED FORMS TO THIS ADDRESS. SEND TO: Commissioner for Patents, Washington, DC 20231.

Under the Paperwork Reduction Act of 1995, no persons are required to respond to a collection of information unless it contains a valid OMB control number.

Substitute for form 1449A/PTO				<b>Complete if Known</b>	
<b>INFORMATION DISCLOSURE STATEMENT BY APPLICANT</b> <i>(use as many sheets as necessary)</i>				Application Number	10/956,121
				Filing Date	January 26, 2005
				First Named Inventor	Mai NGUYEN, <i>et al.</i>
				Art Unit	2131
				Examiner Name	Not Yet Assigned
Sheet	8	of	10	Attorney Docket Number	111325-291300

OTHER PRIOR ART – NON PATENT LITERATURE DOCUMENTS			
Examiner Initials <sup>*</sup>	Cite No. <sup>1</sup>	Include name of the author (in CAPITAL LETTERS), title of the article (when appropriate), title of the item (book, magazine, journal, serial, symposium, catalog, etc.), date, page(s), volume-issue number(s), publisher, city and/or country where published.	T <sup>2</sup>
		“National Semiconductor and EPR Partner for Information Metering/Data Security Cards” March 4, 1994, Press Release from Electronic Publishing Resources, Inc.	
		Weber, R., “Digital Rights Management Technology” October 1995	
		Flasche, U. et al., “Decentralized Processing of Documents”, pp. 119-131, 1986, Comput. & Graphics, Vol. 10, No. 2	
		Mori, R. et al., “Superdistribution: The Concept and the Architecture”, pp. 1133-1146, 1990. The Transactions of the IEICE, Vo. E 73, No. 7, Tokyo, JP	
		Weber, R., “Metering Technologies for Digital Intellectual Property”, pp. 1-29, Oct. 1994, A Report to the International Federation of Reproduction Rights Organizations	
		Clark, P.C. et al., “Bits: A Smartcard protected Operating System”, pp. 66-70 and 94, November 1994, Communications of the ACM, Vol. 37, No. 11	
		Ross, P.E., “Data Guard”, pp. 101, June 6, 1994, Forbes	
		Saigh, W.K., “Knowledge is Sacred”, 1992, Video Pocket/Page Reader Systems, Ltd.	
		Kahn, R.E., “Deposit, Registration and Recordation in an Electronic Copyright Management System”, pp. 1-19, August 1992, Corporation for National Research Initiatives, Virginia	
		Hilts, P. et al., “Books While U Wait”, pp. 48-50, January 3, 1994, Publishers Weekly	
		Stratner, A., “Cash Register on a Chip may Revolutionaize Software Pricing and Distribution; Wave Systems Corp.”, pp. 1-3, April 1994, Computer Shopper, Vol. 14, No. 4, ISSN 0886-0556	

Examiner Signature	/Thomas West/	Date Considered	04/03/2008
-----------------------	---------------	--------------------	------------

\* EXAMINER: Initial if reference considered, whether or not citation is in conformance with MPEP 609. Draw line through citation if not in conformance and not considered. Include copy of this form with next communication to applicant.

<sup>1</sup> Applicant's unique citation designation number (optional). <sup>2</sup> Applicant is to place a check mark here if English language Translation is attached.

Burden Hour Statement: This form is estimated to take 2.0 hours to complete. Time will vary depending upon the needs of the individual case. Any comments on the amount of time you are required to complete this form should be sent to the Chief Information Officer, U.S. Patent and Trademark Office, Washington, DC 20231. DO NOT SEND FEES OR COMPLETED FORMS TO THIS ADDRESS. SEND TO: Commissioner for Patents, Washington, DC 20231.

Under the Paperwork Reduction Act of 1995, no persons are required to respond to a collection of information unless it contains a valid OMB control number.

Substitute for form 1449A/PTO				<b>Complete if Known</b>	
<b>INFORMATION DISCLOSURE STATEMENT BY APPLICANT</b> <i>(use as many sheets as necessary)</i>				Application Number	10/956,121
				Filing Date	January 26, 2005
				First Named Inventor	Mai NGUYEN, <i>et al.</i>
				Art Unit	2131
				Examiner Name	Not Yet Assigned
Sheet	9	of	10	Attorney Docket Number	111325-291300

OTHER PRIOR ART - NON PATENT LITERATURE DOCUMENTS			
Examiner Initials*	Cite No. <sup>1</sup>	Include name of the author (in CAPITAL LETTERS), title of the article (when appropriate), title of the item (book, magazine, journal, serial, symposium, catalog, etc.), date, page(s), volume-issue number(s), publisher, city and/or country where published.	T <sup>2</sup>
		O'Conner, M., "New Distribution Option for Electronic Publishers; iOpener Data Encryption and Metering System for CD-ROM use; Column", pp. 1-6, March 1994, CD-ROM Professional, Vol. 7, No. 2, ISSN: 1409-0833	
		Willett, S., "Metered PCs: Is Your System Watching You? Wave System beta tests new technology", pp. 84, May 2, 1994, InfoWorld	
		Linn, R., "Copyright and Information Services in the Context of the National Research and Education Network", pp. 9-20, January 1994, IMA Intellectual Property Project Proceedings, Vol. 1, Issue 1	
		Perrit, Jr., H., "Permission Headers and Contract Law", pp. 27-48, January 1994, IMA Intellectual Property Project Proceedings, Vol. 1, Issue 1	
		Upthegrove, L., "Intellectual Property Header Descriptors: A Dynamic Approach", pp. 63-66, January 1994, IMA Intellectual Property Project Proceedings, Vol. 1, Issue 1	
		Sirbu, M., "Internet Billing Service Design and prototype Implementation", pp. 67-80, January 1994, IMA Intellectual Property Project Proceedings, Vol. 1, Issue 1	
		Simmell, S. et al., "Metering and Licensing of Resources: Kala's General Purpose Approach", pp. 81-110, January 1994, IMA Intellectual Property Project Proceedings, Vol. 1, Issue 1	
		Kahn, R., "Deposit, Registration and Recordation in an Electronic Copyright Management System", pp. 111-120, January 1994, IMA Intellectual Property Project Proceedings, Vol. 1, Issue 1	
		Tygar, J. et al., "Dyad: A System for Using Physically Secure Coprocessors", pp. 121-152, January 1994, IMA Intellectual Property Project Proceedings, Vol. 1, Issue 1	
		Griswold, G., "A Method for Protecting Copyright on Networks", pp. 169-178, January 1994, IMA Intellectual Property Project Proceedings, Vol. 1, Issue 1	

Examiner Signature	/Thomas West/	Date Considered	04/03/2008
-----------------------	---------------	--------------------	------------

\* EXAMINER: Initial if reference considered, whether or not citation is in conformance with MPEP 609. Draw line through citation if not in conformance and not considered. Include copy of this form with next communication to applicant.

<sup>1</sup> Applicant's unique citation designation number (optional). <sup>2</sup> Applicant is to place a check mark here if English language Translation is attached.

Burden Hour Statement: This form is estimated to take 2.0 hours to complete. Time will vary depending upon the needs of the individual case. Any comments on the amount of time you are required to complete this form should be sent to the Chief Information Officer, U.S. Patent and Trademark Office, Washington, DC 20231. DO NOT SEND FEES OR COMPLETED FORMS TO THIS ADDRESS. SEND TO: Commissioner for Patents, Washington, DC 20231.

Under the Paperwork Reduction Act of 1995, no persons are required to respond to a collection of information unless it contains a valid OMB control number.

Substitute for form 1449A/PTO				<b>Complete if Known</b>	
<b>INFORMATION DISCLOSURE STATEMENT BY APPLICANT</b> <i>(use as many sheets as necessary)</i>				Application Number	10/956
				Filing Date	January 26, 2005
				First Named Inventor	Mai NGUYEN, <i>et al.</i>
				Art Unit	2131
				Examiner Name	Not Yet Assigned
Sheet	10	of	10	Attorney Docket Number	111325-291300

OTHER PRIOR ART - NON PATENT LITERATURE DOCUMENTS			
Examiner Initials*	Cite No. <sup>1</sup>	Include name of the author (in CAPITAL LETTERS), title of the article (when appropriate), title of the item (book, magazine, journal, serial, symposium, catalog, etc.), date, page(s), volume-issue number(s), publisher, city and/or country where published.	T <sup>2</sup>
		Nelson, T., "A Publishing and Royalty Model for Networked Documents", pp. 257-259, January 1994, IMA Intellectual Property Project Proceedings, Vol. 1, Issue 1	
		Robinson, E., "Redefining Mobile Computing", pp. 238-240, 247-248 and 252, July 1993, PC Computing	
		Abadi, M. et al., "Authentication and Delegation with Smart-cards", PP. 1-24, 1990, Research Report DEC Systems Research Center	
		Mark Stefik, "Letting Loose the Light: Igniting Commerce in Electronic Publication", pp. 219-253, 1996, Internet Dreams: Archetypes, Myths, and Metaphors, IDSN 0-262-19373-6	
		Mark Stefik, "Letting Loose the Light: Igniting Commerce in Electronic Publication", pp. 2-35, February 8, 1995, Internet Dreams: Archetypes, Myths and Metaphors	
		Henry H. Perritt, Jr., "Technological Strategies for Protecting Intellectual Property in the Networked Multimedia Environment", April 2-3, 1993, Knowbots, Permissions Headers & Contract Law	

Examiner Signature	/Thomas West/	Date Considered	04/03/2008
-----------------------	---------------	--------------------	------------

\* EXAMINER: Initial if reference considered, whether or not citation is in conformance with MPEP 609. Draw line through citation if not in conformance and not considered. Include copy of this form with next communication to applicant.

<sup>1</sup> Applicant's unique citation designation number (optional). <sup>2</sup> Applicant is to place a check mark here if English language Translation is attached.

Burden Hour Statement: This form is estimated to take 2.0 hours to complete. Time will vary depending upon the needs of the individual case. Any comments on the amount of time you are required to complete this form should be sent to the Chief Information Officer, U.S. Patent and Trademark Office, Washington, DC 20231. DO NOT SEND FEES OR COMPLETED FORMS TO THIS ADDRESS. SEND TO: Commissioner for Patents, Washington, DC 20231.

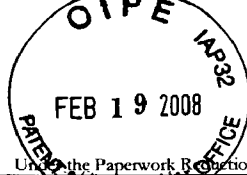

Under the Paperwork Reduction Act of 1995, no persons are required to respond to a collection of information unless it contains a valid OMB control number.

Substitute for form 1472, PTO		<b>Complete if Known</b>	
<b>INFORMATION DISCLOSURE STATEMENT BY APPLICANT</b> <i>(use as many sheets as necessary)</i>		Application Number	10/956,121
		Filing Date	October 4, 2004
		First Named Inventor	Xin Wang et al.
		Art Unit	3621
		Examiner Name	West, Thomas C.
Sheet	1	of	9
		Attorney Docket Number	111325/291300

U.S. PATENT DOCUMENTS						
Examiner Initials*	Cite No. <sup>1</sup>	U.S. Patent Document		Publication Date MM-DD-YYYY	Name of Patentee or Applicant of Cited Document	Pages, Columns, Lines, Where Relevant Passages or Relevant Figures Appear
		Number - Kind Code <sup>2</sup> (if known)				
	1	US 20010009026 A1		07-19-2001	Terao et al.	
	2	US 20010011276 A1		08-02-2001	Durst Jr. et al.	
	3	US 20010014206 A1		08-16-2001	Artigalas et al.	
	4	US 20010037467 A1		11-01-2001	O'Toole Jr. et al.	
	5	US 20010039659 A1		11-08-2001	Simmons et al.	
	6	US 20020001387 A1		01-03-2002	Dillon	
	7	US 20020035618 A1		03-21-2002	Mendez et al.	
	8	US 20020044658 A1		04-18-2002	Wasilewski et al.	
	9	US 20020056118 A1		05-09-2002	Hunter et al.	
	10	US 20020069282 A1		06-06-2002	Reisman	
	11	US 20020099948 A1		07-25-2002	Kocher et al.	
	12	US 20020127423 A1		09-12-2002	Kayanakis	
	13	US 20030097567 A1		05-22-2003	Terao et al.	
	14	US 20040052370 A1		03-18-2004	Katznelson	
	15	US 20040172552 A1		09-02-2004	Boyles et al.	
	16	US 4,159,468		06-26-1979	Barnes et al.	
	17	US 4,200,700		04-29-1980	Mäder	
	18	US 4,361,851		11-30-1982	Asip et al.	
	19	US 4,423,287		12-27-1983	Zeidler	
	20	US 4,429,385		01-31-1984	Cichelli et al.	
	21	US 4,621,321		11-04-1986	Boebert et al.	
	22	US 4,736,422		04-05-1988	Mason	
	23	US 4,740,890		04-26-1988	William	
	24	US 4,796,220		01-03-1989	Wolfe	
	25	US 4,816,655		03-28-1989	Musyck et al.	
	26	US 4,888,638		12-19-1989	Bohn	
	27	US 4,937,863		06-26-1990	Robert et al.	
	28	US 4,953,209		08-28-1990	Ryder et al.	
	29	US 4,977,594		12-11-1990	Shear	
	30	US 5,014,234		05-07-1991	Edwards	
	31	US 5,129,083		07-07-1992	Cutler et al.	
	32	US 5,138,712		08-11-1992	Corbin	
	33	US 5,174,641		12-29-1992	Lim	
	34	US 5,204,897		04-20-1993	Wyman	
	35	US 5,247,575		09-21-1993	Sprague et al.	
	36	US 5,260,999		11-09-1993	Wyman	
	37	US 5,276,444		01-04-1994	McNair	
	38	US 5,291,596		03-01-1994	Mita	
	39	US 5,293,422		03-08-1994	Loiacono	

Examiner Signature	/Thomas West/	Date Considered	04/03/2008
--------------------	---------------	-----------------	------------

\*EXAMINER: Initial if reference considered, whether or not citation is in conformance with MPEP 609. Draw line through citation if not in conformance and not considered. Include copy of this form with next communication to applicant.

<sup>1</sup> Applicant's unique citation designation number (optional). <sup>2</sup> See Kinds Codes of USPTO Patent Documents at 222.uspto.gov or MPEP 901.04. <sup>3</sup> Enter Office that issued the document, by the two-letter code (WIPO Standard ST.3). <sup>4</sup> For Japanese patent documents, the indication of the year of the reign of the Emperor must precede the serial number of the patent document. <sup>5</sup> Kind of document by the appropriate symbols as indicated on the document under WIPO Standard ST.16 if possible. <sup>6</sup> Applicant is to place a check mark here if English language translation is attached.

10886656.1

ALL REFERENCES CONSIDERED EXCEPT WHERE LINED THROUGH. /T.W./

Under the Paperwork Reduction Act of 1995, no persons are required to respond to a collection of information unless it contains a valid OMB control number.

Substitute for form 1449A/PTO		<b>Complete if Known</b>	
<b>INFORMATION DISCLOSURE STATEMENT BY APPLICANT</b> <i>(use as many sheets as necessary)</i>		Application Number	10/956,121
		Filing Date	October 4, 2004
		First Named Inventor	Xin Wang et al.
		Art Unit	3621
		Examiner Name	West, Thomas C.
Sheet	2	of	9
		Attorney Docket Number	111325/291300

U.S. PATENT DOCUMENTS					
Examiner Initials*	Cite No. <sup>1</sup>	U.S. Patent Document		Name of Patentee or Applicant of Cited Document	Pages, Columns, Lines, Where Relevant Passages or Relevant Figures Appear
		Number - Kind Code <sup>2</sup> (if known)	Publication Date MM-DD-YYYY		
	40	US 5,335,275	08-02-1994	Millar et al.	
	41	US 5,337,357	08-09-1994	Chou et al.	
	42	US 5,386,369	01-31-1995	Christiano	
	43	US 5,453,601	09-26-1995	Rosen	
	44	US 5,485,577	01-16-1996	Eyer et al.	
	45	US 5,504,816	04-02-1996	Hamilton et al.	
	46	US 5,530,235	06-25-1996	Stefik et al.	
	47	US 5,535,276	07-09-1996	Ganesan	
	48	US 5,557,678	09-17-1996	Ganesan	
	49	US 5,629,980	05-13-1997	Stefik et al.	
	50	US 5,636,346	06-03-1997	Saxe	
	51	US 5,638,443	06-10-1997	Stefik et al.	
	52	US 5,708,709	01-13-1998	Rose	
	53	US 5,715,403	02-03-1998	Stefik	
	54	US 5,745,879	04-28-1998	Wyman	
	55	US 5,764,807	06-09-1998	Pearlman et al.	
	56	US 5,765,152	06-09-1998	Erickson	
	57	US 5,787,172	07-28-1998	Arnold	
	58	US 5,790,677	08-04-1998	Fox et al.	
	59	US 5,812,664	09-22-1998	Bernobich et al.	
	60	US 5,825,876	10-20-1998	Peterson	
	61	US 5,825,879	10-20-1998	Davis	
	62	US 5,838,792	11-17-1998	Ganesan	
	63	US 5,848,154	12-08-1998	Nishio et al.	
	64	US 5,848,378	12-08-1998	Shelton et al.	
	65	US 5,850,433	12-15-1998	Van Oorschot et al.	
	66	US 5,915,019	06-22-1999	Ginter et al.	
	67	US 5,917,912	06-29-1999	Ginter et al.	
	68	US 5,933,498	08-03-1999	Schneck et al.	
	69	US 5,940,504	08-17-1999	Griswold	
	70	US 5,982,891	11-09-1999	Ginter et al.	
	71	US 5,987,134	11-16-1999	Shin et al.	
	72	US 5,999,624	12-07-1999	Hopkins	
	73	US 6,006,332	12-21-1999	Rabne et al.	
	74	US 6,020,882	02-01-2000	Kinghorn et al.	
	75	US 6,047,067	04-04-2000	Rosen	
	76	US 6,073,234	06-06-2000	Kigo et al.	
	77	US 6,091,777	07-18-2000	Guetz et al.	
	78	US 6,112,239	08-29-2000	Kenner et al.	

Examiner Signature	/Thomas West/	Date Considered	04/03/2008
-----------------------	---------------	--------------------	------------

\*EXAMINER: Initial if reference considered, whether or not citation is in conformance with MPEP 609. Draw line through citation if not in conformance and not considered. Include copy of this form with next communication to applicant.

<sup>1</sup> Applicant's unique citation designation number (optional). <sup>2</sup> See Kinds Codes of USPTO Patent Documents at 222.uspto.gov or MPEP 901.04. <sup>3</sup> Enter Office that issued the document, by the two-letter code (WIPO Standard ST.3). <sup>4</sup> For Japanese patent documents, the indication of the year of the reign of the Emperor must precede the serial number of the patent document. <sup>5</sup> Kind of document by the appropriate symbols as indicated on the document under WIPO Standard ST.16 if possible. <sup>6</sup> Applicant is to place a check mark here if English language Translation is attached.

10886656.1

ALL REFERENCES CONSIDERED EXCEPT WHERE LINED THROUGH. /T.W./

Petitioner Apple Inc. - Exhibit 1002, p. 6184



Under the Paperwork Reduction Act of 1995, no persons are required to respond to a collection of information unless it contains a valid OMB control number.

Substitute for form 1449A/PTO <b>INFORMATION DISCLOSURE STATEMENT BY APPLICANT</b> <i>(use as many sheets as necessary)</i>				<b>Complete if Known</b>		
				Application Number	10/956,121	
Sheet 3 of 9				Filing Date	October 4, 2004	
				First Named Inventor	Xin Wang et al.	
				Art Unit	3621	
				Examiner Name	West, Thomas C.	
				Attorney Docket Number	111325/291300	

U.S. PATENT DOCUMENTS						
Examiner Initials*	Cite No. <sup>1</sup>	U.S. Patent Document		Publication Date MM-DD-YYYY	Name of Patentee or Applicant of Cited Document	Pages, Columns, Lines, Where Relevant Passages or Relevant Figures Appear
		Number -- Kind Code <sup>2</sup> (if known)				
	79	US 6,135,646		10-24-2000	Kahn et al.	
	80	US 6,141,754		10-31-2000	Choy	
	81	US 6,157,719		12-05-2000	Wasilewski et al.	
	82	US 6,169,976 B1		01-02-2001	Colosso	
	83	US 6,185,683 B1		02-06-2001	Ginter et al.	
	84	US 6,189,037 B1		02-13-2001	Adams et al.	
	85	US 6,189,146 B1		02-13-2001	Misra et al.	
	86	US 6,209,092 B1		03-27-2001	Linnartz	
	87	US 6,216,112 B1		04-10-2001	Fuller et al.	
	88	US 6,219,652 B1		04-17-2001	Carter et al.	
	89	US 6,236,971 B1		05-22-2001	Stefik et al.	
	90	US 6,307,939 B1		10-23-2001	Vigarie	
	91	US 6,353,888 B1		03-05-2002	Kakehi et al.	
	92	US 6,397,333 B1		05-28-2002	Söhne et al.	
	93	US 6,401,211 B1		06-04-2002	Brezak Jr. et al.	
	94	US 6,405,369 B1		06-11-2002	Tsuria	
	95	US 6,424,717 B1		07-23-2002	Pinder et al.	
	96	US 6,424,947 B1		07-23-2002	Tsuria et al.	
	97	US 6,487,659 B1		11-26-2002	Kigo et al.	
	98	US 6,516,052 B2		02-04-2003	Voudouris	
	99	US 6,516,413 B1		02-04-2003	Aratani et al.	
	100	US 6,523,745 B1		02-25-2003	Tamori	
	101	US 6,796,555 B1		09-28-2004	Blahut	

Examiner Signature	/Thomas West/	Date Considered	04/03/2008
-----------------------	---------------	--------------------	------------

\*EXAMINER: Initial if reference considered, whether or not citation is in conformance with MPEP 609. Draw line through citation if not in conformance and not considered. Include copy of this form with next communication to applicant.

<sup>1</sup> Applicant's unique citation designation number (optional). <sup>2</sup> See Kinds Codes of USPTO Patent Documents at 222.uspto.gov or MPEP 901.04. <sup>3</sup> Enter Office that issued the document, by the two-letter code (WIPO Standard ST.3). <sup>4</sup> For Japanese patent documents, the indication of the year of the reign of the Emperor must precede the serial number of the patent document. <sup>5</sup> Kind of document by the appropriate symbols as indicated on the document under WIPO Standard ST.16 if possible. <sup>6</sup> Applicant is to place a check mark here if English language Translation is attached.

10886656.1

ALL REFERENCES CONSIDERED EXCEPT WHERE LINED THROUGH. /T.W./

Under the Paperwork Reduction Act of 1995, no persons are required to respond to a collection of information unless it contains a valid OMB control number.

Substitute for form 1449A/PTO				<b>Complete if Known</b>	
<b>INFORMATION DISCLOSURE STATEMENT BY APPLICANT</b> <i>(use as many sheets as necessary)</i>				Application Number	10/956,121
				Filing Date	October 4, 2004
				First Named Inventor	Xin Wang et al.
				Art Unit	3621
				Examiner Name	West, Thomas C.
Sheet	4	of	9	Attorney Docket Number	111325/291300

FOREIGN PATENT DOCUMENTS							
Examiner Initials <sup>1</sup>	Cite No. <sup>1</sup>	Foreign Patent Document		Publication Date MM-DD-YYYY	Name of Patentee or Applicant of Cited Document	Pages, Columns, Lines, Where Relevant Passages or Relevant Figures Appear	T <sup>2</sup>
		Country Code <sup>3</sup>	Number <sup>4</sup>				
	102	WO	83/04461 A1	12-22-1983	Western Electric Company, Inc.		
	103	WO	92/20022 A1	11-12-1992	Digital Equipment Corporation		
	104	WO	93/01550 A1	01-21-1993	Infologic Software, Inc.		
	105	WO	93/11480 A1	06-10-1993	Intergraph Corporation		
	106	WO	94/03003 A1	02-03-1994	Crest Industries, Inc.		
	107	WO	96/24092 A2	08-08-1996	Benson		
	108	WO	96/27155 A2	09-06-1996	Electronic Publishing Resources, Inc.		
	109	WO	97/25800 A1	07-17-1997	Mytec Technologies Inc.		
	110	WO	97/37492 A1	10-09-1997	Macrovision Corporation		
	111	WO	97/41661 A2	11-06-1997	Motorola Inc.		
	112	WO	97/43761 A2	11-20-1997	Intertrust Technologies Corp.		
	113	WO	98/09209 A1	03-05-1998	Intertrust Technologies Corp.		
	114	WO	98/10561 A1	03-12-1998	Telefonaktiebolaget LM Ericsson		
	115	WO	98/11690 A1	03-19-1998	Glover		
	116	WO	98/19431 A1	05-07-1998	Qualcomm Incorporated		
	117	WO	98/43426 A1	10-01-1998	Canal+Societe Anonyme		
	118	WO	98/45768 A1	10-15-1998	Northern Telecom Limited		
	119	WO	99/24928 A2	05-20-1999	Intertrust Technologies Corp.		
	120	WO	99/34553 A1	07-08-1999	V-One Corporation		
	121	WO	99/35782 A1	07-15-1999	Cryptography Research, Inc.		
	122	WO	99/48296 A1	09-23-1999	Intertrust Technologies Corporation		
	123	WO	99/60461 A1	11-25-1999	International Business Machines Corporation		
	124	WO	99/60750 A2	11-25-1999	Nokia Networks Oy		
	125	WO	00/04727 A2	01-27-2000	Koninklijke Philips Electronics N.V.		
	126	WO	00/05898 A2	02-03-2000	Optivision, Inc.		
	127	WO	00/59152 A2	10-05-2000	Microsoft Corporation		
	128	WO	00/72118 A1	11-30-2000	Compaq Computers Inc.		
	129	WO	00/73922 A2	12-07-2000	Entera, Inc.		
	130	WO	01/37209 A1	05-25-2001	Teralogic, Inc.		
	131	EP	0 067 556 B1	12-22-1982	Data General Corporation		
	132	EP	0 257 585 A2	03-02-1988	NEC Corporation		

Examiner Signature	/Thomas West/	Date Considered	04/03/2008
--------------------	---------------	-----------------	------------

EXAMINER: Initial if reference considered, whether or not citation is in conformance with MPEP 609. Draw line through citation if not in conformance and not considered. Include copy of this form with next communication to applicant.

<sup>1</sup> Applicant's unique citation designation number (optional). <sup>2</sup> Applicant is to place a check mark here if English language Translation is attached.

10886656.1

ALL REFERENCES CONSIDERED EXCEPT WHERE LINED THROUGH. /T.W./

Petitioner Apple Inc. - Exhibit 1002, p. 6186

Under the Paperwork Reduction Act of 1995, no persons are required to respond to a collection of information unless it contains a valid OMB control number.

Substitute for form 1449A/PTO  <b>INFORMATION DISCLOSURE                  STATEMENT BY APPLICANT</b>  <i>(use as many sheets as necessary)</i>				<b>Complete if Known</b>	
				<b>Application Number</b>	10/956,121
				<b>Filing Date</b>	October 4, 2004
				<b>First Named Inventor</b>	Xin Wang et al.
				<b>Art Unit</b>	3621
				<b>Examiner Name</b>	West, Thomas C.
				<b>Attorney Docket Number</b>	111325/291300
Sheet	5	of	9		

FOREIGN PATENT DOCUMENTS							
Examiner Initials <sup>1</sup>	Cite No. <sup>1</sup>	Foreign Patent Document		Publication Date MM-DD-YYYY	Name of Patentee or Applicant of Cited Document	Pages, Columns, Lines, Where Relevant Passages or Relevant Figures Appear	T <sup>2</sup>
		Country Code <sup>3</sup>	Number <sup>4</sup>				
	133	EP	0 332 304 A2	09-13-1989	Digital Equipment Corporation		
	134	EP	0 393 806 A2	10-24-1990	TRW Inc.		
	135	EP	0 450 841 A2	10-09-1991	GTE Laboratories Incorporated		
	136	EP	0 529 261 A2	03-03-1993	International Business Machines Corporation		
	137	EP	0 613 073 A1	08-31-1994	International Computers Limited		
	138	EP	0 678 836 A1	10-25-1995	Tandem Computers Incorporated		
	139	EP	0 679 977 A1	11-02-1995	International Business Machines Incorporated		
	140	EP	0 715 243 A1	06-05-1996	Xerox Corporation		
	141	EP	0 715 244 A1	06-05-1996	Xerox Corporation		
	142	EP	0 715 245 A1	06-05-1996	Xerox Corporation		
	143	EP	0 731 404 A1	09-11-1996	International Business Machines Corporation		
	144	EP	0 763 936 A2	03-19-1997	LG Electronics Inc.		
	145	EP	0 818 748 A2	01-14-1998	Murakoshi, Hiromasa		
	146	EP	0 840 194 A2	05-06-1998	Matsushita Electric Industrial Co., Ltd.		
	147	EP	0 892 521 A2	01-20-1999	Hewlett-Packard Company		
	148	GB	1483282	08-17-1977	Compagnie Internationale Pour L'Informatique C11-Honeywell-Bull		
	149	GB	2236604 A	04-10-1991	Sun Microsystems Inc.		
	150	GB	2309364 A	07-23-1997	Northern Telecom Limited		
	151	GB	2316503 A	02-25-1998	ICL Personal Systems Oy		
	152	BR	9810967 A (Abstract only)	10-30-2001	Scientific Atlanta Inc.		
	153	EP	0 934 765 A1	08-11-1999	Canal+Societe Anonyme		
	154	EP	0 946 022 A2	09-29-1999	Nippon Telegraph and Telephone Corporation		
	155	EP	0 964 572 A1	12-15-1999	Canal+Societe Anonyme		
	156	EP	1 103 922 A2 (Abstract only)	05-30-2001	CIT Alcatel		
	157	GB	2022969 A	12-19-1979	Data Recall Limited		
	158	GB	2354102 A	03-14-2001	Barron McCann Limited		
	159	JP	11031130 A2 (Abstract only)	02-02-1999	Fuji Xerox Co. Ltd.		

Examiner Signature	/Thomas West/	Date Considered	04/03/2008
--------------------	---------------	-----------------	------------

EXAMINER: Initial if reference considered, whether or not citation is in conformance with MPEP 609. Draw line through citation if not in conformance and not considered. Include copy of this form with next communication to applicant.

<sup>1</sup> Applicant's unique citation designation number (optional). <sup>2</sup> Applicant is to place a check mark here if English language Translation is attached.

10886656.1

ALL REFERENCES CONSIDERED EXCEPT WHERE LINED THROUGH. /T.W./

Substitute for form 1449A/PTO		<b>Complete if Known</b>	
<b>INFORMATION DISCLOSURE STATEMENT BY APPLICANT</b> <i>(use as many sheets as necessary)</i>		Application Number	10/956,121
		Filing Date	October 4, 2004
		First Named Inventor	Xin Wang et al.
		Art Unit	3621
		Examiner Name	West, Thomas C.
Sheet	6	of	9
		Attorney Docket Number	111325/291300

FOREIGN PATENT DOCUMENTS							
Examiner Initials <sup>1</sup>	Cite No. <sup>1</sup>	Foreign Patent Document		Publication Date MM-DD-YYYY	Name of Patentee or Applicant of Cited Document	Pages, Columns, Lines, Where Relevant Passages or Relevant Figures Appear	T <sup>2</sup>
		Country Code <sup>3</sup>	Number <sup>4</sup>				
	160	JP	11032037 A2 (Abstract only)	02-02-1999	Fuji Xerox Co. Ltd.		
	161	JP	11205306 A2 (Abstract only)	07-30-1999	Fuji Xerox Co. Ltd.		
	162	JP	11215121 A2 (Abstract only)	08-06-1999	Fuji Xerox Co. Ltd.		
	163	JP	2000215165 A2 (Abstract only)	08-04-2000	Nippon Telegraph and Telephone		
	164	JP	2005218143 A2 (Abstract only)	08-11-2005	Scientific Atlanta Inc.		
	165	JP	2005253109 A2 (Abstract only)	09-15-2005	Scientific Atlanta Inc.		
	166	JP	2006180562 A2 (Abstract only)	07-06-2006	Intarsia Software LLC; Mitsubishi Corp.		
	167	JP	5168039 A2 (Abstract only)	07-02-1993	Sony Corp.		
	168	WO	96/13814 A1	05-09-1996	Vazvan		
	169	WO	00/46994 A1	08-10-2000	Canal+Societe Anonyme		
	170	WO	00/62260 A1 (Abstract only)	10-19-2000	Swisscom Mobile AG		
	171	WO	01/03044 A1	01-11-2001	Transcast International, Inc.		
	172	WO	04/103843 (Abstract only)	12/02/2004	S2F Flexico		
	173	WO	04/34223 A2	04-22-2004	Legal IGaming, Inc.		

Examiner Signature	/Thomas West/	Date Considered	04/03/2008
--------------------	---------------	-----------------	------------

EXAMINER: Initial if reference considered, whether or not citation is in conformance with MPEP 609. Draw line through citation if not in conformance and not considered. Include copy of this form with next communication to applicant.

<sup>1</sup> Applicant's unique citation designation number (optional). <sup>2</sup> Applicant is to place a check mark here if English language Translation is attached.

10886656.1

ALL REFERENCES CONSIDERED EXCEPT WHERE LINED THROUGH. /T.W./

Petitioner Apple Inc. - Exhibit 1002, p. 6188

Substitute for form 1449A/PTO		<b>Complete if Known</b>	
<b>INFORMATION DISCLOSURE STATEMENT BY APPLICANT</b> <i>(use as many sheets as necessary)</i>		Application Number	10/956,121
		Filing Date	October 4, 2004
		First Named Inventor	Xin Wang et al.
		Art Unit	3621
		Examiner Name	West, Thomas C.
Sheet	7	of	9
		Attorney Docket Number	111325/291300

OTHER PRIOR ART - NON PATENT LITERATURE DOCUMENTS			
Examiner Initials*	Cite No. <sup>1</sup>	Include name of the author (in CAPITAL LETTERS), title of the article (when appropriate), title of the item (book, magazine, journal, serial, symposium, catalog, etc.), date, page(s), volume-issue number(s), publisher, city and/or country where published.	12
	174	BLAZE et al, "Divertible Protocols and Atomic Proxy Cryptography" 1998 Advances in Cryptography - Euro Crypt International Conference on the Theory and Application of Crypto Techniques, Springer Verlag, DE	
	175	BLAZE et al, "Atomic Proxy Cryptography" DRAFT (Online) (November 2, 1997) XP002239619 Retrieved from the Internet	
	176	NO AUTHOR, "Capability- and Object-Based Systems Concepts," Capability-Based Computer Systems, pp. 1-19 (no date)	
	177	COX, "Superdistribution" Wired Magazine (September 1994) XP002233405 URL: <a href="http://www.wired.com/wired/archive/2.09/superdis_pr.html&amp;gt">http://www.wired.com/wired/archive/2.09/superdis_pr.html&amp;gt</a>	
	178	DUNLOP et al, Telecommunications Engineering, pp. 346-352 (1984)	
	179	ELGAMAL, "A Public Key Cryptosystem and a Signature Scheme Based on Discrete Logarithms," IEEE Transactions on Information Theory IT-31(4):469-472 (July 1985)	
	180	GHEORGHIU et al., "Authorization for Metacomputing Applications" (no date)	
	181	IANNELLA, ed., Open Digital Rights Language (ODRL), pp. 1-31 (November 21, 2000)	
	182	KAHLE, wais.concepts.txt, Wide Area Information Server Concepts, Thinking Machines Version 4, Draft, pp. 1-18 (November 3, 1989)	
	183	KAHN, "Deposit, Registration and Recordation in an Electronic Copyright Management System," Technical Report, Corporation for National Research Initiatives, Reston, Virginia (August 1992) URL: <a href="http://www.cni.org/docs/ima.ip-workshop/kahn.html">http://www.cni.org/docs/ima.ip-workshop/kahn.html</a>	
	184	KAHN et al, "The Digital Library Project, Volume 1: The World of Knowbots (DRAFT), An Open Architecture for a Digital Library System and a Plan for its Development," Corporation for National Research Initiatives, pp. 1-48 (March 1988)	
	185	KOHL et al, Network Working Group Request for Comments: 1510, pp. 1-112 (September 1993)	
	186	LEE et al, CDMA Systems Engineering Handbook (1998) [excerpts but not all pages numbered]	
	187	MAMBO et al, "Protection of Data and Delegated Keys in Digital Distribution," Information Security and Privacy. Second Australian Conference, ACISP '97 Proceedings, pp. 271-282 (Sydney, NSW, Australia, 7-9 July 1997, 1997 Berlin, Germany, Springer-Verlag, Germany), XP008016393 ISBN: 3-540-63232-8	
	188	MAMBO et al, "Proxy Cryptosystems: Delegation of the Power to Decrypt Ciphertexts," IEICE Trans. Fundamentals VOL. E80-A, NO. 1:54-63 (January 1997) XP00742245 ISSN: 0916-8508	
	189	Microsoft Word, Users Guide, Version 6.0, pp. 487-89, 549-55, 560-64, 572-75, 599-613, 616-31 (1993)	
	190	OJANPERÄ and PRASAD, eds., Wideband CDMA for Third Generation Mobile Communications (1998) [excerpts but not all pages numbered]	
	191	PERRITT, "Knowbots, Permissions Headers and Contract Law," Paper for the Conference on Technological Strategies for Protecting Intellectual Property in the Networked Multimedia Environment, pp. 1-22 (April 2-3, 1993 with revisions of April 30, 1993)	

Examiner Signature	/Thomas West/	Date Considered	04/03/2008
-----------------------	---------------	--------------------	------------

EXAMINER: Initial if reference considered, whether or not citation is in conformance with MPEP 609. Draw line through citation if not in conformance and not considered. Include copy of this form with next communication to applicant.

<sup>1</sup> Applicant's unique citation designation number (optional). <sup>2</sup> Applicant is to place a check mark here if English language Translation is attached.

10886656.1

ALL REFERENCES CONSIDERED EXCEPT WHERE LINED THROUGH. /T.W./

Petitioner Apple Inc. - Exhibit 1002, p. 6189

Under the Paperwork Reduction Act of 1995, no persons are required to respond to a collection of information unless it contains a valid OMB control number.

Substitute for form 1449A/PTO		<b>INFORMATION DISCLOSURE STATEMENT BY APPLICANT</b> <i>(use as many sheets as necessary)</i>		<b>Complete if Known</b>	
				Application Number	10/956,121
		Filing Date	October 4, 2004		
		First Named Inventor	Xin Wang et al.		
		Art Unit	3621		
		Examiner Name	West, Thomas C.		
Sheet	8	of	9	Attorney Docket Number	111325/291300

OTHER PRIOR ART - NON PATENT LITERATURE DOCUMENTS			
Examiner Initials <sup>1</sup>	Cite No. <sup>1</sup>	Include name of the author (in CAPITAL LETTERS), title of the article (when appropriate), title of the item (book, magazine, journal, serial, symposium, catalog, etc.), date, page(s), volume-issue number(s), publisher, city and/or country where published.	T <sup>2</sup>
	192	RAGGETT, (Hewlett Packard), "HTML+(Hypertext markup language)," pp. 1-31 (12 July 1993) URL: <a href="http://citeseer.ist.psu.edu/correc/340709">http://citeseer.ist.psu.edu/correc/340709</a>	
	193	SAMUELSON et al, "Intellectual Property Rights for Digital Library and Hypertext Publishing Systems: An Analysis of Xanadu," Hypertext '91 Proceedings, pp. 39-50 (December 1991)	
	194	NO AUTHOR, "Softlock Services Introduces... Softlock Services" Press Release (January 28, 1994)	
	195	NO AUTHOR, "Appendix III - Compatibility with HTML," NO TITLE, pp. 30-31 (no date)	
	196	NO EDITOR, NO TITLE, Dictionary pages, pp. 469-72, 593-94 (no date)	
	197	BENOIT, Digital Television MPEG-1, MPEG-2 and Principles of the DVB System, pp. 75-80, 116-121 (no date)	
	198	BENOIT, Digital Television MPEG-1, MPEG-2 and Principles of the DVB System, 2 <sup>nd</sup> edition, pp. 74-80 (no date)	
	199	AH Digital Audio and Video Series, "DTV Receivers and Measurements," Understanding Digital Terrestrial Broadcasting, pp. 159-64 (no date)	
	200	O'DRISCOLL, The Essential Guide to Digital Set-Top Boxes and Interactive TV, pp. 6-24 (no date)	
	201	IUS MENTIS, "The ElGamal Public Key System," pp. 1-2 (October 1, 2005) online at <a href="http://www.iusmentis.com/technology/encryption/elgamal/">http://www.iusmentis.com/technology/encryption/elgamal/</a>	
	202	SCHNEIER, "Crypto Bibliography," Index of Crypto Papers Available Online, pp. 1-2 (online) (no date)	
	203	NO AUTHOR, NO TITLE, pp. 344-55 (no date)	
	204	NO AUTHOR, "Part Four Networks," NO TITLE, pp. 639-714 (no date)	
	205	Microsoft Word User's Guide, pp. 773-74, 315-16, 487-89, 561-64, 744, 624-33 (1993)	
	206	NO AUTHOR, "What is the ElGamal Cryptosystem," p. 1 (November 27, 2006) online at <a href="http://www.x5.net/faqs/crypto/q29.html">http://www.x5.net/faqs/crypto/q29.html</a>	
	207	JOHNSON et al., "A Secure Distributed Capability Based System," ACM, pp. 392-402 (1985)	
	208	Wikipedia, "El Gamal Encryption," pp.1-3 (last modified November 2, 2006) online at <a href="http://en.wikipedia.org/wiki/ElGamal_encryption">http://en.wikipedia.org/wiki/ElGamal_encryption</a>	
	209	BLAZE, "Atomic Proxy Cryptography," p. 1 Abstract (October 20, 1998)	
	210	BLAZE, "Matt Blaze's Technical Papers," pp. 1-6 (last updated August 6, 2006)]	
	211	Online Search Results for "inverted file", "inverted index" from <a href="http://www.techweb.com">www.techweb.com</a> , <a href="http://www.cryer.co.uk">www.cryer.co.uk</a> , <a href="http://computing-dictionary.thefreedictionary.com">computing-dictionary.thefreedictionary.com</a> , <a href="http://www.nist.gov">www.nist.gov</a> , <a href="http://en.wikipedia.org">en.wikipedia.org</a> , <a href="http://www.cni.org">www.cni.org</a> , <a href="http://www.tiscali.co.uk">www.tiscali.co.uk</a> (July 15-16, 2006)	
	212	Corporation for National Research Initiatives, "Digital Object Architecture Project", <a href="http://www.nnri.reston.va.us/doa.html">http://www.nnri.reston.va.us/doa.html</a> (updated 28 Nov 2006)	

Examiner Signature	/Thomas West/	Date Considered	04/03/2008
--------------------	---------------	-----------------	------------

EXAMINER: Initial if reference considered, whether or not citation is in conformance with MPEP 609. Draw line through citation if not in conformance and not considered. Include copy of this form with next communication to applicant.

<sup>1</sup> Applicant's unique citation designation number (optional). <sup>2</sup> Applicant is to place a check mark here if English language Translation is attached.

10886656.1

ALL REFERENCES CONSIDERED EXCEPT WHERE LINED THROUGH. /T.W./

Petitioner Apple Inc. - Exhibit 1002, p. 6190

Under the Paperwork Reduction Act of 1995, no persons are required to respond to a collection of information unless it contains a valid OMB control number.

Substitute for form 1449A/PTO <b>INFORMATION DISCLOSURE STATEMENT BY APPLICANT</b> <i>(use as many sheets as necessary)</i>				<b>Complete if Known</b>		
				Application Number	10/956,121	
Sheet 9 of 9				Filing Date	October 4, 2004	
				First Named Inventor	Xin Wang et al.	
				Art Unit	3621	
				Examiner Name	West, Thomas C.	
				Attorney Docket Number	111325/291300	

OTHER PRIOR ART - NON PATENT LITERATURE DOCUMENTS			
Examiner Initials*	Cite No. <sup>1</sup>	Include name of the author (in CAPITAL LETTERS), title of the article (when appropriate), title of the item (book, magazine, journal, serial, symposium, catalog, etc.), date, page(s), volume-issue number(s), publisher, city and/or country where published.	T <sup>2</sup>
	213	STEFIK, Summary and Analysis of A13 (Kahn, Robert E and Vinton G Cerf, "The Digital Library Project, Volume 1: The World of Knowbots (DRAFT), An Open Architecture for a Digital Library System and a Plan for its Development," Corporation for National Research Initiatives (March 1988)), pp. 1-25 (May 30, 2007)	

*Examiner Signature	/Thomas West/	Date Considered	04/03/2008
------------------------	---------------	--------------------	------------

EXAMINER: Initial if reference considered, whether or not citation is in conformance with MPEP 609. Draw line through citation if not in conformance and not considered. Include copy of this form with next communication to applicant.

<sup>1</sup> Applicant's unique citation designation number (optional). <sup>2</sup> Applicant is to place a check mark here if English language Translation is attached.

10886656.1

ALL REFERENCES CONSIDERED EXCEPT WHERE LINED THROUGH. /T.W./

Petitioner Apple Inc. - Exhibit 1002, p. 6191



1/Few

<b>TRANSMITTAL FORM</b> <i>(to be used for all correspondence after initial filing)</i>	Application Number	10/956,121	
	Filing Date	October 4, 2004	
	First Named Inventor	Mai NGUYEN, et al.	
	Group Art Unit	2131	
	Examiner Name	Not Yet Assigned	
Total Number of Pages in This Submission		Attorney Docket Number	111325-291300

ENCLOSURES (check all that apply)		
<input type="checkbox"/> Fee Transmittal Form <input type="checkbox"/> Fee Attached <input type="checkbox"/> Amendment / Reply <input type="checkbox"/> After Final <input type="checkbox"/> Affidavits/declaration(s) <input type="checkbox"/> Extension of Time Request <input type="checkbox"/> Express Abandonment Request <input checked="" type="checkbox"/> Information Disclosure Statement <input type="checkbox"/> Certified Copy of Priority Document(s) <input type="checkbox"/> Response to Missing Parts/ Incomplete Application <input type="checkbox"/> Response to Missing Parts under 37 CFR 1.52 or 1.53	<input type="checkbox"/> Assignment Papers (for an Application) <input type="checkbox"/> Drawing(s) <input type="checkbox"/> Declaration and Power of Attorney <input type="checkbox"/> Licensing-related Papers <input type="checkbox"/> Petition <input type="checkbox"/> Petition to Convert to a Provisional Application <input type="checkbox"/> Power of Attorney, Revocation Change of Correspondence Address <input type="checkbox"/> Terminal Disclaimer <input type="checkbox"/> Request for Refund <input type="checkbox"/> CD, Number of CD(s) _____	<input type="checkbox"/> After Allowance Communication to Group <input type="checkbox"/> Appeal Communication to Board of Appeals and Interferences <input type="checkbox"/> Appeal Communication to Group (Appeal Notice, Brief, Reply Brief) <input type="checkbox"/> Proprietary Information <input type="checkbox"/> Status Letter <input type="checkbox"/> Application Data Sheet <input type="checkbox"/> Request for Corrected Filing Receipt with Enclosures <input type="checkbox"/> A self-addressed prepaid postcard for acknowledging receipt <input type="checkbox"/> Other Enclosure(s) (please identify below):
Remarks	<input checked="" type="checkbox"/> The Commissioner is hereby authorized to charge any additional fees required or credit any overpayments to Deposit Account No. 19-2380 for the above identified docket number.	

SIGNATURE OF APPLICANT, ATTORNEY, OR AGENT	
Firm or Individual name	Carlos R. Villamar Registration No. 43,224 Nixon Peabody LLP 401 9 <sup>th</sup> Street, N.W., Suite 900 Washington, D.C. 20004-2128
Signature	/Carlos R. Villamar, Reg.# 43,224/ Carlos R. Villamar
Date	August 4, 2005

**CERTIFICATE OF MAILING OR TRANSMISSION [37 CFR 1.8(a)]**

I hereby certify that this correspondence is being:

deposited with the United States Postal Service on the date shown below with sufficient postage as first class mail in an envelope addressed to: Mail Stop \_\_\_\_\_, Commissioner for Patents, P. O. Box 1450, Alexandria, VA 22313-1450

transmitted by facsimile on the date shown below to the United States Patent and Trademark Office at (703) \_\_\_\_\_.

\_\_\_\_\_  
Date

\_\_\_\_\_  
Signature

\_\_\_\_\_  
Typed or printed name

ALL REFERENCES CONSIDERED EXCEPT WHERE LINED THROUGH. /T.W./





PATENT  
Application Serial No. 10/956,121  
Attorney Docket No.: 111325-291300

**IN THE UNITED STATES PATENT AND TRADEMARK OFFICE**

In re Patent Application of:	)	
Mai NGUYEN, <i>et al.</i>	)	Examiner: Unassigned
	)	
Application No.: 10/956,121	)	Group Art Unit: 2131
	)	
Filed: October 4, 2004	)	
	)	
For: <b>SYSTEM AND METHOD FOR</b>	)	Confirmation No.: 8924
<b>MANAGING TRANSFER OF RIGHTS USING</b>	)	
<b>SHARED STATE VARIABLES</b>	)	

U.S. Patent and Trademark Office  
Customer Service Window  
Randolph Building  
401 Dulany Street  
Alexandria, VA 22314

Sir:

**INFORMATION DISCLOSURE STATEMENT UNDER 37 C.F.R. § 1.97 (b)**

Pursuant to 37 C.F.R. §§ 1.56 and 1.97(b), Applicants bring to the attention of the Examiner the documents listed on the attached PTO-1449. This Information Disclosure Statement is being filed before the first Office Action on the merits for the above reference application. The listed documents were cited in a communication from the International Search Authority. The International Search Report was mailed on March 2, 2005. Copies of the listed documents are attached.

It is requested that the accompanying PTO-1449 be considered and made of record in the above-identified application. To assist the Examiner, the documents are listed on the attached form PTO-1449. It is respectfully requested that an Examiner initialed copy of this form be returned to the undersigned.

The Commissioner is hereby authorized to charge any fees connected with this filing which may be required now, or credit any overpayment to Deposit Account No. 19-2380. (111325-291300).

Respectfully submitted,  
**NIXON PEABODY, LLP**

By: /Carlos R. Villamar, Reg.# 43,224/  
Carlos R. Villamar  
Registration No.: 43,224

**Date: August 4, 2005**

**NIXON PEABODY LLP**  
**Customer No.: 22204**  
401 9<sup>th</sup> Street, N.W., Suite 900  
Washington, DC 20004-2128  
Telephone: (202) 585-8000  
FAX: (202) 585-8080



Substitute for Form 1449A/P/TG			<i>Complete if Known</i>		
<b>INFORMATION DISCLOSURE STATEMENT BY APPLICANT</b> <i>(use as many sheets as necessary)</i>			Application Number	10/956,121	
			Filing Date	October 4, 2004	
			First Named Inventor	Mai NGUYEN, <i>et al.</i>	
			Art Unit	2131	
			Examiner Name	Not Yet Assigned	
Sheet	1	of	1	Attorney Docket Number	111325-291300

U.S. PATENT DOCUMENTS						
Examiner Initials*	Cite No. <sup>1</sup>	U.S. Patent Document		Publication Date MM-DD-YYYY	Name of Patentee or Applicant of Cited Document	Pages, Columns, Lines, Where Relevant Passages or Relevant Figures Appear
		Number - Kind Code <sup>2</sup> (if known)				
		US-5,715,403		February 3, 1998	Stefik	

FOREIGN PATENT DOCUMENTS							
Examiner Initials*	Cite No. <sup>1</sup>	Foreign Patent Document		Publication Date MM-DD-YYYY	Name of Patentee or Application of Cited Document	Pages, Columns, Lines, Where Relevant Passages or Relevant Figures Appear	T <sup>6</sup>
		Country Code <sup>3</sup> Number <sup>4</sup>	Kind Code <sup>5</sup> (if known)				

OTHER PRIOR ART - NON PATENT LITERATURE DOCUMENTS			
Examiner Initials*	Cite No. <sup>1</sup>	Include name of the author (in CAPITAL LETTERS), title of the article (when appropriate), title of the item (book, magazine, journal, serial, symposium, catalog, etc.), date, page(s), volume-issue number(s), publisher, city and/or country where published.	T <sup>2</sup>
		Bill ROSENBLATT, et al., ContentGuard White Pages; "Integrating Content Management with Digital Rights Management - - Imperatives and Opportunities for Digital Content Lifecycles" GiantSteps Media Technology Strategies; May 15, 2005; pages 1-20; <a href="http://www.contentguard.com/whitepapers/CM-DRMwhitepaper.pdf">www.contentguard.com/whitepapers/CM-DRMwhitepaper.pdf</a> ;	
		M. KAMAT; Texas A&M University; "Security Requirements for Digital Rights Management"; In The Proceedings of ISECON 2002, v 19 (San Antonio): §353b. ISSN: 1542-7382; pages 1-4; <a href="http://isedj.org/isecon/2002/353b/ISECON.2002.kamat.ppt">http://isedj.org/isecon/2002/353b/ISECON.2002.kamat.ppt</a>	
		International Search Report; mailed March 2, 2005 (International Application No. PCT/US04/32588)	

Examiner Signature	/Thomas West/	Date Considered	04/03/2008
--------------------	---------------	-----------------	------------

\*EXAMINER: Initial if reference considered, whether or not citation is in conformance with MPEP 609. Draw line through citation if not in conformance and not considered. Include copy of this form with next communication to applicant.

<sup>1</sup> Applicant's unique citation designation number (optional). <sup>2</sup> See Kinds Codes of USPTO Patent Documents at [www.uspto.gov](http://www.uspto.gov) or MPEP 901.04. <sup>3</sup> Enter Office that issued the document, by the two-letter code (WIPO Standard ST.3). <sup>4</sup> For Japanese patent documents, the indication of the year of the reign of the Emperor must precede the serial number of the patent document. <sup>5</sup> Kind of document by the appropriate symbols as indicated on the document under WIPO Standard ST.16 if possible. <sup>6</sup> Applicant is to place a check mark here if English language Translation is attached.

<sup>1</sup> Applicant's unique citation designation number (optional). <sup>2</sup> Applicant is to place a check mark here if English language Translation is attached.

### BATCH PROCESSING SYSTEM BY SELECTING PLURAL ICONS

Publication number: JP3063717

Publication date: 1991-03-19

Inventor: TSUTSUI KENSAKU; DEWA YUJI

Applicant: NIPPON ELECTRIC CO

Classification:

- international: G06F3/02; G06F3/00; G06F3/048; G06F3/14; G06F3/02; G06F3/00; G06F3/048; G06F3/14; (IPC1-7): G06F3/02; G06F3/14

- European:

Application number: JP19890199025 19890731

Priority number(s): JP19890199025 19890731

Report a data error here

#### Abstract of JP3063717

PURPOSE: To decrease the operation burden by determining one from in processings defined in common among all objects corresponding to a selected icon, and repeating this processing to all the objects corresponding to the selected icon.

CONSTITUTION: The subject system is provided with an icon selecting means 11, a processing selecting means 12, and a repetition processing means 13, plural icons corresponding to an arbitrary object being a processing object are selected, and also, one is determined from in processings defined in common among all objects corresponding to the selected icon, and the determined processing is repeated to all the processing request to a computer from a user, especially, at the time of requesting the same processing to plural processing objects, a monotonous repeating operation is replaced with a batch operation, and the operation burden of the user can be reduced.

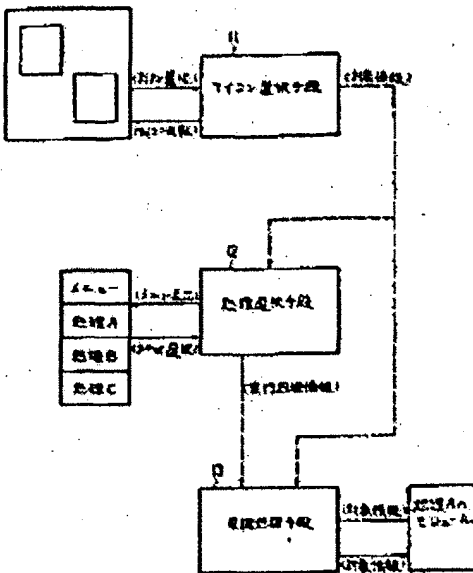

Data supplied from the esp@cenet database - Worldwide



㊦ 公開特許公報(A) 平3-63717

㊦ Int. Cl.<sup>5</sup> 識別記号 庁内整理番号 ㊦ 公開 平成3年(1991)3月19日  
 G 06 F 3/02 3 7 0 A 7530-5B  
 3 6 0 G 7530-5B  
 3/14 3 7 0 A 8323-5B  
 審査請求 未請求 請求項の数 1 (全4頁)

㊦ 発明の名称 アイコンの複数選択による一括処理方式

㊦ 特 願 平1-199025

㊦ 出 願 平1(1989)7月31日

㊦ 発 明 者 筒 井 健 作 東京都港区芝5丁目33番1号 日本電気株式会社内  
 ㊦ 発 明 者 出 羽 雄 二 東京都港区芝5丁目33番1号 日本電気株式会社内  
 ㊦ 出 願 人 日本電気株式会社 東京都港区芝5丁目7番1号  
 ㊦ 代 理 人 弁理士 井ノ口 壽

明 細 書

1. 発明の名称

アイコンの複数選択による一括処理方式

2. 特許請求の範囲

処理対象である任意のオブジェクトに対応するアイコンを複数選択するためのアイコン選択手段と、前記選択されたアイコンに対応するすべてのオブジェクトの間で共通に定義される処理の中から一つを決定するための処理選択手段と、前記決定された処理を前記選択されたアイコンに対応するすべてのオブジェクトに対して反復するための反復処理手段とを具備して構成したことを特徴とするアイコンの複数選択による一括処理方式。

3. 発明の詳細な説明

(産業上の利用分野)

本発明はコンピュータと利用者との間の対話方式に関し、特に、その利用者からコンピュータへの要求の伝達方式に関する。

(従来の技術)

従来、コンピュータと利用者との間でオブジ

クト指向の対話を行う場合には、処理対象であるオブジェクトに対応する1個のアイコンに対し、実行可能な処理を一つ選択していた。また、利用者が複数のオブジェクトに対して同一の処理を要求する際にも、それぞれに対してアイコン選択、および処理選択の操作を繰返して行っていた。

(発明が解決しようとする課題)

上述した従来のコンピュータと利用者との間の対話方式で操作性を向上する必要がある場合には、単調な繰返し操作を一括操作に置換えることにより、利用者の操作負担の軽減を図る必要がある。上述した従来技術では、利用者からコンピュータへの処理要求において、各オブジェクトについて必ずアイコンの選択、および処理の選択の操作を行わなければならない、利用者の操作負担は大きいという欠点がある。

本発明の目的は、処理対象である任意のオブジェクトに対応するアイコンを複数選択するとともに、選択されたアイコンに対応するすべてのオブジェクトの間で共通に定義される処理の中から一

つを決定し、決定された処理を選択されたアイコンに対応するすべてのオブジェクトに対して反復することによつて上記欠点を除去し、操作負担を減ずることができるよう構成したアイコンの複数選択による一括処理方式を提供することにある。

(課題を解決するための手段)

本発明によるアイコンの複数選択による一括処理方式は、アイコン選択手段と、処理選択手段と、反復処理手段とを具備して構成したものである。

アイコン選択手段は、処理対象である任意のオブジェクトに対応するアイコンを複数選択するためのものである。

処理選択手段は、選択されたアイコンに対応するすべてのオブジェクトの間で共通に定義される処理の中から一つを決定するためのものである。

反復処理手段は、上記決定された処理を上記選択されたアイコンに対応するすべてのオブジェクトに対して反復するためのものである。

(実施例)

次に、本発明に関して図面を参照して説明する。

以下に、第2図～第7図を参照して画面での操作例を説明する。

第2図において、アイコンをポインタ20で指示すると、これにより選択が行われ、選択が記憶されたフォルダアイコン51は反転表示される。引続き、第3図において、他のアイコンをポインタ20で指示すると、これにより複数選択が可能であり、選択が記憶された文書アイコン52は同様に反転表示される。これらは、本方式のアイコン選択手段によつて行われる。第4図において、メニュー30をポインタ20で指示すると、これにより選択を記憶したすべてのアイコン51、52に共通に定義された処理が提示される。このとき、共通して選択可能なメニュー項目は、31で代表されるように実線文字で表わされ、そうでないメニュー項目は32で代表されるように破線文字で表わされる。第5図において、ポインタ20でメニュー30中のメニュー項目33を指示することにより、処理の選択が行われて選択が記憶される。これらは、本方式の処理選択手段

第1図は、本発明によるアイコンの複数選択による一括処理方式の一実施例を示すブロック図である。

第1図において、11はアイコン選択手段、12は処理選択手段、13は反復処理手段である。

第1図においてアイコン選択手段11は利用者が選択する画面上の複数のアイコンに対応する各オブジェクトの情報を取得して記憶する。また、当該情報は処理選択手段12に伝えられ、それらオブジェクトで共通に定義されている実行可能処理がメニューとして画面上に表示される。処理選択手段12は利用者にその中の一つを選択させ、選択された処理の情報を取得して記憶する。反復処理手段13は、処理選択手段12で記憶した実行処理を行うモジュールに対し、アイコン選択手段11で記憶したオブジェクトの情報を1件づつ伝達し、オブジェクトの情報がなくなるまで上記動作を繰返す。これにより、本方式は構成される。

第2図～第7図は、それぞれ第1図に示すアイコンによる操作例を示す説明図である。

12によつて行われる。第6図においては、処理選択手段により記憶されている複写という処理がフォルダアイコン51に適用された結果、同様のフォルダアイコン53が画面上に生成されている。引続き、第7図においては、文書アイコン52にも複写処理が適用され、同様の文書アイコン54が画面上に生成されている。これにより、第6図および第7図の処理が実行されている間は、利用者は何等操作をする必要がなくまつたわけである。

(発明の効果)

以上説明したように本発明は、処理対象である任意のオブジェクトに対応するアイコンを複数選択するとともに、選択されたアイコンに対応するすべてのオブジェクトの間で共通に定義される処理の中から一つを決定し、決定された処理を選択されたアイコンに対応するすべてのオブジェクトに対して反復することによつて、利用者からコンピュータへの処理要求において、特に複数処理対象に対して同一処理を要求する際に、単調な繰返し操作が一括操作に置き換えられ、利用者の操作

負担が軽減できるという効果がある。

4. 図面の簡単な説明

第1図は、本発明によるアイコンの複数選択による一括処理方式の一実施例を示すブロック図である。

第2図～第7図は、それぞれ第1図に示すアイコンによる操作例を示す説明図である。

- 11・・・アイコン選択手段
- 12・・・処理選択手段
- 13・・・反復処理手段
- 20・・・ポイント
- 30・・・メニュー
- 31～33・・・項目
- 40、50～54・・・アイコン

第1図

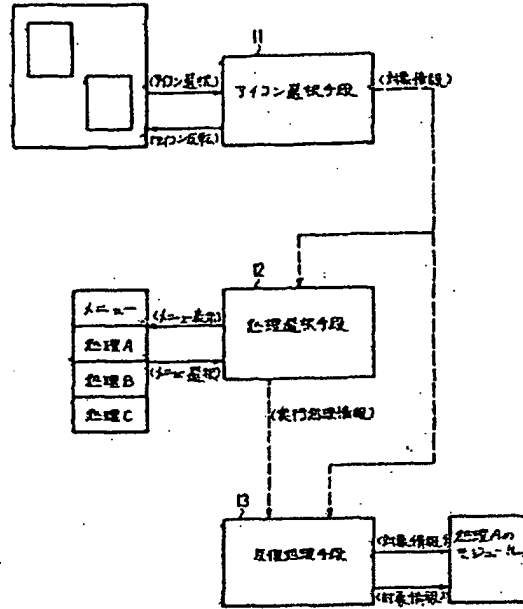

特許出願人 日本電気株式会社  
代理人 弁理士 井ノ口 壽

第2図

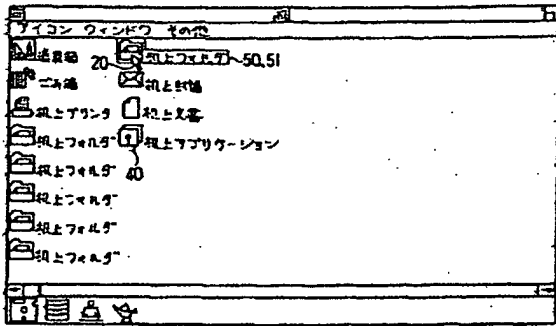

第4図

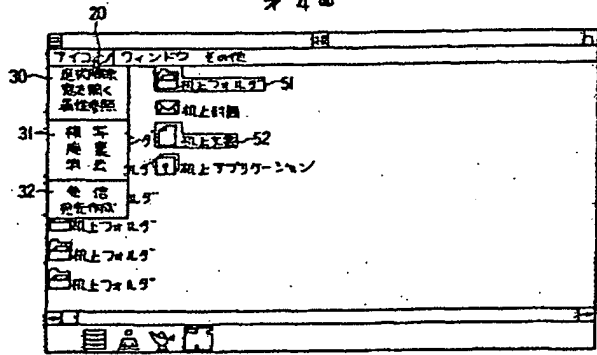

第3図

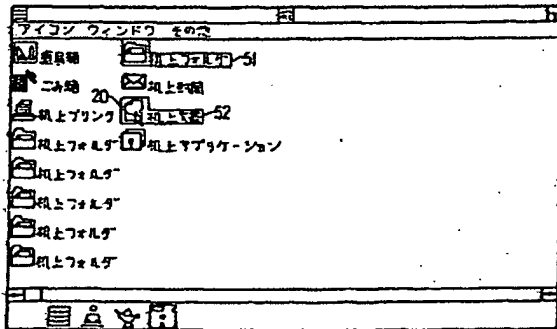

第5図

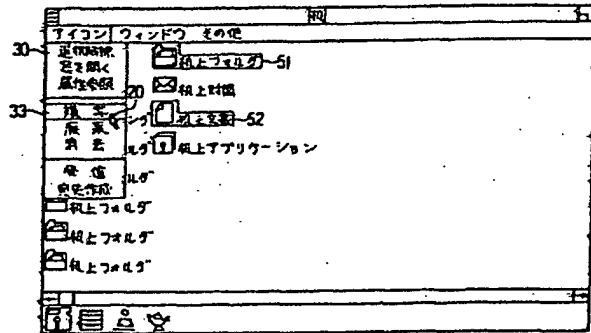



\*6回

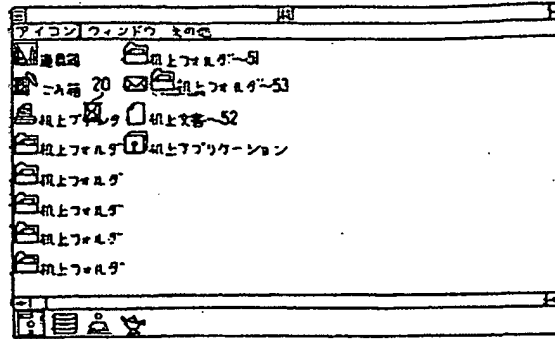

\*7回

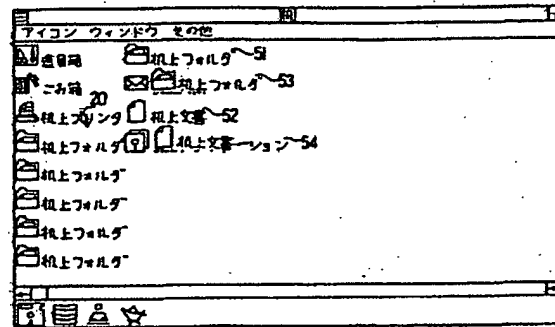

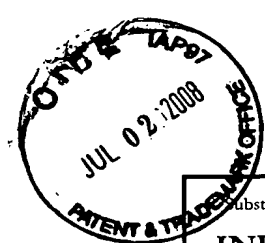

Under the Paperwork Reduction Act of 1995, no persons are required to respond to a collection of information unless it contains a valid OMB control number.

Substitute for form 1449A/PTO <b>INFORMATION DISCLOSURE STATEMENT BY APPLICANT</b> <i>(use as many sheets as necessary)</i>				<b>Complete if Known</b>		
				Application Number	10/956,121	
Sheet		1	of	1	Filing Date	October 4, 2004
					First Named Inventor	WANG et al.
					Art Unit	3621
					Examiner Name	Thomas C. West
					Attorney Docket Number	111325/291300

U.S. PATENT DOCUMENTS						
Examiner Initials <sup>1</sup>	Cite No. <sup>1</sup>	U.S. Patent Document Number - Kind Code <sup>2</sup> (if known)		Publication Date MM-DD-YYYY	Name of Patentee or Applicant of Cited Document	Pages, Columns, Lines, Where Relevant Passages or Relevant Figures Appear
	1.	5,619,570	A1	04-08-1997	Tsutsui	

U.S. PUBLISHED PATENT DOCUMENTS						
Examiner Initials <sup>1</sup>	Cite No. <sup>1</sup>	U.S. Patent Document Number - Kind Code <sup>2</sup> (if known)		Publication Date MM-DD-YYYY	Name of Patentee or Applicant of Cited Document	Pages, Columns, Lines, Where Relevant Passages or Relevant Figures Appear

FOREIGN PATENT DOCUMENTS							
Examiner Initials <sup>1</sup>	Cite No. <sup>1</sup>	Foreign Patent Document		Publication Date MM-DD-YYYY	Name of Patentee or Applicant of Cited Document	Pages, Columns, Lines, Where Relevant Passages or Relevant Figures Appear	T <sup>6</sup>
		Country Code <sup>3</sup>	Number <sup>4</sup> Kind Code <sup>5</sup> (if known)				
	2.	EP 0 262 025	A2	03-30-1988	Ogasawara		
	3.	JP 3-063717	A	03-19-1991	Tsutsui et al.	(Ab in EN)	
	4.	JP 6-131371	A	05-13-1994	Tsutsui	(Ab in EN)	

OTHER PRIOR ART - NON PATENT LITERATURE DOCUMENTS			
Examiner Initials <sup>1</sup>	Cite No. <sup>1</sup>	Include name of the author (in CAPITAL LETTERS), title of the article (when appropriate), title of the item (book, magazine, journal, serial, symposium, catalog, etc.), date, page(s), volume-issue number(s), publisher, city and/or country where published.	T <sup>2</sup>
	5.	Johnson et al., "A Secure Distributed Capability Based System," PROCEEDINGS OF THE 1985 ACM ANNUAL CONFERENCE ON THE RANGE OF COMPUTING: MID-80'S PERSPECTIVE: MID-80'S PERSPECTIVE <i>Association for Computing Machinery</i> pp. 392-402 (1985)	

Examiner Signature		Date Considered	
--------------------	--	-----------------	--

\*EXAMINER: Initial if reference considered, whether or not citation is in conformance with MPEP 609. Draw line through citation if not in conformance and not considered. Include copy of this form with next communication to applicant.

<sup>1</sup> Applicant's unique citation designation number (optional). <sup>2</sup> See Kinds Codes of USPTO Patent Documents at 222.uspto.gov or MPEP 901.04. <sup>3</sup> Enter Office that issued the document, by the two-letter code (WIPO Standard ST.3). <sup>4</sup> For Japanese patent documents, the indication of the year of the reign of the Emperor must precede the serial number of the patent document. <sup>5</sup> Kind of document by the appropriate symbols as indicated on the document under WIPO Standard ST.16 if possible. <sup>6</sup> Applicant is to place a check mark here if English language Translation is attached.

11018220.1



EUROPEAN PATENT APPLICATION

Application number: 87402033.2  
Date of filing: 11.09.87

Int. Cl.: G 07 F 7/10  
G 06 F 12/14

Priority: 16.09.86 JP 217722/86  
Date of publication of application: 30.03.88 Bulletin 88/13  
Designated Contracting States: DE FR GB

Applicant: FUJITSU LIMITED  
1015, Kamikodanaka Nakahara-ku  
Kawasaki-shi Kanagawa 211 (JP)  
Inventor: Ogasawara, Nobuo  
688-11, Suenaga Takatsu-ku  
Kawasaki-shi Kanagawa 213 (JP)  
Representative: Joly, Jean-Jacques et al  
CABINET BEAU DE LOMENIE 55, rue d'Amsterdam  
F-75008 Paris (FR)

System for permitting access to data field area in IC card for multiple services.

A system for permitting access to a data field area in an IC card for multiple services using an individual card holder identification number for each of a plurality of data fields (61, 62, 63) or for each group of data fields. Data field identification information (11), a personal identification number (12), access qualification information (13), and an authentication code (14) are supplied to the IC card before an execution of an access to the data field. An authentication is made (in 32, 33) between the personal identification number and the authentication code stored in identification number and the authentication code supplied to the IC card. Based on the result of authentication, an access to the data field area (61, 62 or 63) to which access is requested is permitted within the limit of the access right stored in the IC card (memories 51, 52, 53) corresponding to the access qualification information supplied to the IC card.

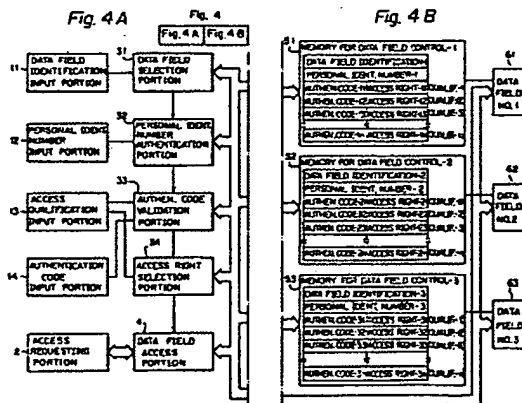

EP 0 262 025 A2

**Description**

**SYSTEM FOR PERMITTING ACCESS TO DATA FIELD AREA IN IC CARD FOR MULTIPLE SERVICES**

**BACKGROUND OF THE INVENTION**

**1. Field of the Invention**

The present invention relates to a system for permitting access to a data field area in an integrated circuit card (IC card) for multiple services.

**2. Description of the Related Art**

In general, in the use of an IC card for multiple services, a card issuer, a service supplier, a card acceptor, and a card holder are involved. An IC card has a plurality of data fields for the multiple services, and for each of the data fields, the access right, access qualification, of card issuer, service supplier, card acceptor, and card holder should be predetermined. Namely, although a person has access right to a predetermined data field of an IC card, that person should not be authorized to have access to a data field of the IC card other than the predetermined data field.

It is desired that access is permitted only within the limit of the access right to a predetermined data field of a card holder, and access outside such limitation is not permitted, so that the data fields cannot be used in an unauthorized manner.

In the prior art, only a personal identification number (PIN) and an authentication code (AC code) for the whole of an IC card are provided for an IC card for multiple services, and therefore, once a coincident result is obtained as the result of an authentication of the personal identification number and the authentication code, access to all data fields in the IC card becomes possible.

As a result, it is possible for a person, for example, a card acceptor, who is not authorized to have access to the data field in question, will be able to obtain access to the data field in question. This constitute an unfair use of the IC card and a violation of the principle of secrecy of the IC card. Therefore, these problems of the prior art must be solved.

**SUMMARY OF THE INVENTION**

It is an object of the present invention to provide an improved system for permitting access to a data field area in an IC card for multiple services.

In accordance with the present invention, there is provided a system for permitting access to a data field area in an IC card for multiple services using an individual card holder identification number for each of a plurality of data fields or for each group of data fields, the system comprising: a plurality of data fields in the IC card; a sequence of a data field selection portion, a personal identification number authentication portion, an authentication code validation portion, and an access right selection portion, input portions for inputting data field identification information, a personal identification number, access qualification information, and an authentication code; a data field access portion and an access request portion; and storage portions for storing

information for data field control. An authentication between the information stored in the storage portions and the information input through the input portions is carried out.

Based on the cumulative result of a selection of a data field, a authentication of the personal identification number, a validation of the authentication code, and a selection of the access right, access to a data field area to which access is requested is permitted within the limit of the selected access right.

**BRIEF DESCRIPTION OF THE DRAWINGS**

In the drawings,

Fig. 1 is a perspective view of an IC card to which the system according to the present invention is applied;

Fig. 2 shows a fundamental combination of an IC card and a terminal apparatus;

Fig. 3 shows a prior art system for access to a data field area in an IC card for multiple services;

Fig. 4 is a schematic diagram of a system for permitting access to a data field area in an IC card for multiple services according to an embodiment of the present invention;

Fig. 5 shows an example of combinations of the authentication code and the access right; and

Fig. 6 is a flow chart of the operation of the system of Fig. 4.

**DESCRIPTION OF THE PREFERRED EMBODIMENTS**

Before describing a preferred embodiment of the present invention, an IC card to which the system according to the present invention is applied, a fundamental combination of an IC card and a terminal apparatus, and a prior art system for access to a data field area in an IC card for multiple services will be explained with reference to Figs. 1, 2, and 3.

As shown in Fig. 1, an IC card has contacts adapted for electrical connection with external apparatuses, an integrated circuit module beneath the area containing the contact electrodes, and an area to be embossed. As shown in Fig. 2, the circuit of the IC card includes the contacts, a central processing unit (CPU), a read only memory (ROM) for storing a control program, and an electrically erasable and programmable read only memory (EEPROM) or an erasable and programmable read only memory (EPROM) for storing data fields, input information, and control information. The circuit of the IC card can communicate with the program portion in the terminal apparatus.

As shown in Fig. 3, in the prior art, the authentication between the input personal identification number 101 and the stored personal identification number 301 is carried out in the personal identification number authentication portion 201. Based on the coincident result of this authentication, the validation between the input authentication code 102

and the stored authentication 302 is carried out in the authentication code validation portion 202, and based on the result of this validation, the decision obtained from the stored information 303, 304, and 305 for data field identification No. 2, and No. 3

Once one of the data fields No. 1, No. 2, and No. 3 is chosen according to the decision of one of the data field identification No. 1, No. 2, and No. 3, access through the access request portion 104 is permitted to the chosen data field.

A system for permitting access to a data field area in an IC card for multiple services according to an embodiment of the present invention is shown in Fig. 4. The system of Fig. 4 includes a data field input portion 11, a personal identification number input portion 12, an access qualification input portion 13, an authentication code input portion 14, an access request portion 2, a data field selection portion 31, a personal identification number authentication portion 32, an authentication code validation portion 33, an access right selection portion 34, and a data field access portion 4.

The system of Fig. 4 also includes a data field (No. 1) 61, a data field (No. 2) 62, a data field (No. 3) 63, a memory for data field control (No. 1) 51, a memory for data field control (No. 2) 52, and a memory for data field control (No. 3) 53. The memories 51, 52, and 53 corresponding to the data fields No. 1, No. 2, and No. 3, respectively.

For example, information for the data field identification No. 1, personal identification number (No. 1), authentication code Nos. 11, 12, 13 ... 1n, and information for the access right Nos. 11, 12, 13 ... 1n are stored in the memory 51. The authentication code No. 11 and the information for the access right No. 11 comprises an access qualification No. 1, the authentication code No. 12, and the information for the access right No. 12 comprises an access qualification No. 2, and so on. The authentication code No. 1n and the information for the access right No. 1n comprises an access qualification No. n.

Here, the information for the access right concerns which one of the processes of reading, writing, deleting, and re-writing should be permitted.

In the data field selection portion 31, a comparison between the input data field identification 11 and the data field identification stored in the memories 51, 52, and 53 is carried out, so that one of the data field Nos. 1, 2, and 3 is selected according to the coincident result of that comparison.

In the personal identification authentication portion 32, after the above-mentioned selection of the data field, the authentication between the input personal identification number and the personal identification number stored in the memory corresponding to the selected data field is carried out so that it can be confirmed whether or not the person inputting the personal identification number is the person authorized to use the data field in question.

In the authentication code validation portion 33, after an affirmative confirmation of the personal

identification, a validation concerning the input authentication code and the authentication code stored in the memory corresponding to the selected data field and the input access qualification is carried out so that it can be confirmed whether or not the access executor has the proper authentication code.

In the access right selection portion 34, after an affirmative confirmation of the authentication code, an extraction of the access right information stored in the memory corresponding to the selected data field and input access qualification information is carried out so that the access right permitted to the access executor is selected.

In the data field access portion 4, after the selection of the access right, the access to the selected data field is carried out corresponding to the permitted access right in response to the input access request through the access request portion 2.

An example of the combinations of the authentication codes and the access rights is shown in Fig. 5.

The operation of the system of Fig. 4 will be described below with reference to the flow chart of Fig. 6.

Upon input of an access start request, a data field identification, a personal identification number, access qualification information, and an authentication code, the data field identifications stored in the memory are searched and the data field corresponding to the input data field identification is selected (step S1). When there is no corresponding data field, the process proceeds to the error indication.

When the data field in question is selected, the process proceeds to step S2, where the personal selected data field is authenticated with regard to the input personal identification number. When the stored personal identification number does not coincide with the input personal identification number, the process proceeds to the error indication.

When the stored personal identification number coincides with the input personal identification number, the process proceeds to step S4 where the authentication code corresponding to the input access qualification information is derived, and the validation concerning the derived authentication code and the input authentication code is carried out. When the derived authentication code does not coincide with the input authentication code, the process proceeds to the error indication.

When the derived authentication code coincides with the input authentication code, the process proceeds to step S6, where the access right corresponding to the input access qualification information is derived from the memory for data field control and the decision for access right is made.

Then, in step S7, the request for access to data in the selected data field is executed within the range of the above-described access right.

#### Claims

1. A system for permitting access to a data

field area in an IC card for multiple services using an individual card holder identification number for each of a plurality of data fields or for each groups of data fields, said system comprising:

- a plurality of data fields in the IC card;
- a sequence of data field selection means, a personal identification number authentication means, an authentication code validation means, and an access right selection means;
- an input means for inputting data field identification information, a personal identification number, access qualification information, and an authentication code;
- a data field access means and access request means; and
- storage means for storing information for data field control;
- comparisons between the information stored in said storage means and the information input through said input means being carried out, for authentication, validation, and selection; and based on the cumulative result of a selection of a data field, an authentication of a personal identification number, a validation of an authentication code, and a selection of an access right, access to a data field area to which access is requested is permitted within a limit of the selected access right.

5

10

15

20

25

30

35

2. A system according to claim 1 wherein each memory for data field control stores data field identification information, a personal identification number, a plurality of authentication codes, and a plurality of access rights information.

3. A system according to claim 1, wherein the access qualification information input by said input means is an information for selecting an authentication code and an access right.

4. A system according to claim 1, wherein the access right information stored in the memories for data field control selected by the access qualification information is represented by one of the processes of reading, writing, deleting, and re-writing.

5. A system according to claim 1, wherein said personal identification number authentication means is operated based on signals from the data field selection means, the personal identification number input means, and the memories for data field control.

6. A system according to claim 1, wherein said authentication code validation means is operated based on signals from the personal identification number authentication means, the access qualification input means, the authentication code input means, and the memories for data field control.

7. A system according to claim 1, wherein said access right selection means is operated based on signals from the authentication code validation means, the access qualification input means, and the memories for data field control.

40

45

50

55

60

65

4

0262025

Fig. 1

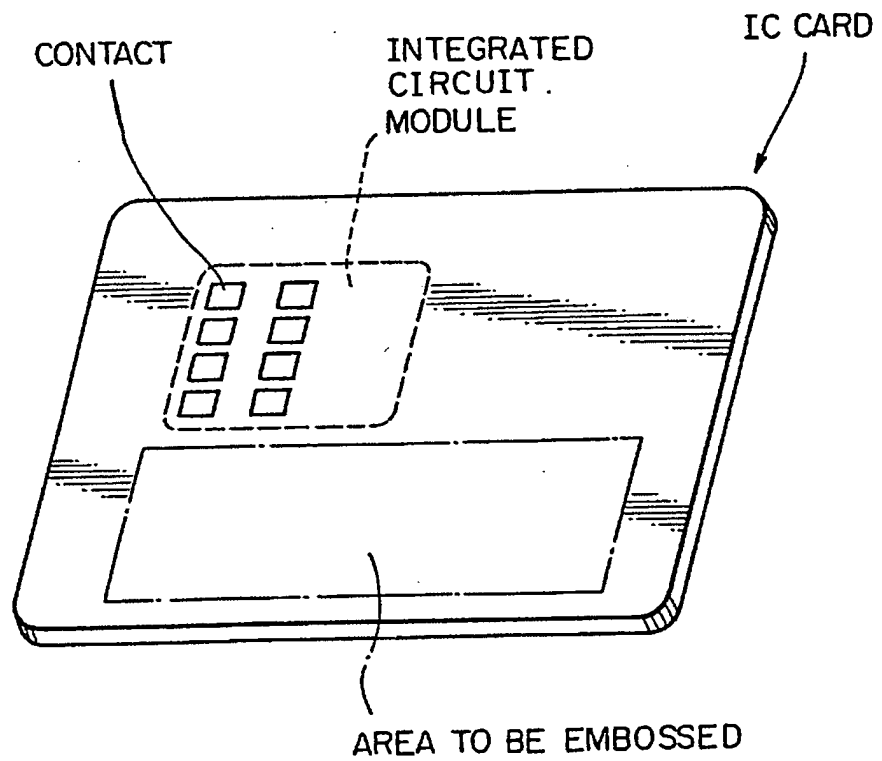

Fig. 2

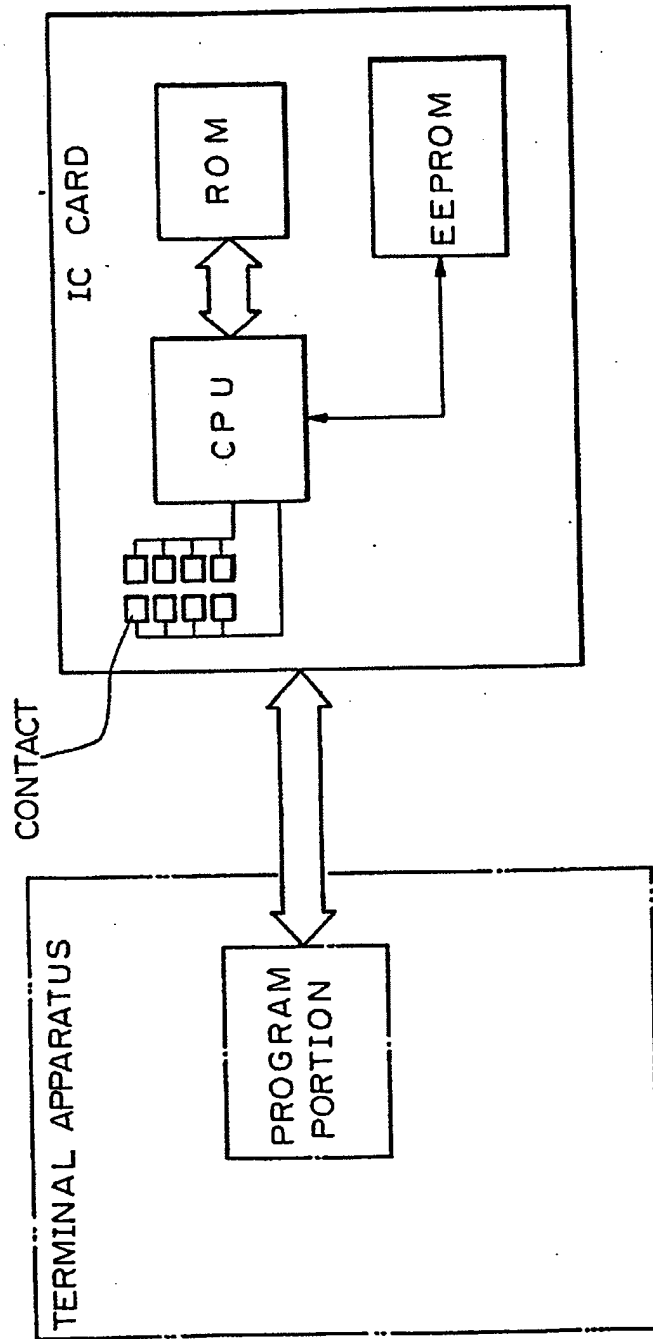



Fig. 3 A

Fig. 3

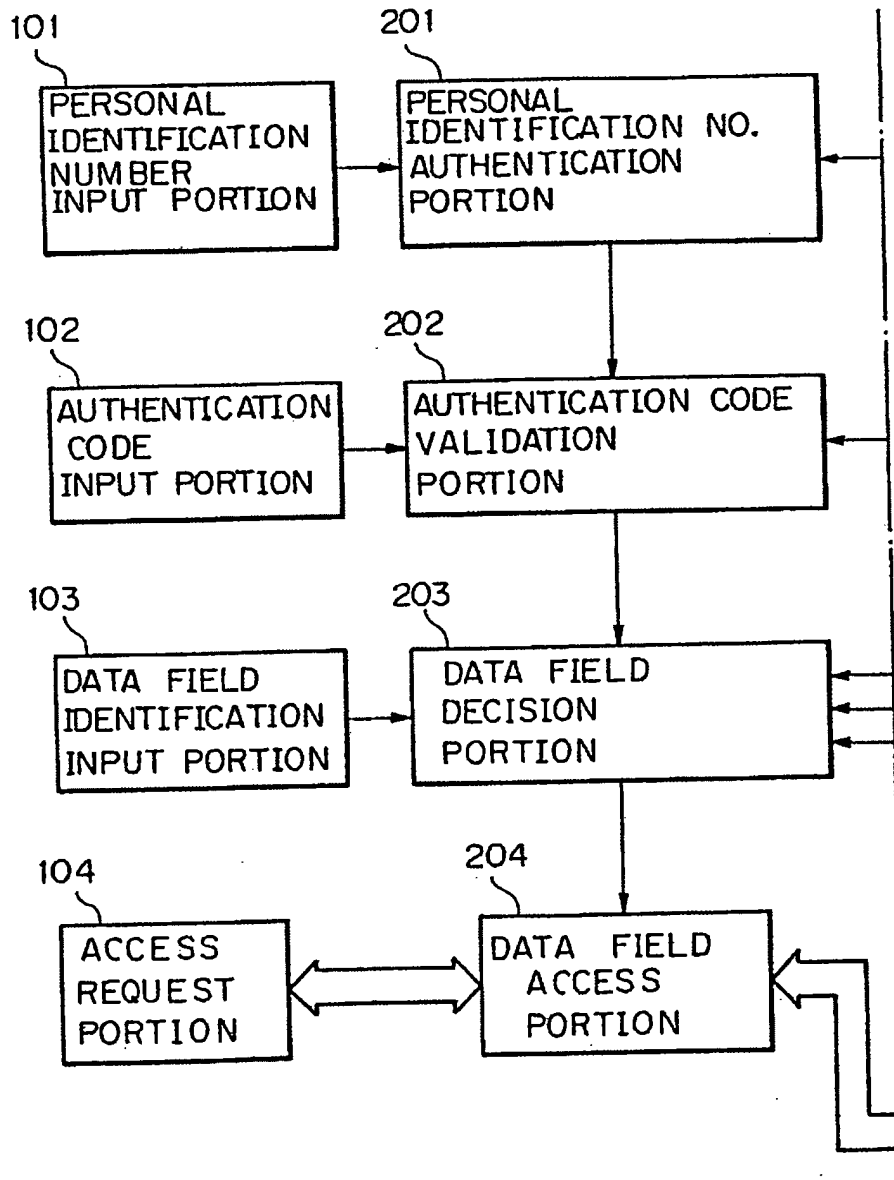

Fig. 3B

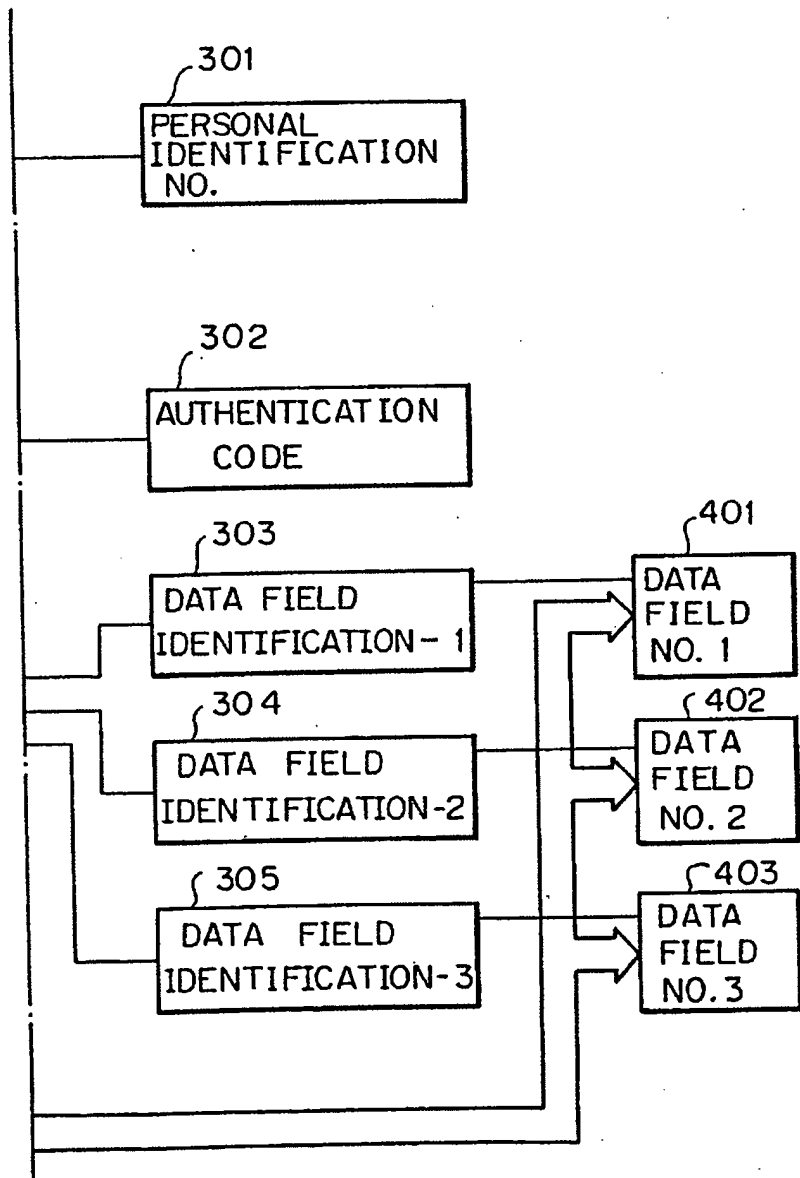

Fig. 4 A

Fig. 4

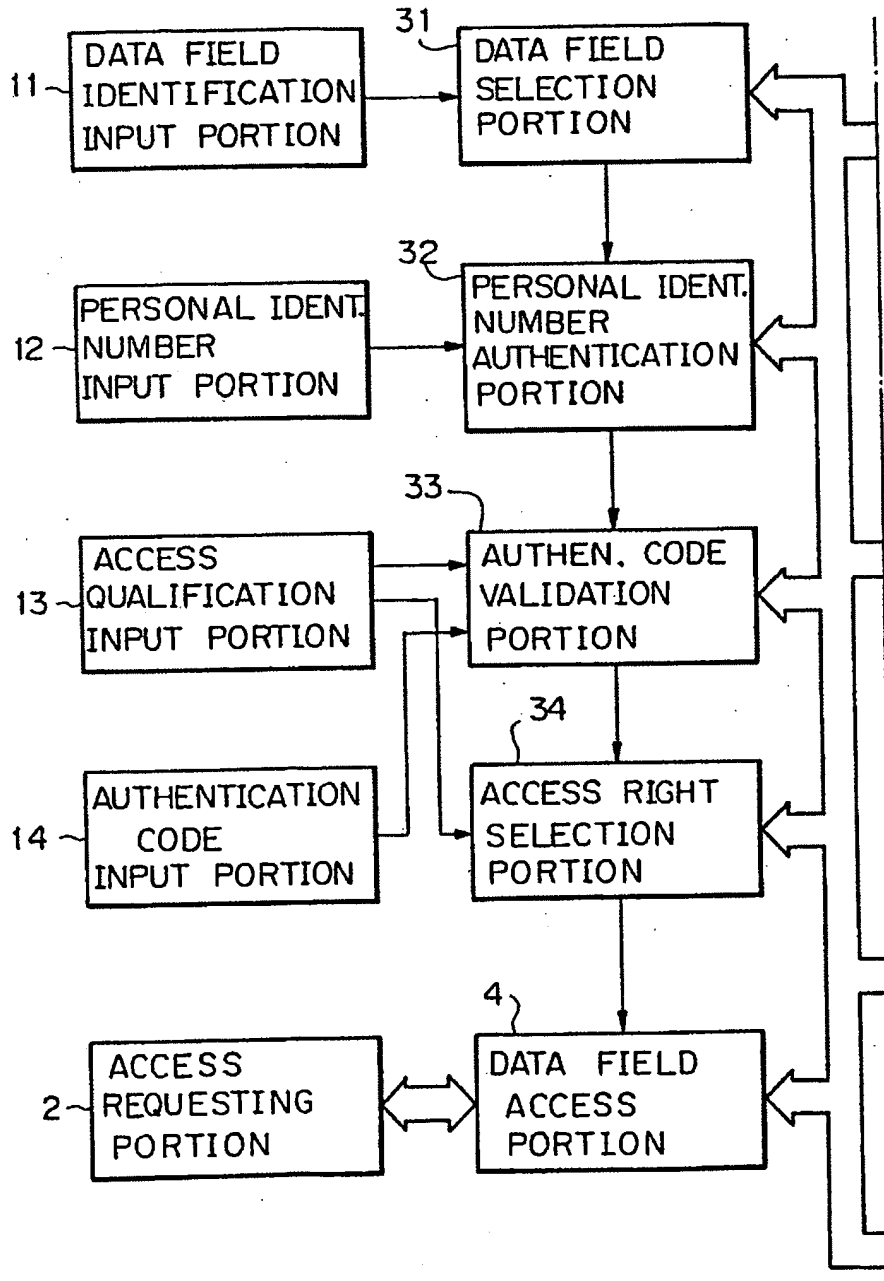

Fig. 4 B

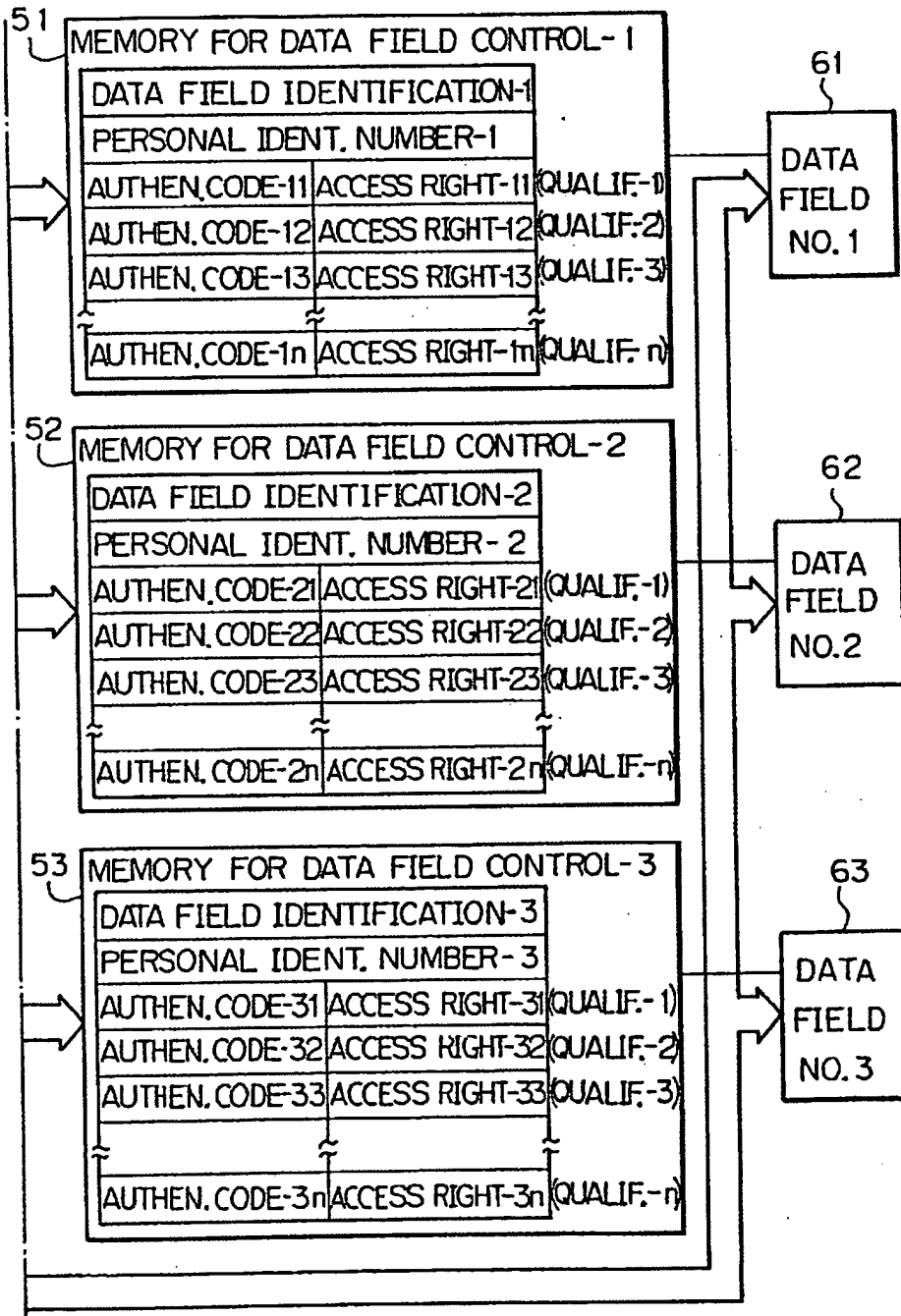

Fig. 5

	AUTHENTICATION CODE	ACCESS RIGHT
CARD ISSUER	X X X X X X X X	R W D RW
SERVICE SUPPLIER	Y Y Y Y Y Y	R W D RW
CARD ACCEPTOR	Z Z Z Z Z Z	R W D RW
CARD HOLDER	(PERSONAL IDENT. NUMBER)	R W D RW

R : READ  
W : WRITE  
D : DELETE  
RW : REWRITE

Fig. 6A

Fig. 6

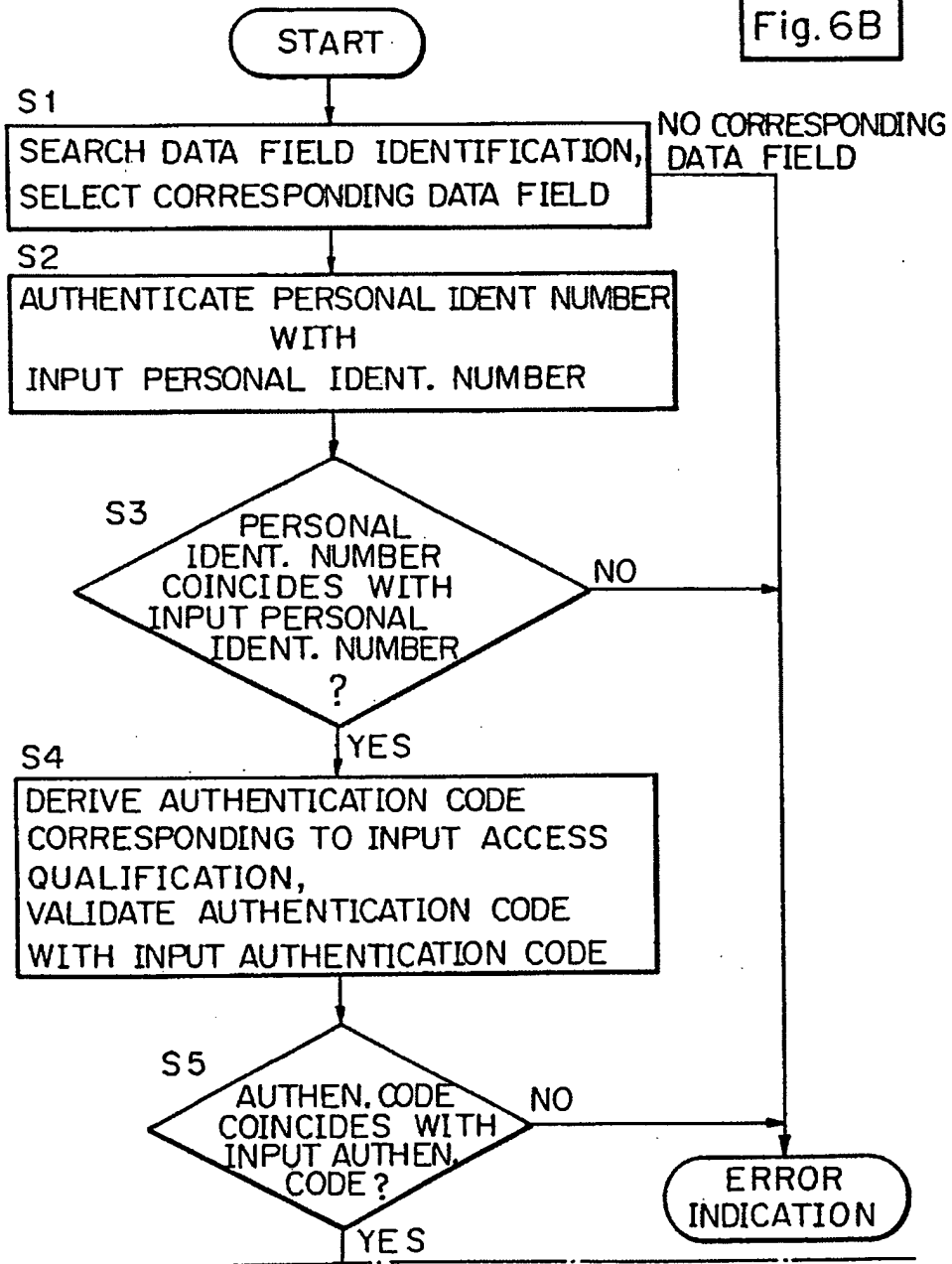
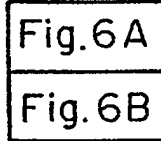

*Fig. 6B*

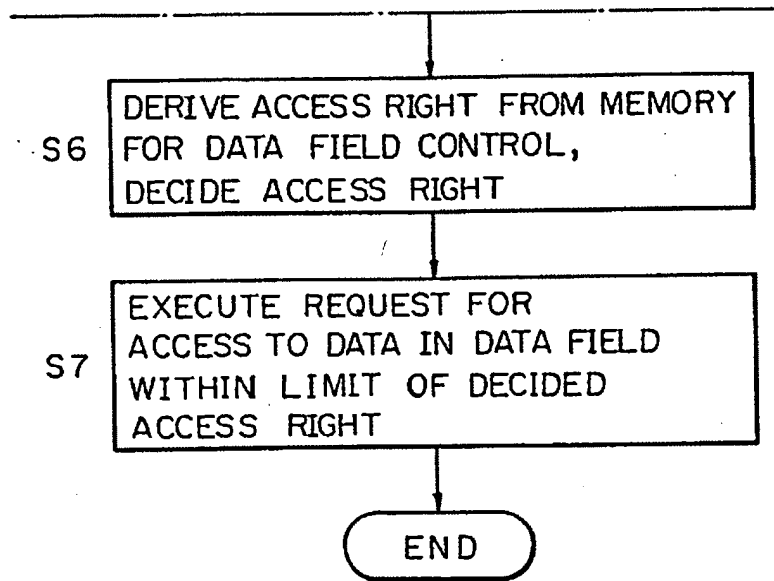

**INFORMATION SUPPLYING/COLLECTING DEVICE**

Publication number: JP6131371

Publication date: 1994-05-13

Inventor: TSUTSUI KIYOUYA

Applicant: SONY CORP

Classification:

- international: G07F7/08; C04B28/04; G06F21/24; G06Q30/00; G06Q50/00; G07F17/00; H04H9/00; H04N5/775; H04N7/173; H04N5/781; H04N5/85; H04N5/907; G07F7/08; C04B28/00; G06F21/00; G06Q30/00; G06Q50/00; G07F17/00; H04H9/00; H04N5/775; H04N7/173; H04N5/781; H04N5/84; H04N5/907; (IPC1-7): G06F15/21; G07F7/08; G07F17/00

- European: C04B28/04; H04H9/00R; H04N5/775; H04N7/173C

Application number: JP19920304706 19921016

Priority number(s): JP19920304706 19921016

Also published as:

 US5619570 (A1)

Report a data error here

**Abstract of JP6131371**

PURPOSE: To obtain the information on the reactions of the viewers and to improve the safety of the information control by acquiring quickly the information and attaining the flexible payment of the charge. CONSTITUTION: The input of information is carried out to an information recording/reproducing device 1011 and also the information is recorded and reproduced to an information recording medium 1012 under the control of a right control part 1015. When the input of information is controlled to an information input part 1013 together with the control of recording given to the medium 1012 respectively, the part 1015 controls the information input function or the information recording function of the part 1013 by a control signal 116. A signal 103 is sent to the medium 1012 through the part 1013 as the information 111. When the reproduction of information is controlled to the medium 1012, the part 1015 reads the information 118 on the type and the reproduction conditions, etc., on the information itself out of those information recorded in the medium 1012. The information 118 is sent to a display part 1017 and shown there as the display information 115.

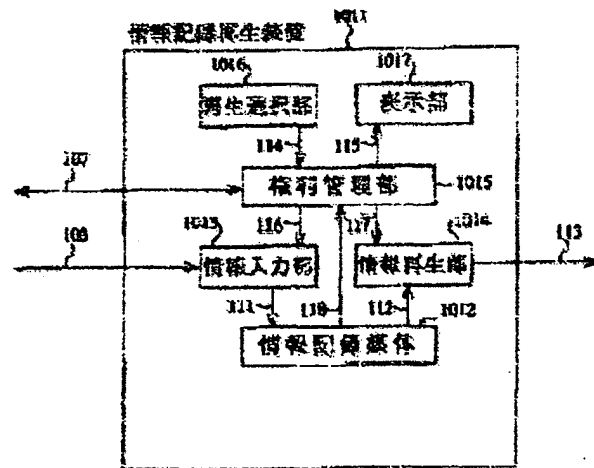

Data supplied from the esp@cenet database - Worldwide



(19) 日本国特許庁 (J P)

(12) 公開特許公報 (A)

(11) 特許出願公開番号

特開平6-131371

(43) 公開日 平成6年(1994)5月13日

(5) IntCl <sup>5</sup>	識別記号	庁内整理番号	F I	技術表示箇所
G 0 6 F 15/21	3 5 0	7052-5L		
G 0 7 F 7/08				
17/00	B	9028-3E	G 0 7 F 7/08	S
		9256-3E		

審査請求 未請求 請求項の数38(全 22 頁)

(21) 出願番号 特願平4-304706

(22) 出願日 平成4年(1992)10月16日

(71) 出願人 000002185

ソニー株式会社

東京都品川区北品川6丁目7番35号

(72) 発明者 筒井 京弥

東京都品川区北品川6丁目7番35号 ソニー株式会社内

(74) 代理人 弁理士 額本 義雄

(54) 【発明の名称】 情報提供収集装置

(57) 【要約】

【目的】 情報の迅速な入手、柔軟な料金支払いを可能とし、視聴者の反応に関する情報を得る。また、情報管理の安全性を高める。

【構成】 権利管理部1015の制御の下に、情報記録再生装置1011への入力、情報記録媒体1012への記録及び再生が行なわれる。情報入力部1013への入力、または情報記録媒体1012への記録を制御する場合には、権利管理部1015は、制御信号116によって、情報入力部1013の情報入力機能または情報記録機能が制御される。信号103は、情報入力部1013を通して情報記録媒体1012に情報111として送られる。一方、情報記録媒体1012からの再生を制御する場合には、権利管理部1015においては、情報記録媒体1012に記録されている情報のうち、その情報自身の種類や再生条件などの情報118を読み出す。それが表示情報115として表示部1017に送って表示される。

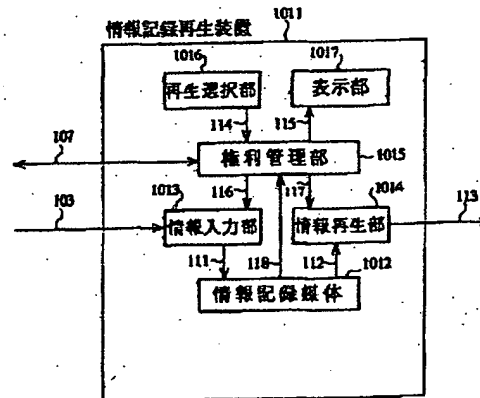

1

【特許請求の範囲】

【請求項1】 情報記録媒体および権利管理手段を備え、権利管理手段の制御により情報の記録または再生の制御を行なう情報記録装置から成ることを特徴とする情報提供収集装置。

【請求項2】 上記権利管理手段においては、上記記録媒体に記録された権利管理情報に基づいて制御を行なうことを特徴とする請求項1に記載の情報提供収集装置。

【請求項3】 上記権利管理情報は、記録もしくは再生前後で内容が変化することを特徴とする請求項2に記載の情報提供収集装置。

【請求項4】 上記権利管理情報は、記録または再生が許可される有効期限であることを特徴とする請求項2に記載の情報提供収集装置。

【請求項5】 上記記録媒体に記録される情報の一部は、その情報自身の内容を示すものであることを特徴とする請求項1に記載の情報提供収集装置。

【請求項6】 上記記録媒体は、半導体メモリであることを特徴とする請求項1に記載の情報提供収集装置。

【請求項7】 上記記録媒体及び上記権利管理手段は、1枚のカードに実装されている情報記録装置から成ることを特徴とする請求項1に記載の情報提供収集装置。

【請求項8】 上記記録媒体には書き換え不可能な情報を記録し、再生時に権利管理を行なうことを特徴とする請求項1に記載の情報提供収集装置。

【請求項9】 上記記録媒体には、情報提供装置から書き換え可能な情報を記録することを特徴とする請求項1に記載の情報提供収集装置。

【請求項10】 上記記録媒体への情報の記録は、上記情報提供装置による正当性認証が成立した場合に行なわれることを特徴とする請求項9に記載の情報提供収集装置。

【請求項11】 上記正当性認証は、上記情報提供装置及び上記情報記録装置に記録され、その値自身が暗号化された鍵情報に基づいて行なわれることを特徴とする請求項10に記載の情報提供収集装置。

【請求項12】 上記情報の再生は再生選択信号に基づいて行なわれることを特徴とする請求項1に記載の情報提供収集装置。

【請求項13】 上記情報の再生は、外部からの再生選択信号に基づいて行なわれることを特徴とする請求項1に記載の情報提供収集装置。

【請求項14】 上記情報の再生は、上記情報提供装置によって、上記情報記録装置の正当性認証が成立した場合に行なわれることを特徴とする請求項13に記載の情報提供収集装置。

【請求項15】 上記正当性認証は、上記情報記録装置及び上記情報記録装置に記録され、暗号化された鍵情報に基づいて行なわれることを特徴とする請求項14に記載の情報提供収集装置。

2

【請求項16】 上記権利管理情報は、権利管理情報更新装置により書き換え可能であることを特徴とする請求項2に記載の情報提供収集装置。

【請求項17】 上記権利管理情報の書き換えは、上記情報記録装置によって、上記権利管理情報更新装置の正当性認証が成立した場合に行なわれることを特徴とする請求項16に記載の情報提供収集装置。

【請求項18】 上記正当性認証は、上記権利管理情報更新装置及び上記情報記録装置に記録され、暗号化された鍵情報に基づいて行なわれることを特徴とする請求項17に記載の情報提供収集装置。

【請求項19】 上記権利管理更新装置に記録された鍵情報と、上記情報記録装置に記録された鍵情報とは異なる値を持つことを特徴とする請求項18に記載の情報記録装置。

【請求項20】 上記情報記録装置の挿入部と挿出部を別々に備え、上記情報記録装置への記録を行なう情報提供装置から成ることを特徴とする情報提供収集装置。

【請求項21】 内部に記録媒体を備え、その記録媒体に記録されている情報を上記情報再生装置に転送する情報提供装置から成ることを特徴とする請求項20に記載の情報提供収集装置。

【請求項22】 上記記録媒体として半導体メモリを用いる情報提供装置から成ることを特徴とする請求項21に記載の情報提供収集装置。

【請求項23】 上記記録媒体から上記情報記録装置への情報の転送を、端子を用いて行なう情報提供装置から成ることを特徴とする請求項20に記載の情報提供収集装置。

【請求項24】 上記記録媒体から上記情報提供装置への情報の転送を非接触の手段で行なうことを特徴とする請求項20に記載の情報提供収集装置。

【請求項25】 上記情報提供装置から転送された情報を、上記情報記録装置に転送し、上記権利管理手段の制御の下に上記情報の再生を行なう情報記録装置から成ることを特徴とする情報提供収集装置。

【請求項26】 再生利用する情報を記録する第1の情報記録媒体と、その情報の再生利用者の入力に係わる情報を記録する第2の情報記録媒体と、

その第2の情報記録媒体に記録された情報を外部に伝達するための伝達手段とを備えていることを特徴とする情報提供収集装置。

【請求項27】 上記第1の情報記録媒体に対し、外部からの情報の書き込みが可能であることを特徴とする請求項26に記載の情報提供収集装置。

【請求項28】 上記情報の再生利用者の入力に係わる情報が、第1の情報記録媒体に記録された情報再生によって入力が見られる選択情報であることを特徴とする請求項26に記載の情報提供収集装置。

3

【請求項29】 上記情報の再生利用者の入力に係わる情報が、その情報の再生利用状況に関する情報であることを特徴とする請求項26に記載の情報提供収集装置。

【請求項30】 上記第1の情報記録媒体は、ICメモリで構成されていることを特徴とする請求項26に記載の情報提供収集装置。

【請求項31】 上記第2の情報記録媒体は、ICメモリで構成されていることを特徴とする請求項26に記載の情報提供収集装置。

【請求項32】 構成要素が1枚のカードに実装されている情報記録装置から成ることを特徴とする請求項26に記載の情報提供収集装置。

【請求項33】 上記第2の情報記録媒体に記録された情報を読みだす手段を備えたことを特徴とする情報提供収集装置。

【請求項34】 上記第2の情報記録媒体から読みだされた情報に基づく情報を記録する媒体を装備することを特徴とする請求項33に記載の情報提供収集装置。

【請求項35】 上記第1の情報記録媒体への情報の書き込み機能を装備していることを特徴とする請求項33に記載の情報提供収集装置。

【請求項36】 有線または無線の伝達手段を装備し、上記第2の情報記録媒体から読み出された情報に基づく情報を、一旦記録媒体に蓄積した後に、または蓄積をせずに、処理を加え、または処理を加えずに上記伝達手段によって送信できることを特徴とする請求項33に記載の情報提供収集装置。

【請求項37】 上記情報記録装置の上記第2の情報記録媒体から読みだされた情報の種類あるいは内容に依存して、情報提供条件あるいは情報利用条件が変化することを特徴とする請求項35に記載の情報提供収集装置。

【請求項38】 複数個の上記情報記録装置から、上記伝達手段によって、上記第2の情報記録媒体から読みだされた情報に基づく情報を収集することを特徴とする情報提供収集装置。

【発明の詳細な説明】

【0001】

【産業上の利用分野】 本発明は、ニュース、音楽等の情報を迅速に入手及び提供し、視聴者の反応を知るための手段を備えた情報記録装置に関するものである。

【0002】

【従来の技術】 従来より、例えば、特開平3-118690号に述べられているように、「無線、または有線により情報送出用の制御機に接続され、情報入力手段、該入力手段より入力した情報を情報記録媒体へ記録する記録手段、該情報記録媒体の排出口、および決済手段から構成されたことを特徴とする情報記録装置」という技術が知られている。

【0003】 これを用いれば、例えば、手持ちのカセットテープを情報記録装置にセットし、コイン、カード、

4

使用度数管理等の決済処理をすることにより情報記録装置を介してニュース、音楽等の情報をダビングし、提供することができる。そして、従来例では、以下の方法が記載されている。利用者は、上記情報記録装置の挿入口にカセットテープ等の記録媒体を挿入するとともに、コインの投下および情報の選択を行なう。そして、上記情報記録装置は、それらに基づいて挿入された上記情報記録媒体に情報をダビングし、挿入口と同一の排出口から上記記録媒体を排出する。

【0004】 一方、流行歌などの音楽やクイズ等を供給する媒体として、ラジオやテレビ等の放送が利用されることが多い。

【0005】

【発明が解決しようとする課題】 従来例の方法では、カセットテープ等、ダビング速度が遅い場合には問題にならない。ところが、例えば、半導体メモリを用いた記録媒体へのダビングを考えた場合には、情報提供は瞬時に行なうことが可能である。しかし、その場合に、記録媒体へのダビングは瞬時に終了するにも拘わらず、いちいちコイン等を使用して決済を行なうのでは、情報入手者にコイン投入等の余分な負担がかかることになり、時間もかかる。そのため、従来例では、例えば駅などで多くの人が情報を入力しようとしても、電車の待ち合わせ時など、限られた時間内に情報が得られる人数には限りができてしまうことになる。

【0006】 また、従来例では、各利用者の情報選択動作やコインの投入動作とともに、情報記録装置の記録媒体の吸引、排出作用が隘路となり、各利用者は、これらの作用が終了するまで情報記録装置を占有することになる。そのため、従来例では、多くの利用者に迅速に情報を供給することができなかった。

【0007】 さらに、従来例では、上記情報記録媒体への記録時に決済がなされる。ところが、例えば、記録された情報のうち、情報入手者に興味があるのは、そのほんの一部だけで、実際にはその部分しか再生しなかった場合がある。しかし従来例では、そうした場合でも、決済は情報記録時に行なわれているので、情報入手者は、すべての情報に対する料金を払わなければならないという不都合が生じる場合がある。

【0008】 また、従来、放送局は一方向的に番組を送るだけである。従って、従来例においては、視聴者が、実際にそれらの番組をどのように視聴しているかの実態や、どの曲に人気があるかといった情報を把握することは困難であった。また、例えば、クイズ番組においても、従来例においては、視聴者の正当率を把握したり、視聴者同士で正当率を競ったりすることは困難であった。

【0009】 これに対し、双方向機能を持ったCATVを使用して、これらの情報を把握するという方法も提案されている。しかし、これらは視聴のための装置が屋内

5

に固定されているため、屋外での視聴者の状況を知るためには適用できない、という欠点があった。

【0010】また、一般に、正当な権利管理情報更新装置は、厳重に管理することが可能である。しかし、情報記録（再生）装置は多数の人が使用するため、厳重に管理することが難しい。しかも、不当な権利管理情報更新装置が1台でもできると、それによって多数の情報記録（再生）装置内の残度数が更新され得るので危険である。

【0011】本発明はこのような状況に鑑みてなされたものであり、情報の迅速な入手、柔軟な料金支払いを可能とし、さらに、視聴者の反応に関する情報を得ることができるようになることを目的とする。また、情報管理の安全性を高めることを目的とする。

【0012】  
【課題を解決するための手段】請求項1に記載の情報提供収集装置は、情報記録媒体1043及び権利管理手段としての権利管理部1045を備え、権利管理手段としての権利管理部1045の制御により情報の記録または再生の制御を行なう情報記録装置1041から成ることを特徴とする。

【0013】請求項2に記載の情報提供収集装置は、上記権利管理手段としての権利管理部1045において、上記記録媒体1043に記録された権利管理情報としての残度数情報Dに基づいて制御を行なうことを特徴とする。

【0014】請求項3に記載の情報提供収集装置は、上記権利管理情報としての残度数情報Dが、記録もしくは再生前後で内容が変化することを特徴とする。

【0015】請求項4に記載の情報提供収集装置は、上記権利管理情報としての残度数情報Dが、記録または再生が許可される有効期限であることを特徴とする。

【0016】請求項5に記載の情報提供収集装置は、上記記録媒体1043に記録される情報の一部が、その情報自身の内容を示すものであることを特徴とする。

【0017】請求項6に記載の情報提供収集装置は、上記記録媒体1043が、半導体メモリであることを特徴とする。

【0018】請求項7に記載の情報提供収集装置は、上記記録媒体1043及び上記権利管理手段としての権利管理部1045が、1枚のカードに実装されている情報記録装置1041から成ることを特徴とする。

【0019】請求項8に記載の情報提供収集装置は、上記記録媒体1043には書き換え不可能な情報を記録し、再生時に権利管理を行なうことを特徴とする。

【0020】請求項9に記載の情報提供収集装置は、上記記録媒体1043には、情報提供装置1001から書き換え可能な情報を記録することを特徴とする。

【0021】請求項10に記載の情報提供収集装置は、上記記録媒体1043への情報の記録が、上記情報提供

6

装置1001による正当性認証が成立した場合に行なわれることを特徴とする。

【0022】請求項11に記載の情報提供収集装置は、上記正当性認証が、上記情報提供装置1001及び上記情報記録装置1041に記録され、暗号化された鍵情報としての秘密鍵Kに基づいて行なわれることを特徴とする。

【0023】請求項12に記載の情報提供収集装置は、上記情報の再生が、再生選択信号としての再生選択情報114に基づいて行なわれることを特徴とする。

【0024】請求項13に記載の情報提供収集装置は、上記情報の再生が、外部からの再生選択信号としての再生選択情報114に基づいて行なわれることを特徴とする。

【0025】請求項14に記載の情報提供収集装置は、上記情報の再生が、上記情報提供装置1001によって、上記情報記録装置1041の正当性認証が成立した場合に行なわれることを特徴とする。

【0026】請求項15に記載の情報提供収集装置は、上記正当性認証が、上記情報提供装置1001及び上記情報記録装置1041に記録され、暗号化された鍵情報としての秘密鍵Kに基づいて行なわれることを特徴とする。

【0027】請求項16に記載の情報提供収集装置は、上記権利管理情報としての残度数情報Dが、権利管理情報更新装置1061により書き換え可能であることを特徴とする。

【0028】請求項17に記載の情報提供収集装置は、上記権利管理情報としての残度数情報Dの書き換えが、上記情報記録装置1041によって、上記権利管理情報更新装置1061の正当性認証が成立した場合に行なわれることを特徴とする。

【0029】請求項18に記載の情報提供収集装置は、上記正当性認証が、上記権利管理情報更新装置1061及び上記情報記録装置1041に記録され、暗号化された鍵情報としての復号化鍵L及び暗号化鍵Mに基づいて行なわれることを特徴とする。

【0030】請求項19に記載の情報提供収集装置は、上記権利管理更新装置1061に記録された鍵情報としての暗号化鍵Mと、上記情報記録装置1041に記録された鍵情報としての復号化鍵Lとは異なる値を持つことを特徴とする。

【0031】請求項20に記載の情報提供収集装置は、上記情報記録装置1041の挿入部と挿出部を別々に備え、上記情報記録装置1041への記録を行なう情報提供装置1001から成ることを特徴とする。

【0032】請求項21に記載の情報提供収集装置は、内部に記録媒体2012を備え、その記録媒体2012に記録されている情報を上記情報記録装置1041に転送する情報提供装置1001から成ることを特徴とす

7

る。

【0033】請求項22に記載の情報提供収集装置は、上記記録媒体2012として半導体メモリを用いる情報提供装置1001から成ることを特徴とする。

【0034】請求項23に記載の情報提供収集装置は、上記記録媒体2012から上記情報記録装置1041への情報の転送を端子2041を用いて行なうことを特徴とする。

【0035】請求項24に記載の情報提供収集装置は、記録媒体2023から情報記録装置2031への情報の転送を非接触の手段で行なうことを特徴とする。

【0036】請求項25に記載の情報提供収集装置は、上記情報提供装置1001から転送された情報を、上記情報記録装置1041に転送し、上記権利管理手段としての権利管理部1045の制御の下に上記情報の再生を行なう情報記録装置1041から成ることを特徴とする。

【0037】請求項26に記載の情報提供収集装置は、再生利用する情報を記録する第1の情報記録媒体4013と、その情報の再生利用者の入力に係わる情報を記録する第2の情報記録媒体4017と、その第2の情報記録媒体4017に記録された情報を外部に伝送するための伝送手段としての伝送部3008とを備えていることを特徴とする。

【0038】請求項27に記載の情報提供収集装置は、上記第1の情報記録媒体4013に対し、外部からの情報の書き込みが可能であることを特徴とする。

【0039】請求項28に記載の情報提供収集装置は、上記情報の再生利用者の入力に係わる情報が、第1の情報記録媒体4013に記録された情報再生によって入力 30が促される選択情報であることを特徴とする。

【0040】請求項29に記載の情報提供収集装置は、上記情報の再生利用者の入力に係わるその情報が、その情報の再生利用状況に関する情報であることを特徴とする。

【0041】請求項30に記載の情報提供収集装置は、上記第1の情報記録媒体4013が、ICメモリで構成されていることを特徴とする。

【0042】請求項31に記載の情報提供収集装置は、上記第2の情報記録媒体4017が、ICメモリで構成されて 40 いることを特徴とする。

【0043】請求項32に記載の情報提供収集装置は、構成要素が1枚のカードに実装されている情報記録装置5021から成ることを特徴とする。

【0044】請求項33に記載の情報提供収集装置は、上記第2の情報記録媒体4017に記録された情報を読み出す手段としての制御部4014を備えたことを特徴とする。

【0045】請求項34に記載の情報提供収集装置は、上記第2の情報記録媒体4017から読みだされた情報 50

8

に基づく情報を記録する媒体としての記録媒体3007を装備することを特徴とする。

【0046】請求項35に記載の情報提供収集装置は、上記第1の情報記録媒体4013への情報の書き込み機能を装備していることを特徴とする。

【0047】請求項36に記載の情報提供収集装置は、有線または無線の伝送手段としての伝送部3002、3008を装備し、上記第2の情報記録媒体4017から読み出された情報に基づく情報を、一旦記録媒体3007に蓄積した後に、または蓄積をせずに、処理を加え、または処理を加えずに上記伝送手段によって送信できることを特徴とする。

【0048】請求項37に記載の情報提供収集装置は、上記第2の情報記録媒体4017から読みだされた情報の種類あるいは内容に依存して、情報提供条件あるいは情報利用条件が変化することを特徴とする。

【0049】請求項38に記載の情報提供収集装置は、複数個の上記情報記録装置5021から、上記伝送部3008によって、上記第2の情報記録媒体3007から読みだされた情報に基づく情報を収集することを特徴とする。

【0050】

【作用】請求項1に記載の情報提供収集装置においては、権利管理部1045の制御により情報の記録または再生の制御が行われる。以上のことにより、柔軟な料金支払いが可能となる。

【0051】請求項2に記載の情報提供収集装置においては、権利管理部1045において、上記記録媒体1043に記録された残度数情報Dに基づいて制御が行なわれる。以上のことにより、柔軟な料金支払いが可能となる。

【0052】請求項3に記載の情報提供収集装置においては、残度数情報Dが、記録もしくは再生前後で内容が変化し、以上のことにより、柔軟な料金支払いが可能となる。

【0053】請求項4に記載の情報提供収集装置においては、残度数情報Dが、記録または再生が許可される有効期限である。以上のことにより、柔軟な料金支払いが可能となる。

【0054】請求項5に記載の情報提供収集装置においては、記録媒体1043に記録される情報の一部が、その情報自身の内容を示す。以上のことにより、柔軟な料金支払いが可能となる。

【0055】請求項6に記載の情報提供収集装置においては、記録媒体1043が、半導体メモリである。以上のことにより、情報の迅速な入手が可能となる。

【0056】請求項7に記載の情報提供収集装置においては、記録媒体1043及び権利管理部1045が、1枚のカードに実装されている情報記録装置1041から成る。以上のことにより、情報の迅速な入手が可能とな

る。

【0057】請求項8に記載の情報提供収集装置においては、記録媒体1043には書き換え不可能な情報が記録され、再生時に権利管理が行なわれる。以上のことにより、柔軟な料金支払いが可能となる。

【0058】請求項9に記載の情報提供収集装置においては、記録媒体1043に、情報提供装置1001から書き換え可能な情報が記録される。以上のことにより、柔軟な料金支払いが可能となる。

【0059】請求項10に記載の情報提供収集装置においては、記録媒体1043への情報の記録が、上記情報提供装置1001による正当性認証が成立した場合に行なわれる。以上のことにより、情報管理の安全性が高められる。

【0060】請求項11に記載の情報提供収集装置においては、上記正当性認証が、情報提供装置1001及び情報記録装置1041に記録され、秘密鍵Kに基づいて行なわれる。以上のことにより、情報管理の安全性が高められる。

【0061】請求項12に記載の情報提供収集装置においては、上記情報の再生が、再生選択信号114に基づいて行なわれる。以上のことにより、柔軟な料金支払いが可能となる。

【0062】請求項13に記載の情報提供収集装置においては、上記情報の再生が、外部からの再生選択信号114に基づいて行なわれる。以上のことにより、柔軟な料金支払いが可能となる。

【0063】請求項14に記載の情報提供収集装置においては、上記情報の再生が、情報提供装置1001によって、情報記録装置1041の正当性認証が成立した場合に行なわれる。以上のことにより、情報管理の安全性が高められる。

【0064】請求項15に記載の情報提供収集装置においては、上記正当性認証が、情報提供装置1001及び情報記録装置1041に記録され、秘密鍵Kに基づいて行なわれる。以上のことにより、情報管理の安全性が高められる。

【0065】請求項16に記載の情報提供収集装置においては、残度数情報Dが、権利管理情報更新装置1061により書き換え可能である。以上のことにより、柔軟な料金支払いが可能となる。

【0066】請求項17に記載の情報提供収集装置においては、残度数情報Dの書き換えが、情報記録装置1041によって、権利管理情報更新装置1061の正当性認証が成立した場合に行なわれる。以上のことにより、情報管理の安全性が高められる。

【0067】請求項18に記載の情報提供収集装置においては、上記正当性認証が、権利管理情報更新装置1061及び情報記録装置1041に記録され、復号化鍵L及び暗号化鍵Mに基づいて行なわれる。以上のことによ

り、情報管理の安全性が高められる。

【0068】請求項19に記載の情報提供収集装置においては、権利管理更新装置1061に記録された暗号化鍵Mと、情報記録装置1041に記録された復号化鍵Lとは異なる値を持つ。以上のことにより、情報管理の安全性が高められる。

【0069】請求項20に記載の情報提供収集装置においては、情報記録装置1041の挿入部と排出部を別々に備え、情報記録装置1041への記録を行なう情報提供装置1001から成る。以上のことにより、情報の迅速な入手が可能となる。

【0070】請求項21に記載の情報提供収集装置においては、内部に記録媒体2012を備え、その記録媒体2012に記録されている情報を情報記録装置1041に転送する情報提供装置1001から成る。以上のことにより、情報の迅速な入手が可能となる。

【0071】請求項22に記載の情報提供収集装置においては、記録媒体2012として半導体メモリを用いる情報提供装置1001から成る。以上のことにより、情報の迅速な入手が可能となる。

【0072】請求項23に記載の情報提供収集装置においては、記録媒体2012から情報記録装置1041への情報の転送が端子2041を用いて行なわれる。以上のことにより、情報の迅速な入手が可能となる。

【0073】請求項24に記載の情報提供収集装置においては、記録媒体2023から情報記録装置2031への情報の転送が非接触の手段で行なわれる。以上のことにより、情報の迅速な入手が可能となる。

【0074】請求項25に記載の情報提供収集装置においては、情報提供装置1001から転送された情報を、情報記録装置1041に転送し、権利管理部1045の制御の下に上記情報の再生を行なう情報記録装置1041から成る。以上のことにより、柔軟な料金支払いが可能となる。

【0075】請求項26に記載の情報提供収集装置においては、情報記録媒体4013により、再生利用する情報が記録され、情報記録媒体4017により、再生利用者の入力に係わる情報が記録される。そして、伝達部3008により、情報記録媒体4017に記録された情報が外部に伝達される。以上のことにより、柔軟な料金支払いが可能となる。

【0076】請求項27に記載の情報提供収集装置においては、情報記録媒体4013に対し、外部からの情報の書き込みが可能である。以上のことにより、柔軟な料金支払いが可能となる。

【0077】請求項28に記載の情報提供収集装置においては、再生利用者の入力に係わる情報が、情報記録媒体4013に記録された情報再生によって入力が必要とされる選択情報である。以上のことにより、視聴者の反応に関する情報が得られる。

【0078】請求項29に記載の情報提供収集装置においては、再生利用者の入力に係わるその情報が、その情報の再生利用状況に関する情報である。以上のことにより、視聴者の反応に関する情報が得られる。

【0079】請求項30に記載の情報提供収集装置においては、情報記録媒体4013が、ICメモリで構成されている。以上のことにより、情報の迅速な入手が可能となる。

【0080】請求項31に記載の情報提供収集装置においては、情報記録媒体4017が、ICメモリで構成されている。以上のことにより、情報の迅速な入手が可能となる。

【0081】請求項32に記載の情報提供収集装置においては、構成要素が1枚のカードに実装されている情報記録装置5021から成る。以上のことにより、情報の迅速な入手が可能となる。

【0082】請求項33に記載の情報提供収集装置においては、情報記録媒体4017に記録された情報が、制御部4014により読み出される。以上のことにより、視聴者の反応に関する情報が得られる。

【0083】請求項34に記載の情報提供収集装置においては、記録媒体3007により、情報記録媒体4017から読みだされた情報に基づく情報が記録される。以上のことにより、視聴者の反応に関する情報が得られる。

【0084】請求項35に記載の情報提供収集装置においては、情報記録媒体4013への情報の書き込み機能が装備されている。以上のことにより、柔軟な料金支払いが可能となる。

【0085】請求項36に記載の情報提供収集装置においては、情報記録媒体4017から読み出された情報に基づく情報が、一旦記録媒体3007に蓄積された後に、伝達部3002、3008により送信される。または、上記情報が蓄積されずに、処理が加えられ、または処理が加えられずに伝達部3002、3008により送信される。以上のことにより、柔軟な料金支払いが可能となる。

【0086】請求項37に記載の情報提供収集装置においては、情報記録媒体4017から読みだされた情報の種類あるいは内容に依存して、情報提供条件あるいは情報利用条件が変化する。以上のことにより、柔軟な料金支払いが可能となる。

【0087】請求項38に記載の情報提供収集装置においては、複数個の情報記録装置5021から、伝達部3008によって、情報記録媒体3007から読みだされた情報に基づく情報が収集される。以上のことにより、視聴者の反応に関する情報が得られる。

【0088】

【実施例】以下、本発明の好ましい実施例について、図面を参照しながら説明する。図1は、本発明の方法によ

る情報提供収集装置の一実施例における情報記録再生装置の外観を示したものである。この実施例の装置の一端には、情報提供装置結合端子が付いている。ここを通じて、情報提供装置から情報記録再生装置内に設置された記録媒体に情報がコピーされる。また、この実施例の装置の前面には、表示手段としての表示部と、再生選択手段としての再生選択ボタンが装備されている。

【0089】次に、その動作について説明する。上記表示部は、上記情報記録再生装置内に記録された情報の内容を表示することができる。情報提供収集装置の利用者は、上記表示部に表示されたものをもとに、ボタン等の再生選択手段を用いて必要な情報を選択的に再生することができる。情報の内容は、テキスト情報、音声情報、映像情報およびコンピュータプログラム等を含み、特に限定されない。ここでプログラムの再生とは、そのプログラムを実行することを意味するが、この場合、実行時に利用者が必要に応じて情報を入力しても良い。再生信号がテキストや映像信号の場合には、その再生信号は液晶装置等でできた表示部に表示され、音声情報の場合にはイヤホンに出力される。図1の実施例には描かれていないが、もちろんイヤホンのかわりに、スピーカが装備されていても良く、あるいは、その両方が装備されていても良い。その場合には、スピーカに音声情報の再生結果が出力されても良い。

【0090】やはり図1の実施例には描かれていないが、さらに再生信号は、外部端子が取り付けられて外部のCRTやスピーカ等に接続されてもよい。なお、記録媒体の種類も、特に限定はない。しかし、一般的に、記録媒体は、高速にコピーが可能で、かつ、ランダムアクセスが容易で、携帯性にも優れたICメモリが使用されると便利である。

【0091】図2は、本発明のもう1つの実施例の外観図である。この例では、図1の情報記録再生装置が、情報記録装置と情報再生装置とに物理的に分離して構成されている。そして、情報記録装置は1枚のカードに実装されている。ただし、再生時には、上記情報記録装置と上記情報再生装置との間でデータおよび制御のやりとりが必要になるので、両者を結合する情報提供装置結合端子及び情報再生装置結合端子が上記情報記録装置及び上記情報再生装置に装備されている。ただし、上記情報記録装置の上記情報記録装置結合端子及び上記情報再生装置結合端子は、実際には1つの端子を切り替えて使用されるように構成されることも可能である。その動作については、図1と同様であり、ここでは省略する。

【0092】図3は、本発明に係わる情報提供収集装置の一実施例における情報提供装置の外観図である。情報提供装置内には記録媒体が設置され、情報が記録されている。図3では省略されているが、記録する情報においては、有線または無線による情報伝達手段によって送信するようにすると便利である。ただし、もちろん、記録

済みの記録媒体が直接に上記情報提供装置に挿入されても良い。

【0093】図3の実施例の情報提供装置の前面には、記録されている情報の内容や価格等を表示する表示手段としての表示部が装備されている。また、上記情報提供装置の前面には、どの情報を情報提供手段から出力するかを選択する出力選択手段としての出力選択ボタンが装備されている。そして、その出力選択ボタンにより、情報入手希望者は欲しい情報を選択することができる。さらに、上記情報提供装置の前面には、情報記録再生装置または情報記録装置を挿入するための挿入排出口が備えてある。その動作について説明する。情報の入手は、上記情報提供装置の挿入排出口に情報記録再生装置または情報記録装置が挿入され、情報のコピーを受けることによって実現される。

【0094】図4は、本発明に係わる情報提供収集装置のもう一つの実施例における情報提供装置の外観図である。この実施例では、挿入口と排出口が距離を置いて分離されている。そして、情報提供装置内には、情報記録装置を運ぶベルトが備えてある。その動作について説明する。上記挿入口から情報記録装置が挿入されると、その情報記録装置は上記ベルトに運ばれて排出口から出てくる。そして、情報入手希望者は歩きながら情報の入手をすることができる。以上のように、この実施例は多くの人に迅速に情報を提供する場合に便利である。

【0095】図5は、本発明の情報提供収集装置の一実施例における情報提供装置のブロック図である。図5において、情報記録媒体1003は、ハードディスクや光磁気ディスク等、何であってても良い。しかし、一般的には、ランダムアクセスが可能で、情報記録再生装置の記録速度と同等の読み出しが可能であると効率が良い。そのため、記録媒体1003は、ICメモリによって構成されていると便利である。情報記録媒体1003は、情報出力部1004に接続され、情報出力部1004は、制御部1005に接続されている。制御部1005には、出力選択部1006及び表示部1007に接続されている。そして、以上の構成により、情報提供装置1001を成している。一方、情報記録媒体1003は情報伝達部1002にも接続されている。

【0096】次に、その動作について説明する。情報101が、有線、無線等の情報伝達部1002によって送られ、情報記録媒体1003に記録される。その情報記録媒体1003から読みだされた情報102は、情報出力部1004を通して信号103として出力される。情報出力部1004は制御部1005により情報の出力制御を受ける。制御部1005は、表示部1007に情報の内容や提供条件、情報提供処理過程の経過等の信号105を送る。それと共に、制御部1005は、情報入手希望者が出力選択部1006を通じて入力した出力選択情報104を受け取る。そして、制御部1005は、図

6に示す情報記録再生装置1011の権利管理部1015と後述する内容の通信107を行なう。その結果に基づいて、信号106により情報出力部1004の制御が行なわれる。その制御に基づいて、情報出力部1004は、情報記録媒体1003から読みだした情報102を情報記録再生装置1011に信号103として出力する。

【0097】図6は、本発明の情報提供収集装置の一実施例における情報記録再生装置のブロック図である。図6において、情報記録媒体1012は、情報入力部1013、権利管理部1015及び情報再生部1014に接続されている。そして、情報再生部1014及び情報入力部1013は、権利管理部1015に接続されている。さらに、権利管理部1015には、再生選択部1016及び表示部1017が接続されている。そして、以上の構成により、情報記録再生装置1011を成している。

【0098】次に、その動作について説明する。情報記録再生装置1011においては、権利管理部1015の制御の下に、情報記録再生装置1011への入力、情報記録媒体1012への記録及び再生が行なわれる。情報入力部1013への入力または情報記録媒体1012への記録を制御する場合には、権利管理部1015は、図5に示す情報提供装置1001の制御部1005と、後述する内容の通信107を行なう。その結果に基づいて、制御信号116によって、情報入力部1013の情報入力機能または情報記録機能が制御される。そして、信号103は、情報入力部1013を通して情報記録媒体1012に情報111として送られる。

【0099】一方、情報記録媒体1012からの再生を制御する場合には、権利管理部1015においては、情報記録媒体1012に記録されている情報のうち、その情報自身の種類や再生条件などの情報118を読み出す。それが表示情報115として表示部1017に送って表示される。この表示情報115に基づいて、装置の使用が再生選択部1016によって入力した再生選択信号としての再生選択情報114が、権利管理部1015に送られる。そして、権利管理部1015においては、後述する処理を行なうことによって、情報再生部1014に再生制御信号117を送る。これに基づいて、情報再生部1014においては、情報記録媒体1012から情報112を読み出し、音や映像、テキストなどの再生信号113を出力する。ただし、再生信号113が映像やテキストである場合には、例えば、その映像やテキストが表示部1017上に再生されても良い。

【0100】図7は、図5に示す情報提供装置1001における制御部1005の実施例を示したものである。図7において、メモリ1021は、CPU1022に接続され、CPU1022は、乱数発生部1023に接続されている。以上のように、制御部1005は、メモリ



1021とCPU1022及び乱数発生部1023で構成されている。そして、メモリ1021には、暗号化された秘密鍵Kが記録されている。その動作については、後のフローチャートで述べる。

【0101】図8は、図6に示す情報記録再生装置1011における権利管理部1015の実施例を示したものである。図8において、メモリ1031は、CPU1032に接続されている。そして、権利管理部1015は、メモリ1031及びCPU1032で構成されている。また、メモリ1031には、暗号化された鍵情報としての秘密鍵K及び権利管理情報としての残度数情報Dが記録されている。

【0102】ここで残度数情報Dとは、情報記録再生装置1011が、その時点で、あと何回外部から情報を入力して記録してもいいか、あるいは、何回その情報を再生してもいいか、という権利情報を表すものである。ただし、残度数情報Dは、それら記録または再生の回数を直接表すものでなくても良い。例えば、残度数情報Dは、その情報を記録または再生するのに必要な権利の単位の数量を表し、情報の内容によって異なる数量の単位が記録または再生時に減じられていくものとしても良い。また、残度数というのも権利管理情報の一例であり、例えば、残度数のかわりに、記録や再生の許される有効期限が記録してあってもよい。その動作については、後のフローチャートで述べる。

【0103】図9は、本発明の情報提供収集装置の一実施例において、情報記録再生装置への記録時に決済が行なわれる場合について説明するフローチャートである。ここで図9において、情報提供装置1001及び情報記録再生装置1011間の通信107及び情報の送受信信号113の実施例について説明を行なう。

【0104】先ずステップ1で、情報の入手希望者は、情報記録再生装置1011を情報提供装置1001に挿入し、出力選択部1006を用いて出力選択を行なう。ステップ2で、制御部1005は、この出力選択情報104を受信する。それと共に、ステップ10で、制御部1005と権利管理部1015との間で通信201が行なわれる。そして、後述する方法により、権利管理部1015の認証が行なわれる。ステップ3で、これにより権利管理部1015の正当性が証明されれば、ステップ5で、その情報の入手に必要な度数202が権利管理部1015に送信される。しかし、ステップ3で、もし正当性が証明されない場合には、ステップ4が実行される。ステップ4では、正当性が証明されないことが表示部1007に表示され、情報記録再生装置1011が排出されるなどのコピー不可処理1が行なわれる。

【0105】一方、ステップ5で、その正当性が証明された権利管理部1015は、ステップ11で、情報の入手に必要な度数情報を受信する。ステップ12では、権利管理部1015は、上記必要度数情報と権利管理部1

015自身が保持する残度数情報Dとを比較する。そして、もし必要度数が残度数よりも等しいか、少なければ、ステップ13で、コピー要求信号203が制御部1005に送信される。ステップ6では、制御部1005は、コピー要求信号203を受信する。ステップ7では、情報記録媒体1003内の情報が情報103として情報記録再生装置1011に送信される。そして、ステップ14で、情報記録再生装置1011は、情報103を受信し記録する。それと共に、ステップ15で、残度数が減るように変更される。

【0106】一方、ステップ12で、必要度数が残度数より大きい場合には、ステップ16で、権利管理部1015はコピー不可処理2要求信号205を送信する。ステップ8では、制御部1005はコピー不可処理2要求信号205を受信する。そして、ステップ9で、コピー不可であることが表示部1007に表示されるなどのコピー不可処理2が行なわれる。このようにして、情報送信が行なわれたり、必要度数が残度数より大きいためにコピー不可処理2が行なわれる。

【0107】ところで、以上の処理後、情報入手希望者が別の情報の入手を希望する場合がある。その場合は、情報記録媒体1012に十分な記録領域が確保できるのであれば、情報入手希望者が、別の情報の入手を希望することを情報記録装置に入力する。そして、情報提供装置1001及び情報記録再生装置1011は上述の処理を繰り返すようにしても良い。なお、権利管理情報として、残度数のかわりに有効期限が記録されている場合も考えられる。その場合には、権利管理部1015は、必要度数と残度数との比較ではなく、図では省略されているクロックに基づいて、現在の日付時刻と有効期限との比較を行なう。そして、残度数の変更にあたるような処理は不用になる。

【0108】図10は、図9に示す認証のための通信201について説明するフローチャートである。先ず、ステップ31で、制御部1005は乱数Pを発生する。ステップ32で、上記乱数Pが権利管理部1015に送信される。それと共に、ステップ33で、秘密鍵Kと乱数Pに依存する関数 $f(K, P)$ の値Aが計算される。

【0109】一方、ステップ36で、権利管理部1015は乱数Pを受信する。そして、ステップ37でも、関数 $f(K, P)$ の値Bが計算される。ステップ38で、上記値Bが制御部1005に送信される。ステップ34で、値Bを受信した制御部1005は、値Aと値Bとを比較する。ステップ35で、値Aと値Bとが、もし一致していれば、この権利管理部1015は正しい秘密鍵Kの値を保持し、正しい決済を行なう正当なものであると判断される。しかし、値Aと値Bとが、もし一致しなければ、この権利管理部1015は不当なものであると見なされる。

【0110】ここで、認証の方法としては、例えば、権

利管理部1015が保持している秘密鍵Kを直接、制御部1005に送付し、制御部1005が正しい秘密鍵Kの値が送られてきたかを検証するという方法も採ることができる。しかし、実施例のような方法が用いられれば、秘密鍵Kが、制御部1005や権利管理部1015の外部に出ることはないの、安全性が高められる。また、認証の方法としては、後述する公開鍵暗号を利用した方法を用いることももちろん、可能である。

【0111】図11は、本発明の情報提供収集装置の一実施例において、権利管理部1015が情報の記録時ではなく、再生時に情報使用の決済を行なう場合の処理の流れのについて説明するフローチャートである。ステップ51で、情報記録媒体1012に記録されている情報のうち、どの部分を再生するか再生選択がなされる。ステップ52で、権利管理部1015においては、残度数が再生に必要な度数以上であるかどうかを調べ、もしそうであれば、ステップ54が実行される。そして、情報が再生されると共に、ステップ55で、残度数が減るように変更される。一方、ステップ52で、残度数が必要度数に満たない場合には、ステップ53で、残度数が必要度数に満たないことが表示部1017に表示されるなどの再生不可処理が行なわれる。

【0112】なお、残度数のかわりに有効期限が記録されている場合も考えられる。その場合には、権利管理部1015においては、必要度数と残度数との比較ではなく、図では省略されているクロックに基づいて、現在の日付時刻と有効期限との比較を行なう。そして、この場合には、残度数の変更にあたるような処理は不用になる。なお、このように再生時に権利管理が行なわれる場合、記録媒体への書き込みは必ずしも情報提供装置を通じて行なわれなくても良い。例えば、マスクROMに記録されている情報が上述の方法で再生時に決済されるようにしても良い。

【0113】図12は、図2の実施例における情報記録再生装置の構成を示すブロック図である。図12において、情報記録再生装置は、情報記録装置1041と情報再生装置1051とに分離している。権利管理部1045は、情報入力部1044及び情報出力部1042とに接続され、情報入力部1044は、情報記録媒体1043に接続されている。また、情報記録媒体1043は、情報出力部1042に接続されている。以上の構成により、情報記録装置1041を成している。

【0114】一方、情報再生部1052は、再生制御部1053に接続され、再生制御部1053は、再生選択部1054及び表示部1055に接続されている。以上の構成により、情報再生装置1051を成している。そして、情報出力部1042は、情報再生装置1051に接続され、権利管理部1045は、再生制御部1053に接続されている。図1の実施例の場合と対応する部分には同一の符号を付してあり、その説明は適宜省略す

る。なお、情報記録装置1041は、1枚のカードに実装されている。

【0115】次に、その動作について説明する。図12の場合には、図6に示す権利管理部1015の機能は、権利管理部1045と再生制御部1053に分離されている。情報記録媒体1043に情報が記録される時に、その情報の権利管理が行なわれる場合には、権利管理部1045は図6の権利管理部1015と同様に機能する。一方、情報記録媒体1043からの再生時に権利管理が行なわれる場合には、権利管理部1045及び再生制御部1053が、それら両者間の通信120を通じて、図6の権利管理部1015と同様の機能を果たす。

【0116】尚、この場合、権利管理部1045は、情報出力部1042の出力を制御信号121によって制御する。そのことにより、情報の再生が許可されたり禁止されたりする。もちろん、情報記録媒体1043からの出力そのものが制御されることによっても、同様の機能を実現することは可能である。尚、不当な情報再生装置によって情報が再生されることを防ぐため、例えば、再生選択の前に、情報記録装置1041による情報再生装置1051の認証が行なわれるようにしても良い。

【0117】本発明において、残度数などの権利管理情報は、重要な役割を持つ。そして、上記権利管理情報は、正当な権利管理情報更新装置を用いて、安全かつ容易に更新することが可能である。以下、これについて説明を行なう。

【0118】図13は、権利管理情報更新装置の実施例の外観を示したものである。権利管理情報更新装置の前面には、情報記録(再生)装置を出し入れする挿入排出口及びコイン投入口がついている。その動作について説明する。権利管理情報の更新が必要な場合には、情報記録(再生)装置が挿入排出口に挿入されると共に、コイン投入口に必要対価が入られる。ただしもちろん、権利管理情報更新装置が人手によって管理され、その人が更新希望者から対価を受け取って、情報記録(再生)装置を挿入排出口に挿入するようにしても良い。

【0119】図14は、図13の実施例において、権利管理部1015及び権利管理情報更新装置1061の構成を示すブロック図である。ただし、権利管理情報の更新に直接関係しない部分については省略してある。図14において、権利管理部1015には、図8に示された他に乱数発生部1033が装備されており、また、メモリ1031には、暗号化された鍵情報としての復号化鍵L及び残度数情報Dが記録されているものとする。この復号化鍵Lの意味と働きについては後述する。そして、乱数発生部1033及びメモリ1031は、CPU1032に接続されている。また一方、権利管理情報更新装置1061には、メモリ1062、CPU1063及びコイン受入部1064が装備されている。そして、メモリ1062には、暗号化鍵Mが記録されているものとする

る。この暗号化鍵Mは前述の復号化鍵Lと対になるものであるが、その意味と働きについては後述する。メモリ1062及びコイン受入部1064はCPU1063に接続されている。そして、CPU1032とCPU1063とが、通信301を行なうことによって、権利管理情報の更新は行なわれる。

【0120】図15は、図13の実施例において、権利管理部1015及び権利管理情報更新装置1061の処理のフローチャートを示したものである。権利管理情報更新装置1061に権利管理部1015が挿入されると、ステップ61で、権利管理部1015によって権利管理情報更新装置1061の認証302が始まる。認証の結果、ステップ62で、権利管理情報更新装置1061が正当なものであると認められれば、ステップ63で、残度数更新のための処理が準備される。しかし、ステップ62で、正当であると認められなければ、残度数更新拒否処理が行なわれる。ここで、残度数更新拒否処理は単に何もしないだけでも良いが、権利管理情報更新装置1061にその残度数更新拒否をすることが送信されても良い。

【0121】次に、残度数更新の処理として、ステップ65で、認証が開始された後、ステップ66で、権利管理情報更新装置1061はコインの投入を確認する。ステップ67で、入金された額303が権利管理部1015に送信される。ステップ63で、権利管理部1015が上記額303を受信し、ステップ64で、その額に応じて残度数が増加するように変更される。一方、権利管理情報更新装置は排出口から情報記録（再生）装置を排出する。

【0122】図16は、図13の実施例において、認証の処理の流れを示したものである。認証の方法としては、例えば、図10に示したものと同様に権利管理部1015と権利管理情報更新装置1061とで共通の秘密鍵を用いて行なうこともできる。しかし、そのような方法をとった場合、万が一、権利管理部1015に記録されている秘密鍵の情報が漏洩すると、不当な権利管理情報更新装置の制作が可能になる。

【0123】一般に、正当な権利管理情報更新装置は、厳重に管理することが可能である。しかし、情報記録（再生）装置は多数の人が使用するため、厳重に管理することが難しい。しかも、不当な権利管理情報更新装置が1台でもできると、それによって多数の情報記録（再生）装置内の残度数が更新され得るので危険である。そのため、この実施例では、公開鍵暗号を用いた認証を利用している。

【0124】公開鍵暗号については、例えば Cryptography and Data Security, Dorothy Elizabeth Robling Denning, 1982 Addison-Wesley Publishing Compa

ny, Inc., Reading, Mass., U. S. A.)

（日本語訳）

暗号とデータセキュリティ

上岡忠弘、小嶋格、奥島晶子訳 培風館

に詳細が記述されている。この技術を使うと、情報の暗号化時に使われる暗号化鍵と、暗号化情報の復号化時に使用される復号化鍵とが別なものに設定できる。しかも、復号化鍵が知られても、それから暗号化鍵を知ることが極めて困難なものにすることができ、安全性が高まる。

【0125】以下、図16に示された認証のための処理手順について述べる。まず、ステップ81で、権利管理部1015は乱数Qを発生する。ステップ82で、乱数Qが権利管理情報更新装置1061に送信される。それと共に、ステップ86で、権利管理情報更新装置1061が乱数Qを受信する。ステップ87で、権利管理情報更新装置1061は、暗号化鍵Mと乱数Qとに依存する関数 $e(M, Q)$ の値Rを計算する（暗号化）。ステップ88で、値Rが権利管理部1015に送信されると共に、ステップ83で、値Rが権利管理部1015を受信される。ステップ84で、権利管理部1015は、復号化鍵Lと値Rとに依存する関数 $d(L, R)$ の値Sを計算する（復号化）。ステップ85で、値Sが乱数Qと一致するかどうか調べられる。そして、値Sと乱数Qとがもし一致しているのであれば、権利管理情報更新装置1061は正当なものであると判断される。しかし、値Sと乱数Qとが一致しなければ、権利管理情報更新装置1061は不当なものであると判断される。

【0126】以上のように、本発明では、情報をコピーする側の情報提供装置ではなく、情報記録媒体と一体となった情報記録（再生）装置の側が決済等の権利管理を行なう機能を持つ。そのことにより、情報記録媒体への記録時だけでなく再生時の決済が可能になる。それと共に、記録時の決済の場合にも、情報入手者に余分な負担がかからないことが可能である。また、本発明による方法では、情報記録装置への記録媒体の挿入口と排出口とが分離している。それで、各利用者は挿入口に記録媒体を挿入した後、排出口へと移動することにより、多数の利用者が次々と情報記録装置を利用することが可能となる。そして、暗号化鍵を知ることが極めて困難なものにすることができ、安全性が高まる。

【0127】図17は図4の情報提供装置の内部の構成例を示したものである。図17において、挿入口2002と排出口2003とが情報転送部2001を介してベルト2004により連絡されている。

【0128】次に、その動作について説明する。挿入口2002から挿入された情報記録装置は、ベルト2004によって、情報転送部2001に送られる。そして、情報転送部2001では、上記情報記録装置内の記録媒

体に情報が記録される。その後、上記情報記録装置は、ベルト2004によって排出口2003へと運ばれ排出される。もちろん、ベルト2004のかわりに、例えば、高圧の空気によって上記情報記録装置が移動されても良い。

【0129】図18は情報転送部2001の内部構成を示したものである。図18において、情報記録媒体2012は、例えば、半導体メモリ等で構成されている。制御部2011は、記録部2013及び情報記録媒体2012に接続されている。そして、情報記録媒体2012と記録部2013とは接続されている。さらに、記録部2013には端子2014が接続されている。

【0130】次に、その動作について説明する。情報記録媒体2012に記録されている情報402は、制御部2011からの制御信号401に基づいて記録部2013へと送られる。さらに、記録部2013から出力された情報404が、端子2014を通じて情報記録装置の端子に送られる。この情報404は、制御信号403に基づいた記録部2013の作用によって情報記録装置内の情報記録媒体に記録される。

【0131】図19は、情報転送部のもう一つの内部構成例を示したものである。この例では、情報転送は非接触の方法で行なわれる。情報転送部2021は、制御部2022と情報記録媒体2023及び送信部2024とで構成されている。制御部2022は、送信部2024及び情報記録媒体2023に接続されている。そして、情報記録媒体2023と送信部2024とは接続されている。さらに、送信部2024は電磁波などの方法により、情報記録装置2031内の受信部2032と連絡されている。また、情報記録装置2031は、受信部2032と記録部2033及び情報記録媒体2034とで構成されている。そして、受信部2032は記録部2033に接続され、記録部2033は情報記録媒体2034に接続されている。

【0132】次に、その動作について説明する。情報記録媒体2023に記録されている情報502は、制御部2022からの制御信号501に基づいて送信部2024へと送られる。送信部2024においては、制御信号503に基づいて、情報504を情報記録装置2031内の受信部2032に電磁波などの方法により送信する。この情報504は、記録部2033の作用によって情報記録媒体2034に記録される。

【0133】以上のように、本発明による方法においては、情報提供装置への記録媒体の挿入口2002と排出口2003とを分離した。そして、利用者は挿入口2002に記録媒体を挿入した後、排出口2003へと移動する。そのことにより、多数の利用者が次々と情報提供装置を利用することが可能である。

【0134】図20は、図19の情報記録装置及び情報再生装置のブロック図である。図20において、情報記

録装置1071には情報記録媒体1073及び権利管理部1072が装備されている。権利管理部1072は、例えばCPU及びメモリから構成されている。そのメモリには、情報記録媒体に記録されている情報を再生する権利が記録されている。その権利は、例えば、情報記録媒体内の情報をあと何度再生することができるか等を表す残度数である。そして情報記録媒体1073は権利管理部1072に接続されている。一方、情報再生部1078は再生制御部1077に接続され、再生制御部1077は再生選択部1075及び表示部1076に接続されている。以上の構成により、情報再生装置1074を成している。

【0135】次に、その動作について説明する。権利管理部1072において、まず、情報記録媒体1073に記録されている情報のうち、その情報自身の種類や再生に必要な権利の度数等の情報122を読み出す。そして、再生制御部1077に通信124が送信される。再生制御部1077においては、信号127を表示部1076に送り通信124の内容を表示する。情報利用希望者が、再生選択部1075を用いて、情報記録媒体1073に記録されているもののうち、どれを再生するかを選択する。すると、その選択情報126は再生制御部1077に送られる。その選択情報126は、さらに通信124を通じて、権利管理部1072に送られる。権利管理部1072においては、残度数が、その情報を再生するのに必要な度数以上であるかを調べる。そして、残度数が、その情報を再生するのに必要な度数以上であれば、その情報は再生可能と見なされる。それと共に、残度数から必要度数分が減じられる。

【0136】しかし、残度数が、その情報を再生するのに必要な度数以下であれば、その情報は再生不可と見なされる。再生可能であれば、制御信号123が情報記録媒体1073に送信される。それと共に、通信124が再生制御部1077に送信される。そこで、情報記録媒体1073は、記録されている情報125を出力する。その情報125は情報再生部1078に送信される。再生制御部1077から、情報再生の制御信号128が情報再生部1078に送られる。そして、情報再生部1078においては、受信した情報125を音声信号等129に変換して出力する。

【0137】以上のように、図20に示された情報記録装置及び情報再生装置を使用すれば、再生時に、その情報利用の選択及び快済を実現することができる。

【0138】図21は、情報提供と情報収集が同時に容易に行なえる実施例における情報記録再生装置の外観を示したものである。図21において、情報記録再生装置の前面には表示部及び選択部が装備されている。また、情報記録再生装置の側面には、イヤホン及び情報提供収集装置結合端子601、602が装備されている。

【0139】次に、その動作について説明する。情報提

供給装置結合端子601を通じて、情報提供装置から情報記録再生装置内に設置された記録媒体に情報がコピーされる。また、情報提供装置結合端子602を通じて、情報提供装置へ情報記録再生装置内に設置された記録媒体から情報が転送される。ただし、情報提供装置結合端子601、602は、実際には同一の端子を切り替えて使用されるようにしてもよい。さらに、この実施例の装置には表示部と再生ボタンが装設されている。表示部には装置内に記録された情報の内容が表示される。上記表示部に表示されたものをもとに、装置の使用者は、選択ボタンを用いて必要な情報を選択的に再生することができる。また、利用者は、その他の選択情報を入力したりすることもできる。

【0140】図22は、図21の実施例に対するもう1つの実施例の外観図である。この例では、図21の情報記録再生装置が、情報記録装置と情報再生装置とに物理的に分離して構成されている。そして、上記情報記録装置の構成要素が1枚のカードに実装されている。図21の場合と対応する部分には同一の符号を付してあり、その説明は適宜省略する。図22の実施例の装置には、情報再生装置結合端子603がついている。

【0141】次に、その動作について説明する。情報提供装置結合端子601を通じて、情報提供装置から情報記録再生装置内に設置された記録媒体に情報がコピーされる。また、情報提供装置結合端子602を通じて、情報提供装置へ情報記録再生装置内に設置された記録媒体から情報が転送される。ただし、情報提供装置結合端子601、602は、実際には同一の端子を切り替えて使用されるようにしてもよい。また、再生時には、情報記録装置と情報再生装置との間で、データ及び制御のやりとりが必要になる。それで、上記情報記録装置と情報再生装置とを結合する情報再生装置結合端子603が、情報記録装置及び情報再生装置に装設されている。ただし、情報記録装置の情報提供装置結合端子601、602及び情報再生装置結合端子603は、実際には1つの端子を切り替えて使用されるように構成されることも可能である。

【0142】図23は、図21または図22の実施例における情報提供装置の外観図である。図3の実施例と対応する部分には同一の符号を付してあり、その説明は適宜省略する。情報提供装置内には記録媒体が設けられ情報が記録されている。この実施例の情報提供装置には、伝達手段としての有線や他の装置に接続されている。

【0143】次に、その動作について説明する。上記有線を通じて、他の装置から情報提供装置へ情報が送信されたり、情報提供装置内の情報が他の装置へ送信されたりすることが可能である。もちろん、上記有線は無線に代えて使用されることも可能である。また、上記情報提供装置への伝達手段とその他の装置からの伝達手段とは物理的に別なものでもよい。ただし、もちろん、情報提

供給装置への情報の入力は通信手段によらなくても、たとえば記録済みの記録媒体が直接、情報提供装置に挿入されてもよい。また、情報提供装置からの情報の出力についても、情報提供装置内の記録媒体が取り外されたり、他の記録媒体へコピーされたりすることによって実現することもできる。そして、情報入手希望者は、欲しい情報を選択することができる。情報入手希望者は、情報提供装置の挿入排出口に、自分のもっている情報記録再生装置または情報記録装置を挿入する。そして、コピーを受けることによって情報が入手される。また、上記情報記録再生装置あるいは情報記録装置内の情報は、それらの装置が情報提供装置に挿入されてから排出されるまでの間に収集される。上記情報は、情報提供装置内の記録媒体に転送されることによって、迅速かつ容易に収集される。なお、情報提供装置内の記録媒体としては、特に限定はないが、高速にコピーが可能でランダム・アクセスが可能なICメモリによって構成されると便利である。

【0144】図24は、図23の実施例における情報提供装置のブロック図である。また、図25は、図10の実施例における情報記録再生装置のブロック図である。

【0145】図24において、記録媒体3003は制御部3004に接続されている。制御部3004には、記録媒体3007と選択部3005及び表示部3006が接続されている。そして、以上の構成により、情報提供装置3001を成している。また、伝達部3008は制御部3004に接続され、伝達部3002は記録媒体3003に接続されている。

【0146】図25において、再生部4012は記録媒体4013に接続され、記録媒体4013は制御部4014に接続されている。そして、制御部4014には、記録媒体4017と選択部4015及び表示部4016が接続されている。

【0147】次に、その動作について説明する。情報提供装置3001では、有線、無線等の伝達部3002によって送られてきた情報401が、記録媒体3003に記録される。制御部3004においては、記録媒体3003から情報の内容等を示す情報404を読み出して、表示部3006に表示情報407として送り表示する。情報入手希望者は、この表示情報を参考にしてどの情報を入力するかを、選択手段3005を通じて入力する。選択部3005は、選択信号406を制御部3004に送る。そして、制御部3004においては、情報記録再生装置4011の制御部4014との通信403に基づいて、情報を出力するか否かの制御信号405を記録媒体3003に送る。さらに、記録媒体3003においては、その制御によって情報402を情報記録再生装置4011に送る。

【0148】ここで、制御部3004と制御部4014との間の通信403の一例について説明を行なう。制御

25

部4014においては、情報記録再生装置4011が情報提供装置3001からコピーを受ける権利情報の値、例えば残度数情報Dを記憶している。一方、制御部3004においては、情報入手希望者がコピーを希望する情報をコピーした場合に、残度数情報Dから減じる値、必要度数dを制御部4014に送信する。制御部4014においては、残度数情報Dと必要度数dとの比較を行なう。ここで、Dがdより大きい等しければ、制御部3004にコピー要求信号が送信されると共に、Dからdを減じた値が新たな残度数情報Dの値とされる。また、Dがdより小さい場合には、制御部3004にコピー不要求信号が送信される。情報402の送信と同時に、または前後して、情報提供装置3001は情報記録再生装置4011から通信403を受信する。ここで、通信403の内容は、情報記録再生装置4011において、記録媒体3003に記録されたどの情報が何回再生されたか、といった情報である。その情報は記録媒体3007に記録される。そして、制御部3004においては、例えば一定時間毎に、記録媒体3007に蓄積された情報408を読み出す。さらに、制御部3004においては、その情報408に統計的な処理を加えた情報409が、計算されて伝達部3008に送出される。

【0149】ただし、情報記録再生装置4011から送られてきた情報（通信403）は、制御部3004によって必ずしも記録媒体3007に蓄積されなくとも良い。そして、情報（通信403）は、直接あるいは統計処理等を施して伝達部3008に送出されても良い。また、情報（通信403）が記録媒体3007に蓄積された場合においても、伝達部3008に送り出す前に、特別の統計処理は行なわれなくても良い。さらにまた、制御部3004が記録媒体3007に情報を記録する前に、統計処理などが施されても良い。

【0150】一方、情報提供装置3001から情報の入手後、情報再生希望者の要求にしたがって、情報記録再生装置4011ではまず、制御部4014は、記録媒体4013から情報の内容等512を読み出す。そして、その情報は表示部4016に表示情報515として送られて表示される。情報再生希望者は、この表示情報を参考にして、どの情報を再生するかを、選択部4015を通じて入力する。選択部4015は選択信号514を制御部3014に送る。そして、制御部4014においては、選択信号514に基づいて、記録媒体4013に制御信号513を送る。その制御信号513に基づいて、記録媒体4013は情報511を出力する。そして、再生部4012は情報511を再生する。また、制御部4014においては、選択部4015への入力に依存する情報516を、記録媒体4017に記録する。情報記録再生装置4011が次回、情報提供装置3001と結合される時、記録媒体4017に記録された情報は、制御部4014を通じて、情報提供装置3001に送られ

26

る。

【0151】ここで、「選択部4015への入力に依存する情報」とは、例えば、再生選択信号514そのものであっても良い。この場合、情報記録再生装置4011の使用者の情報再生利用実績に関する情報が得られる。

「選択部4015への入力に依存する情報」の別の例として、クイズ情報に関する解答選択情報、あるいは、それを統計処理した情報であってもよい。この場合、情報記録再生装置4011の使用者のクイズに対する正解率が得られる。「選択部4015への入力に依存する情報」の別の例として、アンケートに関する解答選択情報、あるいは、それを統計処理した情報であっても良い。上記情報が例えば、記録媒体4013から再生された音楽のうち、情報記録再生装置4011の使用者が最も気に入ったもの選択情報とする。その選択情報が統計処理されることによって、どの音楽に人気があるかが把握される。

【0152】なお、多数の情報提供装置において収集された情報がセンターに集められ、それらの情報が統計処理されることによって、より有益な情報利用にかんするデータが得られる。また、情報記録再生装置から情報提供装置に送られる情報によって、情報提供装置から情報記録再生装置への条件を変化させても良い。例えば、上述のアンケートに協力する場合には、情報提供装置において、情報入手のための必要度数dの値を予め小さくしても良い。こうすることによって、情報使用者はより安価で情報入手が可能となり、情報提供者はより多くの使用者からのアンケート結果を期待することができる。また、クイズ情報を提供する場合には、情報提供装置において、その正解率によって必要度数dの値を変化させてもよい。こうすることにより、情報利用者はゲーム性を楽しむことができる。なお、記録媒体3003及び記録媒体3007においては、一体となっている記録媒体の異なる部分を使用するようにしても良い。

【0153】図26は、図22に示す実施例の構成を示すブロック図である。図26において、記録媒体5017は制御部5018に接続され、制御部5018は記録媒体5013に接続されている。そして、以上の構成により、情報記録装置5021を成している。一方、再生部5012は制御部5019に接続されている。また、制御部5019は選択部5015及び表示部5016に接続されている。そして、以上の構成により、情報再生装置5031を成している。

【0154】次に、その動作について説明する。この実施例の場合には、図25に示す制御部4014の機能が、制御部5018と制御部5019及び通信621によって実現される。まず、情報提供装置3001から送られてきた情報102が、記録媒体5013に記録される。情報情報再生希望者の要求にしたがって、情報記録装置5021では、制御部5018が、記録媒体501

3から情報の内容等612を読み出す。そして、その情報は、制御部5019から通信121を介して表示部5016に表示情報615として送られ、表示される。情報再生希望者は、この表示情報を参考にして、どの情報を再生するかを、選択部5015を通じて入力する。選択部5015は選択信号614を制御部5019に送る。そして、制御部5019においては、選択信号614に基づいて、制御部5018を介して、記録媒体5013に制御信号613を送る。その制御信号613に基づいて、記録媒体5013は情報611を出力する。そして、再生部5012は制御信号617に基づき情報611を再生する。また、制御部5018においては、選択部5015への入力に依存する情報616を、記録媒体5017に記録する。情報記録装置5021が次回、図24に示す情報提供装置3001と結合される時、記録媒体5017に記録された情報は、通信103を介して情報提供装置3001に送られる。

【0155】なお、図24に示す情報提供装置3001は情報提供機能と情報収集機能の両方を備えており、情報提供と情報収集が同時に容易に行なえるという利点を持っているが、これは必ずしも必要条件ではなく、情報提供装置で情報の提供を行ない、情報収集装置で情報の収集を行なうようにしてもよい。

【0156】以上の説明からも明らかなように、本発明では、ICメモリー等で構成された記録媒体を装備した情報記録装置に音楽やクイズ等の番組が、情報提供装置から転送される。それと共に、これらの番組を再生する際に、視聴者が入力した選択情報が記録される。そして、これらの情報が情報提供装置に転送される。そのことにより、視聴者の反応に関する情報が得られる。そして、情報提供者が容易に、情報利用者の情報利用実態や好み等を把握することができる。さらにこうした情報を利用してサービス内容を充実させることができる。

【0157】

【発明の効果】以上のように、請求項1に記載の情報提供収集装置によれば、情報記録媒体および権利管理手段を備え、権利管理手段の制御により情報の記録または再生の制御を行なう情報記録装置から成るようにしたので、柔軟な料金支払いが可能となる。

【0158】請求項2に記載の情報提供収集装置によれば、上記権利管理手段においては、上記記録媒体に記録された権利管理情報に基づいて制御を行なうようにしたので、柔軟な料金支払いが可能となる。

【0159】請求項3に記載の情報提供収集装置によれば、上記権利管理情報は、記録もしくは再生前後で内容が変化するようにしたので、柔軟な料金支払いが可能となる。

【0160】請求項4に記載の情報提供収集装置によれば、上記権利管理情報は、記録または再生が許可される有効期限であるようにしたので、柔軟な料金支払いが可

能となる。

【0161】請求項5に記載の情報提供収集装置によれば、上記記録媒体に記録される情報の一部は、その情報自身の内容を示すものであるようにしたので、柔軟な料金支払いが可能となる。

【0162】請求項6に記載の情報提供収集装置によれば、上記記録媒体は、半導体メモリであるようにしたので、情報の迅速な入手が可能となる。

【0163】請求項7に記載の情報提供収集装置によれば、上記記録媒体及び上記権利管理手段は、1枚のカードに実装されている情報記録装置から成るようにしたので、情報の迅速な入手が可能となる。

【0164】請求項8に記載の情報提供収集装置によれば、上記記録媒体には書き換え不可能な情報を記録し、再生時に権利管理を行なうようにしたので、柔軟な料金支払いが可能となる。

【0165】請求項9に記載の情報提供収集装置によれば、上記記録媒体には、情報提供装置から書き換え可能な情報を記録するようにしたので、柔軟な料金支払いが可能となる。

【0166】請求項10に記載の情報提供収集装置によれば、上記記録媒体への情報の記録は、上記情報提供装置による正当性認証が成立した場合に行なわれるようにしたので、情報管理の安全性が高められる。

【0167】請求項11に記載の情報提供収集装置によれば、上記正当性認証は、上記情報提供装置及び上記情報記録装置に記録され、その値自身が暗号化された鍵情報に基づいて行なわれるようにしたので、情報管理の安全性が高められる。

【0168】請求項12に記載の情報提供収集装置によれば、上記情報の再生は再生選択信号に基づいて行なわれるようにしたので、柔軟な料金支払いが可能となる。

【0169】請求項13に記載の情報提供収集装置によれば、上記情報の再生は、外部からの再生選択信号に基づいて行なわれるようにしたので、柔軟な料金支払いが可能となる。

【0170】請求項14に記載の情報提供収集装置によれば、上記情報の再生は、上記情報提供装置によって、上記情報記録装置の正当性認証が成立した場合に行なわれるようにしたので、情報管理の安全性が高められる。

【0171】請求項15に記載の情報提供収集装置によれば、上記正当性認証は、上記情報記録装置及び上記情報記録装置に記録され、暗号化された鍵情報に基づいて行なわれるようにしたので、情報管理の安全性が高められる。

【0172】請求項16に記載の情報提供収集装置によれば、上記権利管理情報は、権利管理情報更新装置により書き換え可能であるようにしたので、柔軟な料金支払いが可能となる。

【0173】請求項17に記載の情報提供収集装置によ

れば、上記権利管理情報の書き換えは、上記情報記録装置によって、上記権利管理情報更新装置の正当性認証が成立した場合に行なわれるようにしたので、情報管理の安全性が高められる。

【0174】請求項18に記載の情報提供収集装置によれば、上記正当性認証は、上記権利管理情報更新装置及び上記情報記録装置に記録され、暗号化された鍵情報に基づいて行なわれるようにしたので、情報管理の安全性が高められる。

【0175】請求項19に記載の情報提供収集装置によれば、上記権利管理更新装置に記録された鍵情報と、上記情報記録装置に記録された鍵情報とは異なる値を持つようにしたので、情報管理の安全性が高められる。

【0176】請求項20に記載の情報提供収集装置によれば、上記情報記録装置の挿入部と排出部を別々に備え、上記情報記録装置への記録を行なう情報提供装置から成るようにしたので、情報の迅速な入手が可能となる。

【0177】請求項21に記載の情報提供収集装置によれば、内部に記録媒体を備え、その記録媒体に記録されている情報を上記情報再生装置に転送する情報提供装置から成るようにしたので、情報の迅速な入手が可能となる。

【0178】請求項22に記載の情報提供収集装置によれば、上記記録媒体として半導体メモリを用いる情報提供装置から成るようにしたので、情報の迅速な入手が可能となる。

【0179】請求項23に記載の情報提供収集装置によれば、上記記録媒体から上記情報記録装置への情報の転送を、端子を用いて行なう情報提供装置から成るようにしたので、情報の迅速な入手が可能となる。

【0180】請求項24に記載の情報提供収集装置によれば、上記記録媒体から上記情報提供装置への情報の転送を非接触の手段で行なうようにしたので、情報の迅速な入手が可能となる。

【0181】請求項25に記載の情報提供収集装置によれば、上記情報提供装置から転送された情報を、上記情報記録装置に転送し、上記権利管理手段の制御の下に上記情報の再生を行なう情報記録装置から成るようにしたので、柔軟な料金支払いが可能となる。

【0182】請求項26に記載の情報提供収集装置によれば、再生利用する情報を記録する第1の情報記録媒体と、その情報の再生利用者の入力に係わる情報を記録する第2の情報記録媒体と、その第2の情報記録媒体に記録された情報を外部に伝達するための伝達手段とを備えているようにしたので、柔軟な料金支払いが可能となる。

【0183】請求項27に記載の情報提供収集装置によれば、上記第1の情報記録媒体に対し、外部からの情報の書き込みが可能であるようにしたので、柔軟な料金支

払いが可能となる。

【0184】請求項28に記載の情報提供収集装置によれば、上記情報の再生利用者の入力に係わる情報が、第1の情報記録媒体に記録された情報再生によって入力が促される選択情報であるようにしたので、視聴者の反応に関する情報が得られる。

【0185】請求項29に記載の情報提供収集装置によれば、上記情報の再生利用者の入力に係わる情報が、その情報の再生利用状況に関する情報であるようにしたので、視聴者の反応に関する情報が得られる。

【0186】請求項30に記載の情報提供収集装置によれば、上記第1の情報記録媒体は、ICメモリで構成されているようにしたので、情報の迅速な入手が可能となる。

【0187】請求項31に記載の情報提供収集装置によれば、上記第2の情報記録媒体は、ICメモリで構成されているようにしたので、情報の迅速な入手が可能となる。

【0188】請求項32に記載の情報提供収集装置によれば、構成要素が1枚のカードに実装されている情報記録装置から成るようにしたので、情報の迅速な入手が可能となる。

【0189】請求項33に記載の情報提供収集装置によれば、上記第2の情報記録媒体に記録された情報を読み出す手段を備えるようにしたので、視聴者の反応に関する情報が得られる。

【0190】請求項34に記載の情報提供収集装置によれば、上記第2の情報記録媒体から読みだされた情報に基づく情報を記録する媒体を装備するようにしたので、視聴者の反応に関する情報が得られる。

【0191】請求項35に記載の情報提供収集装置によれば、上記第1の情報記録媒体への情報の書き込み機能を装備しているようにしたので、柔軟な料金支払いが可能となる。

【0192】請求項36に記載の情報提供収集装置によれば、有線または無線の伝達手段を装備し、上記第2の情報記録媒体から読み出された情報に基づく情報を、一旦記録媒体に蓄積した後に、または蓄積をせずに、処理を加え、または処理を加えずに上記伝達手段によって送信できるようにしたので、柔軟な料金支払いが可能となる。

【0193】請求項37に記載の情報提供収集装置によれば、上記情報記録装置の上記第2の情報記録媒体から読みだされた情報の種類あるいは内容に依存して、情報提供条件あるいは情報利用条件が変化するようにしたので、柔軟な料金支払いが可能となる。

【0194】請求項38に記載の情報提供収集装置によれば、複数個の上記情報記録装置から、上記伝達手段によって、上記第2の情報記録媒体から読みだされた情報に基づく情報を収集するようにしたので、視聴者の反応



に関する情報が得られる。

【図面の簡単な説明】

【図1】本発明の情報提供収集装置の一実施例における情報記録再生装置の外観を示した外観図である。

【図2】本発明の情報提供収集装置の一実施例において、情報記録再生装置が、情報記録装置と情報再生装置とに物理的に分離して構成されている場合の外観を示す外観図である。

【図3】本発明の情報提供収集装置の一実施例における情報提供装置の外観を示す外観図である。

【図4】本発明の情報提供収集装置のもう1つの実施例における情報提供装置の外観を示す外観図である。

【図5】本発明の情報提供収集装置の一実施例における情報提供装置の構成を示すブロック図である。

【図6】本発明の情報提供収集装置の一実施例における情報記録再生装置の構成を示すブロック図である。

【図7】図5に示す情報提供装置1001における制御部1005の実施例の構成を示すブロック図である。

【図8】図6に示す情報記録再生装置1011における権利管理部1015の実施例の構成を示すブロック図である。

【図9】本発明の情報提供収集装置の一実施例において、情報記録再生装置への記録時に決済が行なわれる場合について説明するフローチャートである。

【図10】図9に示す認証のための通信201について説明するフローチャートである。

【図11】本発明の情報提供収集装置の一実施例において、権利管理部1015が情報の記録時ではなく、再生時に情報使用の決済を行なう場合の処理の流れのについて説明するフローチャートである。

【図12】図2の実施例における情報記録再生装置の構成を示すブロック図である。

【図13】本発明の情報提供収集装置の一実施例において、権利管理情報更新装置の実施例の外観を示す外観図である。

【図14】図13の実施例において、権利管理部1015及び権利管理情報更新装置1061の構成を示すブロック図である。

【図15】図13の実施例において、権利管理部1015及び権利管理情報更新装置1061の処理を説明する

フローチャートである。

【図16】図13の実施例において、認証の処理の流れを説明するフローチャートである。

【図17】図4の実施例における情報提供装置の内部の構成を示すブロック図である。

【図18】図17の実施例における情報転送部2001の内部構成を示したものである。

【図19】図17の実施例における情報転送部のもう1つの内部構成を示したものである。

【図20】図19の実施例における情報記録装置及び情報再生装置の構成を示すブロック図である。

【図21】本発明の情報提供収集装置の一実施例において、情報提供と情報収集が同時に容易に行なえる実施例における情報記録再生装置の外観を示す外観図である。

【図22】図20の実施例における情報記録再生装置に対するもう1つの実施例の外観を示す外観図である。

【図23】図20または図21の実施例における情報提供装置の外観を示す外観図である。

【図24】図22の実施例における情報提供装置の構成を示すブロック図である。

【図25】図10の実施例における情報記録再生装置の構成を示すブロック図である。

【図26】図21に示す実施例における情報記録再生装置の構成を示すブロック図である。

【符号の説明】

- 103 信号
- 111, 112, 118 情報
- 113 再生信号
- 114 再生選択情報 (再生選択信号)
- 115 表示情報
- 116 制御信号
- 117 再生制御信号
- 1011 情報記録再生装置
- 1012 情報記録媒体
- 1013 情報入力部
- 1014 情報再生部
- 1015 権利管理部 (権利管理手段)
- 1016 再生選択部
- 1017 表示部

【図17】

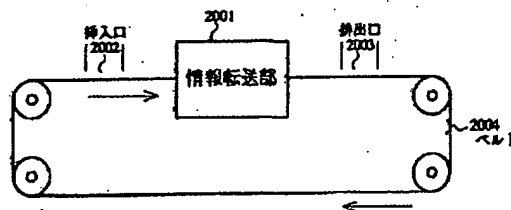

【図1】

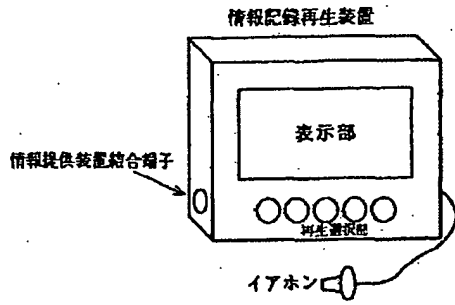

【図2】

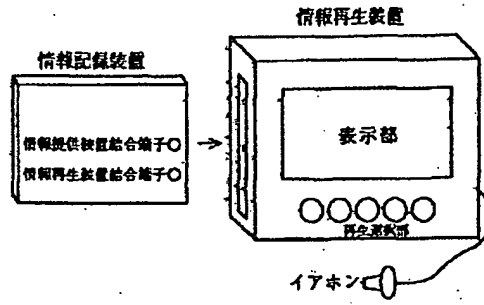

【図3】

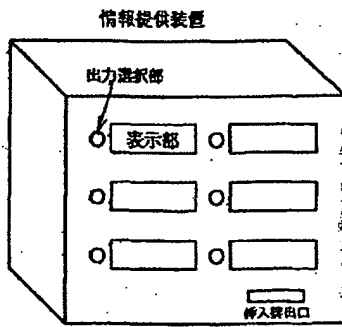

【図4】

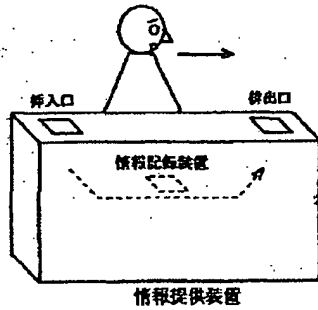

【図5】

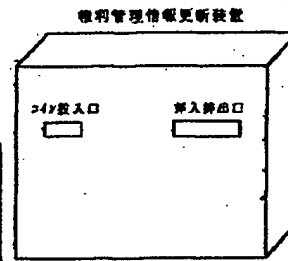

【図6】

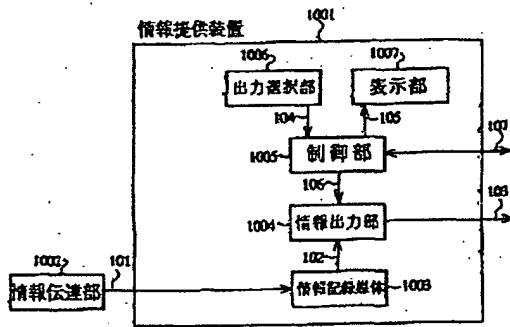

【図7】

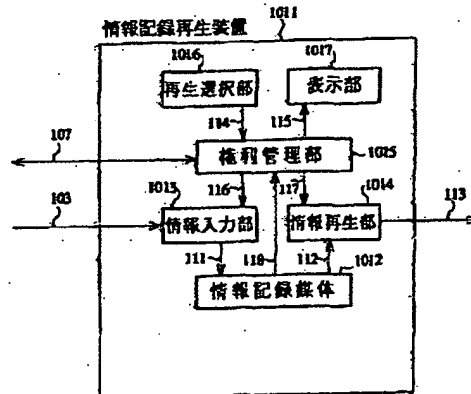

【図7】

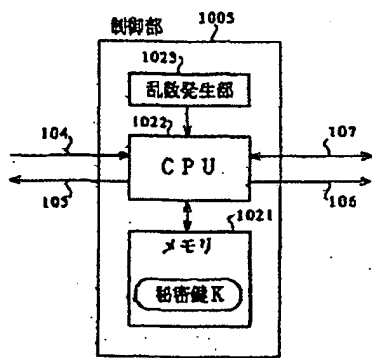

【図8】

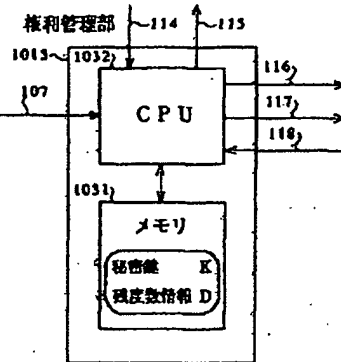

【図9】

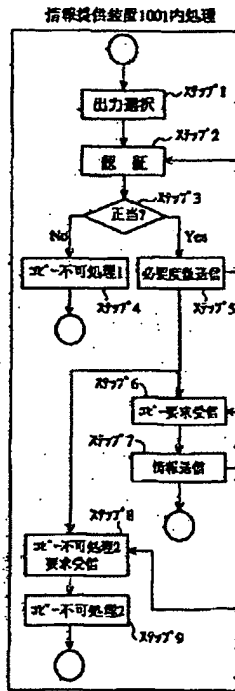

【図10】

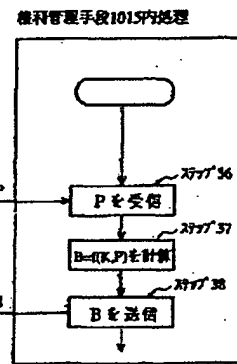
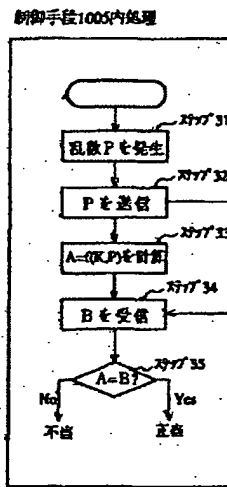
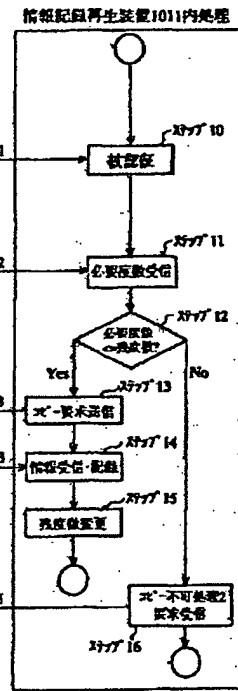

【図11】

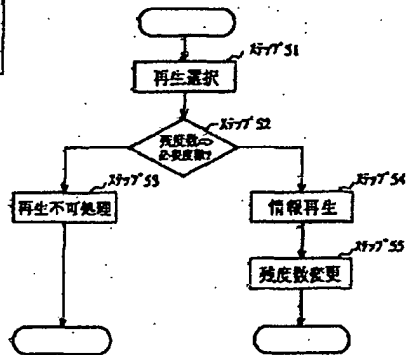

【図12】

【図14】

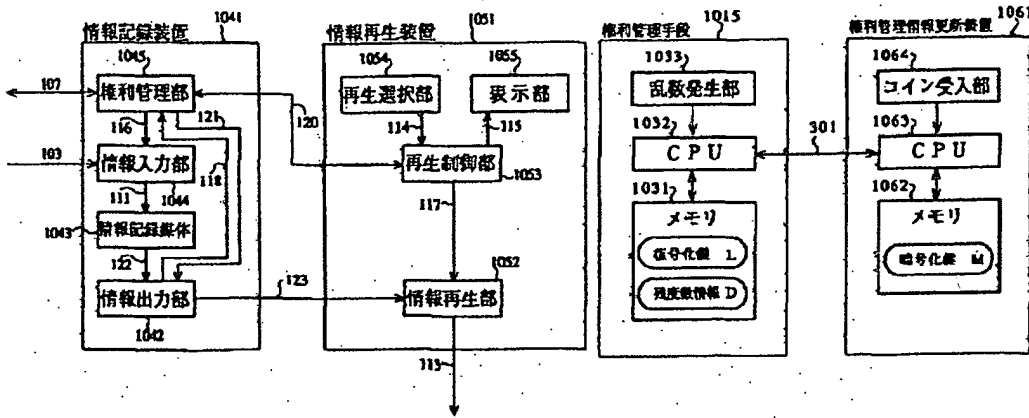

【図15】

【図16】

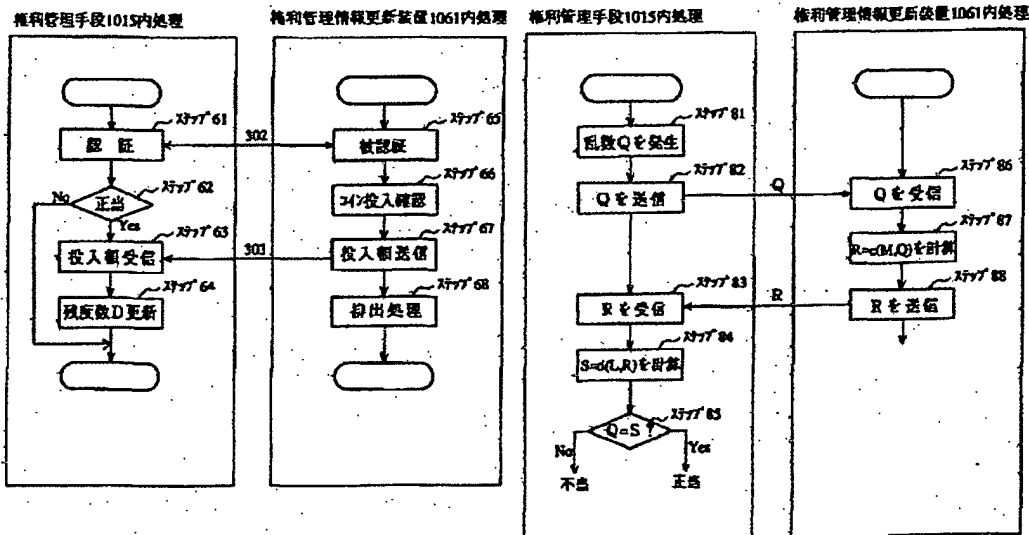

【図18】

【図21】

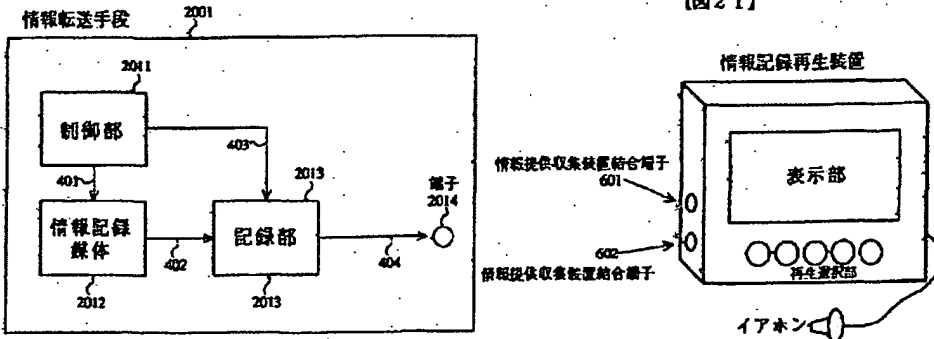

【図19】

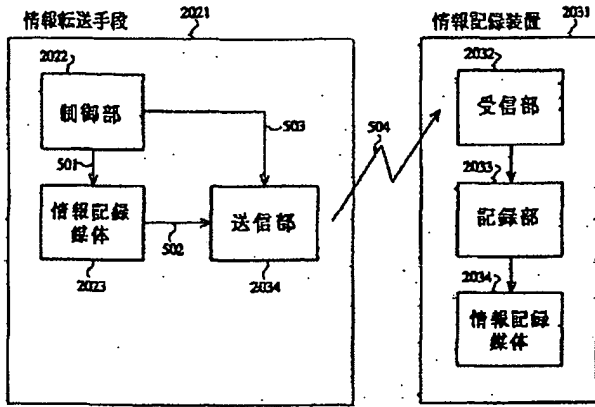

【図25】

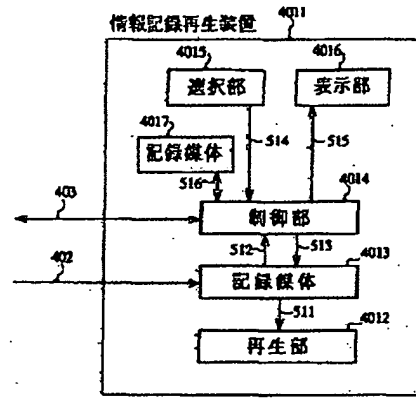

【図20】

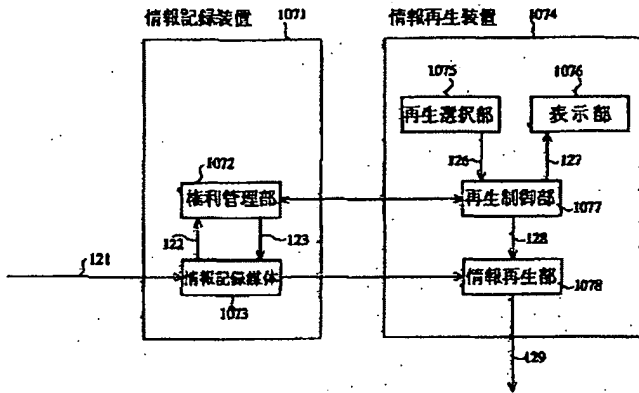

【図22】

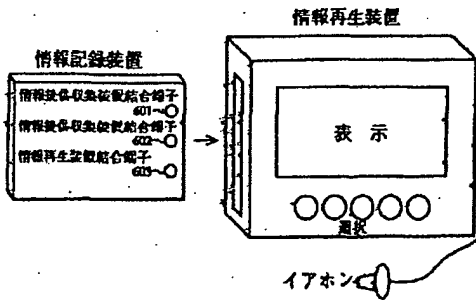

【図23】

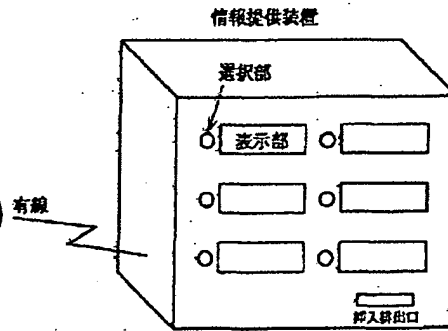

【図24】

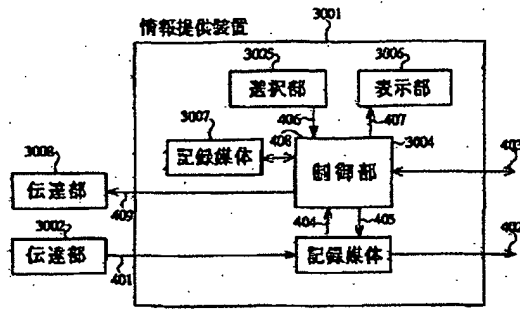

【図26】

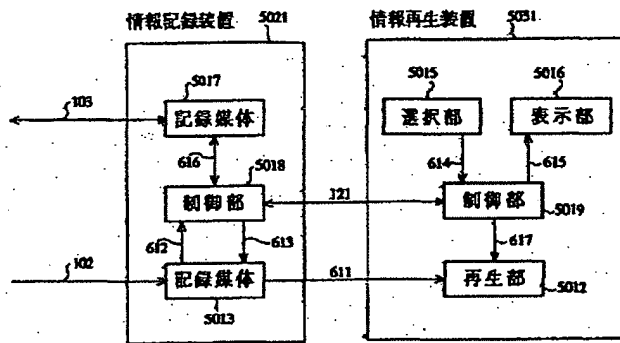

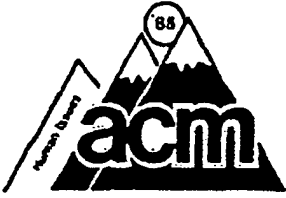

## EXTENDED ABSTRACT

### A Secure Distributed Capability Based System

Howard L. Johnson  
Information Intelligence Sciences, Inc.  
University of Denver, New College

John F. Koegel, Rhonda M. Koegel  
Department of Mathematics and Computer Science  
University of Denver  
Denver, Colorado 80210

A novel design for a secure distributed system is described and evaluated. A capability based computer architecture is combined with cryptographic network security techniques to protect global objects and preserve access rights across system boundaries. The resulting architecture is evaluated against several criteria, including the DoD Computer System Evaluation Criteria. The strengths and weaknesses of the approach are presented.

**key words:** computer security; distributed system security; capability architecture; network encryption

#### 1. Introduction

A distributed system connects various computing entities in several locations so resources can be shared by users. Distributed computing offers the advantage of flexibility so that each facility can be locally controlled and configured for a specific application. It also offers incremental growth so that additional features can be easily added, usually at a lower cost than upgrading a central host. The connection of distributed systems facilitates information sharing. The physical network can be implemented by point-to-point or multi-point links, LAN's or WAN's.

In a single centralized computing facility, system security is achieved through physical, operational, and system controls. System controls include operating system functions such as login passwords, file system protection, and memory management. In a distributed environment, these controls can still be effective for securing each specific system. However, additional problems arise because of the interconnection of systems and the information flows between systems.

There are two areas of concern in securing a distributed system. The first, that of securing the network facilities, has received greater attention in the literature. This need stems from the

fact that physical facilities in most prevalent use today as communication media (land lines, microwave links, and satellite channels) offer little protection for themselves [1]. To secure these facilities, some type of cryptography is employed. The user who wishes to obtain an off-the-shelf solution to the problem can use a conventional substitution-permutation algorithm, such as the NBS's DES [2] or a public key algorithm such as RSA [3]. Although there is active research in both breaking and strengthening these techniques, for many applications currently available methods will suffice.

Even with encryption, a network is still vulnerable to certain types of threats against the communications protocol being employed [4]. Conventional link-level protocols only allow the data field to be encrypted, while control and address fields are transmitted unencrypted. This leaves a network open to such attacks as message modification and message replay.

The second area of concern, that has received relatively little attention in the literature, is the control of information protection across system boundaries. Within a given computer facility, the operating system can be used to enforce uniform and constant protection of information. However, once the information is removed from the computer, these controls no longer apply. Protection of information can only be maintained in a local environment. It would be preferable if access rights could be enforced across system boundaries. This would produce a secure distributed system and protect proprietary software and data.

Consider the case of a remote database user who has purchased read access to certain information in the database. If the user accesses the

Permission to copy without fee all or part of this material is granted provided that the copies are not made or distributed for direct commercial advantage, the ACM copyright notice and the title of the publication and its date appear, and notice is given that copying is by permission of the Association for Computing Machinery. To copy otherwise, or to republish, requires a fee and/or specific permission.

1985 ACM 0-89791-170-9/85/1000-0392 \$00.75

database with a personal computer, it is a straightforward step for the user to read the database and store the information in the PC. Once the user has a local copy, then he/she is free to distribute this data to any other party, regardless of whether that party has purchased access to the database. Thus, the access protection of a single system is easily violated by availability of distributed computing.

The database owner could protect his/her investment by requiring the user to purchase a proprietary interface program to access and manipulate the data. Not only does this restrict the user and provide an economic deterrent to the sale of information, it also makes this protection dependent on the copy protection of the interface program.

Another example is if the host is used as a central distribution point for software, possibly for a CAI application. Once a module is removed from the host, it is very difficult to limit the production of duplicates. Encryption of the key elements of a program has been proposed as a solution [5]. However, not only does this place additional burden on the applications programmer, but also requires a design that may not be met by many programs.

Most secure network strategies deal only with encryption of data as it is transmitted across network facilities, and not at all with the management of protection across system boundaries. However, there are numerous instances of distributed information system security and proprietary software protection not solved by network encryption. The authors believe that an integrated solution involving both capability-based computers and network protection using encryption and a secure protocol can provide distributed system security.

After discussion of network security and capability architectures in a distributed environment, we present an integrated design of a secure distributed capability based system. The resulting architecture is evaluated against several criteria, including the DoD Computer System Evaluation Criteria.

## 2. Network Security

### 2.1 General

This paper pertains to hardware (and a few hardware/software) data system security protection mechanisms, but design must be accomplished in the context of existing or proposed physical security, personnel security, operations security, emanations security, and communications security. The implementation of each guides implementation of the network data system security. A key criteria is minimized degradation in throughput and response.

A brief summary of network security follows. The term "association" is used to refer to a (potentially bidirectional) end-to-end data path through the network. The reader is directed to

Voydock and Kent [4] and to Davies and Price [6] for a more complete treatment of these topics.

### 2.2 Threat

From [4], passive attacks to network security are intended to bring about the unauthorized release of information or authorized release of information sufficient to perform a traffic analysis. Passive attacks usually cannot be detected but can be prevented.

Active attacks include unauthorized modification of information, unauthorized resource use denial, and attempts to initiate spurious associations. Active attacks cannot be prevented, but can usually be detected. In a network environment we are equally concerned with threats internal to the system as those outside.

### 2.3 Protection Principles

#### 2.3.1 Encryption Techniques

Rushby and Randell [7] observed that separation is one of the key elements in enforcing a secure system, and that four separation methods exist: physical, temporal, cryptographical and logical. In a communication system, physical separation is the most desirable, but unless the system is completely contained in a secure building environment or in a specially constructed tunnel vault, the distances involved leave too much line unprotected.

Some transmission media are more secure than others, such as fiber optics, directional satellite links, and exotic military communications systems, but each has a reasonable vulnerability to capture or disruption of data flow. Within a secure environment, either logical or cryptographical means can be employed to protect data authenticity. Methods analogous to periods processing can make use of transmission links for different levels of control at different isolated periods of protection, performing necessary cleansing of storage registers or buffers, if any exist.

Data encryption is the primary means by which communicated data are protected. It directly prevents passive attacks by preventing an intruder from seeing data in the clear. Data patterns can be masked by using a unique key for each association, employing cipher block chaining which causes each encrypted value to be a complex function of previously encrypted data, and appropriately selecting the proper initialization vector for chaining.

There are three ways to incorporate cryptography into a communications system: link, node and end-to-end encryption. In link encryption, cryptographic devices bracket a communication line between two nodes. Node encryption uses a protected security module to absolutely protect data at the node. In end-to-end encryption, data are deciphered only at their final destination, requiring several keys at each origin and destination.



There are several tradeoff variables in choosing between link, node, and end-to-end encryption:

- the number of encryption units required (and therefore the potential response degradation)
- the number of keys required by each node originating and receiving data
- the complexity required in specifying a routing path independent of the specification of data, or alternately the overhead in interim decryption attempts.

The number of security devices are fewer in end-to-end encryption, but number of keys required is greater. Addressing information must be developed independent of the data, or interim decryption attempts must be made. Both create a difficult design problem. Link and node encryption are normally transparent to the user, but so is end-to-end encryption if initiated by system services. The message and its header can both be encrypted with node encryption; however, with link encryption and end-to-end encryption normally both message and header are encrypted. The exception is a technique whereby each node attempts to decrypt the message and passes it if unsuccessful or if the successfully decrypted message indicates another addressee. If not all nodes have encryption facilities or if encryption of only selected messages is desired due to overhead, an additional mechanism is required to enable and disable the encryption function.

Voydock and Kent [4] observed that a communication network can also be viewed as providing a medium for establishing associations between protocol entities. An association oriented approach constitutes a refinement to end-to-end measures. It not only protects the path, but reduces the probability of undetected cross talk, whether induced by hardware or software.

### 2.3.2 Detection Techniques

If the communications header is in clear form, transmitting bogus messages helps prevent traffic analysis. The protocol layer selection determines the precision with which traffic analysis can be done. If encryption is performed in the presentation layer, an intruder could determine which presentation, session, and transport entities were involved. Performing encryption in the transport, network, or link layers limits the intruder to observing patterns at the network address levels. Contradistinctively, the higher the layer, the more of the path protected.

To prevent message stream modification, there are measures that ensure message integrity. Measures that ensure message authenticity rely on the integrity measures. Measures that ensure message ordering rely on both of the previous measures. Countermeasures involve use of unique keys, sequence numbers, and error detection codes.

Denial of service attacks often can be detected by message stream modification countermeasures. If the attacks begin when an association

is quiescent, a request response mechanism must be employed.

For spurious association attacks, hierarchic or public key systems can defeat attempts to establish an association under a false identity. Timestamp, checksums, and/or random challenge-response mechanisms detect playing back of a previously legitimate association-initiation.

A covert channel allows a process to transfer information in a manner that violates the systems security policy. A covert timing channel is a covert channel in which one process signals information to another by modulating its own use of system resource (e.g., CPU time) in such a way that this manipulation affects the real response time observed by the second process. Covert channels with low bandwidths represent a lower threat than those with high bandwidths. In any complex system there are a number of relatively low-bandwidth covert channels whose existence is deeply ingrained in the system design. Faced with the large potential cost of reducing the bandwidths of such covert channels, it is felt that those with a maximum bandwidth of less than one bit per second are acceptable in most applications environments [8]. The channel bandwidth can be reduced by introducing noise, or complicated traffic patterns, making it difficult to detect and extract deliberate modulation.

These measures provide security only in a probabilistic sense, providing a high probability that the intruder cannot subvert the encryption algorithm and that active attacks will be detected. The goal is to make it more difficult for the intruder to break the system than to create the information through other means.

## 2.4 Protection Mechanisms

### 2.4.1 Reference Monitors

A reference monitor [9] must be tamperproof, must always be invoked, and must be small enough to be subject to analysis and tests, the completeness of which can be assured. The reference monitor is the most popular type of authentication mechanism. Interaction is generally only with the message header, whereas cryptographic compatibility serves to authenticate an entire message. Further, data can remain encrypted for continued protection while in buffers, storage, and internal communications. The reference monitor allows such things as separate encryption of the message without the header and requires neither the time and cost spent in encryption nor the cost of a key management and distribution system.

### 2.4.2 Authentication and Secrecy

Cryptography can not only be used for security, but can also be employed for authenticity. Solutions using encryption are equally applicable to local area networks as they are to large long-haul communications networks. Different applications lead to different solutions, as do design tradeoffs based on changing technologies (e.g., fiber optics), speed, cost, and level of protec-

tion. The following are key topics associated with cryptography.

**Secrecy and Authentication** - Secrecy exists when it is computationally infeasible to determine the deciphering transformation. Authenticity exists when it is computationally infeasible to determine the enciphering transformation. The latter establishes the validity of a claimed identity (e.g., of the sender in a digital signature or user verification application).

**Substitution-Permutation Ciphers** (e.g., the DES) - Information theory has allowed theoretical data protection to any degree desired, based on the length of the key and repeated application of the algorithm steps; even when the algorithm is known to the perpetrator. This class of cipher has been implemented into a very fast chip. As cryptanalysis capability increases, the dimensionality of the implementation can be increased, with a corresponding loss in efficiency, (unless microcircuit technology makes up the difference). A DES block cipher breaks the message into blocks and enciphers each with the same key. A stream cipher breaks the message into characters or bits and enciphers them with successive elements of a key stream (which might be the prior encrypted text as in the cipher block chaining mode and the cipher feedback mode of the DES).

**Public Key Ciphers** (e.g., the RSA scheme) - These methods of protection provide both secrecy and authenticity. Several public key ciphers have fallen prey to cryptanalysts, but the RSA cipher stands a good chance of surviving these attacks based on the mathematical history of factorization of large numbers (although a surprisingly large number was factored on the Cray at Sandia Laboratories recently). Keys are large and computation still relatively complex. Technologies such as gallium arsenide and parallel bit stream implementations should solve immediate speed problems, however, as cryptanalysis comes closer, the size of the prime numbers must be increased.

**One-way Ciphers** - These virtually unknown, but simply implemented ciphers are important to design because once data are encrypted they cannot be simply decrypted, even by the originator. They are useful in applications, for example, where authentication of passwords can be accomplished by comparing pairs of encrypted data values. Certain simple functions such as comparison can be accomplished in encryption space.

#### 2.4.3 Key Management Design

The responsibility for key management depends on the security policy and the choice of implementation. Unless keys are given at least the same level of protection as the data, they will be the weak link. Once the penetrator has gained access to the key (generally a very small piece of data) he has gained access to all data. Techniques of generating, transmitting and protecting keys include host keys, hierarchical key protection, partitioning of keys for different protection levels, and diverse means by which the key man-

agement system interfaces with the rest of the system [7].

In the normal implementation of public key systems, the public key is published with no protection whatsoever. The private key is originated and held by only one person. Certain implementations require distribution of the private key under a protected key distribution scheme, especially where the private key is used within the processor as a means of both secrecy and authentication of source of another system variable.

A third party or a host can provide the authentication necessary for key distribution. There are several established approaches for the implementation of a distributed session key system, appropriate to network communications. The public key system has the property that two parties can establish a secret key for use in a unique session between them, obviating involvement of a third party. The strategy can be repeated often for a greater degree of protection. Prolonged use of a single key makes a system more vulnerable to cryptanalysis. The degree of added vulnerability depends on the cryptographic technique used, which in turn is related to the nature of data transmission, intercommunication requirements, and security inherent to the communications system.

#### 2.5 Network Protocol Considerations

In late 1970's, the International Standards Organization adopted a network architecture known as the reference model for open system interconnection, ISO/OSI. Layers 1 to 3 are concerned with data transmission/routing and deal respectively with physical, data link, and network concerns. Layer 4 provides end-to-end control of data transport. Layers 5 and 7 are the session, presentation, and application layers. Some of the possible approaches to implementing security under ISO/OSI are as follows:

<u>Layer</u>	<u>Protocol</u>	<u>Security</u>
7	Applications Services	User identification, encryption of stored data, key distribution.
6	Presentation Formats	User controlled use of encryption for secrecy and identification including a user request for encryption.
5	User Session Control	Establishing secrecy and authentication during the conduct of a session between system users (people and programs). The most desirable encryption point in high level protocols [4].

4 Transport Flow Control

3 Network Routing

2 Data Link Control

Security control entirely in the communications systems such as link encryption where the data are protected between adjacent network nodes and are decrypted and re-encrypted at each node. Security control entirely in the network communications use of node encryption schemes where data are not in the clear at an intermediate node, but are rather decrypted and re-encrypted by a special security module.

1 Physical Connection

Design should be such that acceptance of data or requests into the memory associated with a node should be based on the assurance that the transaction is legitimate and does not violate the security policy. An example of protocol layer 2 (data link) encryption is provided in [10], in which source and destination subnets and trusted interface units are designated in the packet formats for the carrier sense multiple access with collision detection (CSMA/CD) protocol. The protocol also specifies the data security level.

Popek and Kline [11] identified the important issues to be addressed in defining secure protocols:

- establishing initial cleartext/ciphertext/cleartext channel from sender to receiver
- passing cleartext addresses without providing a leakage path
- determining error recovery and resynchronization mechanisms to be employed
- performing flow control
- closing channels
- interaction of the encryption protocols with the rest of the protocols
- dependence on software in implementation.

3. Capability Architectures

3.1 Description

A capability-based computer uses an architecture in which objects are addressed by means of a two-component entity called a capability. One component of the capability is a unique object identification number which is translated by the hardware into an actual machine address. The other component of the capability can be viewed as an access rights field which identifies to the hardware the operations that the owner of the capability may perform on the object.

Capability architectures have been promoted for a number of reasons including their hardware support for object-based programming [12] and system security [13]. A capability-based computer offers greater generality than does a conventional computer architecture. This generality includes hardware support for object identification and management which allows the user to approach the machine interface at a higher level of abstraction. By encapsulating objects and defining unique object identification numbers, the system can provide a more secure hardware base on which to place the operating system.

To maintain system security and integrity, it is typical for a capability-based computer to use hardware tagging of capabilities stored in memory [14,15]. When a user attempts to use a capability to reference an object, the hardware tag indicates that use of the capability is a legal one. The capability itself will be further compared with the operation that the user is attempting to ensure its validity. Since the tag controlled by hardware, the user is not able to arbitrarily modify the tag bits associated with a memory address. If the user attempts to modify a capability, the hardware will reset the associated tag bits.

Another feature of capability architectures is that the machine interface is usually implemented at a higher level than that of a conventional architecture. This higher level includes functions that relate to object addressing and object management. By placing greater functionality in the firmware, the goal is to improve the performance of the architecture while ensuring that the object related operations can not be interrupted and possibly altered by another process. Thus, the security of a capability-based computer follows the precept that hardware is inherently more secure than software.

3.2 Design Issues

There are a number of issues to be faced by the designer of a capability machine. These include:

- generating and maintaining unique object id's for a large number of objects
- managing objects, including object deletion and the dangling pointer problem

- controlling the copying of capabilities for object sharing
- defining object categories
- speeding-up object address translation
- permitting called programs to have more access rights than their callers for operating system functions
- providing object encapsulation to promote object protection.

The resolution of these issues can take various forms. Levy [16] surveys many of these in his book on capability based systems.

### 3.3 Goals

For the purposes of a discussion of capability system goals, we assume that the network facilities for the distributed system have already been secured using encryption and secure high-level protocols as described in the previous section. By employing capabilities for defining and protecting objects in a distributed environment, the following goals can be achieved:

- Objects can be transferred across system boundaries while preserving access rights across these boundaries. This is accomplished by forcing any object transfer between systems to be accompanied by the transfer of the capability needed to access the object. Without this capability, the object can not be accessed.
- The process performing the copy operation must possess the original capability on the source computer to effect the copy operation. The capability which results on the destination computer must uniquely identify the copied object and must have access rights equal to or less than those of the original capability. The network interfaces for each host are responsible for checking the validity of the operation. The network interface at the destination must generate a unique object id (possibly using already existing firmware for object creation) and must translate the source capability accordingly. At the same time it must preserve or decrease the access rights of the translated capability.
- Capabilities for objects can be transferred across system boundaries. This allows capabilities to be used to reference remote objects. This requires that the capability contain a field which identifies the network node containing the object. Alternatively, the capability could reference a local "network reference object" which would contain the information needed by the operating system and network interface to address the remote object.
- Objects can be referenced across system boundaries using either user-local or user-remote capabilities for these objects. This is

analogous to a distributed file system, but is generalized to all the object categories defined in a given architecture.

A user-local capability is one which is contained in the user's capability list in the local host from which the object reference is being made. Similarly, a user-remote capability is one that is contained in the user's capability list on the remote host that contains the object being referenced. Capabilities used to access objects created remotely are derived from the capability generated by the system where the object was created.

In describing these goals, it is assumed that object identification and addressing are defined locally. When a capability is transferred between systems, a new object id will be created by the destination host automatically. This object id will have meaning only in the context of this host. This will preclude the need for designing a universal object identification scheme that would be impractical both in terms of the size of the id needed and the overhead to coordinate the use of id's. It is also assumed that a capability can be safely and accurately transmitted between systems. The network interface for the capability-based computer controls the encryption and protocols needed to effect secure communications.

To support the preceding goals, a number of issues need to be addressed. First, in keeping with the fine granularity of capability access rights, it would be beneficial to define additional access rights that deal with network operations. These might include the capability to copy an object or the capability itself across the network interface. Access rights for remote operations on capabilities or objects might also be defined this way. Controlling the copying of a capability across a network interface has the same implication as controlling it between users on a single system.

Second, in some systems, an object can be given its own capability list for accessing whatever objects are needed in its operations. When the object is copied from one system to another, is this capability list also preserved? Although it may be desirable to define a network copy operation for capability lists, it does not seem advisable to automatically copy this list and translate it when the object itself is copied. This should be a separate operation, if done at all.

In translating a capability copied from one system to another, there are a number of conditions to be observed. First, the translated capability should never be greater than the original capability. This would violate the basic security principles of capability-based architectures. Second, the process receiving the copied capability should not be able to increase its access over any other objects by means of the copy operation. The situation where the copying of a capability gives the owner greater privilege must be avoided. Finally, if the two computers do not define their objects in the same fashion

(heterogeneous distributed capability system case), the host receiving the capability must translate it to an equivalent or lower object and access rights pair, or else reject the operation.

#### 4. A Secure Distributed Capability System

##### 4.1 Integrated Design

In this paper we deal with distributed systems of user terminals, processing hosts, storage elements, and other resources. The processors and terminals may be heterogeneous or of a compatible family. Our goal is to consider a design based on a combination of cryptography and a capability based control to provide network security.

There is a strong desire in a distributed system for the system to be transparent to the user. Rushby and Randell [7] established that network transparency is most easily achieved if all system components have a common interface. The "recursive structuring" principle for the design of distributed systems states: each component of a distributed system should be functionally equivalent to the entire system of which it is a part. This does not preclude heterogeneous sub-elements, since each system interface must contain provisions for exception conditions to be returned when a requested operation cannot be carried out. The value of the recursive structuring of a system is that, by definition, it is indefinitely extensible.

To use the capability approach in a distributed environment, additional capability categories are needed. These include definitions that protect the network interface and that validate specific network operations:

- network interface to a specific node can be used
- network parameters can be modified, examined, or tested
- capability can be copied across network
- object can be copied across network
- object can be used remotely
- object can be deleted remotely if user has delete capability
- capability can be translated (needed by network interface)
- network object (for referencing remote objects) can be created, managed, or deleted
- audit trail enable.

The network interface design should follow the standard seven-layer ISO OSI model. It will be subject to the same protection that the operating system is given on a capability machine, plus additional protection provided by whatever capabilities are required to use the interface.

The various network protocol layers should be designed to promote detection of active network attacks. Data encryption can be built into the user session layer.

All network operations which require capability checking for validation are passed by the network interface to the operating system and/or firmware. Outgoing network transactions are checked in the normal way by comparing the attempted operation with the capability list of the agent process. Incoming transactions that involve the copying of a capability from a remote system will also involve the translation of the object identification within the capability and the object encapsulation to a valid object identification for the destination host. This translation will also be a firmware function that most closely resembles object creation.

##### 4.2 Multilevel Considerations

If a distributed capability system were used in a multilevel security environment, both network security mechanisms and the capability architecture would need to be enhanced to recognize and protect objects of different classification levels.

Here we review some of the characteristics of a multilevel secure system and then discuss its relation to the one proposed. Users are assigned levels, some resources are assigned maximum levels and one must keep track of the high watermark (highest level received since cleansing) of the device. Objects have levels indicated by labels. A process keeps track of the high watermark of objects used in a current period. Users can specify the level of an object created and a process can specify the level of the objects it creates (which must dominate, i.e., be greater than or equal to, the current high watermark). There are several other details that pertain to specific implementations that will not be dealt with here, such as the principals that control the flow of data based on dominance rules.

The protection domain extends across the network, encompassing its nodes. Capabilities are used to determine transmission of objects across nodes, the same as they are within a node. The transmission is not allowed if the process does not possess the capability (e.g., the high watermark is greater than the security level of the destination). At the receiving node the processes cannot have access to the object without the appropriate capability.

Encryption for authenticity, key passing, and secrecy protection is within the encapsulated portion of the capability protocol, implemented in firmware. Also, detection techniques such as those discussed earlier -- unique transmission key, sequence numbers, error detection, request response, and time stamps -- are implemented and initiated at that level.

Encryption is at the user session protocol (layer 5), so that there is end-to-end encryption between geographically separate parts of the protection domain. The capability system would communicate the necessary protocol information to the

transport and other lower layers, providing the necessary protocol parameters.

Modifications to the capability hardware would consist of additional types of capabilities and additional bits to the object identification field of the capability. When a user account is created on a system, the profile of that user would be given capabilities to read, write, create and delete objects of specific classification levels. The capability to perform an operation at one classification level would allow the same operation to be performed at a lower level, provided that an indirect data leakage did not result. The user could also be given the capability to create objects, which could also be given the capability to read, write, create and delete sub-objects of different levels, all of which must be dominated by the user's own capabilities.

When an object is created, it would be created at a given classification level. This level could be economically encoded in the object identification field (2 bits provides 4 levels), which would also be encapsulated with the object itself. Thus, when any data transfer operation is performed on a given object, the object's classification level is used to insure that a legal data flow is occurring.

Additional capabilities would be needed to permit the changing of an object's classification level. Both the classification checks and capability tests would be performed by firmware. The rules governing legal and illegal data movements between levels would also be stored in firmware.

## 5. Evaluation

Just as the user community is slow to accept some of the most obviously beneficial computing improvements, it is felt that part of the task in portraying an unfamiliar way of thinking is to show consistency with present approaches. Rushby and Randell [7] have described a distributed computing system composed of small trustworthy security mechanisms linked together to provide multilevel security in such a way that the entire system appears as single system to its users. A prototype has been successfully demonstrated. Key to this system are separate security processors, operating in parallel with the general purpose processors, and a software subsystem "the Newcastle Connection," that links multiple UNIX systems, and does not require applications programs or operating system to be changed.

The Department of Defense Trusted Computer System Evaluation Criteria [8] will serve as a standard for the accreditation of commercial systems, at least in the near term, thus it was considered important to compare this system against those criteria. We have also considered Saltzer and Schroeder's [17] principles of design.

## 5.1 Definitions [8]

"Trusted Computing Base - All protection mechanisms within a computer system (including hardware, firmware, and software) the combination of which is responsible for enforcing the security policy." The cryptographic capabilities network can be considered a trusted computer base, but has an unusually large scope in that it encompasses a network.

"Domain - The set of objects that a subject has the ability to access." An object is defined here as a passive entity that contains or receives information, for which access potentially implies access to the information it contains. The capabilities system considers domain in the same context, however, it further specifies and controls resources and enforces the extent and type of access.

"Dominate - Security level S1 is said to dominate security level S2 if the hierarchical classification of S1 is greater than or equal to that of S2 and the non-hierarchical categories of S1 include those of S2 as a subset." A dominant capability can be enforced categorizing object id's into the appropriate classifications. Another approach would be to define a capabilities base at each independent level. In either case, the capabilities system can further restrict usage to what is required by a task.

"Reference Monitor Concept - An access control concept that refers to an abstract machine that mediates all accesses to objects by subjects." The hardware, firmware, and software elements of a Trusted Computing Base that implement the reference monitor concept are referred to as the security kernel. The capabilities based system employs and enforces a reference monitor type of control, independent of special hardware (although special hardware may be required to enhance performance).

"Star Property - A Bell-LaPadula security model [18] rule allowing a subject write access to an object only if the security level of an subject is dominated by the security level of the object." This rule can be enforced in a capabilities based system, but the implementation must place capabilities in control of the system and not the user.

### 5.1.2 Requirements [8]

"Discretionary access control - The trusted computer base (TCB) shall define and control access between named users and named objects. The enforcement mechanism shall allow users to specify and control sharing of those objects." Capability access control involves restricting access to objects or resources based on the possession of a ticket that unconditionally authorizes the possessor (user or process) access to the named object with specific rights, where objects include both resources and data. The list is actually inverted from the normal access control list, but contains at least the same information. It can be used by the operating system to emulate the discre-

tionary access model. If the system places the user "in charge", he can establish his own policy with respect to the capabilities possessed by him. In most DoD implementations, however, only a special user (the security officer) can pass capabilities to a user that has not previously possessed them at that level.

"Object Reuse - When a storage object is initially assigned, allocated, or reallocated to a subject from the TCB's pool of unused storage objects, the TCB shall assure that the object contains no data for which the subject is not authorized." This requires cleansing of the resource upon reallocation.

"Labels - Sensitivity labels associated with each ADP system resource that is directly or indirectly accessible by subjects external to the TCB shall be maintained by the TCB and shall be used as the basis for mandatory access control decisions." The assignment of capabilities can be based on the sensitivity of resources. The sensitivity labels can be built directly into the encapsulation scheme as a standard part of the object control. The resources are assigned virtually with the security manager having ownership of the assignment table with the right of revocation and reassignment.

"Label Integrity - Sensitivity labels shall accurately represent security levels of the specific subjects or objects with which they are associated. When exported by the TCB, sensitivity labels shall accurately and unambiguously represent the internal labels and shall be associated with the information being exported." As stated before, the sensitivity labels can be inherent to the definition of the capabilities and become part of the encapsulation scheme. The capability system enforces the authorization for exportation.

"Exportation of Label Information - The TCB shall designate each communications channel and I/O device as either single-level or multilevel, with changes done manually and any changes auditable. When the TCB exports an object to an I/O device, the sensitivity label associated with that object shall also be exported and, in the case of multilevel devices, shall reside on the same physical medium as the exported information and shall be in the same form (i.e., machine readable or human readable form). When the TCB exports or imports an object over a multilevel communication channel, the protocol used on that channel shall provide for the unambiguous pairing between the sensitivity labels and the associated information that is sent or received." This functionality can be incorporated in the capability system. The capability system enforces the transfer request, whereas a conventional system may not.

"Device Labels - The TCB shall support the assignment of minimum and maximum security levels to all attached physical devices to enforce the constraints imposed by the physical environments in which the devices are located." This is indirectly accomplished by the assignment of capabilities. This corresponds better with non data processing information control.

"Mandatory Access Control - The TCB shall enforce a mandatory access control policy over all resources (i.e., subjects, storage objects, and I/O devices) that are directly or indirectly accessible by subjects external to the TCB." External subjects become internally controlled by the capabilities list when they are given the capability of access, otherwise they possess none.

"Identification and Authentication - The TCB shall require users to identify themselves to it before beginning to perform any other actions that the TCB is expected to mediate. Furthermore, the TCB shall maintain authentication data that includes information for verifying the identity of individual users as well as maximum security levels to all attached physical devices." The identification must be part of the issuing of capabilities. The association with devices is more restrictive than simple security levels.

"Trusted Path - The TCB shall support a trusted communications path between itself and users for use when a positive TCB-to-user connection is required. Communications via this trusted path shall be activated exclusively by the user or the TCB and shall be logically isolated and unmistakably distinguishable from other paths." Since user consoles are resources, and because of the cryptographic requirements of this system, this requirement is rigidly enforced.

"Audit - The TCB shall be able to create, maintain, and protect from modification or unauthorized access or destruction an audit trail of access to the object it protects." The audit trail will be a capability assigned solely to the security control function.

## 5.2 Principles of Design

Saltzer and Schroeder [17] identified several design principles for protection mechanisms. Following is an evaluation of this approach against those criteria:

Least privilege - The capability system enforces this principle to a greater extent than existing implementations.

Economy of mechanism - This architecture supports security control to a far greater degree than general architectures and therefore should be verifiable. In general, hardware is simpler to verify than software or software/hardware mechanisms.

Complete mediation - This requirement is a basic design principle.

Open Design - The design is completely open and does not depend on any secret parts.

Separation of privilege - Satisfaction of this requirement is moot, although the implementation depends on the technique for allocation of capabilities and identification when logging on the system. The implementation of labels and a consistency check against user identification should satisfy this requirement.

Least common mechanism - The mechanism is protected and each user has a separate virtual capability. The concept of distributed control in physically distributed elements tends to support this principle, but certainly not to its ultimate intent.

Psychological acceptability - The mechanism cannot be bypassed and is transparent to the user.

### 5.3 Advantages and Disadvantages

A capability approach to distributed system security offers strong object protection in both local and distributed contexts. This strength derives from firmware support of access rights at the machine addressing level. In addition, the design offers greater granularity of access rights than is found in a conventional operating system.

A distributed capability system is not without its complications. One potential problem is the vulnerability of capabilities as they are transmitted across the network. This is analogous to the problem of password transmission across a network in a conventional system. Both can be solved by encryption.

Another possible problem is the translation of capabilities in an environment of heterogeneous capability machines. Because object categories may vary from machine to machine, the difficulty is in preserving the meaning of the capability when it is translated. From a security standpoint, security is not compromised if the original capability dominates the translated capability.

A more difficult situation is the linking of a conventional computer to a network of capability systems. Since conventional operating systems do not support the same granularity of protection, meaningful sharing and strong security will probably not be compatible goals. The conventional computer will be the Achille's heel of the distributed capability network if remote object references are uncontrolled.

A final issue is the translation of the capability list for an object that is being copied from one system to another. For efficiency reasons, we have considered it advantageous for the copy operation to copy only the object and the capability for its use, and ignore the capability lists belonging to the object and any of its creations.

### 6. Summary

The meshing of capability characteristics and a cryptographically supported network is natural. Cryptography will support network communications and detection functions using public key systems or trusted interface modules to provide satisfaction of security protection from the outside world, as well as authentication functions. The capability based resource control provides a simpler environment than that dealt with by a discretionary kernelized system. There is a natural checking mechanism for determination of

system misuse and simpler recovery in the event of a malicious internal attack. The system can be changed as the security policy changes without hardware/software modification.

A capability approach can provide a distributed system where data originators or some central authority determine the data, program, and sharing policy. The distributed capability system described here solves the problem of preserving access rights across system boundaries, since an object can not be referenced or copied across the network interface without processing the capability for a specific operation. In comparison to a conventional operating system, a capability based design offers greater protection and more granularity.

With proper implementation, the system also appears to be capable of supporting the DoD trusted system requirements under the unique DoD security policy implementation. Further, a properly architected capability machine and network interface could provide a secure multilevel distributed system. The DoD security requirements could be met by a design including the following provisions:

- Star property should be enforced by the system through assignment of high water mark levels to capabilities, objects, and resources.
- Sensitivity labels need to be integrated into the capabilities protection mechanism, and then be supported accordingly.
- User identification and authentication must be part of the capability issue and usage mechanism
- End-to-end encryption needs to be integrated and network protocol interfaces need to be developed



References:

1. Grayson, W.C., "Vulnerabilities of Data Telecommunications," in Advances in Computer Security Management, V2, ed. by M.M. Wofsey, John Wiley, 1983, 161-172.
2. "Data Encryption Standard," FIPS PUB 46, National Bureau of Standards, Washington D.C., January 1977.
3. Rivest, R.L., A. Shamir, and L. Adelman, "A Method for Obtaining Digital Signatures and Public-Key Cryptosystems," Communications ACM, V21(2), 120-126, February 1978.
4. Voydock, V.L., and S.T. Kent, "Security Mechanisms in High-Level Network Protocols," ACM Computing Surveys, Vol. 15, No.2, June 1983.
5. DeMillo, R., R. Lipton, and L. McNeil, "Proprietary Software Protection," in Foundations of Secure Communication, ed. by R. A. DeMillo, et al, Orlando, FL: Academic Press, 1978, 115-132.
6. Davies, D.W., and W.L. Price, Security for Computer Networks, John Wiley and Sons, 1984
7. Rushby, J.M., and B. Randell, "A Distributed Secure System," Computing Laboratory, University of Newcastle upon Tyne, December 1982.
8. Department of Defense Trusted Computer System Evaluation Criteria, CSC-STD-01-83, 15 August 1983
9. Anderson, J.P., Computer Security Technology Planning Study, ESD-TR-73-51, Vol. I, AD-758 206, ESD/AFSC, Hanscom AFB, Bedford, Mass., October 1972.
10. Casser, M., and D.P. Sidhu, "A Multilevel Secure Local Area Network," Symposium on Security and Privacy, 1982
11. Popek, G.J., and C.S. Kline, "Encryption Protocols, Public Key Algorithms, and Digital Signatures in Computer Networks," in Foundations of Secure Communication, ed. by R. A. DeMillo, et al, Orlando, FL: Academic Press, 1978, 133-154.
12. Organick, I. E., A Programmer's View of the Intel 432 System, New York: McGraw-Hill, 1983
13. Routh, Capt. R. L., "A Proposal for an Architectural Approach Which Apparently Solves All Known Software-Based Internal Computer Security Problems," ACM Operating Systems Review, (Sept 1984), 31-39.
14. Lorriore, L., "Capability Based Tagged Architectures," IEEE Transaction on Computer, vol C-33, no. 9. (Sept 1984), 786-803
15. Houdek, M. E., F.G. Soltis, and R. L. Hoffman, "IBM System/38 Support for Capability-Based Addressing," Proc. 8th Annual Symposium on Computer Architecture, Minneapolis, MN, 1981, 341-348
16. Levy, H.M., Capability-Based Computer Systems, Digital Press, 1984.
17. Saltzer, J.H., and M.D. Schroeder, "The Protection of Information in Computer Systems," Proceedings IEEE, Vol. 63(9) pp 1278-1308, September 1975.
18. Bell, D.E., and L.S. LaPadula, Secure Computer Systems: Unified Exposition and Multica Interpretation, MTR-2997 Rev. 1, Mitre Corporation, Bedford, Mass., March 1976.
19. Rauch-Hindon, W., "Distributed Databases," Systems and Software, September 1983.



PATENT  
DOCKET NO.: 111325/291300

*[Handwritten initials]*

**IN THE UNITED STATES PATENT AND TRADEMARK OFFICE**

Applicant	:	WANG et al.	)	Examiner:
			)	Thomas C. West
Serial No.	:	10/956,121	)	
			)	Art Unit:
Cnfrm. No.	:	8924	)	3621
			)	
Filed	:	October 4, 2004	)	
			)	
For	:	SYSTEM AND METHOD FOR MANAGING	)	
		TRANSFER OF RIGHTS USING SHARED	)	
		STATE VARIABLES	)	

**INFORMATION DISCLOSURE STATEMENT  
UNDER 37 C.F.R. §§ 1.97-1.98**

United States Patent and Trademark Office  
Customer Window  
Randolph Building  
401 Dulany Street  
Alexandria, VA 22313

Dear Sir:

Pursuant to 37 C.F.R. §§ 1.97-1.98, the references listed on the attached PTO/SB/08 form are hereby brought to the attention of the United States Patent and Trademark Office.

Pursuant to 37 C.F.R. § 1.98(a)(2)(ii), a copy of the cited U.S. patent (*i.e.*, Reference Cite No. 1) is not enclosed. Copies of the other listed references (*i.e.*, Reference Cite Nos. 2-5) are enclosed herewith.

The Commissioner is hereby authorized to charge Deposit Account No. 19-2380 the amount of \$180.00 for the Information Disclosure Statement and thereby complying with 37 C.F.R. § 1.97(c).

Respectfully submitted,

*[Signature]*  
Stephen M. Hertzler  
Registration No. 58,247

Date: July 2, 2008

NIXON PEABODY LLP  
CUSTOMER NO.: 22204  
401 9<sup>th</sup> Street, N.W., Suite 900  
Washington, DC 20004  
Tel: 202-585-8000  
Fax: 202-585-8080

07/03/2008 JAD001 00000032 192380 10956121  
01 FC:1806 180.00 DA

**IN THE UNITED STATES PATENT AND TRADEMARK OFFICE**

In re PATENT application of )  
Xin WANG, et al. )  
Application No. 10/956,121 ) Group Art Unit: 3621  
Filed: October 4, 2004 ) Examiner: Thomas C. WEST  
Confirmation No. 8924 )  
For: SYSTEM AND METHOD FOR ) Date: July 14, 2008  
MANAGING TRANSFER OF RIGHTS )  
USING SHARED STATE VARIABLES )

**RESPONSE TO NON-FINAL OFFICE ACTION**

Mail Stop **AMENDMENT**  
Commissioner for Patents  
P.O. Box 1450  
Alexandria, VA 22313-1450

Sir:

In response to the Office Action mailed April 15, 2008, please amend the above-identified patent application as follows.

**Amendments to the Claims** begin on page 2 of this paper.

**Remarks** begin on page 8 of this paper.

## Electronic Acknowledgement Receipt

<b>EFS ID:</b>	3609848
<b>Application Number:</b>	10956121
<b>International Application Number:</b>	
<b>Confirmation Number:</b>	8924
<b>Title of Invention:</b>	System and method for managing transfer of rights using shared state variables
<b>First Named Inventor/Applicant Name:</b>	Xin Wang
<b>Customer Number:</b>	22204
<b>Filer:</b>	Anthony J. Canning/Peaches Thomas
<b>Filer Authorized By:</b>	Anthony J. Canning
<b>Attorney Docket Number:</b>	111325-291300
<b>Receipt Date:</b>	14-JUL-2008
<b>Filing Date:</b>	04-OCT-2004
<b>Time Stamp:</b>	14:11:24
<b>Application Type:</b>	Utility under 35 USC 111(a)

### Payment information:

Submitted with Payment	no
------------------------	----

### File Listing:

Document Number	Document Description	File Name	File Size(Bytes) /Message Digest	Multi Part /.zip	Pages (if appl.)
1	Amendment - After Non-Final Rejection	291300_- 2008-07-08_Res ponse_to_non-Final_Office_ Action.pdf	603834 <small>dd4a5ba7a93a1adacfeec25cb02cb1d8 3bb05213</small>	no	14

### Warnings:

### Information:

This Acknowledgement Receipt evidences receipt on the noted date by the USPTO of the indicated documents, characterized by the applicant, and including page counts, where applicable. It serves as evidence of receipt similar to a Post Card, as described in MPEP 503.

**New Applications Under 35 U.S.C. 111**

If a new application is being filed and the application includes the necessary components for a filing date (see 37 CFR 1.53(b)-(d) and MPEP 506), a Filing Receipt (37 CFR 1.54) will be issued in due course and the date shown on this Acknowledgement Receipt will establish the filing date of the application.

**National Stage of an International Application under 35 U.S.C. 371**

If a timely submission to enter the national stage of an international application is compliant with the conditions of 35 U.S.C. 371 and other applicable requirements a Form PCT/DO/EO/903 indicating acceptance of the application as a national stage submission under 35 U.S.C. 371 will be issued in addition to the Filing Receipt, in due course.

**New International Application Filed with the USPTO as a Receiving Office**

If a new international application is being filed and the international application includes the necessary components for an international filing date (see PCT Article 11 and MPEP 1810), a Notification of the International Application Number and of the International Filing Date (Form PCT/RO/105) will be issued in due course, subject to prescriptions concerning national security, and the date shown on this Acknowledgement Receipt will establish the international filing date of the application.

**Amendments to the Claims:**

1. (Original) A method for transferring rights adapted to be associated with items from a rights supplier to a rights consumer, the method comprising:

obtaining a set of rights associated with an item, the set of rights including meta-rights specifying derivable rights that can be derived from the meta-rights;

determining whether the rights consumer is entitled to the derivable rights specified by the meta-rights; and

deriving at least one right from the derivable rights, if the rights consumer is entitled to the derivable rights specified by the meta-rights, wherein the derived right includes at least one state variable based on the set of rights and used for determining a state of the derived right.

2. (Original) The method of claim 1, wherein the state variable inherits a state thereof for content usage or rights transfer from the set of rights.

3. (Original) The method of claim 1, wherein the state variable shares a state thereof for content usage or rights transfer with the set of rights.

4. (Original) The method of claim 1, wherein the state variable inherits a remaining state for content usage or rights transfer from the set of rights.

5. (Original) The method of claim 1, wherein the state variable is updated upon exercise of a right associated with the state variable.

6. (Original) The method of claim 1, further comprising deriving a plurality of rights from the derivable rights, wherein the state variable is shared by the derived rights.

7. (Original) The method of claim 1, wherein the state variable represents a collection of states.

8. (Original) The method of claim 1, further comprising a plurality of state variables that determine the state of the derived right.

9. (Original) The method of claim 1, wherein the at least one state variable is unspecified in the derived right, is created during a rights transfer, and is assigned to the derived right.

10. (Original) The method of claim 1, wherein the state variable is transferred from the derivable rights to the derived right.

11. (Original) The method of claim 1, further comprising generating a license including the derived right, if the rights consumer is entitled to the derivable rights specified by the meta-rights.

12. (Original) A system for transferring rights adapted to be associated with items from a rights supplier to a rights consumer, the system comprising:

means for obtaining a set of rights associated with an item, the set of rights including meta-rights specifying derivable rights that can be derived from the meta-rights;

means for determining whether the rights consumer is entitled to the derivable rights specified by the meta-rights; and

means for deriving at least one right from the derivable rights, if the rights consumer is entitled to the derivable rights specified by the meta-rights, wherein the derived right includes at least one state variable based on the set of rights and used for determining a state of the derived right.

13. (Original) The system of claim 12, wherein the state variable inherits a state thereof for content usage or rights transfer from the set of rights.

14. (Original) The system of claim 12, wherein the state variable shares a state thereof for content usage or rights transfer with the set of rights.

15. (Original) The system of claim 12, wherein the state variable inherits a remaining state for content usage or rights transfer from the set of rights.

16. (Original) The system of claim 12, wherein the state variable is updated upon exercise of a right associated with the state variable.

17. (Original) The system of claim 12, further comprising means for deriving a plurality of rights from the derivable rights, wherein the state variable is shared by the derived rights.

18. (Original) The system of claim 12, wherein the state variable represents a collection of states.

19. (Original) The system of claim 12, including a plurality of state variables that determine the state of the derived right.

20. (Original) The system of claim 12, wherein the at least one state variable is unspecified in the derived right, is created during a rights transfer, and is assigned to the derived right.

21. (Original) The system of claim 12, wherein the state variable is transferred from the derivable rights to the derived right.



22. (Original) The system of claim 12, further comprising means for generating a license including the derived right, if the rights consumer is entitled to the derivable rights specified by the meta-rights.

23. (Original) The system of claim 12, wherein the means for obtaining, the means for determining, and the means for deriving comprise at least one of computer-executable instructions, and devices of a computer system.

24. (Original) A device for transferring rights adapted to be associated with items from a rights supplier to a rights consumer, the device comprising:

means for obtaining a set of rights associated with an item, the set of rights including meta-rights specifying derivable rights that can be derived from the meta-rights;

means for determining whether the rights consumer is entitled to the derivable rights specified by the meta-rights; and

means for deriving at least one right from the derivable rights, if the rights consumer is entitled to the derivable rights specified by the meta-rights, wherein the derived right includes at least one state variable based on the set of rights and used for determining a state of the derived right.

25. (Original) The device of claim 24, wherein the state variable inherits a state thereof for content usage or rights transfer from the set of rights.

26. (Original) The device of claim 24, wherein the state variable shares a state thereof for content usage or rights transfer with the set of rights.

27. (Original) The device of claim 24, wherein the state variable inherits a remaining state for content usage or rights transfer from the set of rights.

28. (Original) The device of claim 24, wherein the state variable is updated upon exercise of a right associated with the state variable.

29. (Original) The device of claim 24, further comprising means for deriving a plurality of rights from the derivable rights, wherein the state variable is shared by the derived rights.

30. (Original) The device of claim 24, wherein the state variable represents a collection of states.

31. (Original) The device of claim 24, including a plurality of state variables that determine the state of the derived right.

32. (Original) The device of claim 24, wherein the at least one state variable is unspecified in the derived right, is created during a rights transfer, and is assigned to the derived right.

33. (Original) The device of claim 24, wherein the state variable is transferred from the derivable rights to the derived right.

34. (Original) The device of claim 24, further comprising means for generating a license including the derived right, if the rights consumer is entitled to the derivable rights specified by the meta-rights.

35. (Original) The device of claim 24, wherein the means for obtaining, the means for determining, and the means for deriving comprise at least one of computer-executable instructions, and devices of a computer system.

36. (Original) The device of claim 24, wherein one or more of the means for obtaining, the means for determining, and the means for deriving are specified in a license.

**REMARKS**

The Office Action of April 15, 2008 has been received and carefully reviewed. Reconsideration of this application in light of the amendment and the allowance of this application are respectfully requested.

Claims 1-36 were pending in the present application prior to the above amendment. In response to the Office Action, no claims have been canceled, no claims have been added, and no claims have been amended. Therefore, claims 1-36 remain pending in the present application and are believed to be in proper condition for allowance.

***Double Patenting***

In response to the double patenting rejections, Applicants will consider the filing of a Terminal Disclaimer once the application is otherwise in condition for allowance.

***Rejections under 35 U.S.C. §103***

Claims 1-36 are rejected under 35 U.S.C. §103(a) as allegedly being unpatentable over Anand et al. (U.S. Patent No. 6,044,466) in view of “Workshop on Digital Rights Management, Minutes from Architecture/Infrastructure Session” (hereafter, *Infrastructure*). Applicants fully traverse the rejection as follows.

The present independent claims 1, 12 and 24, and the claims dependent therefrom, are patently distinguishable over *Anand et al.* in view of *Infrastructure*, since *Anand et al.* and *Infrastructure*, either taken alone or in combination, fail to disclose, teach or suggest all of the features recited in the pending claims. For example, independent claim 1 (emphasis added), recites:

A method for transferring rights adapted to be associated with items from a rights supplier to a rights consumer, the method comprising:  
obtaining a set of rights associated with an item, **the set of rights including meta-rights specifying derivable rights that can be derived from the meta-rights;**  
determining whether the rights consumer is entitled to the derivable rights specified by the meta-rights; and  
**deriving at least one right from the derivable rights, if the rights consumer is entitled to the derivable rights specified by the meta-rights,**

**wherein the derived right includes at least one state variable based on the set of rights and used for determining a state of the derived right.**

Independent claim 12 (emphasis added), recites:

A system for transferring rights adapted to be associated with items from a rights supplier to a rights consumer, the system comprising:  
means for obtaining a set of rights associated with an item, **the set of rights including meta-rights specifying derivable rights that can be derived from the meta-rights;**  
means for determining whether the rights consumer is entitled to the derivable rights specified by the meta-rights; and  
**means for deriving at least one right from the derivable rights, if the rights consumer is entitled to the derivable rights specified by the meta-rights, wherein the derived right includes at least one state variable based on the set of rights and used for determining a state of the derived right.**

Independent claim 24 (emphasis added), recites:

A device for transferring rights adapted to be associated with items from a rights supplier to a rights consumer, the device comprising:  
means for obtaining a set of rights associated with an item, **the set of rights including meta-rights specifying derivable rights that can be derived from the meta-rights;**  
means for determining whether the rights consumer is entitled to the derivable rights specified by the meta-rights; and  
**means for deriving at least one right from the derivable rights, if the rights consumer is entitled to the derivable rights specified by the meta-rights, wherein the derived right includes at least one state variable based on the set of rights and used for determining a state of the derived right.**

Thus, independent claims 1, 12 and 24 are directed to the novel features of obtaining or means for obtaining a set of rights associated with an item, the set of rights including meta-rights specifying derivable rights that can be derived from the meta-rights, and deriving at least one right from the derivable rights, if the rights consumer is entitled to the derivable rights specified by the meta-rights, wherein the derived right includes at least one state variable based on the set of rights and used for determining a state of the derived right.

Applicants respectfully submit that the present independent claims 1, 12 and 24 are patentably distinguishable over *Anand et al.* and *Infrastructure*, taken alone or in

combination. Specifically, *Anand et al.* does not disclose obtaining a set of rights associated with an item, the set of rights including meta-rights specifying derivable rights that can be derived from the meta-rights, and deriving at least one right from the derivable rights, if the rights consumer is entitled to the derivable rights specified by the meta-rights, wherein the derived right includes at least one state variable based on the set of rights and used for determining a state of the derived right, as recited in independent claim 1. *Anand et al.* also does not disclose means for obtaining a set of rights associated with an item, the set of rights including meta-rights specifying derivable rights that can be derived from the meta-rights, and means for deriving at least one right from the derivable rights, if the rights consumer is entitled to the derivable rights specified by the meta-rights, wherein the derived right includes at least one state variable based on the set of rights and used for determining a state of the derived right, as recited in independent claims 12 and 24.

In the device disclosed by *Anand et al.*, “a dynamic derivation mechanism enables permissions to be dynamically and flexibly derived for executables based upon their authenticated description” (see *Anand et al.*, e.g., col. 3, lns. 15-31), and is to perform the operations described by the permissions on objects (see *Anand et al.*, e.g., col. 3, lns. 40-42). The permissions of *Anand et al.* are associated with an executable, which is a subject or principal (see *Anand et al.*, e.g., col. 3, lns. 15-31).

By contrast, a derivable right of the invention of present independent claims 1, 12 and 24 is specified within meta-rights associated with an item (or an “object” in the terms of *Anand et al.*), whereas *Anand et al.* has no corresponding notion of meta-rights and only and always provides maximal permission in some site security policy for a derivation instance. Col. 5, lines 1-23 of *Anand et al.* which the Examiner cites as allegedly disclosing the meta-rights of the present invention, recites:

As FIG. 2 depicts, the derivation mechanism (100) consists of the following five steps: (1) create a derivation instance (200) for this content description (120) and downloading principal (110); (2) retrieve the current and maximal permissions propositions (210) from the site security policy (130) for the derivation instance (160); (3) derive the maximal permissions (150) from the contributions of each principal in the maximal permission proposition (220); (4) obtain the current permissions contributions (230) delegated by each principal in the current permission proposition (300), as illustrated in FIG. 3; and (5) compute the current and maximal permissions (140,150,240) using the current and maximal permissions propositions (300,310) and the current and maximal contributions (230,220) of the propositions' principals. The current permissions (150), by definition, must always be a subset of the maximal permissions (140).

The description of executable content (120) is a set of attribute-value pairs. One possible embodiment is RDF ("Resource Description Framework") labels that describe the meta-data of a website's URI ("Universal Resource Identifier"). RDF is a Web Consortium Activity (see <http://www.w3.org/metadata/RDF/overview.html>). Attributes with string values can be used to describe a URI.

Thus, as seen above, *Anand et al.* does not control or regulate who is entitled to derive right through meta-rights, as in the present invention, and moreover is completely silent with regard to "meta-rights specifying derivable rights that can be derived from the meta-rights", as substantially recited in independent claims 1, 12 and 24.

Additionally, since *Anand et al.* fails to disclose, teach or suggest any notion of meta-rights, it follows that *Anand et al.* cannot disclose, teach or suggest a step of determining whether the rights consumer is entitled to the derivable rights specified by the meta-rights in col. 5, lns. 14-21 as alleged by the Examiner. In fact, col. 5, lns. 14-21 of *Anand et al.* actually recites:

sitions' principals. The current permissions (150), by definition, must always be a subset of the maximal permissions (140).<sup>15</sup>

The description of executable content (120) is a set of attribute-value pairs. One possible embodiment is RDF ("Resource Description Framework") labels that describe the meta-data of a website's URI ("Universal Resource Identifier"). RDF is a Web Consortium Activity (see<sup>20</sup>

Thus, as seen from the above passage, *Anand et al.* is completely silent with regard to meta-rights that control or regulate who is entitled to derive rights through meta-rights, and more specifically to a step of determining whether the rights consumer is entitled to the derivable rights specified by the meta-rights, as disclosed in independent claims 1, 12 and 24. Instead, *Anand et al.* merely discloses that the current permissions will always be a subset of the maximal permission, which is clearly distinct from the derivation of rights through meta-rights.

Moreover, as seen from Figure 1 and its corresponding description on col. 4, lns. 51-60 of *Anand et al.*, it is clear that the permission derivation is always customized for the downloaded content and downloading principle according to a site security policy (see *Anand et al.*, the derivation instance in steps (1) and (2) on col. 5, lns. 1-16). Additionally, the derivation does not depend on whether or not a rights consumer (e.g., either the downloaded content or the downloading principal) is entitled to those rights or permissions. Consequently, the derivation of *Anand et al.* always ends up with two sets of permissions: a current permission and maximal permission.

Furthermore, as seen in col. 5, lns. 1-16 of *Anand et al.*, the derivation involves dynamical information such as "current permission contributions (230) delegated by each principal in the current permission proposition". Thus, *Anand et al.* cannot disclose that derivable rights specified by the meta-rights, wherein the derived rights include at least one state variable based on the set of rights and used for determining a state of the derived right, as purported by the Examiner.

The Examiner correctly admits that *Anand et al.* fails to disclose, teach or suggest a state variable (see the first paragraph on page 5 of the Office Action dated April 15, 2008),



and relies on page 8, paragraph 3 of *Infrastructure* for disclosing this feature. However, Applicants respectfully submit that *Infrastructure* also fails to disclose, teach or suggest a state variable, as is recited in the claims, and fails to make up for the deficiencies of *Anand et al.*

*Infrastructure*, page 8, paragraph 3 recites (emphasis added):

**John Erickson (HP):** An event model is powerful, because it allows description of certain rights relationships that we might think of in terms of electronic contracts. If we speak about rights languages, we can imagine a lot of different types of transactions. There are things that need to be declared, between an author and a publisher. It is a dynamic activity with lots of outcomes that the event model can characterize. The event model is the basis of an ontology. we need different vocabularies for different purposes. **A contract between an author and a publisher is like a dynamic state machine.** The event model is a powerful way to express that Things like rights vouchers/licenses and output of individual states are dependant on dynamic events.

Applicants would like to note that *Infrastructure* is completely silent with regard to a method or a system for transferring rights adapted to be associated with items, but rather is merely a transcribed copy of the minutes taken from an open forum discussion group regarding ideas and definitions of DRM, and not a method or system for transferring rights, as in the present invention.

Specifically, *Infrastructure* mentions that “[a] contract between an author and a publisher is like a dynamic state machine” (see *Infrastructure*), which in actuality is only directed to the *behavior of a contract*, and not the contract itself. Thus, the contract of *Infrastructure* cannot be *used for determining a state of the derived right*, as substantially recited by independent claims 1, 12 and 24.

Furthermore, Applicants respectfully submit that the notion of a dynamic state machine, as described in the above cited passage of *Infrastructure*, and the notion of a state variable are unrelated ideas. Applicants respectfully submit that a state machine by definition may not have any state variables, although it can have many concrete states.

Thus, at least for the reasons stated above, neither *Anand et al.* nor *Infrastructure*, taken alone or in combination, disclose, teach or suggest the claimed features recited in independent claims 1, 12 and 24.

The dependent claims are allowable at least by virtue of their dependency from one of the independent claims, but are also distinguishable over the prior art.

In view of the foregoing, it is submitted that the present application is in condition for allowance and a notice to that effect is respectfully requested. However, if any issue remains after considering this response, the Examiner is invited to call the undersigned to expedite the prosecution and work out any such issue by telephone.

**Except** for issue fees payable under 37 C.F.R. § 1.18, the Commissioner is hereby authorized by this paper to charge any additional fees during the entire pendency of this application including fees due under 37 C.F.R. §§ 1.16 and 1.17 which may be required, including any required extension of time fees, or credit any overpayment to Deposit Account No. 19-2380. This paragraph is intended to be a **CONSTRUCTIVE PETITION FOR EXTENSION OF TIME** in accordance with 37 C.F.R. § 1.136(a)(3).

Respectfully submitted,

Date: July 14, 2008

/Anthony J. Canning Reg. No. 62,107/  
Anthony J. Canning  
Registration No. 62,107

NIXON PEABODY LLP  
401 9th Street, N.W., Suite 900  
Washington, D.C. 20004-2128  
(202) 585-8000  
(202) 585-8080 (Fax)  
Customer No. 22204

Under the Paperwork Reduction Act of 1995, no persons are required to respond to a collection of information unless it displays a valid OMB control number.

<b>PATENT APPLICATION FEE DETERMINATION RECORD</b> Substitute for Form PTO-875	Application or Docket Number <b>10/956,121</b>	Filing Date <b>10/04/2004</b>	<input type="checkbox"/> To be Mailed
---	---	----------------------------------	---------------------------------------

APPLICATION AS FILED – PART I			OTHER THAN SMALL ENTITY				
(Column 1)		(Column 2)	SMALL ENTITY <input type="checkbox"/>		OR	SMALL ENTITY	
FOR	NUMBER FILED	NUMBER EXTRA	RATE (\$)	FEE (\$)		RATE (\$)	FEE (\$)
<input type="checkbox"/> BASIC FEE <small>(37 CFR 1.16(a), (b), or (c))</small>	N/A	N/A	N/A		OR	N/A	
<input type="checkbox"/> SEARCH FEE <small>(37 CFR 1.16(k), (l), or (m))</small>	N/A	N/A	N/A			N/A	
<input type="checkbox"/> EXAMINATION FEE <small>(37 CFR 1.16(o), (p), or (q))</small>	N/A	N/A	N/A			N/A	
TOTAL CLAIMS <small>(37 CFR 1.16(i))</small>	minus 20 =	*	X \$ =			X \$ =	
INDEPENDENT CLAIMS <small>(37 CFR 1.16(h))</small>	minus 3 =	*	X \$ =			X \$ =	
<input type="checkbox"/> APPLICATION SIZE FEE <small>(37 CFR 1.16(s))</small>	If the specification and drawings exceed 100 sheets of paper, the application size fee due is \$250 (\$125 for small entity) for each additional 50 sheets or fraction thereof. See 35 U.S.C. 41(a)(1)(G) and 37 CFR 1.16(s).						
<input type="checkbox"/> MULTIPLE DEPENDENT CLAIM PRESENT <small>(37 CFR 1.16(j))</small>							
* If the difference in column 1 is less than zero, enter "0" in column 2.			TOTAL			TOTAL	

APPLICATION AS AMENDED – PART II					OTHER THAN SMALL ENTITY				
(Column 1)		(Column 2)	(Column 3)		SMALL ENTITY		OR	SMALL ENTITY	
AMENDMENT	07/14/2008	CLAIMS REMAINING AFTER AMENDMENT	HIGHEST NUMBER PREVIOUSLY PAID FOR	PRESENT EXTRA	RATE (\$)	ADDITIONAL FEE (\$)		RATE (\$)	ADDITIONAL FEE (\$)
	Total <small>(37 CFR 1.16(i))</small>	* 36	Minus	** 36 = 0	X \$ =		OR	X \$50=	0
	Independent <small>(37 CFR 1.16(h))</small>	* 3	Minus	***3 = 0	X \$ =		OR	X \$210=	0
<input type="checkbox"/> Application Size Fee <small>(37 CFR 1.16(s))</small>									
<input type="checkbox"/> FIRST PRESENTATION OF MULTIPLE DEPENDENT CLAIM <small>(37 CFR 1.16(j))</small>							OR		
					TOTAL ADD'L FEE		OR	TOTAL ADD'L FEE	0

APPLICATION AS AMENDED – PART II					OTHER THAN SMALL ENTITY				
(Column 1)		(Column 2)	(Column 3)		SMALL ENTITY		OR	SMALL ENTITY	
AMENDMENT		CLAIMS REMAINING AFTER AMENDMENT	HIGHEST NUMBER PREVIOUSLY PAID FOR	PRESENT EXTRA	RATE (\$)	ADDITIONAL FEE (\$)		RATE (\$)	ADDITIONAL FEE (\$)
	Total <small>(37 CFR 1.16(i))</small>	*	Minus	** =	X \$ =		OR	X \$ =	
	Independent <small>(37 CFR 1.16(h))</small>	*	Minus	*** =	X \$ =		OR	X \$ =	
<input type="checkbox"/> Application Size Fee <small>(37 CFR 1.16(s))</small>									
<input type="checkbox"/> FIRST PRESENTATION OF MULTIPLE DEPENDENT CLAIM <small>(37 CFR 1.16(j))</small>							OR		
					TOTAL ADD'L FEE		OR	TOTAL ADD'L FEE	

\* If the entry in column 1 is less than the entry in column 2, write "0" in column 3.  
 \*\* If the "Highest Number Previously Paid For" IN THIS SPACE is less than 20, enter "20".  
 \*\*\* If the "Highest Number Previously Paid For" IN THIS SPACE is less than 3, enter "3".  
 The "Highest Number Previously Paid For" (Total or Independent) is the highest number found in the appropriate box in column 1.

Legal Instrument Examiner:  
 /TINA J. BARDEN/

This collection of information is required by 37 CFR 1.16. The information is required to obtain or retain a benefit by the public which is to file (and by the USPTO to process) an application. Confidentiality is governed by 35 U.S.C. 122 and 37 CFR 1.14. This collection is estimated to take 12 minutes to complete, including gathering, preparing, and submitting the completed application form to the USPTO. Time will vary depending upon the individual case. Any comments on the amount of time you require to complete this form and/or suggestions for reducing this burden, should be sent to the Chief Information Officer, U.S. Patent and Trademark Office, U.S. Department of Commerce, P.O. Box 1450, Alexandria, VA 22313-1450. DO NOT SEND FEES OR COMPLETED FORMS TO THIS ADDRESS. **SEND TO: Commissioner for Patents, P.O. Box 1450, Alexandria, VA 22313-1450.**  
 If you need assistance in completing the form, call 1-800-PTO-9199 and select option 2.

Knowbots, Permissions Headers and Contract Law

paper for the conference on

Technological Strategies for Protecting Intellectual  
Property in the Networked Multimedia Environment

April 2-3, 1993 with revisions of 4/30/93

Copyright 1993  
Henry H. Perritt, Jr.  
Professor of Law  
Villanova Law School  
Villanova, PA 19085  
(215) 645-7078  
FAX (215) 645-7033, (215) 896-1723  
Internet: perritt@ucis.vill.edu

## Introduction

One of the ways to protect intellectual property on the NREN is through a digital library concept. Under this concept, a work would have attached to it a "permissions header," defining the terms under which the copyright owner makes the work available. The digital library infrastructure, implemented on the NREN, would match request messages from users with the permissions headers. If the request message and the permissions header match, the user would obtain access to the work. This concept encompasses major aspects of electronic contracting, which is already in wide use employing Electronic Data Interchange ("EDI") standards developed by ANSI Committee X12.1

This paper explains the relationship between the digital library concept and EDI practice, synthesizing appropriate solutions for contract law, evidence, and agency issues that arise in electronic contracting. The question of how electronic signatures should work to be legally effective is an important part of this inquiry. The paper also defines particular types of service identifiers, header descriptors, and other forms of labeling and tagging appropriate to allow copyright owners to give different levels of permission, including outright transfer of the copyright interest, use

permission, copying permission, distribution permission, display permission, and permission to prepare derivative works. The paper considers how payment authorization procedures should work in conjunction with a permissions header and digital library concept in order to integrate the proposed copyright licensing procedures with existing and anticipated electronic payment authorization systems. The paper necessarily considers whether existing standards approaches related to SGML and X12 are sufficient or whether some new standards development efforts will be necessary for implementation of the concepts. The paper considers the relationship between technology and law in enforcing intellectual property, and emphasizes that the traditional adaptation of legal requirements to levels of risk is appropriate as the law is applied to new technologies.

There are certain common issues between the intellectual property question and other applications of wide area digital network technology. The question of signatures and writings to reflect the establishment of duties and permissions and the transfer of rights is common to the intellectual property inquiry and to electronic commerce using EDI techniques. There also are common questions involving rights to use certain information channels: First Amendment privileges, and tort liability. These are common not only to technological means of protecting intellectual property but to all forms of wide area networking.

#### The problem

The law recognizes intellectual property because information technology permits one person to get a free ride on another person's investment in creating information value. Creative activity involving information usually is addressed by copyright, although patent has a role to play in protecting innovative means of processing information.<sup>2</sup>

Intellectual property arose in the context of letterpress printing technology. Newer technologies like xerography and more recently small computer technology and associated word processing and networking have increased the potential for free rides and accordingly increased the pressure on intellectual property.

The concern about free ride potential is especially great when people envision putting creative works on

electronic publishing servers connected to wide area networks intending to permit consumers of information products to access these objects, frequently combining them and generally facilitating "publishing on demand" rather than the well known publishing just in case, typified by guessing how many copies of a work will sell, printing those in advance, and then putting them in inventory until someone wants them.

The concern is that it will be too easy to copy an entire work without detection and without paying for it. Worse, it will be easy to copy an entire work and resell it either by itself or as a part of a new derivative work or collection.

But technology is capable of protecting investment in new ways as well as gaining a free ride. Computer networks make it possible to restrict access and to determine when access occurs. Depending on how new networks are designed, they may actually reduce the potential for a free ride. The digital library is one way of realizing that potential. Professor Pamela Samuelson has observed that the digital library model replaces intellectual property with a system of technological controls.<sup>3</sup>

## Digital Library Concepts

### Basic Concepts

A digital library is a set of information resources ("information objects") distributed throughout an electronic network. The objects reside on servers (computers with associated disk drives connected to the network). They can be retrieved remotely by users using "client" workstations.

### Origin of Concepts

The phrase "digital library" and the basic concept was first articulated in a 1989 report growing out of a workshop sponsored by the Corporation for National Research Initiatives.<sup>4</sup> From its inception, the digital library concept envisioned retrieval of complete information resources and not merely bibliographic information.<sup>5</sup>

The technologies of remote retrieval of complete information objects using electronic technologies is in wide use through the WESTLAW, Dialog, LEXIS, NEXIS, and National Library of Medicine databases. These remotely accessible

databases, however, unlike the digital library involved a single host on which most of the data resides. The digital library concept envisions a multiplicity of hosts (servers).

#### Recent Developments

The remotely accessible database host concept is converging with the digital library concept as more of the electronic database vendors provide gateways to information objects actually residing on other computers. This now is commonplace with WESTLAW access to Dialog, and Dialog's gateways to other information providers.

The most explicit implementation of the digital library concept is the Wide Area Information Service ("WAIS"), which implements ANSI standard Z.39.6 WAIS permits a remote user to formulate a query that is applied to a multiplicity of WAIS servers each of which may contain information responsive to the query. The WAIS architecture permits search engines of varying degrees of sophistication, resident on WAIS information servers to apply the query against their own information objects, reporting matches back to the user.<sup>7</sup> Future implementations of WAIS permit automatic refinement of searches according to statistical matching techniques.

The Corporation for National Research Initiatives has proposed a test bed for an electronic copyright management system.<sup>8</sup> The proposed system would include four major elements: automated copyright recording and registration, automated, on line clearance of rights, private electronic mail and digital signatures to provide security. It would include three subsystems: a Registration and Recording System (RRS), a Digital Library System (DLS), and a Rights Management System (RMS). The RRS would provide the functions enumerated above and would be operated by the Library of Congress. It would provide "change of title" information.<sup>9</sup> The RMS would be an interactive distributed system capable of granting rights on line and permitting the use of copyrighted material in the Digital Library System. The test bed architecture would involve computers connected to the Internet performing the RRS and RMS functions.

Digital signatures would link an electronic bibliographic record with the contents of the work, ensuring against alteration after deposit.<sup>10</sup> Multiple RMS servers would be attached to the Internet. A user wishing to obtain

rights to an electronically published work would interact electronically with the appropriate RMS. When copyright ownership is transferred, a message could be sent from the RMS to the RRS11 - creating an electronic marketplace for copyrighted material.

The EBR submitted with a new work would "identify the rights holder and any terms and conditions on the use of the document or a pointer to a designated contact for rights and permissions."<sup>12</sup> The EBR, thus, is apparently equivalent to the permissions header discussed in this paper. Security in the transfer of rights would be provided by digital signatures using public key encryption, discussed further, *infra* in the section on encryption.

#### Basic Architectural Concepts

The digital library concept in general contemplates three basic architectural elements: a query, also called a "knowbot" in some descriptions; a permissions header attached to each information object; and a procedure for matching the query with the permissions header.

Two kinds of information are involved in all three architectural elements: information about the content of information objects desired and existing, and information about the economic terms on which an information object is made available. For example, a query desiring court opinions involving the enforcement of foreign judgments evidencing a desire to download the full text of such judicial opinions and to pay up to \$1.00 per minute of search and downloading time would require that the knowbot appropriately represent the subject matter "enforcement of foreign judgments." It also requires that the knowbot appropriately represent the terms on which the user is willing to deal: downloading and the maximum price. The permissions header similarly must express the same two kinds of information. If the information object to which the permissions header is attached is a short story rather than a judicial opinion, the permissions header must so indicate. Or, if the information object is a judicial opinion and it is about enforcement of foreign judgments, the permission header may indicate that only a summary is available for downloading at a price of \$10.00 per minute. The searching, matching, and retrieval procedure in the digital library system must be capable of determining whether there is a match on both subject matter and economic terms, also copying and



transmitting the information object if there is a match.

#### Comparison to EDI

Electronic Data Interchange ("EDI") is a practice involving computer-to-computer commercial dealing without human intervention. In the most widespread implementations, computers are programmed to issue purchase orders to trading partners, and the receiving computer is programmed to evaluate the terms of the purchase order and to take appropriate action, either accepting it and causing goods to be manufactured or shipped or rejecting it and sending an appropriate message. EDI is in wide use in American and foreign commerce, using industry-specific standards for discrete commercial documents like purchase orders, invoices, and payment orders, developed through the American National Standards Institute.

There obviously are similarities between the three architectural elements of the digital library concept and EDI. There is a structured way of expressing an offer or instruction, and a process for determining whether there is a match between what the recipient is willing to do and what the sender requests.

There is also, however, an important difference. In the digital library concept, a match results in actual delivery of the desired goods and services in electronic form. In EDI practice, the performance of the contractual arrangement usually involves physical goods or performance of nonelectronic services.

Nevertheless, the digital library and EDI architectures are sufficiently similar and, it turns out the legal issues associated with both are sufficiently similar to make analogies appropriate.

#### Elements of Data Structure

For purposes of this paper, the interesting parts of the data structure are those elements that pertain to permission, more than those elements that pertain to content of the information object to which the header is attached. Accordingly, this section will focus on only permissions-related elements, after noting in passing that the content part of the header well might be a pointer to an inverted file to permit full text searching and matching.

The starting point conceptually for identifying the elements of the permissions header are the rights exclusively reserved to the copyright owner by 106 of the copyright statute. But these exclusive rights need not be tracked directly because the owner of an information object free to impose contractual restrictions as well as to enjoy rights granted by the Copyright Act. Accordingly, it seems that the following kinds of privileges in the requester should be addressed in the permissions header:

outright transfer of all rights

use privilege, either unrestricted or subject to restrictions

copying, either unlimited or subject to restrictions like quantitative limits

distribution, either unlimited or subject to restrictions, like geographic ones or limits on the markets to which distribution can occur

preparation of derivative works

Display and presentation rights, separately identified in 106 would be subsumed into the use element, because they are particular uses.

The simplest implementation would allow only binary values for each of these elements. But a binary approach does not permit the permissions header to express restrictions, like those suggested in the enumerated list. Elements could be defined to accept the most common kinds of restrictions on use, and quantitative limits on copying, but it would be much more difficult to define in advance the kinds of geographic or market-definition restrictions that an owner might wish to impose with respect to distribution.

In addition to these discrete privileges, the permissions header must express pricing information. The most sensible way of doing this is to have a price associated with each type of privilege. In the event that different levels of use, copying, or distribution privilege are identified, the data structure should allow a price to be associated with each level.

A complicating factor in defining elements for price is the likelihood that different suppliers would want to price differently. For example, some would prefer to impose a flat fee for the grant of a particular privilege. Others might wish to impose a volume-based fee, and still others might wish to impose a usage or connect-time based fee. The data structure for pricing terms must be flexible enough to accommodate at least these three different approaches to pricing.

Finally, the data structure must allow for a specification of acceptable payment terms and have some kind of trigger for a payment approval procedure. For example, the permissions header might require presentation of a credit card number and then trigger a process that would communicate with the appropriate credit card database to obtain authorization. Only if the authorization was obtained would the knowbot and the permissions header "match."

There is a relationship between the data structures and legal concepts. The knowbot is a solicitation of offers. The permissions header is an offer. The matching of the two constitutes an acceptance. Mr. Linn's "envelope" could be the "contract."

There are certain aspects of the data structure design that are not obvious. One is how to link price with specific levels of permission. Another is how to describe particular levels of permission. This representation problem may benefit from the use of some deontic logic, possibly in the form of a grammar developed for intellectual property permissions. Finally, it is not clear what the acceptance should look like. Conceptually, the acceptance occurs when the knowbot matches with a permissions header, but it is unclear how this legally significant event should be represented.

### Role of Encryption

The CNRI test bed proposal envisions the use of public key encryption to ensure the integrity of digital signatures and to ensure the authenticity of information objects. Public key encryption permits a person to encrypt a message - like a signature using a secret key, one known only to the sender, while permitting anyone with access to a public key

to decrypt it. Use of public key cryptography in this fashion permits any user to authenticate a message, ensuring that it came from the purported sender.<sup>13</sup> A related technology called "hashing" permits an encrypted digital signature to be linked to the content of a message. The message can be sent in plain text (unencrypted) form, but if any part of it is changed, it will not match the digital signature. The digital signature and hashing technologies thus permit not only the origin but also the content integrity of a message of arbitrary length to be authenticated without necessitating encryption of the content of the message. This technology has the advantage, among others, that it is usable by someone lacking technological access to public key encryption. An unsophisticated user not wishing to incur the costs of signature verification nevertheless can use the content of the signed information object.

It is well recognized that encryption provides higher levels of security than other approaches. But security through encryption comes at a price. Private key encryption systems require preestablished relationships and exchange of private keys in advance of any encrypted communication. The burdens of this approach have led most proponents of electronic commerce to explore public key encryption instead. But public key systems require the establishment and policing of a new set of institutions. An important infrastructure requirement for practicable public key cryptography is the establishment and maintenance of certifying entities that maintain the public keys and ensure that they are genuine ones rather than bogus ones inserted by forgers. A rough analogy can be drawn between the public key certifying entities and notaries public. Both kinds of institutions verify the authenticity of signature. Both kinds require some level of licensing by governmental entities. Otherwise the word of the "electronic notary" (certifying entity) is no better than an uncertified, unencrypted signature. In a political and legal environment in which the limitations of regulatory programs have been recognized and have led to deregulation of major industries, it is not clear that a major new regulatory arrangement for public key encryption is practicable. Nevertheless, experimentation with the concept in support of digital library demonstration programs can help generate more empirical data as to the cost and benefits of public key encryption to reinforce electronic signatures.

On the other hand, it is not desirable to pursue approaches requiring encryption of content. No need to encrypt the contents is apparent in a network environment. Database access controls are sufficient to prevent access to the content if the permissions header terms are not matched by the knowbot. On the other hand, if the electronic publishing is effected through CDROMs or other physical media possessed by a user, then encryption might be appropriate to prevent the user from avoiding the permissions header and going directly to the content.

While encrypted content affords greater security to the owner of copyrighted material. Someone who has not paid the price to the copyright owner must incur much higher cost to steal the material. But the problem is everyone must pay a higher price to use the material. One of the dramatic lessons of the desktop computer revolution was the clear rejection of copyright protection in personal computer software. The reasons that copy protection did not survive in the market place militate against embracing encryption for content. Encryption interferes with realization of electronic markets, because producer and consumer must have the same encryption and decryption protocols. Encryption burdens processing of electronic information objects because it adds another layer. Some specific implementations have encryption require additional hardware at appreciable costs.

Digital libraries cannot become a reality until consumers perceive that the benefits of electronic formats outweigh the costs, compared to paper formats. Encryption interferes with electronic formats' traditional advantages of density, reusability, editability, and computer search ability and also, by impairing open architectures may perpetuate some of papers' advantages with respect with browsibility.<sup>14</sup>

The need for encryption of any kind depends upon whether security is available without it. That depends, in turn, on the kinds of free rides that may be obtainable and the legal status of various kinds of electronics transactions in the digital library system.

#### Legal Issues

Copyright: What legal effect is intended?

The design of the permissions header and the values in the elements of the header must be unambiguous as to whether an outright transfer of a copyright interest is intended or whether only a license is intended. If an outright transfer<sup>15</sup> is intended, then the present copyright statute requires a writing signed by the owner of the rights conveyed.<sup>16</sup> Recordation of the transfer with the Copyright office is not required, but provides advantages in enforcing transferee rights.<sup>17</sup> On the other hand, non exclusive licenses need not be in writing nor registered. If the electronic transaction transfers the copyright in its entirety, then the rights of the transferor are extinguished, and the rights of the transferee are determined by the copyright statute. The only significant legal question is whether the conveyance was effective.

On the other hand, when the copyright is not transferred outright but only certain permissions are granted or certain rights conveyed, the legal questions become more varied. Then, the rights of the transferor and the obligations of the transferee are matters of contract law. It is important to understand the degree to which the contract is enforceable and how it is to be interpreted in the event of subsequent disputes. The following sections consider briefly the first sale doctrine as a potential public policy obstacle to enforcing contractual restrictions different from those imposed by the copyright statute and then explore in greater depth whether electronic techniques satisfy the formalities traditionally required for making a contract, whether they adequately ensure against repudiation, and whether they provide sufficient information to permit predictable interpretation of contractual obligations and privileges.

#### First Sale Doctrine

The first sale doctrine may invalidate restrictions on use. It is impermissible for the holder of a patent to impose restrictions on the use of a patented product after the product has been sold. Restrictions may be imposed, however, on persons who merely license the product.<sup>18</sup> The rationale for this limit on the power of the owner of the intellectual property interest is that to allow limitations on use of the product would interfere with competition beyond what the Congress - and arguably the drafters of the Constitution - intended in setting up the patent system.

The first sale doctrine applies to copyright owners.<sup>19</sup> Indeed, because of the First Amendment's protection of informational activity, the argument against restrictions after the first sale may be even stronger in the copyright arena than in the patent arena.

The first sale doctrine is potentially important because it may invalidate restrictions imposed on the use of information beyond what is authorized by the Copyright Act and by common law trade secret. Thus, there may be serious questions about the legal efficacy of use restrictions suggested in \_\_\_\_, although such restrictions are common in remote database service agreements. The vendors could argue that the limitations pertain to the contractual terms for delivery of a service rather than use of information as such. The characterization avoids the overlap with copyright and thus may also avoid the conflict between federal policy and contract enforcement.<sup>20</sup>

#### Contract Formation Issues

The law does not enforce every promise. Instead, it focuses its power only on promises surrounded with certain formalities to make it likely that the person making the promise (the "promisor") and the person receiving the promise (the "promisee") understood that their communication had legal consequences. A threshold question for the digital library system is whether the traditional formalities for making a contract are present when the contract is made through electronic means. The digital library system considered in this paper clearly contemplates that a contract is formed when the knowbot and the permissions header achieve a match. In this respect, the digital library concept converges with EDI where trading parties contemplate that a contract to perform services or deliver goods is formed when a match occurs either upon the receipt of a purchase order or upon the transmission of a purchase order acknowledgment.

It is not altogether clear, however, whether the match between values and computer data structures meets contract formation requirements, particularly those expressed in various statutes of frauds. Statutes of frauds require "writings" and "signatures" for certain kinds of contracts - basically those contemplating performance extending beyond a period of one year.<sup>21</sup>

In many instances, the digital library contract will be fully performed almost instantaneously upon delivery of the information object after the knowbot and the permissions header match. In such a case, the statute of frauds is not a problem and its requirements need not be satisfied. In other cases, however, as when the intent of the owner of the information object is to grant a license to do things that will extend beyond one year, the statute of frauds writing and signature requirements must be met.

Historical application of Statutes Of Frauds by the courts clearly indicates that there is flexibility in the meaning of "writing" and "signature." A signature is any mark made with the intent that it be a signature.<sup>22</sup> Thus an illiterate person signs by making an "X," and the signature is legally effective. Another person may sign a document by using a signature stamp. Someone else may authorize an agent to sign his name or to use the signature stamp. In all three cases the signature is legally effective. There may of course be arguments about who made the X, or whether the person applying the signature stamp was the signer or his authorized agent, but these are evidentiary and agency questions, not arguments about hard and fast contract-law requirements.

Under the generally accepted legal definition of a signature, there is no legal reason why the "mark" may not be made by a computer printer, or for that matter by the write head on a computer disk drive or the data bus in a computer random access memory. The authorization to the computer agent to make the mark may be given by entering a PIN ("Personal Identification Number") on a keyboard. To extend the logic, there is no conceptual reason to doubt the legal efficacy of authority to make a mark if the signer writes a computer program authorizing the application of a PIN upon the existence of certain conditions that can be tested by the program. The resulting authority is analogous to a signature pen that can be operated only with a mechanical key attached to somebody's key ring, coupled with instructions to the possessor of the key.

Which of these various methods should be selected for particular types of transactions must depend, not on what the law requires, because the law permits any of these methods. Rather, it must depend on the underlying purposes of the legal requirement and which method best serves those



purposes.

The real issue is how to prove that a particular party made the mark. In other words, the contingency to be concerned about is repudiation, not absence of formalities. Repudiation should be dealt with through usual evidentiary and fact finding processes rather than artificial distinctions between signed and unsigned documents.

Authority is skimpier on how flexible the "writing" requirement is. The best approach is to borrow the fixation idea from the copyright statute and conclude that a writing is "embodiment in a copy . . . sufficiently permanent or stable to permit it to be perceived, reproduced, or otherwise communicated for more a period of more than transitory duration."<sup>23</sup>

The most important thing conceptually is to understand the purpose of the writing and signature requirements. They have two purposes: awareness or formality and reliability of evidence. Signature requirements, like requirements for writings and for original documents have an essentially evidentiary purpose. If there is a dispute later, they specify what kind of evidence is probative of certain disputed issues, like "who made this statement and for what purpose?" The legal requirements set a threshold of probativeness. Surely the values in a knowbot as well as the values in a permissions header constitute and "mark," and someone who knowingly sets up potential transactions in a digital library scheme can have the intent that the mark be a signature.

When a contract is made through a signed writing, it is more likely that the parties to the contract understand what they are doing. They are aware of the legal affect of their conduct because the writing in the signature involve a greater degree of formality than a simple conversation.

The awareness/formality purpose can be served by computerized contracting systems. This is so not so much because the computers are "aware" of the affect of their "conduct." Rather, it is true because the computers are agents of human principals. The programming of the computer to accept certain contract terms is the granting of authority to the computer agent to enter into a contract. The fact that a principal acts through an agent engaging in

conduct at a later point and time never has been thought to defeat contract formation in the traditional evolution of agency and contract law. Nor should it when the agent is a computer.

Fulfillment of the evidentiary purpose depends on the reliability of the information retained by the computer systems making up the digital library. Such systems must be designed to permit the proponent of contract formation to establish the following propositions if the other party to the purported contract attempts to repudiate it.

1. It came from computer X
2. It accurately represents what is in computer X<sup>24</sup> now<sup>25</sup>
3. What is in computer X now is what was in computer X at the time of the transaction
4. What was in computer X at the time of the transaction is what was received from the telecommunications channel<sup>26</sup>
5. What was received from the telecommunications channel is what was (a) sent, (b) by computer Y.

Two other questions relate to matters other than the authenticity of the message:

6. Computer Y was the agent of B
7. The message content expresses the content of the contract (or more narrowly, the offer or the acceptance).<sup>27</sup>

Factual propositions 1-4 can be established by testimony as to how information is written to and from telecommunications channel processors, primary storage, and secondary storage. Factual proposition 5 requires testimony as to the accuracy of the telecommunications channel and characteristics of the message that associate it with computer Y. Only the last proposition (number 5) relates to signatures, because signature requirements associate the message with its source.<sup>28</sup> The other propositions necessitate testimony as to how the basic message and database management system works. It is instructive to compare these

propositions with the kinds of propositions that must be established under the business records exception to the hearsay rule when it is applied to computer information.

Those propositions may be supported with non technical evidence, presented by non programmers. A witness can lay a foundation for admission of computer records simply by testifying that the records are generated automatically and routinely in the ordinary course of business. The more inflexible the routine, and the less human intervention in the details of the computer's management of the database the better the evidence.<sup>29</sup>

The ultimate question is trustworthiness, and if the computer methods are apparently reliable, the information should be admitted unless the opponent of admissibility can raise some reasonable factual question undercutting trustworthiness.<sup>30</sup>

#### Contract Interpretation Issues

Assuming that the permissions header and knowbot constitute sufficient writings to permit a contract to be formed and that the signature requirement also is met, through digital signature technology or otherwise, there still are difficult contract interpretation questions. Contract interpretation questions arise not only after contractual relationships are formed, but also in connection with deciding whether there has been offer and acceptance, the prerequisites to contract formation.<sup>31</sup> Contract interpretation always seeks to draw inferences about what the parties intended. When contract interpretation issues arise at the contract formation stage, the questions are what the offeror intended the content of the offer to be and what the offeree intended the content of the purported acceptance to be. The proposed Digital Library System envisions extremely cryptic expressions of offer and acceptance - by means of codes. The codes have no intrinsic meaning. Rather, extrinsic reference must be made to some kind of table, standard, or convention associating particular codes with the concepts they represent. Extrinsic evidence is available to resolve contract interpretation questions when the language of the contract itself is ambiguous, and perhaps at other times as well.<sup>32</sup> The codes in the permissions header and knowbots certainly are ambiguous and become unambiguous only when extrinsic evidence is considered. So there is no problem in getting a standard or

cable into evidence. The problem is whether the parties meant to assent to this standard.

In current EDI practice, this question is resolved by having parties who expect to have EDI transactions with each other to sign a paper trading partner agreement, in which the meaning of values or codes in the transaction sets is established.<sup>33</sup> But requiring each pair of suppliers and users of information in a digital library to have written contracts with each other in advance would defeat much of the utility of the digital library. Thus the challenge is to establish some ground rules for the meaning of permissions header and knowbot values that all participants are bound by. There are analogous situations. One is a standard credit card agreement that establishes contractual terms among credit card issuer, credit card subscriber, and merchant who accepts the credit card. The intermediary - the credit card company - unilaterally establishes contract terms to which the trading partners assent by using and accepting the credit card.<sup>34</sup> Also, it is widely recognized that members of a private association can, through their constitution and bylaws establish contractual relationships that bind all of the members in dealing with each other.<sup>35</sup> In the Digital Library System, similar legal arrangements can establish the standards by which electronic transactions between permissions header and knowbots will bind transferor and transferee of information.

#### Third Party Liability

It is not enough merely to ensure that the licensee is contractually bound. Trading partners also must ensure that the participants in funds transfers have enforceable obligations. For example, if the digital library system envisions that the information object would not be released to the purchaser without simultaneous release of a payment order, the supplier may be interested in enforcing the obligations of financial intermediaries who handle the payment order. This implicates the federal Electronic Funds Transfer Act, and Article 4A of the Uniform Commercial Code, regulating wire transfers.

#### Solutions

Satisfy the Business Records Exception to the Hearsay Rule

The discussion of contract formalities earlier in this

paper concluded that legally enforceable contracts can be formed through electronic means and that the significant legal questions relate to reliability of proof and intent of the parties to be bound by using the electronic techniques. This section considers the reliability of proof further. Traditional evidence law permits computer records to be introduced in evidence when they satisfy the requirements of the business records exception: basically that they are made in the ordinary course of business, that they are relied on for the performance of regular business activities, and that there is no independent reason for questioning their reliability.<sup>36</sup>

The business records exception shares with the authentication concept statute of frauds and the parol evidence rule a common concern with reliability.<sup>37</sup> The same procedural guarantees and established practices that ensure reliability for hearsay purposes also ensure reliability for the other purposes. Under the business records exception, the proponent must identify the source of a record, through testimony by one familiar with a signature on the record, or circumstantially.<sup>38</sup> The steps in qualifying a business record under the common law, which since have been relaxed,<sup>39</sup> were:

Proving that the record is an original entry made in the routine course of business

Proving that the entries were made upon the personal knowledge of the proponent/witness or someone reporting to him

Proving that the entries were made at or near the time of the transaction

Proving that the recorder and his informant are unavailable.<sup>40</sup>

These specific requirements are easier to understand and to adapt to electronic permissions and obligations formed in a digital library system by understanding the rationale for the business records exception. The hearsay rule excludes out of court statements because they are inherently unreliable, primarily because the maker of the statement's demeanor cannot be observed by the jury and because the maker of the statement is not subject to cross examine. On the other hand, there are some out of court statements that

have other guarantees of reliability. Business records are one example. If a continuing enterprise finds the records sufficiently reliable to use them in the ordinary course of business, they should be reliable enough for a court. The criteria for the business records exception all aim at ensuring that the records really are relied upon the business to conduct its ordinary affairs.

The Manual for Multidistrict Litigation suggests steps for qualifying computer information under the business records exception:

1. The document is a business record
2. The document has probative value
3. The computer equipment used is reliable
4. Reliable data processing techniques were used<sup>41</sup>

The key in adapting the business records exception to electronic permissions in a digital library system are points 3 and 4. Establishing these propositions and the propositions set forth in section \_\_\_ of this paper requires expert testimony. Any designer of a digital library system must consult with counsel and understand what testimony an expert would give to establish these propositions. Going through that exercise will influence system design.

Reinforce the Evidentiary Reliability by Using Trusted Third Parties

The evidentiary purpose of contract formation requirements can be satisfied by using a trusted third party as an intermediary, when the third party maintains archival records of the transactions. The third party lacks any incentive for tampering with the records and when the third parties archiving system is properly designed, it can provide evidence sufficient to establish all of the propositions identified in \_\_\_.

This third party intermediary concept is somewhat different from the concept for a certifying agent in digital signature systems. To be sure, the custodian of transaction records envisioned by this section could be the same as the certifying entity for public and key encryption, but the custodian role can be played in the absence of any

encryption. Indeed, the digital library itself is a good candidate for the custodian role. The library has no incentive to manipulate its records in favor of either of the producers of information value or the consumers. In order to carry out its affairs, it must use these transactional records in the ordinary course of business, thereby making it likely that digital library records would qualify under the business records exception.

#### Standardization

Obviously, the digital library concept depends upon the possibility of an automated comparison between the knowbot and the permissions header. This means that potential requesters of information and suppliers of information must know in advance the data structures for representing the elements of the permissions header and the knowbot. This requires compatibility. Compatibility requires standardization. Standardization does not, however, necessarily require "Standard" in the sense that they are developed by some bureaucratic body like ANSI. It may simply imply market acceptance of a particular vendor's approach. Indeed, each digital library might use different data structures. All that is necessary is that the structure of the knowbot and the structure of the permissions header be compatible within any one digital library system. Also, as demands emerge for separate digital libraries to communicate with each other, there can be proprietary translation to assure compatibility between systems much as common word processing programs translate to and from other common formats and much as printers and word processing software communicate with each other through appropriate printer drivers. In neither of these cases has any independent standards organization developed a standard that is at all relevant in the marketplace.

Standardizing the elements of Knowbot and permissions headers involves content standardization, which generally is more challenging than format standardization.<sup>42</sup> A permissions header/Knowbot standard is a system for representing legal concepts and for defining legal relations. As such, the standard is basically a grammar for a rule based substantive system in a very narrow domain.<sup>43</sup> The data elements must correspond to legally meaningful relational attributes. The allowable values must correspond to legally allowable rights, obligations, privileges and powers. In other words, the standard setter must meet many of the challenges that a

legal expert system designer working with Hohfeldian frameworks must meet.<sup>44</sup> This adds a constraint to the standards setting process. Unlike setting format standards, where the participants are free to agree on an arbitrary way of expressing format attributes, participants in setting a content standard must remain within the universe of permissible content. The set of permissible values is determined by the law rather than being determined only by the imagination of format creators.

### Enforcement and Bottlenecks

One of the many profound observations by Ithiel de Sola Pool was that copyright always has depended upon technological bottlenecks for its enforceability. The printing press was the original enforcement bottleneck. Now, a combination of the printing press and the practical need to inventory physical artifacts representing the work constitute the enforcement bottlenecks. As technologies change, old bottlenecks disappear and enforceability requires a search for new bottlenecks. When there are single hosts, like Westlaw, Dialog, Lexis, and CompuServe, access to that host is the bottleneck. The problem with distributed publishing on an open architecture internet is that there is no bottleneck in the middle of the distribution chain corresponding to the printer, the warehouse or the single host.

If new bottlenecks are to be found, they almost surely will be found at the origin and at the point of consumption. Encryption and decryption techniques discussed elsewhere in this volume concentrate on those bottlenecks as points of control. It also is possible that rendering software could become the new bottleneck as Mr. Linn suggests.

Even with those approaches, however, a serious problem remains in that the new technologies make it difficult or impossible to distinguish between mere use and copying. Thus the seller cannot distinguish between an end user<sup>45</sup> and a potential competitor. On the other hand, the new technologies permit a much better audit trail, potentially producing better evidence for enforcement adjudication.

If network architectures for electronic publishing evolve in the way that Ted Nelson suggests with his Xanadu concept, the real value will be in the network and the



pointers, not in the raw content. Thus, the creative and productive effort that the law should reward is the creation and production and delivery of pointers, presentation, distribution, and duplication value. If this is so, then technological means will be particularly important, foreclosing access by those lacking passwords and other keys and limiting through contract what a consumer may do with the information.

In such an architecture, the law either will be relatively unimportant because technology can be counted on to prevent free riding or, the law will need to focus not on prohibiting copying or use without permission, but on preventing circumvention of the technological protections. Thus, legal approaches like that used to prevent the sale of decryption devices for television broadcasts and legal issues associated with contract enforcement may be more important than traditional intellectual property categories.

#### Weighing Risks and Costs

The law generally imposes sensible levels of transaction costs. Usually, transaction costs are proportional to the risk. Figure 1 shows a continuum of risk and transaction cost in traditional and new technologies. A real estate closing involves significant risks if there is some dispute later about the transaction. Therefore, the law affords much protection, including a constitutional officer called a registrar of deeds who is the custodian of records associated with the transaction. The risk level analogous to this in electronic publishing might be access to an entire library including access software as well as contents. Next, is a transaction involving a will or power of attorney. There, the risk is substantial because the maker of the instrument is not around to help interpret it. The law requires relatively high levels of assurance here, though not as great as those for real estate transactions. The law requires witnesses and attestation by a commissioned minor official called a notary public. The electronic publishing analogy of this level of risk might be the contents of an entire CDROM.

Next, in level of risk is the purchase of a large consumer durable like an automobile. The law requires somewhat less, but still significant protections for this

kind of transaction: providing for the filing and enforcement of financing statements under the Uniform Commercial Code. The electronic publishing analogy might be the transfer of copyright to a complete work. Next, down the risk continuum, is the purchase of a smaller consumer durable like a television set. Here, the law typically is reflected in written agreements of sale, but no special third party custodial mechanisms. The electronic publishing analogy might be use permission for a complete work.

Finally, is the purchase of a relatively small consumer item, say a box of diskettes. Neither the law or commercial practice involves much more than the exchange of the product for payment, with no written agreement or anything else to perform channeling, cautionary, evidentiary, or protective functions [make sure these function and the citation appears earlier]. The electronic publishing analogy might be use permission for part of a work.

Cost effectiveness = risk-proportional security

traditional transaction	institutions	electronic equivalent
real estate closing	registrar of deeds	entire library - software and contents
will/power of attorney	witnesses, notary public	contents of entire CDROM
auto purchase	UCC financing statement	complete work - transfer of copyright
television set purchase	written sale agreement	complete work - use permission
box of diskettes	-	part of a work - use permission

An encrypted object combined with rendering software is probably inconsistent with an open architecture. Because of the difficulty of setting standards for such technologies, this approach to intellectual property protection probably would be effectuated by proprietary approaches thus frustrating the vision of an open market for electronic publishing.

Conclusion

Realization of the digital library vision requires a method for collecting money and granting permission to use works protected by intellectual property. The concept of a knowbot and a permissions header attached to the work is the right way to think about such a billing and collection system. Standards for the data structures involved must be agreed to, and systems must be designed to satisfy legal formalities aimed at ensuring awareness of the legal significance of transactions and reliable proof of the terms of the transactions.

In the long run, not only must these technological issues be resolved, with appropriate attention to levels of risk and protections available under traditional legal doctrines, but also further conceptual development must be undertaken. Proponents of electronic publishing over wide area networks need to think about the appropriate metaphors: whether it is a library or a bookstore, if a library whether with or without xerox machines, if a bookstore whether it is a retail bookstore, or a mail order operation. Then, thought must be given to how standards will be set. Finally, and most important, much more needs to be understood about the need for third party institutions. There is a good deal of enthusiasm for public key encryption. Yet the vulnerability of public key encryption systems is in the integrity of the key authority. In traditional legal protections, the third party custodians or authenticating agents like notary public and registrars of deeds receive state sanction and approval, and in the case of registrars of deeds, public funding. We must be clearer as to whether a similar infrastructure must be developed to protect against substantial risks and the use of EDI and electronic publishing technologies.

Finally, and perhaps most importantly, we must be thoughtful about what legal obligations, imposed on whom, are appropriate? The suggested 102(e) and (f) in the High Performance Computing Act looks very much like King James I's licensing of printing presses. It also looks like the FBI's proposal to prohibit the introduction of new technologies until certain conformity with past legal concepts is assured. Such approaches make the law a hurdle to new technology -- an uncomfortable position for both law and technology.

---

1 The use of EDI techniques to meter usage and determine charges for use of intellectual property is an example of billing and collection value in a typology of different types of value that can be produced in electronic marketplaces for information. See Henry H. Perritt, Jr., Market Structures for Electronic Publishing and Electronic Contracting in Brian Kahin, ed., Building Information Infrastructure: Issues in the Development of the National Research and Education Network (Harvard University and McGraw-Hill 1992) (developing typology for different types of value and explaining how market structures differ for the different types); Henry H. Perritt, Jr., Tort Liability, the First Amendment, and Equal Access to Electronic Networks, 5 Harv.J.Law & Tech. 65 (1992) (using typology of ten types of value to analyze access by competing producers of value).

2 See, e.g. U.S. Pat. No. 5,016,009, Data compression apparatus and method (May 14, 1991); U.S. Pat. No. 4,996,690, Write operator with gating capability (Feb. 26, 1991); U.S. Pat. No. 4,701,745, Data compression system (Oct. 20, 1987); Multi Tech Systems, Inc. v. Hayes Microcomputer Products, Inc., 800 F. Supp. 825 (D. Minn. 1992) (denying summary judgment on claim that patent for modem escape sequence is invalid)..

3 Comments on the 8\21 draft of "Knowbots in the Real World" from the intellectual property workshop participants at page 6 (author unknown, source unknown). Professor Samuelson also observed that the workshop, despite its title, actually did not focus much on intellectual property issues.

4 Corporation for National Research Initiatives, Workshop On The Protection Of Intellectual Property Rights In A Digital Library System: Knowbots in the Real World-May 18-19, 1989 (describing digital library system).

5 See generally Clifford A. Lynch, Visions of Electronic Libraries (libraries of future can follow acquisition-on-demand model rather than acquiring an advance of use; Z39.50 protocol will facilitate realization of that possibility, citing Robert E. Kahn & Vinton G. Serf, An Open Architecture for a Digital Library System and a Plan for Its Development. The Digital Library Project, volume 1: The World of Knowbots (draft) (Washington D.C.: Corporation for National Research

Initiatives; 1988)).

6 Clifford A. Lynch, The Z39.50 Information Retrieval Protocol: An Overview and Status Report, ACM Sigcomm Computer Communication Review at 58 (describing Z39.50 as an OSI application layer protocol that relieves clients from having to know the structure of data objects to be queried, and specifies a framework for transmitting and managing queries and results and syntax for formulating queries).

7 Brewster Kahle, Wide Area Information Server Concepts (Nov. 3, 1989 working copy; updates available from Brewster @THINK. (describing WAIS as "open protocol for connecting user interfaces on workstations and server computers") (describing information servers as including bulletin board services, shared databases, text searching and automatic indexing and computers containing current newspapers and periodicals, movie and television schedules with reviews, bulletin boards and chat lines, library catalogues, Usenet articles).

8 Robert E. Kahn, Deposit, Registration, Recordation in an Electronic Copyright Management System (August 1992) (Corporation for National Research Initiatives, Reston, Virginia).

9 Kahn 1992 at 4.

10 Kahn 1992 at 6.

11 Kahn 1992 at 10.

12 Kahn 1992 at 12.

13 Kahn 1992 at 15.

14 Browsability through techniques like the collapsible outliner function in Microsoft Word for Windows and competing products require more chunking and tagging value in the form of style and text element codes. Handling this additional formatting information through encryption and description processes is problematic.

15 " A 'transfer of copyright ownership' is an assignment, mortgage, exclusive license, or any other conveyance, alienation, or hypothecation of a copyright or

of any of the exclusive rights comprised in a copyright, whether or not it is limited in time or place of effect, but not including a non-exclusive license " 17 U.S.C. 101 (1988).

16 17 U.S.C. 204(a) (1988); Valente-Kritzer Video v. Pinckney, 881 F.2d 772, 774 (9th Cir. 1989) (affirming summary judgment for author; oral agreement unenforceable under Copyright Act); Library Publications, Inc. v. Medical Economics Co., 548 F. Supp. 1231, 1233 (E.D. Pa. 1982) (granting summary judgment against trade book publisher who sought enforcement of oral exclusive distribution agreement; transfer of exclusive rights, no matter how narrow, must be in writing), aff'd mem., 714 F.2d 123 (3d Cir. 1983).

17 17 U.S.C. 205 (1988) provides constructive notice of the contents of the recorded document, determining priority as between conflicting transfers, and determines priority as between recorded transfer and non-exclusive license. The former requirement for transfers to be recorded in order for the transferee to maintain an infringement, 17 U.S.C. 205(d), was repealed by the Berne Act Amendments 5.

18 under Adams v. Burke, 84 U.S. (17 Wall.) 453 (1873), a patentee must not attempt to exert control past the first sale. In general, use restrictions may be placed only on licensees, consistent with General Talking Pictures v. Western Elec., 304 U.S. 175 (1938). See generally Baldwin-Lima-Hamilton Corp. v. Tatnall, 169 F. Supp. 1 (E.D. Pa. 1958) (applying no control after purchase rule).

19 See Red-Baron-Franklin Park, Inc. v. Taito Corp., 883 F.2d 275, 278 (4th Cir. 1989) (purchase of video game circuit boards did not create privilege to perform video game under first sale doctrine); United States v. Moore, 604 F.2d 1228, 1232 (9th Cir. 1979) (pirated sound recording not within first sale doctrine in criminal copyright infringement prosecution). But see Mirage Editions, Inc. v. Albuquerque A.R.T. Co., 856 F.2d 1341, 1344 (9th Cir. 1988) (first sale doctrine did not create privilege to prepare derivative work by transferring art in book to ceramic tiles).

20 The way in which the first sale doctrine would impact the electronically imposed use restrictions is by frustrating a breach-of-contract lawsuit by the licensor

against a licensee who exceeds the use restrictions. The licensee exceeding the use restrictions would argue that it violates public policy to enforce the restrictions and therefore that state contract law may not impose liability for their violation. See generally Restatement (second) of Contracts 178 (1981) (stating general rule for determining when contract term is unenforceable on grounds of public policy).

21 In addition, as \_\_\_ of this paper notes, the Copyright Act itself requires signed writings for transfers of copyright interests. 17 U.S.C. 204(a). (1988).

22 Michael S. Baum & Henry H. Perritt, Jr., *Electronic Contracting, Publishing and EDI Law* ch. 6 (1991) (contract, evidence and agency issues) [hereinafter "Baum & Perritt"]. Accord, *Signature Requirements Under EDGAR*, Memorandum from D. Goelzer, Office of the General Counsel, SEC to Kenneth A. Fogash, Deputy Executive Director, SEC (Jan. 13, 1986) (statutory and non-statutory requirements for "signatures" may be satisfied by means other than manual writing on paper in the hand of the signatory . . . "In fact, the electronic transmission of an individual's name may legally serve as that person's signature, providing it is transmitted with the present intention to authenticate.").

23 17 U.S.C. 101 (1988). For copyright purposes, a work is created, and therefore capable of protection, when it is fixed for the first time. 17 U.S.C. 101 (1988). "[I]t makes no difference what the form, manner, or medium of fixation may be - whether it is in words, numbers, notes, sounds, pictures, or any other graphic or symbolic indicia, whether embodied in a physical object in written, printed, photographic, sculptural, punched, magnetic, or any other stable form, and whether it is capable of perception directly or by means of any machine or device 'now known or later developed.'" 1976 U.S. Code Cong. & Admin. News 5659, 5665. The legislative history further says that, "the definition of 'fixation' would exclude from the concepts purely of an evanescent or transitory nature -- reproductions such as those projected briefly on a screen shown electronically on a television or other video display or captured momentarily in the 'memory' of a computer." 17 U.S.C. 102 note (excerpting from House Report 94-1476).

24 Or, more likely, what is on computer medium read by

computer x, such as a magnetic cartridge used for archival records. Further references in the textual discussion to "what is in computer x now" should be understood to include such computer readable media.

25 Cf. Peritz, *Computer Data and Reliability: A Call for Authentication of Business Records Under the Federal Rules of Evidence*, 80 *Nw.U.L.Rev.* 956, 980 (1986) (proof that a printout accurately reflects what is in the computer is too limited a basis for authentication of computer records).

26 In some cases, the electronic transaction will be accomplished by means of a physical transfer of computer readable media. In such a case, this step in the proof would involve proving what was received physically.

27 See generally Peritz, *Computer Data and Reliability: A Call for Authentication of Business Records Under the Federal Rules of Evidence*, 80 *Nw.U.L.Rev.* 956, 979 (1986) (citing as examples of authentication *Ford Motor Credit Co. v. Swarens*, 447 *S.W.2d* 53 (Ky. 1969) (authentication by establishing relationship between computer-generated monthly summary of account activity and the customer reported on); *Ed Guth Realty, Inc. v. Gingold*, 34 *N.Y.2d* 440, 315 *N.E.2d* 441, 358 *N.Y.S.2d* 367 (1974) (authentication of summary of taxpayer liability and the taxpayer)).

28 Of course, a paper document signed at the end also is probative of the fact that no alternations have been made. In this sense, a signature requirement telescopes several steps in the inquiry outlined in the text.

29 *United States v. Linn*, 880 *F.2d* 209, 216 (9th Cir. 1989) (computer printout showing time of hotel room telephone call admissible in narcotics prosecution). See also *United States v. Miller*, 771 *F.2d* 1219, 1237 (9th Cir. 1985) (computer generated toll and billing records in price-fixing prosecution based on testimony by billing supervisor although he had no technical knowledge of system which operated from another office; no need for programmer to testify; sufficient because witness testified that he was familiar with the methods by which the computer system records information).

30 See *United States v. Hutson*, 821 *F.2d* 1015, 1020 (5th Cir. 1987) (remanding embezzlement conviction, although



computer records were admissible under business records exception, despite trustworthiness challenged based on fact that defendant embezzled by altering computer files; access to files offered in evidence was restricted by special code).

31 Restatement (Second) of Contracts \_\_\_ (1981).

32 Cite for when extrinsic evidence is admissible.

33 See Baum & Perritt 2.6; The Electronic Messaging Services Task Force, The Commercial Use of Electronic Data Interchange--A Report and Model Trading Partner Agreement, 45 Bus.Law. 1645 (1990); Jeffrey B. Ritter, Scope of the Uniform Commercial Code: Computer Contracting Cases and Electronic Commercial Practices, 45 Bus.Law. 2533 (1990); Note, Legal Responses to Commercial Transactions Employing Novel Communications Media, 90 Mich.L.Rev. 1145 (1992)

34 Garber v. Harris Trust & Savings Bank, 432 N.E.2d 1309, 1311-1312 (Ill. App. 1982) ("each use of the credit card constitutes a separate contract between the parties;" citing cases).

It is not quite this simple, because both merchant and credit card customer have separate written contracts with the credit card issuer. But there is no reason that a supplier of information to a Digital Library System and all customers of that system might not have their own contracts with the Digital Library System in the same fashion.

35 Rowland v. Union Hills Country Club, 757 P.2d 105 (Ariz. 1988) (reversing summary judgment for country club officers because of factual question whether club followed bylaws in expelling members); Straub v. American Bowling Congress, 353 N.W.2d 11 (Neb. 1984) (rule of judicial deference to private associations, and compliance with association requirements, counseled affirmance of summary judgment against member of bowling league who complained his achievements were not recognized). But see Wells v. Mobile County Board of Realtors, Inc., 387 So.2d 140 (Ala. 1980) (claim of expulsion of realtor from private association was justiciable and bylaws, rules and regulations requiring arbitration were void as against public policy; reversing declaratory judgment for defendant association).

36 F.R.E. 803(6) (excluding business records from inadmissibility as hearsay); 28 U.S.C. 1732 ("Business Records Act" permitting destruction of paper copies of government information reliably recorded by any means and allowing admission of remaining reliable record).

37 See Peritz, Computer Data and Reliability: A Call for Authentication of Business Records Under the Federal Rules of Evidence, 80 Nw.U.L.Rev. 956, 978-80, 984-85 (1986) (noting body of commentator opinion saying that business records exception and authentication are parallel ways of establishing reliability).

38 See F.R.E. 901(b)(4) (appearance, contents, substance, internal patterns, as examples of allowable authentication techniques).

39 Peritz, Computer Data and Reliability: A Call for Authentication of Business Records Under the Federal Rules of Evidence, 80 Nw.U.L.Rev. 956, 963-64 (1986) (identifying steps and trend resulting in F.R.E.).

40 Peritz, Computer Data and Reliability: A Call for Authentication of Business Records Under the Federal Rules of Evidence, 80 Nw.U.L.Rev. 956, 963 (1986).

41 Peritz, Computer Data and Reliability: A Call for Authentication of Business Records Under the Federal Rules of Evidence, 80 Nw.U.L.Rev. 956, 974 (1986) (reporting four requirements of Manual, and endorsing their use generally).

42 See Henry H. Perritt, Jr., \_\_\_, \_\_\_ Jurimetrics \_\_\_ (1993) (distinguishing between format and content standardization).

43 See Marc Lauritsen, \_\_\_ (explaining relationship between substantive legal systems and the field of artificial intelligence).

44 See Thorne, McCarty; Kevin Ashley; and Gardner.

45 It may not be particularly important to limit competition by consumers, because the consumers will never have the pointers and the rest of the network infrastructure.

<b>INFORMATION DISCLOSURE STATEMENT BY APPLICANT</b> ( Not for submission under 37 CFR 1.99)	Application Number		10956121	
	Filing Date		2004-10-04	
	First Named Inventor	Wang		
	Art Unit		3685	
	Examiner Name	Thomas C. West		
	Attorney Docket Number		111325/291300	

U.S.PATENTS							Remove
Examiner Initial*	Cite No	Patent Number	Kind Code <sup>1</sup>	Issue Date	Name of Patentee or Applicant of cited Document	Pages,Columns,Lines where Relevant Passages or Relevant Figures Appear	
	1	5287408		1994-02-15	Samson		
	2	5390297		1995-02-14	Barber et al.		
	3	5553143		1996-09-03	Ross et al.		
	4	5564038		1996-10-08	Grantz et al.		
	5	5625690		1997-04-29	Michel et al.		
	6	5638513		1997-06-10	Ananda		
	7	5414852		1995-05-09	Kramer et al.		
If you wish to add additional U.S. Patent citation information please click the Add button.							Add
U.S.PATENT APPLICATION PUBLICATIONS							Remove

**INFORMATION DISCLOSURE  
STATEMENT BY APPLICANT**  
( Not for submission under 37 CFR 1.99)

Application Number	10956121
Filing Date	2004-10-04
First Named Inventor	Wang
Art Unit	3685
Examiner Name	Thomas C. West
Attorney Docket Number	111325/291300

Examiner Initial*	Cite No	Publication Number	Kind Code <sup>1</sup>	Publication Date	Name of Patentee or Applicant of cited Document	Pages, Columns, Lines where Relevant Passages or Relevant Figures Appear
	1					

If you wish to add additional U.S. Published Application citation information please click the Add button.

**FOREIGN PATENT DOCUMENTS**

Examiner Initial*	Cite No	Foreign Document Number <sup>3</sup>	Country Code <sup>2</sup>	Kind Code <sup>4</sup>	Publication Date	Name of Patentee or Applicant of cited Document	Pages, Columns, Lines where Relevant Passages or Relevant Figures Appear	T <sup>5</sup>
	1	5-100939	JP		1993-04-23			<input type="checkbox"/>

If you wish to add additional Foreign Patent Document citation information please click the Add button.

**NON-PATENT LITERATURE DOCUMENTS**

Examiner Initials*	Cite No	Include name of the author (in CAPITAL LETTERS), title of the article (when appropriate), title of the item (book, magazine, journal, serial, symposium, catalog, etc), date, pages(s), volume-issue number(s), publisher, city and/or country where published.	T <sup>5</sup>
	1	Delaigle, "Digital Watermarking," Spie Conference in Optical Security and Counterfeit Deterrence Techniques, San Jose, CA (Feb. 1996)	<input type="checkbox"/>
	2	Perritt, "Technologies Strategies for Protecting Intellectual Property in the Networked Multimedia Environment," Knowbots, Permissions Headers and Contract Law (Apr. 2 -3 1993)	<input type="checkbox"/>

If you wish to add additional non-patent literature document citation information please click the Add button.

**EXAMINER SIGNATURE**

Examiner Signature	Date Considered
--------------------	-----------------

\*EXAMINER: Initial if reference considered, whether or not citation is in conformance with MPEP 609. Draw line through a citation if not in conformance and not considered. Include copy of this form with next communication to applicant.

**INFORMATION DISCLOSURE  
STATEMENT BY APPLICANT**  
( Not for submission under 37 CFR 1.99)

Application Number	10956121
Filing Date	2004-10-04
First Named Inventor	Wang
Art Unit	3685
Examiner Name	Thomas C. West
Attorney Docket Number	111325/291300

<sup>1</sup> See Kind Codes of USPTO Patent Documents at [www.USPTO.GOV](http://www.USPTO.GOV) or MPEP 901.04. <sup>2</sup> Enter office that issued the document, by the two-letter code (WIPO Standard ST.3). <sup>3</sup> For Japanese patent documents, the indication of the year of the reign of the Emperor must precede the serial number of the patent document. <sup>4</sup> Kind of document by the appropriate symbols as indicated on the document under WIPO Standard ST.16 if possible. <sup>5</sup> Applicant is to place a check mark here if English language translation is attached.

## Electronic Patent Application Fee Transmittal

<b>Application Number:</b>	10956121
<b>Filing Date:</b>	04-Oct-2004
<b>Title of Invention:</b>	System and method for managing transfer of rights using shared state variables
<b>First Named Inventor/Applicant Name:</b>	Xin Wang
<b>Filer:</b>	Marc S. Kaufman/Peaches Thomas
<b>Attorney Docket Number:</b>	111325-291300

Filed as Large Entity

### Utility under 35 USC 111(a) Filing Fees

Description	Fee Code	Quantity	Amount	Sub-Total in USD(\$)
<b>Basic Filing:</b>				
<b>Pages:</b>				
<b>Claims:</b>				
<b>Miscellaneous-Filing:</b>				
<b>Petition:</b>				
<b>Patent-Appeals-and-Interference:</b>				
<b>Post-Allowance-and-Post-Issuance:</b>				
<b>Extension-of-Time:</b>				

Description	Fee Code	Quantity	Amount	Sub-Total in USD(\$)
<b>Miscellaneous:</b>				
Submission- Information Disclosure Stmt	1806	1	180	180
<b>Total in USD (\$)</b>				<b>180</b>

**FILE SYSTEM**

**Publication number:** JP5100939  
**Publication date:** 1993-04-23  
**Inventor:** HAYATA HIROSHI  
**Applicant:** FUJI XEROX CO LTD  
**Classification:**  
 - **international:** G06F12/00; G06F12/00; (IPC1-7): G06F12/00  
 - **European:**  
**Application number:** JP19910213036 19910731  
**Priority number(s):** JP19910213036 19910731

Report a data error here

**Abstract of JP5100939**

**PURPOSE:**To execute read-out and write of a file only from a specific program by deciding an identifier of a program by an identifier of a file management node, and executing the access management by the access right corresponding to the identifier.

**CONSTITUTION:**An access right setting means 13 sets an identifier 11a given to a program of a file 12 as file management information to a file management node 11 for managing the file 12. Also, the access right 11b corresponding to the identifier 11a is registered and set as the access right of the file 12. In such a way, in the case of accessing the file 12 by executing the program, a file access managing means 17 decides an identifier of the program concerned by the identifier 11a set to the file management node 11. Subsequently, by this identifier, the access right 11b registered in the file management node 11 of the file 12 being an access object is discriminated. In accordance with information of this access right 11b, an access of the file 12 is controlled.

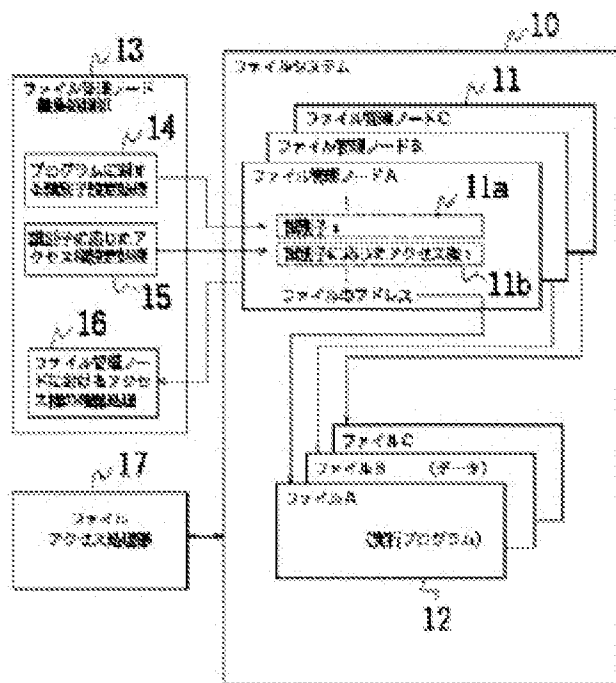

Data supplied from the esp@cenet database - Worldwide



(19) 日本国特許庁 (J P)

(12) 公開特許公報 (A)

(11) 特許出願公開番号

特開平5-100939

(43) 公開日 平成5年(1993)4月23日

(51) Int.Cl.<sup>5</sup>  
G 0 6 F 12/00

識別記号 庁内整理番号  
5 3 7 A 7832-5B

F I

技術表示箇所

審査請求 未請求 請求項の数1(全9頁)

(21) 出願番号 特願平3-213036

(22) 出願日 平成3年(1991)7月31日

(71) 出願人 000005496

富士ゼロックス株式会社  
東京都港区赤坂三丁目3番5号

(72) 発明者 早田 宏

神奈川県川崎市高津区坂戸100番1号K S  
P/R&Dビジネスパークビル 富士ゼロ  
ックス株式会社内

(74) 代理人 弁理士 南野 貞男 (外2名)

(54) 【発明の名称】 ファイルシステム

(57) 【要約】

【目的】 ある特定のプログラムからのみ、ファイルの読み出し、ファイルへの書き込みを可能とするファイルシステムを提供する。

【構成】 ファイル対応のファイル管理ノードに当該ファイルのアクセス権を登録し、ファイル管理ノードに登録したアクセス権により、ファイルアクセスを行うファイルシステムにおいて、ファイル管理ノードに当該ファイルのプログラムに与える識別子と、識別子対応のアクセス権とを登録し、プログラム実行によりファイルをアクセスする場合、ファイル管理ノードの識別子により当該プログラムの識別子を判定し、当該プログラムの識別子により、アクセス対象のファイルのファイル管理ノードの識別子に対応して設定されたアクセス権により、当該ファイルのアクセス管理を行う。

図1

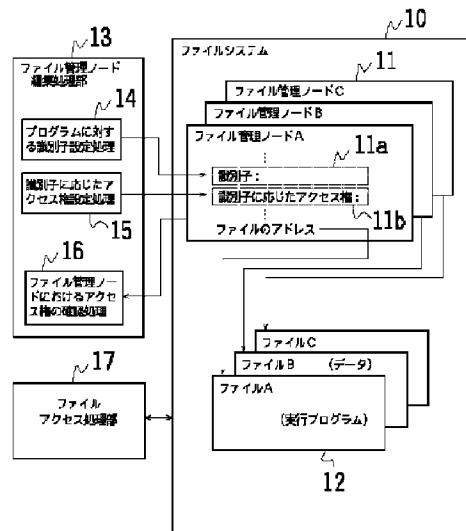

## 【特許請求の範囲】

【請求項1】 各々のファイル対応に設けられるファイル管理ノードに当該ファイルのアクセス権を登録し、ファイル管理ノードに登録したアクセス権により、各々のファイルのアクセスを行うファイルシステムにおいて、ファイル管理ノードに、当該ファイルのプログラムに与える識別子と当該ファイルのアクセス権として更に識別子対応のアクセス権とを登録するアクセス権設定手段と、プログラムの実行によりファイルにアクセスする場合に、ファイル管理ノードの識別子により当該プログラムの識別子を判定し、当該プログラムの識別子により、アクセス対象のファイルのファイル管理ノードに登録された識別子に対応して設定されたアクセス権により、ファイルのアクセスを管理するファイルアクセス管理手段とを含むことを特徴とするファイルシステム。

## 【発明の詳細な説明】

## 【0001】

【産業上の利用分野】本発明は、ファイルシステムに関し、特に、情報処理装置におけるファイルシステムにおいて、アクセス権によるファイル管理機能を有効利用してシステムのセキュリティを高めたファイルシステムに関するものである。

## 【0002】

【従来の技術】従来、情報処理システムにおいて、ある目的を持ったデータの集まりはファイルとして取り扱われ、データ処理がなされる。ファイルはシステム規模が大きくなると、爆発的に増加する。このため、多くの各種のファイルを統一的に取り扱うための手法が開発されている。例えば、ファイル管理は、情報処理装置で取り扱われる各種のファイルを標準的な方法で統一的に管理し、プログラムが簡便な使用方でファイルに関する処理を効率よく、経済的に行える機能を提供する。このようなファイル管理の機能は、オペレーティングシステムの中におけるファイルシステムとして提供される。プログラムは、オペレーティングシステムが提供するファイルシステムのインタフェースを介して、ファイルへの読み出しや書込みを行うことになる。その場合、各々のファイルは、アクセス権によるファイル管理が行なわれ、データ保護、システムの機密保護などが機能できるようになっている。

【0003】例えば、UNIXシステムにおけるファイルシステムでは、ファイルからのデータの読み出しは、readシステムコールで行なわれ、また、ファイルへのデータの書き込みは、writeシステムコールで行なわれる(Maurie J Bach著/坂本文・多田好克・村井純 訳“UNIXカーネルの設計”，1991年6月10日，共立出版発行，pp51～54，pp82～87などを参照)。

【0004】このようなファイルシステムにおいては、ユーザのファイルアクセスリクエストに対してのファイ

ルへの読み出しや書込みの制御は、ファイルに対するアクセス権で管理されている。ファイルのアクセス権に関する情報はiノード(ファイル管理ノード)に設けられ、このiノードにおけるファイル管理情報により管理される。図6はファイル管理ノードであるiノードの一例を説明する図である。iノードは次のようなフィールドから構成される。

ファイル所有者識別子：所有者は個人所有者と「グループ」所有者が分け持ち、ファイルにアクセスする権利を持つ所有者を定義する。

ファイルの種類：ファイルは通常型、ディレクトリ、文字型またはブロック特殊ファイル、FIFO(パイプ)のいずれかである。

ファイルへのアクセス許可：システムは、ファイルの所有者、ファイルのグループ所有者、その他の利用者の3つの等級に従ってファイル保護を行う。各等級に対して当該ファイルの読出し(r)、書込み(w)、実行(x)に関するアクセス権を持ち、個々に設定する。例えば、ディレクトリのファイルは、実行できないため、

ディレクトリに対する実行許可では、当該ディレクトリの中でファイル名を探す権利を有することを意味する。

ファイルへのアクセス時刻：ファイルを最後に更新した時刻、最後にアクセスした時刻、iノードを最後にアクセスした時刻を示す。

ファイル内のデータにディスクアドレスに関するアドレス表：利用者はファイル中のデータをバイトの論理ストリームとして扱うが、システムのカーネルはデータを不連続なディスクブロックとして管理する。iノードはファイルのデータを含むディスクブロックを識別する。

ファイルの大きさ：ファイル中のデータは、バイト0から始まるファイルの最初から数えたバイト数でアドレス指定することができる。このファイルの大きさは、ファイル中のデータの最高のバイト変位よりも1だけ大きい。例えば、利用者があるファイルを作成し、ファイルのバイト変位1000のところから1バイトのデータを書込んだ場合、ファイルの大きさは1001バイトとなる。

【0005】例えば、図6に示すiノードの例は、“MJB”が所有する通常型のファイルのiノードの例である。このファイルは6030バイトのデータを含んでおり、許可モード(アクセス権)として“rwxr-xr-x”の9桁の文字データを設定している。ここでの最初の3桁の文字“rwx”により、ファイルシステムは所有者“MJB”に対して、ファイルの読出し、書込み、実行を許可していることを意味している。また、次の3桁の文字“r-x”により、“OS”というグループのメンバーに対し、ファイルシステムは当該ファイルの読出しと実行のみを許可していることを意味し、そして、最後の3桁の文字“r-x”により、他の利用者に対して、ファイルシステムは当該ファイルの読出しと実

3

行のみを許可することを意味している。。このため、“OS”というグループのメンバーと他の利用者は、当該ファイルに対して、ファイルの読出しと実行だけが可能であり、書込みはできない。

【0006】また、iノードでは、最終アクセス時刻、最終更新時刻などの時刻情報を保持して、ファイルを管理している。この例のiノードでは、最後に誰かがこのファイルを読み出したのは1990年10月23日午後1時45分であり、最後に誰かがこのファイルに書込みをしたのは1990年10月22日午後10時30分であるという管理情報が保持されている。

【0007】このように、UNIXシステムのファイルシステムでは、各々のファイルに1対1に設けられたファイル管理ノード(iノード)を用い、そのファイル管理ノードに当該ファイルのアクセス権、所有者などのファイル管理情報を設定し、当該ファイルを管理している。

【0008】

【発明が解決しようとする課題】ところで、ファイルシステムでは、上述のように、ファイル管理ノードに設定する当該ファイルのアクセス権、所有者などのファイル管理情報により、当該ファイルが管理されているため、利用者がアクセス権さえ、何らの方法により持てば、同じファイルを複数のプログラムから読み出したり、書込んだりできることになる。このようなファイルシステムを用いて、例えば、データベース管理システムのような特定のプログラムからのみファイルへの読み出しや書込みを行い、一般のプログラムからは読み出しのみしか行えないようなシステムを構成する場合には、上述のようなファイル管理機能では、その対応のプログラムを実現する上で不具合が生ずることになる。

【0009】本発明は、上記のような問題点を解決するためになされたものであり、本発明の目的は、ある特定のプログラムからのみファイルの読出し、ファイルへの書込みを可能とするファイルシステムを提供することにある。

【0010】

【課題を解決するための手段】上記の目的を達成するため、本発明のファイルシステムは、各々のファイル対応に設けられるファイル管理ノード(11;図1)に当該ファイル(12;図1)のアクセス権を登録し、ファイル管理ノードに登録したアクセス権により、各々のファイルのアクセスを行うファイルシステムにおいて、ファイル管理ノード(11;図1)に、当該ファイルのプログラムに与える識別子と当該ファイルのアクセス権として更に識別子対応のアクセス権とを登録するアクセス権設定手段(13;図1)と、プログラムの実行によりファイルをアクセスする場合に、ファイル管理ノードの識別子により当該プログラムの識別子を判定し、当該プログラムの識別子により、アクセス対象のファイルのファ

4

イル管理ノードに登録された識別子に対応して設定されたアクセス権により、ファイルのアクセスを管理するファイルアクセス管理手段(17;図1)とを含むことを特徴とする。

【0011】

【作用】ファイルシステムにおいては、各々のファイル対応に設けられるファイル管理ノード(11)に当該ファイル(12)のアクセス権を登録し、ファイル管理ノードに登録したアクセス権によって、各々のファイルのアクセス権が管理され、ファイルのアクセス制御が行なわれる。このようなファイルシステムにおいて、アクセス権設定手段(13)と、ファイルアクセス管理手段(17)とが設けられる。アクセス権設定手段(13)は、ファイルを管理するためのファイル管理ノード(11)に、ファイル管理情報として、当該ファイルのプログラムに与える識別子を設定し、更にファイルのアクセス権として、識別子対応のアクセス権とを登録設定する。これにより、ファイルアクセス管理手段(17)は、プログラムの実行によりファイルをアクセスする場合、ファイル管理ノードに設定した識別子により当該プログラムの識別子を判定し、当該プログラムの識別子により、アクセス対象のファイルのファイル管理ノードに登録された識別子に対応して設定されたアクセス権を判別し、当該アクセス権の情報に従って、ファイルのアクセスを行うアクセス制御を行う。

【0012】このように、実行プログラムのファイルからは、プログラム実行にかかるファイルアクセス要求が発行された場合、当該プログラムの識別子が判定され、その識別子に対応して設定されているアクセス権によりファイルアクセス制御が行なわれる。これにより、単にファイル所有者、利用者に対して設定されているアクセス権によるファイルアクセス制御のみでなく、実行プログラムのレベルでのアクセス権でのファイルのアクセス制御が可能となり、ファイル操作、ファイル処理、ファイル管理などシステム構築の自由度が大きくなり、また、システムの安全性を配慮したシステム構成が容易に実現可能となる。

【0013】

【実施例】以下、本発明の一実施例を図面により具体的に説明する。図1は本発明の一実施例にかかるファイルシステムの要部構成を説明するブロック図である。図1において、10はファイルシステム、11は各々のファイル管理ノード、12は各々のファイルを示している。各々のファイル12とファイル管理ノード11とは1対1に対応している。ファイルAに対してはファイル管理ノードAが対応し、ファイルBに対してはファイル管理ノードBが対応し、また、ファイルCに対してはファイル管理ノードCが対応している。ファイル管理ノード12には自己が管理する該当のファイルにおける実行プログラムに対して、識別子を設定するため識別子フィール

ド11aと、識別子に応じたアクセス権を設定するための識別子アクセス権フィールド11bが設けられている。

【0014】このようなファイル管理ノード12に対して、識別子、識別子に応じたアクセス権などを個別に設定し、また、設定したファイル管理情報の確認を行うため、ファイル管理ノード編集処理部13が設けられる。このファイル管理ノード編集処理部13の処理機能により、プログラムに対する識別子設定処理14、識別子に応じたアクセス権設定処理15、ファイル管理ノードにおけるアクセス権確認処理16などが行なわれる。

【0015】また、このように設定されたファイル管理ノードにおけるファイル管理情報を用いて、ファイルアクセス処理を行う場合のファイルアクセス制御を行うため、ファイルアクセス処理部17がシステム内に設けられる。

【0016】図2は、ファイルシステムにおけるファイル管理ノードと各ファイルの関係をファイル管理情報のデータ例と共に説明する図である。データファイルのファイル管理ノードの例を図2(A)に示し、実行プログラムファイルのファイル管理ノードの例を図2(B)に示している。各ファイル管理ノードは、従来のファイルシステムにおけるファイル管理ノードと同様に、ファイル所有者、ファイル所有者のグループ、ファイルの最終アクセス時刻、ユーザに応じたアクセス権、ファイルの実体のディスク上の位置を示すディスクのアドレスなどのファイル管理情報を保持しており、ここでは、更に、プログラムに与えられる識別子、プログラムに応じたアクセス権のファイル管理情報が付加される。

【0017】ファイル内容がデータであるファイル21に対するファイル管理ノード20には、ファイル管理情報として、所有者“Hayata”，グループ“FXKSP”，最終アクセス時刻“Apr. 5 1991 19:00:00”，最終変更時刻“Apr. 4 1991 12:30:00”，ユーザに応じたアクセス権“rwxr-xr-x”，プログラムに応じたアクセス権“(100rwx)(101r--)(102r-x)”，プログラムに与えられる識別子“0”，ディスクのアドレス“12345”が設定されている。

【0018】ファイル内容が実行プログラムであるファイル23に対するファイル管理ノード22には、ファイル管理情報として、所有者“Hayata”，グループ“FXKSP”，最終アクセス時刻“Apr. 3 1991 19:00:00”，最終変更時刻“Apr. 3 1991 12:30:00”，ユーザに応じたアクセス権“rwxr-xr-x”，プログラムに応じたアクセス権“0”，プログラムに与えられる識別子“100”，ディスクのアドレス“22345”が設定されている。

【0019】この例では、データファイルのファイルA

(21)に関して、そのファイル管理情報であるプログラムに応じたアクセス権として、“(100 rwx)(101 r--)(102 r-x)”が設定されている。この設定のプログラムに応じたアクセス権の意味は、識別子100のプログラムについては、読出し、書込み、実行を許可し、識別子101のプログラムについては、読出しのみを許可し、また、識別子102のプログラムについては、読出し、実行を許可し、書込みは許可しない。それら以外のプログラムについては、読出しも、書込みも、実行も許可しないことを意味している。なお、ファイルAの識別子フィールドは“0”となっており、実行形式ファイルの実行プログラムファイルでないため、ファイルAには識別子は与えられていない。

【0020】また、実行プログラムファイルのファイルBに関しては、そのファイル管理情報であるプログラムに与えられる識別子として“100”が設定されており、このファイルBにおけるプログラムには識別子100が与えられることを示している。また、ファイルBは、データファイルではないので、プログラムに応じたアクセス権のファイル管理情報は設定されておらず、当該フィールドの各々の識別子に応じたアクセス権の情報は与えられていない。

【0021】図3は、ファイル管理ノードのファイル管理情報を用いてファイルアクセス時に行なわれるアクセス権チェック処理の一例を示すフローチャートである。この処理は、ファイルアクセス処理部(17;図1)により行なわれる。このアクセス権チェック処理では、まず、ステップ31において、実行プログラムファイルに対するファイル管理ノードを得ると、次に、ステップ32において、ファイル管理ノードからプログラムに与えられた識別子IDを得る。次に、ステップ33において、読み出し対象ファイルのファイル管理ノードを得る。そして、次のステップ34において、ファイル管理ノードからプログラムに応じたアクセス権データAを読み出す。次に、ステップ35において、読み出したアクセス権データAの中からプログラム識別子IDに対応するアクセス権ACを得る。そして、次のステップ36において、アクセス権ACの内容の判別を行い、アクセス権に応じたアクセス処理を行う。すなわち、アクセス権ACにread許可がある場合には、当該ファイル読出しが可能なので、リターン処理を行い、ファイルアクセスを行っているREADシステムコールのメインルーチンに戻る。アクセス権ACにread許可がない場合には、当該ファイル読出しが不可なので、エラーリターン処理を行い、ファイルのリードエラー処理を行う。

【0022】このようにして、プログラムの実行中にファイルがアクセスがなされた場合、当該実行プログラムに与えられている識別子に対応のファイル管理ノードから得て、この識別子よりアクセス対象のファイル管理ノードから、識別子対応のアクセス権(プログラムに応じ

たアクセス権)を得て、このアクセス権により、ファイルアクセスを行うファイル管理を行う。これにより、アクセス権情報によるアクセス管理は、単にファイル所有者、利用者に対して設定されているアクセス権によるファイルアクセス制御のみでなく、実行プログラムのレベルでのアクセス権でのファイルのアクセス制御が可能となる。また、ファイル処理、ファイル操作にかかるシステム構築の自由度が大きくなり、システムの安全性を配慮したシステム構成が容易に実現可能となる。

【0023】次に、このようなファイルシステムに用いられるファイル管理ノードにおけるファイル管理情報を設定し、確認するための処理機能要素について説明する。前述したように、ここでは、ファイル管理ノードに対して、識別子、識別子に応じたアクセス権などを個別に設定し、また、設定したファイル管理情報の確認を行うため、ファイル管理ノード編集処理部(13;図1)が設けられている。このファイル管理ノード編集処理部の各々の処理機能により、プログラムに対する識別子設定処理、識別子に応じたアクセス権設定処理、ファイル管理ノードにおけるアクセス権確認処理などが行なわれる。

【0024】図4はファイル管理ノードに対するプログラム識別子設定処理を示すフローチャートであり、また、図5はファイル管理ノードに対するプログラム対応のアクセス権設定処理を示すフローチャートである。例えば、図4に示すファイル管理ノードに対するプログラム識別子設定処理では、まず、ステップ41において、ファイル名から対応するファイル管理ノードを得て、次のステップ42で、このファイル管理ノードに対してプログラムに与える識別子をセットする。具体的には、例えば、ファイル毎のファイル管理ノードに、当該ファイルの識別子を設定する手続き関数として、次のような関数形式のプログラムset\_idを作成して実行する。

set\_id(ファイル名, 識別子)

set\_idは、実行プログラムであるファイル名ならびに識別子を引数としてとり、指定したファイル名のファイル管理ノードに指定した識別子を書き込む処理を行う手続き関数である。

【0025】また、図5に示すファイル管理ノードに対するプログラム対応のアクセス権を設定する処理では、まず、ステップ51において、ファイル名から対応するファイル管理ノードを得て、次のステップ52において、このファイル管理ノードに対して、識別子とそれに応じたアクセス権データをセットする。具体的には、例えば、ファイル毎のファイル管理ノードに対し、識別子(プログラム)に応じたアクセス権を設定する手続き関数として、次のような関数形式のプログラムchapmodを作成して実行する。

chapmod(ファイル名, 識別子, アクセス権)

chapmodは、ファイル名、識別子ならびにアクセス権を

引数として取り、指定したファイル名に対応するファイル管理ノードに、指定した識別子に応じとそれに対応したアクセス権の情報を書き込む処理を行う手続き関数である。

【0026】また、ファイルアクセスを行う上でのファイル毎の各々の識別子に応じたアクセス権を確認する機能コマンドは、ファイルの読出し、書込みなどのファイルアクセスを行うreadや、writeなどのシステムインタフェース機能を用いることにより実行する。すなわち、システムにおけるファイルインタフェース機能を用いて、従来からユーザ対応に設定したアクセス権の確認処理と同様にして、プログラム(識別子)に対応して設定したアクセス権の確認を行う。

【0027】以上説明したように、本実施例のファイルシステムによれば、実行プログラムのファイルに識別子を与えて、当該ファイルのプログラムに対応する識別子を設定しておき、また、アクセス対象のデータのファイルには、識別子に応じたアクセス権を与えておく。これにより、プログラム実行により、データファイルへのアクセスが行なわれる場合、実行プログラムのファイルに設定された識別子により、プログラムに設定された識別子を判定し、この識別子に基づいて、データファイルの識別子対応のアクセス権を判定する。そして、このアクセス権によりファイルアクセス制御を行う。これにより、ファイル管理を、ユーザーレベルだけでなく、プログラムレベルにおいても同様に行うことができる。また、プログラム毎に一意の識別子を与えることにより、特定のプログラムからのみのアクセスの制御を可能とするファイルが実現できる。

【0028】

【発明の効果】以上に説明したように、本発明によれば、実行プログラムのファイルからは、プログラム実行にかかるファイルアクセス要求が発行された場合、ファイル管理ノードから当該プログラムの識別子が判定され、データファイルのファイル管理ノードにその識別子に対応して設定されているアクセス権によりファイルアクセス制御が行なわれる。これにより、単にファイル所有者、利用者に対して設定されているアクセス権によるファイルアクセス制御のみでなく、実行プログラムのレベルでのアクセス権でのファイルのアクセス制御が可能となる。また、ファイル操作、ファイルの管理などのシステム構築の自由度が大きくなり、システムの安全性を配慮したシステム構成が容易に実現可能となる。

【図面の簡単な説明】

【図1】 図1は本発明の一実施例にかかるファイルシステムの要部構成を説明するブロック図、

【図2】 図2はファイルシステムにおけるファイル管理ノードと各ファイルの関係をファイル管理情報のデータ例と共に説明する図、

【図3】 図3はファイル管理ノードのファイル管理情

報を用いてファイルアクセス時に行なわれるアクセス権  
チェック処理の一例を示すフローチャート、

【図4】 図4はファイル管理ノードに対するプログラ  
ム識別子設定処理を示すフローチャート、

【図5】 図5はファイル管理ノードに対するプログラ  
ム対応のアクセス権

【図6】 図6はファイル管理ノードであるiノードの  
一例を説明する図である。

【符号の説明】

10…ファイルシステム、11…ファイル管理ノード、  
11a…識別子フィールド、11b…識別子アクセス権  
フィールド、12…ファイル、13…ファイル管理ノ  
ード編集処理部、17…ファイルアクセス処理部、20…  
ファイル管理ノードA、21…ファイルA（データファ  
イル）、22…ファイル管理ノードB、21…ファイル  
B（実行プログラムファイル）。

【図1】

図1

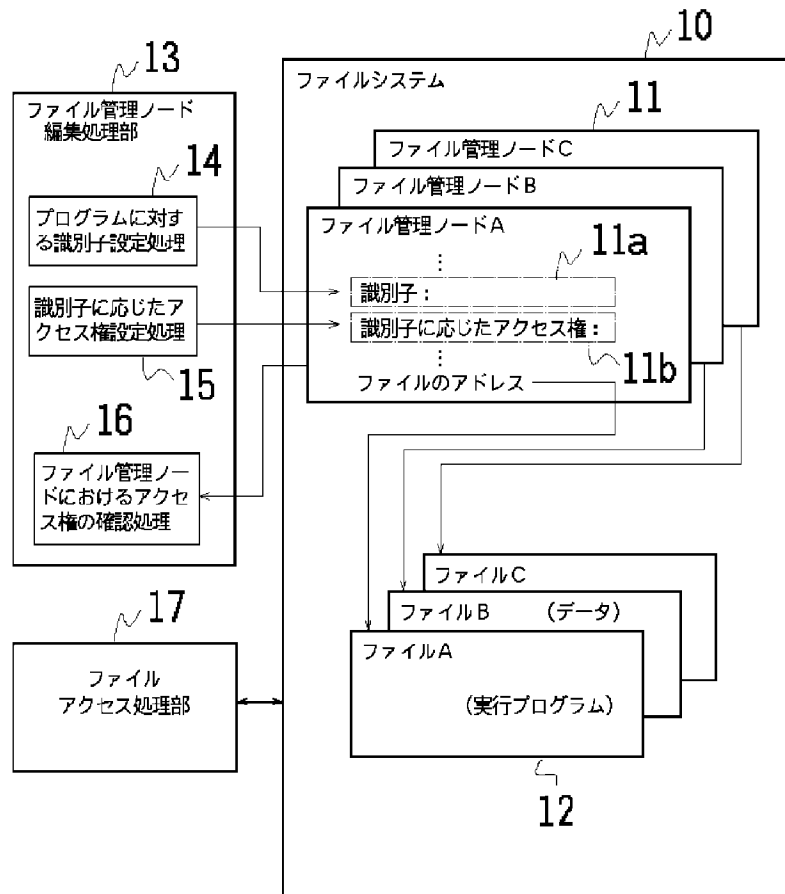

【図2】

図2 (A)



図2 (B)



【図4】

図4

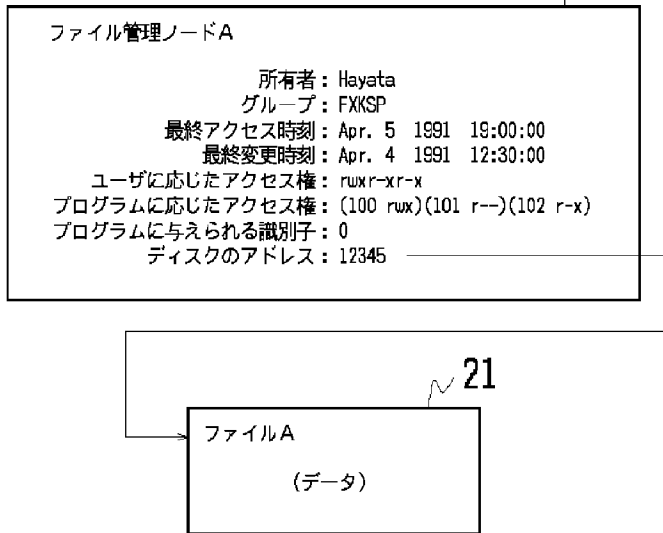
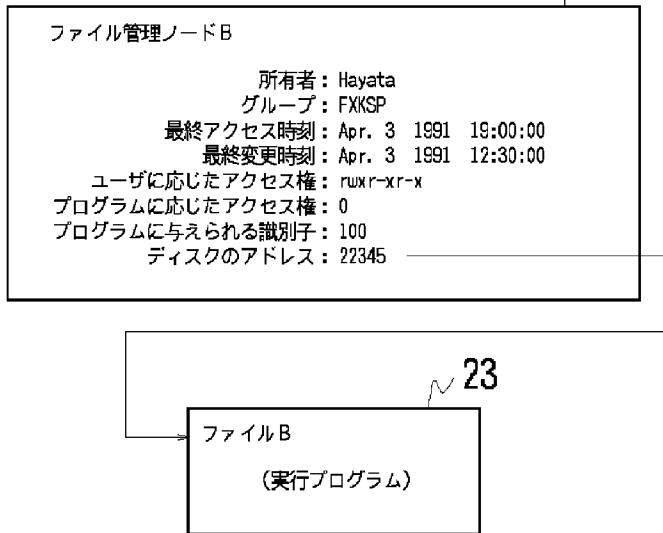
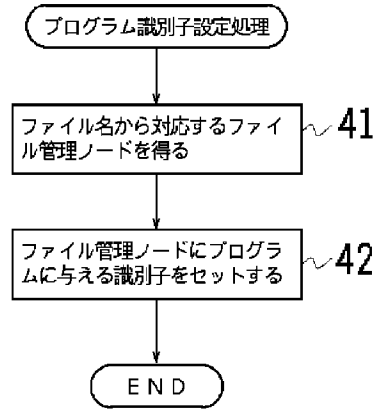

【図5】

図5

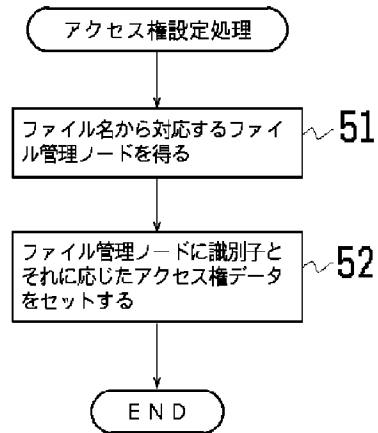

【図3】

図3

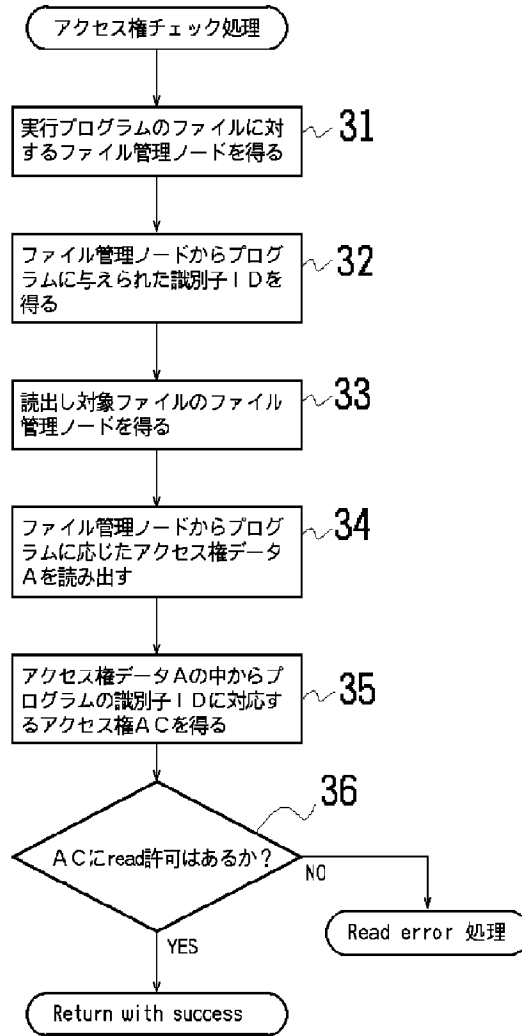



【図6】

## 図6

iノード	
	所有者: MJB
	グループ: OS
	ファイル種類: 通常ファイル型
	許可モード: rwxr-xr-x
	最終アクセス時刻: Oct. 23 1990 1:45 P.M.
	最終変更時刻: Oct. 22 1990 10:30 A.M.
	iノードの最終更新時刻: Oct. 23 1990 1:30 P.M.
	大きさ: 6030バイト
	ディスクのアドレス:

## Electronic Acknowledgement Receipt

<b>EFS ID:</b>	4096761
<b>Application Number:</b>	10956121
<b>International Application Number:</b>	
<b>Confirmation Number:</b>	8924
<b>Title of Invention:</b>	System and method for managing transfer of rights using shared state variables
<b>First Named Inventor/Applicant Name:</b>	Xin Wang
<b>Customer Number:</b>	22204
<b>Filer:</b>	Marc S. Kaufman/Peaches Thomas
<b>Filer Authorized By:</b>	Marc S. Kaufman
<b>Attorney Docket Number:</b>	111325-291300
<b>Receipt Date:</b>	10-OCT-2008
<b>Filing Date:</b>	04-OCT-2004
<b>Time Stamp:</b>	15:47:57
<b>Application Type:</b>	Utility under 35 USC 111(a)

### Payment information:

Submitted with Payment	yes
Payment Type	Deposit Account
Payment was successfully received in RAM	\$180
RAM confirmation Number	1100
Deposit Account	192380
Authorized User	

### File Listing:

Document Number	Document Description	File Name	File Size(Bytes)/ Message Digest	Multi Part /.zip	Pages (if appl.)
-----------------	----------------------	-----------	-------------------------------------	------------------	------------------

1	Foreign Reference	JP_05100939.pdf	609457	no	10
			bbd745e5ccc6a7e23c3d4e26147ee093a0b6b625c		
<b>Warnings:</b>					
<b>Information:</b>					
2	NPL Documents	Delaigle_Digital_1996.pdf	542236	no	12
			533b2ba855f0906f13954d8ccf50c5d04442e485		
<b>Warnings:</b>					
<b>Information:</b>					
3	NPL Documents	Perritt_Technologies_1993.pdf	472130	no	31
			a44b784949bd53b5754a3b65fa1f8c23c249b8e4		
<b>Warnings:</b>					
<b>Information:</b>					
4	Information Disclosure Statement (IDS) Filed (SB/08)	2008-10-10_-_PTOSB08_111325_291300.pdf	727541	no	5
			dd682f6dc2ff84e7b16cc328a4de52b6f46c925e		
<b>Warnings:</b>					
<b>Information:</b>					
5	Fee Worksheet (PTO-06)	fee-info.pdf	30023	no	2
			b91d560fdac5b31887c6f877194ff15084b58510		
<b>Warnings:</b>					
<b>Information:</b>					
<b>Total Files Size (in bytes):</b>			2381387		

**This Acknowledgement Receipt evidences receipt on the noted date by the USPTO of the indicated documents, characterized by the applicant, and including page counts, where applicable. It serves as evidence of receipt similar to a Post Card, as described in MPEP 503.**

**New Applications Under 35 U.S.C. 111**

**If a new application is being filed and the application includes the necessary components for a filing date (see 37 CFR 1.53(b)-(d) and MPEP 506), a Filing Receipt (37 CFR 1.54) will be issued in due course and the date shown on this Acknowledgement Receipt will establish the filing date of the application.**

**National Stage of an International Application under 35 U.S.C. 371**

**If a timely submission to enter the national stage of an international application is compliant with the conditions of 35 U.S.C. 371 and other applicable requirements a Form PCT/DO/EO/903 indicating acceptance of the application as a national stage submission under 35 U.S.C. 371 will be issued in addition to the Filing Receipt, in due course.**

**New International Application Filed with the USPTO as a Receiving Office**

**If a new international application is being filed and the international application includes the necessary components for an international filing date (see PCT Article 11 and MPEP 1810), a Notification of the International Application Number and of the International Filing Date (Form PCT/RO/105) will be issued in due course, subject to prescriptions concerning national security, and the date shown on this Acknowledgement Receipt will establish the international filing date of the application.**

# Digital watermarking

J.-F. Delaigle, C. De Vleeschouwer, B. Macq

Laboratoire de Télécommunications et Télédétection  
Université catholique de Louvain  
Bâtiment Stévin - 2, place du Levant  
B-1348 Louvain-la-Neuve  
Tel.: +32 10 47.80.72 - Fax: +32 10 47.20.89  
E-mail: delaigle@tele.ucl.ac.be

## ABSTRACT

This paper presents a process able to mark digital pictures with an invisible and undetectable secret information, called the watermark. This process can be the basis of a complete copyright protection system. The process first step consists in producing a secret image. The first part of the secret resides in a basic information that forms a binary image. That picture is then frequency modulated. The second part of the secret is precisely the frequencies of the carriers. Both secrets depends on the identity of the copyright owner and on the original picture contents. The obtained picture is called the stamp. The second step consists in modulating the amplitude of the stamp according to a masking criterion stemming from a model of human perception. That too theoretical criterion is corrected by means of morphological tools helping to locate in the picture the places where the criterion is supposed not to match. This is followed by the adaptation of the level of the stamp at that places. The so formed watermark is then added to the original to ensure its protection. That watermarking method allows the detection of watermarked pictures in a stream of digital images, only with the knowledge of the picture owner's secrets.

**Keywords:** copyright protection, watermark, secret key, masking, human vision model, perceptive components, morphology, robustness, detection, correlation.

## 1 GENERAL INTRODUCTION

With the increasing availability of digitally stored information and the development of new multimedia services, security questions are becoming even more urgent. The acceptance of new services depends on whether suitable techniques for the protection of the work providers' interests are available.<sup>1</sup>

Moreover the nature of digital media threatens its own viability:

- First the replication of digital works is very easy and, what is more dangerous, really perfect. The copy is identical to the original.

- The ease of transmission and multiple uses is very worrying, too. Once a single pirate copy has been made, it is instantaneously accessible to anyone who wants it, without any control of the original picture owner.
- Eventually the plasticity of digital media is a great menace. Any malevolent user (*a pirate*) can modify an image at will. Such manipulations are really easy for a pirate and put many copyright protection methods at risk.

According to these considerations the conception of a copyright protection system is really vital and it constitutes a great challenge, because it should cope with all these threats. Without watermarking, most authors will not dare to broadcast their work.

This paper presents an additive watermarking technique. It consists in producing a synthetic picture (also called the stamp) which holds informations about the ownership of the original image and depends on the picture contents. That stamp is added to the original in a way that resulting picture is perceptually identical to the original one and so that the stamp is undetectable by a pirate computer. The aim of that technique is not the authentication of the picture content nor the identification of the owner. It is to allow a controller (i.e. the owner's computer or a Trusted Third Part) to find out watermarked pictures in a stream of images with the knowledge of the owner's secret key in order to detect broadcast of illegal copies.

The most interesting part of that method is the embedding process i.e. the weighting of each pixels of the stamp before adding it to the original. This is based on the masking concept coming from a model of human vision (the perceptive model). From this concept was deduced a method which reveals itself actually efficient. Another interesting part is the presentation of two methods used for the detection of watermarked pictures without the original. This last point is fundamental for the management of the copyright protection. Eventually this paper ends with the analyse of the results and the system robustness.

## 2 THE MASKING

### 2.1 Introduction

The aim of a watermarking technique is to provide an invisible embedding of a secret information, the watermark. This watermark must be masked (hidden) by the picture it is inlaid in. Precisely a master thesis has led to a masking criterion deduced from physiological and psychophysical studies.<sup>2</sup> Nevertheless, this theoretical criterion having been formulated for monochromatic signals, it had to be adapted to suit real images.

### 2.2 The perceptive model: approximation of the eye functioning

It is now admitted that the retina of the eye splits an image in several components. These components circulate from the eye to the cortex by different tuned channels, one channel being tuned to one component.

The characteristics of one component are:

- the location in the visual field (in the image).
- the spatial frequency (in the Fourier domain: the amplitude in polar coordinates).
- the orientation (in the Fourier domain: the phase in polar coordinates)

So, one perceptive channel can only be excited by one component of a signal whose characteristics are tuned to its. Components that have different characteristics are independent.

### 2.3 The masking concept

According to perceptive model of human vision,<sup>3</sup> signals that have same (near) components take the same channels from the eye to the cortex. It appears that such signals interact and are submitted to non-linear effects. The masking is one of those effects.

**Definition:** *the detection threshold* is the minimum level below which a signal can not be seen.

**Definition:** *the masking* occurs when the detection threshold is increased because of the presence of another signal.

In other words, there is masking when a signal can not be seen because of another with near characteristics and at a higher level.

### 2.4 The masking model

With the object of modalizing the masking phenomenon, tests have been made on monochromatic signals, also called *gratings*. It appears that the eye is sensitive to the contrast of those gratings. This contrast is defined by:

$$C = \frac{2(Lmax - Lmin)}{Lmax + Lmin} \tag{1}$$

where L is the luminance.

It is possible to determine experimentally the detection threshold of one signal of contrast  $C_s$  with respect to the contrast  $C_m$  of the masking signal. That threshold can be modalized as follows:

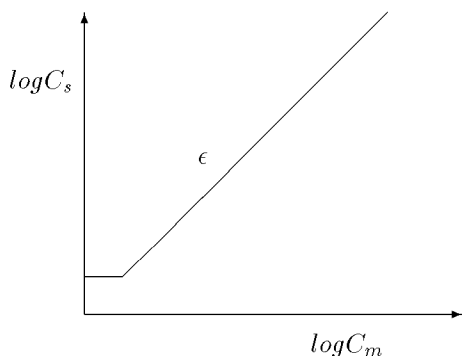

Such bilogarithmic curves are traced for signals of one single frequency and one orientation  $(f_0, \theta_0)$ . The expression of the detection threshold is thus:

$$C_s = \max[C_0, C_0 \left(\frac{C_m}{C_0}\right)^\epsilon] \tag{2}$$

where  $\epsilon$  (the slope) depends on  $(f_0, \theta_0)$ , typically,  $0.6 \leq \epsilon \leq 1.1$ .

It is possible to extend that expression to introduce frequency dependence. The general expression of the detection threshold is becomes:

$$C_s(C_m, f, \theta) = C_0 + k_{(f_0, \theta_0)}(f, \theta)[C_{s(f_0, \theta_0)}(C_m) - C_0] \quad (3)$$

where:

$$k_{(f_0, \theta_0)}(f, \theta) = \exp\left[-\left(\frac{\log^2\left(\frac{f}{f_0}\right)}{F^2(f_0)} + \frac{(\theta - \theta_0)^2}{\Theta^2(f_0)}\right)\right] \quad (4)$$

In that expression,  $f_0$  and  $\theta_0$  are relevant to the masking signal,  $f$  and  $\theta$  are relevant to the masked signal,  $F(f_0)$  and  $\Theta(f_0)$  are parameters that represent the spreading of the Gaussian function,  $C_0$  is often negligible. The spread of the gaussian function depends upon the frequency  $f_0$ : For frequency, typical bandwidth at half response are 2,5 octaves at 1 c/d and 1,5 octaves at 16 c/d with a linear decrease between both frequencies.<sup>4</sup> For orientation, half bandwidth at half response depends on  $f_0$  and it takes typical values like 30 degrees at 1 c/d and 15 degrees at 16 c/d.<sup>5</sup>

After this expression, the frequency dependence of the detection threshold has a Gaussian form. Only near frequency signals can interact. When the frequency of the masking signal (the mask) is far from this of the signal to mask, the detection threshold is almost equal to  $C_0$ .

## 2.5 The masking criterion

It is important to notice that those results concern only gratings signals. To deduce a masking criterion that will apply to signals like real images, the preceding masking condition has to be adapted. So, it is necessary to define a new concept able to take the place of the contrast, because the contrast is not define for real images. That new concept,<sup>2</sup> is the *local energy*.

The local energy is defined on narrowband signals centered around one frequency and one orientation. A picture which is a broadband signal is first filtered by Gabor narrowband filters, whose characteristics are near to human perception. The local energy around one frequency and one orientation is calculated following the scheme presented in this figure:

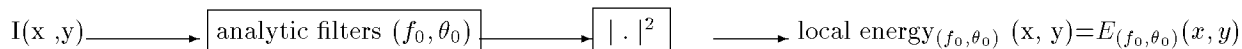

**The masking criterion:** If the local energy of one picture is less than the local energy of the mask, around all the frequencies  $(f_0, \theta_0)$  and for each pixel  $(x, y)$ , then one can say that the picture is masked by the mask. Strictly, a picture is masked by a mask if  $\forall(x, y)$  and  $\forall(f_0, \theta_0), E_{mask, (f_0, \theta_0)}(x, y) \geq E_{picture, (f_0, \theta_0)}(x, y)$ . For real images, a good approximation of this criterion can be obtained by using a bank of filters whose central frequencies correspond to independent components and which are spread on all the Fourier space. It is admitted that 4 or 5 frequencies and 4 to 9 orientations are sufficient. The standard choice is twenty filters (5 frequencies and 4 orientations).



Figure 1: Example of basic information used

## 2.6 Conclusion

This section has led to the expression of an easily implementable masking criterion applicable to any image. But this criterion is only an extension of a theoretic criterion applicable to monochromatic signals. Thus cases where that criterion does not match are possible.

# 3 PRINCIPLE OF THE SYSTEM

## 3.1 Basic information of the watermark

This information is a binary picture looking like a modified checkerboard (figure 1). As explained later, the pixels value of the square forming that picture can correspond to a binary sequence deduced from the copyright owner's (CO) *secrete key*.

## 3.2 The stamp

In order to take advantage of the eye behaviour, the basic information is modulated at different frequencies and orientations corresponding to rather independent components. Moreover, we take care to filter the initial checkerboard with a low pass filter (LPF) (i.e. a Butterworth LPF) so that the resulting signal is bandlimited. This point is very important because it permits to limit the verification of the masking criterion in the corresponding channel.

The position of the modulating carriers is *secret*. It can be deduced from CO's secret key. In practice, the frequency plan is divided into sectors. Each sector is relevant to one perceptive component and defined a group of couples  $(f, \theta)$  where basic information can be modulated. Only one couple is chosen for each sector (because couples of a same sector don't stimulate independent components). The picture obtained from the sum of each modulated grid is called *the stamp*  $S(x, y)$ .

$$S(x, y) = \sum_{j \in K} G(x, y) \cdot \cos(f_{x_j} \cdot x + f_{y_j} \cdot y) \quad (5)$$

$K$  represents the set of sectors and  $(f_{x_j}, f_{y_j})$  correspond to the couple chosen in sector  $j$  ( this couple is designed by the CO's *secrete key*).



### 3.3 The position of the process in a global copyright scheme

The process should be placed in a copyright protection scheme like drawn at figure 2. The skeletization function consists in an image processing program extracting essential characteristics from an image. The result is a bitstream. This must be followed by a *hash-function*<sup>6</sup> whose result is a succession of blocks of bits. Every block has the same length. The skeletization function gives the same result for two near images (i.e. original image and watermarked image). But the H-function always gives different results from different bitstreams as inputs. So, the inscription keys will be different for perceptually distinct pictures. After the H-function, the ciphering function is a trapdoor function.<sup>6</sup> Thanks to this function the inscription keys used to deduce the basic grid and the position of the carriers depends on the CO's secret key. The aim of the use of a trapdoor function is to prevent someone from reproducing the same inscription keys with the knowledge of the H-function result. But it is possible for anyone to inverse that trapdoor function and to find the H-function result from the inscription keys. It can be interesting in a proof procedure.

## 4 IMPLEMENTATION

### 4.1 Inscription

The purpose of the inscription is to adapt the level of each part of the stamp ( for all frequencies ) to make it invisible once added to the picture. As mentioned above, each part of the stamp is narrow band. Inscriptions at different frequencies are thus independent and one can treat the different components of the stamp one at a time. For each frequency designed by the inscription keys, the procedure is divided in three steps : the modulation, the regulation of the level and the correction.

- Modulation

The first step consists in the modulation of the particular carrier by the lowpass grid  $G(x, y)$ . The result is  $G(x, y) \cdot \cos(f_{x_j} \cdot x + f_{y_j} \cdot y)$ , where  $f_{x_j}$  and  $f_{y_j}$  are the carrier position.

- Regulation of the level

According to the perceptual model, in order to guarantee the invisibility of the watermark its local energy has to be inferior to the picture local energy for each pixel around the inscription frequency. A way to reach this objective is to multiply the modulated grid by a weighting mask  $Weight_j(x, y)$  reducing the amplitude of the stamp where energy in the corresponding component of the original picture is weak. Nevertheless, one must take care to keep the narrow band characteristic of the resulting signal  $S_j(x, y)$  ( $= Weight_j(x, y) \cdot G(x, y) \cdot \cos(f_{x_j} \cdot x + f_{y_j} \cdot y)$ ) in order to avoid non linear interactions between different parts of the stamp. In conclusion,  $\forall j$ , we have to find a signal  $Weight_j(x, y)$  so that:

- $\forall(x, y) E_{S_j}(x, y) < E_{I,(f_{x_j}, f_{y_j})}(x, y)$
- $S_j$  is narrow band

For simplification, lets consider  $Weight_j(x, y)$  be composed of two factors:

- $\alpha_j$ , a constant factor (fixing the global level of the stamp).
- $M_j(x, y)$ , a mask whose values  $\in [0, 1]$ .

When  $\alpha_j$  is chosen, the way to find  $M_j(x, y)$  so that  $Weight_j(x, y)$  satisfy the conditions defined above is the following:

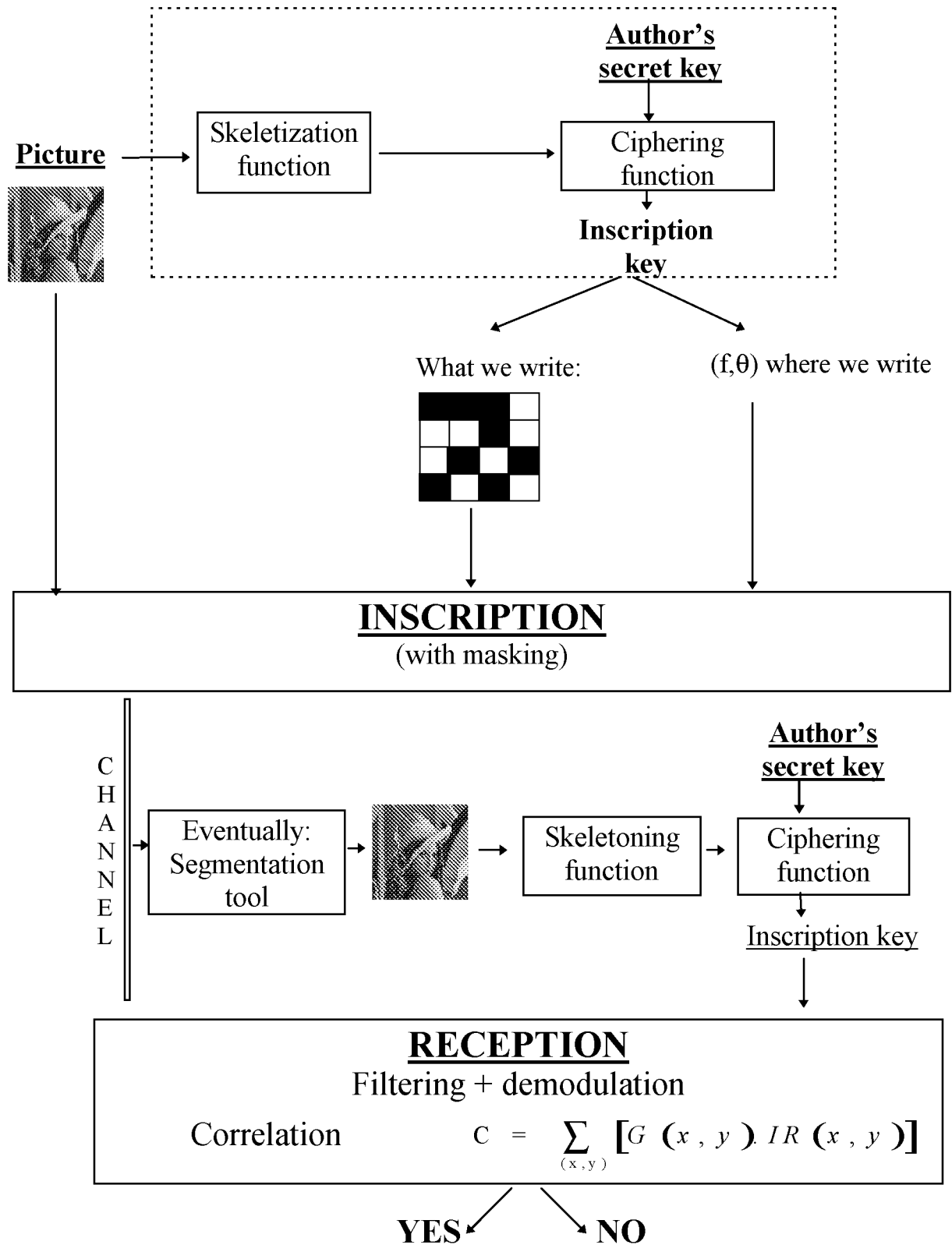

Figure 2: Global scheme for copyright protection.

- Firstly,  $M_j(x, y)$  is a binary mask.  $M_j(x, y) = 1$  when the local energy of the stamp permits the masking and  $M_j(x, y) = 0$  when the local energy of the stamp is too important. It is obvious that the initial choice of  $\alpha_j$  has a direct influence on  $M_j(x, y)$ . Indeed, a great  $\alpha_j$  value will lead to put most of the  $M_j(x, y)$  values to zero, while a small  $\alpha_j$  value will lead to keep most of  $M_j(x, y)$  values at one.
- Secondly,  $Weight_j(x, y)$  is filtered so that the stamp remains narrow band.
- After this second step, one has found a signal  $\alpha_j.M_j(x, y).G(x, y)$  which is better masked than  $\alpha_j.G(x, y)$ . In order to really satisfy the masking criterion  $\forall(x, y)$ , this procedure must be repeated iteratively, taking  $M_j(x, y).G(x, y)$  as new  $G(x, y)$ . Experiments have shown that only two iterations are sufficient to have a result satisfying the masking criterion everywhere.

**One important question remains: how to choose  $\alpha_j$ ?**

It has already been said that the more  $\alpha_j$  increases, the more  $M_j(x, y)$  has points equal to zero. A trade off has to be found by means of a defined criterion. Maximizing the correlation at the detection (by maximizing  $\sum \alpha_j.M_j(x, y).G(x, y)$ ) could have been a good criterion, but such a criterion often tends to impose an optimum with a lot of points equal to zero and a small number of points with a great value. The addition of the so obtained watermark generally entails a degradation of the picture quality. This emphasizes the lack of the masking criterion used.

As mentioned in section 2.6, the invisibility criterion used here is an extension for real images. It appears that this extension entails some imperfections. This criterion being insufficient, some improvements have been brought thanks to experimental results.

The conclusion of these observations is that the invisibility is only strictly observed in high activity regions, where the local energy of high frequencies is important. These regions have to be favoured during the inscription in the sense that the level of the watermark will be increased in those regions while it has to be decreased in other regions.

The correction process first isolates the high activity regions (figure 3.a). Then, an homogeneization of this picture is performed by use of morphological tools, e.g. one opening and one closing (figure 3.b). After a leveling (in fact, a division by the mean or mean square value of the homogenized mask), we obtain a new mask used to multiply the picture local energy and so, giving an advantage to regions of highfrequency energy in comparison with other areas. After that correction, the process is identical to the one described previously. Moreover, the complexity is not increased. Indeed, we first work on the inscription at high frequencies (where there is no quality problems). The value of high frequency local energy is then used for the calculation of the correcting mask used for inscription at lower frequencies. The correction scheme is drawn in the following schema.

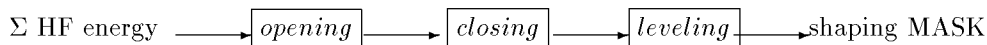

## 4.2 Detection

The aim is to detect if a watermark has been embedded. This can be done with the use of a correlation, but first it is necessary to isolate the watermark and then to demodulate it in order to reconstruct something that is highly correlated with the basic information (the grid).

The formulation of the watermark is:

$$W(x, y) = \sum_{j \in K} A_j \cdot \cos(f_{x_j} \cdot x + f_{y_j} \cdot y) \tag{6}$$

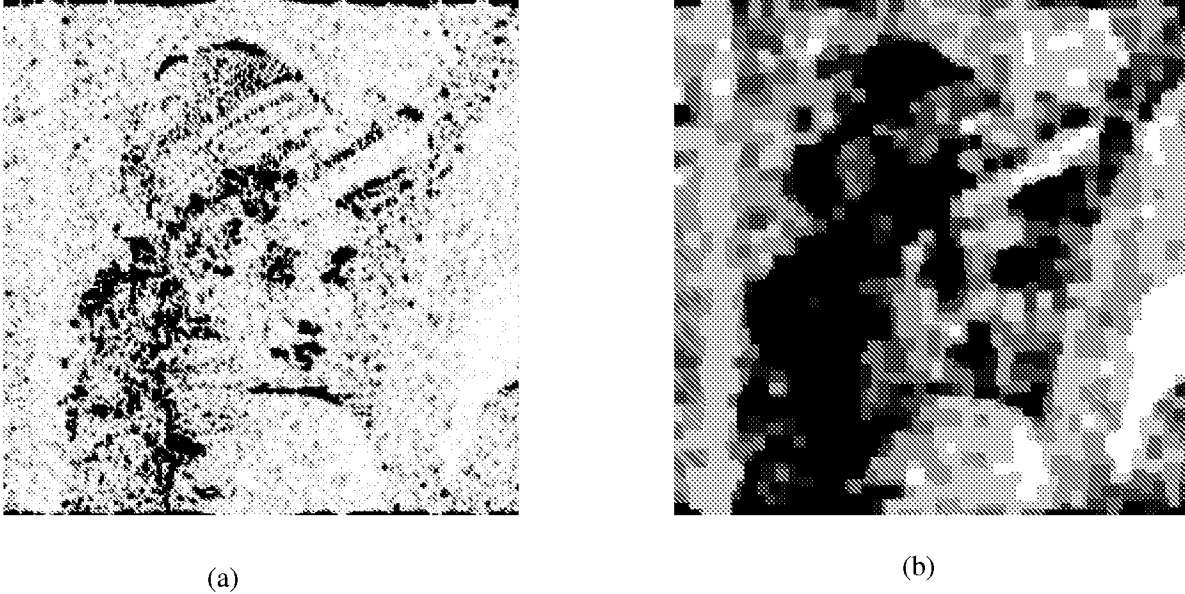

Figure 3: Correcting mask for Lena: (a) Areas of high frequencies, (b) Morphological homogeneity of the mask.

$$\text{where } A_j = \alpha_j \cdot G(x, y) \cdot M(x, y) \quad (7)$$

In this expression,  $M(x, y)$  adjusts the level of the grid in order it becomes invisible, it is called *a mask*, and its maximal value is one.

$\alpha_j$  is a constant that used to normalize the mask, it must be as high as possible.

The detection is divided in three steps : teh demodulation, the correlation and the decision.

- Demodulation

$$I_W(x, y) = \sum_{j \in K} A_j \cdot \cos(f_{x_j} \cdot x + f_{y_j} \cdot y) + I_O + N(x, y) \quad (8)$$

where  $I_W(x, y)$  is the watermarked picture,  $I_O(x, y)$  is the original picture and  $N(x, y)$  is an additive noise from the channel.

The demodulation consists in multiplying  $I_W$  by  $\cos(f_{x_j} \cdot x + f_{y_j} \cdot y), \forall j \in K$  and then to filter with a LP filter.

The result will be :

$$D_j(x, y) = \frac{1}{2} \cdot A_j(x, y) + N^*(x, y) \quad (9)$$

$N^*(x, y)$  depends on the image and on the additive noise. The other parts of the stamp will be eliminated by the LP filter.

- Correlation It consists in mutiplying the demodulated information  $D(x, y) = \sum_{j \in K} D_j(x, y)$  with the basic grid  $G(x, y)$ . If the picture has not been too deteriorated,  $D(x, y)$  and  $G(x, y)$  should be similar.

$$C = \sum_{j \in K} \sum_{x, y} D_j(x, y) \cdot G(x, y) \quad (10)$$

$$= \sum_{j \in K} \alpha_j \sum_{x,y} [G^2(x,y) \cdot M_j(x,y) + G(x,y) \cdot N^*(x,y)] \quad (11)$$

In 11, the first term is even greater than the second, because  $G$  and  $N^*$  have null average values.

So  $C$  exclusively depends on the watermark value.

in the case the grid is not the good one, the correlation gives:

$$C^* = \sum_{j \in K} \alpha_j \sum_{x,y} G(x,y) \cdot G^*(x,y) \cdot M_j(x,y) \quad (12)$$

$C^* \ll C$  if the choice of the basic information has been appropriate.

- decision

The detection algorithm performs demodulations and correlations at diverse frequencies and with diverse grids. The decision is made after the comparison of these correlations.

## 5 RESULTS

The first and probably mostly important result is the invisibility of the stamp in all images that were tested. Figure 4.a and b compares the original and stamped picture for Lena. In figure 4.e, one observes the watermark that was added to the original picture.

Two methods were used to determine whether an image is watermarked or not. The first one consists in comparing the result of  $C$  the correlation made with the right grid  $G(x,y)$  from the right key with  $C^*$  the correlation made with  $G^*(x,y)$ , the grid obtained by random keys see 12. If the picture is watermarked, the correlation with the right key is even greater than the random correlations. The results below (Figure 5) show the pertinence of this method.

The second method uses a grid  $G(x,y)$  formed from a MLS sequence, having good correlation properties. Correlations are made with shifted versions of the basic grid. Due to these good correlation properties, the correlation with the the right grid gives a result even greater than the correlations with shifted grids. Results are presented below (figure 4.c and d), if a picture is watermarked, a pick appears in the center.

## 6 SYSTEM ROBUSTNESS

Many tests have been performed concerning usual pictures deteriorations in image processing like blurring and compression. The inspection of these results are quite satisfying, but expected due to the frequency approach. For all classical pirate attacks like zoom, cropping, overwatermarking it is not as simple. The overwatermarking makes no problem, the presence of the watermark is still detected. But for zoom and cropping, the remaining point is to find a few tools permitting to complete the process. The concept of these tools is already defined but yet no implementation has been achieved.<sup>7</sup>

## 7 CONCLUSION

The process developed here allows the watermarking of the ownership of any picture. The perceptual approach used here is probably the best one, that is why the results obtained are so satisfying compared with other methods and this method is so performant. Nevertheless studies are still running to achieve a new goal, consisting in

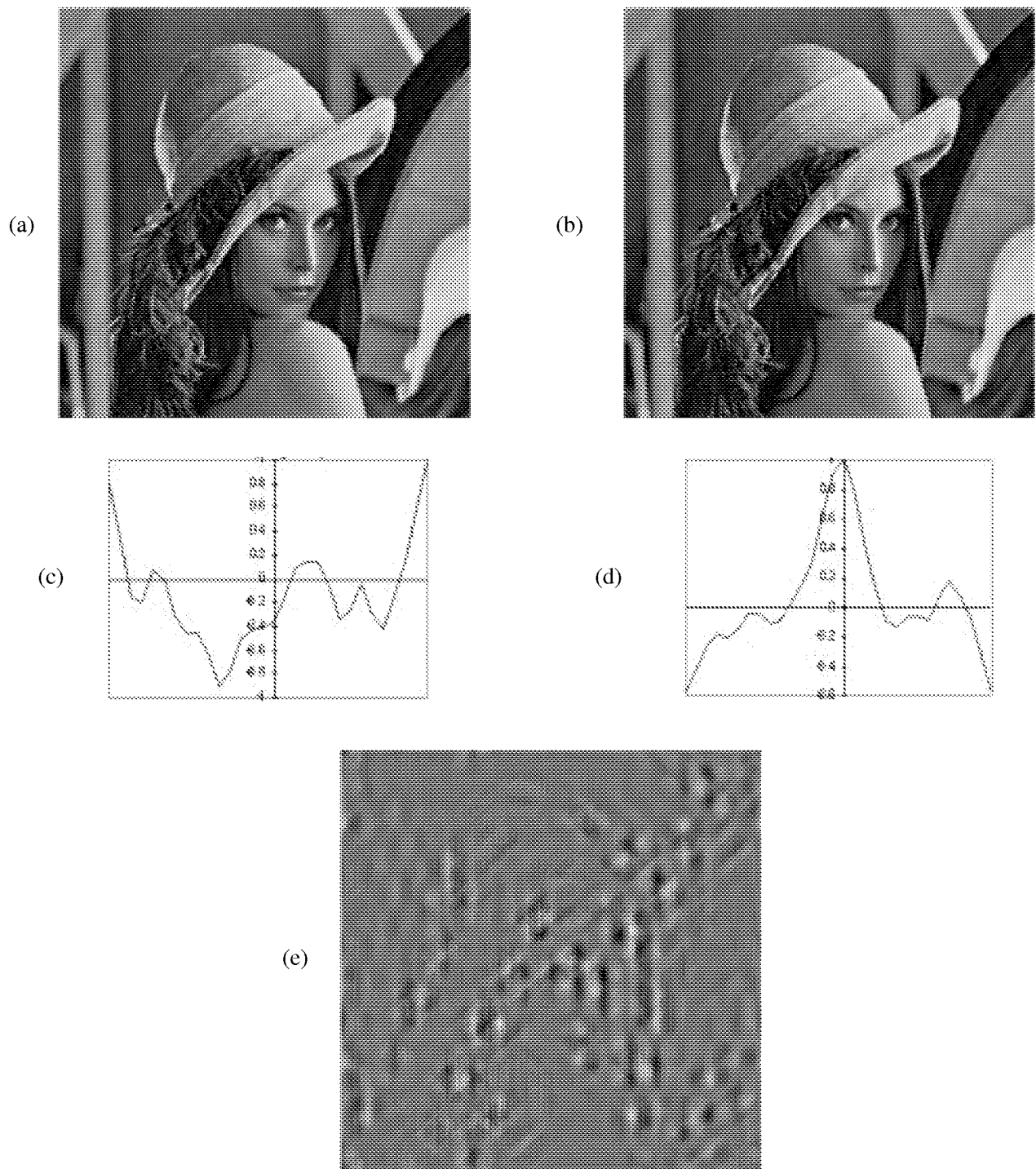

Figure 4: Results for Lena: (a) Original, (b) Watermarked one, (c) Correlation graphic for original, (d) Correlation graphic for watermarked, (e) Watermark.

Image Name	Optimal correlation	Random correlation 1	Random correlation 2	Random correlation3	Random correlation 4	Conclusion
<b>Lena watermarked</b>	<b>584609</b>	92605	133920	80534	143633	<i>watermarked</i>
<b>Lena original</b>	94538	98099	135492	76739	<b>137120</b>	<i>Non watermarked</i>

Figure 5: Results of correlation for Lena and decision.

making more information (e.g. ownership, date of marking) readable by the key owner from the watermark. This could be useful for real copyright protection protocols<sup>8,9</sup>.

## 8 REFERENCES

- [1] Kahin B. The strategic environment for protecting multimedia. volume 1, pages 1-8. IMA Intellectual Property Project Proceedings, January 1994.
- [2] Comes S. *Les traitements perceptifs d'images numérisées*. PhD thesis, Université Catholique de Louvain, June 1995.
- [3] Olzak L.A. and Thomas J.P. Handbook of perception and human performance vol.1: Seeing spatial patterns. chapter 7.
- [4] G.C. Phillips H.R. Wilson, D.K. McFarlane. Spatial frequency tuning of orientation selective units estimated by oblique masking. *Vision Research*, 23(9):873-847, 1983.
- [5] G.C. Phillips H.R. Wilson. Orientation bandwidths of spatial mechanisms measured by masking. *J. Opt. Soc. Am. A*, 1(2):226-232, February 1984.
- [6] Edited by Gustavus J. Simmons. Section 1: Chapter 4: 'public key cryptography' and section 2: Chapter 6: 'authentication: Digital signature' from 'contemporary cryptology: the science of information integrity' ieee press, 1992.
- [7] J.F. Delaigle and C. De Vleeschouwer. Etiquetage d'images numériques en vue de la protection des droits d'auteur, Juin 1995.
- [8] J.F. Delaigle C. Simon and B. Macq. Talisman (ac019): Technical state of the art. January 1996.
- [9] O. Bruyndonckx J.M. Boucqueau and B. Macq. Watermarking: workpackage 5 of accopi. June 1995.

<b>INFORMATION DISCLOSURE STATEMENT BY APPLICANT</b> ( Not for submission under 37 CFR 1.99)	Application Number	10956121
	Filing Date	2004-10-04
	First Named Inventor	Wang
	Art Unit	3685
	Examiner Name	Thomas C. West
	Attorney Docket Number	111325/291300

**CERTIFICATION STATEMENT**

Please see 37 CFR 1.97 and 1.98 to make the appropriate selection(s):

That each item of information contained in the information disclosure statement was first cited in any communication from a foreign patent office in a counterpart foreign application not more than three months prior to the filing of the information disclosure statement. See 37 CFR 1.97(e)(1).

**OR**

That no item of information contained in the information disclosure statement was cited in a communication from a foreign patent office in a counterpart foreign application, and, to the knowledge of the person signing the certification after making reasonable inquiry, no item of information contained in the information disclosure statement was known to any individual designated in 37 CFR 1.56(c) more than three months prior to the filing of the information disclosure statement. See 37 CFR 1.97(e)(2).

See attached certification statement.

Fee set forth in 37 CFR 1.17 (p) has been submitted herewith.

None

**SIGNATURE**

A signature of the applicant or representative is required in accordance with CFR 1.33, 10.18. Please see CFR 1.4(d) for the form of the signature.

Signature	/Marc S. Kaufman, Reg. No. 35,212/	Date (YYYY-MM-DD)	2008-10-10
Name/Print	Marc S. Kaufman	Registration Number	35,212

This collection of information is required by 37 CFR 1.97 and 1.98. The information is required to obtain or retain a benefit by the public which is to file (and by the USPTO to process) an application. Confidentiality is governed by 35 U.S.C. 122 and 37 CFR 1.14. This collection is estimated to take 1 hour to complete, including gathering, preparing and submitting the completed application form to the USPTO. Time will vary depending upon the individual case. Any comments on the amount of time you require to complete this form and/or suggestions for reducing this burden, should be sent to the Chief Information Officer, U.S. Patent and Trademark Office, U.S. Department of Commerce, P.O. Box 1450, Alexandria, VA 22313-1450. **DO NOT SEND FEES OR COMPLETED FORMS TO THIS ADDRESS. SEND TO: Commissioner for Patents, P.O. Box 1450, Alexandria, VA 22313-1450.**



## Privacy Act Statement

The Privacy Act of 1974 (P.L. 93-579) requires that you be given certain information in connection with your submission of the attached form related to a patent application or patent. Accordingly, pursuant to the requirements of the Act, please be advised that: (1) the general authority for the collection of this information is 35 U.S.C. 2(b)(2); (2) furnishing of the information solicited is voluntary; and (3) the principal purpose for which the information is used by the U.S. Patent and Trademark Office is to process and/or examine your submission related to a patent application or patent. If you do not furnish the requested information, the U.S. Patent and Trademark Office may not be able to process and/or examine your submission, which may result in termination of proceedings or abandonment of the application or expiration of the patent.

The information provided by you in this form will be subject to the following routine uses:

1. The information on this form will be treated confidentially to the extent allowed under the Freedom of Information Act (5 U.S.C. 552) and the Privacy Act (5 U.S.C. 552a). Records from this system of records may be disclosed to the Department of Justice to determine whether the Freedom of Information Act requires disclosure of these records.
2. A record from this system of records may be disclosed, as a routine use, in the course of presenting evidence to a court, magistrate, or administrative tribunal, including disclosures to opposing counsel in the course of settlement negotiations.
3. A record in this system of records may be disclosed, as a routine use, to a Member of Congress submitting a request involving an individual, to whom the record pertains, when the individual has requested assistance from the Member with respect to the subject matter of the record.
4. A record in this system of records may be disclosed, as a routine use, to a contractor of the Agency having need for the information in order to perform a contract. Recipients of information shall be required to comply with the requirements of the Privacy Act of 1974, as amended, pursuant to 5 U.S.C. 552a(m).
5. A record related to an International Application filed under the Patent Cooperation Treaty in this system of records may be disclosed, as a routine use, to the International Bureau of the World Intellectual Property Organization, pursuant to the Patent Cooperation Treaty.
6. A record in this system of records may be disclosed, as a routine use, to another federal agency for purposes of National Security review (35 U.S.C. 181) and for review pursuant to the Atomic Energy Act (42 U.S.C. 218(c)).
7. A record from this system of records may be disclosed, as a routine use, to the Administrator, General Services, or his/her designee, during an inspection of records conducted by GSA as part of that agency's responsibility to recommend improvements in records management practices and programs, under authority of 44 U.S.C. 2904 and 2906. Such disclosure shall be made in accordance with the GSA regulations governing inspection of records for this purpose, and any other relevant (i.e., GSA or Commerce) directive. Such disclosure shall not be used to make determinations about individuals.
8. A record from this system of records may be disclosed, as a routine use, to the public after either publication of the application pursuant to 35 U.S.C. 122(b) or issuance of a patent pursuant to 35 U.S.C. 151. Further, a record may be disclosed, subject to the limitations of 37 CFR 1.14, as a routine use, to the public if the record was filed in an application which became abandoned or in which the proceedings were terminated and which application is referenced by either a published application, an application open to public inspections or an issued patent.
9. A record from this system of records may be disclosed, as a routine use, to a Federal, State, or local law enforcement agency, if the USPTO becomes aware of a violation or potential violation of law or regulation.

<b>INFORMATION DISCLOSURE STATEMENT BY APPLICANT</b> ( Not for submission under 37 CFR 1.99)	Application Number	10956121
	Filing Date	2004-10-04
	First Named Inventor	Wang
	Art Unit	3685
	Examiner Name	Thomas C. West
	Attorney Docket Number	111325/291300

U.S.PATENTS							Remove
Examiner Initial*	Cite No	Patent Number	Kind Code <sup>1</sup>	Issue Date	Name of Patentee or Applicant of cited Document	Pages,Columns,Lines where Relevant Passages or Relevant Figures Appear	
	1						

If you wish to add additional U.S. Patent citation information please click the Add button.

Add

U.S.PATENT APPLICATION PUBLICATIONS							Remove
Examiner Initial*	Cite No	Publication Number	Kind Code <sup>1</sup>	Publication Date	Name of Patentee or Applicant of cited Document	Pages,Columns,Lines where Relevant Passages or Relevant Figures Appear	
	1						

If you wish to add additional U.S. Published Application citation information please click the Add button.

Add

FOREIGN PATENT DOCUMENTS								Remove
Examiner Initial*	Cite No	Foreign Document Number <sup>3</sup>	Country Code <sup>2</sup> j	Kind Code <sup>4</sup>	Publication Date	Name of Patentee or Applicant of cited Document	Pages,Columns,Lines where Relevant Passages or Relevant Figures Appear	T <sup>5</sup>
	1	7-36768	JP		1995-02-07			<input type="checkbox"/>

If you wish to add additional Foreign Patent Document citation information please click the Add button

Add

NON-PATENT LITERATURE DOCUMENTS				Remove
Examiner Initials*	Cite No	Include name of the author (in CAPITAL LETTERS), title of the article (when appropriate), title of the item (book, magazine, journal, serial, symposium, catalog, etc), date, pages(s), volume-issue number(s), publisher, city and/or country where published.	T <sup>5</sup>	

<b>INFORMATION DISCLOSURE STATEMENT BY APPLICANT</b> ( Not for submission under 37 CFR 1.99)	Application Number	10956121
	Filing Date	2004-10-04
	First Named Inventor	Wang
	Art Unit	3685
	Examiner Name	Thomas C. West
	Attorney Docket Number	111325/291300

	1		<input type="checkbox"/>
--	---	--	--------------------------

If you wish to add additional non-patent literature document citation information please click the Add button

**EXAMINER SIGNATURE**

Examiner Signature	Date Considered
--------------------	-----------------

\*EXAMINER: Initial if reference considered, whether or not citation is in conformance with MPEP 609. Draw line through a citation if not in conformance and not considered. Include copy of this form with next communication to applicant.

<sup>1</sup> See Kind Codes of USPTO Patent Documents at [www.USPTO.GOV](http://www.USPTO.GOV) or MPEP 901.04. <sup>2</sup> Enter office that issued the document, by the two-letter code (WIPO Standard ST.3). <sup>3</sup> For Japanese patent documents, the indication of the year of the reign of the Emperor must precede the serial number of the patent document. <sup>4</sup> Kind of document by the appropriate symbols as indicated on the document under WIPO Standard ST.16 if possible. <sup>5</sup> Applicant is to place a check mark here if English language translation is attached.

## Electronic Acknowledgement Receipt

<b>EFS ID:</b>	4097120
<b>Application Number:</b>	10956121
<b>International Application Number:</b>	
<b>Confirmation Number:</b>	8924
<b>Title of Invention:</b>	System and method for managing transfer of rights using shared state variables
<b>First Named Inventor/Applicant Name:</b>	Xin Wang
<b>Customer Number:</b>	22204
<b>Filer:</b>	Marc S. Kaufman/Peaches Thomas
<b>Filer Authorized By:</b>	Marc S. Kaufman
<b>Attorney Docket Number:</b>	111325-291300
<b>Receipt Date:</b>	10-OCT-2008
<b>Filing Date:</b>	04-OCT-2004
<b>Time Stamp:</b>	16:06:27
<b>Application Type:</b>	Utility under 35 USC 111(a)

### Payment information:

Submitted with Payment	no
------------------------	----

### File Listing:

Document Number	Document Description	File Name	File Size(Bytes)/ Message Digest	Multi Part /.zip	Pages (if appl.)
1	Foreign Reference	JP_07036768.pdf	897168 <small>599cef0b88e01779a27c41bcf68378dd106372d7</small>	no	16

### Warnings:

### Information:

2	Information Disclosure Statement (IDS) Filed (SB/08)	2008-10-10_- _PTOSB08_111325_291300.pdf	660949  04dafc2623c7a9bdb96a76cc206f9ac29151 b53c	no	4
---	---	--	--	----	---

**Warnings:**

**Information:**

A U.S. Patent Number Citation or a U.S. Publication Number Citation is required in the Information Disclosure Statement (IDS) form for autoloading of data into USPTO systems. You may remove the form to add the required data in order to correct the Informational Message if you are citing U.S. References. If you chose not to include U.S. References, the image of the form will be processed and be made available within the Image File Wrapper (IFW) system. However, no data will be extracted from this form. Any additional data such as Foreign Patent Documents or Non Patent Literature will be manually reviewed and keyed into USPTO systems.

<b>Total Files Size (in bytes):</b>	1558117
-------------------------------------	---------

**This Acknowledgement Receipt evidences receipt on the noted date by the USPTO of the indicated documents, characterized by the applicant, and including page counts, where applicable. It serves as evidence of receipt similar to a Post Card, as described in MPEP 503.**

**New Applications Under 35 U.S.C. 111**

**If a new application is being filed and the application includes the necessary components for a filing date (see 37 CFR 1.53(b)-(d) and MPEP 506), a Filing Receipt (37 CFR 1.54) will be issued in due course and the date shown on this Acknowledgement Receipt will establish the filing date of the application.**

**National Stage of an International Application under 35 U.S.C. 371**

**If a timely submission to enter the national stage of an international application is compliant with the conditions of 35 U.S.C. 371 and other applicable requirements a Form PCT/DO/EO/903 indicating acceptance of the application as a national stage submission under 35 U.S.C. 371 will be issued in addition to the Filing Receipt, in due course.**

**New International Application Filed with the USPTO as a Receiving Office**

**If a new international application is being filed and the international application includes the necessary components for an international filing date (see PCT Article 11 and MPEP 1810), a Notification of the International Application Number and of the International Filing Date (Form PCT/RO/105) will be issued in due course, subject to prescriptions concerning national security, and the date shown on this Acknowledgement Receipt will establish the international filing date of the application.**

# ELECTRONIC FILING DEVICE

**Publication number:** JP7036768  
**Publication date:** 1995-02-07  
**Inventor:** OTSUKA SACHIYO; SASAKI MASAHIRO  
**Applicant:** MATSUSHITA ELECTRIC IND CO LTD  
**Classification:**  
 - **international:** **G06F12/00; G06F12/14; G06F21/24; G06F12/00; G06F12/14; G06F21/00; (IPC1-7): G06F12/00; G06F12/14**  
 - **European:**  
**Application number:** JP19930175470 19930715  
**Priority number(s):** JP19930175470 19930715

*Report a data error here*

## Abstract of JP7036768

**PURPOSE:**To permit any person who owns a right in accordance with respective disclosure level to approach a targeted document without permission or a password and to perform security management in a wide range flexibly by performing a document by attaching disclosure level information and discloser information including disclosure destination information. **CONSTITUTION:**The disclosure information consists of the disclosure level information representing to what degree it can be disclosed and the disclosure destination information representing to whom it can be disclosed. The disclosure information inputted from an input device 1 is sent from an input part 2 to a document processing part 8. and it is delivered from the document processing part 8 to a document disclosure information registration part 11. The document disclosure information registration part 11 retrieves a corresponding document file name from a document map file 13, and furthermore, retrieves a disclosure information managing file name from a document managing file 16, and sets the disclosure information on a corresponding document disclosure information managing file 20. When document disclosure is requested from the input part 1 by a user, the document disclosure information managing part 11 checks the disclosure information by the request of the document processing part 8.

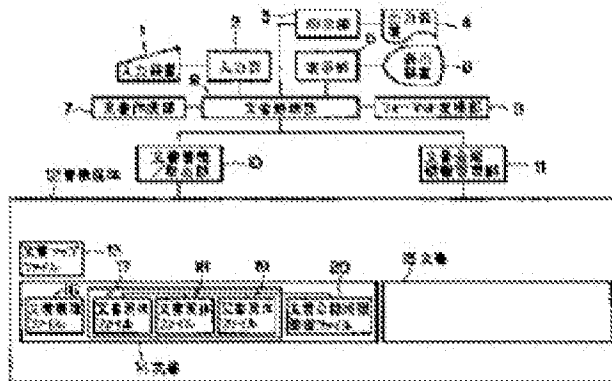

Data supplied from the esp@cenet database - Worldwide



(19)日本国特許庁 (J P)

(12) 公開特許公報 (A)

(11)特許出願公開番号

特開平7-36768

(43)公開日 平成7年(1995)2月7日

(51)Int.Cl. <sup>6</sup>	識別記号	庁内整理番号	F I	技術表示箇所
G 0 6 F 12/00	5 3 7 M	8944-5B		
12/14	3 1 0 A			

審査請求 未請求 請求項の数 5 O L (全 14 頁)

(21)出願番号 特願平5-175470

(71)出願人 000005821

松下電器産業株式会社

大阪府門真市大字門真1006番地

(22)出願日 平成5年(1993)7月15日

(72)発明者 大塚 幸代

大阪府門真市大字門真1006番地 松下電器産業株式会社内

(72)発明者 佐々木 雅宏

大阪府門真市大字門真1006番地 松下電器産業株式会社内

(74)代理人 弁理士 蔵合 正博

(54)【発明の名称】 電子ファイル装置

(57)【要約】

【目的】 文書および文書を階層的に分類した分類ノードの存在明示の許可、閲覧の許可、複写印刷の許可、登録更新の許可からなる公開レベルおよび公開先を管理するための公開情報管理ファイルを備え、公開情報管理ファイルに設定管理されている情報に従い文書または分類単位で処理を行うことにより、ユーザおよびグループに対して文書または分類ノードの詳細なセキュリティ機構を提供することを目的とする。

【構成】 文書公開情報管理部 1 1 を設け、文書の公開レベルおよび公開先を設定管理することにより、公開レベルに応じて文書を処理し、また、分類ノード公開情報管理部 4 1 を設け、文書を階層的に分類した分類ノードの管理を行うとともに、分類ノード公開情報管理部 4 2 を設けることにより、分類単位での公開レベルおよび公開先を設定管理し、公開レベルに応じて分類ノードを処理する。

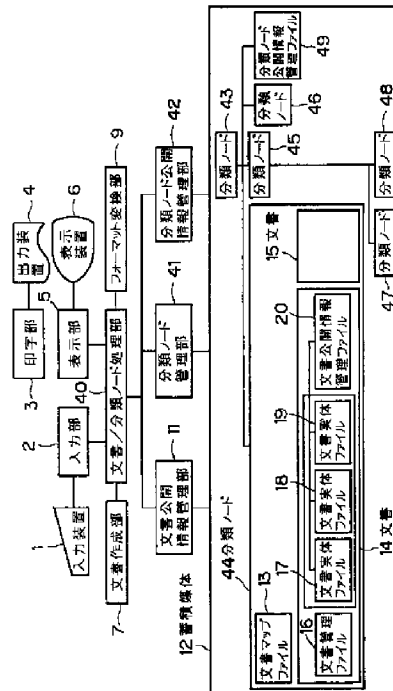



1

## 【特許請求の範囲】

【請求項1】 1以上のファイルで構成された文書ごとに、公開程度を表わす公開レベル情報と公開相手を表わす公開先情報を含む公開情報を付加して管理する手段を備えた電子ファイル装置。

【請求項2】 公開情報を設定、変更可能とした請求項1記載の電子ファイル装置。

【請求項3】 1以上のファイルで構成された文書の蓄積保管および取り出しを管理する文書蓄積/取出部と、蓄積した前記文書の処理の許可レベルとして該当文書の  
10 一覧表示の許可、該当文書の内容表示の許可、該当文書の複写印刷の許可、該当文書の内容更新の許可の少なくとも4レベルが設定可能な公開レベル情報と複数の公開先情報からなる公開情報を格納する文書公開情報格納手段と、前記公開情報を設定管理および検査する文書公開情報管理部と、前記文書公開情報管理部の検査結果に応じて文書を処理する文書処理部とを備えた電子ファイル装置。

【請求項4】 1以上のファイルで構成された文書を分類ノードと呼ぶ文書の集合として処理し、前記分類ノード  
20 を階層的に設定管理するとともに分類ノード内の文書を管理する分類ノード管理部と、前記分類ノード内の文書の処理の許可レベルとして該当文書の一覧表示の許可、該当文書の内容表示の許可、該当文書の複写印刷の許可、該当文書の内容更新の許可の少なくとも4レベルが設定可能な公開レベル情報および複数の公開先情報からなる公開情報を格納する文書公開情報格納手段と、前記公開情報を設定管理および検査する文書公開情報管理部と、前記分類ノードの処理の許可レベルとして該当分類ノードの一覧表示の許可、該当分類ノードおよび該当  
30 分類ノード下の文書の一覧表示の許可、該当分類ノードの複写および該当分類ノード下の文書すべての複写印刷の許可、該当分類ノード下の新規分類ノード作成および新規文書登録の許可の少なくとも4レベルが設定可能な公開レベル情報と複数の公開先情報からなる分類ノード公開情報を格納する分類ノード公開情報格納手段と、前記分類ノード公開情報を設定管理および検査する分類ノード公開情報管理部と、前記文書公開情報管理部および前記分類ノード公開情報管理部の検査結果に応じて文書および分類ノードを処理する文書/分類ノード処理部とを  
40 備えた電子ファイル装置。

【請求項5】 公開情報が公開期間情報を含む請求項1から4のいずれかに記載の電子ファイル装置。

## 【発明の詳細な説明】

【0001】

【産業上の利用分野】本発明は、セキュリティ機構を有する電子ファイル装置に関するものである。

【0002】

【従来の技術】近年、オフィス業務の効率化、ペーパーレス化、省スペース化などを目的とする電子ファイル装  
50

2

置は、システム開発以来オフィス内で急速に普及し、そのシステムに対する要求も、使用範囲として専門に文書を入力管理する業務担当者から、個人および一般作業グループへと広がり、運用形態としてもさまざまな業務および文書への適応が求められてきており、文書の共有形態と文書のセキュリティ機構においてもさまざまな運用形態に適合できる機能が要求されている。

【0003】このような要求に対応するために、従来の電子ファイル装置では、基本的には文書ごとにパーミッションあるいはパスワード等を設け、文書に対する操作レベルと操作範囲を設定し、文書の保護を実現していた。この場合、文書に対して許される操作のレベルとして、該当の文書に対しての読み出し、書き込みの許可を与えるかどうかという許可レベルを設定し、また、許可レベルを与え得る操作者として、該当の文書の持ち主あるいは持ち主が属しているグループのメンバーあるいは全員などの設定を行っていた。

【0004】

【発明が解決しようとする課題】しかしながら、上記の従来の構成では、文書の保護を文書ごとに設けたパスワード等により行っており、許可レベルが文書の読み出しおよび書き込みのみに限られているため、あるいは許可レベルを与え得る操作者としてユーザおよび単一グループ等に限定されているため、さまざまな運用形態に適合できる柔軟なセキュリティ機構を提供することができないという問題点を有していた。

【0005】本発明は、このような従来の問題点を解決するもので、文書に対する公開レベルの設定を細かに行なえるようにするとともに、公開先をユーザおよびグループの区別なく複数設定可能とし、柔軟かつ広範囲なセキュリティ機構を備えた電子ファイル装置を提供することを目的とする。

【0006】

【課題を解決するための手段】上記目的を達成するために、本発明の電子ファイル装置は、1以上のファイルで構成された文書ごとに、公開程度を表わす公開レベル情報と公開相手を表わす公開先情報を含む公開情報を付加して管理するようにしたものである。

【0007】本発明はまた、1以上のファイルで構成された文書を分類ノードで階層的に管理し、文書と同様に各分類ノードについても公開情報を付加して管理するようにしたものである。

【0008】本発明はまた、公開情報に公開期間を加えるようにしたものである。

【0009】

【作用】したがって、本発明によれば、文書を公開レベル情報と公開先情報を含む公開情報を付加して管理することにより、それぞれの公開レベルに対応した権利を有する者であれば、パーミッションやパスワードがなくても誰でも目的的文書に近づくことができ、柔軟で広範囲

なセキュリティ管理を行なうことができる。

【0010】また本発明によれば、文書が分類ノードにより階層的に管理されている場合には、分類ノードについても文書と同様に公開情報を付加して管理することにより、より柔軟で極め細かなセキュリティ管理を行なうことができる。

【0011】さらに本発明によれば、公開情報に公開期間を加えることにより、さらに柔軟で極め細かなセキュリティ管理を行なうことができる。

【0012】

【実施例】

(実施例1) 以下、本発明の実施例について、図面を参照しながら説明する。図1は本発明の第1の実施例における電子ファイル装置の概略構成を示すブロック図である。図1において、1はユーザがデータを入力する入力装置、2は入力装置1を制御する入力部、3は印刷の制御を行なう印刷部、4は印刷を行なう出力装置、5は表示を制御する表示部、6は表示を行なう表示装置、7は文書の作成を行なう文書作成部、8は装置全体の制御を行ない、文書を処理する文書処理部、9は文書処理部8からの指示を受け、文書のフォーマット変換を行なうフォーマット変換部、10は作成された文書の蓄積保管および取り出しを管理する文書蓄積/取出部、11は文書の公開情報を設定管理および検査する文書公開情報管理部、12は文書および各種管理情報の蓄積を行なう蓄積媒体、13は文書を探し出すための情報を格納する文書マップファイル、14、15は複数のファイルによって構成された論理的な集まりを表わす文書、16は文書を構成するファイル群を管理するための情報を格納する文書管理ファイル、17、18、19は個々の文書を構成する文書実体ファイル、20は公開先情報および公開レベル情報からなる公開情報を格納する文書公開情報管理ファイルである。

【0013】以上のように構成された電子ファイル装置について以下その動作を説明する。まず、文書を構成するファイル群が管理されるまでの処理を説明する。ユーザにより作成された文書が入力装置1を通じて入力部2または文書作成部7から文書処理部8へと送られると、文書を構成するファイル群は文書処理部8から文書蓄積/取出部10を経て蓄積媒体12に送られる。蓄積媒体12では、文書蓄積/取出部10によって図2(a)に示す文書管理ファイル16が作成されて文書管理ファイル名と文書名とが登録され、図2(c)に示す文書マップファイル13にその文書名および文書管理ファイル名からなる文書マップ情報が登録される。次に、図2

(b)に示す文書公開管理情報ファイル20が作成され、文書管理ファイル16に文書名と公開情報管理ファイル名と文書実体ファイル名が登録され、その文書に対する構成が管理される。以上のように登録され管理された文書は、文書蓄積/取出部10によって文書を構成す

るファイル群が取り出され、文書処理部8を経て表示および印刷などの文書処理が行なわれる。

【0014】次に、作成された文書の公開情報の初期設定を行なう場合について説明する。公開情報は、どの程度まで公開してよいかを示す公開レベル情報と、だれ(個人またはグループ)に公開してよいかを示す公開先情報からなる。入力装置1から入力された公開情報は、入力部2から文書処理部8へ送られ、文書処理部8から文書公開情報登録部11へ渡される。文書公開情報管理部11は、まず図2に示す文書マップファイル13から、該当の文書管理ファイル名を探し、さらに文書管理ファイル16から公開情報管理ファイル名を探し、該当の文書公開情報管理ファイル20に公開情報を設定する。文書公開情報管理ファイル20に設定された公開情報は、本実施例では、ユーザ1に対しては公開レベルとしてEで表わされる該当文書の一覧表示の許可、グループ1に対しては公開レベルとしてBで表わされる該当文書の内容表示の許可、グループ2に対しては公開レベルとしてCで表わされる該当文書の複写印刷の許可、ユーザ2に対しては公開レベルとしてIで表わされる該当文書の内容更新の許可等が設定されている。公開レベルは、Eを最下位としてB、C、Iの順番に高くなっており、上位のレベルはその下位のレベルをすべて含むように定義されている。このようにして公開情報の設定を行なったある文書に対し、入力部1からユーザまたはグループが文書公開を要求した場合は、文書処理部8の要求により文書公開情報管理部11が公開情報のチェックを行ない、文書処理部8へ処理結果の通知を行なった後、フォーマット変換部9を経由して、表示部5、印刷部3で処理が行なわれる。

【0015】以下、図3を参照して文書公開情報管理部11における公開情報のチェック処理について説明をする。まず入力部1から例えばユーザ1による文書の公開レベルBの要求が入力された場合、文書処理部8からユーザ名とユーザ1の属している全てのグループ名からなる公開先情報群および公開レベルが文書公開情報管理部11に渡され(ステップ31)、文書公開情報管理部11は、この要求に対し文書マップファイル13を読み込み、該当の文書管理ファイル名を探し(ステップ32)、探し出した文書管理ファイル16から該当文書の公開情報管理ファイル名を探す(ステップ33)。探し出した文書公開情報管理ファイル20を読み出し、公開先情報群の一つの情報を文書公開情報管理ファイル20の公開情報の中から検出する(ステップ34)。検出ができなかった場合は、公開先情報群の全てのチェックが終了するまでこの処理を繰り返し(ステップ35)、チェックが終了した場合は異常値を文書処理部8へ返す(ステップ36)。検出できた場合は、公開レベルの設定がB以上(CおよびIを含む。)のレベルかどうかを判定し(ステップ37)、公開レベルがこの条件を満た

5

している場合は正常値を文書処理部8へ返し(ステップ38)、満たしていない場合は、公開先情報群のチェックが全て終了しているかを判定する(ステップ35)。文書処理部8は、文書公開情報管理部11からの公開情報のチェック結果に従って処理を行なう。

【0016】このように、上記第1の実施例によれば、1以上のファイルで構成された文書ごとに、公開程度を表わす公開レベル情報と公開相手を表わす公開先情報とを含む公開情報を任意に設定して管理する手段を備えているので、それぞれの公開レベルに対応する権利を有する者であれば、パーミッションやパスワードによらず、誰でも目的の文書に近づくことができ、柔軟なセキュリティ管理を行なうことができる。

【0017】(実施例2)次に、本発明の第2の実施例について図面を参照しながら説明する。図4は本発明の第2の実施例における電子ファイル装置の概略構成を示すブロック図であり、図1に示した第1の実施例と同じ構成要素には同じ符号を付してある。図4において、1はユーザがデータを入力する入力装置、2は入力装置1を制御する入力部、3は印刷の制御を行なう印刷部、4は印刷を行なう出力装置、5は表示を制御する表示部、6は表示を行なう表示装置、7は文書の作成を行なう文書作成部、9は文書のフォーマット変換を行なうフォーマット変換部、11は文書の公開情報を設定管理および検査する文書公開情報管理部、12は文書および各情報の蓄積を行なう蓄積媒体、13は文書を探し出すための情報を格納する文書マップファイル、14、15は複数のファイルによって構成された論理的な集まりを表わす文書、16は文書を構成するファイル群を管理するための情報を格納する文書管理ファイル、17、18、19は個々の文書を構成する文書実体ファイル、20は公開先および公開レベルからなる公開情報を格納する文書公開情報管理ファイルであり、以上は図1の構成と同様なものである。図1の構成と異なるのは、装置全体の制御を行ない文書を処理する文書処理部8を分類ノードを処理する機能を加えた文書/分類ノード処理部40としたことと、文書を階層的に分類した情報を設定管理する分類ノード管理部41、分類ノードの公開レベルを設定管理する分類ノード公開情報管理部42、文書を階層的に分類している分類ノード43、44、45、46、47、48、分類ノードの公開先および公開レベルからなる公開情報を格納する分類ノード公開情報管理ファイル49を加えたことである。分類ノード公開情報管理ファイル49は、各分類ノード43~48のそれぞれに設けられている。

【0018】以上のように構成された電子ファイル装置の動作について、まず文書の登録を行なう場合について説明する。ユーザにより作成された文書は、入力装置1を通じて入力部2または文書作成部7から文書/分類ノード処理部40へ送られるとともに、登録文書名および

6

その文書を登録される登録場所分類ノード名がユーザにより入力装置1から入力される。文書/分類ノード処理部40は、分類ノード公開情報管理部42で登録場所の分類ノードの公開レベルのチェックを行なった後、分類ノード管理部41に文書を構成するファイル群の登録を依頼する。依頼を受けた分類ノード管理部41は、蓄積媒体12に階層的に設定されている分類ノードをたぐり、ユーザにより指定された登録場所の分類ノードを探し出し、該当分類ノード下に文書を構成するファイル群を登録する。以降、登録場所の分類ノード内でのファイル群の管理は実施例1と同様に行なわれる。

【0019】次に、登録された文書を閲覧する場合について説明する。入力装置1からある文書に対して閲覧要求が入力部2を経て文書/分類ノード処理部40へ通知されると、その閲覧文書名と文書が存在する分類ノード名が文書/分類ノード処理部40へ渡される。文書/分類ノード処理部40は、分類ノード公開情報管理部42における分類ノードの公開情報のチェックを行なった後、さらに文書公開情報管理部11に文書の公開情報のチェックを依頼する。文書公開情報管理部11は、分類ノードをたぐり、指定の分類ノード下で実施例1と同様の処理を行なう。その結果に従って文書/分類ノード処理部40は、分類ノード管理部41に該当文書のファイル群の取り出しを依頼し、文書の処理を行なう。

【0020】分類ノードおよび文書の公開レベル設定内容と効果は、図5に示すような形で定義されている。分類ノードに設定可能な公開レベルは、それぞれ実施例1の文書に設定する公開レベルと同様に、Eで表わされる存在明示許可、Bで表わされる閲覧許可、Cで表わされる複写印刷許可、Iで表わされる登録更新許可の4レベルとなっている。分類ノードは、最上位を1つのルートノードとして、その下に枝分かれした階層構造になっている。したがって、ある分類ノードに対してEが許可されると、階層構造上において該当分類ノードが属している分類ノード以上の分類ノード名の一覧表示が許可され、該当分類ノードの存在が確認される。またある文書に対してEが許可されると、該当文書が属している分類ノードにおける文書の一覧表示が許可され、該当文書の存在が確認される。またある分類ノードに対してBが許可されると、階層構造上において該当分類ノード以上でB以下のレベル(B、E)が設定されている分類ノードおよびそれらに属している文書の一覧表示が許可され、該当分類ノードの内容が確認可能となる。またある文書に対してBが許可されると、該当文書の内容表示が許可され、該当文書の内容が確認可能となる。さらにある分類ノードに対してCが許可されると、該当分類ノードが複写元分類ノードとして設定可能となり、階層構造上において該当分類ノード以上でC以下のレベル(B、E)が設定されている分類ノード群およびそれらに属してC以下のレベルが設定されている文書群がまとめて複写印

刷可能となる。またある文書に対してCが許可されると、階層構造上において該当文書が属している分類ノード以上の分類ノードにおいてC以下のレベルが設定されている文書が複写印刷可能となる。さらにまた、ある分類ノードに対してIが許可されると、階層構造上において該当分類ノード以上でI以下のレベル（I、C、B、E）が設定されている分類ノード群およびそれらに属しているすべての文書群について、移動、削除、更新、新規作成等が可能になる。文書に対してIが許可されると、既に存在するすべての文書について同様な内容更新が可能となる。

【0021】次に、図6および図7を参照して分類ノードの公開情報チェック処理について説明する。まず入力装置1から例えばユーザ2による分類ノードの公開レベルBの要求が入力されると、文書/分類ノード処理部40からユーザ2による分類ノードの公開レベルBの要求が分類ノード公開情報管理部42に通知される（ステップ61）。分類ノード公開情報管理部42は、この要求に対し指定の分類ノードに移動し（ステップ62）、移動先の該当分類ノードで固定ファイル名である分類ノード公開情報管理ファイル49を探し出し（ステップ63）、公開先情報群の一つの情報を分類ノード公開情報管理ファイル49の公開情報の中から検出する（ステップ64）。検出できなかった場合は、公開先情報群の全てのチェックが終了するまでこの処理を繰り返し（ステップ65）、チェックが終了した場合は、異常値を文書/分類ノード処理部40へ返す（ステップ66）。検出できた場合は公開レベルの設定がB以上のレベルかどうかを判定し（ステップ67）、公開レベルがこの条件を満たしている場合は正常値を文書処理部40へ返し（ステップ68）、満たしていない場合は、公開先情報群のチェックが全て終了しているかを判定する（ステップ65）。文書/分類ノード処理部40は、分類ノード公開情報管理部42からの公開情報のチェック結果に従って処理を行なう。

【0022】このように、上記第2の実施例によれば、1以上のファイルで構成された文書を分類ノードで階層的に管理し、文書については上記第1の実施例と同様に管理するとともに、分類ノードについても同様に公開情報を付加して管理することにより、より柔軟で極め細かなセキュリティ管理を行なうことができる。

【0023】（実施例3）次に、本発明の第3の実施例について説明する。図8は本発明の第3の実施例における電子ファイル装置の概略構成を示すブロック図であり、図4に示した第2の実施例と同じ構成要素には同じ符号を付してある。図8において、1はユーザがデータを入力する入力装置、2は入力装置1を制御する入力部、3は印刷の制御を行なう印刷部、4は印刷を行なう出力装置、5は表示を制御する表示部、6は表示を行なう表示装置、7は文書の作成を行なう文書作成部、9は

文書のフォーマット変換を行なうフォーマット変換部、12は文書および各情報の蓄積を行なう蓄積媒体、13は文書を探し出すための情報を格納する文書マップファイル、14、15は複数のファイルによって構成された論理的な集まりを表す文書、17、18、19は個々の文書を構成する文書実体ファイル、40は装置全体の制御を行ない文書と分類ノードを処理する文書/分類ノード処理部、41は文書を階層的に分類した情報を設定管理する分類ノード管理部であり、以上は図4の構成と同様なものである。図4の構成と異なるのは、文書の公開レベルを設定管理する文書公開情報管理部11を、これに文書の公開期間の設定管理を行なう機能を加えて文書公開情報管理部80としたことと、分類ノードの公開レベルを設定管理する分類ノード公開情報管理部42を、これに分類ノードの公開期間の設定管理を行なう機能を加えて分類ノード公開情報管理部81としたことと、文書の公開先および公開レベルからなる公開情報を格納する文書公開情報管理ファイル20を、これに公開期間を設定可能として文書公開情報管理ファイル82としたことと、分類ノードの公開先および公開レベルからなる公開情報を格納する分類ノード公開情報管理ファイル49を、これに公開期間を設定可能として分類ノード公開情報管理ファイル83としたことである。

【0024】次に、以上のように構成された電子ファイル装置の動作について説明するが、文書の登録処理および登録された文書を閲覧する処理については実施例2と同様なので、ここでは文書および分類ノードの公開期間の設定を行なう処理について説明する。まず入力装置1から入力された公開先および公開レベルからなる公開情報と公開期間は、入力部2から文書/分類ノード処理部40へ送られ、文書/分類ノード処理部40の指示により文書公開情報管理部80および分類ノード公開情報管理部81が、それぞれ図9に示す文書公開情報管理ファイル82および分類ノード公開情報管理ファイル83の中に、公開期間および公開情報をそれぞれ設定する。

【0025】図10および図11は分類ノードおよび文書の公開期間のチェックを行なう処理を示している。図10において、入力装置1から例えばユーザ2による分類ノードの公開レベルBのチェックが要求された場合、文書/分類ノード処理部40からユーザ2による分類ノードの公開レベルBの要求が分類ノード公開情報管理部81に通知される（ステップ101）。分類ノード公開情報管理部81は、本要求に対し指定の分類ノードに移動し（ステップ102）、移動先の該当分類ノードで固定ファイル名である分類ノード公開情報管理ファイル63を探し出し（ステップ103）、図9に示す分類ノード公開情報管理ファイル83から公開期間の判定を行ない（ステップ104）、公開期間内であれば正常値を返し（ステップ107）、公開期間外ならば以降、分類ノードの公開情報のチェックを実施例2と同様、まず公開

先情報群の一つの情報を分類ノード公開情報管理ファイル83の公開情報の中から検出し(ステップ105)、検出できなかった場合は、公開先情報群の全てのチェックが終了するまでこの処理を繰り返し(ステップ108)、チェックが終了した場合は、異常値を文書/分類ノード処理部40へ返す(ステップ109)。検出できた場合は、公開レベルの設定がB以上のレベルかどうかを判定し(ステップ106)、公開レベルがこの条件を満たしている場合は、正常値を文書/分類ノード処理部40へ返す(ステップ107)、満たしていない場合は、公開先情報群のチェックが全て終了しているかを判定する(ステップ108)。文書/分類ノード処理部40は、分類ノード公開情報管理部81からの公開情報のチェック結果に従って処理を行なう。

【0026】また、図11において、例えばユーザ1による文書の公開レベルBのチェックが要求された場合(ステップ111)、文書/分類ノード処理部40からユーザ1による文書公開の要求が文書情報管理部80に通知され、文書公開情報管理部80は、本要求に対し以降、文書の公開情報を設定管理しているファイル群から実施例1と同様に、文書管理ファイル16を探し(ステップ112)、次いで文書公開情報管理ファイル82を探し出し(ステップ113)、図9に示す文書公開情報管理ファイル82の公開期間の判定を行ない(ステップ114)、公開期間内であれば正常値を返し(ステップ117)、期間外であれば、以降、文書の公開情報のチェックを実施例1と同様に処理し(ステップ115、116、118)、その処理結果を文書/分類ノード処理部40へ返す(ステップ119)。

【0027】このように、上記第3の実施例によれば、公開情報に公開期間を加えることにより、さらに柔軟で極め細かなセキュリティ管理を行なうことができる。

【0028】

【発明の効果】以上のように、本発明によれば、文書を公開レベル情報と公開先情報を含む公開情報を付加して管理することにより、それぞれの公開レベルに対応した権利を有する者であれば、パーミッションやパスワードがなくても誰でも目的の文書に近づくことができ、柔軟で広範囲なセキュリティ管理を行なうことができる。

【0029】また本発明によれば、文書が分類ノードにより階層的に管理されている場合には、分類ノードについても文書と同様に公開情報を付加して管理することにより、より柔軟で極め細かなセキュリティ管理を行なうことができる。

【0030】さらに本発明によれば、公開情報に公開期間を加えることにより、さらに柔軟で極め細かなセキュリティ管理を行なうことができる。

【図面の簡単な説明】

【図1】本発明の第1の実施例における電子ファイル装置の概略構成を示すブロック図

【図2】本発明の第1の実施例における蓄積媒体におけるファイル構造を示す模式図

【図3】本発明の第1の実施例における公開情報のチェック処理を示すフロー図

【図4】本発明の第2の実施例における電子ファイル装置の概略構成を示すブロック図

【図5】本発明の第2の実施例における公開レベルの一覧を示す模式図

【図6】本発明の第2の実施例における公開情報のチェック処理を示すフロー図

【図7】本発明の第2の実施例における分類ノード公開情報管理ファイルの構造を示す模式図

【図8】本発明の第3の実施例における電子ファイル装置の概略構成を示すブロック図

【図9】本発明の第3の実施例におけるファイル構造を示す模式図

【図10】本発明の第3の実施例における分類ノードの公開期間のチェック処理を示すフロー図

【図11】本発明の第3の実施例における文書の公開期間のチェック処理を示す別のフロー図

【符号の説明】

- 1 入力装置
- 2 入力部
- 3 印刷部
- 4 出力装置
- 5 表示部
- 6 表示装置
- 7 文書作成部
- 8 文書処理部
- 9 フォーマット変換部
- 10 文書蓄積/取出部
- 11 文書公開情報管理部
- 12 蓄積媒体
- 13 文書マップファイル
- 14 文書
- 15 文書
- 16 文書管理ファイル
- 17 文書実体ファイル
- 18 文書実体ファイル
- 19 文書実体ファイル
- 20 公開情報管理ファイル
- 40 文書/分類ノード処理部
- 41 分類ノード管理部
- 42 分類ノード公開情報管理部
- 43 分類ノード
- 44 分類ノード
- 45 分類ノード
- 46 分類ノード
- 47 分類ノード
- 50 48 分類ノード

- 4 9 分類ノード公開情報管理ファイル
- 5 0 公開情報
- 8 0 文書公開情報管理部

- 8 1 分類ノード公開情報管理部
- 8 2 文書公開情報管理部
- 8 3 分類ノード公開情報管理ファイル

【図1】

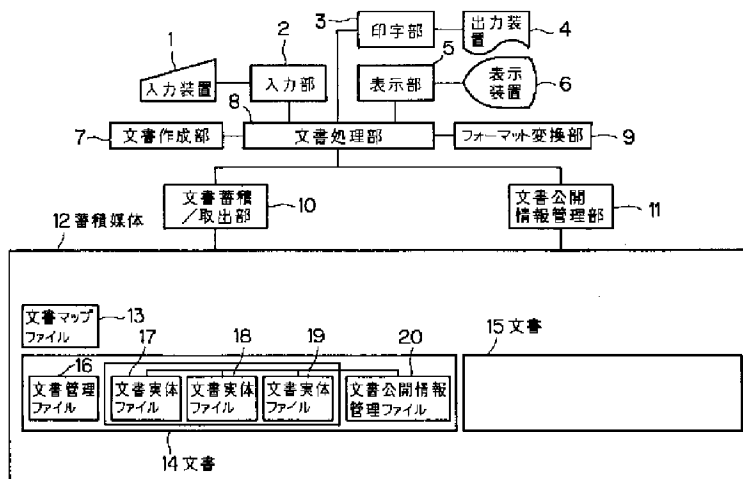

【図4】

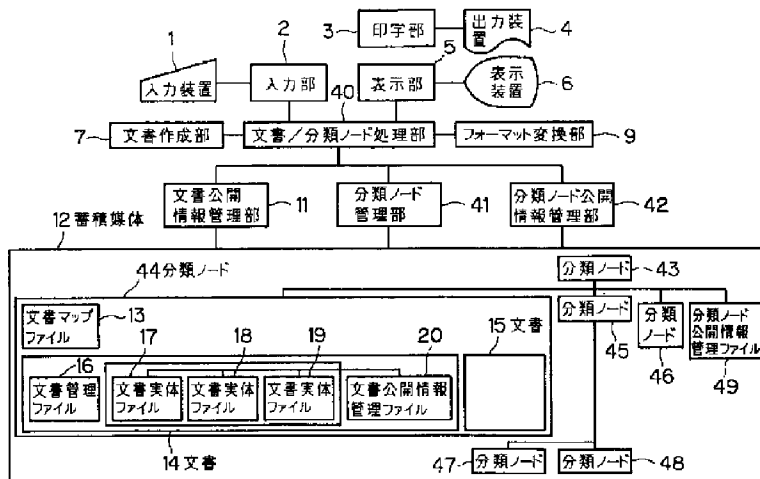

【図7】

49 分類ノード公開情報管理ファイル

公開情報 (ユーザ 1E)
公開情報 (グループ 1:B)
公開情報 (グループ 2:C)
公開情報 (ユーザ 2:I)
公開情報 (ユーザ n:E)

【図2】

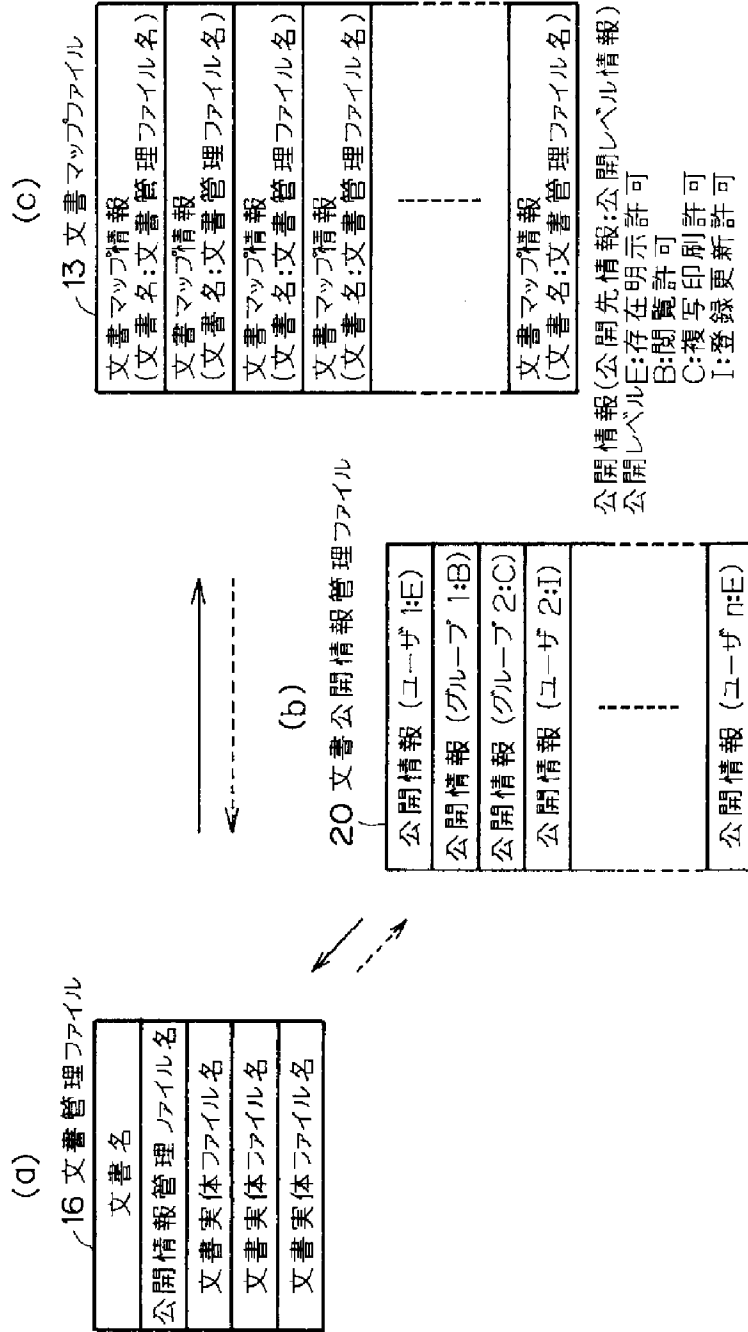

【図3】

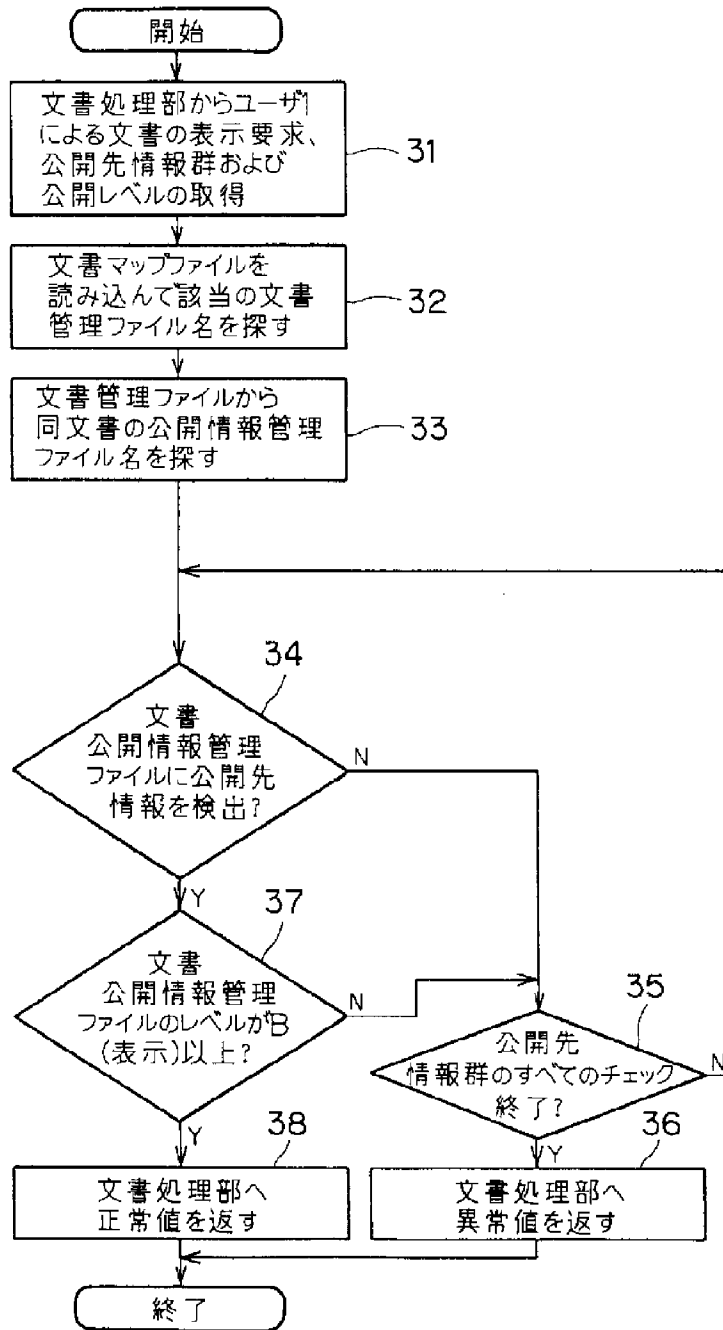



【図5】

公開レベル	効果	
	分類ノード	文書
存在明示許可 E	階層構造上における該当分類ノード以上のノード名一覧表示の許可	該当文書の一覧表示の許可
閲覧許可 B	階層構造上における該当分類ノード以上のノードの内容表示の許可	該当文書の内容表示の許可
複写印刷許可 C	階層構造上における該当分類ノード以上のノードおよびそれらに属する文書についての複写印刷の許可	該当文書の複写印刷の許可
登録更新許可 I	階層構造上における該当分類ノード以上のノードおよびそれらに属する文書についての移動、削除、更新、新規作成の許可	該当文書の内容更新の許可

【図6】

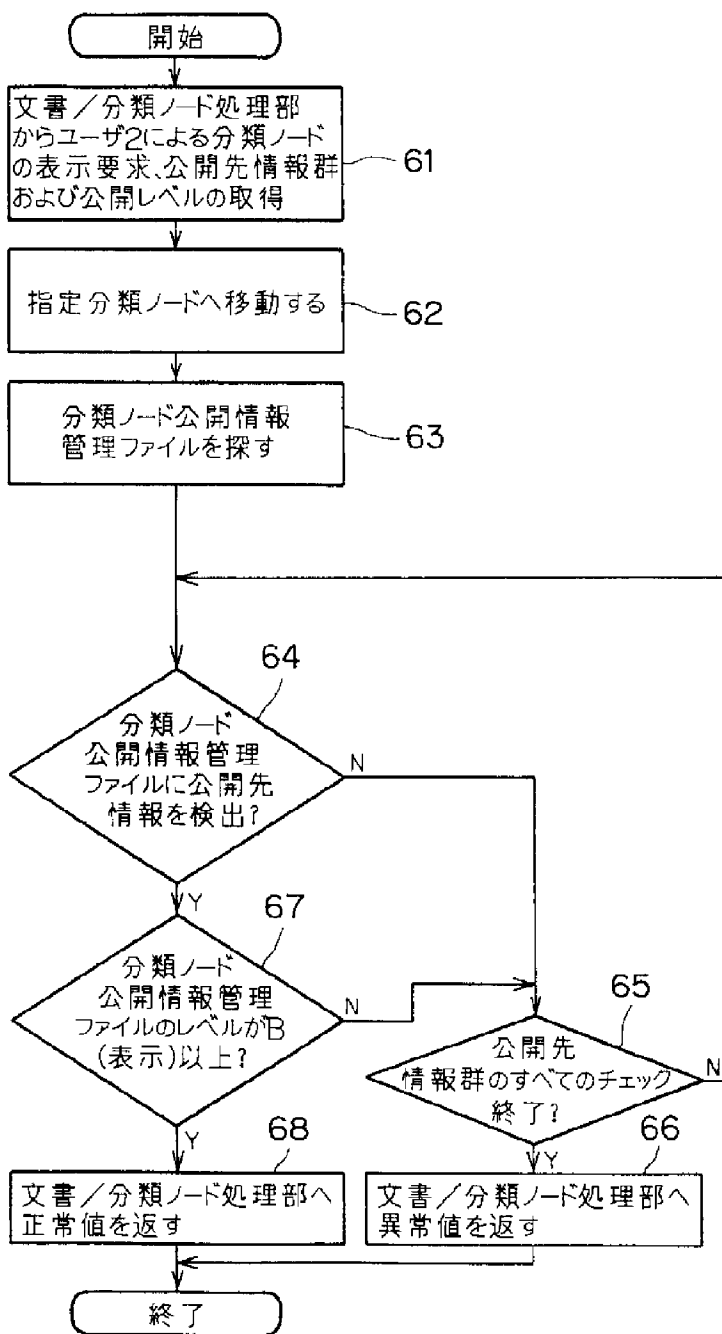



【図10】

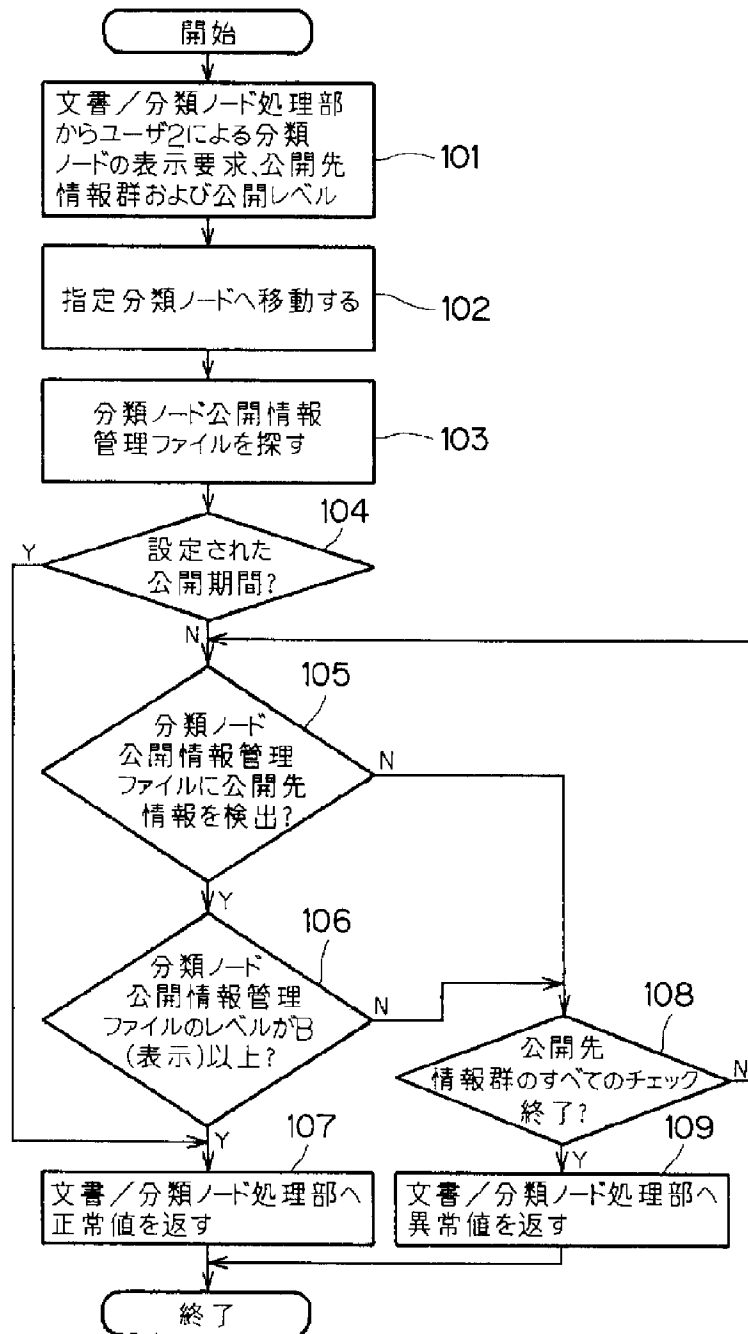

【図11】

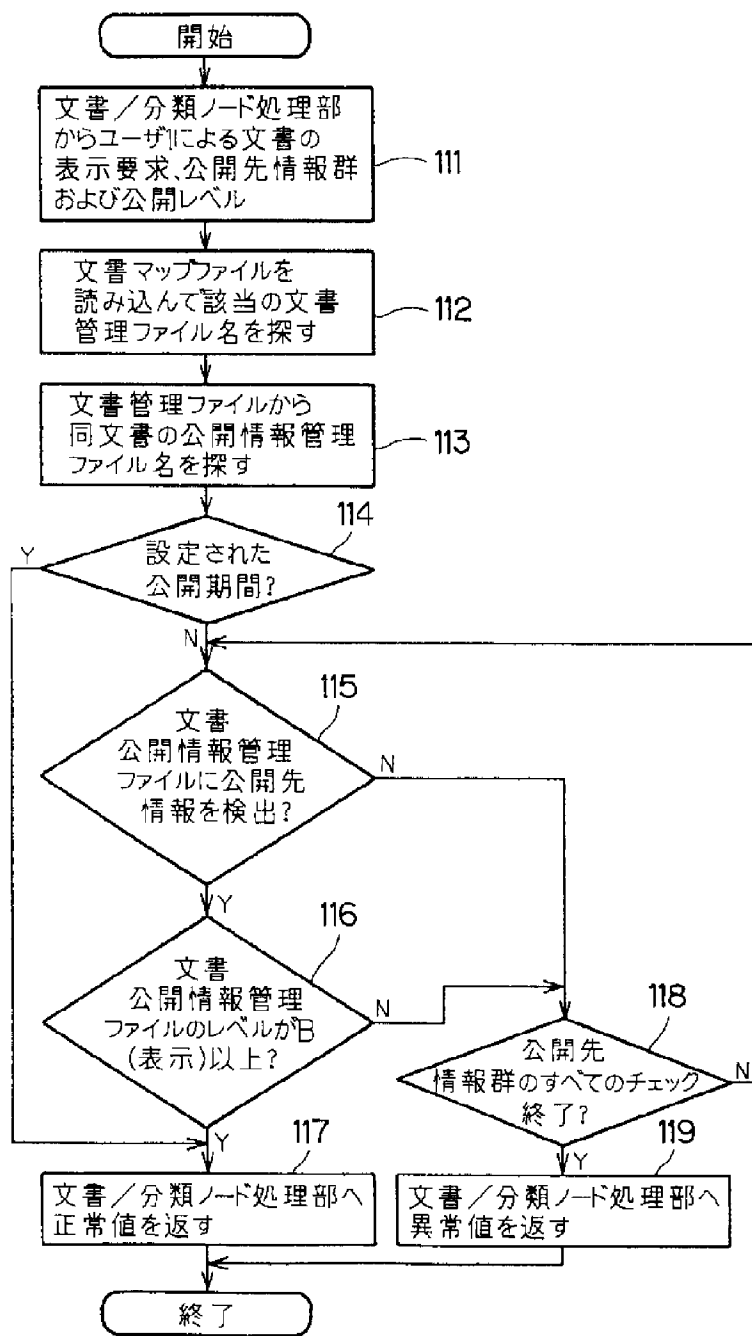

**INFORMATION DISCLOSURE  
STATEMENT BY APPLICANT**  
( Not for submission under 37 CFR 1.99)

Application Number	10956121		
Filing Date	2004-10-04		
First Named Inventor	Wang		
Art Unit	3685		
Examiner Name	Thomas C. West		
Attorney Docket Number	111325/291300		

**CERTIFICATION STATEMENT**

Please see 37 CFR 1.97 and 1.98 to make the appropriate selection(s):

That each item of information contained in the information disclosure statement was first cited in any communication from a foreign patent office in a counterpart foreign application not more than three months prior to the filing of the information disclosure statement. See 37 CFR 1.97(e)(1).

**OR**

That no item of information contained in the information disclosure statement was cited in a communication from a foreign patent office in a counterpart foreign application, and, to the knowledge of the person signing the certification after making reasonable inquiry, no item of information contained in the information disclosure statement was known to any individual designated in 37 CFR 1.56(c) more than three months prior to the filing of the information disclosure statement. See 37 CFR 1.97(e)(2).

See attached certification statement.

Fee set forth in 37 CFR 1.17 (p) has been submitted herewith.

None

**SIGNATURE**

A signature of the applicant or representative is required in accordance with CFR 1.33, 10.18. Please see CFR 1.4(d) for the form of the signature.

Signature	/Marc S. Kaufman, Reg No. 35,212/	Date (YYYY-MM-DD)	2008-10-10
Name/Print	Marc S. Kaufman	Registration Number	35,212

This collection of information is required by 37 CFR 1.97 and 1.98. The information is required to obtain or retain a benefit by the public which is to file (and by the USPTO to process) an application. Confidentiality is governed by 35 U.S.C. 122 and 37 CFR 1.14. This collection is estimated to take 1 hour to complete, including gathering, preparing and submitting the completed application form to the USPTO. Time will vary depending upon the individual case. Any comments on the amount of time you require to complete this form and/or suggestions for reducing this burden, should be sent to the Chief Information Officer, U.S. Patent and Trademark Office, U.S. Department of Commerce, P.O. Box 1450, Alexandria, VA 22313-1450. **DO NOT SEND FEES OR COMPLETED FORMS TO THIS ADDRESS. SEND TO: Commissioner for Patents, P.O. Box 1450, Alexandria, VA 22313-1450.**

## Privacy Act Statement

The Privacy Act of 1974 (P.L. 93-579) requires that you be given certain information in connection with your submission of the attached form related to a patent application or patent. Accordingly, pursuant to the requirements of the Act, please be advised that: (1) the general authority for the collection of this information is 35 U.S.C. 2(b)(2); (2) furnishing of the information solicited is voluntary; and (3) the principal purpose for which the information is used by the U.S. Patent and Trademark Office is to process and/or examine your submission related to a patent application or patent. If you do not furnish the requested information, the U.S. Patent and Trademark Office may not be able to process and/or examine your submission, which may result in termination of proceedings or abandonment of the application or expiration of the patent.

The information provided by you in this form will be subject to the following routine uses:

1. The information on this form will be treated confidentially to the extent allowed under the Freedom of Information Act (5 U.S.C. 552) and the Privacy Act (5 U.S.C. 552a). Records from this system of records may be disclosed to the Department of Justice to determine whether the Freedom of Information Act requires disclosure of these records.
2. A record from this system of records may be disclosed, as a routine use, in the course of presenting evidence to a court, magistrate, or administrative tribunal, including disclosures to opposing counsel in the course of settlement negotiations.
3. A record in this system of records may be disclosed, as a routine use, to a Member of Congress submitting a request involving an individual, to whom the record pertains, when the individual has requested assistance from the Member with respect to the subject matter of the record.
4. A record in this system of records may be disclosed, as a routine use, to a contractor of the Agency having need for the information in order to perform a contract. Recipients of information shall be required to comply with the requirements of the Privacy Act of 1974, as amended, pursuant to 5 U.S.C. 552a(m).
5. A record related to an International Application filed under the Patent Cooperation Treaty in this system of records may be disclosed, as a routine use, to the International Bureau of the World Intellectual Property Organization, pursuant to the Patent Cooperation Treaty.
6. A record in this system of records may be disclosed, as a routine use, to another federal agency for purposes of National Security review (35 U.S.C. 181) and for review pursuant to the Atomic Energy Act (42 U.S.C. 218(c)).
7. A record from this system of records may be disclosed, as a routine use, to the Administrator, General Services, or his/her designee, during an inspection of records conducted by GSA as part of that agency's responsibility to recommend improvements in records management practices and programs, under authority of 44 U.S.C. 2904 and 2906. Such disclosure shall be made in accordance with the GSA regulations governing inspection of records for this purpose, and any other relevant (i.e., GSA or Commerce) directive. Such disclosure shall not be used to make determinations about individuals.
8. A record from this system of records may be disclosed, as a routine use, to the public after either publication of the application pursuant to 35 U.S.C. 122(b) or issuance of a patent pursuant to 35 U.S.C. 151. Further, a record may be disclosed, subject to the limitations of 37 CFR 1.14, as a routine use, to the public if the record was filed in an application which became abandoned or in which the proceedings were terminated and which application is referenced by either a published application, an application open to public inspections or an issued patent.
9. A record from this system of records may be disclosed, as a routine use, to a Federal, State, or local law enforcement agency, if the USPTO becomes aware of a violation or potential violation of law or regulation.

## EAST Search History

Ref #	Hits	Search Query	DBs	Default Operator	Plurals	Time Stamp
L1	48	"5619570"	US-PGPUB; USPAT; USOCR; FPRS; EPO; JPO; DERWENT; IBM_TDB	OR	ON	2008/10/12 19:09
L2	6	ep and "0262025"	US-PGPUB; USPAT; USOCR; FPRS; EPO; JPO; DERWENT; IBM_TDB	OR	ON	2008/10/12 19:11
L3	0	ep0262025	US-PGPUB; USPAT; USOCR; FPRS; EPO; JPO; DERWENT; IBM_TDB	OR	ON	2008/10/12 19:11
L4	2	jp and "3063717"	US-PGPUB; USPAT; USOCR; FPRS; EPO; JPO; DERWENT; IBM_TDB	OR	ON	2008/10/12 19:12
L5	0	jp and "3-063717"	US-PGPUB; USPAT; USOCR; FPRS; EPO; JPO; DERWENT; IBM_TDB	OR	ON	2008/10/12 19:12
L6	2	"5619570".pn.	US-PGPUB; USPAT; USOCR; FPRS; EPO; JPO; DERWENT; IBM_TDB	OR	ON	2008/10/12 19:16
L11	2485	(state adj machine) and (state adj variable)	US-PGPUB; USPAT; USOCR; FPRS; EPO; JPO; DERWENT; IBM_TDB	OR	ON	2008/10/12 21:51
L12	1009	11 and @ad<="20010607"	US-PGPUB; USPAT; USOCR; FPRS; EPO; JPO; DERWENT; IBM_TDB	OR	ON	2008/10/12 21:52



L13	6	12 and metadata	US-PGPUB; USPAT; USOCR; FPRS; EPO; JPO; DERWENT; IBM_TDB	OR	ON	2008/10/12 21:52
L14	0	13 and ((derive derivable) near right)	US-PGPUB; USPAT; USOCR; FPRS; EPO; JPO; DERWENT; IBM_TDB	OR	ON	2008/10/12 21:53
L15	5	13 and right	US-PGPUB; USPAT; USOCR; FPRS; EPO; JPO; DERWENT; IBM_TDB	OR	ON	2008/10/12 21:53
L16	374	(state adj machine) with (state adj variable)	US-PGPUB; USPAT; USOCR; FPRS; EPO; JPO; DERWENT; IBM_TDB	OR	ON	2008/10/12 21:55
L17	54	(state adj machine) near (state adj variable)	US-PGPUB; USPAT; USOCR; FPRS; EPO; JPO; DERWENT; IBM_TDB	OR	ON	2008/10/12 21:55
L18	25	17 and @ad<="20010607"	US-PGPUB; USPAT; USOCR; FPRS; EPO; JPO; DERWENT; IBM_TDB	OR	ON	2008/10/12 21:55
L19	0	18 and metadata	US-PGPUB; USPAT; USOCR; FPRS; EPO; JPO; DERWENT; IBM_TDB	OR	ON	2008/10/12 21:56
L20	0	19 and rights	US-PGPUB; USPAT; USOCR; FPRS; EPO; JPO; DERWENT; IBM_TDB	OR	ON	2008/10/12 21:56
S1	1	"10956121"	US-PGPUB; USPAT; USOCR; FPRS; EPO; JPO; DERWENT; IBM_TDB	OR	ON	2008/04/02 09:39

S2	264	"3263158"	"3609697"	US-PGPUB;	OR	ON	2008/04/02
		"3790700"	"3798605"	USPAT; USOCR;			09:41
		"4159468"	"4220991"	FPRS; EPO;			
		"4278837"	"4323921"	JPO;			
		"4442486"	"4529870"	DERWENT;			
		"4558176"	"4593376"	IBM_TDB			
		"4614861"	"4644493"				
		"4658093"	"4713753"				
		"4796220"	"4817140"				
		"4827508"	"4868376"				
		"4891838"	"4924378"				
		"4932054"	"4937863"				
		"4949187"	"4953209"				
		"4961142"	"4975647"				
		"4977594"	"4999806"				
		"5010571"	"5014234"				
		"5023907"	"5047928"				
		"5050213"	"5052040"				
		"5058164"	"5103476"				
		"5113519"	"5136643"				
		"5138712"	"5146499"				
		"5148481"	"5159182"				
		"5183404"	"5191193"				
		"5204897"	"5222134"				
		"5235642"	"5247575"				
		"5255106"	"5260999"				
		"5263157"	"5263158"				
		"5276444"	"5276735"				
		"5291596"	"5301231"				
		"5311591"	"5319705"				
		"5337357"	"5339091"				
		"5341429"	"5347579"				
		"5381526"	"5394469"				
		"5410598"	"5412717"				
		"5428606"	"5432849"				
		"5438508"	"5444779"				
		"5453601"	"5455953"				
		"5457746"	"5473687"				
		"5473692"	"5499298"				
		"5502766"	"5504814"				
		"5504818"	"5504837"				
		"5509070"	"5530235"				
		"5532920"	"5534975"				
		"5539735"	"5563946"				
		"5568552"	"5621797"				
		"5629980"	"5633932"				
		"5634012"	"5638443"				
		"5649013"	"5655077"				
		"5708717"	"5715403"				
		"5734823"	"5734891"				
		"5737413"	"5737416"				
		"5745569"	"5748783"				
		"5757907"	"5761686"				
		"5765152"	"5768426"				
		"5825892"	"5892900"				
		"5910987"	"5915019"				
		"5917912"	"5920861"				
		"5940504"	"5943422"				
		"5949876"	"5982891"				

		"5999949"   "6047067"   "6112181"   "6115471"   "6138119"   "6157721"   "6185683"   "6226618"   "6233684"   "6237786"   "6240185"   "6253193"   "6266618"   "6292569"   "6301660"   "6327652"   "6330670"   "6345256"   "6363488"   "6389402").PN.				
S3	979	((Derived derivation derivable derivative derive) near right)	US-PGPUB; USPAT; USOCR; FPRS; EPO; JPO; DERWENT; IBM_TDB	OR	ON	2008/04/02 10:13
S4	101	S3 and (digital near right)	US-PGPUB; USPAT; USOCR; FPRS; EPO; JPO; DERWENT; IBM_TDB	OR	ON	2008/04/02 10:15
S6	106	S3 and ((digital near rights) (rights near management))	US-PGPUB; USPAT; USOCR; FPRS; EPO; JPO; DERWENT; IBM_TDB	OR	ON	2008/04/02 10:16
S7	23	S6 and (state near variable)	US-PGPUB; USPAT; USOCR; FPRS; EPO; JPO; DERWENT; IBM_TDB	OR	ON	2008/04/02 10:18
S9	979	((Derived derivation derivable derivative derive) near right)	US-PGPUB; USPAT; USOCR; FPRS; EPO; JPO; DERWENT; IBM_TDB	OR	ON	2008/04/02 11:23
S10	106	S9 and ((digital near rights) (rights near management))	US-PGPUB; USPAT; USOCR; FPRS; EPO; JPO; DERWENT; IBM_TDB	OR	ON	2008/04/02 11:23
S11	23	S10 and (state near variable)	US-PGPUB; USPAT; USOCR; FPRS; EPO; JPO; DERWENT; IBM_TDB	OR	ON	2008/04/02 11:23

S12	0	S11 and @ad<="20010607"	US-PGPUB; USPAT; USOCR; FPRS; EPO; JPO; DERWENT; IBM_TDB	OR	ON	2008/04/02 11:23
S13	9	S10 and inherit\$4	US-PGPUB; USPAT; USOCR; FPRS; EPO; JPO; DERWENT; IBM_TDB	OR	ON	2008/04/02 11:28
S14	55	S10 and (transfer\$3 with right)	US-PGPUB; USPAT; USOCR; FPRS; EPO; JPO; DERWENT; IBM_TDB	OR	ON	2008/04/02 11:30
S15	3	S14 and @ad<="20010607"	US-PGPUB; USPAT; USOCR; FPRS; EPO; JPO; DERWENT; IBM_TDB	OR	ON	2008/04/02 11:31
S16	16426	((Derived derivation derivable derivative derive) with right)	US-PGPUB; USPAT; USOCR; FPRS; EPO; JPO; DERWENT; IBM_TDB	OR	ON	2008/04/02 11:42
S17	136	S9 and ((digital near rights) (rights near management) drm (content near right))	US-PGPUB; USPAT; USOCR; FPRS; EPO; JPO; DERWENT; IBM_TDB	OR	ON	2008/04/02 11:43
S18	11	S17 and @ad<="20010607"	US-PGPUB; USPAT; USOCR; FPRS; EPO; JPO; DERWENT; IBM_TDB	OR	ON	2008/04/02 11:44
S19	71035	((Derived derivation derivable derivative derive transfer\$4) with right)	US-PGPUB; USPAT; USOCR; FPRS; EPO; JPO; DERWENT; IBM_TDB	OR	ON	2008/04/02 11:48
S20	2	"7228426"	US-PGPUB; USPAT; USOCR; FPRS; EPO; JPO; DERWENT; IBM_TDB	OR	ON	2008/04/02 14:50

S21	2	"7130829"	US-PGPUB; USPAT; USOCR; FPRS; EPO; JPO; DERWENT; IBM_TDB	OR	ON	2008/04/02 14:56
S22	0	(rights near definition near language) and (secure near inheritance)	US-PGPUB; USPAT; USOCR; FPRS; EPO; JPO; DERWENT; IBM_TDB	OR	ON	2008/04/02 15:17
S23	0	(rights near definition near language)	US-PGPUB; USPAT; USOCR; FPRS; EPO; JPO; DERWENT; IBM_TDB	OR	ON	2008/04/02 15:18
S24	1	(secure near inheritance)	US-PGPUB; USPAT; USOCR; FPRS; EPO; JPO; DERWENT; IBM_TDB	OR	ON	2008/04/02 15:18
S25	123	rights with inheritance	US-PGPUB; USPAT; USOCR; FPRS; EPO; JPO; DERWENT; IBM_TDB	OR	ON	2008/04/02 15:19
S26	47	S25 and @ad<="20010607"	US-PGPUB; USPAT; USOCR; FPRS; EPO; JPO; DERWENT; IBM_TDB	OR	ON	2008/04/02 15:19
S27	1	digital near rights with inheritance	US-PGPUB; USPAT; USOCR; FPRS; EPO; JPO; DERWENT; IBM_TDB	OR	ON	2008/04/02 17:15
S28	290	"6226618"	US-PGPUB; USPAT; USOCR; FPRS; EPO; JPO; DERWENT; IBM_TDB	OR	ON	2008/04/02 17:18
S29	2	"6226618".pn.	US-PGPUB; USPAT; USOCR; FPRS; EPO; JPO; DERWENT; IBM_TDB	OR	ON	2008/04/02 17:19

S30	49	XML near Ticket	US-PGPUB; USPAT; USOCR; FPRS; EPO; JPO; DERWENT; IBM_TDB	OR	ON	2008/04/03 07:31
S31	12	S30 and @ad<="20010607"	US-PGPUB; USPAT; USOCR; FPRS; EPO; JPO; DERWENT; IBM_TDB	OR	ON	2008/04/03 07:31
S32	1	S31 and ((digital near rights) (rights near management) drm (content near right))	US-PGPUB; USPAT; USOCR; FPRS; EPO; JPO; DERWENT; IBM_TDB	OR	ON	2008/04/03 07:35
S33	0	S31 and inherit\$4	US-PGPUB; USPAT; USOCR; FPRS; EPO; JPO; DERWENT; IBM_TDB	OR	ON	2008/04/03 07:36
S34	0	S31 and ((Derived derivation derivable derivative derive) with right)	US-PGPUB; USPAT; USOCR; FPRS; EPO; JPO; DERWENT; IBM_TDB	OR	ON	2008/04/03 07:37
S35	2287967	(Derived derivation derivable derivative derive inherit\$4)	US-PGPUB; USPAT; USOCR; FPRS; EPO; JPO; DERWENT; IBM_TDB	OR	ON	2008/04/03 07:40
S36	4807	S35 and ((digital near rights) (rights near management) drm (content near right))	US-PGPUB; USPAT; USOCR; FPRS; EPO; JPO; DERWENT; IBM_TDB	OR	ON	2008/04/03 07:41
S37	1025	S36 and @ad<="20010607"	US-PGPUB; USPAT; USOCR; FPRS; EPO; JPO; DERWENT; IBM_TDB	OR	ON	2008/04/03 07:44
S38	20	S37 and (state near variable)	US-PGPUB; USPAT; USOCR; FPRS; EPO; JPO; DERWENT; IBM_TDB	OR	ON	2008/04/03 07:45

S39	2	"5109413".pn.	US-PGPUB; USPAT; USOCR; FPRS; EPO; JPO; DERWENT; IBM_TDB	OR	ON	2008/04/03 08:40
S40	2	"5765152".pn.	US-PGPUB; USPAT; USOCR; FPRS; EPO; JPO; DERWENT; IBM_TDB	OR	ON	2008/04/03 08:41
S41	2	"5922074".pn.	US-PGPUB; USPAT; USOCR; FPRS; EPO; JPO; DERWENT; IBM_TDB	OR	ON	2008/04/03 08:41
S42	2	"6098056".pn.	US-PGPUB; USPAT; USOCR; FPRS; EPO; JPO; DERWENT; IBM_TDB	OR	ON	2008/04/03 08:42
S43	2	"6125349".pn.	US-PGPUB; USPAT; USOCR; FPRS; EPO; JPO; DERWENT; IBM_TDB	OR	ON	2008/04/03 08:43
S44	2	"6226618".pn.	US-PGPUB; USPAT; USOCR; FPRS; EPO; JPO; DERWENT; IBM_TDB	OR	ON	2008/04/03 08:44
S45	2	"6385596".pn.	US-PGPUB; USPAT; USOCR; FPRS; EPO; JPO; DERWENT; IBM_TDB	OR	ON	2008/04/03 10:57
S46	7	(US-20050060571-\$).did. or (US-5109413-\$ or US- 5765152-\$ or US-6098056-\$ or US-6125349-\$ or US- 6226618-\$ or US-6385596-\$). did.	US-PGPUB; USPAT	OR	ON	2008/04/03 10:59
S47	4	S46 and (Derived derivation derivable derivative derive inherit\$4)	US-PGPUB; USPAT; USOCR; FPRS; EPO; JPO; DERWENT; IBM_TDB	OR	ON	2008/04/03 11:02

S48	3	S47 and @ad<="20010607"	US-PGPUB; USPAT; USOCR; FPRS; EPO; JPO; DERWENT; IBM_TDB	OR	ON	2008/04/03 11:03
S49	0	S48 and (state near variable)	US-PGPUB; USPAT; USOCR; FPRS; EPO; JPO; DERWENT; IBM_TDB	OR	ON	2008/04/03 11:05
S50	1	S46 and metadata	US-PGPUB; USPAT; USOCR; FPRS; EPO; JPO; DERWENT; IBM_TDB	OR	ON	2008/04/03 11:11
S51	223	(US-20050060571-\$).did. or (US-6389402-\$ or US- 6363488-\$ or US-6345256-\$ or US-6330670-\$ or US- 6327652-\$ or US-6301660-\$ or US-6292569-\$ or US- 6266618-\$ or US-6253193-\$ or US-6240185-\$ or US- 6237786-\$ or US-6233684-\$ or US-6226618-\$ or US- 6185683-\$ or US-6157721-\$ or US-6138119-\$ or US- 6115471-\$ or US-6112181-\$ or US-6047067-\$ or US- 5999949-\$ or US-5982891-\$ or US-5949876-\$ or US- 5943422-\$ or US-5940504-\$ or US-5920861-\$ or US- 5917912-\$).did. or (US- 5915019-\$ or US-5910987-\$ or US-5892900-\$ or US- 5825892-\$ or US-5768426-\$ or US-5765152-\$ or US- 5761686-\$ or US-5757907-\$ or US-5748783-\$ or US- 5745569-\$ or US-5737416-\$ or US-5737413-\$ or US- 5734891-\$ or US-5734823-\$ or US-5715403-\$ or US- 5708717-\$ or US-5655077-\$ or US-5649013-\$ or US- 5638443-\$ or US-5634012-\$ or US-5633932-\$ or US- 5629980-\$ or US-5621797-\$ or US-5568552-\$ or US- 5563946-\$ or US-5539735-\$ or US-5534975-\$).did. or (US- 5532920-\$ or US-5530235-\$ or US-5509070-\$ or US- 5504837-\$ or US-5504818-\$	US-PGPUB; USPAT; USOCR; EPO; DERWENT	OR	ON	2008/04/03 11:12



or US-5504814-\$ or US-  
5502766-\$ or US-5499298-\$  
or US-5473692-\$ or US-  
5473687-\$ or US-5457746-\$  
or US-5455953-\$ or US-  
5453601-\$ or US-5444779-\$  
or US-5438508-\$ or US-  
5432849-\$ or US-5428606-\$  
or US-5412717-\$ or US-  
5410598-\$ or US-5394469-\$  
or US-5381526-\$ or US-  
5347579-\$ or US-5341429-\$  
or US-5339091-\$ or US-  
5337357-\$ or US-5319705-\$  
or US-5311591-\$).did. or (US-  
5301231-\$ or US-5291596-\$  
or US-5276735-\$ or US-  
5276444-\$ or US-5263158-\$  
or US-5263157-\$ or US-  
5260999-\$ or US-5255106-\$  
or US-5247575-\$ or US-  
5235642-\$ or US-5222134-\$  
or US-5204897-\$ or US-  
5191193-\$ or US-5183404-\$  
or US-5159182-\$ or US-  
5148481-\$ or US-5146499-\$  
or US-5138712-\$ or US-  
5136643-\$ or US-5113519-\$  
or US-5103476-\$ or US-  
5058164-\$ or US-5052040-\$  
or US-5050213-\$ or US-  
5047928-\$ or US-5023907-\$  
or US-5014234-\$).did. or (US-  
5010571-\$ or US-4999806-\$  
or US-4977594-\$ or US-  
4975647-\$ or US-4961142-\$  
or US-4953209-\$ or US-  
4949187-\$ or US-4937863-\$  
or US-4932054-\$ or US-  
4924378-\$ or US-4891838-\$  
or US-4868376-\$ or US-  
4827508-\$ or US-4817140-\$  
or US-4796220-\$ or US-  
4713753-\$ or US-4658093-\$  
or US-4644493-\$ or US-  
4614861-\$ or US-4593376-\$  
or US-4558176-\$ or US-  
4529870-\$ or US-4442486-\$  
or US-4323921-\$ or US-  
4278837-\$ or US-4220991-\$  
or US-4159468-\$).did. or (US-  
3798605-\$ or US-3790700-\$  
or US-3609697-\$ or US-  
3263158-\$ or US-6298316-\$  
or US-6135646-\$ or US-  
6161114-\$ or US-5956737-\$  
or US-5109413-\$ or US-  
6098056-\$ or US-6125349-\$  
or US-6385596-\$).did. or (US-  
3263158-\$).did. or (DE-

4323921-\$ or DE-3609697-\$).  
did. or (EP-1308115-A-\$ or  
EP-1180798-A-\$ or JP-  
2002016565-\$ or US-  
6330670-B-\$ or US-6327652-  
B-\$ or WO-0008909-A-\$ or  
FR-2772486-A-\$ or WO-  
9924928-A-\$ or EP-895149-A-  
\$ or WO-9840969-A-\$ or EP-  
862318-A-\$ or WO-9837481-  
A-\$ or JP-10214297-\$ or US-  
5761686-\$ or EP-838785-A-\$  
or US-5737413-\$ or US-  
5734823-\$ or WO-9809209-  
A-\$ or WO-9743761-A-\$ or  
US-5655077-\$ or WO-  
9726732-A-\$ or US-5649013-  
\$ or WO-9720298-A-\$ or US-  
5633932-\$ or WO-9714087-  
A-\$ or WO-9636163-A-\$).did.  
or (WO-9633476-A-\$ or US-  
5568552-\$ or WO-9627155-  
A-\$ or US-5539735-\$ or US-  
5534975-\$ or US-5530235-\$  
or EP-715246-A-\$ or EP-  
715245-A-\$ or EP-715244-A-  
\$ or EP-715243-A-\$ or DE-  
4442486-A-\$ or US-5509070-  
\$ or US-5504814-\$ or US-  
5473692-\$ or US-5473687-\$  
or WO-9530211-A-\$ or EP-  
679980-A-\$ or EP-679978-A-  
\$ or EP-679977-A-\$ or EP-  
672991-A-\$ or US-5428606-\$  
or WO-9514289-A-\$ or CA-  
2102743-\$ or EP-649074-A-\$  
or WO-9508231-A-\$ or US-  
5394469-\$ or DE-4323921-A-  
\$).did. or (WO-9427411-A-\$  
or WO-9419884-A-\$ or US-  
5337357-\$ or JP-06181924-\$  
or EP-601500-A-\$ or US-  
5319705-\$ or JP-06095591-\$  
or EP-588243-A-\$ or EP-  
575936-A-\$ or EP-570123-A-  
\$ or EP-567800-A-\$ or WO-  
9321581-A-\$ or EP-555715-A-  
\$ or US-5235642-\$ or US-  
5291596-\$ or EP-542298-A-\$  
or WO-9309490-A-\$ or EP-  
534679-A-\$ or US-5183404-\$  
or WO-9301550-A-\$ or WO-  
9220022-A-\$ or WO-  
9214187-A-\$ or US-5136643-  
\$ or WO-9209160-A-\$ or US-  
5103476-\$ or EP-471939-\$  
or US-5058164-\$).did. or (US-  
5052040-\$ or EP-447339-\$  
or US-5047928-\$ or EP-  
442838-\$ or US-5023907-\$

		or EP-425053-\$ or EP-423035-\$ or GB-2236604-\$ or EP-421409-\$ or US-4999806-\$ or EP-398494-\$ or US-4961142-\$ or US-4949187-\$ or DE-3903454-\$ or EP-367700-\$ or EP-366854-\$ or US-4924378-\$ or CA-1267443-\$ or EP-359220-\$ or WO-9002382-\$ or US-4891838-\$ or EP-332304-\$ or US-4796220-\$ or WO-8809019-\$ or EP-266748-\$ or WO-8802960-\$ or WO-8802202-\$.did. or (EP-252646-\$ or DE-3609697-\$ or US-4658093-\$ or EP-192243-\$ or US-4593376-\$ or WO-8603040-\$ or EP-174472-\$ or US-4558176-\$ or US-4529870-\$ or EP-80244-\$ or US-4368162-\$ or US-4278837-\$ or WO-8001635-\$ or DE-2849718-\$ or DE-2840980-\$ or US-3798605-\$.did.				
S52	20	S51 and metadata	US-PGPUB; USPAT; USOCR; FPRS; EPO; JPO; DERWENT; IBM_TDB	OR	ON	2008/04/03 11:12
S53	0	S52 and (state near variable)	US-PGPUB; USPAT; USOCR; FPRS; EPO; JPO; DERWENT; IBM_TDB	OR	ON	2008/04/03 11:13
S54	0	S52 and (state with variable)	US-PGPUB; USPAT; USOCR; FPRS; EPO; JPO; DERWENT; IBM_TDB	OR	ON	2008/04/03 11:13
S55	5	S51 and (state near variable)	US-PGPUB; USPAT; USOCR; FPRS; EPO; JPO; DERWENT; IBM_TDB	OR	ON	2008/04/03 11:13
S56	2287967	(Derived derivation derivable derivative derive inherit\$4)	US-PGPUB; USPAT; USOCR; FPRS; EPO; JPO; DERWENT; IBM_TDB	OR	ON	2008/04/03 12:12

S57	7539	S56 and (state near variable)	US-PGPUB; USPAT; USOCR; FPRS; EPO; JPO; DERWENT; IBM_TDB	OR	ON	2008/04/03 12:12
S58	272	S57 and metadata	US-PGPUB; USPAT; USOCR; FPRS; EPO; JPO; DERWENT; IBM_TDB	OR	ON	2008/04/03 12:13
S59	17	S58 and @ad<="20010607"	US-PGPUB; USPAT; USOCR; FPRS; EPO; JPO; DERWENT; IBM_TDB	OR	ON	2008/04/03 12:14
S60	223	(US-20050060571-\$).did. or (US-6389402-\$ or US- 6363488-\$ or US-6345256-\$ or US-6330670-\$ or US- 6327652-\$ or US-6301660-\$ or US-6292569-\$ or US- 6266618-\$ or US-6253193-\$ or US-6240185-\$ or US- 6237786-\$ or US-6233684-\$ or US-6226618-\$ or US- 6185683-\$ or US-6157721-\$ or US-6138119-\$ or US- 6115471-\$ or US-6112181-\$ or US-6047067-\$ or US- 5999949-\$ or US-5982891-\$ or US-5949876-\$ or US- 5943422-\$ or US-5940504-\$ or US-5920861-\$ or US- 5917912-\$).did. or (US- 5915019-\$ or US-5910987-\$ or US-5892900-\$ or US- 5825892-\$ or US-5768426-\$ or US-5765152-\$ or US- 5761686-\$ or US-5757907-\$ or US-5748783-\$ or US- 5745569-\$ or US-5737416-\$ or US-5737413-\$ or US- 5734891-\$ or US-5734823-\$ or US-5715403-\$ or US- 5708717-\$ or US-5655077-\$ or US-5649013-\$ or US- 5638443-\$ or US-5634012-\$ or US-5633932-\$ or US- 5629980-\$ or US-5621797-\$ or US-5568552-\$ or US- 5563946-\$ or US-5539735-\$ or US-5534975-\$).did. or (US- 5532920-\$ or US-5530235-\$ or US-5509070-\$ or US- 5504837-\$ or US-5504818-\$	US-PGPUB; USPAT; USOCR; EPO; DERWENT	OR	ON	2008/04/03 17:02

or US-5504814-\$ or US-  
5502766-\$ or US-5499298-\$  
or US-5473692-\$ or US-  
5473687-\$ or US-5457746-\$  
or US-5455953-\$ or US-  
5453601-\$ or US-5444779-\$  
or US-5438508-\$ or US-  
5432849-\$ or US-5428606-\$  
or US-5412717-\$ or US-  
5410598-\$ or US-5394469-\$  
or US-5381526-\$ or US-  
5347579-\$ or US-5341429-\$  
or US-5339091-\$ or US-  
5337357-\$ or US-5319705-\$  
or US-5311591-\$).did. or (US-  
5301231-\$ or US-5291596-\$  
or US-5276735-\$ or US-  
5276444-\$ or US-5263158-\$  
or US-5263157-\$ or US-  
5260999-\$ or US-5255106-\$  
or US-5247575-\$ or US-  
5235642-\$ or US-5222134-\$  
or US-5204897-\$ or US-  
5191193-\$ or US-5183404-\$  
or US-5159182-\$ or US-  
5148481-\$ or US-5146499-\$  
or US-5138712-\$ or US-  
5136643-\$ or US-5113519-\$  
or US-5103476-\$ or US-  
5058164-\$ or US-5052040-\$  
or US-5050213-\$ or US-  
5047928-\$ or US-5023907-\$  
or US-5014234-\$).did. or (US-  
5010571-\$ or US-4999806-\$  
or US-4977594-\$ or US-  
4975647-\$ or US-4961142-\$  
or US-4953209-\$ or US-  
4949187-\$ or US-4937863-\$  
or US-4932054-\$ or US-  
4924378-\$ or US-4891838-\$  
or US-4868376-\$ or US-  
4827508-\$ or US-4817140-\$  
or US-4796220-\$ or US-  
4713753-\$ or US-4658093-\$  
or US-4644493-\$ or US-  
4614861-\$ or US-4593376-\$  
or US-4558176-\$ or US-  
4529870-\$ or US-4442486-\$  
or US-4323921-\$ or US-  
4278837-\$ or US-4220991-\$  
or US-4159468-\$).did. or (US-  
3798605-\$ or US-3790700-\$  
or US-3609697-\$ or US-  
3263158-\$ or US-6298316-\$  
or US-6135646-\$ or US-  
6161114-\$ or US-5956737-\$  
or US-5109413-\$ or US-  
6098056-\$ or US-6125349-\$  
or US-6385596-\$).did. or (US-  
3263158-\$).did. or (DE-

4323921-\$ or DE-3609697-\$).  
did. or (EP-1308115-A-\$ or  
EP-1180798-A-\$ or JP-  
2002016565-\$ or US-  
6330670-B-\$ or US-6327652-  
B-\$ or WO-0008909-A-\$ or  
FR-2772486-A-\$ or WO-  
9924928-A-\$ or EP-895149-A-  
\$ or WO-9840969-A-\$ or EP-  
862318-A-\$ or WO-9837481-  
A-\$ or JP-10214297-\$ or US-  
5761686-\$ or EP-838785-A-\$  
or US-5737413-\$ or US-  
5734823-\$ or WO-9809209-  
A-\$ or WO-9743761-A-\$ or  
US-5655077-\$ or WO-  
9726732-A-\$ or US-5649013-  
\$ or WO-9720298-A-\$ or US-  
5633932-\$ or WO-9714087-  
A-\$ or WO-9636163-A-\$).did.  
or (WO-9633476-A-\$ or US-  
5568552-\$ or WO-9627155-  
A-\$ or US-5539735-\$ or US-  
5534975-\$ or US-5530235-\$  
or EP-715246-A-\$ or EP-  
715245-A-\$ or EP-715244-A-  
\$ or EP-715243-A-\$ or DE-  
4442486-A-\$ or US-5509070-  
\$ or US-5504814-\$ or US-  
5473692-\$ or US-5473687-\$  
or WO-9530211-A-\$ or EP-  
679980-A-\$ or EP-679978-A-  
\$ or EP-679977-A-\$ or EP-  
672991-A-\$ or US-5428606-\$  
or WO-9514289-A-\$ or CA-  
2102743-\$ or EP-649074-A-\$  
or WO-9508231-A-\$ or US-  
5394469-\$ or DE-4323921-A-  
\$).did. or (WO-9427411-A-\$  
or WO-9419884-A-\$ or US-  
5337357-\$ or JP-06181924-\$  
or EP-601500-A-\$ or US-  
5319705-\$ or JP-06095591-\$  
or EP-588243-A-\$ or EP-  
575936-A-\$ or EP-570123-A-  
\$ or EP-567800-A-\$ or WO-  
9321581-A-\$ or EP-555715-A-  
\$ or US-5235642-\$ or US-  
5291596-\$ or EP-542298-A-\$  
or WO-9309490-A-\$ or EP-  
534679-A-\$ or US-5183404-\$  
or WO-9301550-A-\$ or WO-  
9220022-A-\$ or WO-  
9214187-A-\$ or US-5136643-  
\$ or WO-9209160-A-\$ or US-  
5103476-\$ or EP-471939-\$  
or US-5058164-\$).did. or (US-  
5052040-\$ or EP-447339-\$  
or US-5047928-\$ or EP-  
442838-\$ or US-5023907-\$

		or EP-425053-\$ or EP-423035-\$ or GB-2236604-\$ or EP-421409-\$ or US-4999806-\$ or EP-398494-\$ or US-4961142-\$ or US-4949187-\$ or DE-3903454-\$ or EP-367700-\$ or EP-366854-\$ or US-4924378-\$ or CA-1267443-\$ or EP-359220-\$ or WO-9002382-\$ or US-4891838-\$ or EP-332304-\$ or US-4796220-\$ or WO-8809019-\$ or EP-266748-\$ or WO-8802960-\$ or WO-8802202-\$.did. or (EP-252646-\$ or DE-3609697-\$ or US-4658093-\$ or EP-192243-\$ or US-4593376-\$ or WO-8603040-\$ or EP-174472-\$ or US-4558176-\$ or US-4529870-\$ or EP-80244-\$ or US-4368162-\$ or US-4278837-\$ or WO-8001635-\$ or DE-2849718-\$ or DE-2840980-\$ or US-3798605-\$.did.				
S61	21	S60 and (state near (variable machine))	US-PGPUB; USPAT; USOCR; FPRS; EPO; JPO; DERWENT; IBM_TDB	OR	ON	2008/04/03 17:02
S62	1611	(state near (variable machine)) and metadata	US-PGPUB; USPAT; USOCR; FPRS; EPO; JPO; DERWENT; IBM_TDB	OR	ON	2008/04/03 17:03
S63	863	S62 and (Derived derivation derivable derivative derive inherit\$4)	US-PGPUB; USPAT; USOCR; FPRS; EPO; JPO; DERWENT; IBM_TDB	OR	ON	2008/04/03 17:04
S65	95	S63 and ((digital near rights) (rights near management) drm (content near right))	US-PGPUB; USPAT; USOCR; FPRS; EPO; JPO; DERWENT; IBM_TDB	OR	ON	2008/04/03 17:05
S66	22	S65 and @ad<="20010607"	US-PGPUB; USPAT; USOCR; FPRS; EPO; JPO; DERWENT; IBM_TDB	OR	ON	2008/04/03 17:05

S67	22	S66 and license	US-PGPUB; USPAT; USOCR; FPRS; EPO; JPO; DERWENT; IBM_TDB	OR	ON	2008/04/03 17:10
S68	1809	(state near (variable machine table)) and metadata	US-PGPUB; USPAT; USOCR; FPRS; EPO; JPO; DERWENT; IBM_TDB	OR	ON	2008/04/03 17:26
S69	958	S68 and (Derived derivation derivable derivative derive inherit\$4)	US-PGPUB; USPAT; USOCR; FPRS; EPO; JPO; DERWENT; IBM_TDB	OR	ON	2008/04/03 17:26
S70	96	S69 and ((digital near rights) (rights near management) drm (content near right))	US-PGPUB; USPAT; USOCR; FPRS; EPO; JPO; DERWENT; IBM_TDB	OR	ON	2008/04/03 17:27
S71	206	S69 and license	US-PGPUB; USPAT; USOCR; FPRS; EPO; JPO; DERWENT; IBM_TDB	OR	ON	2008/04/03 17:28
S72	35	S71 and @ad<="20010607"	US-PGPUB; USPAT; USOCR; FPRS; EPO; JPO; DERWENT; IBM_TDB	OR	ON	2008/04/03 17:28
S74	1809	(state near (variable machine table)) and metadata	US-PGPUB; USPAT; USOCR; FPRS; EPO; JPO; DERWENT; IBM_TDB	OR	ON	2008/04/04 08:11
S75	958	S74 and (Derived derivation derivable derivative derive inherit\$4)	US-PGPUB; USPAT; USOCR; FPRS; EPO; JPO; DERWENT; IBM_TDB	OR	ON	2008/04/04 08:11
S76	206	S75 and license	US-PGPUB; USPAT; USOCR; FPRS; EPO; JPO; DERWENT; IBM_TDB	OR	ON	2008/04/04 08:11



S77	35	S76 and @ad<="20010607"	US-PGPUB; USPAT; USOCR; FPRS; EPO; JPO; DERWENT; IBM_TDB	OR	ON	2008/04/04 08:11
S78	20	S77 and (right with transfer)	US-PGPUB; USPAT; USOCR; FPRS; EPO; JPO; DERWENT; IBM_TDB	OR	ON	2008/04/04 08:11
S80	20	S77 and (right with transfer \$3)	US-PGPUB; USPAT; USOCR; FPRS; EPO; JPO; DERWENT; IBM_TDB	OR	ON	2008/04/04 08:12
S81	64	(state near (variable machine table)) with metadata	US-PGPUB; USPAT; USOCR; FPRS; EPO; JPO; DERWENT; IBM_TDB	OR	ON	2008/04/04 08:39
S82	25	S81 and (Derived derivation derivable derivative derive inherit\$4)	US-PGPUB; USPAT; USOCR; FPRS; EPO; JPO; DERWENT; IBM_TDB	OR	ON	2008/04/04 08:39
S83	1	S81 and ((Derived derivation derivable derivative derive inherit\$4 transfer\$4) with right)	US-PGPUB; USPAT; USOCR; FPRS; EPO; JPO; DERWENT; IBM_TDB	OR	ON	2008/04/04 08:41
S84	0	S83 and license	US-PGPUB; USPAT; USOCR; FPRS; EPO; JPO; DERWENT; IBM_TDB	OR	ON	2008/04/04 08:41
S85	20	"09866101"	US-PGPUB; USPAT; USOCR; FPRS; EPO; JPO; DERWENT; IBM_TDB	OR	ON	2008/04/04 08:48
S86	1	"9866101"	US-PGPUB; USPAT; USOCR; FPRS; EPO; JPO; DERWENT; IBM_TDB	OR	ON	2008/04/04 08:48

S87	1	S85 and @ad<="20010607"	US-PGPUB; USPAT; USOCR; FPRS; EPO; JPO; DERWENT; IBM_TDB	OR	ON	2008/04/04 08:52
S88	2	"20030163597".pn.	US-PGPUB; USPAT; USOCR; FPRS; EPO; JPO; DERWENT; IBM_TDB	OR	ON	2008/04/04 08:54
S89	64	(state near (variable machine table)) with metadata	US-PGPUB; USPAT; USOCR; FPRS; EPO; JPO; DERWENT; IBM_TDB	OR	ON	2008/04/04 11:27
S90	25	S89 and (Derived derivation derivable derivative derive inherit\$4)	US-PGPUB; USPAT; USOCR; FPRS; EPO; JPO; DERWENT; IBM_TDB	OR	ON	2008/04/04 11:27
S91	0	S90 and @ad<="20010607"	US-PGPUB; USPAT; USOCR; FPRS; EPO; JPO; DERWENT; IBM_TDB	OR	ON	2008/04/04 11:27
S92	65	(state near (variable machine table diagram)) with metadata	US-PGPUB; USPAT; USOCR; FPRS; EPO; JPO; DERWENT; IBM_TDB	OR	ON	2008/04/04 11:30
S93	8	S92 and @ad<="20010607"	US-PGPUB; USPAT; USOCR; FPRS; EPO; JPO; DERWENT; IBM_TDB	OR	ON	2008/04/04 11:30
S94	246	(US-20050060571-\$ or US-20020165724-\$ or US-20020069324-\$ or US-20060064666-\$ or US-20030163597-\$ or US-20010054180-\$ or US-20010053996-\$ or US-20010039571-\$).did. or (US-6389402-\$ or US-6363488-\$ or US-6345256-\$ or US-6330670-\$ or US-6327652-\$ or US-6301660-\$ or US-6292569-\$ or US-6266618-\$ or US-6253193-\$ or US-	US-PGPUB; USPAT; USOCR; EPO; DERWENT	OR	ON	2008/04/04 11:46

6240185-\$ or US-6237786-\$  
or US-6233684-\$ or US-  
6226618-\$ or US-6185683-\$  
or US-6157721-\$ or US-  
6138119-\$ or US-6115471-\$  
or US-6112181-\$ or US-  
6047067-\$ or US-5999949-\$  
or US-5982891-\$ or US-  
5949876-\$ or US-5943422-\$  
or US-5940504-\$ or US-  
5920861-\$ or US-5917912-\$).  
did. or (US-5915019-\$ or US-  
5910987-\$ or US-5892900-\$  
or US-5825892-\$ or US-  
5768426-\$ or US-5765152-\$  
or US-5761686-\$ or US-  
5757907-\$ or US-5748783-\$  
or US-5745569-\$ or US-  
5737416-\$ or US-5737413-\$  
or US-5734891-\$ or US-  
5734823-\$ or US-5715403-\$  
or US-5708717-\$ or US-  
5655077-\$ or US-5649013-\$  
or US-5638443-\$ or US-  
5634012-\$ or US-5633932-\$  
or US-5629980-\$ or US-  
5621797-\$ or US-5568552-\$  
or US-5563946-\$ or US-  
5539735-\$ or US-5534975-\$).  
did. or (US-5532920-\$ or US-  
5530235-\$ or US-5509070-\$  
or US-5504837-\$ or US-  
5504818-\$ or US-5504814-\$  
or US-5502766-\$ or US-  
5499298-\$ or US-5473692-\$  
or US-5473687-\$ or US-  
5457746-\$ or US-5455953-\$  
or US-5453601-\$ or US-  
5444779-\$ or US-5438508-\$  
or US-5432849-\$ or US-  
5428606-\$ or US-5412717-\$  
or US-5410598-\$ or US-  
5394469-\$ or US-5381526-\$  
or US-5347579-\$ or US-  
5341429-\$ or US-5339091-\$  
or US-5337357-\$ or US-  
5319705-\$ or US-5311591-\$).  
did. or (US-5301231-\$ or US-  
5291596-\$ or US-5276735-\$  
or US-5276444-\$ or US-  
5263158-\$ or US-5263157-\$  
or US-5260999-\$ or US-  
5255106-\$ or US-5247575-\$  
or US-5235642-\$ or US-  
5222134-\$ or US-5204897-\$  
or US-5191193-\$ or US-  
5183404-\$ or US-5159182-\$  
or US-5148481-\$ or US-  
5146499-\$ or US-5138712-\$  
or US-5136643-\$ or US-

5113519-\$ or US-5103476-\$  
or US-5058164-\$ or US-  
5052040-\$ or US-5050213-\$  
or US-5047928-\$ or US-  
5023907-\$ or US-5014234-\$).  
did. or (US-5010571-\$ or US-  
4999806-\$ or US-4977594-\$  
or US-4975647-\$ or US-  
4961142-\$ or US-4953209-\$  
or US-4949187-\$ or US-  
4937863-\$ or US-4932054-\$  
or US-4924378-\$ or US-  
4891838-\$ or US-4868376-\$  
or US-4827508-\$ or US-  
4817140-\$ or US-4796220-\$  
or US-4713753-\$ or US-  
4658093-\$ or US-4644493-\$  
or US-4614861-\$ or US-  
4593376-\$ or US-4558176-\$  
or US-4529870-\$ or US-  
4442486-\$ or US-4323921-\$  
or US-4278837-\$ or US-  
4220991-\$ or US-4159468-\$).  
did. or (US-3798605-\$ or US-  
3790700-\$ or US-3609697-\$  
or US-3263158-\$ or US-  
6298316-\$ or US-6135646-\$  
or US-6161114-\$ or US-  
5956737-\$ or US-5109413-\$  
or US-6098056-\$ or US-  
6125349-\$ or US-6385596-\$  
or US-6366904-\$ or US-  
7133845-\$ or US-7120800-\$  
or US-7095854-\$ or US-  
7076652-\$ or US-7069451-\$  
or US-6948070-\$ or US-  
6427140-\$ or US-6850252-\$  
or US-7130807-\$ or US-  
7124101-\$ or US-6671818-\$  
or US-6606744-\$ or US-  
6442684-\$ or US-6158001-\$).  
did. or (US-5996073-\$).did.  
or (US-3263158-\$).did. or  
(DE-4323921-\$ or DE-  
3609697-\$).did. or (EP-  
1308115-A-\$ or EP-1180798-  
A-\$ or JP-2002016565-\$ or  
US-6330670-B-\$ or US-  
6327652-B-\$ or WO-0008909-  
A-\$ or FR-2772486-A-\$ or  
WO-9924928-A-\$ or EP-  
895149-A-\$ or WO-9840969-  
A-\$ or EP-862318-A-\$ or WO-  
9837481-A-\$ or JP-10214297-  
\$ or US-5761686-\$ or EP-  
838785-A-\$ or US-5737413-\$  
or US-5734823-\$ or WO-  
9809209-A-\$ or WO-  
9743761-A-\$ or US-5655077-  
\$ or WO-9726732-A-\$ or US-

5649013-\$ or WO-9720298-A-\$ or US-5633932-\$ or WO-9714087-A-\$ or WO-9636163-A-\$).did. or (WO-9633476-A-\$ or US-5568552-\$ or WO-9627155-A-\$ or US-5539735-\$ or US-5534975-\$ or US-5530235-\$ or EP-715246-A-\$ or EP-715245-A-\$ or EP-715244-A-\$ or EP-715243-A-\$ or DE-4442486-A-\$ or US-5509070-\$ or US-5504814-\$ or US-5473692-\$ or US-5473687-\$ or WO-9530211-A-\$ or EP-679980-A-\$ or EP-679978-A-\$ or EP-679977-A-\$ or EP-672991-A-\$ or US-5428606-\$ or WO-9514289-A-\$ or CA-2102743-\$ or EP-649074-A-\$ or WO-9508231-A-\$ or US-5394469-\$ or DE-4323921-A-\$).did. or (WO-9427411-A-\$ or WO-9419884-A-\$ or US-5337357-\$ or JP-06181924-\$ or EP-601500-A-\$ or US-5319705-\$ or JP-06095591-\$ or EP-588243-A-\$ or EP-575936-A-\$ or EP-570123-A-\$ or EP-567800-A-\$ or WO-9321581-A-\$ or EP-555715-A-\$ or US-5235642-\$ or US-5291596-\$ or EP-542298-A-\$ or WO-9309490-A-\$ or EP-534679-A-\$ or US-5183404-\$ or WO-9301550-A-\$ or WO-9220022-A-\$ or WO-9214187-A-\$ or US-5136643-\$ or WO-9209160-A-\$ or US-5103476-\$ or EP-471939-\$ or US-5058164-\$).did. or (US-5052040-\$ or EP-447339-\$ or US-5047928-\$ or EP-442838-\$ or US-5023907-\$ or EP-425053-\$ or EP-423035-\$ or GB-2236604-\$ or EP-421409-\$ or US-4999806-\$ or EP-398494-\$ or US-4961142-\$ or US-4949187-\$ or DE-3903454-\$ or EP-367700-\$ or EP-366854-\$ or US-4924378-\$ or CA-1267443-\$ or EP-359220-\$ or WO-9002382-\$ or US-4891838-\$ or EP-332304-\$ or US-4796220-\$ or WO-8809019-\$ or EP-266748-\$ or WO-8802960-\$ or WO-8802202-\$).did. or

		(EP-252646-\$ or DE-3609697-\$ or US-4658093-\$ or EP-192243-\$ or US-4593376-\$ or WO-8603040-\$ or EP-174472-\$ or US-4558176-\$ or US-4529870-\$ or EP-80244-\$ or US-4368162-\$ or US-4278837-\$ or WO-8001635-\$ or DE-2849718-\$ or DE-2840980-\$ or US-3798605-\$).did.				
S95	7	S94 and (state near (variable machine table diagram)) with metadata	US-PGPUB; USPAT; USOCR; FPRS; EPO; JPO; DERWENT; IBM_TDB	OR	ON	2008/04/04 11:47
S96	1	S95 and (Derived derivation derivable derivative derive inherit\$4)	US-PGPUB; USPAT; USOCR; FPRS; EPO; JPO; DERWENT; IBM_TDB	OR	ON	2008/04/04 11:49
S97	0	S95 and license	US-PGPUB; USPAT; USOCR; FPRS; EPO; JPO; DERWENT; IBM_TDB	OR	ON	2008/04/04 11:51
S98	16931	(Derived derivation derivable derivative derive inherit\$4) with rights	US-PGPUB; USPAT; USOCR; FPRS; EPO; JPO; DERWENT; IBM_TDB	OR	ON	2008/04/04 11:58
S99	440	S98 and metadata	US-PGPUB; USPAT; USOCR; FPRS; EPO; JPO; DERWENT; IBM_TDB	OR	ON	2008/04/04 11:59
S100	1	S98 and (state near (variable machine table diagram)) with metadata	US-PGPUB; USPAT; USOCR; FPRS; EPO; JPO; DERWENT; IBM_TDB	OR	ON	2008/04/04 11:59
S101	2	S98 and (state near (variable machine table diagram)) same metadata	US-PGPUB; USPAT; USOCR; FPRS; EPO; JPO; DERWENT; IBM_TDB	OR	ON	2008/04/04 12:00

S102	116	S98 and (state near (variable machine table diagram)) and metadata	US-PGPUB; USPAT; USOCR; FPRS; EPO; JPO; DERWENT; IBM_TDB	OR	ON	2008/04/04 12:00
S103	97	S102 and license	US-PGPUB; USPAT; USOCR; FPRS; EPO; JPO; DERWENT; IBM_TDB	OR	ON	2008/04/04 12:01
S104	22	S103 and @ad<="20010607"	US-PGPUB; USPAT; USOCR; FPRS; EPO; JPO; DERWENT; IBM_TDB	OR	ON	2008/04/04 12:01
S105	10	S102 and drm	US-PGPUB; USPAT; USOCR; FPRS; EPO; JPO; DERWENT; IBM_TDB	OR	ON	2008/04/04 12:13
S106	0	S105 and @ad<="20010607"	US-PGPUB; USPAT; USOCR; FPRS; EPO; JPO; DERWENT; IBM_TDB	OR	ON	2008/04/04 12:13
S107	22	S104 and (Derived derivation derivable derivative derive inherit\$4) with rights	US-PGPUB; USPAT; USOCR; FPRS; EPO; JPO; DERWENT; IBM_TDB	OR	ON	2008/04/04 12:26
S108	0	S104 and (Derived derivation derivable derivative derive inherit\$4) near rights	US-PGPUB; USPAT; USOCR; FPRS; EPO; JPO; DERWENT; IBM_TDB	OR	ON	2008/04/04 12:26
S109	0	S104 and (Derived derivation derivable derivative derive inherit\$4) near (rights product)	US-PGPUB; USPAT; USOCR; FPRS; EPO; JPO; DERWENT; IBM_TDB	OR	ON	2008/04/04 12:27
S110	0	S104 and ((Derived derivation derivable derivative derive inherit\$4) near (rights product))	US-PGPUB; USPAT; USOCR; FPRS; EPO; JPO; DERWENT; IBM_TDB	OR	ON	2008/04/04 12:27

S111	37700	((Derived derivation derivable derivative derive inherit\$4) near (rights product))	US-PGPUB; USPAT; USOCR; FPRS; EPO; JPO; DERWENT; IBM_TDB	OR	ON	2008/04/04 12:27
S112	42471	((Derived derivation derivable derivative derive inherit\$4) near (rights product content))	US-PGPUB; USPAT; USOCR; FPRS; EPO; JPO; DERWENT; IBM_TDB	OR	ON	2008/04/04 12:28
S113	0	S112 and (state near (variable machine table diagram)) with metadata	US-PGPUB; USPAT; USOCR; FPRS; EPO; JPO; DERWENT; IBM_TDB	OR	ON	2008/04/04 12:28
S114	605	S112 and ((digital near rights) (rights near management) drm (content near right))	US-PGPUB; USPAT; USOCR; FPRS; EPO; JPO; DERWENT; IBM_TDB	OR	ON	2008/04/04 12:29
S115	200	S114 and metadata	US-PGPUB; USPAT; USOCR; FPRS; EPO; JPO; DERWENT; IBM_TDB	OR	ON	2008/04/04 12:30
S116	0	S115 and (state near (variable machine table diagram)) with metadata	US-PGPUB; USPAT; USOCR; FPRS; EPO; JPO; DERWENT; IBM_TDB	OR	ON	2008/04/04 12:30
S117	48	S115 and (state near (variable machine table diagram))	US-PGPUB; USPAT; USOCR; FPRS; EPO; JPO; DERWENT; IBM_TDB	OR	ON	2008/04/04 12:30
S119	21	S117 and @ad<="20010607"	US-PGPUB; USPAT; USOCR; FPRS; EPO; JPO; DERWENT; IBM_TDB	OR	ON	2008/04/04 12:31
S120	53061	"rights expression language" prep	US-PGPUB; USPAT; USOCR; FPRS; EPO; JPO; DERWENT; IBM_TDB	OR	ON	2008/04/04 12:47



S121	119	S120 and metadata	US-PGPUB; USPAT; USOCR; FPRS; EPO; JPO; DERWENT; IBM_TDB	OR	ON	2008/04/04 12:48
S122	29	S121 and (state near (variable machine table diagram))	US-PGPUB; USPAT; USOCR; FPRS; EPO; JPO; DERWENT; IBM_TDB	OR	ON	2008/04/04 12:48
S123	5	S122 and @ad<="20010607"	US-PGPUB; USPAT; USOCR; FPRS; EPO; JPO; DERWENT; IBM_TDB	OR	ON	2008/04/04 12:48
S124	163	"rights expression language"	US-PGPUB; USPAT; USOCR; FPRS; EPO; JPO; DERWENT; IBM_TDB	OR	ON	2008/04/04 12:50
S125	56	S124 and metadata	US-PGPUB; USPAT; USOCR; FPRS; EPO; JPO; DERWENT; IBM_TDB	OR	ON	2008/04/04 12:50
S126	8	S125 and (state near (variable machine table diagram))	US-PGPUB; USPAT; USOCR; FPRS; EPO; JPO; DERWENT; IBM_TDB	OR	ON	2008/04/04 12:50
S127	0	S126 and @ad<="20010607"	US-PGPUB; USPAT; USOCR; FPRS; EPO; JPO; DERWENT; IBM_TDB	OR	ON	2008/04/04 12:50
S128	225	"rights expression language" "open digital rights language" odrl	US-PGPUB; USPAT; USOCR; FPRS; EPO; JPO; DERWENT; IBM_TDB	OR	ON	2008/04/04 12:54
S129	74	S128 and metadata	US-PGPUB; USPAT; USOCR; FPRS; EPO; JPO; DERWENT; IBM_TDB	OR	ON	2008/04/04 12:54

S130	8	S129 and (state near (variable machine table diagram))	US-PGPUB; USPAT; USOCR; FPRS; EPO; JPO; DERWENT; IBM_TDB	OR	ON	2008/04/04 12:55
S131	0	S130 and @ad<="20010607"	US-PGPUB; USPAT; USOCR; FPRS; EPO; JPO; DERWENT; IBM_TDB	OR	ON	2008/04/04 12:55
S132	219	drm and ((Derived derivation derivable derivative derive inherit\$4) with rights)	US-PGPUB; USPAT; USOCR; FPRS; EPO; JPO; DERWENT; IBM_TDB	OR	ON	2008/04/04 13:03
S133	35	S132 and (state near (variable machine table diagram))	US-PGPUB; USPAT; USOCR; FPRS; EPO; JPO; DERWENT; IBM_TDB	OR	ON	2008/04/04 13:04
S134	10	S133 and metadata	US-PGPUB; USPAT; USOCR; FPRS; EPO; JPO; DERWENT; IBM_TDB	OR	ON	2008/04/04 13:04
S135	0	S134 and @ad<="20010607"	US-PGPUB; USPAT; USOCR; FPRS; EPO; JPO; DERWENT; IBM_TDB	OR	ON	2008/04/04 13:06
S136	171	S114 and @ad<="20010607"	US-PGPUB; USPAT; USOCR; FPRS; EPO; JPO; DERWENT; IBM_TDB	OR	ON	2008/04/04 13:07
S137	39	S136 and metadata	US-PGPUB; USPAT; USOCR; FPRS; EPO; JPO; DERWENT; IBM_TDB	OR	ON	2008/04/04 13:07
S138	21	S137 and (state near (variable machine table diagram))	US-PGPUB; USPAT; USOCR; FPRS; EPO; JPO; DERWENT; IBM_TDB	OR	ON	2008/04/04 13:09

10/12/2008 10:49:16 PM

C:\Documents and Settings\twest\My Documents\EAST\Workspaces\10\_9\56121 - Wang\56121 - Wang.wsp



## Workshop on Digital Rights Management for the Web

World Wide Web Consortium

22-23 January 2001

INRIA - Sophia-Antipolis, France

2004, Route des Lucioles

### WORKSHOP PROGRAM

Workshop Notes & Presentations

Workshop Summary Report

Submitted Position Papers

Participants

Mailing List

Call for Participation

Background Reference Material

### **Important dates**

*Papers submission deadline: 22 December 2000*

*Registration deadline: 12 January 2001*

### **Workshop meter**

On 20 December 2000: 62 registrations, 41 position papers received, and 69 persons on the mailing list.

---

Last update \$Date: 2001/04/26 16:55:07 \$ by \$Author: rigo \$



[\[Minutes Overview\]](#) [\[Workshop Home\]](#) [\[Previous: Publishers Requirements\]](#)  
[\[Next: Architecture: Interoperability and Standards\]](#)

## Minutes from the Architecture/Infrastructure Session

***Please refer to the position-papers and slides for authoritative answers. The following minutes are only a snapshot of Presentations and Discussions***

- [INDECS Framework Data Definitions](#)  
Godfrey Rust (Indecs Project)
- [URI's and Object Identifiers](#)  
Dan Connolly (W3C)
- [Principles for Standardization and Interoperability in Web-based Digital Rights Management](#)  
John Erickson (Hewlett-Packard)
- [Open Digital Rights Management](#)  
Renato Iannella (IPR Systems)
- [Digital Object Identifier](#)  
Norman Paskin (Int. DOI Foundation)
- [Discussion](#)

---

### Godfrey Rust (<indecs> Project), INDECS Framework Data Definitions

*See also the [\[Slides \(ppt\)\]](#) and the [<indecs> Framework](#)*

The <indecs> project ended 2000, now we are new company called <indecs> framework. Look at our online document: Principles, model, and data dictionary, June 2000.

We see DRM in terms of metadata, as a metadata problem. The description is covered in Open eBook, ONIX, and my company.

Here is the scheme:

1. people make stuff
2. people use stuff

### 3. people do deals about stuff

The scope is stuff. This can be characterized in terms of:

1. Parties
2. Creations
3. Agreements

Rust projected a diagram showing the high granularity in the <indec> model, with hierarchy of parties and agreements. He noted that you must pass along the metadata in a structured defined way to permit computational processes.

The following things are required:

- functional granularity: you must be able to identify stuff at any level of granularity
- unique id
- who says so - designated authority
- appropriate access (who can do what)

In the 1980s, there were few schemes for description, today there are many, lists ten major ones, including MPEG-7, ONIX, SMPTE, RIAA/IFPI, and several more.

Here are the <indec> principles:

- **All metadata is just a view** (example: about the work versus about the manifestation, and more, each of which may have its own rights)
  - views must not be confused; mistaken identity can be disastrous to rights management
  - views need to be interoperable
- **Almost all terms need identifiers**
  - values must be defined and identified
  - need standard vocabularies and ontologies.
  - automation need for disambiguity. There is an existing vocabulary for some things: territories, language, currency, date/time and some others. But we need dozens of others.
- **Events are key to interoperability**
  - most metadata is stuff or people based
  - events description are key to rights management

Godfrey Rust gave an example how this would work:

1. make event the first class object, e.g., Rust creating these slides
2. then all the other elements are attributes: author, date, title, etc.
3. next event, e.g., Rust showing this Slide -- it has attributes too and references the previous event, thus connecting the creative items
4. next event: Norman Paskin adapts (transforming event) these slides before he shows it at another meeting, thus creating new attributes and references to preceding events, thus connecting the creative items

This model has the same information as other metadata structures, just organized differently to serve rights management.

Here's another event that bears on rights: agreeing. What goes into the agreement is what goes into descriptive metadata, what he had, what he did. Also assertion by a trusted entity that verifies or authenticates.

Using the event structure, now have six events regarding these slide-show. See how you can use events to **integrate** descriptive and rights metadata.

But we need rights vocabularies to make this work, on a parallel with the need for vocabularies to serve descriptive metadata.

## Dan Connolly [W3C], W3C URI Design Principles

*See also the corresponding Activity within W3C and the slides*

He outlined W3C's Philosophy of Standards: Help people do the right thing.

URIs will have a relationship to a potential DRM-Activity. Connolly also suggests that DRM discussion focus on payments and rights negotiation as much as prevention of access.

All names are ultimately local. Global naming depends on social agreements and trust. HTTP is not the only protocol. For the Web, we use DNS (Domain Name System). Don't forget, HTML is not the only file type. Things can evolve, you can use proxies and thus use an old name against new protocol. But URIs are the only thing in that arena. New protocols can be used with existing names. There is no need to change names just because you change protocols. We don't need to make new URI schemes just because we have made a new data format.

There is opacity: Don't peek inside names, names (URIs) are not user interface. Don't reinvent redirection in http, it is not a service, they are not locators. DNS supports multiple A records. Lots of administrative hierarchies fit in current http and DNS, you don't need to

invent a new URI scheme.

URIs were not designed as a user interface. Don't use a URN as a brand name. To establish a new trusted brand name, trying to wedge them into DNS is a problem, you're ought to use <title>

## John Erickson (HP), Principles for Standardization and Interoperability in Web-based Digital Rights Management

*See also the [slides](#) and the [Position Paper](#).*

John Erickson started by re-inforcing what was already heard during previous sessions: When we think about DRM, we have to separate expression of rights information and policies from the enforcement of those rights. We have to think of a layered model, separate the expression of rights information from the info for discovery and from implementing and enforcing those rights.

What is the W3C's role here? We think W3C should recommend a platform. Erickson put emphasis on the development of a language and a protocol for IPR policy expression, discovery, and interpretation.

The W3C should not recommend a standard DRM system. But we should provide a basis for the interoperability of such systems. Core should be to find a reliable way to express and transfer rights information. Remember the design principles of the web, IPR work ought not violate them.

Erickson developed the following set of requirements:

- never interfere with users' ability to discover info (incl rights info) on the web, this is what I mean by universal access, so I can decide about whether to access
- always communicate the policies and technical restraints in understandable language
- policies are communicated in fair and open ways
- need for trust, need to have a basis to trust the assertions being made, need a mechanism to assure trustworthiness
- IPR information and policies must be discoverable and minimally interpretable independent of any given vendor's solution
- the languages and protocols must be designed for evolution
- web based mechanism must allow for owners to choose different tools and consumers to use different tools to discover and interpret rights info
- cool new content that comes along ought not break the DRM systems or break the languages and protocols



Here's our [HP publishing group] proposal: PREP (Policy and Rights Expression Platform, see the [Position Paper](#) for more information). It would be a framework to express and interpret the policies and info. It should complement laws and self-regulatory programs. It should be consistent with prior work, e.g., P3P.

What are the building blocks of PREP?

- semantics - policy interpretation mechanisms
- objects - rights messaging protocol
- syntax - rights expression languages

**Erickson concluded:**

1. W3C should recommend a platform for IPR policy expression, discovery, and interpretation.
2. W3C should not recommend a standardized digital rights management system.
3. Core should be reliable way to express and transfer rights information.

## Renato Iannella (IPR Systems), Open Digital Rights Management

*See also the [slides](#) and the [Position Paper](#)*

We need to define DRM formally. Customary DRM definitions tend to emphasize protection, enforcement, security. We need to remove the security/locking focus of DRM. There are a lot of definitions out there. But we want DRM to be broader: describe, identity, trade, monitor, track, and manage rights holder relationships. We want to leave behind the "creation waterfall" concept of create => trade => use as a line. We want to look at a circular life cycle approach (compare Rust events). We use the same terms: create-trade-use and add reuse = recreate. Then the life cycle is more accurately seen as circular. He gave an example of transparency in presenting rights, from Adobe eBook. You are authorized to get the copy. It is OK to copy (up to 10 times each week), to print, to lend. But you cannot give or read aloud. He suggested, that it should be possible to pay for usage, not possession.

The following are building blocks for a DRM architecture:

- A better metadata framework: He would like it to be in RDF
- Trust (digital signatures)
- There are lessons to learn from P3P, CC/PP
- identification (URIs)
- XML packaging and tools

- use the <indecs> model: content, parties, rights. Each one is a kind of class. Parties described would be: author, corporate, agent, publisher. The content would be classified in work, expression, manifestation, item. Rights would be classified in usages, rewards, constraints.

Renato Iannella presented the ODRL. He sees it as a starting point for a DRM Language, that could be developed within W3C.

Concludes: W3C Role could be:

- W3C Digital Rights Language Working Group to develop semantics of a digital rights language encoded in XML
- Trusted Metadata Working Group to develop architecture to support encoding and transmission of DRM and other metadata
- DRM Interest Group to discuss next steps and establish relationship with other communities

W3C can solve some part of the DRM problem, coordinate others, and empower the user community.

## Norman Paskin (Int. DOI Foundation), Digital Object Identifier (DOI)

*See also the slides (ppt) and the Position Paper*

Paskin was presenting the activity of the DOI Foundation. We have spent three years developing an identifier system for digital objects. We have been influenced by <indecs> analysis and implementations, e.g., ONIX and by consideration of digital object infrastructure (e.g., CNRI work).

DRM must be maximally extensible. DRM is digital management of rights, not just management of digital rights. Practical rights management will require dealing with both digital and non-digital rights. Unique identification is essential for automation to work on this.

Description info and rights info are not distinguishable. Any piece of description may be needed in a rights transaction.

Creative items used to be physical, today we have both a physical and digital manifestation, so sometimes there are two identifiers, e.g., ISBN for one, URL for the other. But if we are going to automate transactions we must dis-ambiguate meanings. We need to define word like book in the spaces it may found in, the ISBN space or the <indecs> space.

There will not be one model for applying identifiers, it will differ for content communities, given practical implications, e.g. ONIX, MPEG-7, etc. A work may be an original manuscript version, the work in the abstract, a draft, a copy in a publication, a digital copy not in a publication, a reprint, etc.. In each role, there will be different ids and attributes. We don't have to have complete knowledge representation. We can build on agreements over what an identifier means within a given namespace

About names and locations, he said that a name is a location in a defined namespace, thus all names are locations is trivially true.

As practical needs for DOI, Paskin identified:

- multiple instances
- persistence in face of change
- mgt of non-digital entities
- de-referencing, resolution

Who should be responsible for naming: Standards bodies, rights collectives? Examples are:

- EAN/UPC bar code system
- ISBN system
- URI system But what in the digital realm?
- URLs are a poor system for publishers

Identifier needs to be actionable. They can be the basis for rights management. But there won't be one place to go for:

- e.g., directory of parties (names of people, sort of, as for music, is developing a directory)
- e.g., ontology of scientific article

We need to involve stakeholders, what is the W3C good for here?

Paskin used an aphorism: I think what is called media convergence really is "people convergence" (with the correlative problem of communication). Formalisms are essential in their place but must be explained. What we ought to care about does not just encompass the web.

DOI system offers :

- numbering - use any identifier
- description - can use <indec> framework

- action - handles allow to link to instances
- It is persistent, granular, flexible, can wrap other identifiers

## Discussion

*Not for all questions and answers, the author was identified. In this case, you'll see only question and answer*

**Question:** is URI primarily address where you find something?

**Dan Connolly (W3C):** I don't think so.

**Danny Weitzner (W3C):** Question to Godfrey Rust and John Erickson: Is there a consensus point? John said there should be a rights management schema. How modular is the <indec> system? Does anyone who uses something that falls under the <indec> model have to use the whole model?

**Godfrey Rust (<indec>):** It is a matter of how you structure your information. If we use the event model to organize our system, this should lead to interoperability. If one wants to express things in most efficient way, an events - systems will be very powerful. Other systems/legacy info can be transformed into events model. One doesn't have to organize all data into high level of functionality. We can still use information that is fairly low grade.

**John Erickson (HP):** An event model is powerful, because it allows description of certain rights relationships that we might think of in terms of electronic contracts. If we speak about rights languages, we can imagine a lot of different types of transactions. There are things that need to be declared, between an author and a publisher. It is a dynamic activity with lots of outcomes that the event model can characterize. The event model is the basis of an ontology. We need different vocabularies for different purposes. A contract between an author and a publisher is like dynamic state machine. The event model is a powerful way to express that. Things like rights vouchers/licenses and output of individual states are dependant on dynamic events.

**Maximilian Herberger (Uni Saarland):** Events are only one side. The event model reflects the state of subjective rights within a specific contract. We also need a way to describe how things fit together or what things have in common. We need a language at a higher level about objective rights. This language should be able to express classes of contract relationships. I think the combination of the two is the solution here.

**Jonathan Schull (Digital Goods):** Suppose I'm a publisher and I want to publish a book electronically. There are a whole lot of ways to do this. Each combination will have a

different address, thus creating a different digital object. A publisher doesn't really care about the locations, he only cares about initial work. He may decide that people shouldn't print it, or that people want their money back. As a publisher, I want to have only one thing to do.

**Jonathan D. Hahn (Versaware):** In a contrarian mode I say, well, about these "events," you know publishers may think of only one event, the one that came into play when I signed on to publish this work.

**Godfrey Rust (<indec>):** A DOI is a single number for the object

**Dan Connolly (W3C):** What's the first letter of most DOIs? Names are little pieces of communication. Making up a name without thinking about communication is sort of silly. We don't decide anything by ourselves, we decide together with people we communicate with. I don't think you can invent new technology that solves all the social problems involved

**Norman Paskin (DOI):** The web is not the universal information space. There are things, which aren't on the web. We need to identify them too.

**Eric Miller (OCLC):** you can place something on the web without using DOI. I represent libraries, so if you publish, you want consumer to get access to stuff - you have to talk to your customer base to find out whether they will use access mechanism you are designing to access content. What are the things we are trying to automate here? Let's think about a scenario with implemented DRM, let's do what-if scenarios.

**Question:** Why are ontologies so important?

**Answer:** Take a look at ontologies and what publishers require and you have your problem defined

**Eric Miller (OCLC):** A question not yet resolved is, what happens in DRM if different kinds of people are accessing the same object, e.g. in the context of a library.

**Robert Bollick, (McGraw-Hill):** This is already covered. It is like every consumer/publisher interaction which is covered by the requirements. More information can be found on [publishers.org](http://publishers.org). The name of the document is publishers DRM requirements.

**Comment:** We will get a lot of input/requirements from many different constituencies, e.g. record industry, book industry etc.. We need to consider the evolution of technology - technical components should be able to move independently from one another. We have a conceptual model: Take a language and a context used by different areas and avoid using

two different terms for same requirement. We need to build a common platform. That gives you a mechanism to do extensions that are truly unique. Medicine, oil-drilling all use different terminology, but a conceptual model helps us to decide whether their need is unique and helps us develop an orthogonal system, and avoid redundancy

**Scott Foshee, (Adobe)** states agreement with the interest in fine-grained identification implied by the <indecs>/DOI ideas.

**Question:** We won't be able to define precisely what work is. We should avoid defining it. While broad categories of interactions may have been studied, do you think your publishing model is extensible to images, text, font? To Godfrey Rust: Do you think we can extend this to publishing of aggregations, e.g. written book by an author combined with paper it is printed on ?

**Godfrey Rust (<indecs>):** Take a look at indecs papers. The answer is yes, I think this is possible.

**Answer:** The same is true for ONIX - thinking about selling pieces of a work

**Danny Weitzner (W3C):** Commenting on Norman's point of the Web not being the universal information space, I think that in the discussions so far we showed lots of attention on commercial needs. The question is whether we would like common framework for discovering rights of document whether or not produced principally for trade or not? E.g., does a picture of my 3-year old fit into this framework? We risk to produce big costs if there are two classes of documents: One that fits into trading and others who don't. If we look at music, we see, that non-traditional documents are traded. I'm a bit concerned about the application of these systems only to "trade" items in the web, ignoring or disenfranchising the little objects which also have rights associated with them.

**Godfrey Rust (<indecs>):**The model we worked on are neutral as far as commerce is concerned. It can be used for picture of 3 year old. We haven't actually developed framework though. A critical piece of work is to decide what those verbs (note: for the actions) are. The model still needs a lot of detailed work. We have roughly agreed on the direction we take. Please don't overestimate what we've done.

**Norman Paskin (DOI):** <indecs>/DOI is about transactions. We mean by transaction anything, whether it's free or not. We focused on e-commerce. Our economic model is based on the barcode model. For some transactions, the financial cost will be zero.

**John Erickson (HP):** What is the methodology for rationalising to interpret new dimensions for a given problem space? There has been a lot of talk about notion of ontologies. We

have a certain way of thinking about a problem, and perhaps another way. Now we try to find ontologies to identify common points. Where does the notion of rationalizing problem spaces conflict with ontologies? I can see that it resonates in a closed room ...

**Rob Koenen, MPEG:** MPEG-7 is standard for describing content. Based on XML schema, there are principle notions like actor, people etc. Those are listed in a concepts list. There are basic concepts like shape, color etc. People can build their own ontology. MPEG has just decided to do a data dictionary for a rights language. MPEG has issued a call for requirements on 19 January 2001. Koenen invited W3C to work with MPEG on working on this problem

**Peter Schirling (IBM & MPEG):** We should try to avoid unnecessary duplication. We allow each discipline to build an ontology from a common frame, to reduce duplication of elements. Under that framework, different sectors can add their own things to a specific concepts list. Currently, we have only concept lists very specific to audio-visual content.

**Scott Foshee (Adobe):** There are two classes of objects (things): Under control and not under control. I wanted to state my agreement with Danny Weitzner, that there should only be one class. Clipart in a presentation software is an aggregation with content you created. By using a product that was licensed, everything on a harddisk is aggregated content work. DRM should be able to handle that. Take a picture of Danny Weitzner and apply a filter may result in aggregate work. The process that is applied results in another object. We need to get something that is workable, because this technology will be everywhere

Coffee Break, but not enough coffee for some

---

[\[Minutes Overview\]](#) [\[Workshop Home\]](#) [\[Previous:Publishers Requirements\]](#)  
[\[Next:Architecture: Interoperability and Standards\]](#)

Created by Rigo Wenning February 2001  
Last update \$Date: 2001/04/18 16:50:31 \$ by \$Author: rigo \$

<b>Index of Claims</b>  	<b>Application/Control No.</b>  10956121	<b>Applicant(s)/Patent Under Reexamination</b>  WANG ET AL.
	<b>Examiner</b>  THOMAS WEST	<b>Art Unit</b>  3685

✓	<b>Rejected</b>
=	<b>Allowed</b>

-	<b>Cancelled</b>
÷	<b>Restricted</b>

N	<b>Non-Elected</b>
I	<b>Interference</b>

A	<b>Appeal</b>
O	<b>Objected</b>

Claims renumbered in the same order as presented by applicant
  CPA
  T.D.
  R.1.47

CLAIM		DATE							
Final	Original	10/12/2008							
	1	✓							
	2	✓							
	3	✓							
	4	✓							
	5	✓							
	6	✓							
	7	✓							
	8	✓							
	9	✓							
	10	✓							
	11	✓							
	12	✓							
	13	✓							
	14	✓							
	15	✓							
	16	✓							
	17	✓							
	18	✓							
	19	✓							
	20	✓							
	21	✓							
	22	✓							
	23	✓							
	24	✓							
	25	✓							
	26	✓							
	27	✓							
	28	✓							
	29	✓							
	30	✓							
	31	✓							
	32	✓							
	33	✓							
	34	✓							
	35	✓							
	36	✓							



<b><i>Index of Claims</i></b>  	<b>Application/Control No.</b>  10956121	<b>Applicant(s)/Patent Under Reexamination</b>  WANG ET AL.
	<b>Examiner</b>  THOMAS WEST	<b>Art Unit</b>  3685

✓	<b>Rejected</b>
=	<b>Allowed</b>

-	<b>Cancelled</b>
÷	<b>Restricted</b>

<b>N</b>	<b>Non-Elected</b>
<b>I</b>	<b>Interference</b>

<b>A</b>	<b>Appeal</b>
<b>O</b>	<b>Objected</b>

<b>INFORMATION DISCLOSURE STATEMENT BY APPLICANT</b> ( Not for submission under 37 CFR 1.99)	Application Number		10956121	
	Filing Date		2004-10-04	
	First Named Inventor	Wang		
	Art Unit		3685	
	Examiner Name	Thomas C. West		
	Attorney Docket Number		111325/291300	

U.S.PATENTS							Remove
Examiner Initial*	Cite No	Patent Number	Kind Code <sup>1</sup>	Issue Date	Name of Patentee or Applicant of cited Document	Pages,Columns,Lines where Relevant Passages or Relevant Figures Appear	
	1	5287408		1994-02-15	Samson		
	2	5390297		1995-02-14	Barber et al.		
	3	5553143		1996-09-03	Ross et al.		
	4	5564038		1996-10-08	Grantz et al.		
	5	5625690		1997-04-29	Michel et al.		
	6	5638513		1997-06-10	Ananda		
	7	5414852		1995-05-09	Kramer et al.		
If you wish to add additional U.S. Patent citation information please click the Add button.							Add
U.S.PATENT APPLICATION PUBLICATIONS							Remove

**INFORMATION DISCLOSURE  
STATEMENT BY APPLICANT**  
( Not for submission under 37 CFR 1.99)

Application Number	10956121
Filing Date	2004-10-04
First Named Inventor	Wang
Art Unit	3685
Examiner Name	Thomas C. West
Attorney Docket Number	111325/291300

Examiner Initial*	Cite No	Publication Number	Kind Code <sup>1</sup>	Publication Date	Name of Patentee or Applicant of cited Document	Pages, Columns, Lines where Relevant Passages or Relevant Figures Appear
	1					

If you wish to add additional U.S. Published Application citation information please click the Add button.

**FOREIGN PATENT DOCUMENTS**

Examiner Initial*	Cite No	Foreign Document Number <sup>3</sup>	Country Code <sup>2</sup>	Kind Code <sup>4</sup>	Publication Date	Name of Patentee or Applicant of cited Document	Pages, Columns, Lines where Relevant Passages or Relevant Figures Appear	T <sup>5</sup>
	1	5-100939	JP		1993-04-23			<input type="checkbox"/>

If you wish to add additional Foreign Patent Document citation information please click the Add button

**NON-PATENT LITERATURE DOCUMENTS**

Examiner Initials*	Cite No	Include name of the author (in CAPITAL LETTERS), title of the article (when appropriate), title of the item (book, magazine, journal, serial, symposium, catalog, etc), date, pages(s), volume-issue number(s), publisher, city and/or country where published.	T <sup>5</sup>
	1	Delaigle, "Digital Watermarking," Spie Conference in Optical Security and Counterfeit Deterrence Techniques, San Jose, CA (Feb. 1996)	<input type="checkbox"/>
	2	Perritt, "Technologies Strategies for Protecting Intellectual Property in the Networked Multimedia Environment," Knowbots, Permissions Headers and Contract Law (Apr. 2 -3 1993)	<input type="checkbox"/>

If you wish to add additional non-patent literature document citation information please click the Add button

**EXAMINER SIGNATURE**

Examiner Signature	/Thomas West/	Date Considered	10/14/2008
--------------------	---------------	-----------------	------------

\*EXAMINER: Initial if reference considered, whether or not citation is in conformance with MPEP 609. Draw line through a citation if not in conformance and not considered. Include copy of this form with next communication to applicant.

**INFORMATION DISCLOSURE  
STATEMENT BY APPLICANT**  
( Not for submission under 37 CFR 1.99)

Application Number	10956121
Filing Date	2004-10-04
First Named Inventor	Wang
Art Unit	3685
Examiner Name	Thomas C. West
Attorney Docket Number	111325/291300

<sup>1</sup> See Kind Codes of USPTO Patent Documents at [www.USPTO.GOV](http://www.USPTO.GOV) or MPEP 901.04. <sup>2</sup> Enter office that issued the document, by the two-letter code (WIPO Standard ST.3). <sup>3</sup> For Japanese patent documents, the indication of the year of the reign of the Emperor must precede the serial number of the patent document. <sup>4</sup> Kind of document by the appropriate symbols as indicated on the document under WIPO Standard ST.16 if possible. <sup>5</sup> Applicant is to place a check mark here if English language translation is attached.

**INFORMATION DISCLOSURE  
STATEMENT BY APPLICANT**  
( Not for submission under 37 CFR 1.99)

Application Number	10956121		
Filing Date	2004-10-04		
First Named Inventor	Wang		
Art Unit	3685		
Examiner Name	Thomas C. West		
Attorney Docket Number	111325/291300		

**CERTIFICATION STATEMENT**

Please see 37 CFR 1.97 and 1.98 to make the appropriate selection(s):

That each item of information contained in the information disclosure statement was first cited in any communication from a foreign patent office in a counterpart foreign application not more than three months prior to the filing of the information disclosure statement. See 37 CFR 1.97(e)(1).

**OR**

That no item of information contained in the information disclosure statement was cited in a communication from a foreign patent office in a counterpart foreign application, and, to the knowledge of the person signing the certification after making reasonable inquiry, no item of information contained in the information disclosure statement was known to any individual designated in 37 CFR 1.56(c) more than three months prior to the filing of the information disclosure statement. See 37 CFR 1.97(e)(2).

See attached certification statement.

Fee set forth in 37 CFR 1.17 (p) has been submitted herewith.

None

**SIGNATURE**

A signature of the applicant or representative is required in accordance with CFR 1.33, 10.18. Please see CFR 1.4(d) for the form of the signature.

Signature	/Marc S. Kaufman, Reg. No. 35,212/	Date (YYYY-MM-DD)	2008-10-10
Name/Print	Marc S. Kaufman	Registration Number	35,212

This collection of information is required by 37 CFR 1.97 and 1.98. The information is required to obtain or retain a benefit by the public which is to file (and by the USPTO to process) an application. Confidentiality is governed by 35 U.S.C. 122 and 37 CFR 1.14. This collection is estimated to take 1 hour to complete, including gathering, preparing and submitting the completed application form to the USPTO. Time will vary depending upon the individual case. Any comments on the amount of time you require to complete this form and/or suggestions for reducing this burden, should be sent to the Chief Information Officer, U.S. Patent and Trademark Office, U.S. Department of Commerce, P.O. Box 1450, Alexandria, VA 22313-1450. **DO NOT SEND FEES OR COMPLETED FORMS TO THIS ADDRESS. SEND TO: Commissioner for Patents, P.O. Box 1450, Alexandria, VA 22313-1450.**

## Privacy Act Statement

The Privacy Act of 1974 (P.L. 93-579) requires that you be given certain information in connection with your submission of the attached form related to a patent application or patent. Accordingly, pursuant to the requirements of the Act, please be advised that: (1) the general authority for the collection of this information is 35 U.S.C. 2(b)(2); (2) furnishing of the information solicited is voluntary; and (3) the principal purpose for which the information is used by the U.S. Patent and Trademark Office is to process and/or examine your submission related to a patent application or patent. If you do not furnish the requested information, the U.S. Patent and Trademark Office may not be able to process and/or examine your submission, which may result in termination of proceedings or abandonment of the application or expiration of the patent.

The information provided by you in this form will be subject to the following routine uses:

1. The information on this form will be treated confidentially to the extent allowed under the Freedom of Information Act (5 U.S.C. 552) and the Privacy Act (5 U.S.C. 552a). Records from this system of records may be disclosed to the Department of Justice to determine whether the Freedom of Information Act requires disclosure of these records.
2. A record from this system of records may be disclosed, as a routine use, in the course of presenting evidence to a court, magistrate, or administrative tribunal, including disclosures to opposing counsel in the course of settlement negotiations.
3. A record in this system of records may be disclosed, as a routine use, to a Member of Congress submitting a request involving an individual, to whom the record pertains, when the individual has requested assistance from the Member with respect to the subject matter of the record.
4. A record in this system of records may be disclosed, as a routine use, to a contractor of the Agency having need for the information in order to perform a contract. Recipients of information shall be required to comply with the requirements of the Privacy Act of 1974, as amended, pursuant to 5 U.S.C. 552a(m).
5. A record related to an International Application filed under the Patent Cooperation Treaty in this system of records may be disclosed, as a routine use, to the International Bureau of the World Intellectual Property Organization, pursuant to the Patent Cooperation Treaty.
6. A record in this system of records may be disclosed, as a routine use, to another federal agency for purposes of National Security review (35 U.S.C. 181) and for review pursuant to the Atomic Energy Act (42 U.S.C. 218(c)).
7. A record from this system of records may be disclosed, as a routine use, to the Administrator, General Services, or his/her designee, during an inspection of records conducted by GSA as part of that agency's responsibility to recommend improvements in records management practices and programs, under authority of 44 U.S.C. 2904 and 2906. Such disclosure shall be made in accordance with the GSA regulations governing inspection of records for this purpose, and any other relevant (i.e., GSA or Commerce) directive. Such disclosure shall not be used to make determinations about individuals.
8. A record from this system of records may be disclosed, as a routine use, to the public after either publication of the application pursuant to 35 U.S.C. 122(b) or issuance of a patent pursuant to 35 U.S.C. 151. Further, a record may be disclosed, subject to the limitations of 37 CFR 1.14, as a routine use, to the public if the record was filed in an application which became abandoned or in which the proceedings were terminated and which application is referenced by either a published application, an application open to public inspections or an issued patent.
9. A record from this system of records may be disclosed, as a routine use, to a Federal, State, or local law enforcement agency, if the USPTO becomes aware of a violation or potential violation of law or regulation.

~~ALL REFERENCES CONSIDERED EXCEPT WHERE LINED THROUGH. /T.W./~~

<b>INFORMATION DISCLOSURE STATEMENT BY APPLICANT</b> ( Not for submission under 37 CFR 1.99)	Application Number	10956121
	Filing Date	2004-10-04
	First Named Inventor	Wang
	Art Unit	3685
	Examiner Name	Thomas C. West
	Attorney Docket Number	111325/291300

U.S.PATENTS							Remove
Examiner Initial*	Cite No	Patent Number	Kind Code <sup>1</sup>	Issue Date	Name of Patentee or Applicant of cited Document	Pages,Columns,Lines where Relevant Passages or Relevant Figures Appear	
	1						

If you wish to add additional U.S. Patent citation information please click the Add button.

Add

U.S.PATENT APPLICATION PUBLICATIONS							Remove
Examiner Initial*	Cite No	Publication Number	Kind Code <sup>1</sup>	Publication Date	Name of Patentee or Applicant of cited Document	Pages,Columns,Lines where Relevant Passages or Relevant Figures Appear	
	1						

If you wish to add additional U.S. Published Application citation information please click the Add button.

Add

FOREIGN PATENT DOCUMENTS								Remove
Examiner Initial*	Cite No	Foreign Document Number <sup>3</sup>	Country Code <sup>2</sup> j	Kind Code <sup>4</sup>	Publication Date	Name of Patentee or Applicant of cited Document	Pages,Columns,Lines where Relevant Passages or Relevant Figures Appear	T <sup>5</sup>
	1	7-36768	JP		1995-02-07			<input type="checkbox"/>

If you wish to add additional Foreign Patent Document citation information please click the Add button

Add

NON-PATENT LITERATURE DOCUMENTS				Remove
Examiner Initials*	Cite No	Include name of the author (in CAPITAL LETTERS), title of the article (when appropriate), title of the item (book, magazine, journal, serial, symposium, catalog, etc), date, pages(s), volume-issue number(s), publisher, city and/or country where published.	T <sup>5</sup>	

<b>INFORMATION DISCLOSURE STATEMENT BY APPLICANT</b> ( Not for submission under 37 CFR 1.99)	Application Number		10956121
	Filing Date		2004-10-04
	First Named Inventor	Wang	
	Art Unit		3685
	Examiner Name	Thomas C. West	
	Attorney Docket Number		111325/291300

	1		<input type="checkbox"/>
--	---	--	--------------------------

If you wish to add additional non-patent literature document citation information please click the Add button

**EXAMINER SIGNATURE**

Examiner Signature	/Thomas West/	Date Considered	10/14/2008
--------------------	---------------	-----------------	------------

\*EXAMINER: Initial if reference considered, whether or not citation is in conformance with MPEP 609. Draw line through a citation if not in conformance and not considered. Include copy of this form with next communication to applicant.

<sup>1</sup> See Kind Codes of USPTO Patent Documents at [www.USPTO.GOV](http://www.USPTO.GOV) or MPEP 901.04. <sup>2</sup> Enter office that issued the document, by the two-letter code (WIPO Standard ST.3). <sup>3</sup> For Japanese patent documents, the indication of the year of the reign of the Emperor must precede the serial number of the patent document. <sup>4</sup> Kind of document by the appropriate symbols as indicated on the document under WIPO Standard ST.16 if possible. <sup>5</sup> Applicant is to place a check mark here if English language translation is attached.



**INFORMATION DISCLOSURE  
STATEMENT BY APPLICANT**  
( Not for submission under 37 CFR 1.99)

Application Number	10956121		
Filing Date	2004-10-04		
First Named Inventor	Wang		
Art Unit	3685		
Examiner Name	Thomas C. West		
Attorney Docket Number	111325/291300		

**CERTIFICATION STATEMENT**

Please see 37 CFR 1.97 and 1.98 to make the appropriate selection(s):

That each item of information contained in the information disclosure statement was first cited in any communication from a foreign patent office in a counterpart foreign application not more than three months prior to the filing of the information disclosure statement. See 37 CFR 1.97(e)(1).

**OR**

That no item of information contained in the information disclosure statement was cited in a communication from a foreign patent office in a counterpart foreign application, and, to the knowledge of the person signing the certification after making reasonable inquiry, no item of information contained in the information disclosure statement was known to any individual designated in 37 CFR 1.56(c) more than three months prior to the filing of the information disclosure statement. See 37 CFR 1.97(e)(2).

- See attached certification statement.
- Fee set forth in 37 CFR 1.17 (p) has been submitted herewith.
- None

**SIGNATURE**

A signature of the applicant or representative is required in accordance with CFR 1.33, 10.18. Please see CFR 1.4(d) for the form of the signature.

Signature	/Marc S. Kaufman, Reg No. 35,212/	Date (YYYY-MM-DD)	2008-10-10
Name/Print	Marc S. Kaufman	Registration Number	35,212

This collection of information is required by 37 CFR 1.97 and 1.98. The information is required to obtain or retain a benefit by the public which is to file (and by the USPTO to process) an application. Confidentiality is governed by 35 U.S.C. 122 and 37 CFR 1.14. This collection is estimated to take 1 hour to complete, including gathering, preparing and submitting the completed application form to the USPTO. Time will vary depending upon the individual case. Any comments on the amount of time you require to complete this form and/or suggestions for reducing this burden, should be sent to the Chief Information Officer, U.S. Patent and Trademark Office, U.S. Department of Commerce, P.O. Box 1450, Alexandria, VA 22313-1450. **DO NOT SEND FEES OR COMPLETED FORMS TO THIS ADDRESS. SEND TO: Commissioner for Patents, P.O. Box 1450, Alexandria, VA 22313-1450.**

## Privacy Act Statement

The Privacy Act of 1974 (P.L. 93-579) requires that you be given certain information in connection with your submission of the attached form related to a patent application or patent. Accordingly, pursuant to the requirements of the Act, please be advised that: (1) the general authority for the collection of this information is 35 U.S.C. 2(b)(2); (2) furnishing of the information solicited is voluntary; and (3) the principal purpose for which the information is used by the U.S. Patent and Trademark Office is to process and/or examine your submission related to a patent application or patent. If you do not furnish the requested information, the U.S. Patent and Trademark Office may not be able to process and/or examine your submission, which may result in termination of proceedings or abandonment of the application or expiration of the patent.

The information provided by you in this form will be subject to the following routine uses:

1. The information on this form will be treated confidentially to the extent allowed under the Freedom of Information Act (5 U.S.C. 552) and the Privacy Act (5 U.S.C. 552a). Records from this system of records may be disclosed to the Department of Justice to determine whether the Freedom of Information Act requires disclosure of these records.
2. A record from this system of records may be disclosed, as a routine use, in the course of presenting evidence to a court, magistrate, or administrative tribunal, including disclosures to opposing counsel in the course of settlement negotiations.
3. A record in this system of records may be disclosed, as a routine use, to a Member of Congress submitting a request involving an individual, to whom the record pertains, when the individual has requested assistance from the Member with respect to the subject matter of the record.
4. A record in this system of records may be disclosed, as a routine use, to a contractor of the Agency having need for the information in order to perform a contract. Recipients of information shall be required to comply with the requirements of the Privacy Act of 1974, as amended, pursuant to 5 U.S.C. 552a(m).
5. A record related to an International Application filed under the Patent Cooperation Treaty in this system of records may be disclosed, as a routine use, to the International Bureau of the World Intellectual Property Organization, pursuant to the Patent Cooperation Treaty.
6. A record in this system of records may be disclosed, as a routine use, to another federal agency for purposes of National Security review (35 U.S.C. 181) and for review pursuant to the Atomic Energy Act (42 U.S.C. 218(c)).
7. A record from this system of records may be disclosed, as a routine use, to the Administrator, General Services, or his/her designee, during an inspection of records conducted by GSA as part of that agency's responsibility to recommend improvements in records management practices and programs, under authority of 44 U.S.C. 2904 and 2906. Such disclosure shall be made in accordance with the GSA regulations governing inspection of records for this purpose, and any other relevant (i.e., GSA or Commerce) directive. Such disclosure shall not be used to make determinations about individuals.
8. A record from this system of records may be disclosed, as a routine use, to the public after either publication of the application pursuant to 35 U.S.C. 122(b) or issuance of a patent pursuant to 35 U.S.C. 151. Further, a record may be disclosed, subject to the limitations of 37 CFR 1.14, as a routine use, to the public if the record was filed in an application which became abandoned or in which the proceedings were terminated and which application is referenced by either a published application, an application open to public inspections or an issued patent.
9. A record from this system of records may be disclosed, as a routine use, to a Federal, State, or local law enforcement agency, if the USPTO becomes aware of a violation or potential violation of law or regulation.

~~ALL REFERENCES CONSIDERED EXCEPT WHERE LINED THROUGH. /T.W./~~

<b>Search Notes</b>  	<b>Application/Control No.</b>  10956121	<b>Applicant(s)/Patent Under Reexamination</b>  WANG ET AL.
	<b>Examiner</b>  THOMAS WEST	<b>Art Unit</b>  3685

<b>SEARCHED</b>			
<b>Class</b>	<b>Subclass</b>	<b>Date</b>	<b>Examiner</b>
705	50-79	10/12/2008	Thomas West

<b>SEARCH NOTES</b>		
<b>Search Notes</b>	<b>Date</b>	<b>Examiner</b>
EAST	10/12/2008	Thomas West

<b>INTERFERENCE SEARCH</b>			
<b>Class</b>	<b>Subclass</b>	<b>Date</b>	<b>Examiner</b>

--	--



Under the Paperwork Reduction Act of 1995, no persons are required to respond to a collection of information unless it contains a valid OMB control number.

Substitute for form 1449A/PTO <b>INFORMATION DISCLOSURE STATEMENT BY APPLICANT</b> <i>(use as many sheets as necessary)</i>				<i>Complete if Known</i>		
				Application Number	10/956,121	
Sheet		1	of	1	Examiner Name	Thomas C. West
					Attorney Docket Number	111325/291300

U.S. PATENT DOCUMENTS						
Examiner Initials <sup>1</sup>	Cite No. <sup>1</sup>	U.S. Patent Document Number - Kind Code <sup>2</sup> (if known)		Publication Date MM-DD-YYYY	Name of Patentee or Applicant of Cited Document	Pages, Columns, Lines, Where Relevant Passages or Relevant Figures Appear
	1.	5,619,570	A1	04-08-1997	Tsutsui	

U.S. PUBLISHED PATENT DOCUMENTS						
Examiner Initials <sup>1</sup>	Cite No. <sup>1</sup>	U.S. Patent Document Number - Kind Code <sup>2</sup> (if known)		Publication Date MM-DD-YYYY	Name of Patentee or Applicant of Cited Document	Pages, Columns, Lines, Where Relevant Passages or Relevant Figures Appear

FOREIGN PATENT DOCUMENTS							
Examiner Initials <sup>1</sup>	Cite No. <sup>1</sup>	Foreign Patent Document		Publication Date MM-DD-YYYY	Name of Patentee or Applicant of Cited Document	Pages, Columns, Lines, Where Relevant Passages or Relevant Figures Appear	T <sup>6</sup>
		Country Code <sup>3</sup>	Number <sup>4</sup> Kind Code <sup>5</sup> (if known)				
	2.	EP 0 262 025	A2	03-30-1988	Ogasawara		
	3.	JP 3-063717	A	03-19-1991	Tsutsui et al.	(Ab in EN)	
	4.	JP 6-131371	A	05-13-1994	Tsutsui	(Ab in EN)	

OTHER PRIOR ART - NON PATENT LITERATURE DOCUMENTS			
Examiner Initials <sup>1</sup>	Cite No. <sup>1</sup>	Include name of the author (in CAPITAL LETTERS), title of the article (when appropriate), title of the item (book, magazine, journal, serial, symposium, catalog, etc.), date, page(s), volume-issue number(s), publisher, city and/or country where published.	T <sup>2</sup>
	5.	Johnson et al., "A Secure Distributed Capability Based System," PROCEEDINGS OF THE 1985 ACM ANNUAL CONFERENCE ON THE RANGE OF COMPUTING: MID-80'S PERSPECTIVE: MID-80'S PERSPECTIVE <i>Association for Computing Machinery</i> pp. 392-402 (1985)	

Examiner Signature	/Thomas West/	Date Considered	10/12/2008
--------------------	---------------	-----------------	------------

\*EXAMINER: Initial if reference considered, whether or not citation is in conformance with MPEP 609. Draw line through citation if not in conformance and not considered. Include copy of this form with next communication to applicant.

<sup>1</sup> Applicant's unique citation designation number (optional). <sup>2</sup> See Kinds Codes of USPTO Patent Documents at 222.uspto.gov or MPEP 901.04. <sup>3</sup> Enter Office that issued the document, by the two-letter code (WIPO Standard ST.3). <sup>4</sup> For Japanese patent documents, the indication of the year of the reign of the Emperor must precede the serial number of the patent document. <sup>5</sup> Kind of document by the appropriate symbols as indicated on the document under WIPO Standard ST.16 if possible. <sup>6</sup> Applicant is to place a check mark here if English language Translation is attached.

11018220.1

ALL REFERENCES CONSIDERED EXCEPT WHERE LINED THROUGH. /T.W./



UNITED STATES PATENT AND TRADEMARK OFFICE

UNITED STATES DEPARTMENT OF COMMERCE
United States Patent and Trademark Office
Address: COMMISSIONER FOR PATENTS
P.O. Box 1450
Alexandria, Virginia 22313-1450
www.uspto.gov

Table with 5 columns: APPLICATION NO., FILING DATE, FIRST NAMED INVENTOR, ATTORNEY DOCKET NO., CONFIRMATION NO.

10/956,121 10/04/2004 Xin Wang 111325-291300 8924

22204 7590 10/16/2008
NIXON PEABODY, LLP
401 9TH STREET, NW
SUITE 900
WASHINGTON, DC 20004-2128

EXAMINER

WEST, THOMAS C

ART UNIT PAPER NUMBER

3685

MAIL DATE DELIVERY MODE

10/16/2008 PAPER

Please find below and/or attached an Office communication concerning this application or proceeding.

The time period for reply, if any, is set in the attached communication.



## **DETAILED ACTION**

### ***Status of Claims***

1. This action is in reply to the Arguments/Remarks filed 7-14-08.
2. Claims 1-36 are currently pending and have been examined.

### ***Information Disclosure Statement***

3. The Information Disclosure Statements filed on 7-2-08, 10-10-08 have been considered. Initialed copies of Form 1449 are enclosed herewith.

### ***Response to Arguments***

5. Applicant's arguments filed 7-14-08 have been fully considered but they are not persuasive. Applicant's arguments will be addressed in sequential order as they were set forth in the "Remarks" section on the above date. Applicant argues that Anand does not disclose meta-rights specifying derivable rights. Anand discloses, "Multiple principals can delegate a subset of their maximal permissions for the executable content. The mechanism uses policy for combining the delegated permissions into the content's current permissions" (col. 3, lines 27-31). Anand further discloses, "electing granted permissions from within an associated maximal set of permissions" (col. 3, lines 59-60). "As FIG. 2 depicts, the derivation mechanism (100) consists of the following five steps:", (col. 5, lines 1-2). "The current permissions (150), by definition, must always be a subset of the maximal permissions (140)", (col. 5, lines 14-16). "The description of executable content (120) is a set of attribute-value pairs. One possible

Art Unit: 3685

embodiment is RDF ("Resource Description Framework") labels that describe the meta-data of a website's URI ("Universal Resource Identifier)", (col. 5, lines 17-21). The attribute-value pairs of Anand correspond to the meta-rights of Wang. Anand further discloses, "FIG. 4 illustrates that the nodes of a policy graph's directed graph consist of an attribute, a value, an entry, and an access control list. FIG. 5 illustrates a preferred embodiment of the permissions structure, and shows that permissions include positive and negative rights and transforms. FIG. 7 illustrates how the first step of the dynamic derivation mechanism creates a derivation instance and sets its attributes values" (col. 4, lines 18-31). The state variables of Wang correspond to the derivation instance of Anand, fig. 7. Anand regulates who is entitled to derive rights through an access control described in fig. 4 referenced above. Anand controls who is entitled to derive rights, "The access control list (325) limits access to the policy graph (320). Principals can be permitted to modify any of the policy graph attributes (321-325)", (col. 6, lines 26-29). Infrastructure further discloses a state machine which consists of state variables, as defined by Curtis. "Within the state machine, while a state variable does not equal exit 1301, the state machine will go from state to state based upon what the state variable is set to", (Curtis, 6,397,355, col. 9, lines 53-55) .

### ***Double Patenting***

4. The nonstatutory double patenting rejection is based on a judicially created doctrine grounded in public policy (a policy reflected in the statute) so as to prevent the unjustified or improper timewise extension of the "right to exclude" granted by a patent



Art Unit: 3685

and to prevent possible harassment by multiple assignees. A nonstatutory obviousness-type double patenting rejection is appropriate where the conflicting claims are not identical, but at least one examined application claim is not patentably distinct from the reference claim(s) because the examined application claim is either anticipated by, or would have been obvious over, the reference claim(s). See, e.g., *In re Berg*, 140 F.3d 1428, 46 USPQ2d 1226 (Fed. Cir. 1998); *In re Goodman*, 11 F.3d 1046, 29 USPQ2d 2010 (Fed. Cir. 1993); *In re Longi*, 759 F.2d 887, 225 USPQ 645 (Fed. Cir. 1985); *In re Van Ornum*, 686 F.2d 937, 214 USPQ 761 (CCPA 1982); *In re Vogel*, 422 F.2d 438, 164 USPQ 619 (CCPA 1970); and *In re Thorington*, 418 F.2d 528, 163 USPQ 644 (CCPA 1969).

A timely filed terminal disclaimer in compliance with 37 CFR 1.321(c) or 1.321(d) may be used to overcome an actual or provisional rejection based on a nonstatutory double patenting ground provided the conflicting application or patent either is shown to be commonly owned with this application, or claims an invention made as a result of activities undertaken within the scope of a joint research agreement.

Effective January 1, 1994, a registered attorney or agent of record may sign a terminal disclaimer. A terminal disclaimer signed by the assignee must fully comply with 37 CFR 3.73(b).

Claims 1-36 are provisionally rejected on the ground of nonstatutory double patenting over claim 6 of copending Application No. 10162701. This is a provisional double patenting rejection since the conflicting claims have not yet been patented.

The subject matter claimed in the instant application is fully disclosed in the referenced copending application and would be covered by any patent granted on that copending application since the referenced copending application and the instant application are claiming common subject matter, as follows: meta-rights, derived rights, rights transfer, generating a license.

Furthermore, there is no apparent reason why applicant would be prevented from presenting claims corresponding to those of the instant application in the other copending application. See *In re Schneller*, 397 F.2d 350, 158 USPQ 210 (CCPA 1968). See also MPEP § 804.

***Claim Rejections - 35 USC §101***

5. 35 U.S.C. §101 reads as follows:

Whoever invents or discovers any new and useful process, machine, manufacture, or composition of matter, or any new and useful improvement thereof, may obtain a patent therefor, subject to the conditions and requirements of this title.

6. Claims 1-36 are rejected under 35 U.S.C. §101 because the claimed invention is directed to non-statutory subject matter.

Based on Supreme Court precedent and recent Federal Circuit decisions, § 101 process must (1) be tied to another statutory class (such as a particular apparatus) or (2) transform underlying subject matter (such as an article or materials) to a different state or thing. If neither of these requirements is met by the claim(s), the method is not a patent eligible process under 35 U.S.C. § 101.

Art Unit: 3685

In this particular case, claims 1, 12, 24 and their dependent claims 2-11, 13-23, 25-36 lack sufficient technology. (Diamond v. Diehr, 450 U.S. 175, 184 (1981); Parker v. Flook, 437 U.S. 584, 588 n.9 (1978); Gottschalk v. Benson, 409 U.S. 63, 70 (1972); Cochrane v. Deener, 94 U.S. 780, 787-88 (1876)).

Claims 2-11, 13-23, 25-36 are also rejected as each depends from either claim 1, 12, 24.

***Claim Rejections - 35 USC § 103***

7. The following is a quotation of 35 U.S.C. 103(a) which forms the basis for all obviousness rejections set forth in this Office action:

(a) A patent may not be obtained though the invention is not identically disclosed or described as set forth in section 102 of this title, if the differences between the subject matter sought to be patented and the prior art are such that the subject matter as a whole would have been obvious at the time the invention was made to a person having ordinary skill in the art to which said subject matter pertains. Patentability shall not be negated by the manner in which the invention was made.

8. Claims 1-36 are rejected under U.S.C. 103(a) as being unpatentable over Anand, US Patent No. 6,044,466 (Anand), in view of Workshop on Digital Rights Management, Minutes from Architecture/Infrastructure Session (Infrastructure).

**Claims 1, 12, 24:**

Anand, as shown, discloses the following limitations:

obtaining a set of rights associated with an item, the set of rights including meta-rights specifying derivable rights that can be derived

Art Unit: 3685

from the meta-rights (see column 3, line 15-31, column 5, lines 17-23, column 5, lines 1-16)

determining whether the rights consumer (user) is entitled to the derivable rights specified by the meta-rights (see col. 3, lines 27-31, column 5, line 14-21, col. 3, lines 32-35)

deriving at least one right from the derivable rights, if the rights consumer is entitled to the derivable rights specified by the meta-rights, wherein the derived right includes at least one state variable based on the set of rights and used for determining a state of the derived right (see column 5, line 1-16, col. 3, lines 32-35, col. 5, lines 17-21)

Anand discloses the limitations as shown above. Anand does not directly disclose a state variable (state machine), but Infrastructure does (page 8, paragraph 3)

It would have been obvious to one of ordinary skill in the art at the time of the invention to modify Anand to include the state machine of Infrastructure since this provides a dynamic structure that can express dynamic rights relationships.

**Claims 2, 13, 25:**

Anand, as shown, discloses the following limitations:

the state variable inherits a state thereof for content usage or rights transfer from the set of rights (see column 5, line 1-16)

**Claims 3, 4, 14, 15, 26, 27:**

Anand/Infrastructure discloses the limitations shown above. Anand further discloses:

the state variable shares a state thereof for content usage or rights transfer with the set of rights (see column 8, line 7-14)

the state variable inherits a remaining state for content usage or rights transfer from the set of rights (see column 5, line 14-16)

**Claims 5, 16, 28:**

Anand, as shown, discloses the following limitations:

the state variable is updated upon exercise of a right associated with the state variable (see column 7, line 5-14)

**Claims 6, 17, 29:**

Anand, as shown, discloses the following limitations:

deriving a plurality of rights from the derivable rights, wherein the state variable is shared by the derived rights (see column 7, line 1-7)

**Claims 7, 8, 18, 19, 30, 31:**

Anand discloses the limitations as shown above. Anand does not directly disclose a state variable (state machine), but Infrastructure does:  
the state variable represents a collection of states (see page 8, paragraph 3)  
a plurality of state variables that determine the state of the derived right (see page 8, paragraph 3)

It would have been obvious to one of ordinary skill in the art at the time of the invention to modify Anand to include the state machine of Infrastructure since this provides a dynamic structure that can express dynamic rights relationships.

**Claims 9, 20, 32:**

Anand, as shown, discloses the following limitations:

at least one state variable is unspecified in the derived right, is created during a rights transfer, and is assigned to the derived right (see column 7, line 1-14)

**Claims 10, 21, 33:**

Anand, as shown, discloses the following limitations:

the state variable is transferred from the derivable rights to the derived right (see column 7, line 15-23)

**Claims 11, 22, 34, 36:**

Art Unit: 3685

Anand, as shown, discloses the following limitations:

generating a license including the derived right, if the rights consumer is entitled to the derivable rights specified by the meta-rights (see column 7, line 24-29)

one or more of the means for obtaining, the means for determining, and the means for deriving are specified in a license (see column 7, line 24-29)

**Claim 35:**

Anand, as shown, discloses the following limitations:

obtaining, the means for determining, and the means for deriving comprise at least one of computer-executable instructions, and devices of a computer system (see column 4, line 51-67)

***Conclusion***

**THIS ACTION IS MADE FINAL.** Applicant is reminded of the extension of time policy as set forth in 37 CFR 1.136(a).

A shortened statutory period for reply to this final action is set to expire THREE MONTHS from the mailing date of this action. In the event a first reply is filed within TWO MONTHS of the mailing date of this final action and the advisory action is not mailed until after the end of the THREE-MONTH shortened statutory period, then the shortened statutory period will expire on the date the advisory action is mailed, and any extension fee pursuant to 37 CFR 1.136(a) will be calculated from the mailing date of

Art Unit: 3685

the advisory action. In no event, however, will the statutory period for reply expire later than SIX MONTHS from the date of this final action.

Any inquiry concerning this communication or earlier communications from the examiner should be directed to Thomas West whose telephone number is 571-270-1236. The examiner can normally be reached on M-R 7:30am - 5pm EST, ALT Fridays off.

If attempts to reach the examiner by telephone are unsuccessful, the examiner's supervisor, Calvin L. Hewitt, can be reached on (571) 272-6709. The fax phone number for the organization where this application or proceeding is assigned is 571-273-8300.

Information regarding the status of an application may be obtained from the Patent Application Information Retrieval (PAIR) system. Status information for published applications may be obtained from either Private PAIR or Public PAIR. Status information for unpublished applications is available through Private PAIR only. For more information about the PAIR system, see <http://pair-direct.uspto.gov>. Should you have questions on access to the Private PAIR system, contact the Electronic Business Center (EBC) at 866-217-9197 (toll-free). If you would like assistance from a USPTO Customer Service Representative or access to the automated information system, call 800-786-9199 (IN USA OR CANADA) or 571-272-1000.

Thomas West  
Patent Examiner  
Art Unit 3685  
October 12, 2008

/Calvin L Hewitt II/  
Supervisory Patent Examiner, Art Unit 3685



<b>Notice of References Cited</b>	Application/Control No. 10/956,121	Applicant(s)/Patent Under Reexamination WANG ET AL.	
	Examiner THOMAS WEST	Art Unit 3685	Page 1 of 1

**U.S. PATENT DOCUMENTS**

*	Document Number Country Code-Number-Kind Code	Date MM-YYYY	Name	Classification
*	A US-6,044,466 A	03-2000	Anand et al.	726/1
	B US-			
	C US-			
	D US-			
	E US-			
	F US-			
	G US-			
	H US-			
	I US-			
	J US-			
	K US-			
	L US-			
	M US-			

**FOREIGN PATENT DOCUMENTS**

*	Document Number Country Code-Number-Kind Code	Date MM-YYYY	Country	Name	Classification
	N				
	O				
	P				
	Q				
	R				
	S				
	T				

**NON-PATENT DOCUMENTS**

*	Document Number Country Code-Number-Kind Code	Date MM-YYYY	Country	Name	Classification
		Include as applicable: Author, Title Date, Publisher, Edition or Volume, Pertinent Pages)			
	U	Workshop on Digital Rights Management for the Web, World Wide Web Consortium, Minutes from the Architecture/Infrastructure Session, January 2001			
	V				
	W				
	X				

\*A copy of this reference is not being furnished with this Office action. (See MPEP § 707.05(a).)  
Dates in MM-YYYY format are publication dates. Classifications may be US or foreign.



## Workshop on Digital Rights Management for the Web

World Wide Web Consortium

22-23 January 2001

INRIA - Sophia-Antipolis, France

2004, Route des Lucioles

### WORKSHOP PROGRAM

Workshop Notes & Presentations

Workshop Summary Report

Submitted Position Papers

Participants

Mailing List

Call for Participation

Background Reference Material

### **Important dates**

*Papers submission deadline: 22 December 2000*

*Registration deadline: 12 January 2001*

### **Workshop meter**

On 20 December 2000: 62 registrations, 41 position papers received, and 69 persons on the mailing list.

---

Last update \$Date: 2001/04/26 16:55:07 \$ by \$Author: rigo \$



[\[Minutes Overview\]](#) [\[Workshop Home\]](#) [\[Previous: Publishers Requirements\]](#)  
[\[Next: Architecture: Interoperability and Standards\]](#)

## Minutes from the Architecture/Infrastructure Session

***Please refer to the position-papers and slides for authoritative answers. The following minutes are only a snapshot of Presentations and Discussions***

- [INDECS Framework Data Definitions](#)  
Godfrey Rust (Indecs Project)
- [URI's and Object Identifiers](#)  
Dan Connolly (W3C)
- [Principles for Standardization and Interoperability in Web-based Digital Rights Management](#)  
John Erickson (Hewlett-Packard)
- [Open Digital Rights Management](#)  
Renato Iannella (IPR Systems)
- [Digital Object Identifier](#)  
Norman Paskin (Int. DOI Foundation)
- [Discussion](#)

---

### Godfrey Rust (<indecs> Project), INDECS Framework Data Definitions

*See also the [\[Slides \(ppt\)\]](#) and the [<indecs> Framework](#)*

The <indecs> project ended 2000, now we are new company called <indecs> framework. Look at our online document: Principles, model, and data dictionary, June 2000.

We see DRM in terms of metadata, as a metadata problem. The description is covered in Open eBook, ONIX, and my company.

Here is the scheme:

1. people make stuff
2. people use stuff

### 3. people do deals about stuff

The scope is stuff. This can be characterized in terms of:

1. Parties
2. Creations
3. Agreements

Rust projected a diagram showing the high granularity in the <indecs> model, with hierarchy of parties and agreements. He noted that you must pass along the metadata in a structured defined way to permit computational processes.

The following things are required:

- functional granularity: you must be able to identify stuff at any level of granularity
- unique id
- who says so - designated authority
- appropriate access (who can do what)

In the 1980s, there were few schemes for description, today there are many, lists ten major ones, including MPEG-7, ONIX, SMPTE, RIAA/IFPI, and several more.

Here are the <indecs> principles:

- **All metadata is just a view** (example: about the work versus about the manifestation, and more, each of which may have its own rights)
  - views must not be confused; mistaken identity can be disastrous to rights management
  - views need to be interoperable
- **Almost all terms need identifiers**
  - values must be defined and identified
  - need standard vocabularies and ontologies.
  - automation need for disambiguity. There is an existing vocabulary for some things: territories, language, currency, date/time and some others. But we need dozens of others.
- **Events are key to interoperability**
  - most metadata is stuff or people based
  - events description are key to rights management

Godfrey Rust gave an example how this would work:

1. make event the first class object, e.g., Rust creating these slides
2. then all the other elements are attributes: author, date, title, etc.
3. next event, e.g., Rust showing this Slide -- it has attributes too and references the previous event, thus connecting the creative items
4. next event: Norman Paskin adapts (transforming event) these slides before he shows it at another meeting, thus creating new attributes and references to preceding events, thus connecting the creative items

This model has the same information as other metadata structures, just organized differently to serve rights management.

Here's another event that bears on rights: agreeing. What goes into the agreement is what goes into descriptive metadata, what he had, what he did. Also assertion by a trusted entity that verifies or authenticates.

Using the event structure, now have six events regarding these slide-show. See how you can use events to **integrate** descriptive and rights metadata.

But we need rights vocabularies to make this work, on a parallel with the need for vocabularies to serve descriptive metadata.

## Dan Connolly [W3C], W3C URI Design Principles

*See also the corresponding Activity within W3C and the slides*

He outlined W3C's Philosophy of Standards: Help people do the right thing.

URIs will have a relationship to a potential DRM-Activity. Connolly also suggests that DRM discussion focus on payments and rights negotiation as much as prevention of access.

All names are ultimately local. Global naming depends on social agreements and trust. HTTP is not the only protocol. For the Web, we use DNS (Domain Name System). Don't forget, HTML is not the only file type. Things can evolve, you can use proxies and thus use an old name against new protocol. But URIs are the only thing in that arena. New protocols can be used with existing names. There is no need to change names just because you change protocols. We don't need to make new URI schemes just because we have made a new data format.

There is opacity: Don't peek inside names, names (URIs) are not user interface. Don't reinvent redirection in http, it is not a service, they are not locators. DNS supports multiple A records. Lots of administrative hierarchies fit in current http and DNS, you don't need to

invent a new URI scheme.

URIs were not designed as a user interface. Don't use a URN as a brand name. To establish a new trusted brand name, trying to wedge them into DNS is a problem, you're ought to use <title>

## John Erickson (HP), Principles for Standardization and Interoperability in Web-based Digital Rights Management

*See also the [slides](#) and the [Position Paper](#)*

John Erickson started by re-inforcing what was already heard during previous sessions: When we think about DRM, we have to separate expression of rights information and policies from the enforcement of those rights. We have to think of a layered model, separate the expression of rights information from the info for discovery and from implementing and enforcing those rights.

What is the W3C's role here? We think W3C should recommend a platform. Erickson put emphasis on the development of a language and a protocol for IPR policy expression, discovery, and interpretation.

The W3C should not recommend a standard DRM system. But we should provide a basis for the interoperability of such systems. Core should be to find a reliable way to express and transfer rights information. Remember the design principles of the web, IPR work ought not violate them.

Erickson developed the following set of requirements:

- never interfere with users' ability to discover info (incl rights info) on the web, this is what I mean by universal access, so I can decide about whether to access
- always communicate the policies and technical restraints in understandable language
- policies are communicated in fair and open ways
- need for trust, need to have a basis to trust the assertions being made, need a mechanism to assure trustworthiness
- IPR information and policies must be discoverable and minimally interpretable independent of any given vendor's solution
- the languages and protocols must be designed for evolution
- web based mechanism must allow for owners to choose different tools and consumers to use different tools to discover and interpret rights info
- cool new content that comes along ought not break the DRM systems or break the languages and protocols

Here's our [HP publishing group] proposal: PREP (Policy and Rights Expression Platform, see the [Position Paper](#) for more information). It would be a framework to express and interpret the policies and info. It should complement laws and self-regulatory programs. It should be consistent with prior work, e.g., P3P.

What are the building blocks of PREP?

- semantics - policy interpretation mechanisms
- objects - rights messaging protocol
- syntax - rights expression languages

**Erickson concluded:**

1. W3C should recommend a platform for IPR policy expression, discovery, and interpretation.
2. W3C should not recommend a standardized digital rights management system.
3. Core should be reliable way to express and transfer rights information.

## Renato Iannella (IPR Systems), Open Digital Rights Management

*See also the [slides](#) and the [Position Paper](#)*

We need to define DRM formally. Customary DRM definitions tend to emphasize protection, enforcement, security. We need to remove the security/locking focus of DRM. There are a lot of definitions out there. But we want DRM to be broader: describe, identity, trade, monitor, track, and manage rights holder relationships. We want to leave behind the "creation waterfall" concept of create => trade => use as a line. We want to look at a circular life cycle approach (compare Rust events). We use the same terms: create-trade-use and add reuse = recreate. Then the life cycle is more accurately seen as circular. He gave an example of transparency in presenting rights, from Adobe eBook. You are authorized to get the copy. It is OK to copy (up to 10 times each week), to print, to lend. But you cannot give or read aloud. He suggested, that it should be possible to pay for usage, not possession.

The following are building blocks for a DRM architecture:

- A better metadata framework: He would like it to be in RDF
- Trust (digital signatures)
- There are lessons to learn from P3P, CC/PP
- identification (URIs)
- XML packaging and tools

- use the <indecs> model: content, parties, rights. Each one is a kind of class. Parties described would be: author, corporate, agent, publisher. The content would be classified in work, expression, manifestation, item. Rights would be classified in usages, rewards, constraints.

Renato Iannella presented the ODRL. He sees it as a starting point for a DRM Language, that could be developed within W3C.

Concludes: W3C Role could be:

- W3C Digital Rights Language Working Group to develop semantics of a digital rights language encoded in XML
- Trusted Metadata Working Group to develop architecture to support encoding and transmission of DRM and other metadata
- DRM Interest Group to discuss next steps and establish relationship with other communities

W3C can solve some part of the DRM problem, coordinate others, and empower the user community.

## Norman Paskin (Int. DOI Foundation), Digital Object Identifier (DOI)

*See also the [slides \(ppt\)](#) and the [Position Paper](#)*

Paskin was presenting the activity of the DOI Foundation. We have spent three years developing an identifier system for digital objects. We have been influenced by <indecs> analysis and implementations, e.g., ONIX and by consideration of digital object infrastructure (e.g., CNRI work).

DRM must be maximally extensible. DRM is digital management of rights, not just management of digital rights. Practical rights management will require dealing with both digital and non-digital rights. Unique identification is essential for automation to work on this.

Description info and rights info are not distinguishable. Any piece of description may be needed in a rights transaction.

Creative items used to be physical, today we have both a physical and digital manifestation, so sometimes there are two identifiers, e.g., ISBN for one, URL for the other. But if we are going to automate transactions we must dis-ambiguate meanings. We need to define word like book in the spaces it may found in, the ISBN space or the <indecs> space.



There will not be one model for applying identifiers, it will differ for content communities, given practical implications, e.g. ONIX, MPEG-7, etc. A work may be an original manuscript version, the work in the abstract, a draft, a copy in a publication, a digital copy not in a publication, a reprint, etc.. In each role, there will be different ids and attributes. We don't have to have complete knowledge representation. We can build on agreements over what an identifier means within a given namespace

About names and locations, he said that a name is a location in a defined namespace, thus all names are locations is trivially true.

As practical needs for DOI, Paskin identified:

- multiple instances
- persistence in face of change
- mgt of non-digital entities
- de-referencing, resolution

Who should be responsible for naming: Standards bodies, rights collectives? Examples are:

- EAN/UPC bar code system
- ISBN system
- URI system But what in the digital realm?
- URLs are a poor system for publishers

Identifier needs to be actionable. They can be the basis for rights management. But there won't be one place to go for:

- e.g., directory of parties (names of people, sort of, as for music, is developing a directory)
- e.g., ontology of scientific article

We need to involve stakeholders, what is the W3C good for here?

Paskin used an aphorism: I think what is called media convergence really is "people convergence" (with the correlative problem of communication). Formalisms are essential in their place but must be explained. What we ought to care about does not just encompass the web.

DOI system offers :

- numbering - use any identifier
- description - can use <indec> framework

- action - handles allow to link to instances
- It is persistent, granular, flexible, can wrap other identifiers

## Discussion

*Not for all questions and answers, the author was identified. In this case, you'll see only question and answer*

**Question:** is URI primarily address where you find something?

**Dan Connolly (W3C):** I don't think so.

**Danny Weitzner (W3C):** Question to Godfrey Rust and John Erickson: Is there a consensus point? John said there should be a rights management schema. How modular is the <indec> system? Does anyone who uses something that falls under the <indec> model have to use the whole model?

**Godfrey Rust (<indec>):** It is a matter of how you structure your information. If we use the event model to organize our system, this should lead to interoperability. If one wants to express things in most efficient way, an events - systems will be very powerful. Other systems/legacy info can be transformed into events model. One doesn't have to organize all data into high level of functionality. We can still use information that is fairly low grade.

**John Erickson (HP):** An event model is powerful, because it allows description of certain rights relationships that we might think of in terms of electronic contracts. If we speak about rights languages, we can imagine a lot of different types of transactions. There are things that need to be declared, between an author and a publisher. It is a dynamic activity with lots of outcomes that the event model can characterize. The event model is the basis of an ontology. We need different vocabularies for different purposes. A contract between an author and a publisher is like dynamic state machine. The event model is a powerful way to express that. Things like rights vouchers/licenses and output of individual states are dependant on dynamic events.

**Maximilian Herberger (Uni Saarland):** Events are only one side. The event model reflects the state of subjective rights within a specific contract. We also need a way to describe how things fit together or what things have in common. We need a language at a higher level about objective rights. This language should be able to express classes of contract relationships. I think the combination of the two is the solution here.

**Jonathan Schull (Digital Goods):** Suppose I'm a publisher and I want to publish a book electronically. There are a whole lot of ways to do this. Each combination will have a

different address, thus creating a different digital object. A publisher doesn't really care about the locations, he only cares about initial work. He may decide that people shouldn't print it, or that people want their money back. As a publisher, I want to have only one thing to do.

**Jonathan D. Hahn (Versaware):** In a contrarian mode I say, well, about these "events," you know publishers may think of only one event, the one that came into play when I signed on to publish this work.

**Godfrey Rust (<indec>):** A DOI is a single number for the object

**Dan Connolly (W3C):** What's the first letter of most DOIs? Names are little pieces of communication. Making up a name without thinking about communication is sort of silly. We don't decide anything by ourselves, we decide together with people we communicate with. I don't think you can invent new technology that solves all the social problems involved

**Norman Paskin (DOI):** The web is not the universal information space. There are things, which aren't on the web. We need to identify them too.

**Eric Miller (OCLC):** you can place something on the web without using DOI. I represent libraries, so if you publish, you want consumer to get access to stuff - you have to talk to your customer base to find out whether they will use access mechanism you are designing to access content. What are the things we are trying to automate here? Let's think about a scenario with implemented DRM, let's do what-if scenarios.

**Question:** Why are ontologies so important?

**Answer:** Take a look at ontologies and what publishers require and you have your problem defined

**Eric Miller (OCLC):** A question not yet resolved is, what happens in DRM if different kinds of people are accessing the same object, e.g. in the context of a library.

**Robert Bollick, (McGraw-Hill):** This is already covered. It is like every consumer/publisher interaction which is covered by the requirements. More information can be found on [publishers.org](http://publishers.org). The name of the document is publishers DRM requirements.

**Comment:** We will get a lot of input/requirements from many different constituencies, e.g. record industry, book industry etc.. We need to consider the evolution of technology - technical components should be able to move independently from one another. We have a conceptual model: Take a language and a context used by different areas and avoid using

two different terms for same requirement. We need to build a common platform. That gives you a mechanism to do extensions that are truly unique. Medicine, oil-drilling all use different terminology, but a conceptual model helps us to decide whether their need is unique and helps us develop an orthogonal system, and avoid redundancy

**Scott Foshee, (Adobe)** states agreement with the interest in fine-grained identification implied by the <indecs>/DOI ideas.

**Question:** We won't be able to define precisely what work is. We should avoid defining it. While broad categories of interactions may have been studied, do you think your publishing model is extensible to images, text, font? To Godfrey Rust: Do you think we can extend this to publishing of aggregations, e.g. written book by an author combined with paper it is printed on ?

**Godfrey Rust (<indecs>):** Take a look at indecs papers. The answer is yes, I think this is possible.

**Answer:** The same is true for ONIX - thinking about selling pieces of a work

**Danny Weitzner (W3C):** Commenting on Norman's point of the Web not being the universal information space, I think that in the discussions so far we showed lots of attention on commercial needs. The question is whether we would like common framework for discovering rights of document whether or not produced principally for trade or not? E.g., does a picture of my 3-year old fit into this framework? We risk to produce big costs if there are two classes of documents: One that fits into trading and others who don't. If we look at music, we see, that non-traditional documents are traded. I'm a bit concerned about the application of these systems only to "trade" items in the web, ignoring or disenfranchising the little objects which also have rights associated with them.

**Godfrey Rust (<indecs>):**The model we worked on are neutral as far as commerce is concerned. It can be used for picture of 3 year old. We haven't actually developed framework though. A critical piece of work is to decide what those verbs (note: for the actions) are. The model still needs a lot of detailed work. We have roughly agreed on the direction we take. Please don't overestimate what we've done.

**Norman Paskin (DOI):** <indecs>/DOI is about transactions. We mean by transaction anything, whether it's free or not. We focused on e-commerce. Our economic model is based on the barcode model. For some transactions, the financial cost will be zero.

**John Erickson (HP):** What is the methodology for rationalising to interpret new dimensions for a given problem space? There has been a lot of talk about notion of ontologies. We

have a certain way of thinking about a problem, and perhaps another way. Now we try to find ontologies to identify common points. Where does the notion of rationalizing problem spaces conflict with ontologies? I can see that it resonates in a closed room ...

**Rob Koenen, MPEG:** MPEG-7 is standard for describing content. Based on XML schema, there are principle notions like actor, people etc. Those are listed in a concepts list. There are basic concepts like shape, color etc. People can build their own ontology. MPEG has just decided to do a data dictionary for a rights language. MPEG has issued a call for requirements on 19 January 2001. Koenen invited W3C to work with MPEG on working on this problem

**Peter Schirling (IBM & MPEG):** We should try to avoid unnecessary duplication. We allow each discipline to build an ontology from a common frame, to reduce duplication of elements. Under that framework, different sectors can add their own things to a specific concepts list. Currently, we have only concept lists very specific to audio-visual content.

**Scott Foshee (Adobe):** There are two classes of objects (things): Under control and not under control. I wanted to state my agreement with Danny Weitzner, that there should only be one class. Clipart in a presentation software is an aggregation with content you created. By using a product that was licensed, everything on a harddisk is aggregated content work. DRM should be able to handle that. Take a picture of Danny Weitzner and apply a filter may result in aggregate work. The process that is applied results in another object. We need to get something that is workable, because this technology will be everywhere

Coffee Break, but not enough coffee for some

---

[\[Minutes Overview\]](#) [\[Workshop Home\]](#) [\[Previous:Publishers Requirements\]](#)  
[\[Next:Architecture: Interoperability and Standards\]](#)

Created by Rigo Wenning February 2001

Last update \$Date: 2001/04/18 16:50:31 \$ by \$Author: rigo \$

<b>INFORMATION DISCLOSURE STATEMENT BY APPLICANT</b> ( Not for submission under 37 CFR 1.99)	Application Number	10956121
	Filing Date	2004-10-04
	First Named Inventor	Wang
	Art Unit	3685
	Examiner Name	Thomas C. West
	Attorney Docket Number	111325/291300

U.S.PATENTS							Remove
Examiner Initial*	Cite No	Patent Number	Kind Code <sup>1</sup>	Issue Date	Name of Patentee or Applicant of cited Document	Pages,Columns,Lines where Relevant Passages or Relevant Figures Appear	
	1						

If you wish to add additional U.S. Patent citation information please click the Add button.

Add

U.S.PATENT APPLICATION PUBLICATIONS							Remove
Examiner Initial*	Cite No	Publication Number	Kind Code <sup>1</sup>	Publication Date	Name of Patentee or Applicant of cited Document	Pages,Columns,Lines where Relevant Passages or Relevant Figures Appear	
	1						

If you wish to add additional U.S. Published Application citation information please click the Add button.

Add

FOREIGN PATENT DOCUMENTS								Remove
Examiner Initial*	Cite No	Foreign Document Number <sup>3</sup>	Country Code <sup>2</sup> j	Kind Code <sup>4</sup>	Publication Date	Name of Patentee or Applicant of cited Document	Pages,Columns,Lines where Relevant Passages or Relevant Figures Appear	T <sup>5</sup>
	1	7-36768	JP		1995-02-07			<input type="checkbox"/>

If you wish to add additional Foreign Patent Document citation information please click the Add button

Add

NON-PATENT LITERATURE DOCUMENTS				Remove
Examiner Initials*	Cite No	Include name of the author (in CAPITAL LETTERS), title of the article (when appropriate), title of the item (book, magazine, journal, serial, symposium, catalog, etc), date, pages(s), volume-issue number(s), publisher, city and/or country where published.	T <sup>5</sup>	

<b>INFORMATION DISCLOSURE STATEMENT BY APPLICANT</b> ( Not for submission under 37 CFR 1.99)	Application Number	10956121
	Filing Date	2004-10-04
	First Named Inventor	Wang
	Art Unit	3685
	Examiner Name	Thomas C. West
	Attorney Docket Number	111325/291300

1		<input type="checkbox"/>
---	--	--------------------------

If you wish to add additional non-patent literature document citation information please click the Add button

**EXAMINER SIGNATURE**

Examiner Signature	/Thomas West/	Date Considered	10/14/2008
--------------------	---------------	-----------------	------------

\*EXAMINER: Initial if reference considered, whether or not citation is in conformance with MPEP 609. Draw line through a citation if not in conformance and not considered. Include copy of this form with next communication to applicant.

<sup>1</sup> See Kind Codes of USPTO Patent Documents at [www.USPTO.GOV](http://www.USPTO.GOV) or MPEP 901.04. <sup>2</sup> Enter office that issued the document, by the two-letter code (WIPO Standard ST.3). <sup>3</sup> For Japanese patent documents, the indication of the year of the reign of the Emperor must precede the serial number of the patent document. <sup>4</sup> Kind of document by the appropriate symbols as indicated on the document under WIPO Standard ST.16 if possible. <sup>5</sup> Applicant is to place a check mark here if English language translation is attached.

<b>INFORMATION DISCLOSURE STATEMENT BY APPLICANT</b> ( Not for submission under 37 CFR 1.99)	Application Number	10956121
	Filing Date	2004-10-04
	First Named Inventor	Wang
	Art Unit	3685
	Examiner Name	Thomas C. West
	Attorney Docket Number	111325/291300

**CERTIFICATION STATEMENT**

Please see 37 CFR 1.97 and 1.98 to make the appropriate selection(s):

That each item of information contained in the information disclosure statement was first cited in any communication from a foreign patent office in a counterpart foreign application not more than three months prior to the filing of the information disclosure statement. See 37 CFR 1.97(e)(1).

**OR**

That no item of information contained in the information disclosure statement was cited in a communication from a foreign patent office in a counterpart foreign application, and, to the knowledge of the person signing the certification after making reasonable inquiry, no item of information contained in the information disclosure statement was known to any individual designated in 37 CFR 1.56(c) more than three months prior to the filing of the information disclosure statement. See 37 CFR 1.97(e)(2).

- See attached certification statement.
- Fee set forth in 37 CFR 1.17 (p) has been submitted herewith.
- None

**SIGNATURE**

A signature of the applicant or representative is required in accordance with CFR 1.33, 10.18. Please see CFR 1.4(d) for the form of the signature.

Signature	/Marc S. Kaufman, Reg No. 35,212/	Date (YYYY-MM-DD)	2008-10-10
Name/Print	Marc S. Kaufman	Registration Number	35,212

This collection of information is required by 37 CFR 1.97 and 1.98. The information is required to obtain or retain a benefit by the public which is to file (and by the USPTO to process) an application. Confidentiality is governed by 35 U.S.C. 122 and 37 CFR 1.14. This collection is estimated to take 1 hour to complete, including gathering, preparing and submitting the completed application form to the USPTO. Time will vary depending upon the individual case. Any comments on the amount of time you require to complete this form and/or suggestions for reducing this burden, should be sent to the Chief Information Officer, U.S. Patent and Trademark Office, U.S. Department of Commerce, P.O. Box 1450, Alexandria, VA 22313-1450. **DO NOT SEND FEES OR COMPLETED FORMS TO THIS ADDRESS. SEND TO: Commissioner for Patents, P.O. Box 1450, Alexandria, VA 22313-1450.**



## Privacy Act Statement

The Privacy Act of 1974 (P.L. 93-579) requires that you be given certain information in connection with your submission of the attached form related to a patent application or patent. Accordingly, pursuant to the requirements of the Act, please be advised that: (1) the general authority for the collection of this information is 35 U.S.C. 2(b)(2); (2) furnishing of the information solicited is voluntary; and (3) the principal purpose for which the information is used by the U.S. Patent and Trademark Office is to process and/or examine your submission related to a patent application or patent. If you do not furnish the requested information, the U.S. Patent and Trademark Office may not be able to process and/or examine your submission, which may result in termination of proceedings or abandonment of the application or expiration of the patent.

The information provided by you in this form will be subject to the following routine uses:

1. The information on this form will be treated confidentially to the extent allowed under the Freedom of Information Act (5 U.S.C. 552) and the Privacy Act (5 U.S.C. 552a). Records from this system of records may be disclosed to the Department of Justice to determine whether the Freedom of Information Act requires disclosure of these records.
2. A record from this system of records may be disclosed, as a routine use, in the course of presenting evidence to a court, magistrate, or administrative tribunal, including disclosures to opposing counsel in the course of settlement negotiations.
3. A record in this system of records may be disclosed, as a routine use, to a Member of Congress submitting a request involving an individual, to whom the record pertains, when the individual has requested assistance from the Member with respect to the subject matter of the record.
4. A record in this system of records may be disclosed, as a routine use, to a contractor of the Agency having need for the information in order to perform a contract. Recipients of information shall be required to comply with the requirements of the Privacy Act of 1974, as amended, pursuant to 5 U.S.C. 552a(m).
5. A record related to an International Application filed under the Patent Cooperation Treaty in this system of records may be disclosed, as a routine use, to the International Bureau of the World Intellectual Property Organization, pursuant to the Patent Cooperation Treaty.
6. A record in this system of records may be disclosed, as a routine use, to another federal agency for purposes of National Security review (35 U.S.C. 181) and for review pursuant to the Atomic Energy Act (42 U.S.C. 218(c)).
7. A record from this system of records may be disclosed, as a routine use, to the Administrator, General Services, or his/her designee, during an inspection of records conducted by GSA as part of that agency's responsibility to recommend improvements in records management practices and programs, under authority of 44 U.S.C. 2904 and 2906. Such disclosure shall be made in accordance with the GSA regulations governing inspection of records for this purpose, and any other relevant (i.e., GSA or Commerce) directive. Such disclosure shall not be used to make determinations about individuals.
8. A record from this system of records may be disclosed, as a routine use, to the public after either publication of the application pursuant to 35 U.S.C. 122(b) or issuance of a patent pursuant to 35 U.S.C. 151. Further, a record may be disclosed, subject to the limitations of 37 CFR 1.14, as a routine use, to the public if the record was filed in an application which became abandoned or in which the proceedings were terminated and which application is referenced by either a published application, an application open to public inspections or an issued patent.
9. A record from this system of records may be disclosed, as a routine use, to a Federal, State, or local law enforcement agency, if the USPTO becomes aware of a violation or potential violation of law or regulation.

~~ALL REFERENCES CONSIDERED EXCEPT WHERE LINED THROUGH. /T.W./~~

Under the Paperwork Reduction Act of 1995, no persons are required to respond to a collection of information unless it contains a valid OMB control number.

<b>INFORMATION DISCLOSURE STATEMENT BY APPLICANT</b> ( Not for submission under 37 CFR 1.99)	Application Number		10956121	
	Filing Date		2004-10-04	
	First Named Inventor	Wang		
	Art Unit		3685	
	Examiner Name	Thomas C. West		
	Attorney Docket Number		111325/291300	

U.S.PATENTS							Remove
Examiner Initial*	Cite No	Patent Number	Kind Code <sup>1</sup>	Issue Date	Name of Patentee or Applicant of cited Document	Pages,Columns,Lines where Relevant Passages or Relevant Figures Appear	
	1	5287408		1994-02-15	Samson		
	2	5390297		1995-02-14	Barber et al.		
	3	5553143		1996-09-03	Ross et al.		
	4	5564038		1996-10-08	Grantz et al.		
	5	5625690		1997-04-29	Michel et al.		
	6	5638513		1997-06-10	Ananda		
	7	5414852		1995-05-09	Kramer et al.		
If you wish to add additional U.S. Patent citation information please click the Add button.							Add
U.S.PATENT APPLICATION PUBLICATIONS							Remove

<b>INFORMATION DISCLOSURE STATEMENT BY APPLICANT</b> ( Not for submission under 37 CFR 1.99)	Application Number		10956121	
	Filing Date		2004-10-04	
	First Named Inventor	Wang		
	Art Unit		3685	
	Examiner Name	Thomas C. West		
	Attorney Docket Number		111325/291300	

Examiner Initial*	Cite No	Publication Number	Kind Code <sup>1</sup>	Publication Date	Name of Patentee or Applicant of cited Document	Pages, Columns, Lines where Relevant Passages or Relevant Figures Appear
	1					

If you wish to add additional U.S. Published Application citation information please click the Add button.

**FOREIGN PATENT DOCUMENTS**

Examiner Initial*	Cite No	Foreign Document Number <sup>3</sup>	Country Code <sup>2</sup>	Kind Code <sup>4</sup>	Publication Date	Name of Patentee or Applicant of cited Document	Pages, Columns, Lines where Relevant Passages or Relevant Figures Appear	T <sup>5</sup>
	1	5-100939	JP		1993-04-23			<input type="checkbox"/>

If you wish to add additional Foreign Patent Document citation information please click the Add button.

**NON-PATENT LITERATURE DOCUMENTS**

Examiner Initials*	Cite No	Include name of the author (in CAPITAL LETTERS), title of the article (when appropriate), title of the item (book, magazine, journal, serial, symposium, catalog, etc), date, pages(s), volume-issue number(s), publisher, city and/or country where published.	T <sup>5</sup>
	1	Delaigle, "Digital Watermarking," Spie Conference in Optical Security and Counterfeit Deterrence Techniques, San Jose, CA (Feb. 1996)	<input type="checkbox"/>
	2	Perritt, "Technologies Strategies for Protecting Intellectual Property in the Networked Multimedia Environment," Knowbots, Permissions Headers and Contract Law (Apr. 2 -3 1993)	<input type="checkbox"/>

If you wish to add additional non-patent literature document citation information please click the Add button.

**EXAMINER SIGNATURE**

Examiner Signature	/Thomas West/	Date Considered	10/14/2008
--------------------	---------------	-----------------	------------

\*EXAMINER: Initial if reference considered, whether or not citation is in conformance with MPEP 609. Draw line through a citation if not in conformance and not considered. Include copy of this form with next communication to applicant.

**INFORMATION DISCLOSURE  
STATEMENT BY APPLICANT**  
( Not for submission under 37 CFR 1.99)

Application Number	10956121
Filing Date	2004-10-04
First Named Inventor	Wang
Art Unit	3685
Examiner Name	Thomas C. West
Attorney Docket Number	111325/291300

<sup>1</sup> See Kind Codes of USPTO Patent Documents at [www.USPTO.GOV](http://www.USPTO.GOV) or MPEP 901.04. <sup>2</sup> Enter office that issued the document, by the two-letter code (WIPO Standard ST.3). <sup>3</sup> For Japanese patent documents, the indication of the year of the reign of the Emperor must precede the serial number of the patent document. <sup>4</sup> Kind of document by the appropriate symbols as indicated on the document under WIPO Standard ST.16 if possible. <sup>5</sup> Applicant is to place a check mark here if English language translation is attached.

**INFORMATION DISCLOSURE  
STATEMENT BY APPLICANT**  
( Not for submission under 37 CFR 1.99)

Application Number	10956121		
Filing Date	2004-10-04		
First Named Inventor	Wang		
Art Unit	3685		
Examiner Name	Thomas C. West		
Attorney Docket Number	111325/291300		

**CERTIFICATION STATEMENT**

Please see 37 CFR 1.97 and 1.98 to make the appropriate selection(s):

That each item of information contained in the information disclosure statement was first cited in any communication from a foreign patent office in a counterpart foreign application not more than three months prior to the filing of the information disclosure statement. See 37 CFR 1.97(e)(1).

**OR**

That no item of information contained in the information disclosure statement was cited in a communication from a foreign patent office in a counterpart foreign application, and, to the knowledge of the person signing the certification after making reasonable inquiry, no item of information contained in the information disclosure statement was known to any individual designated in 37 CFR 1.56(c) more than three months prior to the filing of the information disclosure statement. See 37 CFR 1.97(e)(2).

See attached certification statement.

Fee set forth in 37 CFR 1.17 (p) has been submitted herewith.

None

**SIGNATURE**

A signature of the applicant or representative is required in accordance with CFR 1.33, 10.18. Please see CFR 1.4(d) for the form of the signature.

Signature	/Marc S. Kaufman, Reg. No. 35,212/	Date (YYYY-MM-DD)	2008-10-10
Name/Print	Marc S. Kaufman	Registration Number	35,212

This collection of information is required by 37 CFR 1.97 and 1.98. The information is required to obtain or retain a benefit by the public which is to file (and by the USPTO to process) an application. Confidentiality is governed by 35 U.S.C. 122 and 37 CFR 1.14. This collection is estimated to take 1 hour to complete, including gathering, preparing and submitting the completed application form to the USPTO. Time will vary depending upon the individual case. Any comments on the amount of time you require to complete this form and/or suggestions for reducing this burden, should be sent to the Chief Information Officer, U.S. Patent and Trademark Office, U.S. Department of Commerce, P.O. Box 1450, Alexandria, VA 22313-1450. **DO NOT SEND FEES OR COMPLETED FORMS TO THIS ADDRESS. SEND TO: Commissioner for Patents, P.O. Box 1450, Alexandria, VA 22313-1450.**

## Privacy Act Statement

The Privacy Act of 1974 (P.L. 93-579) requires that you be given certain information in connection with your submission of the attached form related to a patent application or patent. Accordingly, pursuant to the requirements of the Act, please be advised that: (1) the general authority for the collection of this information is 35 U.S.C. 2(b)(2); (2) furnishing of the information solicited is voluntary; and (3) the principal purpose for which the information is used by the U.S. Patent and Trademark Office is to process and/or examine your submission related to a patent application or patent. If you do not furnish the requested information, the U.S. Patent and Trademark Office may not be able to process and/or examine your submission, which may result in termination of proceedings or abandonment of the application or expiration of the patent.

The information provided by you in this form will be subject to the following routine uses:

1. The information on this form will be treated confidentially to the extent allowed under the Freedom of Information Act (5 U.S.C. 552) and the Privacy Act (5 U.S.C. 552a). Records from this system of records may be disclosed to the Department of Justice to determine whether the Freedom of Information Act requires disclosure of these records.
2. A record from this system of records may be disclosed, as a routine use, in the course of presenting evidence to a court, magistrate, or administrative tribunal, including disclosures to opposing counsel in the course of settlement negotiations.
3. A record in this system of records may be disclosed, as a routine use, to a Member of Congress submitting a request involving an individual, to whom the record pertains, when the individual has requested assistance from the Member with respect to the subject matter of the record.
4. A record in this system of records may be disclosed, as a routine use, to a contractor of the Agency having need for the information in order to perform a contract. Recipients of information shall be required to comply with the requirements of the Privacy Act of 1974, as amended, pursuant to 5 U.S.C. 552a(m).
5. A record related to an International Application filed under the Patent Cooperation Treaty in this system of records may be disclosed, as a routine use, to the International Bureau of the World Intellectual Property Organization, pursuant to the Patent Cooperation Treaty.
6. A record in this system of records may be disclosed, as a routine use, to another federal agency for purposes of National Security review (35 U.S.C. 181) and for review pursuant to the Atomic Energy Act (42 U.S.C. 218(c)).
7. A record from this system of records may be disclosed, as a routine use, to the Administrator, General Services, or his/her designee, during an inspection of records conducted by GSA as part of that agency's responsibility to recommend improvements in records management practices and programs, under authority of 44 U.S.C. 2904 and 2906. Such disclosure shall be made in accordance with the GSA regulations governing inspection of records for this purpose, and any other relevant (i.e., GSA or Commerce) directive. Such disclosure shall not be used to make determinations about individuals.
8. A record from this system of records may be disclosed, as a routine use, to the public after either publication of the application pursuant to 35 U.S.C. 122(b) or issuance of a patent pursuant to 35 U.S.C. 151. Further, a record may be disclosed, subject to the limitations of 37 CFR 1.14, as a routine use, to the public if the record was filed in an application which became abandoned or in which the proceedings were terminated and which application is referenced by either a published application, an application open to public inspections or an issued patent.
9. A record from this system of records may be disclosed, as a routine use, to a Federal, State, or local law enforcement agency, if the USPTO becomes aware of a violation or potential violation of law or regulation.

~~ALL REFERENCES CONSIDERED EXCEPT WHERE LINED THROUGH. /T.W./~~



Under the Paperwork Reduction Act of 1995, no persons are required to respond to a collection of information unless it contains a valid OMB control number.

Substitute for form 1449A/PTO <b>INFORMATION DISCLOSURE STATEMENT BY APPLICANT</b> <i>(use as many sheets as necessary)</i>				<b>Complete if Known</b>		
				Application Number	10/956,121	
Sheet		1	of	1	Examiner Name	Thomas C. West
					Attorney Docket Number	111325/291300

U.S. PATENT DOCUMENTS						
Examiner Initials <sup>1</sup>	Cite No. <sup>1</sup>	U.S. Patent Document Number - Kind Code <sup>2</sup> (if known)		Publication Date MM-DD-YYYY	Name of Patentee or Applicant of Cited Document	Pages, Columns, Lines, Where Relevant Passages or Relevant Figures Appear
	1.	5,619,570	A1	04-08-1997	Tsutsui	

U.S. PUBLISHED PATENT DOCUMENTS						
Examiner Initials <sup>1</sup>	Cite No. <sup>1</sup>	U.S. Patent Document Number - Kind Code <sup>2</sup> (if known)		Publication Date MM-DD-YYYY	Name of Patentee or Applicant of Cited Document	Pages, Columns, Lines, Where Relevant Passages or Relevant Figures Appear

FOREIGN PATENT DOCUMENTS							
Examiner Initials <sup>1</sup>	Cite No. <sup>1</sup>	Foreign Patent Document		Publication Date MM-DD-YYYY	Name of Patentee or Applicant of Cited Document	Pages, Columns, Lines, Where Relevant Passages or Relevant Figures Appear	T <sup>6</sup>
		Country Code <sup>3</sup>	Number <sup>4</sup> Kind Code <sup>5</sup> (if known)				
	2.	EP 0 262 025	A2	03-30-1988	Ogasawara		
	3.	JP 3-063717	A	03-19-1991	Tsutsui et al.	(Ab in EN)	
	4.	JP 6-131371	A	05-13-1994	Tsutsui	(Ab in EN)	

OTHER PRIOR ART - NON PATENT LITERATURE DOCUMENTS			
Examiner Initials <sup>1</sup>	Cite No. <sup>1</sup>	Include name of the author (in CAPITAL LETTERS), title of the article (when appropriate), title of the item (book, magazine, journal, serial, symposium, catalog, etc.), date, page(s), volume-issue number(s), publisher, city and/or country where published.	T <sup>2</sup>
	5.	Johnson et al., "A Secure Distributed Capability Based System," PROCEEDINGS OF THE 1985 ACM ANNUAL CONFERENCE ON THE RANGE OF COMPUTING: MID-80'S PERSPECTIVE: MID-80'S PERSPECTIVE <i>Association for Computing Machinery</i> pp. 392-402 (1985)	

Examiner Signature	/Thomas West/	Date Considered	10/12/2008
--------------------	---------------	-----------------	------------

\*EXAMINER: Initial if reference considered, whether or not citation is in conformance with MPEP 609. Draw line through citation if not in conformance and not considered. Include copy of this form with next communication to applicant.

<sup>1</sup> Applicant's unique citation designation number (optional). <sup>2</sup> See Kinds Codes of USPTO Patent Documents at 222.uspto.gov or MPEP 901.04. <sup>3</sup> Enter Office that issued the document, by the two-letter code (WIPO Standard ST.3). <sup>4</sup> For Japanese patent documents, the indication of the year of the reign of the Emperor must precede the serial number of the patent document. <sup>5</sup> Kind of document by the appropriate symbols as indicated on the document under WIPO Standard ST.16 if possible. <sup>6</sup> Applicant is to place a check mark here if English language Translation is attached.

11018220.1

ALL REFERENCES CONSIDERED EXCEPT WHERE LINED THROUGH. /T.W./

## EAST Search History

Ref #	Hits	Search Query	DBs	Default Operator	Plurals	Time Stamp
S1	1	"10956121"	US-PGPUB; USPAT; USOCR; FPRS; EPO; JPO; DERWENT; IBM_TDB	OR	ON	2008/04/02 09:39
S2	264	"3263158"   "3609697"   "3790700"   "3798605"   "4159468"   "4220991"   "4278837"   "4323921"   "4442486"   "4529870"   "4558176"   "4593376"   "4614861"   "4644493"   "4658093"   "4713753"   "4796220"   "4817140"   "4827508"   "4868376"   "4891838"   "4924378"   "4932054"   "4937863"   "4949187"   "4953209"   "4961142"   "4975647"   "4977594"   "4999806"   "5010571"   "5014234"   "5023907"   "5047928"   "5050213"   "5052040"   "5058164"   "5103476"   "5113519"   "5136643"   "5138712"   "5146499"   "5148481"   "5159182"   "5183404"   "5191193"   "5204897"   "5222134"   "5235642"   "5247575"   "5255106"   "5260999"   "5263157"   "5263158"   "5276444"   "5276735"   "5291596"   "5301231"   "5311591"   "5319705"   "5337357"   "5339091"   "5341429"   "5347579"   "5381526"   "5394469"   "5410598"   "5412717"   "5428606"   "5432849"   "5438508"   "5444779"   "5453601"   "5455953"   "5457746"   "5473687"   "5473692"   "5499298"   "5502766"   "5504814"   "5504818"   "5504837"   "5509070"   "5530235"   "5532920"   "5534975"   "5539735"   "5563946"   "5568552"   "5621797"   "5629980"   "5633932"   "5634012"   "5638443"	US-PGPUB; USPAT; USOCR; FPRS; EPO; JPO; DERWENT; IBM_TDB	OR	ON	2008/04/02 09:41



		"5649013"   "5655077"   "5708717"   "5715403"   "5734823"   "5734891"   "5737413"   "5737416"   "5745569"   "5748783"   "5757907"   "5761686"   "5765152"   "5768426"   "5825892"   "5892900"   "5910987"   "5915019"   "5917912"   "5920861"   "5940504"   "5943422"   "5949876"   "5982891"   "5999949"   "6047067"   "6112181"   "6115471"   "6138119"   "6157721"   "6185683"   "6226618"   "6233684"   "6237786"   "6240185"   "6253193"   "6266618"   "6292569"   "6301660"   "6327652"   "6330670"   "6345256"   "6363488"   "6389402").PN.				
S3	979	((Derived derivation derivable derivative derive) near right)	US-PGPUB; USPAT; USOCR; FPRS; EPO; JPO; DERWENT; IBM_TDB	OR	ON	2008/04/02 10:13
S4	101	S3 and (digital near right)	US-PGPUB; USPAT; USOCR; FPRS; EPO; JPO; DERWENT; IBM_TDB	OR	ON	2008/04/02 10:15
S6	106	S3 and ((digital near rights) (rights near management))	US-PGPUB; USPAT; USOCR; FPRS; EPO; JPO; DERWENT; IBM_TDB	OR	ON	2008/04/02 10:16
S7	23	S6 and (state near variable)	US-PGPUB; USPAT; USOCR; FPRS; EPO; JPO; DERWENT; IBM_TDB	OR	ON	2008/04/02 10:18
S9	979	((Derived derivation derivable derivative derive) near right)	US-PGPUB; USPAT; USOCR; FPRS; EPO; JPO; DERWENT; IBM_TDB	OR	ON	2008/04/02 11:23

S10	106	S9 and ((digital near rights) (rights near management))	US-PGPUB; USPAT; USOCR; FPRS; EPO; JPO; DERWENT; IBM_TDB	OR	ON	2008/04/02 11:23
S11	23	S10 and (state near variable)	US-PGPUB; USPAT; USOCR; FPRS; EPO; JPO; DERWENT; IBM_TDB	OR	ON	2008/04/02 11:23
S12	0	S11 and @ad<="20010607"	US-PGPUB; USPAT; USOCR; FPRS; EPO; JPO; DERWENT; IBM_TDB	OR	ON	2008/04/02 11:23
S13	9	S10 and inherit\$4	US-PGPUB; USPAT; USOCR; FPRS; EPO; JPO; DERWENT; IBM_TDB	OR	ON	2008/04/02 11:28
S14	55	S10 and (transfer\$3 with right)	US-PGPUB; USPAT; USOCR; FPRS; EPO; JPO; DERWENT; IBM_TDB	OR	ON	2008/04/02 11:30
S15	3	S14 and @ad<="20010607"	US-PGPUB; USPAT; USOCR; FPRS; EPO; JPO; DERWENT; IBM_TDB	OR	ON	2008/04/02 11:31
S16	16426	((Derived derivation derivable derivative derive) with right)	US-PGPUB; USPAT; USOCR; FPRS; EPO; JPO; DERWENT; IBM_TDB	OR	ON	2008/04/02 11:42
S17	136	S9 and ((digital near rights) (rights near management) drm (content near right))	US-PGPUB; USPAT; USOCR; FPRS; EPO; JPO; DERWENT; IBM_TDB	OR	ON	2008/04/02 11:43
S18	11	S17 and @ad<="20010607"	US-PGPUB; USPAT; USOCR; FPRS; EPO; JPO; DERWENT; IBM_TDB	OR	ON	2008/04/02 11:44

S19	71035	((Derived derivation derivable derivative derive transfer\$4) with right)	US-PGPUB; USPAT; USOCR; FPRS; EPO; JPO; DERWENT; IBM_TDB	OR	ON	2008/04/02 11:48
S20	2	"7228426"	US-PGPUB; USPAT; USOCR; FPRS; EPO; JPO; DERWENT; IBM_TDB	OR	ON	2008/04/02 14:50
S21	2	"7130829"	US-PGPUB; USPAT; USOCR; FPRS; EPO; JPO; DERWENT; IBM_TDB	OR	ON	2008/04/02 14:56
S22	0	(rights near definition near language) and (secure near inheritance)	US-PGPUB; USPAT; USOCR; FPRS; EPO; JPO; DERWENT; IBM_TDB	OR	ON	2008/04/02 15:17
S23	0	(rights near definition near language)	US-PGPUB; USPAT; USOCR; FPRS; EPO; JPO; DERWENT; IBM_TDB	OR	ON	2008/04/02 15:18
S24	1	(secure near inheritance)	US-PGPUB; USPAT; USOCR; FPRS; EPO; JPO; DERWENT; IBM_TDB	OR	ON	2008/04/02 15:18
S25	123	rights with inheritance	US-PGPUB; USPAT; USOCR; FPRS; EPO; JPO; DERWENT; IBM_TDB	OR	ON	2008/04/02 15:19
S26	47	S25 and @ad<="20010607"	US-PGPUB; USPAT; USOCR; FPRS; EPO; JPO; DERWENT; IBM_TDB	OR	ON	2008/04/02 15:19
S27	1	digital near rights with inheritance	US-PGPUB; USPAT; USOCR; FPRS; EPO; JPO; DERWENT; IBM_TDB	OR	ON	2008/04/02 17:15

S28	290	"6226618"	US-PGPUB; USPAT; USOCR; FPRS; EPO; JPO; DERWENT; IBM_TDB	OR	ON	2008/04/02 17:18
S29	2	"6226618".pn.	US-PGPUB; USPAT; USOCR; FPRS; EPO; JPO; DERWENT; IBM_TDB	OR	ON	2008/04/02 17:19
S30	49	XML near Ticket	US-PGPUB; USPAT; USOCR; FPRS; EPO; JPO; DERWENT; IBM_TDB	OR	ON	2008/04/03 07:31
S31	12	S30 and @ad<="20010607"	US-PGPUB; USPAT; USOCR; FPRS; EPO; JPO; DERWENT; IBM_TDB	OR	ON	2008/04/03 07:31
S32	1	S31 and ((digital near rights) (rights near management) drm (content near right))	US-PGPUB; USPAT; USOCR; FPRS; EPO; JPO; DERWENT; IBM_TDB	OR	ON	2008/04/03 07:35
S33	0	S31 and inherit\$4	US-PGPUB; USPAT; USOCR; FPRS; EPO; JPO; DERWENT; IBM_TDB	OR	ON	2008/04/03 07:36
S34	0	S31 and ((Derived derivation derivable derivative derive) with right)	US-PGPUB; USPAT; USOCR; FPRS; EPO; JPO; DERWENT; IBM_TDB	OR	ON	2008/04/03 07:37
S35	2287967	(Derived derivation derivable derivative derive inherit\$4)	US-PGPUB; USPAT; USOCR; FPRS; EPO; JPO; DERWENT; IBM_TDB	OR	ON	2008/04/03 07:40
S36	4807	S35 and ((digital near rights) (rights near management) drm (content near right))	US-PGPUB; USPAT; USOCR; FPRS; EPO; JPO; DERWENT; IBM_TDB	OR	ON	2008/04/03 07:41

S37	1025	S36 and @ad<="20010607"	US-PGPUB; USPAT; USOCR; FPRS; EPO; JPO; DERWENT; IBM_TDB	OR	ON	2008/04/03 07:44
S38	20	S37 and (state near variable)	US-PGPUB; USPAT; USOCR; FPRS; EPO; JPO; DERWENT; IBM_TDB	OR	ON	2008/04/03 07:45
S39	2	"5109413".pn.	US-PGPUB; USPAT; USOCR; FPRS; EPO; JPO; DERWENT; IBM_TDB	OR	ON	2008/04/03 08:40
S40	2	"5765152".pn.	US-PGPUB; USPAT; USOCR; FPRS; EPO; JPO; DERWENT; IBM_TDB	OR	ON	2008/04/03 08:41
S41	2	"5922074".pn.	US-PGPUB; USPAT; USOCR; FPRS; EPO; JPO; DERWENT; IBM_TDB	OR	ON	2008/04/03 08:41
S42	2	"6098056".pn.	US-PGPUB; USPAT; USOCR; FPRS; EPO; JPO; DERWENT; IBM_TDB	OR	ON	2008/04/03 08:42
S43	2	"6125349".pn.	US-PGPUB; USPAT; USOCR; FPRS; EPO; JPO; DERWENT; IBM_TDB	OR	ON	2008/04/03 08:43
S44	2	"6226618".pn.	US-PGPUB; USPAT; USOCR; FPRS; EPO; JPO; DERWENT; IBM_TDB	OR	ON	2008/04/03 08:44
S45	2	"6385596".pn.	US-PGPUB; USPAT; USOCR; FPRS; EPO; JPO; DERWENT; IBM_TDB	OR	ON	2008/04/03 10:57

S46	7	(US-20050060571-\$).did. or (US-5109413-\$ or US-5765152-\$ or US-6098056-\$ or US-6125349-\$ or US-6226618-\$ or US-6385596-\$).did.	US-PGPUB; USPAT	OR	ON	2008/04/03 10:59
S47	4	S46 and (Derived derivation derivable derivative derive inherit\$4)	US-PGPUB; USPAT; USOCR; FPRS; EPO; JPO; DERWENT; IBM_TDB	OR	ON	2008/04/03 11:02
S48	3	S47 and @ad<="20010607"	US-PGPUB; USPAT; USOCR; FPRS; EPO; JPO; DERWENT; IBM_TDB	OR	ON	2008/04/03 11:03
S49	0	S48 and (state near variable)	US-PGPUB; USPAT; USOCR; FPRS; EPO; JPO; DERWENT; IBM_TDB	OR	ON	2008/04/03 11:05
S50	1	S46 and metadata	US-PGPUB; USPAT; USOCR; FPRS; EPO; JPO; DERWENT; IBM_TDB	OR	ON	2008/04/03 11:11
S51	223	(US-20050060571-\$).did. or (US-6389402-\$ or US-6363488-\$ or US-6345256-\$ or US-6330670-\$ or US-6327652-\$ or US-6301660-\$ or US-6292569-\$ or US-6266618-\$ or US-6253193-\$ or US-6240185-\$ or US-6237786-\$ or US-6233684-\$ or US-6226618-\$ or US-6185683-\$ or US-6157721-\$ or US-6138119-\$ or US-6115471-\$ or US-6112181-\$ or US-6047067-\$ or US-5999949-\$ or US-5982891-\$ or US-5949876-\$ or US-5943422-\$ or US-5940504-\$ or US-5920861-\$ or US-5917912-\$).did. or (US-5915019-\$ or US-5910987-\$ or US-5892900-\$ or US-5825892-\$ or US-5768426-\$ or US-5765152-\$ or US-5761686-\$ or US-5757907-\$ or US-5748783-\$ or US-5745569-\$ or US-5737416-\$ or US-5737413-\$ or US-	US-PGPUB; USPAT; USOCR; EPO; DERWENT	OR	ON	2008/04/03 11:12

5734891-\$ or US-5734823-\$  
or US-5715403-\$ or US-  
5708717-\$ or US-5655077-\$  
or US-5649013-\$ or US-  
5638443-\$ or US-5634012-\$  
or US-5633932-\$ or US-  
5629980-\$ or US-5621797-\$  
or US-5568552-\$ or US-  
5563946-\$ or US-5539735-\$  
or US-5534975-\$).did. or (US-  
5532920-\$ or US-5530235-\$  
or US-5509070-\$ or US-  
5504837-\$ or US-5504818-\$  
or US-5504814-\$ or US-  
5502766-\$ or US-5499298-\$  
or US-5473692-\$ or US-  
5473687-\$ or US-5457746-\$  
or US-5455953-\$ or US-  
5453601-\$ or US-5444779-\$  
or US-5438508-\$ or US-  
5432849-\$ or US-5428606-\$  
or US-5412717-\$ or US-  
5410598-\$ or US-5394469-\$  
or US-5381526-\$ or US-  
5347579-\$ or US-5341429-\$  
or US-5339091-\$ or US-  
5337357-\$ or US-5319705-\$  
or US-5311591-\$).did. or (US-  
5301231-\$ or US-5291596-\$  
or US-5276735-\$ or US-  
5276444-\$ or US-5263158-\$  
or US-5263157-\$ or US-  
5260999-\$ or US-5255106-\$  
or US-5247575-\$ or US-  
5235642-\$ or US-5222134-\$  
or US-5204897-\$ or US-  
5191193-\$ or US-5183404-\$  
or US-5159182-\$ or US-  
5148481-\$ or US-5146499-\$  
or US-5138712-\$ or US-  
5136643-\$ or US-5113519-\$  
or US-5103476-\$ or US-  
5058164-\$ or US-5052040-\$  
or US-5050213-\$ or US-  
5047928-\$ or US-5023907-\$  
or US-5014234-\$).did. or (US-  
5010571-\$ or US-4999806-\$  
or US-4977594-\$ or US-  
4975647-\$ or US-4961142-\$  
or US-4953209-\$ or US-  
4949187-\$ or US-4937863-\$  
or US-4932054-\$ or US-  
4924378-\$ or US-4891838-\$  
or US-4868376-\$ or US-  
4827508-\$ or US-4817140-\$  
or US-4796220-\$ or US-  
4713753-\$ or US-4658093-\$  
or US-4644493-\$ or US-  
4614861-\$ or US-4593376-\$  
or US-4558176-\$ or US-

4529870-\$ or US-4442486-\$  
or US-4323921-\$ or US-  
4278837-\$ or US-4220991-\$  
or US-4159468-\$).did. or (US-  
3798605-\$ or US-3790700-\$  
or US-3609697-\$ or US-  
3263158-\$ or US-6298316-\$  
or US-6135646-\$ or US-  
6161114-\$ or US-5956737-\$  
or US-5109413-\$ or US-  
6098056-\$ or US-6125349-\$  
or US-6385596-\$).did. or (US-  
3263158-\$).did. or (DE-  
4323921-\$ or DE-3609697-\$).  
did. or (EP-1308115-A-\$ or  
EP-1180798-A-\$ or JP-  
2002016565-\$ or US-  
6330670-B-\$ or US-6327652-  
B-\$ or WO-0008909-A-\$ or  
FR-2772486-A-\$ or WO-  
9924928-A-\$ or EP-895149-A-  
\$ or WO-9840969-A-\$ or EP-  
862318-A-\$ or WO-9837481-  
A-\$ or JP-10214297-\$ or US-  
5761686-\$ or EP-838785-A-\$  
or US-5737413-\$ or US-  
5734823-\$ or WO-9809209-  
A-\$ or WO-9743761-A-\$ or  
US-5655077-\$ or WO-  
9726732-A-\$ or US-5649013-  
\$ or WO-9720298-A-\$ or US-  
5633932-\$ or WO-9714087-  
A-\$ or WO-9636163-A-\$).did.  
or (WO-9633476-A-\$ or US-  
5568552-\$ or WO-9627155-  
A-\$ or US-5539735-\$ or US-  
5534975-\$ or US-5530235-\$  
or EP-715246-A-\$ or EP-  
715245-A-\$ or EP-715244-A-  
\$ or EP-715243-A-\$ or DE-  
4442486-A-\$ or US-5509070-  
\$ or US-5504814-\$ or US-  
5473692-\$ or US-5473687-\$  
or WO-9530211-A-\$ or EP-  
679980-A-\$ or EP-679978-A-  
\$ or EP-679977-A-\$ or EP-  
672991-A-\$ or US-5428606-\$  
or WO-9514289-A-\$ or CA-  
2102743-\$ or EP-649074-A-\$  
or WO-9508231-A-\$ or US-  
5394469-\$ or DE-4323921-A-  
\$).did. or (WO-9427411-A-\$  
or WO-9419884-A-\$ or US-  
5337357-\$ or JP-06181924-\$  
or EP-601500-A-\$ or US-  
5319705-\$ or JP-06095591-\$  
or EP-588243-A-\$ or EP-  
575936-A-\$ or EP-570123-A-  
\$ or EP-567800-A-\$ or WO-  
9321581-A-\$ or EP-555715-A-



		\$ or US-5235642-\$ or US-5291596-\$ or EP-542298-A-\$ or WO-9309490-A-\$ or EP-534679-A-\$ or US-5183404-\$ or WO-9301550-A-\$ or WO-9220022-A-\$ or WO-9214187-A-\$ or US-5136643-\$ or WO-9209160-A-\$ or US-5103476-\$ or EP-471939-\$ or US-5058164-\$).did. or (US-5052040-\$ or EP-447339-\$ or US-5047928-\$ or EP-442838-\$ or US-5023907-\$ or EP-425053-\$ or EP-423035-\$ or GB-2236604-\$ or EP-421409-\$ or US-4999806-\$ or EP-398494-\$ or US-4961142-\$ or US-4949187-\$ or DE-3903454-\$ or EP-367700-\$ or EP-366854-\$ or US-4924378-\$ or CA-1267443-\$ or EP-359220-\$ or WO-9002382-\$ or US-4891838-\$ or EP-332304-\$ or US-4796220-\$ or WO-8809019-\$ or EP-266748-\$ or WO-8802960-\$ or WO-8802202-\$).did. or (EP-252646-\$ or DE-3609697-\$ or US-4658093-\$ or EP-192243-\$ or US-4593376-\$ or WO-8603040-\$ or EP-174472-\$ or US-4558176-\$ or US-4529870-\$ or EP-80244-\$ or US-4368162-\$ or US-4278837-\$ or WO-8001635-\$ or DE-2849718-\$ or DE-2840980-\$ or US-3798605-\$).did.				
S52	20	S51 and metadata	US-PGPUB; USPAT; USOCR; FPRS; EPO; JPO; DERWENT; IBM_TDB	OR	ON	2008/04/03 11:12
S53	0	S52 and (state near variable)	US-PGPUB; USPAT; USOCR; FPRS; EPO; JPO; DERWENT; IBM_TDB	OR	ON	2008/04/03 11:13
S54	0	S52 and (state with variable)	US-PGPUB; USPAT; USOCR; FPRS; EPO; JPO; DERWENT; IBM_TDB	OR	ON	2008/04/03 11:13

S55	5	S51 and (state near variable)	US-PGPUB; USPAT; USOCR; FPRS; EPO; JPO; DERWENT; IBM_TDB	OR	ON	2008/04/03 11:13
S56	2287967	(Derived derivation derivable derivative derive inherit\$4)	US-PGPUB; USPAT; USOCR; FPRS; EPO; JPO; DERWENT; IBM_TDB	OR	ON	2008/04/03 12:12
S57	7539	S56 and (state near variable)	US-PGPUB; USPAT; USOCR; FPRS; EPO; JPO; DERWENT; IBM_TDB	OR	ON	2008/04/03 12:12
S58	272	S57 and metadata	US-PGPUB; USPAT; USOCR; FPRS; EPO; JPO; DERWENT; IBM_TDB	OR	ON	2008/04/03 12:13
S59	17	S58 and @ad<="20010607"	US-PGPUB; USPAT; USOCR; FPRS; EPO; JPO; DERWENT; IBM_TDB	OR	ON	2008/04/03 12:14
S60	223	(US-20050060571-\$).did. or (US-6389402-\$ or US-6363488-\$ or US-6345256-\$ or US-6330670-\$ or US-6327652-\$ or US-6301660-\$ or US-6292569-\$ or US-6266618-\$ or US-6253193-\$ or US-6240185-\$ or US-6237786-\$ or US-6233684-\$ or US-6226618-\$ or US-6185683-\$ or US-6157721-\$ or US-6138119-\$ or US-6115471-\$ or US-6112181-\$ or US-6047067-\$ or US-5999949-\$ or US-5982891-\$ or US-5949876-\$ or US-5943422-\$ or US-5940504-\$ or US-5920861-\$ or US-5917912-\$).did. or (US-5915019-\$ or US-5910987-\$ or US-5892900-\$ or US-5825892-\$ or US-5768426-\$ or US-5765152-\$ or US-5761686-\$ or US-5757907-\$ or US-5748783-\$ or US-5745569-\$ or US-5737416-\$ or US-5737413-\$ or US-	US-PGPUB; USPAT; USOCR; EPO; DERWENT	OR	ON	2008/04/03 17:02

5734891-\$ or US-5734823-\$  
or US-5715403-\$ or US-  
5708717-\$ or US-5655077-\$  
or US-5649013-\$ or US-  
5638443-\$ or US-5634012-\$  
or US-5633932-\$ or US-  
5629980-\$ or US-5621797-\$  
or US-5568552-\$ or US-  
5563946-\$ or US-5539735-\$  
or US-5534975-\$).did. or (US-  
5532920-\$ or US-5530235-\$  
or US-5509070-\$ or US-  
5504837-\$ or US-5504818-\$  
or US-5504814-\$ or US-  
5502766-\$ or US-5499298-\$  
or US-5473692-\$ or US-  
5473687-\$ or US-5457746-\$  
or US-5455953-\$ or US-  
5453601-\$ or US-5444779-\$  
or US-5438508-\$ or US-  
5432849-\$ or US-5428606-\$  
or US-5412717-\$ or US-  
5410598-\$ or US-5394469-\$  
or US-5381526-\$ or US-  
5347579-\$ or US-5341429-\$  
or US-5339091-\$ or US-  
5337357-\$ or US-5319705-\$  
or US-5311591-\$).did. or (US-  
5301231-\$ or US-5291596-\$  
or US-5276735-\$ or US-  
5276444-\$ or US-5263158-\$  
or US-5263157-\$ or US-  
5260999-\$ or US-5255106-\$  
or US-5247575-\$ or US-  
5235642-\$ or US-5222134-\$  
or US-5204897-\$ or US-  
5191193-\$ or US-5183404-\$  
or US-5159182-\$ or US-  
5148481-\$ or US-5146499-\$  
or US-5138712-\$ or US-  
5136643-\$ or US-5113519-\$  
or US-5103476-\$ or US-  
5058164-\$ or US-5052040-\$  
or US-5050213-\$ or US-  
5047928-\$ or US-5023907-\$  
or US-5014234-\$).did. or (US-  
5010571-\$ or US-4999806-\$  
or US-4977594-\$ or US-  
4975647-\$ or US-4961142-\$  
or US-4953209-\$ or US-  
4949187-\$ or US-4937863-\$  
or US-4932054-\$ or US-  
4924378-\$ or US-4891838-\$  
or US-4868376-\$ or US-  
4827508-\$ or US-4817140-\$  
or US-4796220-\$ or US-  
4713753-\$ or US-4658093-\$  
or US-4644493-\$ or US-  
4614861-\$ or US-4593376-\$  
or US-4558176-\$ or US-

4529870-\$ or US-4442486-\$  
or US-4323921-\$ or US-  
4278837-\$ or US-4220991-\$  
or US-4159468-\$).did. or (US-  
3798605-\$ or US-3790700-\$  
or US-3609697-\$ or US-  
3263158-\$ or US-6298316-\$  
or US-6135646-\$ or US-  
6161114-\$ or US-5956737-\$  
or US-5109413-\$ or US-  
6098056-\$ or US-6125349-\$  
or US-6385596-\$).did. or (US-  
3263158-\$).did. or (DE-  
4323921-\$ or DE-3609697-\$).  
did. or (EP-1308115-A-\$ or  
EP-1180798-A-\$ or JP-  
2002016565-\$ or US-  
6330670-B-\$ or US-6327652-  
B-\$ or WO-0008909-A-\$ or  
FR-2772486-A-\$ or WO-  
9924928-A-\$ or EP-895149-A-  
\$ or WO-9840969-A-\$ or EP-  
862318-A-\$ or WO-9837481-  
A-\$ or JP-10214297-\$ or US-  
5761686-\$ or EP-838785-A-\$  
or US-5737413-\$ or US-  
5734823-\$ or WO-9809209-  
A-\$ or WO-9743761-A-\$ or  
US-5655077-\$ or WO-  
9726732-A-\$ or US-5649013-  
\$ or WO-9720298-A-\$ or US-  
5633932-\$ or WO-9714087-  
A-\$ or WO-9636163-A-\$).did.  
or (WO-9633476-A-\$ or US-  
5568552-\$ or WO-9627155-  
A-\$ or US-5539735-\$ or US-  
5534975-\$ or US-5530235-\$  
or EP-715246-A-\$ or EP-  
715245-A-\$ or EP-715244-A-  
\$ or EP-715243-A-\$ or DE-  
4442486-A-\$ or US-5509070-  
\$ or US-5504814-\$ or US-  
5473692-\$ or US-5473687-\$  
or WO-9530211-A-\$ or EP-  
679980-A-\$ or EP-679978-A-  
\$ or EP-679977-A-\$ or EP-  
672991-A-\$ or US-5428606-\$  
or WO-9514289-A-\$ or CA-  
2102743-\$ or EP-649074-A-\$  
or WO-9508231-A-\$ or US-  
5394469-\$ or DE-4323921-A-  
\$).did. or (WO-9427411-A-\$  
or WO-9419884-A-\$ or US-  
5337357-\$ or JP-06181924-\$  
or EP-601500-A-\$ or US-  
5319705-\$ or JP-06095591-\$  
or EP-588243-A-\$ or EP-  
575936-A-\$ or EP-570123-A-  
\$ or EP-567800-A-\$ or WO-  
9321581-A-\$ or EP-555715-A-

		\$ or US-5235642-\$ or US-5291596-\$ or EP-542298-A-\$ or WO-9309490-A-\$ or EP-534679-A-\$ or US-5183404-\$ or WO-9301550-A-\$ or WO-9220022-A-\$ or WO-9214187-A-\$ or US-5136643-\$ or WO-9209160-A-\$ or US-5103476-\$ or EP-471939-\$ or US-5058164-\$).did. or (US-5052040-\$ or EP-447339-\$ or US-5047928-\$ or EP-442838-\$ or US-5023907-\$ or EP-425053-\$ or EP-423035-\$ or GB-2236604-\$ or EP-421409-\$ or US-4999806-\$ or EP-398494-\$ or US-4961142-\$ or US-4949187-\$ or DE-3903454-\$ or EP-367700-\$ or EP-366854-\$ or US-4924378-\$ or CA-1267443-\$ or EP-359220-\$ or WO-9002382-\$ or US-4891838-\$ or EP-332304-\$ or US-4796220-\$ or WO-8809019-\$ or EP-266748-\$ or WO-8802960-\$ or WO-8802202-\$).did. or (EP-252646-\$ or DE-3609697-\$ or US-4658093-\$ or EP-192243-\$ or US-4593376-\$ or WO-8603040-\$ or EP-174472-\$ or US-4558176-\$ or US-4529870-\$ or EP-80244-\$ or US-4368162-\$ or US-4278837-\$ or WO-8001635-\$ or DE-2849718-\$ or DE-2840980-\$ or US-3798605-\$).did.				
S61	21	S60 and (state near (variable machine))	US-PGPUB; USPAT; USOCR; FPRS; EPO; JPO; DERWENT; IBM_TDB	OR	ON	2008/04/03 17:02
S62	1611	(state near (variable machine)) and metadata	US-PGPUB; USPAT; USOCR; FPRS; EPO; JPO; DERWENT; IBM_TDB	OR	ON	2008/04/03 17:03
S63	863	S62 and (Derived derivation derivable derivative derive inherit\$4)	US-PGPUB; USPAT; USOCR; FPRS; EPO; JPO; DERWENT; IBM_TDB	OR	ON	2008/04/03 17:04

S65	95	S63 and ((digital near rights) (rights near management) drm (content near right))	US-PGPUB; USPAT; USOCR; FPRS; EPO; JPO; DERWENT; IBM_TDB	OR	ON	2008/04/03 17:05
S66	22	S65 and @ad<="20010607"	US-PGPUB; USPAT; USOCR; FPRS; EPO; JPO; DERWENT; IBM_TDB	OR	ON	2008/04/03 17:05
S67	22	S66 and license	US-PGPUB; USPAT; USOCR; FPRS; EPO; JPO; DERWENT; IBM_TDB	OR	ON	2008/04/03 17:10
S68	1809	(state near (variable machine table)) and metadata	US-PGPUB; USPAT; USOCR; FPRS; EPO; JPO; DERWENT; IBM_TDB	OR	ON	2008/04/03 17:26
S69	958	S68 and (Derived derivation derivable derivative derive inherit\$4)	US-PGPUB; USPAT; USOCR; FPRS; EPO; JPO; DERWENT; IBM_TDB	OR	ON	2008/04/03 17:26
S70	96	S69 and ((digital near rights) (rights near management) drm (content near right))	US-PGPUB; USPAT; USOCR; FPRS; EPO; JPO; DERWENT; IBM_TDB	OR	ON	2008/04/03 17:27
S71	206	S69 and license	US-PGPUB; USPAT; USOCR; FPRS; EPO; JPO; DERWENT; IBM_TDB	OR	ON	2008/04/03 17:28
S72	35	S71 and @ad<="20010607"	US-PGPUB; USPAT; USOCR; FPRS; EPO; JPO; DERWENT; IBM_TDB	OR	ON	2008/04/03 17:28
S74	1809	(state near (variable machine table)) and metadata	US-PGPUB; USPAT; USOCR; FPRS; EPO; JPO; DERWENT; IBM_TDB	OR	ON	2008/04/04 08:11

S75	958	S74 and (Derived derivation derivable derivative derive inherit\$4)	US-PGPUB; USPAT; USOCR; FPRS; EPO; JPO; DERWENT; IBM_TDB	OR	ON	2008/04/04 08:11
S76	206	S75 and license	US-PGPUB; USPAT; USOCR; FPRS; EPO; JPO; DERWENT; IBM_TDB	OR	ON	2008/04/04 08:11
S77	35	S76 and @ad<="20010607"	US-PGPUB; USPAT; USOCR; FPRS; EPO; JPO; DERWENT; IBM_TDB	OR	ON	2008/04/04 08:11
S78	20	S77 and (right with transfer)	US-PGPUB; USPAT; USOCR; FPRS; EPO; JPO; DERWENT; IBM_TDB	OR	ON	2008/04/04 08:11
S80	20	S77 and (right with transfer \$3)	US-PGPUB; USPAT; USOCR; FPRS; EPO; JPO; DERWENT; IBM_TDB	OR	ON	2008/04/04 08:12
S81	64	(state near (variable machine table)) with metadata	US-PGPUB; USPAT; USOCR; FPRS; EPO; JPO; DERWENT; IBM_TDB	OR	ON	2008/04/04 08:39
S82	25	S81 and (Derived derivation derivable derivative derive inherit\$4)	US-PGPUB; USPAT; USOCR; FPRS; EPO; JPO; DERWENT; IBM_TDB	OR	ON	2008/04/04 08:39
S83	1	S81 and ((Derived derivation derivable derivative derive inherit\$4 transfer\$4) with right)	US-PGPUB; USPAT; USOCR; FPRS; EPO; JPO; DERWENT; IBM_TDB	OR	ON	2008/04/04 08:41
S84	0	S83 and license	US-PGPUB; USPAT; USOCR; FPRS; EPO; JPO; DERWENT; IBM_TDB	OR	ON	2008/04/04 08:41

S85	20	"09866101"	US-PGPUB; USPAT; USOCR; FPRS; EPO; JPO; DERWENT; IBM_TDB	OR	ON	2008/04/04 08:48
S86	1	"9866101"	US-PGPUB; USPAT; USOCR; FPRS; EPO; JPO; DERWENT; IBM_TDB	OR	ON	2008/04/04 08:48
S87	1	S85 and @ad<="20010607"	US-PGPUB; USPAT; USOCR; FPRS; EPO; JPO; DERWENT; IBM_TDB	OR	ON	2008/04/04 08:52
S88	2	"20030163597".pn.	US-PGPUB; USPAT; USOCR; FPRS; EPO; JPO; DERWENT; IBM_TDB	OR	ON	2008/04/04 08:54
S89	64	(state near (variable machine table)) with metadata	US-PGPUB; USPAT; USOCR; FPRS; EPO; JPO; DERWENT; IBM_TDB	OR	ON	2008/04/04 11:27
S90	25	S89 and (Derived derivation derivable derivative derive inherit\$4)	US-PGPUB; USPAT; USOCR; FPRS; EPO; JPO; DERWENT; IBM_TDB	OR	ON	2008/04/04 11:27
S91	0	S90 and @ad<="20010607"	US-PGPUB; USPAT; USOCR; FPRS; EPO; JPO; DERWENT; IBM_TDB	OR	ON	2008/04/04 11:27
S92	65	(state near (variable machine table diagram)) with metadata	US-PGPUB; USPAT; USOCR; FPRS; EPO; JPO; DERWENT; IBM_TDB	OR	ON	2008/04/04 11:30
S93	8	S92 and @ad<="20010607"	US-PGPUB; USPAT; USOCR; FPRS; EPO; JPO; DERWENT; IBM_TDB	OR	ON	2008/04/04 11:30



S94	246	(US-20050060571-\$ or US-20020165724-\$ or US-20020069324-\$ or US-20060064666-\$ or US-20030163597-\$ or US-20010054180-\$ or US-20010053996-\$ or US-20010039571-\$).did. or (US-6389402-\$ or US-6363488-\$ or US-6345256-\$ or US-6330670-\$ or US-6327652-\$ or US-6301660-\$ or US-6292569-\$ or US-6266618-\$ or US-6253193-\$ or US-6240185-\$ or US-6237786-\$ or US-6233684-\$ or US-6226618-\$ or US-6185683-\$ or US-6157721-\$ or US-6138119-\$ or US-6115471-\$ or US-6112181-\$ or US-6047067-\$ or US-5999949-\$ or US-5982891-\$ or US-5949876-\$ or US-5943422-\$ or US-5940504-\$ or US-5920861-\$ or US-5917912-\$).did. or (US-5915019-\$ or US-5910987-\$ or US-5892900-\$ or US-5825892-\$ or US-5768426-\$ or US-5765152-\$ or US-5761686-\$ or US-5757907-\$ or US-5748783-\$ or US-5745569-\$ or US-5737416-\$ or US-5737413-\$ or US-5734891-\$ or US-5734823-\$ or US-5715403-\$ or US-5708717-\$ or US-5655077-\$ or US-5649013-\$ or US-5638443-\$ or US-5634012-\$ or US-5633932-\$ or US-5629980-\$ or US-5621797-\$ or US-5568552-\$ or US-5563946-\$ or US-5539735-\$ or US-5534975-\$).did. or (US-5532920-\$ or US-5530235-\$ or US-5509070-\$ or US-5504837-\$ or US-5504818-\$ or US-5504814-\$ or US-5502766-\$ or US-5499298-\$ or US-5473692-\$ or US-5473687-\$ or US-5457746-\$ or US-5455953-\$ or US-5453601-\$ or US-5444779-\$ or US-5438508-\$ or US-5432849-\$ or US-5428606-\$ or US-5412717-\$ or US-5410598-\$ or US-5394469-\$ or US-5381526-\$ or US-5347579-\$ or US-5341429-\$ or US-5339091-\$	US-PGPUB; USPAT; USOCR; EPO; DERWENT	OR	ON	2008/04/04 11:46
-----	-----	---	--	----	----	---------------------

or US-5337357-\$ or US-5319705-\$ or US-5311591-\$).  
did. or (US-5301231-\$ or US-5291596-\$ or US-5276735-\$  
or US-5276444-\$ or US-5263158-\$ or US-5263157-\$  
or US-5260999-\$ or US-5255106-\$ or US-5247575-\$  
or US-5235642-\$ or US-5222134-\$ or US-5204897-\$  
or US-5191193-\$ or US-5183404-\$ or US-5159182-\$  
or US-5148481-\$ or US-5146499-\$ or US-5138712-\$  
or US-5136643-\$ or US-5113519-\$ or US-5103476-\$  
or US-5058164-\$ or US-5052040-\$ or US-5050213-\$  
or US-5047928-\$ or US-5023907-\$ or US-5014234-\$).  
did. or (US-5010571-\$ or US-4999806-\$ or US-4977594-\$  
or US-4975647-\$ or US-4961142-\$ or US-4953209-\$  
or US-4949187-\$ or US-4937863-\$ or US-4932054-\$  
or US-4924378-\$ or US-4891838-\$ or US-4868376-\$  
or US-4827508-\$ or US-4817140-\$ or US-4796220-\$  
or US-4713753-\$ or US-4658093-\$ or US-4644493-\$  
or US-4614861-\$ or US-4593376-\$ or US-4558176-\$  
or US-4529870-\$ or US-4442486-\$ or US-4323921-\$  
or US-4278837-\$ or US-4220991-\$ or US-4159468-\$).  
did. or (US-3798605-\$ or US-3790700-\$ or US-3609697-\$  
or US-3263158-\$ or US-6298316-\$ or US-6135646-\$  
or US-6161114-\$ or US-5956737-\$ or US-5109413-\$  
or US-6098056-\$ or US-6125349-\$ or US-6385596-\$  
or US-6366904-\$ or US-7133845-\$ or US-7120800-\$  
or US-7095854-\$ or US-7076652-\$ or US-7069451-\$  
or US-6948070-\$ or US-6427140-\$ or US-6850252-\$  
or US-7130807-\$ or US-7124101-\$ or US-6671818-\$  
or US-6606744-\$ or US-6442684-\$ or US-6158001-\$).  
did. or (US-5996073-\$).did.  
or (US-3263158-\$).did. or (DE-4323921-\$ or DE-3609697-\$).did. or (EP-

1308115-A-\$ or EP-1180798-A-\$ or JP-2002016565-\$ or US-6330670-B-\$ or US-6327652-B-\$ or WO-0008909-A-\$ or FR-2772486-A-\$ or WO-9924928-A-\$ or EP-895149-A-\$ or WO-9840969-A-\$ or EP-862318-A-\$ or WO-9837481-A-\$ or JP-10214297-\$ or US-5761686-\$ or EP-838785-A-\$ or US-5737413-\$ or US-5734823-\$ or WO-9809209-A-\$ or WO-9743761-A-\$ or US-5655077-\$ or WO-9726732-A-\$ or US-5649013-\$ or WO-9720298-A-\$ or US-5633932-\$ or WO-9714087-A-\$ or WO-9636163-A-\$).did. or (WO-9633476-A-\$ or US-5568552-\$ or WO-9627155-A-\$ or US-5539735-\$ or US-5534975-\$ or US-5530235-\$ or EP-715246-A-\$ or EP-715245-A-\$ or EP-715244-A-\$ or EP-715243-A-\$ or DE-4442486-A-\$ or US-5509070-\$ or US-5504814-\$ or US-5473692-\$ or US-5473687-\$ or WO-9530211-A-\$ or EP-679980-A-\$ or EP-679978-A-\$ or EP-679977-A-\$ or EP-672991-A-\$ or US-5428606-\$ or WO-9514289-A-\$ or CA-2102743-\$ or EP-649074-A-\$ or WO-9508231-A-\$ or US-5394469-\$ or DE-4323921-A-\$).did. or (WO-9427411-A-\$ or WO-9419884-A-\$ or US-5337357-\$ or JP-06181924-\$ or EP-601500-A-\$ or US-5319705-\$ or JP-06095591-\$ or EP-588243-A-\$ or EP-575936-A-\$ or EP-570123-A-\$ or EP-567800-A-\$ or WO-9321581-A-\$ or EP-555715-A-\$ or US-5235642-\$ or US-5291596-\$ or EP-542298-A-\$ or WO-9309490-A-\$ or EP-534679-A-\$ or US-5183404-\$ or WO-9301550-A-\$ or WO-9220022-A-\$ or WO-9214187-A-\$ or US-5136643-\$ or WO-9209160-A-\$ or US-5103476-\$ or EP-471939-\$ or US-5058164-\$).did. or (US-5052040-\$ or EP-447339-\$ or US-5047928-\$ or EP-442838-\$ or US-5023907-\$ or EP-425053-\$ or EP-

		423035-\$ or GB-2236604-\$ or EP-421409-\$ or US-4999806-\$ or EP-398494-\$ or US-4961142-\$ or US-4949187-\$ or DE-3903454-\$ or EP-367700-\$ or EP-366854-\$ or US-4924378-\$ or CA-1267443-\$ or EP-359220-\$ or WO-9002382-\$ or US-4891838-\$ or EP-332304-\$ or US-4796220-\$ or WO-8809019-\$ or EP-266748-\$ or WO-8802960-\$ or WO-8802202-\$.did. or (EP-252646-\$ or DE-3609697-\$ or US-4658093-\$ or EP-192243-\$ or US-4593376-\$ or WO-8603040-\$ or EP-174472-\$ or US-4558176-\$ or US-4529870-\$ or EP-80244-\$ or US-4368162-\$ or US-4278837-\$ or WO-8001635-\$ or DE-2849718-\$ or DE-2840980-\$ or US-3798605-\$.did.				
S95	7	S94 and (state near (variable machine table diagram)) with metadata	US-PGPUB; USPAT; USOCR; FPRS; EPO; JPO; DERWENT; IBM_TDB	OR	ON	2008/04/04 11:47
S96	1	S95 and (Derived derivation derivable derivative derive inherit\$4)	US-PGPUB; USPAT; USOCR; FPRS; EPO; JPO; DERWENT; IBM_TDB	OR	ON	2008/04/04 11:49
S97	0	S95 and license	US-PGPUB; USPAT; USOCR; FPRS; EPO; JPO; DERWENT; IBM_TDB	OR	ON	2008/04/04 11:51
S98	16931	(Derived derivation derivable derivative derive inherit\$4) with rights	US-PGPUB; USPAT; USOCR; FPRS; EPO; JPO; DERWENT; IBM_TDB	OR	ON	2008/04/04 11:58
S99	440	S98 and metadata	US-PGPUB; USPAT; USOCR; FPRS; EPO; JPO; DERWENT; IBM_TDB	OR	ON	2008/04/04 11:59

S100	1	S98 and (state near (variable machine table diagram)) with metadata	US-PGPUB; USPAT; USOCR; FPRS; EPO; JPO; DERWENT; IBM_TDB	OR	ON	2008/04/04 11:59
S101	2	S98 and (state near (variable machine table diagram)) same metadata	US-PGPUB; USPAT; USOCR; FPRS; EPO; JPO; DERWENT; IBM_TDB	OR	ON	2008/04/04 12:00
S102	116	S98 and (state near (variable machine table diagram)) and metadata	US-PGPUB; USPAT; USOCR; FPRS; EPO; JPO; DERWENT; IBM_TDB	OR	ON	2008/04/04 12:00
S103	97	S102 and license	US-PGPUB; USPAT; USOCR; FPRS; EPO; JPO; DERWENT; IBM_TDB	OR	ON	2008/04/04 12:01
S104	22	S103 and @ad<="20010607"	US-PGPUB; USPAT; USOCR; FPRS; EPO; JPO; DERWENT; IBM_TDB	OR	ON	2008/04/04 12:01
S105	10	S102 and drm	US-PGPUB; USPAT; USOCR; FPRS; EPO; JPO; DERWENT; IBM_TDB	OR	ON	2008/04/04 12:13
S106	0	S105 and @ad<="20010607"	US-PGPUB; USPAT; USOCR; FPRS; EPO; JPO; DERWENT; IBM_TDB	OR	ON	2008/04/04 12:13
S107	22	S104 and (Derived derivation derivable derivative derive inherit\$4) with rights	US-PGPUB; USPAT; USOCR; FPRS; EPO; JPO; DERWENT; IBM_TDB	OR	ON	2008/04/04 12:26
S108	0	S104 and (Derived derivation derivable derivative derive inherit\$4) near rights	US-PGPUB; USPAT; USOCR; FPRS; EPO; JPO; DERWENT; IBM_TDB	OR	ON	2008/04/04 12:26

S109	0	S104 and (Derived derivation derivable derivative derive inherit\$4) near (rights product)	US-PGPUB; USPAT; USOCR; FPRS; EPO; JPO; DERWENT; IBM_TDB	OR	ON	2008/04/04 12:27
S110	0	S104 and ((Derived derivation derivable derivative derive inherit\$4) near (rights product))	US-PGPUB; USPAT; USOCR; FPRS; EPO; JPO; DERWENT; IBM_TDB	OR	ON	2008/04/04 12:27
S111	37700	((Derived derivation derivable derivative derive inherit\$4) near (rights product))	US-PGPUB; USPAT; USOCR; FPRS; EPO; JPO; DERWENT; IBM_TDB	OR	ON	2008/04/04 12:27
S112	42471	((Derived derivation derivable derivative derive inherit\$4) near (rights product content))	US-PGPUB; USPAT; USOCR; FPRS; EPO; JPO; DERWENT; IBM_TDB	OR	ON	2008/04/04 12:28
S113	0	S112 and (state near (variable machine table diagram)) with metadata	US-PGPUB; USPAT; USOCR; FPRS; EPO; JPO; DERWENT; IBM_TDB	OR	ON	2008/04/04 12:28
S114	605	S112 and ((digital near rights) (rights near management) drm (content near right))	US-PGPUB; USPAT; USOCR; FPRS; EPO; JPO; DERWENT; IBM_TDB	OR	ON	2008/04/04 12:29
S115	200	S114 and metadata	US-PGPUB; USPAT; USOCR; FPRS; EPO; JPO; DERWENT; IBM_TDB	OR	ON	2008/04/04 12:30
S116	0	S115 and (state near (variable machine table diagram)) with metadata	US-PGPUB; USPAT; USOCR; FPRS; EPO; JPO; DERWENT; IBM_TDB	OR	ON	2008/04/04 12:30
S117	48	S115 and (state near (variable machine table diagram))	US-PGPUB; USPAT; USOCR; FPRS; EPO; JPO; DERWENT; IBM_TDB	OR	ON	2008/04/04 12:30

S119	21	S117 and @ad<="20010607"	US-PGPUB; USPAT; USOCR; FPRS; EPO; JPO; DERWENT; IBM_TDB	OR	ON	2008/04/04 12:31
S120	53061	"rights expression language" prep	US-PGPUB; USPAT; USOCR; FPRS; EPO; JPO; DERWENT; IBM_TDB	OR	ON	2008/04/04 12:47
S121	119	S120 and metadata	US-PGPUB; USPAT; USOCR; FPRS; EPO; JPO; DERWENT; IBM_TDB	OR	ON	2008/04/04 12:48
S122	29	S121 and (state near (variable machine table diagram))	US-PGPUB; USPAT; USOCR; FPRS; EPO; JPO; DERWENT; IBM_TDB	OR	ON	2008/04/04 12:48
S123	5	S122 and @ad<="20010607"	US-PGPUB; USPAT; USOCR; FPRS; EPO; JPO; DERWENT; IBM_TDB	OR	ON	2008/04/04 12:48
S124	163	"rights expression language"	US-PGPUB; USPAT; USOCR; FPRS; EPO; JPO; DERWENT; IBM_TDB	OR	ON	2008/04/04 12:50
S125	56	S124 and metadata	US-PGPUB; USPAT; USOCR; FPRS; EPO; JPO; DERWENT; IBM_TDB	OR	ON	2008/04/04 12:50
S126	8	S125 and (state near (variable machine table diagram))	US-PGPUB; USPAT; USOCR; FPRS; EPO; JPO; DERWENT; IBM_TDB	OR	ON	2008/04/04 12:50
S127	0	S126 and @ad<="20010607"	US-PGPUB; USPAT; USOCR; FPRS; EPO; JPO; DERWENT; IBM_TDB	OR	ON	2008/04/04 12:50

S128	225	"rights expression language" "open digital rights language" odrl	US-PGPUB; USPAT; USOCR; FPRS; EPO; JPO; DERWENT; IBM_TDB	OR	ON	2008/04/04 12:54
S129	74	S128 and metadata	US-PGPUB; USPAT; USOCR; FPRS; EPO; JPO; DERWENT; IBM_TDB	OR	ON	2008/04/04 12:54
S130	8	S129 and (state near (variable machine table diagram))	US-PGPUB; USPAT; USOCR; FPRS; EPO; JPO; DERWENT; IBM_TDB	OR	ON	2008/04/04 12:55
S131	0	S130 and @ad<="20010607"	US-PGPUB; USPAT; USOCR; FPRS; EPO; JPO; DERWENT; IBM_TDB	OR	ON	2008/04/04 12:55
S132	219	drm and ((Derived derivation derivable derivative derive inherit\$4) with rights)	US-PGPUB; USPAT; USOCR; FPRS; EPO; JPO; DERWENT; IBM_TDB	OR	ON	2008/04/04 13:03
S133	35	S132 and (state near (variable machine table diagram))	US-PGPUB; USPAT; USOCR; FPRS; EPO; JPO; DERWENT; IBM_TDB	OR	ON	2008/04/04 13:04
S134	10	S133 and metadata	US-PGPUB; USPAT; USOCR; FPRS; EPO; JPO; DERWENT; IBM_TDB	OR	ON	2008/04/04 13:04
S135	0	S134 and @ad<="20010607"	US-PGPUB; USPAT; USOCR; FPRS; EPO; JPO; DERWENT; IBM_TDB	OR	ON	2008/04/04 13:06
S136	171	S114 and @ad<="20010607"	US-PGPUB; USPAT; USOCR; FPRS; EPO; JPO; DERWENT; IBM_TDB	OR	ON	2008/04/04 13:07



S137	39	S136 and metadata	US-PGPUB; USPAT; USOCR; FPRS; EPO; JPO; DERWENT; IBM_TDB	OR	ON	2008/04/04 13:07
S138	21	S137 and (state near (variable machine table diagram))	US-PGPUB; USPAT; USOCR; FPRS; EPO; JPO; DERWENT; IBM_TDB	OR	ON	2008/04/04 13:09
S139	48	"5619570"	US-PGPUB; USPAT; USOCR; FPRS; EPO; JPO; DERWENT; IBM_TDB	OR	ON	2008/10/12 19:09
S140	6	ep and "0262025"	US-PGPUB; USPAT; USOCR; FPRS; EPO; JPO; DERWENT; IBM_TDB	OR	ON	2008/10/12 19:11
S141	0	ep0262025	US-PGPUB; USPAT; USOCR; FPRS; EPO; JPO; DERWENT; IBM_TDB	OR	ON	2008/10/12 19:11
S142	2	jp and "3063717"	US-PGPUB; USPAT; USOCR; FPRS; EPO; JPO; DERWENT; IBM_TDB	OR	ON	2008/10/12 19:12
S143	0	jp and "3-063717"	US-PGPUB; USPAT; USOCR; FPRS; EPO; JPO; DERWENT; IBM_TDB	OR	ON	2008/10/12 19:12
S144	2	"5619570".pn.	US-PGPUB; USPAT; USOCR; FPRS; EPO; JPO; DERWENT; IBM_TDB	OR	ON	2008/10/12 19:16
S145	2485	(state adj machine) and (state adj variable)	US-PGPUB; USPAT; USOCR; FPRS; EPO; JPO; DERWENT; IBM_TDB	OR	ON	2008/10/12 21:51

S146	1009	S145 and @ad<="20010607"	US-PGPUB; USPAT; USOCR; FPRS; EPO; JPO; DERWENT; IBM_TDB	OR	ON	2008/10/12 21:52
S147	6	S146 and metadata	US-PGPUB; USPAT; USOCR; FPRS; EPO; JPO; DERWENT; IBM_TDB	OR	ON	2008/10/12 21:52
S148	0	S147 and ((derive derivable) near right)	US-PGPUB; USPAT; USOCR; FPRS; EPO; JPO; DERWENT; IBM_TDB	OR	ON	2008/10/12 21:53
S149	5	S147 and right	US-PGPUB; USPAT; USOCR; FPRS; EPO; JPO; DERWENT; IBM_TDB	OR	ON	2008/10/12 21:53
S150	374	(state adj machine) with (state adj variable)	US-PGPUB; USPAT; USOCR; FPRS; EPO; JPO; DERWENT; IBM_TDB	OR	ON	2008/10/12 21:55
S151	54	(state adj machine) near (state adj variable)	US-PGPUB; USPAT; USOCR; FPRS; EPO; JPO; DERWENT; IBM_TDB	OR	ON	2008/10/12 21:55
S152	25	S151 and @ad<="20010607"	US-PGPUB; USPAT; USOCR; FPRS; EPO; JPO; DERWENT; IBM_TDB	OR	ON	2008/10/12 21:55
S153	0	S152 and metadata	US-PGPUB; USPAT; USOCR; FPRS; EPO; JPO; DERWENT; IBM_TDB	OR	ON	2008/10/12 21:56
S154	0	S153 and rights	US-PGPUB; USPAT; USOCR; FPRS; EPO; JPO; DERWENT; IBM_TDB	OR	ON	2008/10/12 21:56

12/ 5/ 2008 5:44:05 PM

C:\Documents and Settings\twest\My Documents\EAST\Workspaces\10\_9\56121 - Wang\56121 - Wang.wsp

<b>Search Notes</b>  	<b>Application/Control No.</b>  10956121	<b>Applicant(s)/Patent Under Reexamination</b>  WANG ET AL.
	<b>Examiner</b>  THOMAS WEST	<b>Art Unit</b>  3685

<b>SEARCHED</b>			
<b>Class</b>	<b>Subclass</b>	<b>Date</b>	<b>Examiner</b>
705	50-79	10/12/2008	Thomas West

<b>SEARCH NOTES</b>		
<b>Search Notes</b>	<b>Date</b>	<b>Examiner</b>
EAST	10/12/2008	Thomas West

<b>INTERFERENCE SEARCH</b>			
<b>Class</b>	<b>Subclass</b>	<b>Date</b>	<b>Examiner</b>

--	--



UNITED STATES PATENT AND TRADEMARK OFFICE

UNITED STATES DEPARTMENT OF COMMERCE
United States Patent and Trademark Office
Address: COMMISSIONER FOR PATENTS
P.O. Box 1450
Alexandria, Virginia 22313-1450
www.uspto.gov

Table with 5 columns: APPLICATION NO., FILING DATE, FIRST NAMED INVENTOR, ATTORNEY DOCKET NO., CONFIRMATION NO.
10/956,121 10/04/2004 Xin Wang 111325-291300 8924

22204 7590 12/29/2008
NIXON PEABODY, LLP
401 9TH STREET, NW
SUITE 900
WASHINGTON, DC 20004-2128

EXAMINER

WEST, THOMAS C

ART UNIT PAPER NUMBER

3621

MAIL DATE DELIVERY MODE

12/29/2008

PAPER

Please find below and/or attached an Office communication concerning this application or proceeding.

The time period for reply, if any, is set in the attached communication.

<b>Office Action Summary</b>	<b>Application No.</b> 10/956,121	<b>Applicant(s)</b> WANG ET AL.	
	<b>Examiner</b> THOMAS WEST	<b>Art Unit</b> 3685	

-- The MAILING DATE of this communication appears on the cover sheet with the correspondence address --

**Period for Reply**

A SHORTENED STATUTORY PERIOD FOR REPLY IS SET TO EXPIRE 3 MONTH(S) OR THIRTY (30) DAYS, WHICHEVER IS LONGER, FROM THE MAILING DATE OF THIS COMMUNICATION.

- Extensions of time may be available under the provisions of 37 CFR 1.136(a). In no event, however, may a reply be timely filed after SIX (6) MONTHS from the mailing date of this communication.
- If NO period for reply is specified above, the maximum statutory period will apply and will expire SIX (6) MONTHS from the mailing date of this communication.
- Failure to reply within the set or extended period for reply will, by statute, cause the application to become ABANDONED (35 U.S.C. § 133). Any reply received by the Office later than three months after the mailing date of this communication, even if timely filed, may reduce any earned patent term adjustment. See 37 CFR 1.704(b).

**Status**

- 1)  Responsive to communication(s) filed on 14 July 2008.
- 2a)  This action is **FINAL**.
- 2b)  This action is non-final.
- 3)  Since this application is in condition for allowance except for formal matters, prosecution as to the merits is closed in accordance with the practice under *Ex parte Quayle*, 1935 C.D. 11, 453 O.G. 213.

**Disposition of Claims**

- 4)  Claim(s) 1-36 is/are pending in the application.
  - 4a) Of the above claim(s) \_\_\_\_\_ is/are withdrawn from consideration.
- 5)  Claim(s) \_\_\_\_\_ is/are allowed.
- 6)  Claim(s) 1-36 is/are rejected.
- 7)  Claim(s) \_\_\_\_\_ is/are objected to.
- 8)  Claim(s) \_\_\_\_\_ are subject to restriction and/or election requirement.

**Application Papers**

- 9)  The specification is objected to by the Examiner.
- 10)  The drawing(s) filed on \_\_\_\_\_ is/are: a)  accepted or b)  objected to by the Examiner.  
 Applicant may not request that any objection to the drawing(s) be held in abeyance. See 37 CFR 1.85(a).  
 Replacement drawing sheet(s) including the correction is required if the drawing(s) is objected to. See 37 CFR 1.121(d).
- 11)  The oath or declaration is objected to by the Examiner. Note the attached Office Action or form PTO-152.

**Priority under 35 U.S.C. § 119**

- 12)  Acknowledgment is made of a claim for foreign priority under 35 U.S.C. § 119(a)-(d) or (f).
  - a)  All    b)  Some \*    c)  None of:
    - 1.  Certified copies of the priority documents have been received.
    - 2.  Certified copies of the priority documents have been received in Application No. \_\_\_\_\_.
    - 3.  Copies of the certified copies of the priority documents have been received in this National Stage application from the International Bureau (PCT Rule 17.2(a)).

\* See the attached detailed Office action for a list of the certified copies not received.

**Attachment(s)**

- |   |   |
|---|---|
| 1) <input checked="" type="checkbox"/> Notice of References Cited (PTO-892)   | 4) <input type="checkbox"/> Interview Summary (PTO-413)<br>Paper No(s)/Mail Date. _____ |
| 2) <input type="checkbox"/> Notice of Draftsperson's Patent Drawing Review (PTO-948)  | 5) <input type="checkbox"/> Notice of Informal Patent Application                       |
| 3) <input checked="" type="checkbox"/> Information Disclosure Statement(s) (PTO/SB/08)<br>Paper No(s)/Mail Date <u>7-2-08, 10-10-08</u> . | 6) <input type="checkbox"/> Other: _____  |

## **DETAILED ACTION**

### ***Status of Claims***

1. The Final Office Action dated 10-16-08 is withdrawn. This action is in reply to the Arguments/Remarks filed 7-14-08.
2. Claims 1-36 are currently pending and have been examined.

### ***Information Disclosure Statement***

3. The Information Disclosure Statements filed on 7-2-08, 10-10-08 have been considered. Initialed copies of Form 1449 are enclosed herewith.

### ***Response to Arguments***

5. Applicant's arguments filed 7-14-08 have been fully considered but they are not persuasive. Applicant's arguments will be addressed in sequential order as they were set forth in the "Remarks" section on the above date. Applicant argues that Anand does not disclose meta-rights specifying derivable rights. Anand discloses, "Multiple principals can delegate a subset of their maximal permissions for the executable content. The mechanism uses policy for combining the delegated permissions into the content's current permissions" (col. 3, lines 27-31). Anand further discloses, "electing granted permissions from within an associated maximal set of permissions" (col. 3, lines 59-60). "As FIG. 2 depicts, the derivation mechanism (100) consists of the following five steps:", (col. 5, lines 1-2). "The current permissions (150), by definition, must always be a subset of the maximal permissions (140)", (col. 5, lines 14-16). "The description of executable content (120) is a set of attribute-value pairs. One possible

Art Unit: 3685

embodiment is RDF ("Resource Description Framework") labels that describe the meta-data of a website's URI ("Universal Resource Identifier")", (col. 5, lines 17-21). The attribute-value pairs of Anand correspond to the meta-rights of Wang. Anand further discloses, "FIG. 4 illustrates that the nodes of a policy graph's directed graph consist of an attribute, a value, an entry, and an access control list. FIG. 5 illustrates a preferred embodiment of the permissions structure, and shows that permissions include positive and negative rights and transforms. FIG. 7 illustrates how the first step of the dynamic derivation mechanism creates a derivation instance and sets its attributes values" (col. 4, lines 18-31. The state variables of Wang correspond to the derivation instance of Anand, fig. 7. Anand regulates who is entitled to derive rights through an access control described in fig. 4 referenced above. Anand controls who is entitled to derive rights, "The access control list (325) limits access to the policy graph (320). Principals can be permitted to modify any of the policy graph attributes (321-325)", (col. 6, lines 26-29). Infrastructure further discloses a state machine which consists of state variables, as defined by Curtis. "Within the state machine, while a state variable does not equal exit 1301, the state machine will go from state to state based upon what the state variable is set to", (Curtis, 6,397,355, col. 9, lines 53-55) .

### ***Double Patenting***

4. The nonstatutory double patenting rejection is based on a judicially created doctrine grounded in public policy (a policy reflected in the statute) so as to prevent the unjustified or improper timewise extension of the "right to exclude" granted by a patent and to prevent possible harassment by multiple assignees. A nonstatutory obviousness-type double patenting rejection is appropriate where the conflicting claims are not identical, but at least one examined



Art Unit: 3685

application claim is not patentably distinct from the reference claim(s) because the examined application claim is either anticipated by, or would have been obvious over, the reference claim(s). See, e.g., *In re Berg*, 140 F.3d 1428, 46 USPQ2d 1226 (Fed. Cir. 1998); *In re Goodman*, 11 F.3d 1046, 29 USPQ2d 2010 (Fed. Cir. 1993); *In re Longi*, 759 F.2d 887, 225 USPQ 645 (Fed. Cir. 1985); *In re Van Ornum*, 686 F.2d 937, 214 USPQ 761 (CCPA 1982); *In re Vogel*, 422 F.2d 438, 164 USPQ 619 (CCPA 1970); and *In re Thorington*, 418 F.2d 528, 163 USPQ 644 (CCPA 1969).

A timely filed terminal disclaimer in compliance with 37 CFR 1.321(c) or 1.321(d) may be used to overcome an actual or provisional rejection based on a nonstatutory double patenting ground provided the conflicting application or patent either is shown to be commonly owned with this application, or claims an invention made as a result of activities undertaken within the scope of a joint research agreement.

Effective January 1, 1994, a registered attorney or agent of record may sign a terminal disclaimer. A terminal disclaimer signed by the assignee must fully comply with 37 CFR 3.73(b).

Claims 1-36 are provisionally rejected on the ground of nonstatutory double patenting over claim 6 of copending Application No. 10162701. This is a provisional double patenting rejection since the conflicting claims have not yet been patented.

The subject matter claimed in the instant application is fully disclosed in the referenced copending application and would be covered by any patent granted on that copending application since the referenced copending application and the instant application are claiming common subject matter, as follows: meta-rights, derived rights, rights transfer, generating a license.

Furthermore, there is no apparent reason why applicant would be prevented from presenting claims corresponding to those of the instant application in the other copending application. See *In re Schneller*, 397 F.2d 350, 158 USPQ 210 (CCPA 1968). See also MPEP § 804.

***Claim Rejections - 35 USC §101***

5. 35 U.S.C. §101 reads as follows:

Whoever invents or discovers any new and useful process, machine, manufacture, or composition of matter, or any new and useful improvement thereof, may obtain a patent therefor, subject to the conditions and requirements of this title.

6. Claims 1-36 are rejected under 35 U.S.C. §101 because the claimed invention is directed to non-statutory subject matter.

Based on Supreme Court precedent and recent Federal Circuit decisions, § 101 process must (1) be tied to another statutory class (such as a particular apparatus) or (2) transform underlying subject matter (such as an article or materials) to a different state or thing. If neither of these requirements is met by the claim(s), the method is not a patent eligible process under 35 U.S.C. § 101.

In this particular case, claims 1, 12, 24 and their dependent claims 2-11, 13-23, 25-36 lack sufficient technology. (*Diamond v. Diehr*, 450 U.S. 175, 184 (1981); *Parker v. Flook*, 437 U.S. 584, 588 n.9 (1978); *Gottschalk v. Benson*, 409 U.S. 63, 70 (1972); *Cochrane v. Deener*, 94 U.S. 780, 787-88 (1876)).

Claims 2-11, 13-23, 25-36 are also rejected as each depends from either claim 1, 12, 24.

***Claim Rejections - 35 USC § 103***

7. The following is a quotation of 35 U.S.C. 103(a) which forms the basis for all obviousness rejections set forth in this Office action:

(a) A patent may not be obtained though the invention is not identically disclosed or described as set forth in section 102 of this title, if the differences between the subject matter sought to be patented and the prior art are such that the subject matter as a whole would have been obvious at the time the invention was made to a person having ordinary skill in the art to which said subject matter pertains. Patentability shall not be negated by the manner in which the invention was made.

8. Claims 1-36 are rejected under U.S.C. 103(a) as being unpatentable over Anand, US Patent No. 6,044,466 (Anand), in view of Workshop on Digital Rights Management, Minutes from Architecture/Infrastructure Session (Infrastructure).

**Claims 1, 12, 24:**

Anand, as shown, discloses the following limitations:

obtaining a set of rights associated with an item, the set of rights including meta-rights specifying derivable rights that can be derived from the meta-rights (see column 3, line 15-31, column 5, lines 17-23, column 5, lines 1-16)

determining whether the rights consumer (user) is entitled to the derivable rights specified by the meta-rights (see col. 3, lines 27-31, column 5, line 14-21, col. 3, lines 32-35)

deriving at least one right from the derivable rights, if the rights consumer is entitled to the derivable rights specified by the meta-rights, wherein the derived right

Art Unit: 3685

includes at least one state variable based on the set of rights and used for determining a state of the derived right (see column 5, line 1-16, col. 3, lines 32-35, col. 5, lines 17-21)

Anand discloses the limitations as shown above. Anand does not directly disclose a state variable (state machine), but Infrastructure does (page 8, paragraph 3)

It would have been obvious to one of ordinary skill in the art at the time of the invention to modify Anand to include the state machine of Infrastructure since this provides a dynamic structure that can express dynamic rights relationships.

**Claims 2, 13, 25:**

Anand, as shown, discloses the following limitations:

the state variable inherits a state thereof for content usage or rights transfer from the set of rights (see column 5, line 1-16)

**Claims 3, 4, 14, 15, 26, 27:**

Anand/Infrastructure discloses the limitations shown above. Anand further discloses:

the state variable shares a state thereof for content usage or rights transfer with the set of rights (see column 8, line 7-14)

the state variable inherits a remaining state for content usage or rights transfer from the set of rights (see column 5, line 14-16)

Art Unit: 3685

**Claims 5, 16, 28:**

Anand, as shown, discloses the following limitations:

the state variable is updated upon exercise of a right associated with the state variable (see column 7, line 5-14)

**Claims 6, 17, 29:**

Anand, as shown, discloses the following limitations:

deriving a plurality of rights from the derivable rights, wherein the state variable is shared by the derived rights (see column 7, line 1-7)

**Claims 7, 8, 18, 19, 30, 31:**

Anand discloses the limitations as shown above. Anand does not directly disclose a state variable (state machine), but Infrastructure does:

the state variable represents a collection of states (see page 8, paragraph 3)

a plurality of state variables that determine the state of the derived right (see page 8, paragraph 3)

It would have been obvious to one of ordinary skill in the art at the time of the invention to modify Anand to include the state machine of Infrastructure since this provides a dynamic structure that can express dynamic rights relationships.

Art Unit: 3685

**Claims 9, 20, 32:**

Anand, as shown, discloses the following limitations:

at least one state variable is unspecified in the derived right, is created during a rights transfer, and is assigned to the derived right (see column 7, line 1-14)

**Claims 10, 21, 33:**

Anand, as shown, discloses the following limitations:

the state variable is transferred from the derivable rights to the derived right (see column 7, line 15-23)

**Claims 11, 22, 34, 36:**

Anand, as shown, discloses the following limitations:

generating a license including the derived right, if the rights consumer is entitled to the derivable rights specified by the meta-rights (see column 7, line 24-29)

one or more of the means for obtaining, the means for determining, and the means for deriving are specified in a license (see column 7, line 24-29)

**Claim 35:**

Anand, as shown, discloses the following limitations:

Art Unit: 3685

obtaining, the means for determining, and the means for deriving comprise at least one of computer-executable instructions, and devices of a computer system (see column 4, line 51-67)

***Conclusion***

Any inquiry concerning this communication or earlier communications from the examiner should be directed to Thomas West whose telephone number is 571-270-1236. The examiner can normally be reached on M-R 7:30am - 5pm EST, ALT Fridays off.

If attempts to reach the examiner by telephone are unsuccessful, the examiner's supervisor, Calvin L. Hewitt, can be reached on (571) 272-6709. The fax phone number for the organization where this application or proceeding is assigned is 571-273-8300.

Information regarding the status of an application may be obtained from the Patent Application Information Retrieval (PAIR) system. Status information for published applications may be obtained from either Private PAIR or Public PAIR. Status information for unpublished applications is available through Private PAIR only. For more information about the PAIR system, see <http://pair-direct.uspto.gov>. Should you have questions on access to the Private PAIR system, contact the Electronic Business Center (EBC) at 866-217-9197 (toll-free). If you would like assistance from a USPTO Customer Service Representative or access to the automated information system, call 800-786-9199 (IN USA OR CANADA) or 571-272-1000.

Thomas West  
Patent Examiner  
Art Unit 3685  
December 15, 2008

/ANDREW J. FISCHER/  
Supervisory Patent Examiner, Art Unit 3621

<b>Notice of References Cited</b>	Application/Control No. 10/956,121	Applicant(s)/Patent Under Reexamination WANG ET AL.	
	Examiner THOMAS WEST	Art Unit 3685	Page 1 of 1

**U.S. PATENT DOCUMENTS**

*	Document Number Country Code-Number-Kind Code	Date MM-YYYY	Name	Classification
*	A US-6,044,466 A	03-2000	Anand et al.	726/1
B	US-			
C	US-			
D	US-			
E	US-			
F	US-			
G	US-			
H	US-			
I	US-			
J	US-			
K	US-			
L	US-			
M	US-			

**FOREIGN PATENT DOCUMENTS**

*	Document Number Country Code-Number-Kind Code	Date MM-YYYY	Country	Name	Classification
N					
O					
P					
Q					
R					
S					
T					

**NON-PATENT DOCUMENTS**

*	Document Number Country Code-Number-Kind Code	Date MM-YYYY	Country	Name	Classification
				Include as applicable: Author, Title Date, Publisher, Edition or Volume, Pertinent Pages)	
U				Workshop on Digital Rights Management for the Web, World Wide Web Consortium, Minutes from the Architecture/Infrastructure Session, January 2001	
V					
W					
X					

\*A copy of this reference is not being furnished with this Office action. (See MPEP § 707.05(a).)  
Dates in MM-YYYY format are publication dates. Classifications may be US or foreign.



<b>Index of Claims</b>  	<b>Application/Control No.</b>  10956121	<b>Applicant(s)/Patent Under Reexamination</b>  WANG ET AL.
	<b>Examiner</b>  THOMAS WEST	<b>Art Unit</b>  3685

✓	<b>Rejected</b>
=	<b>Allowed</b>

-	<b>Cancelled</b>
÷	<b>Restricted</b>

N	<b>Non-Elected</b>
I	<b>Interference</b>

A	<b>Appeal</b>
O	<b>Objected</b>

Claims renumbered in the same order as presented by applicant
  CPA
  T.D.
  R.1.47

CLAIM		DATE							
Final	Original	10/12/2008							
	1	✓							
	2	✓							
	3	✓							
	4	✓							
	5	✓							
	6	✓							
	7	✓							
	8	✓							
	9	✓							
	10	✓							
	11	✓							
	12	✓							
	13	✓							
	14	✓							
	15	✓							
	16	✓							
	17	✓							
	18	✓							
	19	✓							
	20	✓							
	21	✓							
	22	✓							
	23	✓							
	24	✓							
	25	✓							
	26	✓							
	27	✓							
	28	✓							
	29	✓							
	30	✓							
	31	✓							
	32	✓							
	33	✓							
	34	✓							
	35	✓							
	36	✓							

<b><i>Index of Claims</i></b>  	<b>Application/Control No.</b>  10956121	<b>Applicant(s)/Patent Under Reexamination</b>  WANG ET AL.
	<b>Examiner</b>  THOMAS WEST	<b>Art Unit</b>  3685

✓	<b>Rejected</b>
=	<b>Allowed</b>

-	<b>Cancelled</b>
÷	<b>Restricted</b>

<b>N</b>	<b>Non-Elected</b>
<b>I</b>	<b>Interference</b>

<b>A</b>	<b>Appeal</b>
<b>O</b>	<b>Objected</b>

**REMARKS**

Claims 1-36 were pending in the present application prior to the above amendment. In response to the Office Action, claims 1, 12, and 24 are amended to clarify the invention, and not for reasons of patentability. No claims have been canceled, and no claims have been added. Therefore, claims 1-36 remain pending in the present application and are believed to be in proper condition for allowance. Applicants request reconsideration and allowance of the application in view of the above amendments and the following remarks.

Claims 1-36 stand provisionally rejected on the ground of nonstatutory double-patenting over claim 6 of copending Application No. 10162701. Applicants respectfully request that this provisional rejection be held in abeyance until this application is otherwise in condition for allowance, at which point Applicants will consider filing a Terminal Disclaimer.

Claims 1-36 stand rejected under 35 U.S.C. § 101 as being related to a process that is not (1) tied to a statutory class, or (2) transforming an underlying subject matter (such as an article or material) to a different state or thing. However, Applicants believe claims 1, 12, and 24 as presented herein fully satisfy the requirements of 35 U.S.C. § 101.

Specifically, claims 1, 12, and 24 each recite that “the meta-rights are provided in digital form and are enforceable by a repository.” Claim 1 further recites a “computer-implemented method” in which the determining step is carried out “by a repository.” Applicants believe these amendments to the claims obviate the Examiner’s rejection under 35 U.S.C. § 101, and respectfully request reconsideration and withdrawal of this rejection.

Claims 1-36 stand rejected under 35 U.S.C. §103(a) as allegedly being unpatentable over Anand et al. (U.S. Patent No. 6,044,466) in view of “Workshop on Digital Rights Management, Minutes from Architecture/Infrastructure Session” (hereafter, Infrastructure). However, Applicants respectfully submit that neither Anand nor Infrastructure, taken alone or in combination, disclose, suggest, or render obvious the invention recited in claims 1-36.

For example, independent claim 1 (emphasis added), recites:

A computer-implemented method for transferring rights adapted to be associated with items from a rights supplier to a rights consumer, the method comprising:

obtaining a set of rights associated with an item, **the set of rights including meta-rights specifying derivable rights that can be derived from the meta-rights**, wherein the meta-rights are provided in digital form and are enforceable by a repository;

determining, by a repository, whether the rights consumer is entitled to the derivable rights specified by the meta-rights; and

**deriving at least one right from the derivable rights, if the rights consumer is entitled to the derivable rights specified by the meta-rights, wherein the derived right includes at least one state variable based on the set of rights and used for determining a state of the derived right.**

Independent claim 12 (emphasis added), recites:

A system for transferring rights adapted to be associated with items from a rights supplier to a rights consumer, the system comprising:

means for obtaining a set of rights associated with an item, **the set of rights including meta-rights specifying derivable rights that can be derived from the meta-rights**, wherein the meta-rights are provided in digital form and are enforceable by a repository;

means for determining whether the rights consumer is entitled to the derivable rights specified by the meta-rights; and

**means for deriving at least one right from the derivable rights, if the rights consumer is entitled to the derivable rights specified by the meta-rights, wherein the derived right includes at least one state variable based on the set of rights and used for determining a state of the derived right.**

Independent claim 24 (emphasis added), recites:

A device for transferring rights adapted to be associated with items from a rights supplier to a rights consumer, the device comprising:

means for obtaining a set of rights associated with an item, **the set of rights including meta-rights specifying derivable rights that can be derived from the meta-rights**, wherein the meta-rights are provided in digital form and are enforceable by a repository;

means for determining whether the rights consumer is entitled to the derivable rights specified by the meta-rights; and

**means for deriving at least one right from the derivable rights, if the rights consumer is entitled to the derivable rights specified by the meta-rights, wherein the derived right includes at least one state variable based on the set of rights and used for determining a state of the derived right.**

Thus, independent claims 1, 12 and 24 are directed to, in relevant part, the features of obtaining a set of rights associated with an item, the set of rights including meta-rights specifying derivable rights that can be derived from the meta-rights, determining whether the rights consumer is entitled to the derivable rights specified by the meta-rights, and deriving at least one right from the derivable rights, if the rights consumer is entitled to the derivable rights specified by the meta-rights, wherein the derived right includes at least one state variable based on the set of rights and used for determining a state of the derived right.

After reviewing the response to arguments section on pages 2-3 of the office action, as well as the rejection set forth on pages 6-10, Applicants respectfully submit that the Examiner may be confused about what is meant by “meta-rights” in the claims. Specifically, when considering whether or not Anand discloses “meta-rights specifying derivable rights”, the Examiner asserts that “the attribute-value pairs of Anand correspond to the meta-rights of Wang.” The Examiner references the following disclosures from Anand

- "Multiple principals can delegate a subset of their maximal permissions for the executable content. The mechanism uses policy for combining the delegated permissions into the content's current permissions" (col. 3, lines 27-31).
- "electing granted permissions from within an associated maximal set of permissions" (col. 3, lines 59-60).
- "As FIG. 2 depicts, the derivation mechanism (100) consists of the following five steps:", (col. 5, lines 1-2).

- "The current permissions (150), by definition, must always be a subset of the maximal permissions (140)", (col. 5, lines 14-16).
- "The description of executable content (120) is a set of attribute-value pairs. One possible embodiment is RDF ("Resource Description Framework") labels that describe the metadata of a website's URI ("Universal Resource Identifier)", (col. 5, lines 17-21).

The above portions of Anand do not disclose "meta-rights specifying derivable rights that can be derived from the meta-rights" as recited in the claims. Instead, these portions of Anand relate to the derivation mechanism of Anand and how it is implemented.

For example, with respect to col. 3, lines 27-31, of Anand, there is a fundamental difference between the notion of capability (i.e. capability to derive) and the notion of right (i.e. the right to derive). Though both are related to doing, a capability is whether or not someone is capable of doing something – often stated by "can do", whereas a right is whether or not someone is allowed or permitted to do something – often stated by "may or may not do" in the situations of "can do". Hence, having a capability (implemented as a mechanism) to, or can, derive rights/permissions does not entail having a right to do the same. This is similar to the situations that one can speak but may not have the right or freedom of speech and that one machine can execute a program but may not have the right to execute the program.

In the present application, a meta-right is considered to be "a right specifying derivable rights" and when a meta-right is exercised, rights can be derived from the derivable rights, resulting in derived rights. In this notion, a meta-right must be a right first, and specify derivable rights second. Therefore, the statement "one can delegate (permissions) ..." does not imply the statement "one has a right to delegate (permissions) ..." or "one has a meta-right to delegate (permission) ...". In summary, disclosing how to implement a capability to derive rights/permissions does not imply disclosing how to specify or implement a right to regulate or govern the capability.

Moreover, as Anand stated in the first line of its Summary of the Invention: “The present invention defines a dynamic derivation mechanism that enables limited permissions to be dynamically and flexibly derived for executables based upon their authenticated description.” (col. 3, lines 15-18). Therefore, Anand is about a derivation mechanism and is not about meta-rights for regulating or governing derivation of rights.

In addition, Applicants respectfully submit that Anand fails to disclose or suggest at least the claimed features of “determining whether the rights consumer is entitled to the derivable rights specified by the meta-rights” as recited in the claims.

Specifically, the Examiner asserts that Anand regulates who is entitled to derive rights through an access control in Fig. 4 described by stating that “The access control list (325) limits access to the policy graph (320). Principals can be permitted to modify any of the policy graph attributes (321-325)”. (Anand, col. 6, lines 26-29).

If the Examiner intended to reference access control list (325) in Fig. 3 of Anand instead of the access control list (325) in Fig. 4, this list only limits which principals may access the policy graph (320) that includes the access control list (325) itself. This, however, would only regulate modification of the attributes of the policy graph, namely, the downloading principal (321), the traversal method (322), the combination method (323), the directed graph (324) and the access control list (325). Modifying these attributes (321-325) is not same as deriving rights or permissions. Moreover, this modification is not part of the five steps of the derivation mechanism depicted in Fig. 2, which means that this modification is not a result of exercising a meta-right to derive (permissions).

If the Examiner instead intended to refer to the access control list of Fig. 4, not in Fig.3, the following description of about Fig. 4 does not support the Examiner’s argument: “As shown in FIG. 4, the nodes (400) of a policy graph's (320) directed graph (324) consist of an attribute (410), a value (420), an entry (430), and an access control list (440). The traversal method uses the node attribute (410) and node value (420) to match the node with the content's description

(120). If a match occurs, then the combination method (323) applies the node entry (430) to the current result derived so far from the policy graph traversal (810). In a preferred embodiment, node entries (430) refer to permissions. The access control list (440) controls access to the node. In a preferred embodiment, principals can be permitted to read, write, delete, and create children of the node.” (Col. 6, lines 30-41).

Applicants point out that “the node” whose access is controlled by the access control list (440) lacks of reference. A reasonable reference from the context is that it refers the node (440) of a policy graph’s (320) directed graph (324). However, this would only limit access to “children of the node”, namely, the attribute (410), the value (420), the entry (430), and the access control list (440). Modifying these children (410, 420, 430 and 440) is not same as deriving rights or permissions or exercising a meta-right to derive rights.

Finally, the site security policy of Anand is only used in deriving permissions, not in determining if one has the right to derive. This can be seen from the disclosure of Anand, Col. 6, lines 28-35: “FIG. 3 shows the site security policy (130). It includes sets of policy graphs (320) used to derive the maximal permissions contributions (150) that any principal can delegate to the content and sets of permissions propositions (300,310) used to compute the current and maximal permissions (140,150) from the maximal permissions contributions (150) and the current permissions contributions delegated by those principals”. Moreover, none of the five steps depicted in Fig. 2 has anything to do with determining or governing the right to derive permissions, that is, the meta-right to derive.

Additionally, with respect to the Examiner’s assertion that Anand discloses a “state variable” as recited in the claims, Applicants respectfully submit that the Examiner appears to consider the attributes values of the Derivation Instance of Anand to be the same as the state variables of the invention (i.e. “wherein the derived right includes at least one state variable based on the set of rights and used for determining a state of the derived right”). Applicants



respectfully disagree. The attributes values of the Derivation Instance of Anand are constant for the instance and do not change to maintain the state of rights as described in the application.

Finally, with respect to the Examiner's assertion that Infrastructure and Curtis in combination discloses a state machine which consists of state variables, Applicants point out that Infrastructure merely discloses a single statement, "[a] contract between an author and a publisher is like a dynamic state machine", and provides no elaboration on what the statement means. It is not clear how a contract as a (static) agreement can be a (dynamic) state machine. In any case, the statement is definitely not directed to any further agreements or promises (e.g., "derived right") that can be derived from the contract. Furthermore, a state variable used in a state machine as disclosed by Curtis, Col. 9, lines 53-55: "Within the state machine, while a state variable does not equal exit 1301, the state machine will go from state to state based upon what the state variable is set to" is created by a software program for carrying out a process flow. Thus, the contract of Infrastructure does not include a "state variable based on the set of rights and used for determining a state of the derived right" as is recited in independent claims 1, 12 and 24. Applicants further submit that the notion of a state variable in a process flow, as described in the above cited passage of Curtis, and the notion of a state variable of the application are unrelated ideas.

At least for the reasons set forth above, Applicants respectfully submit that neither Anand nor Infrastructure, taken alone or in combination, disclose, suggest, or render obvious the invention recited in independent claims 1, 12, and 24. The dependent claims are allowable at least by virtue of their dependency from one of the independent claims, and also on their own merits.

In view of the foregoing, it is submitted that the present application is in condition for allowance and a notice to that effect is respectfully requested. However, if any issue remains after considering this response, the Examiner is invited to call the undersigned to expedite the prosecution and work out any such issue by telephone.

**Except** for issue fees payable under 37 C.F.R. § 1.18, the Commissioner is hereby authorized by this paper to charge any additional fees during the entire pendency of this application including fees due under 37 C.F.R. §§ 1.16 and 1.17 which may be required, including any required extension of time fees, or credit any overpayment to Deposit Account No. 19-2380. This paragraph is intended to be a **CONSTRUCTIVE PETITION FOR EXTENSION OF TIME** in accordance with 37 C.F.R. § 1.136(a)(3).

Respectfully submitted,

**NIXON PEABODY LLP**

Date: May 28, 2009

/Stephen M. Hertzler, Reg. No. 58,247/  
Stephen M. Hertzler  
Reg. No. 58,247

**NIXON PEABODY LLP**  
401 9th Street, N.W., Suite 900  
Washington, D.C. 20004-2128  
(202) 585-8000  
(202) 585-8080 (Fax)  
Customer No. 22204

**Amendments to the Claims:**

This listing of claims replaces all prior versions, and listings, of the claims in the subject application.

1. (Currently Amended) A computer-implemented method for transferring rights adapted to be associated with items from a rights supplier to a rights consumer, the method comprising:

obtaining a set of rights associated with an item, the set of rights including meta-rights specifying derivable rights that can be derived from the meta-rights, wherein the meta-rights are provided in digital form and are enforceable by a repository;

determining, by a repository, whether the rights consumer is entitled to the derivable rights specified by the meta-rights; and

deriving at least one right from the derivable rights, if the rights consumer is entitled to the derivable rights specified by the meta-rights, wherein the derived right includes at least one state variable based on the set of rights and used for determining a state of the derived right.

2. (Original) The method of claim 1, wherein the state variable inherits a state thereof for content usage or rights transfer from the set of rights.

3. (Original) The method of claim 1, wherein the state variable shares a state thereof for content usage or rights transfer with the set of rights.

4. (Original) The method of claim 1, wherein the state variable inherits a remaining state for content usage or rights transfer from the set of rights.

5. (Original) The method of claim 1, wherein the state variable is updated upon exercise of a right associated with the state variable.

6. (Original) The method of claim 1, further comprising deriving a plurality of rights from the derivable rights, wherein the state variable is shared by the derived rights.

7. (Original) The method of claim 1, wherein the state variable represents a collection of states.

8. (Original) The method of claim 1, further comprising a plurality of state variables that determine the state of the derived right.

9. (Original) The method of claim 1, wherein the at least one state variable is unspecified in the derived right, is created during a rights transfer, and is assigned to the derived right.

10. (Original) The method of claim 1, wherein the state variable is transferred from the derivable rights to the derived right.

11. (Original) The method of claim 1, further comprising generating a license including the derived right, if the rights consumer is entitled to the derivable rights specified by the meta-rights.

12. (Currently Amended) A system for transferring rights adapted to be associated with items from a rights supplier to a rights consumer, the system comprising:

means for obtaining a set of rights associated with an item, the set of rights including meta-rights specifying derivable rights that can be derived from the meta-rights, wherein the meta-rights are provided in digital form and are enforceable by a repository;

means for determining whether the rights consumer is entitled to the derivable rights specified by the meta-rights; and

means for deriving at least one right from the derivable rights, if the rights consumer is entitled to the derivable rights specified by the meta-rights, wherein the derived right includes at least one state variable based on the set of rights and used for determining a state of the derived right.

13. (Original) The system of claim 12, wherein the state variable inherits a state thereof for content usage or rights transfer from the set of rights.

14. (Original) The system of claim 12, wherein the state variable shares a state thereof for content usage or rights transfer with the set of rights.

15. (Original) The system of claim 12, wherein the state variable inherits a remaining state for content usage or rights transfer from the set of rights.

16. (Original) The system of claim 12, wherein the state variable is updated upon exercise of a right associated with the state variable.

17. (Original) The system of claim 12, further comprising means for deriving a plurality of rights from the derivable rights, wherein the state variable is shared by the derived rights.

18. (Original) The system of claim 12, wherein the state variable represents a collection of states.

19. (Original) The system of claim 12, including a plurality of state variables that determine the state of the derived right.

20. (Original) The system of claim 12, wherein the at least one state variable is unspecified in the derived right, is created during a rights transfer, and is assigned to the derived right.

21. (Original) The system of claim 12, wherein the state variable is transferred from the derivable rights to the derived right.

22. (Original) The system of claim 12, further comprising means for generating a license including the derived right, if the rights consumer is entitled to the derivable rights specified by the meta-rights.

23. (Original) The system of claim 12, wherein the means for obtaining, the means for determining, and the means for deriving comprise at least one of computer-executable instructions, and devices of a computer system.

24. (Currently Amended) A device for transferring rights adapted to be associated with items from a rights supplier to a rights consumer, the device comprising:

means for obtaining a set of rights associated with an item, the set of rights including meta-rights specifying derivable rights that can be derived from the meta-rights, wherein the meta-rights are provided in digital form and are enforceable by a repository;

means for determining whether the rights consumer is entitled to the derivable rights specified by the meta-rights; and

means for deriving at least one right from the derivable rights, if the rights consumer is entitled to the derivable rights specified by the meta-rights, wherein the derived right includes at least one state variable based on the set of rights and used for determining a state of the derived right.

25. (Original) The device of claim 24, wherein the state variable inherits a state thereof for content usage or rights transfer from the set of rights.

26. (Original) The device of claim 24, wherein the state variable shares a state thereof for content usage or rights transfer with the set of rights.

27. (Original) The device of claim 24, wherein the state variable inherits a remaining state for content usage or rights transfer from the set of rights.

28. (Original) The device of claim 24, wherein the state variable is updated upon exercise of a right associated with the state variable.

29. (Original) The device of claim 24, further comprising means for deriving a plurality of rights from the derivable rights, wherein the state variable is shared by the derived rights.

30. (Original) The device of claim 24, wherein the state variable represents a collection of states.

31. (Original) The device of claim 24, including a plurality of state variables that determine the state of the derived right.

32. (Original) The device of claim 24, wherein the at least one state variable is unspecified in the derived right, is created during a rights transfer, and is assigned to the derived right.

33. (Original) The device of claim 24, wherein the state variable is transferred from the derivable rights to the derived right.

34. (Original) The device of claim 24, further comprising means for generating a license including the derived right, if the rights consumer is entitled to the derivable rights specified by the meta-rights.

35. (Original) The device of claim 24, wherein the means for obtaining, the means for determining, and the means for deriving comprise at least one of computer-executable instructions, and devices of a computer system.

36. (Original) The device of claim 24, wherein one or more of the means for obtaining, the means for determining, and the means for deriving are specified in a license.



## Electronic Patent Application Fee Transmittal

<b>Application Number:</b>	10956121
<b>Filing Date:</b>	04-Oct-2004
<b>Title of Invention:</b>	System and method for managing transfer of rights using shared state variables
<b>First Named Inventor/Applicant Name:</b>	Xin Wang
<b>Filer:</b>	Stephen M. Hertzler
<b>Attorney Docket Number:</b>	111325-291300

Filed as Large Entity

### Utility under 35 USC 111(a) Filing Fees

Description	Fee Code	Quantity	Amount	Sub-Total in USD(\$)
<b>Basic Filing:</b>				
<b>Pages:</b>				
<b>Claims:</b>				
<b>Miscellaneous-Filing:</b>				
<b>Petition:</b>				
<b>Patent-Appeals-and-Interference:</b>				
<b>Post-Allowance-and-Post-Issuance:</b>				
<b>Extension-of-Time:</b>				
Extension - 2 months with \$0 paid	1252	1	490	490

Description	Fee Code	Quantity	Amount	Sub-Total in USD(\$)
<b>Miscellaneous:</b>				
Request for continued examination	1801	1	810	810
<b>Total in USD (\$)</b>				<b>1300</b>

**IN THE UNITED STATES PATENT AND TRADEMARK OFFICE**

In re PATENT application of )  
Xin WANG, et al. )  
Application No. 10/956,121 ) Group Art Unit: 3621  
Filed: October 4, 2004 ) Examiner: Thomas C. WEST  
Confirmation No. 8924 )  
For: SYSTEM AND METHOD FOR ) Date: May 28, 2009  
MANAGING TRANSFER OF RIGHTS )  
USING SHARED STATE VARIABLES )

**RESPONSE TO NON-FINAL OFFICE ACTION**

**Mail Stop: AMENDMENT**

Commissioner for Patents  
P.O. Box 1450  
Alexandria, VA 22313-1450

Sir:

In response to the Office Action mailed December 29, 2008, Applicants request reconsideration and allowance based on the following remarks.

**Amendments to the Claims** begin on page 2 of this paper.

**Remarks** begin on page 8 of this paper.

Under the Paperwork Reduction Act of 1995, no persons are required to respond to a collection of information unless it contains a valid OMB control number.

**REQUEST FOR CONTINUED EXAMINATION(RCE)TRANSMITTAL  
 (Submitted Only via EFS-Web)**

Application Number	10/956,121	Filing Date	2004-10-04	Docket Number (if applicable)	111325-291300	Art Unit	3621
First Named Inventor	Xin WANG			Examiner Name	Thomas C. West		

**This is a Request for Continued Examination (RCE) under 37 CFR 1.114 of the above-identified application.**  
 Request for Continued Examination (RCE) practice under 37 CFR 1.114 does not apply to any utility or plant application filed prior to June 8, 1995, or to any design application. The Instruction Sheet for this form is located at WWW.USPTO.GOV

**SUBMISSION REQUIRED UNDER 37 CFR 1.114**

Note: If the RCE is proper, any previously filed unentered amendments and amendments enclosed with the RCE will be entered in the order in which they were filed unless applicant instructs otherwise. If applicant does not wish to have any previously filed unentered amendment(s) entered, applicant must request non-entry of such amendment(s).

Previously submitted. If a final Office action is outstanding, any amendments filed after the final Office action may be considered as a submission even if this box is not checked.

Consider the arguments in the Appeal Brief or Reply Brief previously filed on \_\_\_\_\_

Other \_\_\_\_\_

Enclosed

Amendment/Reply

Information Disclosure Statement (IDS)

Affidavit(s)/ Declaration(s)

Other \_\_\_\_\_

**MISCELLANEOUS**

Suspension of action on the above-identified application is requested under 37 CFR 1.103(c) for a period of months \_\_\_\_\_  
 (Period of suspension shall not exceed 3 months; Fee under 37 CFR 1.17(i) required)

Other \_\_\_\_\_

**FEES**

**The RCE fee under 37 CFR 1.17(e) is required by 37 CFR 1.114 when the RCE is filed.**

The Director is hereby authorized to charge any underpayment of fees, or credit any overpayments, to  
 Deposit Account No 192380

**SIGNATURE OF APPLICANT, ATTORNEY, OR AGENT REQUIRED**

Patent Practitioner Signature

Applicant Signature

Signature of Registered U.S. Patent Practitioner			
Signature	/Stephen M. Hertzler/	Date (YYYY-MM-DD)	2009-05-28
Name	Stephen M. Hertzler	Registration Number	58247

This collection of information is required by 37 CFR 1.114. The information is required to obtain or retain a benefit by the public which is to file (and by the USPTO to process) an application. Confidentiality is governed by 35 U.S.C. 122 and 37 CFR 1.11 and 1.14. This collection is estimated to take 12 minutes to complete, including gathering, preparing, and submitting the completed application form to the USPTO. Time will vary depending upon the individual case. Any comments on the amount of time you require to complete this form and/or suggestions for reducing this burden, should be sent to the Chief Information Officer, U.S. Patent and Trademark Office, U.S. Department of Commerce, P.O. Box 1450, Alexandria, VA 22313-1450.

*If you need assistance in completing the form, call 1-800-PTO-9199 and select option 2.*

## Privacy Act Statement

The Privacy Act of 1974 (P.L. 93-579) requires that you be given certain information in connection with your submission of the attached form related to a patent application or patent. Accordingly, pursuant to the requirements of the Act, please be advised that: (1) the general authority for the collection of this information is 35 U.S.C. 2(b)(2); (2) furnishing of the information solicited is voluntary; and (3) the principal purpose for which the information is used by the U.S. Patent and Trademark Office is to process and/or examine your submission related to a patent application or patent. If you do not furnish the requested information, the U.S. Patent and Trademark Office may not be able to process and/or examine your submission, which may result in termination of proceedings or abandonment of the application or expiration of the patent.

The information provided by you in this form will be subject to the following routine uses:

1. The information on this form will be treated confidentially to the extent allowed under the Freedom of Information Act (5 U.S.C. 552) and the Privacy Act (5 U.S.C. 552a). Records from this system of records may be disclosed to the Department of Justice to determine whether the Freedom of Information Act requires disclosure of these records.
2. A record from this system of records may be disclosed, as a routine use, in the course of presenting evidence to a court, magistrate, or administrative tribunal, including disclosures to opposing counsel in the course of settlement negotiations.
3. A record in this system of records may be disclosed, as a routine use, to a Member of Congress submitting a request involving an individual, to whom the record pertains, when the individual has requested assistance from the Member with respect to the subject matter of the record.
4. A record in this system of records may be disclosed, as a routine use, to a contractor of the Agency having need for the information in order to perform a contract. Recipients of information shall be required to comply with the requirements of the Privacy Act of 1974, as amended, pursuant to 5 U.S.C. 552a(m).
5. A record related to an International Application filed under the Patent Cooperation Treaty in this system of records may be disclosed, as a routine use, to the International Bureau of the World Intellectual Property Organization, pursuant to the Patent Cooperation Treaty.
6. A record in this system of records may be disclosed, as a routine use, to another federal agency for purposes of National Security review (35 U.S.C. 181) and for review pursuant to the Atomic Energy Act (42 U.S.C. 218(c)).
7. A record from this system of records may be disclosed, as a routine use, to the Administrator, General Services, or his/her designee, during an inspection of records conducted by GSA as part of that agency's responsibility to recommend improvements in records management practices and programs, under authority of 44 U.S.C. 2904 and 2906. Such disclosure shall be made in accordance with the GSA regulations governing inspection of records for this purpose, and any other relevant (i.e., GSA or Commerce) directive. Such disclosure shall not be used to make determinations about individuals.
8. A record from this system of records may be disclosed, as a routine use, to the public after either publication of the application pursuant to 35 U.S.C. 122(b) or issuance of a patent pursuant to 35 U.S.C. 151. Further, a record may be disclosed, subject to the limitations of 37 CFR 1.14, as a routine use, to the public if the record was filed in an application which became abandoned or in which the proceedings were terminated and which application is referenced by either a published application, an application open to public inspections or an issued patent.
9. A record from this system of records may be disclosed, as a routine use, to a Federal, State, or local law enforcement agency, if the USPTO becomes aware of a violation or potential violation of law or regulation.

## Electronic Acknowledgement Receipt

<b>EFS ID:</b>	5412482
<b>Application Number:</b>	10956121
<b>International Application Number:</b>	
<b>Confirmation Number:</b>	8924
<b>Title of Invention:</b>	System and method for managing transfer of rights using shared state variables
<b>First Named Inventor/Applicant Name:</b>	Xin Wang
<b>Customer Number:</b>	22204
<b>Filer:</b>	Stephen M. Hertzler
<b>Filer Authorized By:</b>	
<b>Attorney Docket Number:</b>	111325-291300
<b>Receipt Date:</b>	28-MAY-2009
<b>Filing Date:</b>	04-OCT-2004
<b>Time Stamp:</b>	14:48:09
<b>Application Type:</b>	Utility under 35 USC 111(a)

### Payment information:

Submitted with Payment	yes
Payment Type	Deposit Account
Payment was successfully received in RAM	\$1300
RAM confirmation Number	937
Deposit Account	192380
Authorized User	

The Director of the USPTO is hereby authorized to charge indicated fees and credit any overpayment as follows:

Charge any Additional Fees required under 37 C.F.R. Section 1.21 (Miscellaneous fees and charges)

**File Listing:**

Document Number	Document Description	File Name	File Size(Bytes)/ Message Digest	Multi Part /.zip	Pages (if appl.)
1	Request for Continued Examination (RCE)	111325-291300-RCE.pdf	57049 8ba991432609c134d22216b922a8cc2daac f9405	no	3

**Warnings:**

This is not a USPTO supplied RCE SB30 form.

**Information:**

2	Amendment After Final	291300_-_2009-05-28_-_Response.pdf	64696 38e8e7ae1d808d5e4e27f06ff1177f08785 d5e4	no	15
---	-----------------------	------------------------------------	--	----	----

**Warnings:****Information:**

3	Fee Worksheet (PTO-875)	fee-info.pdf	31873 bb52bda433771906d3fd35c42c6b9cc2ee9 29491	no	2
---	-------------------------	--------------	---	----	---

**Warnings:****Information:**

**Total Files Size (in bytes):** 153618

**This Acknowledgement Receipt evidences receipt on the noted date by the USPTO of the indicated documents, characterized by the applicant, and including page counts, where applicable. It serves as evidence of receipt similar to a Post Card, as described in MPEP 503.**

**New Applications Under 35 U.S.C. 111**

**If a new application is being filed and the application includes the necessary components for a filing date (see 37 CFR 1.53(b)-(d) and MPEP 506), a Filing Receipt (37 CFR 1.54) will be issued in due course and the date shown on this Acknowledgement Receipt will establish the filing date of the application.**

**National Stage of an International Application under 35 U.S.C. 371**

**If a timely submission to enter the national stage of an international application is compliant with the conditions of 35 U.S.C. 371 and other applicable requirements a Form PCT/DO/EO/903 indicating acceptance of the application as a national stage submission under 35 U.S.C. 371 will be issued in addition to the Filing Receipt, in due course.**

**New International Application Filed with the USPTO as a Receiving Office**

**If a new international application is being filed and the international application includes the necessary components for an international filing date (see PCT Article 11 and MPEP 1810), a Notification of the International Application Number and of the International Filing Date (Form PCT/RO/105) will be issued in due course, subject to prescriptions concerning national security, and the date shown on this Acknowledgement Receipt will establish the international filing date of the application.**



Under the Paperwork Reduction Act of 1995, no persons are required to respond to a collection of information unless it displays a valid OMB control number.

<b>PATENT APPLICATION FEE DETERMINATION RECORD</b> Substitute for Form PTO-875	Application or Docket Number <b>10/956,121</b>	Filing Date <b>10/04/2004</b>	<input type="checkbox"/> To be Mailed
---	---	----------------------------------	---------------------------------------

APPLICATION AS FILED – PART I			OTHER THAN SMALL ENTITY				
	(Column 1)	(Column 2)	SMALL ENTITY <input type="checkbox"/>	OR			
FOR	NUMBER FILED	NUMBER EXTRA	RATE (\$)	FEE (\$)	OR	RATE (\$)	FEE (\$)
<input type="checkbox"/> BASIC FEE <small>(37 CFR 1.16(a), (b), or (c))</small>	N/A	N/A	N/A			N/A	
<input type="checkbox"/> SEARCH FEE <small>(37 CFR 1.16(k), (l), or (m))</small>	N/A	N/A	N/A			N/A	
<input type="checkbox"/> EXAMINATION FEE <small>(37 CFR 1.16(o), (p), or (q))</small>	N/A	N/A	N/A			N/A	
TOTAL CLAIMS <small>(37 CFR 1.16(i))</small>	minus 20 =	*	X \$ =		OR	X \$ =	
INDEPENDENT CLAIMS <small>(37 CFR 1.16(h))</small>	minus 3 =	*	X \$ =			X \$ =	
<input type="checkbox"/> APPLICATION SIZE FEE <small>(37 CFR 1.16(s))</small>	If the specification and drawings exceed 100 sheets of paper, the application size fee due is \$250 (\$125 for small entity) for each additional 50 sheets or fraction thereof. See 35 U.S.C. 41(a)(1)(G) and 37 CFR 1.16(s).						
<input type="checkbox"/> MULTIPLE DEPENDENT CLAIM PRESENT <small>(37 CFR 1.16(j))</small>							
* If the difference in column 1 is less than zero, enter "0" in column 2.			TOTAL			TOTAL	

APPLICATION AS AMENDED – PART II					OTHER THAN SMALL ENTITY				
	(Column 1)	(Column 2)	(Column 3)		SMALL ENTITY	OR			
AMENDMENT	05/28/2009	CLAIMS REMAINING AFTER AMENDMENT	HIGHEST NUMBER PREVIOUSLY PAID FOR	PRESENT EXTRA	RATE (\$)	ADDITIONAL FEE (\$)	OR	RATE (\$)	ADDITIONAL FEE (\$)
	Total (37 CFR 1.16(i))	* 36	Minus	** 36 = 0	X \$ =		OR	X \$52=	0
	Independent (37 CFR 1.16(h))	* 3	Minus	***3 = 0	X \$ =		OR	X \$220=	0
	<input type="checkbox"/> Application Size Fee (37 CFR 1.16(s))								
	<input type="checkbox"/> FIRST PRESENTATION OF MULTIPLE DEPENDENT CLAIM (37 CFR 1.16(j))						OR		
					TOTAL ADD'L FEE		OR	TOTAL ADD'L FEE	0

APPLICATION AS AMENDED – PART II					OTHER THAN SMALL ENTITY				
	(Column 1)	(Column 2)	(Column 3)		SMALL ENTITY	OR			
AMENDMENT		CLAIMS REMAINING AFTER AMENDMENT	HIGHEST NUMBER PREVIOUSLY PAID FOR	PRESENT EXTRA	RATE (\$)	ADDITIONAL FEE (\$)	OR	RATE (\$)	ADDITIONAL FEE (\$)
	Total (37 CFR 1.16(i))	*	Minus	** =	X \$ =		OR	X \$ =	
	Independent (37 CFR 1.16(h))	*	Minus	*** =	X \$ =		OR	X \$ =	
	<input type="checkbox"/> Application Size Fee (37 CFR 1.16(s))								
	<input type="checkbox"/> FIRST PRESENTATION OF MULTIPLE DEPENDENT CLAIM (37 CFR 1.16(j))						OR		
					TOTAL ADD'L FEE		OR	TOTAL ADD'L FEE	

\* If the entry in column 1 is less than the entry in column 2, write "0" in column 3.  
 \*\* If the "Highest Number Previously Paid For" IN THIS SPACE is less than 20, enter "20".  
 \*\*\* If the "Highest Number Previously Paid For" IN THIS SPACE is less than 3, enter "3".  
 The "Highest Number Previously Paid For" (Total or Independent) is the highest number found in the appropriate box in column 1.

Legal Instrument Examiner:  
/ERIC DANTZLER/

This collection of information is required by 37 CFR 1.16. The information is required to obtain or retain a benefit by the public which is to file (and by the USPTO to process) an application. Confidentiality is governed by 35 U.S.C. 122 and 37 CFR 1.14. This collection is estimated to take 12 minutes to complete, including gathering, preparing, and submitting the completed application form to the USPTO. Time will vary depending upon the individual case. Any comments on the amount of time you require to complete this form and/or suggestions for reducing this burden, should be sent to the Chief Information Officer, U.S. Patent and Trademark Office, U.S. Department of Commerce, P.O. Box 1450, Alexandria, VA 22313-1450. DO NOT SEND FEES OR COMPLETED FORMS TO THIS ADDRESS. **SEND TO: Commissioner for Patents, P.O. Box 1450, Alexandria, VA 22313-1450.**  
 If you need assistance in completing the form, call 1-800-PTO-9199 and select option 2.

<b>Search Notes</b>  	<b>Application/Control No.</b>  10956121	<b>Applicant(s)/Patent Under Reexamination</b>  WANG ET AL.
	<b>Examiner</b>  THOMAS WEST	<b>Art Unit</b>  3621

<b>SEARCHED</b>			
<b>Class</b>	<b>Subclass</b>	<b>Date</b>	<b>Examiner</b>
705	50-79	8/17/2009	Thomas West

<b>SEARCH NOTES</b>		
<b>Search Notes</b>	<b>Date</b>	<b>Examiner</b>
EAST	8/17/2009	Thomas West

<b>INTERFERENCE SEARCH</b>			
<b>Class</b>	<b>Subclass</b>	<b>Date</b>	<b>Examiner</b>

--	--

<b>Index of Claims</b>  	<b>Application/Control No.</b>  10956121	<b>Applicant(s)/Patent Under Reexamination</b>  WANG ET AL.
	<b>Examiner</b>  THOMAS WEST	<b>Art Unit</b>  3621

✓	<b>Rejected</b>
=	<b>Allowed</b>

-	<b>Cancelled</b>
÷	<b>Restricted</b>

N	<b>Non-Elected</b>
I	<b>Interference</b>

A	<b>Appeal</b>
O	<b>Objected</b>

Claims renumbered in the same order as presented by applicant
  CPA
  T.D.
  R.1.47

CLAIM		DATE							
Final	Original	08/17/2009							
	1	✓							
	2	✓							
	3	✓							
	4	✓							
	5	✓							
	6	✓							
	7	✓							
	8	✓							
	9	✓							
	10	✓							
	11	✓							
	12	✓							
	13	✓							
	14	✓							
	15	✓							
	16	✓							
	17	✓							
	18	✓							
	19	✓							
	20	✓							
	21	✓							
	22	✓							
	23	✓							
	24	✓							
	25	✓							
	26	✓							
	27	✓							
	28	✓							
	29	✓							
	30	✓							
	31	✓							
	32	✓							
	33	✓							
	34	✓							
	35	✓							
	36	✓							

<b><i>Index of Claims</i></b>  	<b>Application/Control No.</b>  10956121	<b>Applicant(s)/Patent Under Reexamination</b>  WANG ET AL.
	<b>Examiner</b>  THOMAS WEST	<b>Art Unit</b>  3621

✓	<b>Rejected</b>
=	<b>Allowed</b>

-	<b>Cancelled</b>
÷	<b>Restricted</b>

<b>N</b>	<b>Non-Elected</b>
<b>I</b>	<b>Interference</b>

<b>A</b>	<b>Appeal</b>
<b>O</b>	<b>Objected</b>



UNITED STATES PATENT AND TRADEMARK OFFICE

UNITED STATES DEPARTMENT OF COMMERCE
United States Patent and Trademark Office
Address: COMMISSIONER FOR PATENTS
P.O. Box 1450
Alexandria, Virginia 22313-1450
www.uspto.gov

Table with 5 columns: APPLICATION NO., FILING DATE, FIRST NAMED INVENTOR, ATTORNEY DOCKET NO., CONFIRMATION NO.
10/956,121 10/04/2004 Xin Wang 111325-291300 8924

22204 7590 08/19/2009
NIXON PEABODY, LLP
401 9TH STREET, NW
SUITE 900
WASHINGTON, DC 20004-2128

EXAMINER

WEST, THOMAS C

ART UNIT PAPER NUMBER

3621

MAIL DATE DELIVERY MODE

08/19/2009

PAPER

Please find below and/or attached an Office communication concerning this application or proceeding.

The time period for reply, if any, is set in the attached communication.

<b>Office Action Summary</b>	<b>Application No.</b> 10/956,121	<b>Applicant(s)</b> WANG ET AL.	
	<b>Examiner</b> THOMAS WEST	<b>Art Unit</b> 3621	

-- The MAILING DATE of this communication appears on the cover sheet with the correspondence address --

**Period for Reply**

A SHORTENED STATUTORY PERIOD FOR REPLY IS SET TO EXPIRE 3 MONTH(S) OR THIRTY (30) DAYS, WHICHEVER IS LONGER, FROM THE MAILING DATE OF THIS COMMUNICATION.

- Extensions of time may be available under the provisions of 37 CFR 1.136(a). In no event, however, may a reply be timely filed after SIX (6) MONTHS from the mailing date of this communication.
- If NO period for reply is specified above, the maximum statutory period will apply and will expire SIX (6) MONTHS from the mailing date of this communication.
- Failure to reply within the set or extended period for reply will, by statute, cause the application to become ABANDONED (35 U.S.C. § 133). Any reply received by the Office later than three months after the mailing date of this communication, even if timely filed, may reduce any earned patent term adjustment. See 37 CFR 1.704(b).

**Status**

- 1)  Responsive to communication(s) filed on 28 May 2009.
- 2a)  This action is **FINAL**.                      2b)  This action is non-final.
- 3)  Since this application is in condition for allowance except for formal matters, prosecution as to the merits is closed in accordance with the practice under *Ex parte Quayle*, 1935 C.D. 11, 453 O.G. 213.

**Disposition of Claims**

- 4)  Claim(s) 1-36 is/are pending in the application.
  - 4a) Of the above claim(s) \_\_\_\_\_ is/are withdrawn from consideration.
- 5)  Claim(s) \_\_\_\_\_ is/are allowed.
- 6)  Claim(s) 1-36 is/are rejected.
- 7)  Claim(s) \_\_\_\_\_ is/are objected to.
- 8)  Claim(s) \_\_\_\_\_ are subject to restriction and/or election requirement.

**Application Papers**

- 9)  The specification is objected to by the Examiner.
- 10)  The drawing(s) filed on \_\_\_\_\_ is/are: a)  accepted or b)  objected to by the Examiner.
  - Applicant may not request that any objection to the drawing(s) be held in abeyance. See 37 CFR 1.85(a).
  - Replacement drawing sheet(s) including the correction is required if the drawing(s) is objected to. See 37 CFR 1.121(d).
- 11)  The oath or declaration is objected to by the Examiner. Note the attached Office Action or form PTO-152.

**Priority under 35 U.S.C. § 119**

- 12)  Acknowledgment is made of a claim for foreign priority under 35 U.S.C. § 119(a)-(d) or (f).
  - a)  All    b)  Some \*    c)  None of:
    - 1.  Certified copies of the priority documents have been received.
    - 2.  Certified copies of the priority documents have been received in Application No. \_\_\_\_\_.
    - 3.  Copies of the certified copies of the priority documents have been received in this National Stage application from the International Bureau (PCT Rule 17.2(a)).

\* See the attached detailed Office action for a list of the certified copies not received.

**Attachment(s)**

- 1)  Notice of References Cited (PTO-892)
- 2)  Notice of Draftsperson's Patent Drawing Review (PTO-948)
- 3)  Information Disclosure Statement(s) (PTO/SB/08)
  - Paper No(s)/Mail Date \_\_\_\_\_.
- 4)  Interview Summary (PTO-413)
  - Paper No(s)/Mail Date \_\_\_\_\_.
- 5)  Notice of Informal Patent Application
- 6)  Other: \_\_\_\_\_.

## DETAILED ACTION

### *Status of Claims*

1. The Final Office Action dated 10-16-08 is withdrawn. This action is in reply to the Arguments/Remarks filed 7-14-08.
2. Claims 1-36 are currently pending and have been examined.

### *Double Patenting*

3. The nonstatutory double patenting rejection is based on a judicially created doctrine grounded in public policy (a policy reflected in the statute) so as to prevent the unjustified or improper timewise extension of the "right to exclude" granted by a patent and to prevent possible harassment by multiple assignees. A nonstatutory obviousness-type double patenting rejection is appropriate where the conflicting claims are not identical, but at least one examined application claim is not patentably distinct from the reference claim(s) because the examined application claim is either anticipated by, or would have been obvious over, the reference claim(s). See, e.g., *In re Berg*, 140 F.3d 1428, 46 USPQ2d 1226 (Fed. Cir. 1998); *In re Goodman*, 11 F.3d 1046, 29 USPQ2d 2010 (Fed. Cir. 1993); *In re Longi*, 759 F.2d 887, 225 USPQ 645 (Fed. Cir. 1985); *In re Van Ornum*, 686 F.2d 937, 214 USPQ 761 (CCPA 1982); *In re Vogel*, 422 F.2d 438, 164 USPQ 619 (CCPA 1970); and *In re Thorington*, 418 F.2d 528, 163 USPQ 644 (CCPA 1969).

A timely filed terminal disclaimer in compliance with 37 CFR 1.321(c) or 1.321(d) may be used to overcome an actual or provisional rejection based on a nonstatutory

Art Unit: 3621

double patenting ground provided the conflicting application or patent either is shown to be commonly owned with this application, or claims an invention made as a result of activities undertaken within the scope of a joint research agreement.

Effective January 1, 1994, a registered attorney or agent of record may sign a terminal disclaimer. A terminal disclaimer signed by the assignee must fully comply with 37 CFR 3.73(b).

Claims 1-36 are provisionally rejected on the ground of nonstatutory double patenting over claim 6 of copending Application No. 10162701. This is a provisional double patenting rejection since the conflicting claims have not yet been patented.

The subject matter claimed in the instant application is fully disclosed in the referenced copending application and would be covered by any patent granted on that copending application since the referenced copending application and the instant application are claiming common subject matter, as follows: meta-rights, derived rights, rights transfer, generating a license.

Furthermore, there is no apparent reason why applicant would be prevented from presenting claims corresponding to those of the instant application in the other copending application. See *In re Schneller*, 397 F.2d 350, 158 USPQ 210 (CCPA 1968). See also MPEP § 804.



***Claim Rejections - 35 USC § 101***

4. Claims 1-36 are rejected under 35 U.S.C. §101 because the claimed invention is directed to non-statutory subject matter. Based on Supreme Court precedent<sup>1</sup> and recent Federal Circuit decisions, a §101 patent eligible process must (1) be tied to a particular machine (or apparatus), or (2) transform a particular article to a different state or thing. See *In re Bilski*, 545 F.3d 943, 88 USPQ2d 1385 (Fed. Cir. 2008)(en banc). This is the Machine-or-Transformation Test (“M-T Test”).

To meet prong (1), the method step should positively recite machine to which it is tied. Alternatively or to meet prong (2), the method step should positively recite the material that is being changed to a different state or positively recite the subject matter that is being transformed. For example, a method claim that would *not* qualify as a patent eligible process because it fails both prongs of the M-T Test would be a claim that recites purely mental steps.

In this particular case, the process claims fail prong (1) because the methods steps “obtaining a set of rights”, “deriving at least one right” are not tied to a specific machine since the methods steps could be performed by a human being, since the steps do not disclose specifically how they are performed. Finally, the Examiner notes that the claims fail prong (2) because the method steps do not transform the underlying subject matter to a different state or thing.

---

<sup>1</sup> See also *Diamond v. Diehr*, 450 U.S. 175, 184 (1981); *Parker v. Flook*, 437 U.S. 584, 588 n.9 (1978); *Gottschalk v. Benson*, 409 U.S. 63, 70 (1972); *Cochrane v. Deener*, 94 U.S. 780, 787-88 (1876).

***Claim Rejections - 35 USC § 103***

5. The following is a quotation of 35 U.S.C. 103(a) which forms the basis for all obviousness rejections set forth in this Office action:

(a) A patent may not be obtained though the invention is not identically disclosed or described as set forth in section 102 of this title, if the differences between the subject matter sought to be patented and the prior art are such that the subject matter as a whole would have been obvious at the time the invention was made to a person having ordinary skill in the art to which said subject matter pertains. Patentability shall not be negated by the manner in which the invention was made.

6. Claims 1-36 are rejected under U.S.C. 103(a) as being unpatentable over Anand, US Patent No. 6,044,466 (Anand), in view of Workshop on Digital Rights Management, Minutes from Architecture/Infrastructure Session (Infrastructure).

**Claims 1, 12, 24:**

Anand, as shown, discloses the following limitations:

obtaining a set of rights associated with an item, the set of rights including meta-rights specifying derivable rights that can be derived from the meta-rights, wherein the meta-rights are provided in digital form and are enforceable by a repository (see column 3, line 15-31, column 5, lines 17-23, column 5, lines 1-16)

determining, by a repository, whether the rights consumer (user) is entitled to the derivable rights specified by the meta-rights (see col. 3, lines 27-31, column 5, line 14-21, col. 3, lines 32-35)

deriving at least one right from the derivable rights, if the rights consumer is entitled to the derivable rights specified by the meta-rights, wherein the derived right includes at least one state variable based on the set of rights and used for

Art Unit: 3621

determining a state of the derived right (see column 5, line 1-16, col. 3, lines 32-35, col. 5, lines 17-21)

Anand discloses the limitations as shown above. Anand does not directly disclose a state variable (state machine), but Infrastructure does (page 8, paragraph 3)

It would have been obvious to one of ordinary skill in the art at the time of the invention to modify Anand to include the state machine of Infrastructure since this provides a dynamic structure that can express dynamic rights relationships.

**Claims 2, 13, 25:**

Anand, as shown, discloses the following limitations:

the state variable inherits a state thereof for content usage or rights transfer from the set of rights (see column 5, line 1-16)

**Claims 3, 4, 14, 15, 26, 27:**

Anand/Infrastructure discloses the limitations shown above. Anand further discloses:

the state variable shares a state thereof for content usage or rights transfer with the set of rights (see column 8, line 7-14)

the state variable inherits a remaining state for content usage or rights transfer from the set of rights (see column 5, line 14-16)

**Claims 5, 16, 28:**

Art Unit: 3621

Anand, as shown, discloses the following limitations:

the state variable is updated upon exercise of a right associated with the state variable (see column 7, line 5-14)

**Claims 6, 17, 29:**

Anand, as shown, discloses the following limitations:

deriving a plurality of rights from the derivable rights, wherein the state variable is shared by the derived rights (see column 7, line 1-7)

**Claims 7, 8, 18, 19, 30, 31:**

Anand discloses the limitations as shown above. Anand does not directly disclose a state variable (state machine), but Infrastructure does:

the state variable represents a collection of states (see page 8, paragraph 3)

a plurality of state variables that determine the state of the derived right (see page 8, paragraph 3)

It would have been obvious to one of ordinary skill in the art at the time of the invention to modify Anand to include the state machine of Infrastructure since this provides a dynamic structure that can express dynamic rights relationships.

Art Unit: 3621

**Claims 9, 20, 32:**

Anand, as shown, discloses the following limitations:

at least one state variable is unspecified in the derived right, is created during a rights transfer, and is assigned to the derived right (see column 7, line 1-14)

**Claims 10, 21, 33:**

Anand, as shown, discloses the following limitations:

the state variable is transferred from the derivable rights to the derived right (see column 7, line 15-23)

**Claims 11, 22, 34, 36:**

Anand, as shown, discloses the following limitations:

generating a license including the derived right, if the rights consumer is entitled to the derivable rights specified by the meta-rights (see column 7, line 24-29)

one or more of the means for obtaining, the means for determining, and the means for deriving are specified in a license (see column 7, line 24-29)

**Claim 35:**

Anand, as shown, discloses the following limitations:

obtaining, the means for determining, and the means for deriving comprise at least one of computer-executable instructions, and devices of a computer system (see column 4, line 51-67)

### ***Response to Arguments***

7. Applicant's arguments filed 7-14-08 have been fully considered but they are not persuasive. Applicant's arguments will be addressed in sequential order as they were set forth in the "Remarks" section on the above date. The 101 rejection is maintained for the reasons described herein under that title. The Double Patenting rejection will be maintained since it may be missed later on. Applicant argues that Anand does not disclose meta-rights specifying derivable rights. Specifically, Anand column 3, lines 15-31 disclose dynamic derivation (can do), superset of rights and delegation of a subset of maximal permissions (derivable rights specified by the meta-rights). Anand discloses, "Multiple principals can delegate a subset of their maximal permissions for the executable content. The mechanism uses policy for combining the delegated permissions into the content's current permissions" (col. 3, lines 27-31). Anand further discloses, "electing granted permissions from within an associated maximal set of permissions" (col. 3, lines 59-60). "As FIG. 2 depicts, the derivation mechanism (100) consists of the following five steps:", (col. 5, lines 1-2). "The current permissions (150), by definition, must always be a subset of the maximal permissions (140)", (col. 5, lines 14-16). "The description of executable content (120) is a set of attribute-value pairs. One possible embodiment is RDF ("Resource Description Framework") labels that describe the meta-data of a website's URI ("Universal Resource Identifier)", (col. 5,

lines 17-21). The attribute-value pairs of Anand correspond to the meta-rights of Wang. The Examiner has referenced the proper figures of Anand that were intended, specifically the ones as shown here. Anand further discloses, "FIG. 4 illustrates that the nodes of a policy graph's directed graph consist of an attribute, a value, an entry, and an access control list. FIG. 5 illustrates a preferred embodiment of the permissions structure, and shows that permissions include positive and negative rights and transforms. FIG. 7 illustrates how the first step of the dynamic derivation mechanism creates a derivation instance and sets its attributes values" (col. 4, lines 18-31). The state variables of Wang correspond to the derivation instance of Anand, fig. 7. Anand regulates who is entitled to derive rights through an access control described in fig. 4 referenced above. Anand controls who is entitled to derive rights, "The access control list (325) limits access to the policy graph (320). Principals can be permitted to modify any of the policy graph attributes (321-325)", (col. 6, lines 26-29). Infrastructure further discloses a state machine which consists of state variables, as defined by Curtis. "Within the state machine, while a state variable does not equal exit 1301, the state machine will go from state to state based upon what the state variable is set to", (Curtis, 6,397,355, col. 9, lines 53-55). A state variable (state machine) is shown by Infrastructure does (page 8, paragraph 3). The applicant has not provided an explanation for the assertion that the derivation instance of Anand is constant and does not change.

***Conclusion***

**THIS ACTION IS MADE FINAL.** Applicant is reminded of the extension of time policy as set forth in 37 CFR 1.136(a).

A shortened statutory period for reply to this final action is set to expire THREE MONTHS from the mailing date of this action. In the event a first reply is filed within TWO MONTHS of the mailing date of this final action and the advisory action is not mailed until after the end of the THREE-MONTH shortened statutory period, then the shortened statutory period will expire on the date the advisory action is mailed, and any extension fee pursuant to 37 CFR 1.136(a) will be calculated from the mailing date of the advisory action. In no event, however, will the statutory period for reply expire later than SIX MONTHS from the date of this final action.

Any inquiry concerning this communication or earlier communications from the examiner should be directed to Thomas West whose telephone number is 571-270-1236. The examiner can normally be reached on Tuesday and Wednesday 7:30am - 5pm EST.

If attempts to reach the examiner by telephone are unsuccessful, the examiner's supervisor, Andrew Fischer can be reached on 571-272-6779. The fax phone number for the organization where this application or proceeding is assigned is 571-273-8300.

Information regarding the status of an application may be obtained from the Patent Application Information Retrieval (PAIR) system. Status information for published applications may be obtained from either Private PAIR or Public PAIR. Status information for unpublished applications is available through Private PAIR only.



Art Unit: 3621

For more information about the PAIR system, see <http://pair-direct.uspto.gov>. Should you have questions on access to the Private PAIR system, contact the Electronic Business Center (EBC) at 866-217-9197 (toll-free). If you would like assistance from a USPTO Customer Service Representative or access to the automated information system, call 800-786-9199 (IN USA OR CANADA) or 571-272-1000.

Thomas West  
Patent Examiner  
Art Unit 3621

/ANDREW J. FISCHER/  
Supervisory Patent Examiner, Art Unit 3621



## Workshop on Digital Rights Management for the Web

World Wide Web Consortium

22-23 January 2001

INRIA - Sophia-Antipolis, France

2004, Route des Lucioles

### WORKSHOP PROGRAM

Workshop Notes & Presentations

Workshop Summary Report

Submitted Position Papers

Participants

Mailing List

Call for Participation

Background Reference Material

### **Important dates**

*Papers submission deadline: 22 December 2000*

*Registration deadline: 12 January 2001*

### **Workshop meter**

On 20 December 2000: 62 registrations, 41 position papers received, and 69 persons on the mailing list.

---

Last update \$Date: 2001/04/26 16:55:07 \$ by \$Author: rigo \$



[\[Minutes Overview\]](#) [\[Workshop Home\]](#) [\[Previous: Publishers Requirements\]](#)  
[\[Next: Architecture: Interoperability and Standards\]](#)

## Minutes from the Architecture/Infrastructure Session

***Please refer to the position-papers and slides for authoritative answers. The following minutes are only a snapshot of Presentations and Discussions***

- [INDECS Framework Data Definitions](#)  
Godfrey Rust (Indecs Project)
- [URI's and Object Identifiers](#)  
Dan Connolly (W3C)
- [Principles for Standardization and Interoperability in Web-based Digital Rights Management](#)  
John Erickson (Hewlett-Packard)
- [Open Digital Rights Management](#)  
Renato Iannella (IPR Systems)
- [Digital Object Identifier](#)  
Norman Paskin (Int. DOI Foundation)
- [Discussion](#)

---

### Godfrey Rust (<indecs> Project), INDECS Framework Data Definitions

*See also the [\[Slides \(ppt\)\]](#) and the [<indecs> Framework](#)*

The <indecs> project ended 2000, now we are new company called <indecs> framework. Look at our online document: Principles, model, and data dictionary, June 2000.

We see DRM in terms of metadata, as a metadata problem. The description is covered in Open eBook, ONIX, and my company.

Here is the scheme:

1. people make stuff
2. people use stuff

### 3. people do deals about stuff

The scope is stuff. This can be characterized in terms of:

1. Parties
2. Creations
3. Agreements

Rust projected a diagram showing the high granularity in the <indecs> model, with hierarchy of parties and agreements. He noted that you must pass along the metadata in a structured defined way to permit computational processes.

The following things are required:

- functional granularity: you must be able to identify stuff at any level of granularity
- unique id
- who says so - designated authority
- appropriate access (who can do what)

In the 1980s, there were few schemes for description, today there are many, lists ten major ones, including MPEG-7, ONIX, SMPTE, RIAA/IFPI, and several more.

Here are the <indecs> principles:

- **All metadata is just a view** (example: about the work versus about the manifestation, and more, each of which may have its own rights)
  - views must not be confused; mistaken identity can be disastrous to rights management
  - views need to be interoperable
- **Almost all terms need identifiers**
  - values must be defined and identified
  - need standard vocabularies and ontologies.
  - automation need for disambiguity. There is an existing vocabulary for some things: territories, language, currency, date/time and some others. But we need dozens of others.
- **Events are key to interoperability**
  - most metadata is stuff or people based
  - events description are key to rights management

Godfrey Rust gave an example how this would work:

1. make event the first class object, e.g., Rust creating these slides
2. then all the other elements are attributes: author, date, title, etc.
3. next event, e.g., Rust showing this Slide -- it has attributes too and references the previous event, thus connecting the creative items
4. next event: Norman Paskin adapts (transforming event) these slides before he shows it at another meeting, thus creating new attributes and references to preceding events, thus connecting the creative items

This model has the same information as other metadata structures, just organized differently to serve rights management.

Here's another event that bears on rights: agreeing. What goes into the agreement is what goes into descriptive metadata, what he had, what he did. Also assertion by a trusted entity that verifies or authenticates.

Using the event structure, now have six events regarding these slide-show. See how you can use events to **integrate** descriptive and rights metadata.

But we need rights vocabularies to make this work, on a parallel with the need for vocabularies to serve descriptive metadata.

## Dan Connolly [W3C], W3C URI Design Principles

*See also the corresponding Activity within W3C and the slides*

He outlined W3C's Philosophy of Standards: Help people do the right thing.

URIs will have a relationship to a potential DRM-Activity. Connolly also suggests that DRM discussion focus on payments and rights negotiation as much as prevention of access.

All names are ultimately local. Global naming depends on social agreements and trust. HTTP is not the only protocol. For the Web, we use DNS (Domain Name System). Don't forget, HTML is not the only file type. Things can evolve, you can use proxies and thus use an old name against new protocol. But URIs are the only thing in that arena. New protocols can be used with existing names. There is no need to change names just because you change protocols. We don't need to make new URI schemes just because we have made a new data format.

There is opacity: Don't peek inside names, names (URIs) are not user interface. Don't reinvent redirection in http, it is not a service, they are not locators. DNS supports multiple A records. Lots of administrative hierarchies fit in current http and DNS, you don't need to

invent a new URI scheme.

URIs were not designed as a user interface. Don't use a URN as a brand name. To establish a new trusted brand name, trying to wedge them into DNS is a problem, you're ought to use <title>

## John Erickson (HP), Principles for Standardization and Interoperability in Web-based Digital Rights Management

*See also the [slides](#) and the [Position Paper](#)*

John Erickson started by re-inforcing what was already heard during previous sessions: When we think about DRM, we have to separate expression of rights information and policies from the enforcement of those rights. We have to think of a layered model, separate the expression of rights information from the info for discovery and from implementing and enforcing those rights.

What is the W3C's role here? We think W3C should recommend a platform. Erickson put emphasis on the development of a language and a protocol for IPR policy expression, discovery, and interpretation.

The W3C should not recommend a standard DRM system. But we should provide a basis for the interoperability of such systems. Core should be to find a reliable way to express and transfer rights information. Remember the design principles of the web, IPR work ought not violate them.

Erickson developed the following set of requirements:

- never interfere with users' ability to discover info (incl rights info) on the web, this is what I mean by universal access, so I can decide about whether to access
- always communicate the policies and technical restraints in understandable language
- policies are communicated in fair and open ways
- need for trust, need to have a basis to trust the assertions being made, need a mechanism to assure trustworthiness
- IPR information and policies must be discoverable and minimally interpretable independent of any given vendor's solution
- the languages and protocols must be designed for evolution
- web based mechanism must allow for owners to choose different tools and consumers to use different tools to discover and interpret rights info
- cool new content that comes along ought not break the DRM systems or break the languages and protocols

Here's our [HP publishing group] proposal: PREP (Policy and Rights Expression Platform, see the [Position Paper](#) for more information). It would be a framework to express and interpret the policies and info. It should complement laws and self-regulatory programs. It should be consistent with prior work, e.g., P3P.

What are the building blocks of PREP?

- semantics - policy interpretation mechanisms
- objects - rights messaging protocol
- syntax - rights expression languages

**Erickson concluded:**

1. W3C should recommend a platform for IPR policy expression, discovery, and interpretation.
2. W3C should not recommend a standardized digital rights management system.
3. Core should be reliable way to express and transfer rights information.

## Renato Iannella (IPR Systems), Open Digital Rights Management

*See also the [slides](#) and the [Position Paper](#)*

We need to define DRM formally. Customary DRM definitions tend to emphasize protection, enforcement, security. We need to remove the security/locking focus of DRM. There are a lot of definitions out there. But we want DRM to be broader: describe, identity, trade, monitor, track, and manage rights holder relationships. We want to leave behind the "creation waterfall" concept of create => trade => use as a line. We want to look at a circular life cycle approach (compare Rust events). We use the same terms: create-trade-use and add reuse = recreate. Then the life cycle is more accurately seen as circular. He gave an example of transparency in presenting rights, from Adobe eBook. You are authorized to get the copy. It is OK to copy (up to 10 times each week), to print, to lend. But you cannot give or read aloud. He suggested, that it should be possible to pay for usage, not possession.

The following are building blocks for a DRM architecture:

- A better metadata framework: He would like it to be in RDF
- Trust (digital signatures)
- There are lessons to learn from P3P, CC/PP
- identification (URIs)
- XML packaging and tools

- use the <indecs> model: content, parties, rights. Each one is a kind of class. Parties described would be: author, corporate, agent, publisher. The content would be classified in work, expression, manifestation, item. Rights would be classified in usages, rewards, constraints.

Renato Iannella presented the ODRL. He sees it as a starting point for a DRM Language, that could be developed within W3C.

Concludes: W3C Role could be:

- W3C Digital Rights Language Working Group to develop semantics of a digital rights language encoded in XML
- Trusted Metadata Working Group to develop architecture to support encoding and transmission of DRM and other metadata
- DRM Interest Group to discuss next steps and establish relationship with other communities

W3C can solve some part of the DRM problem, coordinate others, and empower the user community.

## Norman Paskin (Int. DOI Foundation), Digital Object Identifier (DOI)

*See also the [slides \(ppt\)](#) and the [Position Paper](#)*

Paskin was presenting the activity of the DOI Foundation. We have spent three years developing an identifier system for digital objects. We have been influenced by <indecs> analysis and implementations, e.g., ONIX and by consideration of digital object infrastructure (e.g., CNRI work).

DRM must be maximally extensible. DRM is digital management of rights, not just management of digital rights. Practical rights management will require dealing with both digital and non-digital rights. Unique identification is essential for automation to work on this.

Description info and rights info are not distinguishable. Any piece of description may be needed in a rights transaction.

Creative items used to be physical, today we have both a physical and digital manifestation, so sometimes there are two identifiers, e.g., ISBN for one, URL for the other. But if we are going to automate transactions we must dis-ambiguate meanings. We need to define word like book in the spaces it may found in, the ISBN space or the <indecs> space.



There will not be one model for applying identifiers, it will differ for content communities, given practical implications, e.g. ONIX, MPEG-7, etc. A work may be an original manuscript version, the work in the abstract, a draft, a copy in a publication, a digital copy not in a publication, a reprint, etc.. In each role, there will be different ids and attributes. We don't have to have complete knowledge representation. We can build on agreements over what an identifier means within a given namespace

About names and locations, he said that a name is a location in a defined namespace, thus all names are locations is trivially true.

As practical needs for DOI, Paskin identified:

- multiple instances
- persistence in face of change
- mgt of non-digital entities
- de-referencing, resolution

Who should be responsible for naming: Standards bodies, rights collectives? Examples are:

- EAN/UPC bar code system
- ISBN system
- URI system But what in the digital realm?
- URLs are a poor system for publishers

Identifier needs to be actionable. They can be the basis for rights management. But there won't be one place to go for:

- e.g., directory of parties (names of people, sort of, as for music, is developing a directory)
- e.g., ontology of scientific article

We need to involve stakeholders, what is the W3C good for here?

Paskin used an aphorism: I think what is called media convergence really is "people convergence" (with the correlative problem of communication). Formalisms are essential in their place but must be explained. What we ought to care about does not just encompass the web.

DOI system offers :

- numbering - use any identifier
- description - can use <indec> framework

- action - handles allow to link to instances
- It is persistent, granular, flexible, can wrap other identifiers

## Discussion

*Not for all questions and answers, the author was identified. In this case, you'll see only question and answer*

**Question:** is URI primarily address where you find something?

**Dan Connolly (W3C):** I don't think so.

**Danny Weitzner (W3C):** Question to Godfrey Rust and John Erickson: Is there a consensus point? John said there should be a rights management schema. How modular is the <indec> system? Does anyone who uses something that falls under the <indec> model have to use the whole model?

**Godfrey Rust (<indec>):** It is a matter of how you structure your information. If we use the event model to organize our system, this should lead to interoperability. If one wants to express things in most efficient way, an events - systems will be very powerful. Other systems/legacy info can be transformed into events model. One doesn't have to organize all data into high level of functionality. We can still use information that is fairly low grade.

**John Erickson (HP):** An event model is powerful, because it allows description of certain rights relationships that we might think of in terms of electronic contracts. If we speak about rights languages, we can imagine a lot of different types of transactions. There are things that need to be declared, between an author and a publisher. It is a dynamic activity with lots of outcomes that the event model can characterize. The event model is the basis of an ontology. We need different vocabularies for different purposes. A contract between an author and a publisher is like dynamic state machine. The event model is a powerful way to express that. Things like rights vouchers/licenses and output of individual states are dependant on dynamic events.

**Maximilian Herberger (Uni Saarland):** Events are only one side. The event model reflects the state of subjective rights within a specific contract. We also need a way to describe how things fit together or what things have in common. We need a language at a higher level about objective rights. This language should be able to express classes of contract relationships. I think the combination of the two is the solution here.

**Jonathan Schull (Digital Goods):** Suppose I'm a publisher and I want to publish a book electronically. There are a whole lot of ways to do this. Each combination will have a

different address, thus creating a different digital object. A publisher doesn't really care about the locations, he only cares about initial work. He may decide that people shouldn't print it, or that people want their money back. As a publisher, I want to have only one thing to do.

**Jonathan D. Hahn (Versaware):** In a contrarian mode I say, well, about these "events," you know publishers may think of only one event, the one that came into play when I signed on to publish this work.

**Godfrey Rust (<indec>):** A DOI is a single number for the object

**Dan Connolly (W3C):** What's the first letter of most DOIs? Names are little pieces of communication. Making up a name without thinking about communication is sort of silly. We don't decide anything by ourselves, we decide together with people we communicate with. I don't think you can invent new technology that solves all the social problems involved

**Norman Paskin (DOI):** The web is not the universal information space. There are things, which aren't on the web. We need to identify them too.

**Eric Miller (OCLC):** you can place something on the web without using DOI. I represent libraries, so if you publish, you want consumer to get access to stuff - you have to talk to your customer base to find out whether they will use access mechanism you are designing to access content. What are the things we are trying to automate here? Let's think about a scenario with implemented DRM, let's do what-if scenarios.

**Question:** Why are ontologies so important?

**Answer:** Take a look at ontologies and what publishers require and you have your problem defined

**Eric Miller (OCLC):** A question not yet resolved is, what happens in DRM if different kinds of people are accessing the same object, e.g. in the context of a library.

**Robert Bollick, (McGraw-Hill):** This is already covered. It is like every consumer/publisher interaction which is covered by the requirements. More information can be found on [publishers.org](http://publishers.org). The name of the document is publishers DRM requirements.

**Comment:** We will get a lot of input/requirements from many different constituencies, e.g. record industry, book industry etc.. We need to consider the evolution of technology - technical components should be able to move independently from one another. We have a conceptual model: Take a language and a context used by different areas and avoid using

two different terms for same requirement. We need to build a common platform. That gives you a mechanism to do extensions that are truly unique. Medicine, oil-drilling all use different terminology, but a conceptual model helps us to decide whether their need is unique and helps us develop an orthogonal system, and avoid redundancy

**Scott Foshee, (Adobe)** states agreement with the interest in fine-grained identification implied by the <indecs>/DOI ideas.

**Question:** We won't be able to define precisely what work is. We should avoid defining it. While broad categories of interactions may have been studied, do you think your publishing model is extensible to images, text, font? To Godfrey Rust: Do you think we can extend this to publishing of aggregations, e.g. written book by an author combined with paper it is printed on ?

**Godfrey Rust (<indecs>):** Take a look at indecs papers. The answer is yes, I think this is possible.

**Answer:** The same is true for ONIX - thinking about selling pieces of a work

**Danny Weitzner (W3C):** Commenting on Norman's point of the Web not being the universal information space, I think that in the discussions so far we showed lots of attention on commercial needs. The question is whether we would like common framework for discovering rights of document whether or not produced principally for trade or not? E.g., does a picture of my 3-year old fit into this framework? We risk to produce big costs if there are two classes of documents: One that fits into trading and others who don't. If we look at music, we see, that non-traditional documents are traded. I'm a bit concerned about the application of these systems only to "trade" items in the web, ignoring or disenfranchising the little objects which also have rights associated with them.

**Godfrey Rust (<indecs>):**The model we worked on are neutral as far as commerce is concerned. It can be used for picture of 3 year old. We haven't actually developed framework though. A critical piece of work is to decide what those verbs (note: for the actions) are. The model still needs a lot of detailed work. We have roughly agreed on the direction we take. Please don't overestimate what we've done.

**Norman Paskin (DOI):** <indecs>/DOI is about transactions. We mean by transaction anything, whether it's free or not. We focused on e-commerce. Our economic model is based on the barcode model. For some transactions, the financial cost will be zero.

**John Erickson (HP):** What is the methodology for rationalising to interpret new dimensions for a given problem space? There has been a lot of talk about notion of ontologies. We

have a certain way of thinking about a problem, and perhaps another way. Now we try to find ontologies to identify common points. Where does the notion of rationalizing problem spaces conflict with ontologies? I can see that it resonates in a closed room ...

**Rob Koenen, MPEG:** MPEG-7 is standard for describing content. Based on XML schema, there are principle notions like actor, people etc. Those are listed in a concepts list. There are basic concepts like shape, color etc. People can build their own ontology. MPEG has just decided to do a data dictionary for a rights language. MPEG has issued a call for requirements on 19 January 2001. Koenen invited W3C to work with MPEG on working on this problem

**Peter Schirling (IBM & MPEG):** We should try to avoid unnecessary duplication. We allow each discipline to build an ontology from a common frame, to reduce duplication of elements. Under that framework, different sectors can add their own things to a specific concepts list. Currently, we have only concept lists very specific to audio-visual content.

**Scott Foshee (Adobe):** There are two classes of objects (things): Under control and not under control. I wanted to state my agreement with Danny Weitzner, that there should only be one class. Clipart in a presentation software is an aggregation with content you created. By using a product that was licensed, everything on a harddisk is aggregated content work. DRM should be able to handle that. Take a picture of Danny Weitzner and apply a filter may result in aggregate work. The process that is applied results in another object. We need to get something that is workable, because this technology will be everywhere

Coffee Break, but not enough coffee for some

---

[\[Minutes Overview\]](#) [\[Workshop Home\]](#) [\[Previous:Publishers Requirements\]](#)  
[\[Next:Architecture: Interoperability and Standards\]](#)

Created by Rigo Wenning February 2001

Last update \$Date: 2001/04/18 16:50:31 \$ by \$Author: rigo \$

<b>Notice of References Cited</b>	Application/Control No. 10/956,121	Applicant(s)/Patent Under Reexamination WANG ET AL.	
	Examiner THOMAS WEST	Art Unit 3621	Page 1 of 1

**U.S. PATENT DOCUMENTS**

*	Document Number Country Code-Number-Kind Code	Date MM-YYYY	Name	Classification
*	A US-6,044,466 A	03-2000	Anand et al.	726/1
*	B US-6,397,355 B1	05-2002	Curtis et al.	714/38
C	US-			
D	US-			
E	US-			
F	US-			
G	US-			
H	US-			
I	US-			
J	US-			
K	US-			
L	US-			
M	US-			

**FOREIGN PATENT DOCUMENTS**

*	Document Number Country Code-Number-Kind Code	Date MM-YYYY	Country	Name	Classification
N					
O					
P					
Q					
R					
S					
T					

**NON-PATENT DOCUMENTS**

*	Document Number Country Code-Number-Kind Code	Date MM-YYYY	Country	Name	Classification
				Include as applicable: Author, Title Date, Publisher, Edition or Volume, Pertinent Pages)	
U				Workshop on Digital Rights Management for the Web, World Wide Web Consortium, Minutes from the Architecture/Infrastructure Session, January 2001	
V					
W					
X					

\*A copy of this reference is not being furnished with this Office action. (See MPEP § 707.05(a).)  
Dates in MM-YYYY format are publication dates. Classifications may be US or foreign.

## Electronic Acknowledgement Receipt

<b>EFS ID:</b>	6692629
<b>Application Number:</b>	10956121
<b>International Application Number:</b>	
<b>Confirmation Number:</b>	8924
<b>Title of Invention:</b>	System and method for managing transfer of rights using shared state variables
<b>First Named Inventor/Applicant Name:</b>	Xin Wang
<b>Customer Number:</b>	22204
<b>Filer:</b>	Stephen M. Hertzler
<b>Filer Authorized By:</b>	
<b>Attorney Docket Number:</b>	111325-291300
<b>Receipt Date:</b>	22-DEC-2009
<b>Filing Date:</b>	04-OCT-2004
<b>Time Stamp:</b>	17:19:31
<b>Application Type:</b>	Utility under 35 USC 111(a)

### Payment information:

Submitted with Payment	yes
Payment Type	Deposit Account
Payment was successfully received in RAM	\$670
RAM confirmation Number	4672
Deposit Account	192380
Authorized User	

The Director of the USPTO is hereby authorized to charge indicated fees and credit any overpayment as follows:

Charge any Additional Fees required under 37 C.F.R. Section 1.21 (Miscellaneous fees and charges)

<b>File Listing:</b>					
<b>Document Number</b>	<b>Document Description</b>	<b>File Name</b>	<b>File Size(Bytes)/ Message Digest</b>	<b>Multi Part /.zip</b>	<b>Pages (if appl.)</b>
1	Notice of Appeal Filed	111325-291300_- _Notice_Of_Appeal.pdf	25768  6e9c91b018fde7cd0fab94a7886fed4c1a0a1d88	no	1
<b>Warnings:</b>					
<b>Information:</b>					
2	Fee Worksheet (PTO-875)	fee-info.pdf	31942  007f71f5180cc673ea2c36f3612be3f94c7e7f8b	no	2
<b>Warnings:</b>					
<b>Information:</b>					
<b>Total Files Size (in bytes):</b>			57710		
<p><b>This Acknowledgement Receipt evidences receipt on the noted date by the USPTO of the indicated documents, characterized by the applicant, and including page counts, where applicable. It serves as evidence of receipt similar to a Post Card, as described in MPEP 503.</b></p> <p><b><u>New Applications Under 35 U.S.C. 111</u></b>  <b>If a new application is being filed and the application includes the necessary components for a filing date (see 37 CFR 1.53(b)-(d) and MPEP 506), a Filing Receipt (37 CFR 1.54) will be issued in due course and the date shown on this Acknowledgement Receipt will establish the filing date of the application.</b></p> <p><b><u>National Stage of an International Application under 35 U.S.C. 371</u></b>  <b>If a timely submission to enter the national stage of an international application is compliant with the conditions of 35 U.S.C. 371 and other applicable requirements a Form PCT/DO/EO/903 indicating acceptance of the application as a national stage submission under 35 U.S.C. 371 will be issued in addition to the Filing Receipt, in due course.</b></p> <p><b><u>New International Application Filed with the USPTO as a Receiving Office</u></b>  <b>If a new international application is being filed and the international application includes the necessary components for an international filing date (see PCT Article 11 and MPEP 1810), a Notification of the International Application Number and of the International Filing Date (Form PCT/RO/105) will be issued in due course, subject to prescriptions concerning national security, and the date shown on this Acknowledgement Receipt will establish the international filing date of the application.</b></p>					



<b>NOTICE OF APPEAL FROM THE EXAMINER TO THE BOARD OF PATENT APPEALS AND INTERFERENCES</b>	Docket Number (Optional) 111325-291300
--	---

<p style="text-align: center;">CERTIFICATE OF MAILING OR TRANSMISSION [37 CFR 1.89(a)]</p> <p>I hereby certify that this correspondence is being deposited with the United States Postal Service with sufficient postage for first class mail in an envelope addressed to Mail Stop AF, Commissioner for Patents, P.O. Box 1450, Alexandria, Virginia 22313-1450, or being facsimile transmitted to the USPTO at _____, on _____.</p> <p>Signature: _____ Name: _____</p>	In re Application of: Xin WANG, et al.	
	Application Number: 10/956,121	Filed: October 4, 2004
	For: SYSTEM AND METHOD FOR MANAGING TRANSFER OF RIGHTS USING SHARED STATE VARIABLES	
	Group Art Unit: 3621	Examiner: Thomas C. West

Applicant hereby **appeals** to the Board of Patent Appeals and Interferences from the decision of the examiner.

The fee for this Notice of Appeal is (37 CFR 41.20(b)(1)) \$ 540.00

Applicant claims small entity status. See 37 CFR 1.27. Therefore, the fee shown above is reduced by half, and the resulting fee is: \$ \_\_\_\_\_

A check in the amount of the fee is enclosed.

Payment by credit card. Form PTO-2038 is attached.

The Director has already been authorized to charge fees in this application to a Deposit Account. I have enclosed a duplicate copy of this sheet.

The Director is hereby authorized to charge any fees which may be required, or credit any overpayment to Deposit Account No. **19-2380**. I have enclosed a duplicate copy of this sheet.

A petition for an extension of time under 37 CFR 1.136(a) (PTO/SB/22) is enclosed.

**WARNING: Information on this form may become public. Credit card information should not be included on this form. Provide credit card information and authorization on PTO-2038.**

I am the

applicant/inventor. \_\_\_\_\_/Stephen M. Hertzler, Reg. No. 58,247/  
Signature

assignee of record of the entire interest. See 37 CFR 3.71. Statement under 37 CFR 3.73(b) is enclosed. (Form PTO/SB/96)

attorney or agent of record \_\_\_\_\_  
Stephen M. Hertzler  
Typed or printed name

attorney or agent acting under 37 CFR 1.34(a).  
Registration number if acting under 37 CFR 1.34(a) \_\_\_\_\_ \_\_\_\_\_  
December 22, 2009  
Date

NOTE: Signatures of all the inventors or assignees of record of the entire interest or their representative(s) are required. Submit multiple forms if more than one signature is required, see below\*.

<input checked="" type="checkbox"/> *Total of <u>1</u> forms are submitted.
---

## Electronic Patent Application Fee Transmittal

<b>Application Number:</b>	10956121
<b>Filing Date:</b>	04-Oct-2004
<b>Title of Invention:</b>	System and method for managing transfer of rights using shared state variables
<b>First Named Inventor/Applicant Name:</b>	Xin Wang
<b>Filer:</b>	Stephen M. Hertzler/Lynette James
<b>Attorney Docket Number:</b>	111325-291300

Filed as Large Entity

### Utility under 35 USC 111(a) Filing Fees

Description	Fee Code	Quantity	Amount	Sub-Total in USD(\$)
<b>Basic Filing:</b>				
<b>Pages:</b>				
<b>Claims:</b>				
<b>Miscellaneous-Filing:</b>				
<b>Petition:</b>				
<b>Patent-Appeals-and-Interference:</b>				
Notice of appeal	1401	1	540	540

### Post-Allowance-and-Post-Issuance:

### Extension-of-Time:

Description	Fee Code	Quantity	Amount	Sub-Total in USD(\$)
Extension - 1 month with \$0 paid	1251	1	130	130
<b>Miscellaneous:</b>				
<b>Total in USD (\$)</b>				<b>670</b>

**IN THE UNITED STATES PATENT AND TRADEMARK OFFICE**

In re PATENT application of )  
Xin WANG, et al. )  
Application No. 10/956,121 ) Group Art Unit: 3621  
Filed: October 4, 2004 ) Examiner: Thomas C. WEST  
Confirmation No. 8924 )  
For: SYSTEM AND METHOD FOR ) Date: March 15, 2010  
MANAGING TRANSFER OF RIGHTS )  
USING SHARED STATE VARIABLES )

**SUPPLEMENTAL RESPONSE**

Commissioner for Patents  
P.O. Box 1450  
Alexandria, VA 22313-1450

Sir:

In response to the final Office Action mailed August 19, 2009, in furtherance of the Notice of Appeal filed December 22, 2009, and in response to the recent interviews with Examiner West and Supervisory Examiner Fischer, Applicants request reconsideration and immediate allowance based on the following amendments and remarks.

**Amendments to the Claims** begin on page 2 of this paper.

**Remarks** begin on page 8 of this paper.

**REMARKS**

Claims 1-36 are pending in the present application. Applicants thank Examiner West and Supervisory Examiner Fischer for repeatedly discussing this application with Applicants, and for their willingness to review Applicants' proposals. Claims 1, 6, 8-12, 17, 19-24, 29, and 31-36 are amended herein to clarify the invention in accordance with the Examiner's suggestions. No new matter has been added. In accordance with the discussions with the Examiners, Applicants request reconsideration and allowance of the application in view of the above amendments and the following remarks.

Claims 1-36 stand provisionally rejected on the ground of non-statutory double-patenting over claim 6 of co-pending Application No. 10162701. Applicants respectfully request that this provisional rejection be held in abeyance until this application is otherwise in condition for allowance, at which point Applicants will consider filing a Terminal Disclaimer.

Claims 1-36 stand rejected under 35 U.S.C. § 101 as being related to non-statutory subject matter. As stated previously, claims 1, 12, and 24 each recite that "the meta-rights are provided in digital form and are enforceable by a repository," and a "right" is created by executing the claimed meta-right. Thus, these claims clearly satisfy the requirements of 35 U.S.C. § 101.

Claims 1-36 stand rejected under 35 U.S.C. §103(a) as being unpatentable over Anand et al. (U.S. Patent No. 6,044,466) in view of "Workshop on Digital Rights Management, Minutes from Architecture/Infrastructure Session" (hereafter, Infrastructure).

Based on discussions with the Examiners, Applicants amend the claims herein to clarify that the claimed set of rights includes a "meta-right specifying a right that can be created when the meta-right is exercised," and specify that the meta-right is exercised to "create the right specified by the meta-right if the rights consumer is entitled to the right specified by the meta-right." As acknowledged by the Examiners, the applied prior art, including Anand and Infrastructure), fail to disclose, suggest, or render obvious at least these features.

For at least the reasons set forth above, Applicants respectfully submit that neither Anand nor Infrastructure, taken alone or in combination, disclose, suggest, or render obvious the invention recited in independent claims 1, 12, and 24. The dependent claims are allowable at least by virtue of their dependency from one of the independent claims, and also on their own merits.

In view of the foregoing, Applicants respectfully request entry of the above amendments and submit that this application is in condition for immediate allowance. A notice to that effect is solicited. If any issue remains after considering this response, the Examiner is encouraged to call the undersigned to expedite the prosecution and work out any such issue by telephone.

**Except** for issue fees payable under 37 C.F.R. § 1.18, the Commissioner is hereby authorized by this paper to charge any additional fees during the entire pendency of this application including fees due under 37 C.F.R. §§ 1.16 and 1.17 which may be required, including any required extension of time fees, or credit any overpayment to Deposit Account No. 19-2380. This paragraph is intended to be a **CONSTRUCTIVE PETITION FOR EXTENSION OF TIME** in accordance with 37 C.F.R. § 1.136(a)(3).

Respectfully submitted,

**NIXON PEABODY LLP**

Date: March 15, 2010

/Stephen M. Hertzler, Reg. No. 58,247/  
Stephen M. Hertzler  
Reg. No. 58,247

**NIXON PEABODY LLP**  
401 9th Street, N.W., Suite 900  
Washington, D.C. 20004-2128  
(202) 585-8000  
(202) 585-8080 (Fax)  
Customer No. 22204

## Electronic Acknowledgement Receipt

<b>EFS ID:</b>	7208161
<b>Application Number:</b>	10956121
<b>International Application Number:</b>	
<b>Confirmation Number:</b>	8924
<b>Title of Invention:</b>	System and method for managing transfer of rights using shared state variables
<b>First Named Inventor/Applicant Name:</b>	Xin Wang
<b>Customer Number:</b>	22204
<b>Filer:</b>	Stephen M. Hertzler
<b>Filer Authorized By:</b>	
<b>Attorney Docket Number:</b>	111325-291300
<b>Receipt Date:</b>	15-MAR-2010
<b>Filing Date:</b>	04-OCT-2004
<b>Time Stamp:</b>	15:00:30
<b>Application Type:</b>	Utility under 35 USC 111(a)

### Payment information:

Submitted with Payment	no
------------------------	----

### File Listing:

Document Number	Document Description	File Name	File Size(Bytes)/ Message Digest	Multi Part /.zip	Pages (if appl.)
1	Amendment After Final	111325-291300_- _Supplemental_Response.pdf	40577 <small>ea06e7892347737637131951b8fa86f4d3e72420</small>	no	9

### Warnings:

### Information:

This Acknowledgement Receipt evidences receipt on the noted date by the USPTO of the indicated documents, characterized by the applicant, and including page counts, where applicable. It serves as evidence of receipt similar to a Post Card, as described in MPEP 503.

**New Applications Under 35 U.S.C. 111**

If a new application is being filed and the application includes the necessary components for a filing date (see 37 CFR 1.53(b)-(d) and MPEP 506), a Filing Receipt (37 CFR 1.54) will be issued in due course and the date shown on this Acknowledgement Receipt will establish the filing date of the application.

**National Stage of an International Application under 35 U.S.C. 371**

If a timely submission to enter the national stage of an international application is compliant with the conditions of 35 U.S.C. 371 and other applicable requirements a Form PCT/DO/EO/903 indicating acceptance of the application as a national stage submission under 35 U.S.C. 371 will be issued in addition to the Filing Receipt, in due course.

**New International Application Filed with the USPTO as a Receiving Office**

If a new international application is being filed and the international application includes the necessary components for an international filing date (see PCT Article 11 and MPEP 1810), a Notification of the International Application Number and of the International Filing Date (Form PCT/RO/105) will be issued in due course, subject to prescriptions concerning national security, and the date shown on this Acknowledgement Receipt will establish the international filing date of the application.



**Amendments to the Claims:**

1. (Currently Amended) A computer-implemented method for transferring rights adapted to be associated with items from a rights supplier to a rights consumer, the method comprising:

obtaining a set of rights associated with an item, the set of rights including a meta-right[[s]] specifying ~~derivable rights that can be derived from the meta rights~~ a right that can be created when the meta-right is exercised, wherein the meta-right is ~~meta rights are~~ provided in digital form and [[are]] is enforceable by a repository;

determining, by a repository, whether the rights consumer is entitled to the ~~derivable~~ right[[s]] specified by the meta-right[[s]]; and

~~deriving at least one right from the derivable rights~~, exercising the meta-right to create the right specified by the meta-right if the rights consumer is entitled to the ~~derivable~~ right[[s]] specified by the meta-right[[s]], wherein the ~~derived~~ created right includes at least one state variable based on the set of rights and used for determining a state of the ~~derived~~ created right.

2. (Original) The method of claim 1, wherein the state variable inherits a state thereof for content usage or rights transfer from the set of rights.

3. (Original) The method of claim 1, wherein the state variable shares a state thereof for content usage or rights transfer with the set of rights.

4. (Original) The method of claim 1, wherein the state variable inherits a remaining state for content usage or rights transfer from the set of rights.

5. (Original) The method of claim 1, wherein the state variable is updated upon exercise of a right associated with the state variable.

6. (Currently Amended) The method of claim 1, ~~further comprising deriving a plurality of rights from the derivable rights, wherein exercising the meta-right creates a plurality of rights,~~ wherein the state variable is shared by the ~~derived~~ created rights.

7. (Original) The method of claim 1, wherein the state variable represents a collection of states.

8. (Currently Amended) The method of claim 1, further comprising a plurality of state variables that determine the state of the ~~derived~~ created right.

9. (Currently Amended) The method of claim 1, wherein the at least one state variable is unspecified in the ~~derived~~ created right, is created during a rights transfer, and is assigned to the ~~derived~~ created right.

10. (Currently Amended) The method of claim 1, wherein the state variable is transferred from the ~~derivable rights-right specified by the meta-right~~ to the ~~derived~~ created right.

11. (Currently Amended) The method of claim 1, further comprising generating a license including the ~~derived~~ created right, if the rights consumer is entitled to the ~~derivable rights-right specified by the meta-right~~[[s]].

12. (Currently Amended) A system for transferring rights adapted to be associated with items from a rights supplier to a rights consumer, the system comprising:

means for obtaining a set of rights associated with an item, the set of rights including a meta-right[[s]] specifying ~~derivable rights that can be derived from the meta-rights~~ a right that can be created when the meta-right is exercised, wherein the meta-right is ~~meta-rights are~~ provided in digital form and ~~[[are]]~~ is enforceable by a repository;

means for determining whether the rights consumer is entitled to the ~~derivable~~ right[[s]] specified by the meta-right[[s]]; and

~~means for deriving at least one right from the derivable rights,~~ means for exercising the meta-right to create the right specified by the meta-right if the rights consumer is entitled to the ~~derivable~~ right[[s]] specified by the meta-right[[s]], wherein the ~~derived~~ created right includes at least one state variable based on the set of rights and used for determining a state of the ~~derived~~ created right.

13. (Original) The system of claim 12, wherein the state variable inherits a state thereof for content usage or rights transfer from the set of rights.

14. (Original) The system of claim 12, wherein the state variable shares a state thereof for content usage or rights transfer with the set of rights.

15. (Original) The system of claim 12, wherein the state variable inherits a remaining state for content usage or rights transfer from the set of rights.

16. (Original) The system of claim 12, wherein the state variable is updated upon exercise of a right associated with the state variable.

17. (Currently Amended) The system of claim 12, ~~further comprising means for deriving a plurality of rights from the derivable rights,~~ wherein exercising the meta-right results creates a plurality of rights, wherein the state variable is shared by the ~~derived~~ created rights.

18. (Original) The system of claim 12, wherein the state variable represents a collection of states.

19. (Currently Amended) The system of claim 12, including a plurality of state variables that determine the state of the ~~derived~~ created right.

20. (Currently Amended) The system of claim 12, wherein the at least one state variable is unspecified in the ~~derived~~ created right, is created during a rights transfer, and is assigned to the ~~derived~~ created right.

21. (Currently Amended) The system of claim 12, wherein the state variable is transferred from the ~~derivable rights~~ right specified by the meta-right to the ~~derived~~ created right.

22. (Currently Amended) The system of claim 12, further comprising means for generating a license including the ~~derived~~ created right, if the rights consumer is entitled to the ~~derivable rights~~ right specified by the meta-right[[s]].

23. (Currently Amended) The system of claim 12, wherein the means for obtaining, the means for determining, and the means for ~~deriving~~ exercising comprise at least one of computer-executable instructions, and devices of a computer system.

24. (Currently Amended) A device for transferring rights adapted to be associated with items from a rights supplier to a rights consumer, the device comprising:

means for obtaining a set of rights associated with an item, the set of rights including a meta-right[[s]] specifying ~~derivable rights that can be derived from the meta-rights~~ a right that can be created when the meta-right is exercised, wherein the meta-right is ~~meta-rights~~ are provided in digital form and [[are]] is enforceable by a repository;

means for determining whether the rights consumer is entitled to the ~~derivable~~ right[[s]] specified by the meta-right[[s]]; and

~~means for deriving at least one right from the derivable rights~~, means for exercising the meta-right to create the right specified by the meta-right if the rights consumer is entitled to the ~~derivable~~ right[[s]] specified by the meta-right[[s]], wherein the ~~derived~~ created right includes at least one state variable based on the set of rights and used for determining a state of the ~~derived~~ created right.

25. (Original) The device of claim 24, wherein the state variable inherits a state thereof for content usage or rights transfer from the set of rights.

26. (Original) The device of claim 24, wherein the state variable shares a state thereof for content usage or rights transfer with the set of rights.

27. (Original) The device of claim 24, wherein the state variable inherits a remaining state for content usage or rights transfer from the set of rights.

28. (Original) The device of claim 24, wherein the state variable is updated upon exercise of a right associated with the state variable.

29. (Currently Amended) The device of claim 24, ~~further comprising means for deriving a plurality of rights from the derivable rights,~~ wherein exercising the meta-right results creates a plurality of rights, wherein the state variable is shared by the ~~derived~~ created rights.

30. (Original) The device of claim 24, wherein the state variable represents a collection of states.

31. (Currently Amended) The device of claim 24, including a plurality of state variables that determine the state of the ~~derived~~ created right.

32. (Currently Amended) The device of claim 24, wherein the at least one state variable is unspecified in the ~~derived~~ created right, is created during a rights transfer, and is assigned to the ~~derived~~ created right.

33. (Currently Amended) The device of claim 24, wherein the state variable is transferred from the ~~derivable rights~~ right specified by the meta-right to the ~~derived~~ created right.

34. (Currently Amended) The device of claim 24, further comprising means for generating a license including the ~~derived~~ created right, if the rights consumer is entitled to the ~~derivable rights~~ right specified by the meta-right[[s]].

35. (Currently Amended) The device of claim 24, wherein the means for obtaining, the means for determining, and the means for ~~deriving~~ exercising comprise at least one of computer-executable instructions, and devices of a computer system.

36. (Currently Amended) The device of claim 24, wherein one or more of the means for obtaining, the means for determining, and the means for ~~deriving~~ exercising are specified in a license.

Under the Paperwork Reduction Act of 1995, no persons are required to respond to a collection of information unless it displays a valid OMB control number.

<b>PATENT APPLICATION FEE DETERMINATION RECORD</b> Substitute for Form PTO-875	Application or Docket Number <b>10/956,121</b>	Filing Date <b>10/04/2004</b>	<input type="checkbox"/> To be Mailed
---	---	----------------------------------	---------------------------------------

APPLICATION AS FILED – PART I			OTHER THAN SMALL ENTITY			
	(Column 1)	(Column 2)	SMALL ENTITY <input type="checkbox"/>	OR		
FOR	NUMBER FILED	NUMBER EXTRA	RATE (\$)	FEE (\$)	RATE (\$)	FEE (\$)
<input type="checkbox"/> BASIC FEE <small>(37 CFR 1.16(a), (b), or (c))</small>	N/A	N/A	N/A		N/A	
<input type="checkbox"/> SEARCH FEE <small>(37 CFR 1.16(k), (l), or (m))</small>	N/A	N/A	N/A		N/A	
<input type="checkbox"/> EXAMINATION FEE <small>(37 CFR 1.16(o), (p), or (q))</small>	N/A	N/A	N/A		N/A	
TOTAL CLAIMS <small>(37 CFR 1.16(i))</small>	minus 20 =	*	X \$ =	OR	X \$ =	
INDEPENDENT CLAIMS <small>(37 CFR 1.16(h))</small>	minus 3 =	*	X \$ =		X \$ =	
<input type="checkbox"/> APPLICATION SIZE FEE <small>(37 CFR 1.16(s))</small>	If the specification and drawings exceed 100 sheets of paper, the application size fee due is \$250 (\$125 for small entity) for each additional 50 sheets or fraction thereof. See 35 U.S.C. 41(a)(1)(G) and 37 CFR 1.16(s).					
<input type="checkbox"/> MULTIPLE DEPENDENT CLAIM PRESENT <small>(37 CFR 1.16(j))</small>						
* If the difference in column 1 is less than zero, enter "0" in column 2.			TOTAL		TOTAL	

APPLICATION AS AMENDED – PART II					OTHER THAN SMALL ENTITY			
	(Column 1)	(Column 2)	(Column 3)		SMALL ENTITY	OR		
AMENDMENT	<b>03/15/2010</b>	CLAIMS REMAINING AFTER AMENDMENT	HIGHEST NUMBER PREVIOUSLY PAID FOR	PRESENT EXTRA	RATE (\$)	ADDITIONAL FEE (\$)	RATE (\$)	ADDITIONAL FEE (\$)
	Total <small>(37 CFR 1.16(i))</small>	* 36	Minus ** 36	= 0	X \$ =		OR	X \$52= 0
	Independent <small>(37 CFR 1.16(h))</small>	* 3	Minus ***3	= 0	X \$ =		OR	X \$220= 0
	<input type="checkbox"/> Application Size Fee <small>(37 CFR 1.16(s))</small>						OR	
	<input type="checkbox"/> FIRST PRESENTATION OF MULTIPLE DEPENDENT CLAIM <small>(37 CFR 1.16(j))</small>						OR	
					TOTAL ADD'L FEE		OR	TOTAL ADD'L FEE <b>0</b>

	(Column 1)	(Column 2)	(Column 3)		SMALL ENTITY	OR		
AMENDMENT		CLAIMS REMAINING AFTER AMENDMENT	HIGHEST NUMBER PREVIOUSLY PAID FOR	PRESENT EXTRA	RATE (\$)	ADDITIONAL FEE (\$)	RATE (\$)	ADDITIONAL FEE (\$)
	Total <small>(37 CFR 1.16(i))</small>	*	Minus **	=	X \$ =		OR	X \$ =
	Independent <small>(37 CFR 1.16(h))</small>	*	Minus ***	=	X \$ =		OR	X \$ =
	<input type="checkbox"/> Application Size Fee <small>(37 CFR 1.16(s))</small>						OR	
	<input type="checkbox"/> FIRST PRESENTATION OF MULTIPLE DEPENDENT CLAIM <small>(37 CFR 1.16(j))</small>						OR	
					TOTAL ADD'L FEE		OR	TOTAL ADD'L FEE

\* If the entry in column 1 is less than the entry in column 2, write "0" in column 3.  
 \*\* If the "Highest Number Previously Paid For" IN THIS SPACE is less than 20, enter "20".  
 \*\*\* If the "Highest Number Previously Paid For" IN THIS SPACE is less than 3, enter "3".  
 The "Highest Number Previously Paid For" (Total or Independent) is the highest number found in the appropriate box in column 1.

Legal Instrument Examiner:  
/ERIC DANTZLER/

This collection of information is required by 37 CFR 1.16. The information is required to obtain or retain a benefit by the public which is to file (and by the USPTO to process) an application. Confidentiality is governed by 35 U.S.C. 122 and 37 CFR 1.14. This collection is estimated to take 12 minutes to complete, including gathering, preparing, and submitting the completed application form to the USPTO. Time will vary depending upon the individual case. Any comments on the amount of time you require to complete this form and/or suggestions for reducing this burden, should be sent to the Chief Information Officer, U.S. Patent and Trademark Office, U.S. Department of Commerce, P.O. Box 1450, Alexandria, VA 22313-1450. DO NOT SEND FEES OR COMPLETED FORMS TO THIS ADDRESS. **SEND TO: Commissioner for Patents, P.O. Box 1450, Alexandria, VA 22313-1450.**  
 If you need assistance in completing the form, call 1-800-PTO-9199 and select option 2.



NOTICE OF ALLOWANCE AND FEE(S) DUE

22204 7590 03/29/2010

NIXON PEABODY, LLP
401 9TH STREET, NW
SUITE 900
WASHINGTON, DC 20004-2128

EXAMINER: WEST, THOMAS C
ART UNIT: 3621 PAPER NUMBER:
DATE MAILED: 03/29/2010

Table with 5 columns: APPLICATION NO., FILING DATE, FIRST NAMED INVENTOR, ATTORNEY DOCKET NO., CONFIRMATION NO.

10/956,121 10/04/2004 Xin Wang 111325-291300 8924

TITLE OF INVENTION: SYSTEM AND METHOD FOR MANAGING TRANSFER OF RIGHTS USING SHARED STATE VARIABLES

Table with 7 columns: APPLN. TYPE, SMALL ENTITY, ISSUE FEE DUE, PUBLICATION FEE DUE, PREV. PAID ISSUE FEE, TOTAL FEE(S) DUE, DATE DUE

nonprovisional NO \$1510 \$300 \$0 \$1810 06/29/2010

THE APPLICATION IDENTIFIED ABOVE HAS BEEN EXAMINED AND IS ALLOWED FOR ISSUANCE AS A PATENT. PROSECUTION ON THE MERITS IS CLOSED. THIS NOTICE OF ALLOWANCE IS NOT A GRANT OF PATENT RIGHTS. THIS APPLICATION IS SUBJECT TO WITHDRAWAL FROM ISSUE AT THE INITIATIVE OF THE OFFICE OR UPON PETITION BY THE APPLICANT. SEE 37 CFR 1.313 AND MPEP 1308.

THE ISSUE FEE AND PUBLICATION FEE (IF REQUIRED) MUST BE PAID WITHIN THREE MONTHS FROM THE MAILING DATE OF THIS NOTICE OR THIS APPLICATION SHALL BE REGARDED AS ABANDONED. THIS STATUTORY PERIOD CANNOT BE EXTENDED. SEE 35 U.S.C. 151. THE ISSUE FEE DUE INDICATED ABOVE DOES NOT REFLECT A CREDIT FOR ANY PREVIOUSLY PAID ISSUE FEE IN THIS APPLICATION. IF AN ISSUE FEE HAS PREVIOUSLY BEEN PAID IN THIS APPLICATION (AS SHOWN ABOVE), THE RETURN OF PART B OF THIS FORM WILL BE CONSIDERED A REQUEST TO REAPPLY THE PREVIOUSLY PAID ISSUE FEE TOWARD THE ISSUE FEE NOW DUE.

HOW TO REPLY TO THIS NOTICE:

I. Review the SMALL ENTITY status shown above.

If the SMALL ENTITY is shown as YES, verify your current SMALL ENTITY status:

- A. If the status is the same, pay the TOTAL FEE(S) DUE shown above.
B. If the status above is to be removed, check box 5b on Part B - Fee(s) Transmittal and pay the PUBLICATION FEE (if required) and twice the amount of the ISSUE FEE shown above, or

If the SMALL ENTITY is shown as NO:

- A. Pay TOTAL FEE(S) DUE shown above, or
B. If applicant claimed SMALL ENTITY status before, or is now claiming SMALL ENTITY status, check box 5a on Part B - Fee(s) Transmittal and pay the PUBLICATION FEE (if required) and 1/2 the ISSUE FEE shown above.

II. PART B - FEE(S) TRANSMITTAL, or its equivalent, must be completed and returned to the United States Patent and Trademark Office (USPTO) with your ISSUE FEE and PUBLICATION FEE (if required). If you are charging the fee(s) to your deposit account, section "4b" of Part B - Fee(s) Transmittal should be completed and an extra copy of the form should be submitted. If an equivalent of Part B is filed, a request to reapply a previously paid issue fee must be clearly made, and delays in processing may occur due to the difficulty in recognizing the paper as an equivalent of Part B.

III. All communications regarding this application must give the application number. Please direct all communications prior to issuance to Mail Stop ISSUE FEE unless advised to the contrary.

IMPORTANT REMINDER: Utility patents issuing on applications filed on or after Dec. 12, 1980 may require payment of maintenance fees. It is patentee's responsibility to ensure timely payment of maintenance fees when due.



**PART B - FEE(S) TRANSMITTAL**

**Complete and send this form, together with applicable fee(s), to: Mail Mail Stop ISSUE FEE  
 Commissioner for Patents  
 P.O. Box 1450  
 Alexandria, Virginia 22313-1450  
 or Fax (571)-273-2885**

INSTRUCTIONS: This form should be used for transmitting the ISSUE FEE and PUBLICATION FEE (if required). Blocks 1 through 5 should be completed where appropriate. All further correspondence including the Patent, advance orders and notification of maintenance fees will be mailed to the current correspondence address as indicated unless corrected below or directed otherwise in Block 1, by (a) specifying a new correspondence address; and/or (b) indicating a separate "FEE ADDRESS" for maintenance fee notifications.

CURRENT CORRESPONDENCE ADDRESS (Note: Use Block 1 for any change of address)

22204 7590 03/29/2010

**NIXON PEABODY, LLP**  
 401 9TH STREET, NW  
 SUITE 900  
 WASHINGTON, DC 20004-2128

Note: A certificate of mailing can only be used for domestic mailings of the Fee(s) Transmittal. This certificate cannot be used for any other accompanying papers. Each additional paper, such as an assignment or formal drawing, must have its own certificate of mailing or transmission.

**Certificate of Mailing or Transmission**

I hereby certify that this Fee(s) Transmittal is being deposited with the United States Postal Service with sufficient postage for first class mail in an envelope addressed to the Mail Stop ISSUE FEE address above, or being facsimile transmitted to the USPTO (571) 273-2885, on the date indicated below.

(Depositor's name)
(Signature)
(Date)

APPLICATION NO.	FILING DATE	FIRST NAMED INVENTOR	ATTORNEY DOCKET NO.	CONFIRMATION NO.
-----------------	-------------	----------------------	---------------------	------------------

10/956,121 10/04/2004 Xin Wang 111325-291300 8924

TITLE OF INVENTION: SYSTEM AND METHOD FOR MANAGING TRANSFER OF RIGHTS USING SHARED STATE VARIABLES

APPLN. TYPE	SMALL ENTITY	ISSUE FEE DUE	PUBLICATION FEE DUE	PREV. PAID ISSUE FEE	TOTAL FEE(S) DUE	DATE DUE
-------------	--------------	---------------	---------------------	----------------------	------------------	----------

nonprovisional NO \$1510 \$300 \$0 \$1810 06/29/2010

EXAMINER	ART UNIT	CLASS-SUBCLASS
----------	----------	----------------

WEST, THOMAS C 3621 705-050000

<p>1. Change of correspondence address or indication of "Fee Address" (37 CFR 1.363).</p> <p><input type="checkbox"/> Change of correspondence address (or Change of Correspondence Address form PTO/SB/122) attached.</p> <p><input type="checkbox"/> "Fee Address" indication (or "Fee Address" Indication form PTO/SB/47; Rev 03-02 or more recent) attached. <b>Use of a Customer Number is required.</b></p>	<p>2. For printing on the patent front page, list</p> <p>(1) the names of up to 3 registered patent attorneys or agents OR, alternatively, 1 _____</p> <p>(2) the name of a single firm (having as a member a registered attorney or agent) and the names of up to 2 registered patent attorneys or agents. If no name is listed, no name will be printed. 2 _____</p> <p>3 _____</p>
---	---

3. ASSIGNEE NAME AND RESIDENCE DATA TO BE PRINTED ON THE PATENT (print or type)

PLEASE NOTE: Unless an assignee is identified below, no assignee data will appear on the patent. If an assignee is identified below, the document has been filed for recordation as set forth in 37 CFR 3.11. Completion of this form is NOT a substitute for filing an assignment.

(A) NAME OF ASSIGNEE (B) RESIDENCE: (CITY AND STATE OR COUNTRY)

Please check the appropriate assignee category or categories (will not be printed on the patent) :  Individual  Corporation or other private group entity  Government

<p>4a. The following fee(s) are submitted:</p> <p><input type="checkbox"/> Issue Fee</p> <p><input type="checkbox"/> Publication Fee (No small entity discount permitted)</p> <p><input type="checkbox"/> Advance Order - # of Copies _____</p>	<p>4b. Payment of Fee(s); (Please first reapply any previously paid issue fee shown above)</p> <p><input type="checkbox"/> A check is enclosed.</p> <p><input type="checkbox"/> Payment by credit card. Form PTO-2038 is attached.</p> <p><input type="checkbox"/> The Director is hereby authorized to charge the required fee(s), any deficiency, or credit any overpayment, to Deposit Account Number _____ (enclose an extra copy of this form).</p>
---	--

5. Change in Entity Status (from status indicated above)

a. Applicant claims SMALL ENTITY status. See 37 CFR 1.27.  b. Applicant is no longer claiming SMALL ENTITY status. See 37 CFR 1.27(g)(2).

NOTE: The Issue Fee and Publication Fee (if required) will not be accepted from anyone other than the applicant; a registered attorney or agent; or the assignee or other party in interest as shown by the records of the United States Patent and Trademark Office.

Authorized Signature \_\_\_\_\_ Date \_\_\_\_\_  
 Typed or printed name \_\_\_\_\_ Registration No. \_\_\_\_\_

This collection of information is required by 37 CFR 1.311. The information is required to obtain or retain a benefit by the public which is to file (and by the USPTO to process) an application. Confidentiality is governed by 35 U.S.C. 122 and 37 CFR 1.14. This collection is estimated to take 12 minutes to complete, including gathering, preparing, and submitting the completed application form to the USPTO. Time will vary depending upon the individual case. Any comments on the amount of time you require to complete this form and/or suggestions for reducing this burden, should be sent to the Chief Information Officer, U.S. Patent and Trademark Office, U.S. Department of Commerce, P.O. Box 1450, Alexandria, Virginia 22313-1450. DO NOT SEND FEES OR COMPLETED FORMS TO THIS ADDRESS. SEND TO: Commissioner for Patents, P.O. Box 1450, Alexandria, Virginia 22313-1450.

Under the Paperwork Reduction Act of 1995, no persons are required to respond to a collection of information unless it displays a valid OMB control number.



UNITED STATES PATENT AND TRADEMARK OFFICE

UNITED STATES DEPARTMENT OF COMMERCE
United States Patent and Trademark Office
Address: COMMISSIONER FOR PATENTS
P. O. Box 1450
Alexandria, Virginia 22313-1450
www.uspto.gov

Table with columns: APPLICATION NO., FILING DATE, FIRST NAMED INVENTOR, ATTORNEY DOCKET NO., CONFIRMATION NO., EXAMINER, ART UNIT, PAPER NUMBER. Includes application details for Xin Wang and examiner Thomas C. West.

Determination of Patent Term Adjustment under 35 U.S.C. 154 (b)
(application filed on or after May 29, 2000)

The Patent Term Adjustment to date is 682 day(s). If the issue fee is paid on the date that is three months after the mailing date of this notice and the patent issues on the Tuesday before the date that is 28 weeks (six and a half months) after the mailing date of this notice, the Patent Term Adjustment will be 682 day(s).

If a Continued Prosecution Application (CPA) was filed in the above-identified application, the filing date that determines Patent Term Adjustment is the filing date of the most recent CPA.

Applicant will be able to obtain more detailed information by accessing the Patent Application Information Retrieval (PAIR) WEB site (http://pair.uspto.gov).

Any questions regarding the Patent Term Extension or Adjustment determination should be directed to the Office of Patent Legal Administration at (571)-272-7702. Questions relating to issue and publication fee payments should be directed to the Customer Service Center of the Office of Patent Publication at 1-(888)-786-0101 or (571)-272-4200.

**Notice of Allowability**

**Application No.**

10/956,121

**Examiner**

THOMAS WEST

**Applicant(s)**

WANG ET AL.

**Art Unit**

3621

**-- The MAILING DATE of this communication appears on the cover sheet with the correspondence address--**

All claims being allowable, PROSECUTION ON THE MERITS IS (OR REMAINS) CLOSED in this application. If not included herewith (or previously mailed), a Notice of Allowance (PTOL-85) or other appropriate communication will be mailed in due course. **THIS NOTICE OF ALLOWABILITY IS NOT A GRANT OF PATENT RIGHTS.** This application is subject to withdrawal from issue at the initiative of the Office or upon petition by the applicant. See 37 CFR 1.313 and MPEP 1308.

- 1.  This communication is responsive to Appeal filed 22 May 09.
- 2.  The allowed claim(s) is/are 1-36.
- 3.  Acknowledgment is made of a claim for foreign priority under 35 U.S.C. § 119(a)-(d) or (f).
  - a)  All   b)  Some\*   c)  None   of the:
    - 1.  Certified copies of the priority documents have been received.
    - 2.  Certified copies of the priority documents have been received in Application No. \_\_\_\_\_.
    - 3.  Copies of the certified copies of the priority documents have been received in this national stage application from the International Bureau (PCT Rule 17.2(a)).

\* Certified copies not received: \_\_\_\_\_.

Applicant has THREE MONTHS FROM THE "MAILING DATE" of this communication to file a reply complying with the requirements noted below. Failure to timely comply will result in ABANDONMENT of this application.

**THIS THREE-MONTH PERIOD IS NOT EXTENDABLE.**

- 4.  A SUBSTITUTE OATH OR DECLARATION must be submitted. Note the attached EXAMINER'S AMENDMENT or NOTICE OF INFORMAL PATENT APPLICATION (PTO-152) which gives reason(s) why the oath or declaration is deficient.
  - 5.  CORRECTED DRAWINGS ( as "replacement sheets") must be submitted.
    - (a)  including changes required by the Notice of Draftsperson's Patent Drawing Review ( PTO-948) attached
      - 1)  hereto or 2)  to Paper No./Mail Date \_\_\_\_\_.
    - (b)  including changes required by the attached Examiner's Amendment / Comment or in the Office action of Paper No./Mail Date \_\_\_\_\_.
- Identifying indicia such as the application number (see 37 CFR 1.84(c)) should be written on the drawings in the front (not the back) of each sheet. Replacement sheet(s) should be labeled as such in the header according to 37 CFR 1.121(d).**
- 6.  DEPOSIT OF and/or INFORMATION about the deposit of BIOLOGICAL MATERIAL must be submitted. Note the attached Examiner's comment regarding REQUIREMENT FOR THE DEPOSIT OF BIOLOGICAL MATERIAL.

**Attachment(s)**

- 1.  Notice of References Cited (PTO-892)
- 2.  Notice of Draftsperson's Patent Drawing Review (PTO-948)
- 3.  Information Disclosure Statements (PTO/SB/08), Paper No./Mail Date \_\_\_\_\_
- 4.  Examiner's Comment Regarding Requirement for Deposit of Biological Material
- 5.  Notice of Informal Patent Application
- 6.  Interview Summary (PTO-413), Paper No./Mail Date \_\_\_\_\_.
- 7.  Examiner's Amendment/Comment
- 8.  Examiner's Statement of Reasons for Allowance
- 9.  Other \_\_\_\_\_.

/Thomas West/  
Examiner, Art Unit 3621

## REASONS FOR ALLOWANCE

### *Acknowledgements*

1. Applicants' amendment filed 22 December 2009 is acknowledged. Accordingly, claims 1-36 remain pending.
2. The following is an Examiner's statement of reasons for allowance:
3. Regarding the claimed terms, the Examiner notes that a "general term must be understood in the context in which the inventor presents it." *In re Glaug* 283 F.3d 1335, 1340, 62 USPQ2d 1151, 1154 (Fed. Cir. 2002). Therefore the Examiner must interpret the claimed terms as found on pages 1-24 of the specification. Clearly almost all the general terms in the claims may have multiple meanings. So where a claim term "is susceptible to various meanings, . . . the inventor's lexicography must prevail . . ." *Id.* Using these definitions for the claims, the claimed invention was not reasonably found in the prior art.
4. The primary reference Anand (U.S. 6,044,466) discloses as previously discussed. Anand however does not teach at least "a meta-right specifying a right that can be created when the meta-right is exercised." Moreover, the missing claimed elements from Anand are not found in a reasonable number of references. Yet even if the missing claimed elements were found in a reasonable number of references, a person of ordinary skill in the art at the time the invention was made would *not* have been motivated to include these missing elements in an embodiment in the Anand disclosure because there is no motivation to create a meta-right when the meta-right is exercised.
5. Any comments considered necessary by applicant must be submitted no later than the payment of the issue fee and, to avoid processing delays, should preferably accompany the issue

Art Unit: 3621

fee. Such submissions should be clearly labeled "Comments on Statement of Reasons for Allowance."

***Conclusion***

Any inquiry concerning this communication or earlier communications from the examiner should be directed to Thomas West whose telephone number is 571-270-1236. The examiner can normally be reached on Tuesday and Wednesday 7:30am - 5pm EST.

If attempts to reach the examiner by telephone are unsuccessful, the examiner's supervisor, Andrew Fischer can be reached on 571-272-6779. The fax phone number for the organization where this application or proceeding is assigned is 571-273-8300.

Information regarding the status of an application may be obtained from the Patent Application Information Retrieval (PAIR) system. Status information for published applications may be obtained from either Private PAIR or Public PAIR. Status information for unpublished applications is available through Private PAIR only. For more information about the PAIR system, see <http://pair-direct.uspto.gov>. Should you have questions on access to the Private PAIR system, contact the Electronic Business Center (EBC) at 866-217-9197 (toll-free). If you would like assistance from a USPTO Customer Service Representative or access to the automated information system, call 800-786-9199 (IN USA OR CANADA) or 571-272-1000.

Thomas West  
Patent Examiner  
Art Unit 3621

/ANDREW J. FISCHER/  
Supervisory Patent Examiner, Art Unit 3621

## EAST Search History

## EAST Search History (Prior Art)

Ref #	Hits	Search Query	DBs	Default Operator	Plurals	Time Stamp
L2	239	drm and (creat\$3 near right)	US-PGPUB; USPAT; USOCR; FPRS; EPO; JPO; DERWENT; IBM_TDB	OR	ON	2010/03/13 14:18
L3	2	2 and @ad<="20010607"	US-PGPUB; USPAT; USOCR; FPRS; EPO; JPO; DERWENT; IBM_TDB	OR	ON	2010/03/13 14:19
L4	403	(digital near right) and (creat\$3 near right)	US-PGPUB; USPAT; USOCR; FPRS; EPO; JPO; DERWENT; IBM_TDB	OR	ON	2010/03/13 14:32
L5	44	4 and @ad<="20010607"	US-PGPUB; USPAT; USOCR; FPRS; EPO; JPO; DERWENT; IBM_TDB	OR	ON	2010/03/13 14:33
L6	1	5 and (state near variable)	US-PGPUB; USPAT; USOCR; FPRS; EPO; JPO; DERWENT; IBM_TDB	OR	ON	2010/03/13 14:33
S1	1	"10956121"	US-PGPUB; USPAT; USOCR; FPRS; EPO; JPO; DERWENT; IBM_TDB	OR	ON	2008/04/02 09:39

S2	264	"3263158"	"3609697"	US-PGPUB;	OR	ON	2008/04/02
		"3790700"	"3798605"	USPAT; USOCR;			09:41
		"4159468"	"4220991"	FPRS; EPO;			
		"4278837"	"4323921"	JPO;			
		"4442486"	"4529870"	DERWENT;			
		"4558176"	"4593376"	IBM_TDB			
		"4614861"	"4644493"				
		"4658093"	"4713753"				
		"4796220"	"4817140"				
		"4827508"	"4868376"				
		"4891838"	"4924378"				
		"4932054"	"4937863"				
		"4949187"	"4953209"				
		"4961142"	"4975647"				
		"4977594"	"4999806"				
		"5010571"	"5014234"				
		"5023907"	"5047928"				
		"5050213"	"5052040"				
		"5058164"	"5103476"				
		"5113519"	"5136643"				
		"5138712"	"5146499"				
		"5148481"	"5159182"				
		"5183404"	"5191193"				
		"5204897"	"5222134"				
		"5235642"	"5247575"				
		"5255106"	"5260999"				
		"5263157"	"5263158"				
		"5276444"	"5276735"				
		"5291596"	"5301231"				
		"5311591"	"5319705"				
		"5337357"	"5339091"				
		"5341429"	"5347579"				
		"5381526"	"5394469"				
		"5410598"	"5412717"				
		"5428606"	"5432849"				
		"5438508"	"5444779"				
		"5453601"	"5455953"				
		"5457746"	"5473687"				
		"5473692"	"5499298"				
		"5502766"	"5504814"				
		"5504818"	"5504837"				
		"5509070"	"5530235"				
		"5532920"	"5534975"				
		"5539735"	"5563946"				
		"5568552"	"5621797"				
		"5629980"	"5633932"				
		"5634012"	"5638443"				
		"5649013"	"5655077"				
		"5708717"	"5715403"				
		"5734823"	"5734891"				
		"5737413"	"5737416"				
		"5745569"	"5748783"				
		"5757907"	"5761686"				
		"5765152"	"5768426"				
		"5825892"	"5892900"				
		"5910987"	"5915019"				
		"5917912"	"5920861"				
		"5940504"	"5943422"				
		"5949876"	"5982891"				

		"5999949"   "6047067"   "6112181"   "6115471"   "6138119"   "6157721"   "6185683"   "6226618"   "6233684"   "6237786"   "6240185"   "6253193"   "6266618"   "6292569"   "6301660"   "6327652"   "6330670"   "6345256"   "6363488"   "6389402").PN.				
S3	979	((Derived derivation derivable derivative derive) near right)	US-PGPUB; USPAT; USOCR; FPRS; EPO; JPO; DERWENT; IBM_TDB	OR	ON	2008/04/02 10:13
S4	101	S3 and (digital near right)	US-PGPUB; USPAT; USOCR; FPRS; EPO; JPO; DERWENT; IBM_TDB	OR	ON	2008/04/02 10:15
S6	106	S3 and ((digital near rights) (rights near management))	US-PGPUB; USPAT; USOCR; FPRS; EPO; JPO; DERWENT; IBM_TDB	OR	ON	2008/04/02 10:16
S7	23	S6 and (state near variable)	US-PGPUB; USPAT; USOCR; FPRS; EPO; JPO; DERWENT; IBM_TDB	OR	ON	2008/04/02 10:18
S9	979	((Derived derivation derivable derivative derive) near right)	US-PGPUB; USPAT; USOCR; FPRS; EPO; JPO; DERWENT; IBM_TDB	OR	ON	2008/04/02 11:23
S10	106	S9 and ((digital near rights) (rights near management))	US-PGPUB; USPAT; USOCR; FPRS; EPO; JPO; DERWENT; IBM_TDB	OR	ON	2008/04/02 11:23
S11	23	S10 and (state near variable)	US-PGPUB; USPAT; USOCR; FPRS; EPO; JPO; DERWENT; IBM_TDB	OR	ON	2008/04/02 11:23



S12	0	S11 and @ad<="20010607"	US-PGPUB; USPAT; USOCR; FPRS; EPO; JPO; DERWENT; IBM_TDB	OR	ON	2008/04/02 11:23
S13	9	S10 and inherit\$4	US-PGPUB; USPAT; USOCR; FPRS; EPO; JPO; DERWENT; IBM_TDB	OR	ON	2008/04/02 11:28
S14	55	S10 and (transfer\$3 with right)	US-PGPUB; USPAT; USOCR; FPRS; EPO; JPO; DERWENT; IBM_TDB	OR	ON	2008/04/02 11:30
S15	3	S14 and @ad<="20010607"	US-PGPUB; USPAT; USOCR; FPRS; EPO; JPO; DERWENT; IBM_TDB	OR	ON	2008/04/02 11:31
S16	16426	((Derived derivation derivable derivative derive) with right)	US-PGPUB; USPAT; USOCR; FPRS; EPO; JPO; DERWENT; IBM_TDB	OR	ON	2008/04/02 11:42
S17	136	S9 and ((digital near rights) (rights near management) drm (content near right))	US-PGPUB; USPAT; USOCR; FPRS; EPO; JPO; DERWENT; IBM_TDB	OR	ON	2008/04/02 11:43
S18	11	S17 and @ad<="20010607"	US-PGPUB; USPAT; USOCR; FPRS; EPO; JPO; DERWENT; IBM_TDB	OR	ON	2008/04/02 11:44
S19	71035	((Derived derivation derivable derivative derive transfer\$4) with right)	US-PGPUB; USPAT; USOCR; FPRS; EPO; JPO; DERWENT; IBM_TDB	OR	ON	2008/04/02 11:48
S20	2	"7228426"	US-PGPUB; USPAT; USOCR; FPRS; EPO; JPO; DERWENT; IBM_TDB	OR	ON	2008/04/02 14:50

S21	2	"7130829"	US-PGPUB; USPAT; USOCR; FPRS; EPO; JPO; DERWENT; IBM_TDB	OR	ON	2008/04/02 14:56
S22	0	(rights near definition near language) and (secure near inheritance)	US-PGPUB; USPAT; USOCR; FPRS; EPO; JPO; DERWENT; IBM_TDB	OR	ON	2008/04/02 15:17
S23	0	(rights near definition near language)	US-PGPUB; USPAT; USOCR; FPRS; EPO; JPO; DERWENT; IBM_TDB	OR	ON	2008/04/02 15:18
S24	1	(secure near inheritance)	US-PGPUB; USPAT; USOCR; FPRS; EPO; JPO; DERWENT; IBM_TDB	OR	ON	2008/04/02 15:18
S25	123	rights with inheritance	US-PGPUB; USPAT; USOCR; FPRS; EPO; JPO; DERWENT; IBM_TDB	OR	ON	2008/04/02 15:19
S26	47	S25 and @ad<="20010607"	US-PGPUB; USPAT; USOCR; FPRS; EPO; JPO; DERWENT; IBM_TDB	OR	ON	2008/04/02 15:19
S27	1	digital near rights with inheritance	US-PGPUB; USPAT; USOCR; FPRS; EPO; JPO; DERWENT; IBM_TDB	OR	ON	2008/04/02 17:15
S28	290	"6226618"	US-PGPUB; USPAT; USOCR; FPRS; EPO; JPO; DERWENT; IBM_TDB	OR	ON	2008/04/02 17:18
S29	2	"6226618".pn.	US-PGPUB; USPAT; USOCR; FPRS; EPO; JPO; DERWENT; IBM_TDB	OR	ON	2008/04/02 17:19

S30	49	XML near Ticket	US-PGPUB; USPAT; USOCR; FPRS; EPO; JPO; DERWENT; IBM_TDB	OR	ON	2008/04/03 07:31
S31	12	S30 and @ad<="20010607"	US-PGPUB; USPAT; USOCR; FPRS; EPO; JPO; DERWENT; IBM_TDB	OR	ON	2008/04/03 07:31
S32	1	S31 and ((digital near rights) (rights near management) drm (content near right))	US-PGPUB; USPAT; USOCR; FPRS; EPO; JPO; DERWENT; IBM_TDB	OR	ON	2008/04/03 07:35
S33	0	S31 and inherit\$4	US-PGPUB; USPAT; USOCR; FPRS; EPO; JPO; DERWENT; IBM_TDB	OR	ON	2008/04/03 07:36
S34	0	S31 and ((Derived derivation derivable derivative derive) with right)	US-PGPUB; USPAT; USOCR; FPRS; EPO; JPO; DERWENT; IBM_TDB	OR	ON	2008/04/03 07:37
S35	2287967	(Derived derivation derivable derivative derive inherit\$4)	US-PGPUB; USPAT; USOCR; FPRS; EPO; JPO; DERWENT; IBM_TDB	OR	ON	2008/04/03 07:40
S36	4807	S35 and ((digital near rights) (rights near management) drm (content near right))	US-PGPUB; USPAT; USOCR; FPRS; EPO; JPO; DERWENT; IBM_TDB	OR	ON	2008/04/03 07:41
S37	1025	S36 and @ad<="20010607"	US-PGPUB; USPAT; USOCR; FPRS; EPO; JPO; DERWENT; IBM_TDB	OR	ON	2008/04/03 07:44
S38	20	S37 and (state near variable)	US-PGPUB; USPAT; USOCR; FPRS; EPO; JPO; DERWENT; IBM_TDB	OR	ON	2008/04/03 07:45

S39	2	"5109413".pn.	US-PGPUB; USPAT; USOCR; FPRS; EPO; JPO; DERWENT; IBM_TDB	OR	ON	2008/04/03 08:40
S40	2	"5765152".pn.	US-PGPUB; USPAT; USOCR; FPRS; EPO; JPO; DERWENT; IBM_TDB	OR	ON	2008/04/03 08:41
S41	2	"5922074".pn.	US-PGPUB; USPAT; USOCR; FPRS; EPO; JPO; DERWENT; IBM_TDB	OR	ON	2008/04/03 08:41
S42	2	"6098056".pn.	US-PGPUB; USPAT; USOCR; FPRS; EPO; JPO; DERWENT; IBM_TDB	OR	ON	2008/04/03 08:42
S43	2	"6125349".pn.	US-PGPUB; USPAT; USOCR; FPRS; EPO; JPO; DERWENT; IBM_TDB	OR	ON	2008/04/03 08:43
S44	2	"6226618".pn.	US-PGPUB; USPAT; USOCR; FPRS; EPO; JPO; DERWENT; IBM_TDB	OR	ON	2008/04/03 08:44
S45	2	"6385596".pn.	US-PGPUB; USPAT; USOCR; FPRS; EPO; JPO; DERWENT; IBM_TDB	OR	ON	2008/04/03 10:57
S46	7	(US-20050060571-\$).did. or (US-5109413-\$ or US- 5765152-\$ or US-6098056-\$ or US-6125349-\$ or US- 6226618-\$ or US-6385596-\$). did.	US-PGPUB; USPAT	OR	ON	2008/04/03 10:59
S47	4	S46 and (Derived derivation derivable derivative derive inherit\$4)	US-PGPUB; USPAT; USOCR; FPRS; EPO; JPO; DERWENT; IBM_TDB	OR	ON	2008/04/03 11:02

S48	3	S47 and @ad<="20010607"	US-PGPUB; USPAT; USOCR; FPRS; EPO; JPO; DERWENT; IBM_TDB	OR	ON	2008/04/03 11:03
S49	0	S48 and (state near variable)	US-PGPUB; USPAT; USOCR; FPRS; EPO; JPO; DERWENT; IBM_TDB	OR	ON	2008/04/03 11:05
S50	1	S46 and metadata	US-PGPUB; USPAT; USOCR; FPRS; EPO; JPO; DERWENT; IBM_TDB	OR	ON	2008/04/03 11:11
S51	223	(US-20050060571-\$).did. or (US-6389402-\$ or US- 6363488-\$ or US-6345256-\$ or US-6330670-\$ or US- 6327652-\$ or US-6301660-\$ or US-6292569-\$ or US- 6266618-\$ or US-6253193-\$ or US-6240185-\$ or US- 6237786-\$ or US-6233684-\$ or US-6226618-\$ or US- 6185683-\$ or US-6157721-\$ or US-6138119-\$ or US- 6115471-\$ or US-6112181-\$ or US-6047067-\$ or US- 5999949-\$ or US-5982891-\$ or US-5949876-\$ or US- 5943422-\$ or US-5940504-\$ or US-5920861-\$ or US- 5917912-\$).did. or (US- 5915019-\$ or US-5910987-\$ or US-5892900-\$ or US- 5825892-\$ or US-5768426-\$ or US-5765152-\$ or US- 5761686-\$ or US-5757907-\$ or US-5748783-\$ or US- 5745569-\$ or US-5737416-\$ or US-5737413-\$ or US- 5734891-\$ or US-5734823-\$ or US-5715403-\$ or US- 5708717-\$ or US-5655077-\$ or US-5649013-\$ or US- 5638443-\$ or US-5634012-\$ or US-5633932-\$ or US- 5629980-\$ or US-5621797-\$ or US-5568552-\$ or US- 5563946-\$ or US-5539735-\$ or US-5534975-\$).did. or (US- 5532920-\$ or US-5530235-\$ or US-5509070-\$ or US- 5504837-\$ or US-5504818-\$	US-PGPUB; USPAT; USOCR; EPO; DERWENT	OR	ON	2008/04/03 11:12

or US-5504814-\$ or US-  
5502766-\$ or US-5499298-\$  
or US-5473692-\$ or US-  
5473687-\$ or US-5457746-\$  
or US-5455953-\$ or US-  
5453601-\$ or US-5444779-\$  
or US-5438508-\$ or US-  
5432849-\$ or US-5428606-\$  
or US-5412717-\$ or US-  
5410598-\$ or US-5394469-\$  
or US-5381526-\$ or US-  
5347579-\$ or US-5341429-\$  
or US-5339091-\$ or US-  
5337357-\$ or US-5319705-\$  
or US-5311591-\$).did. or (US-  
5301231-\$ or US-5291596-\$  
or US-5276735-\$ or US-  
5276444-\$ or US-5263158-\$  
or US-5263157-\$ or US-  
5260999-\$ or US-5255106-\$  
or US-5247575-\$ or US-  
5235642-\$ or US-5222134-\$  
or US-5204897-\$ or US-  
5191193-\$ or US-5183404-\$  
or US-5159182-\$ or US-  
5148481-\$ or US-5146499-\$  
or US-5138712-\$ or US-  
5136643-\$ or US-5113519-\$  
or US-5103476-\$ or US-  
5058164-\$ or US-5052040-\$  
or US-5050213-\$ or US-  
5047928-\$ or US-5023907-\$  
or US-5014234-\$).did. or (US-  
5010571-\$ or US-4999806-\$  
or US-4977594-\$ or US-  
4975647-\$ or US-4961142-\$  
or US-4953209-\$ or US-  
4949187-\$ or US-4937863-\$  
or US-4932054-\$ or US-  
4924378-\$ or US-4891838-\$  
or US-4868376-\$ or US-  
4827508-\$ or US-4817140-\$  
or US-4796220-\$ or US-  
4713753-\$ or US-4658093-\$  
or US-4644493-\$ or US-  
4614861-\$ or US-4593376-\$  
or US-4558176-\$ or US-  
4529870-\$ or US-4442486-\$  
or US-4323921-\$ or US-  
4278837-\$ or US-4220991-\$  
or US-4159468-\$).did. or (US-  
3798605-\$ or US-3790700-\$  
or US-3609697-\$ or US-  
3263158-\$ or US-6298316-\$  
or US-6135646-\$ or US-  
6161114-\$ or US-5956737-\$  
or US-5109413-\$ or US-  
6098056-\$ or US-6125349-\$  
or US-6385596-\$).did. or (DE-  
3263158-\$).did. or (DE-

4323921-\$ or DE-3609697-\$).  
did. or (EP-1308115-A-\$ or  
EP-1180798-A-\$ or JP-  
2002016565-\$ or US-  
6330670-B-\$ or US-6327652-  
B-\$ or WO-0008909-A-\$ or  
FR-2772486-A-\$ or WO-  
9924928-A-\$ or EP-895149-A-  
\$ or WO-9840969-A-\$ or EP-  
862318-A-\$ or WO-9837481-  
A-\$ or JP-10214297-\$ or US-  
5761686-\$ or EP-838785-A-\$  
or US-5737413-\$ or US-  
5734823-\$ or WO-9809209-  
A-\$ or WO-9743761-A-\$ or  
US-5655077-\$ or WO-  
9726732-A-\$ or US-5649013-  
\$ or WO-9720298-A-\$ or US-  
5633932-\$ or WO-9714087-  
A-\$ or WO-9636163-A-\$).did.  
or (WO-9633476-A-\$ or US-  
5568552-\$ or WO-9627155-  
A-\$ or US-5539735-\$ or US-  
5534975-\$ or US-5530235-\$  
or EP-715246-A-\$ or EP-  
715245-A-\$ or EP-715244-A-  
\$ or EP-715243-A-\$ or DE-  
4442486-A-\$ or US-5509070-  
\$ or US-5504814-\$ or US-  
5473692-\$ or US-5473687-\$  
or WO-9530211-A-\$ or EP-  
679980-A-\$ or EP-679978-A-  
\$ or EP-679977-A-\$ or EP-  
672991-A-\$ or US-5428606-\$  
or WO-9514289-A-\$ or CA-  
2102743-\$ or EP-649074-A-\$  
or WO-9508231-A-\$ or US-  
5394469-\$ or DE-4323921-A-  
\$).did. or (WO-9427411-A-\$  
or WO-9419884-A-\$ or US-  
5337357-\$ or JP-06181924-\$  
or EP-601500-A-\$ or US-  
5319705-\$ or JP-06095591-\$  
or EP-588243-A-\$ or EP-  
575936-A-\$ or EP-570123-A-  
\$ or EP-567800-A-\$ or WO-  
9321581-A-\$ or EP-555715-A-  
\$ or US-5235642-\$ or US-  
5291596-\$ or EP-542298-A-\$  
or WO-9309490-A-\$ or EP-  
534679-A-\$ or US-5183404-\$  
or WO-9301550-A-\$ or WO-  
9220022-A-\$ or WO-  
9214187-A-\$ or US-5136643-  
\$ or WO-9209160-A-\$ or US-  
5103476-\$ or EP-471939-\$  
or US-5058164-\$).did. or (US-  
5052040-\$ or EP-447339-\$  
or US-5047928-\$ or EP-  
442838-\$ or US-5023907-\$

		or EP-425053-\$ or EP-423035-\$ or GB-2236604-\$ or EP-421409-\$ or US-4999806-\$ or EP-398494-\$ or US-4961142-\$ or US-4949187-\$ or DE-3903454-\$ or EP-367700-\$ or EP-366854-\$ or US-4924378-\$ or CA-1267443-\$ or EP-359220-\$ or WO-9002382-\$ or US-4891838-\$ or EP-332304-\$ or US-4796220-\$ or WO-8809019-\$ or EP-266748-\$ or WO-8802960-\$ or WO-8802202-\$.did. or (EP-252646-\$ or DE-3609697-\$ or US-4658093-\$ or EP-192243-\$ or US-4593376-\$ or WO-8603040-\$ or EP-174472-\$ or US-4558176-\$ or US-4529870-\$ or EP-80244-\$ or US-4368162-\$ or US-4278837-\$ or WO-8001635-\$ or DE-2849718-\$ or DE-2840980-\$ or US-3798605-\$.did.				
S52	20	S51 and metadata	US-PGPUB; USPAT; USOCR; FPRS; EPO; JPO; DERWENT; IBM_TDB	OR	ON	2008/04/03 11:12
S53	0	S52 and (state near variable)	US-PGPUB; USPAT; USOCR; FPRS; EPO; JPO; DERWENT; IBM_TDB	OR	ON	2008/04/03 11:13
S54	0	S52 and (state with variable)	US-PGPUB; USPAT; USOCR; FPRS; EPO; JPO; DERWENT; IBM_TDB	OR	ON	2008/04/03 11:13
S55	5	S51 and (state near variable)	US-PGPUB; USPAT; USOCR; FPRS; EPO; JPO; DERWENT; IBM_TDB	OR	ON	2008/04/03 11:13
S56	2287967	(Derived derivation derivable derivative derive inherit\$4)	US-PGPUB; USPAT; USOCR; FPRS; EPO; JPO; DERWENT; IBM_TDB	OR	ON	2008/04/03 12:12



S57	7539	S56 and (state near variable)	US-PGPUB; USPAT; USOCR; FPRS; EPO; JPO; DERWENT; IBM_TDB	OR	ON	2008/04/03 12:12
S58	272	S57 and metadata	US-PGPUB; USPAT; USOCR; FPRS; EPO; JPO; DERWENT; IBM_TDB	OR	ON	2008/04/03 12:13
S59	17	S58 and @ad<="20010607"	US-PGPUB; USPAT; USOCR; FPRS; EPO; JPO; DERWENT; IBM_TDB	OR	ON	2008/04/03 12:14
S60	223	(US-20050060571-\$).did. or (US-6389402-\$ or US- 6363488-\$ or US-6345256-\$ or US-6330670-\$ or US- 6327652-\$ or US-6301660-\$ or US-6292569-\$ or US- 6266618-\$ or US-6253193-\$ or US-6240185-\$ or US- 6237786-\$ or US-6233684-\$ or US-6226618-\$ or US- 6185683-\$ or US-6157721-\$ or US-6138119-\$ or US- 6115471-\$ or US-6112181-\$ or US-6047067-\$ or US- 5999949-\$ or US-5982891-\$ or US-5949876-\$ or US- 5943422-\$ or US-5940504-\$ or US-5920861-\$ or US- 5917912-\$).did. or (US- 5915019-\$ or US-5910987-\$ or US-5892900-\$ or US- 5825892-\$ or US-5768426-\$ or US-5765152-\$ or US- 5761686-\$ or US-5757907-\$ or US-5748783-\$ or US- 5745569-\$ or US-5737416-\$ or US-5737413-\$ or US- 5734891-\$ or US-5734823-\$ or US-5715403-\$ or US- 5708717-\$ or US-5655077-\$ or US-5649013-\$ or US- 5638443-\$ or US-5634012-\$ or US-5633932-\$ or US- 5629980-\$ or US-5621797-\$ or US-5568552-\$ or US- 5563946-\$ or US-5539735-\$ or US-5534975-\$).did. or (US- 5532920-\$ or US-5530235-\$ or US-5509070-\$ or US- 5504837-\$ or US-5504818-\$	US-PGPUB; USPAT; USOCR; EPO; DERWENT	OR	ON	2008/04/03 17:02

or US-5504814-\$ or US-  
5502766-\$ or US-5499298-\$  
or US-5473692-\$ or US-  
5473687-\$ or US-5457746-\$  
or US-5455953-\$ or US-  
5453601-\$ or US-5444779-\$  
or US-5438508-\$ or US-  
5432849-\$ or US-5428606-\$  
or US-5412717-\$ or US-  
5410598-\$ or US-5394469-\$  
or US-5381526-\$ or US-  
5347579-\$ or US-5341429-\$  
or US-5339091-\$ or US-  
5337357-\$ or US-5319705-\$  
or US-5311591-\$).did. or (US-  
5301231-\$ or US-5291596-\$  
or US-5276735-\$ or US-  
5276444-\$ or US-5263158-\$  
or US-5263157-\$ or US-  
5260999-\$ or US-5255106-\$  
or US-5247575-\$ or US-  
5235642-\$ or US-5222134-\$  
or US-5204897-\$ or US-  
5191193-\$ or US-5183404-\$  
or US-5159182-\$ or US-  
5148481-\$ or US-5146499-\$  
or US-5138712-\$ or US-  
5136643-\$ or US-5113519-\$  
or US-5103476-\$ or US-  
5058164-\$ or US-5052040-\$  
or US-5050213-\$ or US-  
5047928-\$ or US-5023907-\$  
or US-5014234-\$).did. or (US-  
5010571-\$ or US-4999806-\$  
or US-4977594-\$ or US-  
4975647-\$ or US-4961142-\$  
or US-4953209-\$ or US-  
4949187-\$ or US-4937863-\$  
or US-4932054-\$ or US-  
4924378-\$ or US-4891838-\$  
or US-4868376-\$ or US-  
4827508-\$ or US-4817140-\$  
or US-4796220-\$ or US-  
4713753-\$ or US-4658093-\$  
or US-4644493-\$ or US-  
4614861-\$ or US-4593376-\$  
or US-4558176-\$ or US-  
4529870-\$ or US-4442486-\$  
or US-4323921-\$ or US-  
4278837-\$ or US-4220991-\$  
or US-4159468-\$).did. or (US-  
3798605-\$ or US-3790700-\$  
or US-3609697-\$ or US-  
3263158-\$ or US-6298316-\$  
or US-6135646-\$ or US-  
6161114-\$ or US-5956737-\$  
or US-5109413-\$ or US-  
6098056-\$ or US-6125349-\$  
or US-6385596-\$).did. or (DE-  
3263158-\$).did. or (DE-

4323921-\$ or DE-3609697-\$).  
did. or (EP-1308115-A-\$ or  
EP-1180798-A-\$ or JP-  
2002016565-\$ or US-  
6330670-B-\$ or US-6327652-  
B-\$ or WO-0008909-A-\$ or  
FR-2772486-A-\$ or WO-  
9924928-A-\$ or EP-895149-A-  
\$ or WO-9840969-A-\$ or EP-  
862318-A-\$ or WO-9837481-  
A-\$ or JP-10214297-\$ or US-  
5761686-\$ or EP-838785-A-\$  
or US-5737413-\$ or US-  
5734823-\$ or WO-9809209-  
A-\$ or WO-9743761-A-\$ or  
US-5655077-\$ or WO-  
9726732-A-\$ or US-5649013-  
\$ or WO-9720298-A-\$ or US-  
5633932-\$ or WO-9714087-  
A-\$ or WO-9636163-A-\$).did.  
or (WO-9633476-A-\$ or US-  
5568552-\$ or WO-9627155-  
A-\$ or US-5539735-\$ or US-  
5534975-\$ or US-5530235-\$  
or EP-715246-A-\$ or EP-  
715245-A-\$ or EP-715244-A-  
\$ or EP-715243-A-\$ or DE-  
4442486-A-\$ or US-5509070-  
\$ or US-5504814-\$ or US-  
5473692-\$ or US-5473687-\$  
or WO-9530211-A-\$ or EP-  
679980-A-\$ or EP-679978-A-  
\$ or EP-679977-A-\$ or EP-  
672991-A-\$ or US-5428606-\$  
or WO-9514289-A-\$ or CA-  
2102743-\$ or EP-649074-A-\$  
or WO-9508231-A-\$ or US-  
5394469-\$ or DE-4323921-A-  
\$).did. or (WO-9427411-A-\$  
or WO-9419884-A-\$ or US-  
5337357-\$ or JP-06181924-\$  
or EP-601500-A-\$ or US-  
5319705-\$ or JP-06095591-\$  
or EP-588243-A-\$ or EP-  
575936-A-\$ or EP-570123-A-  
\$ or EP-567800-A-\$ or WO-  
9321581-A-\$ or EP-555715-A-  
\$ or US-5235642-\$ or US-  
5291596-\$ or EP-542298-A-\$  
or WO-9309490-A-\$ or EP-  
534679-A-\$ or US-5183404-\$  
or WO-9301550-A-\$ or WO-  
9220022-A-\$ or WO-  
9214187-A-\$ or US-5136643-  
\$ or WO-9209160-A-\$ or US-  
5103476-\$ or EP-471939-\$  
or US-5058164-\$).did. or (US-  
5052040-\$ or EP-447339-\$  
or US-5047928-\$ or EP-  
442838-\$ or US-5023907-\$

		or EP-425053-\$ or EP-423035-\$ or GB-2236604-\$ or EP-421409-\$ or US-4999806-\$ or EP-398494-\$ or US-4961142-\$ or US-4949187-\$ or DE-3903454-\$ or EP-367700-\$ or EP-366854-\$ or US-4924378-\$ or CA-1267443-\$ or EP-359220-\$ or WO-9002382-\$ or US-4891838-\$ or EP-332304-\$ or US-4796220-\$ or WO-8809019-\$ or EP-266748-\$ or WO-8802960-\$ or WO-8802202-\$.did. or (EP-252646-\$ or DE-3609697-\$ or US-4658093-\$ or EP-192243-\$ or US-4593376-\$ or WO-8603040-\$ or EP-174472-\$ or US-4558176-\$ or US-4529870-\$ or EP-80244-\$ or US-4368162-\$ or US-4278837-\$ or WO-8001635-\$ or DE-2849718-\$ or DE-2840980-\$ or US-3798605-\$.did.				
S61	21	S60 and (state near (variable machine))	US-PGPUB; USPAT; USOCR; FPRS; EPO; JPO; DERWENT; IBM_TDB	OR	ON	2008/04/03 17:02
S62	1611	(state near (variable machine)) and metadata	US-PGPUB; USPAT; USOCR; FPRS; EPO; JPO; DERWENT; IBM_TDB	OR	ON	2008/04/03 17:03
S63	863	S62 and (Derived derivation derivable derivative derive inherit\$4)	US-PGPUB; USPAT; USOCR; FPRS; EPO; JPO; DERWENT; IBM_TDB	OR	ON	2008/04/03 17:04
S65	95	S63 and ((digital near rights) (rights near management) drm (content near right))	US-PGPUB; USPAT; USOCR; FPRS; EPO; JPO; DERWENT; IBM_TDB	OR	ON	2008/04/03 17:05
S66	22	S65 and @ad<="20010607"	US-PGPUB; USPAT; USOCR; FPRS; EPO; JPO; DERWENT; IBM_TDB	OR	ON	2008/04/03 17:05

S67	22	S66 and license	US-PGPUB; USPAT; USOCR; FPRS; EPO; JPO; DERWENT; IBM_TDB	OR	ON	2008/04/03 17:10
S68	1809	(state near (variable machine table)) and metadata	US-PGPUB; USPAT; USOCR; FPRS; EPO; JPO; DERWENT; IBM_TDB	OR	ON	2008/04/03 17:26
S69	958	S68 and (Derived derivation derivable derivative derive inherit\$4)	US-PGPUB; USPAT; USOCR; FPRS; EPO; JPO; DERWENT; IBM_TDB	OR	ON	2008/04/03 17:26
S70	96	S69 and ((digital near rights) (rights near management) drm (content near right))	US-PGPUB; USPAT; USOCR; FPRS; EPO; JPO; DERWENT; IBM_TDB	OR	ON	2008/04/03 17:27
S71	206	S69 and license	US-PGPUB; USPAT; USOCR; FPRS; EPO; JPO; DERWENT; IBM_TDB	OR	ON	2008/04/03 17:28
S72	35	S71 and @ad<="20010607"	US-PGPUB; USPAT; USOCR; FPRS; EPO; JPO; DERWENT; IBM_TDB	OR	ON	2008/04/03 17:28
S74	1809	(state near (variable machine table)) and metadata	US-PGPUB; USPAT; USOCR; FPRS; EPO; JPO; DERWENT; IBM_TDB	OR	ON	2008/04/04 08:11
S75	958	S74 and (Derived derivation derivable derivative derive inherit\$4)	US-PGPUB; USPAT; USOCR; FPRS; EPO; JPO; DERWENT; IBM_TDB	OR	ON	2008/04/04 08:11
S76	206	S75 and license	US-PGPUB; USPAT; USOCR; FPRS; EPO; JPO; DERWENT; IBM_TDB	OR	ON	2008/04/04 08:11

S77	35	S76 and @ad<="20010607"	US-PGPUB; USPAT; USOCR; FPRS; EPO; JPO; DERWENT; IBM_TDB	OR	ON	2008/04/04 08:11
S78	20	S77 and (right with transfer)	US-PGPUB; USPAT; USOCR; FPRS; EPO; JPO; DERWENT; IBM_TDB	OR	ON	2008/04/04 08:11
S80	20	S77 and (right with transfer \$3)	US-PGPUB; USPAT; USOCR; FPRS; EPO; JPO; DERWENT; IBM_TDB	OR	ON	2008/04/04 08:12
S81	64	(state near (variable machine table)) with metadata	US-PGPUB; USPAT; USOCR; FPRS; EPO; JPO; DERWENT; IBM_TDB	OR	ON	2008/04/04 08:39
S82	25	S81 and (Derived derivation derivable derivative derive inherit\$4)	US-PGPUB; USPAT; USOCR; FPRS; EPO; JPO; DERWENT; IBM_TDB	OR	ON	2008/04/04 08:39
S83	1	S81 and ((Derived derivation derivable derivative derive inherit\$4 transfer\$4) with right)	US-PGPUB; USPAT; USOCR; FPRS; EPO; JPO; DERWENT; IBM_TDB	OR	ON	2008/04/04 08:41
S84	0	S83 and license	US-PGPUB; USPAT; USOCR; FPRS; EPO; JPO; DERWENT; IBM_TDB	OR	ON	2008/04/04 08:41
S85	20	"09866101"	US-PGPUB; USPAT; USOCR; FPRS; EPO; JPO; DERWENT; IBM_TDB	OR	ON	2008/04/04 08:48
S86	1	"9866101"	US-PGPUB; USPAT; USOCR; FPRS; EPO; JPO; DERWENT; IBM_TDB	OR	ON	2008/04/04 08:48

S87	1	S85 and @ad<="20010607"	US-PGPUB; USPAT; USOCR; FPRS; EPO; JPO; DERWENT; IBM_TDB	OR	ON	2008/04/04 08:52
S88	2	"20030163597".pn.	US-PGPUB; USPAT; USOCR; FPRS; EPO; JPO; DERWENT; IBM_TDB	OR	ON	2008/04/04 08:54
S89	64	(state near (variable machine table)) with metadata	US-PGPUB; USPAT; USOCR; FPRS; EPO; JPO; DERWENT; IBM_TDB	OR	ON	2008/04/04 11:27
S90	25	S89 and (Derived derivation derivable derivative derive inherit\$4)	US-PGPUB; USPAT; USOCR; FPRS; EPO; JPO; DERWENT; IBM_TDB	OR	ON	2008/04/04 11:27
S91	0	S90 and @ad<="20010607"	US-PGPUB; USPAT; USOCR; FPRS; EPO; JPO; DERWENT; IBM_TDB	OR	ON	2008/04/04 11:27
S92	65	(state near (variable machine table diagram)) with metadata	US-PGPUB; USPAT; USOCR; FPRS; EPO; JPO; DERWENT; IBM_TDB	OR	ON	2008/04/04 11:30
S93	8	S92 and @ad<="20010607"	US-PGPUB; USPAT; USOCR; FPRS; EPO; JPO; DERWENT; IBM_TDB	OR	ON	2008/04/04 11:30
S94	246	(US-20050060571-\$ or US-20020165724-\$ or US-20020069324-\$ or US-20060064666-\$ or US-20030163597-\$ or US-20010054180-\$ or US-20010053996-\$ or US-20010039571-\$).did. or (US-6389402-\$ or US-6363488-\$ or US-6345256-\$ or US-6330670-\$ or US-6327652-\$ or US-6301660-\$ or US-6292569-\$ or US-6266618-\$ or US-6253193-\$ or US-	US-PGPUB; USPAT; USOCR; EPO; DERWENT	OR	ON	2008/04/04 11:46

6240185-\$ or US-6237786-\$  
or US-6233684-\$ or US-  
6226618-\$ or US-6185683-\$  
or US-6157721-\$ or US-  
6138119-\$ or US-6115471-\$  
or US-6112181-\$ or US-  
6047067-\$ or US-5999949-\$  
or US-5982891-\$ or US-  
5949876-\$ or US-5943422-\$  
or US-5940504-\$ or US-  
5920861-\$ or US-5917912-\$).  
did. or (US-5915019-\$ or US-  
5910987-\$ or US-5892900-\$  
or US-5825892-\$ or US-  
5768426-\$ or US-5765152-\$  
or US-5761686-\$ or US-  
5757907-\$ or US-5748783-\$  
or US-5745569-\$ or US-  
5737416-\$ or US-5737413-\$  
or US-5734891-\$ or US-  
5734823-\$ or US-5715403-\$  
or US-5708717-\$ or US-  
5655077-\$ or US-5649013-\$  
or US-5638443-\$ or US-  
5634012-\$ or US-5633932-\$  
or US-5629980-\$ or US-  
5621797-\$ or US-5568552-\$  
or US-5563946-\$ or US-  
5539735-\$ or US-5534975-\$).  
did. or (US-5532920-\$ or US-  
5530235-\$ or US-5509070-\$  
or US-5504837-\$ or US-  
5504818-\$ or US-5504814-\$  
or US-5502766-\$ or US-  
5499298-\$ or US-5473692-\$  
or US-5473687-\$ or US-  
5457746-\$ or US-5455953-\$  
or US-5453601-\$ or US-  
5444779-\$ or US-5438508-\$  
or US-5432849-\$ or US-  
5428606-\$ or US-5412717-\$  
or US-5410598-\$ or US-  
5394469-\$ or US-5381526-\$  
or US-5347579-\$ or US-  
5341429-\$ or US-5339091-\$  
or US-5337357-\$ or US-  
5319705-\$ or US-5311591-\$).  
did. or (US-5301231-\$ or US-  
5291596-\$ or US-5276735-\$  
or US-5276444-\$ or US-  
5263158-\$ or US-5263157-\$  
or US-5260999-\$ or US-  
5255106-\$ or US-5247575-\$  
or US-5235642-\$ or US-  
5222134-\$ or US-5204897-\$  
or US-5191193-\$ or US-  
5183404-\$ or US-5159182-\$  
or US-5148481-\$ or US-  
5146499-\$ or US-5138712-\$  
or US-5136643-\$ or US-



5113519-\$ or US-5103476-\$  
or US-5058164-\$ or US-  
5052040-\$ or US-5050213-\$  
or US-5047928-\$ or US-  
5023907-\$ or US-5014234-\$).  
did. or (US-5010571-\$ or US-  
4999806-\$ or US-4977594-\$  
or US-4975647-\$ or US-  
4961142-\$ or US-4953209-\$  
or US-4949187-\$ or US-  
4937863-\$ or US-4932054-\$  
or US-4924378-\$ or US-  
4891838-\$ or US-4868376-\$  
or US-4827508-\$ or US-  
4817140-\$ or US-4796220-\$  
or US-4713753-\$ or US-  
4658093-\$ or US-4644493-\$  
or US-4614861-\$ or US-  
4593376-\$ or US-4558176-\$  
or US-4529870-\$ or US-  
4442486-\$ or US-4323921-\$  
or US-4278837-\$ or US-  
4220991-\$ or US-4159468-\$).  
did. or (US-3798605-\$ or US-  
3790700-\$ or US-3609697-\$  
or US-3263158-\$ or US-  
6298316-\$ or US-6135646-\$  
or US-6161114-\$ or US-  
5956737-\$ or US-5109413-\$  
or US-6098056-\$ or US-  
6125349-\$ or US-6385596-\$  
or US-6366904-\$ or US-  
7133845-\$ or US-7120800-\$  
or US-7095854-\$ or US-  
7076652-\$ or US-7069451-\$  
or US-6948070-\$ or US-  
6427140-\$ or US-6850252-\$  
or US-7130807-\$ or US-  
7124101-\$ or US-6671818-\$  
or US-6606744-\$ or US-  
6442684-\$ or US-6158001-\$).  
did. or (US-5996073-\$).did.  
or (US-3263158-\$).did. or  
(DE-4323921-\$ or DE-  
3609697-\$).did. or (EP-  
1308115-A-\$ or EP-1180798-  
A-\$ or JP-2002016565-\$ or  
US-6330670-B-\$ or US-  
6327652-B-\$ or WO-0008909-  
A-\$ or FR-2772486-A-\$ or  
WO-9924928-A-\$ or EP-  
895149-A-\$ or WO-9840969-  
A-\$ or EP-862318-A-\$ or WO-  
9837481-A-\$ or JP-10214297-  
\$ or US-5761686-\$ or EP-  
838785-A-\$ or US-5737413-\$  
or US-5734823-\$ or WO-  
9809209-A-\$ or WO-  
9743761-A-\$ or US-5655077-  
\$ or WO-9726732-A-\$ or US-

5649013-\$ or WO-9720298-A-\$ or US-5633932-\$ or WO-9714087-A-\$ or WO-9636163-A-\$).did. or (WO-9633476-A-\$ or US-5568552-\$ or WO-9627155-A-\$ or US-5539735-\$ or US-5534975-\$ or US-5530235-\$ or EP-715246-A-\$ or EP-715245-A-\$ or EP-715244-A-\$ or EP-715243-A-\$ or DE-4442486-A-\$ or US-5509070-\$ or US-5504814-\$ or US-5473692-\$ or US-5473687-\$ or WO-9530211-A-\$ or EP-679980-A-\$ or EP-679978-A-\$ or EP-679977-A-\$ or EP-672991-A-\$ or US-5428606-\$ or WO-9514289-A-\$ or CA-2102743-\$ or EP-649074-A-\$ or WO-9508231-A-\$ or US-5394469-\$ or DE-4323921-A-\$).did. or (WO-9427411-A-\$ or WO-9419884-A-\$ or US-5337357-\$ or JP-06181924-\$ or EP-601500-A-\$ or US-5319705-\$ or JP-06095591-\$ or EP-588243-A-\$ or EP-575936-A-\$ or EP-570123-A-\$ or EP-567800-A-\$ or WO-9321581-A-\$ or EP-555715-A-\$ or US-5235642-\$ or US-5291596-\$ or EP-542298-A-\$ or WO-9309490-A-\$ or EP-534679-A-\$ or US-5183404-\$ or WO-9301550-A-\$ or WO-9220022-A-\$ or WO-9214187-A-\$ or US-5136643-\$ or WO-9209160-A-\$ or US-5103476-\$ or EP-471939-\$ or US-5058164-\$).did. or (US-5052040-\$ or EP-447339-\$ or US-5047928-\$ or EP-442838-\$ or US-5023907-\$ or EP-425053-\$ or EP-423035-\$ or GB-2236604-\$ or EP-421409-\$ or US-4999806-\$ or EP-398494-\$ or US-4961142-\$ or US-4949187-\$ or DE-3903454-\$ or EP-367700-\$ or EP-366854-\$ or US-4924378-\$ or CA-1267443-\$ or EP-359220-\$ or WO-9002382-\$ or US-4891838-\$ or EP-332304-\$ or US-4796220-\$ or WO-8809019-\$ or EP-266748-\$ or WO-8802960-\$ or WO-8802202-\$).did. or

		(EP-252646-\$ or DE-3609697-\$ or US-4658093-\$ or EP-192243-\$ or US-4593376-\$ or WO-8603040-\$ or EP-174472-\$ or US-4558176-\$ or US-4529870-\$ or EP-80244-\$ or US-4368162-\$ or US-4278837-\$ or WO-8001635-\$ or DE-2849718-\$ or DE-2840980-\$ or US-3798605-\$).did.				
S95	7	S94 and (state near (variable machine table diagram)) with metadata	US-PGPUB; USPAT; USOCR; FPRS; EPO; JPO; DERWENT; IBM_TDB	OR	ON	2008/04/04 11:47
S96	1	S95 and (Derived derivation derivable derivative derive inherit\$4)	US-PGPUB; USPAT; USOCR; FPRS; EPO; JPO; DERWENT; IBM_TDB	OR	ON	2008/04/04 11:49
S97	0	S95 and license	US-PGPUB; USPAT; USOCR; FPRS; EPO; JPO; DERWENT; IBM_TDB	OR	ON	2008/04/04 11:51
S98	16931	(Derived derivation derivable derivative derive inherit\$4) with rights	US-PGPUB; USPAT; USOCR; FPRS; EPO; JPO; DERWENT; IBM_TDB	OR	ON	2008/04/04 11:58
S99	440	S98 and metadata	US-PGPUB; USPAT; USOCR; FPRS; EPO; JPO; DERWENT; IBM_TDB	OR	ON	2008/04/04 11:59
S100	1	S98 and (state near (variable machine table diagram)) with metadata	US-PGPUB; USPAT; USOCR; FPRS; EPO; JPO; DERWENT; IBM_TDB	OR	ON	2008/04/04 11:59
S101	2	S98 and (state near (variable machine table diagram)) same metadata	US-PGPUB; USPAT; USOCR; FPRS; EPO; JPO; DERWENT; IBM_TDB	OR	ON	2008/04/04 12:00

S102	116	S98 and (state near (variable machine table diagram)) and metadata	US-PGPUB; USPAT; USOCR; FPRS; EPO; JPO; DERWENT; IBM_TDB	OR	ON	2008/04/04 12:00
S103	97	S102 and license	US-PGPUB; USPAT; USOCR; FPRS; EPO; JPO; DERWENT; IBM_TDB	OR	ON	2008/04/04 12:01
S104	22	S103 and @ad<="20010607"	US-PGPUB; USPAT; USOCR; FPRS; EPO; JPO; DERWENT; IBM_TDB	OR	ON	2008/04/04 12:01
S105	10	S102 and drm	US-PGPUB; USPAT; USOCR; FPRS; EPO; JPO; DERWENT; IBM_TDB	OR	ON	2008/04/04 12:13
S106	0	S105 and @ad<="20010607"	US-PGPUB; USPAT; USOCR; FPRS; EPO; JPO; DERWENT; IBM_TDB	OR	ON	2008/04/04 12:13
S107	22	S104 and (Derived derivation derivable derivative derive inherit\$4) with rights	US-PGPUB; USPAT; USOCR; FPRS; EPO; JPO; DERWENT; IBM_TDB	OR	ON	2008/04/04 12:26
S108	0	S104 and (Derived derivation derivable derivative derive inherit\$4) near rights	US-PGPUB; USPAT; USOCR; FPRS; EPO; JPO; DERWENT; IBM_TDB	OR	ON	2008/04/04 12:26
S109	0	S104 and (Derived derivation derivable derivative derive inherit\$4) near (rights product)	US-PGPUB; USPAT; USOCR; FPRS; EPO; JPO; DERWENT; IBM_TDB	OR	ON	2008/04/04 12:27
S110	0	S104 and ((Derived derivation derivable derivative derive inherit\$4) near (rights product))	US-PGPUB; USPAT; USOCR; FPRS; EPO; JPO; DERWENT; IBM_TDB	OR	ON	2008/04/04 12:27

S111	37700	((Derived derivation derivable derivative derive inherit\$4) near (rights product))	US-PGPUB; USPAT; USOCR; FPRS; EPO; JPO; DERWENT; IBM_TDB	OR	ON	2008/04/04 12:27
S112	42471	((Derived derivation derivable derivative derive inherit\$4) near (rights product content))	US-PGPUB; USPAT; USOCR; FPRS; EPO; JPO; DERWENT; IBM_TDB	OR	ON	2008/04/04 12:28
S113	0	S112 and (state near (variable machine table diagram)) with metadata	US-PGPUB; USPAT; USOCR; FPRS; EPO; JPO; DERWENT; IBM_TDB	OR	ON	2008/04/04 12:28
S114	605	S112 and ((digital near rights) (rights near management) drm (content near right))	US-PGPUB; USPAT; USOCR; FPRS; EPO; JPO; DERWENT; IBM_TDB	OR	ON	2008/04/04 12:29
S115	200	S114 and metadata	US-PGPUB; USPAT; USOCR; FPRS; EPO; JPO; DERWENT; IBM_TDB	OR	ON	2008/04/04 12:30
S116	0	S115 and (state near (variable machine table diagram)) with metadata	US-PGPUB; USPAT; USOCR; FPRS; EPO; JPO; DERWENT; IBM_TDB	OR	ON	2008/04/04 12:30
S117	48	S115 and (state near (variable machine table diagram))	US-PGPUB; USPAT; USOCR; FPRS; EPO; JPO; DERWENT; IBM_TDB	OR	ON	2008/04/04 12:30
S119	21	S117 and @ad<="20010607"	US-PGPUB; USPAT; USOCR; FPRS; EPO; JPO; DERWENT; IBM_TDB	OR	ON	2008/04/04 12:31
S120	53061	"rights expression language" prep	US-PGPUB; USPAT; USOCR; FPRS; EPO; JPO; DERWENT; IBM_TDB	OR	ON	2008/04/04 12:47

S121	119	S120 and metadata	US-PGPUB; USPAT; USOCR; FPRS; EPO; JPO; DERWENT; IBM_TDB	OR	ON	2008/04/04 12:48
S122	29	S121 and (state near (variable machine table diagram))	US-PGPUB; USPAT; USOCR; FPRS; EPO; JPO; DERWENT; IBM_TDB	OR	ON	2008/04/04 12:48
S123	5	S122 and @ad<="20010607"	US-PGPUB; USPAT; USOCR; FPRS; EPO; JPO; DERWENT; IBM_TDB	OR	ON	2008/04/04 12:48
S124	163	"rights expression language"	US-PGPUB; USPAT; USOCR; FPRS; EPO; JPO; DERWENT; IBM_TDB	OR	ON	2008/04/04 12:50
S125	56	S124 and metadata	US-PGPUB; USPAT; USOCR; FPRS; EPO; JPO; DERWENT; IBM_TDB	OR	ON	2008/04/04 12:50
S126	8	S125 and (state near (variable machine table diagram))	US-PGPUB; USPAT; USOCR; FPRS; EPO; JPO; DERWENT; IBM_TDB	OR	ON	2008/04/04 12:50
S127	0	S126 and @ad<="20010607"	US-PGPUB; USPAT; USOCR; FPRS; EPO; JPO; DERWENT; IBM_TDB	OR	ON	2008/04/04 12:50
S128	225	"rights expression language" "open digital rights language" odrl	US-PGPUB; USPAT; USOCR; FPRS; EPO; JPO; DERWENT; IBM_TDB	OR	ON	2008/04/04 12:54
S129	74	S128 and metadata	US-PGPUB; USPAT; USOCR; FPRS; EPO; JPO; DERWENT; IBM_TDB	OR	ON	2008/04/04 12:54

S130	8	S129 and (state near (variable machine table diagram))	US-PGPUB; USPAT; USOCR; FPRS; EPO; JPO; DERWENT; IBM_TDB	OR	ON	2008/04/04 12:55
S131	0	S130 and @ad<="20010607"	US-PGPUB; USPAT; USOCR; FPRS; EPO; JPO; DERWENT; IBM_TDB	OR	ON	2008/04/04 12:55
S132	219	drm and ((Derived derivation derivable derivative derive inherit\$4) with rights)	US-PGPUB; USPAT; USOCR; FPRS; EPO; JPO; DERWENT; IBM_TDB	OR	ON	2008/04/04 13:03
S133	35	S132 and (state near (variable machine table diagram))	US-PGPUB; USPAT; USOCR; FPRS; EPO; JPO; DERWENT; IBM_TDB	OR	ON	2008/04/04 13:04
S134	10	S133 and metadata	US-PGPUB; USPAT; USOCR; FPRS; EPO; JPO; DERWENT; IBM_TDB	OR	ON	2008/04/04 13:04
S135	0	S134 and @ad<="20010607"	US-PGPUB; USPAT; USOCR; FPRS; EPO; JPO; DERWENT; IBM_TDB	OR	ON	2008/04/04 13:06
S136	171	S114 and @ad<="20010607"	US-PGPUB; USPAT; USOCR; FPRS; EPO; JPO; DERWENT; IBM_TDB	OR	ON	2008/04/04 13:07
S137	39	S136 and metadata	US-PGPUB; USPAT; USOCR; FPRS; EPO; JPO; DERWENT; IBM_TDB	OR	ON	2008/04/04 13:07
S138	21	S137 and (state near (variable machine table diagram))	US-PGPUB; USPAT; USOCR; FPRS; EPO; JPO; DERWENT; IBM_TDB	OR	ON	2008/04/04 13:09

S139	48	"5619570"	US-PGPUB; USPAT; USOCR; FPRS; EPO; JPO; DERWENT; IBM_TDB	OR	ON	2008/10/12 19:09
S140	6	ep and "0262025"	US-PGPUB; USPAT; USOCR; FPRS; EPO; JPO; DERWENT; IBM_TDB	OR	ON	2008/10/12 19:11
S141	0	ep0262025	US-PGPUB; USPAT; USOCR; FPRS; EPO; JPO; DERWENT; IBM_TDB	OR	ON	2008/10/12 19:11
S142	2	jp and "3063717"	US-PGPUB; USPAT; USOCR; FPRS; EPO; JPO; DERWENT; IBM_TDB	OR	ON	2008/10/12 19:12
S143	0	jp and "3-063717"	US-PGPUB; USPAT; USOCR; FPRS; EPO; JPO; DERWENT; IBM_TDB	OR	ON	2008/10/12 19:12
S144	2	"5619570".pn.	US-PGPUB; USPAT; USOCR; FPRS; EPO; JPO; DERWENT; IBM_TDB	OR	ON	2008/10/12 19:16
S145	2485	(state adj machine) and (state adj variable)	US-PGPUB; USPAT; USOCR; FPRS; EPO; JPO; DERWENT; IBM_TDB	OR	ON	2008/10/12 21:51
S146	1009	S145 and @ad<="20010607"	US-PGPUB; USPAT; USOCR; FPRS; EPO; JPO; DERWENT; IBM_TDB	OR	ON	2008/10/12 21:52
S147	6	S146 and metadata	US-PGPUB; USPAT; USOCR; FPRS; EPO; JPO; DERWENT; IBM_TDB	OR	ON	2008/10/12 21:52



S148	0	S147 and ((derive derivable) near right)	US-PGPUB; USPAT; USOCR; FPRS; EPO; JPO; DERWENT; IBM_TDB	OR	ON	2008/10/12 21:53
S149	5	S147 and right	US-PGPUB; USPAT; USOCR; FPRS; EPO; JPO; DERWENT; IBM_TDB	OR	ON	2008/10/12 21:53
S150	374	(state adj machine) with (state adj variable)	US-PGPUB; USPAT; USOCR; FPRS; EPO; JPO; DERWENT; IBM_TDB	OR	ON	2008/10/12 21:55
S151	54	(state adj machine) near (state adj variable)	US-PGPUB; USPAT; USOCR; FPRS; EPO; JPO; DERWENT; IBM_TDB	OR	ON	2008/10/12 21:55
S152	25	S151 and @ad<="20010607"	US-PGPUB; USPAT; USOCR; FPRS; EPO; JPO; DERWENT; IBM_TDB	OR	ON	2008/10/12 21:55
S153	0	S152 and metadata	US-PGPUB; USPAT; USOCR; FPRS; EPO; JPO; DERWENT; IBM_TDB	OR	ON	2008/10/12 21:56
S154	0	S153 and rights	US-PGPUB; USPAT; USOCR; FPRS; EPO; JPO; DERWENT; IBM_TDB	OR	ON	2008/10/12 21:56
S155	2	(US-6044466-\$ or US-6397355-\$).did.	USPAT	OR	ON	2010/02/24 10:03
S156	2	S155 and generat\$3	US-PGPUB; USPAT; USOCR; FPRS; EPO; JPO; DERWENT; IBM_TDB	OR	ON	2010/02/24 10:04

S157	1	S155 and (right near (offer\$3 grant\$3 negotiat\$3 obtain\$3 transfer delegat\$3 expos\$3 archiv\$3 compil\$3 track\$3 surrend\$3 exchang\$3 revok\$3 modif\$7))	US-PGPUB; USPAT; USOCR; FPRS; EPO; JPO; DERWENT; IBM_TDB	OR	ON	2010/02/24 10:16
S158	1	S155 and (right near (dynamic offer\$3 grant\$3 negotiat\$3 obtain\$3 transfer delegat\$3 expos\$3 archiv\$3 compil\$3 track\$3 surrend\$3 exchang\$3 revok\$3 modif\$7))	US-PGPUB; USPAT; USOCR; FPRS; EPO; JPO; DERWENT; IBM_TDB	OR	ON	2010/02/24 10:49

**3/13/2010 2:47:41 PM**

**C:\Documents and Settings\twest\My Documents\EAST\Workspaces\10\_9\56121 - Wang\56121 - Wang.wsp**

**EAST Search History****EAST Search History (Interference)**

Ref #	Hits	Search Query	DBs	Default Operator	Plurals	Time Stamp
L7	80	726/27.ccls.	UPAD	OR	ON	2010/03/13 14:46
L8	0	7 and @ad<="20010607"	UPAD	OR	ON	2010/03/13 14:47

**3/ 13/ 2010 2:48:37 PM****C:\ Documents and Settings\ twest\ My Documents\ EAST\ Workspaces\ 10\_9\ 56121 - Wang\ 56121 - Wang.wsp**

<b>Issue Classification</b> 	<b>Application/Control No.</b> 10956121	<b>Applicant(s)/Patent Under Reexamination</b> WANG ET AL.
	<b>Examiner</b> THOMAS WEST	<b>Art Unit</b> 3621

ORIGINAL						INTERNATIONAL CLASSIFICATION											
CLASS			SUBCLASS			CLAIMED				NON-CLAIMED							
705			59			G	0	6	F	7 / 04 (2006.01.01)							
CROSS REFERENCE(S)						G	0	6	F	7 / 30 ()							
						H	0	4	N	7 / 16 (2006.01.01)							
CLASS	SUBCLASS (ONE SUBCLASS PER BLOCK)																
726	27																

<input checked="" type="checkbox"/> Claims renumbered in the same order as presented by applicant <input type="checkbox"/> CPA <input type="checkbox"/> T.D. <input type="checkbox"/> R.1.47															
Final	Original	Final	Original	Final	Original	Final	Original	Final	Original	Final	Original	Final	Original	Final	Original

/THOMAS WEST/ Examiner.Art Unit 3621  (Assistant Examiner)	03/13/2010  (Date)	<b>Total Claims Allowed:</b>  36	
/ANDREW J. FISCHER/ Supervisory Patent Examiner.Art Unit 3621  (Primary Examiner)	03/24/2010  (Date)	O.G. Print Claim(s)  1	O.G. Print Figure  1

<b>Search Notes</b>  	<b>Application/Control No.</b>  10956121	<b>Applicant(s)/Patent Under Reexamination</b>  WANG ET AL.
	<b>Examiner</b>  THOMAS WEST	<b>Art Unit</b>  3621

<b>SEARCHED</b>			
<b>Class</b>	<b>Subclass</b>	<b>Date</b>	<b>Examiner</b>
705	50-79	3/13/2010	Thomas West.

<b>SEARCH NOTES</b>		
<b>Search Notes</b>	<b>Date</b>	<b>Examiner</b>
EAST	3/13/2010	.
Dialog Search, see attached search history	3/13/2010	

<b>INTERFERENCE SEARCH</b>			
<b>Class</b>	<b>Subclass</b>	<b>Date</b>	<b>Examiner</b>
726	27	3/13/2010	

/THOMAS WEST/ Examiner.Art Unit 3621	
---	--



Search History Sat Mar 13 13:43:05 CST 2010

Set #	Hits	Query	Databases(s)
L1	385	(digital near right) and (creat\$3 near right)	Core FT1 250 Core FT2 128 Sub35FT 7
L2	0	l1 and (state near variable)	Core FT1 0 Core FT2 0 Sub35FT 0

**Legend**

Core FT1

- Business & Industry™, File 9 (1994 - present)
- ABI/INFORM®, File 15 (1971 - present)
- Gale Group PROMT®, File 16 (1990 - present)
- Gale Group Trade & Industry Database™, File 148 (1976 - present)
- Gale Group PROMT®, File 160 (1972-1989)
- Gale Group Computer Database™, File 275 (full-text 1/1988 - present)
- Business Wire, File 610 (Mar 1999 - present)
- Business Wire, File 810 (1986 - February 1999)

Core FT2

- Dialog Global Reporter, File 20 (May 1997 - present)
- The McGraw-Hill Companies Publications Online, File 624 (1985 - present)
- Gale Group New Product Announcements/ Plus® (NPA/Plus, File 621 (1985 - present)
- Gale Group Newsletter Database™, File 636 (1988 - present)
- PR Newswire, File 613 (May 1999 - present)
- San Jose Mercury News, File 634 (Jun 1985 - present)
- PR Newswire, File 813 (May 1987 - May 1999)

Sub35FT

- McClatchy-Tribune Information Service, File 608 (Jan 1989 - present)
- American Banker Financial Publications, File 625 (1981 - June 2008)
- Banking Information Source, File 268 full-text (1994 - present)
- Bond Buyer Full Text, File 626 (November 1981 - April 2008)
- DIALOG Finance & Banking Newsletters, File 267 (1996 - present)



Click on the History link to display a list of your search sessions conducted in the last 30 days. The sessions are grouped by date; using the plus sign, expand the files to review the search commands issued by session. To see the commands, click on the session you want to review. You can also right-click with your mouse on a specific session to rename, delete, or save to a local or network drive.

13-Mar-2010	
-------------	--

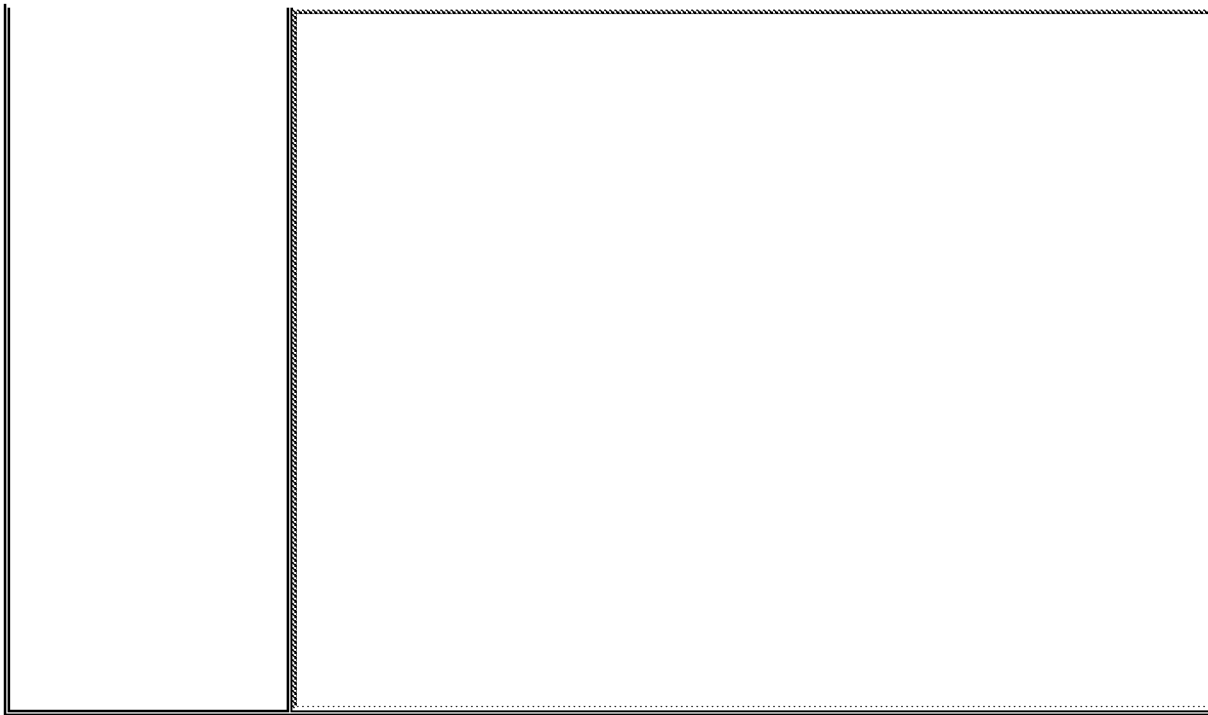



UNITED STATES PATENT AND TRADEMARK OFFICE

UNITED STATES DEPARTMENT OF COMMERCE
United States Patent and Trademark Office
Address: COMMISSIONER FOR PATENTS
P.O. Box 1450
Alexandria, Virginia 22313-1450
www.uspto.gov

Table with 7 columns: APPLICATION NUMBER, FILING or 371(c) DATE, GRP ART UNIT, FIL FEE REC'D, ATTY. DOCKET NO, TOT CLAIMS, IND CLAIMS. Row 1: 10/956,121, 10/04/2004, 3621, 1078, 111325-291300, 36, 3

CONFIRMATION NO. 8924

CORRECTED FILING RECEIPT



22204
NIXON PEABODY, LLP
401 9TH STREET, NW
SUITE 900
WASHINGTON, DC 20004-2128

Date Mailed: 05/26/2010

Receipt is acknowledged of this non-provisional patent application. The application will be taken up for examination in due course. Applicant will be notified as to the results of the examination. Any correspondence concerning the application must include the following identification information: the U.S. APPLICATION NUMBER, FILING DATE, NAME OF APPLICANT, and TITLE OF INVENTION. Fees transmitted by check or draft are subject to collection. Please verify the accuracy of the data presented on this receipt. If an error is noted on this Filing Receipt, please submit a written request for a Filing Receipt Correction. Please provide a copy of this Filing Receipt with the changes noted thereon. If you received a "Notice to File Missing Parts" for this application, please submit any corrections to this Filing Receipt with your reply to the Notice. When the USPTO processes the reply to the Notice, the USPTO will generate another Filing Receipt incorporating the requested corrections

Applicant(s)

- Mai Nguyen, Buena Park, CA;
Xin Wang, Torrance, CA;
Thanh Ta, Huntington Beach, CA;
Guillermo Lao, Torrance, CA;
Eddie J. Chen, Rancho Palos Verdes, CA;

Power of Attorney: The patent practitioners associated with Customer Number 22204

Domestic Priority data as claimed by applicant

This application is a CIP of 10/162,701 06/06/2002 which claims benefit of 60/331,624 11/20/2001 and claims benefit of 60/331,623 11/20/2001 and claims benefit of 60/331,621 11/20/2001 and claims benefit of 60/296,113 06/07/2001 and claims benefit of 60/296,117 06/07/2001 and claims benefit of 60/296,118 06/07/2001

Foreign Applications

If Required, Foreign Filing License Granted: 12/03/2004

The country code and number of your priority application, to be used for filing abroad under the Paris Convention, is US 10/956,121

Projected Publication Date: Not Applicable

Non-Publication Request: No

Early Publication Request: No



**Title**

SYSTEM AND METHOD FOR MANAGING TRANSFER OF RIGHTS USING SHARED STATE VARIABLES

**Preliminary Class**

705

**PROTECTING YOUR INVENTION OUTSIDE THE UNITED STATES**

Since the rights granted by a U.S. patent extend only throughout the territory of the United States and have no effect in a foreign country, an inventor who wishes patent protection in another country must apply for a patent in a specific country or in regional patent offices. Applicants may wish to consider the filing of an international application under the Patent Cooperation Treaty (PCT). An international (PCT) application generally has the same effect as a regular national patent application in each PCT-member country. The PCT process **simplifies** the filing of patent applications on the same invention in member countries, but **does not result** in a grant of "an international patent" and does not eliminate the need of applicants to file additional documents and fees in countries where patent protection is desired.

Almost every country has its own patent law, and a person desiring a patent in a particular country must make an application for patent in that country in accordance with its particular laws. Since the laws of many countries differ in various respects from the patent law of the United States, applicants are advised to seek guidance from specific foreign countries to ensure that patent rights are not lost prematurely.

Applicants also are advised that in the case of inventions made in the United States, the Director of the USPTO must issue a license before applicants can apply for a patent in a foreign country. The filing of a U.S. patent application serves as a request for a foreign filing license. The application's filing receipt contains further information and guidance as to the status of applicant's license for foreign filing.

Applicants may wish to consult the USPTO booklet, "General Information Concerning Patents" (specifically, the section entitled "Treaties and Foreign Patents") for more information on timeframes and deadlines for filing foreign patent applications. The guide is available either by contacting the USPTO Contact Center at 800-786-9199, or it can be viewed on the USPTO website at <http://www.uspto.gov/web/offices/pac/doc/general/index.html>.

For information on preventing theft of your intellectual property (patents, trademarks and copyrights), you may wish to consult the U.S. Government website, <http://www.stopfakes.gov>. Part of a Department of Commerce initiative, this website includes self-help "toolkits" giving innovators guidance on how to protect intellectual property in specific countries such as China, Korea and Mexico. For questions regarding patent enforcement issues, applicants may call the U.S. Government hotline at 1-866-999-HALT (1-866-999-4158).

**LICENSE FOR FOREIGN FILING UNDER****Title 35, United States Code, Section 184****Title 37, Code of Federal Regulations, 5.11 & 5.15****GRANTED**

The applicant has been granted a license under 35 U.S.C. 184, if the phrase "IF REQUIRED, FOREIGN FILING LICENSE GRANTED" followed by a date appears on this form. Such licenses are issued in all applications where

the conditions for issuance of a license have been met, regardless of whether or not a license may be required as set forth in 37 CFR 5.15. The scope and limitations of this license are set forth in 37 CFR 5.15(a) unless an earlier license has been issued under 37 CFR 5.15(b). The license is subject to revocation upon written notification. The date indicated is the effective date of the license, unless an earlier license of similar scope has been granted under 37 CFR 5.13 or 5.14.

This license is to be retained by the licensee and may be used at any time on or after the effective date thereof unless it is revoked. This license is automatically transferred to any related applications(s) filed under 37 CFR 1.53(d). This license is not retroactive.

The grant of a license does not in any way lessen the responsibility of a licensee for the security of the subject matter as imposed by any Government contract or the provisions of existing laws relating to espionage and the national security or the export of technical data. Licensees should apprise themselves of current regulations especially with respect to certain countries, of other agencies, particularly the Office of Defense Trade Controls, Department of State (with respect to Arms, Munitions and Implements of War (22 CFR 121-128)); the Bureau of Industry and Security, Department of Commerce (15 CFR parts 730-774); the Office of Foreign Assets Control, Department of Treasury (31 CFR Parts 500+) and the Department of Energy.

**NOT GRANTED**

No license under 35 U.S.C. 184 has been granted at this time, if the phrase "IF REQUIRED, FOREIGN FILING LICENSE GRANTED" DOES NOT appear on this form. Applicant may still petition for a license under 37 CFR 5.12, if a license is desired before the expiration of 6 months from the filing date of the application. If 6 months has lapsed from the filing date of this application and the licensee has not received any indication of a secrecy order under 35 U.S.C. 181, the licensee may foreign file the application pursuant to 37 CFR 5.15(b).

## Electronic Acknowledgement Receipt

<b>EFS ID:</b>	7904096
<b>Application Number:</b>	10956121
<b>International Application Number:</b>	
<b>Confirmation Number:</b>	8924
<b>Title of Invention:</b>	SYSTEM AND METHOD FOR MANAGING TRANSFER OF RIGHTS USING SHARED STATE VARIABLES
<b>First Named Inventor/Applicant Name:</b>	Mai Nguyen
<b>Customer Number:</b>	22204
<b>Filer:</b>	Stephen M. Hertzler
<b>Filer Authorized By:</b>	
<b>Attorney Docket Number:</b>	111325-291300
<b>Receipt Date:</b>	28-JUN-2010
<b>Filing Date:</b>	04-OCT-2004
<b>Time Stamp:</b>	14:25:38
<b>Application Type:</b>	Utility under 35 USC 111(a)

### Payment information:

Submitted with Payment	yes
Payment Type	Deposit Account
Payment was successfully received in RAM	\$1819
RAM confirmation Number	685
Deposit Account	192380
Authorized User	

The Director of the USPTO is hereby authorized to charge indicated fees and credit any overpayment as follows:

Charge any Additional Fees required under 37 C.F.R. Section 1.20 (Post Issuance fees)

Charge any Additional Fees required under 37 C.F.R. Section 1.21 (Miscellaneous fees and charges)

<b>File Listing:</b>					
<b>Document Number</b>	<b>Document Description</b>	<b>File Name</b>	<b>File Size(Bytes)/ Message Digest</b>	<b>Multi Part /.zip</b>	<b>Pages (if appl.)</b>
1	Issue Fee Payment (PTO-85B)	111325-291300_- _Issue_Fee_Transmittal.pdf	1026480  7db7b674915b685441bd3f6a5ca2d24ea7030b0d	no	1
<b>Warnings:</b>					
<b>Information:</b>					
2	Fee Worksheet (PTO-875)	fee-info.pdf	33833  bd520ddcb870024ae25fe7aef741c1d8262eab3d	no	2
<b>Warnings:</b>					
<b>Information:</b>					
<b>Total Files Size (in bytes):</b>			1060313		
<p><b>This Acknowledgement Receipt evidences receipt on the noted date by the USPTO of the indicated documents, characterized by the applicant, and including page counts, where applicable. It serves as evidence of receipt similar to a Post Card, as described in MPEP 503.</b></p> <p><b><u>New Applications Under 35 U.S.C. 111</u></b>  <b>If a new application is being filed and the application includes the necessary components for a filing date (see 37 CFR 1.53(b)-(d) and MPEP 506), a Filing Receipt (37 CFR 1.54) will be issued in due course and the date shown on this Acknowledgement Receipt will establish the filing date of the application.</b></p> <p><b><u>National Stage of an International Application under 35 U.S.C. 371</u></b>  <b>If a timely submission to enter the national stage of an international application is compliant with the conditions of 35 U.S.C. 371 and other applicable requirements a Form PCT/DO/EO/903 indicating acceptance of the application as a national stage submission under 35 U.S.C. 371 will be issued in addition to the Filing Receipt, in due course.</b></p> <p><b><u>New International Application Filed with the USPTO as a Receiving Office</u></b>  <b>If a new international application is being filed and the international application includes the necessary components for an international filing date (see PCT Article 11 and MPEP 1810), a Notification of the International Application Number and of the International Filing Date (Form PCT/RO/105) will be issued in due course, subject to prescriptions concerning national security, and the date shown on this Acknowledgement Receipt will establish the international filing date of the application.</b></p>					

## Electronic Patent Application Fee Transmittal

<b>Application Number:</b>	10956121
<b>Filing Date:</b>	04-Oct-2004
<b>Title of Invention:</b>	SYSTEM AND METHOD FOR MANAGING TRANSFER OF RIGHTS USING SHARED STATE VARIABLES
<b>First Named Inventor/Applicant Name:</b>	Mai Nguyen
<b>Filer:</b>	Stephen M. Hertzler/Lynette James
<b>Attorney Docket Number:</b>	111325-291300

Filed as Large Entity

### Utility under 35 USC 111(a) Filing Fees

Description	Fee Code	Quantity	Amount	Sub-Total in USD(\$)
<b>Basic Filing:</b>				
<b>Pages:</b>				
<b>Claims:</b>				
<b>Miscellaneous-Filing:</b>				
<b>Petition:</b>				
<b>Patent-Appeals-and-Interference:</b>				
<b>Post-Allowance-and-Post-Issuance:</b>				
Utility Appl issue fee	1501	1	1510	1510
Publ. Fee- early, voluntary, or normal	1504	1	300	300

Description	Fee Code	Quantity	Amount	Sub-Total in USD(\$)
<b>Extension-of-Time:</b>				
<b>Miscellaneous:</b>				
Printed copy of patent - no color	8001	3	3	9
<b>Total in USD (\$)</b>				<b>1819</b>

**PART B - FEE(S) TRANSMITTAL**

Complete and send this form, together with applicable fee(s), to: **Mail** Mail Stop ISSUE FEE  
**Commissioner for Patents**  
**P.O. Box 1450**  
**Alexandria, Virginia 22313-1450**  
**or Fax** (571)-273-2885

**INSTRUCTIONS:** This form should be used for transmitting the ISSUE FEE and PUBLICATION FEE (if required). Blocks 1 through 5 should be completed where appropriate. All further correspondence including the Patent, advance orders and notification of maintenance fees will be mailed to the current correspondence address as indicated unless corrected below or directed otherwise in Block 1, by (a) specifying a new correspondence address; and/or (b) indicating a separate "FEE ADDRESS" for maintenance fee notifications.

CURRENT CORRESPONDENCE ADDRESS (Note: Use Block 1 for any change of address)

Note: A certificate of mailing can only be used for domestic mailings of the Fee(s) Transmittal. This certificate cannot be used for any other accompanying papers. Each additional paper, such as an assignment or formal drawing, must have its own certificate of mailing or transmission.

22204 7590 03/29/2010

**NIXON PEABODY, LLP**  
**401 9TH STREET, NW**  
**SUITE 900**  
**WASHINGTON, DC 20004-2128**

**Certificate of Mailing or Transmission**

I hereby certify that this Fee(s) Transmittal is being deposited with the United States Postal Service with sufficient postage for first class mail in an envelope addressed to the Mail Stop ISSUE FEE address above, or being facsimile transmitted to the USPTO (571) 273-2885, on the date indicated below.

(Depositor's name)
(Signature)
(Date)

APPLICATION NO.	FILING DATE	FIRST NAMED INVENTOR	ATTORNEY DOCKET NO.	CONFIRMATION NO.
10/956,121	10/04/2004	Xin Wang	111325-291300	8924

TITLE OF INVENTION: SYSTEM AND METHOD FOR MANAGING TRANSFER OF RIGHTS USING SHARED STATE VARIABLES

APPLN. TYPE	SMALL ENTITY	ISSUE FEE DUE	PUBLICATION FEE DUE	PREV. PAID ISSUE FEE	TOTAL FEE(S) DUE	DATE DUE
nonprovisional	NO	\$1510	\$300	\$0	\$1810	06/29/2010

EXAMINER	ART UNIT	CLASS-SUBCLASS
WEST, THOMAS C	3621	705-050000

1. Change of correspondence address or indication of "Fee Address" (37 CFR 1.363). <input type="checkbox"/> Change of correspondence address (or Change of Correspondence Address form PTO/SB/122) attached. <input type="checkbox"/> "Fee Address" indication (or "Fee Address" Indication form PTO/SB/47; Rev 03-02 or more recent) attached. Use of a Customer Number is required.	2. For printing on the patent front page, list (1) the names of up to 3 registered patent attorneys or agents OR, alternatively, (2) the name of a single firm (having as a member a registered attorney or agent) and the names of up to 2 registered patent attorneys or agents. If no name is listed, no name will be printed.	1 <u>NIXON PEABODY, LLP</u> 2 <u>Marc S. Kaufman</u> 3 <u>Stephen M. Hertzler</u>
---	---	---

3. ASSIGNEE NAME AND RESIDENCE DATA TO BE PRINTED ON THE PATENT (print or type)

PLEASE NOTE: Unless an assignee is identified below, no assignee data will appear on the patent. If an assignee is identified below, the document has been filed for recordation as set forth in 37 CFR 3.11. Completion of this form is NOT a substitute for filing an assignment.

(A) NAME OF ASSIGNEE ContentGuard Holdings, Inc. (B) RESIDENCE: (CITY and STATE OR COUNTRY) Wilmington, DE

Please check the appropriate assignee category or categories (will not be printed on the patent):  Individual  Corporation or other private group entity  Government

4a. The following fee(s) are submitted: <input checked="" type="checkbox"/> Issue Fee <input checked="" type="checkbox"/> Publication Fee (No small entity discount permitted) <input checked="" type="checkbox"/> Advance Order - # of Copies <u>3</u>	4b. Payment of Fee(s): (Please first reapply any previously paid issue fee shown above) <input type="checkbox"/> A check is enclosed. <input type="checkbox"/> Payment by credit card. Form PTO-2038 is attached. <input checked="" type="checkbox"/> The Director is hereby authorized to charge the required fee(s), any deficiency, or credit any overpayment, to Deposit Account Number <u>19-2380</u> (enclose an extra copy of this form).
--	---

5. Change in Entity Status (from status indicated above)

a. Applicant claims SMALL ENTITY status. See 37 CFR 1.27.  b. Applicant is no longer claiming SMALL ENTITY status. See 37 CFR 1.27(g)(2).

NOTE: The Issue Fee and Publication Fee (if required) will not be accepted from anyone other than the applicant; a registered attorney or agent; or the assignee or other party in interest as shown by the records of the United States Patent and Trademark Office.

Authorized Signature /Stephen M. Hertzler, Reg. No. 58,247/ Date June 28, 2010  
 Typed or printed name Stephen M. Hertzler Registration No. 58,247

This collection of information is required by 37 CFR 1.311. The information is required to obtain or retain a benefit by the public which is to file (and by the USPTO to process) an application. Confidentiality is governed by 35 U.S.C. 122 and 37 CFR 1.14. This collection is estimated to take 12 minutes to complete, including gathering, preparing, and submitting the completed application form to the USPTO. Time will vary depending upon the individual case. Any comments on the amount of time you require to complete this form and/or suggestions for reducing this burden, should be sent to the Chief Information Officer, U.S. Patent and Trademark Office, U.S. Department of Commerce, P.O. Box 1450, Alexandria, Virginia 22313-1450. DO NOT SEND FEES OR COMPLETED FORMS TO THIS ADDRESS. SEND TO: Commissioner for Patents, P.O. Box 1450, Alexandria, Virginia 22313-1450.

Under the Paperwork Reduction Act of 1995, no persons are required to respond to a collection of information unless it displays a valid OMB control number.



UNITED STATES PATENT AND TRADEMARK OFFICE

UNITED STATES DEPARTMENT OF COMMERCE  
United States Patent and Trademark Office  
Address: COMMISSIONER FOR PATENTS  
P.O. Box 1450  
Alexandria, Virginia 22313-1450  
www.uspto.gov

APPLICATION NO.	ISSUE DATE	PATENT NO.	ATTORNEY DOCKET NO.	CONFIRMATION NO.
10/956,121	08/10/2010	7774280	111325-291300	8924

22204 7590 07/21/2010  
NIXON PEABODY, LLP  
401 9TH STREET, NW  
SUITE 900  
WASHINGTON, DC 20004-2128

**ISSUE NOTIFICATION**

The projected patent number and issue date are specified above.

**Determination of Patent Term Adjustment under 35 U.S.C. 154 (b)**  
(application filed on or after May 29, 2000)

The Patent Term Adjustment is 1529 day(s). Any patent to issue from the above-identified application will include an indication of the adjustment on the front page.

If a Continued Prosecution Application (CPA) was filed in the above-identified application, the filing date that determines Patent Term Adjustment is the filing date of the most recent CPA.

Applicant will be able to obtain more detailed information by accessing the Patent Application Information Retrieval (PAIR) WEB site (<http://pair.uspto.gov>).

Any questions regarding the Patent Term Extension or Adjustment determination should be directed to the Office of Patent Legal Administration at (571)-272-7702. Questions relating to issue and publication fee payments should be directed to the Application Assistance Unit (AAU) of the Office of Data Management (ODM) at (571)-272-4200.

APPLICANT(s) (Please see PAIR WEB site <http://pair.uspto.gov> for additional applicants):

Mai Nguyen, Buena Park, CA;  
Xin Wang, Torrance, CA;  
Thanh Ta, Huntington Beach, CA;  
Guillermo Lao, Torrance, CA;  
Eddie J. Chen, Rancho Palos Verdes, CA;



**POWER OF ATTORNEY TO PROSECUTE APPLICATIONS BEFORE THE USPTO**

I hereby revoke all previous powers of attorney given in the application identified in the attached statement under 37 CFR 3.73(b).

I hereby appoint:

Practitioners associated with the Customer Number:

98804

OR

Practitioner(s) named below (if more than ten patent practitioners are to be named, then a customer number must be used).

Name	Registration Number	Name	Registration Number

as attorney(s) or agent(s) to represent the undersigned before the United States Patent and Trademark Office (USPTO) in connection with any and all patent applications assigned only to the undersigned according to the USPTO assignment records or assignment documents attached to this form in accordance with 37 CFR 3.73(b).

Please change the correspondence address for the application identified in the attached statement under 37 CFR 3.73(b) to:

The address associated with Customer Number:

98804

OR

<input type="checkbox"/> Firm or Individual Name			
Address			
City	State	Zip	
Country			
Telephone	Email		

Assignee Name and Address:

ContentGuard Holdings, Inc.  
222 N. Sepulveda Blvd., Suite 1400  
El Segundo, CA 90245

A copy of this form, together with a statement under 37 CFR 3.73(b) (Form PTO/SB/96 or equivalent) is required to be filed in each application in which this form is used. The statement under 37 CFR 3.73(b) may be completed by one of the practitioners appointed in this form if the appointed practitioner is authorized to act on behalf of the assignee, and must identify the application in which this Power of Attorney is to be filed.

**SIGNATURE of Assignee of Record**

The individual whose signature and title is supplied below is authorized to act on behalf of the assignee

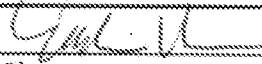
Signature		Date	9/16/2010
Name	Eddie Chen	Telephone	
Title	Chief Technology Officer		

This collection of information is required by 37 CFR 1.31, 1.32 and 1.33. The information is required to obtain or retain a benefit by the public which is to file (and by the USPTO to process) an application. Confidentiality is governed by 35 U.S.C. 122 and 37 CFR 1.11 and 1.14. This collection is estimated to take 3 minutes to complete, including gathering, preparing, and submitting the completed application form to the USPTO. Time will vary depending upon the individual case. Any comments on the amount of time you require to complete this form and/or suggestions for reducing this burden, should be sent to the Chief Information Officer, U.S. Patent and Trademark Office, U.S. Department of Commerce, P.O. Box 1450, Alexandria, VA 22313-1450. **DO NOT SEND FEES OR COMPLETED FORMS TO THIS ADDRESS. SEND TO: Commissioner for Patents, P.O. Box 1450, Alexandria, VA 22313-1450.**

If you need assistance in completing the form, call 1-800-PTO-9199 and select option 2.

## Privacy Act Statement

The **Privacy Act of 1974 (P.L. 93-579)** requires that you be given certain information in connection with your submission of the attached form related to a patent application or patent. Accordingly, pursuant to the requirements of the Act, please be advised that: (1) the general authority for the collection of this information is 35 U.S.C. 2(b)(2); (2) furnishing of the information solicited is voluntary; and (3) the principal purpose for which the information is used by the U.S. Patent and Trademark Office is to process and/or examine your submission related to a patent application or patent. If you do not furnish the requested information, the U.S. Patent and Trademark Office may not be able to process and/or examine your submission, which may result in termination of proceedings or abandonment of the application or expiration of the patent.

The information provided by you in this form will be subject to the following routine uses:

1. The information on this form will be treated confidentially to the extent allowed under the Freedom of Information Act (5 U.S.C. 552) and the Privacy Act (5 U.S.C. 552a). Records from this system of records may be disclosed to the Department of Justice to determine whether disclosure of these records is required by the Freedom of Information Act.
2. A record from this system of records may be disclosed, as a routine use, in the course of presenting evidence to a court, magistrate, or administrative tribunal, including disclosures to opposing counsel in the course of settlement negotiations.
3. A record in this system of records may be disclosed, as a routine use, to a Member of Congress submitting a request involving an individual, to whom the record pertains, when the individual has requested assistance from the Member with respect to the subject matter of the record.
4. A record in this system of records may be disclosed, as a routine use, to a contractor of the Agency having need for the information in order to perform a contract. Recipients of information shall be required to comply with the requirements of the Privacy Act of 1974, as amended, pursuant to 5 U.S.C. 552a(m).
5. A record related to an International Application filed under the Patent Cooperation Treaty in this system of records may be disclosed, as a routine use, to the International Bureau of the World Intellectual Property Organization, pursuant to the Patent Cooperation Treaty.
6. A record in this system of records may be disclosed, as a routine use, to another federal agency for purposes of National Security review (35 U.S.C. 181) and for review pursuant to the Atomic Energy Act (42 U.S.C. 218(c)).
7. A record from this system of records may be disclosed, as a routine use, to the Administrator, General Services, or his/her designee, during an inspection of records conducted by GSA as part of that agency's responsibility to recommend improvements in records management practices and programs, under authority of 44 U.S.C. 2904 and 2906. Such disclosure shall be made in accordance with the GSA regulations governing inspection of records for this purpose, and any other relevant (i.e., GSA or Commerce) directive. Such disclosure shall not be used to make determinations about individuals.
8. A record from this system of records may be disclosed, as a routine use, to the public after either publication of the application pursuant to 35 U.S.C. 122(b) or issuance of a patent pursuant to 35 U.S.C. 181. Further, a record may be disclosed, subject to the limitations of 37 CFR 1.14, as a routine use, to the public if the record was filed in an application which became abandoned or in which the proceedings were terminated and which application is referenced by either a published application, an application open to public inspection or an issued patent.
9. A record from this system of records may be disclosed, as a routine use, to a Federal, State, or local law enforcement agency, if the USPTO becomes aware of a violation or potential violation of law or regulation.

## Electronic Acknowledgement Receipt

<b>EFS ID:</b>	8499574
<b>Application Number:</b>	10956121
<b>International Application Number:</b>	
<b>Confirmation Number:</b>	8924
<b>Title of Invention:</b>	SYSTEM AND METHOD FOR MANAGING TRANSFER OF RIGHTS USING SHARED STATE VARIABLES
<b>First Named Inventor/Applicant Name:</b>	Mai Nguyen
<b>Customer Number:</b>	22204
<b>Filer:</b>	Stephen M. Hertzler
<b>Filer Authorized By:</b>	
<b>Attorney Docket Number:</b>	111325-291300
<b>Receipt Date:</b>	27-SEP-2010
<b>Filing Date:</b>	04-OCT-2004
<b>Time Stamp:</b>	21:01:33
<b>Application Type:</b>	Utility under 35 USC 111(a)

### Payment information:

Submitted with Payment	no
------------------------	----

### File Listing:

Document Number	Document Description	File Name	File Size(Bytes)/ Message Digest	Multi Part /.zip	Pages (if appl.)
1	Power of Attorney	291300POA.pdf	673384 <small>65bb8c41bc47cfc1f8d885dd454c9a76d2af7fb</small>	no	2

### Warnings:

### Information:

2	Miscellaneous Incoming Letter	291300AuthLetter.pdf	457176	no	1
			14f6b1acd391e279d24182bfff821898c15697ac0		

**Warnings:**

**Information:**

3	Assignee showing of ownership per 37 CFR 3.73(b).	291300_37CFR373_Certificate.pdf	434620	no	2
			bee15c0288f1dd727936c8a18b4aa7bc3d1bb42d		

**Warnings:**

**Information:**

<b>Total Files Size (in bytes):</b>			1565180		
-------------------------------------	--	--	---------	--	--

**This Acknowledgement Receipt evidences receipt on the noted date by the USPTO of the indicated documents, characterized by the applicant, and including page counts, where applicable. It serves as evidence of receipt similar to a Post Card, as described in MPEP 503.**

**New Applications Under 35 U.S.C. 111**

**If a new application is being filed and the application includes the necessary components for a filing date (see 37 CFR 1.53(b)-(d) and MPEP 506), a Filing Receipt (37 CFR 1.54) will be issued in due course and the date shown on this Acknowledgement Receipt will establish the filing date of the application.**

**National Stage of an International Application under 35 U.S.C. 371**

**If a timely submission to enter the national stage of an international application is compliant with the conditions of 35 U.S.C. 371 and other applicable requirements a Form PCT/DO/EO/903 indicating acceptance of the application as a national stage submission under 35 U.S.C. 371 will be issued in addition to the Filing Receipt, in due course.**

**New International Application Filed with the USPTO as a Receiving Office**

**If a new international application is being filed and the international application includes the necessary components for an international filing date (see PCT Article 11 and MPEP 1810), a Notification of the International Application Number and of the International Filing Date (Form PCT/RO/105) will be issued in due course, subject to prescriptions concerning national security, and the date shown on this Acknowledgement Receipt will establish the international filing date of the application.**

**AUTHORIZATION TO ACT ON BEHALF OF THE ASSIGNEE**

**UNDER 37 CFR 3.73(b)(2)(i)**

Commissioner for Patents  
P.O. Box 1450  
Alexandria, VA 22313-1450

Sir:

The practitioners associated with Customer Number 98804 have been authorized (or empowered) to act on behalf of ContentGuard Holdings, Inc. before the United States Patent and Trademark Office (i.e. to sign the enclosed submission on behalf of the assignee), pursuant to 37 CFR 3.73(b)(2)(i).

If any additional information is required in this regard, please contact the undersigned as soon as possible.

Respectfully submitted,

Date: September 16, 2010

/Stephen M. Hertzler, Reg. No. 58,247/  
Stephen M. Hertzler  
Registration No. 58,247

**REED SMITH LLP**  
CUSTOMER NO.: 98804  
1301 K Street N.W.  
Suite 1100 – East Tower  
Washington, D.C. 20005

Under the Paperwork Reduction Act of 1995, no persons are required to respond to a collection of information unless it displays a valid OMB control number.

**STATEMENT UNDER 37 CFR 3.73(b)**

Applicant/Patent Owner: CONTENTGUARD HOLDINGS, INC.

Application No./Patent No.: 10/956,121 Filed/Issue Date: 10-04-2004

Titled: SYSTEM AND METHOD FOR MANAGING TRANSFER OF RIGHTS USING SHARED STATE VARIABLES

CONTENTGUARD HOLDINGS, INC., a Corporation  
(Name of Assignee) (Type of Assignee, e.g., corporation, partnership, university, government agency, etc.)

states that it is:

- 1.  the assignee of the entire right, title, and interest in;
- 2.  an assignee of less than the entire right, title, and interest in  
(The extent (by percentage) of its ownership interest is \_\_\_\_\_ %); or
- 3.  the assignee of an undivided interest in the entirety of (a complete assignment from one of the joint inventors was made)

the patent application/patent identified above, by virtue of either:

A.  An assignment from the inventor(s) of the patent application/patent identified above. The assignment was recorded in the United States Patent and Trademark Office at Reel 016596, Frame 0931, or for which a copy therefore is attached.

**OR**

B.  A chain of title from the inventor(s), of the patent application/patent identified above, to the current assignee as follows:

1. From: \_\_\_\_\_ To: \_\_\_\_\_

The document was recorded in the United States Patent and Trademark Office at  
Reel \_\_\_\_\_, Frame \_\_\_\_\_, or for which a copy thereof is attached.

2. From: \_\_\_\_\_ To: \_\_\_\_\_

The document was recorded in the United States Patent and Trademark Office at  
Reel \_\_\_\_\_, Frame \_\_\_\_\_, or for which a copy thereof is attached.

3. From: \_\_\_\_\_ To: \_\_\_\_\_

The document was recorded in the United States Patent and Trademark Office at  
Reel \_\_\_\_\_, Frame \_\_\_\_\_, or for which a copy thereof is attached.

Additional documents in the chain of title are listed on a supplemental sheet(s).

As required by 37 CFR 3.73(b)(1)(i), the documentary evidence of the chain of title from the original owner to the assignee was, or concurrently is being, submitted for recordation pursuant to 37 CFR 3.11.

[NOTE: A separate copy (i.e., a true copy of the original assignment document(s)) must be submitted to Assignment Division in accordance with 37 CFR Part 3, to record the assignment in the records of the USPTO. See MPEP 302.08]

The undersigned (whose title is supplied below) is authorized to act on behalf of the assignee.

/Stephen M. Hertzler, Reg. No. 58,247/

September 27, 2010

Signature

Date

Stephen M. Hertzler, Reg. No. 58,247

Printed or Typed Name

Title

This collection of information is required by 37 CFR 3.73(b). The information is required to obtain or retain a benefit by the public which is to file (and by the USPTO to process) an application. Confidentiality is governed by 35 U.S.C. 122 and 37 CFR 1.11 and 1.14. This collection is estimated to take 12 minutes to complete, including gathering, preparing, and submitting the completed application form to the USPTO. Time will vary depending upon the individual case. Any comments on the amount of time you require to complete this form and/or suggestions for reducing this burden, should be sent to the Chief Information Officer, U.S. Patent and Trademark Office, U.S. Department of Commerce, P.O. Box 1450, Alexandria, VA 22313-1450. DO NOT SEND FEES OR COMPLETED FORMS TO THIS ADDRESS. **SEND TO: Commissioner for Patents, P.O. Box 1450, Alexandria, VA 22313-1450.**

## Privacy Act Statement

The **Privacy Act of 1974 (P.L. 93-579)** requires that you be given certain information in connection with your submission of the attached form related to a patent application or patent. Accordingly, pursuant to the requirements of the Act, please be advised that: (1) the general authority for the collection of this information is 35 U.S.C. 2(b)(2); (2) furnishing of the information solicited is voluntary; and (3) the principal purpose for which the information is used by the U.S. Patent and Trademark Office is to process and/or examine your submission related to a patent application or patent. If you do not furnish the requested information, the U.S. Patent and Trademark Office may not be able to process and/or examine your submission, which may result in termination of proceedings or abandonment of the application or expiration of the patent.

The information provided by you in this form will be subject to the following routine uses:

1. The information on this form will be treated confidentially to the extent allowed under the Freedom of Information Act (5 U.S.C. 552) and the Privacy Act (5 U.S.C. 552a). Records from this system of records may be disclosed to the Department of Justice to determine whether disclosure of these records is required by the Freedom of Information Act.
2. A record from this system of records may be disclosed, as a routine use, in the course of presenting evidence to a court, magistrate, or administrative tribunal, including disclosures to opposing counsel in the course of settlement negotiations.
3. A record in this system of records may be disclosed, as a routine use, to a Member of Congress submitting a request involving an individual, to whom the record pertains, when the individual has requested assistance from the Member with respect to the subject matter of the record.
4. A record in this system of records may be disclosed, as a routine use, to a contractor of the Agency having need for the information in order to perform a contract. Recipients of information shall be required to comply with the requirements of the Privacy Act of 1974, as amended, pursuant to 5 U.S.C. 552a(m).
5. A record related to an International Application filed under the Patent Cooperation Treaty in this system of records may be disclosed, as a routine use, to the International Bureau of the World Intellectual Property Organization, pursuant to the Patent Cooperation Treaty.
6. A record in this system of records may be disclosed, as a routine use, to another federal agency for purposes of National Security review (35 U.S.C. 181) and for review pursuant to the Atomic Energy Act (42 U.S.C. 218(c)).
7. A record from this system of records may be disclosed, as a routine use, to the Administrator, General Services, or his/her designee, during an inspection of records conducted by GSA as part of that agency's responsibility to recommend improvements in records management practices and programs, under authority of 44 U.S.C. 2904 and 2906. Such disclosure shall be made in accordance with the GSA regulations governing inspection of records for this purpose, and any other relevant (*i.e.*, GSA or Commerce) directive. Such disclosure shall not be used to make determinations about individuals.
8. A record from this system of records may be disclosed, as a routine use, to the public after either publication of the application pursuant to 35 U.S.C. 122(b) or issuance of a patent pursuant to 35 U.S.C. 151. Further, a record may be disclosed, subject to the limitations of 37 CFR 1.14, as a routine use, to the public if the record was filed in an application which became abandoned or in which the proceedings were terminated and which application is referenced by either a published application, an application open to public inspection or an issued patent.
9. A record from this system of records may be disclosed, as a routine use, to a Federal, State, or local law enforcement agency, if the USPTO becomes aware of a violation or potential violation of law or regulation.



UNITED STATES PATENT AND TRADEMARK OFFICE

UNITED STATES DEPARTMENT OF COMMERCE  
United States Patent and Trademark Office  
Address: COMMISSIONER FOR PATENTS  
P.O. Box 1450  
Alexandria, Virginia 22313-1450  
www.uspto.gov

APPLICATION NUMBER	FILING OR 371(C) DATE	FIRST NAMED APPLICANT	ATTY. DOCKET NO./TITLE
10/956,121	10/04/2004	Mai Nguyen	111325-291300

**CONFIRMATION NO. 8924**

**POA ACCEPTANCE LETTER**

98804  
Reed Smith LLP  
P.O. Box 488  
Pittsburgh, PA 15230



Date Mailed: 10/07/2010

**NOTICE OF ACCEPTANCE OF POWER OF ATTORNEY**

This is in response to the Power of Attorney filed 09/27/2010.

The Power of Attorney in this application is accepted. Correspondence in this application will be mailed to the above address as provided by 37 CFR 1.33.

/s/brahim/

Office of Data Management, Application Assistance Unit (571) 272-4000, or (571) 272-4200, or 1-888-786-0101





UNITED STATES PATENT AND TRADEMARK OFFICE

UNITED STATES DEPARTMENT OF COMMERCE  
United States Patent and Trademark Office  
Address: COMMISSIONER FOR PATENTS  
P.O. Box 1450  
Alexandria, Virginia 22313-1450  
www.uspto.gov

APPLICATION NUMBER	FILING OR 371(C) DATE	FIRST NAMED APPLICANT	ATTY. DOCKET NO./TITLE
10/956,121	10/04/2004	Mai Nguyen	111325-291300

**CONFIRMATION NO. 8924**

**POWER OF ATTORNEY NOTICE**



22204  
NIXON PEABODY, LLP  
401 9TH STREET, NW  
SUITE 900  
WASHINGTON, DC 20004-2128

Date Mailed: 10/07/2010

**NOTICE REGARDING CHANGE OF POWER OF ATTORNEY**

This is in response to the Power of Attorney filed 09/27/2010.

- The Power of Attorney to you in this application has been revoked by the assignee who has intervened as provided by 37 CFR 3.71. Future correspondence will be mailed to the new address of record(37 CFR 1.33).

/s/brahim/

Office of Data Management, Application Assistance Unit (571) 272-4000, or (571) 272-4200, or 1-888-786-0101