

by its leading standard-setting organization—for example, ANSI (American National Standards Institute) for the United States. The ISO works to establish global standards for communications and information exchange. Primary among its accomplishments is the widely accepted ISO/OSI reference model, which defines standards for the interaction of computers connected by communications networks. *ISO* is not an acronym; rather, it is derived from the Greek word *isos*, which means “equal” and is the root of the prefix “iso-.”

ISO 8601:1988 *n.* A standard entitled “Data elements and interchange formats” from the International Organization for Standardization (ISO) that covers a number of date formats.

ISO 9660 *n.* An international format standard for CD-ROM adopted by the International Organization for Standardization (ISO) that follows the recommendations embodied in the High Sierra specification, with some modifications. *See also* High Sierra specification.

ISOC *n.* *See* Internet Society.

isochronous network *n.* A type of network defined in the IEEE 802.9 specification that combines ISDN and LAN technologies to enable networks to carry multimedia. *Also called:* Integrated Services LAN, ISLAN.

isometric view *n.* A display method for three-dimensional objects in which every edge has the correct length for the scale of the drawing and in which all parallel lines appear parallel. An isometric view of a cube, for example, shows the faces in symmetrical relation to one another and the height and width of each face evenly proportioned; the faces do not appear to taper with distance as they do when the cube is drawn in perspective. *See* the illustration. *Compare* perspective view.

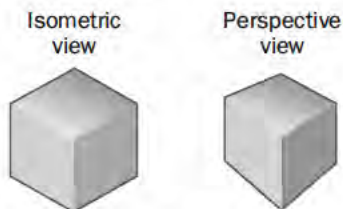

isometric view. *A cube in isometric view and in perspective view.*

ISO/OSI reference model *n.* Short for International Organization for Standardization Open Systems Interconnection **reference model**. A layered architecture (plan)

that standardizes levels of service and types of interaction for computers exchanging information through a communications network. The ISO/OSI reference model separates computer-to-computer communications into seven protocol layers, or levels, each building—and relying—upon the standards contained in the levels below it. The lowest of the seven layers deals solely with hardware links; the highest deals with software interactions at the application-program level. It is a fundamental blueprint designed to help guide the creation of networking hardware and software. *See* the illustration. *Also called:* OSI reference model.

ISO/OSI MODEL	
ISO/OSI Layer	Focus
Application <i>(highest level)</i>	Program-to-program transfer of information
Presentation	Text formatting and display, code conversion
Session	Establishing, maintaining, and coordinating communication
Transport	Accurate delivery, service quality
Network	Transport routes, message handling and transfer
Data-link	Coding, addressing, and transmitting information
Physical	Hardware connections

ISO/OSI reference model.

ISP *n.* Acronym for Internet service provider. A business that supplies Internet connectivity services to individuals, businesses, and other organizations. Some ISPs are large national or multinational corporations that offer access in many locations, while others are limited to a single city or region. *Also called:* access provider, service provider.

ISSE *n.* *See* SSE.

ISV *n.* *See* independent software vendor.

IT *n.* Acronym for Information Technology. *See* Information Services.

italic *n.* A type style in which the characters are evenly slanted toward the right. *This sentence is in italics.* Italics are commonly used for emphasis, foreign-language words and phrases, titles of literary and other works, technical terms, and citations. *See also* font family. *Compare* roman.

Itanium *n.* An Intel microprocessor that uses explicitly parallel instruction set computing and 64-bit memory addressing.

iterate *vb.* To execute one or more statements or instructions repeatedly. Statements or instructions so executed are said to be in a loop. *See also* iterative statement, loop.

iterative statement *n.* A statement in a program that causes the program to repeat one or more statements. Examples of iterative statements in Basic are FOR, DO, REPEAT..UNTIL, and DO..WHILE. *See also* control statement.

ITI *n.* *See* Intelligent Transportation Infrastructure.

I-time *n.* *See* instruction time.

ITM *n.* Short for **I**nternet **t**raffic **m**anagement. The analysis and control of Internet traffic to improve efficiency and optimize for high availability. With ITM, Web traffic is distributed among multiple servers using load balancers and other devices. *See also* load balancing.

ITR *n.* *See* Internet Talk Radio.

ITSP *n.* Acronym for **I**nternet **T**elephony **S**ervice **P**rovider. A business that supplies PC-to-telephone calling capabilities to individuals, businesses, and organizations. Through an ITSP, calls initiated on a PC travel over the Internet to a gateway that, in turn, sends the call to the standard public switched phone network and, eventually, to the receiving telephone. *See also* ISP, telephony.

ITU *n.* Acronym for **I**nternational **T**elecommunication **U**nion. An international organization based in Geneva, Switzerland, that is responsible for making recommendations and establishing standards governing telephone and data communications systems for public and private telecommunications organizations. Founded in 1865 under

the name International Telegraph Union, it was renamed the International Telecommunication Union in 1934 to signify the full scope of its responsibilities. ITU became an agency of the United Nations in 1947. A reorganization in 1992 aligned the ITU into three governing bodies: the Radiocommunication Sector, the Telecommunication Standardization Sector (ITU-TSS, ITU-T, for short; formerly the CCITT), and the Telecommunication Development Sector. *See also* ITU-T.

ITU-T *n.* The standardization division of the International Telecommunication Union, formerly called Comité Consultatif International Télégraphique et Téléphonique (CCITT). The ITU-T develops communications recommendations for all analog and digital communications. *Also called:* ITU-TSS. *See also* CCITT Groups 1-4, ITU.

ITU-TSS *n.* *See* ITU-T.

ITU-T V series *n.* *See* V series.

ITU-T X series *n.* *See* X series.

iTV *n.* Acronym for **I**nteractive **t**elevision. A communications medium combining television with interactive services. iTV offers two-way communications between users and communications providers. From their televisions, users can order special programming, respond to programming options, and access the Internet and additional services such as instant messaging and telephone functions.

IVR *n.* *See* interactive voice response.

IVUE *n.* A proprietary image format (from Live Pictures) that allows files to be adjusted to screen resolution at any zoom level.

i-way *n.* *See* Information Superhighway.

J

J2EE *n.* Acronym for **J**ava **2** Platform **E**nterprise **E**dition. An application server framework from Sun Microsystems, Inc., for the development of distributed applications. It includes all the previous Java APIs targeted for multi-tiered distributed enterprise information systems. The J2EE platform consists of a set of services, application programming interfaces (APIs), and protocols that provide the functionality for developing multitiered, Web-based applications. *See also* application programming interface, Enterprise Java Beans, IDL, Java, JDBC, Jini, JMS, JNDI, JSP, JTA, JTS, RMI-IIOP.

J *n.* A high-level programming language created by Kenneth Iverson, developer of APL, and Roger Hui. J is a successor language to APL that may be run on many platforms, including Windows 95, Windows NT, Macintosh, Linux, RS/6000, and Sun Sparc. Like APL, J is used primarily by mathematicians. *See also* APL.

jabber *n.* A continuous stream of random data transmitted over a network as the result of some malfunction.

Jabber *n.* An XML-based instant messaging system. Jabber software is available for most operating systems and allows user access to other instant messaging services. Jabber is an open source application overseen by Jabber.org.

jack *n.* A connector designed to receive a plug. A jack is commonly used in making audio and video connections.

jacket *n.* *See* disk jacket.

jack in *vb.* **1.** To log on to a computer. **2.** To connect to a network or BBS, especially for purposes of entering an IRC or a virtual reality simulation, such as a MUD. (To leave is to *jack out*.) *See also* IRC, MUD.

jack out *vb.* **1.** To log off a computer. **2.** To disconnect from a network or online bulletin board system. *See also* jack in, log on.

Jacquard loom *n.* The first machine that used punched cards to control its operation. In this loom, developed in 1801 by French inventor Joseph-Marie Jacquard, up to 24,000 cards were placed on a rolling drum. Where a hole was punched on a card, one of a set of rods could pass

through and select a particular thread to be woven into the pattern. Jacquard was awarded a medal by the Emperor Napoleon for his invention. Later in the nineteenth century, punched cards were used in Charles Babbage's computerlike Analytical Engine and in Herman Hollerith's statistical tabulating machine. *See also* Analytical Engine, Hollerith tabulating/recording machine.

jaggies *n.* The "stairsteps" that appear in diagonal lines and curves drawn at low resolutions in computer graphics. *Also called:* aliasing.

Janet *n.* Short for the **J**oint **A**cademic **N**etwork. A wide area network in the United Kingdom that serves as the principal backbone for the Internet in that country. *See also* backbone (definition 1).

.jar *n.* A file name extension that identifies a compressed JAR (**J**ava **A**rchive) file. Note: By changing the .jar extension to .zip, you can use popular extraction tools such as PKZIP or WINZIP to look at a .jar file's contents. *See also* compressed file, JAR, PKZIP, .zip.

JAR *n.* Acronym for **J**ava **A**rchive file. JAR files allow Java developers to efficiently deploy Java classes and their associated resources. The elements in a JAR file are compressed just as in a standard zip file. JAR files include a security mechanism and a special META-INF directory that contains administrative information about the contents of the files. Using a combination of a digital signature and the META-INF data, JAR files can be signed to ensure authenticity and security. *See also* .jar.

Java *n.* An object-oriented programming language developed by Sun Microsystems, Inc. Similar to C++, Java is smaller, more portable, and easier to use than C++ because it is more robust and it manages memory on its own. Java was also designed to be secure and platform-neutral (meaning that it can be run on any platform) through the fact that Java programs are compiled into bytecode, which is not refined to the point of relying on platform-specific instructions and runs on a computer in a special software environment known as a virtual machine. This characteristic of Java makes it a useful language for programming

J

Web applications, since users access the Web from many types of computers. Java is used in programming small applications, or applets, for the World Wide Web, as well as in creating distributed network applications. *See also* bytecode, Java applet, Jini, object-oriented programming.

Java applet *n.* A Java class that is loaded and run by an already-running Java application such as a Web browser or an applet viewer. Java applets can be downloaded and run by any Web browser capable of interpreting Java, such as Internet Explorer, Netscape Navigator, and HotJava. Java applets are frequently used to add multimedia effects and interactivity to Web pages, such as background music, real-time video displays, animations, calculators, and interactive games. Applets can be activated automatically when a user views a page, or they may require some action on the part of the user, such as clicking on an icon in the Web page. *See also* applet, Java.

JavaBean *n.* A Java component architecture defined in the JavaBeans specification developed by Sun Microsystems. A JavaBean, or Bean, is a reusable application component—an independent code segment—that can be combined with other JavaBean components to create a Java applet or application. The JavaBean concept emphasizes the platform-independence of the Java language, in which ideally a program, once written, can run on any computing platform. JavaBeans are similar to Microsoft's ActiveX controls. ActiveX controls, however, can be developed in different programming languages but executed only on a Windows platform. JavaBeans can be developed only in the Java programming language but ideally can run on any platform. *See also* ActiveX, Java.

Java Card *n.* An application programming interface (API) from Sun Microsystems, Inc., that allows Java applets and programs to run on smart cards and other devices with limited memory. Java Card uses a Java Card Virtual Machine designed for severely memory-constrained devices. *See also* applets, Java Card Virtual Machine, smart card (definition 2).

Java Card Virtual Machine *n.* An ultra-small-footprint, highly optimized foundation of a runtime environment within the Java 2 Platform Micro Edition. Derived from the Java Virtual Machine (JVM), it is targeted at smart cards and other severely memory-constrained devices. The Java Card Virtual Machine can run in devices with memory as small as 24 KB of ROM, 16 KB of EEPROM, and 512 bytes of RAM. *See also* EEPROM, Java Card, RAM, ROM.

Java chip *n.* An implementation on a single integrated circuit of the virtual machine specified for execution of the Java programming language. Such chips, which are being developed by Sun Microsystems, Inc., could be used in very small devices and as controllers for appliances. *See also* integrated circuit, Java, virtual machine.

Java-compliant browser *n.* A Web browser with support for the Java programming language built into it. Most current Web browsers are Java-compliant. *See also* Java, Web browser.

Java Developer's Kit *n.* A set of software tools developed by Sun Microsystems, Inc., for writing Java applets or applications. The kit, which is distributed free, includes a Java compiler, interpreter, debugger, viewer for applets, and documentation. *Acronym:* JDK. *See also* applet, Java, Java applet.

Java Foundation Classes *n.* A Java-based set of class libraries developed by Sun Microsystems, Inc. Encompassing fundamentals of the Internet Foundation Classes created by Netscape Communications Corp., the Java Foundation Classes extend the Java Abstract Window Toolkit (AWT) by providing graphical user interface components for use in developing commercial and Internet-related Java applications. *See also* Abstract Window Toolkit, Application Foundation Classes, Internet Foundation Classes, Java, JavaBean, Microsoft Foundation Classes.

Java HotSpot *n.* A Java performance engine introduced by Sun Microsystems, Inc., in 1999 that is designed to run Java applications faster than just-in-time (JIT) compilers. The core of Java HotSpot, and the feature for which it is named, is its ability to perform adaptive optimization—the identification and optimization of “hot spots,” or sections of performance-critical code. Improved garbage collection (freeing of memory occupied by objects no longer in use) and better multithreading are additional features designed to contribute to increased performance. *See also* Java.

Java IDL *n.* Short for **Java Interface Definition Language**. A Java technology that provides CORBA interoperability and connectivity capabilities for the Java platform. These capabilities enable Java applications to invoke operations on remote network services using the Object Management Group Interface Definition Language and Internet Inter-ORB Protocol. *See also* CORBA, IDL, J2EE, RMI-IIOP.

JavaMail *n.* An API in the Sun Microsystems, Inc., Java platform for sending and receiving mail. A set of abstract APIs that model a mail system, JavaMail provides a platform-independent and protocol-independent

framework to build Java-based e-mail client applications. *See also* application programming interface, e-mail, J2EE.

Java Management Application Programming Interface *n.* A set of application programming interface specifications, proposed by Sun Microsystems, Inc., to enable the Java language to be used for network management. *Acronym:* JMAPI. *See also* application programming interface, Java.

JavaOS *n.* An operating system designed to run applications written in the Java programming language. JavaOS was created by JavaSoft, an operating company of Sun Microsystems, Inc., to run the Java Virtual Machine (JVM) directly on microprocessors, and thus eliminate the need for a resident operating system. JavaOS is small and designed for network computers, as well as devices ranging from game machines to pagers and cellular telephones. *See also* Java.

JavaScript *n.* A scripting language developed by Netscape Communications and Sun Microsystems that is loosely related to Java. JavaScript, however, is not a true object-oriented language, and it is limited in performance compared with Java because it is not compiled. Basic online applications and functions can be added to Web pages with JavaScript, but the number and complexity of available application programming interface functions are fewer than those available with Java. JavaScript code, which is included in a Web page along with the HTML code, is generally considered easier to write than Java, especially for novice programmers. A JavaScript-compliant Web browser, such as Netscape Navigator or Internet Explorer, is necessary to run JavaScript code. *See also* application programming interface, HTML, scripting language. *Compare* Java.

JavaServer Pages *n.* *See* JSP.

Java Speech Grammar Format *n.* A platform-independent grammar description format developed for use with speech recognition systems. Java Speech Grammar Format is used extensively with Voice XML and can be used with most speech recognition systems and related applications. *Acronym:* JSGF.

Java Virtual Machine *n.* The environment in which Java programs run. The Java Virtual Machine gives Java programs a software-based “computer” they can interact with. (Programs, even the most seemingly unchallenging ones designed for children or entertainment, must run within an environment from which they can use memory, display

information, gather input, and so on.) Because the Java Virtual Machine is not a real computer but exists in software, a Java program can run on any physical computing platform, such as a Windows 9x computer or a Macintosh, equipped with an interpreter—usually an Internet browser—that can carry out the program’s instructions and a Java Virtual Machine that provides the “hardware” on which the program can run. *Acronym:* JVM.

JCL *n.* Acronym for **Job Control Language**. A command language used in IBM OS/360 mainframe systems. JCL is used to launch applications and specifies information on running time, program size, and the program files used for each application. *See also* command language.

JDBC *n.* A Java API designed to provide access to relational databases and other tabular material, such as spreadsheets and flat files. Using JDBC, a developer can create a cross-platform Java application that can connect with, and send SQL statements to, a number of different relational databases. Although it is commonly thought to stand for Java Database Connectivity, JDBC is the name of the technology; it is not an acronym.

JDK *n.* *See* Java Developer’s Kit.

jDoc *n.* A cross-platform, interactive format for display, distribution, and interaction with live Web pages. jDoc documents are small in size and can be embedded in HTML documents to offer client-side interactivity. jDoc was created by EarthStones and is an extension to Sun’s Java platform.

JetSend Protocol *n.* A platform-independent communications protocol developed by Hewlett-Packard to enable direct device-to-device communication. The JetSend protocol is designed to provide JetSend-enabled devices with the ability to exchange information and data without the need for device drivers or reliance on servers or user intervention. The protocol is intended for use with printers, scanners, fax machines, and other such information “appliances” and was developed to simplify and improve interoperability between and among a wide range of devices.

Jet SQL *n.* A query language. Jet SQL is a dialect used by the Microsoft Access application, specifically by the Microsoft Jet database engine, to extract, manipulate, and structure data that resides in a relational database management system (RDBMS). Jet SQL is based largely on the ANSI SQL-92 standard, with additional extensions.



jewel box *n.* A clear plastic container used to package and store a compact disc. *Also called:* jewel case.

JFC *n.* *See* Java Foundation Classes.

JFIF *n.* Acronym for **JPEG File Interchange Format**. A means of saving photographic images stored according to the Joint Photographic Experts Group image compression technique. JFIF represents a “common language” file format in that it is designed specifically to allow users to transfer JPEG images easily between different computers and applications. *See also* JPEG, TIFF JPEG.

Jini *n.* A technical specification developed by Sun Microsystems that uses a small piece (48 KB) of Java code to allow any network device with a Java Virtual Machine (JVM) to announce its availability and provide its services to any other device connected to the same network. Jini is based on the concept of creating a “federation” of self-configuring devices capable of transparently exchanging code when necessary to simplify interactions between network devices. *See also* Java.

JIT *adj.* *See* just-in-time.

jitter *n.* **1.** Small vibrations or fluctuations in a displayed video image caused by irregularities in the display signal. Jitter is often visible in the form of horizontal lines that are of the same thickness as scan lines. **2.** A rough appearance in a fax caused by dots that are incorrectly recorded during the scanning process and thus wrongly positioned in the output. **3.** In digital communication, distortion caused by lack of synchronization of signals.

JMAPI *n.* *See* Java Management Application Programming Interface.

JMS *n.* Acronym for **Java Messaging Service**. In the J2EE network platform, JMS is an API for using enterprise messaging systems such as IBM MQ Series, TIBCO Rendezvous, and others. *See also* application programming interface, J2EE.

JNDI *n.* Acronym for **Java Naming and Directory Interface**. A set of APIs in the J2EE platform from Sun Microsystems, Inc., that assists with the interfacing to multiple naming and directory services. *See also* application programming interface, J2EE.

job *n.* A specified amount of processing performed as a unit by a computer. On early mainframe computers, data was submitted in batches, often on punched cards, for processing by different programs; work was therefore scheduled and carried out in separate jobs, or operations.

Job Control Language *n.* *See* JCL.

job processing *n.* A computing method in which a series of jobs, each consisting of one or more tasks grouped together as a computationally coherent whole, is processed sequentially. *See also* batch processing (definition 2).

job queue *n.* A list of programs or tasks waiting for execution by a computer. Jobs in the queue are often ordered according to some basis of priority. *See also* queue.

join *n.* **1.** A database table operation that creates a result-entry in another table for each entry in the one table whose key field matches that of an entry in the other. *See also* inner join. **2.** A multiprocessing command that causes a child process to return control to its parent. *See also* child (definition 1), multiprocessing.

join line *n.* In a database query, a line that connects fields between two tables and shows how the data is related. Generally, a join line starts with an arrow just beyond the boundary of the table window pointing at the field in one table and ends just beyond the boundary of another table with an arrow pointing at the related field. The type of join indicates which records are selected for the query’s result set.

Joint Photographic Experts Group *n.* *See* JPEG (definition 1).

Joliet *n.* An extension to the ISO 9660 (1988) standard developed to include long filenames or filenames outside the 8.3 convention. This format is used in some new CD-ROMs for operating systems, such as Windows 9x, that can handle such filenames. *See also* 8.3, ISO 9660, long filenames.

Josephson junction *n.* A cryoelectronic device that can attain extremely high circuit-switching speeds. In the Josephson effect, when two superconducting materials are in close proximity but are separated by an insulator, electric current can jump or tunnel through the gap.

journal *n.* A computer-based log or record of transactions that takes place in a computer or across a network. A journal could be used, for example, to record message transfers on a communications network, to keep track of system activities that alter the contents of a database, or to maintain a record of files that have been archived for storage or deleted from the system. A journal is often kept as a means of reconstructing events or sets of data should they become lost or damaged. *See also* audit trail.

journaled file system *n.* A fault-resilient file system that includes backup and recovery capabilities. When file server indexes are updated, all changes and related

information are recorded and stored in a separate log. If a system failure or other abnormal interruption occurs, the system will use stored backup files to repair files corrupted in the crash. Journalled file systems are widely used for business and intranet file servers. In 2001, IBM contributed journalled file system technology to the open source community to allow development of similar file systems for Linux servers.

Joystick *n.* A pointing device used mainly but not exclusively for computer games. A joystick has a base, on which control buttons can be mounted, and a vertical stem, which the user can move in any direction to control the movement of an object on the screen; the stem may also have control buttons. The buttons activate various software features, generally producing on-screen events. A joystick is usually used as a relative pointing device, moving an object on the screen when the stem is moved and stopping the movement when the stem is released. In industrial control applications, the joystick can also be used as an absolute pointing device, with each position of the stem mapped to a specific location on the screen. See the illustration. *See also* absolute pointing device, relative pointing device. *Compare* game pad.



Joystick.

.jpeg *n.* The file extension that identifies graphic image files in the JPEG format. *See also* JPEG.

JPEG *n.* 1. Acronym for Joint Photographic Experts Group. An ISO/ITU standard for storing images in compressed form using a discrete cosine transform. JPEG trades off compression against loss; it can achieve a compression ratio of 100:1 with significant loss and possibly

20:1 with little noticeable loss. 2. A graphic stored as a file in the JPEG format.

JPEG File Interchange Format *n.* *See* JFIF.

.jpg *n.* The file extension that identifies graphic images encoded in the JPEG File Interchange Format, as originally specified by the Joint Photographic Experts Group (JPEG). Inline graphics on World Wide Web pages are often .jpg files, such as coolgraphic.jpg. *See also* JPEG (definition 2).

JScript *n.* An interpreted, object-based scripting language that borrows from C, C++, and Java. It is Microsoft's implementation of the ECMA 262 language specification (ECMAScript Edition 3). The latest versions of JavaScript and JScript are compliant with the European Computer Manufacturing Association's ECMAScript Language Specification (ECMA 262 standard, for short).

JSGF *n.* *See* Java Speech Grammar Format.

JSP *n.* Short for JavaServer Pages. A technology created by Sun Microsystems to enable development of platform-independent Web-based applications. Using HTML and XML tags and Java scriptlets, JSP helps Web site developers create cross-platform programs. JSP scriptlets run on the server, not in a Web browser, and generate dynamic content on Web pages, with the ability to integrate content from a variety of data sources, such as databases, files, and JavaBean components. Web site developers can concentrate on design and display of a Web site without the need for application development expertise. *See also* Java, JavaBean. *Compare* Active Server Pages.

JSP container *n.* Short for JavaServer Pages container. In the J2EE platform, a JSP container provides the same services as a servlet container, such as providing network services over which requests and responses are sent, decoding requests, and formatting responses. All servlet containers must support HTTP as a protocol for requests and responses, but they may also support additional request-response protocols such as HTTPS. The JSP container is also an engine that interprets and processes JSP pages into a servlet. *See also* container, HTTP, HTTPS, J2EE, servlet, servlet container.

JTA *n.* Acronym for Java Transaction API. In the J2EE platform, JTA specifies transactions, comments, and rollbacks used by EJBs (Enterprise JavaBeans). It is a high-level, implementation-independent protocol API that allows applications and application servers to access transactions. *See also* application programming interface, J2EE, JTS, rollback.

JTS *n.* Acronym for **Java Transaction Services**. In the J2EE platform, JTS specifies the implementation of a transaction manager that supports JTA and implements the Java mapping of the OMG Object Transaction Service specification at a level below the API. JTS propagates transactions using the Internet Inter-ORB Protocol (IIOP). *See also* application programming interface, J2EE, JTA, rollback.

JUG *n.* Acronym for **Java User Group**. A user group that meets to discuss the Java programming language and the Java platform. *See also* user group.

Jughead *n.* Acronym for **Jonzy's Universal Gopher Hierarchy Excavation and Display**. An Internet service that enables a user to locate directories in Gopherspace through a keyword search. A Jughead server indexes keywords appearing in directory titles in top-level Gopher menus but does not index the files within the directories. To access Jughead, users must point their Gopher clients to a Jughead server. *See also* Gopher, Gopherspace. *Compare* Archie, Veronica.

jukebox *n.* Software that is designed to play a list of sound files in a user-specified order reminiscent of jukeboxes used to play vinyl records. *See also* CD-ROM jukebox.

Julian calendar *n.* The calendar introduced by Julius Caesar in 46 B.C. to replace the lunar calendar. The Julian calendar provided for a year of 365 days with a leap year every 4 years, or an average year length of 365.25 days. Because the solar year is slightly shorter, the Julian calendar gradually moved out of phase with the seasons and was superseded by the Gregorian calendar, introduced by Pope Gregory XIII. *Compare* Gregorian calendar, Hijiri calendar.

Julian date *n.* **1.** A date expressed as the number of days elapsed since January 1, 4713 B.C. (on the Julian calendar)—for example, 2,450,000 for October 9, 1995 (Gregorian). Julian dates are useful for finding elapsed times between events that may be many years apart, as in astronomy. The starting point is the beginning of the Julian Period, defined in 1583 by Joseph Scaliger as the coincidence of several cycles based on the Julian calendar. *See also* Gregorian calendar, Julian calendar. **2.** Often (but incorrectly), a date expressed as the year and the number of days elapsed since the beginning of the year—for example, 91.13 for January 13, 1991. *Acronym:* JD.

jumper *n.* A small plug or wire that can be connected between different points in an electronic circuit in order to alter an aspect of a hardware configuration. *Compare* DIP switch.

jump instruction *n.* An instruction that transfers the flow of execution from one statement or instruction to another. *See also* GOTO statement, transfer statement.

jump page *n.* *See* doorway page.

jump table *n.* *See* dispatch table.

Jump to .NET *n.* Acronym for **Java User Migration Path to Microsoft .NET**. A set of Microsoft technologies and services that enable Java programmers to preserve, enhance, and migrate Java language projects onto the Microsoft .NET platform. It includes tools for interoperability of existing code, Java language syntax support, and automated conversion of Java source code to C#. JUMP to .NET enables programmers using the Java language to move existing code to the Microsoft .NET platform. *See also* C#, .NET.

junction *n.* **1.** Any point at which two or more electrical components are connected. **2.** The contact between two types of semiconductors, such as N-type and P-type semiconductors. *See also* N-type semiconductor, P-type semiconductor, semiconductor.

justify *vb.* **1.** To align vertically. **2.** To align lines of text evenly along both the left and right margins of a column by inserting extra space between the words in each line. If the spacing is excessive, it can be reduced by rewriting or by hyphenating words at the ends of lines. *See also* align (definition 1). *Compare* rag.

just-in-time *adj.* **1.** Describing a system of inventory control and industrial production management based on the Japanese *kanban* system. Under a just-in-time system, workers receive materials from suppliers “just in time” for scheduled manufacturing to take place. Line workers generally signal that they require materials by means of a card or a computerized request system. **2.** Describing an action that is taken only when it becomes necessary, such as just-in-time compilation or just-in-time object activation. **3.** Describing a compiler that compiles Java on the fly. *Acronym:* JIT. *See also* Java, on the fly.

JVM *n.* *See* Java Virtual Machine.

K

K¹ *n.* Short for kilobyte.

K² *prefix* See kilo-.

K&R C *n.* Short for (Brian W.) Kernighan and (Dennis M.) Ritchie C. The version of the C programming language, defined by those two authors, that was the informal C standard until a more formal standard was developed by an ANSI committee. *See also* C.

Kalman filter *n.* An adaptive filter used to estimate the state of a system from measurements that contain random errors. This recursive adaptive filter determines the correct parameters of a process model. Each new measurement allows the parameters of a model to be predicted and adjusted, thus providing an estimate of error at each update. The Kalman filter's computational structure and its ability to incorporate the effects of noise (from both measurement and modeling) recommends itself for use in computer vision tracking applications. *See also* active vision, distortion, modeling, noise.

kamikaze packet *n.* *See* Chernobyl packet.

kashidas *n.* Special characters that are used to extend the joiner between two Arabic characters. Kashidas are used to improve the appearance of justified text by visually lengthening words rather than increasing the spacing between words. *See* the illustration.

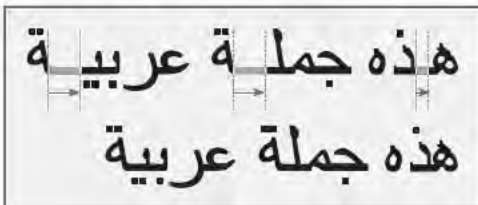

Kashidas.

Kb *n.* *See* kilobit.

KB *n.* 1. *See* kilobyte. 2. Short for Knowledge Base. Primary source of product information for Microsoft support engineers and customers. This comprehensive collection of articles, updated daily, contains detailed how-to information, answers to technical-support questions, and known issues. *Also called:* Microsoft Knowledge Base.

Kbit *n.* *See* kilobit.

Kbps *n.* *See* kilobits per second.

Kbyte *n.* *See* kilobyte.

kc *n.* *See* kilocycle.

KDE *n.* Acronym for K Desktop Environment. A popular open-source desktop environment originally intended for UNIX workstations and now developed for the Linux operating system. KDE provides a graphical user interface (GUI) and basic applications that correspond to those found with Microsoft Windows or the Macintosh operating system. By providing a mainstream environment and familiar desktop appearance, KDE is intended to make Linux easier for users. KDE and GNOME are leading contenders for consideration as a Linux desktop standard. *See also* GNOME, GUI.

Kerberos *n.* A network authentication protocol developed by MIT. Kerberos authenticates the identity of users attempting to log on to a network and encrypts their communications through secret-key cryptography. A free implementation of Kerberos is available from MIT, although it is also available in many commercial products. *Also called:* Kerberos v5 authentication protocol. *See also* authentication, cryptography, IPSec.

Kermit *n.* A file transfer protocol used in asynchronous communications between computers. Kermit is a very flexible protocol used in many software packages designed for communications over telephone lines. *Compare* Xmodem, Ymodem, Zmodem.

K

kern *vb.* To alter selectively the distance between pairs of letters for readability and to make the type spacing more balanced and proportional. See the illustration.

A W A K E
A W A K E

Kern. *The first three letters of the second example are kerned.*

kernel *n.* The core of an operating system—the portion of the system that manages memory, files, and peripheral devices; maintains the time and date; launches applications; and allocates system resources.

Kernel Extension *n.* See KEXT.

kernel panic *n.* In Mac OS X and UNIX-based systems, a type of error that occurs when the core level of the operating system is unable to properly handle an instruction. A kernel panic appears to the user as a text screen containing information about the nature of the error, which often can be corrected with a system reboot.

KEXT *n.* Acronym for **Kernel Extension**. In Mac OS X, an extension mechanism created to expand the functionality of the operating system kernel. KEXTs are modular and dynamic loading, and they may be created for any service that requires access to kernel internal interfaces. Creation of a KEXT allows the loading of pieces of code into the kernel without the need to recompile.

key *n.* **1.** On a keyboard, the combination of a plastic keycap, a tension mechanism that suspends the keycap but allows it to be pressed down, and an electronic mechanism that records the key press and key release. **2.** In database management, an identifier for a record or group of records in a datafile. *See also* B-tree, hash², index¹ (definition 1), inverted list, key field. **3.** In encryption and digital signatures, a string of bits used for encrypting and decrypting information to be transmitted. Encryption commonly relies on two different types of keys, a public key known to more than one person (say, both the sender and the receiver) and a private key known only to one person (typically, the sender). **4.** A metal object used with a physical lock to disable a computer system.

key binary large object *n.* A key binary large object (BLOB) provides a way to store keys outside of the cryptographic service provider (CSP) and is used to transfer

keys securely from one CSP to another. A key BLOB consists of a standard header followed by data representing the key. *Acronym:* key BLOB.

key BLOB *n.* *See* key binary large object.

keyboard *n.* A hardware unit with a set of switches that resembles a typewriter keyboard and that conveys information from a user to a computer or data communications circuit. *See also* Alt key, Apple key, arrow key, Backspace key, Break key, Caps Lock key, character code, Clear key, Command key, control character, Control key, Delete key, Dvorak keyboard, End key, enhanced keyboard, Enter key, ergonomic keyboard, Escape key, function key, Help key, Home key, Insert key, keyboard buffer, keyboard controller, keyboard enhancer, keycap, key code, numeric keypad, Num Lock key, Option key, original Macintosh keyboard, Page Down key, Page Up key, Pause key, PC/XT keyboard, Power-on key, Print Screen key, QWERTY keyboard, Return key, scan code, Scroll Lock key, Shift key, Sys Req key, Tab key.

keyboard buffer *n.* A small amount of system memory that stores the most recently typed characters. This buffer is used to store typed characters that have not yet been processed. *Also called:* type-ahead buffer.

keyboard controller *n.* A microprocessor installed in a keyboard whose primary function is to wait for and report on keystrokes.

keyboard enhancer *n.* A program that monitors keystrokes as they are typed and that can be used to redefine the meaning of certain keys or key combinations. Keyboard enhancers are used to create and store macros—sets of keystrokes, mouse actions, menu selections, or other instructions—that are then assigned to keys. *Also called:* macro program.

keyboard layout *n.* The key arrangement used for a particular keyboard, including such factors as the number of keys (101 is the current standard) and the configuration of the keys (QWERTY is the United States standard). Some proprietary systems use different layouts, and many allow you to map the keys to characters according to your preferences.

keyboard port *n.* The connector on a computer that receives data from the keyboard. *See also* port¹ (definition 1).

keyboard processor *n.* *See* keyboard controller.

keyboard repeat *n.* *See* typematic.

keyboard shortcut *n.* See application shortcut key.

keyboard template *n.* A piece of plastic or heavy paper that fits over or around part of the keyboard, such as the function keys, and has information printed on it about the meanings of the keys.

keycap *n.* The plastic piece identifying a key on a keyboard.

key code *n.* A unique code number assigned to a particular key on a computer keyboard, used to tell the computer which key has been pressed or released. A key code is a special identifier for the key itself and is always the same for a particular key, regardless of the letter, number, or symbol on the key or the character generated by the key. Compare character code, scan code.

key escrow *n.* An approach to key recovery in which an encryption key is provided to a third party approved by a government agency so that any encrypted message can, if necessary, be decrypted and read by the government. See also encryption, key recovery.

key field *n.* A field in a record structure or an attribute of a relational table that has been designated to be part of a key. Any field can be keyed, or indexed, to improve or simplify the performance of retrieval and/or update operations. See also attribute (definition 1), field (definition 1), primary key.

key-frame *adj.* Describing animation in which starting and ending positions of an object are given, and all frames in between are interpolated by a computer to produce smooth automated animation. Most ray-traced computer animation is created using this technique. See also ray tracing.

key in *vb.* To enter information into a computer by typing it on the computer's keyboard.

keymaster *n.* A common host name assigned by network administrators to a gateway or router. Popularized in part by the Keymaster character in the 1984 movie "Ghostbusters." See also gatekeeper.

keypad *n.* See numeric keypad.

key pair *n.* A widely used encryption scheme that allows secure use of digital certificate identification. A key pair consists of a public key and a private key. The public key is shared with other individuals; the private key is known only to its owner. The public and private key form an asymmetric pair, meaning the keys on either end of a transmission are different. A message encrypted with the public key can be decrypted only with the private key, and

a message encrypted with the private key can be decrypted only with the public key.

keypunch *n.* An archaic keyboard-activated device used to punch holes in predetermined locations on paper cards roughly the size of a business envelope. It was used to provide programs and data to early computing systems.

key recovery *n.* General term referring to the ability to retrieve a cryptographic key in order to decode encrypted information. Key recovery can be used to regain a lost key or, as has been publicized in recent years, can be used as a means of enabling government agencies to decode encrypted information. One method of providing for key recovery is known as key escrow. See also encryption, key escrow, private key.

key sort *n.* See tag sort.

keystroke *n.* The act of pressing a key on a keyboard to enter a character or initiate a command in a program. The efficiency and ease of use of certain applications is often measured in terms of how many keystrokes it takes to perform common operations. See also command, key (definition 1), keyboard.

keyword *n.* **1.** A characteristic word, phrase, or code that is stored in a key field and is used to conduct sorting or searching operations on records in a database. See also key field. **2.** Any of the set of words that composes a given programming language or set of operating-system routines. See also reserved word.

keyword density *n.* A measurement of the keywords on a Web page as a percentage of total text. High keyword density can increase a Web site's probability of being found by search engines, some of which use keyword density to rank a Web page's relevance to an Internet search. See also keyword (definition 1).

keyword-in-context *n.* An automatic search methodology that creates indexes of document text or titles. Each keyword is stored in the resulting index along with some surrounding text, usually the word or phrase that precedes or follows the keyword in the text or title. *Acronym:* KWIC.

keyword stuffing *vb.* See spamdexter.

Khornerstone *n.* A benchmark of floating-point calculation performance used to test UNIX workstations. See also benchmark¹, Dhrystone, floating-point operation, Whetstone.

kHz *n.* See kilohertz.



kiddie script *n.* A simple and easy-to-use executable script used to hack into a computer or network. Unlike the traditional hacker's techniques, which require detailed networking and programming knowledge, a kiddie script does not require any specialized skills or knowledge. *See also* script, script kiddie.

kill *vb.* **1.** To stop or abort a process in a program or operating system. **2.** In file management, to erase a file, often without hope of reversing the action.

killer app *n.* **1.** An application of such popularity and widespread standardization that it fuels sales of the hardware platform or operating system for which it was written. *See also* application. **2.** An application that supplants its competition. *See also* application.

kill file *n.* *See* bozo filter.

kilo- *prefix* **1.** Metric prefix meaning 10^3 (one thousand). **2.** In computer-related terms, a prefix meaning 2^{10} (1024).

kilobaud *n.* A unit of measure of the transmission capacity of a communications channel, equal to 2^{10} (1024) baud. *See also* baud.

kilobit *n.* A data unit equal to 1024 bits. Abbreviated Kb or Kbit.

kilobits per second *n.* Data transfer speed, as through a modem or on a network, measured in multiples of 1024 bits per second. Abbreviated Kbps.

kilobyte *n.* A data unit of 1024 bytes. Abbreviated K, KB, or Kbyte. *See also* kilo-.

kilocycle *n.* A unit of measurement representing 1000 cycles, generally meaning 1000 cycles per second. Abbreviated kc. *See also* kilohertz.

kilohertz *n.* A measure of frequency equivalent to 1000 hertz, or 1000 cycles per second. Abbreviated kHz. *See also* hertz.

Kinesis ergonomic keyboard *n.* A keyboard designed ergonomically to eliminate repetitive strain injuries. *See also* ergonomic keyboard, repetitive strain injury.

kiosk *n.* A freestanding computer or terminal that provides information to the public, usually through a multimedia display.

kludge *n.* **1.** A short-term or makeshift hardware construction. **2.** A program characterized by a lack of design or forethought, as if written in a hurry to satisfy an immediate need. A kludge basically operates properly, but its

construction or design is severely lacking in elegance or logical efficiency. *See also* braindamaged, hack¹ (definition 1), spaghetti code.

knockout *n.* **1.** In multicolor printing, the process of removing from one image the overlapping parts of a graphic or text that are to be printed in a different color so that ink colors will not mix. *See the illustration.* *See also* spot color. *Compare* overprint. **2.** In hardware, a section of a panel that can be removed to make space for a switch or other component.



Knockout. A knockout allows an overlapping image to print in the correct color.

knowbot *n.* Short for knowledge robot. An artificial-intelligence program that follows a set of predetermined rules to perform work, such as searching for files or looking for documents that contain specific pieces of information on a network, such as the Internet. *See also* bot (definition 2).

knowledge acquisition *n.* The process of translating knowledge from one or more human experts into a form of representation usable by a computer, for the purpose of developing an expert system. *See also* expert system.

knowledge base *n.* A form of database used in expert systems that contains the accumulated body of knowledge of human specialists in a particular field. The reasoning ability or problem-solving approach that a specialist would use is contained in the inference engine, which forms another crucial part of an expert system. *See also* expert system, inference engine.

knowledge-based system *n.* *See* expert system.

K

knowledge domain *n.* The specific area of expertise to which an expert system is devoted. *See also* expert system.

knowledge engineer *n.* A computer scientist who builds an expert system by acquiring the needed knowledge and translating it into a program. *See also* expert system.

knowledge representation *n.* The methodology that forms the basis for the decision-making structure in an expert system, usually taking the form of if-then rules. *See also* expert system.

knowledge worker *n.* Term invented by a management consultant, Peter Drucker, for an individual whose job centers on the collection, processing, and application of information, especially when meaningful value is added to purely factual information. A knowledge worker is someone with both formal education and the ability to apply

that education—knowledge—in a work situation. *See also* information explosion.

Korn shell *n.* A command-line interface, available under UNIX, that combines features of the Bourne and C shells. The Korn shell is fully compatible with the Bourne shell but also offers the history and command-line editing capabilities of the C shell. *See also* command-line interface, shell¹, UNIX. *Compare* Bourne shell, C shell.

KSR terminal *n.* Short for **keyboard send/receive terminal**. A type of terminal that accepts input from a keyboard only and uses an internal printer rather than a screen to display the keyboard input and the output received from the sending terminal. *See also* TTY.

KWIC *n.* *See* keyword-in-context.

K



L1 cache *n.* A memory cache built into i486 and higher-level processors to help improve processing speed. The L1 cache, typically containing 8 KB, can be read in a single clock cycle, so it is tried first. The i486 contains one L1 cache; the Pentium contains two, one for code and one for data. *Also called:* level 1 cache, on-chip cache. *See also* cache, i486DX, Pentium. *Compare* L2 cache.

L2 cache *n.* A memory cache consisting of static RAM on a motherboard that uses an i486 or higher-level processor. The L2 cache, which typically contains 128 KB to 1 MB, is faster than the system DRAM but slower than the L1 cache built into the CPU chip. *Also called:* level 2 cache. *See also* cache, dynamic RAM, i486DX, static RAM. *Compare* L1 cache.

L2TP *n.* *See* Layer Two Tunneling Protocol.

L8R *adv.* Abbreviation for later, as in “See you later,” an expression often used in e-mail or Usenet groups as a closing remark.

label *n.* An identifier. A label can be a physical item, such as a stick-on tag used to identify disks and other computer equipment, or an electronic label added to floppy disks or hard disks. It can also be a word, symbol, or other group of characters used to identify a file, a storage medium, an element defined in a computer program, or a specific item in a document such as a spreadsheet or a chart. *See also* identifier.

label edge router *n.* *See* MPLS.

label prefix *n.* In a spreadsheet, a character at the beginning of a cell entry that identifies the entry to the program as a label.

label switching *n.* *See* MPLS.

label switch path *n.* *See* MPLS.

label switch router *n.* *See* MPLS.

LACP *n.* Acronym for **Link Aggregation Control Protocol**. *See* link aggregation.

lag *n.* The time difference between two events. In electronics, a lag is a delay between a change in input and a change in output. On computer displays, a lag is a fading

brightness left on the phosphor coating of the screen after an image changes. *See also* persistence.

LAN *n.* Acronym for **local area network**. A group of computers and other devices dispersed over a relatively limited area and connected by a communications link that enables any device to interact with any other on the network.

LANs commonly include PCs and shared resources such as laser printers and large hard disks. The devices on a LAN are known as nodes, and the nodes are connected by cables through which messages are transmitted. *See also* baseband network, broadband network, bus network, client/server architecture, collision detection, communications protocol, contention, CSMA/CD, network, peer-to-peer architecture, ring network, star network. *Compare* WAN.

landscape mode *n.* A horizontal print orientation in which text or images are printed “sideways”—that is, the width of the image on the page is greater than the height. *Compare* portrait mode.

landscape monitor *n.* A monitor that is wider than it is high. Landscape monitors are usually about 33 percent wider than they are high—roughly the same proportion as a television screen. *Compare* full-page display, portrait monitor.

LANE *n.* Acronym for **LAN Emulation**. *See* ATM (definition 1), communications protocol, LAN.

LANGID *n.* *See* language identifier.

language *n.* *See* programming language.

language-description language *n.* *See* metalanguage.

language identifier *n.* A standard international numeric abbreviation for a country or geographical region. A language identifier is a 16-bit value that consists of a primary language identifier and a secondary language identifier. *Acronym:* LANGID. *See also* locale identifier.

language processor *n.* A hardware device or a software program designed to accept instructions written in a particular language and translate them into machine code. *See also* compiler (definition 2), interpreter.

language translation program *n.* A program that translates statements written in one programming language into another programming language (usually from one high-level language into another). *See also* high-level language.

LAN Manager *n.* An older LAN (local area network) technology developed by Microsoft and distributed by Microsoft, IBM (as IBM LAN Server), and other original equipment manufacturers. Superseded by TCP/IP networking protocols in Windows 9x, LAN Manager implemented the NetBEUI protocol and was notable for its small stack size. It was used to connect computers running the MS-DOS, OS/2, or UNIX operating systems to allow users to share files and system resources and to run distributed applications using a client/server architecture. *See also* client/server architecture, LAN, NetBEUI.

LANtastic *n.* A network operating system from Artisoft designed to support both peer-to-peer and client/server networks consisting of PCs running a mix of MS-DOS and Windows operating systems.

laptop *n.* A small, portable personal computer that runs on either batteries or AC power, designed for use during travel. Laptops have flat LCD or plasma screens and small keyboards. Most can run the same software as their desktop counterparts and can accept similar peripherals, such as sound cards, internal or external modems, floppy disks, and CD-ROM drives. Some laptops are designed to be plugged into a docking station, effectively making them desktop computers. Most have connectors for plugging in external keyboards and full-sized monitors. Older laptops weighed as much as 15 pounds; current laptops can weigh as little as 5 pounds without peripherals. While *notebook* is the current term for ultralight portable computers, these machines are also commonly referred to as laptops. *See also* portable computer. *Compare* subnotebook computer.

large model *n.* A memory model of the Intel 80x86 processor family. The large model allows both code and data to exceed 64 kilobytes, but the total of both must generally be less than 1 megabyte. Each data structure must be less than 64 kilobytes in size. *See also* memory model.

large-scale integration *n.* A term describing a chip on which circuit elements number in the thousands. *Acronym:* LSI. *See also* integrated circuit. *Compare* medium-scale integration, small-scale integration, super-large-scale integration, ultra-large-scale integration, very-large-scale integration.

laser or **LASER** *n.* Acronym for light amplification by stimulated emission of radiation. A device that uses certain quantum effects to produce coherent light, which travels with greater efficiency than noncoherent light because the beam diverges only slightly as it travels. Lasers are used in computer technology to transmit data through fiberoptic cables, to read and write data on CD-ROMs, and to place an image on a photosensitive drum in laser printers.

laser engine *n.* *See* printer engine.

laser printer *n.* An electrophotographic printer that is based on the technology used by photocopiers. A focused laser beam and a rotating mirror are used to draw an image of the desired page on a photosensitive drum. This image is converted on the drum into an electrostatic charge, which attracts and holds toner. A piece of electrostatically charged paper is rolled against the drum, which pulls the toner away from the drum and onto the paper. Heat is then applied to fuse the toner to the paper. Finally, the electrical charge is removed from the drum, and the excess toner is collected. By omitting the final step and repeating only the toner-application and paper-handling steps, the printer can make multiple copies. The only serious drawback of a laser printer is that it offers less paper-handling flexibility than do dot-matrix printers. Both multipart forms and wide-carriage printing, for example, are better handled by line printers or dot-matrix printers. *See also* electrophotographic printers, nonimpact printer, page printer. *Compare* dot-matrix printer, ion-deposition printer, LCD printer, LED printer.

laser storage *n.* The use of optical read/write technology with metallic discs for information storage. *See also* compact disc.

LaserWriter 35 *n.* The standard set of 35 PostScript fonts for the Apple LaserWriter family of laser printers. *See also* laser printer, PostScript font.

last in, first out *n.* A method of processing a queue in which items are removed in inverse order relative to the order in which they were added—that is, the last in is the first out. *Acronym:* LIFO. *See also* stack. *Compare* first in, first out.

last mile *n.* The connection (which may in fact be more or less than one mile) between an end user's system and that of a service provider, such as a telephone company. The "last mile" connection historically has referred to the twisted-pair copper wires used between a home and the



telephone company. While this definition remains accurate, “last mile” is now often used more broadly to refer to the link between an end user’s system and the high-speed Internet access technology of a service provider, such as an ISP (Internet service provider). Thus, for modem users accessing the Internet through voice-grade lines, the last mile is still equivalent to the phone company’s twisted-pair copper wiring. However, because standard modem transmission over voice-grade lines is sometimes frustratingly slow, other last mile solutions have been designed to provide greater speed and bandwidth. These include coaxial cable (used in cable TV), fiber optics, or a radio link (such as a cellular telephone or a point-to-point link). DSL and ISDN are methods for providing high-speed last-mile data service through twisted-pair copper wires. *See also* DSL, ISDN, twisted-pair wiring. *Compare* local loop.

latch *n.* A circuit or circuit element used to maintain a particular state, such as on or off, or logical true or false. A latch changes state only in response to a particular input. *See also* flip-flop.

late binding *n.* *See* dynamic binding.

latency *n.* The time required for a signal to travel from one point on a network to another. *See also* ping¹ (definition 1).

LaTeX¹ or **L^AT_EX** *n.* A document preparation system based on TeX, developed by Leslie Lamport. By using simple, intuitive commands for text elements such as headers, LaTeX lets the user focus more on document content than document appearance. *See also* header (definition 1), TeX.

LaTeX² *vb.* To process a LaTeX file. *See also* LaTeX¹.

launch *vb.* To activate an application program (especially on the Macintosh) from the operating system’s user interface.

launcher *n.* In Mac OS, a program that organizes frequently used applications and programs and that allows the user to execute them with a single mouse click.

layer *n.* **1.** The protocol or protocols operating at a particular level within a protocol suite, such as IP within the TCP/IP suite. Each layer is responsible for providing specific services or functions for computers exchanging information over a communications network (such as the layers in the ISO/OSI reference model) and information is

passed from one layer to the next. Although different suites have varying numbers of levels, generally the highest layer deals with software interactions at the application level, and the lowest governs hardware-level connections between different computers. *See the table. See also* ISO/OSI reference model, protocol stack, TCP/IP. **2.** In communications and distributed processing, a set of rules and standards that handles a particular class of events.

Table L.1 *Layers in the ISO/OSI reference model.*

<i>ISO/OSI layer</i>	<i>Focus</i>
Application (highest level)	Program-to-program transfer of information
Presentation	Text formatting and display, code conversion
Session	Establishing, maintaining, and coordinating communication
Transport Network	Accurate delivery, service quality
	Transport routes, message handling and transfer
Data-link	Coding, addressing, and transmitting information
Physical	Hardware connections

layer 4 switching *n.* In Network Address Translation (NAT), a function that handles incoming packets and changes the IP address and destination port to transfer them to the proper server within the private network, and then readdresses return packets leaving the private network. Because layer 4 switching controls the address on packets moving in both directions, the internal network remains transparent to the client. *See also* LVS, NAT.

layered architecture *n.* The division of a network model into multiple discrete layers, or levels, through which messages pass as they are prepared for transmission. In a layered architecture, protocols at each layer provide specific services or functions and rely on protocols in the layers above and below them for other needed services. *See also* protocol.

layered interface *n.* In programming, one or more levels of routines lying between an application and the computing hardware and separating activities according to the type of task the activities are designed to carry out. Ultimately, such an interface makes it easier to adapt a program to different types of equipment. *See the illustration.*

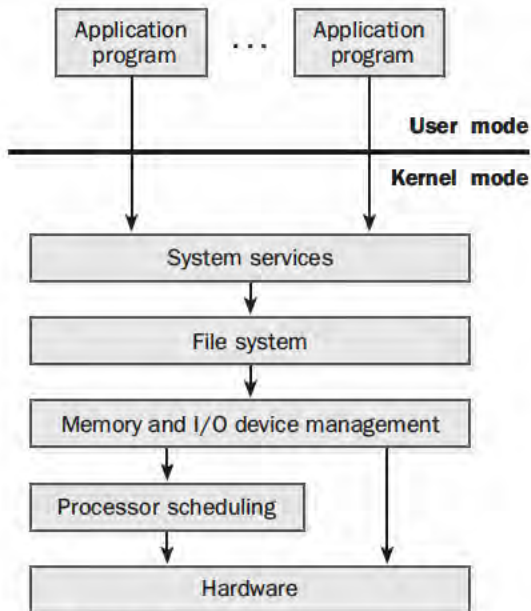

Layered Interface.

layering *n.* In computer graphics, the grouping of logically related elements in a drawing. Layering enables a program user to view, and work on independently, portions of a graphic instead of the entire drawing.

Layer Two Tunneling Protocol *n.* An industry-standard Internet tunneling protocol that provides encapsulation for sending Point-to-Point Protocol (PPP) frames across packet-oriented media. For IP networks, Layer Two Tunneling Protocol traffic is sent as User Datagram Protocol (UDP) messages. In Microsoft operating systems, this protocol is used in conjunction with Internet Protocol security (IPSec) as a virtual private network (VPN) technology to provide remote access or router-to-router VPN connections. Layer Two Tunneling Protocol is described in RFC 2661. *Acronym:* L2TP. *See also* IPSec, Point-to-Point Protocol, tunnel, User Datagram Protocol.

layout *n.* **1.** The overall plan or design of a document system. *See also* page layout. **2.** In programming, the order and sequence of input and output. **3.** In computer design, the arrangement of circuits and other components of the system.

lazy evaluation *n.* A programming mechanism that allows an evaluation action to be performed only when needed and only to a certain extent. Lazy evaluation

allows a program to handle data objects such as extremely large tables and lists in a timely and effective manner.

LBA *n.* *See* logical block addressing.

LCC *n.* *See* leaded chip carrier, leadless chip carrier.

lcd *n.* In some FTP clients, the command that changes the current directory on the local system. *See also* FTP client.

LCD *n.* *See* liquid crystal display.

LCD printer *n.* Short for liquid crystal display printer. An electrophotographic printer similar to a laser printer and often incorrectly labeled as one. LCD printers use a bright light source, typically a halogen lamp. *Also called:* liquid crystal shutter printer. *See also* electrophotographic printers, nonimpact printer, page printer. *Compare* ion-deposition printer, laser printer, LED printer.

LCD projector *n.* Short for liquid crystal display projector. A type of data projector that uses electricity to turn the pixels representing a projected image off or on. Unlike the newer DLP projectors, LCD projectors are able to display shades of color (gray scale) by controlling the amount of electricity used to turn a particular pixel on or off. *See also* gray scale, liquid crystal display. *Compare* DLP projector.

LCP *n.* *See* Point-to-Point Protocol.

LDAP *n.* *See* Lightweight Directory Access Protocol.

lead¹ *n.* In electronics, the metallic connector of certain components such as resistors and capacitors.

lead² *n.* In typography, the amount of vertical space between two lines of text.

leaded chip carrier *n.* A method of mounting chips on boards. A leaded chip carrier has leglike pins for connecting it to the board. The chip makes contact with the board through surface mount technology in which the leads are soldered to the surface rather than into predrilled holes. Somewhat confusingly, a leaded chip carrier goes by the same acronym (LCC) as a leadless chip carrier. *Acronym:* LCC. *Compare* leadless chip carrier.

leader *n.* A row of dots, hyphens, or other such characters used to lead the eye across a printed page to related information. Leaders can be created by many word processors and other programs.

leading *n.* The space, expressed in points, between lines of type, measured from the baseline (bottom) of one line to the baseline of the next. The term is derived from the traditional typesetting practice of inserting a thin bar of

lead between lines of metal type. See the illustration. See also point¹.

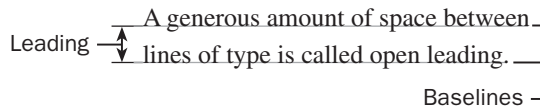

Leading. Ordinary text is typically set with leading one or two points greater than the point size of the type.

leading edge *n.* The initial part of an electronic signal. If a digital signal switches from off to on and then back to off, the transition from off to on is the leading edge of the signal.

leading zero *n.* A zero that precedes the most significant (leftmost) digit of a number. One or more leading zeros may be used as fill characters in a field containing numeric input. Leading zeros have no significance in the value of a number.

lead ion battery *n.* An energy storage device that is based on the conversion of chemical to electrical energy as ions flow from one terminal to another through an acid medium in which lead and copper are suspended. This type of battery is used in laptop and notebook computers.

leadless chip carrier *n.* A method of mounting chips on boards. A leadless chip carrier has contacts, rather than leglike pins, for connecting it to the board. The chip simply rests in a socket that has contacts on its base for completing the connection, and the chip is clamped in place so that the contacts are secure. *Acronym:* LCC. *See also* PLCC. *Compare* DIP (definition 1), pin grid array.

leaf *n.* Any node (location) in a tree structure that is at the farthest distance from the root (primary node), no matter which path is followed. Thus, in any tree, a leaf is a node at the end of a branch—one that has no descendants. *See also* root, subtree, tree.

leapfrog attack *n.* A method used by hackers to make an attack difficult to trace back to the source. In a leapfrog attack the hacker uses a User ID stolen from another source or routes information through a series of hosts to hide their identity and obscure the origin of the attack. *Also called:* network weaving.

leapfrog test *n.* A diagnostic routine, used for testing disk or tape storage, that repeatedly copies itself onto the storage medium.

leap year *n.* A potential problem for some systems that follow an erroneous algorithm for calculating leap years.

There are three rules for calculating leap years: (1) A year is a leap year if it is divisible by 4, *but* (2) not if it is divisible by 100, *unless* (3) it is also divisible by 400. Thus, 1900 was not a leap year, but 2000 was.

leased line *n.* *See* dedicated line (definition 1).

least significant bit *n.* In a sequence of one or more bytes, the low-order (usually rightmost) bit of a binary number. *Acronym:* LSB. *See also* low-order. *Compare* most significant bit.

least significant character *n.* The low-order, or rightmost, character in a string. *Acronym:* LSC. *See also* low-order. *Compare* most significant character.

least significant digit *n.* The low-order, or rightmost, digit in the normal representation of a number. *Acronym:* LSD. *See also* low-order. *Compare* most significant digit.

LED *n.* *See* light-emitting diode.

LED printer *n.* Short for light-emitting diode printer. An electrophotographic printer similar to LCD and laser printers. The significant difference between LED and laser or LCD printers is in the light source; LED printers use an array of light-emitting diodes. *See also* electrophotographic printers, light-emitting diode, nonimpact printer, page printer. *Compare* ion-deposition printer, laser printer, LCD printer.

left justification *n.* In typesetting, word processing, and desktop publishing, the process of aligning text evenly along the left margin of a column or page. The right edge of the text is ragged. *See also* justify (definition 1), rag. *Compare* full justification, right justification.

left-justify *vb.* To justify, as text, along the left. *See also* justify (definition 1), rag. *Compare* right-justify.

legacy *adj.* Of or pertaining to documents, data, or hardware that existed prior to a certain time. The designation refers particularly to a change in process or technique that requires translating old data files to a new system.

legacy data *n.* Data acquired by an organization that was compiled by another organization. The acquiring organization thus receives the existing information as a “legacy” from the information’s prior owner.

legacy system *n.* A computer, software program, network, or other computer equipment that remains in use after a business or organization installs new systems. Compatibility with legacy systems is an important consideration when a new version is installed. For example, will

a new spreadsheet software release be able to read the existing business records without expensive and time-consuming conversion to a new format? Legacy systems in many organizations are based on mainframe computers, which may be either augmented or slowly replaced by client/server architectures. *See also* mainframe computer. *Compare* client/server architecture.

legend *n.* Text that describes or explains a graphic, usually printed below the graphic. On a graph or map, the legend is the key to the patterns or the symbols used.

Lempel Ziv compression *n.* A data compression method designed by Abraham Lempel and Jakob Ziv in 1977 and 1978. Lempel Ziv compression is based on the substitution of certain values for repeated data. It is implemented in two basic forms: LZ77, which is based on values that point to the positions of repeating data, and LZ78, which builds a dictionary and uses the dictionary index to point to repeating data. An enhanced version of LZ78, known as LZW, is implemented in well-known file formats, such as GIF and TIF. *See also* .lzh, LZW compression.

length *n.* The number of linear units of storage space occupied by an object, such as a file on disk or a data structure in a program, typically measured in bits, bytes, or blocks.

LEO *n.* *See* low-Earth-orbit satellite.

LER *n.* *See* MPLS.

less than *adj.* *See* relational operator.

less than or equal to *adj.* *See* relational operator.

letterbomb *n.* An e-mail message that is intended to impair the recipient's computer use. Some sequences of control characters can lock up a terminal, files attached to the message may contain viruses or Trojan horses, and a sufficiently large message can overflow a mailbox or crash a system. *See also* control character, e-mail¹ (definition 1), mailbox, Trojan horse, virus.

letter quality *adj.* Pertaining to or being a level of print quality on dot-matrix printers that is better than draft quality. As the name implies, letter quality is supposed to be crisp and dark enough for use in business letters. *See also* print quality. *Compare* draft quality, near-letter-quality.

letter-quality printer *n.* Any printer that produces output high enough in quality to be acceptable for business letters. *See also* daisy-wheel printer, laser printer.

level 1 cache *n.* *See* L1 cache.

level 2 cache *n.* *See* L2 cache.

lexicographic sort *n.* A sort that arranges items in the order in which they would appear if listed in a dictionary. A lexicographic sort puts numbers, for instance, where they would be if they were spelled out; for example, 567 would fall in the Fs. *Compare* alphanumeric sort.

lexicon *n.* **1.** The words of a language and their definitions. **2.** In programming, the identifiers, keywords, constants, and other elements of a language that make up its "vocabulary." The ways in which these vocabulary elements can be put together is the syntax of the language. *Compare* syntax.

LF *n.* *See* linefeed.

LHARC *n.* A freeware file-compression utility program developed by Haruyasu Yoshizaki and introduced in 1988. With LHARC, the contents of one or more files can be compressed into a singular, smaller file, with the extension .lha. A copy of the program is required to uncompress these files. LHARC can also embed a small program with the compressed information and save everything in a single file, called a self-extracting archive, with an .exe extension. As a result, the recipient of the compressed file does not need a separate utility program to uncompress the file. *See also* freeware, PKZIP, utility program.

library *n.* **1.** In programming, a collection of routines stored in a file. Each set of instructions in a library has a name, and each performs a different task. **2.** A collection of software or data files.

library routine *n.* In programming, a routine stored in a collection of routines (a library) that can be used by any program that can link into the library. *See also* function library, library (definition 1).

license agreement *n.* A legal contract between a software provider and a user specifying the rights of the user regarding the software. Usually the license agreement is in effect with retail software once the user opens the software package. *See also* End-User License Agreement.

licensing key *n.* A short character string that serves as a password during the installation of licensed commercial software. The use of licensing keys is a security device aimed at reducing illegal duplication of licensed software.

LIFO *n.* *See* last in, first out.

ligature *n.* In typography, a single character created from two joined letters that replaces the two separate letters. Because ligatures are not included with all digital



fonts, their use may cause text problems in font substitution situations.

light-emitting diode *n.* A semiconductor device that converts electrical energy into light, used, for example, for the activity lights on computer disk drives. Light-emitting diodes work on the principle of electroluminescence and are highly efficient, producing little heat for the amount of light output. *Acronym:* LED.

light guide *n.* A structure, such as a fiberoptic filament, designed to transmit light over distances with minimal attenuation or loss.

lightmap *n.* A basic lighting scheme used in 3D computer game rendering and other digital animation applications. A lightmap generates a precalculated 3D grid for lighting all objects in a game but cannot be adjusted for player-initiated changes within the scene.

light pen *n.* An input device consisting of a stylus that is connected to a computer's monitor. The user points at the screen with the stylus and selects items or chooses commands either by pressing a clip on the side of the light pen or by pressing the light pen against the surface of the screen (the equivalent of performing a mouse click). *See also* absolute pointing device. *Compare* touch screen.

light source *n.* **1.** The device that provides the luminescence (for example, a bulb or laser) in any technology based on the use and interpretation of light, such as a scanner or CRT. **2.** In computer graphics, the imaginary location of a source of light, which determines the shading in an image.

lightwave system *n.* A system that transmits information by means of light.

Lightweight Directory Access Protocol *n.* A network protocol designed to work on TCP/IP stacks to extract information from a hierarchical directory such as X.500. This gives users a single tool to comb through data to find a particular piece of information, such as a user name, an e-mail address, a security certificate, or other contact information. *Acronym:* LDAP. *See also* CCITT X series.

Lightweight Internet Person Schema *n.* In Lightweight Directory Access Protocol directories, a specification for the retrieval of such information as names and e-mail addresses. *Acronym:* LIPS. *See also* Lightweight Directory Access Protocol.

LIM EMS *n.* Acronym for Lotus/Intel/Microsoft Expanded Memory Specification. *See* EMS.

limit check *n.* In programming, a test that checks specified information to verify that it is within acceptable limits. *See also* array.

limiting operation *n.* Any routine or operation that constrains the performance of a larger process in which it is included; a bottleneck.

line *n.* **1.** Any wire or wires, such as power lines and telephone lines, used to transmit electrical power or signals. **2.** In communications, a connection, usually a physical wire or other cable, between sending and receiving (or calling and called) devices, including telephones, computers, and terminals. **3.** In a SONET network, a segment that runs between two multiplexers. *See also* SONET. **4.** In word processing, a string of characters displayed or printed in a single horizontal row. **5.** In programming, a statement (instruction) that occupies one line of the program. In this context, the common reference is to a "program line" or a "line of code."

line adapter *n.* A device, such as a modem or network card, that connects a computer to a communications line and converts a signal to an acceptable form for transmission.

line analyzer *n.* A monitoring device used to verify the integrity of a communications line and to assist in troubleshooting.

linear *adj.* **1.** Having the characteristics of a line. **2.** Proceeding sequentially. For example, a linear search is one that moves from A to B to C. **3.** In mathematics and electronics, having a direct and proportional relationship among characteristics or variables. For example, the output of a linear amplifier is directly proportional to the input. *See also* linear programming.

linear addressing architecture *n.* An architecture that allows a microprocessor to access any individual memory location by means of a single address value. Thus, each memory location within the entire range of addressable memory has a unique, specified address. *See also* flat address space, segmented address space.

linear bus *n.* *See* bus network.

linear inferences per second *n.* *See* LIPS (definition 2).

linear list *n.* A simple ordered list of elements in which each element except the first immediately succeeds one other element, and each except the last immediately precedes one other. *Compare* linked list.

linear memory *n.* *See* flat memory.

linear programming *n.* The process of creating programs that find optimal solutions for systems of equations (composed of linear functions) in which the terms given are not sufficient to derive a straightforward solution.

linear search *n.* A simple, though inefficient, search algorithm that operates by sequentially examining each element in a list until the target element is found or the last item has been completely processed. Linear searches are primarily used for very short lists. *Also called:* sequential search. *See also* search algorithm. *Compare* binary search, hash search.

linear structure *n.* A structure in which items are organized according to strict rules of precedence. In a linear structure, two conditions apply: if X precedes Y and Y precedes Z, then X precedes Z; and if X precedes Y and X precedes Z, then either Y precedes Z or Z precedes Y.

line-based browser *n.* A Web browser whose display is based on text rather than graphics. A popular line-based browser is Lynx. *See also* Lynx, Web browser.

line cap *n.* The way in which a line segment is terminated when the segment is printed, especially on a PostScript-compatible printer. *See the illustration. See also* line join.

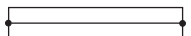
 Butt cap

 Square cap

 Round cap

Line cap. *The dots represent the mathematical endpoints of a specified line.*

line chart *n.* A business graphic in which values from one or more sets of data are connected by lines. *See the illustration.*

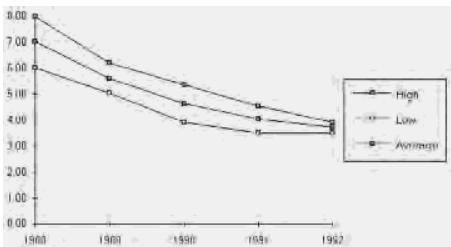

Line chart.

line concentration *n.* The funneling of multiple input channels into a smaller number of output channels. *See also* concentrator.

line conditioner *n.* A device for filtering electrical power to compensate for brownouts, suppress power surges, and act as a buffer between a power line and the computer (or other piece of equipment). Line conditioners contain transformers, capacitors, and other circuitry that help regulate the quality of power to ensure that electrical flow is constant. *See also* brownout, UPS.

line conditioning *n.* *See* conditioning, line conditioner.

line drawing *n.* A drawing made up of solid lines without shading or other features that suggest mass or contouring.

line driver *n.* A device used to increase transmission distance by amplifying a signal before placing it on the line or passing it along the line. *See also* short-haul.

line editor *n.* A text-editing program that numbers each line of text, working with the document on a line-by-line rather than on a word-by-word basis. *See also* editor.

linefeed *n.* A control character that tells a computer or printer to advance one line below the current line without moving the position of the cursor or print head.

Acronym: LF.

line join *n.* The way in which two line segments are connected when they are printed, especially on a PostScript-compatible printer. *See the illustration. See also* line cap.

 Miter join

 Round join

 Beveled join

Line join. *Three styles of line join.*

line level *n.* The strength of a communications signal at a given point on the line, measured in decibels (a multiple of the base-10 logarithm of the ratio between two values) or nepers (the natural logarithm of the ratio between two values).

line load *n.* **1.** In communications, a measure of the usage of a communications line expressed as a percentage of the



maximum capacity of the circuit. **2.** In electronics, the amount of current carried by a line.

line noise *n.* Spurious signals in a communications channel that interfere with the exchange of information. In an analog circuit, line noise may take the form of a pure audio tone, static, or signals leaked from another circuit. In a digital circuit, line noise is any signal that makes it difficult or impossible for the device at the receiving end of the circuit to interpret the transmitted signal accurately. *See also* channel.

line number *n.* **1.** A number assigned by a line editor to a line of text and used to refer to that line for purposes of viewing, editing, or printing. The line numbers are sequential. *See also* line editor. **2.** In communications, an identifying number assigned to a communications channel.

line printer *n.* Any printer that prints one line at a time as opposed to one character at a time (as with many dot-matrix printers) or one page at a time (as with some dot-matrix and most laser printers). Line printers typically produce the familiar 11-by-17-inch fanfold “computer” printouts. They are high-speed devices and are often used with mainframes, minicomputers, or networked machines rather than with single-user systems.

line regulator *n.* *See* voltage regulator.

line segment *n.* A portion of a line, defined by its beginning and ending points.

lines of code *n.* A measure of program length. Depending on circumstances, a line of code can be each line in the program (including blank lines and comments), each line containing actual code, or each statement. *See also* statement.

line spacing *n.* *See* leading.

line speed *n.* *See* baud rate, data rate.

lines per minute *n.* A measurement of printer speed, the number of lines of characters printed in one minute. *Acronym:* LPM.

line style *n.* In desktop publishing, printing, and high-end word processing, the form and quality of a line, such as a dotted line, a double line, or a hairline. *See also* hairline.

line surge *n.* A sudden, transient increase in the voltage or current carried by a line. A nearby lightning strike, for example, can cause a surge in power lines that can damage electrical equipment. Delicate types of equipment such as computers are often protected from line surges by surge suppressors placed in the power lines.

line voltage *n.* The voltage present in a power line. In North America, line voltage is approximately 115 volts alternating current (VAC).

line width *n.* The length of a line of type measured from the left margin to the right margin on a piece of paper or on a computer screen. On a typewriter, line width is usually measured in terms of the number of monospace alphanumeric characters that can fit on the line; on a computer monitor or printer, line width is normally measured in inches, centimeters, points, or picas. *See also* pica (definition 2), point¹ (definition 1).

linguistics *n.* The analytic study of human language. Close ties exist between linguistics and computer science because of the mutual interest in grammar, syntax, semantics, formal language theory, and natural-language processing.

link¹ *vb.* **1.** To produce an executable program from compiled modules (programs, routines, or libraries) by merging the object code (assembly language object code, executable machine code, or a variation of machine code) of the program and resolving interconnecting references (such as a library routine called by a program). *See also* linker. **2.** To connect two elements in a data structure by using index variables or pointer variables. *See also* index (definition 1), pointer (definition 1).

link² *n.* *See* hyperlink.

linkage editor *n.* *See* linker.

link aggregation *n.* A technique for combining two or more Ethernet connections into one logical link, or trunk, between two devices. It is used to increase the bandwidth capacity of connections and to make these connections more resilient. The IEEE 802.3ad specification standardizes this process among different vendors using the Link Aggregation Control Protocol (LACP). *Also called:* bonding, trunking. *See also* IEEE 802.x.

Link Aggregation Control Protocol *n.* *See* link aggregation.

Link Control Protocol *n.* *See* Point-to-Point Protocol.

link edit *vb.* *See* link¹ (definition 1).

linked list *n.* In programming, a list of nodes or elements of a data structure connected by pointers. A singly linked list has one pointer in each node pointing to the next node in the list; a doubly linked list has two pointers in each node that point to the next and previous nodes. In a circular list, the first and last nodes of the list are linked

together. *See also* array, key (definition 2), list, node (definition 1), pointer (definition 1). *Compare* linear list.

linked object *n.* An object that is inserted into a document but still exists in the source file. When information is linked, the new document is updated automatically if the information in the original document changes. If you want to edit the linked information, double-click it and the toolbars and menus from the original program appear, allowing you to edit it in its native format. If the original document is on your computer, changes that you make to the linked information will also appear in the original document. *See also* OLE, package, source document.

linked stylesheet *n.* A stylesheet existing separately from the HTML documents to which it is linked. A linked stylesheet may be used for sets of Web pages or entire Web sites requiring a uniform appearance. Since the style is defined once and linked to associated Web pages, the entire site can be changed by modifying a single stylesheet file. *Compare* inline stylesheet.

linker *n.* A program that links compiled modules and data files to create an executable program. A linker can also have other functions, such as creating libraries. *See also* library, link¹ (definition 1), program creation.

linkrot *n.* A condition affecting inadequately maintained Web pages that results in outdated, inoperative links to other Web pages.

link time *n.* **1.** The length of time required to link a program. *See also* link¹ (definition 1). **2.** The period during which a program is being linked. *See also* compile time (definition 2), link¹ (definition 1), run time (definition 1).

link-time binding *n.* Assignment of a meaning to an identifier (such as a subroutine label) in a program at the time that various files of compiled code are linked together to form an executable program, rather than when the source code is compiled or when the program is run. *Compare* compile-time binding, run-time binding.

Linotronic *n.* Any in the series of high-quality typesetting devices known as Linotronic laser imagesetters, which can print at resolutions such as 1270 and 2540 dots per inch (dpi). These devices are commonly attached to PostScript raster image processors (RIPs) so that desktop publishing applications can typeset directly from a microcomputer. *See also* imagesetter, PostScript, raster image processor.

Linpack *n.* A benchmarking routine that solves 100 simultaneous equations in a test of CPU, floating-point processor,

and memory access speeds. *See also* benchmark², central processing unit, floating-point processor.

Linux *n.* A version of the UNIX System V Release 3.0 kernel developed for PCs with 80386 and higher-level microprocessors. Developed by Linus Torvalds (for whom it is named) along with numerous collaborators worldwide, Linux is distributed free, and its source code is open to modification by anyone who chooses to work on it, although some companies distribute it as part of a commercial package with Linux-compatible utilities. The Linux kernel works with the GNU utilities developed by the Free Software Foundation, which did not produce a kernel. It is used by some as an operating system for network servers and in the 1998/1999 timeframe began to gain increased visibility through support from vendors such as IBM and Compaq. *See also* free software, GNU, kernel, UNIX.

Linux Virtual Server *n.* *See* LVS.

Linux World Expo *n.* The world's largest trade show for designers, engineers, and businesses using the Linux operating system.

Lion worm *n.* A UNIX shellsript worm first detected in early 2001 that infects Linux servers using Berkeley Internet Name Domain (BIND) tools. After it has used a BIND exploit to infect a machine, Lion steals password files and other critical information and transmits them to the hacker. Lion then installs hacking tools and replaces critical files, hiding itself and opening multiple back doors for further compromise. The Lion worm was apparently launched in early 2001 by a group of Chinese hackers with a specific political agenda. In references to this worm, "Lion" may also be spelled as "li0n".

LIPS *n.* **1.** Acronym for **Language Independent Program Subtitling**. A system developed by the GIST group (C-DAC, India) and used by Indian Television for nationwide broadcast of programs with multilingual subtitles in teletext mode. This system was judged the best design in the VLSI (Very Large Scale Integration) design contest in the VLSI '93 International Conference. Three versions of this application-specific integrated circuit (ASIC) with different features were implemented in Xilinx 3K and 4K series FPLAs (field programmable logic arrays). *See also* field-programmable logic array, gate array, very-large-scale integration. **2.** Acronym for **linear inferences per second**. A measure of speed for some types of artificial-intelligence



machines and expert systems. *See also* artificial intelligence, expert system. **3.** *See* Lightweight Internet Person Schema.

liquid crystal display *n.* A type of display that uses a liquid compound having a polar molecular structure, sandwiched between two transparent electrodes. When an electric field is applied, the molecules align with the field, forming a crystalline arrangement that polarizes the light passing through it. A polarized filter laminated over the electrodes blocks polarized light. In this way, a grid of electrodes can selectively “turn on” a cell, or a pixel, containing the liquid crystal material, turning it dark. In some types of liquid crystal displays, an electroluminescent panel is placed behind the screen to illuminate it. Other types of liquid crystal displays are capable of reproducing color. *Acronym:* LCD. *See also* supertwist display, twisted nematic display.

liquid crystal display printer *n.* *See* LCD printer.

liquid crystal shutter printer *n.* *See* LCD printer.

LISP *n.* Short for **List Processing**. A list-oriented programming language developed in 1959–60 by John McCarthy and used primarily to manipulate lists of data. LISP is heavily used in research and academic circles and is considered the standard language for artificial-intelligence research. *See also* artificial intelligence. *Compare* Prolog.

list *n.* A multielement data structure that has a linear (first, second, third, . . .) organization but that allows elements to be added or removed in any order. Queues, deques, and stacks are simply lists with restrictions on adding and removing elements. *See also* deque, element (definition 1), linked list, queue, stack.

list box *n.* A control in Windows that enables the user to choose one option from a list of possibilities. The list box appears as a box, displaying the currently selected option, next to a button marked with a down arrow. When the user clicks the button, the list appears. The list has a scroll bar if there are more options than the list has room to show.

listing *n.* A printed copy of program source code. Some compilers and assemblers produce optional assembly listings during compilation or assembly. Such listings of code often have additional information such as line numbers, nested block depth, and cross-reference tables. *See also* assembly listing.

list processing *n.* The maintenance and manipulation of multielement data structures. This involves adding and deleting elements, writing data into elements, and travers-

ing the list. List processing is the basis of the artificial-intelligence programming language LISP. *See also* LISP, list, node (definition 1).

LISTSERV *n.* One of the most popular commercial mailing list managers, marketed by L-SOFT International in versions for BITNET, UNIX, and Windows. *See also* mailing list, mailing list manager.

literal *n.* A value, used in a program, that is expressed as itself rather than as a variable’s value or the result of an expression. Examples are the numbers 25 and 32.1, the character *a*, the string *Hello*, and the Boolean value TRUE. *See also* constant, variable.

lithium ion battery *n.* An energy storage device based on the conversion of chemical to electrical energy in “dry” chemical cells. Despite the higher cost, the laptop industry is quickly adopting lithium ion batteries because of their increased storage capacity over both nickel cadmium and nickel metal hydride batteries, in response to the demand for greater power brought on by higher processor speeds and the use of devices such as CD-ROM drives. *Compare* nickel cadmium battery, nickel metal hydride battery.

little endian *adj.* Of, pertaining to, or being a method of storing a number so that the least significant byte appears first in the number. For example, given the hexadecimal number A02B, the little endian method would cause the number to be stored as 2BA0. The little endian method is used by Intel microprocessors. *Also called:* reverse byte ordering. *Compare* big endian.

live¹ *adj.* **1.** Of or relating to real-world data or a program working with it, as opposed to test data. **2.** Of or relating to audio or video that is transmitted from one site to another as it is being produced, as opposed to being recorded before broadcast time. *See also* synchronous transmission. **3.** Capable of being manipulated by a user to cause changes in a document or part of a document.

live² *n.* Used to identify a Web site that has been published to a Web server and can be browsed by site visitors. *Also called:* going live.

Live3D *n.* A Netscape proprietary Virtual Reality Modeling Language (VRML) plug-in for Web browsers that allows users to view and interact with a virtual-reality world. *See also* VRML.

liveware *n.* A slang term for people, to distinguish them from hardware, software, and firmware. *Also called:* wetware.

LLC *n.* Acronym for **Logical Link Control**. In the IEEE 802.x specifications, the higher of two sublayers that make up the ISO/OSI data link layer. The LLC is responsible for managing communications links and handling frame traffic. *See also* IEEE 802.x, MAC.

Lmhosts file *n.* A local text file that lists the names of network hosts (sometimes called NetBIOS names) to IP addresses for hosts that are not located on the local subnet. *See also* IP address, systemroot.

load¹ *n.* **1.** The total computing burden a system carries at one time. **2.** In electronics, the amount of current drawn by a device. **3.** In communications, the amount of traffic on a line.

load² *vb.* To place information from storage into memory for processing, if it is data, or for execution, if it is program code.

load-and-go *adj.* In reference to a routine, able to begin execution immediately, once loaded. The term is commonly used in reference to compilers and the machine code they generate.

load balancing *n.* **1.** In distributed processing, the distribution of activity across two or more servers in order to avoid overloading any one with too many requests from users. Load balancing can be either static or dynamic. In the former, the load is balanced ahead of time by assigning different groups of users to different servers. In the latter, software refers incoming requests at runtime to whichever server is most capable of handling them. **2.** In client/server network administration, the process of reducing heavy traffic flows either by dividing a busy network segment into multiple smaller segments or by using software to distribute traffic among multiple network interface cards working simultaneously to transfer information to a server. **3.** In communications, the process of routing traffic over two or more routes rather than one. Such load balancing results in faster, more reliable transmissions.

loaded line *n.* A transmission cable fitted with loading coils, usually spaced about a mile apart, that reduce amplitude distortion in a signal by adding inductance (resistance to changes in current flow) to the line. Loaded lines minimize distortion within the range of frequencies affected by the loading coils, but the coils also reduce the bandwidth available for transmission.

loader *n.* A utility that loads the executable code of a program into memory for execution. On most microcomputers, the loader is an invisible part of the operating system

and is automatically invoked when a program is run. *See also* loader routine, load module.

loader routine *n.* A routine that loads executable code into memory and executes it. A loader routine can be part of an operating system or it can be part of the program itself. *See also* loader, overlay¹ (definition 1).

load module *n.* An executable unit of code loaded into memory by the loader. A program consists of one or more load modules, each of which can be loaded and executed independently. *See also* loader.

load point *n.* The beginning of the valid data area on a magnetic tape.

load sharing *n.* A method of managing one or more tasks, jobs, or processes by scheduling and simultaneously executing portions of them on two or more microprocessors.

load shedding *n.* In electrical systems, the process of turning off power to some electronic equipment in order to maintain the integrity of the power supply to other connected devices. *See also* UPS.

lobby page *n.* A page of information about the broadcast that is displayed in the viewer's browser before the broadcast begins. It can contain a title, subject, host's name, information about the broadcast, and a countdown to the time of the broadcast.

local *adj.* **1.** In general, close at hand or restricted to a particular area. **2.** In communications, a device that can be accessed directly rather than by means of a communications line. **3.** In information processing, an operation performed by the computer at hand rather than by a remote computer. **4.** In programming, a variable that is restricted in scope, that is, used in only one part (subprogram, procedure, or function) of a program. *Compare* remote.

local area network *n.* *See* LAN.

local bus *n.* A PC architecture designed to speed up system performance by allowing some expansion boards to communicate directly with the microprocessor, bypassing the normal system bus entirely. *See also* PCI local bus, VL bus.

local bypass *n.* A telephone connection used by some businesses that links separate buildings but bypasses the telephone company.

locale identifier *n.* A 32-bit value that consists of a language identifier and a sort identifier. In code, a locale



identifier (LCID) identifies the primary language and any secondary language of a specific locale. *Acronym:* LCID. *See also* language identifier.

localhost *n.* The name that is used to represent the same computer on which a TCP/IP message originates. An IP packet sent to localhost has the IP address 127.0.0.1 and does not actually go out to the Internet. *See also* IP address, packet (definition 1), TCP/IP.

localization *n.* The process of altering a program so that it is appropriate for the geographic area in which it is to be used. Localization involves the customization or translation of the separated data and resources required for a specific region or language. For example, the developers of a word processing program must localize the sorting tables in the program for different countries or languages because the correct order of characters in one language might be incorrect in another. L10N is a common abbreviation for Localization, where the “L” in Localization is followed by 10 letters and ends with the letter “N.”

localized version *n.* A version of a program that has been translated into another language. *Also called:* international version.

local loop *n.* The (end) portion of a telephone connection that runs from the subscriber to the local telephone exchange. *See also* last mile.

local memory *n.* In multiprocessor systems, the memory on the same card or high-speed bus as a particular processor. Typically, memory that is local to one processor cannot be accessed by another without some form of permission.

local newsgroups *n.* Newsgroups that are targeted toward a geographically limited area such as a city or educational institution. Posts to these newsgroups contain information that is specific to the area, concerning such topics as events, meetings, and sales. *See also* newsgroup.

local reboot *n.* A reboot of the machine that one is directly working on, rather than of a remote host. *See also* reboot.

LocalTalk *n.* An inexpensive cabling scheme used by AppleTalk networks to connect Apple Macintosh computers, printers, and other peripheral devices. *See also* AppleTalk.

local user profile *n.* A user profile that is created automatically on the computer the first time a user logs on to a

computer. *See also* mandatory user profile, roaming user profile, user profile.

local variable *n.* A program variable whose scope is limited to a given block of code, usually a subroutine. *See also* scope (definition 1). *Compare* global variable.

location *n.* *See* address¹ (definition 1).

location-based service *n.* A service provided to a wireless mobile device based on the device’s location. Location-based services can range from simple services, such as listing nearby restaurants, to more complex features, such as connecting to the Internet to monitor traffic conditions and find the least congested route to a destination.

lock *n.* **1.** A software security feature that requires a key or dongle in order for the application to run correctly. *See also* dongle. **2.** A mechanical device on some removable storage medium (for example, the write-protect notch on a floppy disk) that prevents the contents from being overwritten. *See also* write-protect notch.

locked file *n.* **1.** A file on which one or more of the usual types of manipulative operation cannot be performed—typically, one that cannot be altered by additions or deletions. **2.** A file that cannot be deleted or moved or whose name cannot be changed.

locked volume *n.* On the Apple Macintosh, a volume (storage device, such as a disk) that cannot be written to. The volume can be locked either physically or through software.

lockout *n.* The act of denying access to a given resource (file, memory location, I/O port), usually to ensure that only one program at a time uses that resource.

lock up *n.* A condition in which processing appears to be completely suspended and in which the program in control of the system will accept no input. *See also* crash¹.

log *n.* A record of transactions or activities that take place on a computer system. *See* logarithm.

logarithm *n.* Abbreviated log. In mathematics, the power to which a base must be raised to equal a given number. For example, for the base 10, the logarithm of 16 is (approximately) 1.2041 because $10^{1.2041}$ equals (approximately) 16. Both natural logarithms (to the base e , which is approximately 2.71828) and common logarithms (to the base 10) are used in programming. Languages such as C and Basic include functions for calculating natural logarithms.

log files *n.* A computer file that records requests received by online applications or the number of hits a Web page receives. Log files are useful in analyzing the technical performance of a Web site, redesigning Web site navigation, and revising marketing strategies used by e-businesses.

logic *n.* In programming, the assertions, assumptions, and operations that define what a given program does. Defining the logic of a program is often the first step in developing the program's source code. *See also* formal logic.

logical *adj.* **1.** Based on true and false alternatives as opposed to arithmetic calculation of numeric values. For example, a logical expression is one that, when evaluated, has a single outcome, either true or false. *See also* Boolean algebra. *Compare* fuzzy logic. **2.** Conceptually true to a particular design or idea—for example, network transmissions travel in a circle around a logical ring, even though the ring shape itself is not physically apparent. *Compare* physical.

logical block addressing *n.* A technique in which the cylinder, head, and sector locations on a hard disk are converted to 24-bit addresses for data storage and retrieval. Logical block addressing is used with SCSI drives and is also a feature of Enhanced IDE (EIDE) disk drives, on which it breaks through the earlier 528-MB IDE limit and allows support for drives up to 8.4 GB in capacity if 24-bit logical address space is used. Address conversion is performed by an EIDE drive's disk controller, but also requires support from the BIOS and the computer's operating system. *Acronym:* LBA. *See also* EIDE, SCSI.

logical decision *n.* Any decision that can have one of two outcomes (true/false, yes/no, and so on). *Compare* fuzzy logic.

logical device *n.* A device named by the logic of a software system, regardless of its physical relationship to the system. For example, a single floppy disk drive can simultaneously be, to the MS-DOS operating system, both logical drive A and drive B.

logical drive *n.* *See* logical device.

logical error *n.* *See* logic error.

logical expression *n.* *See* Boolean expression.

logical file *n.* A file as seen from a conceptual standpoint, without reference to and as distinct from its physical realization in memory or storage. For example, a logical file might consist of a contiguous series of records, whereas the file might be physically stored in small pieces scat-

tered over the surface of a disk or even on several disks. A logical file might also consist of some subset of columns (fields) and rows (records) extracted from a database. In this case, the logical file (or view) is only that information required by a particular application program or user.

Logical Link Control *n.* *See* LLC.

logical memory *n.* A correlation between physical memory of the computer system and an address range that is accessible to devices. The hardware abstraction layer (HAL) provides this correlation (or mapping). *See also* map.

logical network *n.* A way to describe the topology, or layout, of a computer network. Referring to a logical (rather than physical) topology describes the way information moves through the network—for example, in a straight line (bus topology) or in a circle (ring topology). The difference between describing a network as logical or physical is sometimes subtle because the physical network (the actual layout of hardware and cabling) doesn't necessarily resemble the logical network (the path followed by transmissions). A logical ring, for example, might include groups of computers cabled octopus-like to hardware "collection points" which, in turn, are cabled to one another. In such a network, even though the physical layout of computers and connecting hardware might not visually resemble a ring, the logical layout followed by network transmissions would, indeed, be circular. *See also* bus network, ring network, star network, token ring network, topology. *Compare* physical network.

logical operator *n.* An operator that manipulates binary values at the bit level. In some programming languages, logical operators are identical to Boolean operators, which manipulate true and false values. *See also* Boolean operator, mask.

logical record *n.* Any unit of information that can be handled by an application program. A logical record can be a collection of distinct fields or columns from a database file or a single line in a text file. *See also* logical file.

logical schema *n.* *See* conceptual schema.

logic analyzer *n.* A hardware device that facilitates sophisticated low-level debugging of programs. Typical features include the ability to monitor bus signals during execution, to halt execution when a given memory location is read or written to, and to trace back through some number of instructions when execution is halted for any reason. *See also* debugger.



logic array *n.* See gate array.

logic board *n.* Another name for motherboard or processor board. The term was used in conjunction with older computers to distinguish the video board (*analog board*) from the motherboard. See also motherboard.

logic bomb *n.* **1.** A logic error in a program that manifests itself only under certain conditions, usually when least expected or desired. The term *bomb* implies an error that causes the program to fail spectacularly. See also logic error. **2.** A type of Trojan horse that executes when certain conditions are met, such as when a user performs a specific action. **3.** See Year 2000 problem. **4.** See fork bomb.

logic chip *n.* An integrated circuit that processes information, as opposed to simply storing it. A logic chip is made up of logic circuits.

logic circuit *n.* An electronic circuit that processes information by performing a logical operation on it. A logic circuit is a combination of logic gates. It produces output based on the rules of logic it is designed to follow for the electrical signals it receives as input. See also gate (definition 1).

logic diagram *n.* A schematic that shows the connections between computer logic circuits and specifies the expected outputs resulting from a specific set of inputs.

logic error *n.* An error, such as a faulty algorithm, that causes a program to produce incorrect results but does not prevent the program from running. Consequently, a logic error is often very difficult to find. See also logic, semantics, syntax.

logic gate *n.* See gate (definition 1).

logic operation *n.* **1.** An expression that uses logical values and operators. **2.** A bit-level manipulation of binary values. See also Boolean operator.

logic programming *n.* A style of programming, best exemplified by Prolog, in which a program consists of facts and relationships from which the programming language is expected to draw conclusions. See also Prolog.

logic-seeking printer *n.* Any printer with built-in intelligence that lets it look ahead of the current print position and move the print head directly to the next area to be printed, thus saving time in printing pages that are filled with spaces.

logic symbol *n.* A symbol that represents a logical operator such as AND or OR. For example, the symbol + in Boolean algebra represents logical OR, as in A + B (read, “A or B,” not “A plus B”).

logic tree *n.* A logic specification method that uses a branching representation. Each of the tree’s forks represents a decision point; the ends of the branches denote actions to be taken.

login *n.* See logon.

log in *vb.* See log on.

Logo *n.* A programming language with features that are heavily drawn from LISP. Logo is often used to teach programming to children and was developed originally by Seymour Papert at MIT in 1968. Logo is considered an educational language, although some firms have sought to make it more widely accepted in the programming community. See also LISP, turtle, turtle graphics.

logout *n.* The process of terminating a session with a computer accessed through a communications line. Also called: log out.

log off *vb.* To terminate a session with a computer accessed through a communications line—usually a computer that is both distant and open to many users. Also called: log out. Compare log on.

logon *n.* The process of identifying oneself to a computer after connecting to it over a communications line. Also called: login.

log on *vb.* To gain access to a specific computer, a program, or a network by identifying oneself with a username and a password. Also called: log in. Compare log off.

logon script *n.* A file assigned to certain user accounts on a network system. A logon script runs automatically every time the user logs on. It can be used to configure a user’s working environment at every logon, and it allows an administrator to influence a user’s environment without managing all aspects of it. A logon script can be assigned to one or more user accounts. Also called: login script. See also user account.

logout *n.* See logoff.

log out *vb.* See log off.

LOL *n.* Acronym for laughing out loud. An interjection used in e-mail, online forums, and chat services to express

appreciation of a joke or other humorous occurrence. *See also* ROFL.

Long data type *n.* A fundamental data type that holds large integers. A Long variable is stored as a 32-bit number ranging in value from -2,147,483,648 to 2,147,483,647.

long filenames *n.* A feature of most current PC operating systems, including the Macintosh, Windows 9x, Windows NT, Windows 2000, and OS/2. Long filenames allow a user to assign a plain-text name to a file, rather than limiting possible names to just a few characters. Names can be over 200 characters long, include uppercase and lowercase letters, and have spaces between characters. *Compare* 8.3.

long-haul *adj.* Of, pertaining to, or being a type of modem that is able to transmit over long distances. *Compare* short-haul.

longitudinal redundancy check *n.* *See* LRC.

LonWorks *n.* An open standard for network automation created by the Echelon Corporation and supported by the LonMark Interoperability Association. LonWorks, introduced in 1991, can be used in building, transportation, industrial, and home applications to implement a distributed control network.

lookup *n.* A function, often built into spreadsheet programs, in which a previously constructed table of values called a lookup table is searched for a desired item of information. A lookup table consists of rows and columns of data. A lookup function examines the table either horizontally or vertically and then retrieves the data that corresponds to the argument specified as part of the lookup function.

loop¹ *n.* 1. A set of statements in a program executed repeatedly, either a fixed number of times or until some condition is true or false. *See also* DO loop, FOR loop, infinite loop, iterative statement. 2. A pair of wires that runs between a telephone central office and customer premises.

loop² *vb.* To execute a group of statements repeatedly.

loop check *n.* *See* echo check.

loop configuration *n.* A communications link in which multiple stations are joined to a communications line that runs in a closed loop. Generally, data sent by one station is received and retransmitted in turn by each station on the

loop. The process continues until the data reaches its final destination. *See the illustration. See also* ring network.

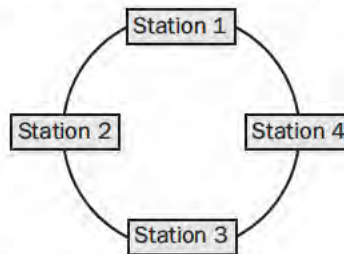

Loop configuration.

loophole *n.* In programming, a logical failure to account for all possible situations. *See also* bug (definition 1), logic error.

loop invariant *n.* A condition that remains true while a loop iterates.

loop structure *n.* *See* iterative statement.

lo-res *adj.* *See* low resolution.

loss balancing *n.* Amplification of a signal or value to compensate for loss during a transmission or translation of a value.

lossless compression *n.* The process of compressing a file such that, after being compressed and decompressed, it matches its original format bit for bit. Text, code, and numeric data files must be compressed using a lossless method; such methods can typically reduce a file to 40 percent of its original size. *Compare* lossy compression.

lossy compression *n.* The process of compressing a file such that some data is lost after the file is compressed and decompressed. Video and sound files often contain more information than is apparent to the viewer or listener; a lossy compression method, which does not preserve that excess information, can reduce such data to as little as 5 percent of its original size. *Compare* lossless compression.

lost cluster *n.* A cluster (disk storage unit) marked by the operating system as being in use but not representing any part of any chain of stored segments of a file. A lost cluster usually represents debris resulting from incomplete data "housekeeping," as might result from the ungraceful exit (messy or abrupt termination) of an application program.

Lotus 1-2-3 *n.* An electronic spreadsheet product introduced in 1983 by Lotus Development Corporation. Notable

L

for its inclusion of graphing and data-management (database) capabilities in addition to spreadsheet functionality, Lotus 1-2-3 is important in the history of the personal computer because it was one of the first “killer apps” that convinced businesses to buy and use a PC. Lotus Development was purchased by IBM in 1995. *See also* killer app.

Lotus cc:Mail *n.* *See* cc:Mail.

Lotus Domino *n.* A groupware application that transforms Lotus Notes into an application and messaging server. *See also* Lotus Notes.

Lotus Notes *n.* A groupware application introduced in 1988 by Lotus Development Corporation and now owned by IBM. Lotus Notes combines e-mail, calendar management, group scheduling, contact and task management, newsgroup access, and Web browsing capability (through the integration of Microsoft Internet Explorer) in one client application. Lotus Notes also offers search capabilities across multiple formats and file types on a network or the Web.

low-Earth-orbit satellite *n.* A communications satellite put into orbit no higher than 500 miles above the earth’s surface. A low-Earth-orbit satellite, or LEO, circles the planet in 90 minutes to 2 hours. LEOs allow for use of smaller dishes and handheld devices, so they are well-suited for interactive conferencing. However, because a LEO remains above the local horizon for about only 20 minutes, large numbers of these satellites, in several different orbits, are required to maintain service. *Acronym:* LEO. *Compare* geostationary orbit satellite.

lowercase *adj.* In reference to letters, not capital—for example, *a, b, c*. *Compare* uppercase.

low frequency *n.* The portion of the electromagnetic spectrum between 30 kilohertz (kHz) and 300 kHz. This range of frequencies is used for several types of radio communication, including the longwave broadcast band in Europe and Asia.

low-level language *n.* A language that is machine dependent or that offers few control instructions and data types. Each statement in a program written in a low-level language usually corresponds to one machine instruction. *See also* assembly language. *Compare* high-level language.

low memory *n.* On computers running MS-DOS, the first 640 kilobytes of RAM. This RAM is shared by MS-DOS, device drivers, data, and application programs. *Also called:* conventional memory. *Compare* high memory.

low-order *adj.* Carrying the least weight or significance; typically, the rightmost element in a group. For example, the rightmost bit in a group of bits is the low-order bit. *Compare* high-order.

lowpass filter *n.* An electronic circuit that allows all frequencies below a specified frequency to pass through it. *Compare* bandpass filter, highpass filter.

low resolution *adj.* Abbreviated lo-res. Appearing in relatively coarse detail, used in reference to text and graphics in raster-oriented computer displays and printing. Low-resolution printing is comparable to draft-quality dot-matrix output printed at 125 dots per inch or less. *See also* resolution. *Compare* high resolution.

LPM *n.* *See* lines per minute.

LPMUD *n.* A type of multiuser dungeon (MUD), typically combat related, that contains its own object-oriented programming language for the creation of new areas and objects in the virtual world. *See also* MUD.

LPT *n.* Logical device name for a line printer, a name reserved by the MS-DOS operating system for up to three parallel printer ports designated LPT1, LPT2, and LPT3. The first port, LPT1, is usually the same as the primary MS-DOS hard-copy output device PRN (the logical device name for the printer). The letters LPT were originally used to stand for *line print terminal*.

LRC *n.* Acronym for **longitudinal redundancy check**. A procedure used to check the accuracy of data stored on magnetic tape or transmitted over a communications line. *See also* parity bit. *Compare* VRC.

ls *n.* A UNIX command that instructs the server to return a list of files and subdirectories in the current directory or the directory specified in the command. Because many FTP sites are built on UNIX systems, this command can also be used on those sites. *See also* FTP site, UNIX.

LS-120 *n.* Acronym for **Laser Storage-120**. A floppy disk drive developed by Imation Corporation that uses proprietary laser storage 120-megabyte (MB) media as well as standard 1.44 MB 3.5-inch floppy media. The LS-120 disk drive is capable of storing 120 MB of data on a single 3.5-inch floppy disk and is compatible with other floppy disk formats. LS-120 drives are ATAPI (AT Attachment Packet Interface) compliant so several different drives can use the same EIDE controller. *Also called:* Super Disk.

LSB *n.* **1.** See least significant bit. **2.** Acronym for **Linux Standard Base**. A standard developed to aid in Linux software development by providing a uniform foundation for all versions of the operating system. The Linux model provided by the LSB provides a stable platform for developers to create software that may be used with any version of the operating system, while leaving companies the ability to add other features on top of the base.

LSC *n.* See least significant character.

LSD *n.* See least significant digit.

LSI *n.* See large-scale integration.

LSP *n.* See MPLS.

LSR *n.* See MPLS.

LU *n.* Acronym for **logical unit**. In an IBM SNA network, a point denoting the beginning or end of a communications session. See also SNA.

Luddite *n.* A person opposed to technological advances, especially those designed to replace human skill and experience with automated machinery. The first Luddites were bands of textile workers in Nottinghamshire, England, who protested the use of new large-scale machinery, which they blamed for low wages and high unemployment. The origin of the term has never been verified, but the most popular theory is that the name derives from Ned Ludd, an apprentice knitter who destroyed his knitting frame with a hammer to protest beatings by his master. See also technophobe. Compare technophile.

LUG *n.* Acronym for **Linux Users Group**. See user group.

luggable computer *n.* The first portable computers, produced in the early to mid-1980s. These early units, all of which had built-in CRT-based displays, weighed over 20 pounds and were the size of a medium suitcase—hence their name. See also portable computer.

luminance *n.* **1.** A measure of the amount of light radiated by a given source, such as a computer display screen. **2.** The perceived brightness component of a given color, as opposed to its hue or its saturation. See also HSB. Compare illuminance.

luminance decay *n.* See persistence.

luminosity *n.* The brightness of a color based on a scale from black to white on your monitor.

Lunar calendar *n.* Predominant calendar type used in Israel among Hebrew speakers, in Islamic cultures, and in most of Asia. Lunar calendars calculate months based on lunar phases.

lurk *vb.* To receive and read articles or messages in a newsgroup or other online conference without contributing to the ongoing exchange.

lurker *n.* A person who lurks in a newsgroup or other online conference. See also lurk. Compare netizen.

LVS *n.* Acronym for **Linux Virtual Server**. A high-performance open source server that handles connections from clients and passes them on to a cluster of real servers. LVS receives incoming packets and forwards them to the proper back-end server. LVS is typically used to build scalable Web, mail, or other network services. Also called: ipvs. See also layer 4 switching.

Lycos *n.* A Web search engine and directory that provides summaries of pages matching search requests. In addition, the Lycos site offers categorized directories of sites, reviews of selected sites, and services for finding names, viewing maps, and so on.

Lynx *n.* A text-only Web browser program for UNIX platforms.

.lzh *n.* The file extension that identifies archive files compressed with the Lempel Ziv and Haruyasu algorithm. See also compressed file, Lempel Ziv compression, LHARC.

LZW compression *n.* A compression algorithm named after Abraham Lempel and Jakob Ziv (creators of Lempel Ziv compression) and LZW designer Terry Welch that makes use of repeating strings of data in its compression of character streams into code streams. It is also the basis of GIF compression. See also GIF, Lempel Ziv compression.



M

m *prefix* See milli-.

M *prefix* See mega-.

Mac- *prefix* A prefix used to indicate a software product's applicability for the Macintosh computer, as in MacDraw.

Mac *n.* See Macintosh.

MAC *n.* Acronym for **Media Access Control**. In the IEEE 802.x specifications, the lower of two sublayers that make up the ISO/OSI data link layer. The MAC manages access to the physical network, delimits frames, and handles error control. *See also* IEEE 802.x, LLC.

MacBinary *n.* A file transfer protocol used to preserve coding for Macintosh-produced files stored in non-Macintosh computers, containing the file's resource fork, data fork, and Finder information block. *See also* data fork, Finder, resource fork.

Mach *n.* A variant of the UNIX operating system developed at Carnegie-Mellon University. Mach was designed to support advanced features such as multitasking, multiprocessing, and distributed systems. *See also* UNIX.

Mach 3.0 *n.* The microkernel forming the lowest level of the Mac OS X operating system. Mach 3.0 provides basic services such as memory management, thread-handling, virtual memory, and address space management to the operating system kernel.

mach 3 kernel *n.* *See* Mach 3.0.

machine address *n.* *See* absolute address.

machine code *n.* The ultimate result of the compilation of assembly language or any high-level language such as C or Pascal: sequences of 1s and 0s that are loaded and executed by a microprocessor. Machine code is the only language computers understand; all other programming languages represent ways of structuring human language so that humans can get computers to perform specific tasks. *Also called:* machine language. *See also* compiler (definition 2).

machine cycle *n.* **1.** The time required for the fastest operation (usually a NOP, or no-op, which does nothing) a

microprocessor can perform. **2.** The steps taken for each machine instruction. These steps are, typically, fetch the instruction, decode it, execute it, and perform any necessary storing.

machine-dependent *adj.* Of, pertaining to, or being a program or a piece of hardware that is linked to a particular type of computer because it makes use of specific or unique features of the equipment and that cannot easily be used with another computer, if at all. *Compare* machine-independent.

machine error *n.* A hardware error. Probably the most common type of machine error involves media, such as an error in reading a hard disk.

machine identification *n.* A code by which an executing program can determine the identity and characteristics of the computer and other devices with which it is operating.

machine-independent *adj.* Of, pertaining to, or being a program or piece of hardware that can be used on more than one type of computer with little or no modification. *Compare* machine-dependent.

machine instruction *n.* An instruction (action statement) in machine code that can be directly executed by a processor or microprocessor. *See also* instruction, statement.

machine language *n.* *See* machine code.

machine-readable *adj.* **1.** Presented in a form that a computer can interpret and use as input. For example, bar codes that can be scanned and used directly as computer input contain machine-readable information. **2.** Coded in the binary form used by computers and stored on a suitable medium such as magnetic tape. *See also* optical character recognition.

machine translation *n.* The use of computer software to translate large amounts of text from one natural language into another. Machine translation is usually used by corporations, publishers, and government agencies that need large amounts of documentation, news stories, or business data translated quickly. *See also* natural-language processing.

Macintosh *n.* A popular series of personal computers introduced by the Apple Computer Corporation in January 1984. The Macintosh was one of the earliest personal computers to incorporate a graphical user interface and the first to use 3.5-inch floppy disks. It was also the first to use the 32-bit Motorola 68000 microprocessor. Despite its user-friendly features, the Macintosh lost market share to PC-compatible computers during the 1990s, but it still enjoys widespread use in desktop publishing and graphics-related applications. In late 1998, both Apple Computer and Macintosh gained increased visibility with release of the home-oriented iMac computer. See the illustration. *Also called:* Mac. *See also* graphical user interface, iMac, PC-compatible.



Macintosh.

Macintosh Application Environment *n.* A system shell for open RISC-based systems that provides a Macintosh interface within an X Window System window. The Macintosh Application Environment is compatible with both Mac and UNIX and will support all off-the-shelf products for the Macintosh. *Acronym:* MAE. *See also* RISC, X Window System.

Macintosh File System *n.* The early, flat file system used on the Macintosh before the Hierarchical File System was introduced. *Acronym:* MFS. *See also* flat file system. *Compare* Hierarchical File System.

Mac OS *n.* Short for Macintosh operating system. The name given to the Macintosh operating system, beginning with version 7.5 in September 1994, when Apple started

licensing the software to other computer manufacturers. *See also* Macintosh.

Mac OS X *n.* The first complete revision of the Macintosh operating system. Mac OS X is BSD 4.4 UNIX-based, uses the Mach 3.0 microkernel, and is built around Apple's open-source Darwin. Mac OS X adds symmetric multiprocessing, multithreading, preemptive multitasking, advanced memory management, and protected memory to the Macintosh. The UNIX foundation of Mac OS X allows greater options for software development, networking, and update and expansion of the operating system. Mac OS X includes a graphical user interface and a command-line interface.

macro *n.* **1.** In applications, a set of keystrokes and instructions recorded and saved under a short key code or macro name. When the key code is typed or the macro name is used, the program carries out the instructions of the macro. Users can create a macro to save time by replacing an often-used, sometimes lengthy, series of strokes with a shorter version. **2.** In programming languages, such as C or assembly language, a name that defines a set of instructions that are substituted for the macro name wherever the name appears in a program (a process called *macro expansion*) when the program is compiled or assembled. Macros are similar to functions in that they can take arguments and in that they are calls to lengthier sets of instructions. Unlike functions, macros are replaced by the actual instructions they represent when the program is prepared for execution; function instructions are copied into a program only once. *Compare* function (definition 2).

macro assembler *n.* An assembler that can perform macro substitution and expansion. The programmer can define a macro that consists of several statements and then use the macro name later in the program, thus avoiding having to rewrite the statements. For example, a macro called *swap* exchanges the values of two variables: After defining *swap*, the programmer can then insert an instruction such as "swap a, b" in the assembly language program. While assembling, the assembler replaces the instruction with the statements within the macro that swap the values of the variables *a* and *b*.



macrocontent *n.* The primary text or other content of a Web page. *Compare* microcontent.

macro expansion *n.* The act of replacing a macro with its defined equivalent. *Also called:* macro substitution. *See also* macro (definition 2), macro assembler, macro processor.

macro instruction *n.* An instruction used to manage macro definitions. *See also* macro language.

macro language *n.* The collection of macro instructions recognized by a given macro processor. *See also* macro instruction, macro processor.

macro processor *n.* A program that performs macro expansion. All programs that support macros have some form of macro processor, but macro processors differ from program to program and in the macro language they support. *See also* macro (definition 2), macro expansion, macro instruction.

macro program *n.* *See* keyboard enhancer.

macro recorder *n.* A program that records and stores keyboard macros. *See also* macro (definition 1).

macro substitution *n.* *See* macro expansion.

macro virus *n.* A virus that is written in a macro language associated with an application. The macro virus is carried by a document file used with that application and executes when the document is opened.

MacTCP *n.* A Macintosh extension that allows Macintosh computers to use TCP/IP. *See also* TCP/IP.

MADCAP *n.* *See* multicast address dynamic client allocation protocol.

MAE *n.* **1.** *See* Macintosh Application Environment. **2.** Acronym for **M**etropolitan **A**rea **E**xchange. One of the Internet exchange points operated by MCI WorldCom, through which Internet service providers (ISPs) connect in order to exchange data. The two largest MAEs, MAE East (outside Washington, D.C.) and MAE West (near San Jose, California) are major national and international network interconnect points; more than half of all traffic through the Internet travels through one or both of these points. MCI WorldCom also operates smaller, regional MAEs in Chicago, Dallas, Houston, Los Angeles, New York, Paris, and Frankfurt. *See also* backbone (definition 1), ISP.

Magellan *n.* A Web directory. Named for the Portuguese explorer, Magellan reviews and rates all Web sites it lists.

Published by the McKinley Group, Magellan is now owned by Excite, Inc.

magic date *n.* A date or dates that in some computer systems resembles a reserved number or flag with a special significance. Examples are the numbers 00 and 99, which have been used in some systems or programs based on two-digit years. Magic dates indicate some special status—for example, that a system component or resource should never expire or should never be purged. Because 99 in particular has been used in this way in many systems, dates in the year 1999 had the potential to cause problems in those systems.

magnetic bubble *n.* A movable magnetic domain in a thin-film substrate. In bubble memory, magnetic bubbles representing bits circulate past circuits that can read and write them. High costs and relatively long access times have relegated magnetic bubbles to specialized applications. *See also* bubble memory, magnetic domain. *Compare* core, RAM.

magnetic disk *n.* A computer disk enclosed in a protective case (hard disk) or jacket (floppy disk) and coated with a magnetic material that enables data to be stored in the form of changes in magnetic polarity (with one polarity representing a binary 1 and the other a 0) on many small sections (magnetic domains) of the disk surface. Magnetic disks should be protected from exposure to sources of magnetism, which can damage or destroy the information they hold. *See also* disk, floppy disk, hard disk. *Compare* compact disc, magneto-optic disc.

magnetic domain *n.* A region of a ferromagnetic material in which the individual atomic or molecular magnetic particles are aligned in the same direction. *Also called:* ferromagnetic domain.

magnetic field *n.* The space around a magnetic object in which magnetic force acts. A magnetic field is conceived of as consisting of flux lines that originate at the north magnetic pole and terminate at the south magnetic pole.

magnetic head *n.* *See* head.

magnetic-ink character recognition *n.* A form of character recognition that reads text printed with magnetically charged ink, determining the shapes of characters by sensing the magnetic charge in the ink. Once the shapes have been determined, character recognition methods are used to translate the shapes into computer text. A familiar use of this form of character recognition is to identify bank checks. *Acronym:* MICR. *See also* character recognition. *Compare* optical character recognition.

magnetic oxide *n.* See ferric oxide.

magnetic storage *n.* A generic term for non-internal-memory computer data storage involving a magnetic medium, such as disk or tape.

magnetic tape *n.* See tape (definition 1).

magneto-optical recording *n.* A type of recording technology used with optical discs in which a laser beam heats a small portion of the magnetic material covering the disc. The heating enables a weak magnetic field to change the orientation of the portion, thus recording onto the disc. This technique can also be used to erase the disc, making the disc rewritable.

magneto-optic disc *n.* An erasable or semi-erasable storage disc, similar to a CD-ROM disc and of very high capacity, in which a laser beam is used to heat the recording surface to a point at which tiny regions on the surface can be magnetically aligned to store bits of data. See also CD-ROM, magneto-optical recording.

magnitude *n.* The size of a number, regardless of its sign (+ or -). For example, 16 and -16 have the same magnitude. See also absolute value.

mailbomb⁴ *n.* An excessively large amount of e-mail data (a very large number of messages or one very large message) sent to a user's e-mail address in an attempt to make the user's mailer program crash or to prevent the user from receiving further legitimate messages. See also e-mail¹ (definition 1). Compare letterbomb.

mailbomb² *vb.* To send a mailbomb to a user. One person might mailbomb a user with a single enormous message; a large number of users might mailbomb an unpopular person by simultaneously sending messages of normal size.

mailbot *n.* A program that automatically responds to e-mail messages or performs actions based on commands within the messages. A mailing list manager is one example. See also mailing list manager.

mailbox *n.* A disk storage area assigned to a network user for receipt of e-mail messages. See also e-mail¹ (definition 1).

mail digest *n.* See digest (definition 2).

mailer-daemon *n.* A program used to transport e-mail between hosts on a network. See also daemon.

mail filter *n.* See e-mail filter.

mail header *n.* A block of text at the top of an e-mail message containing such information as the addresses of the sender and recipients, the date and time sent, the address to which a reply is to be sent, and the subject. The mail header is used by an e-mail client or program. See also e-mail¹ (definition 1).

mailing list *n.* A list of names and e-mail addresses that are grouped under a single name. When a user places the name of the mailing list in a mail client's To: field, the client sends the message to the machine where the mailing list resides, and that machine automatically sends the message to all the addresses on the list (possibly allowing a moderator to edit it first). See also LISTSERV, mailing list manager, Majordomo, moderator.

mailing list manager *n.* Software that maintains an Internet or intranet mailing list. The mailing list manager accepts messages posted by subscribers; sends copies of the messages (which may be edited by a moderator) to all the subscribers; and accepts and processes user requests, such as to subscribe or to unsubscribe to the mailing list. The most commonly used mailing list managers are LISTSERV and Majordomo. See also LISTSERV, mailing list, Majordomo, moderator.

mail merge *n.* A mass-mail facility that takes names, addresses, and sometimes pertinent facts about recipients and merges the information into a form letter or another such basic document.

mail reflector *n.* A newsgroup that consists simply of the messages posted to a mailing list translated into newsgroup format.

mailto *n.* A protocol designator used in the HREF of a hyperlink that enables a user to send e-mail to someone. For instance, Anne E. Oldhacker has the e-mail address aeo@baz.foo.com and an HTML document contains the code E-mail Anne!. If a user clicks on the hyperlink "E-mail Anne!", the user's e-mail application is launched and the user can send e-mail to her without knowing her actual e-mail address. See also e-mail¹ (definition 1), HTML, hyperlink.

mainboard *n.* See motherboard.

main body *n.* The set of statements in a computer program at which execution of the program begins and that invokes the subroutines of the program.



mainframe *n.* A type of large computer system (in the past often water-cooled), the primary data processing resource for many large businesses and organizations. Some mainframe operating systems and solutions are over 40 years old and have the capacity to store year values only as two digits.

mainframe computer *n.* A high-level, typically large and expensive computer designed to handle intensive computational tasks. Mainframe computers are characterized by their ability to simultaneously support many users connected to the computer by terminals. The name is derived from "main frame," the cabinet originally used to house the processing unit of such computers. *See also* computer, supercomputer.

main function *n.* The main body of a program written in a computer language that uses sets of functions to create an entire program. For example, the C language requires each program to contain a function called *main*, which C uses as the starting point of execution. *See also* main body.

main loop *n.* A loop in the main body of a program that performs the principal function of the program over and over until termination is somehow signaled. In event-driven programs, this loop checks for events received from the operating system and handles them appropriately. *See also* event-driven programming, main body.

main memory *n.* *See* primary storage.

main segment *n.* On the Macintosh, the principal code segment of a program, which must remain loaded throughout the execution of the program.

maintenance *n.* The process of taking measures to ensure that a hardware, software, or database system is functioning properly and is up to date.

Majordomo *n.* The name of a popular software program that manages and supports Internet mailing lists. *See also* mailing list, mailing list manager.

major geographic domain *n.* A two-character sequence in an Internet domain name address that indicates the country/region in which a host is located. The major geographic domain is the last part of the domain name address, following the subdomain and domain codes; for example, uiuc.edu.us indicates a host at the University of Illinois in the United States, whereas cam.ac.uk indicates a host at the University of Cambridge in the United Kingdom. The code .us, which indicates a domain in the United

States, is usually omitted. *Also called:* country code. *See also* DNS (definition 1), domain name address.

major key *n.* *See* primary key.

Make Changes *n.* The Macintosh-style permission that gives users the right to make changes to a folder's contents; for example, modifying, renaming, moving, creating, and deleting files. When AppleTalk network integration translates access privileges into permissions, a user who has the Make Changes privilege is given Write and Delete permissions. *See also* permission.

make-table query *n.* In Microsoft Office, an action query that moves the resulting data to a new table in either the current database or another database.

male connector *n.* A type of connector that has pins for insertion into receptacles. Male connector part numbers often include an *M* (male) or *P* (plug). For example, a male DB-25 connector might be labeled *DB-25M* or *DB-25P*. *See the illustration. Compare* female connector.



Male connector.

malicious mobile code *n.* A virus or other destructive program that takes advantage of security weaknesses in wireless transmission systems. Malicious mobile code may affect computers, PDAs, Internet-capable digital phones, and other wireless networking devices.

malware *n.* Software created and distributed for malicious purposes, such as invading computer systems in the form of viruses, worms, or innocent-seeming plug-ins and extensions that mask other destructive capabilities. *Also called:* malicious software.

MAME *n.* Acronym for Multiple Arcade Machine Emulator. MAME is software written in C that emulates the hardware and software of original arcade games, allowing them to run on PCs. *See also* arcade game, C.

MAN *n.* Acronym for metropolitan area network. A high-speed network that can carry voice, data, and images at up to 200 Mbps or faster over distances of up to 75 km. Based on the network architecture, the transmission speed can be higher for shorter distances. A MAN, which can include

M

one or more LANs as well as telecommunications equipment such as microwave and satellite relay stations, is smaller than a wide area network but generally operates at a higher speed. *Compare* LAN, WAN.

managed code *n.* Code that is executed by the common language runtime environment rather than directly by the operating system. Managed code applications gain common language runtime services such as automatic garbage collection, runtime type checking and security support, and so on. These services provide uniform platform- and language-independent behavior of managed-code applications. *See also* unmanaged code.

managed service provider *n.* A business that supplies remote access services to individuals and enterprises. Managed service providers offer remote connections, network management, user support, security, and applications hosting. *Acronym:* MSP. *Compare* ISP.

Management and Monitoring Tools *n.* Software components that include utilities for network management and monitoring, along with services that support client dialing and the updating of client phone books. Also included is the Simple Network Management Protocol (SNMP). *See also* SNMP.

Management Information Base *n.* A set of objects that represents various types of information about a device, used by a network management protocol (for example, SNMP) to manage the device. Because different network management services are used for different types of devices and protocols, each service has its own set of objects. *Acronym:* MIB. *See also* service, SNMP.

Management Information Services *n.* *See* Information Services.

management information system *n.* A computer-based system for processing and organizing information so as to provide various levels of management within an organization with accurate and timely information needed for supervising activities, tracking progress, making decisions, and isolating and solving problems. *Acronym:* MIS.

Management Information Systems *n.* *See* Information Services.

manager *n.* Any program that is designed to perform a certain set of housekeeping tasks related to computer operation, such as the maintenance of files. On the Macintosh, Manager (with a capital M) is used in the names of

various separate portions of the computer's operating system that handle input, output, and internal functions (for example, File Manager and Memory Manager).

Manchester coding *n.* A method of encoding data used in communications, such as on some LANs, that combines both data and timing signals in a stream of transmitted bits. *See also* phase encoding.

mandatory user profile *n.* A user profile that is not updated when the user logs off. It is downloaded to the user's desktop each time the user logs on, and it is created by an administrator and assigned to one or more users to create consistent or job-specific user profiles. *See also* local user profile, roaming user profile, user profile.

Mandelbrot set *n.* *See* fractal.

man-in-the-middle attack *n.* A form of attack in which the intruder intercepts messages between parties in a public key exchange. Each party's messages are diverted to the intruder, who may alter them before sending them on. The parties on each end of the exchange remain unaware that their messages are being intercepted and modified. *Also called:* bucket brigade attack.

man-machine interface *n.* The set of commands, displays, controls, and hardware devices enabling the human user and the computer system to exchange information. *See also* user interface.

man pages *n.* **1.** Online documentation for UNIX commands and programs and the UNIX library routines available for use in C programs. These documents, also found in the UNIX Programmer's Manual, can be displayed on a user's terminal or printed using the command *man*.

2. Short for **manual pages**. A set of help files included with a Linux distribution. Man pages may come with the Linux distribution and be installed along with the operating system or may be available from online sources.

mantissa *n.* **1.** In calculations that have logarithms, the positive decimal fraction of a common (base-10) logarithm. For example, the common logarithm of 16 is 1.2041; the characteristic, or whole-number portion, of the logarithm is 1 (the logarithm of 10); and the mantissa, or fractional portion, is .2041 (the logarithm of 1.6). *See also* characteristic, logarithm. **2.** In floating-point notation, the portion expressing the significant digits of a number. For example, the floating-point representation of 640,000 is 6.4E+05. The mantissa is 6.4;



the exponent (E+05) shows the power of 10 to which 6.4 is raised. *Also called:* significand. *See also* floating-point notation.

manual link *n.* A link that requires you to take action to update your data after the data in the source document changes.

many-to-many relationship *n.* A complex association between two sets of parameters in which many parameters of each set can relate to many others in the second set. A many-to-many relationship is most commonly used to describe an association between two tables in which one record in either table can relate to many records in the other table.

many-to-one relationship *n.* **1.** A server configuration in which several small servers replicate the abilities of one larger, more powerful server. *See also* key pair. **2.** In reference to asymmetric key encryption, the idea that many individuals in possession of the public key can decrypt the digital signature of one individual in possession of the private key.

map¹ *n.* Any representation of the structure of an object. For example, a memory map describes the layout of objects in an area of memory, and a symbol map lists the associations between symbol names and memory addresses in a program. *See also* image map.

map² *vb.* To translate one value into another. For example, in computer graphics one might map a three-dimensional image onto a sphere. In reference to virtual memory systems, a computer might translate (map) a virtual address into a physical address. *See also* virtual memory.

MAPI *n.* Acronym for **M**essaging **A**pplication **P**rogramming **I**nterface. The Microsoft interface specification that allows different messaging and workgroup applications (including e-mail, voice mail, and fax) to work through a single client, such as the Exchange client included with Windows 95 and Windows NT. *See also* application programming interface.

mapped data field *n.* A field that represents commonly used information, such as "First Name." If a data source contains a "First Name" field or variation, such as "FName," the data source field automatically maps to the corresponding mapped data field.

mapped drives *n.* **1.** In the Windows environment, network drives that have been assigned local drive letters and are locally accessible. **2.** Under UNIX, disk drives that have been defined to the system and can be made active.

MapPoint *n.* Business mapping software introduced by Microsoft as an Office-compatible product in 1999. Designed for use by business people, MapPoint consists of a database of United States maps showing detail down to the level of individual streets and demographic data broken out by state, county, zip code, and other regions. *See also* Office.

margin *n.* In printing, those portions of a page—top, bottom, and sides—outside the main body of text.

mark *n.* **1.** In applications and data storage, a symbol or other device used to distinguish one item from others like it. **2.** In digital transmission, the state of a communications line (positive or negative) corresponding to a binary 1. In asynchronous serial communications, a mark condition is the continuous transmission of binary 1s to indicate when the line is idle (not carrying information). In asynchronous error checking, setting the parity bit to 1 in each group of transmitted bits is known as mark parity. *See also* parity. *Compare* space. **3.** In optical sensing, a pencil line, as on a voting form or an IQ test, that can be recognized by an optical reader.

marker *n.* **1.** Part of a data communications signal that enables the communications equipment to recognize the structure of the message. Examples are the start and stop bits that frame a byte in asynchronous serial communications. **2.** A symbol that indicates a particular location on a display surface.

Mark I *n.* **1.** An electromechanical calculating machine designed in the late 1930s and early 1940s by Howard Aiken of Harvard University and built by IBM. *Also called:* Automatic Sequence Controlled Calculator, Harvard Mark I. **2.** The first fully electronic stored-program computer, designed and built at Manchester University in England. It successfully executed its first program in June 1948. **3.** The first commercial computer, which was based on the Manchester Mark I and released in 1951.

markup *n.* Comments and tracked changes such as insertions, deletions, and formatting changes that you can view or print.

markup language *n.* A set of codes in a text file that instructs a computer how to format the file on a printer or video display or how to index and link its contents. Examples of markup languages are Hypertext Markup Language (HTML) and Extensible Markup Language (XML), which are used in Web pages, and Standard Generalized Markup Language (SGML), which is used for typesetting



and desktop publishing purposes and in electronic documents. Markup languages of this sort are designed to enable documents and other files to be platform-independent and highly portable between applications. *See also* HTML, SGML, XML.

marquee *n.* A nonstandard HTML extension that causes scrolling text to appear as part of a Web page. Currently, marquees are viewable only with Internet Explorer. *See also* HTML, Internet Explorer, Web page.

marquee component *n.* A region on a page that displays a horizontally scrolling text message.

mask *n.* **1.** A binary value used to selectively screen out or let through certain bits in a data value. Masking is performed by using a logical operator (AND, OR, XOR, or NOT) to combine the mask and the data value. For example, the mask 00111111, when used with the AND operator, removes (masks off) the two uppermost bits in a data value but does not affect the rest of the value. *See the illustration. See also* logical operator, mask bit. **2.** In television and display technology, a thin perforated sheet of metal or a close-set series of metal strips on the surface of the screen that helps create a clear, sharp image by ensuring that the electron beam for a particular color (red, blue, or green) strikes only the phosphor it is intended to illuminate, while the phosphors for the other colors are shadowed by the mask. Three types of masks are in use: a shadow mask, with round perforations; an aperture grill, with vertical stripes; and a slot mask, with elliptical openings. *See also* aperture mask, shadow mask, slot mask.

11010101	Data value
AND 00111111	Mask
00010101	Resulting value

Mask.

maskable interrupt *n.* A hardware interrupt that can be temporarily disabled (masked) during periods when a program needs the full attention of the microprocessor. *See also* external interrupt, hardware interrupt, interrupt. *Compare* nonmaskable interrupt.

mask bit *n.* A given bit within a binary mask whose function is to screen out or let through the corresponding bit in a data value when the mask is used in an expression with a logical operator. *See also* mask (definition 1).

masking *n.* The process of using the *mask* operation to perform operations on bits, bytes, or words of data. *See also* mask (definition 1).

mask off *vb.* To use a mask to remove bits from a byte of data. *See also* mask (definition 1).

massively parallel processing *n.* A computer architecture in which each of a large number of processors has its own RAM, which contains a copy of the operating system, a copy of the application code, and its own part of the data, on which that processor works independently of the others. *Acronym:* MPP. *Compare* SMP.

massively parallel processor *n.* A computer designed to perform massively parallel processing.

mass storage *n.* A generic term for disk, tape, or optical disc storage of computer data, so called for the large masses of data that can be stored in comparison with computer memory capacity. *Compare* memory.

Master Boot Record *n.* The first sector of the first hard disk; a physically small but critical element in the startup process on an x86-based computer. When a computer is booted, it processes a series of self-tests and then reads the Master Boot Record, or MBR, into memory. The MBR contains instructions that locate the disk's system (startup) partition, read the contents of the first sector of the system partition into memory, and then carry out the instructions contained in that sector. If the sector represents what is known as a Partition Boot Sector, the instructions found there begin the process of loading and starting the operating system. In other words, the startup process on an x86-based computer is as follows: self-test to Master Boot Record; MBR to system partition and Partition Boot Sector; Partition Boot Sector to operating system; and, finally, a computer ready to go to work. *Acronym:* MBR. *See also* Partition Boot Sector.

master file *n.* In a set of database files, the file containing more or less permanent descriptive information about the principal subjects of the database, summary data, and one or more critical key fields. For example, customers' names, account numbers, addresses, and credit terms might be stored in a master file. *See also* master record. *Compare* transaction file.

master key *n.* The server-based component of software or data protection. In some systems, data or applications are stored on a server and must be downloaded to the local machine for use. When a client requests the data, it presents a session key. If the session key supplied matches the master key, the key server sends the requested packet. *See also* client (definition 3), server (definition 2).



master record *n.* A record in a master file; typically, the descriptive and summary data related to the item that is the subject of the record. *See also* master file.

master reseller *n.* A status assigned by computer equipment manufacturers to dealers and distributors who meet certain qualifications, usually related to the number of pieces the reseller expects to sell.

master/slave arrangement *n.* A system in which one device, called the master, controls another device, called the slave. For example, a computer can control devices connected to it.

matching *n.* The process of testing whether two data items are identical or of finding a data item that is identical to a key. *See also* pattern recognition.

Material Requirements Planning *n.* An approach to information management in a manufacturing environment that makes use of software to help monitor and control processes related to manufacturing—for example, managing schedules and determining when and in what quantities to order materials. *Acronym:* MRP. *Also called:* Material Resource Planning. *See also* Enterprise Resource Planning.

math coprocessor *n.* *See* floating-point processor.

mathematical expression *n.* An expression that uses numeric values, such as integers, fixed-point numbers, and floating-point numbers, and operators, such as addition, subtraction, multiplication, and division. *See also* expression.

mathematical function *n.* A function in a program that performs a set of mathematical operations on one or more values or expressions and that returns a numeric value.

mathematical model *n.* The mathematical assumptions, expressions, and equations that underlie a given program. Mathematical models are used to model “real-world” physical systems such as planets in orbit around a star or resource production and consumption within a closed system.

MathML *n.* Acronym for **Mathematical Markup Language**. An XML application for describing mathematical notation and capturing both its structure and content. The goal of MathML is to enable mathematics to be served, received, and processed on the Web, just as HTML has enabled this functionality for text.

matrix *n.* An arrangement of rows and columns used for organizing related items, such as numbers, dots, spreadsheet

cells, or circuit elements. Matrices are used in mathematics for manipulating rectangular sets of numbers. In computing and computer applications, matrices are used for the similar purpose of arranging sets of data in table form, as in spreadsheets and lookup tables. In hardware, matrices of dots are used in creating characters on the screen as well as in print (as by dot-matrix printers). In electronics, matrices of diodes or transistors are used to create networks of logic circuits for such purposes as encoding, decoding, or converting information. *See also* grid.

matrix line printer *n.* *See* line printer.

MAU *n.* Acronym for **Multistation Access Unit**. A hub device in a token-ring network that connects computers in a physical hub-and-spokes arrangement but uses the logical ring required in token ring networks. *Also called:* MSAU. *See also* hub, token-ring network.

maximize *vb.* In a graphical user interface, to cause a window to expand to fill all the space available within a larger window or on the screen. *See also* enlarge, graphical user interface, Maximize button, window. *Compare* minimize, reduce.

Maximize button *n.* In Windows 3.x, Windows 9x, Windows NT, and Windows 2000, a button in the upper right-hand corner of a window that, when clicked, maximizes a window to fill all the space available within a larger window or on the screen. *See also* graphical user interface, window. *Compare* Minimize button, zoom box.

Maximum Transmission Unit *n.* *See* MTU.

Mb *n.* *See* megabit.

MB *n.* *See* megabyte.

MBONE or **Mbone** *n.* Short for **multicast backbone**. A small set of Internet sites, each of which can transmit real-time audio and video simultaneously to all the others. MBONE sites are equipped with special software to send and receive packets at high speed using the IP one-to-many multicasting protocol. The MBONE has been used for video conferencing and even for a Rolling Stones concert in 1994. *See also* RealAudio.

Mbps *n.* Short for **mega bits per second**. One million bits per second.

MBR *n.* *See* Master Boot Record.

MC *n.* *See* megacycle.

MC68000 *n.* *See* 68000.



MC68020 *n.* See 68020.

MC68030 *n.* See 68030.

MC68040 *n.* See 68040.

MC68881 *n.* See 68881.

MCF *n.* See Meta-Content Format.

MCGA *n.* Acronym for **Multi-Color Graphics Array**. An older video adapter included in the IBM PS/2 Models 25 and 30. The MCGA was capable of emulating the CGA (Color/Graphics Adapter) and provided two additional graphics modes: the first mode had 640 horizontal pixels by 480 vertical pixels with 2 colors chosen from a palette of 262,144 colors; the second had 320 horizontal pixels by 200 vertical pixels with 256 colors chosen from a palette of 262,144 colors. *See also* graphics mode (definition 2).

MCI *n.* **1.** Acronym for **Media Control Interface**. Part of the Windows application programming interface that enables a program to control multimedia devices. **2.** A major long-distance telephone service carrier, originally Microwave Communications, Inc.

m-commerce *n.* Short for **mobile commerce**.

M-commerce involves the use of personal digital assistants (PDAs), digital phones, and other wireless handheld devices equipped with microbrowsers for the online buying and selling of goods. M-commerce is distinguished from other electronic commerce by the level of portability. Wireless Application Protocol (WAP) standards form the foundation of m-commerce technology, which takes advantage of smart phone capabilities with e-mail, fax, Internet, and phone in one mobile unit. *See also* microbrowser, Wireless Application Protocol.

MCP *n.* Acronym for **Microsoft Certified Professional**. A basic certification from Microsoft that verifies an individual's ability to successfully implement a Microsoft product or technology as part of a solution for an organization. The MCP certification is often used as a building block for acquiring additional certifications in specialized skill areas such as databases, programming languages, and Web development.

MCSA *n.* Acronym for **Microsoft Certified Systems Administrator**. A certification from Microsoft that verifies an individual's ability to implement, manage, and troubleshoot existing Microsoft Windows and Windows .NET network and system environments. *See also* MCP.

MCSA *n.* Acronym for **Microsoft Certified Solution Developer**. A certification from Microsoft that verifies an individual's ability to use Microsoft development tools, technologies, and platforms to design and develop business solutions. *See also* MCP.

MCSE *n.* Acronym for **Microsoft Certified System Engineer**. A certification from Microsoft that verifies an individual's ability to analyze business requirements and then design and implement business solutions with Microsoft Windows platforms and server software. *See also* MCP.

MD2 *n.* A hashing algorithm that creates a 128-bit hash value used to verify data integrity. MD2 is an earlier, 8-bit version of the more common MD5. *See also* hashing algorithm.

MD4 *n.* A hashing algorithm that creates a 128-bit hash value used to verify data integrity. Like the latest version, MD5, MD4 is optimized for 32-bit machines. *See also* hashing algorithm.

MD5 *n.* An industry-standard, one-way, 128-bit hashing scheme, developed by MIT Laboratory for Computer Science and RSA Data Security, Inc., and used by various Point-to-Point Protocol (PPP) vendors for encrypted authentication. An extension of MD4, MD5 is slightly slower than the earlier version but offers improved data security. *See also* hashing algorithm.

MDA *n.* Acronym for **Monochrome Display Adapter**. The video adapter introduced with the earliest model of the IBM PC in 1981. MDA was capable of only one video mode: a character mode with 25 lines of 80 characters each, with underlining, blinking, and high-intensity characters. IBM did not use the name *Monochrome Display Adapter* or the acronym *MDA*.

MDI *n.* Acronym for **multiple-document interface**. A user interface in an application that allows the user to have more than one document open at the same time. *See also* user interface.

MDIS *n.* *See* Metadata Interchange Specification.

mean time between failures *n.* *See* MTBF.

mean time to repair *n.* *See* MTTR.

mechanical mouse *n.* A type of mouse in which the motion of a ball on the bottom of the mouse is translated into directional signals. As the user moves the mouse, the ball rolls, turning a pair of wheels mounted at right angles inside the mouse that have conductive markings on their



surfaces. Because the markings permit an electric current to flow, a set of conductive brushes that ride on the surface of the conductive wheels can detect these conductive markings. The electronics in the mouse translate these electrical movement signals into mouse-movement information that can be used by the computer. *See also* mouse, trackball. *Compare* optical mouse, optomechanical mouse.

mechatronics *n.* A term derived from the words *mechanical* and *electronics* to describe a field of engineering that applies mechanical, electrical, and electronic engineering concepts to product design and manufacture. A relatively new discipline, mechatronics is applicable to products in fields as diverse as medicine, robotics, manufacturing, and consumer electronics.

media *n.* The physical material, such as paper, disk, and tape, used for storing computer-based information. *Media* is plural; *medium* is singular.

Media Access Control *n.* *See* MAC.

Media Control Interface *n.* *See* MCI (definition 1).

media conversion *n.* Transferring data from one storage medium to another—for example, from disk to tape.

media eraser *n.* A device that removes or obliterates data from a storage medium on a wholesale basis, usually by writing meaningless data (such as zeros) over it. *See also* bulk eraser.

media filter *n.* **1.** A device used with local area networks (LANs) as an adapter between two different types of media. For example, an RJ-45 connector might be used between coaxial cable and unshielded twisted pair (UTP) cables. Media filters are similar in function to transceivers. As with many components to LANs, manufacturers often choose different names for similar products, so a LAN expert is needed to decide which media filters are required for a particular LAN. *See also* coaxial cable, connector (definition 1), LAN, transceiver, UTP. **2.** A device added to data networks to filter out electronic noise from the environment. For example, a media filter might be added to an Ethernet network based on coaxial cabling to prevent data loss from interference by nearby electronic equipment. *See also* coaxial cable, Ethernet (definition 1).

media stream *n.* A continuous sequence of audio or audio-and-video through a network.

medium¹ *adj.* Of or relating to the middle part of a range of possible values.

medium² *n.* A substance in which signals can be transmitted, such as a wire or fiber-optic cable. *See* media.

medium model *n.* A memory model of the Intel 80x86 processor family. The medium model allows only 64 kilobytes for data but generally up to 1 megabyte for code. *See also* memory model.

medium-scale integration *n.* A concentration of circuit elements in the hundreds on a single chip. *Acronym:* MSI. *See also* integrated circuit.

meg *n.* *See* megabyte.

mega- *prefix* One million (10^6). In computing, which is based on the binary (base-2) numbering system, *mega-* has a literal value of 1,048,576, which is the power of 2 (2^{20}) closest to one million. *Abbreviation:* M.

megabit *n.* Usually 1,048,576 bits (2^{20}); sometimes interpreted as 1 million bits. *Abbreviation:* Mb, Mbit.

megabyte *n.* Usually 1,048,576 bytes (2^{20}); sometimes interpreted as 1 million bytes. *Abbreviation:* MB.

megacycle *n.* A term for 1 million cycles—usually used to mean 1 million cycles per second. *Abbreviation:* MC. *See also* megahertz.

megaflops *n.* *See* MFLOPS.

megahertz *n.* A measure of frequency equivalent to 1 million cycles per second. *Abbreviation:* MHz.

megapel display *n.* *See* megapixel display.

megapixel *adj.* A reference to image resolution of one million pixels or more. The term is used in reference to devices such as digital cameras, scanners, and computer monitors and display adapters.

megapixel display *n.* A video display capable of displaying at least 1 million pixels. For example, a video display with a screen size of 1024 horizontal pixels and 1024 vertical pixels is a megapixel display. *Also called:* megapel display.

Melissa *n.* A macro virus that affects Word files in Microsoft Office 97 and Office 2000 and first appeared in the spring of 1999. Melissa is delivered as an attachment to an e-mail with the subject line “An Important Message From <user name>,” a message beginning “Here is that document you asked for...,” or both. When the attachment is opened, the virus propagates (if Microsoft Outlook is installed) by sending itself to the first 50 e-mail addresses in the user’s Outlook address book. On the infected machine,

the virus also changes the registry, infects the Normal.dot Word template (which, in turn, infects new documents), and, in Office 2000, disables the Word macro virus warning. Although the Melissa virus does not destroy data, it can affect e-mail performance through the increased volume of messages. If an infected document is open at a time when the day of the month is the same as the minute value of the current time, the virus inserts the text “Twenty-two points, plus triple-word-score, plus fifty points for using all my letters. Game’s over. I’m outta here” at the current location of the cursor. The virus was named after an acquaintance of the hacker who developed it.

meltdown *n.* **1.** The complete collapse of a computer network caused by a higher level of traffic than the network can support. The term refers, by analogy, to the accidental melting down of a nuclear reactor core. **2.** Colloquially, the breakdown of a person, usually in a job situation, caused by overwork, stress, or failure.

member *n.* **1.** In object-oriented programming, a variable or routine that is part of a class. *See also* C++, class. **2.** A value that is part of a set data structure. *See also* set² (definition 1).

membrane keyboard *n.* A keyboard in which an unbroken plastic or rubber shell (a membrane) covers keys that have little or no travel (movement). Rather than use normal, full-travel keys, membrane keyboards use pressure-sensitive areas that are sometimes, but not always, defined by small bumps under the membrane.

memo field *n.* A field in a database file that can contain unstructured text.

memo pad *n.* A note-taking feature offered by many personal digital assistants and other handheld computing devices. Memo pad allows for the entry of short notes via typing or handwriting recognition applications. The notes can be categorized, organized, and edited later.

memory *n.* A device where information can be stored and retrieved. In the most general sense, memory can refer to external storage such as disk drives or tape drives; in common usage, it refers only to a computer’s main memory, the fast semiconductor storage (RAM) directly connected to the processor. *See also* core, EEPROM, EPROM, flash memory, PROM, RAM, ROM. *Compare* bubble memory, mass storage.

memory bank *n.* The physical location on a motherboard where a memory module can be inserted. *See also* bank (definition 1).

memory board *n.* A plug-in printed circuit board that contains one or more memory chips. *See also* memory chip.

memory cache *n.* *See* CPU cache.

memory card *n.* A memory module that is used to extend RAM storage capacity or in place of a hard disk in a portable computer, such as a laptop, notebook, or handheld PC. The module is usually the size of a credit card and can be plugged into a PCMCIA-compliant portable computer. The module can be composed of EPROM, RAM, or ROM chips or flash memory. *Also called:* RAM card, ROM card. *See also* EPROM, flash memory, handheld PC, hard disk, memory cartridge, module (definition 2), PCMCIA, RAM, ROM.

memory cartridge *n.* A plug-in module containing RAM (random access memory) chips that can be used to store data or programs. Memory cartridges are used primarily in portable computers as smaller, lighter (but more expensive) substitutes for disk drives. Memory cartridges typically use either a nonvolatile form of RAM, which does not lose its contents when power is turned off, or battery-backed RAM, which maintains its contents by drawing current from a rechargeable battery within the cartridge. *Also called:* RAM cartridge. *See also* memory card, RAM. *Compare* ROM cartridge.

memory cell *n.* An electronic circuit that stores one bit of data. *See also* bit.

memory chip *n.* An integrated circuit devoted to memory storage. The memory storage can be *volatile* and hold data temporarily, such as RAM, or *nonvolatile* and hold data permanently, such as ROM, EPROM, EEPROM, or PROM. *See also* EEPROM, EPROM, integrated circuit, memory board, nonvolatile memory, PROM, RAM, volatile memory.

memory management *n.* **1.** In operating systems for personal computers, procedures for optimizing the use of RAM (random access memory). These procedures include selectively storing data, monitoring it carefully, and freeing memory when the data is no longer needed. Most current operating systems optimize RAM usage on their own; some older operating systems, such as early versions of MS-DOS, required the use of third-party utilities to optimize RAM usage and necessitated that the user be more



knowledgeable about how the operating system and applications used memory. *See also* memory management unit, RAM. **2.** In programming, the process of ensuring that a program releases each chunk of memory when it is no longer needed. In some languages, such as C and C++, the programmer must keep track of memory usage by the program. Java, a newer language, automatically frees any chunk of memory that is not in use. *See also* C, C++, garbage collection, Java.

memory management program *n.* **1.** A program used to store data and programs in system memory, monitor their use, and reassign the freed space following their execution. **2.** A program that uses hard disk space as an extension of the random access memory (RAM).

memory management unit *n.* The hardware that supports the mapping of virtual memory addresses to physical memory addresses. In some systems, such as those based on the 68020, the memory management unit is separate from the processor. In most modern microcomputers, however, the memory management unit is built into the CPU chip. In some systems, the memory management unit provides interfacing between the microprocessor and memory. This type of memory management unit is typically responsible for address multiplexing and, in the case of DRAMs, the refresh cycle. *Acronym:* MMU. *See also* physical address, refresh cycle, virtual address.

memory model *n.* The approach used to address the code and the data that are used in a computer program. The memory model dictates how much memory can be used in a program for code and how much for data. Most computers with a flat address space support only a single memory model. Computers with a segmented address space usually support multiple memory models. *See also* compact model, flat address space, large model, medium model, segmented address space, small model, tiny model.

memory module *n.* A removable circuit board, cartridge, or other carrier that contains one or more RAM memory chips. *See also* memory card, memory cartridge, RAM.

memory-resident *adj.* Permanently located in a computer's memory, rather than swapped in and out of memory as needed. *See also* memory, TSR.

memory scrubbing *n.* **1.** In mainframe computers, the process of a computer reading its own memory during idle periods in order to find and fix errors. **2.** The process of

examining and correcting errors as data is transferred from memory to the CPU of a computer.

memory size *n.* The memory capacity of a computer, usually measured in megabytes. *See also* megabyte, memory.

memory typewriter *n.* An electric typewriter with internal memory and typically a one-line liquid crystal display for viewing the contents of that memory. Memory typewriters can usually hold one page of text at a time, to which small modifications can be made. Memory typewriters usually do not retain the contents of memory when power is turned off.

MEMS *n.* Acronym for **micro-electromechanical systems**. A technology combining computers with extremely tiny mechanical devices. MEMS devices contain microcircuitry on a tiny silicon chip onto which a mechanical device such as a sensor or an actuator is attached. MEMS devices are used in switches, pacemakers, games, GPS tracking, data storage, and for accelerometers in air bags. Because MEMS devices have the potential to be manufactured in large quantities for little cost, many additional MEMS products are being planned or studied.

menu *n.* A list of options from which a user can make a selection in order to perform a desired action, such as choosing a command or applying a particular format to part of a document. Many application programs, especially those that offer a graphical interface, use menus as a means of providing the user with an easily learned, easy-to-use alternative to memorizing program commands and their appropriate usage.

menu bar *n.* A rectangular bar displayed in an application program's on-screen window, often at the top, from which menus can be selected by the user. Names of available menus are displayed in the menu bar; choosing one with the keyboard or with a mouse causes the list of options in that menu to be displayed.

menu-driven *adj.* Using menus to present choices of commands and available options. Menu-driven programs are usually considered friendlier and easier to learn than programs with a command-line interface. *Compare* command-line interface.

menu item *n.* A choice on a menu, selectable by either the keyboard or a mouse. In some instances, a menu item that is not available (that is, not appropriate) for a given



situation is “grayed” (dimmed in comparison to the valid menu choices).

Merced *n.* Former code name for the next-generation 64-bit microprocessor designed by Intel and Hewlett-Packard and released in 2000. Based on the IA-64 architecture, the 64-bit microprocessor contains upwards of 10 million transistors and is used primarily in servers and high-performance workstations. *See also* IA-64.

Mercury *n.* A logic/functional programming language that combines the clarity and expressiveness of declarative programming with advanced static analysis and error-detection features.

merge *vb.* To combine two or more items, such as lists, in an ordered way and without changing the basic structure of either. *Compare* concatenate.

merged transistor logic *n.* *See* integrated injection logic.

merge sort *n.* A sorting technique that combines several sorted (input) lists into a single sorted (output) list. *See also* bubble sort, insertion sort, quicksort, sort algorithm.

mesa *n.* An area of a germanium or silicon wafer that was protected during the etching process and is therefore higher than the surrounding etched areas. *See also* photolithography.

mesh network *n.* A communications network having two or more paths to any node.

message *n.* **1.** In communications, a unit of information transmitted electronically from one device to another. A message can contain one or more blocks of text as well as beginning and ending characters, control characters, a software-generated header (destination address, type of message, and other such information), and error-checking or synchronizing information. A message can be routed directly from sender to receiver through a physical link, or it can be passed, either whole or in parts, through a switching system that routes it from one intermediate station to another. *See also* asynchronous transmission, block (definition 4), control character (definition 1), frame (definition 1), frame (definition 2), header (definition 2), message switching, network, packet (definition 1), packet switching, synchronous transmission. **2.** In software, a piece of information passed from the application or operating system to the user to suggest an action, indicate a condition, or inform that an event has occurred. **3.** In message-based

operating environments, such as Windows, a unit of information passed among running programs, certain devices in the system, and the operating environment itself.

message header *n.* A sequence of bits or bytes at the beginning of a message that usually provides a timing sequence and specifies such aspects of the message structure as its length, data format, and block identification number. *See also* header (definition 2).

message of the day *n.* A daily bulletin for users of a network, multiuser computer, or other shared system. In most cases, users are shown the message of the day when they log into the system. *Acronym:* MOTD.

Message Passing Interface *n.* *See* MPI.

message queue *n.* An ordered list of messages awaiting transmission, from which they are taken up on a first in, first out (FIFO) basis.

Message Queuing *n.* A message queuing and routing system for Microsoft Windows that enables distributed applications running at different times to communicate across heterogeneous networks and with computers that may be off line. Message Queuing provides guaranteed message delivery, efficient routing, security, and priority-based messaging. Message Queuing was formerly known as MSMQ.

message reflection *n.* In object-oriented programming environments, such as Visual C++, OLE, and ActiveX, a function that allows a control to handle its own message. *See also* ActiveX controls, control (definition 2), OCX, VBX.

Message Security Protocol *n.* A protocol for Internet messages that is based on the use of encryption and verification to ensure security. It also allows for permissions at the server level for delivery or rejection of e-mail. *Acronym:* MSP.

message switching *n.* A technique used on some communications networks in which a message, with appropriate address information, is routed through one or more intermediate switching stations before being sent to its destination. On a typical message-switching network, a central computer receives messages, stores them (usually briefly), determines their destination addresses, and then delivers them. Message switching enables a network both to regulate traffic and to use communications lines efficiently. *Compare* circuit switching, packet switching.



message transfer agent *n.* See MTA.

messaging *n.* The use of computers and data communication equipment to convey messages from one person to another, as by e-mail, voice mail, or fax.

messaging application *n.* An application that enables users to send messages (such as e-mail or fax) to each other.

Messaging Application Programming Interface *n.* See MAPI.

messaging client *n.* An application program that enables its user to send or receive messages (such as e-mail or fax) to and from other users with the help of a remote server.

messaging-oriented middleware *n.* See MOM.

meta- *prefix* Literally, a prefix that describes a process or characteristic beyond the normal meaning of the word without the prefix. For example, metaphysics is “beyond physics.” In computing, meta- is usually attached to a word to indicate that the “metaterm” describes, defines, or acts upon objects or concepts of the same type as itself. So, for example, metadata is data about data and a meta-tool is a tool for working on tools.

metacharacter *n.* A character embedded in a program source or a data stream that conveys information about other characters, rather than itself representing a character. A simple example is the backslash (\) character, which, when used in strings in the C programming language, indicates that the letter following the backslash is part of an escape sequence that enables C to display a nongraphic character. See also escape character.

metacompiler *n.* A compiler that produces compilers. The UNIX utility *yacc* (Yet Another Compiler-Compiler) is a metacompiler. If it is given a language specification, yacc produces a compiler for that language. See also compiler (definition 2).

Meta-Content Format *n.* An open format for describing information about content of a structured body of data such as a Web page, a set of files on a Windows desktop, or a relational database. Meta-Content Format might be used for indexes, data dictionaries, or price lists. *Acronym:* MCF.

metadata or **meta data** *n.* **1.** Data about data. For example, the title, subject, author, and size of a file constitute metadata about the file. See also data dictionary, repository. **2.** In the Microsoft .NET Framework, information that describes every element managed by the runtime: an

assembly, loadable file, type, method, and so on. This can include information required for debugging and garbage collection, as well as security attributes, marshaling data, extended class and member definitions, version binding, and other information required by the runtime.

Metadata Interchange Specification *n.* A set of specifications dealing with the exchanging, sharing, and managing of metadata. *Acronym:* MDIS. See also metadata (definition 1).

metafile *n.* A file that contains or defines other files. Many operating systems use metafiles to contain directory information about other files on a given storage device.

metaflow *n.* One of the four stages of the data warehousing process, during which metadata (data about data) is tracked and managed; the business modeling stage. During metaflow, the operational environment is mapped to the data warehouse environment. See also data warehouse (definition 2), downflow, inflow, metadata (definition 1), upflow.

metalanguage *n.* A language used to describe other languages. Backus-Naur form (BNF) is a metalanguage commonly used to define programming languages. *Also called:* language-description language. See also Backus-Naur form.

metal-oxide semiconductor *n.* See MOS.

metal-oxide semiconductor field-effect transistor *n.* See MOSFET.

metaoperating system *n.* An operating system under which several other operating systems are active. *Also called:* supervisor.

metatag or **meta tag** *n.* A tag in an HTML or XML document that allows a Web-page creator to include such information as the author's name, keywords identifying content, and descriptive details (for example, non-text objects on the page). The information that is marked with metatags does not appear on the Web page when a user views it in a browser, but it can be viewed in the HTML or XML source. Metatags are included in the head of a document and are often used to assist search engines in indexing the page. See also HTML, source, tag, XML.

method *n.* In object-oriented programming, a process performed by an object when it receives a message. See also object (definition 2), object-oriented programming.

Metropolitan Area Exchange *n.* See MAE (definition 2).

metropolitan area network *n.* See MAN.

M

MFC *n.* See Microsoft Foundation Classes.

MFLOPS *n.* Acronym for **m**illion **f**loating-point **o**perations **p**er second. A measure of computing speed. *Also called:* megaflops.

MFM encoding *n.* See modified frequency modulation encoding.

MFP *n.* See multifunction peripheral.

MFS *n.* See Macintosh File System.

mget *n.* Short for **m**ultiple **g**et. A command in most FTP clients with which a user can request the transfer of several files at once. *See also* FTP¹ (definition 1).

MHTML *n.* Acronym for **M**ultipurpose Internet Mail Extension **H**ypertext **M**arkup **L**anguage, or MIME HTML. A standard method for sending an HTML document encapsulated with inline graphics, applets, linked documents, and other items referred to in the HTML document. *See also* HTML, MIME.

MHz *n.* See megahertz.

MI *n.* See multiple inheritance.

MIB *n.* See Management Information Base.

mickey *n.* A unit of measure for mouse movement. One mickey is typically equal to 1/200th of an inch.

MICR *n.* See magnetic-ink character recognition.

micro- *prefix* **1.** In nonexact measurements, small or compact, as in *microprocessor* or *microcomputer*. **2.** Metric prefix meaning 10⁻⁶ (one millionth).

microbrowser *n.* An application for mobile phones that allows users to access the Internet to send and receive e-mail and browse the Web. Microbrowsers don't have the full functionality of a Web browser on a PC. For instance, microbrowsers are capable of loading only stripped-down text versions of Web pages. Most microbrowser products are built to utilize the Wireless Application Protocol (WAP) standard. *See also* Wireless Application Protocol.

microcapsule *n.* In an electronic paper display, millions of tiny beads filled with dark dye and light pigment that, in response to an electrical charge, change color to create images and text. *See also* electronic paper.

Micro Channel Architecture *n.* The design of the bus in IBM PS/2 computers (except Models 25 and 30). The Micro Channel is electrically and physically incompatible with the IBM PC/AT bus. Unlike the PC/AT bus, the Micro Channel functions as either a 16-bit or a 32-bit bus.

The Micro Channel also can be driven independently by multiple bus master processors.

microchip *n.* See integrated circuit.

microcircuit *n.* A miniaturized electronic circuit etched on a semiconductor chip. A microcircuit is made up of interconnected transistors, resistors, and other components. However, it is fabricated as a unit, rather than as a set of vacuum tubes, discrete transistors, or other elements that have to be wired together. *See also* integrated circuit.

microcode *n.* Very low-level code that defines how a processor operates. Microcode is even lower in level than machine code; it specifies what the processor does when it executes a machine-code instruction. *See also* machine code, microprogramming.

microcomputer *n.* A computer built around a single-chip microprocessor. Less powerful than minicomputers and mainframes, microcomputers have nevertheless evolved into very powerful machines capable of complex tasks. Technology has progressed so quickly that state-of-the-art microcomputers—essentially, in today's terms, a desktop PC—are as powerful as mainframe computers of only a few years ago, at a fraction of the cost. *See also* computer.

microcontent *n.* Short pieces of text on a Web page that help provide an overview of the page's contents. Microcontent introduces, summarizes, or enhances the macrocontent of a Web page, and includes headings, page titles, ALT text, links, and subheads. *Compare* macrocontent.

microcontroller *n.* A special-purpose, single-chip computer designed and built to handle a particular, narrowly defined task. In addition to the central processing unit (CPU), a microcontroller usually contains its own memory, input/output channels (ports), and timers. When part of a larger piece of equipment, such as a car or a home appliance, a microcontroller is an embedded system. *See also* embedded system.

microdisplay *n.* A tiny monitor screen that provides a full-size view when magnified. Microdisplays work by magnifying a screen as small as one-tenth of an inch to fill the user's field of vision. Microdisplays may be used with computers, DVD players, or handheld devices, in headsets and viewfinders, or anywhere a full-size monitor is impractical or undesirable.

Microdrive *n.* A 1-inch disk drive, introduced in 1998 by IBM. The Microdrive is designed for use in handheld



computers and special-purpose devices such as digital cameras and cellular telephones.

micro-electromechanical systems *n.* See MEMS.

microelectronics *n.* The technology of constructing electronic circuits and devices in very small packages. The most significant advance in microelectronics technology has been the integrated circuit. Circuits that 40 years ago required a roomful of power-hungry vacuum tubes can now be fabricated on a silicon chip smaller than a postage stamp and require only a few milliwatts of power. See also integrated circuit.

microfiche *n.* A small sheet of film, about 4 by 6 inches, used for recording photographically reduced images, such as document pages, in rows and columns forming a grid pattern. The resulting images are too small to read with the naked eye, and a microfiche reader is required to view the documents. Compare microfilm.

microfilm *n.* A thin strip of film stored on a roll and used to record sequential data images. As with microfiche, a special device magnifies the images so that they can be read. See also CIM (definition 2), COM (definition 4). Compare microfiche.

microfloppy disk *n.* A 3.5-inch floppy disk of the type used with the Macintosh and with IBM and compatible microcomputers. A microfloppy disk is a round piece of polyester film coated with ferric oxide and encased in a rigid plastic shell equipped with a sliding metal cover. On the Macintosh, a single-sided microfloppy disk can hold 400 kilobytes (KB); a double-sided (standard) disk can hold 800 KB; and a double-sided high-density disk can hold 1.44 megabytes (MB). On IBM and compatible machines, a microfloppy can hold either 720 KB or 1.44 MB of information. See also floppy disk.

microfluidics *n.* Technology for control and manipulation of fluids on a microscopic scale using microscopic pumps and valves placed on a chip. Microfluidics devices have implications for a number of medical, pharmaceutical, genomics, and other biotechnology applications.

microform *n.* The medium, such as microfilm or microfiche, on which a photographically reduced image, called a *microimage*, is stored. A microimage usually represents text, such as archived documents. See also microfiche, microfilm, micrographics.

micrographics *n.* The techniques and methods for recording data on microfilm. See also microform.

microimage *n.* A photographically reduced image, usually stored on microfilm or microfiche, that is too small to be read without magnification. See also microform, micrographics.

microinstruction *n.* An instruction that is part of the microcode. See also microcode.

microjustification *n.* See microspace justification.

microkernel *n.* **1.** In programming, the strictly hardware-dependent part of an operating system that is intended to be portable from one type of computer to another. The microkernel provides a hardware-independent interface to the rest of the operating system, so only the microkernel needs to be rewritten to port the operating system to a different platform. See also kernel, operating system. **2.** A kernel that has been designed with only the basic features and typically in a modular fashion.

micrologic *n.* A set of instructions, stored in binary form, or a set of electronic logic circuits that defines and governs the operation within a microprocessor.

microminiature *n.* An extremely small circuit or other electronic component, especially one that is a refinement of an already miniaturized element.

microphone *n.* **1.** A device that converts sound waves into analog electrical signals. Additional hardware can convert the microphone's output into digital data that a computer can process; for example, to record multimedia documents or analyze the sound signal. **2.** A communication program that runs on the Macintosh computer.

microphotonics *n.* Technology for directing light on a microscopic scale. Microphotonics employs tiny mirrors or photonic crystals to reflect and transmit specific wavelengths of light, which can carry digital signals. Microphotonics technology has implications for optical networks under development for the telecommunications industry. See also MEMS, optical switching.

microprocessor *n.* A central processing unit (CPU) on a single chip. A modern microprocessor can have several million transistors in an integrated-circuit package that can easily fit into the palm of one's hand. Microprocessors are at the heart of all personal computers. When memory and power are added to a microprocessor, all the pieces, excluding peripherals, required for a computer are present.

M

The most popular lines of microprocessors today are the 680x0 family from Motorola, which powers the Apple Macintosh line, and the 80x86 family from Intel, which is at the core of all IBM PC-compatible computers. *See also* 6502, 65816, 6800, 68000, 68020, 68030, 68040, 80286, 80386DX, 80386SX, 8080, 8086

microprogramming *n.* The writing of microcode for a processor. Some systems, chiefly minicomputers and mainframes, allow modification of microcode for an installed processor. *See also* microcode.

microsecond *n.* One millionth (10^{-6}) of a second.
Abbreviation: μ s.

microsite *n.* **1.** A small Web site targeted to a single message or topic and nested within a larger site. Microsites geared to promotional and sales of specific products and services may be integrated into popular Web sites by advertisers. **2.** A small Web site with a single focus. *Also called:* minisite.

Microsoft Access *n.* *See* Access.

Microsoft Active Accessibility *n.* *See* Active Accessibility.

Microsoft DOS *n.* *See* MS-DOS.

Microsoft Excel *n.* *See* Excel.

Microsoft Foundation Classes *n.* A C++ class library developed by Microsoft. The Microsoft Foundation Class library, or MFC, provides the framework and classes that make it easier and faster for programmers to build Windows applications. MFC supports ActiveX and is bundled with several C++ compilers, including Microsoft Visual C++, Borland C++, and Symantec C++. *Acronym:* MFC. *See also* ActiveX, C++. *Compare* Application Foundation Classes.

Microsoft FrontPage *n.* A program you can use to create and manage Internet and intranet sites without programming; FrontPage is available as part of one of the Microsoft Office suites or as a stand-alone product.

Microsoft intermediate language *n.* The CPU-independent instruction set into which .NET Framework programs are compiled. It contains instructions for loading, storing, initializing, and calling methods on objects.

Combined with metadata and the common type system, Microsoft intermediate language allows for true cross-language integration. Prior to execution, MSIL is converted to machine code. It is not interpreted. *Acronym:* MSIL.

Microsoft Internet Explorer *n.* *See* Internet Explorer.

Microsoft Knowledge Base *n.* *See* KB (definition 2).

Microsoft Management Console *n.* *See* MMC.

Microsoft MapPoint *n.* *See* MapPoint.

Microsoft Money *n.* *See* Money.

Microsoft MSN Explorer *n.* *See* MSN Explorer.

Microsoft MSN Messenger Service *n.* *See* .NET Messenger Service.

Microsoft .NET Messenger Service *n.* *See* .NET Messenger Service.

Microsoft Network *n.* *See* MSN.

Microsoft Office *n.* *See* Office.

Microsoft Operations Manager *n.* A server and application management solution developed by Microsoft Corporation to deliver event and performance management for the Windows 2000-based environment and .NET Enterprise Server applications. Operations management features include enterprise event log reports from across the corporate network, proactive monitoring and alert messaging, and reporting and trend analysis for problem tracking. Microsoft Operations Manager provides flexibility through sophisticated management rules, which can be customized to meet the needs of individual businesses. Microsoft Operations Manager support for management technology standards permits easy integration with other enterprise management systems.

Microsoft Outlook *n.* *See* Outlook.

Microsoft PowerPoint *n.* *See* PowerPoint.

Microsoft Project *n.* A software application developed by Microsoft Corporation to simplify the planning and management of projects. Microsoft Project includes features that help you build and manage projects, set schedules and milestones, and communicate and share ideas with team members.



Microsoft Reader *n.* A software application developed by Microsoft for downloading electronic books and other publications onto any personal computer, laptop computer, or Pocket PC handheld device. Additional features allow users to bookmark pages, highlight text, write notes, and look up definitions.

Microsoft Tech•Ed *n.* An annual training conference held by Microsoft Corporation to educate engineers and businesses using Microsoft technology. The conference provides attendees with access to information, experts, and training labs on Microsoft's latest technologies.

Microsoft Visual InterDev *n.* *See* Visual InterDev.

Microsoft Visual Studio *n.* *See* Visual Studio.

Microsoft Visual Studio .NET *n.* A complete development environment for building on the Microsoft .NET technology. Using Visual Studio .NET, developers can create secure, scalable applications and Web services quickly in the language of their choice, leveraging existing systems and skills.

Microsoft Windows *n.* *See* Windows.

Microsoft Windows 2000 *n.* *See* Windows 2000.

Microsoft Windows 95 *n.* *See* Windows 95.

Microsoft Windows 98 *n.* *See* Windows 98.

Microsoft Windows CE *n.* *See* Windows CE.

Microsoft Windows Messenger *n.* *See* .NET Messenger Service.

Microsoft Windows NT *n.* *See* Windows NT.

Microsoft Word *n.* *See* Word.

Microsoft XML *n.* *See* MSXML.

microspace justification *n.* The addition of thin spaces between characters within words to fill out a line for justification, instead of relying only on adding space between words. Good microspace justification gives justified text a more polished, professional look; excessive microspace justification causes words to lose visual coherence. *Also called:* microjustification. *See also* justify (definition 2), microspacing.

microspacing *n.* In printing, the process of adjusting character placement by very small increments.

microtransaction *n.* A business transaction that involves a very small amount of money, typically under about \$5. *See also* millicent technology.

microwave relay *n.* A communications link that uses point-to-point radio transmissions at frequencies higher than approximately 1 gigahertz (1000 megahertz).

middleware *n.* **1.** Software that sits between two or more types of software and translates information between them. Middleware can cover a broad spectrum of software and generally sits between an application and an operating system, a network operating system, or a database management system. Examples of middleware include CORBA and other object broker programs and network control programs. *See also* CORBA. **2.** Software that provides a common application programming interface (API). Applications written using that API will run in the same computer systems as the middleware. An example of this type of middleware is ODBC, which has a common API for many types of databases. *See also* application programming interface, ODBC. **3.** Software development tools that enable users to create simple programs by selecting existing services and linking them with a scripting language. *See also* scripting language.

MIDI *n.* Acronym for **M**usical **I**nstrument **D**igital **I**nterface. A serial interface standard that allows for the connection of music synthesizers, musical instruments, and computers. The MIDI standard is based partly on hardware and partly on a description of the way in which music and sound are encoded and communicated between MIDI devices. The information transmitted between MIDI devices is in a form called a *MIDI message*, which encodes aspects of sound such as pitch and volume as 8-bit bytes of digital information. MIDI devices can be used for creating, recording, and playing back music. Using MIDI, computers, synthesizers, and sequencers can communicate with each other, either keeping time or actually controlling the music created by other connected equipment. *See also* synthesizer.

MIDL *n.* Acronym for **M**icrosoft **I**nterface **D**efinition **L**anguage. Microsoft implementation and extension of the Interface Definition Language (IDL). *See also* IDL.

midrange computer *n.* A medium-size computer. The term is used interchangeably with *minicomputer*, except midrange computers do not include single-user workstations. *See also* minicomputer.



migration *n.* The process of making existing applications and data work on a different computer or operating system.

.mil *n.* In the Internet's Domain Name System, the top-level domain that identifies addresses operated by U.S. military organizations. The designation .mil appears at the end of the address. *See also* DNS (definition 1), domain (definition 3). *Compare* .com, .edu, .gov, .net, .org.

Military Network *n.* *See* MILNET.

millennium bug *n.* *See* Year 2000 problem.

millennium-compliant *adj.* *See* Year 2000-compliant.

millennium computer bug *n.* *See* Year 2000 problem.

millennium transition *n.* *See* Year 2000 rollover.

milli- *prefix* Metric prefix meaning 10^{-3} (one thousandth). *Abbreviation:* m.

millicent technology *n.* A set of protocols for small-scale commercial transactions over the Internet, developed by Digital Equipment Corporation. Millicent technology is intended to handle purchases of items of information at prices less than a cent.

millions of instructions per second *n.* *See* MIPS.

millisecond *n.* One thousandth of a second. *Abbreviation:* ms or msec.

millivolt *n.* One thousandth of a volt. *Abbreviation:* mV.

MILNET *n.* Short for **Military Network**. A wide area network that represents the military side of the original ARPANET. MILNET carries nonclassified U.S. military traffic. *See also* ARPANET. *Compare* NSFnet.

MIMD *n.* Acronym for **multiple instruction, multiple data** stream processing. A category of computer architecture engaged in parallel processing in which central processing units independently fetch instructions and operate on data. *See also* architecture (definition 1), central processing unit, instruction, parallel processing. *Compare* SIMD.

MIME or **mime** *n.* Acronym for **Multipurpose Internet Mail Extensions**. A protocol widely used on the Internet that extends the SMTP (Simple Mail Transfer Protocol) to permit data, such as video, sound, and binary files, to be transmitted by Internet e-mail without having to be translated into ASCII format first. This is accomplished by the use of MIME types, which describe the contents of a document. A MIME-compliant application sending a file, such as some e-mail programs, assigns a MIME type to the file. The receiving application, which must also be

MIME-compliant, refers to a standardized list of documents that are organized into MIME types and subtypes to interpret the content of the file. For instance, one MIME type is *text*, and it has a number of subtypes, including *plain* and *html*. A MIME type of *text/html* refers to a file that contains text written in HTML. MIME is part of HTTP, and both Web browsers and HTTP servers use MIME to interpret e-mail files they send and receive. *See also* HTTP, HTTP server, Simple Mail Transfer Protocol, Web browser. *Compare* BinHex¹ (definition 1).

mindshare *n.* The presence and familiarity of a product, service, or company in the minds of users or consumers. Unlike *market share*, which is the percentage of the market won by a particular product, service, or company, mindshare is a less quantifiable but still important factor in engaging customer attention and generating sales. The term is used frequently by, but is not limited to, the computer industry.

miniaturization *n.* In the development of integrated circuits, the process of reducing the size and increasing the density of transistors and other elements on a semiconductor chip. In addition to providing the benefits of small size, miniaturization of electronic circuits also lowers power requirements, reduces heat, and shortens delays in the propagation of signals from one circuit element to the next. *See also* integrated circuit, integration (definition 2).

minicomputer *n.* A mid-level computer built to perform complex computations while dealing efficiently with a high level of input and output from users connected via terminals. Minicomputers also frequently connect to other minicomputers on a network and distribute processing among all the attached machines. Minicomputers are used heavily in transaction-processing applications and as interfaces between mainframe computer systems and wide area networks. *See also* computer, mainframe computer, microcomputer, supercomputer, wide area network. *Compare* midrange computer, workstation (definition 2).

mini-driver architecture *n.* An architecture in Windows 3.1, Windows 95, Windows 98, Windows NT, and Windows 2000 that uses a relatively small and simple driver, containing any additional instructions needed by a specific hardware device, to interface with the universal driver for that class of devices. *See also* driver.

minifloppy *n.* A 5.25-inch floppy disk. *See also* floppy disk.



minimize *vb.* In a graphical user interface, to hide a window without shutting down the program responsible for the window. Usually an icon, a button, or a name for the window is placed on the desktop; when the user clicks on the button, icon, or name, the window is restored to its previous size. *See also* graphical user interface, Minimize button, taskbar, window. *Compare* maximize.

Minimize button *n.* In Windows 3.x, Windows 9x, Windows NT, and Windows 2000, a button in the upper right-hand corner of a window that when clicked hides the window. In Windows 3.x and Windows NT 3.5 and earlier, an icon appears on the desktop that represents the window; in Windows 95, Windows NT 4, and later versions, the name of the window appears on the taskbar at the bottom of the desktop screen. When the icon or the name is clicked, the window is restored to its previous size. *See also* graphical user interface, taskbar, window.

mini-notebook *n.* A portable computer in a case smaller than that of a standard laptop computer. Most mini-notebook computers have small keyboards, LCD screens built into folding cases, Pentium processors, and built-in hard drives. They are designed to run on standard operating systems, such as Windows 98, rather than on the Windows CE operating system used by the even smaller handheld computers.

miniport driver *n.* A kernel-mode driver that is specific to a device. A miniport driver is linked to a port driver that provides an interface between the port driver and the operating system. This is typically implemented as a dynamic-link library.

minisite *n.* *See* microsite.

minitower *n.* A vertical floor-standing computer cabinet that is about half the height (13 inches) of a tower case (24 inches). *See also* tower.

minor key *n.* *See* alternate key (definition 1).

MIP mapping *n.* Short for **multum in parvo** (Latin, “much in little”) **mapping**. A form of mapping in which the appearance of a bitmapped image is precalculated from a distance and used in a texture mapper. This allows for smoother texture-mapped images calculated in the distance, since pixel conversion may alter colors relative to human perception.

MIPS *n.* Acronym for **millions of instructions per second**. A common measure of processor speed. *See also* central processing unit, MFLOPS.

mirror image *n.* An image that is an exact duplicate of the original with the exception that one dimension is reversed. For example, a right-pointing arrow and a left-pointing arrow of the same size and shape are mirror images.

mirroring *n.* **1.** In computer graphics, the ability to display a mirror image of a graphic—a duplicate rotated or reflected relative to some reference such as an axis of symmetry. *See* the illustration. **2.** In a network, a means of protecting data on a network by duplicating it, in its entirety, on a second disk. Mirroring is one strategy implemented in RAID security. **3.** On the Internet, replicating a Web site or an FTP site on another server. A site is often mirrored if it is frequently visited by multiple users. This eases the network traffic to the site, making it easier for users to gain access to the information or files on it. A site may also be mirrored in different geographic locations to facilitate downloading by users in various areas. *See also* RAID.

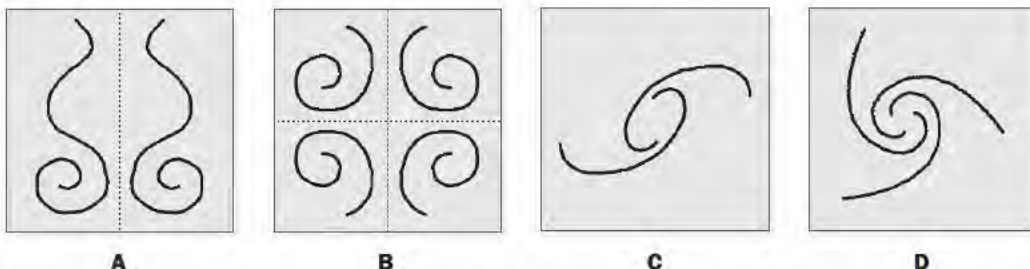

Mirroring. (A) twofold symmetry with vertical axis; (B) fourfold symmetry with vertical and horizontal axes; (C) twofold radial symmetry; (D) threefold radial symmetry.

mirror site *n.* A file server that contains a duplicate set of files to the set on a popular server. Mirror sites exist to spread the distribution burden over more than one server or to eliminate the need to use high-demand international circuits.

MIS *n.* See IS.

misc. newsgroups *n.* Usenet newsgroups that are part of the misc. hierarchy and have the prefix *misc.* These newsgroups cover topics that do not fit into the other standard Usenet hierarchies (comp., news., rec., sci., soc., talk.). See also newsgroup, traditional newsgroup hierarchy, Usenet.

mission critical *adj.* Pertaining to information, equipment, or other assets of a business or project that are essential to the successful operation of the organization. For example, accounting data and customer records are often considered mission critical information.

misuse detection *n.* See IDS.

mixed cell reference *n.* In spreadsheets, a cell reference (the address of a cell needed to solve a formula) in which either the row or the column is relative (automatically changed when the formula is copied or moved to another cell) and the other is absolute (not changed when the formula is copied or moved). See also cell (definition 1).

MMC *n.* Acronym for **Microsoft Management Console**. A framework for hosting administrative tools called snap-ins. A console might contain tools, folders or other containers, World Wide Web pages, and other administrative items. These items are displayed in the left pane of the console, called a console tree. A console has one or more windows that can provide views of the console tree. The main MMC window provides commands and tools for authoring consoles. The authoring features of MMC and the console tree itself might be hidden when a console is in User Mode. See also snap-in.

MMDS *n.* Short for **multichannel multipoint distribution service**. A fixed wireless service proposed for use as an alternative when DSL or cable modem options are not practical or desirable. The MMDS spectrum was originally used for distance learning and wireless cable video services before attracting interest for fixed broadband wireless services. See also broadband.

MMU *n.* See memory management unit.

MMX *n.* Short for **Multimedia Extensions**. An enhancement to the architecture of Intel Pentium processors that

improves the performance of multimedia and communications applications.

mnemonic *n.* A word, rhyme, or other memory aid used to associate a complex or lengthy set of information with something that is simple and easy to remember. Mnemonics are widely used in computing. Programming languages other than machine language, for example, are known as *symbolic languages* because they use short mnemonics, such as *ADD* (for *addition*) and *def* (for *define*) to represent instructions and operations. Similarly, operating systems and applications based on typed commands use mnemonics to represent instructions to the program. MS-DOS, for example, uses *dir* (for *directory*) to request a list of files.

MNP10 *n.* Short for **Microcom Networking Protocol, Class 10**. An industry-standard communication protocol used for modem connections over analog cellular telephone connections. The most recent version of MNP10 is MNP 10EC (EC stands for Enhanced Cellular). See also communications protocol.

mobile computing *n.* The process of using a computer while traveling. Mobile computing usually requires a portable computer that is battery powered, rather than a desktop system.

Mobile Explorer *n.* A modular wireless applications and services platform designed by Microsoft to power Web-enabled wireless telephones. When connected to a wireless network, Mobile Explorer provides secure mobile access to corporate or personal e-mail, corporate networks, and the Internet. It includes a multimode microbrowser, which can display Web content coded in a variety of markup languages used for small, handheld devices, including cHTML, HTML, WAP 1.1, and WML. See also microbrowser.

Mobile Information Server *n.* A software application developed by Microsoft to allow telecommunications carriers, enterprise customers, and business partners to securely extend Microsoft Exchange Server information, corporate intranet applications, and services to users of wireless handheld computing devices. Microsoft Information Server provides mobile users with access to personal services and data stored on the intranet, such as e-mail, document files, appointment calendars, and contacts.

mobile IP *n.* Acronym for **mobile Internet Protocol**. An Internet protocol designed to support host mobility. Mobile IP enables a host to remain connected to the Internet with the same IP address (called the home address)



while moving to different locations. Mobile IP tracks a moving host by registering the presence of the host with a foreign agent; the home agent then forwards packets to the remote network. *See also* IP.

mobile telephone switching office *n.* Computer that controls wireless phone calls. The mobile telephone switching office controls the operation of wireless cell sites, tracks calls, and transfers signals between wireless networks and traditional wired telephone systems. *Acronym:* MTSO.

mode *n.* The operational state of a computer or a program. For example, edit mode is the state in which a program accepts changes to a file. *See also* address mode, compatibility mode, safe mode, video mode, virtual real mode.

modem *n.* In telecommunications, a device that generates analog modem signals digitally. The term *modem* is a combination of the terms *modem* and *codec*. *See also* codec (definition 1), modem (definition 2).

model *n.* A mathematical or graphical representation of a real-world situation or object—for example, a mathematical model of the distribution of matter in the universe, a spreadsheet (numeric) model of business operations, or a graphical model of a molecule. Models can generally be changed or manipulated so that their creators can see how the real version might be affected by modifications or varying conditions. *See also* modeling, simulation.

modeling *n.* **1.** The use of computers to describe the behavior of a system. Spreadsheet programs, for example, can be used to manipulate financial data representing the health and activity of a company, to develop business plans and projections, or to evaluate the impact of proposed changes on the company's operations and financial status. *See also* simulation, spreadsheet program. **2.** The use of computers to describe physical objects and the spatial relationships among them mathematically. CAD programs, for example, are used to create on-screen representations of such physical objects as tools, office buildings, complex molecules, and automobiles. These models use equations to create lines, curves, and other shapes and to place those shapes accurately in relation to each other and to the two-dimensional or three-dimensional space in which they are drawn. *See also* CAD, rendering, solid model, surface modeling, three-dimensional model, two-dimensional model, wire-frame model.

modem *n.* **1.** Short for **modulator/demodulator**. A communications device that converts between digital data from a computer or terminal and analog audio signals that can pass through a standard telephone line. Because the telephone system was designed to handle voice and other audio signals and a computer processes signals as discrete units of digital information, a modem is necessary at both ends of the telephone line to exchange data between computers. At the transmit end, the modem converts from digital to analog audio; at the receiving end, a second modem converts the analog audio back to its original digital form. In order to move a high volume of data, high-speed modems rely on sophisticated methods for “loading” information onto the audio carrier—for example, they may combine frequency shift keying, phase modulation, and amplitude modulation to enable a single change in the carrier's state to represent multiple bits of data. In addition to the basic modulation and demodulation functions, most modems also include firmware that allows them to originate and answer telephone calls. International standards for modems are specified by the International Telecommunications Union, or ITU. Despite their capabilities, modems do require communications software in order to function. *See also* amplitude modulation, frequency modulation, quadrature amplitude modulation. *Compare* digital modem. **2.** Any communications device that acts as an interface between a computer or terminal and a communications channel. Although such a device may not actually modulate or demodulate analog signals, it may be described as a modem because a modem is perceived by many users to be a black box that connects a computer to a communications line (such as a high-speed network or a cable TV system). *See also* digital modem.

modem bank *n.* A collection of modems connected to a server maintained by an ISP or the operator of a BBS or remote-access LAN. Most modem banks are configured to allow a remote user to dial a single phone number that routes calls to an available phone number on the bank. *See also* BBS (definition 1), ISP, LAN.

modem eliminator *n.* A device that enables two computers to communicate without modems. *See also* null modem.

modem port *n.* A serial port used for connecting an external modem to a personal computer. *See also* modem (definition 1), serial port.

modem ready *n.* *See* MR.

M

moderated *adj.* Subjected to review by a moderator, who may remove irrelevant or inflammatory articles or messages before redistributing them through a newsgroup, mailing list, or other messaging system.

moderated discussion *n.* Communication taking place on a mailing list, newsgroup, or other online forum that is edited by a moderator. When a user submits a message to a moderated discussion, the moderator decides if the message is relevant to the discussion topic. If so, it is forwarded to the discussion group. The content of a moderated discussion is often perceived as more valuable than that of an unmoderated one because the information has been read and approved by a “gatekeeper,” who has (presumably) filtered out irrelevant submissions. Some moderators also filter submissions for obscene or pornographic material or material that is potentially offensive. *See also* mailing list, moderator, newsgroup.

moderator *n.* In some Internet newsgroups and mailing lists, a person through whom all messages are filtered before they are distributed to the members of the newsgroup or list. The moderator discards or edits any messages that are not considered appropriate. *See also* mailing list, newsgroup.

modified frequency modulation encoding *n.* An older method of storing data on disks. Modified frequency modulation encoding is based on an earlier technique called frequency modulation encoding but improves on its efficiency by reducing the need for synchronizing information and by basing the magnetic coding of each bit on the status of the previously recorded bit. This method of encoding stores more information on a disk than does frequency modulation encoding. It is not, however, as efficient a space saver as the technique known as *run-length limited encoding*, or RLL. *Abbreviation:* MFM encoding. *Compare* frequency modulation encoding, run-length limited encoding.

modifier key *n.* A key on the keyboard that, when held down while another key is pressed, changes the meaning of the keystroke. *See also* Alt key, Command key, Control key, Shift key.

modify structure *n.* An operator available in some database management systems that permits fields (columns) to be added or deleted without the need to rebuild the entire database.

MO disk *n.* *See* magneto-optic disc.

MO disk drive *n.* *See* magneto-optic disc.

Modula-2 *n.* A modular high-level language designed in 1980 by Niklaus Wirth. Derived from Pascal, Modula-2 is noted for its emphasis on modular programming, its early support for data abstraction, and its lack of standard functions and procedures. *See also* modular programming.

modular design *n.* An approach to designing hardware or software in which a project is broken into smaller units, or modules, each of which can be developed, tested, and finished independently before being combined with the others in the final product. Each unit is designed to perform a particular task or function and can thus become part of a library of modules that can often be reused in other products having similar requirements. In programming, for example, one module might consist of instructions for moving the cursor in a window on the screen. Because it is deliberately designed as a stand-alone unit that can work with other sections of the program, the same module might be able to perform the same task in another program as well, thus saving time in development and testing.

modular jack *n.* *See* phone connector.

modular programming *n.* An approach to programming in which the program is broken into several independently compiled modules. Each module exports specified elements (such as constants, data types, variables, functions, and procedures); all other elements remain private to the module. Other modules can use only the exported elements. Modules clarify and regularize the interfaces among the major parts of a program. Thus, they facilitate group programming efforts and promote reliable programming practices. Modular programming is a precursor of object-oriented programming. *See also* module (definition 1), object-oriented programming.

modular software *n.* A program created from multiple stand-alone software components. Modular components can work together to perform the work for which the larger program is designed while still remaining individually usable—and reusable—in other programs. Modular software is, in effect, made up of recyclable parts. Because each component is functionally autonomous and self-contained, other components can call on its services without having to “know” how it works. Thus, a programmer can change or modify the way one component performs its work without adversely affecting other components in the same program. *See also* component software, integrated software, modular design.

modulate *vb.* To change some aspect of a signal intentionally, usually for the purpose of transmitting information.



modulation *n.* **1.** The process of changing or regulating the characteristics of a carrier wave vibrating at a certain amplitude (height) and frequency (timing) so that the variations represent meaningful information. **2.** In computer communications, the means by which a modem converts digital information sent by a computer to the audio form that it sends over a telephone line.

modulation standards *n.* Protocols that determine how modems convert digital data into analog signals that can be transmitted over telephone lines. Initially, Bell created modulation standards used in the United States, and the CCITT created international recommendations. The ITU-T (formerly called the CCITT) now makes recommendations generally adopted by modem manufacturers both internationally and in the United States. The ITU-TV series recommendations (such as V.34 and V.90) define data communication over the telephone network. The suffixes *-bis* and *-ter* (for example, V.32bis) indicate later versions. *See also* V.34, V.90.

module *n.* **1.** In programming, a collection of routines and data structures that performs a particular task or implements a particular abstract data type. Modules usually consist of two parts: an interface, which lists the constants, data types, variables, and routines that can be accessed by other modules or routines; and an implementation, which is private (accessible only to the module) and which contains the source code that actually implements the routines in the module. *See also* abstract data type, information hiding, Modula-2, modular programming. **2.** In hardware, a self-contained component that can provide a complete function to a system and can be interchanged with other modules that provide similar functions. *See also* memory card, SIMM.

modulo *n.* An arithmetic operation whose result is the remainder of a division operation. For example, *17 modulo 3 = 2* because 17 divided by 3 yields a remainder of 2. Modulo operations are used in programming.

moiré *n.* A visible wavy distortion or flickering in an image that is displayed or printed with an inappropriate resolution. Several parameters affect moiré patterns, including the size and resolution of the image, resolution of the output device, and halftone screen angle.

molecular beam epitaxy *n.* A process used in the fabrication of semiconductor devices, such as integrated circuits. A device employing molecular beam epitaxy creates thin

layers of semiconducting material by vaporizing the material and then directing a beam of molecules at the substrate on which the layer is to be formed. This technique allows very precise and very thin layers to be created.

MOM *n.* Acronym for **m**essaging-oriented **m**iddleware. A class of programs that translates data and messages between applications that use one format and communications services (such as NetBIOS and TCP/IP) that expect a different format.

monadic *adj.* *See* unary.

Money *n.* Microsoft's Windows-based financial-management software for individuals, families, and small businesses. Money includes tools for managing bank accounts and investments, budgeting, tax estimating and financial planning, and paying bills.

monitor *n.* The device on which images generated by the computer's video adapter are displayed. The term *monitor* usually refers to a video display and its housing. The monitor is attached to the video adapter by a cable. *See also* CRT.

monitoring software *n.* A program or set of programs used to oversee computer-based systems and networks for the purpose of tracking usage or identifying, reporting on, and solving problems at the earliest possible stage. Monitoring software is used in a variety of areas ranging from hardware platforms and their components to operating systems, databases, Internet/intranet access, and business applications. Typically, different tools are used to monitor individual system components, though the individual monitors might feed information to a higher-level monitor in order to encompass an entire computing environment.

monitor port *n.* *See* display port.

monochrome *adj.* Of, pertaining to, or being a monitor that displays images in only one color—black on white (as on early monochrome Macintosh screens) or amber or green on black (as on early IBM and other monochrome monitors). The term is also applied to a monitor that displays only variable levels of a single color, such as a gray-scale monitor.

monochrome adapter *n.* A video adapter capable of generating a video signal for one foreground color or sometimes for a range of intensities in a single color, as for a gray-scale monitor.



monochrome display *n.* **1.** A video display capable of rendering only one color. The color displayed depends on the phosphor of the display (often green or amber). **2.** A display capable of rendering a range of intensities in only one color, as in a gray-scale monitor.

Monochrome Display Adapter *n.* See MDA.

monochrome graphics adapter *n.* See HGC.

monochrome monitor *n.* See monochrome display.

monographics adapter *n.* Any video adapter that can display only monochrome text and graphics; any video adapter functionally compatible with the Hercules Graphics Card (HGC). See also HGC.

monospace font *n.* A font (set of characters in a particular style and size), similar to that used on a typewriter, in which each character occupies the same amount of horizontal space regardless of its width—an *i*, for example, taking as much room as an *m*. See the illustration. Also called: fixed-width font. See also monospacing. Compare proportional font.

Monospace

Proportional

Monospace font. *Monospace font vs. proportional font.*

monospacing *n.* A form of print and display spacing in which each character occupies the same amount of horizontal space on the line, regardless of whether the character is wide (such as *m*) or narrow (such as *I*). Also called: fixed-pitch spacing, fixed spacing, fixed-width spacing. See also monospace font. Compare proportional spacing.

Monte Carlo method *n.* A mathematical technique that uses repeated calculations and random numbers to find an approximate solution to a complex problem. The Monte Carlo method, named for its relationship to games of chance played in the casinos at Monte Carlo, Monaco, can be used in situations in which it is possible to calculate the probability of a particular event occurring but not to factor in the complex effects of many other contributing factors.

MOO *n.* Short for MUD, object-oriented. A type of virtual environment on the Internet, similar to a game-oriented

MUD but based on an object-oriented language and generally focused more on programming than on games. See also MUD.

Moore's Law *n.* A prediction by Intel cofounder Gordon Moore in the early days of the computer revolution regarding the growth of semiconductor technology. Moore predicted that the number of transistors that could be put on a chip would double every year, and it did. Ten years later, Moore predicted that chip capacity would double every two years, and capacity has actually doubled every 18 months since then. The doubling of capacity every 18 months is popularly referred to as a "law."

.moov *n.* A file extension indicating a QuickTime MooV video file for a Macintosh computer. See also MooV.

MooV *n.* The file format for QuickTime movies that stores synchronized tracks for control, video, audio, and text. See also QuickTime.

morphing *n.* Short for metamorphosing. A process by which one image is gradually transformed into another, creating the illusion of a metamorphosis occurring in a short time. A common motion picture special-effects technique, morphing is available in many advanced computer animation packages. See also tween.

MOS *n.* Acronym for metal-oxide semiconductor. An integrated-circuit technology in which field-effect transistors (FETs) are made with an insulating layer of silicon dioxide between a metal gate electrode and a semiconductor channel. MOS designs are widely used both in discrete components and in integrated circuits. MOS integrated circuits have the advantages of high component density, high speed, and low power consumption. MOS devices are easily damaged by static electricity, so before they are inserted in a circuit, they should be kept with their connectors embedded in conducting foam to prevent the buildup of static charges. See also FET, MOSFET.

Mosaic *n.* The first popular graphical World Wide Web browser. Released on the Internet in early 1993 by the National Center for Supercomputing Applications (NCSA) at the University of Illinois at Urbana-Champaign, Mosaic is available as freeware and shareware for Windows, Macintosh, and X Window systems. Mosaic is distinguished from other early Web browsers by its ease of use and its addition of inline images to Web documents. Also called: NCSA Mosaic.

MOSFET *n.* Acronym for metal-oxide semiconductor field-effect transistor. A common type of field-effect transistor in which a layer of silicon dioxide insulates the

M

metal gate from the semiconductor current channel. MOSFETs have extremely high input impedance and therefore require almost no driving power. They are used in many audio applications, including high-gain amplifier circuits. Like all metal-oxide semiconductor (MOS) devices, MOSFETs are easily damaged by static electricity. See the illustration. *See also* FET, MOS.

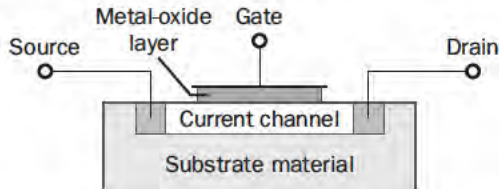

MOSFET.

most significant bit *n.* In a sequence of one or more bytes, the highest-order bit of a binary number, not including the sign bit. *Acronym:* MSB. *See also* high-order. *Compare* least significant bit.

most significant character *n.* The high-order, or leftmost, character in a string. *Acronym:* MSC. *See also* high-order. *Compare* least significant character.

most significant digit *n.* In a sequence of one or more digits, the highest-order digit, which is the leftmost digit. In 456.78, 4 is the most significant digit. *Acronym:* MSD. *Compare* least significant digit.

MOTD *n.* *See* message of the day.

motherboard *n.* The main circuit board containing the primary components of a computer system. This board contains the processor, main memory, support circuitry, and bus controller and connector. Other boards, including expansion memory and input/output boards, may attach to the motherboard via the bus connector. *See also* expansion slot. *Compare* daughterboard.

Motion JPEG *n.* A standard for storing motion video, proposed by the Joint Photographic Experts Group (JPEG), that uses JPEG image compression for each frame. *See also* JPEG (definition 1). *Compare* MPEG (definition 1).

motion path *n.* The path that a specified object or text will follow as part of an animation sequence for a slide.

mount *vb.* To make a physical disk or tape accessible to a computer's file system. The term is most commonly used to describe accessing disks in Macintosh and UNIX-based computers.

mount *n.* In NFS, a folder or file retrieved from elsewhere on the network and accessed locally. *See also* NFS.

MOUS *n.* Acronym for Microsoft Office User Specialist. A certification from Microsoft that verifies an individual's skills with the Microsoft Office desktop programs. *See also* MCP.

mouse *n.* A common pointing device. The basic features of a mouse are a flat-bottomed casing designed to be gripped by one hand, one or more buttons on the top, a multidirectional detection device (usually a ball) on the bottom, and a cable connecting the mouse to the computer. By moving the mouse on a surface (such as a desk top), the user typically controls an on-screen cursor. A mouse is a relative pointing device because there are no defined limits to the mouse's movement and because its placement on a surface does not map directly to a specific screen location. To select items or choose commands on the screen, the user presses one of the mouse's buttons, producing a "mouse click." *See* the illustration. *See also* bus mouse, mechanical mouse, optical mouse, optomechanical mouse, relative pointing device, serial mouse. *Compare* trackball.



Mouse. Two types of mouse: for the Macintosh (left) and for the PC (right).

MouseKeys *n.* A feature in Windows that allows a user to use the numeric keyboard to move the mouse pointer. MouseKeys is primarily intended for people who may have physical limitations that make it difficult to move a conventional mouse. *See also* mouse.

mouse pad *n.* A surface on which a mouse can be moved, typically a rectangular rubber pad covered with fabric, providing more traction than a wooden or glass desktop or tabletop. *See also* mouse.

mouse pointer *n.* An on-screen element whose location changes as the user moves the mouse. Depending on the location of the mouse pointer and the operation of the pro-

gram with which it is working, the area of the screen where the mouse pointer appears serves as the target for an action when the user presses one of the mouse buttons. *See also* block cursor, cursor (definition 3).

mouse port *n.* **1.** In many PC-compatible computers, a dedicated connector where a mouse or other pointing device plugs into the computer. If a mouse port is not available, a serial port can be used to connect the mouse to the computer. *See the illustration. See also* connector, mouse, pointing device, serial port. **2.** In a Macintosh, the Apple Desktop Bus port. *See also* Apple Desktop Bus.



Mouse port

Mouse port.

mouse scaling *n.* *See* mouse sensitivity.

mouse sensitivity *n.* The relationship of mouse movement to screen cursor movement. A more sensitive mouse signals to the computer more “mouse moves” per inch of physical mouse movement than does a less sensitive mouse. Increasing the sensitivity of the program or mouse driver can result in smaller cursor moves for a given mouse move, making it easier for the user to position the cursor precisely. High sensitivity is good for exacting work, such as CAD/CAM and graphic art; low sensitivity is good for tasks in which getting around the screen quickly is important and for applications such as Web browsers, word processors, and spreadsheets, in which the cursor is used mostly to select buttons or text. *Also called:* mouse scaling, mouse tracking.

mouse tracking *n.* *See* mouse sensitivity.

mouse trails *n.* The creation of a shadowlike trail following the mouse pointer on screen in order to make it easier to see. Mouse trails are useful for laptops and notebooks, particularly ones with passive matrix displays or older models with monochrome screens. The relatively low resolution and contrast of these screens made it easy to lose sight of a small mouse pointer. *See also* mouse pointer, submarining.

mousetrapping *n.* A practice employed by some Web sites in which the back and exit buttons of a visitor’s Web browser are disabled and attempts to leave the site are redirected to other pages on the site or to other sites against the visitor’s will. Mousetrapping is most often associated with adult-oriented Web sites. *Compare* page-jacking.

.mov *n.* A filename extension for a movie file in Apple’s QuickTime format. *See also* QuickTime.

move *n.* A command or an instruction to transfer information from one location to another. Depending on the operation involved, a move can affect data in a computer’s memory or it can affect text or a graphical image in a data file. In programming, for example, a move instruction might transfer a single value from one memory location to another. In applications, on the other hand, a move command might relocate a paragraph of text or all or part of a graphic from one place in a document to another. Unlike a copy procedure, which duplicates information, a move indicates that information either is or can be deleted from its original location. *Compare* copy.

.movie *n.* *See* .mov.

Moving Picture Experts Group *n.* *See* MPEG (definition 1).

Mozilla *n.* **1.** A nickname for the Netscape Navigator (later, Netscape Communicator) Web browser, coined by the Netscape Corporation. *See also* Mosaic, Netscape Navigator. **2.** Since 1998, when the Communicator source code was released for free, for use by any interested parties, the name Mozilla has been extended as a generic reference to any Web browser based on Navigator source code.

mozilla.org *n.* The name of the group charged by the Netscape Corporation to act as a clearinghouse for Mozilla-related matters, such as questions, changes to code, bug reporting, forums, and so on.

MP3 *n.* Acronym for MPEG Audio Layer-3. A digital audio coding scheme used in distributing recorded music over the Internet. MP3 shrinks the size of an audio file by a factor of 10 to 12 without seriously degrading the quality (CD-recording level) of the sound. MP3 files are given the file extension .mp3. Although MP3 is part of the MPEG family, it is audio-only and is not the same as the now-defunct MPEG-3 standard. *See also* MPEG-3.

MP3 encoder *n.* *See* encoder.

M

MPC *n.* See Multimedia PC.

.mpeg *n.* The file extension that identifies video and sound files compressed in the MPEG format specified by the Moving Pictures Experts Group. *See also* MPEG.

MPEG *n.* **1.** Acronym for **M**oving **P**icture **E**xperts **G**roup. A set of standards for audio and video compression established by the Joint ISO/IEC Technical Committee on Information Technology. The MPEG standard has different types that have been designed to work in different situations. *Compare* Motion JPEG. **2.** A video/audio file in the MPEG format. Such files generally have the extension .mpg. *See also* JPEG. *Compare* Motion JPEG.

MPEG-1 *n.* The original MPEG standard for storing and retrieving video and audio information, designed for CD-ROM technology. MPEG-1 defines a medium bandwidth of up to 1.5 Mbps, two audio channels, and noninterlaced video. *See also* MPEG (definition 1). *Compare* MPEG-2, MPEG-3, MPEG-4.

MPEG-2 *n.* An extension of the MPEG-1 standard designed for broadcast television, including HDTV. MPEG-2 defines a higher bandwidth of up to 40 Mbps, five audio channels, a wider range of frame sizes, and interlaced video. *See also* HDTV, MPEG (definition 1). *Compare* MPEG-1, MPEG-3, MPEG-4.

MPEG-3 *n.* Initially an MPEG standard designed for HDTV (high-definition television), but it was found that MPEG-2 could be used instead. Therefore, this standard no longer exists. *See also* HDTV, MPEG (definition 1). *Compare* MP3, MPEG-1, MPEG-2, MPEG-4.

MPEG-4 *n.* A standard currently under development designed for videophones and multimedia applications. MPEG-4 provides a lower bandwidth of up to 64 Kbps. *See also* MPEG (definition 1). *Compare* MPEG-1, MPEG-2, MPEG-3.

.mpg *n.* *See* .mpeg.

MPI *n.* Acronym for **M**essage **P**assing **I**nterface. A specification for message passing on workstation clusters and massively parallel processing (MPP) architectures. MPI was designed as a proposed standard by the MPI Forum, a committee of vendors and users.

MPLS *n.* Acronym for **M**ultiprotocol **L**abel **S**witching. A standards-based technique used to manage and optimize traffic flow for large-scale networks. In an MPLS network, incoming packets are assigned a label by a label edge router (LER). Label switch routers (LSRs) use these labels

to forward the packets through the network along a label switch path (LSP). Each LSR removes the existing label and assigns a new one. MPLS combines the advantages of bridges (Layer 2 switching, which is used in ATM and frame relay) and routers (Layer 3 switching, which is used in IP). MPLS serves to create faster and more scalable networks to facilitate quality of service, class of service, and the use of VPNs.

MP/M *n.* Acronym for **M**ultitasking **P**rogram for **M**icrocomputers. A multitasking, multiuser version of the CP/M operating system. *See also* CP/M.

MPOA *n.* Acronym for **M**ulti-**P**rotocol **O**ver **A**TM. A specification established by the ATM Forum (an industry group of Asynchronous Transfer Mode users and vendors) to integrate ATM into existing Ethernet, token ring, and TCP/IP networks. *See also* ATM (definition 1).

MPP *n.* *See* massively parallel processing, massively parallel processor.

MPPP *n.* *See* Multilink Point-to-Point Protocol.

MPR II *n.* A standard for limiting magnetic and electric field emissions from video monitors, including VLF radiation. MPR II is a voluntary standard developed by the Swedish Board for Measurement and Testing in 1987 and updated in 1990. *See also* VLF radiation.

mput *n.* In many FTP clients, the command that instructs the local client to transmit multiple files to the remote server.

MR *n.* Acronym for **m**odem **r**eady. A light on the front panel of a modem indicating that the modem is ready.

MRP *n.* *See* Material Requirements Planning.

ms *n.* *See* millisecond.

MSAA *n.* Short for **M**icrosoft **A**ctive **A**ccessibility. *See* Active Accessibility.

MSAU *n.* *See* MAU.

MS Audion. *n.* The code name, or working name, of Windows Media Audio, before the technology was released by Microsoft. *See also* Windows Media Audio.

MSB *n.* *See* most significant bit.

MSC *n.* *See* most significant character.

MSD *n.* *See* most significant digit.

MSDN *n.* Acronym for the **M**icrosoft **D**eveloper **N**etwork. An online, print, and CD-DVD resource for developers



that features content and programs focused on development trends and Microsoft technologies. Some features of MSDN include technical articles and reference material; information on upcoming conferences and events; developer support through peer-to-peer interaction, information sharing, and direct interaction with Microsoft; and software subscription programs.

MS-DOS *n.* Short for **Microsoft Disk Operating System**. A single-tasking, single-user operating system with a command-line interface, released in 1981, for IBM PCs and compatibles. MS-DOS, like other operating systems, oversees operations such as disk input and output, video support, keyboard control, and many internal functions related to program execution and file maintenance.

MS-DOS mode *n.* A shell in which the MS-DOS environment is emulated in 32-bit systems such as Windows 95. *See also* MS-DOS, shell¹.

MS-DOS shell *n.* A shell environment based on a command-line prompt that allows a user to interact with MS-DOS or an MS-DOS-emulating operating system.

MSDOS.SYS *n.* One of two hidden system files installed on an MS-DOS startup disk. MSDOS.SYS, called IBM-DOS.SYS in IBM releases of MS-DOS, contains the software that makes up the heart (kernel) of the operating system. *See also* IO.SYS.

msec *n.* *See* millisecond.

MSI *n.* *See* medium-scale integration.

MSIL *n.* *See* Microsoft intermediate language.

MSN *n.* Acronym for **Microsoft Network**. An online service and Internet portal, launched with the introduction of Windows 95 in August 1995.

MSN Explorer *n.* Microsoft software that integrates the functionality of Internet Explorer, Windows Media Player, Hotmail, MSN Messenger, MSN Communities, Music Central, and other MSN content and services. *See also* MSN.

MSN Messenger Service *n.* *See* .NET Messenger Service.

MSP *n.* *See* Message Security Protocol, managed service provider.

MS-Windows *n.* *See* Windows.

MSXML *n.* Acronym for **Microsoft XML**. A Java-based XML parser from Microsoft that provides support for World Wide Web Consortium (W3C) standards for XML documents and applications.

MTA *n.* Acronym for **message transfer agent**. An application process, as described in the X.400 message-handling system, responsible for delivering e-mail messages. After receiving a message, an MTA stores it temporarily and either delivers it or forwards it to another MTA. During this process, the MTA can change the message headers. *See also* X series.

MTBF *n.* Acronym for **mean time between failures**. The average time interval, usually expressed in thousands or tens of thousands of hours (sometimes called *power-on hours* or *POH*), that will elapse before a hardware component fails and requires service.

MTTR *n.* Acronym for **mean time to repair**. The average time interval, usually expressed in hours, that it takes to repair a failed component.

MTU *n.* Acronym for **Maximum Transmission Unit**. The largest packet of data that can be transmitted on a network. MTU size varies, depending on the network—576 bytes on X.25 networks, for example, 1500 bytes on Ethernet, and 17,914 bytes on 16 Mbps Token Ring. Responsibility for determining the size of the MTU lies with the link layer of the network. When packets are transmitted across networks, the path MTU, or PMTU, represents the smallest packet size (the one that all networks can transmit without breaking up the packet) among the networks involved.

MUD *n.* Acronym for **multiuser dungeon**. A virtual environment on the Internet in which multiple users simultaneously participate in a role-playing game—generally a medieval fantasy, hence the “dungeon”—and interact with each other in real time. *Also called:* multiuser simulation environment.

MUD, object-oriented *n.* *See* MOO.

multiband phone *n.* Wireless phone that operates on two or more broadcast frequencies.

multiboot *n.* **1.** Startup capability of some operating systems, such as Windows NT, OS/2, UNIX, and some Power Macs, that allows users to choose which of two or more installed operating systems—for example, Windows NT or UNIX—they want to use for the current session. *See also* boot. **2.** A computer configuration that runs two or more operating systems. *See also* dual boot, startup.

Multibus *n.* A computer expansion bus designed by Intel Corporation that is used extensively by designers of high-performance workstations. A high-bandwidth bus



(capable of extremely fast data transmission), Multibus also allows multiple bus masters. *See also* bus.

multicast address dynamic client allocation

protocol *n.* An extension to the DHCP protocol standard used to support dynamic assignment and configuration of IP multicast addresses on TCP/IP-based networks. *Acronym:* MADCAP.

multicast backbone *n.* *See* MBONE.

multicasting *n.* The process of sending a message simultaneously to more than one destination on a network. *Compare* anycasting.

multichannel multipoint distribution service *n.* *See* MMDS.

Multi-Color Graphics Array *n.* *See* MCGA.

multi-element *adj.* Consisting of multiple data elements that all have the same format for storing the same kind of information. The data elements may be simple variables, as in an array of integer variables, or they may be more complicated data structures, as in an array of employee records each of which contains fields for an employee's name, Social Security number, pay rate, and so on.

multifile sorting *n.* The process of sorting a body of data that resides in more than one file.

MultiFinder *n.* A version of the Macintosh Finder that provides support for multitasking. The primary use of MultiFinder is to allow multiple applications to be simultaneously resident in memory. A single mouse click switches between applications, and information from one application can be copied to another. If the active application allows true multitasking, background tasks can be processed. *See also* Finder.

multifunction board *n.* A computer add-in board that provides more than one function. Multifunction boards for personal computers frequently offer additional memory, serial/parallel ports, and a clock/calendar.

multifunction peripheral *n.* A multipurpose device that combines printing with faxing, scanning (color or black and white), and copying (color or black and white) in a single unit. Multifunction peripherals are especially popular with the SOHO (small office, home office) market, where cost-effectiveness and space limitations can be significant considerations. *Acronym:* MFP. *Also called:* multifunction printer.

multifunction printer *n.* *See* multifunction peripheral.

multihoming *n.* **1.** In Mac OS X, an automatic network selection feature that allows one computer to maintain multiple network addresses. Multihoming may be used with a computer that is used from multiple locations, such as home and office, or to create special connection settings, such as separate systems for communication inside and outside of an intranet. **2.** The use of multiple addresses and/or multiple interfaces for a single node. A multihomed host has either multiple network interfaces connected to two or more networks, or a single network interface that has been assigned multiple IP addresses. Multihoming can be used to provide redundancy to achieve quality of service.

multilayer *adj.* **1.** In board design, of or pertaining to a printed circuit board consisting of two or more layers of board material. Each separate layer has its own metallic tracings to provide electrical connections between various electronic components and to provide connections to the other layers. The layers are laminated together to produce a single circuit board to which the components, such as integrated circuits, resistors, and capacitors, are attached. Multilayer design allows many more discrete paths between components than single-layer boards do. **2.** In computer-aided design (CAD), of or pertaining to drawings, such as electronic circuits, that are built up using multiple layers, each with a different level of detail or a different object, so that distinct parts of the drawing can easily be manipulated, overlaid, or peeled off.

multilayer switch *n.* A network switch that uses information from more than one ISO/OSI layer (Layer 2, Layer 3, Layer 4, and/or Layer 7) to forward traffic. *See also* ISO/OSI reference model, switch (definition 4).

Multilink Point-to-Point Protocol *n.* An Internet protocol that allows computers to establish multiple physical links to combine their bandwidths. This technology creates a virtual link with more capacity than a single physical link. *Acronym:* MPPP. *See also* PPP.

multimedia *n.* The combination of sound, graphics, animation, and video. In the world of computers, multimedia is a subset of hypermedia, which combines the aforementioned elements with hypertext. *See also* hypermedia, hypertext.

Multimedia Extensions *n.* *See* MMX.

Multimedia PC *n.* Software and hardware standards set forth by the Multimedia PC Marketing Council, which

M

sets minimum standards for a PC's sound, video, and CD-ROM playing capabilities. *Acronym:* MPC.

Multimedia Personal Computer *n.* See Multimedia PC.

multimode phone *n.* Wireless phone that operates on both analog and digital networks. A multimode phone may be dual-mode (analog and one digital network) or tri-mode (analog and two digital networks).

multinode computer *n.* A computer that uses multiple processors to share in the computation of a complex task. See also central processing unit, parallel processing.

multipart forms *n.* Computer printer paper arranged in sets with carbon paper between the sheets (or with a chemical coating that emulates carbon on the back of each sheet except the last) to produce copies of output from impact printers. Multipart forms are designated by the number of copies in a set, such as two-part, three-part, and so on.

multipartite virus *n.* A type of virus that combines characteristics and techniques of both boot sector and file viruses. Multipartite viruses first infect either system sectors or files and then spread quickly to infect the entire system. Because of their multiple capabilities, multipartite viruses are difficult to remove from an infected system. Also called: bimodal virus, bipartite virus. See also boot.

multipass sort *n.* A sorting operation that, usually because of the sorting algorithm being used, requires two or more passes through the data before completion. See also bubble sort, insertion sort, Shell sort, sort algorithm.

multiple-document interface *n.* See MDI.

multiple inheritance *n.* A feature of some object-oriented programming languages that allows a new class to be derived from several existing classes. Multiple inheritance both extends and combines existing types. *Acronym:* MI. See also class, inherit, type.

multiple instruction, multiple data streams *n.* See MIMD.

multiple master font *n.* An advanced font creation and management classification developed by Adobe. A multiple master font contains two or more sets of font outlines or master designs that determine the dynamic range of each design axis in a typeface. Multiple master fonts include one or more design axes—weight, width, style, and optical size—that allow the user to create thousands of variations on a single typeface.

multiple-pass printing *n.* A form of dot-matrix printing in which the print head makes more than one pass across the page for each printed line, printing each line a second time exactly on top of the first pass. Multiple-pass printing can be used with dot-matrix printers to darken the print and smooth out errors in alignment. On better printers, a second pass might occur after the paper is moved up slightly, so that the dots in the characters overlap to create a crisper, darker image.

multiple recipients *n.* **1.** The capability of sending e-mail to more than one user at a time by listing more than one e-mail address on a line. Delimiters such as commas or semicolons are used to separate the e-mail addresses. See also e-mail¹ (definition 1), mailing list. **2.** The subscribers on a mailing list. A message sent to the list is addressed to the “multiple recipients of” the list.

multiple regression *n.* A statistical technique that seeks to describe the behavior of a so-called “dependent” variable in terms of the observed behavior of numerous other, “independent” variables thought to affect it. For each independent variable, a regression analysis can determine the correlation coefficient of the independent variable—that is, the degree to which variations in the independent variable cause changes in the dependent variable. See also dependent variable.

multiple-user system *n.* See multiuser system.

multiplexer *n.* A device for funneling several different streams of data over a common communications line. Multiplexers are used either to attach many communications lines to a smaller number of communications ports or to attach a large number of communications ports to a smaller number of communications lines. *Acronym:* MUX.

multiplexer channel *n.* One of the inputs to a multiplexer. See also multiplexer.

multiplexing *n.* A technique used in communications and input/output operations for transmitting a number of separate signals simultaneously over a single channel or line. To maintain the integrity of each signal on the channel, multiplexing can separate the signals by time, space, or frequency. The device used to combine the signals is a *multiplexer*. See also FDM, space-division multiplexing, time-division multiplexing.

multiplicand *n.* In arithmetic, the number that is multiplied by another number (the multiplier). In mathematics, the multiplicand and the multiplier are interchangeable, depending on how the problem is stated, because the result



is the same if the two are reversed—for example, 2×3 and 3×2 . In arithmetic performed by computers, however, the multiplicand is different from the multiplier because computer multiplication is usually performed as addition. Therefore, 2×3 means “add 2 three times,” whereas 3×2 means “add 3 two times.” *See also* factor. *Compare* multiplier (definition 1).

multiplier *n.* 1. In arithmetic, the number that indicates how many times another number (the multiplicand) is multiplied. *See also* factor. *Compare* multiplicand. 2. In computing, an electronic device independent of the central processing unit (CPU) that performs multiplication by adding the multiplicand according to the value of the digits in the multiplier.

multiport configuration *n.* A communications link in which multiple stations are connected sequentially to the same communications line. Typically, the communications line is controlled by a primary station, such as a computer, and the stations attached to the line are secondary. *See* the illustration.

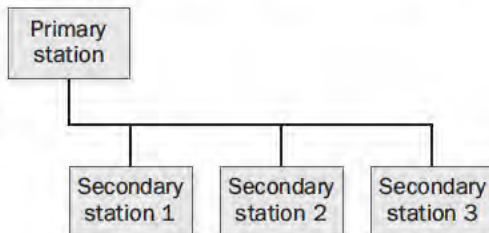

Multiport configuration.

multiport repeater *n.* *See* active hub.

multiprocessing *n.* A mode of operation in which two or more connected and roughly equal processing units each carry out one or more processes (programs or sets of instructions) in tandem. In multiprocessing, each processing unit works on a different set of instructions or on different parts of the same process. The objective is increased speed or computing power, the same as in parallel processing and in the use of special units called *coprocessors*. *Compare* coprocessor, parallel processing.

multiprogramming *n.* A form of processing in which a computer holds more than one program in memory and works on them in round-robin fashion—that is, by sharing out the processor’s time so that each program receives some

attention some of the time. This way of working is in contrast to using the processor to run one program at a time.

Multiprotocol Label Switching *n.* *See* MPLS.

Multi-Protocol Over ATM *n.* *See* MPOA.

Multipurpose Internet Mail Extensions *n.* *See* MIME.

Multipurpose Internet Mail Extensions HTML *n.* *See* MHTML.

multiscan monitor *n.* A computer monitor capable of adapting to different video frequencies to accommodate multiple screen resolutions and to support different video adapters and graphics display methods.

Multistation Access Unit *n.* *See* MAU.

multisystem network *n.* A communications network in which two or more host computers can be accessed by network users.

multitasking *n.* A form of processing supported by most current operating systems in which a computer works on multiple tasks—roughly, separate “pieces” of work—seemingly at the same time by parceling out the processor’s time among the different tasks. Multitasking can be either cooperative or preemptive. In the former, the operating system relies on the task to voluntarily cede control to another task; in the latter, the operating system decides which task receives priority. *See also* background¹, context switching, cooperative multitasking, foreground¹, time slice.

multithreaded application *n.* A program capable of running more than one program thread simultaneously. *See also* multithreading (definition 1), thread (definition 1).

multithreading *n.* 1. The running of several processes in rapid sequence (multitasking) within a single program. *See also* thread (definition 1). 2. In data manipulation, a technique in which nodes in a tree data structure contain pointers to higher nodes to make traversal of the structure more efficient. *See also* thread (definition 2).

multi-tier *n.* *See* three-tier.

multiuser *n.* *See* multiuser system.

multiuser dungeon *n.* *See* MUD.

multiuser simulation environment *n.* *See* MUD.

multiuser system *n.* Any computer system that can be used by more than one person. Although a microcomputer

shared by several people can be considered a multiuser system, the term is generally reserved for machines that can be accessed simultaneously by several people through communications facilities or via network terminals. *Compare* single-user computer.

multum in parvo mapping *n.* See MIP mapping.

MUMPS *n.* Acronym for **M**assachusetts **U**tility **M**ulti **P**rogramming **S**ystem. An advanced, high-level programming language and integrated database developed in 1966 at Massachusetts General Hospital and used widely by health care businesses. A unique feature of MUMPS is its ability to store both data and program fragments in its database.

munging *n.* See address munging.

MUSE *n.* Short for **m**ultiuser simulation **e**nvironment. See MUD.

.museum *n.* One of seven new top-level domain names approved in 2000 by the Internet Corporation for Assigned Names and Numbers (ICANN), .museum is meant for use by museum Web sites.

Musical Instrument Digital Interface *n.* See MIDI.

mutual exclusion *n.* A programming technique that ensures that only one program or routine at a time can

access some resource, such as a memory location, an I/O port, or a file, often through the use of semaphores, which are flags used in programs to coordinate the activities of more than one program or routine. *See also* semaphore.

MUX *n.* See multiplexer.

My Briefcase *n.* A Windows 9x utility, helpful for workers away from the office, that manages the updating of modified files once the remote user's computer is connected back on the office network.

Mylar *n.* A polyester film product created by DuPont, often used as the base for magnetically coated storage media (disks and tape) and for carbon ribbons used with impact printers.

Mylar ribbon *n.* See carbon ribbon.

MYOB *n.* Acronym for **M**ind your **o**wn **b**usiness. An expression used in e-mail and newsgroups.

my two cents *n.* An expression used informally in newsgroup articles and, less frequently, e-mail messages or mailing lists, to indicate that the message is the writer's contribution to an ongoing discussion. *Also called:* \$0.02. *See also* mailing list, newsgroup.

M

N

n prefix *n.* See nano-.

NACN *n.* See North American Cellular Network.

nagware *n.* Slang for computer shareware that, on starting or before closing, displays a prominent reminder to pay for the program. *See also* shareware.

NAK *n.* Acronym for **negative acknowledgement**. A control code, ASCII character 21 (hexadecimal 15), transmitted to a sending station or computer by the receiving unit as a signal that transmitted information has arrived incorrectly. *Compare* ACK.

NAK attack *n.* Acronym for **negative acknowledgement attack**. A hacker attack that uses the negative acknowledgement control code character to enter a seemingly secure system. A NAK attack uses weaknesses in the system handling NAK replies that may leave it temporarily unprotected. *See also* NAK.

naked PC *n.* A personal computer sold without an operating system (OS) installed. The purchaser of a naked PC must then choose and install an OS before the computer can be used. Naked PCs are chiefly purchased by users with some degree of expertise with computer equipment who may want to install a version of Linux or an offshoot OS. Computer and software manufacturers have expressed concern over the possibility of software piracy with the sale of naked PCs.

.name *n.* One of seven new top-level domain names approved in 2000 by the Internet Corporation for Assigned Names and Numbers (ICANN), .name is meant for registration by individuals for personal Web sites. The seven new domain names became available for use in the spring of 2001.

Name Binding Protocol *n.* *See* NBP.

named anchor *n.* In HTML, a tag within a document that can act as a destination for a hyperlink. Named anchors are useful because they allow a link to a specific location within a document. *Also called:* named target. *See also* anchor (definition 2), HTML, hyperlink.

named entity *n.* *See* character entity.

named pipes *n.* In programming, one-way (simplex) or two-way (duplex) connections used to transfer data between processes. Named pipes are portions of memory set aside for temporary data storage. They are created by server processes and can be used simultaneously by more than one client process, each accessing a separate instance with its own buffers and handles. Named pipes can be used to transfer data either locally or on a network.

named target *n.* *See* named anchor.

name server *n.* *See* CSO name server, DNS server.

namespace *n.* **1.** A grouping of one or more names that represent individual objects within the group in a shared computing environment, such as a network. The names within a namespace are unique, are created according to the same rules, and can be resolved into a particular identifying item of information, such as an IP address or a network device. A namespace can be either flat—a single collection of unique names—or hierarchical, as is the Internet's DNS (Domain Name System), which is based on a treelike structure that is refined through successive levels beginning with the root server and the Internet's top-level domains (.com, .net, .org, and so on). In everyday terms, a namespace is comparable to a telephone book, in which each name is unique and resolves to the phone number and address of a particular individual, business, or other entity. **2.** A means of identifying elements and attributes in an XML document by assigning them a two-part name with the first part being the namespace and the second part being the functional name. A namespace identifies a set of names to prevent confusion when multiple objects with identical functional names are taken from different sources and brought together in the same XML document. Namespaces typically reference a Uniform Resource Identifier (URI) because each URI will be unique.

name-value pair *n.* **1.** In the Perl programming language, a data set in which the data is associated with a name. *See also* Perl. **2.** In CGI programming, one of the data items collected from an HTML form by the browser and passed

through the server to a CGI script for processing. *See also* CGI, CGI script, HTML.

naming container *n.* Any ASP.NET control that implements the INamingContainer interface. This is a marker interface that enables a control to create a new naming scope under itself so that ID attributes assigned to its child controls are unique within the entire ASP.NET page that contains the control.

NAMPS *n.* Acronym for **N**arrow-band **A**nalog **M**obile **P**hone **S**ervice. A standard proposed by Motorola Corporation that combines the current AMPS cellular telephone standard with digital signaling information, resulting in higher performance and increased capabilities. *See also* AMPS.

NAND *n.* Short for **NOT AND**. A logical operation that combines the values of two bits (0,1) or two Boolean values (false, true) that returns a value of 1 (or true) if one input value is 0 (or false), and returns a 0 (false) only if both inputs are true.

NAND gate *n.* Short for **NOT AND gate**. A digital circuit whose output is true (1) if any input is false (0). A NAND gate is an AND circuit (output with the value of 1 when all input values are 1) followed by a NOT circuit (output that is the logical complement of the input). Thus, NAND gate output is high if any of its inputs are low. *See also* AND gate, gate (definition 1), NOT gate.

nano- *prefix* Abbreviated *n.* Metric prefix meaning 10^{-9} (one billionth).

nanosecond *n.* One billionth of a second. A nanosecond is a time measure used to represent computing speed, particularly the speed at which electrical signals travel through circuits within the computer. *Acronym:* ns.

NAP *n.* *See* **N**etwork **A**ccess **P**oint.

Napster *n.* An Internet music search application that allows users to search for and swap MP3 files over the Web. In response to a user request for a song or an artist, Napster searches the hard drives of all other Napster users on line. When the requested item is found, the file is downloaded to the computer making the request. Napster also includes a chat room and a library of most popular items. The introduction of Napster in 1999 sparked heated debate over copyright and digital distribution issues. *See also* MP3.

narrowband *n.* A bandwidth set aside by the FCC for mobile or portable radio services, such as advanced two-way paging systems, including transmission rates between 50 bps and 64 Kbps. Narrowband formerly referred to the bandwidth from 50 to 150 bps. *See also* bandwidth, FCC. *Compare* broadband.

narrowband ISDN *n.* Name used to distinguish current ISDN lines from the developing broadband ISDN technology. *See also* broadband ISDN, ISDN.

narrowcast *vb.* To transmit data or programming to a defined or limited area or audience. A cable television company narrowcasts its programs only to subscribers, whereas network television stations *broadcast* to everyone with reception equipment in their transmission range. On the Web, content delivered to users via push technology represents a form of narrowcasting. *See also* unicast. *Compare* broadcast (definition 2), multicasting.

Narrow SCSI *n.* A SCSI or SCSI-2 interface that can transfer data only 8 bits at a time. *See also* SCSI, SCSI-2. *Compare* Fast/Wide SCSI, Wide SCSI.

NAS *n.* Acronym for **N**etwork-**A**ttached **S**torage. A platform-independent storage appliance connected to a network. NAS uses a storage unit with a built-in server that can communicate with clients over a network. NAS devices are popular for ease of maintenance, manageability, and scalability. *Compare* SAN.

NAT *n.* Acronym for **N**etwork **A**ddress **T**ranslation. The process of converting between IP addresses used within an intranet or other private network and Internet IP addresses. This approach makes it possible to use a large number of addresses within the private network without depleting the limited number of available numeric Internet IP addresses. Variations of NAT displaying similar functions include IP aliasing, IP masquerading, and Port Address Translation.

national attachment point *n.* *See* Network Access Point.

National Center for Supercomputing Applications *n.* *See* NCSA (definition 1).

National Committee for Information Technology Standards *n.* A committee formed by the Information Technology Industry Council to develop national standards for use in the information technology industry and to promote those standards for international use. *Acronym:* NCITS.

National Computer Security Association *n.* *See* ICSA.



National Information Infrastructure *n.* A U.S. government program to extend and oversee the development of the Information Superhighway. The National Information Infrastructure is made up of a high-bandwidth, wide area network that can carry data, fax, video, and voice transmissions to users throughout the United States. The network is being developed mostly by private carriers. Many of the services, which are aimed at enabling the efficient creation and dissemination of information, are already available on the Internet itself, including increased accessibility to quality education through distance learning and increased access to government services. *Acronym:* NII. *See also* Information Superhighway, Internet2, Next Generation Internet. *Compare* Internet.

National Institute of Standards and Technology *n.* A branch of the U.S. Commerce Department that works to develop and encourage standards for measurement, science, and technology in order to promote commerce and improve productivity in the marketplace. Prior to 1988, the National Institute of Standards and Technology was known as the National Bureau of Standards. *Acronym:* NIST.

national language support *n.* **1.** The practice of creating programs that can display text in any language necessary. **2.** A function in Windows that enables you to specify system and user locale information. *Acronym:* NLS.

National Science Foundation *n.* A U.S. government agency intended to promote scientific research by funding both research projects and projects that facilitate scientific communication, such as NSFnet, the former backbone of the Internet. *Acronym:* NSF. *See also* backbone (definition 1), NSFnet.

National Television System Committee *n.* *See* NTSC.

native *adj.* Of, pertaining to, or characteristic of something that is in its original form. For example, many applications are able to work with files in a number of formats; the format the application uses internally is its native file format. Files in other formats must be converted to the application's native format before they can be processed by the application.

native application *n.* A program that is designed specifically for a particular type of microprocessor, that is, a program that is binary compatible with a processor. A native application generally will run much faster than a nonnative application, which must be run with the help of an emulator program. *See also* binary compatibility, emulator.

native code *n.* Code that has been compiled to processor-specific machine code.

native compiler *n.* A compiler that produces machine code for the computer on which it is running, as opposed to a cross-compiler, which produces code for another type of computer. Most compilers are native compilers. *See also* compiler (definition 2), cross-compiler.

native file format *n.* The format an application uses internally to process data. The application must convert files in other formats to the native format before it can work with them. For example, a word processor might recognize text files in ASCII text format, but it will convert them to its own native format before it displays them.

native language *n.* *See* host language.

natural language *n.* A language spoken or written by humans, as opposed to a programming language or a machine language. Understanding natural language and approximating it in a computer environment is one goal of research in artificial intelligence.

natural-language processing *n.* A field of computer science and linguistics that studies computer systems that can recognize and react to human language, either spoken or written. *See also* artificial intelligence. *Compare* speech recognition.

natural language query *n.* A query to a database system that is composed in a subset of a natural language, such as English or Japanese. The query must conform to some restrictive syntax rules so that the system can parse it. *See also* parse, syntax.

natural-language recognition *n.* *See* speech recognition.

natural language support *n.* A voice recognition system that allows the user to use verbal commands in his or her own language to direct a computer's actions. *Acronym:* NLS.

natural number *n.* An integer, or whole number, that is equal to or greater than zero. *See also* integer.

navigation bar *n.* On a Web page, a grouping of hyperlinks for getting around in that particular Web site. *See also* hyperlink.

navigation keys *n.* The keys on a keyboard controlling cursor movement, including the four arrow keys and the Backspace, End, Home, Page Down, and Page Up keys. *See also* arrow key, Backspace key, End key, Home key, Page Down key, Page Up key.

N

Navigator *n.* See Netscape Navigator.

NBP *n.* Acronym for Name **B**inding **P**rotocol. A protocol used on AppleTalk local area networks to translate between node names (known to users) and numeric AppleTalk addresses. NBP operates at the transport level (level 4 of the ISO/OSI reference model). See also AppleTalk, communications protocol, ISO/OSI reference model.

NC *n.* See network computer.

NCC *n.* See network-centric computing.

N-channel MOS *n.* See NMOS.

NCITS *n.* See National Committee for Information Technology Standards.

NCP *n.* See Point-to-Point Protocol.

NCR paper *n.* Short for **no carbon required paper**. A special paper used for multipart forms. NCR paper is impregnated with a chemical that darkens it when pressure is applied. See also multipart forms.

NCSA *n.* **1.** Acronym for **N**ational **C**enter for **S**upercomputing **A**pplications. A research center located at the University of Illinois at Urbana-Champaign. NCSA was founded in 1985 as a part of the National Science Foundation, specializing in scientific visualization tasks, but is best known as the home of NCSA Mosaic, the first graphical Web browser, and of NCSA Telnet. See also Mosaic, NCSA Telnet. **2.** See ICSA.

NCSA Mosaic *n.* See Mosaic.

NCSA server *n.* The HTTP server developed by the National Center for Supercomputing Applications of the University of Illinois. This server and the CERN server were the first HTTP servers developed for the World Wide Web and are available free through downloading. See also HTTP server (definition 1), NCSA (definition 1). Compare CERN server.

NCSA Telnet *n.* A freeware telnet client program developed and distributed by the National Center for Supercomputing Applications. See also client (definition 2), NCSA (definition 1).

NDIS *n.* Acronym for **N**etwork **D**river **I**nterface **S**pecification, a software interface, or set of rules, designed to enable different network protocols to communicate with a variety of network adapters. Providing a standard—a common “language”—for the drivers used by network adapters, NDIS enables a single network adapter to support multiple protocols and, conversely, also enables a single

protocol to work with network adapters from different vendors. See also device driver.

NDMP *n.* Acronym for **N**etwork **D**ata **M**anagement **P**rotocol. An open protocol for network-based backups of file servers that allows platform-independent data storage. See also backup, communications protocol, file server.

NDR *n.* See nondestructive readout.

NDRO *n.* See nondestructive readout.

NDS *n.* Acronym for **N**ovell **D**irectory **S**ervices. A feature introduced in Novell Netware 4.0 that provides access to directories that may be located on one or more servers.

near-letter-quality *adj.* A print mode on high-end dot-matrix printers that produces clearer, darker characters than normal (draft-quality) printing. Near-letter-quality printing, although it is sharper than plain dot-matrix printing, is not as legible as output from a fully-formed-character printer, such as a daisy-wheel printer. Acronym: NLQ. See also print quality. Compare draft quality, letter quality.

negation *n.* The conversion of a two-state (binary) signal or bit pattern to its opposite state—for example, the conversion of 1001 to 0110.

negative acknowledgement *n.* See NAK.

negative entry *n.* The act of assigning a negative sign to a number that has been entered into a calculator, thereby transforming the number to a negative number.

nest *vb.* To embed one construct inside another. For example, a database may contain a nested table (a table within a table), a program may contain a nested procedure (a procedure declared within a procedure), and a data structure may include a nested record (a record containing a field that is itself a record).

nested transaction *n.* In programming, an operation or sequence of operations taking place within a larger transaction. A nested transaction can be aborted without requiring abortion of the larger transaction. Also called: subtransaction. See also nest.

.net *n.* In the Internet's Domain Name System, the top-level domain that identifies addresses of network providers. The designation .net appears at the end of the address. See also DNS (definition 1), domain (definition 3). Compare .com, .edu, .gov, .mil, .org.

net.- prefix A prefix used to describe people and institutions on the Internet. For example, a very well respected person might be described as a net.god.



Net *n.* **1.** Short for Internet. **2.** Short for Usenet.

.NET *n.* The set of Microsoft technologies that provides tools for connecting information, people, systems, and devices. The technologies provide individuals and organizations with the ability to build, host, deploy, and use XML Web service connected solutions.

net address *n.* **1.** A World Wide Web address (URL). *See also* URL. **2.** An e-mail address. **3.** The DNS name or IP address of a machine. *See also* DNS (definition 1), IP address. **4.** The address, burned into a network adapter, that is used to uniquely identify a node on a network. *See also* network interface card.

NetBEUI *n.* Short for **NetBIOS Extended User Interface**. NetBEUI is a network protocol created by IBM and now used by Microsoft, HP, and Compaq. It is usually used in small, department-size local area networks (LANs) of 1 to 200 clients. It can use Token Ring source routing as its only method of routing. It is the extended version of the NetBIOS standard. *See also* CCP, communications protocol, LAN, NetBIOS.

NetBIOS *n.* An application programming interface (API) that can be used by application programs on a local area network consisting of IBM and compatible microcomputers running MS-DOS, OS/2, or some version of UNIX. Primarily of interest to programmers, NetBIOS provides application programs with a uniform set of commands for requesting the lower-level network services required to conduct sessions between nodes on a network and to transmit information back and forth. *See also* application programming interface.

NetBIOS Extended User Interface *n.* *See* NetBEUI.

net boot *n.* *See* PXE boot.

NetBSD *n.* A free version of the BSD UNIX operating system developed as a result of a volunteer effort. NetBSD is highly interoperable, runs on many hardware platforms, and is nearly POSIX compliant. *See also* BSD UNIX, POSIX.

Netcaster *n.* *See* netcasting (definition 2).

netcasting *n.* **1.** Synonym for webcasting. **2.** A Netscape technology used in Netscape Netcaster that enabled a user to subscribe to channels that pushed Web content to the user's desktop without actively retrieving the information. Netscape Netcaster, which was part of previous versions of Netscape Navigator, competed with Microsoft Active Desktop. Unlike Active Desktop, which uses Microsoft's

Channel Definition Format (CDF), the Netcaster push client was based on existing open standards (HTML, Java, and JavaScript). *See also* push (definition 2). *Compare* Active Desktop.

.NET Compact Framework *n.* A hardware-independent environment for running programs on resource-constrained computing devices. It inherits the full .NET Framework architecture of the common language runtime, supports a subset of the .NET Framework class library, and contains classes designed exclusively for the .NET Compact Framework. Supported devices include personal data assistants (PDAs) (such as the Pocket PC), mobile phones, set-top boxes, automotive computing devices, and custom-designed embedded devices built with the Microsoft Windows CE operating system.

.NET data provider *n.* A component of ADO.NET that provides access to data from a relational database.

netfilter *n.* The packet-filtering system for Linux introduced in the 2.4 kernel. Netfilter is the first stateful firewall implemented in Linux. *See also* firewall, iptables. *Compare* IP Filter.

NetFind *n.* *See* AOL NetFind.

.NET Framework *n.* A platform for building, deploying, and running XML Web services and applications. It provides a highly productive, standards-based, multilanguage environment for integrating existing investments with next generation applications and services, as well as the agility to solve the challenges of deployment and operation of Internet-scale applications. The .NET Framework consists of three main parts: the common language runtime, a hierarchical set of unified class libraries, and a componentized version of ASP called ASP.NET. *See also* ASP.NET, common language runtime, .NET Framework class library.

.NET Framework class library *n.* A Common Language Specification (CLS)-compliant library of classes, interfaces, and value types that are included in the Microsoft .NET Framework SDK. This library provides access to system functionality and is designed to be the foundation on which .NET Framework applications, components, and controls are built.

.NET Framework data provider *n.* A component of ADO.NET that provides access to data from a relational data source. A .NET Framework data provider contains classes to connect to a data source, execute commands at the data source, and return query results from the data

source, including the ability to execute commands within transactions. A .NET Framework data provider also contains classes to populate a DataSet with results from a data source and propagate changes in a DataSet back to the data source.

net.god *n.* A highly respected person within the Internet community.

nethead *n.* **1.** A person who uses the Internet as if addicted to it. **2.** A Grateful Dead fan who participates in the rec.music.gdead newsgroup or some other forum dedicated to that band.

netiquette *n.* Short for **network etiquette**. Principles of courtesy observed in sending electronic messages, such as e-mail and Usenet postings. The consequences of violating netiquette include being flamed and having one's name placed in the bozo filter of one's intended audience. Disapproved behavior includes gratuitous personal insults; posting of large amounts of irrelevant material; giving away the plot of a movie, television show, or novel without warning; posting offensive material without encrypting it; and excessive cross-posting of a message to multiple groups without regard to whether the group members are likely to find it interesting. *See also* bozo filter, flame².

netizen *n.* A person who participates in online communication through the Internet and other networks, especially conference and chat services, such as Internet news or Fidonet. *Compare* lurker.

NetMeeting *n.* A software application developed by Microsoft Corporation to allow video conferencing among parties using personal computers connected via the Internet. NetMeeting allows participants in different locations to view each other, engage in text chat conversations, send and receive videos, exchange information graphically via an electronic whiteboard, share Windows-based applications, and transfer files.

.NET Messenger Service *n.* A popular instant-messaging service provided by Microsoft as part of the .NET strategy. With .NET Messenger Service, formerly called MSN Messenger Service, users can communicate using the Windows Messenger, included in Windows XP, or MSN Messenger applications. *See also* instant messaging. *Compare* AIM, ICQ, Yahoo! Messenger.

.NET My Services *n.* A suite of XML Web services for managing and protecting personal information and interactions across applications, devices, and services. Formerly

code-named HailStorm, .NET My Services is based on the Microsoft .NET Passport user-authentication system. The suite of .NET My Services includes services such as .NET ApplicationSettings, .NET Calendar, .NET Contacts, .NET Devices, .NET Documents, .NET Inbox, .NET Locations, .NET Profile, and .NET Wallet. *See also* .NET, Passport.

NetPC *n.* Short for **Network PC**. An industry-defined, Windows-based PC system that is small and meant to act as simply an access point. These PCs generally have very small hard drives, no disk drives, and are built to have a very low cost. Some older NetPCs can boot through remote access to a server and user server-based resources for most computing actions.

net.personality *n.* A slang term for a person who has attained some degree of celebrity on the Internet.

net.police *n.* Persons (usually self-appointed) who try to enforce their understanding of the "rules" that apply to conduct on the Internet. Their activities may be directed toward users who violate the rules of netiquette, spammers who send unsolicited advertising as e-mail or to newsgroups, or even people who post "politically incorrect" comments to newsgroups or mailing lists. *See also* netiquette, spam.

Netscape Navigator *n.* The widely used family of Web browser programs, made by Netscape Corporation. Versions of Netscape Navigator are available for the Windows and Macintosh platforms, and for many varieties of UNIX. Netscape Navigator, which is based on NCSA's Mosaic Web browser, was one of the first commercially available Web browsers. In 1999, Netscape Corporation was purchased by America Online. *See also* Mosaic, Web browser.

Netscape Netcaster *n.* *See* netcasting (definition 2).

Netscape Server Application Programming Interface *n.* *See* NSAPI.

Netspeak *n.* The set of conventions for writing English in e-mail, IRCs, and newsgroups. Netspeak is characterized by acronyms (such as IMHO or ROFL) and clarifying devices such as emotags and emoticons. Use of Netspeak should be governed by netiquette. *See also* emotag, emoticon, IMHO, IRC, netiquette, ROFL.

netspionage *n.* Corporate-sponsored hacking of a competitor's digital information for the theft of trade secrets.



Net surfing *n.* The practice of exploring the Internet without a specific goal in mind. The concept of Net surfing is similar to (and probably derived from) “channel surfing” in reference to watching television.

Net TV *n.* See Internet television.

NetWare *n.* A family of LAN (local area network) operating system products developed by Novell, Inc. Designed to run on PCs and Macintoshes, Novell NetWare allows users to share files and system resources such as hard disks and printers. See also network operating system.

network *n.* A group of computers and associated devices that are connected by communications facilities. A network can involve permanent connections, such as cables, or temporary connections made through telephone or other communication links. A network can be as small as a LAN (local area network) consisting of a few computers, printers, and other devices, or it can consist of many small and large computers distributed over a vast geographic area (WAN, or wide area network). See also ALOHAnet, Ethernet (definition 1), LAN, WAN.

Network Access Point *n.* One of the interchange points for Internet traffic, where various Internet network carriers and major ISPs exchange data. When Internet traffic originates on one network and goes to another network, it almost always passes through at least one Network Access Point, or NAP. In the United States, major NAPs include MAE East, in Vienna, Virginia, and MAE West, in San Jose, California (both operated by MCI WorldCom); the Chicago NAP (operated by Ameritech); the Pacific Bell NAP (with multiple locations in California); the Digital Internet Exchange in Palo Alto, California (operated by Digital/Compaq); and the Sprint NAP in Pennsauken, New Jersey. Additional local and regional exchange points are located in many other locations around the world. *Acronym:* NAP. *Also called:* National Attachment Point.

network adapter *n.* See network interface card.

Network Address Translation *n.* See NAT.

network administrator *n.* The person in charge of operations on a computer network. The duties of a network administrator can be broad and might include such tasks as installing new workstations and other devices, adding and removing individuals from the list of authorized users, archiving files, overseeing password protection and other security measures, monitoring usage of shared resources, and handling malfunctioning equipment. See also system administrator.

network architecture *n.* The underlying structure of a computer network, including hardware, functional layers, interfaces, and protocols, used to establish communication and ensure the reliable transfer of information. Network architectures are designed to provide both philosophical and physical standards for the complexities of establishing communications links and transferring information without conflict. Various network architectures exist, including the internationally accepted seven-layer ISO Open Systems Interconnection (OSI) model and IBM’s Systems Network Architecture (SNA). See also ISO/OSI reference model, SNA.

Network-Attached Storage *n.* See NAS.

network boot *n.* See PXE boot.

network card *n.* See network interface card.

network-centric computing *n.* A computing environment in which a network server or servers represent the hub of activity. Considered the “third wave” in large-system computing after mainframe and desktop developments, network-centric computing establishes servers as the main source of computing power, to give users direct access to network-based applications and information. In network-centric computing systems, applications are not preinstalled or uninstalled locally, that is, on the desktop; they are accessed on an as-needed, “on-the-fly” basis. Thus, individual desktop computers do not have to maintain large amounts of disk storage or load and manage application programs. See also server.

network computer *n.* A computer designed for use on a network in which programs and storage are provided by servers. Network computers, unlike dumb terminals, have their own processing power, but their design does not include local storage and they depend on network servers for applications. *Acronym:* NC.

network congestion *n.* See congestion.

network connection *n.* See Ethernet.

network control program *n.* In a communications network that includes a mainframe computer, a program that usually resides in a communications controller and takes over communications tasks such as routing, error control, line control, and polling (checking terminals for transmissions), leaving the main computer free for other functions. See also communications controller.

Network Control Protocol *n.* See Point-to-Point Protocol.

N

network database *n.* 1. A database that runs in a network. 2. A database containing the address of other users in the network. 3. In information management, a type of database in which data records can be related to one another in more than one way. A network database is similar to a hierarchical database in the sense that it contains a progression from one record to another. It differs in being less rigidly structured: any single record can point to more than one other record and, conversely, can be pointed to by one or more records. In effect, a network database allows more than one path between any two records, whereas a hierarchical database allows only one, from parent (higher-level record) to child (lower-level record). *Compare* hierarchical database, relational database.

Network Data Management Protocol *n.* See NDMP.

network device driver *n.* Software that coordinates communication between the network adapter card and the computer's hardware and other software, controlling the physical function of the network adapter card.

network directory *n.* On a local area network, a directory on a disk that is located on a computer other than the one the user is operating. A network directory differs from a network drive in that the user has access to only that directory. Whether the rest of the disk is accessible to the user depends on whether he or she has been granted access rights by the network administrator. On the Macintosh, a network directory is referred to as a shared folder. *Also called:* networked directory, shared directory. *See also* network drive, shared folder.

network drive *n.* On a local area network, a disk drive whose disk is available to other computers on the network. Access to a network drive might not be allowed to all users of the network; many operating systems contain security provisions that enable a network administrator to grant or deny access to part or all of a network drive. *Also called:* networked drive. *See also* network directory.

Network Driver Interface Specification *n.* See NDIS.

networked directory *n.* See network directory.

networked drive *n.* See network drive.

networked home *n.* See smart home.

Network File System *n.* See NFS.

network information center *n.* See NIC (definition 2).

network interface card *n.* An expansion card or other device used to provide network access to a computer or other device, such as a printer. Network interface cards

mediate between the computer and the physical media, such as cabling, over which transmissions travel. *Acronym:* NIC. *Also called:* network adapter, network card.

Network Kernel Extension *n.* See NKE.

network latency *n.* The time it takes for information to be transferred between computers in a network.

network layer *n.* The third of the seven layers in the ISO/OSI reference model for standardizing computer-to-computer communications. The network layer is one level above the data-link layer and ensures that information arrives at its intended destination. It is the middle of the three layers (data-link, network, and transport) concerned with the actual movement of information from one device to another. See the illustration. *See also* ISO/OSI reference model.

ISO/OSI MODEL	
ISO/OSI Layer	Focus
Application (highest level)	Program-to-program transfer of information
Presentation	Text formatting and display, code conversion
Session	Establishing, maintaining, and coordinating communication
Transport	Accurate delivery, service quality
Network	Transport routes, message handling and transfer
Data-link	Coding, addressing, and transmitting information
Physical	Hardware connections

Network layer.

network meltdown *n.* See broadcast storm, meltdown.

network model *n.* A database structure, or layout, similar to a hierarchical model, except that records can have multiple parent records as well as multiple child records. A database management system that supports a network model can be used to simulate a hierarchical model. *See also* CODASYL, network database (definition 3). *Compare* hierarchical model.

network modem *n.* A modem that is shared by users of a network for calling an online service provider, an ISP, a service bureau, or other online source. *See also* ISP, modem online information service, service bureau (definition 2).

N

network news *n.* The newsgroups on the Internet, especially those in the Usenet hierarchy.

Network News Transfer Protocol *n.* See NNTP.

network operating system *n.* An operating system specifically designed to support networking. A server-based network operating system provides networking support for multiple simultaneous users as well as administrative, security, and management functions. On the desktop, a network-aware operating system provides users with the ability to access network resources. Unlike a single-user operating system, a network operating system must acknowledge and respond to requests from many workstations, managing such details as network access and communications, resource allocation and sharing, data protection, and error control. *Acronym:* NOS. *Also called:* network OS.

network operation center *n.* The office in an enterprise that is responsible for maintaining network integrity and improving network efficiency while reducing system downtime. *Acronym:* NOC.

network OS *n.* See network operating system.

network protocol *n.* A set of rules and parameters that defines and enables communication through a network.

Network Query Language *n.* A scripting language for controlling intelligent agents for Web applications. *Acronym:* NQL.

network server *n.* See server.

network services *n.* **1.** In a corporate environment, the division that maintains the network and the computers. **2.** In a Windows environment, extensions to the operating system that allow it to perform network functions such as network printing and file sharing.

network software *n.* Software including a component that facilitates connection to or participation in a network.

Network Solutions, Inc. *n.* See NSI.

network structure *n.* The record organization used in a particular network model.

Network Terminator 1 *n.* An ISDN device that acts as an interface between an ISDN telephone line and one or more terminal adapters or terminal devices, such as an ISDN telephone. *Acronym:* NT-1. *See also* ISDN, ISDN terminal adapter.

Network Time Protocol *n.* An Internet protocol used to synchronize the clocks in computers connected to the Internet. *Acronym:* NTP. *See also* communications protocol.

network topology *n.* See topology.

network weaving *n.* See leapfrog attack.

NetWorld+Interop *n.* International conference and exhibition for the networking and information technology industry. NetWorld+Interop draws attendees from a variety of industries, including telecommunications, Internet services, and e-commerce. NetWorld+Interop features product exhibits, educational conferences, tutorials, and workshops.

NeuralCast Technology *n.* Technology developed by RealNetworks to improve the transmission of digital media over RealNetworks servers. NeuralCast Technology uses a variety of protocols, introduces new techniques to correct errors in streaming signals, and uses telephone and satellite transmissions to coordinate server networks to optimize digital media transmission.

neural network *n.* A type of artificial-intelligence system modeled after the neurons (nerve cells) in a biological nervous system and intended to simulate the way a brain processes information, learns, and remembers. A neural network is designed as an interconnected system of processing elements, each with a limited number of inputs and an output. These processing elements are able to “learn” by receiving weighted inputs that, with adjustment, time, and repetition, can be made to produce appropriate outputs. Neural networks are used in areas such as pattern recognition, speech analysis, and speech synthesis. *See also* artificial intelligence (definition 1), pattern recognition.

newbie *n.* **1.** An inexperienced user on the Internet. **2.** In a particularly derogatory sense, an inexperienced Usenet user who asks for information that is readily available in the FAQ. *See also* FAQ.

newline character *n.* A control character that causes the cursor on a display or the printing mechanism on a printer to move to the beginning of the next line. It is functionally equivalent to a combination of the carriage return (CR) and linefeed (LF) characters. *Acronym:* NL. *See also* carriage return, linefeed.

news *n.* The Internet protocol for retrieving files from an Internet newsgroup. You can create hyperlinks to newsgroups using news://.

N

news.announce.newusers *n.* A newsgroup that contains general information for new users about using Internet newsgroups.

newsfeed or **news feed** *n.* Deliveries, exchanges, or distributions of newsgroup articles to and from news servers. Newsfeeds are accomplished through cooperating news servers, which communicate via NNTP through network connections. *Also called:* feed. *See also* newsgroup, news server, NNTP.

newsgroup *n.* A forum on the Internet for threaded discussions on a specified range of subjects. A newsgroup consists of articles and follow-up posts. An article with all of its follow-up posts—which are (supposed to be) related to the specific subject named in the original article’s subject line—constitutes a thread. Each newsgroup has a name that consists of a series of words, separated by periods, indicating the newsgroup’s subject in terms of increasingly narrow categories, such as rec.crafts.textiles.needlework. Some newsgroups can be read and posted to only on one site; others, such as those in the seven Usenet hierarchies or those in ClariNet, circulate throughout the Internet. *See also* article, bit, newsgroups, ClariNet, follow-up, Great Renaming, local newsgroups, mail reflector, threaded discussion, traditional newsgroup hierarchy, Usenet. *Compare* mailing list.

newsmaster *n.* The person in charge of maintaining the Internet news server at a particular host. Sending e-mail to “newsmaster@domain.name” is the standard way to reach a given newsmaster.

news. newsgroups *n.* Usenet newsgroups that are part of the news. hierarchy and begin with “news.” These newsgroups cover topics that deal with Usenet itself, such as Usenet policy and the creation of new Usenet newsgroups. *See also* newsgroup, traditional newsgroup hierarchy, Usenet. *Compare* comp. newsgroups, misc. newsgroups, rec. newsgroups, sci. newsgroups, soc. newsgroups, talk. newsgroups.

.newsrsc *n.* The file extension that identifies a setup file for UNIX-based newsreaders. The setup file typically contains a current list of newsgroups that the user subscribes to and the articles in each newsgroup that the user has already read. *See also* newsreader, setup (definition 2).

newsreader *n.* A Usenet client program that enables a user to subscribe to Usenet newsgroups, read articles, post follow-ups, reply by e-mail, and post articles. Many Web browsers also provide these functions. *See also* article,

e-mail (definition 1), follow-up, newsgroup, Usenet, Web browser.

news server *n.* A computer or program that exchanges Internet newsgroups with newsreader clients and other servers. *See also* newsgroup, newsreader.

Newton *n.* A personal digital assistant (PDA) developed by Apple Computer, Inc. *See also* PDA.

Newton OS *n.* The operating system that controls the Newton MessagePad personal digital assistant (PDA). *See also* PDA.

NeXT *n.* A computer designed and produced by NeXT Computer, Inc. (later NeXT Software, Inc.), a computer manufacturer and software developer founded in 1985 by Steven Jobs. NeXT was purchased by Apple Computer in 1997.

Next Generation Internet *n.* An initiative funded by the U.S. federal government designed to develop faster, more powerful networking technologies than are available on the current global Internet. The Next Generation Internet, or NGI, was begun in 1997 under the auspices of a number of government agencies, including DARPA (Defense Advanced Research Projects Agency), NASA (National Aeronautics & Space Administration), and the NSF (National Science Foundation). Its objective is to develop advanced networking technologies and to demonstrate them on university and government test networks running 100 to 1000 times faster than the current Internet. The technologies developed are intended for eventual use by schools, businesses, and the general public. *Acronym:* NGI. *Compare* Internet, Internet2.

NFS *n.* Acronym for Network File System. A distributed file system that allows users to access remote files and directories on a network as if they were local. NFS is compatible with Microsoft Windows and UNIX-based systems, including Linux and Mac OS X.

NGI *n.* *See* Next Generation Internet.

nibble or **nybble** *n.* Half a byte (4 bits). *Compare* quadbit.

NIC *n.* **1.** *See* network interface card. **2.** Acronym for network information center. An organization that provides information about a network and other support to users of the network. The principal NIC for the Internet is InterNIC. Intranets and other private networks may have their own NICs. *See also* InterNIC.

NiCad battery *n.* *See* nickel cadmium battery.



NIC handle *n.* See handle.

nickel cadmium battery *n.* A rechargeable battery that uses an alkaline electrolyte. Nickel cadmium batteries typically have a longer operating life and storage life than similar lead-acid batteries. *Also called:* NiCad battery. *Compare* lead ion battery, lithium ion battery, nickel metal hydride battery.

nickel metal hydride battery *n.* A rechargeable battery that offers longer life and superior performance compared with similar nickel cadmium or other alkaline batteries. *Also called:* NiMH battery. *Compare* lead ion battery, lithium ion battery, nickel cadmium battery.

nickname *n.* A name used in the destination field of an e-mail editor in place of one or more complete network addresses. For example “Fred” might be a nickname for fred@history.washington.edu. If the nickname has been established within the program, a user need only type “Fred” instead of the entire address, or perhaps “history faculty” instead of all the individual faculty addresses. *See also* alias (definition 2).

NIDS *n.* Acronym for **n**etwork-based **i**ntrusion-**d**etection **S**ystem. A type of intrusion detection system (IDS) that analyzes the individual packets moving across a network. NIDS can detect packets that a firewall might not catch. *See also* IDS.

NII *n.* See National Information Infrastructure.

nil pointer *n.* See null pointer.

Nimda worm *n.* A persistent worm that can slow or freeze mail servers, take control of Web pages, and infect systems through several different means. The Nimda worm spreads as an attached file through e-mail, through an Internet scan for vulnerable Web servers, through a JavaScript on an infected Web page, or through network sharing. The Nimda worm first appeared in 2001, with several variants following the original version.

NiMH battery *n.* See nickel metal hydride battery.

nine's complement *n.* A number in the base-10 (decimal) system that is the complement of another number. It is derived by subtracting each digit of the number to be complemented from 1 less than the base. For example, the nine's complement of 64 is 35—the number derived by subtracting 6 from 9 and 4 from 9. *See also* complement.

NIS *n.* Acronym for **N**etwork **I**nformation **S**ervice. *See* Yellow Pages (definition 1).

NIST *n.* See National Institute of Standards and Technology.

***NIX** *n.* Slang for any UNIX-related operating system, or all UNIX-related operating systems. *NIX typically refers to UNIX and Linux, and may also include Mac OS X.

nixpub *n.* A list of ISPs (Internet service providers) available in the newsgroups comp.bbs.misc and alt.bbs. *See also* ISP.

NKE *n.* Acronym for **N**etwork **K**ernel **E**xtension. A modification or extension of the Mac OS X networking infrastructure. NKEs may be loaded or unloaded dynamically, without recompiling the kernel or without the need to reboot the system. NKEs allow the creation and configuration of protocol stacks and modules that may monitor or modify network traffic or add other networking features to the kernel.

NL *n.* See newline character.

NLQ *n.* See near-letter-quality.

NLS *n.* See natural language support.

NMI *n.* See nonmaskable interrupt.

NMOS or **N-MOS** *n.* Acronym for **N**-channel **m**etal-**o**xide semiconductor. A semiconductor technology in which the conduction channel in MOSFETs is formed by the movement of electrons rather than holes (electron “vacancies” created as electrons move from atom to atom). Because electrons move faster than holes, NMOS is faster than PMOS, although it is more difficult and more expensive to fabricate. *See also* MOS, MOSFET, N-type semiconductor. *Compare* CMOS, PMOS.

NNTP *n.* Acronym for **N**etwork **N**ews **T**ransfer **P**rotocol. A de facto protocol standard on the Internet used to distribute news articles and query news servers.

NOC *n.* See network operation center.

node *n.* **1.** A junction of some type. **2.** In networking, a device, such as a client computer, a server, or a shared printer, that is connected to the network and is capable of communicating with other network devices. **3.** In tree structures, a location on the tree that can have links to one or more nodes below it. Some authors make a distinction between node and element, with an element being a given data type and a node comprising one or more elements as well as any supporting data structures. *See also* element (definition 1), graph, pointer (definition 1), queue, stack, tree.

noise *n.* **1.** Any interference that affects the operation of a device. **2.** Unwanted electrical signals, produced either naturally or by the circuitry, that distort or degrade the quality or performance of a communications channel. *See also* distortion.

nonbreaking space *n.* A character that replaces the standard space character in order to keep two words together on one line rather than allowing a line to break between them.

noncompetes *n.* An agreement between employer and employee that states that the employee will not accept work with a competing company for a specified length of time after leaving the employer's company. Noncompete agreements are common in high-tech companies and are typically requested to help maintain company secrets and retain valuable employees.

nonconductor *n.* *See* insulator.

noncontiguous data structure *n.* In programming, a data structure whose elements are not stored contiguously in memory. Data structures such as graphs and trees, whose elements are connected by pointers, are noncontiguous data structures. *Compare* contiguous data structure.

nondedicated server *n.* A computer on a network that can function as both a client and a server; typically, a desktop machine on a peer-to-peer network. *Compare* dedicated server.

nondestructive readout *n.* A reading operation that does not destroy the data read, either because the storage technology is capable of retaining the data or because the reading operation is accompanied by a data refresh (update) function. *Acronym:* NDR, NDRO. *Compare* destructive read.

nonexecutable statement *n.* **1.** A program statement that cannot be executed because it lies outside the flow of execution through the program. For example, a statement immediately following a *return()* statement but before the end of the block in C is nonexecutable. **2.** A type definition, variable declaration, preprocessor command, comment, or other statement in a program that is not translated into executable machine code.

nonimpact printer *n.* Any printer that makes marks on the paper without striking it mechanically. The most common types are ink-jet, thermal, and laser printers. *See also* ink-jet printer, laser printer, thermal printer. *Compare* impact printer.

noninterlaced *adj.* Pertaining to a display method on raster-scan monitors in which the electron beam scans each line of the screen once during each refresh cycle. *Compare* interlaced.

nonmaskable interrupt *n.* A hardware interrupt that bypasses and takes priority over interrupt requests generated by software and by the keyboard and other such devices. A nonmaskable interrupt cannot be overruled (masked) by another service request and is issued to the microprocessor only in disastrous circumstances, such as severe memory errors or impending power failures. *Acronym:* NMI. *Compare* maskable interrupt.

nonprocedural language *n.* A programming language that does not follow the procedural paradigm of executing statements, subroutine calls, and control structures sequentially but instead describes a set of facts and relationships and then is queried for specific results. *Compare* procedural language.

nonreturn to zero *n.* **1.** In data transmission, a method of encoding data in which the signal representing binary digits alternates between positive and negative voltage when there is a change in digits from 1 to 0 or vice versa. In other words, the signal does not return to a zero, or neutral, level after transmission of each bit. Timing is used to distinguish one bit from the next. **2.** In the recording of data on a magnetic surface, a method in which one magnetic state represents a 1 and, usually, the opposite state represents a 0. *Acronym:* NRZ.

nontrivial *adj.* Being either difficult or particularly meaningful. For example, a complicated programmed procedure to handle a difficult problem would represent a nontrivial solution.

Non-Uniform Memory Access *n.* *See* NUMA.

nonuniform memory architecture *n.* A system architecture designed for Sequent's Non-Uniform Access Memory, a type of distributed shared memory using a number of shared memory segments instead of a single centralized physical memory. *Acronym:* NUMA.

nonvolatile memory *n.* A storage system that does not lose data when power is removed from it. Intended to refer to core memory, ROM, EPROM, flash memory, bubble memory, or battery-backed CMOS RAM, the term is occasionally used in reference to disk subsystems as well. *See also* bubble memory, CMOS RAM, core, EPROM, flash memory, ROM.

NO-OP *n.* *See* no-operation instruction.



no-operation instruction *n.* A machine instruction that has no results other than to cause the processor to use up clock cycles. Such instructions are useful in certain situations, such as padding out timing loops or forcing subsequent instructions to align on certain memory boundaries. *Acronym:* NO-OP, NOP. *See also* machine instruction.

NOP *n.* *See* no-operation instruction.

NOR gate *n.* Short for **NOT OR gate**. A digital circuit whose output is true (1) only if all inputs are false (0). A NOR gate is an OR circuit (output with the value of 1 if any input value is 1) followed by a NOT circuit (output that is the logical complement of the input). *See also* gate (definition 1), NOT gate, OR gate.

normal distribution *n.* In statistics, a type of function that describes the probabilities of the possible values of a random variable. The function, whose graph is the familiar bell-shaped curve, can be used to determine the probability that the value of the variable will fall within a particular interval of values.

normal form *n.* **1.** In a relational database, an approach to structuring (organizing) information in order to avoid redundancy and inconsistency and to promote efficient maintenance, storage, and updating. Several “rules” or levels of normalization are accepted, each a refinement of the preceding one. Of these, three forms are commonly used: first normal (1NF), second normal (2NF), and third normal (3NF). First normal forms, the least structured, are groups of records (such as employee lists) in which each field (column) contains unique and nonrepeating information. Second and third normal forms break down first normal forms, separating them into different tables by defining successively finer interrelationships between fields. Second normal forms do not include fields that are subsets of fields other than the primary (key) field; for example, a second normal form keyed to employee name would not include both job grade and hourly rate if pay were dependent on job grade. Third normal forms do not include fields that provide information about fields other than the key field; for example, a third normal form keyed to employee name would not include project name, crew number, and supervisor unless the crew number and supervisor were assigned only to the project the employee was working on. Further normalization refinements include Boyce-Codd Normal Form (BCNF), fourth normal form (4NF), and projection-join (or fifth) normal form (PJ/NF or 5NF). These levels, however, are not as commonly used as the first, second, and third normal forms. **2.** In program-

ming, the metalanguage sometimes called the Backus normal form (Backus-Naur form)—a language used for describing the syntax of other languages, specifically ALGOL 60, for which it was invented. *See also* Backus-Naur form.

normal hyphen *n.* *See* hyphen.

normalize *vb.* **1.** In programming, to adjust the fixed-point and exponent portions of a floating-point number to bring the fixed-point portions within a specific range. **2.** In database management, to apply a body of techniques to a relational database in order to minimize the inclusion of duplicate information. Normalization greatly simplifies query and update management, including security and integrity considerations, although it does so at the expense of creating a larger number of tables. *See also* normal form (definition 1).

North American Cellular Network *n.* Telecommunications network that enables wireless phone users in North America to send and receive calls when roaming outside their service area. *Acronym:* NACN.

NOS *n.* *See* network operating system.

NOT *n.* An operator that performs Boolean or logical negation. *See also* Boolean operator, logical operator.

NOT AND *n.* *See* NAND.

notation *n.* In programming, the set of symbols and formats used to describe the elements of programming, mathematics, or a scientific field. A language’s syntax is defined in part by notation. *See also* syntax.

notebook computer *n.* *See* portable computer.

NOT gate *n.* One of the three basic logic gates (with AND and OR) from which all digital systems can be built. The NOT circuit, also referred to as an *inverter*, has output that is the reverse of its input—that is, the output is true (1) if the input is false (0) and false (0) if the input is true (1). *See also* AND gate, gate (definition 1), OR gate.

notification *n.* A signal from the operating system that an event has occurred.

Novell Directory Services *n.* *See* NDS.

Novell NetWare *n.* *See* NetWare.

NPN transistor *n.* A type of transistor in which a base of P-type material is sandwiched between an emitter and a collector of N-type material. The base, emitter, and collector are the three terminals through which current flows. In

N

an NPN transistor, electrons represent the majority of the charge carriers, and they flow from the emitter to the collector. See the illustration. *See also* N-type semiconductor, P-type semiconductor. *Compare* PNP transistor.

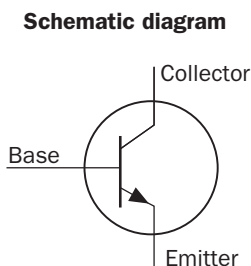
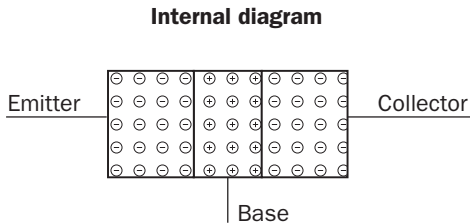

NPN transistor.

NQL *n.* *See* Network Query Language.

NRZ *n.* *See* nonreturn to zero.

ns *n.* *See* nanosecond.

NSAPI *n.* Acronym for Netscape Server Application Programming Interface. A specification for interfaces between the Netscape HTTP server and other application programs. NSAPI can be used to provide access to application programs from a Web browser through a Web server. *See also* HTTP server (definition 1), Web browser.

NSF *n.* *See* National Science Foundation.

NSFnet *n.* Short for the National Science Foundation Network. A WAN (wide area network), developed by the National Science Foundation to replace ARPANET for civilian purposes. NSFnet served as a major backbone for the Internet until mid-1995. Backbone services in the United States for the Internet are now provided by commercial carriers. *See also* ARPANET, backbone (definition 1).

NSFnet Network Information Center *n.* *See* InterNIC.

NSI *n.* Acronym for Network Solutions, Inc. The organization responsible, since 1992, for registering top-level

Internet domain names and maintaining the authoritative (“A”) database of top-level domains replicated daily on 12 other root servers on the Internet. In 1998, with the privatization of Internet administration, the functions performed by NSI (under cooperative agreement with the U.S. National Science Foundation) became the responsibility of ICANN, a new, nonprofit organization. NSI remains active, but its association with the U.S. government entered the “ramping down” phase in 1998/1999. *See also* IANA, ICANN.

NT *n.* *See* Windows NT.

NT-1 *n.* *See* Network Terminator 1.

NT file system *n.* *See* NTFS.

NTFS *n.* Acronym for NT file system. An advanced file system designed for use specifically with the Windows NT operating system. It supports long filenames, full security access control, file system recovery, extremely large storage media, and various features for the Windows NT POSIX subsystem. It also supports object-oriented applications by treating all files as objects with user-defined and system-defined attributes. *See also* FAT file system, HPFS, POSIX.

NTLM authentication protocol *n.* A challenge/response authentication protocol. The NTLM authentication protocol was the default for network authentication in Windows NT version 4.0 and earlier and Windows Millennium Edition (Windows Me) and earlier. The protocol continues to be supported in Windows 2000 and Windows XP but no longer is the default. *See also* Kerberos.

NTP *n.* Acronym for Network Time Protocol. A protocol used for synchronizing the system time on a computer to that of a server or other reference source such as a radio, satellite receiver, or modem. NTP provides time accuracy within a millisecond on local area networks and a few tens of milliseconds on wide area networks. NTP configurations may utilize redundant servers, diverse network paths, and cryptographic authentication to achieve high accuracy and reliability.

NTSC *n.* Acronym for National Television System (later changed to Standards) Committee. The standards-setting body for television and video in the United States. It is the sponsor of the NTSC standard for encoding color, a coding system compatible with black-and-white signals and the system used for color broadcasting in the United States.

N

N-type semiconductor *n.* Semiconductor material in which electrical conduction is carried by electrons, in contrast to P-type semiconductors, in which conduction is carried by holes—that is, electron “vacancies.” N-type semiconductors are created by adding a dopant with an excess of electrons during the manufacturing process. *See also* semiconductor. *Compare* P-type semiconductor.

NuBus *n.* A high-performance expansion bus used in Macintosh computers, offering high bandwidth and multiple bus controllers. Invented at the Massachusetts Institute of Technology (MIT), NuBus was eventually licensed to Texas Instruments and other companies. *See also* bus.

nudge *vb.* To move an object one pixel at a time.

nuke *vb.* **1.** To erase a file, directory, or entire hard disk. **2.** To stop a process in an operating system, an application, or a program. *Also called:* kill.

NUL *n.* **1.** A character code with a null value; literally, a character meaning “nothing.” Although it is real in the sense of being recognizable, occupying space internally in the computer, and being sent or received as a character, a NUL character displays nothing, takes no space on the screen or on paper, and causes no specific action when sent to a printer. In ASCII, NUL is represented by the character code 0. *See also* ASCII. **2.** A “device,” recognized by the operating system, that can be addressed like a physical output device (such as a printer) but that discards any information sent to it.

null character *n.* *See* NUL.

null cycle *n.* The shortest amount of time required for execution of a program; the time needed to cycle through the program without requiring it to process new data or loop through sets of instructions.

null modem *n.* A way of connecting two computers via a cable that enables them to communicate without the use of modems. A null modem cable accomplishes this by crossing the sending and receiving wires so that the wire used for transmitting by one device is used for receiving by the other and vice versa. *See* the illustration.

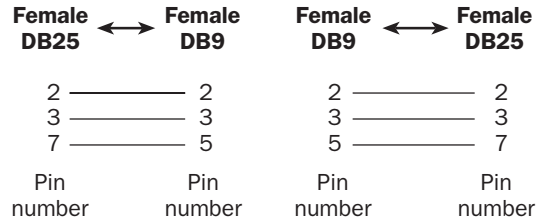
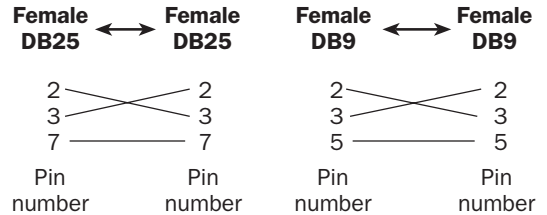

Null modem. *Null modem cable-wiring schematics for IBM PC-compatible computers.*

null modem cable *n.* A serial data cable used to connect two personal computers, without a modem or other DCE device in between, through the computers’ serial ports. Because both computers use the same pins to send data, a null modem cable connects the output pins in one computer’s serial port to the input pins in the other. A null modem cable is used to transfer data between two personal computers in close proximity. *See also* serial port.

null pointer *n.* A pointer to nothing—usually a standardized memory address, such as 0. A null pointer usually marks the last of a linear sequence of pointers or indicates that a data search operation has come up empty. *Also called:* nil pointer. *See also* pointer (definition 1).

null string *n.* A string containing no characters; a string whose length is zero. *See also* string.

null-terminated string *n.* *See* ASCIIZ string.

NUMA *n.* Acronym for **Non-Uniform Memory Access**. A multiprocessing architecture that manages memory according to its distance from the processor. Banks of memory at various distances require different amounts of access time, with local memory accessed faster than remote memory. *See also* SMP.

number cruncher *n.* 1. A computer that is able to quickly perform large amounts of mathematical computations. 2. A powerful workstation. 3. A program whose main task is to perform mathematical computations—for example, a statistical program. 4. A person who uses a computer to analyze numbers.

number crunching *vb.* The calculation of large amounts of numeric data. Number crunching can be repetitive, mathematically complex, or both, and it generally involves far more internal processing than input or output functions. Numeric coprocessors greatly enhance the ability of computers to perform these tasks.

numerical analysis *n.* The branch of mathematics devoted to finding ways to solve abstract mathematical problems and finding concrete or approximate solutions for them.

numeric coprocessor *n.* *See* floating-point processor.

numeric keypad *n.* A calculator-style block of keys, usually at the right side of a keyboard, that can be used to enter numbers. In addition to keys for the digits 0 through 9 and keys for indicating addition, subtraction, multiplication, and division, a numeric keypad often includes an Enter key (usually not the same as the Enter or Return key on the main part of the keyboard). On Apple keyboards, the numeric keypad also includes a Clear key that usually functions like the Backspace key for deleting characters. In addition, many of the keys can serve dual purposes, such as cursor movement, scrolling, or editing tasks, depending on the status of the Num Lock key. *See* the illustration. *See also* Num Lock key.



Numeric keypad.

numeric messaging *n.* Service that enables wireless phones and pagers to receive messages consisting only of numeric information, such as phone numbers.

numeric paging *n.* *See* numeric messaging.

Num Lock key *n.* Short for **Numeric Lock key**. A toggle key that, when turned on, activates the numeric keypad so that its keys can be used for calculator-style data entry. When the Num Lock key is toggled off, most of the numeric keypad keys are used for cursor movement and on-screen scrolling. *See also* numeric keypad.

NVM *n.* Acronym for **Non-Volatile Memory**. Memory that persists in its state when the power is removed. *Also called:* Flash memory.

NVRAM *n.* Acronym for **Non-Volatile Random Access Memory**. Non-volatile read/write memory or normally volatile memory that has been fitted with a battery backup to retain data. *See also* NVM.

NWLink *n.* An implementation of the Internetwork Packet Exchange (IPX), Sequenced Packet Exchange (SPX), and NetBIOS protocols used in Novell networks. NWLink is a standard network protocol that supports routing and can support NetWare client-server applications, where NetWare-aware Sockets-based applications communicate with IPX/SPX Sockets-based applications. *See also* IPX/SPX, NetBIOS, RIPX.

nybble *n.* *See* nibble.

N



OAGI *n.* Acronym for **Open Applications Group, Inc.** A nonprofit consortium of software vendors and businesses created to develop and define XML-based interoperability specifications and standards among enterprise-scale applications. The OAGI was formed in 1995 by a small number of business enterprise software companies and organizations and has grown to more than sixty member companies.

OAGIS *n.* Acronym for **Open Applications Group Integration Specification.** A set of XML-based specifications and standards designed to promote B2B e-commerce by providing interoperability between enterprise-scale applications and between companies. OAGIS includes business document specifications and definitions, business process scenarios, and templates for business forms such as invoices and requisitions. OAGIS is overseen by the Open Applications Group, Inc., a nonprofit consortium of software vendors and customers. *See also* OAGI.

OASIS *n.* Acronym for **Organization for the Advancement of Structured Information Standards.** A consortium of technology companies formed to develop guidelines for use of XML (Extensible Markup Language) and related information standards.

Oberon *n.* An extensible object-oriented language based on Modula-2, whose later versions support the .NET Framework. *Also called:* Active Oberon for .NET.

object *n.* **1.** Short for object code (machine-readable code). **2.** In object-oriented programming, a variable comprising both routines and data that is treated as a discrete entity. *See also* abstract data type, module (definition 1), object-oriented programming. **3.** In graphics, a distinct entity. For example, a bouncing ball might be an object in a graphics program. **4.** A single, runtime instance of object type that the operating system defines. Objects visible in user mode include event, file, I/O completion port, key, object directory, port, process, section, semaphore, symbolic link, thread, timer, and token objects. Many user-mode objects are implemented through the use of a corresponding kernel-mode object. Kernel-mode-only objects

include adapter, APC, controller, device, device queue, DPC, driver, interrupt, mutex, and stream file objects.

object code *n.* The code, generated by a compiler or an assembler, that was translated from the source code of a program. The term most commonly refers to machine code that can be directly executed by the system's central processing unit (CPU), but it can also be assembly language source code or a variation of machine code. *See also* central processing unit.

object computer *n.* The computer that is the target of a specific communications attempt.

object database *n.* *See* object-oriented database.

Object Database Management Group *n.* An organization that promotes standards for object databases and defines interfaces to object databases. *Acronym:* ODMG. *See also* OMG.

object file *n.* A file containing object code, usually the output of a compiler or an assembler and the input for a linker. *See also* assembler, compiler (definition 2), linker, object code.

Objective-C *n.* An object-oriented version of the C language developed in 1984 by Brad Cox. It is most widely known for being the standard development language for the NeXT operating system. *See also* object-oriented programming.

object linking and embedding *n.* *See* OLE.

Object Management Architecture *n.* *See* OMA.

Object Management Group *n.* *See* OMG.

object model *n.* **1.** The structural foundation for an object-oriented language, such as C++. This foundation includes such principles as abstraction, concurrency, encapsulation, hierarchy, persistence, polymorphism, and typing. *See also* abstract data type, object (definition 2), object-oriented programming, polymorphism. **2.** The structural foundation for an object-oriented design. *See also* object-oriented design. **3.** The structural foundation for an object-oriented application.

object module *n.* In programming, the object-code (compiled) version of a source-code file that is usually a collection of routines and is ready to be linked with other object modules. *See also* linker, module (definition 1), object code.

object-oriented *adj.* Of, pertaining to, or being a system or language that supports the use of objects. *See also* object (definition 2).

object-oriented analysis *n.* A procedure that identifies the component objects and system requirements of a system or process that involves computers and describes how they interact to perform specific tasks. The reuse of existing solutions is an objective of this sort of analysis. Object-oriented analysis generally precedes object-oriented design or object-oriented programming when a new object-oriented computer system or new software is developed. *See also* object (definition 2), object-oriented design, object-oriented programming.

object-oriented database *n.* A flexible database that supports the use of abstract data types, objects, and classes and that can store a wide range of data, often including sound, video, and graphics, in addition to text and numbers. Some object-oriented databases allow data retrieval procedures and rules for processing data to be stored along with the data or in place of the data. This allows the data to be stored in areas other than in the physical database, which is often desirable when the data files are large, such as those for video files. *Acronym:* OODB. *See also* abstract data type, class, object (definition 2). *Compare* relational database.

object-oriented design *n.* A modular approach to creating a software product or computer system, in which the modules (objects) can be easily and affordably adapted to meet new needs. Object-oriented design generally comes after object-oriented analysis of the product or system and before any actual programming. *See also* object (definition 2), object-oriented analysis.

object-oriented graphics *n.* Computer graphics that are based on the use of graphics primitives, such as lines, curves, circles, and squares. Object-oriented graphics, used in applications such as computer-aided design and drawing and illustration programs, describe an image mathematically as a set of instructions for creating the objects in the image. This approach contrasts with the use of bitmapped graphics, in which a graphic is represented as a group of black-and-white or colored dots arranged in a certain pattern. Object-oriented graphics enable the user to manipulate objects as units. Because objects are

described mathematically, object-oriented graphics can be layered, rotated, and magnified relatively easily. *Also called:* structured graphics. *See also* graphics primitive. *Compare* bitmapped graphics, paint program.

object-oriented interface *n.* A user interface in which elements of the system are represented by visible screen entities, such as icons, that are used to manipulate the system elements. Object-oriented display interfaces do not necessarily imply any relation to object-oriented programming. *See also* object-oriented graphics.

object-oriented operating system *n.* An operating system based on objects and designed in a way that facilitates software development by third parties, using an object-oriented design. *See also* object (definition 2), object-oriented design.

object-oriented programming *n.* A programming paradigm in which a program is viewed as a collection of discrete objects that are self-contained collections of data structures and routines that interact with other objects. *Acronym:* OOP. *See also* C++, object (definition 2), Objective-C.

Object Pascal *n.* An object-oriented derivative of Pascal. *See also* Pascal.

object-relational server *n.* A database server that supports object-oriented management of complex data types in a relational database. *See also* database server, relational database.

object request broker *n.* *See* ORB.

object wrapper *n.* In object-oriented applications, a means of encapsulating a set of services provided by a non-object-oriented application so that the encapsulated services can be treated as an object. *See also* object (definition 2).

oblique *adj.* Describing a style of text created by slanting a roman font to simulate italics when a true italic font isn't available on the computer or printer. *See also* font, italic, roman.

OC3 *n.* Short for **optical carrier 3**. One of several optical signal circuits used in the SONET high-speed fiberoptic data transmission system. OC3 carries a signal of 155.52 Mbps, the minimum transmission speed for which SONET and the European standard, SDH, are fully interoperable. *See also* SONET.

OCR *n.* *See* optical character recognition.

octal *n.* The base-8 number system consisting of the digits 0 through 7, from the Latin *octo*, meaning “eight.” The octal system is used in programming as a compact means of representing binary numbers. *See also* base (definition 2).

octet *n.* A unit of data that consists of exactly 8 bits, regardless of the number of bits a computer uses to represent a small amount of information such as a character. *Compare* byte.

OCX *n.* Short for **OLE** custom control. A software module based on OLE and COM technologies that, when called by an application, produces a control that adds some desired feature to the application. OCX technology is portable across platforms, works on both 16-bit and 32-bit operating systems, and can be used with many applications. It is the successor to VBX (Visual Basic custom control) technology, which supported only Visual Basic applications, and is the basis for ActiveX controls. OCXs have, in fact, been superseded by ActiveX controls, which are much smaller and therefore work much better over the Internet. *See also* ActiveX control, COM (definition 2), control (definition 2), OLE, VBX, Visual Basic.

ODBC *n.* Acronym for **Open Database Connectivity**. In the Microsoft WOSA (Windows Open System Architecture) structure, an interface providing a common language for Windows applications to gain access to a database on a network. *See also* WOSA.

ODBC driver *n.* Short for **Open Database Connectivity driver**. A program file used to connect to a particular database. Each database program, such as Access or dBASE, or database management system, such as SQL Server, requires a different driver.

ODBMG *n.* *See* Object Database Management Group.

odd parity *n.* *See* parity.

ODI *n.* Acronym for **Open Data-link Interface**. A specification developed by Novell to enable a network interface card (NIC) to support multiple protocols, such as TCP/IP and IPX/SPX. ODI also simplifies development of device drivers by eliminating concern about the particular protocol to be used in transferring information over the network. ODI is comparable in some ways to the Network Driver Interface Specification, or NDIS. *See also* NDIS, network adapter.

ODMA *n.* Acronym for **Open Document Management API**. A specification for a standard application program interface that enables desktop applications, such as

Microsoft Word, to interact seamlessly with specialized document management systems (DMS) installed on network servers. The ODMA specification is the property of the Association for Information & Image Management (AIIM). *See also* API, document management system.

OEM *n.* *See* original equipment manufacturer.

OFC *n.* *See* Open Financial Connectivity.

Office *n.* Microsoft’s family of individual and business application software suites for the Windows and Macintosh platforms. Office is built around three core products: Word for word processing, Excel for spreadsheets, and Outlook for e-mail and collaboration. Office XP, the most recent version for the Windows platform, is available in several versions: the Office XP Standard or Standard for Students and Teachers version, which includes Word, Excel, Outlook, and PowerPoint; the Office XP Professional version, which adds Access; Office XP Developer, which includes Word, Excel, Outlook, PowerPoint, Access, FrontPage, Microsoft’s new SharePoint Team Services collaboration and team Web solution, and Developer Tools; and finally, Office XP Professional Special Edition, which offers all the programs in Office XP Professional plus FrontPage, SharePoint Team Services, Publisher, and IntelliMouse Explorer. Office v. X for Mac is the most recent version for the Macintosh and includes Word, Entourage (for e-mail and collaboration), Excel, and PowerPoint. *See* the table.

Table 0.1 *Application Specifications*

<i>Product</i>	<i>Function</i>	<i>Platform</i>
Word	Word processing	Windows, Macintosh
Excel	Spreadsheets	Windows, Macintosh
Outlook	E-mail, collaboration	Windows
Entourage	E-mail, collaboration	Macintosh
Publisher	Desktop publishing	Windows
Access	Database management	Windows
PowerPoint	Presentation graphics	Windows, Macintosh
FrontPage	Web site creation	Windows
SharePoint		
Team Services	Team Web solution	Windows

office automation *n.* The use of electronic and communications devices, such as computers, modems, and fax machines and any associated software, to perform office functions mechanically rather than manually.

offline *adj.* **1.** In reference to a computing device or a program, unable to communicate with or be controlled by a computer. *Compare* online (definition 1). **2.** In reference to one or more computers, being disconnected from a network. *Compare* online (definition 2). **3.** Colloquially, a reference to moving a discussion between interested parties to a later, more appropriate, time. For example, “We can talk about this offline. Let’s get back on topic now.”

offline navigator *n.* Software designed to download e-mail, Web pages, or newsgroup articles or postings from other online forums and save them locally to a disk, where they can be browsed without the user paying the cost of idle time while being connected to the Internet or an online information service. *Also called:* offline reader.

offline reader *n.* *See* offline navigator.

offline storage *n.* A storage resource, such as a disk, that is not currently available to the system.

offload *vb.* To assume part of the processing demand from another device. For example, some LAN-attached gateways can offload TCP/IP processing from the host machine, thereby freeing up significant processing capacity in the CPU. *See also* central processing unit, gateway, host, TCP/IP.

offset *n.* In relative addressing methods, a number that tells how far from a starting point a particular item is located. *See also* relative address.

off-the-shelf *adj.* Ready-to-use; packaged. The term can refer to hardware or software.

ohm *n.* The unit of measure for electrical resistance. A resistance of 1 ohm will pass 1 ampere of current when a voltage of 1 volt is applied.

OLAP *n.* *See* OLAP database.

OLAP database *n.* Short for **online analytical processing database**. A relational database system capable of handling queries more complex than those handled by standard relational databases, through multidimensional access to data (viewing the data by several different criteria), intensive calculation capability, and specialized indexing techniques. *See also* database, query (definition 1), relational database.

OLAP provider *n.* A set of software that provides access to a particular type of OLAP database. This software can include a data source driver and other client software that is necessary to connect to a database. *See also* OLAP database.

OLE *n.* Acronym for **object linking and embedding**. A technology for transferring and sharing information among applications. When an object, such as an image file created with a paint program, is linked to a compound document, such as a spreadsheet or a document created with a word processing program, the document contains only a reference to the object; any changes made to the contents of a linked object will be seen in the compound document. When an object is embedded in a compound document, the document contains a copy of the object; any changes made to the contents of the original object will not be seen in the compound document unless the embedded object is updated.

OLED *n.* Acronym for **Organic Light-Emitting Device**. Technology developed for the production of thin, lightweight digital displays. An OLED features a series of thin organic films between two conductors. When current is applied, bright light is emitted. OLED displays are lightweight, durable, and power-efficient.

OLE Database *n.* An application programming interface developed by Microsoft for accessing databases. OLE Database is an open specification that can interface with all types of data files on a computer network. *Acronym:* OLE DB.

OLTP *n.* Acronym for **online transaction processing**. A system for processing transactions as soon as the computer receives them and updating master files immediately in a database management system. OLTP is useful in financial record keeping and inventory tracking. *See also* database management system, transaction processing. *Compare* batch processing (definition 3).

OM-1 *n.* *See* OpenMPEG Consortium.

OMA *n.* Acronym for **Object Management Architecture**. A definition developed by the Object Management Group (OMG) for object-oriented distributed processing. OMA includes the Common Object Request Broker Architecture (CORBA). *See also* CORBA, OMG.

OMG *n.* Acronym for **Object Management Group**. A non-profit organization that provides a framework of standards for object-oriented interfaces. The open and nonproprietary architecture developed and managed by the OMG allows developers to work with a large toolkit of standard components in building applications with a solid common foundation. The OMG was formed in 1989 by a group of software developers and system vendors and now has more than six hundred member companies.

on-board computer *n.* A computer that resides within another device.

on-chip cache *n.* *See* L1 cache.

on-demand publishing point *n.* A type of publishing point that streams content in such a way that the client can control (start, stop, pause, fast-forward, or rewind) the content. Typically, the on-demand content is a Windows Media file or a directory of files. Content streamed from an on-demand publishing point is always delivered as a unicast stream. Formerly called a station.

one-off *n.* **1.** A product that is produced one at a time, instead of being mass produced. **2.** A CD-ROM created on a CD-R machine, which can create only one copy of a CD-ROM at a time.

one-pass compiler *n.* A compiler that needs to read through a source file only once to produce the object code. The syntax of some languages makes it impossible to write a one-pass compiler for those languages. *See also* compiler (definition 2).

one's complement *n.* A number in the binary (base-2) system that is the complement of another number. *See also* complement.

one-to-many relationship *n.* An association between two tables in which the primary key value of each record in the primary table corresponds to the value in the matching field or fields of many records in the related table.

one-to-many replication *n.* A server configuration allowing replication of data from one or more large servers to a greater number of smaller servers.

one-to-one relationship *n.* An association between two tables in which the primary key value of each record in the primary table corresponds to the value in the matching field or fields of one and only one record in the related table.

one-way trust *n.* A type of trust relationship in which only one of the two domains trusts the other domain. For example, domain A trusts domain B and domain B does not trust domain A. All one-way trusts are nontransitive. *See also* transitive trust, two-way trust.

onion routing *n.* An anonymous communication technique first developed by the U.S. Navy, in which a message is wrapped in layers of encryption and passed through several intermediate stations to obscure its point of origin. In onion routing, data packets are sent through a complex network of routers, each of which opens an anon-

ymous connection to the next, until it reaches its destination. When the packet is received by the first onion router, it is encrypted once for each additional router it will pass through. Each subsequent onion router unwraps one layer of encryption until the message reaches its destination as plain text.

online *adj.* **1.** In reference to a computing device or a program, activated and ready for operation; capable of communicating with or being controlled by a computer. *Compare* offline (definition 1). **2.** In reference to one or more computers, connected to a network. *Compare* offline (definition 2). **3.** In reference to a user, currently connected to the Internet, an online service, or a BBS or using a modem to connect to another modem. **4.** In reference to a user, being able to connect to the Internet, an online service, or a BBS by virtue of having an account that gives one access.

online analytical processing *n.* *See* OLAP database.

online community *n.* **1.** All users of the Internet and World Wide Web collectively. **2.** A local community that places political forums on line for the discussion of local government or issues of public concern. **3.** Members of a specific newsgroup, mailing list, MUD, BBS, or other online forum or group. *See also* BBS (definition 1), mailing list, MUD, newsgroup.

online game *n.* A game that is meant to be played while connected to the Internet, intranet, or other network, with one or more other people simultaneously connected. Online games allow gamers to interact with other players without having their physical presence necessary. *See also* computer game.

online help *n.* *See* help.

online information service *n.* A business that provides access to databases, file archives, conferences, chat groups, and other forms of information through dial-up, or dedicated communications links, or through the Internet. Most online information services also offer access to the Internet connections along with their own proprietary services. The largest consumer online information services in the U.S. are America Online, CompuServe, and MSN.

Online Privacy Alliance *n.* *See* OPA.

online service *n.* *See* online information service.

online state *n.* The state of a modem when it is communicating with another modem. *Compare* command state.

online transaction processing *n.* See OLTP.

on-screen keyboard *n.* An interactive keyboard that appears as a graphical image on the display screen of a computing device. A user spells words by tapping the letters on the screen with a stylus. On-screen keyboards appear primarily on personal digital assistants (PDAs) and other handheld computing devices that are too small to contain a traditional keyboard.

on the fly *adv.* Doing a task or process as needed without suspending or disturbing normal operations. For example, it is often said that an HTML document can be edited on the fly because its content can be revised without the need to completely shut down or re-create the Web site on which it resides. See also HTML document, Web site.

OO *adj.* See object-oriented.

OOP *n.* See object-oriented programming.

OPA *n.* Acronym for **Online Privacy Alliance**. An organization of over eighty Internet companies and trade associations created to be the voice of the industry on digital privacy issues. The OPA stresses the need for consumer trust and encourages online businesses to post privacy policies. The OPA created a set of guidelines for privacy policies that have become the industry standard.

opacity *n.* The quality that defines how much light passes through an object's pixels. If an object is 100 percent opaque, no light passes through it.

opcode *n.* See operation code.

open¹ *adj.* Of, pertaining to, or providing accessibility. For example, an open file is one that can be used because a program has issued an open file command to the operating system.

open² *vb.* To make an object, such as a file, accessible.

Open Applications Group, Inc. *n.* See OAGI.

open architecture *n.* **1.** Any computer or peripheral design that has published specifications. A published specification lets third parties develop add-on hardware for a computer or device. Compare closed architecture (definition 1). **2.** A design that provides for expansion slots on the motherboard, thereby allowing the addition of boards to enhance or customize a system. Compare closed architecture (definition 2).

OpenCyc *n.* An open source artificial intelligence platform. OpenCyc forms the foundation of knowledge-dependent applications such as speech understanding,

database integration, and e-mail routing and prioritizing. OpenCyc development is administered through OpenCyc.org.

Open Data-link Interface *n.* See ODI.

OpenDoc *n.* An object-oriented application programming interface (API) that enables multiple independent programs (component software) on several platforms to work together on a single document (compound document). Similar to OLE, OpenDoc allows images, sound, video, other documents, and other files to be embedded or linked to the document. OpenDoc is supported by an alliance that includes Apple, IBM, the Object Management Group, and the X Consortium. See also application programming interface, component software. Compare ActiveX, OLE.

Open Document Management API *n.* See ODMA.

open file *n.* A file that can be read from, written to, or both. A program must first open a file before the file's contents can be used, and it must close the file when done. See also open².

Open Financial Connectivity *n.* The Microsoft specification for an interface between electronic banking services and Microsoft Money personal finance software. *Acronym:* OFC.

OpenGL *n.* An industry standard application programming interface (API) for 3D graphics rendering and 3D hardware acceleration. OpenGL is cross-platform and is available for all major operating systems.

Open Group *n.* A consortium of computer hardware and software manufacturers and users from industry, government, and academia that is dedicated to the advancement of multi-vendor information systems. The Open Group was formed in 1996 as a consolidation of the Open Software Foundation and X/Open Company Limited.

OpenMPEG Consortium *n.* An international organization of hardware and software developers for promoting the use of the MPEG standards. *Acronym:* OM-1. See also MPEG.

Open Prepress Interface *n.* See OPI.

Open Profiling Standard *n.* An Internet personalization and privacy specification submitted for consideration to the World Wide Web Consortium by Netscape Communications Corporation, Firefly Network, Inc., and VeriSign, Inc. Open Profiling Standard (OPS) enables users to customize online services while protecting their privacy. To



achieve personalization and privacy concomitantly, OPS is based on the concept of a Personal Profile, which is stored on the individual's computer and contains the user's unique identification, demographic and contact data, and possibly content preferences. This information remains under the user's control and can be released wholly or in part to the requesting site. *Acronym:* OPS. *See also* cookie, digital certificate.

open shop *n.* A computer facility that is open to users and not restricted to programmers or other personnel. An open shop is one in which people can work on or attempt to solve computer problems on their own rather than handing them over to a specialist.

Open Shortest Path First *n.* *See* OSPF.

Open Software Foundation *n.* *See* OSF.

open source *n.* The practice of making the source code (program instructions) for a software product freely available, at no cost, to interested users and developers, even though they were not involved in creating the original product. The distributors of open source software expect and encourage users and outside programmers to examine the code in order to identify problems, and to modify the code with suggested improvements and enhancements. Widely used open source products include the Linux operating system and the Apache Web server.

open standard *n.* A publicly available set of specifications describing the characteristics of a hardware device or software program. Open standards are published to encourage interoperability and thereby help popularize new technologies. *See also* standard (definition 2).

open system *n.* **1.** In communications, a computer network designed to incorporate all devices—regardless of the manufacturer or model—that can use the same communications facilities and protocols. **2.** In reference to computer hardware or software, a system that can accept add-ons produced by third-party suppliers. *See also* open architecture (definition 1).

Open Systems Interconnection reference model *n.* *See* ISO/OSI reference model.

OpenType *n.* A collaborative initiative by Microsoft and Adobe to unify support for Microsoft TrueType and Adobe PostScript Type 1 fonts. The OpenType font format enables font creators and users to work with the font type that best suits their needs without having to worry about

whether the font is based on TrueType or PostScript technology. *Also called:* TrueType Open version 2. *See also* PostScript font, TrueType.

Opera *n.* A Web browser developed by Opera Software S/A. Opera is notable for its strict W3C standards support. Opera is often chosen by Web developers to test Web sites for W3C compliance. *See also* W3C, Web browser.

operand *n.* The object of a mathematical operation or a computer instruction.

operating system *n.* The software that controls the allocation and usage of hardware resources such as memory, central processing unit (CPU) time, disk space, and peripheral devices. The operating system is the foundation software on which applications depend. Popular operating systems include Windows 98, Windows NT, Mac OS, and UNIX. *Acronym:* OS. *Also called:* executive.

operation *n.* **1.** A specific action carried out by a computer in the process of executing a program. **2.** In mathematics, an action performed on a set of entities that produces a new entity. Examples of mathematical operations are addition and subtraction.

operation code *n.* The portion of a machine language or assembly language instruction that specifies the type of instruction and the structure of the data on which it operates. *Also called:* opcode. *See also* assembly language, machine code.

operations research *n.* The use of mathematical and scientific approaches to analyze and improve efficiency in business, management, government, and other areas. Developed around the beginning of World War II, operations research was initially used to improve military operations during the war. The practice later spread to business and industry as a means of breaking down systems and procedures and studying their parts and interactions to improve overall performance. Operations research involves use of the critical path method, statistics, probability, and information theory.

operator *n.* **1.** In mathematics and in programming and computer applications, a symbol or other character indicating an operation that acts on one or more elements. *See also* binary¹, unary. **2.** A person who controls a machine or system such as a computer or telephone switchboard.

operator associativity *n.* A characteristic of operators that determines the order of evaluation in an expression

when adjacent operators have equal precedence. The two possibilities are left to right and right to left. The associativity for most operators is left to right. *See also* expression, operator (definition 1), operator precedence.

operator overloading *n.* The assignment of more than one function to a particular operator, with the implication that the operation performed will vary depending on the data type (operands) involved. Some languages, such as Ada and C++, specifically allow for operator overloading. *See also* Ada, C++, function overloading, operator (definition 1).

operator precedence *n.* The priority of the various operators when more than one is used in an expression. In the absence of parentheses, operations with higher precedence are performed first. *See also* expression, operator (definition 1), operator associativity.

OPI *n.* Acronym for **Open Prepress Interface**. A format for preparing digital publication text and graphics for printing, introduced by Aldus (now Adobe), creating a low-resolution graphic for layout and a high-resolution graphic for print. Depending on the method used, the OPI process creates a single file that allows for color layer extraction through a desktop color separation program or creates multiple color-separated files when using DCS (Desktop Color Separation). *Compare* DCS.

OPS *n.* *See* Open Profiling Standard.

optical character recognition *n.* The process in which an electronic device examines printed characters on paper and determines their shapes by detecting patterns of dark and light. Once the scanner or reader has determined the shapes, character recognition methods—pattern matching with stored sets of characters—are used to translate the shapes into computer text. *Acronym:* OCR. *See also* character recognition. *Compare* magnetic-ink character recognition.

optical communications *n.* The use of light and of light-transmitting technology, such as optical fibers and lasers, in sending and receiving data, images, or sound.

optical disc *n.* *See* compact disc.

optical drive *n.* A disk drive that reads and often can write data on optical (compact) discs. Examples of optical drives include CD-ROM drives and WORM disk drives. *See also* CD-ROM drive, compact disc, WORM.

optical fiber *n.* A thin strand of transparent material used to carry optical signals. Optical fibers are constructed from special kinds of glass and plastic, and they are designed so that a beam of light introduced at one end will remain within the fiber, reflecting off the inner surfaces as it travels down the length of the fiber. Optical fibers are inexpensive, compact, and lightweight and are often packaged many hundred to a single cable. *See also* fiber optics.

optical mouse *n.* **1.** A type of mouse that uses a CMOS digital camera and a digital signal processor to detect motion. The camera photographs the surface over which the mouse moves 1500 times per second, and the digital signal processor uses the photographs to convert the mouse movement into onscreen movements of the cursor. IntelliMouse Explorer and IntelliMouse with IntelliEye, two optical mouse models with no moving parts and requiring no special mouse pad, were introduced by Microsoft in 1999. *See also* mouse. **2.** A type of mouse that uses a pair of light-emitting diodes (LEDs) and a special reflective grid pad to detect motion. The two lights are of different colors, and the special mouse pad has a grid of lines in the same colors, one color for vertical lines and another for horizontal lines. Light detectors paired with the LEDs sense when a colored light passes over a line of the same color, indicating the direction of movement. *See also* mouse. *Compare* mechanical mouse, optomechanical mouse.

optical reader *n.* A device that reads text from printed paper by detecting the pattern of light and dark on a page and then applying optical character recognition methods to identify the characters. *See also* optical character recognition.

optical recognition *n.* *See* optical character recognition.

optical scanner *n.* An input device that uses light-sensing equipment to scan paper or another medium, translating the pattern of light and dark or color into a digital signal that can be manipulated by either optical character recognition software or graphics software. Scanners have different methods for holding the input medium, including flatbed, whereby the medium is held on a piece of glass; sheet-fed, whereby sheets of paper are pulled over a stationary scanning mechanism; handheld, whereby the user moves the device over the document to be scanned; and overhead, whereby the document is placed face up on a stationary bed below a small tower, which moves across



the page. *Compare* magnetic-ink character recognition, spatial digitizer.

optical switching *n.* A technology in which transmissions are sent as light from origin to destination. With optical switching, transmissions are switched through banks of adjustable, circular millimeter mirrors at cross connections, meaning signals don't need to be converted from light to electronic and back during transmission. When used with wave-division multiplexing (WDM), all-optical traffic may be 100 times faster than electrical transmission. *See also* photonics.

optimization *n.* **1.** In programming, the process of producing more efficient (smaller or faster) programs through selection and design of data structures, algorithms, and instruction sequences. **2.** The process of a compiler or assembler in producing efficient executable code. *See also* optimizing compiler.

optimize *vb.* **1.** In Web design functions, to reduce the file size of a photo or graphic to allow faster loading. Files are typically optimized through a combination of means such as reducing overall image quality and fine-tuning color information. **2.** To fine-tune an application for improved performance. *See also* optimization.

optimizer *n.* A program or device that improves the performance of a computer, network, or other device or system. For example, a disk optimizer program reduces file access time.

optimizing compiler *n.* A compiler that analyzes its output (assembly language or machine code) to produce more efficient (smaller or faster) instruction sequences.

opt-in *vb.* To choose to receive certain services or features offered by an e-business. With the opt-in process, a user is not automatically enrolled in services or features. The user must choose to enroll in a service or feature.

optional hyphen *n.* *See* hyphen.

Option key *n.* A key on Apple Macintosh keyboards that, when pressed in combination with another key, produces special characters—graphics, such as boxes; international characters, such as currency symbols; and special punctuation marks, such as en dashes and em dashes. The Option key serves a purpose similar to that of the Control key or the Alt key on IBM and compatible keyboards in that it changes the meaning of the key with which it is used.

Options *n.* *See* Preferences.

optoelectronics *n.* The branch of electronics in which the properties and behavior of light are studied. Optoelec-

tronics deals with electronic devices that generate, sense, transmit, and modulate electromagnetic radiation in the infrared, visible, and ultraviolet portions of the electromagnetic spectrum.

optomechanical mouse *n.* A type of mouse in which motion is translated into directional signals through a combination of optical and mechanical means. The optical portion includes pairs of light-emitting diodes (LEDs) and matching sensors; the mechanical portion consists of rotating wheels with cutout slits. When the mouse is moved, the wheels turn and the light from the LEDs either passes through the slits and strikes a light sensor or is blocked by the solid portions of the wheels. These changes in light contact are detected by the pairs of sensors and interpreted as indications of movement. Because the sensors are slightly out of phase with one another, the direction of movement is determined based on which sensor is the first to regain light contact. Because it uses optical equipment instead of mechanical parts, an optomechanical mouse eliminates the need for many of the wear-related repairs and maintenance necessary with purely mechanical mice, but it does not require the special operating surfaces associated with optical mice. *See the illustration. See also* mouse. *Compare* mechanical mouse, optical mouse.

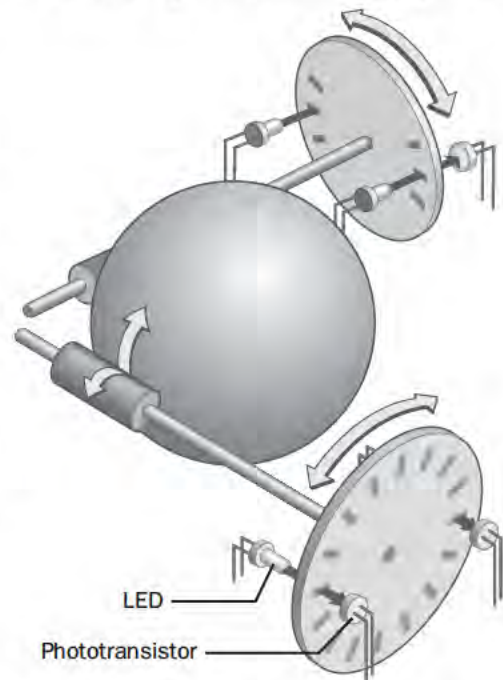

Optomechanical mouse.

opt-out *vb.* To choose not to receive certain services or features offered by an e-business. Some e-businesses automatically enroll users in a predetermined range of services, but allow users to opt-out of features in which they do not choose to participate.

OR *n.* A logical operation for combining two bits (0 or 1) or two Boolean values (false or true). If one or both values are 1 (true), it returns the value 1 (true). See the table.

Table 0.2 *The results of the OR logical operation.*

<i>a</i>	<i>b</i>	<i>a OR b</i>
0	0	0
0	1	1
1	0	1
1	1	1

Orange Book *n.* **1.** A U.S. Department of Defense standards document entitled “Trusted Computer System Evaluation Criteria, DOD standard 5200.28-STD, December, 1985,” which defines a system of ratings from A1 (most secure) to D (least secure), indicating the ability of a computer system to protect sensitive information. *Compare* Red Book (definition 1). **2.** A specifications book written by the Sony and Philips Corporations, covering the compact disc write-once formats (CD-R, PhotoCD). *See also* CD-R, ISO 9660, PhotoCD. *Compare* Green Book, Red Book (definition 2).

ORB *n.* Acronym for **object request broker**. In client/server applications, an interface to which the client makes a request for an object. The ORB directs the request to the server containing the object and then returns the resulting values to the client. *See also* client (definition 1), CORBA.

order¹ *n.* **1.** In computing, the relative significance of a digit or byte. *High-order* refers to the most significant (usually leftmost) digit or byte; *low-order* refers to the least significant (usually rightmost) digit or byte. **2.** The magnitude of a database in terms of the number of fields it contains. **3.** The sequence in which arithmetic operations are performed.

order² *vb.* To arrange in a sequence, such as alphabetic or numeric.

ordinal number *n.* A number whose form indicates position in an ordered sequence of items, such as first, third, or twentieth. *Compare* cardinal number.

.org *n.* In the Internet’s Domain Name System, the top-level domain that identifies addresses operated by organizations that do not fit any of the other standard domains. For

instance, the Public Broadcasting System (PBS) is neither a commercial, for-profit corporation (.com) nor an educational institution with enrolled students (.edu), so it has the Internet address pbs.org. The designation .org appears at the end of the address. *See also* DNS (definition 1), domain (definition 3). *Compare* .com, .edu, .gov, .mil, .net.

Organic Light-Emitting Device *n.* *See* OLED.

Organization for the Advancement of Structured Information Standards *n.* *See* OASIS.

OR gate *n.* One of the three basic logic gates (with AND and NOT) from which all digital systems can be built. The output of an OR circuit is true (1) if any input is true. *See also* AND gate, gate (definition 1), NOT gate.

orientation *n.* *See* landscape mode, portrait mode.

original equipment manufacturer *n.* The maker of a piece of equipment. In making computers and related equipment, manufacturers of original equipment typically purchase components from other manufacturers of original equipment, integrate them into their own products, and then sell the products to the public. *Acronym:* OEM. *Compare* value-added reseller.

original Macintosh keyboard *n.* The keyboard supplied as standard equipment with the 128-KB Apple Macintosh and the Mac 512K. The original Macintosh keyboard is small and has no numeric keypad or function keys. Also, because the overall design goal was that the Macintosh should feel familiar, the only elements of this 58-key keyboard that differ from a typewriter keyboard are the Option keys at both ends of the bottom row, the Command key to the left of the Spacebar, and the Enter key to the right of the Spacebar.

orphan *n.* The first line of a paragraph printed alone at the bottom of a page or column of text, or the last line of a paragraph printed alone at the top of a page or column. Orphans are visually unattractive and thus undesirable in printed materials. *Compare* widow.

orphan file *n.* A file that remains on a system after it has ceased to be of use. For example, a file may be created to support a particular application but may remain after the application has been removed.

OS *n.* *See* operating system.

OS/2 *n.* Short for **Operating System/2**. A protected-mode, virtual-memory, multitasking operating system for personal computers based on the Intel 80286, 80386, i486, and Pentium processors. OS/2 can run most MS-DOS

O

applications and can read all MS-DOS disks. OS/2's Presentation Manager provides a graphical user interface. The latest version, known as OS/2 Warp 4, is a 32-bit operating system that provides networking, Internet, and Java support, as well as speech recognition technology. OS/2 was initially developed as a joint project of Microsoft and IBM but later became an IBM product. *See also* protected mode, virtual memory.

oscillation *n.* A periodic change or alternation. In electronics, oscillation refers to a periodic change in an electrical signal.

oscillator *n.* An electronic circuit that produces a periodically varying output at a controlled frequency. Oscillators, an important type of electronic circuit, can be designed to provide a constant or an adjustable output. Some oscillator circuits use a quartz crystal to generate a stable frequency. Personal computers use an oscillator circuit to provide the clock frequency—typically 1 to 200 megahertz (MHz)—that drives the processor and other circuits.

oscilloscope *n.* A test and measurement instrument that provides a visual display for an electrical signal. Most commonly, oscilloscopes are used to create a display of voltage over time. *Also called:* cathode-ray oscilloscope.

OSF *n.* Acronym for **Open Software Foundation**. A nonprofit consortium of firms (including DEC, Hewlett-Packard, and IBM), formed in 1988, that promotes standards and specifications for programs operating under UNIX and licenses software (as source code) to its members. OSF's products include the Distributed Computing Environment, the graphical user interface Motif, and the OSF/1 operating system (a variant of UNIX).

OSI *n.* *See* ISO/OSI reference model.

OSI protocol stack *n.* The set of protocols based on—and corresponding to—the ISO/OSI reference model.

OSI reference model *n.* *See* ISO/OSI reference model.

OSPF *n.* Acronym for **Open Shortest Path First**. A routing protocol for IP networks, such as the Internet, that allows a router to calculate the shortest path to each node for sending messages. The router sends information on the nodes it is linked to, called link-state advertisements, to other routers on the network to accumulate link-state information to make its calculations. *See also* communications protocol, node (definition 2), path (definition 1), router.

OS X *n.* *See* Mac OS X.

OTOH *n.* Acronym for **on the other hand**. A shorthand expression often used in e-mail, Internet news, and discussion groups.

Outbox *n.* In many e-mail applications, the default mailbox where the program stores outgoing messages. *See also* e-mail¹ (definition 1), mailbox. *Compare* Inbox.

outdent *n.* *See* hanging indent.

outer join *n.* In database management, an operator in relational algebra. An outer join performs an extended join operation in which the tuples (rows) in one relation (table) that have no counterpart in the second relation appear in the resulting relation concatenated with all null values. *Compare* inner join.

outline font *n.* A font (type design) stored in a computer or printer as a set of outlines for drawing each of the alphabetic and other characters in a character set. Outline fonts are templates rather than actual patterns of dots and are scaled up or down to match a particular type size. Such fonts are most often used for printing, as is the case with most PostScript fonts on a PostScript-compatible laser printer and TrueType fonts. *Compare* bitmapped font, screen font, stroke font.

Outlook *n.* Microsoft's messaging and collaboration application software. A member of the Microsoft Office suite, Outlook includes e-mail, an integrated calendar, and contact-management and task-management features, and it also provides support for building customized tools, such as special-purpose forms, for collaborative functions.

out-of-band signaling *n.* Transmission of some signals, such as control information, on frequencies outside the bandwidth available for voice or data transfer on a communications channel. *Compare* in-band signaling.

output¹ *n.* The results of processing, whether sent to the screen or printer, stored on disk as a file, or sent to another computer in a network.

output² *vb.* To send out data by a computer or sound by a speaker.

output area *n.* *See* output buffer.

output-bound *n.* *See* input/output-bound.

output buffer *n.* A portion of memory set aside for temporary storage of information, leaving main memory for storage, display, printing, or transmission. *See also* buffer¹.

output channel *n.* *See* channel (definition 1), input/output channel.

output simulation *n.* A feature of color management applications in which a computer display is calibrated to help predict the results of printing a graphics file on a specific device. *Also called:* soft proofing.

output stream *n.* A flow of information that leaves a computer system and is associated with a particular task or destination. In programming, an output stream can be a series of characters sent from the computer's memory to a display or to a disk file. *Compare* input stream.

outsourcing *n.* The assignment of tasks to independent contractors, such as individual consultants or service bureaus. Tasks such as data entry and programming are often performed via outsourcing.

OverDrive *n.* A type of microprocessor from Intel designed to replace a computer's existing i486SX or i486DX microprocessor. The OverDrive is functionally identical to Intel's i486DX2 microprocessor, but it is an end-user product, whereas the i486DX2 is sold only to computer manufacturers who build it into their own systems. Upgrading a system with an OverDrive processor differs from system to system, and some systems might not be able to support an OverDrive processor. *See also* i486DX, i486SL, i486SX, microprocessor. *Compare* i486DX2.

overflow *n.* **1.** Generally, the condition that occurs when data resulting from input or processing requires more bits than have been provided in hardware or software to store the data. Examples of overflow include a floating-point operation whose result is too large for the number of bits allowed for the exponent, a string that exceeds the bounds of the array allocated for it, and an integer operation whose result contains too many bits for the register into which it is to be stored. *See also* overflow error. *Compare* underflow. **2.** The part of a data item that cannot be stored because the data exceeds the capacity of the available data structure.

overflow error *n.* An error that arises when a number, often the result of an arithmetic operation, is too large to be contained in the data structure that a program provides for it.

overhead *n.* Work or information that provides support—possibly critical support—for a computing process but is not an intrinsic part of the operation or data. Overhead often adds to processing time but is generally necessary.

overlaid windows *n.* *See* cascading windows.

overlapped communication operation *n.* The performance of two distinct communication operations simultaneously; for example, a simultaneous read/write operation. Windows CE does not support overlapped communication operation, but it does support multiple read/writes pending on a device.

overlay¹ *n.* **1.** A section of a program designed to reside on a designated storage device, such as a disk, and to be loaded into memory when needed, usually overwriting one or more overlays already in memory. Use of overlays allows large programs to fit into a limited amount of memory, but at the cost of speed. **2.** A printed form positioned over a screen, tablet, or keyboard for identification of particular features. *See also* keyboard template.

overlay² *vb.* **1.** In computer graphics, to superimpose one graphic image over another. **2.** In video, to superimpose a graphic image generated on a computer over video signals, either live or recorded.

overprint *vb.* The process of printing an element of one color over one of another color without removing, or knocking out, the material underneath. *Compare* knockout (definition 1).

override *vb.* To prevent something from happening in a program or in an operating system or to initiate another response. For example, a user can often override and thus abort a lengthy sorting procedure in a database program by pressing the Escape key.

overrun *n.* In information transfer, an error that occurs when a device receiving data cannot handle or make use of the information as rapidly as it arrives. *See also* input/output-bound.

overscan *n.* The part of a video signal sent to a raster display that controls the area outside the rectangle containing visual information. The overscan area is sometimes colored to form a border around the screen.

overshoot *n.* The phenomenon in which a system suffers from a time delay in responding to input and continues to change state even after it has reached the desired state. This situation requires that correcting input be made so that the system reaches the desired state. For example, the arm carrying the heads in a hard disk drive might move slightly past the desired track before it stops, requiring another signal to pull it back.

overstrike *vb.* To type or print one character directly over another so that the two occupy the same space on the page or screen.



overtyping mode *n.* See overwrite mode.

overwrite mode *n.* A text-entry mode in which newly typed characters replace existing characters under or to the left of the cursor insertion point. *Also called:* overtype mode, typeover mode. *Compare* insert mode.

overwriting virus *n.* A type of virus that overwrites the host file it has infected, destroying the original data. *Also called:* overwrite virus.

Oz *n.* A concurrent, object-oriented programming language.

P

p *prefix* See pico-.

P *prefix* See peta-.

P2P or P-to-P *n.* An Internet-based networking option in which two or more computers connect directly to each other to communicate and share files without use of a central server. Interest in P2P networking blossomed with the introduction of Napster and Gnutella. Short for Peer-to-Peer. *See also* peer-to-peer architecture, peer-to-peer communications.

P3P *n.* Acronym for **Platform for Privacy Preferences**. An open W3C protocol that allows Internet users to control the type of personal information that is collected by the Web sites they visit. P3P uses User Agents built into browsers and Web applications to allow P3P-enabled Web sites to communicate privacy practices to users before they log on to the Web site. P3P compares the Web site's privacy policies with the user's personal set of privacy preferences, and it reports any disagreements to the user.

P5 *n.* Intel's internal working name for the Pentium microprocessor. Although it was not intended to be used publicly, the name P5 leaked out to the computer-industry trade press and was commonly used to reference the microprocessor before it was released. *See also* 586, Pentium.

pack *vb.* To store information in a more compact form. Packing eliminates unnecessary spaces and other such characters and may use other special methods of compressing data as well. It is used by some programs to minimize storage requirements.

package *n.* **1.** A computer application consisting of one or more programs created to perform a particular type of work—for example, an accounting package or a spreadsheet package. **2.** In electronics, the housing in which an electronic component is packaged. *See also* DIP. **3.** A group of classes or interfaces and a keyword in the Java programming language. Packages are declared in Java by using the "package" keyword. *See also* class, declare, interface (definition 1), keyword.

packaged software *n.* A software program sold through a retail distributor, as opposed to custom software. *See also* canned software.

packed decimal *adj.* A method of encoding decimal numbers in binary form that maximizes storage space by using each byte to represent two decimal digits. When signed decimal numbers are stored in packed decimal format, the sign appears in the rightmost four bits of the rightmost (least significant) byte.

packet *n.* **1.** A unit of information transmitted as a whole from one device to another on a network. **2.** In packet-switching networks, a transmission unit of fixed maximum size that consists of binary digits representing both data and a header containing an identification number, source and destination addresses, and sometimes error-control data. *See also* packet switching.

packet assembler and disassembler *n.* *See* packet assembler/disassembler.

packet assembler/disassembler *n.* An interface between non-packet-switching equipment and a packet-switching network. *Acronym:* PAD.

packet filtering *n.* The process of controlling network access based on IP addresses. Firewalls will often incorporate filters that allow or deny users the ability to enter or leave a local area network. Packet filtering is also used to accept or reject packets such as e-mail, based on the origin of the packet, to ensure security on a private network. *See also* firewall, IP address, packet (definition 1).

packet flooding *n.* A technique employed in a number of DoS (denial of service) attacks in which a flood of packets of data are sent to a target server, overwhelming the computer and rendering it unable to respond to legitimate network requests. Examples of specific types of packet flooding include smurf attacks and SYN flood attacks. *See also* DoS, packet, smurf attack, SYN flood.

packet header *n.* The portion of a data packet that precedes the body (data). The header contains data, such as

P

source and destination addresses and control and timing information, that is needed for successful transmission.

Packet Internet Groper *n.* See ping¹ (definition 1).

packet sniffer *n.* A hardware and/or software device that examines every packet sent across a network. To work, a packet sniffer must be installed in the same network block as the network it is intended to sniff. Designed as a problem-solving tool to isolate problems degrading network performance, packet sniffers have become security risks on some networks because crackers can use them to capture nonencrypted user IDs, passwords, credit card numbers, e-mail addresses, and other confidential information. See also cracker, packet. Compare monitoring software.

packet switching *n.* A message-delivery technique in which small units of information (packets) are relayed through stations in a computer network along the best route available between the source and the destination. A packet-switching network handles information in small units, breaking long messages into multiple packets before routing. Although each packet may travel along a different path, and the packets composing a message may arrive at different times or out of sequence, the receiving computer reassembles the original message correctly. Packet-switching networks are considered to be fast and efficient. To manage the tasks of routing traffic and assembling/disassembling packets, such a network requires some intelligence from the computers and software that control delivery. The Internet is an example of a packet-switching network. Standards for packet switching on networks are documented in the International Telecommunication Union (ITU) recommendation X.25. Compare circuit switching.

Packet Switching Exchange *n.* An intermediary switching station in a packet-switching network.

packet trailer *n.* The portion of a data packet that follows the body (data). The trailer typically contains information related to error checking and correction. See also packet.

packing density *n.* The number of storage units per length or area of a storage device. Bits per inch is one measure of packing density.

PackIT *n.* A file format used on the Apple Macintosh to represent collections of Mac files, possibly Huffman compressed. See also Huffman coding, Macintosh.

PAD *n.* See packet assembler/disassembler.

pad character *n.* In data input and storage, an extra character inserted as filler to use up surplus space in a predefined block of a specified length, such as a fixed-length field.

padding *n.* In data storage, the addition of one or more bits, usually zeros, to a block of data to fill it, to force the actual data bits into a certain position, or to prevent the data from duplicating a bit pattern that has an established meaning, such as an embedded command.

paddle *n.* An early type of input device often used with computer games especially for side-to-side or up-and-down movements of an on-screen object. A paddle is less sophisticated than a joystick because it permits the user, by turning a dial, to specify movement along only a single axis. The paddle got its name because its most popular use was to control the on-screen paddles in the simple early video games, such as Pong. See the illustration.



Paddle.

paddle switch *n.* Any switch that has a wide handle. The large on/off switch on many IBM personal computers is one type of paddle switch.

page *n.* 1. In word processing, the text and display elements to be printed on one side of a sheet of paper, subject to formatting specifications such as depth, margin size, and number of columns. 2. A fixed-size block of memory. When used in the context of a paging memory system, a page is a block of memory whose physical address can be changed via mapping hardware. See also EMS, memory management unit, virtual memory. 3. In computer graphics, a portion of display memory that contains one complete full-screen image; the internal representation of a screenful of information. 4. See Web page.

page banner *n.* A section of a Web page containing a graphic element and text, such as the page title. Page banners are usually displayed at the top of a Web page. Page banners can also be used to link to other Web sites for advertising purposes. Also called: banner.

P

page break *n.* The point at which the flow of text in a document moves to the top of a new page. Most word processors automatically place page breaks when the material on the page reaches a specified maximum. By contrast, a “hard” or “manual” page break is a command or a code inserted by the user to force a page break at a specific place in the text. *See also* form feed.

paged address *n.* In the 80386, i486, and Pentium paged memory architecture, an address in memory created by combining the processes of segment translation and page translation. In the paged-memory scheme, which requires that the microprocessor’s paging feature be enabled, logical addresses are transformed into physical addresses in two steps: segment translation and page translation. The first step, segment translation, converts a logical to a linear address—an address that refers indirectly to a physical address. After the linear address is obtained, the microprocessor’s paging hardware converts the linear address to a physical address by specifying a page table (an array of 32-bit page specifiers), a page (a 4-KB unit of contiguous addresses within physical memory) within that table, and an offset within that page. This information collectively refers to a physical address.

page-description language *n.* A programming language, such as PostScript, that is used to describe output to a printer or a display device, which then uses the instructions from the page-description language to construct text and graphics to create the required page image. Page-description languages are like other computer languages, with logical program flow allowing for sophisticated manipulation of the output. A page-description language, like a blueprint, sets out specifications (as for fonts and type sizes) but leaves the work of drawing characters and graphics to the output device itself. Because this approach delegates the detail work to the device that produces the output, a page-description language is machine-independent. These abilities come at a price, however. Page-description languages require printers with processing power and memory comparable to, and often exceeding, that of personal computers. *Acronym:* PDL. *See also* PostScript.

paged memory management unit *n.* A hardware unit that performs tasks related to accessing and managing

memory used by different applications or by virtual-memory operating systems. *Acronym:* PMMU.

Page Down key *n.* A standard key (often labeled “PgDn”) on most computer keyboards whose specific meaning is different in different programs. In many cases, it moves the cursor down to the top of the next page or a specific number of lines.

page fault *n.* The interrupt that occurs when software attempts to read from or write to a virtual memory location that is marked “not present.” The mapping hardware of a virtual memory system maintains status information about every page in the virtual address space. A page either is mapped onto a physical address or is not present in physical memory. When a read or write to an unmapped virtual address is detected, the memory management hardware generates the page fault interrupt. The operating system must respond to the page fault by swapping in the data for the page and updating the status information in the memory management unit. *See also* page (definition 2), swap (definition 2), virtual memory.

page frame *n.* A physical address to which a page of virtual memory may be mapped. In a system with 4096-byte pages, page frame 0 corresponds to physical addresses 0 through 4095. *See also* paging, virtual memory.

page-image buffer *n.* Memory in a page printer used to hold the bit map (image) of a page as the printer’s raster image processor builds the page and as the printer produces the page. *See also* page printer, raster image processor.

page-image file *n.* A file containing the necessary code for a printer or other display device to create the page or screen image. *See also* PostScript.

page-jacking *n.* A deceptive practice that detours Web visitors from legitimate sites generated as search engine results to copycat Web pages, from which they will be redirected to pornographic or other unwanted sites. Page-jacking is accomplished by copying the contents and metatags of a Web page, altering its title and content so that, on search results, it displays before the original, and then submitting the copied page to search engines. When clicking on the link to the copied site, the visitor will instead be redirected to an unwanted and unrelated site. *See also* metatag. *Compare* mousetrapping.



page layout *n.* In desktop publishing, the process of arranging text and graphics on the pages of a document. Page-layout programs excel in text placement and management of special effects applied to text. Although page-layout programs are generally slower than word-processing programs, they can perform such advanced tasks as flowing text into complex multicolumn page designs, printing documents in signatures, managing color separations, and supporting sophisticated kerning and hyphenation.

page makeup *n.* The assembling of graphics and text on a page in preparation for printing.

page mode RAM *n.* A specially designed dynamic RAM that supports access to sequential memory locations with a reduced cycle time. This is especially attractive in video RAM, in which each location is accessed in ascending order to create the screen image. Page mode RAM can also improve the execution speed of code because code tends to execute sequentially through memory. *See also* cycle time, dynamic RAM.

page orientation *n.* *See* landscape mode, portrait mode.

page printer *n.* Any printer, such as a laser printer, that prints an entire page at once. Because page printers must store the entire page in memory before printing, they require relatively large amounts of memory. *Compare* line printer.

pager *n.* Pocket-sized wireless electronic device that uses radio signals to record incoming phone numbers or short text messages. Some pagers allow users to send messages as well. *Also called:* beeper.

page reader *n.* *See* document reader.

page setup *n.* A set of choices that affect how a file is printed on the page. Page setup might reflect the size of paper going into the printer, the page margins, the specific pages in the document to be printed, whether the image is to be reduced or enlarged when printed, and whether another file is to be printed immediately after the first file is printed.

pages per minute *n.* *See* PPM.

Page Up key *n.* A standard key (often labeled “PgUp”) on most computer keyboards whose specific meaning is different in different programs. In many cases, it moves the cursor up to the top of the previous page or a specific number of lines.

pagination *n.* **1.** The process of dividing a document into pages for printing. **2.** The process of adding page numbers, as in a running head.

paging *n.* A technique for implementing virtual memory. The virtual address space is divided into a number of fixed-size blocks called pages, each of which can be mapped onto any of the physical addresses available on the system. Special memory management hardware (MMU or PMMU) performs the address translation from virtual addresses to physical addresses. *See also* memory management unit, paged memory management unit, virtual memory.

paging file *n.* A hidden file on the hard disk that operating systems (such as Windows, Mac OS X, and UNIX) use to hold parts of programs and data files that do not fit in memory. The paging file and physical memory, or RAM, make up virtual memory. Data is moved from the paging file to memory as needed and moved from memory to the paging file to make room for new data in memory. *Also called:* swap file. *See also* virtual memory.

paint¹ *n.* A color and pattern used with graphics programs to fill areas of a drawing, applied with tools such as a paintbrush or a spraycan.

paint² *vb.* To fill a portion of a drawing with paint (color or a pattern).

paintbrush *n.* An artist’s tool in a paint program or another graphics application for applying a streak of solid color to an image. The user can usually select the width of the streak. *See also* paint program. *Compare* spraycan.

paint program *n.* An application program that creates graphics as bit maps. A paint program, because it treats a drawing as a group of dots, is particularly appropriate for freehand drawing. Such a program commonly provides tools for images requiring lines, curves, and geometric shapes but does not treat any shape as an entity that can be moved or modified as a discrete object without losing its identity. *Compare* drawing program.

palette *n.* **1.** In paint programs, a collection of drawing tools, such as patterns, colors, brush shapes, and different line widths, from which the user can choose. **2.** A subset of the color look-up table that establishes the colors that can be displayed on the screen at a particular time. The number of colors in a palette is determined by the number of bits used to represent a pixel. *See also* color bits, color look-up table, pixel.

P

palmtop *n.* A portable personal computer whose size enables it to be held in one hand while it is operated with the other hand. A major difference between palmtop computers and laptop computers is that palmtops are usually powered by off-the-shelf batteries such as AA cells. Palmtop computers typically do not have disk drives; rather, their programs are stored in ROM and are loaded into RAM when they are switched on. More recent palmtop computers are equipped with PCMCIA slots to provide wider flexibility and greater capability. *See also* handheld PC, PCMCIA slot, portable computer. *Compare* laptop.

PAM *n.* *See* pulse amplitude modulation.

panning *n.* In computer graphics, a display method in which a viewing window on the screen scans horizontally or vertically, like a camera, to bring offscreen extensions of the current image smoothly into view.

PANTONE MATCHING SYSTEM *n.* In graphic arts and printing, a standard system of ink color specification consisting of a swatch book in which each of about 500 colors is assigned a number. *Acronym:* PMS. *See also* color model.

PAP *n.* **1.** Acronym for **P**assword **A**uthentication **P**rotocol. A method for verifying the identity of a user attempting to log on to a Point-to-Point Protocol (PPP) server. PAP is used if a more rigorous method, such as the Challenge Handshake Authentication Protocol (CHAP), is not available or if the user name and password that the user submitted to PAP must be sent to another program without encryption. **2.** Acronym for **P**rinter **A**ccess **P**rotocol. The protocol in AppleTalk networks that governs communication between computers and printers.

paper feed *n.* A mechanism that moves paper through a printer. In laser printers and other page printers, the paper feed is usually a series of rollers that firmly grip and align the paper. In dot-matrix printers, the paper feed is usually a pin feed or tractor feed, in which small pins drag or push paper that has detachable edges punched with sprocket holes. Friction feed is another type of paper feed, in which the paper is gripped between the platen and pressure rollers and pulled by rotation of the platen.

paperless office *n.* The idealized office in which information is entirely stored, manipulated, and transferred electronically rather than on paper.

paper-white *adj.* Of, pertaining to, or being a type of monochrome computer monitor whose default operating colors are black text on a white background. Paper-white monitors are popular in desktop publishing and word processing environments because the monitor most closely resembles a white sheet of paper printed with black characters.

paper-white monitor *n.* A display monitor in which text and graphics characters are displayed in black against a white background to resemble the appearance of a printed page. Some manufacturers use the name to refer to a background that is tinted in a manner corresponding to bonded paper.

paradigm *n.* An archetypal example or pattern that provides a model for a process or system.

paragraph *n.* **1.** In word processing, any part of a document preceded by one paragraph mark and ending with another. To the program, a paragraph represents a unit of information that can be selected as a whole or given formatting distinct from the surrounding paragraphs. **2.** On IBM and other computers built around the Intel 8088 or 8086 microprocessor, a 16-byte section of memory beginning at a location (address) that can be divided evenly by 16 (hexadecimal 10).

parallel *adj.* **1.** Of or relating to electronic circuits in which the corresponding terminals of two or more components are connected. **2.** In geometry and graphics, of, relating to, or being lines that run side by side in the same direction in the same plane without intersecting. **3.** In data communications, of, relating to, or being information that is sent in groups of bits over multiple wires, one wire for each bit in a group. *See also* parallel interface. *Compare* serial. **4.** In data handling, of or relating to handling more than one event at a time, with each event having its own portion of the system's resources. *See also* parallel processing.

parallel access *n.* The ability to store or retrieve all of the bits composing a single unit of information, such as a byte or a word (usually two bytes), at the same time. *Also called:* simultaneous access.

parallel adder *n.* A logic device that processes the addition of several (typically 4, 8, or 16) binary inputs simultaneously rather than sequentially, as is the case with half adders and full adders. Parallel adders speed processing

P

because they require fewer steps to produce the result. *Compare* full adder, half adder.

parallel algorithm *n.* An algorithm in which more than one portion of the algorithm can be followed at one time. Parallel algorithms are usually used in multiprocessing environments. *Compare* sequential algorithm.

parallel circuit *n.* A circuit in which the corresponding leads of two or more of the circuit components are connected. In a parallel circuit, there are two or more separate pathways between points. The individual components in a parallel circuit all receive the same voltage but share the current load. See the illustration. *Compare* series circuit.

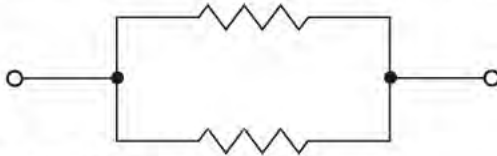

Parallel circuit.

parallel computer *n.* A computer that uses several processors that work concurrently. Software written for parallel computers can increase the amount of work done in a specific amount of time by dividing a computing task among several simultaneously functioning processors. *See also* parallel processing.

parallel computing *n.* The use of multiple computers or processors to solve a problem or perform a function. *See also* array processor, massively parallel processing, pipeline processing, SMP.

parallel connection *n.* *See* parallel interface.

parallel database *n.* A database system involving the concurrent use of two or more processors or operating system processes to service database management requests such as SQL queries and updates, transaction logging, I/O handling, and data buffering. A parallel database is capable of performing a large number of simultaneous tasks across multiple processors and storage devices, providing quick access to databases containing many gigabytes of data.

Parallel Data Structure *n.* *See* PDS (definition 2).

parallel execution *n.* *See* concurrent execution.

parallel interface *n.* The specification of a data transmission scheme that sends multiple data and control bits simultaneously over wires connected in parallel. The most

common parallel interface is the Centronics interface. *See also* Centronics parallel interface. *Compare* serial interface.

parallel port *n.* An input/output connector that sends and receives data 8 bits at a time, in parallel, between a computer and a peripheral device such as a printer, scanner, CD-ROM, or other storage device. The parallel port, often called a Centronics interface after the original design standard, uses a 25-pin connector called a DB-25 connector that includes three groups of lines: four for control signals, five for status signals, and eight for data. *See also* Centronics parallel interface, ECP, EPP, IEEE 1284, input/output port. *Compare* serial port.



Parallel port.

parallel printer *n.* A printer that is connected to the computer via a parallel interface. In general, a parallel connection can move data between devices faster than a serial connection can. The parallel interface is preferred in the IBM PC world because its cabling is more standardized than that of the serial interface and because the computer's operating system assumes that the system printer is attached to the parallel port. *See also* parallel interface. *Compare* serial printer.

parallel processing *n.* A method of processing that can run only on a computer that contains two or more processors running simultaneously. Parallel processing differs from multiprocessing in the way a task is distributed over the available processors. In multiprocessing, a process might be divided up into sequential blocks, with one processor managing access to a database, another analyzing the data, and a third handling graphical output to the screen. Programmers working with systems that perform parallel processing must find ways to divide a task so that it is more or less evenly distributed among the processors available. *Compare* coprocessor, multiprocessing.

P

parallel server *n.* A computer system that implements some form of parallel processing to improve its performance as a server. *See also* SMP server.

parallel transmission *n.* The simultaneous transmission of a group of bits over separate wires. With microcomputers, parallel transmission refers to the transmission of 1 byte (8 bits). The standard connection for parallel transmission is known as the Centronics interface. *See also* Centronics parallel interface. *Compare* serial transmission.

parameter *n.* In programming, a value that is given to a variable, either at the beginning of an operation or before an expression is evaluated by a program. Until the operation is completed, a parameter is effectively treated as a constant value by the program. A parameter can be text, a number, or an argument name assigned to a value that is passed from one routine to another. Parameters are used as a means of customizing program operation. *See also* argument, pass by address, pass by value, routine.

parameter-driven *adj.* Of, pertaining to, or being a program or an operation whose character or outcome is determined by the values of the parameters that are assigned to it.

parameter passing *n.* In programming, the substitution of an actual parameter value for a formal parameter when a procedure or function call is processed.

parameter RAM *n.* A few bytes of battery-backed CMOS RAM on the motherboards of Apple Macintosh computers. Information about the configuration of the system is stored in parameter RAM. *Acronym:* PRAM. *See also* CMOS RAM. *Compare* CMOS (definition 2).

PARC *n.* *See* Xerox PARC.

parent/child *adj.* **1.** Pertaining to or constituting a relationship between processes in a multitasking environment in which the parent process calls the child process and most often suspends its own operation until the child process aborts or is completed. **2.** Pertaining to or constituting a relationship between nodes in a tree data structure in which the parent is one step closer to the root (that is, one level higher) than the child.

parity *n.* The quality of sameness or equivalence, in the case of computers usually referring to an error-checking procedure in which the number of 1s must always be the same—either even or odd—for each group of bits trans-

mitted without error. If parity is checked on a per-character basis, the method is called vertical redundancy checking, or VRC; if checked on a block-by-block basis, the method is called longitudinal redundancy checking, or LRC. In typical modem-to-modem communications, parity is one of the parameters that must be agreed upon by sending and receiving parties before transmission can take place. *See* the table. *See also* parity bit, parity check, parity error.

Table P1 *Types of Parity.*

<i>Type</i>	<i>Description</i>
Even parity	The number of 1s in each successfully transmitted set of bits must be an even number.
Odd parity	The number of 1s in each successfully transmitted set of bits must be an odd number.
No parity	No parity bit is used.
Space parity	A parity bit is used and is always set to 0.
Mark parity	A parity bit is used and is always set to 1.

parity bit *n.* An extra bit used in checking for errors in groups of data bits transferred within or between computer systems. With PCs, the term is frequently encountered in modem-to-modem communications, in which a parity bit is often used to check the accuracy with which each character is transmitted, and in RAM, where a parity bit is often used to check the accuracy with which each byte is stored.

parity check *n.* The use of parity to check the accuracy of transmitted data. *See also* parity, parity bit.

parity error *n.* An error in parity that indicates an error in transmitted data or in data stored in memory. If a parity error occurs in communications, all or part of a message must be retransmitted; if a parity error occurs in RAM, the computer usually halts. *See also* parity, parity bit.

park *vb.* To position the read/write head over a portion of a disk that stores no data (and therefore can never be damaged) or beyond the surface of the disk, prior to shutting down the drive, especially in preparation for moving it. Parking can be performed manually, automatically, or by a disk utility program.



parrallaxing *n.* A 3-D animation technique, often used by computer game developers, where backgrounds are displayed using different levels of speed to achieve realism. For example, distant levels move at a slower speed than closer levels, thereby giving the illusion of depth. *See also* animation.

parse *vb.* To break input into smaller chunks so that a program can act upon the information.

parser *n.* An application or device that breaks data into smaller chunks so that an application can act on the information. *See also* parse.

partition *n.* **1.** A logically distinct portion of memory or a storage device that functions as though it were a physically separate unit. **2.** In database programming, a subset of a database table or file.

Partition Boot Sector *n.* The first sector in the system (startup) partition of a computer's bootable hard disk, or the first sector of a bootable floppy disk. On an x86-based computer, the Partition Boot Sector is read into memory at startup by the Master Boot Record. It is the Partition Boot Sector that contains the instructions required to begin the process of loading and starting the computer's operating system. *See also* Master Boot Record, partition table.

partition table *n.* A table of information in the first sector of a computer's hard disk that tells where each partition (discrete portion of storage) on the disk begins and ends. The physical locations are given as the beginning and ending head, sector, and cylinder numbers. In addition to these "addresses," the partition table identifies the type of file system used for each partition and identifies whether the partition is bootable—whether it can be used to start the computer. Although it is a small data structure, the partition table is a critical element on the hard disk.

partnership *n.* The settings on a desktop computer and Windows CE device that allow information to be synchronized, as well as copied or moved between the computer and device. The mobile device can have partnerships with up to two desktop computers. *See also* synchronization (definition 6).

Pascal *n.* A concise procedural language designed between 1967 and 1971 by Niklaus Wirth. Pascal, a compiled, structured language built upon ALGOL, simplifies syntax while adding data types and structures such as

subranges, enumerated data types, files, records, and sets. *See also* ALGOL, compiled language. *Compare* C.

pASP *n.* *See* pocket Active Server Pages.

pass¹ *n.* In programming, the carrying out of one complete sequence of events.

pass² *vb.* To forward a piece of data from one part of a program to another. *See also* pass by address, pass by value.

pass by address *n.* A means of passing an argument or parameter to a subroutine. The calling routine passes the address (memory location) of the parameter to the called routine, which can then use the address to retrieve or modify the value of the parameter. *Also called:* pass by reference. *See also* argument, call¹. *Compare* pass by value.

pass by reference *n.* *See* pass by address.

pass by value *n.* A means of passing an argument or a parameter to a subroutine. A copy of the value of the argument is created and passed to the called routine. When this method is used, the called routine can modify the copy of the argument, but it cannot modify the original argument. *See also* argument, call¹. *Compare* pass by address.

passivation *n.* In Sun Microsystems's J2EE network platform, the process of "turning off" an enterprise java bean (EJB) by caching it from memory to secondary storage. *See also* Enterprise JavaBeans, J2EE. *Compare* activation.

passive hub *n.* A type of hub used on ARCnet networks that passes signals along but has no additional capability. *See also* ARCnet. *Compare* active hub, Intelligent hub.

passive-matrix display *n.* An inexpensive, low-resolution liquid crystal display (LCD) made from a large array of liquid crystal cells that are controlled by transistors outside of the display screen. One transistor controls an entire row or column of pixels. Passive-matrix displays are commonly used in portable computers, such as laptops and notebooks, because of their thin width. While these displays have good contrast for monochrome screens, the resolution is weaker for color screens. These displays are also difficult to view from any angle other than straight on, unlike active-matrix displays. However, computers with passive-matrix displays are considerably cheaper than those with active-matrix screens. *See the illustration. Also called:* dual-scan display. *See also* liquid crystal display, supertwist display, transistor, twisted nematic display. *Compare* active-matrix display.

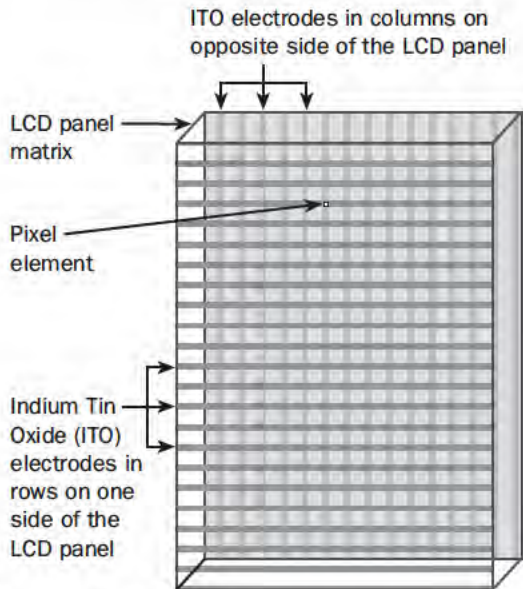

Passive-matrix display.

passive node *n.* A network node that “listens” for transmissions but is not actively involved in passing them along the network; typical of a node on a bus network. *See also* bus network, node (definition 2).

Passport *n.* A suite of personal identification services from Microsoft that consolidates user names, passwords, and other information. With the Passport single sign-in service, a user enters one name and password at any Passport site on the Internet; after signing in to one Passport site, a user can sign in to others without reentering the information. Passport also provides a server-based wallet service that stores credit card and billing information, a Kids Passport service, and a public-profile service. Passport is one of the foundation services of the Microsoft .NET initiative. *See also* .NET, .NET My Services, single sign-on, wallet.

pass-through *adj.* **1.** In general, a reference to something that acts as an intermediary between other entities. For example, a pass-through proxy server allows external access to an internal (protected) server by passing requests from the requesting client to the server without allowing direct access. **2.** Pertaining to a device or connector that

moves a signal or set of signals from the input to the output without making any changes. For example, a peripheral device such as a SCSI adapter might have a pass-through parallel I/O port for connecting a printer through the same connector.

password *n.* The string of characters entered by a user to verify his or her identity to the network. The system compares the code against a stored list of authorized passwords and users. If the code is legitimate, the system allows the user access at whatever security level has been approved for the owner of the password. Ideally a password is a combination of text, numbers, and punctuation or other characters that cannot be guessed at or easily cracked by intruders.

password attack *n.* An attack on a computer or network in which a password is stolen and decrypted or is revealed by a password dictionary program. The compromised password opens the network to the hacker and may also be used to reveal additional network passwords. *See also* password sniffing.

Password Authentication Protocol *n.* *See* PAP (definition 1).

password protection *n.* The use of passwords as a means of allowing only authorized users access to a computer system or its files.

password shadowing *n.* A security system in which an encrypted password is stored in a separate “shadow” file, and its place is taken by a token representing the password. Password shadowing is used as protection from password attacks. *See also* password attack, password sniffing.

password sniffing *n.* A technique employed by hackers to capture passwords by intercepting data packets and searching them for passwords. *Also called:* packet sniffing.

paste *vb.* To insert text or a graphic that has been cut or copied from one document into a different location in the same or a different document. *See also* cut, cut and paste.

patch¹ *n.* A piece of object code that is inserted in an executable program as a temporary fix for a bug.

patch² *vb.* In programming, to repair a deficiency in the functionality of an existing routine or program, generally in response to an unforeseen need or set of operating

P

circumstances. Patching is a common means of adding a feature or a function to a program until the next version of the software is released. *Compare* hack (definition 2), kludge (definition 2).

path *n.* **1.** In communications, a link between two nodes in a network. **2.** A route through a structured collection of information, as in a database, a program, or files stored on disk. **3.** In programming, the sequence of instructions a computer carries out in executing a routine. **4.** In information processing, such as the theory underlying expert (deductive) systems, a logical course through the branches of a tree of inferences leading to a conclusion. **5.** In file storage, the route followed by the operating system through the directories in finding, sorting, and retrieving files on a disk. **6.** In graphics, an accumulation of line segments or curves to be filled or drawn.

path menu *n.* In windowed environments, the menu or drop box used to enter the universal naming convention path to a shared network resource.

pathname *n.* In a hierarchical filing system, a listing of the directories or folders that lead from the current directory to a file. *Also called:* directory path.

pattern recognition *n.* **1.** A broad technology describing the ability of a computer to identify patterns. The term usually refers to computer recognition of visual images or sound patterns that have been converted to arrays of numbers. **2.** The recognition of purely mathematical or textual patterns.

Pause key *n.* **1.** A key on a keyboard that temporarily stops the operation of a program or a command. The Pause key is used, for example, to halt scrolling so that a multi-screen listing or document can be read. **2.** Any key that creates a pause in an operation. For example, many game programs have a Pause key, often simply the P key, that temporarily suspends the game.

payload *n.* The effects caused by a virus or other malicious code. The payload of a virus may include moving, altering, overwriting, and deleting files, or other destructive activity. A virus or worm may contain more than one payload, each with a separate trigger.

PB *n.* *See* petabyte.

PB SRAM *n.* *See* pipeline burst static RAM.

PBX *n.* Acronym for Private Branch Exchange. An automatic telephone switching system that enables users within an organization to place calls to each other without going through the public telephone network. Users can also place calls to outside numbers.

PC *n.* **1.** A microcomputer that conforms to the standard developed by IBM for personal computers, which uses a microprocessor in the Intel 80x86 family (or compatible) and can execute the BIOS. *See* the illustration. *See also* 8086, BIOS, clone, IBM PC. **2.** A computer in IBM's Personal Computer line. *Also called:* IBM PC. *See also* PC-compatible (definition 1), personal computer.



PC.

PCB *n.* *See* printed circuit board.

PC board *n.* *See* printed circuit board.

PC Card *n.* An add-in card that conforms to the PCMCIA specification. A PC Card is a removable device, approximately the same size as a credit card, that is designed to plug into a PCMCIA slot. Release 1 of the PCMCIA specification, introduced in June 1990, specified a Type I card that is 3.3 millimeters thick and is intended to be used primarily as a memory-related peripheral. Release 2 of the PCMCIA specification, introduced in September 1991, specifies both a 5-millimeter-thick Type II card and a 10.5-millimeter-thick Type III card. Type II cards accommodate devices such as modem, fax, and network cards. Type III cards accommodate devices that require more space, such as wireless communications devices and rotating storage media (such as hard disks). *See also* PCMCIA, PCMCIA slot.

PC Card slot *n.* See PCMCIA slot.

PC-compatible *adj.* Conforming to IBM PC/XT and PC/AT hardware and software specifications, which have been the de facto standard in the computing industry for personal computers that use the Intel 80x86 family or compatible chips. Most PC-compatible computers today are developed outside of IBM; they are still sometimes referred to as clones. *Also called:* IBM PC. *See also* 8086, clone, de facto standard, IBM AT, Wintel.

PC-DOS *n.* Acronym for **P**ersonal **C**omputer **D**isk **O**perating **S**ystem. The version of MS-DOS sold by IBM. MS-DOS and PC-DOS are virtually identical, although filenames of utility programs sometimes differ in the two versions. *See also* MS-DOS.

PC Expo *n.* Annual exposition centering on issues relating to the personal computer industry. PC Expo encompasses product exhibitions and educational events covering a wide range of topics affecting personal computing.

P-channel MOS *n.* See PMOS.

PCI *n.* See PCI local bus.

PCI card *n.* Short for **P**eripheral **C**omponent **I**nterconnect **C**ard. A card that fits into a PCI local bus to add functionality to a PC. Examples of the types of PCI cards available include TV tuner cards, video adapters, and network interface cards. *See also* card, PCI local bus.

PCI expansion slot *n.* A connection socket for a peripheral designed for the Peripheral Component Interconnect (PCI) local bus on a computer motherboard.

PCI Industrial Computer Manufacturers Group *n.* See PICMG.

PCI local bus *n.* Short for **P**eripheral **C**omponent **I**nterconnect **L**ocal **B**us. A specification introduced by Intel Corporation that defines a local bus system that allows up to 10 PCI-compliant expansion cards to be installed in the computer. A PCI local bus system requires the presence of a PCI controller card, which must be installed in one of the PCI-compliant slots. Optionally, an expansion bus controller for the system's ISA, EISA, or Micro Channel Architecture slots can be installed as well, providing increased synchronization over all the system's bus-installed resources. The PCI controller can exchange data with the system's CPU

either 32 bits or 64 bits at a time, depending on the implementation, and it allows intelligent, PCI-compliant adapters to perform tasks concurrently with the CPU using a technique called bus mastering. The PCI specification allows for multiplexing, a technique that permits more than one electrical signal to be present on the bus at one time. *See also* local bus. *Compare* VL bus.

PCIX *n.* **1.** Acronym for **P**eripheral **C**omponent **I**nterconnect **E**xtended. A computer bus technology developed by IBM, Compaq, and Hewlett-Packard that allows data to be transferred at greater speeds. PCIX increases the speed of data from 66 MHz to 133 MHz, but it will not run faster than the connected peripherals or computer processor will allow. PCI and PCIX peripherals are compatible with one another. *Also called:* PCI-X. **2.** Acronym for **P**ermission-based **C**ustomer **I**nformation **E**xchange. A framework for the organization and exchange of information between customer and vendor. PCIX allows different companies to map information into a customer-friendly, permission-based format without changing internal database structures.

PCL *n.* See Printer Control Language.

PCM *n.* See pulse code modulation.

PCMCIA *n.* Acronym for **P**ersonal **C**omputer **M**emory **C**ard **I**nternational **A**ssociation. A group of manufacturers and vendors formed to promote a common standard for PC Card-based peripherals and the slot designed to hold them, primarily on laptop, palmtop, and other portable computers, as well as for intelligent electronic devices. PCMCIA is also the name of the standard for PC Cards, first introduced in 1990 as release 1. *See also* PC Card, PCMCIA slot.

PCMCIA card *n.* See PC Card.

PCMCIA connector *n.* The 68-pin female connector inside a PCMCIA slot designed to hold the 68-pin male connector on a PC Card. *See also* PC Card, PCMCIA slot.

PCMCIA slot *n.* An opening in the housing of a computer, peripheral, or other intelligent electronic device designed to hold a PC Card. *Also called:* PC Card slot. *See also* PC Card, PCMCIA connector.

PC memory card *n.* **1.** An add-in circuit card that increases the amount of RAM in a system. *See also* memory card. **2.** A Type I PC Card as specified by PCMCIA. In



this context, such a card consists of conventional static RAM chips powered by a small battery and is designed to provide additional RAM to the system. *See also* PC Card. *Compare* flash memory.

PCMCIA device *n.* *See* PC Card.

p-code *n.* *See* pseudocode.

PCS *n.* *See* Personal Communications Services.

PCT *n.* **1.** Acronym for **program** comprehension tool. A software engineering tool that facilitates the process of understanding the structure and/or functionality of computer programs. **2.** Acronym for **Private Communications Technology**, a protocol standard drafted by Microsoft and submitted to the IETF for consideration. PCT, like the Netscape-designed SSL (Secure Sockets Layer), supports authentication and encryption for securing privacy in Internet communications. **3.** Acronym for **Personal Communications Technology**. An enhanced version of Secure Sockets Layer (SSL).

.pcx *n.* The file extension that identifies bitmapped images in the PC Paintbrush file format.

PC/XT *n.* The second-generation of the original IBM Personal Computer. The IBM PC/XT was introduced in 1983 and was the first of the PC computers to support hard disks. *See also* IBM PC.

PC/XT keyboard *n.* The keyboard for the PC/XT. Strong, reliable, and equipped with 83 keys, the PC/XT keyboard offers a typist an audible click. *See also* IBM PC, PC/XT.

PDA *n.* Acronym for **Personal Digital Assistant**. A light-weight palmtop computer designed to provide specific functions like personal organization (calendar, note taking, database, calculator, and so on) as well as communications. More advanced models also offer multimedia features. Many PDA devices rely on a pen or other pointing device for input instead of a keyboard or mouse, although some offer a keyboard too small for touch typing to use in conjunction with a pen or pointing device. For data storage, a PDA relies on flash memory instead of

power-hungry disk drives. *See also* firmware, flash memory, handheld PC, PC Card, pen computer.

PDC *n.* *See* Primary Domain Controller.

PD-CD drive *n.* Short for **phase change rewritable disc—compact disc drive**. A storage device that combines a CD-ROM drive and a phase change rewritable disc (PD) drive, which can store up to 650 megabytes of data on cartridges of rewritable optical discs. *See also* phase-change recording.

PDD *n.* Acronym for **Portable Digital Document**. A graphics file created from a document by QuickDraw GX under Mac OS. PDDs are stored in a form that is independent of printer resolution; they print at the highest resolution available on the printer used; and they can contain the original fonts used in the document. Therefore, a PDD can be printed by a computer other than the one on which it was created.

.pdf *n.* The file extension that identifies documents encoded in the Portable Document Format developed by Adobe Systems. To display or print a .pdf file, the user should obtain the freeware Adobe Acrobat Reader. *See also* Acrobat, Portable Document Format.

PDL *n.* *See* page-description language.

PDM *n.* *See* pulse duration modulation.

PDO *n.* *See* Portable Distributed Objects.

PDS *n.* **1.** Acronym for **Processor Direct Slot**. An expansion slot in Macintosh computers that is connected directly to the CPU signals. There are several kinds of PDS slots with different numbers of pins and different sets of signals, depending on which CPU is used in a particular computer. **2.** Acronym for **Parallel Data Structure**. A hidden file, located in the root directory of a disk that is shared under AppleShare, that contains access privilege information for folders.

Peachy virus *n.* A virus, first detected in 2001, that was the first to attempt to spread itself through PDF files. The Peachy virus takes advantage of an Adobe Acrobat feature that enables users to embed files in PDF documents. The embedded Peachy virus file infects the computer of a user

P

who downloads the PDF file and then opens the file in Adobe Acrobat.

peek *vb.* **1.** To read a byte from an absolute memory location. Peek commands are often found in programming languages such as Basic that do not normally allow access to specific memory locations. **2.** To look at the next character in a buffer associated with an input device without actually removing the character from the buffer.

peer *n.* Any of the devices on a layered communications network that operate on the same protocol level. *See also* network architecture.

peer-to-peer architecture *n.* A network of two or more computers that use the same program or type of program to communicate and share data. Each computer, or *peer*, is considered equal in terms of responsibilities and each acts as a server to the others in the network. Unlike a client/server architecture, a dedicated file server is not required. However, network performance is generally not as good as under client/server, especially under heavy loads. *Also called:* peer-to-peer network. *See also* peer, peer-to-peer communications, server. *Compare* client/server architecture.

peer-to-peer communications *n.* Interaction between devices that operate on the same communications level on a network based on a layered architecture. *See also* network architecture.

peer-to-peer network *n.* *See* peer-to-peer architecture.

PE file *n.* *See* portable executable file.

pel *n.* Short for **picture element**. *See* pixel.

PEM *n.* *See* Privacy Enhanced Mail.

pen *n.* *See* light pen, stylus.

pen-based computing *n.* The process of entering handwritten symbols into a computer via a stylus and pressure-sensitive pad. *See also* pen computer.

pen computer *n.* Any of a class of computers whose primary input device is a pen (stylus) instead of a keyboard. A pen computer is usually a smaller, handheld device and

has a flat semiconductor-based display such as an LCD display. It requires either a special operating system designed to work with the pen input device or a proprietary operating system designed to work with a specific-purpose device. The pen computer is the primary model for an emerging class of computers known as personal digital assistants (PDAs). *See also* clipboard computer, PC Card, PDA.

Penguin *n.* Slang for the Linux operating system or a Linux user. The name comes from the penguin character used as the Linux mascot. *See also* Tux.

pen plotter *n.* A traditional graphics plotter that uses pens to draw on paper. Pen plotters use one or more colored pens, either fiber-tipped pens or, for highest-quality output, drafting pens. *See also* plotter. *Compare* electrostatic plotter.

Pentium *n.* A family of 32-bit microprocessors introduced by Intel in March 1993 as the successor to the i486. The Pentium family is composed of superscalar, CISC-based microprocessors containing between 3 million (earlier models) and 28 million transistors. They have a 32-bit address bus, a 64-bit data bus, a built-in floating-point unit and memory management unit, built-in caches, and a System Management Mode (SMM), which provides the microprocessor with the ability to slow or halt some system components when the system is idle or performing non-CPU-intensive tasks, thereby lessening power consumption. The Pentium also employs *branch prediction*, resulting in faster system performance. In addition, the Pentium has built-in features to ensure data integrity, and it supports functional redundancy checking (FRC). The Pentium II introduced MMX media enhancement support. *See also* branch prediction, CISC, functional redundancy checking, i486DX, L1 cache, L2 cache, microprocessor, MMX, P5, SIMD, superscalar.

Pentium upgradable *n.* **1.** An i486 motherboard capable of being adapted to run a Pentium-class processor. *See also* i486DX, microprocessor, motherboard, Pentium.



2. A 486 PC that can be upgraded to Pentium class by adding a Pentium processor. *See also* i486DX.

perfboard *n.* Short for **perforated fiber board**. *See* bread-board.

performance monitor *n.* A process or program that appraises and records status information about various system devices and other processes.

period *n.* The length of time required for an oscillation to complete one full cycle. For an oscillating electrical signal, the period is the time between waveform repetitions. If f is the frequency of oscillation in hertz, and t is the period in seconds, then $t = 1/f$. *See* the illustration.

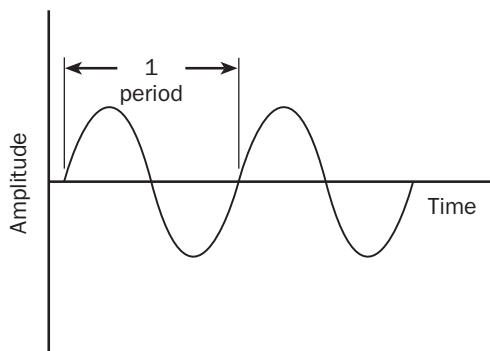

Period. *The period of an oscillating signal.*

peripheral *n.* In computing, a device, such as a disk drive, printer, modem, or joystick, that is connected to a computer and is controlled by the computer's microprocessor. *Also called:* peripheral device. *See also* console.

Peripheral Component Interconnect *n.* *See* PCI local bus.

peripheral device *n.* *See* peripheral.

peripheral power supply *n.* An auxiliary source of electricity used by a computer or a device as a backup in case of a power failure. *Acronym:* PPS.

Perl *n.* Acronym for **P**ractical **E**xtraction and **R**eport Language. An interpreted language, based on C and several UNIX utilities. Perl has powerful string-handling features for extracting information from text files. Perl can assemble a string and send it to the shell as a command; hence, it

is often used for system administration tasks. A program in Perl is known as a script. Perl was devised by Larry Wall at NASA's Jet Propulsion Laboratory.

permanent storage *n.* A recording medium that retains the data recorded on it for long periods of time without power. Ink on paper is by far the most widely used permanent storage, but data can be transferred from paper to a computer only with difficulty. Typically, some form of magnetic medium, such as floppy disk or tape, is preferable. Magnetic media are generally accepted as permanent, even though the magnetic fields that encode data in the media tend to fade eventually (in five years or more). *See also* nonvolatile memory.

permanent swap file *n.* In Windows, a file composed of contiguous disk sectors used for virtual memory operations. *See also* swap file, virtual memory.

permanent virtual circuit *n.* *See* PVC.

permission *n.* In a networked or multiuser computer environment, the ability of a particular user to access a particular resource by means of his or her user account. Permissions are granted by the system administrator or other authorized person. Several levels of access can be given: read only, read and write (view and change), or read, write, and delete. *Also called:* Access permission.

permission class *n.* A class that defines access to a resource or defines an identity by supporting authorization checks.

permission object *n.* An instance of a permission class that represents access rights to resources or identity. A permission object can be used to specify a request, a demand, or a grant of permission.

permissions log *n.* A file on a network or multiuser computer environment where permissions for users are stored. When a user attempts to access a resource on the system, the permissions log is checked to see whether the user has permission to use it.

perpendicular recording *n.* A method of increasing storage capacity on magnetic media by aligning the magnetic dipoles, whose orientation determines bit values, in a direction that is perpendicular to the recording surface. *Also called:* vertical recording.

P

per-pixel lighting *n.* A lighting scheme used in 3D computer game rendering and other digital animation applications that calculates proper lighting for every pixel displayed. Per-pixel lighting allows highly realistic lighting effects but requires significant video card capabilities to display properly. *Also called:* Phong shading.

Per Seat Licensing *n.* A licensing mode that requires a separate Client Access License for each client computer, regardless of whether all the clients access the server at the same time. *See also* client. *Compare* Per Server Licensing.

Per Server Licensing *n.* A licensing mode that requires a separate Client Access License for each concurrent connection to the server, regardless of whether there are other client computers on the network that do not happen to connect concurrently. *Compare* Per Seat Licensing.

persistence *n.* A characteristic of some light-emitting materials, such as the phosphors used in CRTs, that causes an image to be retained for a short while after being irradiated, as by an electron beam in a CRT. The decay in persistence is sometimes called *luminance decay*.

persistent client connection *n.* *See* persistent connection.

persistent connection *n.* A connection to a client that remains open after a server sends a response. Included in HTTP 1.1 and similar to the Netscape HTTP 1.0 Keep-Alive extension, persistent connections are used to improve Internet efficiency and performance by eliminating the overhead associated with multiple connections. *Also called:* persistent client connection. *See also* pipelining (definition 1).

persistent data *n.* Data that is stored in a database or on tape so that it is retained by the computer between sessions.

persistent link *n.* *See* hot link (definition 1).

persistent storage *n.* Memory that remains intact when the power to a device is turned off, such as ROM. *See also* memory.

Personal Communications Services *n.* Term used by the United States Federal Communications Commission (FCC) to cover a range of wireless, all-digital communications technologies and services, including cordless phones, voice mail, paging, faxing, and personal digital assistants (PDAs). Personal Communications Services, or PCS, is

divided into narrowband and broadband categories. Narrowband, which operates in the 900 MHz band of frequencies, provides paging, data messaging, faxing, and one- and two-way electronic messaging capabilities. Broadband, which operates in the 1850 MHz to 1990 MHz range and is considered the next-generation PCS, enables two-way voice, data, and video communications. The cellular phone technologies known as GSM (Global System for Mobile Communications), CDMA (Code Division Multiple Access), and TDMA (Time Division Multiple Access) are included in the PCS category. *Acronym:* PCS. *Compare* Code Division Multiple Access, Global Systems for Mobile Communications, Time Division Multiple Access.

personal computer *n.* A computer designed for use by one person at a time. Personal computers do not need to share the processing, disk, and printer resources of another computer. IBM PC-compatible computers and Apple Macintoshes are both examples of personal computers. *Acronym:* PC.

Personal Computer *n.* *See* IBM PC.

Personal Computer Memory Card International Association *n.* *See* PCMCIA.

personal digital assistant *n.* *See* PDA.

personal finance manager *n.* A software application designed to assist the user in performing simple financial accounting tasks, such as balancing checkbooks and paying bills.

Personal Handyphone System *n.* A device developed in Japan to act as a cellular phone that can handle phone, FAX, and voice. *Acronym:* PHS.

personal identification number *n.* *See* PIN.

personal information manager *n.* *See* PIM.

personalization technology *n.* An e-commerce marketing technique in which Web sites and services analyze the interests of individual customers. The e-business then uses this information to deliver services, product offerings, and advertising that match each customer's personal interests.

Personal Web Server *n.* Microsoft applications that allow a computer running the Windows family of operating systems to function as a Web server for publishing personal Web pages and intranet sites. Personal Web



Server is available as part of Microsoft Windows NT 4.0 Option Pack (NTOP), Windows 98, and Windows 95 OEM Service Release 2. FrontPage Personal Web Server is available as part of FrontPage 1.1, FrontPage 97, FrontPage 98, and FrontPage 2000.

perspective view *n.* In computer graphics, a display method that shows objects in three dimensions (height, width, and depth), with the depth aspect rendered according to the desired perspective. An advantage of perspective view is that it presents a more accurate representation of what the human eye perceives. *Compare* isometric view.

peta- *prefix* Denotes 1 quadrillion (10^{15}). In computing, which is based on the binary (base 2) numbering system, *peta-* has a literal value of 1,125,899,906,842,624, which is the power of 2 (2^{50}) closest to 1 quadrillion. *Abbreviation:* P.

petabyte *n.* Either 1 quadrillion bytes or 1,125,899,906,842,624 bytes. *Abbreviation:* PB.

PGA *n.* See pin grid array, Professional Graphics Adapter.

PgDn key *n.* See Page Down key.

PGP *n.* Acronym for **Pretty Good Privacy**. A program for public key encryption, using the RSA algorithm, developed by Philip Zimmermann. PGP software is available in unsupported free versions and supported commercial versions. See also privacy, public key encryption, RSA encryption.

PgUp key *n.* See Page Up key.

phage virus *n.* A destructive virus that affects the Palm operating system (OS). Phage copies itself, overwriting application files and destroying them. Once the first host file is infected, Phage will spread to all available files. Phage may be spread from one Palm device to another by beaming or connection with a docking station. Phage was one of the first viruses created specifically to affect handheld wireless devices and the first to impact the Palm OS.

phase *n.* A relative measurement that describes the temporal relationship between two signals that have the same frequency. Phase is measured in degrees, with one full oscillation cycle having 360 degrees. The phase of one signal can lead or follow the other by 0 through 180 degrees. See the illustration.

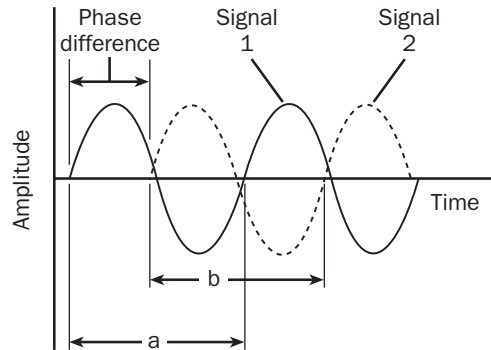

Phase. *The ratio of a to b is the phase difference, expressed in degrees.*

phase-change recording *n.* In optical media, a recording technique that uses a laser beam focused on a microscopic portion of metallic crystal to alter the reflectiveness of its structure in such a way that the change can be read as a 0 bit or 1 bit, depending on whether the resulting structure reflects or absorbs the laser light. See also PD-CD drive.

phase encoding *n.* **1.** The process of placing digital information on an analog carrier wave while periodically changing the phase of the carrier to increase the bit density of the transmission. See also Manchester coding, phase. **2.** A recording technique used with magnetic storage devices in which each data-holding unit is divided into two parts, each of which is magnetized so that it is opposite in polarity to the other.

phase-locked *adj.* Of, pertaining to, or characteristic of the relationship between two signals whose phases relative to each other are kept constant by a controlling mechanism, such as an electronic device.

phase modulation *n.* A method of imposing information onto a waveform signal by shifting the phase of the wave to represent information, such as the binary digits 0 and 1. See the illustration. See also phase-shift keying.

P

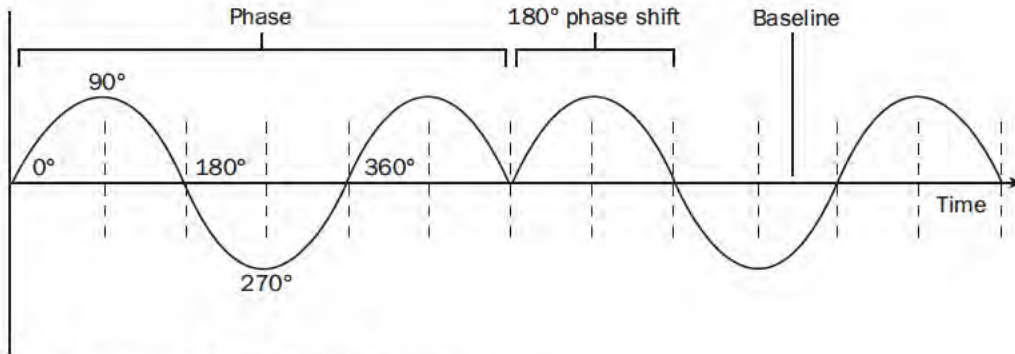

Phase modulation. A phase shift of 180 degrees.

phase-shift keying *n.* A communications method used by modems to encode data that relies on phase shifts in a carrier wave to represent digital information. In its simplest form, phase-shift keying allows the phase of the carrier wave to be in either of two states: shifted 0 degrees or shifted 180 degrees, effectively reversing the phase of the wave. This straightforward phase-shift keying, however, is useful only when each phase can be measured against an unchanging reference value, so a more sophisticated technique called *differential phase-shift keying*, or *DPSK*, is used in many modems. In differential phase-shift keying, the phase of the carrier wave is shifted to represent more than two possible states, and each state is interpreted as a relative change from the state preceding it. No reference values or timing considerations are required and because more than two states are possible, more than one binary digit can represent each state. *Acronym:* PSK. *See also* phase modulation.

Phoenix BIOS *n.* An IBM-compatible ROM BIOS manufactured by Phoenix Technologies, Ltd. A popular ROM BIOS in many so-called PC clone computers, the Phoenix BIOS was an early leader among the IBM-compatible computers shortly after they began to appear in the marketplace. *See also* BIOS, ROM BIOS. *Compare* AMI BIOS.

phone connector *n.* An attachment, usually an RJ-11 connector, used to join a telephone line to a device such as a modem. *See the illustration.*

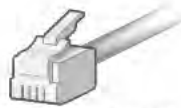

Phone connector.

phoneline networking *n.* The use of telephone wiring for connecting computers and other devices in a small network, such as a home network. *See also* HomePNA.

phoneme *n.* In linguistics, the smallest unit of speech that distinguishes one word sound from another. Phonemes are the elements on which computer speech is based.

phono connector *n.* An attachment used to connect a device, such as a microphone or a pair of headphones, to a piece of audio equipment or to a computer peripheral or adapter with audio capability. *See the illustration.*



Phono connector.

phosphor *n.* Any substance capable of emitting light when struck by radiation. The inside surface of a CRT screen is coated with a phosphor that, when excited by an electron beam, displays an image on the screen. *See also* persistence.

P

PhotoCD *n.* A digitizing system from Kodak that allows 35mm film pictures, negatives, slides, and scanned images to be stored on a compact disc. Images are stored in a file format called Kodak PhotoCD IMAGE PAC File Format, or PCD. Many photography or film development businesses offer this service. Images stored on a PhotoCD can usually be viewed by any computer with CD-ROM capabilities and the software required to read PCD. Such images can also be viewed using one of a variety of players designed to display images stored on CDs.

photo cell *n.* *See* photoelectric device.

photocomposition *n.* In traditional typesetting, the use of photographic and electronic equipment in laying out and producing a printed page. In desktop publishing, phototypesetters are used to accomplish the same ends. *See also* phototypesetter. *Compare* imagesetter.

photoconductor *n.* A material that exhibits increased conductivity when it is exposed to a source of light. Photoconductors are used in photodetectors, which are used in fiber optics to register light and convert it into electrical pulses. *See also* fiber optics.

photo editor *n.* A graphics application used to manipulate an image, such as a scanned photograph, digitally.

photoelectric device *n.* A device that uses light to create or modulate an electric signal. A photoelectric device uses semiconductor material and falls in one of two categories. In one type (photocell), light falling on the semiconductor generates an electrical current. In another type of device (photosensor), light changes the resistance of the semiconductor material, modulating an applied voltage.

photolithography *n.* A technique used in the fabrication of integrated circuits. The circuit pattern is drawn, photographed, and reduced to a negative having the desired final size. This negative is called the *photomask*. Light is passed through the photomask onto a wafer made of semiconductor material that has been coated with a photoresistive material. Where light strikes the photoresistive material, its composition is changed. In the next step, the photoresistive material not affected by light is washed off. Finally, the semiconductor material is exposed to an etching solution that eats away the surface not protected by the photoresistive material, creating the desired circuit pattern on the surface of the wafer. *See also* photomask, photoresist.

photomask *n.* A photographic negative image of a circuit pattern used in fabrication of integrated circuits. *See also* photolithography.

photonics *n.* Optoelectronic systems that transmit visible light or infrared energy. Photonic systems are used with fiber optic networks and optical circuits. Photonic networks offer dramatic increases in speed and bandwidth, allowing significantly greater amounts of information to be encoded and transmitted than with traditional cabling solutions.

photorealism *n.* The process of creating images that are as close to photographic or “real-life” quality as possible. In computer graphics, photorealism requires powerful computers and highly sophisticated software and is heavily mathematical. *See also* ray tracing.

photoresist *n.* A compound that is used in photolithographic fabrication of integrated circuits and printed circuit boards. When exposed to ultraviolet light through a photomask, the photoresistive material exposed to the light polymerizes (hardens); the areas not exposed can be washed away, leaving the pattern of traces on the substrate. Subsequent etching removes areas not protected by the polymerized photoresist.

photosensor *n.* *See* photoelectric device.

Photoshop *n.* Adobe software product for digital image editing and enhancement, photo retouching, and color management of graphic images. Photoshop includes such features as multiple undo, text editing with formatting control, and enhanced color management and controls. The program supports numerous Web and graphics file formats and runs on both the Windows and Power Macintosh platforms.

phototypesetter *n.* A printer similar to a laser printer but capable of resolutions over 2,000 dots per inch. Phototypesetters apply light directly to a photographic film or photosensitive paper. *See also* photocomposition. *Compare* imagesetter.

photovoltaic cell *n.* *See* solar cell.

PHP *n.* Acronym for **PHP: Hypertext Preprocessor**. An open source scripting language used with HTML documents to execute server-side interactive functions. PHP runs on all major operating systems and is primarily used with Linux and UNIX Web servers or on Windows servers with add-on software. PHP may be embedded in a Web

P

page and used to access and present database information. An HTML document that contains a PHP script usually has a .php filename extension. Originally PHP stood for “Personal Home Page,” with later versions standing for “PHP Hypertext Preprocessor” or simply PHP. The syntax of PHP is fairly simple and very similar to that of Perl, with some aspects of Bourne shell, JavaScript, and C. It can also be regarded as a technology (server-side environment for ported script engines, like ASP).

phreak¹ *n.* A person who breaks into, or *cracks*, telephone networks or other secured systems. In the 1970s, the telephone system used audible tones as switching signals, and *phone phreaks* used homebrew hardware to match the tones and steal long-distance service. *See also* homebrew. *Compare* cracker, hacker (definition 2).

phreak² *vb.* To break into, or *crack*, phone networks or computer systems. *See also* homebrew. *Compare* hack.

PHS *n.* *See* Personal Handyphone System.

physical *adj.* In computing, of, pertaining to, or characteristic of a real, as opposed to a conceptual, piece of equipment or frame of reference. *Compare* logical (definition 2).

physical address *n.* An address that corresponds to a hardware memory location. In simple processors such as the 8088 and the 68000, every address is a physical address. In processors supporting virtual memory, programs reference virtual addresses, which are then mapped by memory management hardware onto physical addresses. *Also called:* hardware address. *See also* memory management unit, paging, virtual memory.

physical-image file *n.* A hard disk copy of the material to be recorded onto a CD-ROM. Creating a complete copy precludes problems in writing the CD-ROM because of delays in assembling the material from a scattered group of files. *See also* CD-ROM. *Compare* virtual-image file.

physical layer *n.* The first, or lowest, of the seven layers in the ISO/OSI reference model for standardizing computer-to-computer communications. The physical layer is totally hardware-oriented and deals with all aspects of establishing and maintaining a physical link between communicating computers. Among specifications covered on the physical layer are cabling, electrical signals, and mechanical connections. *See the illustration. See also* ISO/OSI reference model.

ISO/OSI MODEL	
ISO/OSI Layer	Focus
Application <i>(highest level)</i>	Program-to-program transfer of information
Presentation	Text formatting and display, code conversion
Session	Establishing, maintaining, and coordinating communication
Transport	Accurate delivery, service quality
Network	Transport routes, message handling and transfer
Data-link	Coding, addressing, and transmitting information
Physical	Hardware connections

Physical layer. *Lowest layer in the ISO/OSI reference model.*

physical memory *n.* Memory actually present in the system, as opposed to virtual memory. A computer might have 64 megabytes of physical RAM but support a virtual memory capacity of 1 gigabyte or more. *Compare* virtual memory.

physical network *n.* One of two ways of describing the topology, or layout, of a computer network; the other is logical network. A physical network refers to the actual configuration of the hardware forming a network—that is, to the computers, connecting hardware, and especially the cabling patterns that give the network its shape. Basic physical layouts include the bus, ring, and star topologies. *See also* bus network, logical network, ring network, star network.

physical storage *n.* *See* real storage.

pi *n.* A mathematical constant equal to approximately 3.1415926535897932, describing the ratio of the circumference of a circle to its diameter.

PIC *n.* *See* programmable interrupt controller.

pica *n.* **1.** With reference to typewriters, a fixed-width type font that fits 10 characters to the linear inch. *See also* pitch. **2.** As used by typographers, a unit of measure equal to 12 points or approximately 1/6 inch. *See also* point¹ (definition 1).

P

PICMG *n.* Acronym for the PCI Industrial Computer Manufacturers Group. A consortium of more than 350 computer product vendors, this non-profit organization develops specifications for PCI-based devices, such as the CompactPCI specification. *See also* CompactPCI.

pico- *prefix* Denotes one trillionth (10^{-12}), or, in the British numbering system, one million millionth.

Abbreviation: p.

picoJava *n.* A microprocessor developed by Sun Microsystems, Inc., that executes Java code. *See also* Java.

picosecond *n.* One trillionth of a second.

Abbreviation: psec.

PICS *n.* *See* Platform for Internet Content Selection.

.pict *n.* The file extension that identifies graphic images in the Macintosh PICT format. *See also* PICT.

PICT *n.* A file-format standard for encoding graphical images, both object-oriented and bitmapped. The PICT file format was first used in Macintosh applications, but many PC applications can read the format too. *See also* bitmapped graphics, object-oriented graphics.

picture element *n.* *See* pixel.

pie chart *n.* A type of graph that presents values as percentages (slices) of a whole (a pie).

piezoelectric *adj.* Of, pertaining to, or characteristic of crystals that can convert between mechanical and electrical energy. An electric potential applied to a piezoelectric crystal causes a small change in the shape of the crystal. Likewise, physical pressure applied to the crystal creates an electrical potential difference between the surfaces of the crystal.

piggyback board *n.* A printed circuit board that plugs into another circuit board to enhance its capabilities. A piggyback board is sometimes used to replace a single chip, in which case the chip is removed and the piggyback board is inserted into the empty socket. *See also* daughterboard.

Pilot *n.* A series of popular handheld personal digital assistants (PDAs) designed by Palm and based on the Palm OS operating system. Palm introduced its first Pilot model in 1996, followed in 1997 by the PalmPilot, and thereafter by a series of other Palm handheld models.

PILOT *n.* Acronym for Programmed Inquiry, Learning or Teaching. A programming language developed in 1976 by John A. Starkweather and designed primarily for creating applications for computer-aided instruction.

PIM *n.* Acronym for **personal information manager**. An application that usually includes an address book and organizes unrelated information, such as notes, appointments, and names, in a useful way.

pin *n.* A slender prong. Pins are commonly encountered as the contacts protruding from a male connector. Connectors are often identified by the number of pins they have. Other types of pins are the spidery, leglike metal appendages that connect computer chips to sockets on a circuit board or directly to the circuit board. *See* the illustration.

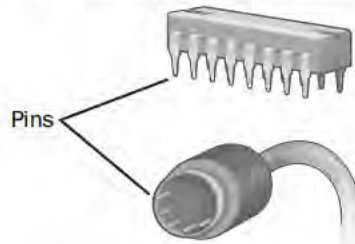

Pin. A 16-pin DIP (top) and a 6-pin DIN (bottom).

PIN *n.* Acronym for **personal identification number**. A unique code number used to gain access to personal information or assets via an electronic device. PINs are used by a variety of electronic services such as automated bank tellers, Internet sites, and wireless phone services.

pinch roller *n.* A small cylindrical pulley that presses magnetic tape against the drive's capstan to move the tape over the tape machine's heads. *See also* capstan.

pinch-roller plotter *n.* A type of plotter, intermediate between drum and flatbed types, that uses hard rubber or metal wheels to hold the paper against the main roller. *See also* plotter. *Compare* drum plotter, flatbed plotter.

pin-compatible *adj.* Having pins that are equivalent to the pins on another chip or device. A chip, for example, might have different internal circuitry from that used in another chip, but if the two chips use the same pins for input and output of identical signals, they are pin-compatible. *Compare* plug-compatible.

pine *n.* Acronym for **pine** is **not** elm, or for **P**rogram for **I**nternet **N**ews and **E**-mail. One of the most commonly encountered programs for reading and composing e-mail on character-based UNIX systems. The pine program was developed as an improved version of elm at the University of Washington. *Compare* elm.

pin feed *n.* A method of feeding paper through a printer in which small pins, mounted on rollers on the ends of the platen, engage holes near the edges of continuous-form paper. *See also* continuous-form paper, paper feed. *Compare* tractor feed.

ping¹ *n.* **1.** Acronym for **P**acket **I**nternet **G**roper. A protocol for testing whether a particular computer is connected to the Internet by sending a packet to its IP address and waiting for a response. The name actually comes from submarine active sonar, where a sound signal—called a “ping”—is broadcast, and surrounding objects are revealed by their reflections of the sound. **2.** A UNIX utility that implements the ping protocol.

ping² *vb.* **1.** To test whether a computer is connected to the Internet using the ping utility. **2.** To test which users on a mailing list are current by sending e-mail to the list asking for a response.

Ping of Death *n.* A form of Internet vandalism that entails sending a packet that is substantially larger than the usual 64 bytes over the Internet via the ping protocol to a remote computer. The size of the packet causes the computer to crash or reboot. *See also* packet (definition 2), ping¹ (definition 1).

ping packet *n.* An “are you there” message transmitted by a Packet Internet Groper program. A ping packet is sent from one node to the IP (Internet Protocol) address of a network computer to determine whether that node is able to send and receive transmissions. Many shareware and freeware ping utilities for PCs are available for download from the Internet. *See also* ping¹ (definition 1), packet¹ (definition 1).

ping pong *n.* **1.** In communications, a technique that changes the direction of transmission so that the sender becomes the receiver and vice versa. **2.** In information processing and transfer, the technique of using two temporary storage areas (buffers) rather than one to hold both input and output.

ping-pong buffer *n.* A double buffer in which each part is alternately filled and flushed, resulting in a more or less continuous stream of input and output data. *See also* ping pong (definition 2).

pin grid array *n.* A method of mounting chips on boards, preferred for chips with a very large number of pins. Pin grid array packages have pins protruding from the bottom surface of the chip, as opposed to dual in-line packages and leadless chip carrier packages, which have pins protruding from the edges. *Acronym:* PGA. *Compare* DIP, leadless chip carrier.

pink contract *n.* A non-standard addendum to a contract with an Internet service provider (ISP), specifically offering the client the opportunity to send unsolicited commercial e-mail and put up spam-related Web sites. *See also* spam.

pinout *n.* A description or diagram of the pins of a chip or connector. *See also* pin.

PIO *n.* Acronym for **P**rogrammed **I**nput/**O**utput (or, less frequently, Processor Input/Output). One of two transfer methods used in moving data between a disk drive and memory. With PIO, the disk controller moves a block of data into the CPU’s registers, and the CPU then moves the data to its intended destination. PIO is characteristic of IDE drives. The alternative data-transfer method, direct memory access (DMA), bypasses the CPU and moves data directly between disk and memory. *See also* Bus, bus mastering, controller. *Compare* direct memory access.

pipe *n.* **1.** A portion of memory that can be used by one process to pass information along to another. Essentially, a pipe works like its namesake: it connects two processes so that the output of one can be used as the input to the other. *See also* input stream, output stream. **2.** The vertical line character (|) that appears on a PC keyboard as the shift character on the backslash (\) key. **3.** In MS-DOS and UNIX, a command function that transfers the output of one command to the input of a second command.

pipeline burst static RAM *n.* A type of static RAM that uses burst and pipelining technologies to increase the speed at which information can be provided to a computer’s CPU. By pipelining requests so that one is being acted upon at the same time the next is getting underway, pipeline burst static RAM, or PB SRAM, can provide information to the CPU at high speed. PB SRAM is used in L2 caches (rapid-response memory dedicated to storing

P

frequently requested data) on computers running at bus speeds of 75 MHz or higher. *Acronym:* PB SRAM. *See also* burst (definition 2), L2 cache, pipelining, static RAM. *Compare* asynchronous static RAM, dynamic RAM, synchronous burst static RAM.

pipeline processing *n.* A method of processing on a computer that allows fast parallel processing of data. This is accomplished by overlapping operations using a *pipe*, or a portion of memory that passes information from one process to another. *See also* parallel processing, pipe (definition 1), pipelining (definition 3).

pipelining *n.* **1.** A method of fetching and decoding instructions (preprocessing) in which, at any given time, several program instructions are in various stages of being fetched or decoded. Ideally, pipelining speeds execution time by ensuring that the microprocessor does not have to wait for instructions; when it completes execution of one instruction, the next is ready and waiting. *See also* superpipelining. **2.** In parallel processing, a method in which instructions are passed from one processing unit to another, as on an assembly line, and each unit is specialized for performing a particular type of operation. **3.** The use of pipes in passing the output of one task as input to another until a desired sequence of tasks has been carried out. *See also* pipe (definition 1), pour.

piracy *n.* **1.** The theft of a computer design or program. **2.** Unauthorized distribution and use of a computer program.

.pit *n.* A file extension for an archive file compressed with PackIT. *See also* PackIT.

pitch *n.* A measure, generally used with monospace fonts, that describes the number of characters that fit in a horizontal inch. *See also* characters per inch, screen pitch. *Compare* point¹ (definition 1).

PivotChart *adj.* A graphical tool in Microsoft Excel or Access that can be used to display data from a list or database in chart form. Based on user-selected information incorporated in an Excel PivotTable report or list, a PivotChart report provides the ability to chart the data interactively—for example, to “pivot” the chart’s point of view from product sales by category to product sales by region or by salesperson. *See also* PivotTable.

PivotTable *adj.* An interactive table in Microsoft Excel or Access that can show the same data from a list or a database in more than one arrangement. A user can manipulate the rows and columns in a PivotTable to view or summarize the information in different ways for purposes of analysis. In Excel, a PivotTable report is the basis for creating a PivotChart report that displays the same data in chart form. *See also* PivotChart.

pivot year *n.* In Year 2000 windowing, a date in a 100-year period that serves as the point from which correct dates can be calculated in systems or software that can store only 2-digit years. For example, a pivot year of 1970 means that the numbers 70 through 99 are interpreted as the years 1970 to 1999, and the numbers 00 through 69 as the years 2000 through 2069. *See also* windowing.

pixel *n.* Short for picture (**pix**) element. One spot in a rectilinear grid of thousands of such spots that are individually “painted” to form an image produced on the screen by a computer or on paper by a printer. A pixel is the smallest element that display or print hardware and software can manipulate in creating letters, numbers, or graphics. *See* the illustration. *Also called:* pel.

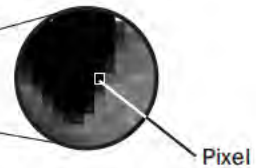
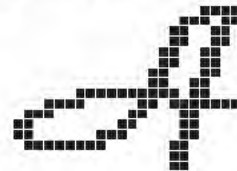

Pixel. *The letter A is actually made up of a pattern of pixels in a grid, as is the cat's eye.*

pixel image *n.* The representation of a color graphic in a computer's memory. A pixel image is similar to a bit image, which also describes a screen graphic, but a pixel image has an added dimension, sometimes called depth, that describes the number of bits in memory assigned to each on-screen pixel.

P

pixel map *n.* A data structure that describes the pixel image of a graphic, including such features as color, image, resolution, dimensions, storage format, and number of bits used to describe each pixel. *See also* pixel, pixel image.

PJL *n.* *See* Printer Job Language.

PJ/NF *n.* Acronym for **projection-join normal form**. *See* normal form (definition 1).

PKUNZIP *n.* A shareware utility program that uncompresses files compressed by the PKZIP shareware utility program. PKUNZIP is generally made available with PKZIP; distribution of PKUNZIP for commercial purposes is not permitted without obtaining permission from its publisher, PKware, Inc. *See also* PKZIP.

PKZIP *n.* A widely used shareware utility program for compressing files. Developed by PKware, Inc., in 1989 and available from a wide variety of sources, PKZIP can combine one or more files into a compressed output file having the extension .zip. A companion utility program, PKUNZIP, is required to uncompress the compressed files. *See also* PKUNZIP, shareware, utility program.

PLA *n.* Acronym for **programmable logic array**. *See* field-programmable logic array.

placeholder *n.* **1.** A character that masks or hides another character for security reasons. For example, when a user types a password, an asterisk is displayed on the screen to take the place of each character typed. **2.** Text or some other element used in an application as an indicator that the user should enter in his or her own text.

Plain Old Telephone Service *n.* *See* POTS.

plaintext *n.* **1.** Nonencrypted or decrypted text. *See also* decryption, encryption. **2.** A file that is stored as plain ASCII data. *Compare* ciphertext.

plain vanilla *adj.* Ordinary; the standard version of hardware or software without any enhancements. For example, a plain vanilla modem might have data transfer capability but no fax or voice features.

.plan *n.* A file in a UNIX user's home directory that is displayed when other users finger that account. Users can enter information into .plan files at their discretion to provide information in addition to that normally displayed by the finger command. *See also* finger.

planar *adj.* **1.** In computer graphics, lying within a plane. **2.** In the fabrication of semiconductor materials, maintaining the original flat surface of the silicon wafer throughout processing, while the chemicals that make up the elements that control the flow of current are diffused into (and beneath) the surface.

planar transistor *n.* A special form of transistor that is fabricated with all three elements (collector, emitter, and base) on a single layer of semiconductor material. The structure of a planar transistor permits it to dissipate relatively large amounts of heat, making this design suitable for power transistors. *See* the illustration.

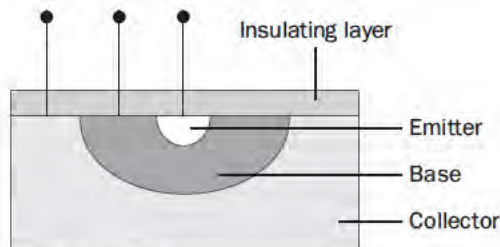

Planar transistor.

plasma display *n.* *See* gas-discharge display.

plastic leadless chip carrier *n.* *See* PLCC.

plastic transistor *n.* A transistor produced entirely from plastic rather than the traditional silicon. A plastic transistor is flexible enough to be embedded in curved surfaces or folded. Production of plastic transistors begins with a thin piece of clear plastic, onto which layers of plastic are printed or sprayed through a mesh. The result is a lightweight, flexible and transparent transistor that can be manufactured in high volumes for a fraction of the cost of silicon transistors. The flexibility and low-cost of plastic transistors make them useful in applications from transparent foldable displays to one-use product containers. *See also* electronic paper.

platen *n.* The cylinder in most impact printers and typewriters, around which the paper wraps and against which the print mechanism strikes the paper. The paper bail, a spring-loaded bar with small rollers, holds the paper smoothly against the platen just above the print mechanism.

platform *n.* **1.** The foundation technology of a computer system. Because computers are layered devices composed

P

of a chip-level hardware layer, a firmware and operating-system layer, and an applications program layer, the bottommost layer of a machine is often called a platform.

2. In everyday usage, the type of computer or operating system being used.

Platform for Internet Content Selection *n.* A specification for rating and labeling Internet content. Originally developed by the World Wide Web Consortium to enable parents, teachers, administrators, and other caretakers to control the material to which children have online access, its use has expanded to include the protection of privacy and intellectual property. PICS is not itself a system for rating Internet content. Rather, it specifies the format conventions to be used by rating systems in devising labels that can be read by PICS-compatible software. *Acronym:* PICS.

Platform for Privacy Preference Project *n.* See P3P.

Platform for Privacy Preferences *n.* See P3P.

platform invoke *n.* The functionality provided by the run time to enable managed code to call unmanaged native DLL entry points.

platter *n.* One of the individual metal data storage disks within a hard disk drive. Most hard disks have from two to eight platters. See the illustration. See also hard disk.



Platter.

player *n.* In relation to digital audio, a program that plays music and other audio files that have been ripped (transferred from a compact disc to a hard disk) and then encoded in a playable format, such as MP3. See also encoder, MP3, ripper.

PlayStation *n.* Sony Corporation's console computer entertainment gaming system. PlayStation 2, the latest version, is a 128-bit system that features a 300-MHz pro-

cessor, 32 MB of Direct RDRAM main memory, and a floating-point performance of 6.2 GFLOPS. PlayStation 2 also offers the capability to play CDs and DVDs. See also computer game, console game. Compare Dreamcast, GameCube, Xbox.

PL/C *n.* A version of the PL/I programming language developed at Cornell University and used on mainframe computers. See also PL/I.

PLCC *n.* Acronym for plastic leadless chip carrier. An inexpensive variation of the leadless chip carrier (LCC) method of mounting chips on boards. Although the two carriers are similar in appearance, PLCCs are physically incompatible with leadless chip carriers, which are made from a ceramic material. See also leadless chip carrier.

PLD *n.* See programmable logic device.

PL/I *n.* Acronym for Programming Language I (One). A programming language developed by IBM (1964–1969), designed to bring together the key features of FORTRAN, COBOL, and ALGOL while introducing such new concepts as condition-based error handling and multitasking. The result of this effort was a compiled, structured language that was so complex that it never gained widespread acceptance. Nevertheless, PL/I is still used in some academic and research environments. See also ALGOL, COBOL, compiled language, FORTRAN.

PL/M *n.* Acronym for Programming Language for Microcomputers. A programming language derived from PL/I and developed in the early 1970s by Intel Corporation for microprocessors. PL/M was used primarily for the creation of operating systems. See also PL/I.

plot *vb.* To create a graphic or a diagram by connecting points representing variables (values) that are defined by their positions in relation to a horizontal (*x*) axis and a vertical (*y*) axis (and sometimes a depth, or *z*, axis).

plotter *n.* Any device used to draw charts, diagrams, and other line-based graphics. Plotters use either pens or electrostatic charges and toner. Pen plotters draw on paper or transparencies with one or more colored pens. Electrostatic plotters “draw” a pattern of electrostatically charged dots on the paper and then apply toner and fuse it in place. Plotters use three basic types of paper handling: flatbed,

drum, and pinch roller. Flatbed plotters hold the paper still and move the pen along both *x* and *y* axes. Drum plotters roll the paper over a cylinder. The pen moves along one axis while the drum, with the paper attached, moves along the other. Pinch-roller plotters are a hybrid of the two, in which the pen moves only along one axis while the paper is moved back and forth by small rollers.

PL/SQL *n.* Short for **Procedural Language Extension to SQL**. Oracle's data manipulation language that allows sequenced or grouped execution of SQL statements and is commonly used to manipulate data in an Oracle database. The syntax is similar to the Ada programming language.

plug *n.* A connector, especially a male connector, one that fits into a socket. *See also* male connector.

plug and play *n.* **1.** Generally, a reference to the ability of a computer system to automatically configure a device added to it. Plug and play capability exists in Macintoshes based on the NuBus and, since Windows 95, on PC-compatible computers. **2.** When capitalized and, especially, when abbreviated PnP, a set of specifications developed by Intel and Microsoft that allows a PC to configure itself automatically to work with peripherals such as monitors, modems, and printers. A user can plug in a peripheral and "play" it without manually configuring the system. A Plug and Play PC requires both a BIOS that supports Plug and Play and a Plug and Play expansion card. *Abbreviation:* PnP. *See also* BIOS, expansion board, peripheral.

plugboard *n.* A board that permits users to control the operation of a device by plugging cables into sockets.

plug-compatible *adj.* Equipped with connectors that are equivalent both in structure and in usage. For example, most modems having DB-25 connectors on their rear panels are plug-compatible—that is, one can be replaced by another without the cable having to be rewired. *Compare* pin-compatible.

plug-in *n.* **1.** A small software program that plugs into a larger application to provide added functionality. **2.** A software component that plugs into the Netscape Navigator. Plug-ins permit the Web browser to access and execute files embedded in HTML documents that are in formats the browser normally would not recognize, such as many animation, video, and audio files. Most plug-ins are devel-

oped by software companies who have proprietary software in which the embedded files are created. *Compare* helper application.

p-machine *n.* *See* pseudomachine.

PMML *n.* Acronym for **Predictive Model Markup Language**. An XML-based language that enables sharing of defined predictive models between compliant vendor applications.

PMMU *n.* *See* paged memory management unit.

PMOS *n.* Acronym for **P-channel metal-oxide semiconductor**. A MOSFET semiconductor technology in which the conduction channel is formed by the movement of holes (electron "vacancies" created as electrons move from atom to atom) rather than electrons. Because holes move more slowly than electrons do, PMOS is slower than NMOS, but it is also easier and less expensive to fabricate. *See also* MOS, MOSFET, P-type semiconductor. *Compare* CMOS, NMOS.

PMS *n.* *See* PANTONE MATCHING SYSTEM.

PNG *n.* Acronym for **Portable Network Graphics**. A file format for bitmapped graphic images, designed to be a replacement for the GIF format, without the legal restrictions associated with GIF. *See also* GIF.

PNNI *n.* Short for **Private Network-to-Network Interface**. A routing protocol used in ATM networks that provides switches with the ability to communicate changes in the network. Through PNNI, switches can be informed of changes to the network as they occur and can then use the information to make appropriate routing decisions. *See also* ATM.

PnP *n.* *See* plug and play (definition 2).

PNP *n.* *See* PNP transistor.

PNP transistor *n.* A type of bipolar transistor in which a base of N-type material is sandwiched between an emitter and a collector of P-type material. The base, emitter, and collector are the three terminals of the transistor through which current flows. In a PNP transistor, holes (electron "vacancies") are the majority of the charge carriers, and they flow from the emitter to the collector. *See the illustration.* *See also* N-type semiconductor, P-type semiconductor. *Compare* NPN transistor.

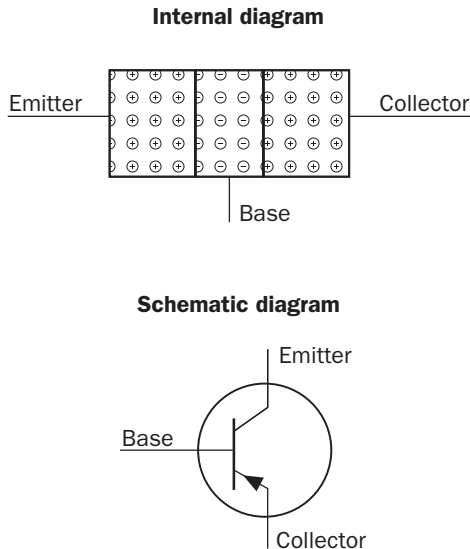

**PNP transistor.**

pocket Active Server Pages *n.* A scaled-down version of the Active Server Pages optimized for server-side Mobile Channels scripting. *Acronym:* pASP.

pocket Excel *n.* A scaled-down version of Microsoft Excel for the Pocket PC. *See also* Microsoft Excel.

Pocket PC *n.* A personal handheld computing device based on specifications designed by Microsoft and running the Microsoft Windows for Pocket PC operating system. Pocket PCs maintain the look of a Windows operating system display screen and offer compact versions of many of the applications that run on Windows-powered personal computers. A number of manufacturers produce Pocket PCs, including Hewlett-Packard, Compaq, and Casio.

pocket Word *n.* A scaled-down version of Microsoft Word for the Pocket PC. *See also* Microsoft Word.

point¹ *n.* **1.** A unit of measure used in printing, equal to approximately $\frac{1}{72}$ of an inch. Character height and the amount of space (leading) between lines of text are usually specified in points. **2.** A single pixel on the screen, identified by its row and column numbers. **3.** A location in

a geometric form, represented by two or more numbers that constitute its coordinates.

point² *vb.* To move an arrow or other such indicator to a particular item or position on the screen by using direction keys or by maneuvering a pointing device such as a mouse.

point-and-click *adj.* Enabling a user to select data and activate programs by using a mouse or other pointing device to move a cursor to a desired location (“point”) and pressing a button on the mouse or other pointing device (“click”).

PointCast *n.* An Internet service that delivers and displays a personalized set of news articles to individual users. Unlike the World Wide Web and other Internet applications, PointCast is a *push* technology, where the server automatically uploads data without a specific command from the client. *See also* server (definition 2).

point chart *n.* *See* scatter diagram.

point diagram *n.* *See* scatter diagram.

pointer *n.* In programming and information processing, a variable that contains the memory location (address) of some data rather than the data itself. *See also* address¹ (definition 1), handle (definition 1), mouse pointer, reference¹.

pointing device *n.* An input device used to control an on-screen cursor for such actions as “pressing” on-screen buttons in dialog boxes, choosing menu items, and selecting ranges of cells in spreadsheets or groups of words in a document. A pointing device is often used to create drawings or graphical shapes. The most common pointing device is the mouse, which was popularized by its use with the Apple Macintosh. Other pointing devices include graphics tablets, styluses, light pens, joysticks, pucks, and trackballs. *See also* graphics tablet, joystick, light pen, mouse, puck, stylus, trackball.

point listing *n.* A database of popular Web sites categorized by topics of interest and often rated by design and content.

point of presence *n.* **1.** A point in a wide area network to which a user can connect with a local telephone call. **2.** A point at which a long distance telephone carrier connects to a local telephone exchange or to an individual user. *Acronym:* POP.

point of sale *n.* See POS.

point-to-point configuration *n.* A communications link in which dedicated links exist between individual origins and destinations, as opposed to a point-to-multipoint configuration, in which the same signal goes to many destinations (such as a cable TV system), or a switched configuration, in which the signal moves from the origin to a switch that routes the signal to one of several possible destinations. *Also called:* point-to-point connection.

point-to-point connection *n.* See point-to-point configuration.

point-to-point message system *n.* In Sun Microsystems's J2EE network platform, a messaging system that uses message queues to store asynchronous, formatted data for coordinating enterprise applications. Each message is addressed to a specific queue, and client applications retrieve messages from the queues. *See also* asynchronous, J2EE.

Point-to-Point Protocol *n.* See PPP.

point-to-point tunneling *n.* A means of setting up secure communications over an open, public network such as the Internet. *See also* PPTP.

Point-to-Point Tunneling Protocol *n.* See PPTP.

Poisson distribution *n.* A mathematical curve often used in statistics and simulation to represent the likelihood of some event occurring, such as the arrival of a customer in a queue, when the average likelihood is known. This distribution, named after the French mathematician S. D. Poisson, is simpler to calculate than the normal and binomial distributions. *See also* binomial distribution, normal distribution.

poke *vb.* To store a byte into an absolute memory location. PEEK (read a byte from memory) and POKE commands are often found in programming languages, such as Basic, that do not normally allow access to specific memory locations.

polar coordinates *n.* Coordinates of the form (r, θ) used to locate a point in two dimensions (on a plane). The polar coordinate r is the length of the line that starts at the origin and ends at the point, and θ (Greek theta) is the angle between that line and the positive x -axis. *Compare* Cartesian coordinates.

polarity *n.* The sign of the potential (voltage) difference between two points in a circuit. When a potential difference exists between two points, one point has a positive polarity and the other a negative polarity. Electrons flow from negative to positive; by convention, however, current is considered to flow from positive to negative.

polarized component *n.* A circuit component that must be installed with its leads in a particular orientation with respect to the polarity of the circuit. Diodes, rectifiers, and some capacitors are examples of polarized components.

polarizing filter *n.* A transparent piece of glass or plastic that polarizes the light passing through it; that is, it allows only waves vibrating in a certain direction to pass through. Polarizing filters are often used to reduce glare on monitor screens. *See also* glare filter.

Polish notation *n.* See prefix notation.

polling *n.* See autopolling.

polling cycle *n.* The time and sequence required for a program to poll each of its devices or network nodes. *See also* autopolling.

polygon *n.* Any two-dimensional closed shape composed of three or more line segments, such as a hexagon, an octagon, or a triangle. Computer users encounter polygons in graphics programs.

polyline *n.* An open shape consisting of multiple connected segments. Polylines are used in CAD and other graphics programs. *See also* CAD.

polymorphism *n.* In an object-oriented programming language, the ability to redefine a routine in a derived class (a class that inherited its data structures and routines from another class). Polymorphism allows the programmer to define a base class that includes routines that perform standard operations on groups of related objects, without regard to the exact type of each object. The programmer then redefines the routines in the derived class for each type, taking into account the characteristics of the object. *See also* class, derived class, object (definition 2), object-oriented programming.

Pong *n.* The first commercial video game, a table tennis simulation, created by Nolan Bushnell of Atari in 1972.



pop *vb.* To fetch the top (most recently added) element of a stack, removing that element from the stack in the process. *Compare* push² (definition 1).

POP *n.* See point of presence, Post Office Protocol.

POP3 *n.* Acronym for **Post Office Protocol 3**. This is the current version of the Post Office Protocol standard in common use on TCP/IP networks. *See also* Post Office Protocol, TCP/IP.

populate *vb.* **1.** To put chips in the sockets of a circuit board. **2.** To import prepared data into a database from a file using a software procedure rather than by having a human operator enter individual records.

pop-under ad *n.* An advertisement on the Internet that appears in a new window in the background, behind the Web site content. Users may be unaware of the presence of pop-under ads until they close foreground windows at the end of a Web session. Pop-under ads may appear in response to a mouse click, a rollover, or after a user has spent a predetermined amount of time at a Web site. *See also* pop-up ad.

pop-up ad *n.* An advertisement on the Internet that appears in a new window in the foreground, often whenever a new page is opened within a site. Pop-up ads may appear in response to a mouse click, a rollover, or after a user has spent a predetermined amount of time at a Web site. *See also* pop-under ad.

pop-up Help *n.* An online help system whose messages appear as pop-up windows when the user clicks on a topic or area of the screen about which help is desired. Typically, a special form of click, such as clicking the right mouse button or Option-clicking, will activate pop-up Help, if it is available. *See also* Balloon Help.

pop-up menu or **popup menu** *n.* In a graphical user interface, a menu that appears on-screen when a user selects a certain item. Pop-up menus can appear anywhere on the screen and generally disappear when the user selects an item in the menu. *Also called:* popup. *Compare* drop-down menu, pull-down menu.

pop-up messages *n.* The messages that appear when pop-up Help is used.

pop-up window *n.* A window that appears when an option is selected. Typically, the window remains visible until the mouse button is released.

port¹ *n.* **1.** An interface through which data is transferred between a computer and other devices (such as a printer, mouse, keyboard, or monitor), a network, or a direct connection to another computer. The port appears to the CPU as one or more memory addresses that it can use to send or receive data. Specialized hardware, such as in an add-on circuit board, places data from the device in the memory addresses and sends data from the memory addresses to the device. Ports may also be dedicated solely to input or to output. Ports typically accept a particular type of plug used for a specific purpose. For example, a serial data port, a keyboard, and a high-speed network port all use different connectors, so it's not possible to plug a cable into the wrong port. *Also called:* input/output port. **2.** port number.

port² *vb.* **1.** To change a program in order to be able to run it on a different computer. **2.** To move documents, graphics, and other files from one computer to another.

port 25 blocking *n.* An anti-spam technique adopted by many ISPs to prevent bulk mailings of unsolicited commercial e-mail. Spammers may try to use SMTP servers to relay a single commercial e-mail to multiple recipients. Port 25 blocking filters prevent this spam distribution method. Although it is a popular remedy for some spam problems, port 25 blocking may cause problems for legitimate users of non-compatible e-mail programs.

portable *adj.* **1.** Capable of running on more than one computer system or under more than one operating system. Highly portable software can be moved to other systems with little effort, moderately portable software can be moved only with substantial effort, and nonportable software can be moved only with effort similar to or greater than the effort of writing the original program. **2.** Light enough, rugged enough, and free enough of encumbering external connections to be carried by a user.

portable computer *n.* Any computer designed to be moved easily. Portable computers can be characterized by size and weight. *See the table.*

P

Table P.2 Portable Computers.

Type	Approximate weight	Power source	Comments
Transportable	15–30 lb.	House current	Sometimes called luggage; usually has floppy and hard drives; standard CRT screen.
Laptop	8–15 lb.	House current or batteries	Can be held on the lap; usually has a floppy drive; uses flat LCD or plasma screen.
Ultralight	2–8 lb.	Batteries or transformer pack	Easy to carry in a briefcase; sometimes uses RAM drive or EPROM instead of floppy or hard drive; thinner models are known as notebook computers.
Handheld	Less than 2 lb.	Batteries or transformer pack	Also called palmtop or palm-sized; can be held in one hand.

Portable Digital Document *n.* See PDD.

Portable Distributed Objects *n.* Software from NeXT, running under UNIX, that supports an object model in which objects to be stored at various locations on a network can be accessed as though they were at a single location. *Acronym:* PDO.

Portable Document Format *n.* The Adobe specification for electronic documents that use the Adobe Acrobat family of servers and readers. *Acronym:* PDF. See also Acrobat, .pdf.

portable executable file *n.* The file format used for executable programs as well as for files that are linked together to form executable programs.

portable keyboard *n.* A portable keyboard for use with personal digital assistants (PDAs), wireless phones with advanced digital features, and other handheld mobile devices. Light, compact, and easy to carry, most portable keyboards fold for convenient storage and connect to the handheld device via a built-in cradle.

portable language *n.* A language that runs in the same way on different systems and therefore can be used for developing software for all of them. C, FORTRAN, and Ada are portable languages because their implementations on different systems are highly uniform; assembly language is extremely nonportable.

Portable Network Graphics *n.* See PNG.

portal *n.* A Web site that serves as a gateway to the Internet. A portal is a collection of links, content, and services designed to guide users to information they are likely to find interesting—news, weather, entertainment, commerce sites, chat rooms, and so on. Yahoo!, Excite, MSN.com, and Netscape NetCenter are examples of portals. See also home page (definition 1), Web site.

port enumerator *n.* In Windows, part of the Plug and Play system that detects I/O ports and reports them to the configuration manager. See also plug and play (definition 2).

port expander *n.* A hardware mechanism used for connecting several devices to a single port. Although several devices might be connected, only one can use the port at any given moment.

portmapper *n.* A service used by Remote Procedure Call (RPC) to assign port numbers. RPC doesn't follow the Well-Known Ports port designations, and only Portmapper is assigned a permanent port number. Because hackers may gain access to portmapper communication, various portmapper security tools are often used to prevent theft of information. See also remote procedure call.

port number *n.* A number that enables IP packets to be sent to a particular process on a computer connected to the Internet. Some port numbers, called “well-known” port numbers, are permanently assigned; for example, e-mail data under SMTP goes to port number 25. A process such as a telnet session receives an “ephemeral” port number



when it starts; data for that session goes to that port number, and the port number goes out of use when the session ends. A total of 65,535 port numbers are available for use with TCP, and the same number are available for UDP. *See also* IP, Simple Mail Transfer Protocol, socket (definition 1), TCP, UDP. *Compare* IP address.

portrait mode *n.* A vertical print orientation in which a document is printed across the narrower dimension of a rectangular sheet of paper. This is the print mode typical of most letters, reports, and other such documents. *Compare* landscape mode.

portrait monitor *n.* A monitor with a screen shape higher than it is wide. The proportions (but not necessarily the size) of the screen are usually the same as for a sheet of 8½-by-11-inch paper. *Compare* landscape monitor.

port replicator *n.* A device that enables easy connection of portable computers to less portable devices, such as printers, monitors, and full-sized keyboards. Instead of having to connect each such device individually to a portable computer, a user can plug it permanently into a port replicator and use it simply by plugging the computer into a single socket, also on the port replicator. Port replicators are comparable to docking stations, but without the same capability for expansion and storage. *Also called:* convenience adapter. *See also* docking station, port.

POS *n.* Acronym for **point of sale**. The place in a store at which goods are paid for. Computerized transaction systems, such as those in use at automated supermarkets, use scanners for reading tags and bar codes, electronic cash registers, and other special devices to record purchases at this point.

POSIT *n.* Acronym for **Profiles for Open Systems Inter-networking Technology**. A set of nonmandatory standards for U.S. government network equipment. POSIT, which recognizes the prevalence of TCP/IP, is the successor to GOSIP. *See also* GOSIP, TCP/IP.

positional notation *n.* In mathematics, a form of notation whose meaning relies in part on the relative location of the elements involved. For example, common numeric notation is positional notation. In the decimal number 34, the position of the numeral 3 signifies three 10s and the position of the numeral 4 signifies four 1s.

POSIX *n.* Acronym for **Portable Operating System Interface for UNIX**. An Institute of Electrical and Electronics Engineers (IEEE) standard that defines a set of operating-system services. Programs that adhere to the POSIX standard can be easily ported from one system to another. POSIX was based on UNIX system services, but it was created in a way that allows it to be implemented by other operating systems. *See also* service (definition 2).

post¹ *n.* *See* article.

post² *vb.* **1.** To submit an article in a newsgroup or other online conference or forum. The term is derived from the “posting” of a notice on a physical bulletin board. *See also* newsgroup. **2.** To place a file on a server on a network or on a Web site.

POST *n.* *See* power-on self test.

posterization *n.* *See* contouring.

postfix notation *n.* A form of algebraic notation in which the operators appear after the operands. *Also called:* reverse Polish notation. *Compare* infix notation, prefix notation.

postmaster *n.* The logon name (and therefore the e-mail address) of an account that is responsible for maintaining e-mail services on a mail server. When an account holder is having trouble with e-mail, a message to postmaster or “postmaster@machine.org.domain.name” will usually reach a human who can solve the problem.

post office *n.* The server and associated storage and mail handling services that provide the centralized location for collection and distribution of e-mail over a network.

Post Office Protocol *n.* A protocol for servers on the Internet that receive, store, and transmit e-mail and for clients on computers that connect to the servers to download and upload e-mail. *Acronym:* POP.

postprocessor *n.* A device or a software routine, such as a linker, that operates on data manipulated first by another processor. *See also* back-end processor (definition 2). *Compare* preprocessor.

PostScript *n.* A page-description language from Adobe Systems that offers flexible font capability and high-quality graphics. The most well-known page-description lan-



guage, PostScript uses English-like commands to control page layout and to load and scale outline fonts. Adobe Systems is also responsible for Display PostScript, a graphics language for computer displays that gives users of both PostScript and Display PostScript absolute WYSIWYG (what-you-see-is-what-you-get), which is difficult when different methods are used for displaying and printing. *See also* outline font, page-description language.

PostScript font *n.* A font defined in terms of the PostScript page-description language rules and intended to be printed on a PostScript-compatible printer. PostScript fonts are distinguished from bitmapped fonts by their smoothness, detail, and faithfulness to standards of quality established in the typographic industry. *See also* PostScript. *Compare* screen font.

pot *n.* *See* potentiometer.

potential *n.* *See* electromotive force.

potentiometer *n.* A circuit element that can be adjusted to provide varying amounts of resistance. The twist-knob and slider-type volume controls on many radios and television sets are potentiometers. *Also called:* pot.

POTS *n.* Acronym for **Plain Old Telephone Service**. Basic dialup telephone connections to the public switched network without any added features or functions. A POTS line is nothing but a phone line connected to a simple, single-line telephone instrument.

pour *vb.* To send a file or the output from a program to another file or to a device using a pipe. *See also* pipe (definition 1).

power *n.* **1.** In mathematics, the number of times a value is multiplied by itself—for example, 10 to the third power means 10 times 10 times 10. **2.** In computing, the electricity used to run a computer. **3.** The speed at which a computer performs and the availability of various features. *See also* computer power.

PowerBook *n.* Any of several computers in the family of portable Macintosh computers made by Apple.

power conditioning *n.* A feature of uninterruptible power supply (UPS) that removes spikes, surges, sags, and

noise from the power supply. *Also called:* line conditioning. *See also* UPS.

power down *vb.* To shut down (a computer); to turn off the power.

power failure *n.* Loss of electricity, which causes a loss of unsaved data in a computer's random access memory (RAM) if no backup power supply is connected to the machine. *Compare* surge.

Power Mac *n.* *See* Power Macintosh.

Power Macintosh *n.* A Macintosh computer based on the PowerPC processor. The first Power Macintoshes, 6100/60, 7100/66, and 8100/80, were unveiled in 1994. Several upgraded versions followed, and in early 1999 the G3, a PowerPC 750, was released. This was followed later in the year with the unveiling of the Power Macintosh G4. The Power Mac G4 uses the PowerPC 7400 processor and features significant boosts in processing speed. The Power Mac G4 uses Apple's Velocity Engine to process information in 128-bit chunks, allowing sustained performance in excess of one gigaflop. *Also called:* Power Mac. *See also* PowerPC.

power management *n.* The regulation of power consumption on a computer, especially a portable battery-operated device such as a laptop. Power management reduces power to certain components, such as the screen and CPU, to use power efficiently and extend battery life. *See also* ACPI, Advanced Power Management.

Power-on key *n.* A special key on the Apple ADB and Extended keyboards used for turning on a Macintosh II. The Power-on key is marked with a left-pointing triangle and is used in lieu of the on/off switch. There is no Power-off key; the system is shut down by choosing the Shut Down command from the Special menu.

power-on self test *n.* A set of routines stored in a computer's read-only memory (ROM) that tests various system components such as RAM, the disk drives, and the keyboard to see whether they are properly connected and operating. If problems are found, these routines alert the user by sounding a series of beeps or displaying a message, often accompanied by a diagnostic numeric value, to



the standard output or standard error device (usually the screen). If the power-on self test is successful, it passes control to the system's bootstrap loader. *Acronym*: POST. *See also* bootstrap loader.

PowerPC *n.* A microprocessor architecture developed in 1992 by Motorola and IBM, with some participation by Apple. A PowerPC microprocessor is RISC-based and superscalar, with a 64-bit data bus and 32-bit address bus. It also has separate data and instruction caches, although the size of each varies by implementation. All PowerPC microprocessors have multiple integer and floating-point units. The voltage and operating speed varies with the implementation. Starting with the PowerPC 740, the microprocessors were manufactured with copper, instead of aluminum, for better performance and reliability. *See also* L1 cache, L2 cache, microprocessor, RISC, superscalar.

PowerPC Platform *n.* A platform developed by IBM, Apple, and Motorola based on the 601 and later chips. This platform supports the use of multiple operating systems such as Mac OS, Windows NT, and AIX as well as software designed for those individual operating systems. *Acronym*: PPCP.

PowerPC Reference Platform *n.* An open system standard developed by IBM. IBM's goal in designing the PowerPC Reference Platform was to ensure compatibility among PowerPC systems built by different companies. Apple's PowerPC Macintoshes are not yet compliant with the PowerPC Reference Platform, but future versions are expected to be. *Acronym*: PReP. *See also* Common Hardware Reference Platform, open system, PowerPC.

PowerPoint *n.* Microsoft's presentation software. PowerPoint includes text-editing and graphics tools that can create slides for public presentations. The presentations can be printed, projected, displayed on a monitor, or, in the version included with Office 2000, saved and published as Web pages.

power supply *n.* An electrical device that transforms standard wall outlet electricity (115–120 VAC in the United States) into the lower voltages (typically 5 to 12 volts DC) required by computer systems. Personal computer power supplies are rated by wattage; they usually

range from about 90 watts at the low end to 250 watts at the high end.

power surge *n.* *See* surge.

power up *vb.* To start up a computer; to begin a cold boot procedure; to turn on the power.

power user *n.* A person adept with computers, particularly on an applications-oriented level rather than on a programming level. A power user is someone who knows a considerable amount about computers and is comfortable enough with applications to be able to work with their most sophisticated features.

PPCP *n.* *See* PowerPC Platform.

PPM or **ppm** *n.* **1.** Acronym for **pages per minute**. A rating of a printer's output capacity—that is, the number of printed pages the printer can produce in one minute. A printer's PPM rating is usually provided by the manufacturer and is based on a "normal" page. Pages with excessive graphics or fonts may reduce a printer's PPM rate dramatically. **2.** *See* pulse position modulation.

PPP *n.* Acronym for **Point-to-Point Protocol**. A widely used data link protocol for transmitting TCP/IP packets over dial-up telephone connections, such as between a computer and the Internet. PPP, which supports dynamic allocation of IP addresses, provides greater protection for data integrity and security and is easier to use than SLIP, at a cost of greater overhead. PPP itself is based on a Link Control Protocol (LCP) responsible for setting up a computer-to-computer link over telephone lines and a Network Control Protocol (NCP) responsible for negotiating network-layer details related to the transmission. It was developed by the Internet Engineering Task Force in 1991. *Compare* SLIP.

PPPoE *n.* Acronym for **Point-to-Point Protocol over Ethernet**. A specification for connecting users on an Ethernet network to the Internet through a broadband connection, such as a single DSL line, wireless device, or cable modem. Using PPPoE and a broadband modem, LAN users can gain individual authenticated access to high-speed data networks. By combining Ethernet and Point-to-Point Protocol (PPP), PPPoE provides Internet Service Providers (ISPs) with the ability to manipulate a limited number of IP addresses by assigning an address

P

only when the user is connected to the Internet. PPPoE is an efficient way to create a separate connection for each user to a remote server. When the Internet connection is broken, the IP address becomes available to be assigned to another user.

PPS *n.* See peripheral power supply.

PPTP *n.* Acronym for **Point-to-Point Tunneling Protocol**. An extension of the Point-to-Point Protocol used for communications on the Internet. PPTP was developed by Microsoft to support virtual private networks (VPNs), which allow individuals and organizations to use the Internet as a secure means of communication. PPTP supports encapsulation of encrypted packets in secure wrappers that can be transmitted over a TCP/IP connection. See also virtual network.

PRAM *n.* Short for **parameter RAM**. A portion of RAM in Macintosh computers that contains configuration information such as the date and time, desktop pattern, and other control panel settings. See also RAM.

P-rating *n.* Short for **performance rating**. A microprocessor rating system by IBM, Cyrix, and others, based on throughput in realistic applications. Formerly, microprocessor clock speed was widely used as a method of rating, but it does not account for differing chip architectures or different types of work people do with computers. See also central processing unit, clock (definition 1), microprocessor.

precedence *n.* In applications, the order in which values in a mathematical expression are calculated. In general, application programs perform multiplication and division first, followed by addition and subtraction. Sets of parentheses can be placed around expressions to control the order in which they are calculated. See also operator associativity, operator precedence.

precision *n.* **1.** The extent of detail used in expressing a number. For example, 3.14159265 gives more precision—more detail—about the value of pi than does 3.14. Precision is related to, but different from, accuracy. Precision indicates degree of detail; accuracy indicates correctness. The number 2.83845 is also more precise than 3.14, but it is less accurate for pi. Compare accuracy. **2.** In program-

ming, numeric values are often referred to as single-precision or double-precision values. The difference between the two is in the amount of storage space allotted to the value. See also double-precision, single-precision.

precompiler *n.* A program that reads in a source file and makes certain changes to prepare the source file for compilation. Also called: preprocessor. See also compiler (definition 2).

preemptive multitasking *n.* A form of multitasking in which the operating system periodically interrupts the execution of a program and passes control of the system to another waiting program. Preemptive multitasking prevents any one program from monopolizing the system. Also called: time-slice multitasking. See also multitasking. Compare cooperative multitasking.

Preferences *n.* A menu choice in many graphical user interface applications that allows the user to specify how the application will act each time it is used. For example, in a word processing application the user may be allowed to specify whether the ruler will appear, whether the document will appear in the same way as it will print (including margins), and other choices. Also called: Options, Prefs.

prefetch *vb.* Preloading buffering data for a streaming video clip before the clip begins playing. When prefetched data is stored on a computer, the video clip can be played without waiting for the initial buffering that usually occurs with streaming media. See also preroll.

prefix notation *n.* A form of algebraic notation, developed in 1929 by Jan Lukasiewicz, a Polish logician, in which the operators appear before the operands. For example, the expression $(a + b) \times (c - d)$ would be written in prefix notation as $\times + a b - c d$. Also called: Polish notation. See also infix notation, postfix notation.

Prefs *n.* See Preferences.

Premiere *n.* Digital video editing software developed by Adobe Systems. The Premiere user interface uses command menus, windows, and floating pallets to make modifications to video clips. A timeline feature presents a graphic presentation of the length of the individual scenes and the order in which they appear. The editor can modify



the edits and preview the results before exporting the file into one of several video formats.

PReP *n.* See PowerPC Reference Platform.

preprocessor *n.* A device or routine that performs preliminary operations on input before passing it on for further processing. See also front-end processor (definition 1). Compare postprocessor.

preroll *vb.* Data buffering that occurs before a streaming media clip plays. Preroll time varies depending on available bandwidth and the size of the file being buffered.

presence technology *n.* An application, such as instant messaging, which finds specific users when they are connected to the network and which may alert interested users to each other's presence. Third-generation wireless networks will integrate presence technology with digital cell phones, PDAs, pagers, and other communications and entertainment devices.

presentation broadcast *n.* A PowerPoint feature that allows you to run a presentation over the Web. The presentation is saved in HTML format and can contain audio and video. It can also be recorded and saved to be viewed later.

presentation graphics *n.* The representation of business information, such as sales figures and stock prices, in chart form rather than as lists of numbers. Presentation graphics are used to give viewers an immediate grasp of business statistics and their significance. Common examples are area charts, bar charts, line charts, and pie charts. Also called: business graphics.

presentation layer *n.* The sixth of the seven layers in the ISO/OSI reference model for standardizing computer-to-computer communications. The presentation layer is responsible for formatting information so that it can be displayed or printed. This task generally includes interpreting codes (such as tabs) related to presentation, but it can also include converting encryption and other codes and translating different character sets. See the illustration. See also ISO/OSI reference model.

ISO/OSI MODEL	
ISO/OSI Layer	Focus
Application (highest level)	Program-to-program transfer of information
Presentation	Text formatting and display, code conversion
Session	Establishing, maintaining, and coordinating communication
Transport	Accurate delivery, service quality
Network	Transport routes, message handling and transfer
Data-link	Coding, addressing, and transmitting information
Physical	Hardware connections

Presentation layer.

Presentation Manager *n.* The graphical user interface provided with OS/2 versions 1.1 and later. The Presentation Manager derives from the MS-DOS-based Windows environment and provides similar capabilities. The user sees a graphical, window-oriented interface, and the programmer uses a standard set of routines for handling screen, keyboard, mouse, and printer input and output, no matter what hardware is attached to the system. See also OS/2, Windows.

pressure-sensitive *adj.* Of or pertaining to a device in which pressing on a thin surface produces an electrical connection and causes an event to be registered by the computer. Pressure-sensitive devices include touch-sensitive drawing pens, membrane keyboards, and some touch screens. See also touch screen.

Pretty Good Privacy *n.* See PGP.

pretty print *n.* A feature of some editors used in programming that formats code so that it is easier to read and understand when printed. For example, a pretty-print feature might insert blank lines to set off modules or indent nested routines to make them easier to spot. See also code¹ (definition 1), editor, module (definition 1), routine.

P

preventive maintenance *n.* Routine servicing of hardware intended to keep equipment in good operating condition and to find and correct problems before they develop into severe malfunctions.

preview *n.* In word processors and other applications, the feature that formats a document for printing but displays it on the video monitor rather than sending it directly to the printer.

PRI *n.* Acronym for **Primary Rate Interface**. One of two ISDN transmission rate services (the other is the basic rate interface, BRI). PRI has two variations. The first, which operates at 1.536 Mbps, transmits data over 23 B channels and sends signaling information at 64 Kbps over one D channel in the United States, Canada, and Japan. The second, which operates at 1.984 Mbps, transmits data over 30 B channels and sends signaling information at 64 Kbps over one D channel in Europe and Australia. *See also* BRI, ISDN.

primary channel *n.* The data-transmission channel in a communications device, such as a modem. *Compare* secondary channel.

Primary Domain Controller *n.* **1.** In Windows NT, a database providing a centralized administration site for resources and user accounts. The database allows users to log onto the domain, rather than onto a specific host machine. A separate account database keeps track of the machines in the domain and allocates the domain's resources to users. **2.** In any local area network, the server that maintains the master copy of the domain's user accounts database and that validates logon requests. *Acronym:* PDC.

primary key *n.* In databases, the key field that serves as the unique identifier of a specific tuple (row) in a relation (database table). *Also called:* major key. *See also* alternate key (definition 1), candidate key. *Compare* secondary key.

Primary Rate Interface *n.* *See* PRI.

primary storage *n.* Random access memory (RAM); the main general-purpose storage region to which the microprocessor has direct access. A computer's other storage options, such as disks and tape, are called *secondary storage* or (sometimes) *backing storage*.

primitive *n.* **1.** In computer graphics, a shape, such as a line, circle, curve, or polygon, that can be drawn, stored, and manipulated as a discrete entity by a graphics program. A primitive is one of the elements from which a large graphic design is created. **2.** In programming, a fundamen-

tal element in a language that can be used to create larger procedures that do the work a programmer wants to do.

print *vb.* In computing, to send information to a printer. The word is also sometimes used in the sense of "show me" or "copy this." For example, the PRINT statement in Basic causes output to be displayed (printed) on the screen. Similarly, an application program that can be told to print a file to disk interprets the command as an instruction to route output to a disk file instead of to a printer.

print buffer *n.* A section of memory to which print output can be sent for temporary storage until the printer is ready to handle it. A print buffer can exist in a computer's random access memory (RAM), in the printer, in a separate unit between the computer and the printer, or on disk. Regardless of its location, the function of a print buffer is to free the computer for other tasks by taking print output at high speed from the computer and passing it along at the much slower rate required by the printer. Print buffers vary in sophistication: some simply hold the next few characters to be printed, and others can queue, reprint, or delete documents sent for printing.

printed circuit board *n.* A flat board made of nonconducting material, such as plastic or fiberglass, on which chips and other electronic components are mounted, usually in predrilled holes designed to hold them. The component holes are connected electrically by predefined conductive metal pathways that are printed on the surface of the board. The metal leads protruding from the electronic components are soldered to the conductive metal pathways to form a connection. A printed circuit board should be held by the edges and protected from dirt and static electricity to avoid damage. *See* the illustration. *Acronym:* PCB.

P

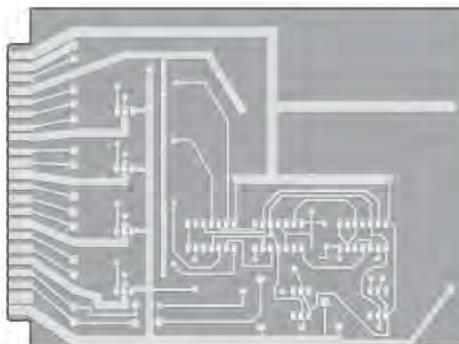

Printed circuit board.

printer *n.* A computer peripheral that puts text or a computer-generated image on paper or on another medium, such as a transparency film. Printers can be categorized in any of several ways: impact versus nonimpact; print technology; character formation; method of transmission; method of printing; print capability; and print quality.

- **Impact versus nonimpact** The most common distinction is impact versus nonimpact. Impact printers physically strike the paper and are exemplified by pin dot-matrix printers and daisy-wheel printers; nonimpact printers include every other type of print mechanism, including laser, ink-jet, and thermal printers.
- **Print technology** Chief among types of print technology are pin dot-matrix, ink-jet, laser, thermal, and (although somewhat outdated) daisy-wheel or thimble printers. Pin dot-matrix printers can be further classified by the number of pins in the print head: 9, 18, 24, and so on.
- **Character formation** Fully formed characters made of continuous lines (such as those produced by a daisy-wheel printer) versus dot-matrix characters composed of patterns of dots (such as those produced by standard dot-matrix, ink-jet, and thermal printers). Laser printers, while technically dot-matrix, are generally considered to produce fully formed characters because their output is very clear and the dots are extremely small and closely spaced.
- **Method of transmission** Parallel (byte-by-byte transmission) versus serial (bit-by-bit transmission). These categories refer to the means by which output is sent to the printer rather than to any mechanical distinctions. Many printers are available in either parallel or serial versions, and still other printers offer both choices, yielding greater flexibility in installation options.
- **Method of printing** Character by character, line by line, or page by page. Character printers include standard dot-matrix, ink-jet, thermal, and daisy-wheel printers. Line printers include the band, chain, and drum printers that are commonly associated with large computer installations or networks. Page printers include the electrophotographic printers, such as laser printers.
- **Print capability** Text-only versus text-and-graphics. Text-only printers, including most daisy-wheel and thimble printers and some dot-matrix and laser printers, can reproduce only characters for which they have matching patterns, such as embossed type or internal

character maps. Text-and-graphics printers—dot-matrix, ink-jet, laser, and others—can reproduce all manner of images by “drawing” each as a pattern of dots.

- **Print quality** Draft versus near-letter quality versus letter quality.

Printer Access Protocol *n.* See PAP (definition 2).

Printer Control Language *n.* A printer control language from Hewlett-Packard, used in its LaserJet, DeskJet, and RuggedWriter printer lines. Because of the LaserJet’s dominance in the laser printer market, Printer Control Language has become a de facto standard. *Acronym:* PCL. Also called: Hewlett-Packard Printer Control Language.

printer controller *n.* The processing hardware in a printer, especially in a page printer. It includes the raster image processor, the memory, and any general-purpose microprocessors. A printer controller can also reside in a personal computer, attached via a high-speed cable to a printer that simply carries out its instructions. *Compare* printer engine.

printer driver *n.* A software program designed to enable other programs to work with a particular printer without concerning themselves with the specifics of the printer’s hardware and internal language. Application programs can communicate properly with a variety of printers by using printer drivers, which handle all of the subtleties of each printer so that the application program doesn’t have to. Today graphical user interfaces offer their own printer drivers, eliminating the need for an application that runs under the interface to have its own printer driver.

printer engine *n.* The part of a page printer, such as a laser printer, that actually performs the printing. Most printer engines are self-contained, replaceable cartridges. The engine is distinct from the printer controller, which includes all the processing hardware in the printer. The most widely used printer engines are manufactured by Canon. *Compare* printer controller.

printer file *n.* Output that would normally be destined for the printer but has been diverted to a computer file instead. A printer file is created for any of several reasons. For example, it allows output to be transferred to another program or to another computer. It also allows additional copies to be made at any time by simply copying the print image to the printer. Occasionally, the term *printer file* is used, incorrectly, to refer to the printer driver.

P

printer font *n.* A font residing in or intended for a printer. A printer font can be internal, downloaded, or on a font cartridge. *Compare* screen font.

Printer Job Language *n.* The printer command language developed by Hewlett-Packard that provides printer control at the print-job level. Using PJI commands, you can change default printer settings such as the number of copies to print. PJI commands also permit switching printer languages between print jobs without action by the user. If bi-directional communication is supported, a PJI-compatible printer can send information such as printer model and job status to the print server. *Also called:* Hewlett-Packard Printer Job Language. *Acronym:* PJI. *See also* page-description language, PostScript, Printer Control Language.

printer port *n.* A port through which a printer can be connected to a personal computer. On PC-compatible machines, printer ports are usually parallel ports and are identified in the operating system by the logical device name LPT. On many newer PCs, the parallel port on the case of the CPU has a printer icon beside it to identify it as a printer port. Serial ports can also be used for some printers (logical device name COM), although configuration is generally required. On Macintoshes, printer ports are usually serial ports and are also used to connect Macs to an AppleTalk network. *See also* AppleTalk, central processing unit, logical device, parallel port, serial port.

printer server *n.* *See* print server.

print head or **printhead** *n.* A component of an impact printer that contains the pins or other components that force ink from a ribbon onto paper.

printing pool *n.* Two or more identical printers that are connected to one print server and act as a single printer. In this case, when you print a document, the print job will be sent to the first available printer in the pool. *See also* print job, printer.

print job *n.* A single batch of characters printed as a unit. A print job usually consists of a single document, which can be one page or hundreds of pages long. To avoid having to print individual documents separately, some software can group multiple documents into a single print job. *See also* print spooler.

print mode *n.* A general term for the format of print output by a printer. Print modes range from portrait or landscape orientation of the paper to letter quality and size of

the print. Dot-matrix printers support two print modes: draft and letter quality (LQ) or near-letter-quality (NLQ). Some printers can interpret both plain text (ASCII) and a page definition language such as PostScript. *See also* PostScript, printer.

printout *n.* *See* hard copy.

print quality *n.* The quality and clarity of characters produced by a printer. Print quality varies with the type of printer; in general, dot-matrix printers produce lower-quality output than laser printers. The printer mode can also affect quality. *See also* resolution (definition 1).

print queue *n.* A buffer for documents and images waiting to be printed. When an application places a document in a print queue, it is held in a special part of the computer's memory, where it waits until the printer is ready to receive it.

Print Screen key *n.* A key on IBM PC and compatible keyboards that normally causes the computer to send a character-based "picture" of the screen contents to the printer. The print screen feature works only when the display is in text mode or CGA graphics mode (the lowest-resolution color and graphics mode available on IBM compatibles). It will not work properly in other graphics modes. Some programs use the Print Screen key to capture a screen image and record it as a file on disk. These programs can typically work in any graphics mode and record the file as a graphics image. When the user is working directly with the MS-DOS operating system, and with some programs, the combination Control-Print Screen toggles the printer on or off. With printing turned on, the system sends every character to the printer as well as to the screen. The Print Screen key on the Apple Extended Keyboard is included for compatibility with operating systems such as MS-DOS. *Also called:* PrtSc key.

print server *n.* A workstation that is dedicated to managing printers on a network. The print server can be any station on the network. *Also called:* printer server.

Print Server for Macintosh *n.* An AppleTalk network integration service that enables computers running the Macintosh and Windows operating systems to share printers. *Also called:* MacPrint.

print spooler *n.* Computer software that intercepts a print job on its way to the printer and sends it to disk or memory instead, where the print job is held until the printer is



ready for it. The term *spooler* is an acronym created from “simultaneous peripheral operations on line.”

print to file *n.* A command in many applications that instructs the program to format a document for printing and store the formatted document as a file rather than sending it to a printer.

print wheel *n.* See daisy wheel.

priority *n.* Precedence in receiving the attention of the microprocessor and the use of system resources. Within a computer, unseen and unnoticed levels of priority are the means by which many different types of potential clashes and disruptions are avoided. Similarly, tasks running on a computer can be assigned priorities that determine when and for how long they receive time from the microprocessor. On networks, stations can be assigned priorities that determine when and how often they can control the communications line, and messages can be assigned priorities that indicate how soon they must be transmitted. See also interrupt.

Priority Frame *n.* A telecommunications protocol developed by Infonet and Northern Telecom, Inc., designed to carry data, facsimile, and voice information.

privacy *n.* The concept that a user’s data, such as stored files and e-mail, is not to be examined by anyone else without that user’s permission. A right to privacy is not generally recognized on the Internet. Federal law protects only e-mail in transit or in temporary storage, and only against access by Federal agencies. Employers often claim a right to inspect any data on their systems. To obtain privacy, the user must take active measures such as encryption. See also encryption, PGP, Privacy Enhanced Mail. Compare security.

Privacy Enhanced Mail *n.* An Internet standard for e-mail systems that use encryption techniques to ensure the privacy and security of messages. *Acronym:* PEM. See also encryption, standard. Compare PGP.

privacy policy *n.* Public statement delineating how a Web site uses the information it gathers from visitors to the site. Some Web sites sell this information to third parties or use the information for marketing purposes. Other sites have strict policies limiting how that information may be used.

private *adj.* A keyword used in some programming languages to signify that methods or variables can be

accessed only by elements residing in the same class or module. See also class, keyword (definition 2), local variable, reserved word, scope. Compare public.

private assembly *n.* An assembly that is used by only one application. A private assembly is deployed into the directory structure of the application that uses it. Also called: private side-by-side assembly. See also shared assembly.

Private Branch Exchange *n.* See PBX.

private channel *n.* In Internet relay chat (IRC), a channel reserved for the use of a certain group of people. Private channel names are hidden from view by the public at large. Also called: secret channel. See also IRC.

Private Communications Technology *n.* See PCT (definition 2).

private folders *n.* In a shared network environment, those folders on a user’s computer that are not accessible by other users on the network. Compare public folders.

private key *n.* One of two keys in public key encryption. The user keeps the private key secret and uses it to encrypt digital signatures and to decrypt received messages. See also public key encryption. Compare public key.

private line *n.* See dedicated line (definition 1).

Private Network-to-Network Interface *n.* See PNNI.

privatization *n.* Generally, the process of turning something over from government to commercial industry control. In the context of computer science and the Internet, the term refers to the government’s turning over of various Internet backbones to private industry—for example, control of NSFnet was passed from the government to private business in 1992—and to the government’s more recent (1998) privatization of responsibility for domain names and addresses, which was shifted from IANA and NSI/InterNIC to a new organization known as ICANN. See also IANA, ICANN, InterNIC.

privileged instruction *n.* An instruction (usually a machine instruction) that can be executed only by the operating system. Privileged instructions exist because the operating system needs to perform certain operations that applications should not be allowed to perform; therefore, only the operating-system routines have the necessary privilege to execute these particular instructions.

P

privileged mode *n.* A mode of execution, supported by the protected mode of the Intel 80286 and higher microprocessors, in which software can carry out restricted operations that manipulate critical components of the system, such as memory and input/output ports (channels). Application programs cannot be executed in privileged mode; the heart (kernel) of the OS/2 operating system can be, as can the programs (device drivers) that control devices attached to the system.

privileges *n.* *See* access privileges.

PRN *n.* The logical device name for *printer*. A name reserved by the MS-DOS operating system for the standard print device. PRN usually refers to a system's first parallel port, also known as LPT1.

.pro *n.* One of seven new top-level domain names approved in 2000 by the Internet Corporation for Assigned Names and Numbers (ICANN), .pro is meant for use in Web sites relating to professions such as physicians, accountants, and lawyers. Six of the new domains became available for use in the spring of 2001; negotiations are still underway for the final registry agreement for the .pro domain.

probability *n.* The likelihood that an event will happen, which can often be estimated mathematically. In mathematics, statistics and probability theory are related fields. In computing, probability is used to determine the likelihood of failure or error in a system or device.

problem solving *n.* **1.** The process of devising and implementing a strategy for finding a solution or for transforming a less desirable condition into a more desirable one. **2.** An aspect of artificial intelligence wherein the task of problem solving is performed solely by a program. *See also* artificial intelligence.

procedural language *n.* A programming language in which the basic programming element is the procedure (a named sequence of statements, such as a routine, subroutine, or function). The most widely used high-level languages (C, Pascal, Basic, FORTRAN, COBOL, Ada) are all procedural languages. *See also* procedure. *Compare* nonprocedural language.

procedural rendering *n.* The rendering of a two-dimensional image from three-dimensional coordinates with texturing according to user-specified conditions, such as direction and degree of lighting.

procedure *n.* In a program, a named sequence of statements, often with associated constants, data types, and variables, that usually performs a single task. A procedure can usually be called (executed) by other procedures, as well as by the main body of the program. Some languages distinguish between a procedure and a function, with the latter (the function) returning a value. *See also* function, parameter, procedural language, routine, subroutine.

procedure call *n.* In programming, an instruction that causes a procedure to be executed. A procedure call can be located in another procedure or in the main body of the program. *See also* procedure.

process¹ *n.* A program or part of a program; a coherent sequence of steps undertaken by a program.

process² *vb.* To manipulate data with a program.

process-bound *adj.* Limited in performance by processing requirements. *See also* computation-bound.

process color *n.* A method of handling color in a document in which each block of color is separated into its subtractive primary color components for printing: cyan, magenta, and yellow (as well as black). All other colors are created by blending layers of various sizes of halftone spots printed in cyan, magenta, and yellow to create the image. *See also* color model, color separation (definition 1). *Compare* spot color.

processing *n.* The manipulation of data within a computer system. Processing is the vital step between receiving data (input) and producing results (output)—the task for which computers are designed.

processor *n.* *See* central processing unit, microprocessor.

Processor Direct Slot *n.* *See* PDS (definition 1).

Processor Input/Output *n.* *See* PIO.

Procmail *n.* An open-source e-mail-processing utility for Linux and other UNIX-based computers and networks. Procmail can be used to create mail servers and mailing lists, filter mail, sort incoming mail, preprocess mail, and perform other mail-related functions.

Prodigy *n.* An Internet service provider (ISP) that offers Internet access and a wide range of related services. Prodigy was founded by IBM and Sears as a proprietary online service, was acquired by International Wireless in 1996, and in 1999 entered into a partnership with SBC Commu-



nications. The addition of SBC's Internet customer base made Prodigy the third largest ISP in the United States.

Prodigy Information Service *n.* An online information service founded by IBM and Sears. Like its competitors America Online and CompuServe, Prodigy offers access to databases and file libraries, online chat, special interest groups, e-mail, and Internet connectivity. *Also called:* Prodigy.

product *n.* **1.** An operator in the relational algebra used in database management that, when applied to two existing relations (tables), results in the creation of a new table containing all possible ordered concatenations (combinations) of tuples (rows) from the first relation with tuples from the second. The number of rows in the resulting relation is the product of the number of rows in the two source relations. *Also called:* Cartesian product. *Compare* inner join. **2.** In mathematics, the result of multiplying two or more numbers. **3.** In the most general sense, an entity conceived and developed for the purpose of competing in a commercial market. Although computers are products, the term is more commonly applied to software, peripherals, and accessories in the computing arena.

production system *n.* In expert systems, an approach to problem solving based on an "IF this, THEN that" approach that uses a set of rules, a database of information, and a "rule interpreter" to match premises with facts and form a conclusion. Production systems are also known as rule-based systems or inference systems. *See also* expert system.

P

Professional Graphics Adapter *n.* A video adapter introduced by IBM, primarily for CAD applications. The Professional Graphics Adapter is capable of displaying 256 colors, with a horizontal resolution of 640 pixels and a vertical resolution of 480 pixels. *Acronym:* PGA.

Professional Graphics Display *n.* An analog display introduced by IBM, intended for use with their Professional Graphics Adapter. *See also* Professional Graphics Adapter.

profile¹ *n.* *See* user profile.

profile² *vb.* To analyze a program to determine how much time is spent in different parts of the program during execution.

profiler *n.* A diagnostic tool for analyzing the run-time behavior of programs.

Profiles for Open Systems Internetworking Technology

n. *See* POSIT.

program¹ *n.* A sequence of instructions that can be executed by a computer. The term can refer to the original source code or to the executable (machine language) version. *Also called:* software. *See also* program creation, routine, statement.

program² *vb.* To create a computer program, a set of instructions that a computer or other device executes to perform a series of actions or a particular type of work.

program button *n.* On a handheld device, a navigation control that is pressed to launch an application. *Also called:* application button.

program card *n.* *See* PC Card, ROM card.

program cartridge *n.* *See* ROM cartridge.

program comprehension tool *n.* A software engineering tool that facilitates the process of understanding the structure and/or functionality of computer applications. *Acronym:* PCT. *Also called:* software exploration tool.

program counter *n.* A register (small, high-speed memory circuit within a microprocessor) that contains the address (location) of the instruction to be executed next in the program sequence.

program creation *n.* The process of producing an executable file. Traditionally, program creation comprises three steps: (1) compiling the high-level source code into assembly language source code; (2) assembling the assembly language source code into machine-code object files; and (3) linking the machine-code object files with various data files, run-time files, and library files into an executable file. Some compilers go directly from high-level source to machine-code object, and some integrated development environments compress all three steps into a single command. *See also* assembler, compiler (definition 2), linker, program.

program encapsulation *n.* A method of dealing with programs with Year 2000 problems that entailed modifying the data with which a program worked. The input data is modified to reflect a parallel date in the past that the program can handle. When output is generated, that data is changed again, to reflect the correct date. The program itself remains unchanged.

program file *n.* A disk file that contains the executable portions of a computer program. Depending on its size and

complexity, an application or other program, such as an operating system, can be stored in several different files, each containing the instructions necessary for some part of the program's overall functioning. *Compare* document file.

program generator *n.* A program that creates other programs (usually in source code) based on a set of specifications and relationships given by the user. Program generators are often used to simplify the task of creating an application. *See also* 4GL, application generator.

program listing *n.* A copy, usually on paper, of the source code of a program. Some compilers can generate program listings with line numbers, cross-references, and so on.

program logic *n.* The logic behind the design and construction of a program—that is, the reasons it works the way it does. *See also* logic error.

programmable *adj.* Capable of accepting instructions for performing a task or an operation. Being programmable is a characteristic of computers.

programmable function key *n.* Any of several, sometimes unlabeled, keys on some third-party keyboards that allow the user to “play back” previously stored key combinations or sequences of keystrokes called *macros*. The same effect can be achieved with a standard keyboard and a keyboard enhancer, the latter of which intercepts the keyboard codes and substitutes modified values; but programmable function keys accomplish this without requiring RAM-resident software. *Compare* keyboard enhancer.

programmable interrupt controller *n.* An Intel chip that handles interrupt requests (IRQs). IBM AT machines use two programmable interrupt controllers to accommodate a maximum of 15 IRQs. The programmable interrupt controller has been replaced by the advanced programmable interrupt controller (APIC), which supports multiprocessing. *Acronym:* PIC. *See also* IBM AT, IRQ.

programmable logic array *n.* *See* field-programmable logic array.

programmable logic device *n.* A logic chip that is programmed by the customer rather than by the manufacturer. Like a gate array, a programmable logic device consists of a collection of logic gates; unlike a gate array, a programmable logic device need not have its programming completed as part of the manufacturing process. *Acronym:* PLD. *See also* logic chip. *Compare* gate array.

programmable read-only memory *n.* *See* PROM.

program maintenance *n.* The process of supporting, debugging, and upgrading a program in response to feedback from individual or corporate users or the marketplace in general.

programmatic interface *n.* **1.** A user interface dependent on user commands or on a special programming language, as contrasted with a graphical user interface. UNIX and MS-DOS have programmatic interfaces; the Apple Macintosh and Microsoft Windows have graphical user interfaces. *See also* command-line interface, graphical user interface, iconic interface. **2.** The set of functions any operating system makes available to a programmer developing an application. *See also* application programming interface.

Programmed Input/Output *n.* *See* PIO.

Programmed Inquiry, Learning or Teaching *n.* *See* PILOT.

programmer *n.* **1.** An individual who writes and debugs computer programs. Depending on the size of the project and the work environment, a programmer might work alone or as part of a team, be involved in part or all of the process from design through completion, or write all or a portion of the program. *See also* program. **2.** In hardware, a device used to program read-only memory chips. *See also* PROM, ROM (definition 2).

programmer's switch *n.* A pair of buttons on Macintosh computers that enable the user to reboot the system or to enter a command-line interface at a low level of the operating system. Originally, only programmers testing software were expected to need those functions, so early models of the Macintosh hid the buttons inside the cabinet and supplied a plastic clip that could be attached so that the programmer could push them. In many later models the buttons are built into the cabinet; the button to reboot the system is marked with a triangle pointing leftward, and the other button is marked with a circle.

programming *n.* The art and science of creating computer programs. Programming begins with knowledge of one or more programming languages, such as Basic, C, Pascal, or assembly language. Knowledge of a language alone does not make a good program. Much more can be involved, such as expertise in the theory of algorithms, user interface design, and characteristics of hardware devices. Computers are rigorously logical machines, and

P

programming requires a similarly logical approach to designing, writing (coding), testing, and debugging a program. Low-level languages, such as assembly language, also require familiarity with the capabilities of a microprocessor and the basic instructions built into it. In the modular approach advocated by many programmers, a project is broken into smaller, more manageable modules—stand-alone functional units that can be designed, written, tested, and debugged separately before being incorporated into the larger program. *See also* algorithm, kludge (definition 2), modular design, object-oriented programming, spaghetti code, structured programming.

programming language *n.* Any artificial language that can be used to define a sequence of instructions that can ultimately be processed and executed by the computer. Defining what is or is not a programming language can be tricky, but general usage implies that the translation process—from the source code expressed using the programming language to the machine code that the computer needs to work with—be automated by means of another program, such as a compiler. Thus, English and other natural languages are ruled out, although some subsets of English are used and understood by some fourth-generation languages. *See also* 4GL, compiler (definition 2), natural language, program.

Programming Language I *n.* *See* PL/I.

program specification *n.* In software development, a statement of the goals and requirements of a project, as well as the relation of the project to other projects.

program state *n.* The condition of a program (stack contents, memory contents, instruction being executed) at a given moment.

program statement *n.* The statement defining the name, briefly describing the operation, and possibly giving other information about a program. Some languages, such as Pascal, have an explicit program statement; others do not, or they use other forms (such as the `main()` function in C).

progressive JPEG *n.* An enhancement to the JPEG graphics file format that gradually displays a photo-realistic picture in a Web browser, showing increasingly detailed versions of the picture until the entire file has finished downloading.

progressive scanning *n.* **1.** A display technique used on computer monitors in which the image is created, line by line, in a single top-to-bottom sweep of the electron gun.

The resulting image is of higher quality than is possible with the interlace scanning used for television sets. Progressive scanning might be used on next-generation digital television equipment. It does, however, require twice the signal bandwidth of interlace scanning. *Compare* interlace scanning. **2.** A line-by-line (rather than every-other-line) technique used with some video cameras to capture images of moving objects. Such cameras are used primarily for tasks such as monitoring assembly lines and traffic flow.

project *n.* An operator in the relational algebra used in database management. Given relation (table) A, the *project* operator builds a new relation containing only a specified set of attributes (columns) of A.

Project 802 *n.* The IEEE project to define networking standards that resulted in the 802.x specifications. *See also* IEEE, IEEE 802.x.

Project Gutenberg *n.* A project that makes the texts of books that are in the public domain available over the Internet. The files for the books are in plain ASCII, to make them accessible to as many people as possible. Project Gutenberg, based at the University of Illinois at Urbana-Champaign, can be reached at `mrcnext.cso.uiuc.edu` via FTP or through the Web page <http://www.promo.net/pg/>. *See also* ASCII.

projection-join normal form *n.* *See* normal form (definition 1).

project life cycle *n.* A sequence of preplanned stages for taking a project from beginning to end.

project management *n.* The process of planning, monitoring, and controlling the course and development of a particular undertaking.

Prolog *n.* Short for **Programming in Logic**. A language designed for logic programming. Prolog evolved during the 1970s in Europe (primarily France and Scotland), and the first Prolog compiler was developed in 1972 by Philippe Roussel, at the University of Marseilles. The language has subsequently attained wide use in the field of artificial intelligence. Prolog is a compiled language that works with the logical relationship between pieces of data rather than mathematical relationships. *See also* artificial intelligence.

PROM *n.* Acronym for **programmable read-only memory**. A type of read-only memory (ROM) that allows data to be written into the device with hardware called a PROM programmer. After a PROM has been programmed, it is

P

dedicated to that data, and it cannot be reprogrammed. *See also* EEPROM, EPROM, ROM (definition 2).

PROM blaster *n.* *See* PROM programmer.

PROM blower *n.* *See* PROM programmer.

promiscuous-mode transfer *n.* In network communications, a transfer of data in which a node accepts all packets regardless of their destination address.

PROM programmer *n.* A hardware device that records instructions or data on a PROM (programmable read-only memory) chip or an EPROM (erasable programmable read-only memory) chip. *Also called:* PROM blaster, PROM blower. *See also* EPROM, PROM.

prompt *n.* **1.** In command-driven systems, one or more symbols that indicate where users are to enter commands. For instance, in MS-DOS, the prompt is generally a drive letter followed by a greater than symbol (C>). In UNIX, it is usually %. *See also* command-driven system, DOS prompt. **2.** Displayed text indicating that a computer program is waiting for input from the user.

propagated error *n.* An error used as input to another operation, thus producing another error.

propagation *n.* Travel of a signal, such as an Internet packet, from its source to one or more destinations. Propagation of messages over different paths with different lengths can cause messages to appear at a user's computer with varying delivery times. *See also* propagation delay.

propagation delay *n.* The time needed by a communications signal to travel between two points; in satellite links, a noticeable delay of between one-quarter second and one-half second, caused by the signal traveling through space.

propeller head *n.* Slang for a person who is obsessed with computers or other technology; a geek. The name refers to a child's beanie cap topped by a spinning propeller.

property *n.* In Windows 9x, a characteristic or parameter of an object or device. Properties of a file, for example, include type, size, and creation date and can be identified by accessing the file's property sheet. *See also* property sheet.

property sheet *n.* A type of dialog box in Windows 9x, accessed by choosing Properties in the File menu or by right-clicking on an object and selecting Properties, that lists the attributes or settings of an object such as a file, application, or hardware device. A property sheet presents the user with a tabbed, index-card-like selection of prop-

erty pages, each of which features standard dialog-style controls for customizing parameters.

proportional font *n.* A set of characters in a particular style and size in which a variable amount of horizontal space is allotted to each letter or number. In a proportional font, the letter *i*, for example, is allowed less space than the letter *m*. *Compare* monospace font.

proportional spacing *n.* A form of character spacing in which the horizontal space each character occupies is proportional to the width of the character. The letter *w*, for example, takes up more space than the letter *i*. *Compare* monospacing.

proprietary *adj.* Of, pertaining to, or characteristic of something that is privately owned. Generally, the term refers to technology that has been developed by a particular corporation or entity, with specifications that are considered by the owner to be trade secrets. Proprietary technology may be legally used only by a person or entity purchasing an explicit license. Also, other companies are unable to duplicate the technology, both legally and because its specifications have not been divulged by the owner. *Compare* public domain.

proprietary software *n.* A program owned or copyrighted by an individual or a business and available for use only through purchase or by permission of the owner. *Compare* open source, public-domain software.

protected *n.* A keyword in a programming language (such as Java or C++) used in a method or variable declaration. It signifies that the method or variable can be accessed only by elements residing in its class, subclasses, or classes in the same package. *See also* class, declaration, method, package, variable.

protected mode *n.* An operating mode of the Intel 80286 and higher microprocessors that supports larger address spaces and more advanced features than real mode. When started in protected mode, these CPUs provide hardware support for multitasking, data security, and virtual memory. The Windows (version 3.0 and later) and OS/2 operating systems run in protected mode, as do most versions of UNIX for these microprocessors. *Compare* real mode.

protocol *n.* *See* communications protocol.

protocol analyzer *n.* A management tool designed to identify and diagnose computer network problems. A protocol analyzer looks at LAN (local area network) or WAN (wide area network) traffic and finds protocol errors, connection delays, and other network faults. The protocol



analyzer can filter and decode traffic, suggest solutions to problems, provide graphical reports, and show traffic by protocol and percent utilization. *See also* communications protocol.

protocol layer *n.* *See* layer.

protocol stack *n.* The set of protocols that work together on different levels to enable communication on a network. For example, TCP/IP, the protocol stack on the Internet, incorporates more than 100 standards including FTP, IP, SMTP, TCP, and Telnet. *See also* ISO/OSI reference model. *Compare* protocol suite.

protocol suite *n.* A set of protocols designed, usually by one vendor, as complementary parts of a protocol stack. *Compare* protocol stack.

prototyping *n.* The creation of a working model of a new computer system or program for testing and refinement. Prototyping is used in the development of both new hardware and software systems and new systems of information management. Tools used in the former include both hardware and support software; tools used in the latter can include databases, screen mockups, and simulations that, in some cases, can be developed into a final product.

proxy *n.* A computer (or the software that runs on it) that acts as a barrier between a network and the Internet by presenting only a single network address to external sites. By acting as a go-between representing all internal computers, the proxy protects network identities while still providing access to the Internet. *See also* proxy server.

proxy server *n.* A firewall component that manages Internet traffic to and from a local area network (LAN) and can provide other features, such as document caching and access control. A proxy server can improve performance by supplying frequently requested data, such as a popular Web page, and can filter and discard requests that the owner does not consider appropriate, such as requests for unauthorized access to proprietary files. *See also* firewall.

PrtSc key *n.* *See* Print Screen key.

.ps *n.* The file extension that identifies PostScript printer files. *See also* PostScript.

PS/2 bus *n.* *See* Micro Channel Architecture.

PSD *n.* A graphics file format used to create, modify, and display still images in Photoshop, a software application designed by Adobe Systems. PSD files have a file extension of .psd.

PSE *n.* *See* Packet Switching Exchange.

psec *n.* *See* picosecond.

pseudocode *n.* **1.** A machine language for a nonexistent processor (a pseudomachine). Such code is executed by a software interpreter. The major advantage of p-code is that it is portable to all computers for which a p-code interpreter exists. The p-code approach has been tried several times in the microcomputer industry, with mixed success. The best known attempt was the UCSD p-System. *Abbreviation:* p-code. *See also* pseudomachine, UCSD p-System. **2.** Any informal, transparent notation in which a program or algorithm description is written. Many programmers write their programs first in a pseudocode that looks much like a mixture of English and their favorite programming language, such as C or Pascal, and then translate it line by line into the actual language being used.

pseudo compiler *n.* A compiler that generates a pseudo-language. *See also* pseudolanguage.

pseudocomputer *n.* *See* pseudomachine.

pseudolanguage *n.* A nonexistent programming language—that is, one for which no implementation exists. The term can refer either to the machine language for a nonexistent processor or to a high-level language for which no compiler exists. *See also* pseudocode.

pseudomachine *n.* A processor that doesn't actually exist in hardware but that is emulated in software. A program written for the pseudomachine can run on several platforms without having to be recompiled. *Abbreviation:* p-machine. *See also* pseudocode, UCSD p-System.

pseudo-op *n.* *See* pseudo-operation.

pseudo-operation *n.* In programming, a program instruction that conveys information to an assembler or compiler but is not translated into a machine language instruction—for example, an instruction that establishes the value of a constant or the manner in which Boolean (logical) expressions are to be evaluated. *Abbreviation:* pseudo-op.

pseudo-streaming *n.* A method used for real-time display of audio and video over the Web. Unlike sound or video files that are downloaded to a computer in their entirety before they can be played back, pseudo-streaming enables playback after only a portion of the file—enough to fill a buffer on the receiving computer—has been downloaded. Pseudo-streaming, unlike “true,” or Web, streaming, does not depend on server software to dynamically monitor the transmission. It can, however, play back only

P

from the beginning of the file, rather than from any point, as can be the case with true streaming. *See also* stream.

PSK *n.* *See* phase-shift keying.

PSN *n.* Acronym for **packet-switching network**. *See* packet switching.

PSTN *n.* *See* Public Switched Telephone Network.

p-system *n.* An operating system based on a pseudomachine implemented in software. A program written for the p-system is more portable than one written for a machine-dependent operating system. *See also* UCSD p-System.

P-type semiconductor *n.* Semiconductor material in which electrical conduction is carried by holes (“vacancies” left by electrons). Whether a semiconductor is N-type or P-type depends on the kind of dopant added during manufacture. A dopant with a shortage of electrons results in a P-type semiconductor. *Compare* N-type semiconductor.

pub *n.* *See* /pub.

/pub *n.* Short for **public**. A directory in an anonymous FTP archive that is accessible by the public and that generally contains files available for free download. *See also* anonymous FTP.

public *adj.* A keyword in some programming languages to signify that methods or variables can be accessed by elements residing in other classes or modules. *See also* class., keyword (definition 2), global variable, reserved word, scope. *Compare* private.

public directory *n.* A directory on an FTP server that is accessible by anonymous users for the purpose of retrieving or storing files. Often the directory is called /pub. *See also* anonymous FTP, FTP (definition 1), FTP server /pub.

public domain *n.* The set of all creative works, such as books, music, or software, that are not covered by copyright or other property protection. Works in the public domain can be freely copied, modified, and otherwise used in any manner for any purpose. Much of the information, texts, and software on the Internet is in the public domain, but putting a copyrighted work on the Internet does not put it in the public domain. *Compare* proprietary.

public-domain software *n.* A program donated for public use by its owner or developer and freely available for copying and distribution. *Compare* free software, free-ware, proprietary software, shareware.

public files *n.* Files with no access restrictions.

public folders *n.* The folders that are made accessible on a particular machine or by a particular user in a shared networking environment. *Compare* private folders.

public key *n.* One of two keys in public key encryption. The user releases this key to the public, who can use it for encrypting messages to be sent to the user and for decrypting the user’s digital signature. *See also* public key encryption. *Compare* private key.

public key cryptography *n.* *See* public key encryption.

public key encryption *n.* An asymmetric scheme that uses a pair of keys for encryption: the public key encrypts data, and a corresponding secret key decrypts it. For digital signatures, the process is reversed: the sender uses the secret key to create a unique electronic number that can be read by anyone possessing the corresponding public key, which verifies that the message is truly from the sender. *See also* private key, public key.

public rights *n.* In the context of the Internet, the extent to which members of the public are permitted to use (and to place) information on the Internet under intellectual property law. *See also* fair use, public domain, public-domain software.

Public Switched Telephone Network *n.* The public telephone system.

Publisher *n.* A software application developed by Microsoft Corporation to help businesses create high-quality marketing and business material. A part of the Office product family, Publisher provides business users with design options for a variety of publications, such as newsletters, flyers, brochures, and Web pages.

publishing point *n.* A publishing point is a virtual directory used for storing content or delivering a live stream. End users reach a publishing point through its URL. There are two types of unicast publishing points: on-demand for stored content and broadcast for live streams. *See also* on-demand publishing point, broadcast publishing point. *Compare* unicast.

puck *n.* A pointing device used with a graphics tablet. A puck, which is often used in engineering applications, is a mouselike device with buttons for selecting items or choosing commands and a clear plastic section extending from one end with cross hairs printed on it. The intersection of the cross hairs on the puck points to a location on the graphics tablet, which in turn is mapped to a specific



location on the screen. Because the puck's cross hairs are on a transparent surface, a user can easily trace a drawing by placing it between the graphics tablet and the puck and moving the cross hairs over the lines of the drawing. *See also* graphics tablet, stylus.



Puck.

puff and sip device *n.* An assistive computer technology for people with mobility impairments. A puff and sip device is a head-mounted alternative to using a mouse or keyboard. For mouse functionality, the device allows a user to move the mouse pointer without using his or her hands by puffing air into a tube.

pull *vb.* The process of retrieving data from a network server. *Compare* push (definition 2). *See* pop.

pull-down menu *n.* A menu that is pulled down from the menu bar and that remains available as long as the user holds it open. *Compare* drop-down menu.

pulse *n.* A transient signal, usually brief and with a discrete onset and offset.

pulse amplitude modulation *n.* A method of encoding information in a signal by varying the amplitude of pulses. The unmodulated signal consists of a continuous train of pulses of constant frequency, duration, and amplitude. During modulation the pulse amplitudes are changed to reflect the information being encoded. *See* the illustration. *Acronym:* PAM. *Compare* pulse code modulation, pulse duration modulation, pulse position modulation.

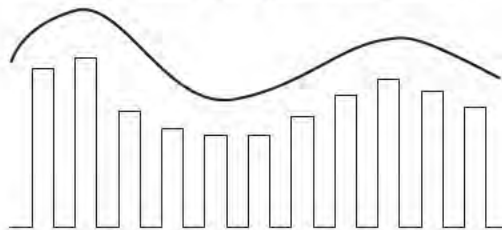

Pulse amplitude modulation.

pulse code modulation *n.* A method of encoding information in a signal by varying the amplitude of pulses. Unlike pulse amplitude modulation (PAM), in which pulse amplitude can vary continuously, pulse code modulation limits pulse amplitudes to several predefined values. Because the signal is discrete, or digital, rather than analog, pulse code modulation is more immune to noise than PAM. *Acronym:* PCM. *Compare* pulse amplitude modulation, pulse duration modulation, pulse position modulation.

pulse dialing *n.* *See* rotary dialing.

pulse duration modulation *n.* A method of encoding information in a signal by varying the duration of pulses. The unmodulated signal consists of a continuous train of pulses of constant frequency, duration, and amplitude. During modulation, the pulse durations are changed to reflect the information being encoded. *See* the illustration. *Acronym:* PDM. *Also called:* pulse length modulation, pulse width modulation.

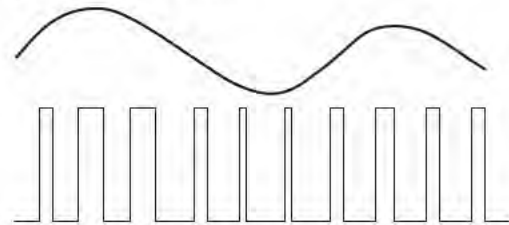

Pulse duration modulation.

pulse length modulation *n.* *See* pulse duration modulation.

pulse position modulation *n.* A method of encoding information in a signal by varying the position of pulses. The unmodulated signal consists of a continuous train of pulses of constant frequency, duration, and amplitude. During modulation, the pulse positions are changed to reflect the information being encoded. *See* the illustration. *Acronym:* PPM. *Compare* pulse amplitude modulation, pulse code modulation, pulse duration modulation.

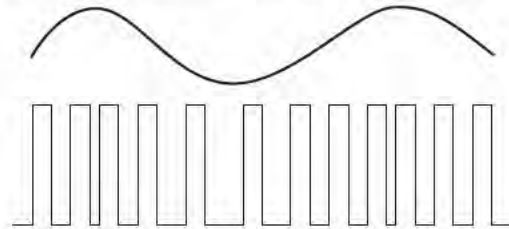

Pulse position modulation.

pulse width modulation *n.* See pulse duration modulation.

punched card *n.* An outdated computer-input medium made of stiff paper that stores data bits in columns containing patterns of punched holes. The method for creating the patterns used for different byte values is called Hollerith coding. See also Hollerith tabulating/recording machine.

punched-card reader *n.* See card reader.

pure procedure *n.* Any procedure that modifies only data that is dynamically allocated (usually on the stack). A pure procedure cannot modify either global data or its own code. This restriction allows a pure procedure to be called simultaneously by separate tasks. See also reentrant code.

purge *vb.* To eliminate old or unneeded information systematically; to clean up, as files.

push¹ *n.* A technology developed in relation to the World Wide Web, designed to provide end users with personalized Web access by having a site actively “push” requested information to the user’s desktop, either automatically or at specified intervals. Push was developed as a means of relieving users from having to actively retrieve (“pull”) information from the Web. It is not, as yet, especially popular.

push² *vb.* **1.** To add a new element to a stack, a data structure generally used to temporarily hold pieces of data being transferred or the partial result of an arithmetic operation. See also stack. Compare pop. **2.** In networks and the Internet, to send data or a program from a server to a client at the instigation of the server. See also push². Compare pull.

put *vb.* In programming, to write data, typically to a file; in particular, to write a very small unit of data, such as a character.

PVC *n.* Acronym for **permanent virtual circuit**. A permanent logical connection between two nodes on a packet-switching network. The PVC appears as a dedicated line to the nodes, but the data can be transmitted on a common carrier. See also common carrier, node (definition 2), packet switching, virtual private network. Compare SVC.

pwd *n.* Acronym for **print working directory**. The UNIX command for displaying the current directory.

PWM *n.* Acronym for **pulse width modulation**. See pulse duration modulation.

PXE boot *n.* Acronym for **Preboot Execution Environment boot**. A BIOS-supported technology used to boot a PC remotely. To power on a PC and boot it from the network, PXE must be enabled in the BIOS, and the NIC in the PC must be PXE compliant. PXE boot is specified in the Intel Wired for Management (WfM) standard. Also called: network boot.

pyramid diagram *n.* A diagram that is used to show foundation-based relationships.

Python *n.* A portable, interpreted, object-oriented programming language developed and freely distributed by its developer. Python runs on many platforms, including UNIX, Windows, OS/2, and Macintosh, and is used for writing TCP/IP applications.



Q

QAM *n.* See quadrature amplitude modulation, queued access method.

QBasic *n.* An interpreted language. QBasic is a dialect of Basic created by Microsoft for the MS-DOS platform. This language is no longer supported.

QBE *n.* See query by example.

QIC *n.* **1.** Acronym for **quarter-inch cartridge**. A storage technology used with tape backup drives and cartridges. A means of backing up data on computer systems, QIC represents a set of standards devised to enable tapes to be used with drives from different manufacturers. The QIC standards specify the length of tape, the number of recording tracks, and the magnetic strength of the tape coating, all of which determine the amount of information that can be written to the tape. Older QIC-80 drives can hold up to 340 MB of compressed data. Newer versions can hold more than 1 GB of information. **2.** A consortium of quarter-inch tape manufacturers. Quarter-Inch Cartridge Drive Standards Inc. (QIC) establishes standards for the production of quarter-inch tapes. For example, QIC-40 and QIC-80, designed to use a PC's floppy disk drive controller, are called the "floppy tape standards."

QOS or **QoS** *n.* See quality of service.

quadbit *n.* A set of 4 bits representing one of 16 possible combinations. In communications, quadbits are a means of increasing transmission rates by encoding 4 bits at a time, instead of 1 or 2. The 16 quadbits are 0000, 0001, 0010, 0011, 0100, 0101, 0110, 0111, 1000, 1001, 1010, 1011, 1100, 1101, 1110, and 1111. *Compare* nibble.

quadrature amplitude modulation *n.* In communications, an encoding method that combines amplitude modulation and phase modulation to create a constellation of signal points, each representing one unique combination of bits that can be identified with one possible state that the carrier wave can be in. *Acronym:* QAM. See also amplitude modulation, constellation, phase-shift keying, trellis-coded modulation.

quadrature encoding *n.* The most common method used to determine in which direction a mouse is moving. In

mechanical mice, movement of the mouse ball is translated into horizontal or vertical movement by a pair of turning disks, one disk for horizontal movement and one disk for vertical movement, each of which makes and breaks contact with two sensors located on it. The two sensors are placed out of phase with each other, and the mouse notes which sensor receives contact first. The phrase *quadrature encoding* comes from the fact that each sensor sends a square-wave signal 90 degrees out of phase with the other. If the first signal occurs before the second, the mouse is assumed to have been moved in one direction; if the second signal occurs before the first, the mouse is assumed to have been moved in the opposite direction. See also mechanical mouse, mouse, optomechanical mouse.

quality assurance *n.* A system of procedures carried out to ensure that a product or a system adheres or conforms to established standards. *Also called:* quality control.

quality of service *n.* **1.** Generally, the handling capacity of a system or service; the time interval between request and delivery of a product or service to the client or customer. **2.** In computer technology, the guaranteed throughput (data transfer rate) level.

quantity *n.* A number—positive or negative, whole or fractional—that is used to indicate a value.

quantize *vb.* To divide an element into separate, distinct units (quanta) and to assign a value to each resulting unit, especially in the domain of time. *Compare* digitize.

quantum *n.* **1.** In communications, the unit resulting from division of a signal by quantization. **2.** A portion of time allotted on a time-sharing system. *Compare* time slice. **3.** An amount of something; for example, in physics, a unit of radiant energy.

quantum bit *n.* See qubit.

quantum computing *n.* A theoretical design for computers based on quantum mechanics. Unlike classic (current) digital computers, which calculate sets of values sequentially because a single bit can represent only 1 or 0 at any given time, a quantum computer is based on the ability of each bit to represent more than one value at the same time.

Q

Because each quantum bit—called a qubit—represents multiple values, a quantum computer can be in multiple states simultaneously and can thus work on numerous problems at the same time to offer far more computing power than is currently available. Quantum computing is under investigation by the United States Defense Advanced Research Projects Agency (DARPA) and other groups. Although atoms of hydrogen and carbon have been used to create the rudiments of a quantum computer, the technology is still in its infancy.

quarter-inch cartridge *n.* See QIC (definition 1).

Quartz *n.* The 2-D drawing engine that forms the imaging foundation of the Mac OS X Aqua interface. The Quartz graphics application programming interface (API) is based on Adobe's Portable Document Format (PDF) standard.

quartz crystal *n.* A precisely shaped and precisely sized piece of the mineral quartz, used for its piezoelectric properties. When a voltage is applied to a quartz crystal, it vibrates at a frequency determined by its size and shape. Quartz crystals are commonly used to control the frequency of oscillator circuits such as the clocks in microcomputers. See also piezoelectric.

quasi-language *n.* A derogatory term for any programming language that, because of deficiencies, is not suitable for any serious work.

qubit *n.* Short for **quantum bit**. The bits (currently, atomic particles) that make up the theoretical machines known as quantum computers. Qubits are unlike bits in current computers in that they exist in more than one state at the same time. They can, therefore, represent both 0 and 1 simultaneously. Qubits, like quantum computers, are based on the science of quantum mechanics.

query¹ *n.* A specific set of instructions for extracting particular data.

query² *vb.* To extract data from a database and present it for use.

query by example *n.* A simple-to-use query language implemented on several relational database management systems. Using query by example, the user specifies fields to be displayed, intertable linkages, and retrieval criteria directly onto forms displayed on the screen. These forms are a direct pictorial representation of the table and row structures that make up the database. Thus, the construction of a query becomes a simple "checkoff" procedure from the viewpoint of the user. *Acronym:* QBE.

query language *n.* A subset of the data manipulation language; specifically, that portion relating to the retrieval and display of data from a database. It is sometimes used loosely to refer to the entire data manipulation language. See also data manipulation language.

question mark *n.* See ?.

queue¹ *n.* A multi-element data structure from which (by strict definition) elements can be removed only in the same order in which they were inserted; that is, it follows a first in, first out (FIFO) constraint. There are also several types of queues in which removal is based on factors other than order of insertion—for example, some priority value assigned to each element. See also deque, element (definition 1). Compare stack.

queue² *vb.* To place (an item) in a queue.

queued access method *n.* A programming technique that minimizes input/output delays by synchronizing the transfer of information between the program and the computer's input and output devices. *Acronym:* QAM.

queuing *n.* In networking, the process of buffering data in preparation for transmission. See also fair queuing; first in, first out; last in, first out; weighted fair queuing.

QuickDraw *n.* On the Apple Macintosh, the built-in group of routines within the operating system that controls the display of graphics and text. Application programs call QuickDraw for on-screen displays. See also Toolbox.

QuickDraw 3-D *n.* A version of the Macintosh QuickDraw library that includes routines for doing 3-D graphics calculations. See also QuickDraw.

Quicken *n.* Financial-management software from Intuit, Inc. The personal-finance version, introduced by Intuit in 1984, includes tools for balancing and tracking bank accounts and investments, budgeting, paying bills, planning and preparing tax returns, financial planning, and estate planning. A small-business version, Quicken Home & Business, adds tools for business-related matters, such as invoicing and accounts receivable and payable.

quicksort *n.* An efficient sort algorithm, described by C.A.R. Hoare in 1962, in which the essential strategy is to "divide and conquer." A quicksort begins by scanning the list to be sorted for a median value. This value, called the *pivot*, is then moved to its final position in the list. Next, all items in the list whose values are less than the pivot value are moved to one side of the list, and the items with values greater than the pivot value are moved to the other



side. Each resulting side is sorted the same way, until a fully sorted list results. *See also* sort algorithm. *Compare* bubble sort, insertion sort, merge sort.

QuickTime *n.* Software components developed by Apple for creating, editing, publishing, and viewing multimedia content. QuickTime, which supports video, animation, graphics, 3-D, VR (virtual reality), MIDI, music, sound, and text, has been part of the Mac OS since version 7 of the operating system and is used in many Macintosh applications. Windows applications can also run QuickTime files but require the installation of special player software. QuickTime is often used on the Web to provide Web pages with video and animation. Most Web browsers support plug-ins for running these types of files. QuickTime is also part of the new MPEG-4 specification. *See also* MPEG-4.

Quick View *n.* A feature, optionally installed as part of Windows 9x, that provides a set of file viewers for previewing the contents of files without having to start the application(s) that created them. The feature is accessed through the Quick View command, available either from the File menu or by right-clicking a filename. If the feature has been installed but the file type is not supported by a viewer, the Quick View command does not appear.

quiet answer *n.* A telephone-answering protocol in which incoming calls are answered with silence instead of a tone signal. Some telephone-switching systems use quiet answering. These switching systems expect the caller to provide another phone number, code, or extension after the quiet answer.

quit¹ *n.* **1.** An FTP command that instructs the server to drop the current connection with the client from which it received the command. **2.** A command in many applications for exiting the program.

quit² *vb.* **1.** To stop in an orderly manner. **2.** To execute the normal shutdown of a program and return control to the operating system. *Compare* abort, bomb², crash² (definition 1), hang.

QWERTY keyboard *n.* A keyboard layout named for the six leftmost characters in the top row of alphabetic characters on most keyboards—the standard layout of most typewriters and computer keyboards. *Compare* Dvorak keyboard.



R

R&D *n.* Acronym for research and development.

race condition *n.* 1. A condition in which a feedback circuit interacts with internal circuit processes in a way that produces chaotic output behavior. 2. A condition in which data propagates rapidly through a logic circuit far ahead of the clock signal intended to control its passage.

rack-mounted *adj.* Built for installation in a metal frame or cabinet of standard width (typically 19 inches or 23 inches) and mounting arrangements.

RAD *n.* Acronym for rapid application development. A method of building computer systems in which the system is programmed and implemented in segments, rather than

waiting until the entire project is completed for implementation. Developed by programmer James Martin, RAD uses such tools as CASE and visual programming. See also CASE, visual programming.

radian *n.* The angle between two radii of a circle such that the length of the arc between them is equal to the radius. The circumference of a circle is equal to 2π times the radius, so one radian contains $360/(2\pi) = 180/\pi =$ approximately 57.2958 degrees. Conversely, multiplying the number of degrees by $\pi/180$ gives the number of radians; 360 degrees equals 2π radians. See the illustration.

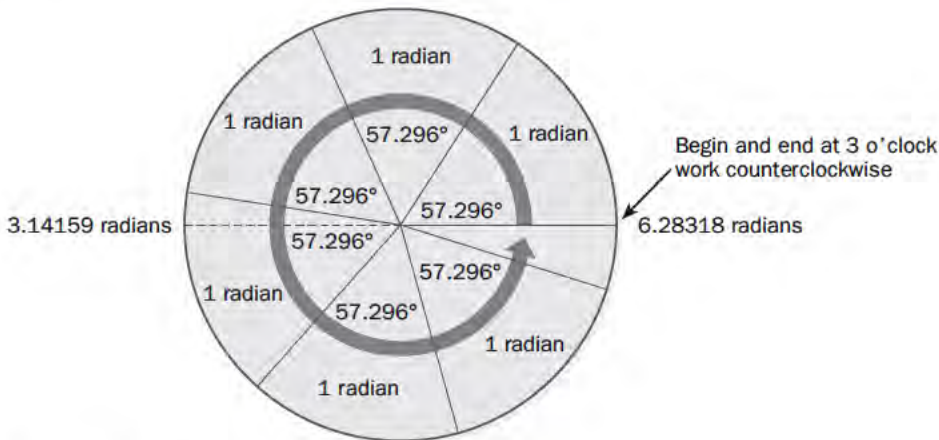

R

$$\text{Radians} = (3.14159 \times (\text{angle of degree})) \div 180$$

$$1 \text{ degree} = 0.017453 \text{ radian}$$

Radian.

radio *n.* **1.** Electromagnetic waves longer than about 0.3 mm (frequencies lower than about 1 THz). Radio is used to transmit a wide variety of signals, using various frequency ranges and types of modulation, such as AM and FM broadcasts, microwave relays, and television broadcasts. *See also* hertz, radio frequency. **2.** Audio signals transmitted over the Internet of quality comparable to those broadcast by commercial radio stations. *See also* Internet Talk Radio, MBONE, RealAudio.

radio button *n.* In graphical user interfaces, a means of selecting one of several options, usually within a dialog box. A radio button appears as a small circle that, when selected, has a smaller, filled circle inside it. Radio buttons act like the station selector buttons on a car radio. Selecting one button in a set deselects the previously selected button, so one and only one of the options in the set can be selected at any given time. In contrast, check boxes are used when more than one option in the set can be selected at the same time. *Compare* check box.

radio clock *n.* A device that receives a broadcast containing a standard time signal. Radio clocks are used in network communications to synchronize the host's hardware clock to the Universal Time Coordinate format in accordance with the Network Time Protocol (NTP). *See also* NTP, Universal Time Coordinate.

radio frequency *n.* The portion of the electromagnetic spectrum with frequencies between 3 kilohertz and 300 gigahertz. This corresponds to wavelengths between 30 kilometers and 0.3 millimeter. *Acronym:* RF. *See also* radio (definition 1).

radio frequency interference *n.* *See* RFI.

radiosity *n.* A method used in computer graphics to render photographic-quality, realistic images. Radiosity is based on dividing an image into smaller polygons, or patches, for purposes of calculating the global illumination emitted by sources of light and reflected from surfaces. Unlike ray tracing, which follows rays of light between a light source and the objects it illuminates, radiosity takes into account both the light emitted from a light source and the light reflected by all objects in the image environment. Radiosity thus accounts not only for a source of illumination (such as a lightbulb) but also for the effects of that illumination as it is absorbed by, and reflected from, every object in the "picture." *See also* form factor. *Compare* ray tracing.

RADIUS *n.* Acronym for **R**emote **A**uthentication **D**ial-**I**n **U**ser **S**ervice protocol. A proposed Internet protocol in which an authentication server provides authorization and authentication information to a network server to which a user is attempting to link. *See also* authentication, communications protocol, server (definition 2).

radix *n.* The base of a number system—for example, 2 in the binary system, 10 in the decimal system, 8 in the octal system, and 16 in the hexadecimal system. *See also* base (definition 2).

radix-minus-1 complement *n.* In a system for representing numbers using a fixed number of possible digits (radix) and a fixed number of positions for them, the number obtained from another number by subtracting each of the digits of the other number from the largest possible digit (equal to the radix minus 1). For example, in a system of five-digit decimal numbers, the radix-minus-1 complement of 1,234 is 98,765. Adding any number to its radix-minus-1 complement produces the largest possible number in the system (in the example, 99,999). Adding another 1 to this number produces, in our example, 100,000—but since only the lower five digits are used, the result is zero. Thus, the negative of any number in the system is its radix-minus-1 complement plus 1, because $-a + a = 0$. In the binary system, the radix-minus-1 complement is the one's complement, which is easily formed electronically by inverting all bits.

radix point *n.* The period or other character that separates the integer portion of a number from the fractional portion. In the decimal system, the radix point is the decimal point, as in the number 1.33.

radix sort *n.* *See* digital sort.

radix sorting algorithm *n.* A sorting algorithm that sorts by grouping elements according to successive parts of their keys. A simple example is sorting a list of numbers in the range 0–999. First the list is sorted by the hundreds digit into a set of (up to) 10 lists; then each list, one at a time, is sorted into a set of (up to) 10 lists based on the tens digit; and finally each of those lists is sorted by the ones digit. This algorithm is usually most efficient when the sorting is done using binary values, which simplifies comparisons (is a given bit on or off?) and reduces the number of lists (each pass produces at most two lists).

RADSL *n.* Acronym for **r**ate-**a**daptive **a**symmetric **d**igital subscriber line. A flexible, high-speed version of ADSL

R

(asymmetric digital subscriber line) that is capable of adjusting transmission speed (bandwidth) based on signal quality and length of the transmission line. As the signal quality improves or deteriorates while a transmission line is being used, the transmission speed is adjusted accordingly. *See also* ADSL, xDSL.

rag *n.* Irregularity along the left or right edge of a set of lines of text on a printed page. Rag complements justification, in which one or both edges of the text form a straight vertical line. *See the illustration. See also* justify, ragged left, ragged right.

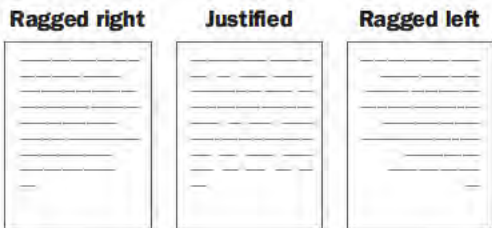

Rag.

ragged left *adj.* Of, relating to, or being lines of text whose left ends are not vertically aligned but form an irregular edge. Text may be right-justified and have a ragged left margin. Ragged-left text is used infrequently—typically, for visual effect in advertisements. *See also* rag, right-justify.

ragged right *adj.* Of, relating to, or being lines of text whose right ends are not vertically aligned but form an irregular edge. Letters and other word-processed documents are commonly left-justified, with ragged-right margins. *See also* left-justify, rag.

RAID *n.* Acronym for redundant array of independent (or inexpensive) disks. A data storage method in which data is distributed across a group of computer disk drives that function as a single storage unit. All the information stored on each of the disks is duplicated on other disks in the array. This redundancy ensures that no information will be lost if one of the disks fails. RAID is generally used on network servers where data accessibility is critical and fault tolerance is required. There are various defined levels of RAID, each offering differing trade-offs among access speed, reliability, and cost. *See also* disk controller, error-correction coding, Hamming code, hard disk, parity bit, server (definition 1).

RAID array *n.* *See* RAID.

RAM *n.* Acronym for random access memory. Semiconductor-based memory that can be read and written by the central processing unit (CPU) or other hardware devices. The storage locations can be accessed in any order. Note that the various types of ROM memory are capable of random access but cannot be written to. The term *RAM*, however, is generally understood to refer to volatile memory that can be written to as well as read. *Compare* core, EPROM, flash memory, PROM, ROM (definition 2).

RAMAC *n.* 1. Acronym for Random Access Method of Accounting Control. Developed by an IBM team led by Reynold B. Johnson, RAMAC was the first computer disk drive. It was introduced in 1956. The original RAMAC consisted of a stack of 50 24-inch platters, with a storage capacity of 5 megabytes and an average access time of 1 second. 2. A high-speed, high-capacity disk storage system introduced by IBM in 1994. Based on the original RAMAC storage device, it was designed to fulfill enterprise requirements for efficient and fault-tolerant storage.

Rambus DRAM *n.* *See* RDRAM.

Rambus dynamic random access memory *n.* *See* RDRAM.

RAM cache *n.* Short for random access memory cache. Cache memory that is used by the system to store and retrieve data from the RAM. Frequently accessed segments of data may be stored in the cache for quicker access compared with secondary storage devices such as disks. *See also* cache, RAM.

RAM card *n.* Short for random access memory card. An add-in circuit board containing RAM memory and the interface logic necessary to decode memory addresses.

RAM cartridge *n.* *See* memory cartridge.

RAM chip *n.* Short for random access memory chip. A semiconductor storage device. RAM chips can be either dynamic or static memory. *See also* dynamic RAM, RAM, static RAM.

RAM compression *n.* Short for random access memory compression. This technology was an attempt by a number of software vendors to solve the problem of running out of global memory under Windows 3.x. Compression of the usual contents of RAM may lessen the system's need to read or write to virtual (hard disk-based) memory and thus speed up the system, as virtual memory is much slower than physical RAM. Because of the falling prices of RAM and the introduction of operating systems that handle RAM

R

more efficiently, such as Windows 9x, Windows NT, and OS/2, RAM compression is generally used only on older PCs. *See also* compression, RAM, Windows.

RAMDAC *n.* Acronym for **random access memory digital-to-analog converter**. A chip built into some VGA and SVGA video adapters that translates the digital representation of a pixel into the analog information needed by the monitor to display it. The presence of a RAMDAC chip generally enhances overall video performance. *See also* SVGA, VGA.

RAM disk *n.* Short for **random access memory disk**. A simulated disk drive whose data is actually stored in RAM memory. A special program allows the operating system to read from and write to the simulated device as if it were a disk drive. RAM disks are extremely fast, but they require that system memory be given up for their use. Also, RAM disks usually use volatile memory, so the data stored on them disappears when power is turned off. Many portables offer RAM disks that use battery-backed CMOS RAM to avoid this problem. *See also* CMOS RAM. *Compare* disk cache.

RAM refresh *n.* *See* refresh (definition 2).

RAM resident *adj.* *See* memory-resident.

RAM-resident program *n.* *See* terminate-and-stay-resident program.

random *adj.* Specifically, a reference to an arbitrary or unpredictable situation or event. The term is also given an extended, pejorative or semi-pejorative meaning, however, in which it is used in the sense of *nonspecific, incoherent, poorly organized, loser*, and so on.

random access *n.* The ability of a computer to find and go directly to a particular storage location without having to search sequentially from the beginning location. The human equivalent of random access would be the ability to find a desired address in an address book without having to proceed sequentially through all the addresses. A computer's semiconductor memory (both RAM and ROM) provides random access. Certain types of files stored on disk under some operating systems also allow random access. Such files are best used for data in which each record has no intrinsic relationship to what comes physically before or after it, as in a client list or an inventory. *Also called:* direct access. *See also* RAM, ROM (definition 2). *Compare* indexed sequential access method, sequential access.

random access memory *n.* *See* RAM.

random noise *n.* A signal in which there is no relationship between amplitude and time and in which many frequencies occur randomly, without pattern or predictability.

random number generation *n.* Production of an unpredictable sequence of numbers in which no number is any more likely to occur at a given time or place in the sequence than any other. Truly random number generation is generally viewed as impossible. The process used in computers would be more properly called "pseudorandom number generation."

range *n.* **1.** A block of cells selected for similar treatment in a spreadsheet. A range of cells can extend across a row, down a column, or over a combination of the two, but all cells in the range must be contiguous, sharing at least one common border. Ranges allow the user to affect many cells with a single command—for example, to format them similarly, enter the same data into all of them, give them a name in common and treat them as a unit, or select and incorporate them into a formula. **2.** In more general usage, the spread between specified low and high values. Range checking is an important method of validating data entered into an application.

range check *n.* In programming, a limit check of both the upper and lower limits of a value, thus determining whether the value lies within an acceptable range. *See also* limit check.

RAPI *n.* *See* Remote Application Programming Interface.

RARP *n.* Acronym for **Reverse Address Resolution Protocol**. A TCP/IP protocol for determining the IP address (or logical address) of a node on a local area network connected to the Internet, when only the hardware address (or physical address) is known. While RARP refers only to finding the IP address and ARP technically refers to the opposite procedure, ARP is commonly used for both senses. *See also* ARP.

RAS *n.* **1.** *See* remote access server, Remote Access Service. **2.** Acronym for **reliability, availability, serviceability**. *See* high availability.

raster *n.* A rectangular pattern of lines; on a video display, the horizontal scan lines from which the term *raster scan* is derived.

raster display *n.* A video monitor (typically a CRT) that displays an image on the screen as a series of horizontal

R

scan lines from top to bottom. Each scan line consists of pixels that can be illuminated and colored individually. Television screens and most computer monitors are raster displays. *See also* CRT, pixel. *Compare* vector display.

raster fonts *n.* Fonts that are stored as bitmaps. Raster fonts are designed with a specific size and resolution for a specific printer and cannot be scaled or rotated. If a printer does not support raster fonts, it will not print them. The five raster fonts are Courier, MS Sans Serif, MS Serif, Small, and Symbol. *Also called:* bitmapped fonts. *See also* font, printer.

raster graphics *n.* A method of generating graphics that treats an image as a collection of small, independently controlled dots (pixels) arranged in rows and columns. *Compare* vector graphics.

raster image *n.* A display image formed by patterns of light and dark or differently colored pixels in a rectangular array. *See also* raster graphics.

raster image processor *n.* A device, consisting of hardware and software, that converts vector graphics or text into a raster (bitmapped) image. Raster image processors are used in page printers, phototypesetters, and electrostatic plotters. They compute the brightness and color value of each pixel on the page so that the resulting pattern of pixels re-creates the vector graphics and text originally described. *Acronym:* RIP.

rasterization *n.* The conversion of vector graphics (images described in terms of mathematical elements, such as points and lines) to equivalent images composed of pixel patterns that can be stored and manipulated as sets of bits. *See also* pixel.

raster-scan display *n.* *See* raster display.

rate-adaptive asymmetric digital subscriber line *n.* *See* RADSL.

raw data *n.* 1. Unprocessed, typically unformatted, data, such as a stream of bits that has not been filtered for commands or special characters. *See also* raw mode. *Compare* cooked mode. 2. Information that has been collected but not evaluated.

raw infrared *n.* A method of receiving data through an infrared (IR) transceiver. Raw infrared treats the IR transceiver like a serial cable and does not process data in any way. The application is responsible for handling collision detection and other potential problems.

raw mode *n.* A way in which the UNIX and MS-DOS operating systems “see” a character-based device. If the identifier for the device indicates raw mode, the operating system does not filter input characters or give special treatment to carriage returns, end-of-file markers, and linefeed and tab characters. *Compare* cooked mode.

ray tracing *n.* A sophisticated and complex method of producing high-quality computer graphics. Ray tracing calculates the color and intensity of each pixel in an image by tracing single rays of light backward and determining how they were affected on their way from a defined source of light illuminating the objects in the image. Ray tracing is demanding in terms of processing capability because the computer must account for reflection, refraction, and absorption of individual rays, as well as for the brightness, transparency level, and reflectivity of each object and the positions of the viewer and the light source. *Compare* radiosity.

RCA connector *n.* A connector used for attaching audio and video devices, such as stereo equipment or a composite video monitor, to a computer’s video adapter. *See the illustration.* *See also* composite video display. *Compare* phono connector.



RCA connector. A female version (left) and a male version (right).

RDBMS *n.* Acronym for relational data base management system. *See* relational database.

RDF *n.* *See* Resource Description Framework.

RDO *n.* *See* Remote Data Objects.

RDRAM *n.* Acronym for Rambus dynamic random access memory. A type of DRAM designed by Rambus, Inc. In its fastest form, known as Direct RDRAM, this technology provides a 16-bit data path and a peak bandwidth of 1.6 GB per second (approximately eight to ten times faster than synchronous DRAM, or SDRAM). RDRAM has been used in graphics and video chips; Direct RDRAM is expected to replace DRAM and SDRAM in personal computers. *Also called:* Rambus DRAM. *See also* dynamic RAM, SDRAM.

R

read¹ *n.* The action of transferring data from an input source into a computer's memory or from memory into the CPU (central processing unit). *Compare* write¹.

read² *vb.* To transfer data from an external source, such as from a disk or the keyboard, into memory or from memory into the central processing unit (CPU). *Compare* write².

read-after-write *n.* A feature of certain data storage devices, such as tape drives, in which the device reads data immediately after it is written as a means of verifying data integrity.

reader *n.* *See* card reader.

Reader *n.* *See* Microsoft Reader.

read error *n.* An error encountered while a computer is in the process of obtaining information from storage or from another source of input. *Compare* write error.

README *n.* A file containing information that the user either needs or will find informative and that might not have been included in the documentation. README files are placed on disk in plain-text form (without extraneous or program-specific characters) so that they can be read easily by a variety of word processing programs.

read notification *n.* An e-mail feature providing feedback to the sender that a message has been read by the recipient.

read-only *adj.* Capable of being retrieved (read) but not changed (written). A read-only file or document can be displayed or printed but not altered in any way. Read-only memory (ROM) holds programs that cannot be changed; a read-only storage medium, such as CD-ROM, can be played back but cannot be used for recording information. *Compare* read/write.

read-only attribute *n.* A file attribute, stored with a file's directory entry, indicating whether or not a file may be changed or erased. When the read-only attribute is off, the file can be modified or deleted; when it is on, the file can only be displayed.

read-only memory *n.* *See* ROM.

read-only terminal *n.* *See* RO terminal.

read/write *adj.* Able to be both read from and written to. *Abbreviation:* R/W. *Compare* read-only.

read/write channel *n.* *See* input/output channel.

read/write head *n.* *See* head.

read/write memory *n.* Memory that can be both read from and written to (modified). Semiconductor RAM and core memory are typical read/write memory systems. *Compare* ROM (definition 2).

real address *n.* An absolute (machine) address specifying a physical location in memory. *See also* physical address. *Compare* relative address, virtual address.

RealAudio *n.* Streaming audio technology developed by RealNetworks, Inc., for distributing radio and FM-quality sound files over the Internet in real time. RealAudio is based on two components: client software for decompressing the sound on the fly and server software for delivering it. The client software is free, distributed either as a downloadable program or as part of browser software. *See also* RealPlayer, RealVideo, stream, streaming.

realloc *n.* A function in C that allows the programmer to request a larger portion of heap memory than was previously assigned to a particular pointer. *See also* dynamic memory allocation, heap (definition 1).

reallysafe palette *n.* A color look-up table (CLUT) consisting of 22 colors from the 216-color websafe palette that are completely consistent when viewed with all Web browsers on all major computer platforms. The reallysafe palette arose from an experiment that indicated that most of the colors of the websafe palette shift to some degree in different viewing environments. *See also* browser CLUT, websafe palette.

real mode *n.* An operating mode in the Intel 80x86 family of microprocessors. In real mode, the processor can execute only one program at a time. It can access no more than about 1 MB of memory, but it can freely access system memory and input/output devices. Real mode is the only mode possible in the 8086 processor and is the only operating mode supported by MS-DOS. In contrast, the protected mode offered in the 80286 and higher microprocessors provides the memory management and memory protection needed for multitasking environments such as Windows. *See also* 8086, privileged mode. *Compare* protected mode, virtual real mode.

R

real-mode mapper *n.* An enhancement for Windows 3.x systems that allows 32-bit file system access. The real-mode mapper provides a 32-bit disk access interface to the DOS device driver chain. *Acronym:* RMM.

real number *n.* **1.** A number that can be represented in a number system with a given base, such as the decimal system, by a finite or infinite sequence of digits and a radix point. For example, 1.1 is a real number, as is 0.33333.... *See also* irrational number. *Compare* complex number, imaginary number. **2.** A data type, in a programming language such as Pascal, that is used for storing, to some limit of precision, values that include both integer and fractional parts. *See also* double-precision, single-precision. *Compare* floating-point number, integer.

RealPlayer *n.* An Internet media player and browser plug-in developed by RealNetworks, Inc., that supports playback of RealAudio and RealVideo, as well as certain other formats, after installation of appropriate plug-ins. The current version allows RealPlayer users to surf for media content directly from the player or through a Web browser. *See also* RealAudio, RealVideo.

Real Soon Now *adv.* Soon, but not really expected to be as soon as claimed. One might say, for example, that a commercial program will have some desired feature Real Soon Now if several versions ago the vendor knew of the need for the feature and has done nothing. *Acronym:* RSN.

real storage *n.* The amount of RAM memory in a system, as distinguished from virtual memory. *Also called:* physical memory, physical storage. *See also* virtual memory.

RealSystem G2 *n.* An open, standards-based platform for delivery of streaming audio and video over the Internet and other TCP/IP networks developed by RealNetworks, Inc. RealSystem G2 was introduced by RealNetworks in its audio and video players, servers, and development tools in 1998. Among other features, RealSystem G2 scales to different bandwidths, includes streaming that adjusts delivery to available bandwidth, and supports SMIL (Synchronized Multimedia Integration Language) for multimedia presentations. *See also* RealPlayer, RealVideo, SMIL, streaming.

RealSystem Producer *n.* A software application developed by RealNetworks that converts most types of video and sound files into RealMedia formats for use as streaming media over the Internet or within a corporate intranet.

RealSystem Server *n.* Software developed by RealNetworks to enable a server to broadcast streaming media. Several versions of RealSystem Server are available, designed to meet needs ranging from small intranet servers to large proxy servers.

real-time *adj.* Of, or relating to, a time frame imposed by external constraints. Real-time operations are those in which the machine's activities match the human perception of time or those in which computer operations proceed at the same rate as a physical or external process. Real-time operations are characteristic of aircraft guidance systems, transaction-processing systems, scientific applications, and other areas in which a computer must respond to situations as they occur (for example, animating a graphic in a flight simulator or making corrections based on measurements).

real-time animation *n.* Computer animation in which images are computed and updated on the screen at the same rate at which the objects simulated might move in the real world. Real-time animation allows dynamic involvement by the user because the computer can accept and incorporate keystrokes or controller movements as it is drawing the next image in the animation sequence. Arcade-style animation (such as in a flight simulator program) makes use of real-time animation in translating game plays into on-screen actions. In contrast, in animation done in virtual time, image frames are first calculated and stored and later replayed at a higher rate to achieve smoother movement. *See also* animation, bit block.

real-time clock *n.* In PCs, a circuit or other hardware element that provides the system with real-world time. Upon startup of the system, the real-time clock puts the date and time in memory, where it can then be systematically incremented by the BIOS. A real-time clock generally has a battery that is separate from the rest of the system, so it's not dependent upon the system's power source. This is not the same thing as a system clock, which synchronizes the processor. *Acronym:* RTC. *See also* clock (definition 2).

real-time conferencing *n.* *See* teleconferencing.

R

Real-Time Control Protocol *n.* A scalable transport control protocol that works with the Real-Time Protocol (RTP) to monitor real-time transmissions to multiple participants over a network—for example, during videoconferencing. The Real-Time Control Protocol, or RTCP, transmits packets of control information at regular intervals and is used to determine how well information is being delivered to recipients. *Acronym:* RTCP. *See also* Real-Time Protocol, Real-Time Streaming Protocol, Resource Reservation Setup Protocol.

real-time operating system *n.* An operating system designed for the needs of a process-controlled environment. A real-time operating system recognizes that responses must be made and tasks handled instantly, with no lag time. Real-time operating systems are typically used as embedded systems in devices and applications requiring time-critical reaction, such as telecommunications, air traffic control, and robotic functions. *Acronym:* RTOS. *See also* real-time system.

Real-Time Protocol *n.* An Internet-standard network transport protocol used in delivering real-time data, including audio and video. The Real-Time Protocol, or RTP, works with both unicast (single sender, single recipient) and multicast (single sender, multiple recipients) services. RTP is often used in conjunction with the Real-Time Control Protocol (RTCP), which monitors delivery. *Acronym:* RTP. *See also* Real-Time Control Protocol, Real-Time Streaming Protocol, stream.

real-time streaming *n.* The process of delivering a streaming media file via a specialized streaming media server using real-time streaming protocol (RTSP). With real-time streaming, the file itself actually plays on the streaming media server, even though it is viewed on the computer that opened the file. Real-time streaming transmits at a higher bandwidth than HTTP streaming. It is often used to broadcast live events, such as concerts or keynote conference addresses. *See also* HTTP streaming.

Real-Time Streaming Protocol *n.* A control protocol for the delivery of streamed multimedia data over Internet Protocol (IP) networks. The Real-Time Streaming Protocol, or RTSP, was developed by Columbia University, Progressive Networks, and Netscape and has been submitted as a proposed standard to the IETF (Internet Engineering Task Force). RTSP is designed to deliver real-time, live, or stored audio and video efficiently over a network. It can be used either for groups of recipients or for on-demand

delivery to a single recipient. *Acronym:* RTSP. *See also* Advanced Streaming Format, Real-Time Protocol, Resource Reservation Setup Protocol, stream.

real-time system *n.* A computer and/or a software system that reacts to events before the events become obsolete. For example, airline collision avoidance systems must process radar input, detect a possible collision, and warn air traffic controllers or pilots while they still have time to react.

RealVideo *n.* The streaming technology developed by RealNetworks, Inc., for distributing video over intranets and the Internet. RealVideo transmits video from a server in encoded (compressed) form. The video and accompanying sound are viewed on the client end with the help of a software player. RealVideo works with both IP and IP multicasting and, as with RealAudio, does not require transmission of complete files before playback can begin. *See also* RealAudio, RealPlayer, streaming.

reboot *vb.* To restart a computer by reloading the operating system. *See also* boot², cold boot, warm boot.

receipt notification *n.* An e-mail feature providing feedback to the sender that a message has been received by the recipient.

receive *vb.* To accept data from an external communications system, such as a local area network (LAN) or a telephone line, and store the data as a file.

Receive Data *n.* *See* RXD.

rec. newsgroups *n.* Usenet newsgroups that are part of the rec. hierarchy and whose names have the prefix *rec.* These newsgroups cover topics devoted to discussions of recreational activities, hobbies, and the arts. *See also* newsgroup, traditional newsgroup hierarchy, Usenet. *Compare* comp. newsgroups, misc. newsgroups, news. newsgroups, sci. newsgroups, soc. newsgroups, talk. newsgroups.

recompile *vb.* To compile a program again, usually because of changes that needed to be made in the source code in response to error messages generated by the compiler. *See also* compile.

record¹ *n.* A data structure that is a collection of fields (elements), each with its own name and type. Unlike an array, whose elements all represent the same type of information and are accessed using an index, the elements of a record represent different types of information and are accessed by name. A record can be accessed as a collective

R

unit of elements, or the elements can be accessed individually. *See also* array, data structure, type¹ (definition 1).

record² *vb.* To retain information, usually in a file.

record format *n.* *See* record structure.

record head *n.* The device in a tape machine that places data on the tape. In some tape machines, the record head is combined with the read head.

record layout *n.* The organization of data fields within a record. *See also* record¹.

record length *n.* The amount of storage space required to contain a record, typically given in bytes. *See also* record¹.

record locking *n.* A strategy employed in distributed processing and other multiuser situations to prevent more than one user at a time from writing data to a record. *See also* record¹.

record number *n.* A unique number assigned to a record in a database in order to identify it. A record number can identify an existing record by its position (for example, the tenth record from the beginning of a database), or it can be assigned to the record to serve as a key (for example, the number 00742 assigned to the tenth record from the beginning of the database). *See also* record¹.

record structure *n.* An ordered list of the fields that compose a record, together with a definition of the domain (acceptable values) of each field. *See also* record¹.

recover *vb.* **1.** To return to a stable condition after some error has occurred. A program recovers from an error by stabilizing itself and resuming execution of instructions without user intervention. **2.** To put back into a stable condition. A computer user may be able to recover lost or damaged data by using a program to search for and salvage whatever information remains in storage. A database may be recovered by restoring its integrity after some problem has damaged it, such as abnormal termination of the database management program.

recoverable error *n.* An error that can be successfully managed by software. For example, when the user enters a number when a letter is required, the program can simply display an error message and prompt the user again.

recovery *n.* The restoration of lost data or the reconciliation of conflicting or erroneous data after a system failure. Recovery is often achieved using a disk or tape backup and system logs. *See also* backup.

Recreational Software Advisory Council *n.* An independent, nonprofit organization established in the fall of 1994 by a group of six trade organizations, led by the Software Publishers Association. The Council's goal was to create a new, objective content-labeling rating system for recreational software and other media such as the Internet. *Acronym:* RSAC.

rectangle ad *n.* An Internet ad format that is larger than a traditional banner ad and is generally inserted directly into page content for greater visibility.

rectifier *n.* A circuit component that passes current flowing in one direction but stops current flowing in the other direction. Rectifiers are used to convert alternating current to direct current.

recto *n.* The right-hand page of two facing pages. A recto is characteristically an odd-numbered page. *Compare* verso.

recursion *n.* The ability of a routine to call itself. Recursion enables certain algorithms to be implemented with small, simple routines, but it does not guarantee speed or efficiency. Erroneous use of recursion can cause a program to run out of stack space during execution, causing the program, and sometimes the entire system, to crash. *See also* call¹ (definition 2), routine.

Recycle Bin *n.* A folder in Windows 9x, Windows CE, Windows NT, Windows 2000, and Windows XP represented by an icon on the screen resembling a basket decorated with the recycling logo. To remove a file, the user drags its icon to the Recycle Bin. However, a file in the Recycle Bin is not actually deleted from the disk until the user opens the Recycle Bin, selects the file, and presses the Delete key; until then, the user can retrieve it. *Compare* Trash.

Red Book *n.* **1.** The standards documents of the U.S. National Security Agency entitled "Trusted Network Interpretation of the Trusted Computer System Evaluation Criteria (NCSC-TG-005)" and "Trusted Network Interpretation (NCS-TG-011)." These documents define a system of ratings from A1 (most secure) to D (nonsecure), indicating the ability of a computer network to protect sensitive information. *Compare* Orange Book (definition 1). **2.** A specifications book written by the Sony Corporation and Philips Corporation and endorsed by ISO, covering audio compact discs. *Compare* Green Book, Orange Book (definition 2). **3.** Telecommunications standards published by the CCITT.

red-green-blue *n.* *See* RGB.

R

redirection *n.* The process of writing to or reading from a file or device different from the one that would normally be the target or the source. For example, the MS-DOS or OS/2 command *dir >prn* redirects a directory listing from the screen to the printer. *Compare* pipe.

redirector *n.* Software on a client computer that intercepts requests for information and, when appropriate, directs them to the network. Redirectors can either be built into the client operating system or be part of an added networking package.

redlining *n.* A feature of a word processing application that marks changes, additions, or deletions made to a document by a coauthor or editor. The purpose of redlining is to produce a record of the changes made to a document during the course of its development.

redraw *n.* *See* refresh (definition 1).

reduce *vb.* In a graphical user interface, to decrease the size of a window. A user can reduce a window either by clicking the appropriate button in the title bar or by clicking the mouse on the border of the window and dragging the border toward the middle of the window. *See also* maximize, minimize.

Reduced Instruction Set Computing *n.* *See* RISC.

redundancy *n.* Using one or more servers on a Web site to perform identical tasks. If one of the servers crashes, another server assumes its tasks. Redundancy ensures that the Web site will continue to function if one of the servers stops working.

redundancy check *n.* *See* CRC, LRC.

redundant code *n.* Code that duplicates a function performed elsewhere—for example, code to sort a list that has already been sorted.

R

reengineer *vb.* To rethink and redefine processes and procedures. In the context of computer systems, to reengineer means to change the way work is done in order to maximize the benefits of new technology.

reengineering *vb.* **1.** With regard to software, changing existing software to strengthen desirable characteristics and remove weaknesses. **2.** With regard to corporate management, using information technology principles to address the challenges posed by a global economy and to consolidate management of a rapidly expanding work force.

reentrant code *n.* Code written so that it can be shared by several programs at the same time. When a program is executing reentrant code, another program can interrupt

the execution and can then start or continue execution of that same code. Many operating-system routines are written to be reentrant so that only one copy needs to reside in memory to serve all executing applications. *See also* relocatable code.

refactoring *n.* An optimization process in object-oriented programming intended to improve the design or structure of a program without changing its functionality. The goal of refactoring is to make the program clearer and easier to work with—in part by removing duplication, abstracting common behaviors, and refining class hierarchies—and to improve the extensibility and reusability of existing code.

reference¹ *n.* A data type in the C++ programming language. A reference must be initialized with a variable name. The reference then becomes an alias for that variable but actually stores the address of the variable.

reference² *vb.* To access a variable, such as an element in an array or a field in a record.

reference parameter *n.* A parameter in which the address of a variable, rather than the explicit value, is passed to the called routine. *See also* parameter.

reference type *n.* A data type that is represented by a reference (similar to a pointer) to the type's actual value. If a reference type is assigned to a variable, that variable references (or "points to") the original value. No copy is made. Reference types comprise classes, interfaces, delegates, and boxed value types. *See also* data type, value type.

reflecting software *n.* *See* reflector.

reflective liquid-crystal display *n.* A liquid crystal display that is not equipped with edge light or backlight to enhance readability but rather depends on reflecting ambient light, making it difficult to read in brightly lit environments such as the outdoors. *Also called:* reflective LCD.

reflective routing *n.* In wide area networks, the process of using a reflector to distribute data, thereby reducing the load of the network server. *See also* reflector.

reflector *n.* A program that sends messages to a number of users upon receipt of a signal from a single user. A common type of reflector is an e-mail reflector, which forwards any e-mail sent to it to the multiple recipients currently on its list. *See also* multiple recipients. *Compare* mail reflector.

reformat *vb.* **1.** In applications, to change the look of a document by altering stylistic details, such as font, layout, indentation, and alignment. **2.** In data storage, to prepare for

reuse a disk that already contains programs or data, effectively destroying the existing contents.

refresh *vb.* **1.** To retrace a video screen at frequent intervals, even if the image does not change, so as to keep the phosphors irradiated. **2.** To recharge dynamic random access memory chips (DRAMs) so that they continue to retain the information stored in them. Circuitry on the memory board automatically performs this function. *See also* refresh cycle.

refreshable *adj.* In programming, referring to a program module capable of being replaced in memory without affecting processing of the program or the information being used by the program.

refresh cycle *n.* The process in which controller circuitry provides repeated electric pulses to dynamic random access memory chips in order to renew the stored electric charges in those locations that contain binary 1. Each pulse is one refresh cycle. Without constant refreshing, dynamic semiconductor RAM loses any information stored in it—as it does when the computer is turned off or when the power fails. *See also* dynamic RAM, static RAM.

refresh rate *n.* In reference to video hardware, the frequency with which the entire screen is redrawn to maintain a constant, flicker-free image. On TV screens and raster-scan monitors, the electron beam that lights the phosphor coating on the inner surface of the screen typically refreshes the entire image area at a rate of about 60 hertz, or 60 times per second. Interlaced monitors, which redraw alternate lines during each sweep of the electron beam, actually refresh any particular line only 30 times per second. Because odd and even lines are refreshed on successive sweeps, however, the effective refresh rate is 60 times per second. *See also* refresh (definition 1).

REGEDIT *n.* *See* Registry Editor.

regenerate *vb.* *See* rewrite.

regeneration buffer *n.* *See* video buffer.

regenerator *n.* *See* repeater.

region *n.* **1.** An area dedicated to or reserved for a particular purpose. **2.** In video programming, a contiguous group of pixels that are treated as a unit. On the Apple Macintosh, for example, a region is an area in a grafPort that can be defined and manipulated as an entity. The visible working area within a window is an example of a region. *See also* grafPort.

region code *n.* Codes on DVD movie titles and DVD-ROM drives that prevent playback of certain DVDs in certain geographical regions. Region codes are part of the DVD specification. *See also* CSS, DeCSS.

region fill *n.* In computer graphics, the technique of filling a defined region on the screen with a selected color, pattern, or other attribute. *See also* region (definition 2).

register *n.* A set of bits of high-speed memory within a microprocessor or other electronic device, used to hold data for a particular purpose. Each register in a central processing unit is referred to in assembly language programs by a name such as *AX* (the register that contains the results of arithmetic operations in an Intel 80x86 processor) or *SP* (the register that contains the memory address of the top of the stack in various processors).

registered file type *n.* File types that are tracked by the system registry and are recognized by the programs you have installed on your computer. *See also* file type.

registration *n.* The process of precisely aligning elements or superimposing layers in a document or a graphic so that everything will print in the correct relative position. *See also* registration marks.

registration marks *n.* Marks placed on a page so that in printing, the elements or layers in a document can be arranged correctly with respect to each other. Each element to be assembled contains its own registration marks; when the marks are precisely superimposed, the elements are in the correct position. *See* the illustration.



Registration marks.

registry *n.* A central hierarchical database in Windows 9x, Windows CE, Windows NT, and Windows 2000 used to store information necessary to configure the system for one or more users, applications, and hardware devices. The Registry contains information that Windows continually references during operation, such as profiles for each user, the applications installed on the computer and the types of documents each can create, property sheet settings for folders and application icons, what hardware exists on the system, and which ports are being used. The Registry replaces most of the text-based .ini files used in Windows 3.x and MS-DOS configuration files, such as AUTOEXEC.BAT and CONFIG.SYS. Although the Registry is common to the several Windows platforms, there

R

are some differences among them. *Also called:* system registry. *See also* hierarchical database, .ini, input/output port, property sheet, Registry Editor.

Registry Editor *n.* An application under Windows that allows the user to edit the entries in the registry. *Acronym:* REGEDIT. *See also* registry.

regression analysis *n.* In statistics, an analysis of the degree to which variations in an independent variable affect a dependent variable (a variable whose value depends on the value of another variable). *See also* multiple regression.

regression testing *n.* Complete retesting of a modified program, rather than a test of only the modified routines, to ensure that no errors have been introduced with the modifications.

relation *n.* A structure composed of attributes (individual characteristics, such as name or address, corresponding to the columns in a table) and tuples (sets of attribute values describing particular entities, such as customers, corresponding to the rows in a table). Within a relation, tuples cannot be repeated; each must be unique. Further, tuples are unordered within a relation; interchanging two tuples does not change the relation. Finally, if relational theory is to be applicable, the domain of each attribute must be atomic—that is, a simple value, rather than a structure such as an array or a record. A relation in which the domains of all attributes are atomic is said to be normalized or in first normal form. *See also* normal form (definition 1).

relational algebra *n.* A collection of rules and operators that permits relations (tables) to be manipulated. Relational algebra is usually described as having the following operators: SELECT, PROJECT, PRODUCT, UNION, INTERSECT, DIFFERENCE, JOIN (or INNER JOIN), and DIVIDE. In a relational database, relational algebra is used to develop procedures to build new relations based on the existing relations.

relational calculus *n.* In database management, a non-procedural method for manipulating relations (tables). There are two families of relational calculus: domain calculus and tuple calculus. The two families of relational calculus are mathematically equivalent to each other and to relational algebra. Using either family, one can formulate a description of a desired relation, based on the existing relations in the database.

relational database *n.* A database or database management system that stores information in tables—rows and columns of data—and conducts searches by using data in specified columns of one table to find additional data in another table. In a relational database, the rows of a table represent records (collections of information about separate items) and the columns represent fields (particular attributes of a record). In conducting searches, a relational database matches information from a field in one table with information in a corresponding field of another table to produce a third table that combines requested data from both tables. For example, if one table contains the fields EMPLOYEE-ID, LAST-NAME, FIRST-NAME, and HIRE-DATE, and another contains the fields DEPT, EMPLOYEE-ID, and SALARY, a relational database can match the EMPLOYEE-ID fields in the two tables to find such information as the names of all employees earning a certain salary or the departments of all employees hired after a certain date. In other words, a relational database uses matching values in two tables to relate information in one to information in the other. Microcomputer database products typically are relational databases. *Compare* flat-file database, inverted-list database.

relational database management system *n.* *See* relational database.

relational expression *n.* An expression that uses a relational operator such as “less than” or “greater than” to compare two or more expressions. A relational expression resolves to a Boolean (true/false) value. *See also* Boolean, relational operator.

relational model *n.* A data model in which the data is organized in relations (tables). This is the model implemented in most modern database management systems.

relational operator *n.* An operator that allows the programmer to compare two (or more) values or expressions. Typical relational operators are greater than (>), equal to (=), less than (<), not equal to (<>), greater than or equal to (>=), and less than or equal to (<=). *See also* relational expression.

relational structure *n.* The record organization used in the implementation of a relational model.

relative address *n.* A location, as in a computer’s memory, that is specified in terms of its distance (displacement or offset) from a starting point (base address). A relative

R

address is typically computed by adding an offset to the base. In everyday terms, this is similar to creating the address 2001 Main Street, in which the base is the 2000 block of Main Street and the offset is 1, which specifies the first house from the beginning of the block. *Also called:* indirect address.

relative coordinates *n.* Coordinates that are defined in terms of their distance from a given starting point, rather than from the origin (intersection of two axes). For example, from a starting point on the screen, a square defined by relative coordinates can be drawn as a series of lines, each representing a displacement in distance and direction from the end of the preceding point. The entire square can be redrawn at another location simply by changing the coordinates of the starting point rather than by recalculating the coordinates of each corner with reference to the origin. See the illustration. *Compare* absolute coordinates.

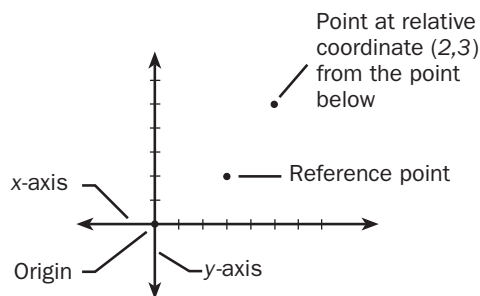

Relative coordinates.

relative movement *n.* **1.** Motion whose distance and direction are relative to a starting point. For example, when a mouse pointer is moved on the screen, the coordinates of its new position are relative to the previous location of the pointer. *See also* relative coordinates, relative pointing device. **2.** In computer graphics and cinematography, the movement of one object in relation to another, such as the movement of horse A from the perspective of horse B on a racetrack.

relative path *n.* A path that is implied by the current working directory. When a user enters a command that refers to a file, if the full pathname is not entered the current working directory becomes the relative path of the file referred to. *Compare* full path.

relative pointing device *n.* A cursor-control device, such as a mouse or a trackball, in which the movement of an on-screen cursor is linked to the movement of the device but not to the position of the device. For example, if a user picks

up a mouse and puts it down in a different location on a desk, the position of the on-screen cursor does not change because no movement (rolling) is detected. When the user rolls the mouse again, the cursor moves to reflect the mouse movement against the surface of the desk. Relative pointing devices differ from absolute pointing devices, such as graphics tablets, in which the device's location within a defined area is always associated with a predefined on-screen position. *See also* relative coordinates, relative movement (definition 1). *Compare* absolute pointing device.

relative URL *n.* Short for **relative uniform resource locator**. A form of URL in which the domain and some or all directory names are omitted, leaving only the document name and extension (and perhaps a partial list of directory names). The indicated file is found in a location relative to the pathname of the current document. *Acronym:* RELURL. *See also* file extension, URL.

RELAX NG *n.* An XML schema language based on Tree Regular Expressions for XML (TREG) and Regular Language Description for XML (RELAX). RELAX NG supports XML namespaces, uses XML syntax, maintains the information set of the XML document, and provides unrestricted support for mixed or unordered content.

relay *n.* A switch activated by an electrical signal. A relay allows another signal to be controlled without the need for human action to route the other signal to the control point, and it also allows a relatively low-power signal to control a high-power signal.

release¹ *n.* **1.** A particular version of a piece of software, most commonly associated with the most recent version (as in "the latest release"). Some companies use the term *release* as an integral part of the product name (as in Lotus 1-2-3 Release 2.2). **2.** A version of a product that is available in general distribution. *Compare* alpha², beta².

release² *vb.* **1.** To relinquish control of a block of memory, a device, or another system resource to the operating system. **2.** To formally make a product available to the marketplace.

reliability *n.* The likelihood of a computer system or device continuing to function over a given period of time and under specified conditions. Reliability is measured by different performance indexes. For example, the reliability of a hard disk is often given as mean time between failures (MTBF): the average length of time the disk can be expected to function without failing. *See also* MTBF, MTTR.

R

reliability, availability, serviceability *n.* Acronym: RAS. See high availability.

reload *vb.* **1.** To load a program into memory from a storage device again in order to run it, because the system has crashed or the program's operation was otherwise interrupted. **2.** To retrieve a new copy of the Web page currently visible in a Web browser.

relocatable address *n.* In programming, an address that is to be adjusted to reflect the actual place in memory into which a program is loaded for execution. In "Get the byte located 12 bytes from this instruction," the address is relocatable; in "Get the byte located at address 255," the address is not relocatable. This convention is comparable to describing the "address" of a parked car as "level 2, row G" on one day and "level 5, row B" on another.

relocatable code *n.* A program written in such a way that it can be loaded into any part of available memory rather than having to be placed in one specific location. In relocatable code, address references that depend on the program's physical location in memory are calculated at run time so that program instructions can be carried out correctly. See also reentrant code.

relocate *n.* To move programs and blocks of memory about within available space so as to use memory resources flexibly and efficiently. A relocatable program can be loaded by the operating system into any part of available memory rather than into only one specific area. A relocatable block of memory is a portion of memory that can be moved around by the operating system as required; for example, the system might collect several available, relocatable blocks of memory to form one larger block of the size requested for use by a program.

RELURL *n.* See relative URL.

R

remailer *n.* A service that will forward e-mail while concealing the e-mail address of the originator of the message. Remailers may be used by individuals who wish to retain their privacy or avoid unsolicited commercial e-mail (UCE). Remailers may also be used to hide the identities of individuals and businesses sending spam or malicious or fraudulent e-mail.

remark *n.* See comment, REM statement.

remote *adj.* Not in the immediate vicinity, as a computer or other device located in another place (room, building,

or city) and accessible through some type of cable or communications link.

remote access *n.* The use of a remote computer.

remote access server *n.* A host on a LAN (local area network) that is equipped with modems to enable users to connect to the network over telephone lines. Acronym: RAS.

Remote Access Service *n.* Windows software that allows a user to gain remote access to the network server via a modem. Acronym: RAS. See also remote access.

remote administration *n.* The performance of system administration-related tasks via access from another machine in a network.

Remote Application Programming Interface *n.* A Remote Procedure Call (RPC) mechanism that enables an application running on a desktop computer to make function calls on a Windows CE-based device. The desktop computer is known as the Remote Application Programming Interface (RAPI) client, and the Windows CE device is known as the RAPI server. RAPI runs over Winsock and TCP/IP. Acronym: RAPI. See also remote procedure call.

Remote Authentication Dial-In User Service *n.* See RADIUS.

remote communications *n.* Interaction with a remote computer through a telephone connection or another communications line.

remote computer system *n.* See remote system.

Remote Data Objects *n.* An object-oriented data access tool featured in Visual Basic 4 and later. Remote Data Objects have no native file format of their own; they can be used only with databases complying with the most recent ODBC standards. This feature is popular for its speed and minimal coding requirements. Acronym: RDO. See also ODBC, Visual Basic.

Remote Installation Services *n.* Software services that allow an administrator to set up new client computers remotely, without having to visit each client. The target clients must support remote booting. Acronym: RIS.

remote login *n.* The action of logging in to a computer at a distant location by means of a data communications connection with the computer that one is presently using. After remote login, the user's own computer behaves like a terminal connected to the remote system. On the Inter-

net, remote login is done primarily by rlogin and telnet. *See also* rlogin¹ (definition 1), telnet¹.

remote monitoring *n.* *See* RMON.

remote network monitoring *n.* *See* RMON.

Remote PC *n.* *See* remote system.

remote procedure call *n.* In programming, a call by one program to a second program on a remote system. The second program generally performs a task and returns the results of that task to the first program. *Acronym:* RPC.

remote system *n.* The computer or network that a remote user is accessing via a modem. *See also* remote access. *Compare* remote terminal.

remote terminal *n.* A terminal that is located at a site removed from the computer to which it is attached. Remote terminals rely on modems and telephone lines to communicate with the host computer. *See also* remote access. *Compare* remote system.

removable disk *n.* A disk that can be removed from a disk drive. Floppy disks are removable; hard disks usually are not. *Also called:* exchangeable disk.

REM statement *n.* Short for **remark statement**. A statement in the Basic programming language and the MS-DOS and OS/2 batch file languages that is used to add comments to a program or batch file. Any statement beginning with the word *REM* is ignored by the interpreter or compiler or the command processor. *See also* comment.

rename *n.* A command in most file transfer protocol (FTP) clients and in many other systems that allows the user to assign a new name to a file or files.

render *vb.* To produce a graphic image from a data file on an output device such as a video display or printer.

rendering *n.* The creation of an image containing geometric models, using color and shading to give the image a realistic look. Usually part of a geometric modeling package such as a CAD program, rendering uses mathematics to describe the location of a light source in relation to the object and to calculate the way in which the light would create highlights, shading, and variations in color. The degree of realism can range from opaque, shaded polygons to images approximating photographs in their complexity. *See also* ray tracing.

RenderMan Shading Language *n.* A C-like graphics and rendering language developed by Pixar.

repaginate *vb.* To recalculate the page breaks in a document.

Repeat *n.* A command in Microsoft Word that causes all information contained in either the last command dialog box or the last uninterrupted editing session to be repeated.

repeat counter *n.* A loop counter; typically, a register that holds a number representing how many times a repetitive process has been or is to be executed.

Repeat delay *n.* A delay for the amount of time that elapses before a character begins repeating when you hold down a key.

repeater *n.* A device used on communications circuits that decreases distortion by amplifying or regenerating a signal so that it can be transmitted onward in its original strength and form. On a network, a repeater connects two networks or two network segments at the physical layer of the ISO/OSI reference model and regenerates the signal.

repeating Ethernet *n.* *See* repeater.

repeat key *n.* On some keyboards, a key that must be held down at the same time as a character key to cause the character key's key code to be sent repeatedly. On most computer keyboards, however, a repeat key is not needed because a key automatically repeats if held down for longer than a brief delay. *Compare* typematic.

RepeatKeys *n.* A feature of Windows 9x and Windows NT that allows a user to adjust or disable the typematic keyboard feature so as to accommodate users with restricted mobility, who may activate typematic by accident because they have trouble lifting their fingers from the keys. *See also* typematic. *Compare* BounceKeys, FilterKeys, MouseKeys, ShowSounds, SoundSentry, StickyKeys, ToggleKeys.

repetitive strain injury *n.* An occupational disorder of the tendons, ligaments, and nerves caused by the cumulative effects of prolonged repetitious movements. Repetitive strain injuries are appearing with increasing frequency among office workers who spend long hours typing at computerized workstations that are not equipped with safeguards such as wrist supports. *Acronym:* RSI. *See also* carpal tunnel syndrome, ergonomic keyboard, wrist support.

replace *vb.* To put new data in the place of other data, usually after conducting a search for the data to be replaced. Text-based applications such as word processors typically include search-and-replace commands. In such

R

operations, both old and new data must be specified, and search-and-replace procedures may or may not be sensitive to uppercase and lowercase, depending on the application program. *See also* search¹, search and replace.

replay attack *n.* An attack in which a valid message is intercepted and then repeatedly retransmitted, either for fraudulent purposes or as part of a larger attack scheme.

replication *n.* In a distributed database management system, the process of copying the database (or parts of it) to the other parts of the network. Replication allows distributed database systems to remain synchronized. *See also* distributed database, distributed database management system.

report *n.* The presentation of information about a given topic, typically in printed form. Reports prepared with computers and appropriate software can include text, graphics, and charts. Database programs can include special software for creating report forms and generating reports. Desktop publishing software and laser printers or typesetting equipment can be used to produce publication-quality output.

report generator *n.* An application, commonly part of a database management program, that uses a report “form” created by the user to lay out and print the contents of a database. A report generator is used to select specific record fields or ranges of records, to make the output attractive by including such features as headings, running heads, page numbers, and fonts.

Report Program Generator *n.* *See* RPG (definition 2).

report writer *n.* *See* report generator.

repository *n.* **1.** A collection of information about a computing system. **2.** A superset of a data dictionary. *See also* data dictionary.

reprogrammable PROM *n.* *See* EPROM.

reprogrammable read-only memory *n.* *See* EPROM.

requested permissions *n.* Optionally specified permissions in an assembly that represent the minimum required, optionally desired, and always refused permissions for all code in the assembly. If there is no request, the code is granted the maximum that policy allows.

Request for Comments *n.* *See* RFC.

Request for Discussion *n.* A formal proposal for a discussion concerning the addition of a newsgroup to the

Usenet hierarchy, the first step in a process that ends with a call for votes. *Acronym:* RFD. *See also* traditional newsgroup hierarchy, Usenet.

Request to Send *n.* *See* RTS.

required hyphen *n.* *See* hyphen.

Research Libraries Information Network *n.* The combined online catalog of the Research Libraries Group, which includes many of the major research libraries in the United States. *Acronym:* RLIN.

reserve *n.* A command that allocates contiguous disk space for the device instance’s workspace. Digital video devices recognize this command.

reserve accumulator *n.* An auxiliary storage register generally used to store the intermediate results of an extended calculation.

reserved character *n.* A keyboard character that has a special meaning to a program and, as a result, normally cannot be used in assigning names to files, documents, and other user-generated tools, such as macros. Characters commonly reserved for special uses include the asterisk (*), forward slash (/), backslash (\), question mark (?), and vertical bar (|).

reserved date *n.* A date with a special meaning, rather than the date on the calendar. For example, some programs use 9999 to indicate an account or a database listing that does not expire. *See also* magic dates.

reserved memory *n.* *See* UMA.

reserved word *n.* A word that has special meaning to a program or in a programming language. Reserved words usually include those used for control statements (IF, FOR, END), data declarations, and the like. A reserved word can be used only in certain predefined circumstances; it cannot be used in naming documents, files, labels, variables, or user-generated tools such as macros.

reset button *n.* A device that restarts a computer without turning off its power. *Compare* big red switch.

resident font *n.* *See* internal font.

resident program *n.* *See* TSR.

resistance *n.* The ability to impede (resist) the flow of electric current. With the exception of superconductors, all substances have a greater or lesser degree of resistance. Substances with very low resistance, such as metals, conduct

R

electricity well and are called *conductors*. Substances with very high resistance, such as glass and rubber, conduct electricity poorly and are called *nonconductors* or *insulators*.

resistor *n.* A circuit component designed to provide a specific amount of resistance to current flow.

resize *vb.* To make an object or space larger or smaller. *Also called:* scale.

resolution *n.* **1.** The fineness of detail attained by a printer or a monitor in producing an image. For printers that form characters from small, closely spaced dots, resolution is measured in dots per inch, or dpi, and ranges from about 125 dpi for low-quality dot-matrix printers to about 600 dpi for some laser and ink-jet printers (typesetting equipment can print at resolutions of over 1000 dpi). For a video display, the number of pixels is determined by the graphics mode and video adapter, but the size of the display depends on the size and adjustment of the monitor; hence the resolution of a video display is taken as the total number of pixels displayed horizontally and vertically. *See also* high resolution, low resolution. **2.** The process of translation between a domain name address and an IP address. *See also* DNS, IP address.

resolve *vb.* **1.** To match one piece of information to another in a database or lookup table. **2.** To find a setting in which no hardware conflicts occur. **3.** To convert a logical address to a physical address or vice versa. **4.** To convert an Internet domain name to its corresponding IP address. *See also* DNS, IP address.

resource *n.* **1.** Any part of a computer system or a network, such as a disk drive, printer, or memory, that can be allotted to a program or a process while it is running. **2.** An item of data or code that can be used by more than one program or in more than one place in a program, such as a dialog box, a sound effect, or a font in a windowing environment. Many features in a program can be altered by adding or replacing resources without the necessity of recompiling the program from source code. Resources can also be copied and pasted from one program into another, typically by a specialized utility program called a *resource editor*. **3.** Any nonexecutable data that is logically deployed with an application. A resource might be displayed in an application as error messages or as part of the user interface. Resources can contain data in a number of forms, including strings, images, and persisted objects.

resource allocation *n.* The process of distributing a computer system's facilities to different components of a job in order to perform the job.

resource data *n.* The data structures, templates, definition procedures, management routines, icon maps, and so forth associated with a particular resource, such as a menu, window, or dialog box. *See also* resource (definition 2), resource fork.

Resource Description Framework *n.* A specification developed by the World Wide Web Consortium (W3C) to define a flexible infrastructure for organizing and managing metadata (data about data) across the Web and the Internet. The Resource Description Framework is intended to provide a framework based on XML (eXtensible Markup Language) that can standardize the way applications exchange metadata (or metacontent). Possible uses include search engines, content rating systems, and other areas in which exchange of information about data is valuable. *Acronym:* RDF. *See also* XML.

resource file *n.* A file that consists of resource data and the resource map that indexes it. *See also* resource (definition 2), resource fork.

resource fork *n.* One of the two forks of an Apple Macintosh file (the other being the *data fork*). The resource fork of a program file contains reusable items of information that the program can use during the course of execution, such as fonts, icons, windows, dialog boxes, menus, and the program code itself. A user-created document typically stores its data in the data fork, but it can also use its resource fork for storing items that might be used more than once in the document. For example, in a HyperCard stack, the data that constitutes each card, or record, in the stack is stored in the data fork; digitized sounds and icons that might be used more than once are stored in the resource fork. The use of such resources makes program development easier because resources can be developed and altered independently of the program code. *See also* HyperCard, resource (definition 2). *Compare* data fork.

resource ID *n.* A number that identifies a particular resource within a given resource type on the Apple Macintosh—for example, a particular menu among many resources of type MENU that a program might use. *See also* resource (definition 2).

Resource Reservation Setup Protocol *n.* A communications protocol designed to allow for "bandwidth on demand." A remote receiver requests that a certain amount



of bandwidth be reserved by the server for a data stream; the server sends back a message (similar to the RSVP sent in reply to an invitation) indicating whether or not the request has been granted. *Acronym:* RSVP (Resource Reservation Setup Protocol).

resource sharing *n.* The act of making files, printers, and other network resources available for use by others.

resource type *n.* One of numerous classes of structural and procedural resources in the Macintosh operating system, such as code, fonts, windows, dialog boxes, templates, icons, patterns, strings, drivers, cursors, color tables, and menus. Resource types have characteristic identifying labels, such as CODE for blocks of program instructions, FONT for fonts, and CURS for mouse cursors. *See also* resource (definition 2), resource fork.

response time *n.* **1.** The time, often an average, that elapses between the issuance of a request and the provision of the data requested (or notification of inability to provide it). **2.** The time required for a memory circuit or storage device to furnish data requested by the central processing unit (CPU).

restart *vb.* *See* reboot.

restore¹ *n.* The act of restoring a file or files. *See also* backup, recovery.

restore² *vb.* To copy files from a backup storage device to their normal location, especially if the files are being copied to replace files that were accidentally lost or deleted.

restricted function *n.* A function or an operation that can be executed only under certain circumstances, especially when the central processing unit (CPU) is in privileged mode. *See also* privileged mode.

Restructured Extended Executor *n.* *See* REXX.

retrace *n.* The path followed by the electron beam in a raster-scan computer monitor as it returns either from the right to the left edge of the screen or from the bottom to the top of the screen. The retrace positions the electron beam for its next sweep across or down the screen; during this interval, the beam is briefly turned off to avoid drawing an unwanted line on the screen. Retracing occurs many times each second and uses tightly synchronized signals to ensure that the electron beam is turned off and on during the retrace. *See also* blanking, horizontal retrace, raster display, vertical retrace.

retrieve *vb.* To obtain a specific requested item or set of data by locating it and returning it to a program or to the user. Computers can retrieve information from any source of storage—disks, tapes, or memory.

retro virus *n.* A type of virus that avoids detection by attacking or disabling antivirus programs. *Also called:* anti-anti-virus.

return *vb.* **1.** To transfer control of the system from a called routine or program back to the calling routine or program. Some languages support an explicit *return* or *exit* statement; others allow return only at the end (last statement) of the called routine or program. *See also* call² (definition 2). **2.** To report the outcome of a called routine to the calling routine or program.

return code *n.* In programming, a code that is used to report the outcome of a procedure or to influence subsequent events when a routine or process terminates (returns) and passes control of the system to another routine. Return codes can, for example, indicate whether an operation was successful or not and can thus be used to determine what is to be done next.

return from the dead *vb.* To regain access to the Internet after having been disconnected.

Return key *n.* A key on a keyboard that is used to terminate input of a field or record or to execute the default action of a dialog box. On IBM PCs and compatibles, this key is called ENTER. The corresponding key on a typewriter causes the carriage holding the paper to return to the starting position to begin a new line; hence the name. *See also* Enter key.

return to zero *n.* A method of recording on magnetic media in which the reference condition, or “neutral state,” is the absence of magnetization. *Abbreviation:* RZ. *Compare* nonreturn to zero.

reusability *n.* The ability of code or a design to be usable again in another application or system.

Reverse Address Resolution Protocol *n.* *See* RARP.

Reverse ARP *n.* *See* RARP.

reverse byte ordering *n.* *See* little endian.

reverse engineering *n.* A method of analyzing a product in which the finished item is studied to determine its makeup or component parts—for example, studying a

R

completed ROM chip to determine its programming or studying a new computer system to learn about its design. For computer software, reverse engineering typically involves decompilation of a substantial portion of the object code and studying the resulting decompiled code.

reverse path forwarding *n.* A technique that makes routing decisions through a TCP/IP network by using the source address of a datagram rather than the destination address. Reverse path forwarding is used in broadcast and multicast applications because it reduces redundant transmissions to multiple recipients. *Acronym:* RPF. *See also* datagram, TCP/IP.

reverse Polish notation *n.* *See* postfix notation.

reverse video *n.* The reversal of light and dark in the display of selected characters on a video screen. For example, if text is normally displayed as white characters on a black background, reverse video presents text as black letters on a white background. Programmers commonly use reverse video as a means of highlighting text or special items (such as menu choices or the cursor) on the screen.

revert *vb.* To return to the last saved version of a document. Choosing this command tells the application to abandon all changes made in a document since the last time it was saved.

Revisable-Form-Text DCA *n.* A standard within Document Content Architecture (DCA) for storing documents in such a way that the formatting can be changed by the receiver. A related standard is Final-Form-Text DCA. *Acronym:* RFTDCA. *See also* DCA. *Compare* Final-Form-Text DCA.

revision mark *n.* A mark that shows where a deletion, insertion, or other editing change has been made in a document.

rewind *vb.* To wind a magnetic tape spool or cassette to its beginning.

rewritable digital video disc *n.* Technology for recording data on disks that have the same storage capacity as digital video discs (DVDs) but can be rewritten like the compact disc-rewritable (CD-RW) devices. *See also* digital video disc, PD-CD drive.

rewrite *vb.* To write again, especially in situations where information is not permanently recorded, such as RAM or a video display. *Also called:* refresh, regenerate. *See also* dynamic RAM.

REXX *n.* Acronym for **R**estructured **E**xtended **E**xecutor. A structured programming language used on IBM mainframes and with OS/2 Version 2.0. REXX programs invoke application programs and operating system commands.

RF *n.* *See* radio frequency.

RFC *n.* Acronym for **R**equest for **C**omments. A document in which a standard, a protocol, or other information pertaining to the operation of the Internet is published. The RFC is actually issued, under the control of the IAB, *after* discussion and serves as the standard. RFCs can be obtained from sources such as InterNIC.

RFD *n.* *See* Request for Discussion.

RFI *n.* Acronym for **r**adio **f**requency **i**nterference. Noise introduced into an electronic circuit, such as a radio or television, by electromagnetic radiation produced by another circuit, such as a computer.

RF shielding *n.* A structure, generally sheet metal or metallic foil, designed to prevent the passage of radio frequency (RF) electromagnetic radiation. RF shielding is intended to keep RF radiation either inside a device or out of a device. Without proper RF shielding, devices that use or emit RF radiation can interfere with each other; for example, running an electric mixer might cause interference on a television. Computers generate RF radiation and, to meet Federal Communications Commission (FCC) standards, must be properly shielded to prevent this RF radiation from leaking out. The metal case of a PC provides most of the needed RF shielding. Devices meeting FCC type A standards are suitable for business use. Devices meeting the more stringent FCC type B standards are suitable for home use. *See also* radio frequency, RFI.

RFTDCA *n.* *See* Revisable-Form-Text DCA.

RGB *n.* Acronym for **r**ed-**g**reen-**b**lue. A model for describing colors that are produced by emitting light, as on a video monitor, rather than by absorbing it, as with ink on paper. The three kinds of cone cells in the eye respond to red, green, and blue light, respectively, so percentages of these additive primary colors can be mixed to get the appearance of any desired color. Adding no color produces black; adding 100 percent of all three colors results in white. *See also* CMYK, RGB monitor. *Compare* CMY.

RGB display *n.* *See* RGB monitor.

RGB monitor *n.* A color monitor that receives its signals for red, green, and blue levels over separate lines. An RGB monitor generally produces sharper and cleaner images

R

than those produced by a composite monitor, which receives levels for all three colors over a single line. *See also* RGB. *Compare* composite video display.

ribbon cable *n.* A flat cable containing up to 100 parallel wires for data and control lines. For example, ribbon cables are used inside a computer's case to connect the disk drives to their controllers.

ribbon cartridge *n.* A disposable module containing an inked fabric ribbon or a carbon-coated plastic film ribbon. Many impact printers use ribbon cartridges to make ribbon changing easier and cleaner.

Rich Text Format *n.* An adaptation of DCA (Document Content Architecture) that is used for transferring formatted text documents between applications, even those applications running on different platforms, such as between IBM and compatibles and Macintoshes. *Acronym:* RTF. *See also* DCA.

RIFF *n.* Acronym for Resource Interchange File Format. Developed jointly by IBM and Microsoft, RIFF is a broad-based specification designed to be used in defining standard formats for different types of multimedia files. A tagged-file specification, RIFF relies on headers that "tag" individual data elements in a file, identifying them by type and length. Because tags identify data elements, the RIFF specification can be extended to cover new types of elements while continuing to support older applications, which can simply ignore new, unrecognized elements they encounter in a file. *See also* AVI, MCI.

right click *vb.* To make a selection using the button on the right side of a mouse or other pointing device. Doing so in Windows 9x and Windows NT 4.0 and later typically brings up a pop-up menu with options applicable to the object over which the cursor is positioned. *See also* mouse, pointing device.

right click disabler *n.* A program or script that prevents a user from employing any functions controlled by clicking the right mouse button. A right click disabler script may be run when a user visits a Web site to control the user's actions and options.

right justification *n.* In typesetting, word processing, and desktop publishing, the process of aligning text evenly along the right margins of a column or page. The left edge of the text is ragged. *See also* justify (definition 1), rag. *Compare* full justification, left justification.

right-justify *vb.* To align lines of text and other display elements so that the right edges form a smooth line. *See also* align (definition 1), rag. *Compare* left-justify.

rigid disk *n.* *See* hard disk.

RIMM *n.* A plug-in module jointly developed by Rambus and Intel for the high-bandwidth computer memory known as Direct RDRAM. A RIMM is comparable to a DIMM in size and shape, but the two are not pin-compatible. *See also* DIMM, RDRAM.

ring network *n.* A LAN (local area network) in which devices (nodes) are connected in a closed loop, or ring. Messages in a ring network pass around the ring from node to node in one direction. When a node receives a message, it examines the destination address attached to the message. If the address is the same as the node's, the node accepts the message; otherwise, it regenerates the signal and passes the message along to the next node in the ring. Such regeneration allows a ring network to cover larger distances than star and bus networks. The ring can also be designed to bypass any malfunctioning or failed node. Because of the closed loop, however, adding new nodes can be difficult. *See the illustration. Also called:* ring topology. *See also* token passing, token ring network. *Compare* bus network, star network.

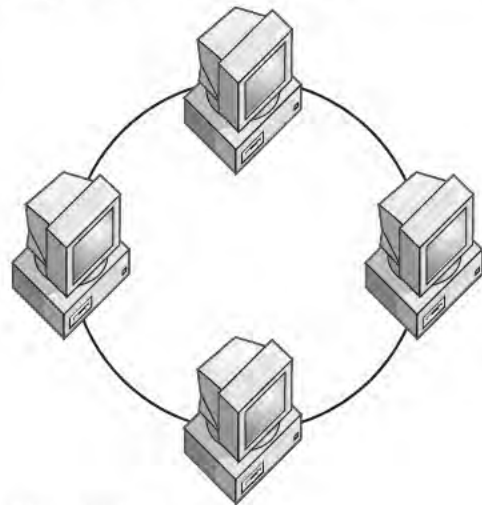

Ring network.

ring topology *n.* *See* ring network.

R

rip *vb.* To convert audio data from a compact disc into a WAV file or other digital format, typically in preparation for further encoding as an MP3 file. *See also* MP3.

RIP *n.* **1.** Acronym for **R**outing **I**nformation **P**rotocol. An Internet protocol, defined in RFC 1058, that defines the exchange of routing table information. Through RIP, each router on a network sends its routing table to its nearest neighbor every 30 seconds. Under RIP, routing is determined by the number of hops between source and destination. RIP is an interior gateway protocol (a protocol used by gateways for exchanging routing information). Because it is not the most efficient of routing protocols, it is being replaced by the more efficient Open Shortest Path First (OSPF) protocol. *See also* Bellman-Ford distance-vector routing algorithm, communications protocol, interior gateway protocol, OSPF. **2.** *See* raster image processor.

RIPE *n.* Acronym for **R**éseaux **I**P **E**uropéens. A voluntary organization of ISPs (Internet service providers) dedicated to the goal of a smoothly functioning, pan-European Internet network. Most of the work performed by RIPE is handled by discrete working groups that deal with issues such as management of the RIPE database and technical networking questions. RIPE also provides services that include registering domain names within top-level Internet domains and assigning IP (Internet Protocol) addresses. Member organizations of RIPE are supported by the RIPE NCC (Network Coordination Centre), based in Amsterdam, The Netherlands. *See also* American Registry for Internet Numbers.

ripper *n.* Digital audio technology that converts audio data from a compact disc into a WAV file or other digital format. An encoder then converts this file into a file (typically an MP3 file) that can be played back by software known as a player. *See also* encoder, MP3.

RIPX *n.* A protocol used by routers to exchange information between routers on an IPX network and by hosts to determine the best routers to use when forwarding IPX traffic to a remote IPX network. *Also called:* RIP for IPX. *See also* communications protocol, IPX, NWLink, router.

RIS *n.* *See* Remote Installation Services.

RISC *n.* Acronym for **R**educed **I**nstruction **S**et **C**omputing. A microprocessor design that focuses on rapid and efficient processing of a relatively small set of simple instructions that comprises most of the instructions a computer decodes and executes. RISC architecture opti-

mizes each of these instructions so that it can be carried out very rapidly—usually within a single clock cycle. RISC chips thus execute simple instructions more quickly than general-purpose CISC (Complex Instruction Set Computing) microprocessors, which are designed to handle a much wider array of instructions. They are, however, slower than CISC chips at executing complex instructions, which must be broken down into many machine instructions that RISC microprocessors can perform. Families of RISC chips include Sun Microsystems' SPARC, Motorola's 88000, Intel's i860, and the PowerPC developed by Apple, IBM, and Motorola. *See also* architecture, SPARC. *Compare* CISC.

RISC86 *n.* A "hybrid" microprocessor technology in which CISC (Complex Instruction Set Computing) instructions are translated into RISC (Reduced Instruction Set Computing) instructions for processing. RISC86 is designed to support the 80x86 CISC architecture while providing the speed gains characteristic of RISC technology. RISC86 was developed by NexGen and is implemented in AMD's K6 microprocessor.

Rivest-Shamir-Adleman encryption *n.* *See* RSA encryption.

RJ-11 connector *n.* *See* phone connector.

RJ-11 jack *n.* *See* phone connector.

RJ-45 connector *n.* Short for **R**egistered **J**ack-**45** **c**onnecto**r**. An eight-wire connector used to attach devices to cables. The eight wires are encased in a plastic sheath and color-coded to match corresponding slots in jacks. RJ-45 jacks are used to connect computers to LANs (local area networks) and to link ISDN (Integrated Services Digital Network) devices to NT-1 (Network Terminator 1) devices. *Also called:* RJ-45 jack. *See also* ISDN.

RJ-45 jack *n.* *See* RJ-45 connector.

RLE *n.* Short for **R**un **L**ength **E**ncoding. A data compression format in which only the first of a series of consecutive identical pixels is saved, along with the total number of pixels in the run. When the file is decompressed, each representative pixel is copied the correct number of times to replace those not saved. RLE compression works best with simple black and white or flat color graphics.

RLIN *n.* *See* Research Libraries Information Network.

RLL encoding *n.* *See* run-length limited encoding.

R

rlogin¹ *n.* 1. A protocol used to log in to a networked computer in which the local system automatically supplies the user's login name. *See also* communications protocol, logon. *Compare* telnet1. 2. A UNIX command in BSD UNIX that enables a user to log in to a remote computer on a network using the rlogin protocol. *See also* BSD UNIX.

rlogin² *vb.* To connect to a networked computer using the rlogin protocol.

RLSD *n.* Acronym for Received Line Signal Detect. *See* DCD.

RMI-IIOP *n.* Acronym for Remote Method Invocation over Internet Inter-ORB Protocol. A subsystem of the Java 2 Platform, Enterprise Edition (J2EE). It provides the ability to write CORBA applications for the Java platform without learning the CORBA Interface Definition Language (IDL). RMI-IIOP includes the full functionality of a CORBA Object Request Broker and allows the programming of CORBA servers and applications via the RMI application programming interface (API). RMI-IIOP is useful for developers using Enterprise Java Beans (EJBs), since the remote object model for an EJB is RMI-based. *Also called:* RMI over IIOP. *See also* CORBA, Enterprise JavaBeans, J2EE.

RMM *n.* *See* real-mode mapper.

RMON *n.* Acronym for remote monitoring or remote network monitoring. A protocol that enables network information to be monitored and analyzed at a central site. The nine management information bases (MIBs) defined by RMON provide statistics about network traffic. *See also* MIB. *Compare* SNMP.

roaming user profile *n.* A server-based user profile that is downloaded to the local computer when a user logs on; it is updated both locally and on the server when the user logs off. A roaming user profile is available from the server when logging on to a workstation or server computer. When logging on, the user can use the local user profile if it is more current than the copy on the server. *See also* local user profile, mandatory user profile, user profile.

robopost *vb.* To post articles to newsgroups automatically, usually by means of a bot. *See also* bot (definition 3), newsgroup, post.

robot *n.* 1. A machine that can sense and react to input and cause changes in its surroundings with some degree of intelligence, ideally without human supervision. Although robots are often designed to mimic human movements in

carrying out their work, they are seldom humanlike in appearance. Robots are commonly used in manufacturing products such as automobiles and computers. *See also* robotics. 2. *See* bot, spider.

robotics *n.* The branch of engineering devoted to the creation and training of robots. Roboticists work within a wide range of fields, such as mechanical and electronic engineering, cybernetics, bionics, and artificial intelligence, all toward the end of endowing their creations with as much sensory awareness, physical dexterity, independence, and flexibility as possible. *See also* artificial intelligence, bionics, cybernetics.

robust *adj.* Able to function or to continue functioning well in unexpected situations.

ROFL *n.* Acronym for rolling on the floor, laughing. An expression, used mostly in newsgroups and online conferences, to indicate one's appreciation of a joke or other humorous circumstance. *Also called:* ROTFL.

role-playing game *n.* A game that is played on line, such as MUD, in which participants take on the identities of characters who interact with each other. These games often have a fantasy or science fiction setting and a set of rules that all players need to follow. Role-playing games may be similar to adventure games in terms of story line, but also feature management and decision making for the character assumed during the course of the game. *Acronym:* RPG. *See also* MUD. *Compare* adventure game.

rollback *n.* 1. A return to a previous stable condition, as when the contents of a hard disk are restored from a backup after a destructive hard disk error. 2. The point in an online transaction when all updates to any databases involved in the transaction are reversed.

rollover *n.* *See* Year 2000 rollover.

ROM *n.* 1. Acronym for read-only memory. A semiconductor circuit into which code or data is permanently installed by the manufacturing process. The use of this technology is economically viable only if the chips are produced in large quantities; experimental designs or small volumes are best handled using PROM or EPROM.

2. Acronym for read-only memory. Any semiconductor circuit serving as a memory that contains instructions or data that can be read but not modified (whether placed there by manufacturing or by a programming process, as in PROM and EPROM). *See also* EEPROM, EPROM, PROM.

R

roman *adj.* Having upright rather than slanted characters in a typeface. *See also* font family. *Compare* italic.

ROM Basic *n.* Short for read-only memory Beginner's All-purpose Symbolic Instruction Code. A Basic interpreter stored in ROM (read-only memory) so that the user can start programming after simply turning on the machine, without having to load Basic from a disk or tape. ROM Basic was a feature of many early home computers.

ROM BIOS *n.* Acronym for read-only memory basic input/output system. *See* BIOS.

ROM card *n.* Short for read-only memory card. A plug-in module that contains one or more printer fonts, programs, or games or other information stored in ROM (read-only memory). A typical ROM card is about the size of a credit card and several times thicker. It stores information directly in integrated circuit boards. *Also called:* font card, game card. *See also* ROM (definition 1), ROM cartridge.

ROM cartridge *n.* Short for read-only memory cartridge. A plug-in module that contains one or more printer fonts, programs, games, or other information stored in ROM (read-only memory) chips on a board enclosed in a plastic case with a connector exposed at one end so that it can easily plug into a printer, computer, game system, or other device. For example, a cartridge that plugs into a game system is a ROM cartridge. *Also called:* game cartridge. *See also* ROM (definition 1), ROM card.

ROM emulator *n.* Short for read-only memory emulator. A special circuit containing RAM memory that is connected to a target computer in place of the target computer's ROM chips. A separate computer writes the contents into the RAM, and then the target computer reads the RAM as if it were ROM. ROM emulators are used to debug ROM-resident software without the high cost and delay of manufacturing chips. Even though the use of a ROM emulator is more expensive than programming an EPROM, it is often preferred today because its contents can be changed much more quickly than those of an EPROM. *Also called:* ROM simulator. *See also* EEPROM, EPROM, ROM (definition 1).

ROM simulator *n.* *See* ROM emulator.

root *n.* The main or uppermost level in a hierarchically organized set of information. The root is the point from which subsets branch in a logical sequence that moves from a broad focus to narrower perspectives. *See also* leaf, tree.

root account *n.* On UNIX systems, the account having control over the operation of a computer. The system administrator uses this account for system maintenance. *Also called:* superuser. *See also* system administrator.

root directory *n.* The point of entry into the directory tree in a disk-based hierarchical directory structure. Branching from this root are various directories and subdirectories, each of which can contain one or more files and subdirectories of its own. For example, in the MS-DOS operating system the root directory is identified by a name consisting of a single backslash character (\). Beneath the root are other directories, which may contain further directories, and so on. *See the illustration.*

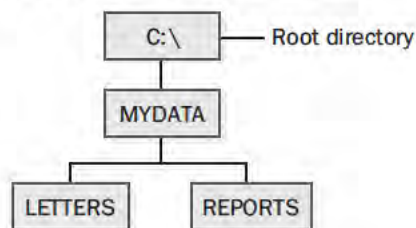

Root directory.

root folder *n.* The folder on a drive from which all other folders branch. The root folder's name consists of a single backslash character (\). For example, on drive C, this folder would be represented in the file system as C:\.

rootless *n.* A mode in which an application belonging to a different user interface can run on top of a computer's underlying operating system without affecting that desktop or applications it may be running. For example, programs belonging to a rootless version of the X Window System can be run on a Mac OS X computer without disturbing the Aqua desktop. *See also* Mac OS X, X Window System.

root name *n.* In MS-DOS and Windows, the first part of a filename. In MS-DOS and earlier versions of Windows, the maximum length of the root name was eight characters; in Windows NT and later versions of Windows, the root name may be as long as 255 characters. *See also* 8.3, extension (definition 1), filename, long filenames.

root name server *n.* *See* root server.

root server *n.* A computer with the ability to locate DNS servers containing information about top-level Internet domains, such as com, org, uk, it, jp, and other country domains, in the Internet's Domain Name System (DNS) hierarchy. Beginning with the root server and

R

continuing through referrals to name servers at lower levels of the hierarchy, the DNS is able to match a “friendly” Internet address, such as microsoft.com, with its numerical counterpart, the IP address. Root servers thus contain the data needed for referrals to name servers at the highest level of the hierarchy. There are 13 root servers in the world, located in the United States, the United Kingdom, Sweden, and Japan. *Also called:* root name server. *See also* DNS (definition 1), DNS server, top-level domain.

root web *n.* The default, top-level web provided by a Web server. To access the root web, you supply the URL of the server without specifying a page name or subweb.

ROT13 encryption *n.* A simple encryption method in which each letter is replaced with the letter of the alphabet 13 letters after the original letter, so that A is replaced by N, and so forth; N, in turn, is replaced by A, and Z is replaced by M. ROT13 encryption is not used to protect messages against unauthorized readers; rather, it is used in newsgroups to encode messages that a user may not want to read, such as sexual jokes or spoilers. Some newsreaders can automatically perform ROT13 encryption and decryption at the touch of a key.

rotary dialing *n.* The signaling system used in telephones with rotary dials, in which each digit is associated with a set number of pulses. During dialing, these pulses, which are audible as series of clicks, momentarily turn the current in the telephone wires on and off. *Also called:* pulse dialing. *Compare* touch tone dialing.

rotate *vb.* **1.** To turn a model or other graphical image so that it is viewed at a different angle. **2.** To move bits in a register to the left or to the right. The bit that moves out of the end position rotates to the newly vacated position at the opposite end of the register. *Compare* shift.

rotational delay *n.* The time required for a desired disk sector to rotate to the read/write head. *Also called:* rotational latency.

rotational latency *n.* *See* rotational delay.

RO terminal *n.* Short for **read-only terminal**. A terminal that can receive data but cannot send data. Nearly all printers can be classified as RO terminals.

ROTFL *n.* *See* ROFL.

round *vb.* To shorten the fractional part of a number, increasing the last remaining (rightmost) digit or not, according to whether the deleted portion was over or

under five. For example, 0.3333 rounded to two decimal places is 0.33, and 0.6666 is 0.67. Computer programs often round numbers, sometimes causing confusion when the resulting values do not add up “correctly.” Percentages in a spreadsheet can thus total 99 percent or 101 percent because of rounding.

round robin *n.* A sequential, cyclical allocation of resources to more than one process or device.

roundtripping *n.* The process of converting files from one format to another for viewing or editing and then converting the files back to the original format again. In some cases, roundtripping can involve repeated conversions of the file from one format to another and back. Frequent roundtripping may be a concern because each conversion has the potential to introduce unwanted changes to the file.

routable protocol *n.* A communications protocol that is used to route data from one network to another by means of a network address and a device address. TCP/IP is an example of a routable protocol.

router *n.* An intermediary device on a communications network that expedites message delivery. On a single network linking many computers through a mesh of possible connections, a router receives transmitted messages and forwards them to their correct destinations over the most efficient available route. On an interconnected set of LANs (local area networks)—including those based on differing architectures and protocols—using the same communications protocols, a router serves the somewhat different function of acting as a link between LANs, enabling messages to be sent from one to another. *See also* bridge, gateway.

routine *n.* Any section of code that can be invoked (executed) within a program. A routine usually has a name (identifier) associated with it and is executed by referencing that name. Related terms (which may or may not be exact synonyms, depending on the context) are *function*, *procedure*, and *subroutine*. *See also* function (definition 3), procedure, subroutine.

routing *n.* The process of forwarding packets between networks from source to destination. *See also* dynamic routing, static routing.

Routing Information Protocol *n.* *See* RIP (definition 1).

routing table *n.* In data communications, a table of information that provides network hardware (bridges and routers) with the directions needed to forward packets of data to locations on other networks. The information contained

R

in a routing table differs according to whether it is used by a bridge or a router. A bridge relies on both the source (originating) and destination addresses to determine where and how to forward a packet. A router relies on the destination address and on information in the table that gives the possible routes—in hops or in number of jumps—between itself, intervening routers, and the destination. Routing tables are updated frequently as new or more current information becomes available. *See also* bridge, hop, internetwork, router.

row *n.* A series of items arranged horizontally within some type of framework—for example, a continuous series of cells running from left to right in a spreadsheet; a horizontal line of pixels on a video screen; or a set of data values aligned horizontally in a table. *Compare* column.

royalty-free *n.* The absence of a requirement to pay the original owner of music, images, software, or other content for the right to use, edit, or distribute their content.

RPC *n.* *See* remote procedure call.

RPF *n.* *See* reverse path forwarding.

RPG *n.* **1.** *See* role-playing game. **2.** Acronym for **Report Program Generator**. An IBM programming platform introduced in 1964. The earliest version of RPG was not a language but a program generator intended to aid in producing business reports. Versions of RPG have been developed for various platforms, including IBM's AS/400 server, UNIX, MS-DOS, and Windows.

RPN *n.* Acronym for **reverse Polish notation**. *See* postfix notation.

RPROM *n.* Short for **reprogrammable PROM**. *See* EPROM.

RS-232-C standard *n.* An accepted industry standard for serial communications connections. Adopted by the Electrical Industries Association, this Recommended Standard (RS) defines the specific lines and signal characteristics used by serial communications controllers to standardize the transmission of serial data between devices. The letter C denotes that the current version of the standard is the third in a series. *See also* CTS, DSR, DTR, RTS, RXD, TXD.

RS-422/423/449 *n.* Standards for serial communications with transmission distances over 50 feet. RS-449 incorporates RS-422 and RS-423. Macintosh serial ports are RS-422 ports. *See also* RS-232-C standard.

RSA *n.* A widely used public/private key algorithm. It is the default cryptographic service provider (CSP) for

Microsoft Windows. It was patented by RSA Data Security, Inc., in 1977. *See also* cryptographic service provider.

RSAC *n.* *See* Recreational Software Advisory Council.

RSA encryption *n.* Short for **Rivest-Shamir-Adleman encryption**. The public key encryption algorithm, introduced by Ronald Rivest, Adi Shamir, and Leonard Adleman in 1978, on which the PGP (Pretty Good Privacy) encryption program is based. *See also* PGP, public key encryption.

RSI *n.* *See* repetitive strain injury.

RSN *adv.* *See* Real Soon Now.

R-squared value *n.* An indicator from 0 to 1 that reveals how closely the estimated values for the trendline correspond to your actual data. A trendline is most reliable when its R-squared value is at or near 1. *Also called:* the coefficient of determination.

RSVP *n.* *See* Resource Reservation Setup Protocol.

RTC *n.* *See* clock (definition 2).

RTCP *n.* *See* Real-Time Control Protocol.

RTF *n.* *See* Rich Text Format.

RTFM *n.* Acronym for **read the flaming (or friendly) manual**. A common answer to a question in an Internet newsgroup or product support conference that is adequately explained in the instruction manual. (The F in this acronym is not necessarily assumed to represent polite language.) *Also called:* RTM.

RTM *n.* Acronym for **read the manual**. *See* RTFM.

RTOS *n.* *See* real-time operating system.

RTP *n.* *See* Real-Time Protocol.

RTS *n.* Acronym for **Request to Send**. A signal sent, as from a computer to its modem, to request permission to transmit; the signal is often used in serial communications. RTS is a hardware signal sent over pin 4 in RS-232-C connections. *See also* RS-232-C standard. *Compare* CTS.

RTSP *n.* *See* Real-Time Streaming Protocol.

rubber banding *n.* In computer graphics, changing the shape of an object made up of connected lines by “grabbing” a point on an anchored line and “pulling” it to the new location.

Ruby *n.* An interpreted open source scripting language for object-oriented programming. Its simple syntax is partially based on the syntax of Eiffel and Ada. Considered to



be similar to Perl, it has many features to process text files and perform system management tasks.

rudder control *n.* A device, consisting of a pair of pedals, that enables a user to input rudder movements in a flight simulation program. The rudder control is used along with a joystick (which controls the simulated ailerons and elevators) and possibly a throttle control.

rule *n.* **1.** A line printed above, below, or to the side of some element, either to set that item off from the remainder of the page or to improve the look of the page. Footnotes, for example, often appear below a short rule that sets them off from the main text on the page. The thickness of a rule is typically measured in points. (A point is approximately $1/72$ inch.) *See also* point¹ (definition 1). **2.** In expert systems, a statement that can be used to verify premises and to enable a conclusion to be drawn. *See also* expert system.

rule-based system *n.* *See* expert system, production system.

ruler *n.* In some application programs, such as word processors, an on-screen scale marked off in inches or other units of measure and used to show line widths, tab settings, paragraph indents, and so on. In programs in which the ruler is “live,” the on-screen ruler can be used with the mouse or with the keyboard to set, adjust, or remove tab stops and other settings.

run *vb.* To execute a program.

run around *vb.* In page composition, to position text so that it flows around an illustration or other display.

run-length encoding *n.* A simple compression method that replaces a contiguous series (run) of identical values in a data stream with a pair of values that represent the length of the series and the value itself. For example, a data stream that contains 57 consecutive entries with the value 10 could replace them all with the much shorter pair of values 57, 10. *Acronym:* RLE.

Run Length Encoding *n.* *See* RLE.

run-length limited encoding *n.* A fast and highly efficient method of storing data on a disk (usually a hard disk) in which patterns in the bits representing information are translated into codes rather than being stored literally bit by bit and character by character. In RLL encoding, changes in magnetic flux are based on the number of zeros

that occur in sequence. This scheme allows data to be stored with fewer changes in magnetic flux than would otherwise be needed for the number of data bits involved and results in considerably higher storage capacity than is possible with older technologies, such as frequency modulation (FM) and modified frequency modulation (MFM) encoding. *Abbreviation:* RLL encoding. *Compare* frequency modulation encoding, modified frequency modulation encoding.

running foot *n.* One or more lines of text in the bottom margin area of a page, composed of one or more elements such as the page number, the name of the chapter, and the date. *Also called:* footer.

running head *n.* One or more lines of text in the top margin area of a page, composed of one or more elements such as the page number, the name of the chapter, and the date. *Also called:* header.

RUNOFF *n.* A very early text editor/text formatting program, developed by J. E. Saltzer at M.I.T. for the CTSS (Compatible Time-Sharing System) operating system in the mid-1960s, in order to format his Ph.D. thesis. RUNOFF was the ancestor of many other text processors, including TeX, and the UNIX programs roff, nroff, and troff.

run-time *adj.* Occurring after a program has begun to be executed, such as evaluation of variable expressions and dynamic allocation of memory.

run time *n.* **1.** The time period during which a program is running. *See also* compile time, dynamic allocation, dynamic binding, link time. **2.** The amount of time needed to execute a given program.

runtime *n.* *See* common language runtime.

run-time binding *n.* Assignment of a meaning to an identifier (such as a variable) in a program at the time the program is executed rather than at the time the program is compiled. *Compare* compile-time binding, link-time binding.

run-time error *n.* A software error that occurs while a program is being executed, as detected by a compiler or other supervisory program.

run-time library *n.* A file containing one or more prewritten routines to perform specific, commonly used functions. A run-time library, used primarily in high-level languages such as C, saves the programmer from having to rewrite those routines.

R

run-time version *n.* **1.** Program code that is ready to be executed. Generally, this code has been compiled and can operate without error under most user command sequences and over most ranges of data sets. **2.** A special release that provides the computer user with some, but not all, of the capabilities available in the full-fledged software package.

R/W *adj.* *See* read/write.

RXD *n.* Short for Receive (**rx**) Data. A line used to carry received serial data from one device to another, such as from a modem to a computer. Pin 3 is the RXD line in RS-232-C connections. *See also* RS-232-C standard. *Compare* TXD.

RZ *n.* *See* return to zero.

R

S

S-100 bus *n.* A 100-pin bus specification used in the design of computers built around the Intel 8080 and Zilog Z-80 microprocessors. System designs using the Motorola 6800, 68000, and Intel iAPx86 family of microprocessors have also been built around the S-100 bus. S-100 computers were extremely popular with early computer enthusiasts. They had an open architecture, which permitted the configuration of systems with a wide range of add-on expansion boards.

SA *n.* Identifier for Intel's line of RISC-based microprocessors for portable and embedded devices. *See also* StrongARM.

SAA *n.* Acronym for **S**ystems **A**pplication **A**rchitecture. An IBM-developed standard for the appearance and operation of application software that will give programs written for all IBM computers—mainframe computers, minicomputers, and personal computers—a similar look and feel. SAA defines how an application interfaces with both the user and the supporting operating system. True SAA-compliant applications are compatible at the source level (before being compiled) with any SAA-compliant operating system—provided the system is capable of furnishing all the services required by the application.

Sad Mac *n.* An error indication that occurs on Apple Macintosh computers when the system fails the initial diagnostic test. A Sad Mac is a picture of a Macintosh with a frowning face and X's for eyes, with an error code beneath the picture.

S

safe mode *n.* In some versions of Windows, such as Windows 95, a boot mode that bypasses startup files and loads only the most basic drivers. Safe mode allows the user to correct some problem with the system—for example, if the system fails to boot or the registry has become corrupted. *See also* boot¹.

salt *n.* Random data used to supplement encryption schemes. A salt value allows two identical packets of data to be encrypted into two different packets of ciphertext using the same key by changing the salt value with each packet. *Also called:* salt string, salt value.

Samba *n.* A popular freeware program that provides file and print services, authentication and authorization, name resolution, and service announcement (browsing). As a file server, Samba enables the sharing of files, printers, and other resources on a UNIX Samba server with Windows clients over a network. Based on the Server Message Block (SMB) protocol, Samba originally was developed as a Network File System (NFS) for UNIX by Andrew Tridgell. *See also* NFS, SMB.

sampling *vb.* **1.** In statistics, gathering data from a representative subset of a larger group (called a population)—for example, determining a country's presumed voting pattern by polling a demographic cross section of voters. Other uses of this type of sampling might include checking the accuracy and efficiency of computerized transactions by reviewing every hundredth transaction or predicting traffic volumes by measuring traffic flow in a few strategic streets. There are many statistical procedures for estimating how accurately a given sample reflects the behavior of a group as a whole. **2.** The conversion of analog signals to a digital format; samples are taken at periodic intervals to measure and record some parameter, such as a signal from a temperature sensor or a microphone. Analog-to-digital converters are used in computers to sample analog signals as voltages and convert them to the binary form a computer can process. The two primary characteristics of this type of sampling are the sampling rate (usually expressed in samples per second) and the sampling precision (expressed in bits; 8-bit samples, for instance, can measure an input voltage accurate to 1/256 of the measured range).

sampling rate *n.* The frequency with which samples of a physical variable, such as sound, are taken. The higher the sampling rate (that is, the more samples taken per unit of time), the more closely the digitized result resembles the original. *See also* sampling (definition 2).

sampling synthesizer *n.* A device designed to reproduce sounds, at differing frequencies, based on a digitized sound stored in read-only memory. For example, a

recorded piano note, digitized and stored in memory, is used by the synthesizer to create other piano-like notes.

samurai *n.* A hacker employed by a company or organization to manage network security or conduct legal cracking operations. A samurai uses the skills of a hacker to meet the legitimate needs of an employer.

SAN *n.* *See* storage area network.

sandbox *n.* **1.** Java Virtual Machine security area for downloaded (remote or untrusted) applets, an area in which such applets are confined and prevented from accessing system resources. Confinement to the sandbox prevents downloaded applets from carrying out potentially dangerous operations, maliciously or otherwise. They have to “play” inside the sandbox, and any attempt to “escape” is thwarted by the Java Security Manager.

2. Slang for the research and development department at many software and computer companies. *See also* applet, Java Virtual Machine.

sans serif *adj.* Literally, “without stroke”; describes any typeface in which the characters have no serifs (the short lines or ornaments at the upper and lower ends of the strokes). A sans serif typeface usually possesses a more straightforward, geometric appearance than a typeface with serifs and typically lacks the contrast between thick and thin strokes found in serif faces. Sans serif typefaces are used more frequently in display type, such as headlines, than in blocks of text. *Compare* serif¹.

SAOL *n.* Acronym for **Structured Audio Orchestra Language**. Part of the MPEG-4 standard, SAOL describes a set of tools for producing computer music, audio for computer games, streaming Internet sound or music, and other multimedia applications. SAOL is a flexible computer language for describing music synthesis and integrating synthetic sound with recorded sound in an MPEG-4 bit stream. *See also* bit stream, MPEG-4, streaming (definition 1).

SAP *n.* *See* Service Advertising Protocol.

SAPI *n.* Acronym for **Speech Application Programming Interface**. A feature in Windows 9x and Windows NT that allows applications to include speech recognition or convert text to speech. *Also called:* Speech API. *See also* voice recognition.

SAS *n.* *See* single attachment station.

SASL *n.* Acronym for **Simple Authentication and Security Layer**. An authentication support mechanism for use with connection-based protocols. SASL allows a client to request identification from a server and negotiate use of an added security layer for authentication during subsequent client/server interaction.

satellite *n.* *See* communications satellite.

satellite computer *n.* A computer that is connected to another computer, with which it interacts over a communications link. As its name indicates, a satellite computer is of lesser “stature” than the main, or host, computer; the host controls either the satellite itself or the tasks the satellite performs. *See also* remote communications.

satellite dish *n.* A parabolic (dish-shaped) reflector and antenna that is used for transmitting and receiving signals between the ground and earth satellites. Satellite dishes are commonly used for receiving television transmissions.

saturated mode *n.* The state in which a switching device or amplifier is passing the maximum possible current. A device is in saturated mode when increasing the control signal does not result in output of additional current.

saturation *n.* **1.** In a switching device or amplifier, the fully conducting state. At saturation, the device is passing the maximum possible current. The term is most commonly used with reference to circuits containing bipolar or field-effect transistors. **2.** In color graphics and printing, the amount of color in a specified hue, often specified as a percentage. *See also* HSB.

save *vb.* To write data (typically a file) to a storage medium, such as a disk or tape.

SAX *n.* Acronym for **Simple API for XML**. An event-driven application program interface (API) used to interpret an XML file. SAX works with an XML parser, providing an interface between the parser and an XML application. SAX is used as an alternative to the more complex object-based Document Object Model (DOM) interface. *See also* DOM.

scalability *n.* A measure of how well a computer, service, or application can grow to meet increasing performance demands. For server clusters, it is the ability to incrementally add one or more systems to an existing cluster when the overall load of the cluster exceeds its capabilities. *See also* server cluster.



scalable *adj.* Of or relating to the characteristic of a piece of hardware or software or a network that makes it possible for it to expand—or shrink—to meet future needs and circumstances. For example, a scalable network allows the network administrator to add many additional nodes without the need to redesign the basic system.

scalable font *n.* Any font that can be scaled to produce characters in varying sizes. Examples of scalable fonts are screen fonts in a graphical user interface, stroke fonts (such as Courier) and outline fonts common to most PostScript printers, TrueType fonts, and the method for screen font definition used in Macintosh System 7. In contrast, most text-based interfaces and printing devices (such as daisy-wheel printers) offer text in only one size. *See also* outline font, PostScript font, screen font, stroke font, TrueType.

scalable parallel processing *n.* Multiprocessing architectures in which additional processors and additional users can easily be added without excessive increases in complexity and loss of performance. *Acronym:* SPP.

Scalable Processor Architecture *n.* *See* SPARC.

Scalable Vector Graphics *n.* *See* SVG.

scalar *n.* A factor, coefficient, or variable consisting of a single value (as opposed to a record, an array, or some other complex data structure). *Compare* vector.

scalar data type *n.* A data type defined as having a predictable and enumerable sequence of values that can be compared for greater-than/less-than relationships. Scalar data types include integers, characters, user-defined enumerated data types, and (in most implementations) Boolean values. Some debate exists as to whether or not floating-point numbers can be considered a scalar data type; although they can be ordered, enumeration is often questionable because of rounding and conversion errors. *See also* Boolean expression, enumerated data type, floating-point number.

scalar processor *n.* A processor designed for high-speed computation of scalar values. A scalar value can be represented by a single number.

scalar variable *n.* *See* scalar.

scale¹ *n.* A horizontal or vertical line on a graph that shows minimum, maximum, and interval values for the data plotted.

scale² *vb.* **1.** To enlarge or reduce a graphic display, such as a drawing or a proportional character font, by adjusting

its size proportionally. **2.** To alter the way in which values are represented so as to bring them into a different range—for example, to change linear feet to quarter inches on a blueprint drawing of a house. **3.** In programming, to determine the number of digits occupied by fixed-point or floating-point numbers. *See also* fixed-point notation, floating-point number.

scaling *n.* In computer graphics, the process of enlarging or reducing a graphical image—scaling a font to a desired size or scaling a model created with a CAD program, for example. *See also* CAD.

scan *vb.* **1.** In television and computer display technologies, to move an electron beam across the inner surface of the screen, one line at a time, to light the phosphors that create a displayed image. **2.** In facsimile and other optical technologies, to move a light-sensitive device across an image-bearing surface such as a page of text, converting the light and dark areas on the surface to binary digits that can be interpreted by a computer.

scan code *n.* A code number transmitted to an IBM or compatible computer whenever a key is pressed or released. Each key on the keyboard has a unique scan code. This code is not the same as the ASCII code for the letter, number, or symbol shown on the key; it is a special identifier for the key itself and is always the same for a particular key. When a key is pressed, the scan code is transmitted to the computer, where a portion of the ROM BIOS (read-only memory basic input/output system) dedicated to the keyboard translates the scan code into its ASCII equivalent. Because a single key can generate more than one character (lowercase *a* and uppercase *A*, for example), the ROM BIOS also keeps track of the status of keys that change the keyboard state, such as the Shift key, and takes them into account when translating a scan code. *Compare* key code.

scan head *n.* An optical device found in scanners and fax machines that moves across the subject being scanned, converts light and dark areas to electrical signals, and sends those signals to the scanning system for processing.

scan line *n.* **1.** One of many horizontal lines of a graphics display screen, such as a television or raster-scan monitor. **2.** A single row of pixels read by a scanning device.

scanner *n.* An optical input device that uses light-sensing equipment to capture an image on paper or some other subject. The image is translated into a digital signal that can then be manipulated by optical character recognition

S

(OCR) software or graphics software. Scanners come in a number of types, including flatbed (scan head passes over a stationary subject), feed (subject is pulled across a stationary scan head), drum (subject is rotated around a stationary scan head), and handheld (user passes device over a stationary subject).

scan rate *n.* See refresh rate.

scatter diagram *n.* A graph consisting of points whose coordinates represent values of data, often used to illustrate a correlation between one or more variables and a test group. See the illustration. *Also called:* point chart, point diagram.

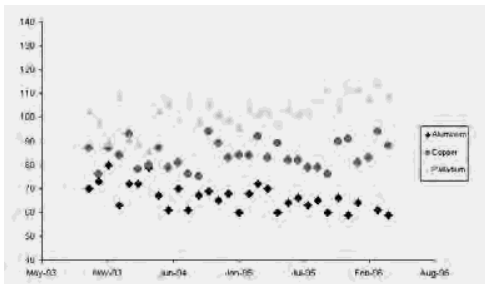

Scatter diagram.

schedule *vb.* To program a computer to perform a specified action at a specified time and date.

scheduler *n.* An operating-system process that starts and ends tasks (programs), manages concurrently running processes, and allocates system resources. *Also called:* dispatcher.

scheduling algorithm *n.* An algorithm that governs the proper timing of a sequence of events in an operating system or application. For example, an effective motion graphics scheduling algorithm would be able to retrieve the graphic objects, process them, and display them without causing stutter or disruptions. *See also* algorithm.

schema *n.* A description of a database to a database management system (DBMS) in the language provided by the DBMS. A schema defines aspects of the database, such as attributes (fields) and domains and parameters of the attributes.

schematic *n.* A diagram that shows a circuit's components and the connections between them using lines and a

set of standard symbols to represent various electronic components. See the illustration.

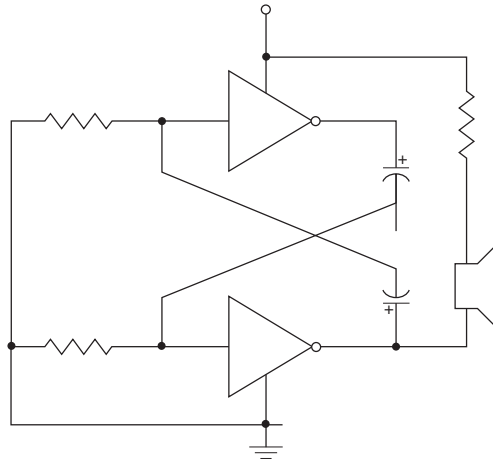

Schematic.

Schottky diode *n.* A type of diode (device that passes current in one direction) in which a semiconductor layer and a metal layer are brought into contact. It is characterized by very fast switching speeds. *Also called:* hot carrier diode, Schottky barrier diode.

scientific notation *n.* A floating-point method of representing a number, especially a very large or very small one, in which numbers are expressed as products consisting of a number between 1 and 10 multiplied by a power of 10. Scientific notation commonly uses the letter E in place of "times 10," as in 5.0E3, meaning 5.0 times 10 to the third power, or 10^3 . *See also* floating-point notation.

sci. newsgroups *n.* Usenet newsgroups that are part of the sci. hierarchy and begin with "sci." These newsgroups are devoted to discussions of scientific research and applications, except for computer science, which is discussed in the comp. newsgroups. *See also* newsgroup, traditional newsgroup hierarchy, Usenet. *Compare* comp. newsgroups, misc. newsgroups, news. newsgroups, rec. newsgroups, soc. newsgroups, talk. newsgroups.

scissoring *n.* See clip.

scope *n.* **1.** In programming, the extent to which an identifier, such as a constant, data type, variable, or routine, can be referenced within a program. Scope can be global

S

or local. Scope can also be affected by redefining identifiers, such as by giving the same name to both a global variable and a local variable. *See also* block¹(definition 3), global, local. **2.** In electronics, slang for oscilloscope. *See also* oscilloscope.

score *n.* When referring to a spelling checker, a score is a number that indicates how much a replacement word differs from the original misspelled word. A low score indicates that the misspelled word was changed slightly, while a high score indicates that the word was changed a great deal.

SCP *n.* Acronym for **S**imple **C**ontrol **P**rotocol. A lightweight peer-to-peer networking protocol for devices that have limited processing and memory resources and operate over limited-bandwidth networks such as powerline carrier (PLC) systems. Products using SCP can interoperate with products using the Universal Plug and Play (UPnP), CEBus, and Home Plug & Play (HPnP) standards. Developed by a team of companies including Microsoft and General Electric, SCP enables the interaction between UPnP devices, devices based on Internet Protocol (IP), and non-IP-capable devices such as coffeemakers and alarm clocks. SCP, which was designed as a stand-alone protocol, can be used in residential, commercial, industrial, and utility applications. *See also* UPnP networking.

SCR *n.* *See* silicon-controlled rectifier.

scrambler *n.* A device or program that reorders a signal sequence in order to render it indecipherable. *See also* encryption.

scrap *n.* An application or system file maintained for storing data that has been marked for movement, copying, or deletion. *See also* clipboard (definition 1).

scrapbook *n.* **1.** A file in which a series of text and graphical images can be saved for subsequent use. **2.** A Macintosh system file that can hold a number of text and graphical images for later use. *Compare* clipboard (definition 1).

scratch¹ *n.* A memory region or file used by a program or operating system to hold work in progress temporarily. Created and maintained usually without the end user's knowledge, the scratch is needed only until the current session is terminated, at which time the data is saved or discarded. *Also called:* scratch file. *See also* temporary file. *Compare* scrap.

scratch² *vb.* To erase or discard data.

scratch file *n.* *See* scratch¹.

scratchpad *n.* **1.** A temporary storage area used by a program or operating system for calculations, data, and other work in progress. *See also* scratch¹, temporary file. **2.** A high-speed memory circuit used to hold small items of data for rapid retrieval. *See also* cache.

scratchpad memory *n.* *See* cache.

scratchpad RAM *n.* Memory used by a central processing unit (CPU) for temporary data storage. *Also called:* scratchpad, scratchpad memory. *See also* central processing unit, register.

scream *vb.* To operate at very high speed. For example, a modem that can transfer data several times faster than the one it replaced or a computer with a very high clock speed could be said to "scream."

screamer *n.* Slang for a piece of computer equipment that operates at a very high speed. Generally, "screamers" are the newest versions of a particular piece of equipment, such as a PC with the latest, fastest microprocessor, or are comprised of multiple components that increase the operating speed over standard models, such as a PC that has a huge amount of RAM (Random Access Memory), a high-performance video board, a superfast CD-ROM drive, and the latest microprocessor. However, as technology evolves and new, faster devices are introduced, yesterday's screamer rapidly becomes today's snail.

screen angle *n.* The angle at which the dots in a halftone screen are printed. A correct angle will minimize blur and other undesirable effects, such as moiré patterns. *See also* color separation (definition 1), halftone, moiré.

screen buffer *n.* *See* video buffer.

screen dump *n.* A duplicate of a screen image; essentially, a snapshot of the screen that is either sent to a printer or saved as a file.

screen flicker *n.* *See* flicker.

screen font *n.* A typeface designed for display on a computer monitor screen. Screen fonts often have accompanying PostScript fonts for printing to PostScript-compatible printers. *See also* derived font, intrinsic font. *Compare* PostScript font, printer font.

screen frequency *n.* *See* halftone.

screen grabber *n.* *See* grabber (definition 3).

S

screen name *n.* A name under which an America Online user is known. The screen name may be the same as the user's real name. *See also* America Online.

screen phone *n.* A type of Internet appliance combining a telephone with an LCD display screen, a digital fax modem, and a computer keyboard, with ports for a mouse, printer, and other peripheral devices. Screen phones can be used as regular telephones for voice communications and can also be used as terminals to gain access to the Internet and other online services.

screen pitch *n.* A measurement of a computer monitor's screen density, representing the distance between phosphors on the display. The lower the number, the more detail can be displayed clearly. For example, a .28-dot-pitch screen has better resolution than one with .32. *See the illustration. See also* phosphor.

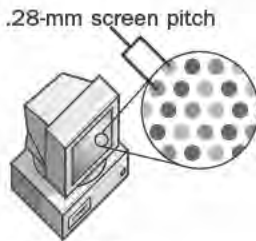

Screen pitch.

screen saver *n.* A utility that causes a monitor to blank out or display a certain image after a specified amount of time passes without the keyboard being touched or the mouse being moved. Touching a key or moving the mouse deactivates the screen saver. Screen savers were originally used to prevent images from becoming permanently etched on a monitor's screen. Although modern monitors are not susceptible to this problem, screen savers remain popular for their decorative and entertainment value. *See the illustration.*



Screen saver.

screen shot *n.* An image that shows all or part of a computer display.

ScreenTips *n.* Notes that appear on the screen to provide information about a toolbar button, tracked change, or comment or to display a footnote or an endnote. Screen-Tips also display the text that will appear if you choose to insert a date or AutoText entry.

script *n.* A program consisting of a set of instructions to an application or a utility program. The instructions usually use the rules and syntax of the application or utility. On the World Wide Web, scripts are commonly used to customize or add interactivity to Web pages. *See also* macro.

scripting language *n.* A simple programming language designed to perform special or limited tasks, sometimes associated with a particular application or function. An example of a scripting language is Perl. *See also* Perl, script.

script kiddie *n.* A would-be hacker who does not have the technical skills or knowledge needed for traditional hacking methods; one who relies on easy-to-use kiddie scripts. *See also* hacker, kiddie script.

scriptlet *n.* A reusable Web page based on the features of Dynamic HTML (DHTML) that can be created with HTML text and a scripting language and then inserted as a control in another Web page or in an application. Developed by Microsoft and introduced in Internet Explorer version 4, scriptlets are implemented as .htm files that give developers a relatively easy, object-based means of creating components that reflect the Web metaphor and that can be used to add interactivity and functionality—for example, animation, color changes, pop-up menus, or drag-and-drop capability—to Web pages without requiring repeated trips to the server. *Also called:* Microsoft Scripting Component. *See also* dynamic HTML. *Compare* applet.

scroll *vb.* To move a document or other data in a window in order to view a particular portion of the document. Scrolling may be controlled by the mouse, arrow keys, or other keys on the keyboard. *See also* scroll bar.

scroll arrow *n.* *See* scroll bar.

scroll bar *n.* In some graphical user interfaces, a vertical or horizontal bar at the side or bottom of a display area that can be used with a mouse for moving around in that area. Scroll bars often have four active areas: two scroll arrows for moving line by line, a sliding scroll box for moving to an arbitrary location in the display area, and gray areas for moving in increments of one window at a time.

scroll box *n.* *See* elevator.

S

Scroll Lock key *n.* On the IBM PC/XT and AT and compatible keyboards, a key on the top row of the numeric keypad that controls the effect of the cursor control keys and sometimes prevents the screen from scrolling. On the enhanced and Macintosh keyboards, this key is to the right of the function keys on the top row. Many modern applications ignore the Scroll Lock setting.

scroll wheel *n.* A thumbwheel on a mouse that, when turned, enables the user to scroll or zoom without clicking the scroll bar or using the keyboard. Depending on the mouse, a scroll wheel can also double as a third mouse button. *See also* scroll bar.

SCSI *n.* Acronym for Small Computer System Interface, a standard high-speed parallel interface defined by the X3T9.2 committee of the American National Standards Institute (ANSI). A SCSI (pronounced “scuzzy”) interface is used to connect microcomputers to SCSI peripheral devices, such as many hard disks and printers, and to other computers and local area networks. *Also called:* SCSI-1, SCSI I. *Compare* ESDI, IDE.

SCSI-1 *n.* *See* SCSI.

SCSI-2 *n.* An enhanced ANSI standard for SCSI (Small Computer System Interface) buses. Compared with the original SCSI standard (now called SCSI-1), which can transfer data 8 bits at a time at up to 5 MB per second, SCSI-2 offers increased data width, increased speed, or both. A SCSI-2 disk drive or host adapter can work with SCSI-1 equipment at the older equipment’s maximum speed. *Also called:* SCSI II. *See also* Fast SCSI, Fast/Wide SCSI, SCSI, Wide SCSI. *Compare* UltraSCSI.

SCSI bus *n.* A parallel bus that carries data and control signals from SCSI devices to a SCSI controller. *See also* bus, controller, SCSI device.

SCSI chain *n.* A set of devices on a SCSI bus. Each device (except the host adapter and the last device) is connected to two other devices by two cables, forming a daisy chain. *See also* daisy chain, SCSI.

SCSI connector *n.* A cable connector used to connect a SCSI device to a SCSI bus. *See the illustration. See also* bus, connector (definition 1), SCSI device.



SCSI connector.

SCSI device *n.* A peripheral device that uses the SCSI standard to exchange data and control signals with a computer’s CPU. *See also* peripheral, SCSI.

SCSI I *n.* *See* SCSI.

SCSI II *n.* *See* SCSI-2.

SCSI ID *n.* The unique identity of a SCSI device. Each device connected to a SCSI bus must have a different SCSI ID. A maximum of eight SCSI IDs can be used on the same SCSI bus. *See also* bus, SCSI device.

SCSI network *n.* A set of devices on a SCSI bus, which acts like a local area network. *See also* SCSI.

SCSI port *n.* **1.** A SCSI host adapter within a computer, which provides a logical connection between the computer and all of the devices on the SCSI bus. *See also* SCSI. **2.** A connector on a device for a SCSI bus cable. *See also* SCSI.

SDH *n.* *See* Synchronous Digital Hierarchy.

SDK *n.* Acronym for software development kit. *See* developer’s toolkit.

SDLC *n.* Acronym for Synchronous Data Link Control, the data transmission protocol most widely used by networks conforming to IBM’s Systems Network Architecture (SNA). SDLC is similar to the HDLC (High-level Data Link Control) protocol developed by the International Organization for Standardization (ISO). *See also* HDLC.

SDM *n.* *See* space-division multiplexing.

S

SDMI *n.* See Secure Digital Music Initiative.

SDRAM *n.* Acronym for synchronous **DRAM**. A form of dynamic random access memory (DRAM) that can run at higher clock speeds than conventional DRAM by employing a bursting technique in which the DRAM predicts the address of the next memory location to be accessed. See also dynamic RAM.

SDSL *n.* Acronym for symmetric (or single-line) digital subscriber line, a digital telecommunications technology that is a variation of HDSL. SDSL uses one pair of copper wires rather than two pairs of wires and transmits at 1.544 Mbps. Compare ADSL.

.sea *n.* A file extension for a self-extracting Macintosh archive compressed with StuffIt. See also self-extracting file.

seamless integration *n.* The favorable result that occurs when a new hardware component or program blends smoothly into the overall operation of the system. It is usually the result of thoughtful design and programming.

search¹ *n.* The process of seeking a particular file or specific data. A search is carried out by a program through comparison or calculation to determine whether a match to some pattern exists or whether some other criteria have been met. See also binary search, hash search, linear search, search and replace, wildcard character.

search² *vb.* **1.** To look for the location of a file. **2.** To seek specific data within a file or data structure. See also replace.

search algorithm *n.* An algorithm designed to locate a certain element, called the target, in a data structure. See also algorithm, binary search, hash search, linear search.

search and replace *n.* A common process in applications such as word processors in which the user specifies two strings of characters. The process finds instances of the first string and replaces them with the second string.

search criteria *n.* The terms or conditions that a search engine uses to find items in a database. See also search engine.

search engine *n.* **1.** A program that searches for keywords in documents or in a database. **2.** On the Internet, a program that searches for keywords in files and documents found on the World Wide Web, newsgroups, Gopher menus, and FTP archives. Some search engines are used for a single Internet site, such as a dedicated search engine for a Web site. Others search across many sites, using such agents as spiders to gather lists of avail-

able files and documents and store these lists in databases that users can search by keyword. Examples of the latter type of search engine are Lycos and Excite. Most search engines reside on a server. See also agent (definition 2), FTP, Gopher or gopher, newsgroup, spider, World Wide Web.

search key *n.* **1.** The particular field (or column) of the records to be searched in a database. See also primary key, secondary key. **2.** The value that is to be searched for in a document or any collection of data.

search path *n.* The route followed by an operating system to find the location of a stored file. The search path begins with a drive or volume (disk) designator or a network share, continues through a chain of directories and subdirectories, if any, and ends with the file name. C:\books\diction\start.exe is an example of a search path. Also called: access path.

search string *n.* The string of characters to be matched in a search—typically (but not necessarily) a text string.

seat¹ *n.* One workstation or computer, in the context of software licensing on a per-seat basis. See also license agreement, workstation (definition 1).

seat² *vb.* To insert a piece of hardware fully and position it correctly in a computer or affiliated equipment, as in seating a single inline memory module (SIMM) in its socket.

secondary channel *n.* A transmission channel in a communications system that carries testing and diagnostic information rather than actual data. Compare primary channel.

secondary key *n.* A field that is to be sorted or searched within a subset of the records having identical primary key values. See also alternate key (definition 1), candidate key. Compare primary key.

secondary service provider *n.* An Internet service provider that provides a Web presence but not direct connectivity. See also ISP.

secondary storage *n.* Any data storage medium other than a computer's random access memory (RAM)—typically tape or disk. Compare primary storage.

Second Generation *n.* See 2G.

second-level domain *n.* The level immediately beneath the top-level domain in the Internet's DNS hierarchy. See also domain (definition 3).

second normal form *n.* See normal form (definition 1).

S

secret channel *n.* See private channel.

section *n.* A length of fiberoptic cable in a SONET network. See also line, path.

sector *n.* A portion of the data storage area on a disk. A disk is divided into sides (top and bottom), tracks (rings on each surface), and sectors (sections of each ring). Sectors are the smallest physical storage units on a disk and are of fixed size; typically, they are capable of holding 512 bytes of information apiece. See the illustration.

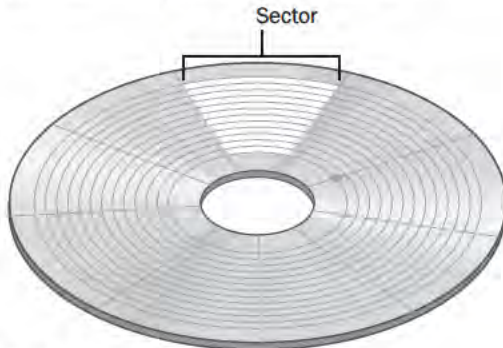

Sector.

sector interleave *n.* See interleave.

sector map *n.* 1. A map that indicates the unusable sectors on a disk. 2. A table used to translate the sector numbers that are requested by the operating system into physical sector numbers. The sector map represents a different method of performing sector interleaving. When a sector map is used, the sectors are formatted on the disk in sequential order. The mapping enables the system to read sectors in a nonsequential order. For example, using a 3-to-1 sector interleaving map, a system request for sectors 1 through 4 will result in the disk driver reading physical sectors 1, 4, 7, and 10. See also interleave.

secure channel *n.* A communications link that has been protected against unauthorized access, operation, or use by means of isolation from the public network, encryption, or other forms of control. See also encryption.

Secure Digital Music Initiative *n.* A coalition of companies from the recording, electronics, and information technology industries founded in February 1999 for the purpose of developing an open standard for the secure distribution of music in digital form. The Secure Digital Music Initiative specification is designed to provide consumers with flexibility and convenient access to electroni-

cally distributed music (that is, over the Internet) while also protecting the rights of artists. *Acronym:* SDMI. See also MP3, Windows Media Technologies.

Secure Electronics Transactions protocol *n.* Protocol for conducting secure transactions over the Internet, the result of a joint effort by GTE, IBM, MasterCard, Microsoft, Netscape, SAIC, Terisa Systems, VeriSign, and Visa. *Acronym:* SET.

Secure Hash Algorithm *n.* See SHA.

Secure HTTP *n.* See S-HTTP, HTTPS.

Secure Hypertext Transfer Protocol *n.* See S-HTTP.

Secure/Multipurpose Internet Mail Extensions *n.* See S/MIME.

Secure Password Authentication *n.* A feature that allows a server to confirm the identity of the person logging on. *Acronym:* SPA.

secure site *n.* A Web site having the capability of providing secure transactions, ensuring that credit card numbers and other personal information will not be accessible to unauthorized parties.

Secure Sockets Layer *n.* See SSL.

Secure Transaction Technology *n.* The use of the SSL (Secure Sockets Layer), S-HTTP (Secure HTTP), or both in online transactions, such as form transmission or credit card purchases. *Acronym:* STT. See also S-HTTP, SSL.

secure wide area network *n.* A set of computers that communicate over a public network, such as the Internet, but use security measures, such as encryption, authentication, and authorization, to prevent their communications from being intercepted and understood by unauthorized users. *Acronym:* S/WAN. See also authentication, authorization, encryption, virtual private network (definition 1).

security *n.* The technologies used to make a service resistant to unauthorized access to the data that it holds or for which it is responsible. A major focus of computer security, especially on systems that are accessed by many people or through communications lines, is the prevention of system access by unauthorized individuals.

security kernel *n.* An operating-system kernel that is protected from unauthorized use. See also kernel.

security log *n.* A log, generated by a firewall or other security device, that lists events that could affect security, such as access attempts or commands, and the names of the users involved. See also firewall, log (definition 1).

S

seed *n.* A starting value used in generating a sequence of random or pseudorandom numbers. *See also* random number generation.

seek *n.* The process of moving the read/write head in a disk drive to the proper site, typically for a read or write operation.

seek time *n.* The time required to move a disk drive's read/write head to a specific location on a disk. *See also* access time (definition 2).

segment *n.* A section of a program that, when compiled, occupies a contiguous address space and that is usually position independent; that is, it can be loaded anywhere in memory. With Intel-based microcomputers, a native-mode segment is a logical reference to a 64-KB contiguous portion of RAM in which the individual bytes are accessed by means of an offset value. Collectively, the segment:offset values reference a single physical location in RAM. *See also* overlay¹ (definition 1), real mode, segmentation.

segmentation *n.* The act of breaking up a program into several sections, or segments. *See also* segment.

segmented addressing architecture *n.* A memory-access technique typified by Intel 80x86 processors. Memory is divided into 64-KB segments in this architecture for addressing locations under the 16-bit address scheme; 32-bit schemes can address memory in segments as large as 4 GB. *Also called:* segmented instruction addressing, segmented memory architecture. *Compare* linear addressing architecture.

segmented address space *n.* An address space that is logically divided into chunks called segments. To address a given location, a program must specify both a segment and an offset within that segment. (The offset is a value that references a specific point within the segment, based on the beginning of the segment.) Because segments may overlap, addresses are not unique; there are many logical ways to access a given physical location. The Intel 80x86 real-mode architecture is segmented; most other microprocessor architectures are flat. *See also* segment. *Compare* flat address space.

segmented instruction addressing *n.* *See* segmented addressing architecture.

segmented memory architecture *n.* *See* segmented addressing architecture.

select *vb.* **1.** In general computer use, to specify a block of data or text on screen by highlighting it or otherwise marking it with the intent of performing some operation on it. **2.** In database management, to choose records according to a specified set of criteria. *See also* sort. **3.** In information processing, to choose from a number of options or alternatives, such as subroutines or input/output channels.

selected cell *n.* *See* active cell.

selection *n.* **1.** In applications, the highlighted portion of an on-screen document. **2.** In communications, the initial contact made between a computer and a remote station receiving a message. **3.** In programming, a conditional branch. *See also* conditional branch.

selective calling *n.* The capability of a station on a communications line to designate the station that is to receive a transmission.

selector channel *n.* An input/output data transfer line used by one high-speed device at a time.

selector pen *n.* *See* light pen.

select query *n.* A query that asks a question about the data stored in your tables and returns a result set in the form of a datasheet, all without changing the data.

self-adapting *adj.* The ability of systems, devices, or processes to adjust their operational behavior to environmental conditions.

self-checking digit *n.* A digit, appended to a number during its encoding, whose function is to confirm the accuracy of the encoding. *See also* checksum, parity bit.

self-clocking *n.* A process in which timing signals are inserted into a data stream rather than being provided by an external source, such as in phase encoding.

self-documenting code *n.* Program source code that, through its use of a high-level language and descriptive identifiers, can be understood by other programmers without the need for additional comments.

self-extracting archive *n.* *See* self-extracting file.

self-extracting file *n.* An executable program file that contains one or more compressed text or data files. When a user runs the program, it uncompresses the compressed files and stores them on the user's hard drive. *See* the illustration.



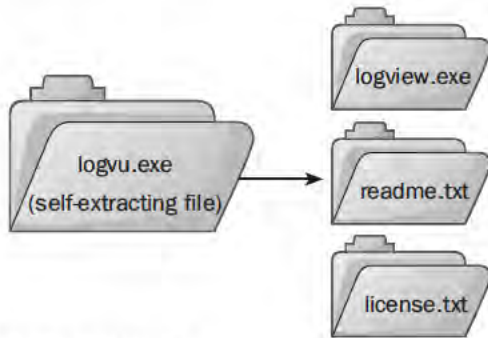

Self-extracting file.

self-modifying code *n.* Program code, usually object code generated by a compiler or an assembler, that modifies itself during instruction by writing new operation codes, addresses, or data values over existing instructions. *See also* pure procedure.

self-monitoring analysis and reporting technology system *n.* *See* SMART system.

self-organizing map *n.* *See* SOM (definition 2).

self-test *n.* A set of one or more diagnostic tests that a computer or peripheral device (such as a printer) performs on itself. *See also* power-on self test.

self-validating code *n.* Program code that can test itself to verify that it behaves correctly, usually by feeding itself a set of standard input values and testing the results against a set of expected output values.

semantic error *n.* An error in meaning; a statement in a program that is syntactically correct (legal) but functionally incorrect. *See also* logic, semantics (definition 1), syntax.

semantics *n.* **1.** In programming, the relationship between words or symbols and their intended meanings. Programming languages are subject to certain semantic rules; thus, a program statement can be syntactically correct but semantically incorrect; that is, a statement can be written in an acceptable form and still convey the wrong meaning. *See* the illustration. *See also* syntax. **2.** In artificial-intelligence research, the capacity of a network to represent relationships among objects, ideas, or situations in a humanlike way. *Compare* syntax.

CANARY — is a — BIRD
 |
 has
 |
 FEATHERS

Semantics.

semaphore *n.* In programming, a signal—a flag variable—used to govern access to shared system resources. A semaphore indicates to other potential users that a file or other resource is in use and prevents access by more than one user. *See also* flag (definition 1).

Semicon *n.* Short for Semiconductors Equipment and Material International Conference. A series of international conferences sponsored by the Semiconductors Equipment and Material International (SEMI), a trade group for the international semiconductor industry. The conference provides members with up-to-date information on issues affecting the semiconductor industry and provides SEMI members with a forum for showcasing products and services.

semiconductor *n.* A substance, commonly silicon or germanium, whose ability to conduct electricity falls between that of a conductor and that of a nonconductor (insulator). The term is used loosely to refer to electronic components made from semiconductor materials.

send *vb.* To transmit a message or file through a communications channel.

sendmail *n.* A popular open-source UNIX-based implementation of the Simple Mail Transfer Protocol (SMTP) for delivering e-mail. Written in 1981 by Eric Allman at the University of California at Berkeley, sendmail was the first Internet message transfer agent (MTA).

send statement *n.* In SLIP and PPP scripting languages, a statement that tells the program that dials an Internet service provider's number (a *dialer program*) to send certain characters. *See also* ISP, PPP, scripting language, SLIP.

sensor *n.* A device that detects or measures something by converting nonelectrical energy to electrical energy. A photocell, for example, detects or measures light by converting it to electrical energy. *See also* transducer.

sensor glove *n.* A hand-worn computer input device for virtual-reality environments. The glove translates finger movements by the user to commands for manipulating objects in the environment. *Also called:* data glove. *See also* virtual reality.

S

SEPP *n.* Acronym for Software Engineering for Parallel Processing. A project of nine European universities and research institutions to develop tools for the development of parallel application programs for distributed memory multiprocessors.

sequence *n.* An ordered arrangement, as in a set of numbers, such as the Fibonacci sequence. *See also* Fibonacci numbers.

sequence check *n.* A process that verifies that data or records conform to a particular order. *Compare* completeness check, consistency check, duplication check.

Sequenced Packet Exchange *n.* *See* SPX (definition 1).

sequential access *n.* A method of storing or retrieving information that requires the program to start reading at the beginning and continue until it finds the desired data. Sequential access is best used for files in which each piece of information is related to the information that comes before it, such as mailing list files and word processing documents. *Also called:* serial access. *See also* indexed sequential access method. *Compare* random access.

sequential algorithm *n.* An algorithm in which each step must occur in a particular order. *See also* algorithm. *Compare* parallel algorithm.

sequential execution *n.* The act of executing routines or programs in a linear sequence. *Compare* concurrent execution.

sequential logic element *n.* A logic circuit element that has at least one input and one output and in which the output signal depends on the present and past states of the input signal or signals.

sequential processing *n.* **1.** The processing of items of information in the order in which they are stored or input. **2.** The execution of one instruction, routine, or task followed by the execution of the next in line. *Compare* multiprocessing, parallel processing, pipelining (definition 1).

sequential search *n.* *See* linear search.

serial *adj.* One by one. For example, in serial transmission, information is transferred one bit at a time; a serial computer has only one arithmetic logic unit, which must execute the whole program one step at a time. *Compare* parallel (definition 3).

serial access *n.* *See* sequential access.

serial adder *n.* A circuit that adds two numbers one bit position (one digit place) at a time.

serial communication *n.* The exchange of information between computers or between computers and peripheral devices one bit at a time over a single channel. Serial communications can be synchronous or asynchronous. Both sender and receiver must use the same baud rate, parity, and control information. *See also* baud rate, parity, start bit, stop bit.

Serial Infrared *n.* A system developed by Hewlett-Packard for transmitting data between two devices up to 1 meter apart using an infrared light beam. Infrared ports on the receiving and the sending devices must be aligned. Generally, Serial Infrared is used with laptops and many notebook computers, as well as with peripherals such as printers. *Acronym:* SIR. *See also* infrared port.

serial interface *n.* A data transmission scheme in which data and control bits are sent sequentially over a single channel. In reference to a serial input/output connection, the term usually implies the use of an RS-232 or RS-422 interface. *See also* RS-232-C standard, RS-422/423/449. *Compare* parallel interface.

serialize *vb.* To change from parallel transmission (byte by byte) to serial transmission (bit by bit). *Compare* deserialize.

SerialKey device *n.* Enables you to attach an alternative input device (also called an augmentative communication device) to your computer's serial port. This feature is designed for people who are unable to use the computer's standard keyboard and mouse.

SerialKeys *n.* A feature of Windows 9x, Windows NT, Windows 2000, and Windows XP that, in conjunction with a communications aid interface device, allows keystrokes and mouse controls to be accepted through a computer's serial port.

Serial Line Internet Protocol *n.* *See* SLIP.

serial mouse *n.* A pointing device that attaches to the computer through a standard serial port. *See also* mouse. *Compare* bus mouse.

serial port *n.* An input/output location (channel) that sends and receives data to and from a computer's central processing unit or a communications device one bit at a time. Serial ports are used for serial data communication and as interfaces with some peripheral devices, such as mice and printers.



serial port adapter *n.* An interface card or device that either provides a serial port or converts a serial port to another use. *See also* adapter, serial port.

serial printer *n.* A printer connected to the computer via a serial interface (commonly RS-232-C or compatible). Connectors for this type of printer vary widely, which is one reason they are less popular than parallel printers among those who use IBM and IBM-compatible PCs. Serial printers are standard for Apple computers. *See also* DB connector, serial, serial transmission. *Compare* parallel printer.

serial processing *n.* *See* sequential processing (definition 2).

Serial Storage Architecture *n.* *See* SSA.

serial transmission *n.* The transfer of discrete signals one after another. In communications and data transfer, serial transmission involves sending information over a single line one bit at a time, as in modem-to-modem connections. *Compare* parallel transmission.

series circuit *n.* A circuit in which two or more components are linked in series. All the current passes through each component in a series circuit, but the voltage is divided among the components. *See* the illustration. *Compare* parallel circuit.



Series circuit.

serif¹ *adj.* Marked by the use of serifs. For example, Goudy is a serif typeface, whereas Helvetica is a sans serif typeface. *See* the illustration. *See also* serif². *Compare* sans serif.

ABC
Serifs

ABC

Serif. A serif typeface (top) and a sans serif typeface (bottom).

serif² *n.* Any of the short lines or ornaments at the ends of the strokes that form a typeface character.

server *n.* **1.** On a local area network (LAN), a computer running administrative software that controls access to the network and its resources, such as printers and disk drives, and provides resources to computers functioning as workstations on the network. **2.** On the Internet or other network, a computer or program that responds to commands from a client. For example, a file server may contain an archive of data or program files; when a client submits a request for a file, the server transfers a copy of the file to the client. *See also* application server (definitions 1 and 2), client/server architecture. *Compare* client (definition 3).

server appliance *n.* A device designed to deliver one or more specific network services in a single turnkey package that includes both hardware and software. All necessary programs are preinstalled on a server appliance, which has minimal, simplified options and controls. Server appliances can be used to complement or replace traditional servers on a network and can provide such services as file and printer sharing and Internet connectivity. *Also called:* appliance. *See also* information appliance.

server-based application *n.* A program that is shared over a network. The program is stored on the network server and can be used at more than one client machine at a time.

server cluster *n.* A group of independent computer systems, known as nodes, working together as a single system to ensure that mission-critical applications and resources remain available to clients. A server cluster is the type of cluster that Cluster service implements. *See also* cluster.

server control *n.* *See* ASP.NET server control.

server error *n.* A failure to complete a request for information through HTTP that results from an error at the server rather than an error by the client or the user. Server errors are indicated by HTTP status codes beginning with 5. *See also* HTTP, HTTP status codes.

server farm *n.* A centralized grouping of network servers maintained by an enterprise or, often, an Internet service provider (ISP). A server farm provides a network with load balancing, scalability, and fault tolerance. Individual servers may be connected in such a way that they appear to represent a single resource.

serverlet *n.* *See* servlet.

Server Message Block *n.* *See* SMB.

server push-pull *n.* A combination of Web client/server techniques individually called “server push” and “client pull.” In server push, the server loads data to the client, but the data connection stays open. This allows the server to continue sending data to the browser as necessary. In client pull, the server loads data to the client, but the data connection does not stay open. The server sends an HTML directive to the browser telling it to reopen the connection after a certain interval to get more data or possibly to open a new URL. See the illustration. *See also* HTML, server (definition 2), URL.

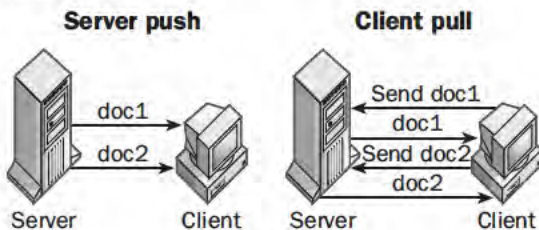

Server push-pull.

server-side include *n.* A mechanism for including dynamic text in World Wide Web documents. Server-side includes are special command codes that are recognized and interpreted by the server; their output is placed in the document body before the document is sent to the browser. Server-side includes can be used, for example, to include the date/time stamp in the text of the file. *Acronym:* SSI. *See also* server (definition 2).

service *n.* **1.** A customer-based or user-oriented function, such as technical support or network provision. **2.** In reference to programming and software, a program or routine that provides support to other programs, particularly at a low (close to the hardware) level. **3.** In networking, specialized, software-based functionality provided by network servers—for example, directory services that provide the network equivalent of “phone books” needed for locating users and resources. *See also* utility.

Service Advertising Protocol *n.* A method used by a service-providing node in a network (such as a file server or application server) to notify other nodes on the network that it is available for access. When a server boots, it uses the protocol to advertise its service; when the same server goes off line, it uses the protocol to announce that it is no longer available. *Acronym:* SAP. *See also* server (definition 1).

service bureau *n.* **1.** A company that provides various services related to publishing, such as prepress production, desktop publishing, typesetting, imagesetting, and optical scanning of graphics. **2.** An organization that provides data processing services and access to software packages for a fee.

service provider *n.* *See* ISP.

servlet or **servelet** *n.* A small Java program that runs on a server. The term is a companion to applet, a Java program that usually runs on the client. Servlets perform lightweight Web services, such as redirecting a Web user from an outdated address to the correct page—tasks traditionally handled by CGI (Common Gateway Interface) applications. Because servlets are automatically threaded and highly responsive, they execute quickly, thereby reducing system overhead. *Also called:* serverlet. *See also* applet, CGI.

servlet container *n.* In Sun Microsystems’s J2EE network platform, a container that decodes requests, formats responses, and provides the network services over which requests and responses are sent. All servlet containers must support HTTP as a protocol for requests and responses, but they may also support additional request-response protocols such as HTTPS. *See also* container, HTTP, HTTPS, J2EE.

servo *n.* The part of a servomechanism, controlled by the servomechanism’s feedback circuit, that produces the final mechanical output. *Also called:* servomotor. *See also* servomechanism.

servomechanism *n.* A control system in which the final output is mechanical movement. A servomechanism uses feedback to control the position, velocity, or acceleration of a mechanical component. *Also called:* servo system.

servomotor *n.* *See* servo.

servo system *n.* *See* servomechanism.

session *n.* **1.** The time during which a program is running. In most interactive programs, a session is the time during which the program accepts input and processes information. **2.** In communications, the time during which two computers maintain a connection. **3.** A specific protocol layer in the ISO/OSI reference model that manages communication between remote users or processes. *See also* ISO/OSI reference model, session layer.

session bean *n.* In the Java programming language and J2EE network platform, an enterprise bean that is created

S

by a client and usually exists only for the duration of a single client/server session. It performs operations, such as calculations or accessing a database, for the client. While a session bean may be transactional, it is not recoverable should a system crash occur. Session bean objects can either be stateless or can maintain conversational state across methods and transactions. If a session bean maintains state, the Enterprise JavaBean (EJB) container manages this state if the object must be removed from memory. However, the session bean object itself must manage its own persistent data. *See also* EJB, stateless.

session layer *n.* The fifth of seven layers in the ISO/OSI reference model. The session layer handles the details that must be agreed on by the two communicating devices. See the illustration. *See also* ISO/OSI reference model.

ISO/OSI MODEL	
ISO/OSI Layer	Focus
Application (highest level)	Program-to-program transfer of information
Presentation	Text formatting and display, code conversion
Session	Establishing, maintaining, and coordinating communication
Transport	Accurate delivery, service quality
Network	Transport routes, message handling and transfer
Data-link	Coding, addressing, and transmitting information
Physical	Hardware connections

Session layer.

set¹ *n.* In printing and display, a group of related characters, such as a character set. *See also* character set.

set² *vb.* 1. To change the value of a bit to 1. 2. To establish a particular condition, such as setting tab stops, setting a counter to 0, or setting a breakpoint. *See also* breakpoint.

SET protocol *n.* *See* Secure Electronics Transactions protocol.

settling time *n.* The time required for a disk drive's read/write head to stabilize over a new location on the disk after being moved.

set-top box *n.* A device that converts a cable TV signal to an input signal to the TV set. Set-top boxes can be used to

access the World Wide Web and are a type of information appliance. *See also* information appliance.

setup *n.* 1. A computer along with all its devices. 2. The procedures involved in preparing a software program or application to operate within a computer.

setup program *n.* 1. A built-in BIOS program for reconfiguring system parameters to accommodate a new disk drive. *See also* BIOS. 2. *See* installation program.

setup string *n.* *See* control code.

setup wizard *n.* In Windows, a utility that asks users a structured series of questions and gives them options to aid the process of installing a new program.

seven-segment display *n.* A light-emitting diode (LED) display or liquid crystal display (LCD) that can show any of the 10 decimal digits. The seven segments are the seven bars that form a numeral 8 as in a calculator display.

sex changer *n.* *See* gender changer.

sfx *n.* A computer language used to generate digital audio effects and synthesizer instrument audio. It is a superset of the MPEG-4 standard SAOL audio compiler language. Sfx provides professional-quality audio synthesis, real-time MIDI and audio generation, and fully customizable instruments and effects. Because the sfx compiler is a C++ front-end compiler, code is converted to C++ and then compiled into executable orchestras that are used to generate real-time audio. As a result, the current release of sfx requires that Microsoft Visual C++ be installed on the system on which sfx is running. *See also* C++, compiler, MIDI, MPEG-4, SAOL, Visual C++.

.sgm *n.* The MS-DOS/Windows 3.x file extension that identifies files encoded in Standard Generalized Markup Language (SGML). Because MS-DOS and Windows 3.x cannot recognize file extensions longer than three letters, the .sgml extension is truncated to three letters in those environments. *See also* SGML.

.sgml *n.* The file extension that identifies files encoded in Standard Generalized Markup Language. *See also* SGML.

SGML *n.* Acronym for Standard Generalized Markup Language. An information management standard adopted by the International Organization for Standardization (ISO) in 1986 as a means of providing platform- and application-independent documents that retain formatting, indexing, and linked information. SGML provides a grammarlike mechanism for users to define the structure of

their documents and the tags they will use to denote the structure in individual documents. *See also* ISO.

SGRAM *n.* *See* synchronous graphics RAM.

sh *n.* *See* Bourne shell.

SHA *n.* Acronym for Secure Hash Algorithm. A technique that computes a 160-bit condensed representation of a message or data file, called a *message digest*. The SHA is used by the sender and the receiver of a message in computing and verifying a digital signature, for security purposes. *See also* algorithm, digital signature.

shade¹ *n.* A particular color variation produced by mixing black with a pure color. *See also* brightness, IRGB.

shade² *vb.* To give added dimension to an image by including changes in appearance caused by light and shadow. *See also* color model.

shadow mask *n.* A type of mask used in cathode ray tube (CRT) monitors in which an opaque sheet perforated by tiny pinholes ensures that the electron beam for a particular color strikes only the phosphor it is supposed to illuminate. Like the aperture grill, which relies on vertical stripes, and the slot mask, which is based on elliptical openings, a shadow mask helps create a clear, sharp image by narrowly focusing the electron beam. *See also* CRT, mask (definition 2). *Compare* aperture grill, slot mask.

shadow memory *n.* A technique employed by the BIOS in some 80x86-based computers to copy the system's ROM BIOS routines into an unused section of RAM during the computer's startup process. This helps boost system performance by diverting system requests for the BIOS routines to their "shadow" copies. *Also called:* shadow RAM, shadow ROM.

shadow print *n.* A style applied to text in which a duplicate of each character is shifted, typically down and to the right, to create a shadow effect. *See* the illustration.

Shadows

Shadows

Shadow print.

shadow RAM *n.* *See* shadow memory.

shadow ROM *n.* *See* shadow memory.

share *vb.* To make files, directories, or folders accessible to other users over a network.

shared assembly *n.* An assembly that can be referenced by more than one application. An assembly must be explicitly built to be shared by giving it a cryptographically strong name. *See also* private assembly, strong name.

shared directory *n.* *See* network directory.

shared folder *n.* On a Macintosh computer connected to a network and running System 6.0 or higher, a folder that a user has made available to others on the network. A shared folder is analogous to a network directory on a PC. *See also* network directory.

shared logic *n.* The use, by multiple circuits or software routines, of common circuits or routines to implement an operation.

shared medium *n.* The communications medium shared by network nodes; essentially, the network bandwidth.

shared memory *n.* **1.** Memory accessed by more than one program in a multitasking environment. **2.** A portion of memory used by parallel-processor computer systems to exchange information. *See also* parallel processing.

shared name *n.* *See* strong name

shared network directory *n.* *See* network directory.

shared printer *n.* A printer that receives input from more than one computer.

shared resource *n.* **1.** Any device, data, or program used by more than one device or program. **2.** On a network, any resource made available to network users, such as directories, files, and printers.

SharePoint team Web site *n.* A customizable Web site with features that help a team work together. The default site has pages for document libraries, announcements, and team events. Only members, specified by the site creator, can use the site.

shareware *n.* Copyrighted software that is distributed on a try-before-you-buy basis. Users who want to continue using the program after the trial period are encouraged to send a payment to the program's author. *Compare* free software, freeware, public-domain software.

sharpness *n.* *See* resolution (definition 1).

sheet *n.* A feature for handling dialog boxes included in the Mac OS X Aqua interface. When the user chooses to

S

save or print a document, a translucent sheet emerges from the window title bar and remains attached to that window even if it is moved to the background. The sheet allows the user to continue working in the window, or in other windows, without closing the sheet.

sheet-fed scanner *n.* A scanner with a single-sheet feed mechanism, in which sheets of paper are pulled in by the scanner and scanned as they pass over a stationary scanning mechanism. Sheet-fed scanners allow for automatic scanning of multiple-sheet documents. *See also* scanner. *Compare* drum scanner, flatbed scanner, handheld scanner.

sheet feeder *n.* A device that accepts a stack of paper and feeds it to a printer one page at a time.

shelfware *n.* Software that has been unsold or unused for a long time, and so has remained on a retailer's or user's shelf.

shell¹ *n.* A piece of software, usually a separate program, that provides direct communication between the user and the operating system. Examples of shells are Macintosh Finder and the MS-DOS command interface program COMMAND.COM. *See also* Bourne shell, C shell, Finder, Korn shell. *Compare* kernel.

shell² *vb.* *See* shell out.

shell account *n.* A computer service that permits a user to enter operating-system commands on the service provider's system through a command-line interface (usually one of the UNIX shells) rather than having to access the Internet through a graphical user interface. Shell accounts can provide Internet access through character-based tools such as Lynx for browsing the World Wide Web. *See also* shell¹.

shell archive *n.* In UNIX and GNU, a collection of compressed files that has been prepared for transmission by an e-mail service using the shar command.

shell out *vb.* To obtain temporary access to the operating-system shell without having to shut down the current application and return to that application after performing the desired shell function. Many UNIX programs allow the user to shell out; the user can do the same in windowing environments by switching to the main system window.

shell script *n.* A script executed by the command interpreter (shell) of an operating system. The term generally refers to scripts executed by the Bourne, C, and Korn shells on UNIX platforms. *Also called:* batch file. *See also* batch file, script, shell¹.

Shell sort *n.* A programming algorithm used for ordering data in which data are sorted in subsets so that the process works its way from unsorted to progressively more sorted. Named after its inventor, Donald Shell, it is faster than the bubble sort and the insertion sort. *See also* algorithm. *Compare* bubble sort, insertion sort.

Sherlock *n.* An advanced search mechanism included with the Macintosh OS. Sherlock provides the ability to search multiple Internet search engines simultaneously and incorporates the Macintosh Find File interface for searches of local volumes. Additional plug-ins can expand the number of search engines available for access and increase search options.

shielded twisted-pair wiring *n.* *See* twisted-pair wiring.

shift *vb.* In programming, to move the bit values one position to the left or right in a register or memory location. *See also* end-around shift. *Compare* rotate (definition 2).

Shift+click or **Shift click** *vb.* To click the mouse button while holding down the Shift key. Shift+clicking performs different operations in different applications, but its most common use in Windows is to allow users to select multiple items in a list, for example, to select a number of files for deletion or copying.

Shift key *n.* A keyboard key that, when pressed in combination with another key, gives that key an alternative meaning; for example, producing an uppercase character when a letter key is pressed. The Shift key is also used in various key combinations to create nonstandard characters or to perform special operations. The term is adapted from usage in relation to manual typewriters, in which the key physically shifted the carriage to print an alternative character. *See also* Caps Lock key.

Shift-PrtSc *n.* *See* Print Screen key.

shift register *n.* A circuit in which all bits are shifted one position at each clock cycle. It can be either linear (a bit is inserted at one end and "lost" at the other during each cycle) or it can be cyclic or looped (the "lost" bit is inserted back at the beginning). *See also* register, shift.

Shockwave *n.* A format for multimedia audio and video files within HTML documents, created by Macromedia, which markets a family of Shockwave servers and plug-in programs for Web browsers. *See also* HTML.

shopping cart *n.* In e-commerce programs, a file in which an online customer stores information on potential purchases until ready to order. Usually represented on

S

screen with a drawing of a shopping cart, the virtual shopping cart provides a recognizable point of reference to users new to the e-commerce experience. *See also* e-commerce.

short card *n.* A printed circuit board that is half as long as a standard-size circuit board. *Also called:* half-card. *See also* printed circuit board.

short-circuit evaluation *n.* A form of expression evaluation that guarantees that Boolean expressions will be evaluated only far enough to determine their value. *See also* AND, Boolean operator, OR.

shortcut *n.* In Windows 9x, Windows XP, Windows NT 4, and Windows 2000, an icon on the desktop that a user can double-click to immediately access a program, a text or data file, or a Web page. *See also* symbolic link.

shortcut key *n.* *See* accelerator.

short-haul *adj.* Of or pertaining to a communications device that transmits a signal over a communications line for a distance less than approximately 20 miles. *Compare* long-haul.

short message service *n.* Service for wireless phones that allows users to send and receive brief messages consisting of text and numbers. *Acronym:* SMS.

shout *vb.* To use ALL CAPITAL LETTERS for emphasis in e-mail or a newsgroup article. Excessive shouting is considered a violation of netiquette. A word can be more acceptably emphasized by placing it between *asterisks* or _underscores_. *See also* netiquette.

shovelware *n.* A commercially sold CD-ROM containing a miscellaneous assortment of software, graphic images, text, or other data that could otherwise be obtained at little or no cost, such as freeware or shareware from the Internet and BBSs or public-domain clip art. *See also* BBS (definition 1), freeware, shareware.

ShowSounds *n.* In Windows 9x and Windows NT 4, a global flag that instructs application programs to provide some kind of visual indication that the program is generating a sound in order to alert users with hearing impairments or those in a noisy location such as a factory floor.

shredder *n.* An application designed to completely destroy digital data so it cannot be reconstructed with file recovery software.

shrinkwrap agreement *n.* A contract or license in or on a software box or package that sets forth conditions for use of the software. Typically, a shrinkwrap agreement

states that a user accepts the terms of the agreement when he or she opens the box. A shrinkwrap agreement is a print version of an End-User License Agreement. *Also called:* box-top license. *See also* End-User License Agreement. *Compare* clickwrap agreement.

shrink-wrapped *adj.* Boxed and sealed in clear plastic film for commercial distribution. Use of the term implies a final version of a product as opposed to a beta version. *See also* beta¹.

SHS virus *n.* Any of a class of viruses that infect a user's system by hiding in files with an .shs extension. These viruses typically spread through e-mail attachments. A widely distributed e-mail warning cautions readers to beware of the "SHS virus," but no one specific virus by that name exists.

SHTML *n.* Short for server-parsed HTML. Hypertext Markup Language (HTML) text that contains embedded server-side include commands. SHTML documents are fully read, parsed, and modified by the server before being passed to the browser. *See also* HTML, server-side include.

S-HTTP or **SHTTP** *n.* Acronym for Secure Hypertext Transfer Protocol. An extension to HTTP that supports various encryption and authentication measures to keep all transactions secure from end to end. S-HTTP is designed to ensure the security of individual transmissions over the Internet and has been approved as a standard by the Internet Engineering Task Force (IETF). S-HTTP should not be confused with HTTPS, a Netscape-developed technology based on SSL (Secure Sockets Layer). HTTPS is also designed to ensure secure transmissions, but does so between communicating computers rather than on a message-by-message basis. *Also called:* Secure HTTP. *See also* SSL.

shut down *vb.* To close a program or an operating system in a manner ensuring that no data is lost.

sibling *n.* A process or node in a data tree that is descended from the same immediate ancestor(s) as other processes or nodes. *See also* generation (definition 2), node (definition 3).

sideband *n.* The upper or lower portion of a modulated carrier wave. One portion can be processed while the other is used to carry separate data, a technique that doubles the amount of information that can be carried over a single line. *See the illustration.*

S

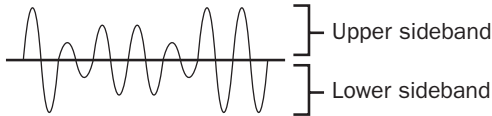

Sideband.

sidebar *n.* A block of text placed to the side of the main body of text in a document, often set off by a border or other graphic element.

side-by-side execution *n.* The ability to install and use multiple versions of an assembly in isolation at the same time. This can occur on the same machine, or in the same process or application domain. Side-by-side execution can apply to applications and components as well as the components of the .NET Framework. Allowing assemblies to run side-by-side is essential to support robust versioning in the common language runtime.

side effect *n.* Any change of state caused by a subroutine, such as a routine that reads a value from a file and advances the current file position.

side head *n.* A heading placed in the margin of a printed document and top-aligned with the body text, rather than being vertically aligned with text, as is a normal head.

sieve of Eratosthenes *n.* An algorithm for finding prime numbers. It is often used as a benchmark in testing the speed of a computer or programming language. *See also* benchmark¹.

.sig *n.* A file extension for a signature file for e-mail or Internet newsgroup use. The contents of this file are automatically appended to e-mail correspondence or newsgroup articles by their respective client software. *See also* signature file (definition 1).

SIG *n.* Acronym for special interest group. An e-mail online discussion group or a group of users who meet and share information, especially one of the groups supported by the Association for Computing Machinery (ACM), such as SIGGRAPH for computer graphics.

SIGGRAPH *n.* Short for Special Interest Group on Computer Graphics, a part of the Association for Computing Machinery (ACM).

sigmoid function *n.* A kind of S-shaped mathematical function arising in many dynamical systems, including neural networks, because it is the solution to a first-order differential equation. It typically maps a real value, which may be arbitrarily large in magnitude (positive or nega-

tive), to another real value, which lies within some narrow range. The sigmoid function, in neural network computation literature, is also sometimes referred to as the logistic function. The reason for its prevalence is that it is thought to resemble the probability that a true neuron generates as an action potential in response to particular input and output. *See also* artificial intelligence, neural network.

sign *n.* The character used to indicate a positive or negative number. In assembly-level programming, the sign is indicated by the sign bit accompanying the number. *See also* sign bit.

signal *n.* **1.** Any electrical quantity, such as voltage, current, or frequency, that can be used to transmit information. **2.** A beep or tone from a computer's speaker or a prompt displayed on screen that tells a user that the computer is ready to receive input.

signal converter *n.* A device or circuit that converts a signal from one form to another, such as analog to digital, or pulse code modulation to frequency modulation.

signal-to-noise ratio *n.* The amount of power, measured in decibels, by which the signal exceeds the amount of channel noise at the same point in transmission. *Abbreviation:* S/N. *See also* noise (definition 2).

signature *n.* **1.** A sequence of data used for identification, such as text appended to an e-mail message or a fax. **2.** A unique number built into hardware or software for authentication purposes.

signature block *n.* A block of text that an e-mail client or a newsreader automatically places at the end of every message or article before the message or article is transmitted. Signature blocks typically contain the name, e-mail address, and affiliation of the person who created the message or article.

signature file *n.* **1.** A file that contains information inserted by a user and automatically appended to e-mail correspondence or newsgroup articles by client software. A signature file typically contains the name or nickname of the user and might include such information as the user's e-mail address, Web page, company, or job title. **2.** A file that updates an antivirus program so that the program recognizes signatures of new viruses and removes the viruses from the user's computer. *See also* antivirus program, virus signature.

sign bit *n.* The most significant, or leftmost, bit of a number field, usually set to 1 if the number is negative.



sign extension *n.* See sign bit.

significand *n.* See mantissa.

significant digits *n.* The sequence from the first nonzero digit to the last digit in a number (the last nonzero digit in an integer), used to express the number's precision (for example, 12,300 has three significant digits, and 0.000120300 has six). See also floating-point notation.

sign off *vb.* See log off.

sign on *vb.* See log on.

sign propagation *n.* See sign bit.

SIIA *n.* Acronym for Software & Information Industry Association. A nonprofit trade association representing over 1200 high-tech companies worldwide and charged with watching over the interests of the software and digital content industry. The SIIA was formed in 1999 when the Software Publishers Association (SPA) merged with the Information Industry Association (IIA). The SIIA focuses on three areas: providing information and forums in which to distribute information to the high-tech industry; protection in the form of an antipiracy program geared to help members enforce their copyrights; and promotion and education.

silica gel *n.* A desiccant (moisture-absorbing substance) often packaged with optical or electronic equipment.

silicon *n.* A semiconductor used in many devices, especially microchips. Silicon, with atomic number 14 and atomic weight 28, is the second most common element in nature. Compare silicone.

Silicon Alley *n.* The Manhattan, New York, metropolitan area. Originally the term referred to the area of Manhattan below 41st Street, which had a heavy concentration of technology companies, but it now includes the entire island, reflecting the number of businesses involved in computer technology in that area. The name was inspired by Silicon Valley, the area of northern California that is home to many technology firms. See also Silicon Valley.

silicon chip *n.* An integrated circuit that uses silicon as its semiconductor material.

silicon-controlled rectifier *n.* A semiconductor rectifier whose conductance can be controlled by a gate signal. *Acronym:* SCR. See also gate (definition 1), rectifier.

silicon dioxide *n.* An insulator used to form thin insulating layers in some types of semiconductors; also the primary component of glass.

silicone *n.* A polymer in which silicon and oxygen are major components. Silicone is an excellent electrical insulator and conducts heat well. Compare silicon.

silicon foundry *n.* A factory or machine used to create wafers of crystalline silicon.

silicon on insulator *n.* See SOI.

silicon-on-sapphire *n.* A method of fabricating semiconductors in which the semiconductor devices are formed in a thin single layer of silicon that has been grown on an insulating substrate of synthetic sapphire. *Acronym:* SOS.

Silicon Valley *n.* The region of California south of San Francisco Bay, otherwise known as the Santa Clara Valley, roughly extending from Palo Alto to San Jose. Silicon Valley is a major center of electronics and computer research, development, and manufacturing. See the illustration.



Silicon Valley.

Silicorn Valley *n.* Clusters of high-tech companies headquartered in small cities in the Midwestern United States, particularly in areas of rural Iowa.

SIM *n.* See Society for Information Management.

SIM card *n.* Short for Subscriber Identity Module card. A smart card designed for use with GSM (Global System for Mobile Communications) mobile phones. SIM cards contain chips that store a subscriber's personal identifier (SIM PIN), billing information, and data (names, phone numbers). See also Global System for Mobile Communications, smart card (definition 2).

SIMD *n.* Acronym for single-instruction, multiple-data stream processing. A category of parallel-processor computer architecture in which one instruction processor fetches instructions and distributes orders to several other processors. See the illustration. See also parallel processing. Compare MIMD.

S

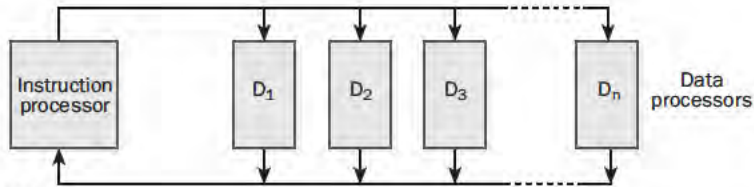
**SIMD.**

SIMM *n.* Acronym for single inline memory module. A small circuit board designed to accommodate surface-mount memory chips.

Simple API for XML *n.* See SAX.

Simple Authentication and Security Layer *n.* See SASL.

Simple Control Protocol *n.* See SCP.

Simple Mail Transfer Protocol *n.* A TCP/IP protocol for sending messages from one computer to another on a network. This protocol is used on the Internet to route e-mail. *Acronym:* SMTP. See also communications protocol, TCP/IP. Compare CCITT X series, Post Office Protocol.

Simple Network Management Protocol *n.* See SNMP.

Simple Object Access Protocol *n.* See SOAP.

simplex *n.* Communication that takes place only from sender to receiver. Compare duplex² (definition 1), half-duplex².

simplex transmission *n.* See simplex.

SIMULA *n.* Short for simulation language. A general-purpose programming language based on ALGOL 60, with special features designed to aid the description and simulation of active processes. Visual C++ is based on aspects of this language.

simulation *n.* The imitation of a physical process or an object by a program that causes a computer to respond mathematically to data and changing conditions as though it were the process or object itself. See also emulator, modeling (definition 1).

simultaneous access *n.* See parallel access.

simultaneous processing *n.* 1. True multiple-processor operation in which more than one task can be processed at a time. See also multiprocessing, parallel processing. 2. Loosely, concurrent operation in which more than one task is processed by dividing processor time among the tasks. See also concurrent, multitasking.

sine wave *n.* A uniform, periodic wave often generated by an object that vibrates at a single frequency. See the illustration. Compare square wave.

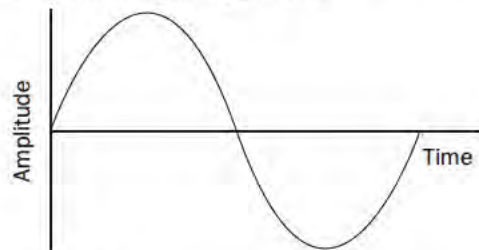

Sine wave.

single attachment station *n.* An FDDI node that connects to the primary ring through a concentrator. Compare dual attachment station.

single-board *adj.* Of or pertaining to a computer that occupies only one circuit board, usually with no capacity for additional boards.

single-density *adj.* Of or pertaining to a disk that is certified only for use with frequency modulation (FM) recording. A single-density disk can store much less data than a disk using modified FM encoding or run-length limited encoding. See also modified frequency modulation encoding, run-length limited encoding.

Single Image Random Dot Stereogram *n.* See auto-stereogram.

Single Image Stereograms *n.* See autostereogram.

single inline memory module *n.* See SIMM.

single inline package *n.* See SIP.

single inline pinned package *n.* See SIP.

single-instruction, multiple-data stream processing *n.* See SIMD.

single-line digital subscriber line *n.* See SDSL.

single-precision *adj.* Of or pertaining to a floating-point number having the least precision among two or more

options commonly offered by a programming language, such as single-precision versus double-precision. *See also* floating-point notation, precision (definition 2). *Compare* double-precision.

single-sided *adj.* Of or pertaining to a floppy disk in which data can be stored on only one side.

single sign-on *n.* A system enabling a user to enter one name and password to log on to different computer systems or Web sites. Single sign-on is also available for enterprise systems so a user with a domain account can log on to a network once, using a password or smart card, and thereby gain access to any computer in the domain. *See also* domain, smart card (definition 1).

single step *vb.* To execute a program one step at a time, usually within the context of a debugger. *See also* debugger.

single switch device *n.* An assistive computer technology for people with mobility impairments. A single switch device allows users to interact with a computer by using slight body movements.

single threading *n.* **1.** Within a program, the running of a single process at a time. **2.** A condition in which each leaf node of a tree data structure contains a pointer to its parent. *See also* node (definition 3), pointer (definition 1), threading.

single-user computer *n.* A computer designed for use by a single individual; a personal computer. *Compare* multi-user system.

sink *n.* A device or part of a device that receives something from another device. *See also* data sink, heat sink.

SIP *n.* Acronym for **single inline package**. A type of housing for an electronic component in which all leads (connections) protrude from one side of the package. *Also called:* single inline pinned package. *Compare* DIP.

SIPP *n.* Acronym for **single inline pinned package**. *See* SIP.

SIR *n.* *See* Serial Infrared.

SirCam worm *n.* A malicious worm that combines fast infection with the potential to deliver multiple malicious payloads. SirCam spreads through multiple means, both by mailing infected personal files from a compromised disk to other potential victims and through Windows network shares on unprotected machines. One time in 20 SirCam deletes the contents of the infected drive, and one time in 50 it fills all free space on the disk with trash data.

SirCam was discovered in mid-2001 and has reappeared regularly since that time.

SIRDS *n.* Acronym for **Single Image Random Dot Stereogram**. *See* autostereogram.

SIS *n.* Acronym for **Single Image Stereogram**. *See* autostereogram.

.sit *n.* The file extension for a Macintosh file compressed with StuffIt. *See also* StuffIt.

site *n.* *See* Web site.

site license *n.* A purchase agreement for using multiple copies of the same software at a business or an institution, usually at a volume discount.

size box *n.* A control in the upper right corner of the frame of a window on the Macintosh screen. When the user clicks the size box, the window toggles between the size the user has set for it by dragging and the maximum size. *Compare* Maximize button.

skew *n.* The difference between what is and what should be—for example, the misalignment of a page that prevents accurate reproduction, or the difference between input and output when circuits do not respond evenly to a propagated signal.

skin *n.* An alternative graphical interface for an operating system (OS) or a software program. A skin customizes the look of the OS or program but does not affect its functionality. Programs that allow the use of skins usually make standards available for the creation and distribution of new skins. *See also* graphical user interface.

skin mode *n.* An operational state of various media players, including RealPlayer, Winamp, and Windows Media Player, in which the user interface is customized and displayed as a skin. Often some features of the player are not accessible in skin mode. Skin mode was called compact mode in Windows Media Player 7. *See also* full mode.

Skutch box *n.* A slang term for a device manufactured by Skutch Electronics, Inc., that simulates the functioning of a telephone line with a good connection. Telephone line simulators are used to test telecommunications systems and devices.

skyscraper *n.* One of several larger formats for online ads developed to replace traditional banner ads on the Internet. *See* avalanche ad.



slave *n.* Any device, including a computer, that is controlled by another computer, referred to as the master. *See also* master/slave arrangement.

sleep¹ *n.* **1.** In a multiprocessing environment, a temporary state of suspension during which a process remains in memory so that some event, such as an interrupt or a call from another process, can “awaken” it. **2.** In programming, a state of suspension caused by a loop statement that creates an intentional delay.

sleep² *vb.* To suspend operation without terminating.

sleep mode *n.* A power management mode that shuts down all unnecessary computer operations to save energy after it has received no input or other activity for a specified period of time. A computer in sleep mode usually awakens when it receives an input signal from a user or a network, such as a keyboard entry or an incoming call through a modem. Many battery-powered devices, including portable computers, support sleep mode. *See also* green PC, sleep¹ (definition 1), Suspend command.

sleeve *n.* *See* disk envelope.

slice *n.* *See* time slice.

SLIP *n.* Acronym for **S**erial **L**ine **I**nternet **P**rotocol. A data link protocol that allows transmission of TCP/IP data packets over dial-up telephone connections, thus enabling a computer or a LAN (local area network) to be connected to the Internet or some other network. It is an older, less secure protocol than the PPP (Point-to-Point Protocol) and does not support dynamic allocation of IP addresses. A newer form of SLIP, known as CSLIP (Compressed SLIP), optimizes transmission of long documents by compressing header information. *See also* data link, IP. *Compare* PPP.

SLIP emulator *n.* Software that mimics a SLIP connection in UNIX shell accounts that do not offer a direct SLIP connection. Many Internet service providers (ISPs) are UNIX based and offer shell accounts to users for Internet access. Like a SLIP connection, the SLIP emulator allows the user to avoid dealing with the ISP’s UNIX environment directly when accessing the Internet and to use Internet applications such as graphical Web browsers. *See also* ISP, shell account, SLIP.

slot *n.* **1.** *See* expansion slot. **2.** An integrated circuit mounting connector designed to connect a microprocessor with a PC’s data bus. Currently, only newer models of

Intel’s Pentium family employ this. *See also* Pentium, Slot 1, Slot 2.

Slot 1 *n.* A receptacle on a PC motherboard designed to hold a Pentium II microprocessor. The microprocessor, which is encased in Intel’s Single Edge Contact (SEC) packaging, slides into the slot on the motherboard. Slot 1 includes 242 electrical contact points and communicates with the chip’s L2 cache at half of the PC’s clock speed. Slot 1 replaced socket 7 and socket 8 in Intel architectures, but has been superceded by Slot 2 in newer model Pentiums. *See also* L2 cache, motherboard, Pentium. *Compare* Slot 2, socket 7, socket 8.

Slot 2 *n.* A receptacle on a PC motherboard designed to hold Intel microprocessors beginning with the Pentium II Xeon and including the Pentium III microprocessor. Like Slot 1, Slot 2 is encased in Intel’s Single Edge Contact packaging, so it slides easily into the slot on the motherboard. It includes 330 electrical contact points and is slightly wider than Slot 1. It also supports communication between the CPU and the L2 cache at the full clock speed of the PC. *See also* L2 cache, motherboard, Pentium. *Compare* Slot 1.

slot mask *n.* A type of mask used in cathode ray tube (CRT) monitors in which a thin sheet of metal perforated with elliptical holes is used to ensure that the electron beam for a particular color (red, green, or blue) strikes only the phosphor (of the corresponding color) that it is intended to illuminate. The elliptical—lozenge-shaped—holes in a slot mask place it between a shadow mask, which is based on round openings, and an aperture grill, which is based on vertical strips of metal. Slot masks were introduced by NEC in its ChromaClear technology. *See also* CRT, mask (definition 2). *Compare* aperture grill, shadow mask.

slot pitch *n.* The distance, measured horizontally, between phosphor dots of the same color on a cathode ray tube (CRT) display based on slot mask technology. Although the measurements are based on different methods of applying phosphor to the screen surface, slot pitch is comparable to dot pitch, the measurement used with CRTs based on shadow mask technology. *See also* CRT, mask (definition 2), slot mask. *Compare* dot pitch, stripe pitch.

slotted-ring network *n.* A ring network allowing data to be transmitted between data stations in one direction. A slotted-ring network transfers data in predefined time slots (fixed-length portions of a data frame) in the transmission

S

stream over one transmission medium. *See also* data frame, ring network. *Compare* token ring network.

SlowKeys *n.* An accessibility feature built into Macintosh computers and available for DOS and Windows that allows the user to add a delay to the keyboard so that a key must be held down for a certain amount of time before it is accepted. This feature facilitates the use of the keyboard by individuals with poor motor control who might accidentally bump keys when moving around the keyboard.

SLSI *n.* *See* super-large-scale integration.

Small Business Server *n.* A software application developed by Microsoft Corporation to increase the efficiency of Web-based services for small businesses with 50 or fewer personal computers. Small Business Server provides shared Internet access, features for building Web-based customer management and customer communications tools, and additional features that increase productivity by streamlining employee access to files and applications over the Web.

small caps *n.* A font of capital letters that are smaller than the standard capital letters in that typeface.

Small Computer System Interface *n.* *See* SCSI.

small model *n.* A memory model of the Intel 80x86 processor family that allows only 64 kilobytes (KB) for code and 64 KB for data. *See also* memory model.

Small Office/Home Office *n.* *See* SOHO.

small-scale integration *n.* A concentration of fewer than 10 components on a single chip. *Acronym:* SSI. *See also* integrated circuit.

Smalltalk *n.* An object-oriented language and development system developed at Xerox Palo Alto Research Center (PARC) in 1980. Smalltalk pioneered many language and user interface concepts that are now widely used in other environments, such as the concept of an object that contains data and routines and on-screen icons that the user can choose to make the computer perform certain tasks. *See also* object-oriented programming.

smart *adj.* A synonym for intelligent. *See* intelligence.

smart cable *n.* *See* intelligent cable.

smart card *n.* **1.** In computers and electronics, a circuit board with built-in logic or firmware that gives it some kind of independent decision-making ability. **2.** In banking and finance, a credit card that contains an integrated cir-

cuit that gives it a limited amount of intelligence and memory.

smart card reader *n.* A device that is installed in computers to enable the use of smart cards for enhanced security features. *See also* smart card (definition 2).

smart device *n.* An electronic device capable of being networked and remotely controlled in a smart home. Smart devices can include appliances, lighting, heating and cooling systems, entertainment systems, and security systems. *See also* home automation, home network (definition 1), smart home.

smart home *n.* A home or building wired for networking and home automation. In a smart home, occupants control smart devices programmatically or on command using a home-networking communications protocol. *Also called:* automated home, digital home, e-home, Internet home, networked home, smart house, wired home. *See also* home automation, home network (definition 1).

smart house *n.* *See* smart home.

smart linkage *n.* A feature of programming languages that guarantees that routines will always be called with correct parameter types. *See also* link (definition 1).

smartphone *n.* A hybrid between a wireless telephone and a personal digital assistant (PDA). Smartphones integrate wireless telephones with many of the personal organizational functions of PDAs, such as calendar, calculator, database, e-mail, wireless Web access, note taking, and other programs common to lightweight palm-style computers. Smartphones may rely on a stylus, keypad, or both for data entry or may use voice recognition technology. *See also* cell, palmtop, PDA, pen computer, wireless phone.

smart quotes *n.* In word processors, a function that automatically converts the ditto marks (") produced by most computer keyboards to the inverted commas (“ and ”) used in typeset text.

SmartSuite *n.* A suite of business application programs sold by Lotus Development. Lotus SmartSuite includes six programs: Lotus 1-2-3 spreadsheet, Lotus WordPro word processor, Lotus Approach database, Lotus Freelance Graphics presentation software, Lotus Organizer time-management software, and Lotus FastSite Internet/intranet publishing tool. SmartSuite Millennium Edition 9.7 supports collaboration, Web publishing, use of Internet/intranet resources, and customizable document and project organizers. SmartSuite competes with Microsoft Office and WordPerfect Office.



SMART system *n.* Short for self-monitoring analysis and reporting technology system. A system by which technology is used to monitor and predict device performance and reliability. A SMART system employs various diagnostic tests to detect problems with devices, with the object of increasing productivity and protecting data.

smart terminal *n.* A terminal that contains a microprocessor and random access memory (RAM) and that does some rudimentary processing without intervention from the host computer. *Compare* dumb terminal.

SMB *n.* Acronym for Server Message Block. A file-sharing protocol designed to allow networked computers to transparently access files that reside on remote systems over a variety of networks. The SMB protocol defines a series of commands that pass information between computers. SMB uses four message types: session control, file, printer, and message. *See also* LAN Manager, NetBIOS, Samba.

SMDS *n.* Acronym for Switched Multimegabit Data Services. A very high-speed, connectionless, packet-switched data transport service that connects LANs (local area networks) and WANs (wide area networks).

SMIL *n.* Acronym for Synchronized Multimedia Integration Language. A markup language that enables separate elements, including audio, video, text, and still images, to be accessed separately and then integrated and played back as a synchronized multimedia presentation. Based on XML (eXtensible Markup Language), SMIL allows Web authors to define the objects in the presentation, describe their locations onscreen, and determine when they will be played back. The language is based on statements that can be entered with a text editor and was developed under the auspices of the World Wide Web Consortium (W3C). *See also* markup language, XML.

smiley *n.* *See* emoticon.

S/MIME *n.* Acronym for Secure/Multipurpose Internet Mail Extensions. An Internet e-mail security-oriented protocol that adds public key encryption and support for digital signatures to the widely used MIME e-mail protocol. *See also* public key encryption.

SMIS *n.* Acronym for Society for Management Information Systems. *See* Society for Information Management.

smoke test *n.* The testing of a piece of hardware after assembly or repairs by turning it on. The device fails the test if it produces smoke, explodes, or has some other unexpected violent or dramatic reaction, even if it appears to work.

smooth *vb.* **1.** To eliminate irregularities in statistical data by some process such as continuous averaging or by removing random (irrelevant) values. **2.** In graphics, to remove jagged edges from a figure or line. *See also* anti-aliasing.

SMP *n.* Acronym for symmetric multiprocessing. A computer architecture in which multiple processors share the same memory, which contains one copy of the operating system, one copy of any applications that are in use, and one copy of the data. Because the operating system divides the workload into tasks and assigns those tasks to whichever processors are free, SMP reduces transaction time. *See also* architecture, multiprocessing.

SMP server *n.* Short for symmetric multiprocessing server. A computer that is designed with the SMP architecture to improve its performance as a server in client/server applications. *See also* SMP.

SMS *n.* *See* Systems Management Server.

SMS *n.* *See* short message service.

SMT *n.* *See* surface-mount technology.

SMTP *n.* *See* Simple Mail Transfer Protocol.

smurf attack *n.* A form of denial-of-service attack on an Internet server that sends simultaneous echo request packets ("ping" packets) to one or more broadcast IP addresses (such as an IRC server), each of which in turn relays the request to as many as 255 individual host computers, with the address of the attack's victim as the forged (spoofed) source address. When the hosts return echo packets to the apparent source of the request, the volume of the responses is enough to disable the network. *See also* denial of service attack, spoofing.

SNA *n.* Acronym for Systems Network Architecture. A network model devised by IBM to enable IBM products, including mainframes, terminals, and peripherals, to communicate and exchange data. SNA started out as a five-layer model and was later extended with two additional layers to correspond more closely to the ISO/OSI refer-

S

ence model. More recently, the SNA model was modified to include minicomputers and microcomputers in a specification known as APPC (Advanced Program to Program Communications). See the illustration. See also APPC. Compare ISO/OSI reference model.

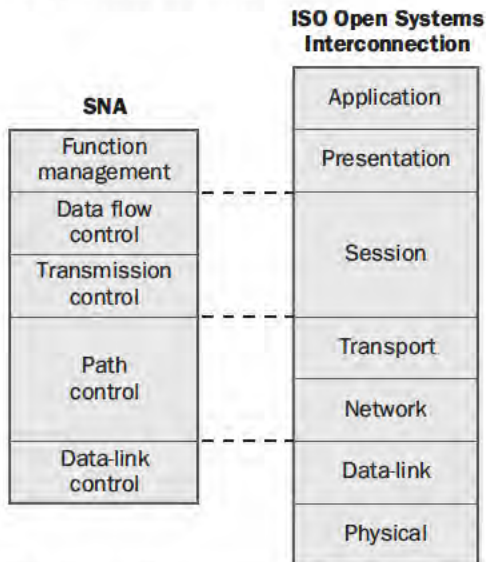

SNA. *Comparable (not compatible) layers in the SNA and ISO/OSI architectures.*

snail mail *n.* A popular phrase on the Internet for referring to mail services provided by the U.S. Postal Service and similar agencies in other countries. The term has its origins in the fact that regular postal mail is slow compared with e-mail.

snap-in *n.* 1. See plug-in. 2. A software component that provides system administration and system management capability within the framework of the Microsoft Management Console (MMC) for Windows NT, Windows 2000, and Windows XP. A snap-in (also capitalized as Snap-In) is a COM object that represents one unit of management behavior, the smallest extension available through the MMC. There are two types of snap-ins: stand-alone (not reliant on any other snap-in) and extension (invoked by a parent snap-in). Multiple snap-ins can be combined to create larger management tools.

snapshot *n.* A copy of main memory or video memory at a given instant, sent to the printer or hard disk. *Also called:* snapshot dump. *See also* screen dump.

snapshot program *n.* A program that performs a trace by taking a snapshot of certain chunks of memory at specified times.

.snd *n.* A file extension for a type of interchangeable sound file format used on Sun, NeXT, and Silicon Graphics computers, consisting of raw audio data preceded by a text identifier.

sneaker *n.* An individual employed by a company or organization to test their security by breaking into the employer's network. Information gathered by the sneaker can be used to repair network security weaknesses. *See also* tiger team.

sneakernet *n.* Transfer of data between computers that are not networked together. The files must be written onto floppy disks on the source machine, and a person must physically transport the disks to the destination machine.

sniffer *n.* *See* packet sniffer.

SNMP *n.* Acronym for Simple Network Management Protocol. The network management protocol of TCP/IP. In SNMP, agents, which can be hardware as well as software, monitor the activity in the various devices on the network and report to the network console workstation. Control information about each device is maintained in a structure known as a management information block. *See also* agent (definition 4), TCP/IP.

SNOBOL *n.* Acronym for String-Oriented Symbolic Language. A string- and text-processing language developed between 1962 and 1967 by Ralph Griswold, David Farber, and I. Polonsky at AT&T Bell Laboratories. *See also* string.

snow *n.* 1. In television, temporary distortion of a displayed image caused by interference, usually in a weak signal, that takes the form of random white spots. 2. In computer displays, a specific type of distortion characterized by the blinking on and off of random pixels that occurs when the microprocessor and the display hardware interfere with each other by attempting to use the computer's video memory at the same time.

SOAP *n.* Acronym for Simple Object Access Protocol. A simple, XML-based protocol for exchanging structured and type information on the Web. The protocol contains

S

no application or transport semantics, which makes it highly modular and extensible.

SOC *n.* Acronym for system on a chip. A chip integrating computer, microprocessors, and all necessary support components in a single unit. SOC technology is used in firewalls, gateways, specialized servers, and interactive devices like Web pads and vending machines.

social engineering *n.* The practice of penetrating system security by tricking individuals into divulging passwords and information about network vulnerabilities. Often done by calling the individual on phone and pretending to be another employee of company with a computer-related question.

Society for Information Management *n.* A professional society based in Chicago for information systems executives, formerly the Society for Management Information Systems. *Acronym:* SIM.

Society for Management Information Systems *n.* See Society for Information Management.

socket *n.* **1.** An identifier for a particular service on a particular node on a network. The socket consists of a node address and a port number, which identifies the service. For example, port 80 on an Internet node indicates a Web server. *See also* port number, sockets API. **2.** The receptacle part of a connector, which receives a plug. *See also* female connector. **3.** A receptacle on a PC motherboard into which a microprocessor is plugged. A socket-mounted microprocessor, such as the Pentium, connects to the motherboard through numerous pins on the underside. Newer Intel microprocessors, such as the Pentium II and later, plug into the motherboard through an edge connector along the side of the chip. *See also* socket 4, socket 5, socket 7, socket 8. *Compare* Slot 1, Slot 2.

socket 4 *n.* A 5-volt mounting socket on a PC motherboard designed to hold a Pentium microprocessor operating at 60 MHz or 66 MHz. Socket 4 includes openings for 273 pins. *See also* Pentium, socket (definition 3). *Compare* Slot 1, Slot 2, socket 5, socket 7, socket 8.

socket 5 *n.* A 3.3-volt mounting socket on a PC motherboard designed to hold a Pentium microprocessor operating at the following speeds: 75, 90, 100, 120, 133, 150, 166, 180, and 200 MHz. Socket 5 includes openings for 320 pins. It has been superseded by socket 7, socket 8, slot 1, and slot 2. *See also* Pentium, socket (definition 3). *Compare* Slot 1, Slot 2, socket 4, socket 7, socket 8.

socket 7 *n.* A mounting socket on a PC motherboard designed to hold a microprocessor operating at the following speeds: 150, 166, 180, 200, 210, and 233 MHz. Socket 7 includes openings for 321 pins and operates at two voltages, 2.5 volts at the core and 3.3 volts input/output. It is used with the Pentium MMX chip and competitive microprocessor chips from other manufacturers, such as AMD and Cyrix. *See also* MMX, Pentium, socket (definition 3). *Compare* Slot 1, Slot 2, socket 4, socket 5, socket 8.

socket 8 *n.* A 2.5-volt mounting socket on a PC motherboard designed to hold a Pentium Pro microprocessor. Socket 8 has openings for 387 pins. *See also* Pentium, socket (definition 3). *Compare* Slot 1, Slot 2, socket 4, socket 5, socket 7.

sockets API *n.* An application programming interface implemented to create and use sockets in client/server networking. The most common sockets API is the University of California at Berkeley UNIX/BSD implementation (Berkeley Sockets API), which is the basis for Winsock. *See also* socket (definition 1).

soc. newsgroups *n.* Usenet newsgroups that are part of the soc. hierarchy and have the prefix soc. These newsgroups are devoted to discussions of current events and social issues. Soc. newsgroups are one of the seven original Usenet newsgroup hierarchies. The other six are comp., misc., news., rec., sci., and talk. *See also* newsgroup, traditional newsgroup hierarchy, Usenet.

soft *adj.* **1.** In computing, temporary or changeable. For example, a soft error is a problem from which the system can recover, and a soft patch is a temporary program fix that holds only while the program is running. *Compare* hard (definition 1). **2.** In electronics, characterized by magnetic materials that do not retain their magnetism when a magnetic field is removed. *Compare* hard (definition 2).

soft boot *n.* *See* warm boot.

soft copy *n.* The temporary images presented on a computer display screen. *Compare* hard copy.

soft error *n.* An error from which a program or operating system is able to recover. *Compare* hard error.

soft font *n.* *See* downloadable font.

soft hyphen *n.* *See* hyphen.

soft link *n.* *See* symbolic link.

softmodem *n.* *See* software-based modem.

S

soft patch *n.* A fix or modification performed only while the code being patched is loaded into memory, so that the executable or object file is not modified in any way. *See also* patch¹.

soft return *n.* A line break inserted in a document by a word processor when the next word in the current line of text would cause the line to overflow into the margin—a movable line break. *See also* wordwrap. *Compare* hard return.

soft-sectored disk *n.* A disk, especially a floppy disk, whose sectors have been marked with recorded data marks rather than punched holes. *See also* index hole. *Compare* hard-sectored disk.

software *n.* Computer programs; instructions that make hardware work. Two main types of software are system software (operating systems), which controls the workings of the computer, and applications, such as word processing programs, spreadsheets, and databases, which perform the tasks for which people use computers. Two additional categories, which are neither system nor application software but contain elements of both, are network software, which enables groups of computers to communicate, and language software, which provides programmers with the tools they need to write programs. In addition to these task-based categories, several types of software are described based on their method of distribution. These include packaged software (canned programs), sold primarily through retail outlets; freeware and public domain software, which are distributed free of charge; shareware, which is also distributed free of charge, although users are requested to pay a small registration fee for continued use of the program; and vaporware, software that is announced by a company or individuals but either never makes it to market or is very late. *See also* application, canned software, freeware, network software, operating system, shareware, system software, vaporware. *Compare* firmware, hardware, liveware.

Software & Information Industry Association *n.* *See* SIIA.

software-based modem *n.* A modem that uses a general-purpose, reprogrammable digital signal processor chip and RAM-based program memory rather than a dedicated chip with the modem functions burned into the silicon. A software-based modem can be reconfigured to update and change the modem's features and functions.

software bloat *n.* A software condition caused by the addition of excessive number of possibly unnecessary features and functions as new versions of the software are released. Software bloat is generally assumed to result in long loading times and inordinate resource (memory and storage) requirements. *See also* bloatware, creeping featurism.

software conversion *n.* Changing or moving a program designed to run on one computer to run on another. Usually this involves detailed (professional) work on the program itself.

software-dependent *adj.* Of, pertaining to, or being a computer or device that is tied to a particular program or set of programs developed for it.

software development kit *n.* *See* developer's kit.

software engineer *n.* **1.** In general, one who works at the code level with software. Although such engineering can be considered to encompass everything from software design to management and testing, the term is generally considered more or less synonymous with *programmer*—one who actually writes the code. **2.** *See* developer.

software engineering *n.* The design and development of software. *See also* programming.

software handshake *n.* A handshake that consists of signals transmitted over the same wires used to transfer the data, as in modem-to-modem communications over telephone lines, rather than signals transmitted over special wires. *See also* handshake.

software house *n.* An organization that develops and supports software for its customers.

software IC *n.* *See* software integrated circuit.

software integrated circuit *n.* An existing software module that can be designed into a program, much as an integrated circuit can be designed into a logic board. *Abbreviation:* software IC. *See also* abstract data type, module (definition 1), object-oriented programming.

software interrupt *n.* A program-generated interrupt that stops current processing in order to request a service provided by an interrupt handler (a separate set of instructions designed to perform the task required). *Also called:* trap.

software package *n.* A program sold to the public, ready to run and containing all necessary components and documentation.

software piracy *n.* *See* piracy.



software portability *n.* See portable (definition 1).

software program *n.* See application.

software protection *n.* See copy protection.

software publisher *n.* A business engaged in the development and distribution of computer software.

Software Publishers Association *n.* See SIIA.

software publishing *n.* The design, development, and distribution of noncustom software packages.

software rot *n.* See dead code.

software stack *n.* See stack.

software suite *n.* See suite (definition 1).

software tools *n.* Programs, utilities, libraries, and other aids, such as editors, compilers, and debuggers, that can be used to develop programs.

SOHO *n.* Acronym for **S**mall **O**ffice/**H**ome **O**ffice, a term used for home-based and small businesses. The fast-growing SOHO market has sparked a concomitant expansion in computer software and hardware products designed specifically to meet the needs of self-employed individuals or small businesses. See also distributed workplace, telecommuter.

SOI *n.* Acronym for **s**ilicon **o**n **i**nsulator. A method used in the construction of microprocessors in which the chip's transistors—the tiny circuits that conduct electrical charges—are built on a layer of silicon placed on top of a layer of insulating material, such as glass. SOI construction improves speed at the same time it reduces the amount of power required by the microprocessor.

solar cell *n.* A photoelectric device that produces electrical power when exposed to light. Also called: photovoltaic cell.

Solaris *n.* A distributed UNIX-based computing environment created by Sun Microsystems, Inc., widely used as a server operating system. Versions of Solaris exist for SPARC computers, 386 and higher Intel platforms, and the PowerPC.

solenoid *n.* An electromagnetic device that converts electrical energy to mechanical movement, typically consisting of an electromagnet with a movable rod through the center.

solid ink *n.* Ink manufactured in the form of solid sticks resembling crayons, for use in solid-ink printers. See also solid-ink printer.

solid-ink printer *n.* A computer printer using solid ink sticks. The ink sticks are heated until they melt, and the molten ink is sprayed onto the page, where it cools and solidifies. See also solid ink.

solid model *n.* A geometric shape or construction that has continuity in length, width, and depth and is treated by a program as if it had both surface and internal substance. Compare surface modeling, wire-frame model.

solid-state device *n.* A circuit component whose properties depend on the electrical or magnetic characteristics of a solid substance (as opposed to a gas or vacuum). Transistors, diodes, and integrated circuits are solid-state devices.

solid-state disk drive *n.* A mass storage device that holds data in RAM rather than in magnetic storage. See also magnetic storage, RAM.

solid-state memory *n.* Computer memory that stores information in solid-state devices.

solid-state relay *n.* A relay that depends on solid-state components, rather than mechanical components, to open and close a circuit.

SOM *n.* **1.** Acronym for **S**ystem **O**bject **M**odel. A language-independent architecture from IBM that implements the CORBA standard. See also CORBA, OMA.

2. Acronym for **s**elf-**o**rganizing **m**ap. A form of neural network in which neurons and their connections are added automatically as needed to develop the desired mapping from input to output.

SONET *n.* Acronym for **S**ynchronous **O**ptical **N**etwork. A high-speed network that provides a standard interface for communications carriers to connect networks based on fiberoptic cable. SONET is designed to handle multiple data types (voice, video, and so on). It transmits at a base rate of 51.84 Mbps, but multiples of this base rate go as high as 2.488 Gbps (gigabits per second).

sort *vb.* To organize data, typically a set of records, in a particular order. Programs and programming algorithms for sorting vary in performance and application. See also bubble sort, distributive sort, insertion sort, merge sort, quicksort, Shell sort.

sort algorithm *n.* An algorithm that puts a collection of data elements into some sequenced order, sometimes based on one or more key values in each element. See also algorithm, bubble sort, distributive sort, insertion sort, merge sort, quicksort, Shell sort.

S

sorter *n.* A program or routine that sorts data. *See also* sort.

sort field *n.* *See* sort key.

sort key *n.* A field (commonly called a key) whose entries are sorted to produce a desired arrangement of the records containing the field. *See also* field (definition 1), primary key, secondary key.

SOS *n.* *See* silicon-on-sapphire.

Sound Blaster *n.* **1.** A family of sound cards manufactured by Creative Technology or its subsidiary, Creative Labs. *See also* sound card. **2.** A de facto standard set by the family of sound cards developed by Creative Technologies and its subsidiaries. Many other manufacturers also make Sound Blaster-compatible products.

sound board *n.* *See* sound card.

sound buffer *n.* A region of memory used to store the bit image of a sequence of sounds to be sent to a computer's speaker(s).

sound card *n.* A type of expansion board on PC-compatible computers that allows the playback and recording of sound, such as from a WAV or MIDI file or a music CD-ROM. Most PCs sold at retail include a sound card. *Also called:* sound board. *See also* expansion board, MIDI, WAV.

sound clip *n.* A file that contains a short audio item, usually an excerpt from a longer recording.

sound editor *n.* A program that allows the user to create and manipulate sound files.

sound generator *n.* A chip or chip-level circuit that can produce electronic signals that can drive a speaker and synthesize sound.

sound hood *n.* A five-sided box, lined with soundproofing material, that is placed over a loud printer to muffle its noise.

SoundSentry *n.* An optional Windows feature that instructs Windows to produce a visual cue such as a screen flash or a blinking title bar whenever a system beep occurs. SoundSentry is designed for users with hearing impairments or users who operate a computer in a noisy environment.

source *n.* **1.** In information processing, a disk, file, document, or other collection of information from which data is taken or moved. *Compare* destination. **2.** In a FET, the electrode toward which charge carriers (electrons or holes) move from the source under control of the gate. *See also*

CMOS (definition 1), drain (definition 1), FET, gate (definition 2), MOSFET, NMOS, PMOS.

source code *n.* Human-readable program statements written by a programmer or developer in a high-level or assembly language that are not directly readable by a computer. Source code needs to be compiled into object code before it can be executed by a computer. *Compare* object code.

source code control system *n.* A tool designed to track changes made to source code files. Changes are documented in such a way that previous versions of the files can be retrieved. Source code control is used in software development, particularly in situations involving concurrent development and multiple user access to source code files.

source computer *n.* **1.** A computer on which a program is compiled. *Compare* object computer. **2.** A computer from which data is transferred to another computer.

source data *n.* The original data on which a computer application is based.

source data acquisition *n.* The process of sensing, as with a bar code reader or other scanning device, or receiving source data. *See also* source data.

source data capture *n.* *See* source data acquisition.

source directory *n.* During a file copy operation, the directory in which the original versions of the files are located.

source disk *n.* Any disk from which data will be read, as during a copy operation or when an application is loaded from a disk into memory. *Compare* target disk.

source document *n.* The original document from which data is taken.

source drive *n.* The disk drive from which files are being copied during a copy operation.

source file *n.* **1.** A file that contains source code. *See also* source code. **2.** A file that contains the data that a program will process and store in a destination file. **3.** In MS-DOS and Windows commands that involve the copying of data or program instructions, the file containing the data or instructions that are copied.

source language *n.* The programming language in which the source code for a program is written. *See also* programming language, source code.

source program *n.* The source code version of a program. *See also* source code. *Compare* executable program.



source statement *n.* A single statement in the source code of a program. *See also* source code, statement.

SPA *n.* *See* SIIA.

spacebar *n.* The long key occupying much of the bottom row of most keyboards that sends a space character to the computer.

space character *n.* A character that is entered by pressing the Spacebar on the keyboard and that typically appears on the screen as a blank space.

space-division multiplexing *n.* The first automated form of communications multiplexing, which replaced the human-operated switchboard. Space-division multiplexing was replaced by frequency-division multiplexing (FDM), which was in turn replaced by time-division multiplexing (TDM). *Acronym:* SDM. *See also* FDM, multiplexing, time-division multiplexing.

spaghetti code *n.* Code that results in convoluted program flow, usually because of excessive or inappropriate use of GOTO or JUMP statements. *See also* GOTO statement, jump instruction.

spam¹ *vb.* To distribute unwanted, unrequested mail widely on the Internet by posting a message to too many recipients or too many newsgroups. The act of distributing such mail, known as spamming, angers most Internet users and has been known to invite retaliation, often in the form of return spamming that can flood and possibly disable the electronic mailbox of the original spammer.

spam² *n.* **1.** An unsolicited e-mail message sent to many recipients at one time, or a news article posted simultaneously to many newsgroups. Spam is the electronic equivalent of junk mail. In most cases, the content of a spam message or article is not relevant to the topic of the newsgroup or the interests of the recipient; spam is an abuse of the Internet in order to distribute a message to a huge number of people at minimal cost. **2.** An unsolicited e-mail message from a business or individual that seeks to sell the recipient something. *Also called:* UCE, unsolicited commercial e-mail.

spam blocking *n.* *See* address munging.

spambot *n.* A program or device that automatically posts large amounts of repetitive or otherwise inappropriate material to newsgroups on the Internet. *See also* bot (definition 3), robopost, spam¹.

spamdexter *n.* An individual who lures users to spam-related Web sites by loading the site with hundreds of hid-

den copies of popular keywords, even if those words have no relation to the Web site. Because the keywords appear so many times, the spamdexter's site will appear near the top of search result and indexing lists. The term spamdexter was created by combining the words *spam* and *index*. *Also called:* keyword stuffing.

span *n.* *See* range.

SPARC *n.* Short for Scalable Processor Architecture. A RISC (reduced instruction set computing) microprocessor specification from Sun Microsystems, Inc. *See also* RISC.

sparse array *n.* An array (arrangement of items) in which many of the entries are identical, commonly zero. It is not possible to define precisely when an array is sparse, but it is clear that at some point, usually when about one-third of the array consists of identical entries, it becomes worthwhile to redefine the array. *See also* array.

sparse infector *n.* A type of virus or other malicious code that delivers its payload only when certain predetermined conditions are met. A sparse infector might hide on an infected computer until a certain date or until a certain number of files or applications have been run. By restricting their active phases to only certain situations, sparse infectors are more likely to avoid detection.

spatial data management *n.* The representation of data as a collection of objects in space, particularly as icons on a screen, in order to make the data easier to comprehend and manipulate.

spatial digitizer *n.* A three-dimensional scanner most often used in medical and geographical work. *Compare* optical scanner.

speaker dependent recognition *n.* A type of automatic speech recognition (ASR) in which the computer system becomes accustomed to the voice and accent of a specific speaker, allowing a larger vocabulary can be recognized. *See also* ASR, speaker independent recognition.

speaker independent recognition *n.* A type of automatic speech recognition (ASR) in which the computer system will respond to commands from any speaker. Because the system does not adjust to the nuances of a specific voice, only a limited vocabulary is possible. *See also* ASR, speaker dependent recognition.

spec *n.* *See* specification.

special character *n.* Any character that is not alphabetic, numeric, or the space character (for example, a

punctuation character). *See also* reserved character, wild-card character.

special interest group *n.* *See* SIG.

special-purpose language *n.* A programming language whose syntax and semantics are best suited for a given field or approach. *See also* Prolog.

specification *n.* **1.** A detailed description of something. **2.** In relation to computer hardware, an item of information about the computer's components, capabilities, and features. **3.** In relation to software, a description of the operating environment and proposed features of a new program. **4.** In information processing, a description of the data records, programs, and procedures involved in a particular task. *Also called:* spec.

spectral color *n.* In video, the hue represented by a single wavelength in the visible spectrum. *See also* color model.

spectral response *n.* In relation to sensing devices, the relationship between the device's sensitivity and the frequency of the detected energy.

spectrum *n.* The range of frequencies of a particular type of radiation. *See also* electromagnetic spectrum.

Speech API *n.* *See* SAPI.

Speech Application Programming Interface *n.* *See* SAPI.

speech recognition *n.* *See* voice recognition.

Speech Recognition API *n.* *See* SRAPI.

Speech Recognition Application Programming Interface *n.* *See* SRAPI.

speech synthesis *n.* The ability of a computer to produce "spoken" words. Speech synthesis is produced either by splicing together prerecorded words or by programming the computer to produce the sounds that make up spoken words. *See also* artificial intelligence, neural network, synthesizer.

spelling checker *n.* An application that employs a disk-based dictionary to check for misspellings in a document. *Also called:* spell checker.

spew *vb.* On the Internet, to post an excessive number of e-mail messages or newsgroup articles.

spider *n.* An automated program that searches the Internet for new Web documents and indexes their addresses and content-related information in a database, which can be examined for matches by a search engine. Spiders are generally considered to be a type of bot, or Internet robot.

Also called: crawler. *See also* bot (definition 3), search engine (definition 2).

spike *n.* A transient electrical signal of very short duration and usually high amplitude. *Compare* surge.

spindle *n.* **1.** An axle for mounting a disk or reel of magnetic tape. **2.** Any drive included within the chassis of a laptop or other portable computer. A laptop including a floppy disk drive and a hard drive would be considered a two-spindle machine.

spintronics *n.* An emerging field of study in electronics and physics that is based on the ability to detect and control the spin of electrons in magnetic materials. Using spintronics, it might eventually be possible to produce small, fast electronic devices, including transistors, memory devices, and quantum computers.

Spirale virus *n.* *See* Hybris virus.

splash screen *n.* A screen containing graphics, animation, or other attention-getting elements that appears while a program is loading or as an introductory page to a Web site. A splash screen used with an application typically contains a logo, version information, author credits, or a copyright notice, and it appears when a user opens a program and disappears when loading is complete. A splash screen used on a Web site serves as a front door, typically loading before any content-related pages.

spline *n.* In computer graphics, a curve calculated by a mathematical function that connects separate points with a high degree of smoothness. *See the illustration. See also* Bézier curve.

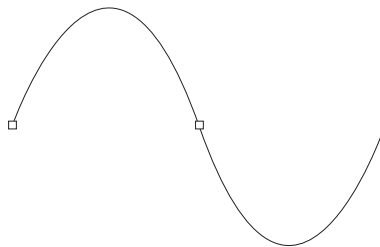

Spline.

split screen *n.* A display method in which a program can divide the display area into two or more sections, which can contain different files or show different parts of the same file.

spoiler *n.* A post to a newsgroup or mailing list that reveals what is intended to be a surprise, such as a plot twist in a film or television episode or the solution to a

S

game. The subject line should contain the word *spoiler*, but netiquette requires that the sender further protect readers who do not or cannot scan posts for subject lines in advance by encrypting the post, putting one or more screenfuls of white space above the text, or both. *See also* netiquette.

spoofing *n.* The practice of making a transmission appear to come from an authorized user. For example, in IP spoofing, a transmission is given the IP address of an authorized user in order to obtain access to a computer or network. *See also* IP address.

spool *vb.* To store a data document in a queue, where it awaits its turn to be printed. *See also* print spooler.

spot *n.* A “composite dot” produced through the halftone creation process on a PostScript printer that consists of a group of dots arranged in a pattern reflecting the gray level of a particular pixel. *See also* gray scale, halftone. *Compare* dot (definition 2).

spot color *n.* A method of handling color in a document in which a particular color of ink is specified and each page having elements in that color is printed as a separate layer. The printer then prints one layer for each spot color in the document. *See also* color model, color separation (definition 1), PANTONE MATCHING SYSTEM. *Compare* process color.

spot function *n.* The PostScript procedure used to create a given type of screen in a halftone. *See also* halftone, PostScript, spot.

SPP *n.* *See* scalable parallel processing.

spraycan *n.* An artist’s tool in Paintbrush or another graphics application for applying a pattern of dots to an image.

spreadsheet program *n.* An application commonly used for budgets, forecasting, and other finance-related tasks that organizes data values using cells, where the relationships between cells are defined by formulas. A change to one cell produces changes to related cells. Spreadsheet programs usually provide graphing capabilities for output and a variety of formatting options for text, numeric values, and graph features. *See also* cell (definition 1).

spread spectrum *adj.* Of or pertaining to a system of secure radio communication in which the content of a transmission is broken into split-second pieces, which are transmitted over separate frequencies. When a receiver identifies a spread spectrum signal, it reassembles it to its original form. Spread spectrum was invented

by the actress Hedy Lamarr in 1940, but it was not used until 1962.

Springboard *n.* Handspring Inc.’s expansion platform for its line of Visor handheld personal digital assistants. The term describes both the 68-pin Springboard socket incorporated into the Visor, as well as a series of add-on Springboard modules that fit into the socket. Add-on modules include features such as multimedia, games, e-books, additional memory storage, and a wireless phone module. *See also* Visor.

sprite *n.* In computer graphics, a small image that can be moved on the screen independently of other images in the background. Sprites are widely used in animation sequences and video games. *See also* object (definition 3).

sprocket feed *n.* A paper feed in which pins engage holes in the paper to move it through a printer. Pin feed and tractor feed are both sprocket feeds. *See also* paper feed, pin feed, tractor feed.

SPX *n.* **1.** Acronym for Sequenced Packet Exchange. The transport level (ISO/OSI level 4) protocol used by Novell NetWare. SPX uses IPX to transfer the packets, but SPX ensures that messages are complete. *See also* ISO/OSI reference model. *Compare* IPX. **2.** Acronym for **simplex**. *See* simplex.

SQL *n.* *See* structured query language.

square wave *n.* A blocklike waveform that is generated by a source that changes instantly between alternate states, usually at a single frequency. *See* the illustration. *Compare* sine wave.

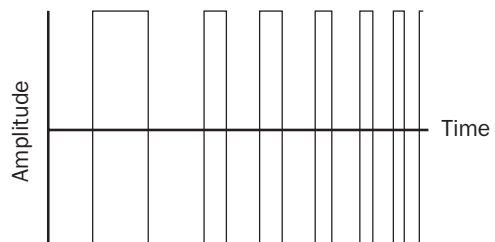

Square wave.

SRAM *n.* *See* static RAM.

SRAPI *n.* Acronym for Speech Recognition Application Programming Interface. A cross-platform application programming interface for speech recognition and text-to-speech functions supported by a consortium of developers including Novell, IBM, Intel, and Philips Dictation Sys-

tems. *See also* application programming interface, speech recognition.

SSA *n.* Acronym for **S**erial **S**torage **A**rchitecture. An interface specification from IBM in which devices are arranged in a ring topology. In SSA, which is compatible with SCSI devices, data can be transferred at up to 20 megabytes per second in each direction. *See also* SCSI device.

SSD *n.* Acronym for solid-state **d**isk. *See* solid-state disk drive.

SSE *n.* Short for **S**treaming **S**IMD **E**xtensions. A set of 70 new instructions implemented in Intel's Pentium III microprocessor. SSE, more formally called Internet SSE (ISSE), uses SIMD (single-instruction, multiple-data) operations to accelerate floating point calculations. Designed to improve performance in visual areas such as real-time 3-D and graphics rendering, SSE also provides support for development of such applications as real-time video and speech recognition. *See also* SIMD.

SSI *n.* **1.** *See* small-scale integration. **2.** *See* server-side include.

SSL *n.* Acronym for **S**ecure **S**ockets **L**ayer. A protocol developed by Netscape Communications Corporation for ensuring security and privacy in Internet communications. SSL supports authentication of client, server, or both, as well as encryption during a communications session. While primary purpose of SSL is to enable secure electronic financial transactions on the World Wide Web, it is designed to work with other Internet services as well. This technology, which uses public key encryption, is incorporated into the Netscape Navigator Web browser and Netscape's commerce servers. *See also* commerce server, open standard, public key encryption, PCT. *Compare* S-HTTP.

SSO *n.* *See* single sign-on.

ST506 interface *n.* The hardware signal specification developed by Seagate Technologies for hard-disk-drive controllers and connectors. The ST506/412 version of this interface has become a de facto standard.

stack *n.* A region of reserved memory in which programs store status data such as procedure and function call addresses, passed parameters, and sometimes local variables. *See also* pop, push (definition 1). *Compare* heap (definition 1).

stacking order *n.* The order in which layers in a digital graphic file are arranged. Foreground elements are typi-

cally stacked on top of background elements. Changes in stacking order can affect the way the final graphic is seen by the viewer. *See also* layering.

stack pointer *n.* A register that contains the current address of the top element of the stack. *See also* pointer (definition 1), stack.

stackware *n.* A HyperCard application consisting of a HyperCard data stack and HyperCard programming. *See also* HyperCard.

staging web *n.* A local Web site maintained on a file system or local Web server that currently cannot be browsed by site visitors. These Web sites allow authors and workgroups to make changes or updates to Web sites before they are published.

staging Web server *n.* A Web server where you publish and test your Web site before putting it on a production server. A staging Web server cannot be browsed by an Internet or intranet audience.

stairstepping *n.* A rough outline like the steps of a stair in a graphic line or curve that should be smooth. *Also called:* aliasing, jaggies.

stale link *n.* A hyperlink to an HTML document that has been deleted or moved, rendering the hyperlink useless. *See also* HTML document, hyperlink.

stale pointer bug *n.* *See* aliasing bug.

stand-alone or **standalone** *adj.* Of, pertaining to, or being a device that does not require support from another device or system, for example, a computer that is not connected to a network.

standard *n.* **1.** A de jure technical guideline advocated by a recognized noncommercial or government organization that is used to establish uniformity in an area of hardware or software development. The standard is the result of a formal process, based on specifications drafted by a cooperative group or committee after an intensive study of existing methods, approaches, and technological trends and developments. The proposed standard is later ratified or approved by a recognized organization and adopted over time by consensus as products based on the standard become increasingly prevalent in the market. Standards of this type are numerous, including the ASCII character set, the RS-232-C standard, the SCSI interface, and ANSI-standard programming languages, such as C and FORTRAN. *See also* ANSI, convention, RS-232-C standard,



SCSI. 2. A de facto technical guideline for hardware or software development that occurs when a product or philosophy is developed by a single company and, through success and imitation, becomes so widely used that deviation from the norm causes compatibility problems or limits marketability. This type of highly informal standard setting is exemplified by Hayes-compatible modems and IBM PC-compatible computers. *See also* compatibility (definition 3).

standard ASCII *n.* The set of characters assigned to ASCII (American Standard Code for Information Interchange) values between decimal 0 and 127 (hexadecimal 00 through 7F). These characters include most found on a standard keyboard, including the letters A–Z (uppercase and lowercase), numerals (0 through 9), and some special characters, such as colons and parentheses. Standard ASCII has for years been used as a near-universal “common language” in the PC environment for enabling different programs to exchange information reliably. *See also* ASCII. *Compare* Extended ASCII.

standard deviation *n.* In statistics, a measure of the dispersion of a group of measurements relative to the mean (average) of that group. Each score’s difference from the mean is squared, and the standard deviation is defined as the square root of the average of these squared values.

standard disclaimer *n.* A phrase placed in an e-mail message or news article that is intended to replace the statement required by some businesses and institutions that the contents of the message or article do not necessarily represent the opinions or policies of the organization from whose e-mail system the message originated.

standard function *n.* A function that is always available within a particular programming language. *See also* function (definition 1).

Standard Generalized Markup Language *n.* *See* SGML.

standby *n.* A state in which your computer consumes less power when it is idle but remains available for immediate use. While your computer is on standby, information in computer memory is not saved on your hard disk. If there is an interruption in power, the information in memory is lost.

star *n.* *See* *.

star bus *n.* A network topology in which nodes connect to hubs in a star pattern, but the hubs are connected by a bus trunk. Star bus is a combination of star and bus topologies.

star-dot-star or **star dot star** *n.* A file specification (*.*) using the asterisk wildcard, which means “any combination of file name and extension” in operating systems such as MS-DOS. *See also* *.* , asterisk, wildcard character.

star network *n.* A LAN (local area network) in which each device (node) is connected to a central computer in a star-shaped configuration (topology); commonly, a network consisting of a central computer (the hub) surrounded by terminals. *See* the illustration. *Compare* bus network, ring network.

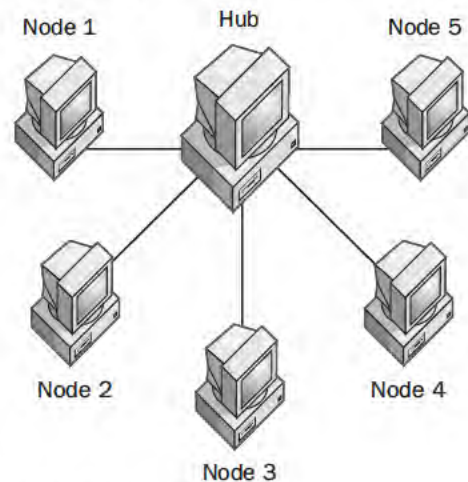

Star network.

start bit *n.* In asynchronous transmission, the bit (actually, a timing signal) that represents the beginning of a character. *See also* asynchronous transmission. *Compare* parity bit, stop bit.

Start button *n.* In Microsoft Windows 9x and Windows NT 4 and later, the control on the desktop task bar that opens the main menu.

starting point *n.* A World Wide Web document designed to help users begin navigating the Web. A starting point often contains tools such as search engines and hyperlinks to selected Web sites. *See also* hyperlink, search engine (definition 2), World Wide Web.

star topology *n.* A network configuration based on a central hub, from which nodes radiate in a star-shaped pattern. *See also* topology.

start page *n.* *See* home page (definition 2).

S

start/stop transmission *n.* See asynchronous transmission.

startup *n.* See boot¹.

startup application *n.* On the Macintosh, the application that takes control of the system when the computer is turned on.

STARTUP.COMD *n.* A special-purpose batch file stored in the root directory of the startup disk in OS/2—the OS/2 equivalent of an MS-DOS AUTOEXEC.BAT file.

startup disk *n.* See system disk.

startup ROM *n.* The bootstrap instructions coded into a computer's ROM (read-only memory) and executed at startup. The startup ROM routines enable a computer to check itself and its devices (such as the keyboard and disk drives), prepare itself for operation, and run a short program to load an operating-system loader program. See also boot¹, power-on self test.

startup screen *n.* A text or graphics display that appears on the screen when a program is started (run). Startup screens usually contain information about the software's version and often contain a product or corporate logo.

star-wired ring *n.* A network topology in which hubs and nodes connect to a central hub in typical star fashion, but the connections within the central hub form a ring. Star-wired ring is a combination of star and ring topologies.

state *n.* See status.

stateful *adj.* Of or pertaining to a system or process that monitors all details of the state of an activity in which it participates. For example, stateful handling of messages takes account of their content. Compare stateless.

stateless *adj.* Of or pertaining to a system or process that participates in an activity without monitoring all details of its state. For example, stateless handling of messages might take account of only their sources and destinations but not their content. Compare stateful.

statement *n.* The smallest executable entity within a programming language.

state-of-the-art *adj.* Up to date; at the forefront of current hardware or software technology.

static¹ *adj.* In information processing, fixed or predetermined. For example, a static memory buffer remains invariant in size throughout program execution. The opposite condition is *dynamic*, or ever-changing.

static² *n.* In communications, a crackling noise caused by electrical interference with a transmitted signal. See also noise (definition 2).

static allocation *n.* Apportionment of memory that occurs once, usually when the program starts. The memory remains allocated during the program's execution and is not deallocated until the program is finished. See also allocate, deallocate. Compare dynamic allocation.

static binding *n.* Binding (converting symbolic addresses in the program to storage-related addresses) that occurs during program compilation or linkage. Also called: early binding. Compare dynamic binding.

static buffer *n.* A secondary sound buffer that contains an entire sound; these buffers are convenient because the entire sound can be written once to the buffer. See also streaming buffer.

static electricity *n.* An electrical charge accumulated in an object. Although generally harmless to humans, the discharge of static electricity through an electronic circuit can cause severe damage to the circuit.

static RAM *n.* A form of semiconductor memory (RAM) based on the logic circuit known as a flip-flop, which retains information as long as there is enough power to run the device. Static RAMs are usually reserved for use in caches. Acronym: SRAM. See also cache, RAM, synchronous burst static RAM. Compare dynamic RAM.

static routing *n.* Routing based on a fixed forwarding path. Unlike dynamic routing, static routing does not adjust to changing network conditions. Compare dynamic routing.

static Web page *n.* Web page that displays the same content to all viewers. Usually written in hypertext markup language (HTML), a static Web page displays content that changes only if the HTML code is altered. See also dynamic Web page.

station *n.* 1. In the IEEE 802.11 wireless LAN specification, a single, often mobile, node. 2. See workstation.

stationery¹ *adj.* Describing a type of document that, when opened by the user, is duplicated by the system; the copy is opened for the user's modification while the original document remains intact. Stationery documents can be used as document templates or boilerplates. See also boilerplate, template (definition 5).

stationery² *n.* A stationery document. See also stationery¹.

S

statistical multiplexer *n.* A multiplexing device that adds intelligence to time-division multiplexing by using buffering (temporary storage) and a microprocessor to combine transmission streams into a single signal and to allocate available bandwidth dynamically. *Also called:* stat mux. *See also* dynamic allocation, multiplexing, time-division multiplexing.

statistics *n.* The branch of mathematics that deals with the relationships among groups of measurements and with the relevance of similarities and differences in those relationships. *See also* binomial distribution, Monte Carlo method, probability, regression analysis, standard deviation, stochastic.

stat mux *n.* *See* statistical multiplexer.

status *n.* The condition at a particular time of any of numerous elements of computing—a device, a communications channel, a network station, a program, a bit, or other element—used to report on or to control computer operations.

status bar *n.* In Windows 9x and Windows NT 4 and later, a space at the bottom of many program windows that contains a short text message about the current condition of the program. Some programs also display an explanation of the currently selected menu command in the status bar. *See* the illustration.

Page 2 Sec 1 2/46 At 4" Ln 19 Col 9

Status bar.

status codes *n.* Strings of digits or other characters that indicate the success or failure of some attempted action. Status codes were commonly used to report the results of early computer programs, but most software today uses words or graphics. Internet users, especially those with UNIX shell accounts, are likely to encounter status codes while using the Web or FTP. *See also* HTTP status codes.

steganography *n.* A “hide-in-plain-sight” technique for concealing information by embedding a message within an innocuous cover message. In steganography, bits of unnecessary data within an image, sound, text, or even a blank file are replaced with bits of invisible information. The term steganography comes from the Greek for “covered writing” and has traditionally included any method of secret communication that conceals the existence of the message. Because steganography cannot be detected by decryption software, it is often used to replace or supplement encryption.

step-frame *n.* The process of capturing video images one frame at a time. This process is used by computers that are too slow to capture analog video images in real time.

stepper motor *n.* A mechanical device that rotates only a fixed distance each time it receives an electrical pulse. A stepper motor is part of a disk drive.

step-rate time *n.* The time required to move a disk actuator arm from one track to the next. *See also* actuator, stepper motor.

stereogram *n.* *See* autostereogram.

sticky *adj.* In reference to a Web site, properties such as targeted content or services that increase the amount of time users choose to spend at the site and increase user’s desire to return to the site repeatedly.

StickyKeys *n.* An accessibility feature built into Macintosh and Windows computers that causes modifier keys such as Shift, Control, or Alt to “stay on” after they are pressed, eliminating the need to press multiple keys simultaneously. This feature facilitates the use of modifier keys by users who are unable to hold down one key while pressing another.

stochastic *adj.* Based on random occurrences. For example, a stochastic model describes a system by taking into account chance events as well as planned events.

stop bit *n.* In asynchronous transmission, a bit that signals the end of a character. In early electromechanical teleprinters, the stop bit provided time for the receiving mechanism to coast back to the idle position and, depending on the mechanism, had a duration of 1, 1.5, or 2 data bits. *See also* asynchronous transmission. *Compare* parity bit, start bit.

Stop error *n.* A serious error that affects the operating system and that could place data at risk. The operating system generates an obvious message, a screen with the Stop error, rather than continuing on and possibly corrupting data. *Also called:* blue screen error, fatal system error. *See also* Blue Screen of Death.

storage *n.* In computing, any device in or on which information can be kept. Microcomputers have two main types of storage: random access memory (RAM) and disk drives and other external storage media. Other types of storage include read-only memory (ROM) and buffers.

storage area network *n.* A high-speed network that provides a direct connection between servers and storage, including shared storage, clusters, and disaster-recovery

devices. A storage area network, or SAN, includes components such as hubs and routers that are also used in local area networks (LANs), but it differs in being something of a “subnetwork” dedicated to providing a high-speed connection between storage elements and servers. Most SANs rely on fiber-channel connections that deliver speeds up to 1000 Mbps and can support up to 128 devices. SANs are implemented to provide the scalability, speed, and manageability required in environments that demand high data availability. *Acronym: SAN. Also called: system area network.*

storage device *n.* An apparatus for recording computer data in permanent or semipermanent form. When a distinction is made between primary (main) storage devices and secondary (auxiliary) storage devices, the former refers to random access memory (RAM) and the latter refers to disk drives and other external devices.

storage location *n.* The position at which a particular item can be found—either an addressed location or a uniquely identified location on a disk, tape, or similar medium.

storage media *n.* The various types of physical material on which data bits are written and stored, such as floppy disks, hard disks, tape, and optical discs.

storage tube *n.* *See* direct view storage tube.

store-and-forward *n.* A method of delivering transmissions in which messages are held temporarily by an intermediary before being sent on to their destination. Store and forward is used by some switches in delivering packets to their destinations. *Compare* cut-through switch.

stored procedure *n.* A precompiled collection of SQL statements and optional control-of-flow statements stored under a name and processed as a unit. They are stored in an SQL database and can be run with one call from an application.

stored program concept *n.* A system architecture scheme, credited largely to the mathematician John von Neumann, in which both programs and data are in direct-access storage (random access memory, or RAM), thereby allowing code and data to be treated interchangeably. *See also* von Neumann architecture.

storefront *n.* *See* virtual storefront.

storm *n.* On a network, a sudden, excessive burst of traffic. Storms are often responsible for network outages.

STP *n.* Acronym for shielded twisted pair. A cable consisting of one or more twisted pairs of wires and a sheath

of foil and copper braid. The twists protect the pairs from interference by each other, and the shielding protects the pairs from interference from outside. Therefore, STP cable can be used for high-speed transmission over long distances. *See also* twisted-pair cable. *Compare* UTP.

straight-line code *n.* Program code that follows a direct sequence of statements rather than skipping ahead or jumping back via transfer statements such as GOTO and JUMP. *See also* GOTO statement, jump instruction. *Compare* spaghetti code.

stream¹ *n.* Any data transmission, such as the movement of a file between disk and memory, that occurs in a continuous flow. Manipulating a data stream is a programming task. Consumers, however, are likely to encounter references to streams and streaming in connection to the Internet, which has increased reliance on stream techniques to enable users (even those with slower equipment) to access large multimedia files—especially those containing audio and video components—and to display or play them before all the data has been transferred.

stream² *vb.* To transfer data continuously, beginning to end, in a steady flow. Many aspects of computing rely on the ability to stream data: file input and output, for example, and communications. If necessary, an application receiving a stream must be able to save the information to a buffer in order to prevent loss of data. On the Internet, streaming enables users to begin accessing and using a file before it has been transmitted in its entirety.

stream cipher *n.* A method for encrypting a data sequence of unlimited length using a key of fixed length. *See also* key (definition 3). *Compare* block cipher.

streaming *n.* **1.** On the Internet, the process of delivering information, especially multimedia sound or video, in a steady flow that the recipient can access as the file is being transmitted. **2.** In magnetic tape storage devices, a low-cost technique to control the motion of the tape by removing tape buffers. Although streaming tape compromises start/stop performance, it achieves highly reliable storage and retrieval of data, and is useful when a steady supply of data is required by a particular application or computer.

streaming buffer *n.* A small sound buffer that can play lengthy sounds because the application dynamically loads audio data into the buffer as it plays. For example, an application could use a buffer that can hold 3 seconds of audio data to play a 2-minute sound. A streaming buffer requires much less memory than a static buffer. *See also* static buffer.

S

Streaming Server *n.* A server technology designed by Apple Computer to send streaming QuickTime media files over the Internet. Built on RTP and RTSP standard Internet protocols, Streaming Server can set up a QuickTime streaming media Web broadcasting station capable of streaming digital videos and music files to more than 3000 users via the Internet. Streaming Server may be used with Mac OS X and other UNIX-based operating systems. *Also called:* Darwin Streaming Server, QuickTime Streaming Server.

streaming tape *n.* *See* tape (definition 1).

stream interface device driver *n.* A user-level DLL that controls devices connected to a Windows CE-based platform. A stream interface device driver presents the services of a hardware device to applications by exposing Win32 stream interface functions. Stream interface drivers also can control devices built into a Windows CE-based platform, depending on the software architecture for the drivers. *Also called:* installable device driver.

stream-oriented file *n.* A file used to store a fairly continuous series of bits, bytes, or other small, structurally uniform units.

street price *n.* The actual retail or mail-order price of a consumer hardware or software product. In most cases, the street price is somewhat lower than the “suggested retail price.”

stress test *n.* A test of a software or hardware system’s functional limits, performed by subjecting the system to extreme conditions, such as peak volumes of data or extremes in temperature.

strikethrough *n.* One or more lines drawn through a selected range of text, usually to show deletion or the intent to delete. *See* the illustration.

s ~~strikethrough~~

Strikethrough.

string *n.* A data structure composed of a sequence of characters usually representing human-readable text.

string variable *n.* An arbitrary name assigned by the programmer to a string of alphanumeric characters and used to reference that entire string. *See also* string.

stripe *vb.* *See* disk striping.

stripe pitch *n.* The distance, measured horizontally, between bands of phosphor that are the same color on a cathode ray tube (CRT) display based on aperture grill technology. Although the measurements are based on different methods of applying phosphor to the screen surface, stripe pitch is comparable to dot pitch, the measurement used with CRTs based on shadow mask technology. *See also* aperture grill, CRT, mask (definition 2). *Compare* dot pitch, slot pitch.

striping *n.* A means of protecting data on a network by spreading it across multiple disks. In the most commonly used approach, striping is combined with parity (error-correcting information) to ensure that if some portion of the data is lost, it can be reconstructed. Striping is implemented in RAID security. *See also* RAID. *Compare* disk mirroring.

strobe *n.* A timing signal that initiates and coordinates the passage of data, typically through an input/output (I/O) device interface, such as a keyboard or printer.

stroke *n.* **1.** In data entry, a keystroke—a signal to the computer that a key has been pressed. **2.** In typography, a line representing part of a letter. **3.** In paint programs, a “swipe” of the brush made with the mouse or keyboard in creating a graphic. **4.** In display technology, a line created as a vector (a path between two coordinates) on a vector graphics display (as opposed to a line of pixels drawn dot by dot on a raster graphics display).

stroke font *n.* A font printed by drawing a combination of lines rather than by filling a shape, as with an outline font. *Compare* outline font.

stroke weight *n.* The width, or thickness, of the lines (strokes) that make up a character. *See also* font.

stroke writer *n.* In video, a display unit that draws characters and graphic images as sets of strokes—lines or curves connecting points—rather than as sets of dots, as on a typical raster-scan monitor. *See also* vector graphics.

StrongARM *n.* The architecture underlying Intel’s low-power, high-performance SA microprocessors. StrongARM is based on the 32-bit RISC architecture licensed by ARM Limited. StrongARM-based SA microprocessors support a number of platforms, including Windows CE and Java, and are designed for use in four primary areas:

smart portable devices, such as cellular phones and hand-held computers; Internet access devices, such as set-top boxes; networking devices, such as switches and routers; and embedded controls, such as entertainment devices and automation equipment. *See also* ARM.

strong name *n.* A name that consists of an assembly's identity: its simple text name, version number, and often the culture information strengthened by a public key and a digital signature generated over the assembly. Assemblies with the same strong name are expected to be identical.

strong typing *n.* A characteristic of a programming language that does not allow the program to change the data type of a variable during program execution. *See also* data type, variable. *Compare* weak typing.

structure *n.* **1.** The design and composition of a program, including program flow, hierarchy, and modularity. **2.** A collection of data elements. *See also* data structure.

structured graphics *n.* *See* object-oriented graphics.

structured programming *n.* Programming that produces programs with clean flow, clear design, and a degree of modularity or hierarchical structure. *See also* modular programming, object-oriented programming. *Compare* spaghetti code.

structured query language *n.* A database sublanguage used in querying, updating, and managing relational databases—the de facto standard for database products. *Acronym:* SQL.

structured walkthrough *n.* **1.** A meeting of programmers working on different aspects of a software development project, in which the programmers attempt to coordinate the various segments of the overall project. The goals, requirements, and components of the project are systematically reviewed in order to minimize the error rate of the software under development. **2.** A method for examining a computer system, including its design and implementation, in a systematic fashion.

STT *n.* *See* Secure Transaction Technology.

stub *n.* A routine that contains no executable code and that generally consists of comments describing what will eventually be there; it is used as a placeholder for a routine to be written later. *Also called:* dummy routine. *See also* top-down programming.

Stuffit *n.* A file compression program originally written for the Apple Macintosh, used for storing a file on one or

more disks. Originally shareware, StuffIt is now a commercial product for Macs and PCs that supports multiple compression techniques and allows file viewing. StuffIt files can be uncompressed using a freeware program, StuffIt Expander.

style sheet *n.* **1.** A file of instructions used to apply character, paragraph, and page layout formats in word processing and desktop publishing. **2.** A text file containing code to apply semantics such as page layout specifications to an HTML document. *See also* HTML document, semantics (definition 1).

stylus *n.* A pointing device, similar to a pen, used to make selections, usually by tapping, and to enter information on the touch-sensitive surface.

subclass *n.* A class in object-oriented programming that is derived from, and inherits its attributes and methods from, another class known as a superclass. *Compare* superclass.

subcommand *n.* A command in a submenu (a menu that appears when a user selects an option in a higher-level menu).

subdirectory *n.* A directory (logical grouping of related files) within another directory.

subdomain *n.* A domain, often representing an administrative or other organizational subgroup within a second-level domain. *See also* domain.

subform *n.* A form contained within another form or a report.

subject drift *n.* *See* topic drift.

subject tree *n.* A type of World Wide Web index that is organized by subject categories, many of which are broken down into subcategories, or “branches.” An example of a World Wide Web subject tree is Yahoo! *See also* Yahoo!

submarining *n.* A phenomenon that occurs when some part of a screen display moves more quickly than the screen can show. The object (such as the mouse pointer) disappears from the screen and reappears where it comes to rest, just as a submarine resurfaces after a dive. Submarining is especially a problem with the slowly responding passive-matrix LCD displays on many laptop computers.

submenu *n.* A menu that appears as the result of the selection of an item on another, higher-level menu.



subnet *n.* **1.** In general, a network that forms part of a larger network. **2.** In terms of the ISO/OSI reference model, the subnet comprises the layers below the transport layer—that is, the network, data link, and physical layers.

subnet mask *n.* *See* address mask.

subnetting *n.* The division of a network into subnets to improve network security and performance. *See also* subnet (definition 1). *Compare* supernetting.

subnetwork *n.* A network that is part of another, larger network.

subnotebook *n.* A class of portable computer that is smaller in size and lighter in weight than a full-sized laptop. Subnotebooks feature a reduced-sized keyboard and screen and often use an external floppy drive to save space and weight. Despite their size, subnotebooks retain all the functions of a full-sized portable computer.

subportable *n.* *See* subnotebook.

subprogram *n.* A term used in some languages for *routine* (procedure or function) because the structure and syntax of a subprogram closely model those of a program. *See also* program, routine.

subreport *n.* A report contained within another report.

subroutine *n.* A common term for *routine*, likely to be used in reference to shorter, general, frequently called routines. *See also* procedure, routine.

subschemata *n.* The definition of a user view of the database (in CODASYL/DBTG systems only), roughly equivalent to the external schema of an ANSI/X3/SPARC database management system or to a view in a relational database management system. *See also* schema.

subscribe *vb.* **1.** To add a newsgroup to the list of such groups from which a user receives all new articles. **2.** To add a name to a LISTSERV distribution list. *See also* LISTSERV.

Subscriber Identity Module card *n.* *See* SIM card.

subscript *n.* **1.** One or more characters printed slightly below the baseline of surrounding text. *See also* baseline. *Compare* superscript. **2.** In programming, one or more numbers or variables that identify the location of an element in an array. *See also* array, index (definition 2).

subscription site *n.* E-commerce Web site that provides information or services to customers who pay a subscription fee.

substrate *n.* The inactive supporting material used in a manufacturing process. In circuit boards, it is the base to which the traces (foil areas) are attached. In tapes and disks, it is the material on which the magnetic particles are fused.

substring *n.* A sequential section of a string. *See also* string.

subtransaction *n.* *See* nested transaction.

subtree *n.* Any node within a tree, along with any selection of connected descendant nodes. *See also* node (definition 3), tree.

subweb *n.* A named subdirectory of the root Web site that is a complete FrontPage-based Web site. Each subweb can have independent administration, authoring, and browsing permissions from the root Web site and other subwebs.

suitcase *n.* A file on Macintosh computers that contains one or more fonts or desk accessories. In early versions of the operating system, such files are indicated with the icon of a suitcase. *See also* font suitcase.

suite *n.* **1.** A set of application programs sold as a package, usually at a lower price than that of the individual applications sold separately. A suite for office work, for example, might contain a word processing program, a spreadsheet, a database management program, and a communications program. **2.** *See* protocol suite.

summarize *vb.* To post the results of a survey or vote in short form to a newsgroup or mailing list after collecting the results by e-mail.

SunOS *n.* Short for **Sun Operating System**. A variety of the UNIX operating system used on workstations from Sun Microsystems, Inc.

superclass *n.* A class in object-oriented programming from which another class—a subclass—is derived. The subclass inherits its attributes and methods from the superclass. *Compare* subclass.

supercomputer *n.* A large, extremely fast, and expensive computer used for complex or sophisticated calculations. *See also* computer.

superconductor *n.* A substance that has no resistance to the flow of electricity.

SuperDrive *n.* An Apple 3.5-inch disk drive that can read and write in both Apple Macintosh (400K and 800K) and MS-DOS/Windows (720K and 1.44-MB) formats.

S

super-large-scale integration *n.* A reference to the density with which components (transistors and other elements) are packed onto an integrated circuit and to the fineness of the connections between them. The actual number of components is nonspecific, but generally considered to be in of 50,000 to 100,000 range. *Acronym:* SLSI. *See also* integrated circuit. *Compare* large-scale integration, medium-scale integration, small-scale integration, ultra-large-scale integration, very-large-scale integration.

superminicomputer *n.* *See* computer.

supernetting *n.* The aggregation of multiple network addresses of the same class into a single block. *See also* classless interdomain routing, IP address classes. *Compare* subnetting.

superpipelining *n.* A method of preprocessing used by some microprocessors in which two or more of a microprocessor's execution stages (fetch, decode, execute, and write-back) are divided into two or more pipelined stages, resulting in higher performance. *See also* DECchip 21064, pipelining (definition 1).

superscalar *adj.* Of, pertaining to, or being a microprocessor architecture that enables the microprocessor to execute multiple instructions per clock cycle. *See also* CISC, RISC.

superscript *n.* A character printed slightly above the surrounding text, usually in smaller type. *Compare* subscript (definition 1).

superserver *n.* A network server with especially high capabilities for speed and data storage. *See also* server (definition 1).

superstitial *n.* An Internet ad format that downloads in the background while a user is viewing a Web page and then plays in a pop-up window when triggered by a mouse click or a break in surfing. Because the superstitial doesn't appear until it has completely downloaded and temporarily cached itself on the user's system, attention-getting effects like animation, sound, and large graphics can be used without slowing down the ad. Unicast developed the "polite cache and play" technology used with the superstitial ad format.

supertwist display *n.* A form of passive-matrix liquid crystal displays (LCDs) that rotates polarized light as it passes through liquid crystal molecules in which the top and bottom orientations of the molecules causes them to twist 180 to 270 degrees. This technology is used to

improve contrast and widen the screen's viewing angle. Supertwist displays, also known as supertwist nematic displays, are widely used and are less expensive than active-matrix displays. Different forms of supertwist displays include DSTN (double supertwist nematic), which is based on two supertwist layers with opposite twist directions, and CSTN (color supertwist nematic), which produces wide-angle, high-quality color. *Nematic* refers to microscopic threadlike bodies characteristic of the liquid crystals used in these displays. Supertwist displays are widely used in cellular telephones and other devices that may be used in low-light environments. *Also called:* color supertwist nematic display, CSTN, double supertwist nematic, DSTN, twisted nematic display. *See also* twisted nematic display.

superuser *n.* A UNIX user account with root (i.e., unrestricted) access privileges, usually that of a system administrator. *See also* root account, system administrator, user account.

super VAR *n.* Short for **super value-added reseller**. A large value-added reseller. *See also* value-added reseller.

Super VGA *n.* *See* SVGA.

supervisor *n.* **1.** *See* operating system. **2.** A metaoperating system under which several operating systems are active. *See also* metaoperating system.

supervisor state *n.* The most privileged of the modes in which a Motorola 680x0 microprocessor can operate. Every operation of which the microprocessor is capable can be executed in the supervisor state. *See also* privileged mode. *Compare* user state.

support¹ *n.* Assistance, such as technical advice provided to customers.

support² *vb.* To work with another program or product; for example, an application might support file transfers from another program.

surf *vb.* To browse among collections of information on the Internet, in newsgroups, in Gopherspace, and especially on the World Wide Web. As in channel surfing while watching television, users ride the wave of what interests them, jumping from topic to topic or from one Internet site to another. *Also called:* cruise.

surface modeling *n.* A display method used by some CAD programs that gives on-screen constructions the appearance of solidity. *See also* CAD. *Compare* solid model, wire-frame model.

S

surface-mount technology *n.* A method of manufacturing printed circuit boards in which chips are fixed directly to the surface of the board instead of being soldered into holes predrilled to hold them. Its advantages are compactness, resistance to vibration, and the capacity for dense interconnections on both sides of the board. *Acronym:* SMT. *Compare* DIP, leadless chip carrier, pin grid array.

surge *n.* A sudden—and possibly damaging—increase in line voltage. *See also* surge protector, voltage regulator. *Compare* power failure, spike.

surge protector *n.* A device that prevents surges from reaching a computer or other kinds of electronic equipment. *Also called:* surge suppressor. *See also* surge, transient suppressor.

surge suppressor *n.* *See* surge protector.

suspend *vb.* To halt a process temporarily. *See also* sleep².

Suspend command *n.* A power management feature of Windows 9x and Windows NT 4 and later for portable computers. Clicking on the Suspend command in the Start menu allows the user to temporarily suspend operations of the machine (enter “Suspend mode”) without turning the power off, saving battery power without having to restart applications or reload data.

suspend mode *n.* *See* sleep mode.

sustained transfer rate *n.* A measure of the speed at which data can be transferred to a storage device such as a disk or a tape. The sustained transfer rate is the data transfer speed that can be kept up by the device for an extended period of time.

SVC *n.* Acronym for switched virtual circuit. A logical connection between two nodes on a packet-switching network that is established only when data is to be transmitted. *See also* node (definition 1), packet switching. *Compare* PVC.

SVG *n.* Acronym for Scalable Vector Graphics. An XML-based language for device-independent description of two-dimensional graphics. SVG images maintain their appearance when printed or when viewed with different screen sizes and resolutions. SVG is a recommendation of the World Wide Web Consortium (W3C).

SVGA *n.* Acronym for Super Video Graphics Array. A video standard established by the Video Electronics Standards Association (VESA) in 1989 to provide high-resolution color display on IBM-compatible computers.

Although SVGA is a standard, compatibility problems can occur with the video BIOS. *See also* BIOS, video adapter.

S-video connector *n.* A hardware interface for video devices that handles chrominance (color) and luminance (black and white) separately. An S-video connector is capable of providing a sharper image than those achieved with systems using RCA-type, or composite, connectors.

S/WAN *n.* *See* secure wide area network.

swap *vb.* **1.** To exchange one item for another, as in swapping floppy disks in and out of a single drive. **2.** To move segments of programs or data between memory and disk storage. *See also* virtual memory.

swap file *n.* A hidden file on the hard drive that Windows uses to hold parts of programs and data files that do not fit in memory. The operating system moves data from the swap file to memory as needed and moves data out of memory to the swap file to make room for new data. The swap file is a form of virtual memory. *See also* memory, virtual memory.

swap-on-the-fly *n.* In Linux, a process which allows swap space to be added as needed. Swap-on-the-fly allows a swap file to be created at any time on any available disk, and active only until the system is shut down.

swapping *n.* **1.** A technique for enabling an operating system, and therefore a computer, to address—roughly, have available—more memory than is physically present in the system. Swapping in this sense (as opposed to swapping disks in and out of a drive, for example) involves moving blocks of information in units known as pages between memory and disk as they are needed during the execution of the application. Swapping is supported by operating systems such as Windows NT and later, Windows 9x and later, OS/2, and Linux. **2.** A technique for moving entire processes in and out of main memory. **3.** In programming, the process of exchanging two values—for example, exchanging values between two variables. *See also* page (definition 2), swap, swap file, virtual memory.

swap space *n.* *See* swap file.

swarm intelligence *n.* An emerging subfield of artificial intelligence that relies on the collective knowledge of relatively simple particles or agents. Based loosely on the principles of social insect colonies, it seeks to apply the collective intelligence of fragmented agents or groups. It emphasizes distributedness, direct or indirect interactions, flexibility, and robustness. Successful appli-

S

cations of its principles have been evidenced in communications networks, and robotics. *See also* artificial intelligence, robotics.

Swatch *n.* Short for **Simple Watcher**. A UNIX log monitoring and alarm program. Swatch filters system log data as specified by the user, forwarding only important data. Swatch also looks for patterns of changes made in the log file and alerts the user to system problems as they occur.

swim *n.* A condition in which images slowly move about the positions they are supposed to occupy on screen.

SWING set *n.* A library of Java GUIs that run uniformly on any native platform that supports the Java Virtual Machine (JVM). Swing Set components have largely supplanted Sun Microsystems's Abstract Window Toolkit. *See also* Abstract Window Toolkit, graphical user interface, Java Virtual Machine.

switch *n.* **1.** A circuit element that has two states: on and off. **2.** A control device that allows the user to choose one of two or more possible states. **3.** In communications, a computer or electromechanical device that controls routing and operation of a signal path. **4.** In networking, a device capable of forwarding packets directly to the ports associated with particular network addresses. *See also* bridge, multilayer, router. **5.** In operating systems such as MS-DOS, an argument used to control the execution of a command or an application, typically starting with a slash character (/).

switch box *n.* An enclosure that contains a selector switch. When a user selects a switch setting, the signal passing through the box may be directed either from a single input to one of multiple outputs, or from the selected input to a single output. Switch boxes are often used to connect multiple peripherals, such as printers, to a single port.

switched configuration *n.* A communications link in which a signal moves from the origin to a switch that routes the signal to one of several possible destinations. *Compare* point-to-point configuration.

switched Ethernet *n.* An Ethernet network run through a high-speed switch instead of an Ethernet hub. A switched Ethernet involves dedicated bandwidth of 10 Mbps between stations rather than a shared medium. *See also* Ethernet (definition 1), switch (definition 3).

switched line *n.* A standard dial-up telephone connection; the type of line established when a call is routed through a switching station. *Compare* leased line.

Switched Multimegabit Data Services *n.* *See* SMDS.

switched network *n.* A communications network that uses switching to establish a connection between parties, such as the dial-up telephone system.

Switched T1 *n.* A circuit-switched form of T1 communications. *See also* T1.

switched virtual circuit *n.* *See* SVC.

Switcher *n.* A special Macintosh utility that allowed more than one program to be resident in memory at one time. Switcher was made obsolete by MultiFinder. *See also* MultiFinder.

switching *n.* A communications method that uses temporary rather than permanent connections to establish a link or to route information between two parties. In the dial-up telephone network, for example, a caller's line goes to a switching center, where the actual connection is made to the called party. In computer networks, message switching and packet switching allow any two parties to exchange information. In both instances, messages are routed (switched) through intermediary stations that together serve to connect the sender and the receiver.

switching hub *n.* A central device (switch) that connects separate communication lines in a network and routes messages and packets among the computers on the network. The switch functions as a hub, or PBX, for the network. *See also* hub, packet (definition 1), PBX, switch (definition 3), switched Ethernet, switched network.

switching speed *n.* In a packet-switching telecommunications technology, such as ATM, the speed at which data packets are sent through the network. Switching speed is generally measured in kilobits or megabits per second. *See also* ATM (definition 1), packet switching.

SYLK file *n.* Short for **symbolic linkfile**. A file constructed with a proprietary Microsoft format, used primarily for exchanging spreadsheet data in such a way that formatting information and intercellular data value relationships are preserved.

symbol *n.* In programming, a name that represents a register, an absolute value, or a memory address (relative or absolute). *See also* identifier, operator (definition 1).

symbol font *n.* A special font or typeface that replaces the characters normally accessible from the keyboard with alternative characters used as symbols, such as scientific, linguistic, or foreign-alphabet characters.

S

symbolic address *n.* A memory address that can be referred to in a program by name rather than by number.

symbolic coding *n.* The expression of an algorithm in words, decimal numbers, and symbols rather than in binary numbers, so that a person can read and understand it. Symbolic coding is used in high-level programming languages. *See also* algorithm, high-level language.

symbolic language *n.* A computer language that uses symbols such as keywords, variables, and operators to form instructions. All computer languages except machine language are symbolic.

symbolic link *n.* A disk directory entry that takes the place of a directory entry for a file but is actually a reference to a file in a different directory. *Also called:* alias, shortcut, soft link, symlink.

symbolic logic *n.* A representation of the laws of reasoning, so named because symbols rather than natural-language expressions are used to state propositions and relationships. *See also* logic.

symbol set *n.* Any collection of symbols legitimized by a data-coding system, such as extended ASCII, or a programming language.

symbol table *n.* A list of all identifiers encountered when a program is compiled (or assembled), their locations in the program, and their attributes, such as variable, routine, and so on. *See also* compile, identifier, linker, module (definition 1), object code.

symlink *n.* *See* symbolic link.

symmetric digital subscriber line *n.* *See* SDSL.

symmetric multiprocessing *n.* *See* SMP.

symmetric multiprocessing server *n.* *See* SMP server.

SYN *n.* Short for **synchronous** idle character. A character used in synchronous (timed) communications that enables the sending and receiving devices to maintain the same timing. *Also called:* sync character.

sync character *n.* *See* SYN.

syncDRAM *n.* *See* SDRAM.

synchronization *n.* **1.** In networking, a communications transmission in which multibyte packets of data are sent and received at a fixed rate. *See also* packet (definition 1). **2.** In networking, the matching of timing between computers on the network. All of the computers are generally assigned identical times to facilitate and coordinate com-

munications. **3.** In a computer, the matching of timing between components of the computer so that all are coordinated. For instance, operations performed by the operating system are generally synchronized with the signals of the machine's internal clock. *See also* clock (definition 1), operating system. **4.** In application or database files, version comparisons of copies of the files to ensure they contain the same data. **5.** In multimedia, precise real-time processing. Audio and video are transmitted over a network in synchronization so that they can be played back together without delayed responses. *See also* real-time. **6.** In handheld computing, the process of updating or backing up the data on a handheld computer to the linked software applications on a desktop computer. Data changes made on the desktop computer may also be copied to the handheld during synchronization. *See also* partnership.

synchronization signal *n.* *See* sync signal.

synchronize *vb.* To cause to occur at the same time.

Synchronized Multimedia Integration Language *n.* *See* SMIL.

synchronous *adj.* Occurring at the same time. In computer transmissions, a reference to activity governed by a clock or by synchronized timing.

synchronous burst static RAM *n.* A type of static RAM that is synchronized with the system clock. Synchronous burst static RAM is used in a computer's L2 cache, where frequently accessed information is stored for fast retrieval by the CPU. Synchronous burst static RAM is faster than asynchronous static RAM but is limited to a maximum bus speed of 66 MHz. Computers running at faster speeds can use another form of cache memory known as pipeline burst static RAM. *Also called:* sync SRAM. *See also* L2 cache, static RAM. *Compare* asynchronous static RAM, dynamic RAM, pipeline burst static RAM.

synchronous communications *n.* Computer-to-computer communications in which transmissions are synchronized by timing between the sending and receiving machines.

Synchronous Data Link Control *n.* *See* SDLC.

Synchronous Digital Hierarchy *n.* An ITU recommendation implemented in Europe and similar in most respects to the SONET standard used in North America and Japan. *See also* SONET.

S

synchronous DRAM *n.* See SDRAM.

synchronous graphics RAM *n.* A form of dynamic RAM optimized for the high-speed, high-volume data transfers required by 3D graphics, video, and other memory-intensive applications. Used primarily on video accelerator cards, synchronous graphics RAM makes use of burst operations and includes features such as block writes that increase efficiency in retrieving and writing graphics data to the screen. *Acronym:* SGRAM. See also block, mask.

synchronous idle character *n.* See SYN.

synchronous operation *n.* **1.** Any procedure under the control of a clock or timing mechanism. *Compare* asynchronous operation. **2.** In communications and bus operation, data transfer accompanied by clock pulses either embedded in the data stream or provided simultaneously on a separate line.

synchronous operation *n.* **1.** Two or more processes that depend on the occurrences of specific events such as common timing signals. **2.** A data transmission method in which there is constant time between successive bits, characters, or events. The timing is achieved by the sharing of a single clock. Each end of the transmission synchronizes itself with the use of clocks and information sent along with the transmitted data. Characters are spaced by time and not by start and stop bits. **3.** A function call that blocks execution of a process until it returns. See also asynchronous operation.

Synchronous Optical Network *n.* See SONET.

synchronous protocol *n.* A set of guidelines developed to standardize synchronous communications between computers, usually based on either bit stream transmission or recognized character codes. Examples include the character-oriented binary synchronous (BISYNC) protocol and the bit-oriented High-level Data Link Control (HDLC) and Synchronous Data Link Control (SDLC) protocols. See also BISYNC, HDLC, SDLC.

synchronous transmission *n.* Data transfer in which information is transmitted in blocks (frames) of bits separated by equal time intervals. *Compare* asynchronous transmission.

synchronous UART *n.* A universal asynchronous receiver/transmitter (UART) that supports synchronous serial transmission, where the sender and receiver share a timing signal. See also UART.

sync signal *n.* Short for **synchronization signal**. The part of a raster-display video signal that denotes the end of each scan line (the horizontal sync signal) and the end of the last scan line (the vertical sync signal).

sync SRAM *n.* See synchronous burst static RAM.

SYN flood *n.* A method of overwhelming a host computer on a network, especially the Internet, by sending the host a high volume of SYN (synchronization) packets requesting a connection, but never responding to the acknowledgment packets returned by the host. A SYN flood is a form of denial of service attack. See also denial of service attack. *Compare* Ping of Death.

synonym *n.* **1.** A word that is an equivalent of another word. When used in reference to data input, for example, the verbs *type* and *keyboard* are synonyms. **2.** In hashing, one of two distinct keys that produce the same hash address. See also hash².

syntax *n.* The grammar of a language; the rules governing the structure and content of statements. See also logic, programming language, syntax error. *Compare* semantics (definition 1).

syntax checker *n.* A program for identifying errors in syntax for a programming language. See also syntax, syntax error.

syntax error *n.* An error resulting from a statement that violates one or more of the grammatical rules of a language and is thus not "legal." See also logic, semantics (definition 1), syntax.

synthesis *n.* The combining of separate elements to form a coherent whole, or the result of such a combining (for example, combining digital pulses to replicate a sound, or combining digitized words to synthesize human speech). See also speech synthesis.

synthesizer *n.* A computer peripheral, chip, or stand-alone system that generates sound from digital instructions rather than through manipulation of physical equipment or recorded sound. See also MIDI.

.sys *n.* A file extension for system configuration files.

sysadmin *n.* The usual logon name or e-mail address for the system administrator of a UNIX-based system. See also system administrator.

sysgen *n.* See system generation.

sysop *n.* Short for **system operator**. The overseer of a bulletin board system (BBS) or a small multiuser computer system.

S

Sys Req key *n.* Short for **System Request key**. A key on some IBM and compatible keyboards that is intended to provide the same function as the Sys Req key on an IBM mainframe computer terminal: to reset the keyboard or to change from one session to another.

system *n.* Any collection of component elements that work together to perform a task. Examples are a hardware system consisting of a microprocessor, its allied chips and circuitry, input and output devices, and peripheral devices; an operating system consisting of a set of programs and data files; or a database management system used to process specific kinds of information.

system administrator *n.* The person responsible for administering use of a multiuser computer system, communications system, or both. A system administrator performs such duties as assigning user accounts and passwords, establishing security access levels, allocating storage space, and watching for unauthorized access to prevent virus or Trojan horse programs from entering the system. *Also called:* sysadmin. *See also* superuser, Trojan horse, virus. *Compare* sysop.

system area network *n.* *See* storage area network.

system board *n.* *See* motherboard.

system clock *n.* *See* clock (definition 1).

system console *n.* The control center of a computer system, primarily with reference to mainframe and minicomputers. In networked or distributed systems, one workstation is designated as the system administrator's; this workstation is analogous to the LAN system console. *See also* console, LAN.

system conversion *n.* Changing from one operating system to another—for example, from Windows 98 to Windows 2000, UNIX, or OS/2.

system development *n.* The process of defining, designing, testing, and implementing a new system.

system disk *n.* A disk that contains an operating system and can be used to boot a computer. *Also called:* startup disk. *See also* boot², operating system.

system error *n.* A software condition that renders the operating system incapable of continuing to function normally. This type of error usually requires rebooting the system.

system failure *n.* The inability of a computer to continue functioning, usually caused by software rather than hardware.

System file *n.* A resource file on the Macintosh that contains the resources needed by the operating system, such as fonts, icons, and default dialog boxes.

System folder *n.* The Macintosh file folder (directory) that contains the System file and other vital files, such as Finder, device drivers, INIT files, and control panel files. *See also* control panel, Finder, INIT, System file.

system font *n.* On the Macintosh and in some PC applications, the font used by the computer for on-screen text, such as menu titles and items (but not on-screen text within a word processor or other application). *See also* font.

system generation *n.* The process of configuring and installing system software for a particular set of hardware components. Complex operating systems such as UNIX are shipped with device drivers and utilities that are often not relevant to a particular hardware configuration; putting together only the necessary components, as well as specifying important system characteristics, is part of the system generation process. *Also called:* sysgen.

system heap *n.* *See* heap (definition 1).

system.ini *n.* In Windows 3.x, the initialization file used to store the hardware configuration information necessary to run the Windows operating environment. The system.ini file was replaced by the registry database in Windows 9x and in Windows NT. *See also* ini file.

system life cycle *n.* An information system's useful life. At the end of a system's life cycle it is not feasible to repair or expand it, so it must be replaced.

system memory *n.* *See* memory.

System Object Model *n.* *See* SOM (definition 1).

system on a chip *n.* *See* SOC.

system operator *n.* *See* sysop.

system prompt *n.* *See* prompt (definition 1).

system recovery *n.* Processing that takes place after a system failure in order to restore a system to normal operation. System recovery takes place after the operating system is initiated. It sometimes requires that tasks in process during the failure be backed out of and that structures in memory during the failure be reconstructed.

System Registry *n.* *See* registry.

system replacement *n.* *See* replacement strategy.

System Request key *n.* *See* Sys Req key.

S

system resource *n.* On the Macintosh, any of numerous routines, definitions, and data fragments that are stored in the Macintosh System file, such as floating-point arithmetic routines, font definitions, and peripheral drivers. *See also* resource (definition 2).

systems analysis *n.* The examination of a system or problem with the goal of either improving an existing system or designing and implementing a new one. As a science, systems analysis is related to cybernetics, a branch of engineering that studies the behavior of systems.

systems analyst *n.* A person who works on designing and developing systems. Systems analysts generally combine technical, managerial, and human-relations activities in order to complete their analyses.

Systems Application Architecture *n.* *See* SAA.

systems integration *n.* The development of a computer system for a particular customer by combining products from different original equipment manufacturers (OEMs).

Systems Management Server *n.* A Microsoft BackOffice component that provides services for centralized network management. *Acronym:* SMS.

Systems Network Architecture *n.* *See* SNA.

system software *n.* The collection of programs and data that make up and relate to the operating system. *Compare* application.

systems programming *n.* The development or maintenance of programs designed to execute as part of an operating system, such as I/O routines, user interfaces, command-line interpreters, and task-scheduling and memory management routines.

system support *n.* The provision of services and material resources for the use, maintenance, and improvement of an implemented system.

system timer *n.* *See* clock (definition 1).

system unit *n.* *See* console.

System V *n.* A version of the UNIX system provided by AT&T and others. It is both a standard (principally controlled by AT&T) and a set of commercial products. *See also* UNIX.

S

T

T *prefix* See *tera-*.

T1 or **T-1** *n.* A high-speed communications line that can handle digital communications and Internet access at the rate 1.544 Mbps (megabits per second). Although originally designed by AT&T to carry multiple voice calls over standard twisted-pair telephone wiring, this high-bandwidth telephone line can also transmit text and images. T1 speed is attained through multiplexing 24 separate 64 Kbps channels into a single data stream. T1 lines are commonly used by larger organizations for Internet connectivity. *Also called:* T-1 carrier. *See also* T-carrier. *Compare* fractional T1, T2, T3, T4.

T.120 standard *n.* A family of International Telecommunications Union (ITU) specifications for multipoint data communications services within computer applications, such as conferencing and multipoint file transfer.

T2 or **T-2** *n.* A T-carrier that can handle 6.312 Mbps (megabits per second) or 96 voice channels. *See also* T-carrier. *Compare* T1, T3, T4.

T3 or **T-3** *n.* A T-carrier that can handle 44.736 Mbps (megabits per second) or 672 voice channels. *See also* T-carrier. *Compare* T1, T2, T4.

T4 or **T-4** *n.* A T-carrier that can handle 274.176 Mbps (megabits per second) or 4032 voice channels. *See also* T-carrier. *Compare* T1, T2, T3.

TA *n.* *See* terminal adapter.

tab character *n.* A character used to align lines and columns on screen and in print. Although a tab is visually indistinguishable from a series of blank spaces in most programs, the tab character and the space character are different to a computer. A tab is a single character and therefore can be added, deleted, or overtyped with a single keystroke. The ASCII coding scheme includes two codes for tab characters: a horizontal tab for spacing across the screen or page and a vertical tab for spacing down the screen or page. *See also* Tab key.

Tab key *n.* A key, often labeled with both a left-pointing and a right-pointing arrow, that traditionally (as in word processing) is used to insert tab characters into a docu-

ment. In other applications, such as menu-driven programs, the Tab key is often used to move the on-screen highlight from place to place. Many database and spreadsheet programs allow the user to press the Tab key to move around within a record or between cells. The word *tab* is short for “tabulator,” which was the name given to this key on typewriters, where it was used in creating tables. *See also* tab character.

table *n.* **1.** In programming, a data structure usually consisting of a list of entries, each entry being identified by a unique key and containing a set of related values. A table is often implemented as an array of records, a linked list, or (in more primitive languages) several arrays of different data types, all using a common indexing scheme. *See also* array, list, record¹. **2.** In relational databases, a data structure characterized by rows and columns, with data occupying or potentially occupying each cell formed by a row-column intersection. The table is the underlying structure of a relation. *See also* relational database. **3.** In word processing, desktop publishing, and in HTML documents, a block of text formatted in aligned rows and columns.

table lookup *n.* The process of using a known value to search for data in a previously constructed table of values—for example, using a purchase price to search a tax table for the appropriate sales tax. *See also* lookup.

tablet *n.* *See* graphics tablet.

Tablet PC *n.* A touch-sensitive computer screen tablet designed by Microsoft for the entry of handwritten text using a stylus or digital pen. The Tablet PC runs Windows applications and can function as a primary personal computer as well as a note-taking device.

tabulate *vb.* **1.** To total a row or column of numbers. **2.** To arrange information in table form.

TACACS *n.* Acronym for **Terminal Access Controller Access Control System**. A network access technique in which users log into a single centralized server that contains a database of authorized accounts. After the access server authenticates the user, it forwards the login information to the data server requested by the user. *See also* authentication, server (definition 2).

tag *n.* **1.** In programming, one or more characters containing information about a file, record type, or other structure. **2.** In certain types of data files, a key or an address that identifies a record and its storage location in another file. *See also* tag sort. **3.** In markup languages such as SGML and HTML, a code that identifies an element in a document, such as a heading or a paragraph, for the purposes of formatting, indexing, and linking information in the document. In both SGML and HTML, a tag is generally a pair of angle brackets that contain one or more letters and numbers. Usually one pair of angle brackets is placed before an element, and another pair is placed after, to indicate where the element begins and ends. For example, in HTML, `<I>hello world</I>` indicates that the phrase “hello world” should be italicized. *See also* `<>`, element, emotag, HTML, SGML. **4.** An early-generation raster graphics format used for Macintosh Ready, Set, Go programs and Letraset’s ImageStudio. *See also* raster graphics.

Tagged Image File Format *n.* *See* TIFF.

tag sort *n.* A sort performed on one or several key fields for the purpose of establishing the order of their associated records. *Also called:* key sort.

tag switching *n.* A multilayer Internet switching technology developed by Cisco Systems that integrates routing and switching.

talk¹ *n.* The UNIX command that, when followed by another user’s name and address, is used to generate a request for a synchronous chat session on the Internet. *See also* chat¹ (definition 1).

talk² *vb.* *See* chat².

talker *n.* An Internet-based synchronous communication mechanism most commonly used to support multiuser chat functions. Such systems typically provide specific commands for movement through separate *rooms*, or chat areas, and allow users to communicate with other users in real time through text messages, indicate simple gestures, use a bulletin board system (BBS) for posting comments, and send internal e-mail. *See also* BBS (definition 1), chat¹ (definition 1).

talk. newsgroups *n.* Usenet newsgroups that are part of the talk. hierarchy and have the prefix talk. as part of their names. These newsgroups are devoted to debate and discussion of controversial topics. Talk. newsgroups are one of the seven original Usenet newsgroup hierarchies. The

other six are comp., misc., news., rec., sci., and soc. *See also* newsgroup, traditional newsgroup hierarchy, Usenet.

tandem processors *n.* Multiple processors wired so that the failure of one processor transfers central processing unit (CPU) operation to another processor. Using tandem processors is part of the strategy for implementing fault-tolerant computer systems. *See also* central processing unit.

TANSTAAFL *n.* Acronym for **There ain’t no such thing as a free lunch**. An expression used on the Internet in e-mail, chat sessions, mailing lists, newsgroups, and other online forums; derived from *The Moon Is a Harsh Mistress*, a science-fiction classic by Robert A. Heinlein. *See also* chat¹ (definition 1), e-mail¹ (definition 1), mailing list, newsgroup.

tap¹ *n.* A device that can be attached to an Ethernet bus to enable a computer to be connected.

tap² *vb.* To use a stylus to quickly touch a device screen to perform an activity. Tapping is analogous to clicking with a mouse.

tap and hold *vb.* To hold a stylus on a device screen to open a pop-up or shortcut menu. Analogous to right-clicking with a mouse.

tape *n.* **1.** A thin strip of polyester film coated with magnetic material that permits the recording of data. Because tape is a continuous length of data storage material and because the read/write head cannot “jump” to a desired point on the tape without the tape first being advanced to that point, tape must be read or written sequentially, not randomly (as can be done on a floppy disk or a hard disk). **2.** A storage medium consisting of a thin strip of paper used to store information in the form of sequences of punched holes, chemical impregnation, or magnetic ink imprinting.

tape cartridge *n.* A module that resembles an audio cassette and contains magnetic tape that can be written on and read from by a tape drive. Tape cartridges are primarily used to back up hard disks. *See also* tape (definition 1).

tape drive *n.* A device for reading and writing tapes. *See also* tape (definition 1).

tape dump *n.* The process of simply printing the data contained on a tape cartridge without performing any report formatting. *See also* tape cartridge.

tape tree *n.* A means of audiotape distribution, used in Usenet music newsgroups and mailing lists, in which a

T

recording is copied and sent to a number of *branch* participants, who in turn send copies to their *children*, or *leaves*. *See also* branch (definition 1), child (definition 2), leaf, tree structure. *Compare* vine.

TAPI *n.* Acronym for **Telephony Application Programming Interface**. In the Windows Open Systems Architecture (WOSA), a programming interface that gives Windows client applications access to a server's voice services. TAPI facilitates interoperability between personal computers and telephone equipment. *Also called:* Telephony API. *See also* application programming interface, WOSA. *Compare* TSAPI.

.tar *n.* The file extension that identifies uncompressed UNIX archives in the format produced by the tar program.

tar¹ *n.* Acronym for **tape archive**. A UNIX utility for making a single file out of a set of files that a user wishes to store together. The resulting file has the extension .tar. Unlike PKZIP, tar does not compress files, so compress or gzip is usually run on the .tar file to produce a file with extensions .tar.gz or .tar.Z. *See also* compress¹, gzip, PKZIP. *Compare* untar¹.

tar² *vb.* To make a single file out of a set of files using the tar utility. *See also* compress², PKZIP. *Compare* untar².

target *n.* Loosely, the objective of a computer command or operation. Examples are a computer that is to run a program translated for its use, a "foreign" language (for another computer) into which a program is to be translated, or a group of people for whom a particular product is designed. In MS-DOS usage, the target is often the disk referred to by prompts in a copy operation (for example, "insert *target* diskette"). In terms of the SCSI (small computer system interface) connection, the target is the device that receives commands. *See also* SCSI, target computer, target disk, target language.

target computer *n.* The computer that receives data from a communications device, a hardware add-in, or a software package.

target disk *n.* The disk to which data is to be written, as in a copy operation. *See also* target. *Compare* source disk.

target language *n.* The language into which source code is compiled or assembled. *See also* assembler, compiler (definition 2), cross-compiler.

task *n.* A stand-alone application or a subprogram that is run as an independent entity.

taskbar *n.* A graphic toolbar used in Windows 9x, Windows CE, Windows NT, and Windows 2000 to select, via the mouse, one of a number of active applications. *See also* task button, toolbar.

task button *n.* In Windows 9x, Windows CE, Windows NT, and Windows 2000, a button that appears on the taskbar on the screen when an application is run. By clicking on the button, the user can switch from another application to the application corresponding to the button. *See also* taskbar.

task management *n.* The operating-system process of tracking the progress of and providing necessary resources for separate tasks that are running on a computer, especially in a multitasking environment.

task swapping *n.* The process of switching from one application to another by saving the data for the application presently running in the foreground to a storage device and loading the other application. *See also* foreground² (definition 2), task, task switching.

task switching *n.* The act of moving from one program to another without shutting down the first program. Task switching is a single act, as compared to multitasking, in which the central processing unit rapidly switches back and forth between two or more programs. *See also* task, task swapping. *Compare* multitasking.

TB *n.* *See* terabyte.

T-carrier *n.* A long-distance, digital communications line provided by a common carrier. Multiplexers at either end merge several voice channels and digital data streams for transmission and separate them when received. T-carrier service, introduced by AT&T in 1993, is defined at several capacity levels: T1, T2, T3, and T4. In addition to voice communication, T-carriers are used for Internet connectivity. *See also* T1, T2, T3, T4.

TCB *n.* Acronym for **Trusted Computing Base**. The complete set of security mechanisms that create security on a network. The TCB includes all the hardware, software, and firmware components that are responsible for system security.

Tcl/Tk *n.* Acronym for **Tool Command Language/Tool Kit**. A programming system that includes a scripting language (Tcl) and a graphical user interface toolkit (Tk). The Tcl language issues commands to interactive programs, such as text editors, debuggers, and shells, which



tie together complex data structures into scripts. *See also* graphical user interface, script, scripting language.

TCM *n.* *See* trellis-coded modulation.

TCO *n.* *See* total cost of ownership.

TCP *n.* Acronym for **T**ransmission **C**ontrol **P**rotocol. The protocol within TCP/IP that governs the breakup of data messages into packets to be sent via IP (Internet Protocol), and the reassembly and verification of the complete messages from packets received by IP. A connection-oriented, reliable protocol (reliable in the sense of ensuring error-free delivery), TCP corresponds to the transport layer in the ISO/OSI reference model. *See also* ISO/OSI reference model, packet, TCP/IP. *Compare* UDP.

TCP/IP *n.* Acronym for **T**ransmission **C**ontrol **P**rotocol/**I**nternet **P**rotocol. A protocol suite (or set of protocols) developed by the U.S. Department of Defense for communications over interconnected, sometimes dissimilar, networks. It is built into the UNIX system and has become the de facto standard for data transmission over networks, including the Internet.

TCP/IP reference model *n.* A networking model designed around the concept of internetworking—the exchange of information among different networks, often built on different architectures. The TCP/IP reference model, often called the Internet reference model, consists of four layers, the most distinctive of which is the internet-work that deals with routing messages and that has no equivalent in the ISO/OSI reference model or the SNA model. *Compare* ISO/OSI reference model, SNA.

TCP/IP stack *n.* The set of TCP/IP protocols. *See also* protocol stack, TCP/IP.

TDM *n.* *See* time-division multiplexing.

TDMA *n.* Short for **T**ime **D**ivision **M**ultiple **A**ccess. A multiplexing technology used to divide a single cellular phone channel into multiple subchannels. TDMA works by allocating separate time slots to each user. It is implemented in D-AMPS (Digital Advanced Mobile Phone Service), which relies on TDMA to divide each of the 30 analog AMPS channels into 3 separate subchannels, and GSM (Global System for Mobile Communications). *See also* D-AMPS, Global System for Mobile Communications. *Compare* AMPS, FDMA.

team Web site *n.* *See* SharePoint team Web site.

Teardrop attack *n.* An Internet-based attack that breaks a message into a series of IP fragments with overlapping offset fields. When these fragments are reassembled at

their destination, the fields don't match, causing the system to hang, reboot, or crash.

tearing *n.* A visual artifact produced when the screen refresh rate is out of sync with an application's frame rate. The top portion of one frame is displayed at the same time as the bottom portion of another frame, with a discernible tear between the two partial images.

tear-off *adj.* Capable of being dragged from an original position in a graphical user interface and placed where the user desires. For example, many graphics applications feature tear-off menus of tool palettes that can be dragged to locations other than the menu bar.

techie *n.* A technically oriented person. Typically, a techie is the person on whom a user calls when something breaks or the user cannot understand a technical problem. A techie may be an engineer or a technician, but not all engineers are techies. *See also* guru.

technical author *n.* *See* tech writer.

technobabble *n.* Language that includes incomprehensible technical terms and jargon. In ordinary conversation, many of the words in this dictionary might be considered technobabble.

technology *n.* The application of science and engineering to the development of machines and procedures in order to enhance or improve human conditions, or at least to improve human efficiency in some respect. *See also* high tech.

technophile *n.* Someone who is enthusiastic about emerging technology. *Compare* computerphile.

technophobe *n.* A person who is afraid of or dislikes technological advances, especially computers. *See also* Luddite. *Compare* technophile.

tech writer *n.* Short for technical writer. One who writes the documentation material for a hardware or software product. *Also called:* technical author. *See also* documentation.

telco *n.* Short for **t**elephone **c**ompany. A term generally used in reference to a telephone company's provision of Internet services.

telecom closet *n.* *See* wiring closet.

telecommunications *n.* The transmission and reception of information of any type, including data, television pictures, sound, and facsimiles, using electrical or optical signals sent over wires or fibers or through the air.

telecommunications closet *n.* *See* wiring closet.

T

telecommute *vb.* To work in one location (often at home) and communicate with a main office at a different location through a personal computer equipped with a modem and communications software.

telecommuter *n.* A member of the workforce who conducts business outside the traditional office setting, collaborating with business associates and colleagues through communications and computer technologies. Some workers telecommute full-time; others part-time. The telecommuting ranks include self-employed home workers, small-business entrepreneurs, and employees of large corporations or organizations. *See also* distributed workplace, SOHO.

teleconferencing *n.* The use of audio, video, or computer equipment linked through a communications system to enable geographically separated individuals to participate in a meeting or discussion. *See also* video conferencing.

telecopy *vb.* *See* fax.

telematics *n.* In communications technology, the linking of computers and telecommunications. Telematics technology is becoming standard in the automotive industry, with dashboard navigation systems, roadside assistance, entertainment, Internet, and cellular services available in vehicles.

telephony *n.* Telephone technology—voice, fax, or modem transmissions based on either the conversion of sound into electrical signals or wireless communication via radio waves.

Telephony API *n.* *See* TAPI.

telephony device *n.* A mechanism designed to translate sound into electrical signals, transmit them, and then convert them back to sound.

Telephony Service Provider *n.* A modem driver that enables access to vendor-specific equipment through a standard device driver interface. *Acronym:* TSP. *See also* Telephony Service Provider Interface.

Telephony Service Provider Interface *n.* The external interface of a service provider to be implemented by vendors of telephony equipment. A telephony service provider accesses vendor-specific equipment through a standard device driver interface. Installing a service provider allows Windows CE–based applications that use elements of telephony to access the corresponding telephony equipment. *Acronym:* TSPI. *See also* Telephony Service Provider.

teleprocess *vb.* To use a terminal or computer and communications equipment to access computers and computer files located elsewhere. *Teleprocess* is a term originated by IBM. *See also* distributed processing, remote access.

teleprocessing monitor *n.* *See* TP monitor.

Telescript *n.* A communications-oriented programming language, released in 1994 by General Magic, that was designed to address the need for cross-platform, network-independent messaging and abstraction of complex network protocols. *See also* communications protocol.

teletext *n.* All-text information broadcast by a television station to a subscriber's television set.

Teletype *n.* The Teletype Corporation, developer of the teletypewriter (TTY) and various other printers used with computers and communications systems. *See also* TTY.

teletype mode *n.* A mode of operation in which a computer or an application limits its actions to those characteristic of a teletypewriter (TTY). On the display, for example, teletype mode means that only alphanumeric characters can be shown, and they are simply “typed” on the screen, one letter after the other, and cannot be placed in any desired position. *See also* Teletype, TTY.

teletypewriter *n.* *See* TTY.

teleworker *n.* A businessperson who substitutes information technologies for work-related travel. Teleworkers include home-based and small business workers who use computer and communications technologies to interact with customers and/or colleagues. *See also* distributed workplace, SOHO.

telnet¹ *n.* **1.** A client program that implements the Telnet protocol. **2.** A protocol in the TCP/IP suite that enables individuals to log on to and use a remote computer as if they were sitting at a terminal directly connected to the machine.

telnet² *vb.* To access a remote computer over the Internet using the Telnet protocol. *See also* telnet¹.

Telnet *n.* A protocol that enables an Internet user to log on to and enter commands on a remote computer linked to the Internet, as if the user were using a text-based terminal directly attached to that computer. Telnet is part of the TCP/IP suite of protocols.

template *n.* **1.** In an application package, an overlay for the keyboard that identifies special keys and key combinations. **2.** In image processing, a pattern that can be used to identify or match a scanned image. **3.** In spreadsheet pro-

grams, a predesigned spreadsheet that contains formulas, labels, and other elements. 4. In MS-DOS, a small portion of memory that holds the most recently typed MS-DOS command. 5. In word processing and desktop publishing programs, a predesigned document that contains formatting and, in many cases, generic text.

temporary file *n.* A file created either in memory or on disk, by the operating system or some other program, to be used during a session and then discarded. *Also called:* temp file. *See also* scratch¹.

temporary storage *n.* A region in memory or on a storage device that is temporarily allocated for use in storing intermediate data in a computational, sorting, or transfer operation.

ten's complement *n.* A number in the base-10 system that is the true complement of another number and is derived either by subtracting each digit from 1 less than the base and adding 1 to the result or by subtracting each number from the next higher power of the base. For example, the ten's complement of 25 is 75, and it can be derived either by subtracting each digit from 9, which is 1 less than the base ($9 - 2 = 7$, $9 - 5 = 4$) and then adding 1 ($74 + 1 = 75$) or by subtracting 25 from the next higher power of 10, which is 100 ($100 - 25 = 75$). *See also* complement. *Compare* nine's complement.

tera- *prefix* A prefix meaning 10^{12} : 1 trillion in the American numbering system, 1 million million in British numbering. *Abbreviation:* T. *See also* terabyte.

terabyte *n.* A measurement used for high-capacity data storage. One terabyte equals 2^{40} , or 1,099,511,627,776, bytes, although it is commonly interpreted as simply one trillion bytes. *Abbreviation:* TB.

teraflops *n.* One trillion floating-point operations (FLOPS) per second. Teraflops serves as a benchmark for larger computers that measures the number of floating-point operations they can perform in a set amount of time. *Also called:* TFLOPS. *See also* FLOPS.

terminal *n.* 1. In networking, a device consisting of a video adapter, a monitor, and a keyboard. The adapter and monitor and, sometimes, the keyboard are typically combined in a single unit. A terminal does little or no computer processing on its own; instead, it is connected to a computer with a communications link over a cable. Terminals are used primarily in multiuser systems and today are not often found on single-user personal computers. *See also* dumb terminal, smart terminal, terminal emulation. 2. In electronics, a point that can be physically linked to something else, usually by a wire, to form an electrical connection.

Terminal *n.* An application that provides command-line access to the Mac OS X UNIX core. The Terminal command-line environment allows UNIX functions from within Mac OS X.

Terminal Access Controller Access Control System *n.* *See* TACACS.

terminal adapter *n.* The correct name for an ISDN modem, which connects a PC to an ISDN line but does not modulate or demodulate signals as a typical modem does.

terminal emulation *n.* The imitation of a terminal by using software that conforms to a standard, such as the ANSI standard for terminal emulation. Terminal-emulation software is used to make a microcomputer act as if it were a particular type of terminal while it is communicating with another computer, such as a mainframe. *See also* VT-52, VT-100, VT-200.

terminal server *n.* In a LAN (local area network), a computer or a controller that allows terminals, microcomputers, and other devices to connect to a network or host computer, or to devices attached to that particular computer. *See the illustration. See also* controller, LAN, microcomputer, terminal.

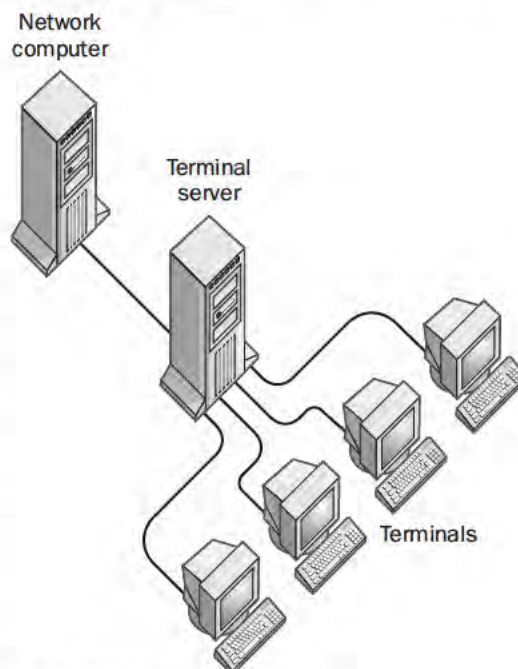

Terminal server.

T

terminal session *n.* The period of time spent actively using a terminal. *See also* session.

terminal strip *n.* A usually long and narrow assembly containing one or more electrical connectors. Commonly, terminal strips consist of screws on which bare wires are wrapped before the screws are tightened; for example, some consumer-grade stereo receiver/amplifiers incorporate a set of terminal strips on the rear panel for attaching speaker wires to the unit.

terminate *vb.* **1.** With reference to software, to end a process or program. Abnormal termination occurs in response to user intervention or because of a hardware or software error. **2.** With reference to hardware, to install a plug, jack, or other connector at the end of a wire or cable.

terminate-and-stay-resident program *n.* *See* TSR.

terminator *n.* **1.** A character that indicates the end of a string, such as the null character in an ASCII string. *See also* ASCII, ASCII string. **2.** An item of hardware that must be installed in the last device in a daisy chain or bus network, such as Ethernet or SCSI. The terminator caps the end of a cable in a bus network in order to keep signals from bouncing back along the line. *See also* terminator cap.

terminator cap *n.* A special connector that must be attached to each end of an Ethernet bus. If one or both terminator caps are missing, the Ethernet network will not work.

ternary *adj.* In programming, of, pertaining to, or characteristic of an element with three possible values, a condition that has three possible states, or a base-3 number system. *Compare* binary¹, unary.

tessellate *vb.* To break an image into small, square regions for processing or output.

test *vb.* To check program correctness by trying out various sequences and input values. *See also* debug, test data.

test automation software *n.* A program that automatically enters a predetermined set of characters or user commands in order to test new or modified versions of software applications.

test data *n.* A set of values used to test proper functioning of a program. Reasons for choosing particular test data include verifying known output (anticipated output) and pushing boundary conditions that might cause the program to fail.

test post *n.* A newsgroup article that contains no actual message but is used simply as a means of checking the connection. *See also* article, newsgroup.

TeX or **T_EX** *n.* A text-formatting software system created by mathematician and computer scientist Donald Knuth for producing typeset-quality scientific, mathematical, or other complex technical documents from plain ASCII text input. Implementations of TeX for UNIX systems, MS-DOS and Windows, and the Apple Macintosh are available free over the Internet (<ftp://ftp.tex.ac.uk/tex-archive/>) or in commercial distributions (which often include enhancements). Commands in the input file produce format elements and special symbols; for example, $\{\pi\}r^2$ produces the expression πr^2 . TeX is extensible through macros, and macro files are available for a wide variety of applications. *See also* LaTeX¹.

Texas Instruments Graphics Architecture *n.* *See* TIGA.

texel *n.* A single element in a texture. When a texture has been applied to an object, the texels rarely correspond to pixels on the screen. Applications can use texture filtering to control how texels are sampled and interpolated to pixels.

text *n.* **1.** Data that consists of characters representing the words and symbols of human speech; usually, characters coded according to the ASCII standard, which assigns numeric values to numbers, letters, and certain symbols. **2.** In word processing and desktop publishing, the main portion of a document, as opposed to headlines, tables, figures, footnotes, and other elements.

text box *n.* In a dialog box or HTML form, a box in which the user may enter text.

TextEdit *n.* A standard set of routines in the Macintosh operating system that are available to programs for controlling the way text is displayed. *See also* Toolbox.

text editor *n.* *See* editor.

text entry *n.* The inputting of text characters by means of a keyboard.

text file *n.* A file composed of text characters. A text file can be a word-processing file or a “plain” ASCII file encoded in a format practically all computers can use. *See also* ASCII file, text (definition 1).

text mode *n.* A display mode in which the monitor can display letters, numbers, and other text characters but no graphical images or WYSIWYG (“what-you-see-is-what-you-get”) character formatting (italics, superscript, and so on). *Also called:* alphanumeric mode, character mode. *Compare* graphics mode.

text-only file *n.* *See* ASCII file.



text-to-speech *n.* The conversion of text-based data into voice output by speech synthesis devices to allow users to gain access to information by telephone or to allow blind or illiterate people to use computers.

Text-to-Speech *n.* See TTS (definition 1).

texture *n.* In computer graphics, shading or other attributes added to the “surface” of a graphical image to give it the illusion of a physical substance. For example, a surface could be made to appear reflective to simulate metal or glass, or a scanned image of wood grain could be applied to a shape intended to simulate an object made of wood.

texture mapping *n.* In 3-D graphics, the process of adding detail to an object by creating a picture or a pattern that can be “wrapped” around the object. For example, a texture map of stones might be wrapped around a pyramid shape to create a realistic image. Texture mapping can also account for changes in perspective as the picture is wrapped around the shape. The technique is valued in 3-D graphics because it enables creation of detailed images without the performance degradation that can result from the computation required to manipulate images created with large numbers of polygons.

TFLOPS *n.* See teraflops.

TFT *n.* Acronym for thin film transistor. A transistor created using thin film methodology. See also active matrix display, thin film, transistor.

TFT display *n.* See active matrix display.

TFT LCD *n.* Acronym for thin film transistor liquid crystal display. See active matrix display.

TFTP *n.* See Trivial File Transfer Protocol.

TGA *n.* **1.** Short for **Targa**. A raster graphics file format from Truevision, Inc., that handles 16-, 24-, and 32-bit color. See also 16-bit color, 24-bit color, 32-bit color, raster graphics, video graphics board. **2.** The brand name of a series of high-resolution video graphics boards.

theme *n.* **1.** A set of visual elements that provide a unified look for your computer desktop. A theme determines the look of the various graphic elements of your desktop, such as the windows, icons, fonts, colors, and the background and screen saver pictures. It can also define sounds associated with events, such as opening or closing a program.

2. A set of coordinated graphic elements applied to a document or Web page, or across all pages in a Web site. Themes can consist of designs and color schemes for fonts, link bars, and other page elements.

The Microsoft Network *n.* See MSN.

thermal printer *n.* A nonimpact printer that uses heat to generate an image on specially treated paper. The printer uses pins to produce an image, but rather than striking the pins against a ribbon to mark the paper as does a wire-pin dot-matrix printer, it heats the pins and brings them into gentle contact with the paper. The special coating on the paper discolors when it is heated.

thermal transfer printer *n.* See thermal wax-transfer printer.

thermal wax printer *n.* See thermal wax-transfer printer.

thermal wax-transfer printer *n.* A special type of non-impact printer that uses heat to melt colored wax onto paper to create an image. Like a standard thermal printer, it uses pins to apply the heat. Rather than making contact with coated paper, however, the pins touch a wide ribbon saturated with different colored waxes. The wax melts under the pins and adheres to the paper.

thesaurus *n.* **1.** A book of words and their synonyms.

2. In microcomputer applications, both a file of synonyms stored on disk and the program used to search the file.

The World—Public Access UNIX *n.* One of the oldest public access Internet service providers, based in Boston. In 1990, The World began offering full dial-up Internet access to the public. Other services include World Wide Web access, Usenet, SLIP/PPP support, telnet, FTP, IRC, Gopher, and e-mail. In 1995, The World began supporting local dial-up access via UUNET. See also ISP.

thick Ethernet *n.* See 10Base5.

thick film *adj.* A term describing a method used in the manufacture of integrated circuits. Thick film technology uses a stencil-like technique called *photosilkscreening* to deposit multiple layers of special inks or pastes on a ceramic substrate. The inks or pastes can be conducting, insulating, or resistive. The passive components (wires, resistors, and capacitors) of the integrated circuits are formed by depositing a series of films of different characteristics and patterns. Compare thin film.

ThickNet *n.* See 10Base5.

ThickWire *n.* See 10Base5.

thimble *n.* A type element, similar to a daisy wheel, that bears a full character set, with each character on a separate type bar. As with a daisy wheel, the spokes, or type bars, radiate out from a central hub. On a thimble print element,

T

however, each type bar is bent 90 degrees at its halfway point, so the type bars stick straight up with the type facing away from the hub. *See also* thimble printer. *Compare* daisy wheel, daisy-wheel printer.

thimble printer *n.* A printer that uses a thimble print element, best known in a line of printers from NEC. Because these printers use fully formed characters like those on a typewriter, they generate letter-quality output that is indistinguishable from that of a typewriter. This includes the slight impression created by the type hitting the paper hard through the ribbon, which distinguishes this type of print-out from that of laser printers. *See also* thimble. *Compare* daisy-wheel printer.

thin client *n.* A software layer of a small client for a centrally managed, network terminal. The thin client allows the user access to server-hosted applications and data.

thin Ethernet *n.* *See* 10Base2.

thin film *adj.* A method used in the fabrication of integrated circuits. Thin film technology operates on the same basic principles as thick film technology. Rather than using inks or pastes, however, thin film technology uses metals and metal oxides that are “evaporated” and then deposited on the substrate in the desired pattern to form the integrated circuit’s passive components (wires, resistors, and capacitors). *See also* molecular beam epitaxy. *Compare* thick film.

thin film transistor *n.* *See* TFT.

ThinNet *n.* *See* 10Base2.

thin server *n.* A client/server architecture in which most of an application is run on the client machine, which is called a fat client, with occasional data operations on a remote server. Such a configuration yields good client performance, but complicates administrative tasks, such as software upgrades. *See also* client/server architecture, fat client, thin client. *Compare* fat server.

thin space *n.* An amount of horizontal space in a font, equal to one-quarter the point size of the font. For example, a thin space in a 12-point font is 3 points wide. *See also* point¹ (definition 1). *Compare* em space, en space, fixed space.

thin system *n.* *See* thin server.

ThinWire *n.* *See* 10Base2.

Third Generation *n.* *See* 3G.

third-generation computer *n.* Any of the computers produced from the mid-1960s to the 1970s that were based on integrated circuits rather than on separately wired transistors. *See also* computer.

third-generation language *n.* *See* 3GL.

third normal form *n.* *See* normal form (definition 1).

third-party¹ *adj.* In computer console games, a game made for a specific console by a company other than the console manufacturer.

third party² *n.* A company that manufactures and sells accessories or peripherals for use with a major manufacturer’s computer or peripheral, usually without any involvement from the major manufacturer.

thrashing *n.* The state of a virtual memory system that is spending almost all its time swapping pages in and out of memory rather than executing applications. *See also* swap (definition 2), virtual memory.

thread *n.* **1.** In programming, a process that is part of a larger process or program. **2.** In a tree data structure, a pointer that identifies the parent node and is used to facilitate traversal of the tree. **3.** In electronic mail and Internet newsgroups, a series of messages and replies related to a specific topic.

threaded discussion *n.* In a newsgroup or other online forum, a series of messages or articles in which replies to an article are nested directly under it, instead of the articles being arranged in chronological or alphabetical order. *See also* newsgroup, thread (definition 3).

threaded newsreader *n.* A newsreader that displays posts in newsgroups as threads. Replies to a post appear directly after the original post, rather than in chronological or any other order. *See also* newsreader, post, thread (definition 3).

threaded tree *n.* A tree in which the leaf (end) nodes contain pointers to some of the nodes from which they arise. The pointers facilitate searching the tree for information. *See also* thread (definition 2).

threading *n.* A technique used by certain interpretive languages, such as many Forth implementations, to speed execution. The references to other support routines in each threaded support routine, such as a predefined word in Forth, are replaced by pointers to those routines. *See also* Forth, thread (definition 1).

three-dimensional array *n.* An ordered arrangement of information in which three numbers (integers) are used to



locate a particular item. A three-dimensional array treats data as if it were laid out in rows, columns, and layers. *See also* 3-D array, array, two-dimensional array.

three-dimensional model *n.* A computer simulation of a physical object in which length, width, and depth are real attributes—a model, with *x*-, *y*-, and *z*-axes, that can be rotated for viewing from different angles.

three-finger salute *n.* Slang term for a warm, or soft, boot, in which the Ctrl, Alt, and Delete keys are pressed simultaneously to restart a computer without first turning off the power. *Also called:* Vulcan death grip. *See also* warm boot.

three-nines availability *n.* The availability of a system 99.9% of the time. Three-nines availability equates to approximately 526 minutes of downtime in a standard 365-day year. *See also* high availability.

three-point editing *n.* In digital video editing, a feature that simplifies the process of placing new video within a sequence by assisting in calculating edit points. To make an edit, in and out points must be defined in the video clip to be added and in the sequence into which the clip is to be inserted. The user provides any three of these edit points and the editing software determines the fourth.

three-tier client/server *n.* A client/server architecture in which software systems are structured into three tiers or layers: the user interface layer, the business logic layer, and the database layer. Layers may have one or more components. For example, there can be one or more user interfaces in the top tier, each user interface may communicate with more than one application in the middle tier at the same time, and the applications in the middle tier may use more than one database at a time. Components in a tier may run on a computer that is separate from the other tiers, communicating with the other components over a network. *See also* client/server architecture. *Compare* two-tier client/server.

throbber *n.* An animated icon that moves while an application is completing a task, such as a browser loading a Web page. Throbbers serve to reassure the user that the application is still working on the task and has not frozen. Web browsers and some other applications come with a throbber icon. In some cases, the user can replace the original throbber with a customized icon of the user's choice.

throttle control *n.* A device that enables the user of a flight simulator or game to control simulated engine power. The throttle control is used along with a joystick

(which controls the simulated ailerons and elevators) and possibly a rudder control.

throughput *n.* **1.** The data transfer rate of a network, measured as the number of bits per second transmitted. **2.** A measure of the data processing rate in a computer system.

throughput test *n.* *See* bandwidth test.

thumb *n.* *See* elevator.

thumbnail *n.* A miniature version of an image or electronic version of a page that is generally used to allow quick browsing through multiple images or pages. For example, Web pages often contain thumbnails of images (which can be loaded much more quickly by the Web browser than the full-size image). Many of these thumbnails can be clicked on to load the complete version of the image.

thumbwheel *n.* A wheel embedded in a case so that only a portion of the outside rim is revealed. When rolled with the thumb, the wheel can control an on-screen element such as a pointer or a cursor. Thumbwheels are used with three-dimensional joysticks and trackballs to control the depth aspect of the pointer or cursor. *See also* joystick, relative pointing device, trackball.

thunk¹ *n.* Code that enables 16-bit code to call 32-bit code, and vice versa. There are three different types of thunk: a flat thunk relies on a thunk compiler to allow 32-bit code to call a 16-bit DLL and 16-bit code to call a 32-bit DLL; a generic thunk enables a 16-bit application to load and call a 32-bit DLL; and a universal thunk allows 32-bit code to load and call a 16-bit DLL. All thunks are Windows-based, but the type of thunk used depends on the Windows version.

thunk² *vb.* To call 32-bit code from 16-bit code, or vice versa. Thunking involves, in large part, the translation to and from 16-bit segment offset memory addressing and 32-bit flat, or linear, memory addressing. *See also* address space, flat address space, segmented address space.

TIA *n.* Acronym for **thanks in advance**. On the Internet, a popular sign-off to a request of some sort. *Also called:* aTdHvAaNnKcSe.

tick *n.* **1.** A regular, rapidly recurring signal emitted by a clocking circuit; also, the interrupt generated by this signal. **2.** In some microcomputer systems, notably Macintosh, one sixtieth of a second, the basic time unit used by the internal clock that is accessible by programs.



tiebreaker *n.* A circuit that arbitrates competing circuits and resolves bottlenecks by giving priority to one circuit at a time.

tie line *n.* A private line leased from a communications carrier and often used to link two or more points in an organization.

Tier 1 *n.* An Internet Network Access Point that provides access to and interconnection among major national and international network backbone providers, such as MCI WorldCom, Sprint, BBN, and IBM. *See also* Network Access Point. *Compare* Tier 2.

Tier 2 *n.* A regional Internet Network interchange location where local ISPs exchange data. By using a Tier 2 exchange point, ISPs in the same area can move data between their users without the need to transport that data over long distances. For example, if a user in Singapore connects to a Web site in the same city through a local Tier 2 exchange point, it is not necessary to move the data through a major Network Access Point, or NAP, in Japan or North America. Tier 2 locations generally have much smaller capacities than the national and international Tier 1 NAPs. *See also* Network Access Point. *Compare* Tier 1.

.tif or **.tiff** *n.* The file extension that identifies bitmap images in Tagged Image File Format (TIFF). *See also* TIFF.

TIFF or **TIF** *n.* Acronym for **Tagged Image File Format** or **Tag Image File Format**. A standard file format commonly used for scanning, storage, and interchange of gray-scale graphic images. TIFF may be the only format available for older programs (such as older versions of MacPaint), but most modern programs are able to save images in a variety of other formats, such as GIF or JPEG. *See also* gray scale. *Compare* GIF, JPEG.

TIFF JPEG *n.* Acronym for **Tagged Image File Format JPEG**. A means of saving photographic images compressed according to the JPEG (Joint Photographic Experts Group) standard. TIFF JPEG saves more information about an image than does the lower-end JFIF (JPEG File Interchange Format), but TIFF JPEG files are limited in portability because of differences in implementation among applications. *See also* JFIF, JPEG.

TIGA *n.* Acronym for **Texas Instruments Graphics Architecture**. A video adapter architecture based on the Texas Instruments 340x0 graphics processor.

tiger team *n.* A group of users, programmers, or hackers who are charged with finding flaws in networks, applica-

tions, or security procedures. Tiger teams may be hired or may be composed of volunteers, and may have a single, short-term goal or may be used for a number of investigative purposes over a longer period of time. The term “tiger team” was originally used by the military to describe infiltration groups, and was first used in the computer industry to refer to hackers hired to expose flaws in network security.

tightly coupled *adj.* **1.** Refers to two computing processes whose successful completion and individual performance rates are highly interdependent. **2.** Of, pertaining to, or characteristic of a relationship of interdependency between computers, as in multiprocessing.

tile *vb.* **1.** In computer-graphics programming, to fill adjacent blocks of pixels on the screen with a design or pattern without allowing any blocks to overlap. **2.** To fill the space on a monitor or within a smaller area with multiple copies of the same graphic image. **3.** In an environment with multiple windows, to rearrange and resize all open windows so that they appear fully on the screen without any overlap.

time and date *n.* In computing, the timekeeping and datekeeping functions maintained by the computer’s operating system, used most visibly as a means of “stamping” files with the date and time of creation or last revision.

time and date stamp *n.* *See* time stamp.

time bomb *n.* **1.** A feature often built into evaluation or beta versions of software that renders the software unusable after a certain period of time. With some evaluation versions of software containing time bombs, users are given codes or registration numbers after purchasing the software that will deactivate the time bomb. **2.** *See* logic bomb. **3.** *See* Year 2000 problem.

Time Division Multiple Access *n.* *See* TDMA.

time-division multiplexing *n.* A form of multiplexing in which transmission time is broken into segments, each of which carries one element of one signal. *Acronym:* TDM. *See also* statistical multiplexer. *Compare* FDM.

time horizon to failure *n.* *See* event horizon.

time out or **timeout** or **time-out** *n.* An event that indicates that a predetermined amount of time has elapsed without some other expected event taking place. The time-out event is used to interrupt the process that had been waiting for the other expected event. For example, a dial-up remote system might allow the user 60 seconds to log in after making a connection. If the user fails to enter a

valid login name and password within this time, the computer breaks the connection, thus protecting itself against crackers as well as freeing a phone line that may have gone dead.

timer *n.* A register (high-speed memory circuit) or a special circuit, chip, or software routine used to measure time intervals. A timer is not the same as the system clock, although its pulses can be derived from the system clock frequency. *See also* time and date. *Compare* clock (definition 1), clock/calendar.

time server *n.* A computer that periodically synchronizes the time on all computers within a network. This ensures that the time used by network services and local functions remains accurate.

time-sharing or **timesharing** *n.* **1.** The use of a computer system by more than one individual at the same time. Time-sharing runs separate programs concurrently by interleaving portions of processing time allotted to each program (user). *See also* quantum (definition 2), time slice. **2.** A method, used primarily in the 1960s and 1970s, for sharing the capabilities (and cost) of a computer, such as a mainframe. Time-sharing allowed different clients to “rent” time on a large computer and pay for only the portion of time they used.

time shifting *n.* A method of dealing with programs with Year 2000 problems that entails modifying the date either in data with which a program works (program encapsulation) or in the input/output logic of the program (data encapsulation). In both cases, the date is moved back in time to process the input, and forward in time to the correct date to produce output. *See also* encapsulation.

time slice *n.* A brief period of time during which a particular task is given control of the microprocessor in a time-sharing multitasking environment. *See also* multitasking, preemptive multitasking. *Compare* quantum (definition 2).

time-slice multitasking *n.* *See* preemptive multitasking.

timestamp *n.* A certification by a trusted third party specifying that a particular message existed at a specific time and date. In a digital context, trusted third parties generate a trusted timestamp for a particular message by having a timestamping service append a time value to a message and then digitally signing the result. *See also* digital signature, service.

time stamp *n.* A time signature that is added by a program or system to files, e-mail messages, or Web pages. A

time stamp indicates the time and usually the date when a file or Web page was created or last modified or when an e-mail message was sent or received. Most time stamps are created by programs and are based on the time kept by the system clock of a computer on which the program resides. Commercial time stamp services are available on the Web or by e-mail, and offer proof of posting certificates to corroborate the time and date a message was sent. *Also called:* date and time stamp, date stamp, time and date stamp.

time-synchronization service *n.* A program used to ensure that all systems on a network use a common time. Time-synchronization services on the Internet typically update real-time clocks to Universal Time Coordinate (UTC) using Network Time Protocol (NTP). Windows Time Synchronization Service (Win32Time) is a time-synchronization service. *See also* clock (definition 2), Network Time Protocol, Universal Time Coordinate.

Time to Live *n.* A header field for a packet sent over the Internet indicating how long the packet should be held. *Acronym:* TTL. *See also* header (definition 2), packet (definition 1).

timing attack *n.* An attack on a cryptographic system that exploits the fact that different cryptographic operations take slightly different amounts of time to process. The attacker exploits these slight time differences by carefully measuring the amount of time required to perform private key operations. Taking these measurements from a vulnerable system can reveal the entire secret key. Cryptographic tokens, network-based cryptosystems, and other applications where attackers can make reasonably accurate timing measurements are potentially at risk from this form of attack.

timing signals *n.* **1.** Any of several types of signals used to coordinate activities within a computer system. **2.** A signal used to coordinate data transfer operations.

Tinkerbelle program *n.* A program used to monitor network traffic and alert security administrators when connections are made from a predetermined list of sites and individuals. A Tinkerbelle program acts as a low-level security reporting feature.

tiny model *n.* A memory model in the Intel 80x86 processor family. The tiny model allows a combined total of only 64 kilobytes (KB) for code and for data. *See also* 8086, memory model.

T

title bar *n.* In a graphical user interface, a horizontal space at the top of a window that contains the name of the window. Most title bars also contain boxes or buttons for closing and resizing the window. Clicking on the title bar allows the user to move the entire window.

TLA *n.* Acronym for **three-letter acronym**. An ironic term, usually used in jest on the Internet in e-mail, newsgroups, and other online forums, referring to the large number of acronyms in computer terminology, particularly those consisting of three letters.

TLD *n.* *See* top-level domain.

TLS *n.* Acronym for **Transport Layer Security**. A standard protocol that is used to provide secure Web communications on the Internet or intranets. It enables clients to authenticate servers or, optionally, servers to authenticate clients. It also provides a secure channel by encrypting communications. TLS is the latest and a more secure version of the SSL protocol. *See also* authentication, communications protocol, SSL.

TMS34010 *n.* *See* 34010, 34020.

TN display *n.* *See* twisted nematic display.

TOF *n.* *See* top-of-file.

toggle¹ *n.* An electronic device with two states or a program option that can be turned on or off using the same action, such as a mouse click.

toggle² *vb.* To switch back and forth between two states. For example, the Num Lock key on an IBM-style keyboard toggles the numeric keypad between numbers and cursor movement.

ToggleKeys *n.* A feature of Windows 9x and Windows NT 4 that sounds high and low beeps when one of the toggle keys (Caps Lock, Num Lock, or Scroll Lock) is turned on or off. *See also* typematic. *Compare* BounceKeys, FilterKeys, MouseKeys, ShowSounds, SoundSentry, StickyKeys.

token *n.* **1.** A unique structured data object or message that circulates continuously among the nodes of a token ring and describes the current state of the network. Before any node can send a message, it must first wait to control the token. *See also* token bus network, token passing, token ring network. **2.** Any nonreducible textual element in data that is being parsed—for example, the use in a program of a variable name, a reserved word, or an operator. Storing tokens as short codes shortens program files and speeds execution. *See also* Basic, parse.

token bus *n.* The IEEE 802.4 specification for token-passing networks based on a bus or tree topology. Token bus networks were designed primarily for manufacturing but the specification also corresponds to the ARCnet architecture used for LANs.

token bus network *n.* A LAN (local area network) formed in a bus topology (stations connected to a single, shared data highway) that uses token passing as a means of regulating traffic on the line. On a token bus network, a token governing the right to transmit is passed from one station to another, and each station holds the token for a brief time, during which it alone can transmit information. The token is transferred in order of priority from an “upstream” station to the next “downstream” station, which might or might not be the next station on the bus. In essence, the token “circles” through the network in a logical ring rather than a physical one. Token bus networks are defined in the IEEE 802.4 standards. *See also* bus network, IEEE 802 standards, token passing. *Compare* token ring network.

token passing *n.* A method of controlling network access through the use of a special signal, called a *token*, that determines which station is allowed to transmit. The token, which is actually a short message or a small packet, is passed from station to station around the network. Only the station with the token can transmit information. *See also* token bus network, token ring network. *Compare* collision detection, contention, CSMA/CD.

token ring *n.* Spelled with lowercase *t* and *r*, the IEEE specification 802.5 for token ring networks. *See also* token ring network.

Token Ring *n.* *See* Token Ring network.

token ring network *n.* A LAN (local area network) formed in a ring (closed loop) topology that uses token passing as a means of regulating traffic on the line. On a token ring network, a token governing the right to transmit is passed from one station to the next in a physical circle. If a station has information to transmit, it “seizes” the token, marks it as being in use, and inserts the information. The “busy” token, plus message, is then passed around the circle, copied when it arrives at its destination, and eventually returned to the sender. The sender removes the attached message and then passes the freed token to the next station in line. Token ring networks are defined in the IEEE 802.5 standards. *See also* IEEE 802 standards, ring network, token passing. *Compare* token bus network.



Token Ring network *n.* A token-passing, ring-shaped local area network (LAN) developed by IBM that operates at 4 megabits (4 million bits) per second. With standard telephone wiring, the Token Ring network can connect up to 72 devices; with shielded twisted-pair (STP) wiring, the network supports up to 260 devices. Although it is based on a ring (closed loop) topology, the Token Ring network uses star-shaped clusters of up to eight workstations connected to a wiring concentrator (Multistation Access Unit, or MSAU), which, in turn, is connected to the main ring. The Token Ring network is designed to accommodate microcomputers, minicomputers, and mainframes; it follows the IEEE 802.5 standards for token ring networks. See the illustration. *See also* ring network, STP, token passing.

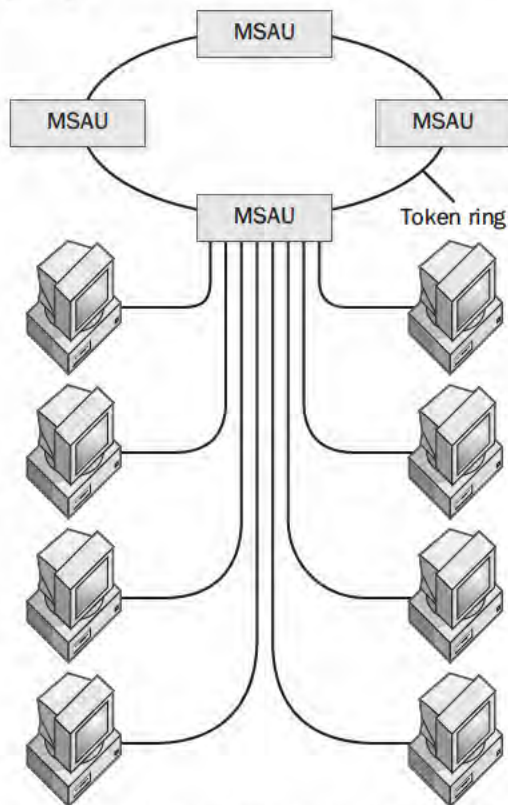

Token Ring network. An IBM Token Ring configuration with MSAUs.

tone *n.* 1. A particular tint of a color. *Also called:* shade, value. *See also* brightness, color model. 2. One sound or signal of a particular frequency.

tone compression *n.* In digital graphics, the compression of the complete color range of an image to the narrower range of the chosen output device. Allowing for tone compression in scanning and graphics editing may improve the quality of the final printed image.

toner *n.* Powdered pigment that is used in office copiers and in laser, LED, and LCD printers. *See also* electrophotographic printers.

toner cartridge *n.* A disposable container that holds toner for a laser printer or other page printer. Some types of toner cartridge contain toner only; however, the most popular printer engines pack all expendables, including toner and the photosensitive drum, in a single cartridge. Toner cartridges are interchangeable among printers that use the same engine.

toolbar *n.* In an application in a graphical user interface, a row, column, or block of on-screen buttons or icons. When these buttons or icons are clicked on with the mouse, macros or certain functions of the application are activated. For example, word processors often feature toolbars with buttons for changing text to italic, boldface, and other styles. Toolbars often can be customized by the user and usually can be moved around on the screen according to the user's preference. *See the illustration. See also* graphical user interface. *Compare* menu bar, palette (definition 1), taskbar, title bar.



Toolbar.

toolbox *n.* A set of predefined (and usually precompiled) routines a programmer can use in writing a program for a particular machine, environment, or application. *Also called:* toolkit. *See also* library (definition 1).

Toolbox *n.* A set of routines stored mostly in the read-only memory of a Macintosh that provides application programmers with the tools needed to support the graphical interface characteristic of the computer. *Also called:* User Interface Toolbox.

Tool Command Language/Tool Kit *n.* *See* Tcl/Tk.

toolkit *n.* *See* toolbox.

ToolTips *n.* Brief descriptions of the names of buttons and boxes on toolbars and in the toolbox. A ToolTip is displayed when the mouse pointer rests on the button or combo box. *See also* ScreenTips.

T

top-down design *n.* A program design methodology that starts with defining program functionality at the highest level (a series of tasks) and then breaks down each task into lower-level tasks, and so on. *See also* bottom-up programming, top-down programming. *Compare* bottom-up design.

top-down programming *n.* An approach to programming that implements a program in top-down fashion. Typically, this is done by writing a main body with calls to several major routines (implemented as stubs). Each routine is then coded, calling other, lower-level, routines (also done initially as stubs). *See also* bottom-up design, stub, top-down design. *Compare* bottom-up programming.

topic drift *n.* The tendency of an online discussion to move from its original subject to other related or unrelated subjects. For example, someone in a conference devoted to television may ask about a news program; then somebody else may say something about a story on that program about food poisoning, which leads somebody else to start a general discussion on the advantages of organic fruits and vegetables.

topic group *n.* An online discussion area for participants with a common interest in a particular subject.

top-level domain *n.* In the domain-name system of Internet addresses or DNS hierarchy, any of the broadest category of names, under which all domain names fit. Top-level domains for sites in the United States include .com, .edu, .gov, .net, and .org. *See also* DNS (definition 1), major geographic domain.

top-of-file *n.* **1.** The beginning of a file. **2.** A symbol used by a program to mark the beginning of a file—the first character in the file or, in an indexed (ordered) database, the first indexed record. *Acronym:* TOF. *See also* beginning-of-file.

topology *n.* The configuration or layout of a network formed by the connections between devices on a LAN (local area network) or between two or more LANs. *See also* bus network, LAN, ring network, star network, token ring network, tree network.

top posting *n.* In e-mail and newsgroup discussions, placing new material before material quoted from earlier posts rather than after. Because top-posted messages are read out of chronological order, top-posting is considered an undesirable practice.

total bypass *n.* A communications network that uses satellite transmission to bypass both local and long-distance telephone links.

total cost of ownership *n.* Specifically, the cost of owning, operating, and maintaining a single PC; more generally, the cost to businesses and organizations of setting up and maintaining complex and far-reaching networked computer systems. Total cost of ownership includes the up-front costs of hardware and software added to later costs of installation, personnel training, technical support, upgrades, and repairs. Industry initiatives designed to lower the total cost of ownership include centralized network management and administration, as well as hardware solutions in the form of network-based computers with or without local storage and expansion capability. *Acronym:* TCO.

touch pad *n.* A variety of graphics tablet that uses pressure sensors, rather than the electromagnetics used in more expensive high-resolution tablets, to track the position of a device on its surface. *See also* absolute pointing device, graphics tablet.

touch screen *n.* A computer screen designed or modified to recognize the location of a touch on its surface. By touching the screen, the user can make a selection or move a cursor. The simplest type of touch screen is made up of a grid of sensing lines, which determine the location of a touch by matching vertical and horizontal contacts. Another, more accurate type uses an electrically charged surface and sensors around the outer edges of the screen to detect the amount of electrical disruption and pinpoint exactly where contact has been made. A third type has infrared light-emitting diodes (LEDs) and sensors around the outer edges of the screen. These LEDs and sensors create an invisible infrared grid, which the user's finger interrupts, in front of the screen. *Compare* light pen.

touch-sensitive display *n.* *See* touch screen.

touch-sensitive tablet *n.* *See* touch pad.

touch tone dialing *n.* The signaling system used in telephones with touch-tone keypads, in which each digit is associated with two specific frequencies. During dialing, these frequencies—for example, 1336 Hz and 697 Hz for the number 2—are transmitted to the telephone company. *Also called:* DTMF, Dual Tone Multiple Frequency.

tower *n.* A microcomputer system in which the cabinet for the central processing unit (CPU) is tall, narrow, and



deep rather than short, wide, and deep. The motherboard is usually vertical, and the disk drives are often perpendicular to the motherboard. A tower cabinet is at least 24 inches tall. See the illustration. *See also* cabinet, micro-computer, motherboard. *Compare* minitower.



Tower.

TP *n.* *See* transaction processing.

TPC *n.* *See* Transaction Processing Council.

TPC-D *n.* Acronym for Transaction Processing Council Benchmark D. A benchmark standard that addresses a broad range of decision support applications working with complex data structures. *See also* Transaction Processing Council.

TPI *n.* *See* tracks per inch.

TP monitor *n.* Short for teleprocessing monitor or transaction processing monitor. A program that controls the transfer of data between terminals (or clients) and a mainframe (or one or more servers) so as to provide a consistent environment for one or more online transaction processing (OLTP) applications. A TP monitor may also control the appearance of the screen displays and check input data for proper format. *See also* client (definition 3), mainframe computer, OLTP, server (definition 1).

trace *vb.* To execute a program in such a way that the sequence of statements being executed can be observed. *See also* debugger, single step.

traceroute *n.* A utility that shows the route a packet takes through a network to arrive at a remote host. A traceroute also reports the IP addresses of all intermediate hosts or routers and the time required for the packet to reach each of them. *See also* IP address, packet.

track¹ *n.* One of numerous circular data storage areas on a floppy disk or a hard drive, comparable to a groove on a record but not spiral. Tracks, composed of sectors, are recorded on a disk by an operating system during a disk format operation. On other storage media, such as tape, a track runs parallel to the edge of the medium. *See the illustration.*

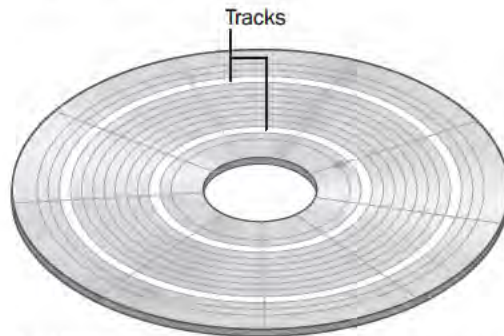

Track¹. *The storage areas on a floppy disk or hard drive.*

track² *vb.* **1.** To follow a path. **2.** In data management, to follow the flow of information through a manual or an automated system. **3.** In data storage and retrieval, to follow and read from a recording channel on a disk or a magnetic tape. **4.** In computer graphics, to cause a displayed symbol, such as a pointer, to match on the screen the movements of a mouse or another pointing device.

trackball *n.* A pointing device that consists of a ball resting on two rollers at right angles to each other, which translate the ball's motion into vertical and horizontal movement on the screen. A trackball also typically has one or more buttons to initiate other actions. A trackball's housing is stationary; its ball is rolled with the hand. *See the illustration.* *Compare* mechanical mouse.



Trackball.

tracked change *n.* A mark that shows where a deletion, insertion, or other editing change has been made in a document.

T

trackpad *n.* A pointing device consisting of a small, flat pad that is sensitive to touch. Users move the mouse cursor on screen by touching the trackpad and moving their fingers across the trackpad's surface. Such devices are most commonly installed on laptop computers. *See also* pointing device.

tracks per inch *n.* The density with which concentric tracks (data storage rings) are recorded or can be recorded in an inch of radius on a disk. The greater the density (the more tracks per inch), the more information a disk can hold. *Acronym:* TPI.

tractor feed *n.* A method of feeding paper through a printer using pins mounted on rotating belts. The pins engage holes near the edges of continuous-form paper and either push or pull the paper through. *See also* continuous-form paper. *Compare* pin feed.

trademark *n.* A word, phrase, symbol, or design (or some combination thereof) used to identify a proprietary product, often accompanied by the symbol TM or [®].

trade show *n.* A multivendor sales event or exposition that showcases companies' products. The computer industry has a number of trade shows every year, including COMDEX.

traditional newsgroup hierarchy *n.* The seven standard newsgroup categories in Usenet: comp., misc., news., rec., sci., soc., and talk. Newsgroups can be added within the traditional hierarchy only following a formal voting process. *See also* comp. newsgroups, misc. newsgroups, newsgroup, news. newsgroups, rec. newsgroups, Request for Discussion, sci. newsgroups, soc. newsgroups, talk. newsgroups, Usenet. *Compare* alt. newsgroups.

traffic *n.* The load carried by a communications link or channel.

traffic management *n.* *See* ITM.

traffic shaping *n.* A technique for allocating bandwidth and preventing packet loss by enforcing prioritization policies on the transmission of data over a network. *Also called:* bandwidth shaping. *See also* bandwidth management, bandwidth reservation, token passing.

trailer *n.* Information, typically occupying several bytes, at the tail end of a block (section) of transmitted data and often containing a checksum or other error-checking data useful for confirming the accuracy and status of the transmission. *See also* checksum. *Compare* header (definition 2).

trailer label *n.* **1.** A small block of information used in tape processing that marks the end of a file or the end of the tape and that can contain other information, such as the number of records in the file or files on the tape. *Compare* header label. **2.** A label used in communications data frames that follows the data and might contain an end-of-message mark, a checksum, and some synchronization bits.

trailing edge *n.* The latter part of an electronic signal. When a digital signal switches from on to off, the transition is the trailing edge of the signal.

train¹ *n.* A sequence of items or events, such as a digital pulse train consisting of transmitted binary signals.

train² *vb.* To teach an end user how to use a software or hardware product.

transaction *n.* A discrete activity within a computer system, such as an entry of a customer order or an update of an inventory item. Transactions are usually associated with database management, order entry, and other online systems.

transactional e-mail *n.* A form of Web-based marketing in which goods and services are sold to consumers directly from an e-mail message. Unlike traditional e-mail marketing that requires the e-mail recipient to visit the seller's Web site, transactional e-mail allows an entire sales transaction to be completed from within the marketing e-mail. To take advantage of transactional e-mail buying options, the recipient must view the e-mail message in HTML format.

transaction file *n.* A file that contains the details of transactions, such as items and prices on invoices. It is used to update a master database file. *See also* transaction. *Compare* master file.

transaction log *n.* *See* change file.

transaction processing *n.* A processing method in which transactions are executed immediately after they are received by the system. *Acronym:* TP. *See also* transaction. *Compare* batch processing (definition 3).

Transaction Processing Council *n.* A group of hardware and software vendors with the goal of publishing benchmark standards. *Acronym:* TPC.

transaction processing monitor *n.* *See* TP monitor.

Transaction Tracking System *n.* *See* TTS (definition 2).

Transact-SQL *n.* A query language. Transact-SQL is sophisticated SQL dialect loaded with additional features beyond what is defined in the ANSI SQL 92 Standard. *Also called:* T-SQL, TSQL.



transceiver *n.* Short for **transmitter/receiver**. A device that can both transmit and receive signals. On LANs (local area networks), a transceiver is the device that connects a computer to the network and that converts signals to and from parallel and serial form.

transceiver cable *n.* A cable that is used to connect a host adapter within a computer to a LAN (local area network). *See also* AUI cable, LAN.

transducer *n.* A device that converts one form of energy into another. Electronic transducers either convert electric energy to another form of energy or convert nonelectric to electric energy.

transfer¹ *n.* 1. The movement of data from one location to another. 2. The passing of program control from one portion of code to another.

transfer² *vb.* To move data from one place to another, especially within a single computer. *Compare* transmit.

transfer rate *n.* The rate at which a circuit or a communications channel transfers information from source to destination, as over a network or to and from a disk drive. Transfer rate is measured in units of information per unit of time—for example, bits per second or characters per second—and can be measured either as a raw rate, which is the maximum transfer speed, or as an average rate, which includes gaps between blocks of data as part of the transmission time.

transfer statement *n.* A statement in a programming language that transfers the flow of execution to another location in the program. *See also* branch instruction, CALL statement, GOTO statement, jump instruction.

transfer time *n.* The time elapsed between the start of a data transfer operation and its completion.

transform *vb.* 1. To change the appearance or format of data without altering its content; that is, to encode information according to predefined rules. 2. In mathematics and computer graphics, to alter the position, size, or nature of an object by moving it to another location (translation), making it larger or smaller (scaling), turning it (rotation), changing its description from one type of coordinate system to another, and so on.

transformer *n.* A device used to change the voltage of an alternating current signal or to change the impedance of an alternating current circuit.

transient *adj.* 1. Fleeting, temporary, or unpredictable. 2. Of or pertaining to the region of memory used for programs, such as applications, that are read from disk storage and that reside in memory temporarily until they are replaced by other programs. In this context, *transient* can also refer to the programs themselves. 3. In electronics, of or pertaining to a short-lived, abnormal, and unpredictable increase in power supply, such as a voltage spike or surge. *Transient time* is the interval during which a change in current or voltage is building up or decaying.

transient suppressor *n.* A circuit designed to reduce or eliminate unwanted electrical signals or voltages.

transistor *n.* Short for **transfer resistor**. A solid-state circuit component, usually with three leads, in which a voltage or a current controls the flow of another current. The transistor can serve many functions, including those of amplifier, switch, and oscillator, and is a fundamental component of almost all modern electronics. *See the illustration.* *See also* base (definition 3), FET, NPN transistor, PNP transistor.

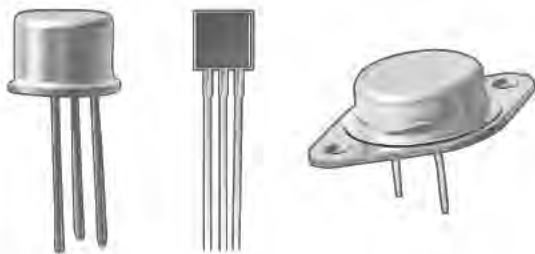

Transistor.

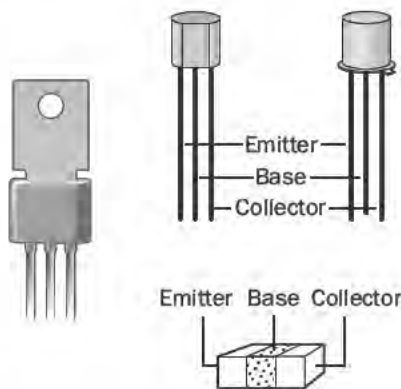

T

transistor-transistor logic *n.* A type of bipolar circuit design that utilizes transistors connected to each other either directly or through resistors. Transistor-transistor logic offers high speed and good noise immunity and is used in many digital circuits. A large number of transistor-transistor logic gates can be fabricated on a single integrated circuit. *Acronym:* TTL.

transitive trust *n.* The standard type of trust relationship between Windows domains in a domain tree or forest. When a domain joins an existing forest or domain tree, a transitive trust is automatically established. Transitive trusts are always two-way relationships. This series of trusts, between parent and child domains in a domain tree and between root domains of domain trees in a forest, allows all domains in a forest to trust each other for the purposes of authentication. For example, if domain A trusts domain B and domain B trusts domain C, then domain A trusts domain C. *See also* domain, forest, one-way trust, two-way trust.

translate *vb.* **1.** In programming, to convert a program from one language to another. Translation is performed by special programs such as compilers, assemblers, and interpreters. **2.** In computer graphics, to move an image in the "space" represented on the display, without turning (rotating) the image.

translated file *n.* A file containing data that has been changed from binary (8-bit) format to ASCII (7-bit) format. BinHex and uuencode both translate binary files into ASCII. Such translation is necessary to transmit data through systems (such as e-mail) that may not preserve the eighth bit of each byte. A translated file must be decoded to its binary form before being used. *See also* BinHex, uuencode.

translator *n.* A program that translates one language or data format into another.

transmission channel *n.* *See* channel.

Transmission Control Protocol *n.* *See* TCP.

Transmission Control Protocol/Internet Protocol *n.* *See* TCP/IP.

transmit *vb.* To send information over a communications line or a circuit. Computer transmissions can take place in the following ways: asynchronous (variable timing) or synchronous (exact timing); serial (essentially, bit by bit) or parallel (byte by byte; a group of bits at once); duplex or full-duplex (simultaneous two-way communication), half-duplex (two-way communication in one direction at a

time), or simplex (one-way communication only); and burst (intermittent transmission of blocks of information). *Compare* transfer².

Transmit Data *n.* *See* TXD.

transmitter *n.* Any circuit or electronic device designed to send electrically encoded data to another location.

transparency *n.* The quality that defines how much light passes through an object's pixels. If an object is 100 percent transparent, light passes through it completely and renders the object invisible; in other words, you can see through the object.

transparency scanner *n.* *See* scanner.

transparent *adj.* **1.** In computer use, of, pertaining to, or characteristic of a device, function, or part of a program that works so smoothly and easily that it is invisible to the user. For example, the ability of one application to use files created by another is transparent if the user encounters no difficulty in opening, reading, or using the second program's files or does not even know the use is occurring. **2.** In communications, of, pertaining to, or characteristic of a mode of transmission in which data can include any characters, including device-control characters, without the possibility of misinterpretation by the receiving station. For example, the receiving station will not end a transparent transmission until it receives a character in the data that indicates end of transmission. Thus, there is no danger of the receiving station ending communications prematurely. **3.** In computer graphics, of, pertaining to, or characteristic of the lack of color in a particular region of an image so that the background color of the display shows through.

transponder *n.* A transceiver in a communications satellite that receives a signal from an earth station and retransmits it on a different frequency to one or more other earth stations.

transportable computer *n.* *See* portable computer.

transport layer *n.* The fourth of the seven layers in the International Organization for Standardization's Open Systems Interconnection (OSI) reference model for standardizing computer-to-computer communications. The transport layer is one level above the network layer and is responsible for both quality of service and accurate delivery of information. Among the tasks performed on this layer are error detection and correction. *See* the illustration. *See also* ISO/OSI reference model.



ISO/OSI MODEL	
ISO/OSI Layer	Focus
Application (highest level)	Program-to-program transfer of information
Presentation	Text formatting and display, code conversion
Session	Establishing, maintaining, and coordinating communication
Transport	Accurate delivery, service quality
Network	Transport routes, message handling and transfer
Data-link	Coding, addressing, and transmitting information
Physical	Hardware connections

Transport layer.

Transport Layer Security *n.* See TLS.

transpose¹ *n.* The result of rotating a matrix.

transpose² *vb.* **1.** To reverse, as the order of the letters *h* and *t* in *hte*, in correcting the spelling of *the*; or reversing two wires in a circuit. **2.** In mathematics and spreadsheets, to rotate a matrix (a rectangular array of numbers) about a diagonal axis.

transputer *n.* Short for **transistor computer**. A complete computer on a single chip, including RAM and an FPU, designed as a building block for parallel computing systems.

trap¹ *n.* See interrupt.

trap² *vb.* **1.** To intercept an action or event before it occurs, usually in order to do something else. Trapping is commonly used by debuggers to allow interruption of program execution at a given spot. See also interrupt, interrupt handler. **2.** To slightly overlap adjacent colors in preparing material for printing. Page layout and prepress programs trap color to prevent gaps between colors caused by minor variations in registration during printing.

trapdoor *n.* See back door.

trap handler *n.* See interrupt handler.

Trash *n.* An icon on the screen in the Macintosh Finder, resembling a garbage can. To delete a file or eject a diskette, the user drags the icon for the file or diskette to the Trash. However, until the user shuts down the system or

chooses the menu option "Empty Trash," a file in the Trash is not actually deleted; the user can retrieve it by double-clicking the Trash icon and dragging the file's icon out of the resulting window. Compare Recycle Bin.

traverse *vb.* In programming, to access in a particular order all of the nodes of a tree or similar data structure.

tree *n.* A data structure containing zero or more nodes that are linked together in a hierarchical fashion. If there are any nodes, one node is the root; each node except the root is the child of one and only one other node; and each node has zero or more nodes as children. See also child (definition 2), graph, leaf, node (definition 3), parent/child (definition 2), root.

tree network *n.* A topology for a local area network (LAN) in which one machine is connected to one or more other machines, each of which is connected to one or more others, and so on, so that the structure formed by the network resembles that of a tree. See the illustration. See also bus network, distributed network, ring network, star network, token ring network, topology.

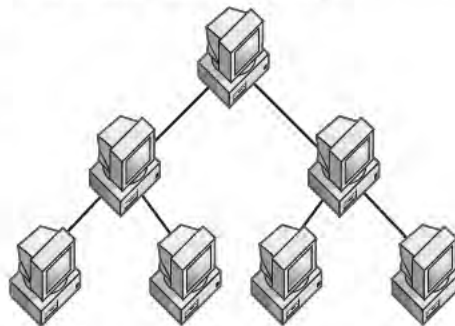

Tree network.

tree search *n.* A search procedure performed on a tree data structure. At each step of the search, a tree search is able to determine, by the value in a particular node, which branches of the tree to eliminate, without searching those branches themselves. See also branch (definition 1), tree structure.

tree structure *n.* Any structure that has the essential organizational properties of a tree. See also tree.

tree view *n.* A hierarchical representation of the folders, files, disk drives, and other resources connected to a computer or network. For example, Windows Explorer uses a tree view to display the resources that are attached to a computer or a network. See also resource.

T

trellis-coded modulation *n.* An enhanced form of quadrature amplitude modulation that is used by modems that operate at or above 9,600 bps (bits per second). Trellis-coded modulation encodes information as unique sets of bits associated with changes in both the phase and amplitude of the carrier, as well as using extra signal points for error-checking bits. *Acronym:* TCM. *See also* quadrature amplitude modulation.

trendline *n.* A graphic representation of trends in data series, such as a line sloping upward to represent increased sales over a period of months. Trendlines are used for the study of problems of prediction. *Also called:* regression analysis.

triage¹ *n.* The process of prioritizing projects or elements of a project (such as bug fixes) to ensure that available resources are assigned in the most effective, time-efficient, and cost-efficient manner. Traditionally, triage has referred to the prioritization of treatment to the wounded during wartime or medical disaster situations. More recently, the term also refers to anticipating and preventing computer system crashes brought on by the Year 2000 (Y2K) problem. *See also* Year 2000 Problem.

triage² *vb.* To identify and prioritize the elements of a project or problem to order them in a way that makes best use of labor, funds, and other resources.

tri-band phone *n.* A wireless phone designed for international travel. Tri-band phones broadcast on the personal communication service (PCS) frequency used in North America as well as PCS frequencies used in other regions of the world.

trichromatic *adj.* Of, pertaining to, or characteristic of a system that uses three colors (red, green, and blue in computer graphics) to create all other colors. *See also* color model.

trigger¹ *n.* **1.** In a database, an action that causes a procedure to be carried out automatically when a user attempts to modify data. A trigger can instruct the database system to take a specific action, depending on the particular change attempted. Incorrect, unwanted, or unauthorized changes can thereby be prevented, helping to maintain the integrity of the database. **2.** A function built into a virus or worm that controls the release of a malicious payload or similar event. The trigger may be activated at a predetermined time or date or in response to a user-initiated event, such as opening a specific program or file. In some cases,

the trigger may reset itself repeatedly until the virus is neutralized.

trigger² *vb.* To activate a function or program, such as the release of a virus payload, in response to a specific event, date, or time.

trigonometry *n.* The branch of mathematics dealing with arcs and angles, expressed in functions (for example, sine and cosine) that show relationships—for example, between two sides of a right triangle or between two complementary angles.

trilinear filtering *n.* A technique used in 3-D computer game rendering and other digital animation applications that produces the illusion of depth of field by making distant objects less distinct and detailed than nearer objects.

tri-mode phone *n.* A wireless phone that broadcasts on 1900 MHz personal communication service (PCS), 800 MHz digital cellular networks, and 800 MHz analog networks.

triple-pass scanner *n.* A color scanner that performs one scanning pass on an image for each of the three primary colors of light (red, green, and blue). *See also* color scanner.

tristimulus values *n.* In color graphics, the varying amounts of three colors, such as red, blue, and green, that are combined to produce another color. *See also* color, color model.

Trivial File Transfer Protocol *n.* A simplified version of File Transfer Protocol (FTP) that provides basic file transfer with no user authentication and is often used to download the initial files needed to begin an installation process. *Acronym:* TFTP. *See also* communications protocol.

troff *n.* Short for typesetting **run off**. A UNIX text formatter often used to format man pages. *See also* man pages, RUNOFF. *Compare* TeX.

Trojan horse *n.* A destructive program disguised as a game, utility, or application. When run, a Trojan horse does something harmful to the computer system while appearing to do something useful. *See also* virus, worm.

troll *vb.* To post a message in a newsgroup or other online conference in the hopes that somebody else will consider the original message so outrageous that it demands a heated reply. A classic example of trolling is an article in favor of torturing cats posted in a pet lovers' newsgroup. *See also* YHBT.



troubleshoot *vb.* To isolate the source of a problem in a program, computer system, or network and remedy it.

troubleshooter *n.* A person trained and hired to find and resolve problems or breakdowns in machinery and technical equipment or systems. Troubleshooters often work as short-term consultants or freelancers because many organizations and businesses regard troubleshooting as a short-term effort or possibly an exceptional—unplanned—part of a project or system. *See also* troubleshoot.

trouble ticket *n.* A report of a problem with a particular device or system that is tracked through the workflow process. Originally written on paper, electronic trouble tickets are featured by many workflow and help-desk applications. *See also* help desk (definition 2), workflow application.

True BASIC *n.* A version of Basic created in 1983 by John Kemeny and Thomas Kurtz, the creators of the original Basic, to standardize and modernize the language. True BASIC is a compiled, structured version of Basic that does not require line numbers. True BASIC includes advanced control structures that make structured programming possible. *See also* Basic, structured programming.

true color *n.* *See* 24-bit color.

true complement *n.* *See* complement.

TrueType *n.* An outline font technology introduced by Apple Computer, Inc., in 1991 and by Microsoft Corporation in 1992 as a means of including high-grade fonts within the Macintosh and Windows operating systems. TrueType is a WYSIWYG font technology, which means that the printed output of TrueType fonts is identical to what appears on the screen. *See also* bitmapped font, outline font, PostScript.

TrueType Open version 2 *n.* *See* OpenType.

truncate *vb.* To cut off the beginning or end of a series of characters or numbers; specifically, to eliminate one or more of the least significant (typically rightmost) digits. In truncation, numbers are simply eliminated, unlike rounding, in which the rightmost digit might be incremented to preserve accuracy. *Compare* round.

trunk *n.* **1.** In communications, a channel connecting two switching stations. A trunk usually carries a large number of calls at the same time. **2.** In networking, the cable forming the main communications path on a network. On a bus network, the single cable to which all nodes connect. *See also* backbone.

trunking *n.* *See* link aggregation.

Trusted Computing Base *n.* *See* TCB.

trust relationship *n.* A logical relationship established between domains to allow pass-through authentication, in which a trusting domain honors the logon authentications of a trusted domain. User accounts and global groups defined in a trusted domain can be given rights and permissions in a trusting domain, even though the user accounts or groups don't exist in the trusting domain's directory. *See also* authentication, domain, group, permission, user account.

truth table *n.* A table showing the value of a Boolean expression for each of the possible combinations of variable values in the expression. *See also* AND, Boolean operator, exclusive OR, NOT, OR.

try *n.* A keyword used in the Java programming language to define a block of statements that may throw a Java language exception. If an exception is thrown, an optional "catch" block can handle specific exceptions thrown within the "try" block. Also, an optional "finally" block will be executed regardless of whether an exception is thrown. *See also* block, catch, exception, finally.

TSAPI *n.* Acronym for **Telephony Services Application Programming Interface**. The set of standards for the interface between a large telephone system and a computer network server, developed by Novell and AT&T and supported by many telephone equipment manufacturers and software developers. *Compare* TAPI.

TSP *n.* *See* Telephony Service Provider.

TSPI *n.* *See* Telephony Service Provider Interface.

T-SQL or **TSQL** *n.* *See* Transact-SQL.

TSR *n.* Acronym for **terminate-and-stay-resident**. A program that remains loaded in memory even when it is not running, so that it can be quickly invoked for a specific task performed while another program is operating. Typically, these programs are used with operating systems that are not multitasking, such as MS-DOS. *See also* hot key.

TSV *n.* Filename extension, short for **tab separated values**, assigned to text files containing tabular (row and column) data of the type stored in database fields. As the name indicates, individual data entries are separated by tabs. *Compare* CSV (definition 3).

TTFN *n.* Acronym for **Ta ta for now**. An expression sometimes used in Internet discussion groups, such as Internet Relay Chat (IRC), to signal a participant's temporary departure from the group. *See also* IRC.

T

TTL *n.* See Time to Live, transistor-transistor logic.

TTS *n.* **1.** Acronym for **Text-to-Speech**. The process of converting digital text into speech output. TTS is used extensively in fax, e-mail, and other services for the blind, and for telephone-based informational and financial services. **2.** Acronym for **Transaction Tracking System**. A feature developed to protect databases from corruption caused by incomplete transactions. TTS monitors attempted transactions and in the event of a hardware or software failure, TTS will cancel the update and back out to maintain database integrity.

TTY *n.* Acronym for **teletypewriter**. A device for low-speed communications over a telephone line, consisting of a keyboard that sends a character code for each keystroke and a printer that prints characters as their codes are received. The simplest video display interface behaves like a TTY. See also KSR terminal, teletype mode.

tunnel *vb.* To encapsulate or wrap a packet or a message from one protocol in the packet for another. The wrapped packet is then transmitted over a network via the protocol of the wrapper. This method of packet transmission is used to avoid protocol restrictions. See also communications protocol, packet (definition 2).

tunneling *n.* A method of transmission over internet-networks based on differing protocols. In tunneling, a packet based on one protocol is wrapped, or encapsulated, in a second packet based on whatever differing protocol is needed in order for it to travel over an intermediary network. In effect, the second wrapper “insulates” the original packet and creates the illusion of a tunnel through which the wrapped packet travels across the intermediary network. In real-life terms, tunneling is comparable to “encapsulating” a present (the original packet) in a box (the secondary wrapper) for delivery through the postal system.

tunnel server *n.* A server or router that terminates tunnels and forwards traffic to the hosts on the target network. See also host, router, server, tunnel.

tuple *n.* In a database table (relation), a set of related values, one for each attribute (column). A tuple is stored as a row in a relational database management system. It is the analog of a record in a nonrelational file. See also relation.

Turing machine *n.* **1.** A theoretical model created by British mathematician Alan Turing in 1936 that is considered the prototype for digital computers. Described in a paper (“On Computable Numbers with an Application to

the Entscheidungsproblem”) published in the *Proceedings of the London Mathematical Society*, the Turing machine was a logical device that could scan one square at a time (either blank or containing a symbol) on a paper tape. Depending on the symbol read from a particular square, the machine would change its status and/or move the tape backward or forward to erase a symbol or to print a new one. See also status. **2.** A computer that can successfully mimic human intelligence in the Turing test.

Turing test *n.* A test of machine intelligence proposed by Alan Turing, British mathematician and developer of the Turing machine. In the Turing test, also known as the Imitation Game, a person uses any series of questions to interrogate two unseen respondents, a human and a computer, to try to determine which is the computer.

turnaround time *n.* **1.** The elapsed time between submission and completion of a job. **2.** In communications, the time required to reverse the direction of transmission in half-duplex communication mode. See also half-duplex transmission.

turnkey system *n.* A finished system, complete with all necessary hardware and documentation and with software installed and ready to be used.

turnpike effect *n.* The communications equivalent of gridlock; a reference to bottlenecks caused by heavy traffic over a communications system or network.

turtle *n.* A small on-screen shape, usually a triangle or a turtle shape, that acts as a drawing tool in graphics. A turtle is a friendly, easily manipulated tool designed for children learning to use computers. It takes its name from a mechanical, dome-shaped turtle that was developed for the Logo language and moved about the floor in response to Logo commands, raising and lowering a pen to draw lines.

turtle graphics *n.* A simple graphics environment, present in Logo and other languages, in which a turtle is manipulated by simple commands. Some versions display the turtle and its track on screen; others use electromechanical turtles that write on paper.

tutorial *n.* A teaching aid designed to help people learn to use a product or procedure. In computer applications, a tutorial might be presented in either a book or a manual or as an interactive disk-based series of lessons provided with the program package.

Tux *n.* The mascot of the Linux operating system. Tux is a rotund cartoonish penguin and the Tux image is available for use by any provider of Linux products or services. The



name Tux is both short for tuxedo, in reference to a penguin's appearance, and an acronym for **T**orvalds's **U**ni**X**, after Linus Torvalds, the creator of the Linux operating system.

TV tuner card *n.* A PCI card that allows a computer to receive television programming and display it on the computer's monitor. *See also* PCI card.

TWAIN *n.* The de facto standard interface between software applications and image-capturing devices such as scanners. Nearly all scanners contain a TWAIN driver, but only TWAIN-compatible software can use the technology. The TWAIN specification was developed by the TWAIN Working Group, a consortium of industry vendors formed in 1992. The name is thought by some to be an acronym for the phrase "technology without an interesting name," although the TWAIN Working Group maintains the name is not an acronym. Others attribute the name to the quote "Ne'er the twain shall meet," because the TWAIN driver and the application receiving the image are separated. *See also* scanner.

tweak *vb.* To make final small changes to improve hardware or software performance; to fine-tune a nearly complete product.

tween *vb.* In a graphics program, to calculate intermediary shapes during the metamorphosis of one shape into another.

twinaxial *adj.* Having two coaxial cables contained in a single insulated jacket. *See also* coaxial cable.

twip *n.* A unit of measure used in typesetting and desktop publishing, equal to one-twentieth of a printer's point, or 1/1440th of an inch. *See also* point¹ (definition 1).

twisted nematic display *n.* A type of passive-matrix liquid crystal display (LCD) in which the glass sheets enclosing nematic liquid crystal material are treated in such a way that the crystal molecules twist 90 degrees between top and bottom—in other words, the orientation at the bottom of the crystal is perpendicular to the orientation at the top. When an electrical charge is applied selectively to these crystals, they become temporarily untwisted and block the passage of polarized light. This blockage is what produces the dark pixels on an LCD display. The *nematic* part of the description refers to microscopic threadlike bodies that characterize the type of liquid crystals used in these displays. *Also called:* TN display.

twisted-pair cable *n.* A cable made of two separately insulated strands of wire twisted together. It is used to

reduce signal interference introduced by a strong radio source such as a nearby cable. One of the wires in the pair carries the sensitive signal, and the other wire is grounded.

twisted-pair wiring *n.* Wiring consisting of two insulated strands of copper twisted around one another to form a cable. Twisted-pair wiring comes in two forms, unshielded twisted pair (UTP) and shielded twisted pair (STP), the latter named for an extra protective sheath wrapped around each insulated pair of wires. Twisted-pair wiring can consist of a single pair of wires or, in thicker cables, two, four, or more pairs of wires. Twisted-pair wiring is typical of telephone cabling. *Compare* coaxial cable, fiberoptic cable.

two-digit date storage *n.* A limitation in many computer systems and programs that store the year portion of a date as two digits instead of four. This practice in programming dates from the earliest days of computers when space on punch cards and memory in the computer were very limited, and many programmers used a two-digit year in date fields to economize on space or memory requirements.

two-digit shortcut *n.* The practice of using two digits to indicate the year in a program, particularly those written in programming languages or running on systems that have the capability to work with a four-digit year (hence the term shortcut).

two-dimensional *adj.* Existing in reference to two measures, such as height and width—for example, a two-dimensional model drawn with reference to an *x*-axis and a *y*-axis, or a two-dimensional array of numbers placed in rows and columns. *See also* Cartesian coordinates.

two-dimensional array *n.* An ordered arrangement of information in which the location of any item is described by two numbers (integers) identifying its position in a particular row and column of a matrix.

two-dimensional model *n.* A computer simulation of a physical object in which length and width are real attributes but depth is not; a model with *x*- and *y*-axes. *Compare* three-dimensional model.

two-nines availability *n.* The availability of a system 99% of the time. Two-nines availability equates to approximately 87.6 hours of downtime in a standard 365-day year. *See also* high availability.

two-out-of-five code *n.* An error-sensitive code for data transmission that stores each of the ten decimal digits (0 through 9) as a set of five binary digits: either two of the

T

digits are 1s and the other three digits are 0s or two of the digits are 0s and the other three digits are 1s.

two's complement *n.* A number in the base-2 system (binary system) that is the true complement of another number. A two's complement is usually derived by reversing the digits in a binary number (changing 1s to 0s and 0s to 1s) and adding 1 to the result. When two's complements are used to represent negative numbers, the most significant (leftmost) digit is always 1. *See also* complement.

two-tier client/server *n.* A client/business logic layer and the database layer. Fourth-generation languages (4GL) have helped to popularize the two-tier client/server architecture. *Compare* three-tier client/server.

two-way trust *n.* A type of trust relationship in which both of the domains in the relationship trust each other. In a two-way trust relationship, each domain has established a one-way trust with the other domain. For example, domain A trusts domain B and domain B trusts domain A. Two-way trusts can be transitive or nontransitive. All two-way trusts between Windows domains in the same domain tree or forest are transitive. *See also* domain, forest, one-way trust, transitive trust.

TXD *n.* Short for Transmit (tx) Data. A line used to carry transmitted data from one device to another, as from computer to modem; in RS-232-C connections, pin 2. *See also* RS-232-C standard. *Compare* RXD.

.txt *n.* A file extension that identifies ASCII text files. In most cases, a document with a .txt extension does not include any formatting commands, so it is readable in any text editor or word processing program. *See also* ASCII.

Tymnet *n.* A public data network available in over 100 countries, with links to some online services and Internet service providers.

type¹ *n.* **1.** In programming, the nature of a variable—for example, integer, real number, text character, or floating-point number. Data types in programs are declared by the programmer and determine the range of values a variable can take as well as the operations that can be performed on it. *See also* data type. **2.** In printing, the characters that make up printed text, the design of a set of characters (typeface), or, more loosely, the complete set of characters in a given size and style (font). *See also* font, typeface.

type² *vb.* To enter information by means of the keyboard.

Type I PC Card *n.* *See* PC Card.

Type II PC Card *n.* *See* PC Card.

Type III PC Card *n.* *See* PC Card.

type-ahead buffer *n.* *See* keyboard buffer.

type-ahead capability *n.* The ability of a computer program to gather incoming keystrokes in a temporary memory reservoir (buffer) before displaying them on the screen. This capability ensures that keystrokes are not lost if they are typed faster than the program can display them.

type ball *n.* A small ball mounted on the print head of a printer or a typewriter (for example, the IBM Selectric) that bears all the characters in the character set on its surface. The ball rotates to align the correct character with the paper and with an inked or carbon ribbon before striking against the paper. *See* the illustration.



Type ball.

type checking *n.* The process performed by a compiler or interpreter to make sure that when a variable is used, it is treated as having the same data type as it was declared to have. *See also* compiler (definition 2), data type, interpreter.

type declaration *n.* A declaration in a program that specifies the characteristics of a new data type, usually by combining more primitive existing data types.

typeface *n.* A specific, named design of a set of printed characters, such as Helvetica Bold Oblique, that has a specified obliqueness (degree of slant) and stroke weight (thickness of line). A typeface is not the same as a *font*, which is a specific size of a specific typeface, such as 12-point Helvetica Bold Oblique. Nor is a typeface the same as a *typeface family*, which is a group of related typefaces, such as the Helvetica family including Helvetica, Helvetica Bold, Helvetica Oblique, and Helvetica Bold Oblique. *See also* font.

type font *n.* *See* font.

typematic *adj.* The keyboard feature that repeats a key-stroke when a key is held down longer than usual. *Also called:* auto-key, auto-repeat. *See also* repeat key, Repeat-Keys.

typeover mode *n.* *See* overwrite mode.

type size *n.* The size of printed characters, usually measured in points (a point is approximately $1/72$ inch). *See also* point¹ (definition 1).

type style *n.* **1.** The obliqueness, or degree of slant, of a typeface. **2.** Loosely, the overall design of a typeface or a typeface family. **3.** One of the variant forms of a type character, including roman, bold, italic, and bold italic.

typography *n.* **1.** The art of font design and typesetting. *See also* computer typesetting, font. **2.** The conversion of unformatted text into camera-ready type, suitable for printing. *See also* camera-ready.

typosquatter *n.* A form of cybersquatter that takes advantage of typographical errors to snare Web surfers. The typosquatter registers variations of popular trademarked domain names that contain the most likely spelling errors (for example: JCPenny). A user who makes a mistake typing in a Web site address will be taken to the typosquatter's site, which typically is loaded with banner and pop-up ads. The typosquatter is paid by the number of users who see the ads. *See also* cybersquatter.



U

u- prefix A letter sometimes substituted for the Greek letter μ (mu), meaning micro, used as a prefix in measurements denoting one millionth, or 10^{-6} . *See also* micro- (definition 2).

UA *n.* *See* user agent.

UART *n.* Acronym for **u**niversal **a**synchronous **r**eceiver-transmitter. A module, usually composed of a single integrated circuit, that contains both the receiving and transmitting circuits required for asynchronous serial communication. A UART is the most common type of circuit used in personal computer modems. *Compare* USRT.

ubiquitous computing *n.* A term coined by Mark Wieser (1988) at the Xerox PARC Computer Science Lab to describe a computing environment so pervasive in daily life that it's invisible to the user. Household appliances such as VCRs and microwave ovens are contemporary low-level examples of ubiquitous computing. In the future, prognosticators say, computers will be so embedded in all facets of life—so ubiquitous—that their presence will fade into the background. Ubiquitous computing is considered to be the third stage in the evolution of computing technology, after the mainframe and the personal computer. *Acronym:* UC.

UC *n.* *See* ubiquitous computing.

UCAID *n.* Acronym for **U**niversity **C**orporation for **A**dvanced **I**nternet **D**evelopment. An organization created to provide guidance in advanced networking development within the university community. UCAID is responsible for the development of the Abilene fiber-optic backbone network that will interconnect over 150 universities into the Internet2 project.

UCE *n.* Acronym for **u**nsolicited **c**ommercial **e**-mail. *See* spam.

UCITA *n.* Acronym for **U**niform **C**omputer **I**nformation **T**ransactions **A**ct. Legislation proposed or enacted in several states that will set legal standards and control systems for dealing with computer information. UCITA is a model law intended as an amendment to the Uniform Commercial Code to cover new technology-related issues. One of

UCITA's main provisions is a standard for mass market software shrinkwrap and clickwrap agreements. *See also* clickwrap agreement, shrinkwrap agreement.

UCSD p-system *n.* A portable operating system and development environment that was developed by Kenneth Bowles at the University of California at San Diego. The system was based on a simulated, 16-bit, stack-oriented "pseudomachine." The development environment included a text editor and compilers for several languages, such as FORTRAN and Pascal. Programs written for a p-system were more portable than programs compiled to machine language. *See also* bytecode, pseudomachine, p-system, virtual machine.

UDDI *n.* Acronym for **U**niversal **D**escription, **D**iscovery, and **I**ntegration. A platform-independent framework functioning like a directory (similar to a telephone book) that provides a way to locate and register Web services on the Internet. The UDDI specification calls for three elements: white pages, which provide business contact information; yellow pages, which organize Web services into categories (for example, credit card authorization services); and green pages, which provide detailed technical information about individual services. The UDDI also contains an operational registry, which is available today.

UDP *n.* Acronym for **U**ser **D**atagram **P**rotocol. The connectionless protocol within TCP/IP that corresponds to the transport layer in the ISO/OSI reference model. UDP converts data messages generated by an application into packets to be sent via IP, but it is "unreliable" because it does not establish a path between sender and receiver before transmitting and does not verify that messages have been delivered correctly. UDP is more efficient than TCP, so it is used for various purposes, including SNMP; the reliability depends on the application that generates the message. *See also* communications protocol, ISO/OSI reference model, packet, SNMP, TCP/IP. *Compare* IP, TCP.

UDT *n.* Acronym for **u**niform **d**ata **t**ransfer. The service used in the OLE extensions to Windows that allows two

applications to exchange data without either program knowing the internal structure of the other.

UI *n.* See user interface.

UKnet *n.* **1.** The University of Kentucky's campus network. **2.** In the United Kingdom, an Internet service provider (ISP) based at the University of Kent. *See also* ISP.

ULSI *n.* See ultra-large-scale integration.

UltimateTV *n.* A television digital recording technology developed by Microsoft. UltimateTV can record up to 35 hours of DIRECTV broadcasts. Because the television signal is recording on UltimateTV's hard drive, viewers can pause a live show, rewind scenes, and watch previously shown parts of the show in slow or fast motion while UltimateTV records the remainder of the show live.

Ultra DMA/33 *n.* A data transfer protocol, based on direct memory access, for transferring data between a hard drive and a computer's RAM. Ultra DMA/33 improves ATA/IDE performance, doubles burst transfer rates to 33 megabytes per second, and increases data transfer integrity. *See also* ATA, direct memory access, IDE (definition 1).

ultrafiche *n.* Microfiche with very high density. The image in ultrafiche is reduced at least 90 times from its original size. *See also* microfiche.

ultra-large-scale integration *n.* The highest currently possible density at which components (transistors and other elements) are packed onto an integrated circuit. "Ultra-large-scale" is generally applied to component densities of 1,000,000 or greater. *Acronym:* ULSI. *See also* integrated circuit. *Compare* large-scale integration, medium-scale integration, small-scale integration, super-large-scale integration, very-large-scale integration.

ultralight computer *n.* See portable computer.

UltraSCSI *n.* An extension of the SCSI-2 standard that doubles the transfer speed of Fast-SCSI to allow a transfer rate of 20 megabytes per second (MBps) on an 8-bit connection and 40 MBps on a 16-bit connection. *See also* SCSI, SCSI-2.

Ultra Wide SCSI *n.* See UltraSCSI.

UMA *n.* **1.** Acronym for **upper memory area**. The portion of DOS memory between the first 640K and 1 MB. *Compare* high memory area. **2.** Acronym for **Uniform Memory Architecture**. *See* SMP.

UMB *n.* Acronym for **upper memory block**. A block of memory in the UMA (upper memory area) that can be

used for device drivers or TSRs. A UMB is allocated and managed by special memory manager programs such as EMM386.EXE. *See also* device driver, TSR, UMA (definition 1).

UML *n.* Acronym for **Unified Modeling Language**. A language developed by Grady Booch, Ivar Jacobson, and Jim Rumbaugh of Rational Software that can be used for specifying, building, and documenting software and non-software systems, such as business models. UML notation provides a common foundation for object-oriented design by providing descriptions of modeling concepts including object class, associations, interface, and responsibility. The UML standard is supported by software developers and vendors and overseen by the Object Management Group (OMG).

UMTS *n.* Acronym for **Universal Mobile Telecommunications System**. Third-generation wireless communications standard developed to provide a consistent set of packet-based voice, text, video, and multimedia capabilities to users in any communications environment worldwide. When UMTS reaches full implementation, users will be able maintain computer and phone Internet connections from anywhere in the world.

unary *adj.* Of, pertaining to, or characteristic of a mathematical operation with a single operand (object); monadic. *Compare* dyadic.

unary operator *n.* An operator that takes only one operand—for example, unary minus (as in -2.5). *See also* operator. *Compare* binary operator.

unbuffered *adj.* Of, pertaining to, or characteristic of something that does not store data characters in memory but instead processes them as they are received. *See also* buffer².

unbundle *vb.* To separate the items of a composite sales package; for example, to sell components of a software package separately rather than as a package. *Compare* bundle.

unbundled *adj.* Not included as part of a complete hardware/software package; the term particularly applies to a product that was previously bundled, as opposed to one that has always been sold separately.

UNC *n.* Acronym for **Universal Naming Convention** or, sometimes, **Uniform Naming Convention**. The system of naming files among computers on a network so that a file on a given computer will have the same pathname when accessed from any of the other computers on the network.

U

For example, if the directory `c:\path1\path2\...pathn` on computer *servern* is shared under the name *pathdirs*, a user on another computer would open `\\servern\pathdirs\filename.ext` to access the file `c:\path1\path2\...pathn\filename.ext` on *servern*. *See also* URL, virtual path.

uncompress *vb.* To restore the contents of a compressed file to its original form. *Also called:* decompress. *Compare* compress².

unconditional branch *n.* A transfer of execution to another line of code in a program without a check for some condition being true or false. The transfer always takes place whenever such an instruction is encountered. *See also* branch (definition 2). *Compare* conditional branch.

undelete¹ *n.* The act of restoring deleted information. An undelete is comparable to (and usually included as part of) an undo command; it is more restricted, however, in that “undo” reverses any previous act, but *undelete* reverses only a deletion. *Undelete* generally refers only to excised text or deleted files. *See also* undo.

undelete² *vb.* **1.** To restore deleted information, usually the last item deleted. **2.** In file storage, to restore a file’s storage information so that a deleted file becomes available for access again. *Also called:* unerase. *See also* file recovery.

undeliverable *adj.* Not able to be delivered to an intended recipient. If an e-mail message is undeliverable, it is returned to the sender with information added by the mail server explaining the problem; for example, the e-mail address may be incorrect, or the recipient’s mailbox may be full.

undercolor separation *n.* In the CMYK color model, the process of converting equal quantities of cyan, magenta, and yellow to equivalent gray levels, which are then printed in black ink. This produces grays that are clearer and sharper than those produced by mixing colored inks. *See also* CMY, CMYK, color model.

underflow *n.* A condition in which a mathematical calculation produces a result too near to zero to be represented by the range of binary digits available to the computer for holding that value in the specified precision. *See also* precision (definition 2), single-precision.

underline *vb.* To format a selection of text so that the text is printed with a line slightly below it.

Undernet *n.* An international network of Internet Relay Chat (IRC) servers created in 1992 as an alternative to the

larger and more chaotic main IRC network. For information about connecting to Undernet, see <http://www.undernet.org>. *See also* IRC.

underscore *n.* An underline character often used to emphasize a letter or a word; on nongraphics displays, generally used to indicate italic characters.

undo *vb.* To reverse the last action—for example, to undo a deletion, thus restoring deleted text to a document. Many application programs enable the user both to undo and to redo an action. *See also* undelete (definition 1).

undock *vb.* **1.** To detach a laptop or other portable computer from a docking station. *See also* docking station, laptop. **2.** To move a toolbar from the edge of a window so that the toolbar becomes its own free-floating window. *See also* toolbar.

unerase *n.* *See* undelete¹.

unfold *adj.* *See* inline (definition 1).

unhandled exception *n.* An error condition that an application does not internally resolve. When an unhandled exception occurs, the operating system terminates the application that caused the error.

Unibus *n.* A bus architecture introduced by Digital Equipment Corporation in 1970.

unicast *vb.* To transmit between a single sender and a single receiver over a network. A two-way, point-to-point transmission, unicast is typical of network communications. *Compare* anycasting, narrowcast.

Unicode *n.* A 16-bit character encoding standard developed by the Unicode Consortium between 1988 and 1991. By using 2 bytes to represent each character, Unicode enables almost all the written languages of the world to be represented using a single character set. (By contrast, 8-bit ASCII is not capable of representing all the combinations of letters and diacritical marks that are used just with the Roman alphabet.) Approximately 39,000 of the 65,536 possible Unicode character codes have been assigned to date, 21,000 of them being used for Chinese ideographs. The remaining combinations are open for expansion. *Compare* ASCII.

unified messaging *n.* The integration of various communications technologies such as voicemail, fax, and e-mail into a single service. Unified messaging is designed to be a time-saving tool to provide users with a single package with which they can receive, organize, and respond to messages in a variety of media.



Unified Modeling Language *n.* See UML.

Uniform Computer Information Transactions Act *n.* See UCITA.

Uniform Data Transfer *n.* See UDT.

Uniform Memory Access *n.* See SMP.

Uniform Naming Convention *n.* See UNC.

Uniform Resource Citation *n.* A description of an object on the World Wide Web, consisting of pairs of attributes and their values, such as the Uniform Resource Identifiers (URIs) of associated resources, author names, publisher names, dates, and prices. *Acronym:* URC.

Uniform Resource Identifier *n.* A character string used to identify a resource (such as a file) from anywhere on the Internet by type and location. The set of Uniform Resource Identifiers includes Uniform Resource Names (URNs) and Uniform Resource Locators (URLs). *Acronym:* URI. See also relative URL, Uniform Resource Name, URL.

Uniform Resource Locator *n.* See URL.

Uniform Resource Name *n.* A scheme for uniquely identifying resources that might be available on the Internet by name, without regard to where they are located. The specifications for the format of Uniform Resource Names are still under development by the Internet Engineering Task Force (IETF). They include all Uniform Resource Identifiers (URIs) having the schemes urn:, fpi:, and path:; that is, those that are not Uniform Resource Locators (URLs). *Acronym:* URN. See also IETF, Uniform Resource Identifier, URL.

UniForum *n.* **1.** The International Association of Open System Professionals, an organization of UNIX users and administrators. **2.** A series of UNIX trade shows sponsored by UniForum and managed by Softbank COMDEX, Inc. See also COMDEX.

Unimodem *n.* **1.** The universal modem driver, provided with Windows CE, that translates Telephony Service Provider Interface (TSPI) calls into AT commands and sends the commands to a virtual device driver that talks to the modem. **2.** A universal modem that supports standard modem AT commands. Windows CE currently supports only PCMCIA modems.

uninstall *vb.* To remove software completely from a system, including the elimination of files and components

residing in system locations such as the registry in Windows 9x, Windows NT, or Windows 2000. Some applications have built-in uninstall utilities, and in other cases a separate uninstall program can be used. *Also called:* deinstall.

uninterruptible power supply *n.* See UPS.

union *n.* **1.** In set theory, the smallest combination of two sets that contains all elements of both sets. **2.** In logic, an inclusive OR operation—that is, the result, C, of any union of A and B is true (1) except when A and B are both false (0). See the table. **3.** In programming, a structure that can be used to store different types of variables (such as integer, character, or Boolean). **4.** In database management, a relational operator. Given two relations (tables), A and B, that are union-compatible (contain the same number of fields, with corresponding fields containing the same types of values), A UNION B builds a new relation containing those tuples (records) that appear either in A or in B or in both. *Compare* difference, intersect.

Table U.1 A Truth Table Showing the Results of Unions.

<i>A</i>	<i>OR</i>	<i>B</i>	=	<i>C</i>
1		1		1
1		0		1
0		1		1
0		0		0

union-compatible *adj.* In database management, of, pertaining to, or characteristic of two relations (tables) that are of the same order (have the same number of attributes) and whose corresponding attributes are based on the same domain (the set of acceptable values).

unipolar *adj.* Having one state. In electronics, a unipolar device or signal is one in which the same voltage polarity (positive or negative) is used to represent binary states—on/off or true/false. *Compare* bipolar.

unique user *n.* An individual visitor to a Web site. Tracking unique users is important in ascertaining the success of a given Web site because it indicates how many different visitors access the site, as opposed to the number of hits—visits by the same or different individuals—the site receives. *Also called:* unique visitor.

unique visitor *n.* See unique user.

United States of America Standards Institute *n.* The former name of the American National Standards Institute. See also ANSI.



unit position *n.* The “one’s place” in a multiple-digit number—for example, the 3 in the number 473.

UNIVAC I *n.* Short for **Universal Automatic Calculator I**. The first commercially available electronic computer, designed by J. Presper Eckert and John Mauchly, also the inventors of ENIAC (generally considered the first fully electronic computer). UNIVAC I was the first computer to handle both numeric and textual information.

universal asynchronous receiver-transmitter *n.* See UART.

Universal Description, Discovery, and Integration *n.* See UDDI.

Universal Mobile Telecommunications System *n.* See UMTS.

Universal Naming Convention *n.* See UNC.

Universal Plug and Play *n.* See UPnP.

Universal Plug and Play Forum *n.* See UPnP Forum.

Universal Plug and Play networking *n.* See UPnP networking.

Universal Product Code *n.* See UPC.

Universal Resource Locator *n.* See URL.

universal serial bus *n.* See USB.

Universal Server *n.* **1.** Software from Oracle Corporation that supplies information from its database in a variety of forms, such as text, sound, and video, in response to HTTP requests. **2.** Database software from Informix that works with snap-in software modules to handle user needs for specific data types and ways of processing.

universal synchronous receiver-transmitter *n.* See USRT.

Universal Time Coordinate *n.* For all practical purposes, the same as Greenwich Mean Time, which is used for the synchronization of computers on the Internet. *Acronym:* UTC. *Also called:* coordinated universal time format.

University Corporation for Advanced Internet Development *n.* SeeUCAID.

UNIX *n.* A multiuser, multitasking operating system. Originally developed by Ken Thompson and Dennis Ritchie at AT&T Bell Laboratories from 1969 through 1973 for use on minicomputers, UNIX has evolved into a complex, powerful operating system that, because it is

written in the C language, is more portable—that is, less machine-specific—than many other operating systems. UNIX has been released in a wide variety of versions, or flavors, including System V (developed by AT&T for commercial release; many current flavors are based on it), BSD UNIX (freeware developed at the University of California Berkeley, which has spun off many related flavors), AIX (a version of System V adapted by IBM to run on RISC-based workstations), A/UX (a graphical version for the Macintosh), Linux (a newer version that runs on the Intel chip), and SunOS (based on BSD UNIX and available on Sun workstations). Many flavors of UNIX are available free. With some flavors, the source code is also free, making it an instrumental part of the open source movement. UNIX is widely used as a network operating system, especially in conjunction with the Internet. See also BSD UNIX, Linux, open source, System V.

UNIX shell account *n.* A shell account providing command-line access to a UNIX system. See also shell account.

UNIX shell scripts *n.* Sequences of UNIX commands stored as files that can be run as programs. In MS-DOS, batch (.bat) files provide similar capabilities. See also batch file, shell¹, shell script.

UNIX-to-UNIX Copy *n.* See UUCP.

UNIX wizard *n.* A particularly expert and helpful UNIX programmer. Some companies actually use this phrase as a job title. The newsgroup comp.unix.wizards provides answers to many user questions.

unknown host *n.* A response to a request for a connection to a server that indicates that the network is unable to find the specified address. See also server (definition 1).

unknown recipients *n.* A response to an e-mail message that indicates that the mail server is unable to identify one or more of the destination addresses.

unload *vb.* **1.** To remove a storage medium, such as a tape or disk, from its drive. **2.** To remove software from system memory. See also memory.

unmanaged code *n.* Code that is executed directly by the operating system, outside of the common language runtime environment. Unmanaged code must provide its own garbage collection, type checking, security support, and so on, unlike managed code, which receives these services

U

from the common language runtime. *See also* managed code.

unmoderated *adj.* Of, pertaining to, or characteristic of a newsgroup or mailing list in which all articles or messages received by the server are automatically available or distributed to all subscribers. *Compare* moderated.

unmount *vb.* To remove a disk or tape from active use. *Compare* mount.

unpack *vb.* To restore packed data to its original format. *Compare* pack.

unpopulated board *n.* A circuit board whose sockets are empty. *Compare* fully populated board.

unread *adj.* **1.** Of, pertaining to, or being an article in a newsgroup that a user has not yet received. Newsreader client programs distinguish between “read” and “unread” articles for each user and download only unread articles from the server. **2.** Of, pertaining to, or being an e-mail message that a user has received but has not yet opened in an e-mail program.

unrecoverable error *n.* A fatal error—one that a program is unable to recover from without the use of external recovery techniques. *Compare* recoverable error.

unreliable protocol *n.* A communications protocol that makes a “best effort” attempt to deliver a transmission but does not provide for verifying that the transmission arrives without error.

unroll *adj.* *See* inline (definition 1).

unset *vb.* To make the value of a bit position equal to 0. *Compare* set (definition 1).

unshielded cable *n.* Cable that is not surrounded with a metal shield. If the wires in an unshielded cable are not at least twisted around each other in pairs, the signals they carry have no protection from interference by external electromagnetic fields. Consequently, unshielded cable should be used only over very short distances. *Compare* coaxial cable, ribbon cable, twisted-pair cable, UTP.

unshielded twisted pair *n.* *See* UTP.

unshielded twisted-pair wiring *n.* *See* UTP.

unsolicited commercial e-mail *n.* *See* spam.

unsubscribe *vb.* **1.** In a newsreader client program, to remove a newsgroup from the list of newsgroups to which

one subscribes. *See also* newsgroup. **2.** To remove oneself as a recipient on a mailing list. *See also* mailing list.

untar¹ *n.* A utility, available for systems in addition to UNIX, for separating the individual files out of an archive assembled using the UNIX *tar* program. *Compare* tar¹.

untar² *vb.* To separate the individual files out of an archive assembled with the UNIX *tar* program. *Compare* tar².

unzip *vb.* To uncompress an archive file that has been compressed by a program such as compress, gzip, or PKZIP.

up *adj.* Functioning and available for use; used in describing computers, printers, communications lines on networks, and other such hardware.

UPC *n.* Acronym for Universal Product Code. A system of numbering commercial products using bar codes. A UPC consists of 12 digits: a number system character, a five-digit number assigned to the manufacturer, a five-digit product code assigned by the manufacturer, and a modulo 10 check digit. *See also* bar code.

update¹ *n.* A new release of an existing software product. A software update usually adds relatively minor new features to a product or corrects errors (bugs) found after the program was released. Updates are generally indicated by small changes in software version numbers, such as *4.0b* from *4.0*. *See also* version number. *Compare* release¹.

update² *vb.* To change a system or a data file to make it more current.

update query *n.* A database query that changes a set of records according to search conditions or criteria.

upflow *n.* In the data warehousing process, the stage during which stored information is checked for completeness, summarized, and readied for distribution. *See also* data warehouse². *Compare* downflow, inflow, metaflow.

upgrade¹ *n.* The new or enhanced version of a product.

upgrade² *vb.* To change to a newer, usually more powerful or sophisticated version.

uplink *n.* The transmission link from an earth station to a communications satellite.

upload¹ *n.* **1.** In communications, the process of transferring a copy of a file from a local computer to a remote computer by means of a modem or network. **2.** The copy of the file that is being or has been transferred.

U

upload² *vb.* To transfer a copy of a file from a local computer to a remote computer. *Compare* download.

UPnP *n.* Acronym for Universal Plug and Play. A Microsoft initiative which prompted the creation of the UPnP Forum for interconnecting computers, appliances, networks, and services. UPnP extends conventional Plug and Play to include devices connected to networks. It allows peripheral devices to discover and connect to other devices and to enumerate the characteristics of those devices. UPnP is intended to be an element of home networking, in which PCs, appliances, and the services they provide are linked together.

UPnP Device Architecture *n.* A specification developed by the Universal Plug and Play (UPnP) Forum that defines the structure of UPnP networking. The UPnP Device Architecture, formerly known as the DCP Framework, provides information about discovery, description, control, eventing, and presentation in a UPnP network. *See also* UPnP networking.

UPnP Forum *n.* A consortium of companies and individuals that oversees Universal Plug and Play (UPnP) specifications, protocols, logos, sample implementations, test suites, white papers, and other UPnP-related efforts. *See also* UPnP, UPnP Device Architecture, UPnP networking.

UPnP networking *n.* The peer-to-peer networking of intelligent machines, appliances, wireless devices, computers, and other devices according to the Universal Plug and Play (UPnP) Device Architecture. UPnP networking uses control points, devices, services, and protocols including GENA, SOAP, SSDP, standard TCP/IP, and other Internet protocols. *See also* UPnP Device Architecture.

uppercase *adj.* Of, pertaining to, or characterized by capital letters. *Compare* lowercase.

upper memory area *n.* *See* UMA (definition 1).

upper memory block *n.* *See* UMB.

UPS *n.* Acronym for uninterruptible power supply. A device, connected between a computer (or other electronic equipment) and a power source (usually an outlet receptacle), that ensures that electrical flow to the computer is not interrupted because of a blackout and, in most cases, protects the computer against potentially damaging events, such as power surges and brownouts. All UPS units are equipped with a battery and a loss-of-power sensor; if the sensor detects a loss of power, it switches over to the battery so that the user has time to save his or her work and shut off the computer. *See also* blackout, brownout.

upstream¹ *n.* The direction in which information is delivered from a client to a (Web) server. *Compare* downstream¹.

upstream² *adj.* **1.** The location of a server in relation to another server. *Compare* downstream² (definition 1). **2.** The direction in which data moves *from* an individual computer *to* the remote network. With certain communications technologies, such as ADSL, cable modems, and high-speed 56-Kbps modems, data flows upstream more slowly than downstream. For example, a 56-Kbps modem can deliver data at a 56-Kbps maximum only downstream; upstream, it delivers data at either 28.8 or 33.6 Kbps. *Compare* downstream² (definition 2).

uptime *n.* The amount or percentage of time a computer system or associated hardware is functioning and available for use. *Compare* downtime.

upward-compatible *adj.* Of, pertaining to, or characteristic of a computer product, especially software, designed to perform adequately with other products that are expected to become widely used in the foreseeable future. The use of standards and conventions makes upward compatibility easier to achieve.

urban legend *n.* A widely distributed story that remains in circulation in spite of the fact that it is not true. Many urban legends have been floating around the Internet and other online services for years, including the request for cards for the sick boy in England (he's long since recovered and grown up), the cookie or cake recipe that cost \$250 (it's a myth), and the Good Times or Penpal Greetings virus, which will infect your computer when you read an e-mail message (it does not exist). *See also* Good Times virus.

URC *n.* *See* Uniform Resource Citation.

URI *n.* *See* Uniform Resource Identifier.

URL *n.* Acronym for Uniform Resource Locator. An address for a resource on the Internet. URLs are used by Web browsers to locate Internet resources. A URL specifies the protocol to be used in accessing the resource (such as http: for a World Wide Web page or ftp: for an FTP site), the name of the server on which the resource resides (such as //www.whitehouse.gov), and, optionally, the path to a resource (such as an HTML document or a file on that server). *See also* FTP¹ (definition 1), HTML, HTTP, path (definition 1), server (definition 2), virtual path (definition 1), Web browser.

URN *n.* *See* Uniform Resource Name.

U

usable *adj.* Of, pertaining to, or characteristic of the ease and adaptability with which a product can be applied to the performance of the work for which it is designed. A high degree of usability implies ease of learning, flexibility, freedom from bugs, and good design that does not involve unnecessarily complicated procedures.

usage analysis *n.* Data collected to evaluate how a Web site is being used, such as visitor user names, how often each page was visited, and the types of Web browsers used.

USB *n.* Acronym for **universal serial bus**. A serial bus with a data transfer rate of 12 megabits per second (Mbps) for connecting peripherals to a microcomputer. USB can connect up to 127 peripherals, such as external CD-ROM drives, printers, modems, mice, and keyboards, to the system through a single, general-purpose port. This is accomplished by daisy chaining peripherals together. USB is designed to support the ability to automatically add and configure new devices and the ability to add such devices without having to shut down and restart the system (hot plugging). USB was developed by Intel, Compaq, DEC, IBM, Microsoft, NEC, and Northern Telecom. It competes with DEC's ACCESS.bus for lower-speed applications. *See also* bus, daisy chain, hot plugging, input/output port, peripheral. *Compare* ACCESS.bus.

U.S. Department of Defense *n.* The military branch of the United States government. The Department of Defense developed ARPANET, the origin of today's Internet and MILNET, through its Advanced Research Projects Agency (ARPA). *See also* ARPANET, Internet, MILNET.

Usenet or **UseNet** or **USENET** *n.* A worldwide network of UNIX systems that has a decentralized administration and is used as a bulletin board system by special-interest discussion groups. Usenet, which is considered part of the Internet (although Usenet predates it), is comprised of thousands of newsgroups, each devoted to a particular topic. Users can post messages and read messages from others in these newsgroups in a manner similar to users on dial-in BBSs. Usenet was originally implemented using UUCP (UNIX-to-UNIX Copy) software and telephone connections; that method remains important, although more modern methods, such as NNTP and network connections, are more commonly used. *See also* BBS (definition 1), newsgroup, newsreader, NNTP, UUCP.

Usenet User List *n.* A list maintained by the Massachusetts Institute of Technology that contains the name and e-mail address of everyone who has posted to the Usenet. *See also* Usenet.

user account *n.* On a secure or multiuser computer system, an established means for an individual to gain access to the system and its resources. Usually created by the system's administrator, a user account consists of information about the user, such as password, rights, and permissions. *See also* group¹, logon, user profile.

user agent *n.* In the terminology established by the ISO/OSI reference model for LANs (local area networks), a program that helps a client connect with a server. *Acronym:* UA. *See also* agent (definition 3), ISO/OSI reference model, LAN.

user control *n.* In ASP.NET: A server control that is authored declaratively using the same syntax as an ASP.NET page and is saved as a text file with an .ascx extension. User controls allow page functionality to be partitioned and reused. Upon first request, the page framework parses a user control into a class that derives from System.Web.UI.UserControl and compiles that class into an assembly, which it reuses on subsequent requests. User controls are easy to develop due to their page-style authoring and deployment without prior compilation. In Windows Forms: A composite control that provides consistent behavior and user interface within or across applications. The user control can be local to one application or added to a library and compiled into a DLL for use by multiple applications.

User Datagram Protocol *n.* *See* UDP.

user-defined data type *n.* A data type defined in a program. User-defined data types are usually combinations of data types defined by the programming language being used and are often used to create data structures. *See also* data structure, data type.

user-defined function key *n.* *See* keyboard enhancer, programmable function key.

user-friendly *adj.* Easy to learn and easy to use.

user group *n.* A group of people drawn together by interest in the same computer system or software. User groups, some of which are large and influential organizations, provide support for newcomers and a forum where members can exchange ideas and information.

user-initiated update *n.* An operating system update mechanism, provided by the dial-up boot loader, which is designed to be used by remote users and field technicians. The operating system image is downloaded using a modem connection. *See also* automatic update, factory update.



user interface *n.* The portion of a program with which a user interacts. Types of user interfaces, or UIs, include command-line interfaces, menu-driven interfaces, and graphical user interfaces. *Acronym:* UI.

User Interface Toolbox *n.* See Toolbox.

username *n.* The name by which a user is identified to a computer system or network. During the logon process, the user must enter the username and the correct password. If the system or network is connected to the Internet, the username generally corresponds to the leftmost part of the user's e-mail address (the portion preceding the @ sign, as in username@company.com). See also e-mail address, logon.

user name *n.* The name by which a person is known and addressed on a communications network. See also alias (definition 2).

user profile *n.* A computer-based record maintained about an authorized user of a multiuser computer system. A user profile is needed for security and other reasons; it can contain such information as the person's access restrictions, mailbox location, type of terminal, and so on. See also user account.

user state *n.* The least privileged of the modes in which a Motorola 680x0 microprocessor can operate. This is the mode in which application programs are run. See also 68000. Compare supervisor state.

USnail *n.* 1. Slang for the United States Postal Service. USnail, a term used on the Internet, is a reference to how slow the postal service is in comparison to e-mail. 2. Mail delivered by the United States Postal Service. See also snail mail.

/usr *n.* A directory in a computer system that contains subdirectories owned or maintained by individual users of the computer system. These subdirectories can contain files and additional subdirectories. Typically, /usr directories are used in UNIX systems and can be found on many FTP sites. See also FTP site.

USRT *n.* Acronym for universal synchronous receiver-transmitter. A module, usually composed of a single integrated circuit, that contains both the receiving and transmitting circuits required for synchronous serial communication. Compare UART.

UTC *n.* See Universal Time Coordinate.

UTF-8 *n.* Acronym for UCS Transformation Format 8. A character set for protocols evolving beyond the use of ASCII. The UTF-8 protocol provides for support of extended ASCII characters and translation of UCS-2, an international 16-bit Unicode character set. UTF-8 enables a far greater range of names than can be achieved using ASCII or extended ASCII encoding for character data. See also ASCII, Unicode.

utility *n.* A program designed to perform a particular function; the term usually refers to software that solves narrowly focused problems or those related to computer system management. See also application.

utility program *n.* A program designed to perform maintenance work on the system or on system components (for example, a storage backup program, disk and file recovery program, or resource editor).

UTP *n.* Acronym for unshielded twisted pair. A cable containing one or more twisted pairs of wires without additional shielding. UTP is more flexible and takes up less space than shielded twisted-pair (STP) cable but has less bandwidth. See the illustration. See also twisted-pair cable. Compare STP.



UTP.

.uu *n.* The file extension for a binary file that has been translated into ASCII format using uuencode. Also called: .uud. See also ASCII, binary file, uuencode¹. Compare .uue.

UUCP *n.* Acronym for UNIX-to-UNIX Copy. A set of software programs that facilitates transmission of information between UNIX systems using serial data connec-

U

tions, primarily the public switched telephone network. *See also* uupc.

.uud *n.* *See* .uu.

uudecode¹ *n.* A UNIX program that converts a uuencoded file back into its original binary format. This program (along with uuencode) allows binary data, such as images or executable code, to be disseminated through e-mail or newsgroups. *Compare* uuencode¹.

uudecode² *vb.* To transform a uuencoded file back into its binary original using the uudecode program. *Compare* uuencode².

.uue *n.* The file extension for a file that has been decoded from ASCII format back into binary format using uudecode. *See also* ASCII, binary file, uudecode¹.

uuencode¹ *n.* A UNIX program that converts a binary file, in which all 8 bits of every byte are significant, into printable 7-bit ASCII characters without loss of information. This program (along with uudecode) allows binary data, such as images or executable code, to be disseminated through e-mail or newsgroups. A file thus encoded

is one-third again as long as the original. *Compare* uuencode¹.

uuencode² *vb.* To transform a binary file into printable 7-bit ASCII text using the uuencode program. *Compare* uuencode².

UUID *n.* Acronym for **u**niversally **u**nique **i**dentifier. A 128-bit value that uniquely identifies objects such as OLE servers, interfaces, manager entry-point vectors, and client objects. Universally unique identifiers are used in cross-process communication, such as remote procedure calling (RPC) and OLE. *Also called:* GUID.

uupc *n.* The version of UUCP for IBM PCs and PC-compatibles running DOS, Windows, or OS/2. This version is a collection of programs for copying files to, logging in to, and running programs on remote networked computers. *See also* UUCP.



V

V.120 *n.* The ITU-T (formerly CCITT) standard that governs serial communications over ISDN lines. Data is encapsulated using a protocol similar to the Lightweight Directory Access Protocol (LDAP), and more than one connection may be multiplexed on a communications channel. *See also* communications channel, communications protocol, International Telecommunications Union, ISDN, Lightweight Directory Access Protocol, multiplexing, standard (definition 1), V series.

V20, V30 *n.* NEC microprocessors that were slight improvements on Intel's 8088 and 8086, using the same command sets but different microcode.

V.2x, V.3x, V.4x, V.5x series *n.* *See* V series.

V.32terbo *n.* A modem protocol developed by AT&T for 19,200-bps modems, with fallback to the speeds supported by the ITU-T (formerly CCITT) V.32 standard. This protocol is proprietary to AT&T and was not adopted by CCITT or ITU-T. In the V series, V.34 takes the place of V.32terbo. *See also* International Telecommunications Union, V series.

V.34 *n.* Data transmission standard that provides for up to 28,800 bits per second (bps) communications over telephone lines. It defines a full-duplex (two-way) modulation technique and includes error-correcting and negotiation. *See also* bits per second, full-duplex, modulation standards, V.90.

V.42 *n.* The ITU-T (formerly CCITT) recommendation specifying procedures for error correction in data communications equipment (DCEs) designed for asynchronous-to-synchronous conversion. *See also* V series.

V.42bis *n.* The ITU-T (formerly CCITT) recommendation specifying procedures for data compression in data-circuit terminating equipment utilizing error-correction operations. *See also* V series.

V86 mode *n.* *See* virtual real mode.

V.90 *n.* Data transmission standard that provides for up to 56,000 bits per second (bps) communications over telephone lines. The transmission speed from the client-side

modem for uploads is 33,600 bps. The transmission speed for downloads from the host-side modem such as an Internet service provider (ISP) or a corporate network is up to 56,000 bps, with an average speed of 40,000 to 50,000 bps. When the host-side modem does not support this standard, the alternative is V.34. *See also* bits per second, client, host, ISP, modem, modulation standards, V.34.

VAB *n.* *See* voice answer back.

VAC *n.* *See* volts alternating current.

vacuum tube *n.* A set of metal electrodes and intervening metal grids, contained in a glass or metal tube from which all gas has been removed. Voltages on the grids control electrical currents between the electrodes. Formerly used for amplification and switching in electronic circuits, vacuum tubes are now used in applications such as cathode-ray tubes and those requiring very high power levels. A vacuum tube is known as a *valve* in Great Britain.

validation server controls *n.* A set of server controls, included with ASP.NET, that verify user input. The input is checked as it comes from HTML server controls and Web server controls (for example, a Web page form) against programmer-defined requirements. Validation controls perform input checking in server code. If the user is working with a browser that supports DHTML, the validation controls can also perform validation using client script. *See also* ASP.NET server control, HTML server control, Web server control.

validation suite *n.* A set of tests that measures compliance with a standard, especially a standard definition of a programming language. *See also* standard (definition 1).

valid date interval *n.* A span of time during which a computer will maintain the correct date. For many PCs, the valid date interval is 1980 forward.

validity check *n.* The process of analyzing data to determine whether it conforms to predetermined completeness and consistency parameters.

value *n.* A quantity assigned to an element such as a variable, symbol, or label. *See* tone (definition 1).

V

value-added network *n.* A communications network that offers additional services, such as message routing, resource management, and conversion facilities, for computers communicating at different speeds or using different protocols. *Acronym:* VAN.

value-added reseller *n.* A company that buys hardware and software and resells it to the public with added services, such as user support. *Acronym:* VAR.

value list *n.* A list of values used by some application, such as a database, as a search string or as values for a filtered query. *See also* filter (definition 1), query (definition 1), search string.

value type *n.* A data type that is represented by the type's actual value. If a value type is assigned to a variable, that variable is given a fresh copy of the value. (This is in contrast to a reference type, where assignment does not create a copy.) Value types are usually created on a method's stack frame, rather than in the garbage-collected heap. A value type can be boxed, which is a process that creates a corresponding reference type. *See also* reference type.

valve *n.* *See* electron tube, vacuum tube.

vampire tap *n.* A type of transceiver used on Ethernet networks that is equipped with sharp metal prongs that pierce the insulation on thicknet cable to make contact with the copper core over which signals travel.

VAN *n.* *See* value-added network.

vanilla *adj.* *See* plain vanilla.

vaporware *n.* Software that has been announced but not released to customers. The term implies sarcastically that the product exists only in the minds of the marketing department. *Compare* freeware, shareware.

VAR *n.* *See* value-added reseller.

variable *n.* In programming, a named storage location capable of containing data that can be modified during program execution. *See also* data structure, data type, global variable, local variable. *Compare* constant.

variable expression *n.* An expression that depends on the value of at least one variable and, hence, must be evaluated during program execution. *See also* run time (definition 1), variable. *Compare* constant expression.

variable-length field *n.* In a record, a field that can vary in length according to how much data it contains. *See also* field (definition 1).

variable-length record *n.* A record that can vary in length because it contains variable-length fields, certain fields only under certain conditions, or both of these. *See also* variable-length field.

VAX *n.* Acronym for **virtual address extension**. A family of 32-bit minicomputers introduced by Digital Equipment Corporation in 1978. The VAX, like the later 68000 microprocessor, has a flat address space and a large instruction set. The VAX was highly favored within the hacker community but has been superseded by microprocessors and RISC workstations. *See also* flat address space, instruction set, microprocessor, minicomputer, RISC.

VBA *n.* *See* Visual Basic for Applications.

vBNS *n.* Short for **very high-speed Backbone Network Service**. A network connecting several supercomputer centers and reserved for high-performance, high-bandwidth scientific applications requiring massive computing power. The vBNS was developed by the National Science Foundation and MCI Telecommunications. It began operation in 1995, reaching speeds of 2.4 Gbps, using MCI's network of advanced switching and fiberoptic transmission technologies. Later, vBNS expanded to provide backbone services for Internet2.

VBScript *n.* *See* Visual Basic, Scripting Edition.

VBS/VBSWG virus *n.* Acronym for **Visual Basic Script/Visual Basic Script Worm Generator virus**. Any virus created using the VBSWG virus creation toolkit. The tools available in VBSWG worm kit allow individuals to write viruses without having significant computer knowledge. Homepage and the Anna Kournikova virus are examples of VBS/VBSWG viruses.

VBX *n.* Short for **Visual Basic custom control**. A software module that, when called by a Visual Basic application, produces a control that adds some desired feature to the application. A VBX is a separate executable file, usually written in C, that is dynamically linked to the application at run time and can be used by other applications, including some applications not developed in Visual Basic. Although VBX technology was developed by Microsoft, most VBXs have been written by third-party developers. VBXs are still in use, but the technology has been superseded by OCXs and ActiveX controls. *See also* control (definition 2), Visual Basic. *Compare* ActiveX controls, dynamic-link library, OCX.

VCACHE *n.* The disk caching software used with VFAT driver in Windows 9x. VCACHE uses 32-bit code, runs in



protected mode, and automatically allocates space in RAM rather than requiring the user to reserve space for the cache. *See also* cache, driver, protected mode, RAM, VFAT.

vCalendar *n.* A specification defining the format for applications to exchange scheduling information. The vCalendar specification is based on existing industry standards, including international standards for representing dates and times, and permits the exchange of schedules and “to-do” lists of the sort users commonly enter into personal calendars. Like the companion vCard specification for electronic business cards, it was created by the versit consortium founded by Apple, AT&T, IBM, and Siemens. Handed off to the Internet Mail Consortium (IMC) in 1996, vCalendar is supported by numerous hardware and software vendors. *See also* vCard.

vCard *n.* A specification for creating an electronic business card (or personal-information card) and for the card itself. Designed to be exchanged through applications such as e-mail and teleconferencing, a vCard includes information such as name, address, telephone and fax number(s), and e-mail address. It can also include time-zone, geographic location, and multimedia data such as photographs, company logos, and sound clips. Based on the ITU’s X.500 directory services specification, vCard was developed by versit, a consortium whose principal members include Apple, AT&T, IBM, and Siemens. The specification is under the guidance of the Internet Mail consortium Version 3.0 of the vCard specification has been approved as a proposed standard by the IETF. A companion specification known as vCalendar supports electronic exchange of scheduling information. *See also* vCalendar, X series.

V-chip *n.* Electronic chip for installation in a television, VCR, cable box, or stand-alone device to provide adults with the ability to block programming they deem inappropriate. Intended to provide parents with a means of controlling the programming viewed by children, the V-chip allows adults to screen programs based on a rating level transmitted in the portion of the TV signal known as the vertical blanking interval (the same portion that carries closed captioning information). When programs exceed the chosen level, the V-chip signals the television, which then displays an “unauthorized to receive” message on a blank screen.

VCOMM *n.* The communications device driver in Windows 9x that provides the interface between Windows-based applications and drivers on one side, and port drivers and modems on the other. *See also* driver.

VCPI *n.* *See* Virtual Control Program Interface.

VCR-style mechanism *n.* **1.** A user interface for playing movie files that has controls similar to those on a video-cassette recorder (VCR). **2.** A type of motorized docking mechanism in which a laptop or notebook computer is physically locked into place by the docking station. The advantage to a VCR-style mechanism is that it provides an electrically consistent, secure bus connection. *See also* docking mechanism, docking station, laptop, portable computer.

VDD *n.* Acronym for **virtual display device driver**. *See* virtual device driver.

VDL *n.* Acronym for **Vienna Definition Language**. A metalanguage, containing both a syntactic and a semantic metalanguage, used to define other languages. *See also* metalanguage.

VDM *n.* *See* video display metafile.

VDSL *n.* Short for **very-high-speed digital subscriber line**. The high-speed version of the xDSL (digital subscriber line) communication technologies, all of which operate over existing phone lines. VDSL can deliver up to 52 Mbps downstream, but it is effective only within about 4500 to 5000 feet of the central exchange. The data delivery rate is, in fact, related to the distance the signal must travel. To attain a rate of 52 Mbps, for example, the subscriber must be within 1000 feet of the exchange office. At a distance of 3000 feet, the data rate drops to about 26 Mbps; and at 5000 feet, the data rate drops to about 13 Mbps. *See also* central office, xDSL.

VDT *n.* Acronym for **video display terminal**. A terminal that includes a CRT (cathode-ray tube) and keyboard. *See also* CRT.

VDU *n.* Acronym for **video display unit**. A computer monitor. *See also* monitor.

vector *n.* **1.** In mathematics and physics, a variable that has both distance and direction. *Compare* scalar. **2.** In computer graphics, a line drawn in a certain direction from a starting point to an endpoint, both of whose locations are identified by the computer using *x-y*-coordinates on a grid. Vectors are used in the output of some graphics programs instead of groups of dots (on paper) or pixels (on screen). *See also* vector graphics. **3.** In data structures, a one-dimensional array—a set of items arranged in a single column or row. *See also* array, matrix.

vector display *n.* A CRT (cathode-ray tube), commonly used in oscilloscopes and DVST (direct view storage

tube) displays, that allows the electron beam to be arbitrarily deflected, based on *x-y*-coordinate signals. For example, to draw a line on a vector display, the video adapter sends signals to the X and Y yokes to move the electron beam over the path of the line; there is no background composed of scan lines, so the line drawn on the screen is not constructed of pixels. *See also* CRT, yoke. *Compare* raster display.

vector font *n.* A font in which the characters are drawn using arrangements of line segments rather than arrangements of bits. *See also* font. *Compare* bitmapped font.

vector graphics *n.* Images generated from mathematical descriptions that determine the position, length, and direction in which lines are drawn. Objects are created as collections of lines rather than as patterns of individual dots or pixels. *Compare* raster graphics.

Vector Markup Language *n.* *See* VML.

vector table *n.* *See* dispatch table.

Velocity Engine *n.* A component of Apple's Macintosh G4 processor that processes data in 128-bit chunks. The Velocity Engine is capable of over one gigaflop of floating-point operations per second.

Venn diagram *n.* A type of diagram, used to express the result of operations on sets, in which a rectangle represents the universe and circles inside the rectangle represent sets of objects. Relationships between sets are indicated by the positions of the circles in relation to one another. The Venn diagram is named after John Venn (1834–1923), an English logician at Cambridge University. *See* the illustration.

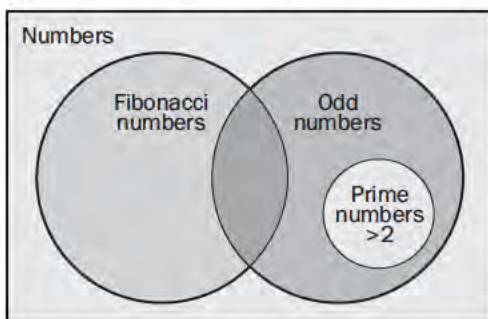

Venn diagram.

verbose *adj.* Displaying messages as English text rather than as concise (but cryptic) codes.

verify *vb.* To confirm either that a result is correct or that a procedure or sequence of operations has been performed.

Veronica *n.* Acronym for very easy rodent-oriented Net-wide index to computerized archives. An Internet service developed at the University of Nevada that searches for Gopher archives by keywords. Users can enter Boolean operators, such as AND, OR, and XOR, to help narrow or expand their search. If any matching archives are found, they are listed on a new Gopher menu. *See also* Boolean operator, Gopher. *Compare* Archie, Jughead.

version *n.* A particular issue or release of a hardware product or software title.

version control *n.* The process of maintaining a database of all the source code and related files in a software development project to keep track of changes made during the project.

version number *n.* A number assigned by a software developer to identify a particular program at a particular stage, before and after public release. Successive public releases of a program are assigned increasingly higher numbers. Version numbers usually include decimal fractions. Major changes are generally marked by a change in the whole number, whereas for minor changes only the number after the decimal point increases.

verso *adj.* The publishing term for a left-hand page, which is always even-numbered. *Compare* recto.

vertex *n.* The highest point of a curve, the point where a curve ends, or the point where two line segments meet in a polygon or freeform.

vertical application *n.* A specialized application designed to meet the unique needs of a particular business or industry—for example, an application to keep track of billing, tips, and inventory in a restaurant.

vertical bandwidth *n.* The rate at which a display screen is refreshed entirely, expressed in hertz (Hz). The vertical bandwidth of display systems ranges from 45 Hz to over 100 Hz. *Also called:* vertical scan rate, vertical sync, V-sync.

vertical blanking interval *n.* The time required for the electron beam in a raster-scan display to perform a vertical retrace. *See also* blanking, vertical retrace.

vertical recording *n.* *See* perpendicular recording.

vertical redundancy check *n.* *See* VRC.

vertical retrace *n.* On raster-scan displays, the movement of the electron beam from the lower right corner back to the upper left corner of the screen after the beam has completed a full sweep of the screen. *See also* blanking, vertical blanking interval. *Compare* horizontal retrace.

V

vertical scan rate *n.* See vertical bandwidth.

vertical scrolling *n.* Movement up or down in a displayed document. See also scroll bar.

vertical sync *n.* See vertical bandwidth.

vertical sync signal *n.* The part of a video signal to a raster display that denotes the end of the last scan line at the bottom of the display.

very-high-level language *n.* See 4GL.

very-high-rate digital subscriber line *n.* See VDSL.

very-high-speed integrated circuit *n.* An integrated circuit that performs operations, usually logic operations, at a very high speed. *Acronym:* VHSIC.

Very Large Database *n.* A database system containing volumes of data hundreds of gigabytes, or even terabytes, in size. A Very Large Database must often support thousands of users and tables with billions of rows of data, must often be able to operate across several different platforms and operating systems, and must often be able to work with many different software applications. *Acronym:* VLDB. See also data warehouse.

Very Large Memory *n.* A memory system designed to handle the huge data blocks associated with a Very Large Database. Very Large Memory uses 64-bit RISC technology to allow the use of addressable main memory and file sizes larger than 2 gigabytes (GB) and to cache as much as 14 GB of memory. *Acronym:* VLM. See also RISC, Very Large Database.

very-large-scale integration *n.* A reference to the density with which transistors and other elements are packed in an integrated circuit and to the thinness of the connections between them. Very-large-scale integration is generally considered to encompass the range from 5000 to 50,000 components. *Acronym:* VLSI. See also integrated circuit. Compare large-scale integration, medium-scale integration, small-scale integration, super-large-scale integration, ultra-large-scale integration.

Very Long Instruction Word *n.* See VLIW.

very-low-frequency electromagnetic radiation *n.* See VLF radiation.

VESA¹ *adj.* Having VL bus expansion slots. Also called: VLB. See also expansion slot, VL bus. Compare VESA/EISA, VESA/ISA.

VESA² *n.* Acronym for Video Electronics Standards Association. An organization of hardware manufacturers

and vendors dedicated to drafting and improving standards for video and multimedia devices. Standards developed by VESA include the Display Data Channel (DDC), Display Power Management Signaling (DPMS), and VESA local bus (VL bus). See also DDC, DPMS, VL bus.

VESA DDC *n.* See DDC.

VESA Display Data Channel *n.* See DDC.

VESA Display Power Management Signaling *n.* See DPMS.

VESA/EISA *adj.* Having both EISA and VL bus expansion slots. See also EISA, expansion slot, VESA², VL bus. Compare VESA¹, VESA/ISA.

VESA/ISA *adj.* Having both ISA and VL bus expansion slots. See also expansion slot, ISA, VESA², VL bus. Compare VESA¹, VESA/EISA.

VESA local bus *n.* See VL bus.

vesicular film *n.* A coating for optical discs that facilitates erasing and rewriting. The surface is marked by small bumps, which can be flattened and thereby erased, rather than by the pits used in standard CD-ROM discs.

V.everything *n.* A marketing term used by some modem manufacturers to describe modems that comply with both the ITU-T (formerly CCITT) V.34 standard and the various proprietary protocols that were used before the standard was adopted, such as V.Fast Class. A V.everything modem should be compatible with any other modem that operates at the same speed. See also V.Fast Class, V series.

V.Fast Class *n.* A de facto modulation standard for modems implemented by Rockwell International prior to approval of the V.34 protocol, which is the standard. Although both V.Fast Class and V.34 are capable of 28.8-Kbps transmission, V.Fast Class modems cannot communicate with V.34 modems without an upgrade. *Acronym:* V.FC. See also V series.

VFAT *n.* Acronym for Virtual File Allocation Table. The file system driver software used under the Windows 9x Installable File System Manager (IFS) for accessing disks. VFAT is compatible with MS-DOS disks but runs more efficiently. VFAT uses 32-bit code, runs in protected mode, uses VCACHE for disk caching, and supports long filenames. See also Installable File System Manager, long filenames, protected mode, VCACHE, Windows. Compare file allocation table.

V.FC *n.* See V.Fast Class.



VGA *n.* Acronym for **V**ideo **G**raphics **A**dapter. A video adapter that duplicates all the video modes of the EGA (Enhanced Graphics Adapter) and adds several more. *See also* video adapter. *Compare* EGA.

VHLL *n.* Acronym for very-**h**igh-**l**evel **l**anguage. *See* 4GL.

VHSIC *n.* *See* very-high-speed integrated circuit.

vi¹ *n.* Short for **v**isual. The first full-screen text editor under UNIX. The vi editor offers many powerful but not very intuitive keyboard commands. It is still in use on UNIX systems, despite the existence of other editors such as Emacs. *See also* editor, UNIX.

vi² *vb.* To edit a file using the vi editor. *See also* vi¹.

VIA *n.* *See* Virtual Interface Architecture.

VI Architecture *n.* *See* Virtual Interface Architecture.

video *adj.* Of or pertaining to the visual component of a television signal. In relation to computers, *video* refers to the rendering of text and graphics images on displays. *Compare* audio.

video accelerator *n.* *See* graphics engine (definition 1).

video adapter *n.* The electronic components that generate the video signal sent through a cable to a video display. The video adapter is usually located on the computer's main system board or on an expansion board, but it is sometimes built into the terminal. *Also called:* video adapter board, video board, video card, video controller, video display adapter.

video adapter board *n.* *See* video adapter.

video board *n.* *See* video adapter.

video buffer *n.* The memory on a video adapter that is used to store data to be shown on the display. When the video adapter is in a character mode, this data is in the form of ASCII character and attribute codes; when it is in a graphics mode, the data defines each pixel. *See also* bit image, bit plane, color bits, pixel image.

video capture board *n.* *See* video capture device.

video capture card *n.* *See* video capture device.

video capture device *n.* An expansion board that converts analog video signals to digital form and stores them in a computer's hard disk or other mass storage device. Some video capture devices are also capable of converting digital video to analog video for use in a VCR. *Also called:* video capture board, video capture card. *See also* expansion board.

video card *n.* *See* video adapter.

video clip *n.* A file that contains a short video item, usually an excerpt from a longer recording.

video compression *n.* Reduction of the size of files containing video images stored in digital form. If no compression were done, 24-bit color video at 640 x 480 pixels would occupy almost one megabyte per frame, or over a gigabyte per minute. Video compression can, however, be lossy without affecting the perceived quality of the image. *See also* lossy compression, Motion JPEG, MPEG.

video conferencing *n.* Teleconferencing in which video images are transmitted among the various geographically separated participants in a meeting. Originally done using analog video and satellite links, today video conferencing uses compressed digital images transmitted over wide area networks or the Internet. A 56K communications channel supports freeze-frame video; with a 1.544-Mbps (T1) channel, full-motion video can be used. *See also* 56K, desktop conferencing, freeze-frame video, full-motion video, T1, teleconferencing. *Compare* data conferencing.

video controller *n.* *See* video adapter.

video digitizer *n.* A device used in computer graphics that uses a video camera, rather than a scan head, to capture a video image and then stores it in memory with the aid of a special-purpose circuit board. *See also* digitize. *Compare* digital camera.

videodisc *n.* An optical disc used to store video images and associated audio information. *See also* CD-ROM.

video display *n.* Any device capable of displaying, but not printing, text or graphics output from a computer.

video display adapter *n.* *See* video adapter.

video display board *n.* A video adapter implementation using an expansion board rather than the computer's main system board. *See also* video adapter.

video display card *n.* *See* video display board.

video display metafile *n.* A file containing video display information for the transport of images from one system to another. *Acronym:* VDM.

video display page *n.* A portion of a computer's video buffer that holds one complete screen image. If the buffer can hold more than one page, or frame, screen updates can be completed more rapidly because an unseen page can be filled while another is being displayed.

video display terminal *n.* *See* VDT.



video display tube *n.* See CRT.

video display unit *n.* See monitor.

video DRAM *n.* See video RAM.

video driver *n.* Software that provides the interface between the video adapter hardware and other programs, including the operating system. The user can access the video driver to specify the resolution and color-bit depth of images on the monitor during the setup process. See also driver, monitor, video adapter.

video editor *n.* A device or program used to modify the contents of a video file.

Video Electronics Standards Association *n.* See VESA².

video game *n.* See computer game.

Video Graphics Adapter or **Video Graphics Array** *n.* See VGA.

video graphics board *n.* A video adapter that generates video signals for displaying graphical images on a video screen.

video look-up table *n.* See color look-up table.

video memory *n.* Memory from which a display image is created, located in the video adapter or video subsystem. If both the video processor and the central processing unit (CPU) have access to video memory, images are produced by the CPU's modification of video memory. Video circuitry normally has priority over the processor when both attempt to read or write to a video memory location, so updating video memory is often slower than accessing main memory. See also video RAM.

video mode *n.* The manner in which a computer's video adapter and monitor display on-screen images. The most common modes are text (character) mode and graphics mode. In text mode, characters include letters, numbers, and some symbols, none of which are "drawn" on screen dot by dot. In contrast, graphics mode produces all screen images, whether text or art, as patterns of pixels (dots) that are drawn one pixel at a time.

videophone *n.* A device equipped with camera and screen, as well as a microphone and speaker, capable of transmitting and receiving video signals as well as voice over a telephone line. Using conventional telephone lines, a videophone can transmit only freeze-frame video. See also freeze-frame video.

video port *n.* A cable connector or port on a computer that outputs video signals to a monitor.

video RAM *n.* A special type of dynamic RAM (DRAM) used in high-speed video applications. Video RAM uses separate pins for the processor and the video circuitry, providing the video circuitry with a back door to the video RAM. The video circuitry can access the video RAM serially (bit by bit), which is more appropriate for transferring pixels to the screen than is the parallel access provided by conventional DRAM. *Acronym:* VRAM. See also dynamic RAM.

video server *n.* A server designed to deliver digital video-on-demand and other broadband interactive services to the public over a wide area network.

video signal *n.* The signal sent from a video adapter or other video source to a raster display. The signal can include horizontal and vertical synchronization signals, as well as image information. See also composite video display, RGB monitor.

video terminal *n.* See terminal (definition 1).

videotex *n.* An interactive information retrieval service designed to be accessed by subscribers over telephone lines. Information can be displayed on a home television screen or a videotex terminal. Subscribers use keypads to choose from menus and to request specific screens, or pages. Also called: videotext.

videotext *n.* See videotex.

Vienna Definition Language *n.* See VDL.

view¹ *n.* **1.** The display of data or an image from a given perspective or location. **2.** In relational database management systems, a logical table created through the specification of one or more relational operations on one or more tables. A view is equivalent to a divided relation in the relational model. See also relational database, relational model.

view² *vb.* To cause an application to display information on a computer screen.

viewer *n.* An application that displays or otherwise outputs a file in the same way as the application that created the file. An example of a viewer is a program to display the images stored in GIF or JPEG files. See also GIF, JPEG.

viewport *n.* In computer graphics, a view of a document or an image. A viewport is similar to the view in a window, but usually only part of the document or graphical image is visible. Compare window.

vine *n.* A means of distributing audiotape copies that is similar to a tape tree. Because vine tapes are digital in for-



mat, there is no degradation of sound quality as tapes are copied down the vine from one participant to the next. *Compare* tape tree.

Vines *n.* A UNIX-based networking operating system from Banyan Systems.

viral marketing *n.* A marketing concept that relies on computer users to distribute marketing materials, possibly without even being aware of their participation. Viral marketing is often tied in with free e-mail accounts or other free online services, from which users pass along advertisements with every message they send.

virgule *n.* The forward slash (/) character. *Compare* backslash.

virtual *adj.* Of or pertaining to a device, service, or sensory input that is perceived to be what it is not in actuality, usually as more “real” or concrete than it actually is.

virtual 8086 mode *n.* *See* virtual real mode.

virtual 86 mode *n.* *See* virtual real mode.

virtual address *n.* In a virtual memory system, the address that the application uses to reference memory. The memory management unit (MMU) translates this address into a physical address before the memory is actually read or written to. *See also* physical address, virtual memory. *Compare* real address.

virtual channel *n.* In Asynchronous Transfer Mode (ATM), the path taken by data sent from one sender to one receiver. *See also* ATM (definition 1), virtual path (definition 2).

virtual circuit *n.* A connection between communicating computers that provides the computers with what appears to be a direct link but can actually involve routing data over a defined but longer path.

virtual community *n.* *See* online community.

Virtual Control Program Interface *n.* A specification for MS-DOS programs to allow access to extended memory under a multitasking environment (for example, Windows) for 386 and higher-level processors. *Acronym:* VCPI. *See also* 80386DX, extended memory, multitasking. *Compare* protected mode.

virtual desktop *n.* A desktop enhancement tool that provides access to the desktop when it is covered by open windows or that expands the size of the working desktop. *See also* desktop.

virtual device *n.* A device that can be referenced but that does not physically exist. Virtual-memory addressing, for

example, uses magnetic disk storage to simulate memory larger than that physically available.

virtual device driver *n.* Software in Windows 9x that manages a hardware or software system resource. If a resource retains information from one access to the next that affects the way it behaves when accessed (for example, a disk controller with its status information and buffers), a virtual device driver must exist for it. Virtual device drivers are described using three-letter abbreviations beginning with V and ending with D; the middle letter indicates the type of device, such as D for a display, P for a printer, T for a timer, and *x* when the type of device is not under discussion. *Acronym:* VxD. *See also* device driver.

virtual disk *n.* *See* RAM disk.

virtual display device driver *n.* *See* virtual device driver.

Virtual File Allocation Table *n.* *See* VFAT.

virtual hosting *n.* A form of hosting that provides a Web server, communication, and other services to customers for their own Web sites. In addition to hardware, software, and communication, virtual hosting can include assistance with domain name registration, e-mail addresses, and other Web-related issues. *See also* host, hosting.

virtual image *n.* An image that is stored in computer memory but is too large to be shown in its entirety on the screen. Scrolling and panning are used to bring unseen portions of the image into view. *See also* virtual screen.

virtual-image file *n.* A file that specifies the material to be recorded onto a CD-ROM. A virtual-image file generally contains pointers to files that are distributed across a hard disk rather than gathered in one area. Since a complete copy of the material is not assembled, problems may occur in writing the CD-ROM due to delays in assembling the material from a scattered group of files. *See also* CD-ROM. *Compare* physical-image file.

Virtual Interface Architecture *n.* An interface specification that defines a standard low-latency, high-bandwidth means of communication between clusters of servers in a System Area Network (SAN). Developed by Compaq, Intel, Microsoft, and more than 100 industry groups, the Virtual Interface Architecture is processor and operating system independent. By reducing the time required for message-passing between applications and the network, it seeks to reduce overhead and thus deliver enterprise-level scalability for mission-critical applications. *Acronym:* VIA. *Also called:* VI Architecture. *See also* cluster, System Area Network.



virtual LAN *n.* Short for **virtual** local area network. A local area network consisting of groups of hosts that are on physically different segments but that communicate as though they were on the same wire. *See also* LAN.

virtual machine *n.* Software that mimics the performance of a hardware device, such as a program that allows applications written for an Intel processor to be run on a Motorola chip. *Acronym:* VM.

virtual memory *n.* Memory that appears to an application to be larger and more uniform than it is. Virtual memory may be partially simulated by secondary storage such as a hard disk. Applications access memory through virtual addresses, which are translated (mapped) by special hardware and software onto physical addresses. *Acronym:* VM. *Also called:* disk memory. *See also* paging, segmentation.

virtual monitor *n.* An enhanced monitor viewing system for visually impaired users that uses a virtual-reality headset to move enlarged text across the screen in a direction opposite to head motion. *See also* virtual reality.

virtual name space *n.* The set of all hierarchical sequences of names that can be used by an application to locate objects. One such sequence of names defines a path through the virtual name space, regardless of whether the hierarchy of names reflects the actual arrangement of objects around the system. For example, the virtual name space of a Web server consists of all possible URLs on the network on which it runs. *See also* URL.

virtual network *n.* A part of a network that appears to a user to be a network of its own. For example, an Internet service provider can set up multiple domains on a single HTTP server so that each one can be addressed with its company's registered domain name. *See also* domain name, HTTP server (definition 1), ISP.

virtual path *n.* **1.** A sequence of names that is used to locate a file and that has the same form as a pathname in the file system but is not necessarily the actual sequence of directory names under which the file is located. The part of a URL that follows the server name is a virtual path. For example, if the directory *c:\bar\sinister\forces\distance* on the server *miles* is shared on the local area network at *foo.com* under the name *\\miles\baz* and contains the file *elena.html*, that file may be returned by a Web request for *http://miles.foo.com/baz/elena.html*. **2.** In Asynchronous Transfer Mode (ATM), a set of virtual channels that are switched together as a unit through the network. *See also* ATM (definition 1), virtual channel.

virtual peripheral *n.* A peripheral that can be referenced but does not physically exist. For example, an application might treat a serial port through which data is being transmitted as a printer, but the device receiving the data might be another computer instead.

virtual printer *n.* A feature in many operating systems that allows printer output to be saved to a file until a printer becomes available.

virtual printer device driver *n.* *See* virtual device driver.

virtual private network *n.* **1.** Nodes on a public network such as the Internet that communicate among themselves using encryption technology so that their messages are as safe from being intercepted and understood by unauthorized users as if the nodes were connected by private lines. **2.** A WAN (wide area network) formed of permanent virtual circuits (PVCs) on another network, especially a network using technologies such as ATM or frame relay. *Acronym:* VPN. *See also* ATM (definition 1), frame relay, PVC.

virtual reality *n.* A simulated 3-D environment that a user can experience and manipulate as if it were physical. The user sees the environment on display screens, possibly mounted in a special pair of goggles. Special input devices, such as gloves or suits fitted with motion sensors, detect the user's actions. *Acronym:* VR.

Virtual Reality Modeling Language *n.* *See* VRML.

virtual real mode *n.* A feature of the Intel 80386 (SX and DX) and later microprocessors that allows them to emulate several 8086 (real-mode) environments at the same time. The microprocessor provides a set of virtual registers and virtual memory space to each virtual 8086 environment. A program running in a virtual 8086 environment is completely protected from other virtual 8086 environments in the system and behaves as if it had control of the entire system. *Also called:* V86 mode, virtual 8086 mode, virtual 86 mode. *See also* real mode.

virtual root *n.* The root directory that a user sees when connected to an Internet server, such as an HTTP or FTP server. The virtual root is actually a pointer to the physical root directory, which may be in a different location, such as on another server. The advantages of using a virtual root include being able to create a simple URL for the Internet site and to move the root directory without affecting the URL. *Also called:* v-root. *See also* pointer (definition 1), root directory, server (definition 2), URL.

virtual route *n.* *See* virtual circuit.



virtual screen *n.* An image area that extends beyond the dimensions of the physical screen on the monitor, allowing manipulation of large documents or of multiple documents that lie partially outside the normal screen view. *See also* monitor.

virtual server *n.* A virtual machine that resides on an HTTP server but has the appearance to the user of being a separate HTTP server. Several virtual servers can reside on one HTTP server, each capable of running its own programs and each with individualized access to input and peripheral devices. Each virtual server has its own domain name and IP address and appears to the user as an individual Web site. Some Internet service providers use virtual servers for those clients who want to use their own domain names. *See also* domain name, HTTP server (definition 2), IP address.

virtual storefront *n.* A company's point of presence on the Web, providing opportunities for online sales. *Also called:* electronic storefront.

virtual terminal *n.* *See* terminal emulation.

virtual timer device driver *n.* *See* virtual device driver.

virtual world *n.* **1.** A 3-D modeled environment, often created in VRML, where a user can interact with the viewer to change variables. *See also* viewer, VRML. **2.** An electronic environment that has no basis in the physical world. Multiuser dungeons (MUDs), talkers, and chat rooms are often considered virtual worlds. *See also* chat¹ (definition 1), MUD, talker.

virus *n.* An intrusive program that infects computer files by inserting in those files copies of itself. The copies are usually executed when the file is loaded into memory, allowing the virus to infect still other files, and so on. Viruses often have damaging side effects—sometimes intentionally, sometimes not. For example, some viruses can destroy a computer's hard disk or take up memory space that could otherwise be used by programs. *See also* Good Times virus, Trojan horse, worm.

virus signature *n.* A portion of unique computer code contained in a virus. Antivirus programs search for known virus signatures to identify infected programs and files. *See also* virus.

visible page *n.* In computer graphics, the image that is being displayed on the screen. Screen images are written into display memory in sections called pages, each of which contains one screen display.

Visio *n.* A software application offered by Microsoft that allows users to create diagrams and visual presentations in electronic form. Visio enables users to share ideas and concepts visually by using diagrams to augment written material in documents or by expanding visual elements in a public presentation. Microsoft acquired the Visio application in 1999, when it purchased Visio Corporation.

visit *n.* A session during which a person views one or more pages in a particular Web site.

visitor *n.* A person who views a Web page or Web site.

Visor *n.* A product line of handheld personal digital assistants (PDAs) developed by Handspring Corporation. Features include an address list, an appointments calendar, a to-do list, and memos. Visor also features a 68-pin Springboard socket that allows plug-ins of additional devices offered by Handspring. *See also* Springboard.

Visual Basic *n.* A trademarked name owned by Microsoft Corporation for a high-level, visual-programming version of Basic. Visual Basic was designed for building Windows-based applications. *See also* Basic, Visual Basic for Applications, Visual Basic, Scripting Edition, visual programming.

Visual Basic Editor *n.* An environment in which you write new and edit existing Visual Basic for Applications code and procedures. The Visual Basic Editor contains a complete debugging toolset for finding syntax, run-time, and logic problems in your code.

Visual Basic for Applications *n.* A macro-language version of Visual Basic that is used to program many Windows 9x applications and is included with several Microsoft applications. *Acronym:* VBA. *See also* macro language, Visual Basic.

Visual Basic Script *n.* *See* Visual Basic, Scripting Edition.

Visual Basic, Scripting Edition *n.* A subset of the Visual Basic programming language, optimized for Web-related programming. As with JavaScript, code for Visual Basic, Scripting Edition is embedded in HTML documents. This version is included with the Internet Explorer Web browser. *Also called:* VBScript, Visual Basic Script. *See also* Visual Basic for Applications.

Visual C++ *n.* A Microsoft application development system for the programming language C++ that runs under MS-DOS and Windows. Visual C++ is a visual programming environment. *See also* visual programming. *Compare* Visual Basic, Visual J++.



Visual Café *n.* The Java-based suite of software development tools from Symantec Corporation. Visual Café is available in several product packages. The Standard Edition, intended for beginning Java programmers, includes an integrated editor, debugger, and compiler, as well as a JavaBean library, wizards, and utilities. The Professional Edition provides a larger library of JavaBeans and more sophisticated tools for development and debugging. The Database Edition, as the name indicates, adds support for database functionality. The Enterprise Suite provides a high-end environment for development of enterprise applications. *See also* Java.

Visual FoxPro Database and Command Language

n. A Microsoft product for developing database applications that includes a rich object-oriented programming language derived from the Xbase language.

Visual InterDev *n.* Microsoft's integrated development environment for Web applications. Visual InterDev includes tools for end-to-end (design through deployment) development, as well as integrated tools for database programming and design. The first version of Microsoft Visual InterDev was released in 1997.

visual interface *n.* *See* graphical user interface.

visualization *n.* A feature of an application that displays data in the form of a video image. For example, some databases can interpret and show data in the form of a two- or three-dimensional model.

Visual J++ *n.* Microsoft's Java visual programming environment, which can be used to create applets and applications in the Java language. *See also* applet, Java, Java applet, visual programming.

visual programming *n.* A method of programming using a programming environment or language in which basic program components can be selected through menu choices, buttons, icons, and other predetermined methods.

Visual SourceSafe *n.* A project-oriented version control system designed by Microsoft to manage software and Web site development. Visual SourceSafe stores files in a secure repository that provides easy access to authorized users and tracks all changes made to files. Visual SourceSafe works with any type of file produced by any development language, authoring tool, or application.

Visual Studio *n.* Microsoft's suite of software development tools for rapid development of business applications and components. Visual Studio is provided in two editions. The Professional Edition, for professional programmers, includes the Visual Basic and Visual C++

languages, Visual FoxPro for database development, Visual InterDev for Web development, and Visual J++ for Java development. The Enterprise Edition, for enterprise-level development, also includes Visual SourceSafe (a team-based source code control system) and the Developer Edition of Microsoft BackOffice Server.

Visual Studio .NET *n.* A development environment for creating XML Web services and applications on the Microsoft .NET platform. *See also* .NET, .NET My Services.

VLAN *n.* *See* virtual LAN.

VLB¹ *adj.* *See* VESA¹.

VLB² *n.* *See* VL bus.

VL bus *n.* Short for **VESA local bus**. A type of local bus architecture introduced by the Video Electronics Standards Association. The VL bus specification allows up to three VL bus slots to be built into a PC motherboard and allows for bus mastering (wherein intelligent adapter cards can do some processing independently of the CPU). A VL bus slot consists of a standard connector plus an additional 16-bit Micro Channel Architecture connector and must be built into the motherboard by the manufacturer. Standard connectors cannot simply be converted to VL bus slots. A non-VL bus adapter card can be used in a VL bus slot, but it cannot use the local bus and so performs as it normally would in a non-VL bus slot. *Also called:* VL local bus. *See also* local bus, PCI local bus.

VLF radiation *n.* Short for **very-low-frequency radiation**. Electromagnetic radiation (radio) at frequencies within the range of approximately 300 Hz to 30,000 Hz (30 kHz). Computer monitors emit this type of radiation. A voluntary standard, MPR II, regulates the amount of VLF radiation that a monitor can emit. *See also* MPR II.

VLIW *n.* Acronym for **Very Long Instruction Word**. An architecture that combines many simple instructions into a single long instruction word that uses different registers.

VL local bus *n.* *See* VL bus.

VLSI *n.* *See* very-large-scale integration.

VM *n.* Acronym for **Virtual Machine**. An operating system for IBM mainframes that provides virtual-machine capability. VM was developed by IBM customers and later taken over by IBM itself under the name OS/VM. *See also* virtual machine, virtual memory.

VML *n.* Acronym for **Vector Markup Language**. An XML-based specification for the exchange, editing, and



delivery of 2-D vector graphics on the Web. An application of XML (Extensible Markup Language), VML uses XML tags and Cascading Style Sheets to create and place vector graphics, such as circles and squares, in an XML or HTML document, such as a Web page. These graphics, which are rendered in the native operating system, can include color and are editable in a variety of graphics programs. *See also* Cascading Style Sheets, XML.

VoATM *n.* Short for **Voice over Asynchronous Transfer Mode**. The transmission of voice and other telephony over an ATM network. *See also* ATM, VoFR, VoIP.

VoFR *n.* Short for **Voice over Frame Relay**. Voice transmission over a frame relay network. *See also* frame relay, VoATM, VoIP.

voice answer back *n.* The use of sound-recorded messages by a computer in responding to commands or queries. *Acronym:* VAB.

voice-capable modem *n.* A modem that can support voice messaging applications along with its data-handling functions.

voice chat *n.* A feature offered by Internet service providers (ISPs) that allows users to converse with each other directly through an Internet connection. *See also* Internet telephone.

voice coil *n.* A device that moves a disk drive actuator arm using electromagnetism. It works more quickly than a stepper motor. *See also* actuator. *Compare* stepper motor.

voice-grade channel *n.* A communications channel, such as a telephone line, with an audio bandwidth of 300 to 3000 Hz, suitable for carrying speech. A voice-grade channel can also be used for transmitting facsimile, analog, and digital information at rates up to 33 kilobits per second (Kbps).

voice input *n.* Spoken instructions that a computer translates into executable commands using speech recognition technology or that are embedded into documents with the aid of a microphone. *See also* speech recognition.

voice mail *n.* A system that records and stores telephone messages in a computer's memory. Unlike a simple answering machine, a voice mail system has separate mailboxes for multiple users, each of whom can copy, store, or redistribute messages.

voice messaging *n.* A system that sends and receives messages in the form of sound recordings.

voice modem *n.* A modulation/demodulation device that supports a switch to change between telephony and data transmission modes. Such a device might contain a built-in loudspeaker and microphone for voice communication, but more often it uses the computer's sound card. *See also* modem, sound card, telephony.

voice navigation *n.* The use of spoken commands to control a Web browser. Voice navigation is a feature of some plug-in applications that embellish Web browsers to allow the user to navigate the Web by means of his or her voice. *See also* Web browser.

voice-net *n.* A term used on the Internet to refer to the telephone system, often preceding the user's telephone number in an e-mail signature.

voice output *n.* *See* speech synthesis.

Voice over Asynchronous Transfer Mode *n.* *See* VoATM.

Voice over Frame Relay *n.* *See* VoFR.

Voice over IP *n.* *See* VoIP.

voice recognition *n.* The capability of a computer to understand the spoken word for the purpose of receiving commands and data input from the speaker. Systems that can recognize limited vocabularies as spoken by specific individuals have been developed, but developing a system that deals with a variety of speech patterns and accents, as well as with the various ways in which a request or a statement can be made, is more difficult, although advances are being made in this area. *Also called:* speech recognition. *See also* artificial intelligence, dictation software, neural network.

voice synthesis *n.* *See* speech synthesis.

VoIP *n.* Acronym for **Voice over IP**. The use of the Internet Protocol (IP) for transmitting voice communications. VoIP delivers digitized audio in packet form and can be used for transmitting over intranets, extranets, and the Internet. It is essentially an inexpensive alternative to traditional telephone communication over the circuit-switched Public Switched Telephone Network (PSTN). VoIP covers computer-to-computer, computer-to-telephone, and telephone-based communications. For the sake of compatibility and interoperability, a group called the VoIP Forum promotes product development based on the ITU-T H.323 standard for transmission of multimedia over the Internet. *Also called:* Internet telephony. *See also* H.323.



volatile memory *n.* **1.** Memory, such as RAM, that loses its data when the power is shut off. *Compare* nonvolatile memory. **2.** Memory used by a program that can change independently of the program, such as memory shared by another program or by an interrupt service routine.

volt *n.* The unit used to measure potential difference or electromotive force. One volt is defined as the potential across which 1 coulomb of charge will do 1 joule of work, or the potential generated by 1 ampere of current flowing through 1 ohm of resistance. *See also* electromotive force.

voltage *n.* *See* electromotive force.

voltage regulator *n.* A circuit or circuit component that maintains a constant output voltage despite variations in input voltage.

volts alternating current *n.* The measure of the peak-to-peak voltage swing of an electrical signal. *Acronym:* VAC.

volume *n.* **1.** A disk or tape that stores computer data. Sometimes, large hard disks are divided into several volumes, each of which is treated as a separate disk. **2.** The loudness of an audio signal.

volume label *n.* A name for a disk or tape. MS-DOS systems, which seldom use disk names except in directory listings, use the term *volume label*. Apple Macintosh systems, which often refer to disks by name, use the term *volume name*.

volume name *n.* *See* volume label.

volume reference number *n.* *See* volume serial number.

volume serial number *n.* The optional identifying volume number of a disk or tape. MS-DOS systems use the term *volume serial number*. Apple Macintosh systems use the term *volume reference number*. A volume serial number is not the same as a volume label or volume name. *Compare* volume label.

VON *n.* Acronym for **voice on the net**. A broad category of hardware and software technology for real-time voice and video transmission over the Internet. The term was coined by Jeff Pulver, who formed a group called the VON Coalition, which opposes regulation of VON technology and promotes VON to the public.

von Neumann architecture *n.* The most common structure for computer systems, attributed to the mathematician John von Neumann. It uses the concept of a program that can be permanently stored in a computer and manipulated or made self-modifying through machine-based instructions. Sequential processing is characteristic of von Neu-

mann architecture. Parallel architectures have evolved to improve on the encumbrances of sequential instructions. *See also* parallel computer.

von Neumann bottleneck *n.* Competition between data and instructions for CPU time. Mathematician John von Neumann was the first to show that a computer based on architecture linking a single processor with memory will actually spend more time retrieving data from memory than processing it. The bottleneck arises when the processor has to trade off between executing a large number of instructions per second and reading in a large amount of data in the same time. *See also* CPU.

VPD *n.* Acronym for **virtual printer device driver**. *See* virtual device driver.

VPN *n.* *See* virtual private network.

VR *n.* *See* virtual reality.

VRAM *n.* *See* video RAM.

VRC *n.* Acronym for **vertical redundancy check**. A method for checking the accuracy of transmitted data. VRC generates an extra bit (parity bit) for each character transmitted. The parity bit indicates whether the character contains an odd or an even number of 1 bits. If its value does not match the type of the character, that character is assumed to be incorrectly transmitted. *See also* parity. *Compare* LRC.

VRML *n.* Acronym for **Virtual Reality Modeling Language**. A scene description language for creating 3-D interactive Web graphics similar to those found in some video games, allowing the user to “move around” within a graphic image and interact with objects. VRML, a subset of Silicon Graphics’ Inventor File Format (ASCII), was created by Mark Pesce and Tony Parisi in 1994. VRML files can be created in a text editor, although CAD packages, modeling and animation packages, and VRML authoring software are the tools preferred by most VRML authors. VRML files reside on an HTTP server; links to these files can be embedded in HTML documents, or users can access the VRML files directly. To view VRML Web pages, users need a VRML-enabled browser or a VRML plug-in for Internet Explorer or Netscape Navigator. *See also* 3-D graphic, HTML document, HTTP server (definition 1).

v-root *n.* *See* virtual root.

V series *n.* The series of ITU-T (formerly CCITT) recommendations relating to modems and modem communications over the public phone system, including signaling, coding, and circuit characteristics. *See* the table.



Table V.1 Recommendations In the V Series for Modem Communications.

<i>Recommendation</i>	
<i>Number</i>	<i>What It Covers</i>
V.17	14,000-bps two-wire modems used for facsimile applications
V.21	300-bps modems used with dial-up lines; full-duplex transmission; not the same as Bell 103 (in North America)
V.22	1200-bps modems used with dial-up and leased lines; full-duplex transmission; not the same as Bell 212A (in North America)
V.22bis	2400-bps modems used with dial-up and leased lines; full-duplex transmission
V.23	600/1200-bps synchronous or asynchronous modems used with dial-up and leased lines; half-duplex transmission
V.26	2400-bps modems used with four-wire leased lines; full-duplex transmission
V.26bis	1200/2400-bps modems used with dial-up lines; full-duplex transmission
V.26ter	2400-bps modems used with dial-up and two-wire leased lines; DPSK modulation; fallback to 1200 bps; echo canceling to remove phone-line echo; full-duplex transmission
V.27	4800-bps modems used with leased lines; manual equalizer; full-duplex transmission
V.27bis	2400/4800-bps modems used with leased lines; automatic equalizer; full-duplex transmission
V.27ter	2400/4800-bps modems used with dial-up lines; full-duplex transmission
V.29	9600-bps modems used with point-to-point leased circuits; half-duplex transmission or full-duplex transmission
V.32	9600-bps modems used with dial-up lines; echo canceling to remove phone-line echo; full-duplex transmission
V.32bis	4800/7200/9600/12,000/14,400-bps modems used with dial-up lines; echo canceling; full-duplex transmission
V.33	12,000/14,400-bps modems used with four-wire leased lines; synchronous; QAM modulation; time-division multiplexing; full-duplex transmission
V.34	28,800-bps modems; full-duplex transmission
V.35	Group band modems, which combine the bandwidth of more than one telephone circuit
V.54	Operation of loop test devices in modems
V.56	Network transmission model for evaluating modem performance over standard voice-grade telephone connections
V.56bis	Network transmission model for evaluating modem performance over two-wire voice-grade connections
V.56ter	Network transmission model for evaluating modem performance over two-wire, 4-kilohertz duplex modems
V.61	4800-bps modems operating at voice plus data rate or 14,000-bps modems operating at data-only rate over standard switched telephone circuits or on point-to-point, two-wire phone circuits

V-sync *n.* See vertical bandwidth.

VT-52, VT-100, VT-200 *n.* A popular set of control codes used in terminals with those model numbers that were originally manufactured by Digital Equipment Corporation. Appropriate software can enable a microcomputer to use these codes to emulate such terminals.

VTD *n.* Acronym for virtual timer device driver. See virtual device driver.

Vulcan death grip *n.* A warm boot by pressing the Alt+Ctrl+Delete keys. The name is a reference from *Star Trek*. See also three-finger salute, warm boot.

VxD *n.* See virtual device driver.



W

w³ *n.* See World Wide Web.

W3 *n.* See World Wide Web.

W3C *n.* Abbreviation for the World Wide Web Consortium, a standards body based in the United States, Europe, and Japan. The W3C is dedicated (in part) to encouraging the development of open Web standards, such as the HTML and XML document markup languages, to promote interoperability and assist the Web in achieving its potential.

wafer *n.* A thin, flat piece of semiconductor crystal used in the fabrication of integrated circuits. Various etching, doping, and layering techniques are used to create the circuit components on the surface of the wafer. Usually multiple identical circuits are formed on a single wafer, which is then cut into sections. Each integrated circuit then has leads attached and is packaged in a holder. See also integrated circuit, semiconductor.

wafer-scale integration *n.* The fabrication on a single wafer of different microcircuits that are then connected to form a single circuit the full size of the wafer. See also wafer.

WAI *n.* Acronym for **Web Accessibility Initiative**. A set of guidelines released by the World Wide Web Consortium (W3C) in May 1999. The WAI is intended to promote Web accessibility for users with disabilities by setting Web design and compatibility guidelines that help assure Web access and usability for all users. See also accessibility.

WAIS *n.* Acronym for **Wide Area Information Server**. A UNIX-based document search and retrieval system on the Internet that can be used to search over 400 WAIS libraries, such as Project Gutenberg, for indexed files that match keywords entered by the user. WAIS can also be used on an individual Web site such as a search engine. WAIS, developed by Thinking Machines Corporation, Apple Computer, and Dow Jones, uses the Z39.50 standard to process natural language queries. The list of documents returned by WAIS often contains numerous false matches. Users need a WAIS client to use a WAIS server. See also natural language query, Project Gutenberg, search engine, Z39.50 standard.

WAIS client *n.* The program needed for accessing the WAIS (Wide Area Information Server) system to search

its databases. A WAIS client program must be installed on a user's own machine or accessed from a computer with such a program already installed. Many freeware and shareware WAIS programs for various operating systems, including UNIX, MS-DOS, OS/2, and Windows, are available for download on the Internet. To look for documents in a WAIS database, the user selects the database(s) to search and types a query containing keywords to search for. The WAIS client sends this query to the server, communicating with the server via the Z39.50 protocol. The server processes the request using indexes and returns a list of document headlines matching the query to the client. The user can then choose which document to retrieve, send that request to the server, and receive the complete document in return. See also WAIS.

WAIS database *n.* See WAIS.

waisindex *n.* **1.** A UNIX utility for building an index to text files for access using WAIS (Wide Area Information Server) query software. **2.** A URL for accessing WAIS. The URL takes the form `wais://hostport/database[? search]`.

WAIS library *n.* A WAIS (Wide Area Information Server) database. A WAIS library is a comprehensive collection of online documents on a specific topic—for example, Project Gutenberg's collection of public-domain literary and historical texts available over the Internet, and the Dow Jones Information Service collection of business and financial information products. Because the hundreds of WAIS free libraries currently accessible are updated and maintained by volunteers, the quality of topic coverage is uneven. See also WAIS, WAIS client, Project Gutenberg.

WAIS server or **waisserver** *n.* See WAIS.

wait state *n.* A processing cycle of the microprocessor during which it only waits for data from an input/output device or from memory. While a single wait state is not humanly perceptible, the cumulative effect of wait states is to slow system performance. See also zero wait state.

wallet *n.* In electronic commerce, a software program that contains a user's address and credit card information for use in paying for online purchases. When the wallet is opened at the electronic checkout, it identifies the user to

W

the merchant's server and allows the user to authorize the appropriate debit to a credit card.

wallpaper *n.* In a graphical user interface such as Windows, a pattern or picture in the screen background that can be chosen by the user. *See also* graphical user interface.

WAN *n.* Acronym for **wide area network**. A geographically widespread network, one that relies on communications capabilities to link the various network segments. A WAN can be one large network, or it can consist of a number of linked LANs (local area networks).

wand *n.* Any pen-shaped device used for data entry, such as a graphics tablet's stylus or, most commonly, the scanning instrument used with many bar code readers. *See also* optical scanner, scan head. *Compare* stylus.

wanderer *n.* A person who frequently uses the World Wide Web. Many of these people make indexes of what they find.

WAP *n.* *See* Wireless Application Protocol.

war dialer *n.* A computer program that calls a range of phone numbers to identify those numbers that make a connection to a computer modem. War dialers are typically used by hackers to search for vulnerable computers and, once a connection is made, the war dialers may automatically probe the computer for potential weaknesses. Early war dialer programs called demon dialers were used to crack telephone systems in the 1970s and 1980s.

warez *n.* Illegal copies of computer software distributed through the Internet and other online channels, such as bulletin boards and FTP servers. The spelling is part of the tendency among some online groups to use odd symbols and intentional misspellings. *Compare* freeware, shareware.

warm boot *n.* The restarting of a running computer without first turning off the power. *Also called:* soft boot, three-finger salute, vulcan death grip, warm start.

warm start *n.* *See* warm boot.

warp *vb.* Sometimes used by computer game developers to describe the need to completely redraw a screen within a game. For example, moving through a door or advancing to a higher level would require a complete screen overhaul. *See also* computer game.

watchdog *n.* A hardware device (usually a timer or driver) used to monitor continuing system health and functionality through communications with the system software using a dedicated device driver.

watermark *n.* A semitransparent image often used for letters and business cards. In currency, a watermark is visible when you hold a bill up to the light.

watt *n.* The unit of power equal to the expenditure of 1 joule of energy in 1 second. The power of an electrical circuit is a function of the potential across the circuit and the current flowing through the circuit. If E = potential, I = current, and R = resistance, power in watts can be calculated as $I \times E$, $I^2 \times R$, or E^2/R .

.wav *n.* The file extension that identifies sound files stored in waveform (WAV) audio format. *See also* WAV.

WAV *n.* A file format in which Windows stores sounds as waveforms. Such files have the extension .wav. Depending on the sampling frequency, on whether the sound is monaural or stereo, and on whether 8 or 16 bits are used for each sample, one minute of sound can occupy as little as 644 kilobytes or as much as 27 megabytes of storage. *See also* sampling, waveform.

wave *n.* **1.** Any disturbance or change that has an oscillatory, periodic nature, for example, a light or sound wave. *See also* waveform. **2.** In electronics, the time-amplitude profile of an electrical signal.

wave division multiplexing *n.* *See* dense wavelength division multiplexing.

waveform *n.* The manner in which a wave's amplitude changes over time. *See also* period, phase, wavelength.

wavelength *n.* The distance between successive peaks or troughs in a periodic signal that is propagated through space. Wavelength is symbolized by the Greek letter lambda and can be calculated as speed divided by frequency.

wavelet *n.* A mathematical function that varies over a limited extent of time. Wavelets are coming into increasing use for analyzing signals (such as sound). They have limited duration and sudden changes in frequency and amplitude rather than the infinite duration and constant amplitude and frequency of the sine and cosine functions. *Compare* Fourier transform.

wave table synthesis or **wavetable synthesis** *n.* A method of producing sound, especially music, through a PC. Wave table synthesis is based on use of a wave table, which is a collection of digitized sound samples taken from recordings of actual instruments. These samples are typically stored on a sound card and are edited and mixed together to produce music. Wave table synthesis produces



higher quality audio output than FM (frequency modulation) techniques.

WBEM *n.* Acronym for **Web-Based Enterprise Management**. A protocol that links a Web browser directly to a device or an application that monitors a network. *See also* communications protocol.

WDEF *n.* *See* window definition function.

WDL *n.* *See* Windows Driver Library.

WDM *n.* *See* dense wavelength division multiplexing, Windows Driver Model.

weak typing *n.* A characteristic of a programming language that allows the program to change the data type of a variable during program execution. *See also* data type, variable. *Compare* strong typing.

wearable computer *n.* A portable personal computer that its user wears like eyeglasses, clothing, or a wrist-watch but which, unlike those items, is interactive, responds to commands, and carries out instructions. A wearable computer may be used like a conventional computer for data collection, storage, and retrieval, but without tying the user to a stationary location while operating the computer. The earliest wearable computers were clandestine devices used in the mid-1960s to predict the performance of roulette wheels. Today, wearable computers are used for such applications as inventory and express package tracking.

web *n.* A set of interlinked documents in a hypertext system. The user enters the web through a home page. *See also* World Wide Web.

Web *n.* *See* World Wide Web.

Web Accessibility Initiative *n.* *See* WAI.

Web address *n.* *See* URL.

Web application *n.* A set of clients and servers that cooperate to provide the solution to a problem.

Web architect *n.* An individual who analyzes the purpose of a Web site and forms a plan for assembling and integrating the hardware, software, and other technical resources necessary to make the site function properly.

Web author *n.* A person who creates content for the World Wide Web. A Web author might be a writer who produces text for a designer to include in a Web page, or a Web designer who writes the text and also adds graphic elements and prepares the HTML code.

Web-Based Enterprise Management *n.* *See* WBEM.

Web browser *n.* Software that lets a user view HTML documents and access files and software related to those documents. Originally developed to allow users to view or browse documents on the World Wide Web, Web browsers can blur the distinction between local and remote resources for the user by also providing access to documents on a network, an intranet, or the local hard drive. Web browser software is built on the concept of hyperlinks, which allow users to point and click with a mouse in order to jump from document to document in whatever order they desire. Most Web browsers are also capable of downloading and transferring files, providing access to newsgroups, displaying graphics embedded in the document, playing audio and video files associated with the document, and executing small programs, such as Java applets or ActiveX controls included by programmers in the documents. Helper applications or plug-ins are required by some Web browsers to accomplish one or more of these tasks. *Also called:* browser. *See also* ActiveX control, helper application, hyperlink, Internet Explorer, Java applet, Lynx, Mosaic, Netscape Navigator, plug-in.

Web bug *n.* A small, nearly undetectable graphic that links to a Web page and is embedded in a document for use as an eavesdropping device. A Web bug usually takes the form of a 1-by-1-pixel transparent GIF file, so it is nearly invisible. This file is placed in a Web page, Microsoft Word file, or other document that users will access. The application in which the document is opened immediately links to the Web to download and display the embedded graphic. Information about the user, including IP address, browser, referrer, and time viewed, is passed to the author of the file when the application retrieves the invisible graphic information.

Webby Award *n.* Award bestowed annually by the International Academy of Digital Arts and Sciences to Web sites. The academy bestows awards to Web sites in more than 20 categories, which include technical achievement, humor, and best community site.

Web cam or **webcam** *n.* A video camera whose output appears on a Web page, usually updated on a regular and frequent schedule. Web cams are used to display weather and traffic conditions, to allow customers and other users to observe current activities at the site owner's business or home (for example, at a day care center), for promotional purposes, and as a form of "gee whiz, look at this!" entertainment.

webcast¹ *n.* Live or delayed audio or video programming delivered to users over the Web. Downloading these broadcasts requires a user to have the appropriate video or audio application, such as RealPlayer. The necessary application is usually available from the webcaster without cost.

webcast² *vb.* To produce and disseminate Web-based audio, video, and text programming.

webcaster *n.* A company or organization that produces and disseminates Web-based audio, video, and text programming.

webcasting *n.* Popular term for broadcasting information via the World Wide Web, using push and pull technologies to move selected information from a server to a client. An emergent technology in 1997, webcasting was developed to provide users with customized content—for example, sports, news, stocks, and weather—that can be updated both regularly and automatically. Webcasting gives users the ability to specify the type of content they want to see, and it gives content providers a means of delivering such information directly to the user's desktop. *Also called:* netcasting. *See also* pull, push (definition 2).

Web clipping *n.* A Web service that delivers brief snippets of information to handheld Web-enabled devices, such as wireless phones and personal digital assistants. Rather than opening a Web site and browsing for information, Web clipping allows a customer to request specific types of information from a service. The Web clipping service then downloads the information to the handheld device.

web CLUT *n.* *See* browser CLUT.

Web container *n.* A container that implements the Web component contract of Sun Microsystems's Java 2 Platform Enterprise Edition (J2EE) network architecture. This contract specifies a run time environment for Web components that includes security, concurrency, life cycle management, transaction, deployment, and other services. Provided by a Web or J2EE server, a Web container provides the same services as a JavaServer Pages (JSP) container and provides a federated view of the J2EE platform APIs. *See also* API, container, J2EE, JSP container, servlet container.

Web cramming *n.* A common form of fraud in which Internet Service Providers (ISPs) add charges to the monthly bill for fictitious services or for services the customer had been told were free.

WebCrawler *n.* A World Wide Web search engine operated by America Online. *See also* search engine.

WebDAV *n.* Short for **Web Distributed Authoring and Versioning**. A set of extensions to the HTTP protocol that allows users to collaboratively edit, publish, and manage resources on the World Wide Web. WebDAV-enabled additions to HTTP include document writing, editing, and publishing tools and search, storage, and file sharing options.

Web development *n.* The design and coding of World Wide Web pages.

Web directory *n.* A list of Web sites, giving the URL and a description of each. *See also* URL.

Web Distributed Authoring and Versioning *n.* *See* WebDAV.

Web Forms *n.* The ASP.NET page framework, which consists of programmable Web pages (called Web Forms pages) that contain reusable server controls. *See also* ASP.NET server control.

Web hosting *n.* *See* hosting.

Web index *n.* A Web site intended to enable a user to locate other resources on the Web. The Web index may include a search facility or may merely contain individual hyperlinks to the resources indexed.

Weblicaton *n.* Slang for Web application. *See* Web application.

Weblog or **weblog** or **web log** *n.* A Web site that has regularly updated content reflecting the interests of the site's host. Often, but not always, the content is in journal form, has highlights of news and information from other Web sites, and is presented from a personal point of view. On some sites, the Weblog is a collaboration between visitors to the site. The high-tech-oriented Slashdot.org is frequently cited as being among the best-known Weblogs.

Webmaster or **webmaster** *n.* A person responsible for creating and maintaining a World Wide Web site. A Webmaster is often responsible for responding to e-mail, ensuring the site is operating properly, creating and updating Web pages, and maintaining the overall structure and design of the site. *Also called:* webmistress, webweaver.

webmistress *n.* *See* Webmaster.

webographics *n.* Demographics of Web users specifically focusing on surfing and online shopping habits and on other related information, such as connection method, browser, and platform.



WebPad *n.* A class of wireless Internet appliances offering full Internet and personal digital assistant (PDA) functions. A WebPad features a larger LCD screen than other handheld communications devices and resembles a tablet.

Web page *n.* A document on the World Wide Web. A Web page consists of an HTML file, with associated files for graphics and scripts, in a particular directory on a particular machine (and thus identifiable by a URL). Usually a Web page contains links to other Web pages. *See also* URL.

Web page embedding *n.* Embedding a digital streaming media player directly onto a Web page using HTML code. Rather than displaying a hyperlink to the media file, Web page embedding uses browser plug-ins to present the media player as a visual element in the layout of the Web page.

Web phone *n.* *See* Internet telephone.

Web Presence Provider *n.* A Web hosting and Internet service provider who manages the Web server hardware and software required to make a Web site available on the Internet. *Acronym:* WPP.

Web rage *n.* **1.** Anger or frustration related to the use or operation of the Internet. **2.** An intemperate, rude, or angry posting on the Internet; a flame. **3.** The latest fad to gain popularity among Web users.

websafe palette *n.* *See* browser CLUT.

Web server *n.* *See* HTTP server.

Web server control *n.* An ASP.NET server control that belongs to the System.Web.UI.WebControls namespace. Web server controls are richer and more abstract than HTML server controls. A Web server control has an <asp:ControlName> prefix on an ASP.NET page. *See also* ASP.NET server control, HTML server control, namespace.

Web services *n.* A modular collection of Web protocol-based applications that can be mixed and matched to provide business functionality through an Internet connection. Web services can be used over the Internet or an intranet to create products, business processes, and B2B interactions. Web services use standard Internet protocols such as HTTP, XML, and SOAP to provide connectivity and interoperability between companies.

Web Services Description Language *n.* *See* WSDL.

Web site *n.* A group of related HTML documents and associated files, scripts, and databases that is served up by

an HTTP server on the World Wide Web. The HTML documents in a Web site generally cover one or more related topics and are interconnected through hyperlinks. Most Web sites have a home page as their starting point, which frequently functions as a table of contents for the site. Many large organizations, such as corporations, will have one or more HTTP servers dedicated to a single Web site. However, an HTTP server can also serve several small Web sites, such as those owned by individuals. Users need a Web browser and an Internet connection to access a Web site. *See also* home page, HTML, HTTP server (definition 1), Web browser.

Web Storage System *n.* The storage component of Exchange 2000 Server and SharePoint Portal servers, which integrates Web server, database, file system, and workgroup functionality. The Web Storage System lets you store and share many types of data in a single integrated system. *Acronym:* WSS.

Web switch *n.* A network device—a switch—designed to optimize Web traffic routing by using the information embedded in HTTP requests to route the requests to the most appropriate servers, no matter where they are located. Web switches are intended to address issues of speed, scalability, and performance for high-volume Web sites. *See also* switch.

Web terminal *n.* A system containing a central processing unit (CPU), RAM, a high-speed modem or other means of connecting to the Internet, and powerful video graphics, but no hard disk, intended to be used solely as a client to the World Wide Web rather than as a general-purpose computer. *Also called:* network computer.

Web-to-host *n.* A service that allows remote users to access programs and data on legacy or mainframe systems through a Web browser. Web-to-host packages typically include a combination of services such as emulation support, legacy access, centralized management, host services, and security options, with some degree of customization possible. *See also* legacy system, mainframe computer.

WebTV *n.* A system that provides consumers with the ability to access the Web as well as send and receive e-mail on a television by means of a set-top box equipped with a modem. Users must have an ISP (Internet service provider) and subscribe to the WebTV Network. Developed by WebTV Networks, WebTV was purchased by Microsoft in 1996.

webweaver *n.* See Webmaster.

webzine *n.* An electronic publication distributed primarily through the World Wide Web, rather than as an ink-on-paper magazine. See also e-zine.

weighted code *n.* A data representation code in which each bit position has a specified inherent value, which might or might not be included in the interpretation of the data, depending on whether the bit is on or off.

weighted fair queuing *n.* A technique used to improve quality of service that prioritizes each session flow passing through a network device. With weighted fair queuing, high-bandwidth traffic is given a smaller proportion of network capacity than low-bandwidth traffic. *Acronym:* WFQ. Compare fair queuing.

welcome page *n.* See home page.

WELL *n.* Acronym for **W**hole **E**arth **'L**ectronic **L**ink. A conferencing system based in San Francisco, California, that is accessible through the Internet and through dial-up access points in many major cities. The WELL attracts many computer professionals, along with other people who enjoy participating in one of the Internet's most successful virtual communities. Because of the number of journalists and other prominent people who participate in the WELL, it has substantial influence beyond its own relatively small number of subscribers.

well-behaved *adj.* **1.** Of, pertaining to, or characteristic of a program that performs properly even when given extreme or erroneous input values. **2.** Obeying the rules of a particular programming environment.

well-formed *n.* An XML or HTML document that follows all the rules of syntax outlined in the protocol's specification. A well-formed XML or HTML document can be read by all Web browsers without difficulty.

well-mannered *adj.* See well-behaved.

WEP *n.* Acronym for **W**ired **E**quivalent **P**rivacy. An encryption algorithm system included as part of the 802.11 standard, developed by the Institute of Electrical and Electronics Engineers as a security measure to protect wireless LANs from casual eavesdropping. WEP uses a shared secret key to encrypt packets before transmission between wireless LAN devices and monitors packets in

transit to detect attempts at modification. WEP offers both 40-bit and 128-bit hardware-based encryption options.

wetware *n.* Slang for human beings—part of the environment that also includes hardware and software. Also called: liveware.

WFC *n.* See Windows Foundation Classes.

WFQ *n.* See weighted fair queuing.

whatis *n.* **1.** A UNIX utility for obtaining a summary of a keyword's documentation. See also man pages. **2.** An Archie command for locating software whose description contains desired words.

What You See Before You Get It *adj.* See WYSBYGI.

What You See Is What You Get *adj.* See WYSIWYG.

wheel printer *n.* See daisy-wheel printer.

Whetstone *n.* A benchmark test that attempts to measure the speed and efficiency with which a computer carries out floating-point operations. The result of the test is given in units called *whetstones*. The Whetstone benchmark has fallen out of favor because it produces inconsistent results compared with other benchmarks such as the Dhrystone and the sieve of Eratosthenes. See also benchmark¹, Dhrystone, sieve of Eratosthenes.

WHIRLWIND *n.* A digital computer using vacuum tubes, developed at the Massachusetts Institute of Technology in the 1940s and used during the 1950s. The innovations introduced with WHIRLWIND included CRT displays and real-time processing. WHIRLWIND project members included Kenneth H. Olsen, who founded Digital Equipment Corporation in 1957. See also CRT, real-time, vacuum tube.

Whistler *n.* The code name for Microsoft Windows XP that was used during its development cycle. New visual and operational features are designed to make Windows XP easy for the home user to operate. Features include real-time voice, video and application sharing, enhanced mobility, added support for digital photos and video, and download and playback of high-quality audio and video content. Like Microsoft Windows 2000, Windows XP was developed from Windows NT, consolidating consumer and business operating systems into a single code base.



whiteboard *n.* Software that allows multiple users across a network to work together on a document that is simultaneously displayed on all the users' screens, as though they are all gathered around a physical whiteboard.

Whiteboard *n.* Microsoft NetMeeting feature that opens a separate window in which multiple users can simultaneously review, create, and update graphic information. The Whiteboard is object-oriented, not pixel-oriented, allowing participants to manipulate the contents by clicking and dragging with the mouse. In addition, they can use a remote pointer or highlighting tool to point out specific contents or sections of shared pages. The NetMeeting Whiteboard is T.126 compliant and is interoperable with other T.126-compatible whiteboards.

white box *n.* A nonbranded PC assembled by a reseller, potentially including components from a number of manufacturers. The name refers to the typical color of the shipping carton, a box unadorned by brand name or logo.

white box testing *n.* A method of testing software that is based on knowledge of how the software is intended to function. Unlike black box testing, which focuses on how the software functions without reference to how it is designed, white box testing relies on detailed knowledge of the program code itself and is intended to find flaws and/or errors in its design and specification. *Also called:* glass box testing. *Compare* black box testing.

white hat *n.* A hacker who operates without malicious intent. A white hat will not break into a system with the intention of doing damage. White hats may be employed to provide security against other hackers. *See also* hacker. *Compare* black hat.

white noise *n.* Noise that contains components at all frequencies, at least within the frequency band of interest. It is called "white" by analogy to white light, which contains light at all the visible frequencies. In the audible spectrum, white noise is a hiss or a roar, such as that produced when a television set is tuned to a channel over which no station is broadcasting.

white pages *n.* *See* DIB (definition 2).

white space *n.* The areas of blank space on a page that can be used in a design for balance, contrast, and visual appeal.

whois *n.* **1.** An Internet service, provided by some domains, that enables a user to find e-mail addresses and other information for users listed in a database at that domain. **2.** A UNIX command to access the whois service. **3.** A command that displays a list of all users logged onto a Novell network.

whois client *n.* A program (such as the UNIX whois command) that enables a user to access databases of usernames, e-mail addresses, and other information. *See also* whois (definition 1).

whois server *n.* Software that provides the usernames and e-mail addresses from a database (often listing people who have accounts at an Internet domain) to users who request the information using whois clients. *See also* whois (definition 1).

Whole Earth 'Lectronic Link *n.* *See* WELL.

whole number *n.* A number without a fractional component—for example, 1 or 173; an integer.

WID *n.* Acronym for **Wireless Information Device**. Smart phone or other handheld wireless device capable of multiple communications functions, including e-mail and Internet access.

Wide Area Information Server *n.* *See* WAIS.

wide area network *n.* *See* WAN.

wideband transmission *n.* *See* broadband network.

Wide SCSI *n.* A form of the SCSI-2 interface that can transfer data 16 bits at a time at up to 20 megabytes per second. The Wide SCSI connector has 68 pins. *Also called:* Wide SCSI-2. *See also* SCSI, SCSI-2. *Compare* Fast SCSI, Fast/Wide SCSI.

Wide SCSI-2 *n.* *See* Wide SCSI.

widow *n.* A last line of a paragraph, shorter than a full line, appearing at the top of a page. A widow is considered visually undesirable on the printed page. *Compare* orphan.

wildcard character *n.* A keyboard character that can be used to represent one or many characters. The asterisk (*), for example, typically represents one or more characters, and the question mark (?) typically represents a single character. Wildcard characters are often used in operating systems as a means of specifying more than one file by name.

WIMP *n.* Acronym for **Windows, Icons, Mouse, and Pointers**. A graphical user interface (GUI) such as those provided by the Apple Macintosh and Microsoft Windows operating systems. WIMP is usually said to stand for Windows, Icons, Mouse, and Pointers, but the acronym is sometimes spelled out as either Windows, Icons, Menus, and Pointers or Windows, Icons, Mouse, and Pull-down menus. The WIMP interface was invented at the Xerox Palo Alto Research Center (PARC), where it was first used in the Alto computer in the early 1970s. *See also* graphical user interface.

Win32 *n.* The application programming interface in Windows 95 and Windows NT that enables applications to use the 32-bit instructions available on 80386 and higher processors. Although Windows 95 and Windows NT support 16-bit 80x86 instructions as well, Win32 offers greatly improved performance. *See also* 16-bit machine, 32-bit machine, 80386DX, 8086, application programming interface, central processing unit, Win32s.

Win32 Driver Model *n.* *See* Windows Driver Model.

Win32s *n.* A subset of the Win32 application programming interface that works under Windows 3.x. By including the Win32s software, which is distributed as freeware, an application can gain in performance from using the 32-bit instructions available on 80386 and higher processors while running on Windows 3.x. *See also* 32-bit machine, 80386DX, central processing unit, Win32.

Winchester disk *n.* An early IBM name for a hard disk. The term is derived from IBM's internal code name for its first hard disk, which stored 30 megabytes (MB) and had a 30-millisecond access time, reminding its inventors of a Winchester .30-caliber rifle known as a ".30-.30."

window *n.* In applications and graphical interfaces, a portion of the screen that can contain its own document or message. In window-based programs, the screen can be divided into several windows, each of which has its own boundaries and can contain a different document (or another view into the same document).

window definition function *n.* A resource associated with a window in a Macintosh application. The Macintosh Window Manager calls this function to perform

such actions as drawing and resizing the window. *Also called:* WDEF.

windowing *n.* An approach to remediation (correction of problems) or simply user convenience in which two-digit years are interpreted in relation to a window of time. Logical procedures based on windowing thus enable software to correctly produce accurate four-digit years. In windowing, the century is determined by presuming that the year falls within a 100-year span. So if the window ranges from 1995 to 2094, any year that is 95 or greater is presumed to be in the twentieth century (19xx), while any number less than 95 is presumed to be in the twenty-first century (20xx). *Fixed windowing* presupposes that a window always starts with the same date, or pivot year. *Moving windowing* permits a user or another system to specify the pivot year when the program is installed or started. *Sliding windowing* is calculated every time a program runs and can be based on a predetermined span of time, called a slider, that can be added to the current date to produce the pivot year for the window. Potential differences in windows require analysis whenever importing or exporting data between systems. *Also called:* logic fix. *See also* pivot year.

windowing environment *n.* An operating system or shell that presents the user with specially delineated areas of the screen called *windows*. Windowing environments typically allow windows to be resized and moved around on the display. The Macintosh Finder, Windows, and the OS/2 Presentation Manager are all examples of windowing environments. *See also* graphical user interface, window.

window random access memory *n.* *See* WRAM.

Windows *n.* An operating system introduced by Microsoft Corporation in 1983. Windows is a multitasking graphical user interface environment that runs on MS-DOS-based computers (Windows 3.x. and Windows for Workgroups), and as a self-contained operating system for desktop computers (Windows 9x and Windows Me), workstations (Windows NT Workstation, Windows 2000 Professional), and network servers (Windows NT Server, Windows NT Enterprise Edition, Windows 2000 Server, and Windows 2000 Advanced Server). The most recent



versions of Windows are Windows XP Home (home and entertainment use) and Professional (advanced computing, businesses, and large organizations). The next generation of Windows server products will be the Windows Server 2003 family. Windows provides a standard graphical interface based on drop-down menus, windowed regions on the screen, and a pointing device such as a mouse.

Windows 95 n. An operating system with a graphical user interface for 80386 and higher processors, released by Microsoft Corporation in 1995. Intended to replace Windows 3.11, Windows for Workgroups 3.11, and MS-DOS, Windows 95 is a complete operating system, rather than a shell that requires MS-DOS, as does Windows 3.x. For backward compatibility, Windows 95 can run MS-DOS software. Under Windows 95, filenames can be up to 255 characters long and may include dots and spaces. Windows 95 supports the Plug and Play method for installing and configuring hardware and can access Windows, NetWare, and UNIX networks. The minimum configuration for Windows 95 is an 80386 processor with 4 MB of RAM, but an i486 or higher processor with at least 8 MB of RAM is recommended. Internet functionality is provided in large part in Windows 95 by Microsoft Internet Explorer. *See also* MS-DOS, NetWare, Plug and Play, Windows.

Windows 98 n. An operating system with a graphical user interface for i486 and higher processors, released by Microsoft Corporation in 1998. Building upon Windows 95, Windows 98 features an improved interface and more robust functionality. With the Active Desktop, Windows 98 integrates Internet connectivity even more closely, allowing users to access remote files in the same way they would access files on their hard drives. Hardware support includes USB, IEEE 1394, AGP ports, television tuner cards, DVD drives, multiple modems, and multiple monitors. Windows 98, Second Edition, released in 1999, builds on the features in the initial release and offers home networking and improved maintenance features. *See also* Windows, Windows 95.

Windows 9x n. The architecture upon which Windows 95 and Windows 98 were built. *See also* Windows 95, Windows 98.

Windows 2000 n. A Microsoft operating system, the successor to Windows NT, designed for business rather than consumer use. Like its predecessor, Windows 2000 is a multithreaded, multitasking 32-bit operating system.

Implemented in desktop and several server versions, Windows 2000 focuses overall on improved ease of use, networking, management, reliability, scalability, and security. See the table.

Table W.1 ATA Specifications.

<i>Version</i>	<i>Designed For</i>	<i>Features</i>
Windows 2000 Professional	Business desktop	Improvements in: Ease of use; security, performance, and reliability; support for mobile computing
Windows 2000 Server	Small to medium-sized deployments—workgroups, branch offices, departmental application, file, print servers	Two-way symmetric multiprocessing (SMP); ActiveDirectory; management tools; Kerberos and PKI security; COM+; Windows Terminal Support; improved Internet services
Windows 2000 Advanced Server	Mid-range departmental and application deployments	Windows 2000 Server features, plus four-way SMP; load balancing; clustering; high-performance sorting; 64-GB physical memory
Windows 2000 Datacenter Server	Large operations—data warehouses, online transaction-processing (OLTP), science and engineering simulations, enterprise solutions	Windows 2000 Advanced Server features, plus 16-way SMP

Windows 2000 Advanced Server n. Microsoft's network server for larger organizations. Designed to replace Windows NT 4 Enterprise Edition, it supports up to four-way SMP, large physical memories, and database-intensive work. It integrates clustering and load balancing support. *See also* SMP, Windows.

Windows 2000 Datacenter Server n. Microsoft's network server for larger organizations. Considered the most



powerful and functional server operating system ever offered by Microsoft, it supports up to 16-way SMP and up to 64 GB of physical memory (depending on system architecture). Like Windows 2000 Advanced Server, it provides both clustering and load balancing services as standard features. It is optimized for large data warehouses, econometric analysis, large-scale simulations in science and engineering, OLTP, and server consolidation projects. *See also* OLTP, SMP, Windows.

Windows 2000 Professional *n.* Microsoft's mainstream desktop operating system for businesses of all sizes. Designed to replace Windows NT Workstation 4, which many people are using today as the standard business desktop, Windows 2000 Professional builds upon the interface and kernel in NT 4. It also includes improved security, state-of-the-art features for mobile users, industrial-strength reliability, and better performance.

Windows 2000 Server *n.* Microsoft's network server for small to medium businesses. Designed to replace Windows NT 4 Server, Windows 2000 Server offers improved functionality and supports new systems with up to two-way symmetric multiprocessing (SMP).

Windows application *n.* A software application designed for use with the Microsoft Windows environment.

Windows-based accelerator *n.* A type of super VGA (SVGA) video adapter designed specifically to run Windows and Windows-based applications more quickly. A Windows-based accelerator achieves performance improvements over a standard SVGA video adapter with the help of special routines built into the adapter's read-only memory. These routines relieve the Windows operating system of some of the video-related duties it must perform on a nonaccelerated system. *Also called:* Windows-based accelerator card. *See also* SVGA.

Windows CE *n.* A small operating system from Microsoft designed for use with handheld and palm-size PCs and in embedded systems, such as the AutoPC. Windows CE, which has a user interface that is similar to Windows 9x and Windows NT, includes scaled-down versions of several Microsoft applications, including Excel, Word, Internet Explorer, Schedule+, and an e-mail client. *See also* handheld PC.

Windows CE Services *n.* A set of technologies that makes Windows CE-based devices Web enabled. It provides the functionality to deliver Web content information

to Windows CE-based devices from a wireless network or by desktop synchronization.

Windows Distributed interNet Applications Architecture *n.* *See* Windows DNA.

Windows DNA *n.* Short for Microsoft **Windows Distributed interNet Applications Architecture**. A framework introduced in 1997 as a means of integrating client/server and Web technologies in the creation of scalable, multitier applications delivered over an enterprise network. Windows DNA is based on a number of technologies, among them COM (Component Object Model), ActiveX, and dynamic HTML.

Windows Driver Library *n.* A collection of hardware device drivers for a Microsoft Windows operating system that were not included in the original Windows package. *Acronym:* WDL. *See also* driver.

Windows Driver Model *n.* A 32-bit layered architecture for device and bus drivers that allows for drivers that can be used by both Windows NT and Windows 98. It provides common input/output services understood by both operating systems and supports Plug and Play, USB (Universal Serial Bus), IEEE 1394 bus, and various devices, including input, communication, imaging, and DVD. *Acronym:* WDM. *Also called:* Win32 Driver Model.

Windows Explorer *n.* A utility in Windows that enables the user to locate and open files and folders. Windows Explorer resembles the File Manager of Windows 3.1. The user can select folders from a list displayed on the left side of the screen and access files in a selected folder from a list displayed on the right side of the screen.

Windows Forms *n.* A rich Windows client library for building Windows client applications.

Windows Foundation Classes *n.* A Java class library for developing Java applications to run in the Windows environment. Designed by Microsoft to make it easy to write code for the Windows platform using the powerful Java programming language, the Windows Foundation Classes represent an object-oriented framework that encapsulates and unifies the Microsoft Win32 API and Dynamic HTML programming models. This framework enables developers to link Java code directly to Windows APIs. *Acronym:* WFC. *See also* Java, Java Foundation Classes.

Windows Image Acquisition *n.* A device-driver interface that supports still digital cameras and low-end and



high-end scanners and allows retrieving of still images from IEEE 1394-based DV camcorders and USB-based Web cams. *Acronym:* WIA.

Windows IP Configuration *n.* See Winipcfg.

Windows Management Instrumentation *n.* A management infrastructure in Windows that supports monitoring and controlling system resources through a common set of interfaces and provides a logically organized, consistent model of Windows operation, configuration, and status. *Acronym:* WMI. See also resource.

Windows Me *n.* Released in 2000, the Windows Millennium Edition (Windows Me) operating system designed for home users as an upgrade from Windows 95 or Windows 98. Windows Me offers an improved home user experience including making it easier for users to share and manipulate digital photos, music, and videos, enhanced home networking capabilities, a rich Internet experience with support for broadband connections, different Internet communication tools, and online gaming.

Windows Media Audio *n.* A digital audio coding scheme developed by Microsoft that is used in distributing recorded music, usually over the Internet. Windows Media Audio shrinks the size of the audio file by a factor of 20 to 24 without seriously degrading the quality (CD-recording level) of the sound. Windows Media Audio files are given the file extension .wma and can be created with Windows Media Tools and played with the Windows Media Player. *Acronym:* WMA. See also Windows Media Technologies. Compare MP3, RealAudio, Secure Digital Music Initiative.

Windows Media Encoder *n.* A Windows Media technology that compresses live or prerecorded audio and video into a Windows Media stream, which can either be distributed immediately or saved as a Windows Media file for later distribution. The technology allows content developers to convert both live and prerecorded audio, video, and computer screen images to Windows Media Format for live and on-demand delivery. Windows Media Encoder also can save a stream as a Windows Media file and convert a file into Windows Media Format. Windows Media Encoder can distribute a stream via HTTP protocol. *Also called:* (if context is clear) Encoder, the encoder, the encoder engine.

Windows Media Player *n.* A client/control that receives a stream from a Windows Media server or local content for playback. It can run as a stand-alone client executable program. Windows Media Player can also be embedded in

a Web page, a C++ program, or a Microsoft Visual Basic program that uses the client ActiveX control.

Windows Media server *n.* A server on which Windows Media Services has been installed.

Windows Media Services *n.* A digital media platform that runs on a server, such as Windows 2000, to support streaming media, such as video and audio.

Windows Media Technologies *n.* Microsoft technologies for the creation, delivery, and playing of streaming audio and video over a network, including both intranets and the Internet. Windows Media Technologies, downloadable from the Microsoft Web site, support both live and on-demand (delivered from storage) content and are based on files delivered in Advanced Streaming Format (ASF). Three major components—Windows Media Tools, Windows Media Services, and Windows Media Player—comprise Windows Media Technologies. See the table. See also Advanced Streaming Format. Compare Real-System G2.

Table W.2 ATA Specifications.

<i>Component</i>	<i>Purpose</i>	<i>Features</i>
Windows Media Tools	Content creation	ASF authoring and editing tools, including tools for converting files from other formats (WAV, AVI, MPEG, and MP3) to ASF.
Windows Media Services	Content delivery	Tools for real-time and on-demand content delivery, administration tools, and Windows Media Rights Manager for piracy control.
Windows Media Player for PC platforms, Windows Media Player for Macintosh, Windows Media Player for UNIX	Content playback	ASF player for audio, audio plus still images, and full-motion video. Also supports other multimedia data, including RealAudio.

Windows Media Tools *n.* See Windows Media Technologies.

Windows Messenger *n.* See .NET Messenger Service.

Windows Metafile Format *n.* A graphics file format used by Windows to store vector graphics in order to exchange graphics information between applications and to store information between sessions. *Acronym:* WMF. *See also* vector graphics.

Windows Movie Maker *n.* Software from Microsoft for capturing, editing, and arranging audio and video source material to create movies. *Acronym:* WMM.

Windows NT *n.* An operating system released by Microsoft Corporation in 1993. The Windows NT operating system, sometimes referred to as simply NT, is the high-end member of a family of operating systems from Microsoft. It is a completely self-contained operating system with a built-in graphical user interface. Windows NT is a 32-bit, preemptive multitasking operating system that features networking, symmetric multiprocessing, multithreading, and security. It is a portable operating system that can run on a variety of hardware platforms including those based on the Intel 80386, i486, and Pentium microprocessors and MIPS microprocessors; it can also run on multiprocessor computers. Windows NT supports up to 4 gigabytes of virtual memory and can run MS-DOS, POSIX, and OS/2 (character-mode) applications. *See also* MS-DOS, operating system, OS/2, POSIX, Windows.

Windows NT Advanced Server *n.* A superset of Windows NT that provides centralized, domain-based network management and security. Windows NT Advanced Server also offers advanced hard disk fault-tolerance features, such as mirroring and additional connectivity. *See also* Windows NT.

Windows NT Embedded *n.* A version of the Microsoft Windows NT operating system designed for devices and other products that have embedded systems. Windows NT Embedded, released in 1999, targets devices in the midrange to high end of the embedded device industry, including high-speed copiers, patient monitors, private branch exchanges (PBXs), and point-of-sale terminals. Windows NT Embedded features include headless operation (with no keyboard, mouse, or display devices needed), diskless operation, and remote management infrastructure. *See also* embedded system, Windows NT.

Windows Open Services Architecture *n.* See WOSA.

Windows Open System Architecture *n.* See WOSA.

Windows Script Host *n.* The language-independent scripting host for Microsoft Windows platforms. Windows Script Host is a tool that allows users to run VBScript, JScript, or any other scripting language to automate common tasks and to create macros and logon scripts.

Windows Server 2003 *n.* The next generation of Windows servers. Built on Windows 2000, the Windows Server 2003 family includes the functionality, dependability, scalability, and security options to serve as the computing foundation for businesses of all sizes. The flexible computing architecture, built on industry standards, allows businesses to create robust and innovative applications, improve collaboration across the organization, and connect securely with customers.

Windows Sockets *n.* See Winsock.

Windows terminal *n.* A thin-client solution from Microsoft, designed to enable terminals and minimally configured computers to display Windows applications even if they are not, in themselves, capable of running Windows software. Windows terminals work in conjunction with Windows NT Server, Terminal Server edition. *See also* thin client.

Windows XP *n.* A member of the Microsoft Windows family of operating systems. Windows XP was released in 2001 in two versions: Windows XP Home Edition for home use and Windows XP Professional for advanced home computing, businesses, and larger organizations. Windows XP features a new visual design that simplifies navigation and search capabilities, improved file management, additional media and Web publishing capabilities, an improved system for device discovery and installation, and advanced features for mobile computing.

WinG *n.* Short for **Windows Games**. An application programming interface for games in the Windows 9x environment. Under WinG, games can access the video frame buffer directly for increased speed. *See also* application programming interface, buffer¹, frame buffer.

WinHEC *n.* Short for Microsoft **Windows Hardware Engineering Conference**. Annual meeting of the computer hardware industry featuring forums, seminars, exhibits, and educational sessions for developers, technical managers, engineers, and product planners who use the Microsoft Windows family of operating systems.

win.ini *n.* In Windows 3.x and MS-DOS, the initialization file used to pass the program configuration information



necessary to run the Windows operating environment. The win.ini file has been supplanted by the registry database in Windows 95 and later and Windows NT and later. *See also* configuration file, ini file, registry.

Winipcfg *n.* Short for **Windows IP Configuration**. A Windows 9x utility that enables users to access information about their TCP/IP (Transmission Control Protocol/Internet Protocol) and network adapter card settings. Running the Winipcfg program (winipcfg.exe) opens the IP Configuration window, which reveals the physical address, IP address, subnet mask, and default gateway settings of the primary TCP/IP adapter (or settings of multiple adapters if more than one is installed). This information is also helpful for troubleshooting. *See also* TCP/IP.

WINS *n.* Acronym for **Windows Internet Naming Service**. A Windows NT Server method for associating a computer's host name with its address. *Also called:* INS, Internet Naming Service. *Compare* DNS (definition 1).

Winsock *n.* Short for **Windows Sockets**. An application programming interface standard for software that provides a TCP/IP interface under Windows. The Winsock standard developed out of a Birds of a Feather (BOF) discussion that arose among software vendors at a UNIX conference in 1991; it has gained the general support of software developers, including Microsoft. *See also* application programming interface, BOF, socket (definition 1), sockets API, TCP/IP.

Wintel *adj.* Of, pertaining to, or characteristic of a computer that uses the Microsoft Windows operating system and an Intel central processing unit (CPU). *See also* Windows.

wired *adj.* **1.** Of, pertaining to, or characteristic of an electronic circuit or hardware grouping in which the configuration is determined by the physical interconnection of the components (as opposed to being programmable in software or alterable by a switch). *See also* hardwired (definition 1). **2.** Knowledgeable about Internet resources, systems, and culture. **3.** Having access to the Internet.

Wired Equivalent Privacy *n.* *See* WEP.

wired home *n.* *See* smart home.

wire-frame model *n.* In computer graphics applications such as CAD programs, a representation of a three-dimensional object using separate lines that resemble strands of wire joined to create a model. *Compare* solid model, surface modeling.

wireless *adj.* Of, pertaining to, or characteristic of communications that take place without the use of interconnecting wires or cables, such as by radio, microwave, or infrared light.

Wireless Application Protocol *n.* A specification for a global standard for enabling digital cellular phones and other wireless devices to access Internet and other information services. The Wireless Application Protocol, or WAP, is supported by an organization known as WAP Forum, which includes such members as Motorola, Nokia, L. M. Ericsson, and Unwired Planet. The goal of the forum is to create an open standard that works with different wireless technologies. *Acronym:* WAP.

wireless communication *n.* Communication between a computer and another computer or device without wires. The form of wireless communication provided as part of the Windows operating system uses infrared light to transmit files. Radio frequencies, as used by cellular and cordless telephones, are another form of wireless communication. *See also* infrared, infrared device, infrared port.

Wireless Information Device *n.* *See* WID.

wireless Internet *n.* Version of the Internet designed for use on wireless phones and handheld devices with small display screens, limited memory, and slower data transmission speeds than a personal computer. Most wireless Internet sites offer content as basic text with limited graphics.

wireless LAN *n.* A LAN (local area network) that sends and receives data via radio, infrared optical signaling, or some other technology that does not require a physical connection between individual nodes and the hub. Wireless LANs are often used in office or factory settings where a user must carry a portable computer from place to place. *Also called:* WLAN.

Wireless Markup Language *n.* *See* WML.

Wireless Multimedia Forum *n.* *See* WMF (definition 2).

wireless phone *n.* Telephone that operates by means of radio waves without a wire connection. A base station (cell tower) relays the phone's signal to a wireless carrier's network, where it is transmitted to another wireless phone or to a wired telephone network.

Wireless Services server component *n.* A component that allows a content provider or carrier to configure and schedule any number of information acquisition/encoding/transmission components to create a data stream to be transmitted by a carrier to a device. The server component builds

on an open architecture to allow new server components to be installed in any part of the stream at any time.

Wireless Transaction Protocol *n.* A lightweight request/reply transaction protocol for devices with limited resources over networks with low to medium bandwidth. It is not called the Wireless Transport Protocol or the Wireless Transfer Protocol. *Acronym:* WTP.

Wireless Transport Layer Security *n.* See WTLS.

wire-pin printer *n.* See dot-matrix printer.

wire-wrapped circuits *n.* Circuits constructed on perforated boards using wire instead of the metal traces found on printed circuit boards. The stripped ends of insulated wires are wrapped around the long pins of special wire-wrapped integrated circuit sockets. Wire-wrapped circuits are generally handmade, one-of-a-kind devices used for prototyping and research in electrical engineering. *Compare* printed circuit board.

wiring closet *n.* A room or location in a building where telecommunications and/or networking equipment such as hubs, switches, and routers are installed. *Also called:* data closet, telecom closet, telecommunications closet.

wizard *n.* **1.** Someone who is adept at making computers perform their “magic.” A wizard is an outstanding and creative programmer or a power user. *Compare* guru, UNIX wizard. **2.** A participant in a multiuser dungeon (MUD) who has permission to control the domain, even to delete other players’ characters. *See also* MUD. **3.** An interactive help utility within an application that guides the user through each step of a particular task, such as starting up a word processing document in the correct format for a business letter.

wizzywig *n.* See WYSIWYG.

WLAN *n.* See wireless LAN.

WMA *n.* Acronym for **Windows Media Audio**. *See* Windows Media Audio.

.wmf *n.* A file extension that identifies a vector image encoded as a Microsoft Windows Metafile.

WMF *n.* **1.** *See* Windows Metafile Format. **2.** Acronym for **Wireless Multimedia Forum**. A consortium of technology companies formed to promote open standards for wireless streaming products. WMF members include Cisco Systems, Intel, and the Walt Disney Internet Group. *See also* ISMA.

WMI *n.* *See* Windows Management Instrumentation.

WML *n.* Acronym for **Wireless Markup Language**. A markup language developed for Web sites that are accessed with microbrowsers on Wireless Application Protocol (WAP)-enabled devices. A Web site written with WML would be viewable on handheld devices with small screens, such as cell phones. *See also* markup language, microbrowser, Wireless Application Protocol.

WMLScript *n.* A scripting language derived from the JavaScript language for use in the development of Wireless Markup Language (WML).

WMM *n.* *See* Windows Movie Maker.

word *n.* The native unit of storage on a particular machine. A word is the largest amount of data that can be handled by the microprocessor in one operation and also, as a rule, is the width of the main data bus. Word sizes of 16 bits and 32 bits are the most common. *Compare* byte, octet.

Word *n.* Microsoft’s word processing software, available for the Windows and Macintosh platforms. In addition to extensive editing, formatting, and customization features, Word provides such tools as automatic text completion and correction. The most recent version, Word 2002 (part of Office XP) adds Web functionality—for example, the ability to save documents in HTML format. The first version, Microsoft Word for MS-DOS 1.00, was introduced in 1983.

word-addressable processor *n.* A processor that cannot access an individual byte of memory but can access a larger unit. In order to perform operations on an individual byte, the processor must read and write memory in the larger unit. *See also* central processing unit.

WordPerfect Office *n.* A suite of business application programs from Corel Corporation. The basic (Standard Edition) WordPerfect Office suite includes the WordPerfect word processor, Quattro Pro spreadsheet, Corel Presentations presentation software, CorelCENTRAL personal information manager, Microsoft Visual Basic for Applications scripting tools, and Trellix Web publisher. A home and small-business package, the Voice-Powered Edition, adds speech recognition and publishing products; a business and corporate package, the Professional Edition, adds database and Internet tools to all of the preceding.

word processing *n.* The act of entering and editing text with a word processor. *Acronym:* WP.

word processor *n.* An application program for creating and manipulating text-based documents. A word processor is the electronic equivalent of paper, pen, typewriter, eraser, and, most likely, dictionary and thesaurus. Depending on



the program and the equipment in use, word processors can display documents either in text mode (using highlighting, underlining, or color to represent italics, boldfacing, and other such formatting) or in graphics mode (in which formatting and, sometimes, a variety of fonts appear on the screen as they will on the printed page). All word processors offer at least limited facilities for document formatting, such as font changes, page layout, paragraph indentation, and the like. Some word processors can also check spelling, find synonyms, incorporate graphics created with another program, align mathematical formulas, create and print form letters, perform calculations, display documents in multiple on-screen windows, and enable users to record macros that simplify difficult or repetitive operations. *Compare* editor, line editor.

wordwrap or **word wrap** *n.* The ability of a word processing program or a text-editing program to break lines of text automatically to stay within the page margins or window boundaries of a document without the user having to do so with carriage returns, as is typically necessary when using a typewriter. *See also* hard return, soft return.

workaround *n.* A tactic for accomplishing a task despite a bug or other inadequacy in software or hardware without actually fixing the underlying problem. *See also* kludge.

workbook *n.* In a spreadsheet program, a file containing a number of related worksheets. *See also* worksheet.

workflow application *n.* A set of programs that aids in the tracking and management of all the activities in a project from start to finish.

workgroup *n.* A group of users working on a common project and sharing computer files, typically over a LAN (local area network). *See also* groupware.

workgroup computing *n.* A method of working electronically in which various individuals on the same project share resources and access to files using a network arrangement, such as a local area network, enabling them to coordinate their separate tasks. This is accomplished through using software designed for workgroup computing. *See also* groupware.

Workplace Shell *n.* The graphical user interface of OS/2. Like the Mac OS and Windows 95, the Workplace Shell is document-centric. Document files are displayed as icons; clicking an icon starts the corresponding application, and the user can print a document by dragging the document's icon to a printer icon. The Workplace Shell uses the graphical functions of Presentation Manager. *Acronym:* WPS.

worksheet *n.* In a spreadsheet program, a page organized into rows and columns appearing on screen and used for constructing a single table.

workstation *n.* **1.** A combination of input, output, and computing hardware that can be used for work by an individual. **2.** A powerful stand-alone computer of the sort used in computer-aided design and other applications requiring a high-end, usually expensive, machine with considerable calculating or graphics capability. **3.** A microcomputer or terminal connected to a network.

World Wide Web *n.* The total set of interlinked hypertext documents residing on HTTP servers all around the world. Documents on the World Wide Web, called pages or Web pages, are written in HTML (Hypertext Markup Language), identified by URLs (Uniform Resource Locators) that specify the particular machine and pathname by which a file can be accessed, and transmitted from server to end user under HTTP (Hypertext Transfer Protocol). Codes, called tags, embedded in an HTML document associate particular words and images in the document with URLs so that a user can access another file, which may be halfway around the world, at the press of a key or the click of a mouse. These files may contain text (in a variety of fonts and styles), graphics images, movie files, and sounds as well as Java applets, ActiveX controls, or other small embedded software programs that execute when the user activates them by clicking a link. A user visiting a Web page also may be able to download files from an FTP site and send messages to other users via e-mail by using links on the Web page. The World Wide Web was developed by Timothy Berners-Lee in 1989 for the European Laboratory for Particle Physics, or Conseil Européen pour le Recherche Nucléaire, in French (CERN). *Acronym:* WWW. *Also called:* w³, W3, Web. *See also* ActiveX controls, HTML, HTTP, HTTP server (definition 2), Java applet, URL.

World Wide Web Consortium *n.* *See* W3C.

worm *n.* A program that propagates itself across computers, usually by creating copies of itself in each computer's memory. A worm might duplicate itself in one computer so often that it causes the computer to crash. Sometimes written in separate segments, a worm is introduced surreptitiously into a host system either as a prank or with the intent of damaging or destroying information. *See also* bacterium, Internet Worm, Trojan horse, virus.

WORM *n.* Acronym for write **once**, read **many**. A type of optical disc that can be read and reread but cannot be

altered after it has been recorded. WORMs are high-capacity storage devices. Because they cannot be erased and rerecorded, they are suited to storing archives and other large bodies of unchanging information. *See also* compact disc.

WOSA *n.* Acronym for **Windows Open Services Architecture**, also known as **Windows Open System Architecture**. A set of application programming interfaces from Microsoft that is intended to enable Windows-based applications from different vendors to communicate with each other, such as over a network. The interfaces within the WOSA standard include Open Database Connectivity (ODBC), the Messaging Application Programming Interface (MAPI), the Telephony Application Programming Interface (TAPI), Windows Sockets (Winsock), and Microsoft Remote Procedure Calls (RPC). *See also* MAPI, ODBC, remote procedure call, TAPI, Winsock.

.wp *n.* A file extension used to identify files formatted for the WordPerfect word processor.

WP *n.* *See* word processing.

WPS *n.* *See* Workplace Shell.

WRAM *n.* Acronym for **w**indow **r**andom **a**ccess **m**emory. A type of RAM used in video adapters. Like video RAM (VRAM), WRAM allows the screen to be repainted while a graphical image is being written, but WRAM is faster. *Compare* video RAM.

wrap around *vb.* To continue movement, as with the cursor or a search operation, to the beginning or to a new starting point rather than stopping when the end of a series is reached. For example, the screen cursor might wrap around to the first column of the next line rather than stopping when it reaches the last column of the current line. Likewise, a program starting a search or replace operation in the middle of a document might be instructed to wrap around to the beginning rather than stop when it reaches the end of the document.

wrapper *n.* In the Java programming language, an object that encapsulates and delegates to another object with the aim of altering its behavior or interface. *See also* Java, object.

.wri *n.* The file format that identifies document files in the Microsoft Write format.

wrist support *n.* A device placed in front of a computer keyboard to support the wrists in an ergonomically neutral position, thereby safeguarding against repetitive strain injuries, such as carpal tunnel syndrome. *Also called:* wrist rest. *See also* carpal tunnel syndrome, repetitive strain injury.

write¹ *n.* A transfer of information to a storage device, such as a disk, or to an output device, such as a monitor or a printer. For example, a disk write means that information is transferred from memory to storage on disk. *See also* output¹. *Compare* read¹.

write² *vb.* To transfer information either to a storage device, such as a disk, or to an output device, such as a monitor or a printer. Writing is the means by which a computer provides the results of processing. A computer can also be said to write to the screen when it displays information on the monitor. *See also* output¹. *Compare* read¹.

write access *n.* A privilege on a computer system that allows a user to save, change, or delete stored data. Write access is usually set by the system administrator for a networked or server system and by the owner of the computer for a stand-alone machine. *See also* access privileges.

write-back cache *n.* A type of cache with the following feature: when changes are made to cached data, they are not simultaneously made to the original data as well. Instead, the changed data is marked, and the original data is updated when the cached data is deallocated. A write-back cache can perform more quickly than a write-through cache. But in some contexts, differences between cached and original data could lead to problems, and write-through caches must be used. *See also* cache. *Compare* write-through cache.

write-behind cache *n.* A form of temporary storage in which data is held, or cached, for a short time in memory before being written on disk for permanent storage. Caching improves system performance in general by reducing the number of times the computer must go through the relatively slow process of reading from and writing to disk. *See also* CPU cache, disk cache.

write cache *n.* *See* write-behind cache.

write error *n.* An error encountered while a computer is in the process of transferring information from memory to storage or to another output device. *Compare* read error.

write mode *n.* In computer operation, the state in which a program can write (record) information in a file. In write mode, the program is permitted to make changes to existing information. *Compare* read-only.

write protect *vb.* To prevent the writing (recording) of information, usually on a disk. Either a floppy disk or an individual file on a floppy disk or a hard disk can be



write protected (though not necessarily infallibly). *See also* write-protect notch.

write-protect notch *n.* A small opening in the jacket of a floppy disk that can be used to make the disk unwritable. On a 5.25-inch floppy disk, the write-protect notch is a rectangular hole on the edge of the disk jacket. When this notch is covered, a computer can read from the disk but cannot record new information on it. On 3.5-inch micro-floppy disks that are enclosed in plastic shells, the write-protect notch is an opening in a corner. When the sliding tab in this opening is moved to uncover a small hole, the disk is protected and cannot be written to. *Also called:* write-protect tab. *See also* write².

write-protect tab *n.* *See* write-protect notch.

write-through cache *n.* A type of cache in which changes made to cached data are simultaneously made in the original copy, rather than being marked for later updating. A write-through cache, though not as fast as a write-back cache, is needed in situations where problems would occur if both the original and cached data did not match. *Compare* write-back cache.

.wrl *n.* File extension required for saving all Virtual Reality Modeling Language (VRML) documents; for example, cube.wrl. *See also* VRML.

WSDL *n.* Acronym for **Web Services Description Language**. An XML format developed to allow for better interoperability among Web services and development tools. WSDL describes network services as collections of communication endpoints capable of exchanging messages and is extensible to allow description of endpoints

and their messages regardless of what message formats or network protocols are used to communicate.

WSS *n.* *See* Web Storage System.

WTLS *n.* Acronym for **Wireless Transport Layer Security**. A security protocol that provides encryption and authentication services for the Wireless Application Protocol (WAP). The WTLS layer uses data integrity, authentication, and encryption mechanisms to provide end-to-end security and privacy for wireless transactions. WTLS is based on Transport Layer Security (TLS), a Secure Socket Layer equivalent used with Internet applications. *See also* Wireless Application Protocol.

WWW *n.* *See* World Wide Web.

WYSBYGI *adj.* Acronym for **What You See Before You Get It**. Providing a preview of the effects of the changes the user has selected before the changes are finally applied. For example, a dialog box in a word processing program might display a sample of the font a user has chosen before the font is actually changed in the document. The user can cancel any changes after previewing them, and the document will be unaffected. *See also* WYSIWYG.

WYSIWYG *adj.* Acronym for **What You See Is What You Get**, pronounced “wizzywig.” Allowing a user to view a document as it will appear in the final product, and to directly edit the text, graphics, or other elements within that view. A WYSIWYG language is often easier to use than a markup language, which provides no immediate visual feedback regarding the changes being made. *Compare* markup language.

X

X10 *n.* A popular communications protocol for powerline carrier (PLC) systems that uses existing electrical wiring in a home or building for home networking. X10 uses RF signals to communicate between transmitters and receivers. *See also* home automation, home network, powerline carrier system.

X.200 *n.* *See* X series.

X.25 *n.* A recommendation published by the ITU-T (formerly CCITT) international communications standards organization that defines the connection between a terminal and a packet-switching network. X.25 incorporates three definitions: the electrical connection between the terminal and the network, the transmission or link-access protocol, and the implementation of virtual circuits between network users. Taken together, these definitions specify a synchronous, full-duplex terminal-to-network connection. Packet format, error control, and other features are equivalent to portions of the HDLC (High-level Data Link Control) protocol defined by the International Organization for Standardization (ISO). *See also* CCITT X series, HDLC, packet switching, virtual circuit.

X3D *n.* Acronym for **3D XML**. An XML-based 3-D graphics specification incorporating the behavior capabilities of the Virtual Reality Modeling Language (VRML). X3D is compatible with existing VRML content and tools and supports full integration with other XML-based technologies. The X3D specification was developed and administered by the Web 3D Consortium.

X.400 *n.* *See* X series.

X.445 *n.* *See* X series.

X.500 *n.* *See* X series.

X.509 *n.* *See* X series.

X.75 *n.* *See* X series.

x86 *n.* Any computer based on an 8086, 80286, 80386, 80486, or Pentium microprocessor.

x-axis *n.* The horizontal reference line on a grid, chart, or graph that has horizontal and vertical dimensions. *See also* Cartesian coordinates.

Xbase *n.* A generic name for a family of database languages based on dBASE, a copyrighted product of the Ashton-Tate Corporation. Xbase languages have since developed characteristics of their own and are now only partly compatible with the dBASE family. Xbase primarily refers to three different file types (.dbf, .dbt, and .ndx). *Also called:* xBase, xbase, XBase.

Xbox *n.* A video game console developed by Microsoft Corporation and released in 2001. Powered by an Intel 733-MHz processor, the Xbox delivers increased graphics capability over previously released game consoles and provides extensive storage capacity for gaming information. Peripherals plug into four game controller ports. An Ethernet port enables online gaming via a broadband connection. *See also* computer game, console game, GameCube, PlayStation. *Compare* Dreamcast.

X button *n.* *See* close button.

XCMD *n.* Short for **external command**. An external code resource used in HyperCard, a hypermedia program developed for the Macintosh. *See also* HyperCard, XFCN.

X Consortium *n.* The body, composed of several hardware firms, that governed the standards for the X Window System. The Open Group's X Project Team now has responsibility for the X Window System. *See also* X Window System.

xDSL *n.* An umbrella term for all of the digital subscriber line (DSL) technologies, which use a variety of modulation schemes to pack data onto copper wires. The *x* is a placeholder for the first or first two letters of a member technology, which might be ADSL, HDSL, IDSL, RADSL, or SDSL. *See also* DSL.

XENIX *n.* A version of UNIX that was originally adapted by Microsoft for Intel-based personal computers. Although it has been sold by many vendors, including Microsoft, Intel, and the Santa Cruz Operation (SCO), it has become principally identified with SCO. *See also* UNIX.

xerography *n.* *See* electrophotography.

Xerox Network System *n.* *See* XNS.



Xerox PARC *n.* Short for **Xerox Palo Alto Research Center**. Xerox's research and development facility in Palo Alto, California. Xerox PARC is the birthplace of such innovations as the local area network (LAN), the laser printer, and the graphical user interface (GUI).

XFCN *n.* Short for **external function**. An external code resource that returns a value after it has completed executing. XFCNs are used in HyperCard, a hypermedia program developed for the Macintosh. *See also* HyperCard, XCMD.

XFDL *n.* Short for **Extensible Forms Description Language**, a document description language introduced and submitted to the World Wide Web Committee in 1998 by the Canadian Internet forms company UWI.Com. XFDL is an XML-based language for describing complex forms, such as legal and government documents. It is designed to allow for interactivity yet remain consistent with Internet standards.

XGA *n.* *See* Extended Graphics Array.

x-height *n.* In typography, the height of the lowercase letter x in a particular font. The x-height thus represents the height of the body only of a lowercase letter, excluding ascenders (such as the top of the letter b) and descenders (such as the tail on the letter g). *See also* ascender, descender.

XHTML *n.* Short for **Extensible Hypertext Markup Language**. A markup language incorporating elements of HTML and XML. Web sites designed using XHTML can be more readily displayed on handheld computers and digital phones equipped with microbrowsers. XHTML was released for comments by the World Wide Web Consortium (W3C) in September 1999. *See also* HTML, microbrowser, XML.

XIP *n.* *See* execute in place.

XLANG *n.* A derivative XML language that describes the logical sequencing of business processes, as well as the implementation of the business process by using various application services.

XLink *n.* An XML language that provides a set of attributes that are used to create links between resources. XLink provides complex extended linking, link behavior, and management capabilities. XLink is able to describe links that connect sets of resources, point to multiple targets, or serve multiple roles within an XML document.

XLL *n.* Acronym for **eXtensible Linking Language**. Broad term intended to denote the family of XML linking/pointing/addressing languages, which include XLink, XPointer, and XPath.

XMI *n.* **1.** Acronym for **XML Metadata Interchange Format**. An object-based model for exchanging program data across the Internet. XMI is sponsored by IBM, Unisys, and others and was submitted as a proposed standard to the Object Management Group (OMG); it is now one of OMG's recommended technologies. XMI is designed to allow for storing and sharing programming information and exchanging data among tools, applications, and storage locations through a network or the Internet so that software developers can collaborate on applications, even if they are not all using the same development tools. **2.** As **XMI bus**, a 64-bit parallel bus supported on certain DEC and Alpha-Server processors. An XMI bus is capable of transferring data, exclusive of addressing overhead, at 100 Mbps.

XML *n.* Acronym for **eXtensible Markup Language**, a condensed form of SGML (Standard Generalized Markup Language). XML lets Web developers and designers create customized tags that offer greater flexibility in organizing and presenting information than is possible with the older HTML document coding system. XML is defined as a language standard published by the W3C and supported by the industry. *See also* SGML.

XML attribute *n.* Information added to a tag to provide more information about the tag, such as `<ingredient quantity="2" units="cups">flour</ingredient>`.

XML element *n.* Information delimited by a start tag and an end tag in an eXtensible Markup Language (XML) document. An example would be `<Last-name>Davalio</Last-name>`.

XML entities *n.* Combinations of characters and symbols that replace other characters when an XML document is parsed, usually those that have other meanings in XML. For example, `<` represents the `<` symbol, which is also the opening bracket for a tag.

XML Metadata Interchange Format *n.* *See* XMI (definition 1).

XML-RPC *n.* Acronym for **eXtensible Markup Language-Remote Procedure Call**. A set of XML-based implementations that allows cross-platform and cross-programming language procedure calls over the Internet. XML-RPC



permits complex data structures to be transmitted, processed, and returned between different operating systems running in different environments.

XML Schema *n.* A specification providing a common base for data description and validation in XML environments. XML schema replaces Document Type Definition (DTD) by defining a greater set of data types with more explicit data descriptions. XML schema has been developed as an open, vendor-neutral format to enhance information exchange and e-commerce over the Internet. It is also a standard for the description and encoding of data.

XML Schema Description Language *n.* See XSDL.

XML stylesheet *n.* Contains formatting rules that are applied to an XML file referencing the stylesheet. The standard set of rules for XML stylesheets is the Extensible Stylesheet Language (XSL). See also XSL.

XML Web services *n.* Units of application logic providing data and services to other applications. Applications access XML Web services via standard Web protocols and data formats such as HTTP, XML, and SOAP, independent of how each XML Web service is implemented. XML Web services combine the best aspects of component-based development and the Web and are a cornerstone of the Microsoft .NET programming model.

Xmodem *n.* A file transfer protocol used in asynchronous communications that transfers information in blocks of 128 bytes.

Xmodem 1K *n.* A version of the Xmodem file transfer protocol designed for larger, longer-distance file transfers. Xmodem 1K transmits information in 1-kilobyte (1024-byte) blocks and uses a more reliable form of error checking. See also Xmodem.

Xmodem-CRC *n.* An enhanced version of the Xmodem file transfer protocol that incorporates a 2-byte cyclical redundancy check (CRC) to detect transmission errors. See also CRC.

XMS *n.* See extended memory specification.

XMT *n.* Short for **transmit**. A signal used in serial communications.

XNS *n.* Acronym for **Xerox Network System**. A set of protocols assigned to five numbered layers (0 through 4) that form a suite designed to handle packaging and delivery of network transmissions.

XON/XOFF *n.* An asynchronous communications protocol in which the receiving device or computer uses special characters to control the flow of data from the transmitting device or computer. When the receiving computer cannot continue to receive data, it transmits an XOFF control character that tells the sender to stop transmitting; when transmission can resume, the computer signals the sender with an XON character. Also called: software handshake. See also handshake.

XOR *n.* See exclusive OR.

XOR encryption *n.* Short for **Exclusive-OR encryption**. A simple encryption scheme using the “exclusive-or” concept, in which a decision is based on only one of two conditions being met. Using a provided key, XOR encryption performs an exclusive-or process on each byte of data to be encrypted. Because XOR encryption is not a strong security tool used alone, it is typically used as an additional level of security for Internet transmission of sensitive information.

XPath *n.* An XML language for addressing items in an XML document by specifying a path through the document structure. XPath is used by XPointer and XSLT to locate and identify XML document data. XPath is also considered a query language complement to XQuery. XPath is more supported than XQuery even though there is no approved standard yet for either. See also XPointer.

XPointer *n.* An XML language used to locate data within an XML document based on data property descriptions, such as attributes, location, and content. XPointer references the internal structure of a document, allowing links to be made to occurrences of a word, character set, content attribute, or other element, rather than to a specific point within the document. See also XPath.

XQuery *n.* Short for **eXtensible Query Language**. Designed to be a functional query language that is broadly applicable to a variety of XML data types derived from XQuery, XPath, and XQL. Both Ipedo and Software AG implement their own versions of the W3C’s proposed specification for the XQuery language. Also called: XML Query, XQL.

XSD *n.* Acronym for **eXtensible Schema Definition**. A prefix used by convention to indicate a W3C schema namespace.



XSDL *n.* Acronym for **XML Schema Description Language**. A World Wide Web Consortium (W3C) recommendation for representing XML structure. XSDL is capable of describing complex XML-based data structures, and provides options not available with Document Type Definitions (DTDs), including namespace support, XML datatypes, and improved extensibility and data type support.

X series *n.* A set of recommendations adopted by the International Telecommunication Union Telecommunication Standardization Sector (ITU-T), formerly the CCITT, and International Organization for Standardization (ISO) for standardizing equipment and protocols used in both public access and private computer networks. See the table.

Table X.1 Recommendations in X Series for Network Communications.

Recommendation Number	What It Covers
X.25	Interface required to connect a computer to a packet-switched network such as the Internet
X.75	Protocols for connecting two public data networks
X.200	Seven-layer set of protocols known as the ISO/OSI reference model for standardizing computer-to-computer connections
X.400	Format at the ISO/OSI application layer for e-mail messages over various network transports, including Ethernet, X.25, and TCP/IP. Gateways must be used to translate e-mail messages between the X.400 and Internet formats
X.445	Asynchronous Protocol Specification, which governs the transmission of X.400 messages over dial-up telephone lines
X.500	Protocols for client/server systems that maintain and access directories of users and resources in X.400 form
X.509	Digital certificates

XSL *n.* Acronym for **Extensible Stylesheet Language**. A World Wide Web Consortium (W3C) standard stylesheet

language for XML documents. XSL determines how data in an XML document is displayed on the Web. XSL controls what data will be displayed, in what format, and in what type size and style. XSL contains two major extensions: XSL Transformations (XSLT), a language used to convert XML documents to HTML or other document types, and XSL Formatting Objects (XSL-FO), a language for specifying formatting semantics. *See also* XSL-FO, XSLT.

XSL-FO *n.* Acronym for **Extensible Stylesheet Language Formatting Objects**. An XML-based markup language for specifying formatting semantics. XSL-FO allows format and style information to be applied to an XML document and can be used with XSLT to produce source documents. *See also* XSL.

XSLT *n.* Acronym for **Extensible Stylesheet Language Transformations**. A language used in transforming an existing XML document into a restructured XML document. Formalized as a W3C Recommendation in 1999, XSLT is primarily intended for use as part of XSL. XSL describes the styling of a document in terms of XSLT transformations into an XML document. *See also* XML, XSL.

X terminal *n.* An intelligent display device, connected to an Ethernet network, that performs operations on request from client applications in an X Window System. *See also* Ethernet (definition 1), X Window System.

XT keyboard *n.* *See* PC/XT keyboard.

XUL *n.* A standards-based interface description language that provides a standard way to exchange data describing a program's user interface. XUL balances simplicity, flexibility, and ease of use with precise layout control. XUL was developed by Netscape and Mozilla and is used with XML, CSS, DOM, and HTML.

X Windows *n.* *See* X Window System.

X Window System *n.* A nonproprietary standardized set of display-handling routines, developed at MIT. Most often encountered on UNIX workstations, the X Window System is independent of hardware and operating system. An X Window System client calls on the server, which is located on the user's workstation, to provide a window in which the client can generate a display of text or graphics. *Also called:* X Windows. *See also* X Consortium.



X-Y display *n.* See vector display.

x-y matrix *n.* An arrangement of rows and columns with a horizontal (*x*) axis and a vertical (*y*) axis.

x-y plotter *n.* See plotter.

x-y-z coordinate system *n.* A three-dimensional system of Cartesian coordinates that includes a third (*z*) axis running perpendicular to the horizontal (*x*) and vertical (*y*) axes. The *x-y-z* coordinate system is used in computer graphics for creating models with length, breadth, and depth. See the illustration. See also Cartesian coordinates.

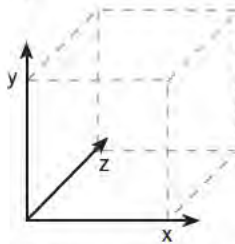

x-y-z coordinate system.

Y

Y2K *n.* See Year 2000 problem.

Y2K BIOS patch card *n.* An ISA board that ensures that system calls to the BIOS return the correct year. The BIOS patch card checks the date the BIOS gets from the real-time clock and sends the correct date to whichever application or process requested it. While a BIOS patch card proved effective for most situations once the year 2000 was reached, some applications and processes that work directly with the real-time clock (not an advisable practice) actually received the wrong date on non-Year-2000-compliant PCs.

Y2K BIOS test *n.* See BIOS test.

Y2K bug *n.* See Year 2000 problem.

Y2K-compliant *adj.* See Year 2000 compliant.

Y2K computer bug *n.* See Year 2000 problem.

Y2K ready *adj.* See Year 2000 compliant.

Yahoo! *n.* The first major online Web-based directory and search engine for Internet resources, which can be found at <http://www.yahoo.com>. See also search engine (definition 2).

Yahoo! Mail *n.* A popular Web-based e-mail service provided for free by Yahoo! Inc. Compare Hotmail.

Yahoo! Messenger *n.* A popular instant-messaging application provided for free by Yahoo! Inc. on a variety of operating systems. See also instant messaging. Compare AIM, ICQ, .NET Messenger Service.

Yanoff list *n.* The informal name of the Internet services list created and maintained by Scott Yanoff. The Yanoff list was one of the earliest directories of Internet services and resources. It is located at <http://www.spectracom.com/islist/>.

y-axis *n.* The vertical reference line on a grid, chart, or graph that has horizontal and vertical dimensions. See also Cartesian coordinates.

YB *n.* See yottabyte.

Year 2000 compliant *adj.* The criteria for this varied among companies and organizations; however, a general

theme was that software or hardware would make the transition from 1999 to 2000 without producing errors. For a PC, the general thinking was that if the real-time clock passed a Year 2000 BIOS test, it was Year 2000 compliant. However, testing the computing environment from end to end, considering the readiness of the operating systems, applications, custom code, data, and system interfaces, was also strongly recommended.

Year 2000 Information and Readiness Disclosure Act

n. A U.S. statute enacted in October 1998 that required U.S. companies to publicly disclose how they were attempting to make their systems or products ready for the year 2000. Many companies made this information available on the World Wide Web.

Year 2000 problem *n.* Prior to January 1, 2000, a potential software problem stemming from the use of two digits (99) rather than four (1999) as year indicators in computer programs. Such programs assumed that 19 preceded every year value, and so could potentially fail or produce incorrect calculations by interpreting the year 2000 (00) as an earlier date than 19xx when the year rolled over into a new century. The use of two-digit year indicators was prevalent in, though not limited to, older programs that had been written when a saving of two bytes (digits) per year value was significant in terms of computer memory. Because the use of two-digit year indicators was widespread, companies, governments, and other organizations took measures on a large scale to prevent the Year 2000 problem from affecting their computing systems. In the end, however, the problem—luckily—proved largely uneventful.

Year 2000 ready *adj.* See Year 2000 compliant.

Year 2000 rollover *n.* The moment when the year in a computer system changed from 1999 to 2000. Also called: date rollover, millennium transition, rollover, Year 2000 transition.

Year 2000 time problem *n.* See Year 2000 problem.

Year 2000 transition *n.* See Year 2000 rollover.

Yellow Pages *n.* **1.** The former name of a UNIX utility, provided by SunSoft (Sun Microsystems system software), that maintains a central database of names and locations of the resources on a network. The Yellow Pages enables processes on any node to locate resources by name. This utility is now known formally as NIS (Network Information Service). **2.** InterNIC Registration Services' database of domain names and their IP addresses. *See also* domain name, IP address. **3.** Any of several Internet business directory services. Some are print publications, some are strictly electronic, and some are both.

Yes/No data type *n.* A data type used to define database fields that will contain only one of two values, such as Yes or No and True or False. Null values are not allowed. *See also* boolean.

Yettie *n.* Short for **Y**oung, **E**ntrepreneurial **T**ech-based **T**wenty-something or **Y**oung, **E**ntrepreneurial **T**echnocrat. A person who works in a technology or Internet-related field and who embraces technological change and opportunity. Yettie is intended to be a successor to the older term "yuppie."

YHBT *n.* Acronym for **y**ou **h**ave **b**een **t**rolled. An expression used in e-mail and newsgroups to indicate that the receiver has taken a deliberately set bait. *See also* troll.

YHL *n.* Acronym for **y**ou **h**ave **l**ost. An expression used in e-mail and newsgroups, often following YHBT. *See also* YHBT.

Ymodem *n.* A variation of the Xmodem file transfer protocol that includes the following enhancements: the ability to transfer information in 1-kilobyte (1024-byte) blocks,

the ability to send multiple files (batch file transmission), cyclical redundancy checking (CRC), and the ability to abort transfer by transmitting two CAN (cancel) characters in a row. *See also* CRC, Xmodem.

yocto- prefix A metric prefix meaning 10^{-24} (one septillionth in the U.S. system).

yoke *n.* The part of a CRT (cathode-ray tube) that deflects the electron beam, causing it to strike a specific area on the screen. *Also called:* deflection coils. *See also* CRT.

yotta- prefix A metric prefix meaning 10^{24} (one septillion in the U.S. system).

yottabyte *n.* A unit of measure equal to 2^{80} bytes, or approximately 1 septillion (10^{24}) bytes. When calculated as a multiple of 1000 zettabytes (the next highest unit of measure), a yottabyte is 1,000,000,000,000,000,000,000 bytes; when calculated as 1024 zettabytes, a yottabyte is 1,208,925,819,614,629,174,706,176 bytes. The prefix *yotta-* is meant to sound like the Greek letter *iota*. *Abbreviation:* YB.

YY *n.* The form in which the year part of a date is stored in some, mostly older, computer systems. Before 2000, the possibility existed that computers that used a 2-digit date would incorrectly interpret the year 2000 (year 00) as the year 1900 and disrupt the computer's operation.

YYYY *n.* Symbolic of providing fully distinguished dates, including 4-digit years. Using 4-digit years was an important step in many Year 2000 remediation programs—especially those focused on data.

Z

.z *n.* The file extension identifying a UNIX file compressed using the gzip or compact utility. *See also* gzip.

.Z *n.* The file extension for UNIX files that have been compressed using the compress utility. *See also* compress¹.

Z39.50 standard *n.* A specification for a query language based on SQL (structured query language). It is used by WAIS, among other Internet services, to search for files through the use of keywords and is widely used for remote access to library catalogs. *See also* structured query language, WAIS.

Z80 *n.* An 8-bit microprocessor from Zilog, a company founded by former Intel engineers. The Z80 has a 16-bit address bus, yielding a 64-kilobyte addressable memory space, and an 8-bit data bus. A descendant of the Intel 8080, it was the favored processor in the days of the CP/M operating system. One of the most popular computers of the early 1980s, the Radio Shack TRS-80, was based on this chip. *See also* CP/M.

zap *vb.* **1.** To erase permanently. For example, to zap a file means to remove it without hope of retrieval. **2.** To damage a device, usually by discharging static electricity through it.

z-axis *n.* The third axis in a three-dimensional coordinate system, used in computer graphics to represent depth. *See also* Cartesian coordinates, x-y-z coordinate system.

ZB *n.* *See* zettabyte.

zepto- *prefix* A metric prefix meaning 10^{-21} (one sextillionth in the American system).

zero¹ *n.* The arithmetic symbol (0) representing no magnitude.

zero² *vb.* To fill or replace with zeros (for example, to zero a specified portion of memory, a field, or some other limited structure).

zero divide *n.* A division operation in which the divisor is zero. Division by zero is mathematically undefined, is not allowed in a program, and is considered a bug.

zero flag *n.* A flag (bit) in a microprocessor that is set (turned on), typically in a flag register, when the result of an operation is zero. *See also* flag (definition 1).

zero-insertion-force socket *n.* *See* ZIF socket.

zero-length string *n.* A string that contains no characters. You can use a zero-length string to indicate that you know there's no value for a field. You enter a zero-length string by typing two double quotation marks with no space between them ("").

zero out *vb.* To set a variable value or a series of bits to zero.

zero suppression *n.* The elimination of leading (nonsignificant) zeros in a number. For example, zero suppression would truncate 000123.456 to 123.456. *See also* significant digits.

zero wait state *n.* The condition of random access memory (RAM) that is fast enough to respond to the processor without requiring wait states. *See also* wait state.

zetta- *prefix* A metric prefix meaning 10^{21} (one sextillion in the American system).

zettabyte *n.* A unit of measure equal to 2^{70} bytes, or one sextillion (10^{21}) bytes. When calculated as a multiple of 1000 exabytes (the next highest unit of measure), a zettabyte is 1,000,000,000,000,000,000,000 bytes; when calculated as 1024 exabytes, a zettabyte is 1,180,591,620,717,411,303,424

bytes. The prefix (*zetta-*) is meant to sound like the Greek letter *zeta*. *Abbreviation:* ZB.

z-fold paper *n.* See fanfold paper.

ZIF socket *n.* Short for zero-insertion-force socket. A kind of socket for integrated circuits that can be opened with a lever or screw, allowing the chip to be placed in the socket without the application of pressure. The lever or screw of the socket is then closed, causing the socket contacts to grip the chip's pins. ZIF sockets facilitate frequent insertion and removal of chips, but they take up more space and are more expensive than conventional sockets.

zinc-air battery *n.* Non rechargeable battery that is relatively inexpensive, offers extended battery life, and contains none of the harsh chemicals or metals found in conventional nickel metal cadmium (NiCad), nickel metal hydride (NiMH), or lithium ion (Li-ion) batteries.

.zip *n.* A file extension that identifies a compressed archive file encoded in ZIP format, as by PKZIP. See also compressed file, PKZIP.

Zip drive *n.* A disk drive developed by Iomega that uses 3.5-inch removable disks (Zip disks) capable of storing 100 megabytes of data. See the illustration. See also disk drive.



Zip drive.

Zmodem *n.* An enhancement of the Xmodem file transfer protocol that handles larger data transfers with less error. Zmodem includes a feature called checkpoint restart, which resumes transmission at the point of interruption, rather than at the beginning, if the communications link is broken during data transfer. *See also* Xmodem.

zombie *n.* A computer that has become the unwilling host of a DDoS (distributed denial of services) attack program and that is controlled by remote signals from the attacker. To create a zombie, a hacker utilizes security vulnerabilities to crack a Web, mail, news, or application server and plant hidden DDoS tools such as Trinoo and Tribal Flood Network. Later, at a signal from the attacker, the server becomes a zombie that will participate in a coordinated attack on other servers. *See also* DDoS, hacker.

zone *n.* **1.** On a LAN (local area network), a subgroup of users within a larger group of interconnected networks. **2.** In Macintosh programming, a portion of memory that is allocated and reallocated by the memory manager facility as memory is requested and released by applications and by other parts of the operating system. *See also* heap (definition 1).

zone header *n.* On the Apple Macintosh, a header at the beginning of a block of memory that contains information needed by the memory management facility in order to use that memory block effectively. *See also* header (definition 2).

zone transfer *n.* The process whereby a secondary DNS server obtains information about a zone or domain from the primary server. *See also* zone (definition 1).

.zoo *n.* The file extension that identifies compressed archive files created with the zoo file compression utility. *See also* zoo210.

zoo210 *n.* Version 2.1 of zoo, a program for creating compressed archive files (whose names have the extension .zoo). The algorithm for zoo210 is based on that of LHARC. Implementations of zoo210 are available for UNIX and Intel systems. *See also* archive file, LHARC.

zoom *vb.* To enlarge a selected portion of a graphical image or document to fill a window or the screen. Zooming is a feature of many programs, including drawing,

word processing, and spreadsheet programs, that allows the user to select a small part of the screen, zoom it, and make changes to the enlarged portion at a finer level of detail. *See also* window.

zoom box *n.* A control in the upper right corner of the frame of a window on the Macintosh screen. When the user clicks on the zoom box, the window toggles between the maximum size and the size the user has set for it by dragging. *See also* window. *Compare* Maximize button.

zoomed video port *n.* *See* ZV port.

zoo virus *n.* A virus that is kept in an isolated environment for the benefit of anti-virus research and training. Zoo viruses are not found outside the labs of anti-virus companies.

Zope *n.* An open source application server for publishing objects on the Internet. Zope provides tools to integrate data and content from multiple sources into complete Web applications and can be used in conjunction with XML-RPC to form a system for remotely scriptable Web objects. Zope runs on UNIX, Windows NT and later, and most other major operating systems. *See also* XML-RPC.

z-order *n.* **1.** The order in which objects are drawn on top of one another onscreen to simulate depth (the third dimension) in conjunction with the x and y (height and width) coordinates. **2.** The visual layering of windows or controls on a form along the z-axis (depth). The z-order determines which controls are in front of other controls. Each window or control has a unique position in the z-order.

Zulu time *n.* Slang for Greenwich Mean Time.

ZV port *n.* Short for **zoomed video port**. Port available on many portable computers as an inexpensive multimedia alternative to traditional video input. The ZV port allows data to flow uninterrupted from source to destination without need for buffering. Zoomed video was adopted by the Personal Computer Memory Card International Association (PCMCIA) to enable high transfer rates for portable computers, connected video cameras, and other multimedia devices.

Appendix A

Common Character Sets

ANSI Character Set

<i>Character</i>	<i>Unicode Value (Hex)</i>	<i>ANSI code (decimal)</i>	<i>Description</i>
NUL	0000	0	Null
SOH	0001	1	Start of heading
STX	0002	2	Start of text
ETX	0003	3	End of text
EOT	0004	4	End of transmission
ENQ	0005	5	Enquiry
ACK	0006	6	Acknowledge
BEL	0007	7	Bell
BS	0008	8	Backspace
HT	0009	9	Horizontal tabulation
LF	000A	10	Line feed
VT	000B	11	Vertical tabulation
FF	000C	12	Form feed
CR	000D	13	Carriage return
SO	000E	14	Shift out
SI	000F	15	Shift in
DLE	0010	16	Data link escape
DC1	0011	17	Device control 1
DC2	0012	18	Device control 2
DC3	0013	19	Device control 3
DC4	0014	20	Device control 4
NAK	0015	21	Negative acknowledge
SYN	0016	22	Synchronous idle
ETB	0017	23	End of transmission block
CAN	0018	24	Cancel
EM	0019	25	End of medium
SUB	001A	26	Substitute
ESC	001B	27	Escape
FS	001C	28	File separator
GS	001D	29	Group separator
RS	001E	30	Record separator
US	001F	31	Unit separator
SP	0020	32	Space
!	0021	33	Exclamation point
"	0022	34	Quotation mark

ANSI Character Set *continued*

<i>Character</i>	<i>Unicode Value (Hex)</i>	<i>ANSI code (decimal)</i>	<i>Description</i>
#	0023	35	Number sign
\$	0024	36	Dollar sign
%	0025	37	Percent
&	0026	38	Ampersand
'	0027	39	Apostrophe
(0028	40	Left parenthesis
)	0029	41	Right parenthesis
*	002A	42	Asterisk
+	002B	43	Plus sign
,	002C	44	Comma
-	002D	45	Hyphen
.	002E	46	Full stop
/	002F	47	Solidus
0	0030	48	Digit zero
1	0031	49	Digit one
2	0032	50	Digit two
3	0033	51	Digit three
4	0034	52	Digit four
5	0035	53	Digit five
6	0036	54	Digit six
7	0037	55	Digit seven
8	0038	56	Digit eight
9	0039	57	Digit nine
:	003A	58	Colon
;	003B	59	Semicolon
<	003C	60	Less-than sign
=	003D	61	Equals sign
>	003E	62	Greater-than sign
?	003F	63	Question mark
@	0040	64	Commercial at
A	0041	65	Latin capital letter A
B	0042	66	Latin capital letter B
C	0043	67	Latin capital letter C
D	0044	68	Latin capital letter D
E	0045	69	Latin capital letter E
F	0046	70	Latin capital letter F
G	0047	71	Latin capital letter G
H	0048	72	Latin capital letter H
I	0049	73	Latin capital letter I
J	004A	74	Latin capital letter J
K	004B	75	Latin capital letter K
L	004C	76	Latin capital letter L
M	004D	77	Latin capital letter M
N	004E	78	Latin capital letter N
O	004F	79	Latin capital letter O

ANSI Character Set *continued*

<i>Character</i>	<i>Unicode Value (Hex)</i>	<i>ANSI code (decimal)</i>	<i>Description</i>
P	0050	80	Latin capital letter P
Q	0051	81	Latin capital letter Q
R	0052	82	Latin capital letter R
S	0053	83	Latin capital letter S
T	0054	84	Latin capital letter T
U	0055	85	Latin capital letter U
V	0056	86	Latin capital letter V
W	0057	87	Latin capital letter W
X	0058	88	Latin capital letter X
Y	0059	89	Latin capital letter Y
Z	005A	90	Latin capital letter Z
[005B	91	Left square bracket
\	005C	92	Reverse solidus
]	005D	93	Right square bracket
^	005E	94	Circumflex accent
_	005F	95	Low line
`	0060	96	Grave accent
a	0061	97	Latin small letter a
b	0062	98	Latin small letter b
c	0063	99	Latin small letter c
d	0064	100	Latin small letter d
e	0065	101	Latin small letter e
f	0066	102	Latin small letter f
g	0067	103	Latin small letter g
h	0068	104	Latin small letter h
i	0069	105	Latin small letter i
j	006A	106	Latin small letter j
k	006B	107	Latin small letter k
l	006C	108	Latin small letter l
m	006D	109	Latin small letter m
n	006E	110	Latin small letter n
o	006F	111	Latin small letter o
p	0070	112	Latin small letter p
q	0071	113	Latin small letter q
r	0072	114	Latin small letter r
s	0073	115	Latin small letter s
t	0074	116	Latin small letter t
u	0075	117	Latin small letter u
v	0076	118	Latin small letter v
w	0077	119	Latin small letter w
x	0078	120	Latin small letter x
y	0079	121	Latin small letter y
z	007A	122	Latin small letter z
{	007B	123	Left curly bracket
	007C	124	Vertical line

ANSI Character Set *continued*

<i>Character</i>	<i>Unicode Value (Hex)</i>	<i>ANSI code (decimal)</i>	<i>Description</i>
}	007D	125	Right curly bracket
~	007E	126	Tilde
DEL	007F	127	Delete
	0080	128	Reserved
	0081	129	Reserved
	0082	130	Reserved
	0083	131	Reserved
IND	0084	132	Index
NEL	0085	133	Next line
SSA	0086	134	Start of selected area
ESA	0087	135	End of selected area
	0088	136	Character tabulation set
	0089	137	Character tabulation with justification
	008A	138	Line tabulation set
PLD	008B	139	Partial line down
PLU	008C	140	Partial line up
	008D	141	Reverse line feed
SS2	008E	142	Single shift two
SS3	008F	143	Single shift three
DCS	0090	144	Device control string
PU1	0091	145	Private use one
PU2	0092	146	Private use two
STS	0093	147	Set transmit state
CCH	0094	148	Cancel character
MW	0095	149	Message waiting
	0096	150	Start of guarded area
	0097	151	End of guarded area
	0098	152	Start of string
	0099	153	Reserved
	009A	154	Single character introducer
CSI	009B	155	Control sequence introducer
ST	009C	156	String terminator
OSC	009D	157	Operating system command
PM	009E	158	Privacy message
APC	009F	158	Application program command
	00A0	160	No-break space
¡	00A1	161	Inverted exclamation mark
¢	00A2	162	Cent sign
£	00A3	163	Pound sign
¤	00A4	164	Currency sign
¥	00A5	165	Yen sign
¦	00A6	166	Broken bar
§	00A7	167	Section sign
¨	00A8	168	Diaeresis

ANSI Character Set *continued*

<i>Character</i>	<i>Unicode Value (Hex)</i>	<i>ANSI code (decimal)</i>	<i>Description</i>
©	00A9	169	Copyright sign
ª	00AA	170	Feminine ordinal indicator
«	00AB	171	Left-pointing double angle quotation mark
¬	00AC	172	Not sign
-	00AD	173	Soft hyphen
®	00AE	174	Registered sign
-	00AF	175	Macron
°	00B0	176	Degree sign
±	00B1	177	Plus-minus sign
²	00B2	178	Superscript two
³	00B3	179	Superscript three
´	00B4	180	Acute accent
µ	00B5	181	Micro sign
¶	00B6	182	Pilcrow sign
·	00B7	183	Middle dot
¸	00B8	184	Cedilla
¹	00B9	185	Superscript one
º	00BA	186	Masculine ordinal indicator
»	00BB	187	Right-pointing double angle quotation mark
¼	00BC	188	Vulgar fraction one quarter
½	00BD	189	Vulgar fraction one half
¾	00BE	190	Vulgar fraction three quarters
¿	00BF	191	Inverted question mark
À	00C0	192	Latin capital letter A with grave
Á	00C1	193	Latin capital letter A with acute
Â	00C2	194	Latin capital letter A with circumflex
Ã	00C3	195	Latin capital letter A with tilde
Ä	00C4	196	Latin capital letter A with diaeresis
Å	00C5	197	Latin capital letter A with ring above
Æ	00C6	198	Latin capital ligature AE
Ç	00C7	199	Latin capital letter C with cedilla
È	00C8	200	Latin capital letter E with grave
É	00C9	201	Latin capital letter E with acute
Ê	00CA	202	Latin capital letter E with circumflex
Ë	00CB	203	Latin capital letter E with diaeresis
Ì	00CC	204	Latin capital letter I with grave
Í	00CD	205	Latin capital letter I with acute
Î	00CE	206	Latin capital letter I with circumflex
Ï	00CF	207	Latin capital letter I with diaeresis
Ð	00D0	208	Latin capital letter ETH
Ñ	00D1	209	Latin capital letter N with tilde
Ò	00D2	210	Latin capital letter O with grave
Ó	00D3	211	Latin capital letter O with acute
Ô	00D4	212	Latin capital letter O with circumflex

ANSI Character Set *continued*

<i>Character</i>	<i>Unicode Value (Hex)</i>	<i>ANSI code (decimal)</i>	<i>Description</i>
Ō	00D5	213	Latin capital letter O with tilde
Ö	00D6	214	Latin capital letter O with diaeresis
×	00D7	215	Multiplication sign
Ø	00D8	216	Latin capital letter O with stroke
Û	00D9	217	Latin capital letter U with grave
Ú	00DA	218	Latin capital letter U with acute
Û	00DB	219	Latin capital letter U with circumflex
Ü	00DC	220	Latin capital letter U with diaeresis
Ý	00DD	221	Latin capital letter Y with acute
Þ	00DE	222	Latin capital letter thorn
ß	00DF	223	Latin small letter sharp s
à	00E0	224	Latin small letter a with grave
á	00E1	225	Latin small letter a with acute
â	00E2	226	Latin small letter a with circumflex
ã	00E3	227	Latin small letter a with tilde
ä	00E4	228	Latin small letter a with diaeresis
å	00E5	229	Latin small letter a with ring above
æ	00E6	230	Latin small ligature ae
ç	00E7	231	Latin small letter c with cedilla
è	00E8	232	Latin small letter e with grave
é	00E9	233	Latin small letter e with acute
ê	00EA	234	Latin small letter e with circumflex
ë	00EB	235	Latin small letter e with diaeresis
ì	00EC	236	Latin small letter i with grave
í	00ED	237	Latin small letter i with acute
î	00EE	238	Latin small letter i with circumflex
ï	00EF	239	Latin small letter i with diaeresis
ð	00F0	240	Latin small letter eth
ñ	00F1	241	Latin small letter n with tilde
ò	00F2	242	Latin small letter o with grave
ó	00F3	243	Latin small letter o with acute
ô	00F4	244	Latin small letter o with circumflex
õ	00F5	245	Latin small letter o with tilde
ö	00F6	246	Latin small letter o with diaeresis
÷	00F7	247	Division sign
ø	00F8	248	Latin small letter o with stroke
ù	00F9	249	Latin small letter u with grave
ú	00FA	250	Latin small letter u with acute
û	00FB	251	Latin small letter u with circumflex
ü	00FC	252	Latin small letter u with diaeresis
ý	00FD	253	Latin small letter y with acute
þ	00FE	254	Latin small letter thorn
ÿ	00FF	255	Latin small letter y with diaeresis

Apple Macintosh Extended Character Set

<i>ASCII</i>	<i>Hex</i>	<i>Times</i>	<i>New York</i>	<i>Courier</i>	<i>Zapf Dingbats</i>	<i>Symbol</i>
128	80	Ä	Ä	Ä	(
129	81	Å	Å	Å)	
130	82	Ç	Ç	Ç	(
131	83	É	É	É)	
132	84	Ñ	Ñ	Ñ	(
133	85	Ö	Ö	Ö)	
134	86	Ü	Ü	Ü	<	
135	87	á	á	á	>	
136	88	à	à	à	(
137	89	â	â	â)	
138	8A	ä	ä	ä	(
139	8B	ã	ã	ã)	
140	8C	â	â	â	(
141	8D	ç	ç	ç)	
142	8E	é	é	é		
143	8F	è	è	è		
144	90	ê	ê	ê		
145	91	ë	ë	ë		
146	92	í	í	í		
147	93	ì	ì	ì		
148	94	î	î	î		
149	95	ï	ï	ï		
150	96	ñ	ñ	ñ		
151	97	ó	ó	ó		
152	98	ò	ò	ò		
153	99	ô	ô	ô		
154	9A	ö	ö	ö		
155	9B	õ	õ	õ		
156	9C	ú	ú	ú		
157	9D	ù	ù	ù		
158	9E	û	û	û		
159	9F	ü	ü	ü		
160	A0	†	†	†		

Apple Macintosh Extended Character Set *continued*

<i>ASCII</i>	<i>Hex</i>	<i>Times</i>	<i>New York</i>	<i>Courier</i>	<i>Zapf Dingbats</i>	<i>Symbol</i>
161	A1	°	°	°	♠	Y
162	A2	¢	¢	¢	♠	'
163	A3	£	£	£	♠	≤
164	A4	§	§	§	♥	/
165	A5	•	•	•	♠	∞
166	A6	¶	¶	¶	♠	f
167	A7	ß	ß	ß	♠	♣
168	A8	®	®	®	♣	♦
169	A9	©	©	©	♦	♥
170	AA	™	™	™	♥	♠
171	AB	ˆ	ˆ	ˆ	♠	↔
172	AC	˙	˙	˙	①	←
173	AD	≠	≠	≠	②	↑
174	AE	Æ	Æ	Æ	③	→
175	AF	∅	∅	∅	④	↓
176	B0	∞	∞	∞	⑤	◊
177	B1	±	±	±	⑥	†
178	B2	≤	≤	≤	⑦	"
179	B3	≥	≥	≥	⑧	∞
180	B4	¥	¥	¥	⑨	x
181	B5	μ	μ	μ	⑩	α
182	B6	∂	∂	∂	⑪	∂
183	B7	Σ	Σ	Σ	⑫	•
184	B8	Π	Π	Π	⑬	+
185	B9	π	π	π	⑭	≠
186	BA	∫	∫	∫	⑮	≡
187	BB	ä	ä	ä	⑯	≠
188	BC	ø	ø	ø	⑰	::
189	BD	Ω	Ω	Ω	⑱	
190	BE	æ	æ	æ	⑲	
191	BF	∅	∅	∅	⑳	↙
192	C0	ˆ	ˆ	ˆ	㉑	↘
193	C1	˙	˙	˙	㉒	↘

Apple Macintosh Extended Character Set *continued*

<i>ASCII</i>	<i>Hex</i>	<i>Times</i>	<i>New York</i>	<i>Courier</i>	<i>Zapf Dingbats</i>	<i>Symbol</i>
194	C2	¬	¬	¬	③	℘
195	C3	√	√	√	④	∅
196	C4	f	f	f	⑤	⊗
197	C5	≈	≈	≈	⑥	⊕
198	C6	Δ	Δ	Δ	⑦	∅
199	C7	«	«	«	⑧	∩
200	C8	»	»	»	⑨	∪
201	C9	⑩	∩
202	CA	——NBSP (nonbreaking space)——			①	∩
203	CB	À	À	À	②	♀
204	CC	Ã	Ã	Ã	③	∩
205	CD	Ö	Ö	Ö	④	∩
206	CE	Œ	Œ	Œ	⑤	€
207	CF	œ	œ	œ	⑥	€
208	D0	-	-	-	⑦	∠
209	D1	—	—	—	⑧	∇
210	D2	“	“	“	⑨	®
211	D3	”	”	”	⑩	©
212	D4	‘	‘	‘	➔	™
213	D5	’	’	’	➔	∏
214	D6	÷	÷	÷	↔	√
215	D7	◊	◊	◊	↕	·
216	D8	ÿ	ÿ	ÿ	➔	¬
217	D9	Ÿ	Ÿ	Ÿ	➔	^
218	DA	/	/	/	➔	v
219	DB	α	α	α	➔	↔
220	DC	<	<	<	➔	⇐
221	DD	>	>	>	➔	⇑
222	DE	fi	fi	fi	➔	⇒
223	DF	fl	fl	fl	➔	⇓
224	E0	‡	‡	‡	➔	◊
225	E1	·	·	·	➔	<
226	E2	,	,	,	➔	®

Apple Macintosh Extended Character Set *continued*

<i>ASCII</i>	<i>Hex</i>	<i>Times</i>	<i>New York</i>	<i>Courier</i>	<i>Zapf Dingbats</i>	<i>Symbol</i>
227	E3	”	”	”	➤	©
228	E4	‰	‰	‰	➤	™
229	E5	Â	Â	Â	➤	Σ
230	E6	Ê	Ê	Ê	➤	/
231	E7	Á	Á	Á	➤	
232	E8	Ë	Ë	Ë	➤	
233	E9	È	È	È	➤	
234	EA	Í	Í	Í	➤	
235	EB	Î	Î	Î	➤	
236	EC	Ï	Ï	Ï	➤	
237	ED	Ì	Ì	Ì	➤	
238	EE	Ó	Ó	Ó	➤	
239	EF	Ô	Ô	Ô	➤	
240	F0			Not Used		
241	F1	Ò	Ò	Ò	➤	}
242	F2	Ú	Ú	Ú	➤	
243	F3	Û	Û	Û	➤	
244	F4	Ù	Ù	Ù	➤	
245	F5	ı	ı	ı	➤	
246	F6	ˆ	ˆ	ˆ	➤	
247	F7	˜	˜	˜	➤	
248	F8	-	-	-	➤	
249	F9	˘	˘	˘	➤	
250	FA	·	·	·	➤	
251	FB	°	°	°	➤	
252	FC	˙	˙	˙	➤	
253	FD	˚	˚	˚	➤	
254	FE	¸	¸	¸	➤	
255	FF	˘	˘	˘	➤	

IBM Extended Character Set

<i>Dec</i>	<i>Hex</i>	<i>Char</i>	<i>Dec</i>	<i>Hex</i>	<i>Char</i>	<i>Dec</i>	<i>Hex</i>	<i>Char</i>	<i>Dec</i>	<i>Hex</i>	<i>Char</i>
128	80	Ç	156	9C	£	184	B8	ƒ	212	D4	ℓ
129	81	ü	157	9D	¥	185	B9	‡	213	D5	ƒ
130	82	é	158	9E	ƒ	186	BA	‡	214	D6	π
131	83	â	159	9F	f	187	BB	‡	215	D7	‡
132	84	ä	160	A0	á	188	BC	‡	216	D8	‡
133	85	à	161	A1	í	189	BD	‡	217	D9	‡
134	86	â	162	A2	ó	190	BE	‡	218	DA	Γ
135	87	ç	163	A3	ú	191	BF	‡	219	DB	■
136	88	ê	164	A4	ñ	192	C0	‡	220	DC	■
137	89	ë	165	A5	Ñ	193	C1	‡	221	DD	■
138	8A	è	166	A6	a	194	C2	‡	222	DE	■
139	8B	ï	167	A7	e	195	C3	‡	223	DF	■
140	8C	î	168	A8	ç	196	C4	—	224	E0	α
141	8D	ì	169	A9	ƒ	197	C5	‡	225	E1	β
142	8E	Ä	170	AA	ƒ	198	C6	‡	226	E2	Γ
143	8F	Å	171	AB	½	199	C7	‡	227	E3	π
144	90	É	172	AC	¼	200	C8	‡	228	E4	Σ
145	91	æ	173	AD	i	201	C9	‡	229	E5	σ
146	92	Æ	174	AE	<<	202	CA	‡	230	E6	μ
147	93	ô	175	AF	>>	203	CB	‡	231	E7	τ
148	94	ö	176	B0	☼	204	CC	‡	232	E8	Φ
149	95	ò	177	B1	☼	205	CD	=	233	E9	Θ
150	96	û	178	B2	■	206	CE	‡	234	EA	Ω
151	97	ù	179	B3		207	CF	‡	235	EB	δ
152	98	ÿ	180	B4	‡	208	D0	‡	236	EC	∞
153	99	Ö	181	B5	‡	209	D1	‡	237	ED	φ
154	9A	Û	182	B6	‡	210	D2	‡	238	EE	ε
155	9B	ç	183	B7	‡	211	D3	‡	239	EF	∩

IBM Extended Character Set *continued*

<i>Dec</i>	<i>Hex</i>	<i>Char</i>	<i>Dec</i>	<i>Hex</i>	<i>Char</i>	<i>Dec</i>	<i>Hex</i>	<i>Char</i>	<i>Dec</i>	<i>Hex</i>	<i>Char</i>
240	F0	≡	244	F4	ƒ	248	F8	○	252	FC	η
241	F1	±	245	F5	♪	249	F9	●	253	FD	₂
242	F2	≥	246	F6	÷	250	FA	•	254	FE	•
243	F3	≤	247	F7	≈	251	FB	√	255	FF	

EBCDIC Character Set

<i>Dec</i>	<i>Hex</i>	<i>Name</i>	<i>Character</i>	<i>Meaning</i>
0	00	NUL		Null
1	01	SOH		Start of heading
2	02	STX		Start of text
3	03	ETX		End of text
4	04	SEL		Select
5	05	HT		Horizontal tab
6	06	RNL		Required new line
7	07	DEL		Delete
8	08	GE		Graphic escape
9	09	SPS		Superscript
10	0A	RPT		Repeat
11	0B	VT		Vertical tab
12	0C	FF		Form feed
13	0D	CR		Carriage return
14	0E	SO		Shift out
15	0F	SI		Shift in
16	10	DLE		Data length escape
17	11	DC1		Device control 1
18	12	DC2		Device control 2
19	13	DC3		Device control 3
20	14	RES/ENP		Restore/enable presentation
21	15	NL		New line
22	16	BS		Backspace
23	17	POC		Program-operator communication
24	18	CAN		Cancel
25	19	EM		End of medium
26	1A	UBS		Unit backspace
27	1B	CU1		Customer use 1
28	1C	IFS		Interchange file separator
29	1D	IGS		Interchange group separator
30	1E	IRS		Interchange record separator
31	1F	IUS/ITB		Interchange unit separator/intermediate transmission block
32	20	DS		Digit select
33	21	SOS		Start of significance
34	22	FS		Field separator
35	23	WUS		Word underscore
36	24	BYP/INP		Bypass/inhibit presentation
37	25	LF		Line feed
38	26	ETB		End of transmission block
39	27	ESC		Escape
40	28	SA		Set attribute
41	29	SFE		Start field extended

EBCDIC Character Set *continued*

<i>Dec</i>	<i>Hex</i>	<i>Name</i>	<i>Character</i>	<i>Meaning</i>
42	2A	SM/SW		Set mode/switch
43	2B	CSP		Control sequence prefix
44	2C	MFA		Modify field attribute
45	2D	ENQ		Enquiry
46	2E	ACK		Acknowledge
47	2F	BEL		Bell
48	30			(not assigned)
49	31			(not assigned)
50	32	SYN		Synchronous idle
51	33	IR		Index return
52	34	PP		Presentation position
53	35	TRN		Transparent
54	36	NBS		Numeric backspace
55	37	EOT		End of transmission
56	38	SBS		Subscript
57	39	IT		Indent tab
58	3A	RFF		Required form feed
59	3B	CU3		Customer use 3
60	3C	DC4		Device control 4
61	3D	NAK		Negative acknowledge
62	3E			(not assigned)
63	3F	SUB		Substitute
64	40	SP		Space
65	41	RSP		Required space
66	42			(not assigned)
67	43			(not assigned)
68	44			(not assigned)
69	45			(not assigned)
70	46			(not assigned)
71	47			(not assigned)
72	48			(not assigned)
73	49			(not assigned)
74	4A		¢	
75	4B		.	
76	4C		<	
77	4D		(
78	4E		+	
79	4F			Logical OR
80	50		&	
81	51			(not assigned)
82	52			(not assigned)
83	53			(not assigned)
84	54			(not assigned)
85	55			(not assigned)
86	56			(not assigned)

EBCDIC Character Set *continued*

<i>Dec</i>	<i>Hex</i>	<i>Name</i>	<i>Character</i>	<i>Meaning</i>
87	57			(not assigned)
88	58			(not assigned)
89	59			(not assigned)
90	5A		!	
91	5B		\$	
92	5C		*	
93	5D)	
94	5E		:	
95	5F		¬	Logical NOT
96	60		–	
97	61		/	
98	62			(not assigned)
99	63			(not assigned)
100	64			(not assigned)
101	65			(not assigned)
102	66			(not assigned)
103	67			(not assigned)
104	68			(not assigned)
105	69			(not assigned)
106	6A		⋮	Broken pipe
107	6B		,	
108	6C		%	
109	6D		–	
110	6E		>	
111	6F		?	
112	70			(not assigned)
113	71			(not assigned)
114	72			(not assigned)
115	73			(not assigned)
116	74			(not assigned)
117	75			(not assigned)
118	76			(not assigned)
119	77			(not assigned)
120	78			(not assigned)
121	79		`	Grave accent
122	7A		:	
123	7B		#	
124	7C		@	
125	7D		'	
126	7E		=	
127	7F		"	
128	80			(not assigned)
129	81		a	
130	82		b	
131	83		c	

EBCDIC Character Set *continued*

<i>Dec</i>	<i>Hex</i>	<i>Name</i>	<i>Character</i>	<i>Meaning</i>
132	84		d	
133	85		e	
134	86		f	
135	87		g	
136	88		h	
137	89		i	
138	8A			(not assigned)
139	8B			(not assigned)
140	8C			(not assigned)
141	8D			(not assigned)
142	8E			(not assigned)
143	8F			(not assigned)
144	90			(not assigned)
145	91		j	
146	92		k	
147	93		l	
148	94		m	
149	95		n	
150	96		o	
151	97		p	
152	98		q	
153	99		r	
154	9A			(not assigned)
155	9B			(not assigned)
156	9C			(not assigned)
157	9D			(not assigned)
158	9E			(not assigned)
159	9F			(not assigned)
160	A0			(not assigned)
161	A1		~	
162	A2		s	
163	A3		t	
164	A4		u	
165	A5		v	
166	A6		w	
167	A7		x	
168	A8		y	
169	A9		z	
170	AA			(not assigned)
171	AB			(not assigned)
172	AC			(not assigned)
173	AD			(not assigned)
174	AE			(not assigned)
175	AF			(not assigned)

EBCDIC Character Set *continued*

<i>Dec</i>	<i>Hex</i>	<i>Name</i>	<i>Character</i>	<i>Meaning</i>
176	B0			(not assigned)
177	B1			(not assigned)
178	B2			(not assigned)
179	B3			(not assigned)
180	B4			(not assigned)
181	B5			(not assigned)
182	B6			(not assigned)
183	B7			(not assigned)
184	B8			(not assigned)
185	B9			(not assigned)
186	BA			(not assigned)
187	BB			(not assigned)
188	BC			(not assigned)
189	BD			(not assigned)
190	BE			(not assigned)
191	BF			(not assigned)
192	C0		{	Opening brace
193	C1		A	
194	C2		B	
195	C3		C	
196	C4		D	
197	C5		E	
198	C6		F	
199	C7		G	
200	C8		H	
201	C9		I	
202	CA	SHY		Syllable hyphen
203	CB			(not assigned)
204	CC			(not assigned)
205	CD			(not assigned)
206	CE			(not assigned)
207	CF			(not assigned)
208	D0		}	Closing brace
209	D1		J	
210	D2		K	
211	D3		L	
212	D4		M	
213	D5		N	
214	D6		O	
215	D7		P	
216	D8		Q	
217	D9		R	
218	DA			(not assigned)
219	DB			(not assigned)

EBCDIC Character Set *continued*

<i>Dec</i>	<i>Hex</i>	<i>Name</i>	<i>Character</i>	<i>Meaning</i>
220	DC			(not assigned)
221	DD			(not assigned)
222	DE			(not assigned)
223	DF			(not assigned)
224	E0		\	Reverse slash
225	E1	NSP		Numeric space
226	E2		S	
227	E3		T	
228	E4		U	
229	E5		V	
230	E6		W	
231	E7		X	
232	E8		Y	
233	E9		Z	
234	EA			(not assigned)
235	EB			(not assigned)
236	EC			(not assigned)
237	ED			(not assigned)
238	EE			(not assigned)
239	EF			(not assigned)
240	F0		0	
241	F1		1	
242	F2		2	
243	F3		3	
244	F4		4	
245	F5		5	
246	F6		6	
247	F7		7	
248	F8		8	
249	F9		9	
250	FA			(not assigned)
251	FB			(not assigned)
252	FC			(not assigned)
253	FD			(not assigned)
254	FE			(not assigned)
255	FF	EO		Eight ones

Appendix B

Common File Extensions

<i>File Extension</i>	<i>Type of File</i>
.0	File containing information on hard disk compressed with DoubleSpace.
.123	Spreadsheet file in Lotus 123.
.4th	Source file in Forth.
.a	Source file in Macintosh Assembly.
.ad	Screensaver file in After Dark.
.ada	Source file in Ada.
.ai	Vector graphic file in Adobe Illustrator.
.aif	<i>See .aiff.</i>
.aifc	<i>See .aiff.</i>
.aiff	Audio file in the Apple Audio Interchange Format originally used on Apple and Silicon Graphics (SGI) computers.
.ani	<ol style="list-style-type: none">1. Animated cursor file in Microsoft Windows 9x and Windows NT.2. Animation file.
.aol	File related to America Online.
.aps	Source file in Microsoft Visual C++.
.arc	Archive file compressed with ARC.
.arj	Archive file compressed with ARJ.
.asc	<ol style="list-style-type: none">1. ASCII text file.2. File encrypted with PGP (Pretty Good Privacy).
.asf	File in Microsoft Advanced Streaming Format.
.asm	Source file in Assembler.
.asp	File in Active Server Page format, generally found on the World Wide Web.
.atm	File in Adobe Type Manager.
.au	Sound file, generally on UNIX systems or the World Wide Web.
.avi	Audio visual interleaved data file in the Microsoft RIFF format.
.bac	<i>See .bak.</i>
.bak	Backup file.
.bas	Source file in Basic.
.bat	Batch program file.
.bfc	Briefcase file in Microsoft Windows 9x.
.bin	<ol style="list-style-type: none">1. Archive file compressed with MacBinary.2. Binary file.
.bk	<i>See .bak.</i>

Common File Extensions *continued*

<i>File Extension</i>	<i>Type of File</i>
.bmk	Bookmarked file.
.bmp	Raster graphics file stored in bitmap format.
.box	Mailbox file in Lotus Notes.
.c	Source file in C.
.c++	Source file in C++.
.cab	Microsoft cabinet file—multiple files compressed into one and extractable with the extract.exe utility.
.cas	Comma-delimited ASCII text file.
.cb	Clean boot file in Microsoft Windows.
.cbl	Source file in Cobol.
.cca	E-mail message in Lotus cc:mail.
.cda	CD audio track.
.cdf	<ol style="list-style-type: none"> 1. File in Microsoft Channel Definition Format. 2. File in Common Data Format.
.cdi	File in Phillips Compact Disk Interactive format.
.cdr	Vector graphics file in CorelDraw.
.cgi	File containing Common Gateway Interface scripts, generally for use on the World Wide Web.
.cgm	Vector graphics file in Computer Graphics Metafile format.
.chk	Portions of unidentifiable files saved in Windows by the Disk Defragmentor or ScanDisk utilities.
.chm	File containing compiled HTML.
.cil	Microsoft Clip Gallery download package.
.class	Class file in Java.
.clp	Temporary file created by Microsoft Windows Clipboard utility.
.cmd	Command file in Windows NT, OS/2, MS-DOS, and CP/M.
.cmf	File in Corel Metafile.
.cob	Source file in Cobol.
.com	Command file or program.
.cpl	Control Panel file in Microsoft Windows 9x.
.cpp	Source file in C++.
.crt	Certificate file.
.css	Cascading Style Sheet file, generally used in conjunction with Web sites.
.csv	Comma-delimited text file.
.ct	Graphics file in Paint Shop Pro.
.cur	Cursor file in Windows.
.cxx	Source file in C++.
.dat	Data file.
.dbf	Database in dBASE and FoxPro.
.dcr	Multimedia file in Macromedia Shockwave.
.dib	Graphics file in Device Independent Bitmap format.
.dif	File in Data Interchange Format.
.dll	Dynamic-link library file.

Common File Extensions *continued*

<i>File Extension</i>	<i>Type of File</i>
.doc	<ol style="list-style-type: none"> 1. Document file in Microsoft Word. 2. In the past, document file in Adobe FrameMaker or WordStar. 3. Document file formatted for a word processor.
.dos	MS-DOS–related files in Microsoft Windows 9x.
.dot	Document template in Microsoft Word.
.drv	Device driver.
.dtd	Document Type Definition file in SGML or XML.
.dtp	Document file in Microsoft Publisher or PublishIt!
.dv	Video file.
.dvi	Document file in TEX Device Independent File format.
.emf	File in Enhanced Windows Metafile format.
.eml	Mail message in Microsoft Outlook Express.
.eps	Encapsulated PostScript file.
.exe	Executable program or file.
.F	Source file in Fortran.
.F77	Source file in Fortran 77.
.F90	Source file in Fortran 90.
.fax	Fax file in many Fax programs.
.fdf	File in Adobe Acrobat Forms.
.fla	Movie file in Macromedia Flash.
.fli	Animation file in AutoDesk FLIC file.
.flf	Device driver in OS/2.
.fm	Document file in Adobe FrameMaker.
.fon	System font file in Windows.
.for	Source file in Fortran.
.fp	File in FileMaker Pro.
.fpt	<i>See .fp.</i>
.frm	Document file in Adobe FrameMaker.
.gid	Index file in Windows 9x.
.gif	Raster image file in GIF format.
.giff	<i>See .gif.</i>
.gtar	UNIX archive file compressed in GNU tar utility.
.gz	UNIX archive file compressed by gzip.
.gzip	<i>See .gz.</i>
.h	Header file.
.hdf	File in Hierarchical Data Format.
.hex	File encoded with Macintosh BinHex utility.
.hlp	Help file in Microsoft Windows.
.hqx	File encoded with BinHex utility.
.htm	<i>See .html.</i>
.html	HTML file, most commonly used as a Web page.

Common File Extensions *continued*

<i>File Extension</i>	<i>Type of File</i>
.ico	Icon file in Microsoft Windows 9x.
.iff	<ol style="list-style-type: none"> 1. Image or sound file in IFF format. 2. Data file on Amiga systems.
.image	Image file in Macintosh Disk Image format.
.inf	Device information file, which contains scripts used to control hardware operations.
.ini	In MS-DOS and Windows 3.x, an initialization file, which contains user preferences and startup information about an application program.
.ins	File containing InstallShield install script.
.isu	File containing InstallShield uninstall script.
.jas	Image file in JAS format.
.jav	<i>See</i> .java.
.java	Source file in Java.
.jff	<i>See</i> .jpg.
.jfif	<i>See</i> .jpg.
.jpe	<i>See</i> .jpg.
.jpeg	<i>See</i> .jpg.
.jpg	Graphic image file encoded in the JPEG File Interchange Format.
.js	Source file in JavaScript.
.l	Source file in LISP.
.latex	Text file in LaTeX.
.lha	Archive file compressed with LZH.
.lib	Library file in many programming languages.
.lnk	Shortcut file in Windows 9x and Windows NT 4.
.log	Log file.
.lsp	Source file in LISP.
.lzh	<i>See</i> .lha.
.mac	Image file in MacPaint.
.mak	Project file in Microsoft Visual Basic or Microsoft Visual C++.
.man	Manual page in UNIX.
.mbox	Mailbox file in BSD UNIX.
.mbx	<ol style="list-style-type: none"> 1. Address file in Microsoft Outlook. 2. Mailbox file in Eudora.
.mcw	Document file in Microsoft Word for the Macintosh.
.mdb	Database in Microsoft Access.
.mic	Image file in Microsoft Image Composer.
.mid	Music file in MIDI format.
.midi	<i>See</i> .mid.
.mime	File encoded in MIME format.
.moov	Video file in Apple QuickTime.
.mov	<i>See</i> .moov.
.movie	<i>See</i> .moov.

Common File Extensions *continued*

<i>File Extension</i>	<i>Type of File</i>
.mp2	Audio file compressed and encoded according to the MPEG Audio Layer-2 standard.
.mp3	Audio file compressed and encoded according to the MPEG Audio Layer-3 standard.
.mpe	<i>See</i> .mpg.
.mpeg	<i>See</i> .mpg.
.mpg	Compressed video and audio file in MPEG format.
.mpp	<ol style="list-style-type: none"> 1. Graphics file in CAD format. 2. File in Microsoft Project.
.msg	E-mail message in Microsoft Outlook.
.ncb	File in Microsoft Developer Studio.
.ncf	Command file in Novell NetWare.
.ncf	Temporary file created by Microsoft Windows Clipboard utility.
.net	Network configuration file.
.newsrsc	Setup file for UNIX-based newsreaders.
.nlb	Data file in Oracle 7.
.nlm	Module file in Novell NetWare.
.nsf	Database in Lotus Notes.
.nws	News message file in Microsoft Outlook Express.
.obd	File in Microsoft Office Binder.
.ocx	Microsoft OLE control.
.ole	Microsoft OLE object.
.opt	<i>See</i> .ncb.
.p	Source file in Pascal.
.p65	Document file in PageMaker 6.5.
.pab	Address book file in Microsoft Outlook.
.pcd	Image file in Kodak Photo-CD.
.pcl	File in Hewlett-Packard Printer Control Language.
.pcx	Bitmapped image file in PC Paintbrush.
.pdf	Document file encoded in Adobe Portable Document Format.
.pgp	File encrypted in PGP (Pretty Good Privacy).
.pic	<ol style="list-style-type: none"> 1. Image file in PC Paint format. 2. <i>See</i> .pict.
.pict	Image file in the Macintosh PICT.
.pl	<ol style="list-style-type: none"> 1. Source file in Perl. 2. Source file in Prolog.
.png	Bitmap image file in PNG format.
.pps	<ol style="list-style-type: none"> 1. Image file in Paint Shop Pro. 2. Slide show file in Microsoft PowerPoint.
.ppt	Presentation file in Microsoft PowerPoint.
.prc	Text or program file for 3Com PalmPilot.
.prg	File in Microsoft FoxPro, Ashton-Tate dBase, or CA Clipper.
.ps	PostScript printer file.

Common File Extensions *continued*

<i>File Extension</i>	<i>Type of File</i>
.psd	Image file in Adobe PhotoShop.
.pst	Personal File Folder file in Microsoft Outlook.
.pub	Document file in Ventura Publisher, Adobe PageMaker, or Microsoft Publisher.
.pwd	Document file in Microsoft Pocket Word for handheld and palm-size computers.
.pxl	Password file in Microsoft Windows 9x.
.xls	Spreadsheet file in Microsoft Pocket Excel for handheld and palm-size computers.
.qic	Backup file in Microsoft Backup.
.qif	<i>See</i> .qti.
.qt	<i>See</i> .qtm.
.qti	Image file in Apple QuickTime.
.qtif	<i>See</i> .qti.
.qtm	Movie file in Apple QuickTime.
.qts	<i>See</i> .qti.
.qtx	<i>See</i> .qti.
.qxd	Document file in QuarkXPress.
.ra	Sound file in RealAudio.
.ram	Metafile in RealAudio.
.ras	Raster image bitmap on Sun systems.
.rast	<i>See</i> .ras.
.raw	Bitmap file in RAW format.
.rdf	Resource Description Framework file in XML.
.rgb	<i>See</i> .raw.
.rif	Bitmap file in RIFF format.
.riff	<i>See</i> .rif.
.rle	Bitmap file in RLE compression scheme.
.rm	Video file in RealAudio.
.rtf	Document file in Rich Text Format.
.s	<ol style="list-style-type: none"> 1. Source file in Assembler. 2. Source file in Scheme.
.sam	Document file in Lotus Ami Professional.
.sav	<ol style="list-style-type: none"> 1. Saved file in many games. 2. Saved backup file.
.scc	File in Microsoft SourceSafe.
.scd	File in Microsoft Schedule+.
.scr	Screensaver file in Microsoft Windows.
.sea	Self-extracting Macintosh archive file compressed with StuffIt.
.set	File set in Microsoft Backup.
.sgm	File in SGML.
.sgml	<i>See</i> .sgm.
.shtml	<ol style="list-style-type: none"> 1. File in HTML format that has SSI (server side includes). 2. Secure file in HTML.

Common File Extensions *continued*

<i>File Extension</i>	<i>Type of File</i>
.sig	Signature file for e-mail or Internet newsgroup use.
.sit	Macintosh archive file compressed with StuffIt.
.sm	Source file in Smalltalk.
.snd	<ol style="list-style-type: none"> 1. Interchangeable sound file format used on Sun, NeXT, and Silicon Graphics computers, consisting of raw audio data preceded by a text identifier. 2. Sound resource file on the Macintosh.
.spl	File in Macromedia Shockwave Flash.
.sql	Query or report file in SQL.
.stm	See .shtml.
.sun	Raster graphics file in Sun systems.
.swa	Audio file in Macromedia Shockwave.
.swf	File in Macromedia Shockwave Flash.
.swp	Swap file in Microsoft Windows.
.sys	System configuration file.
.tar	Uncompressed UNIX archive in tar format.
.taz	UNIX archive file in Gzip or tar format.
.tcl	Source file in TCL.
.tga	Bitmap file in Targa format.
.tif	Bitmap images in TIFF format.
.tiff	See .tif.
.tmp	Temporary file in Windows.
.tsv	Tab separated values file.
.ttf	TrueType font file.
.txt	ASCII text file.
.udf	Database file in Microsoft Windows NT.
.uri	File containing list of URIs.
.url	Shortcut file on the Internet for a URL.
.uu	See .uud.
.uud	Binary file that has been translated into ASCII format using uuencode.
.uue	File that has been decoded from ASCII format back into binary format using uudecode.
.vbx	Custom control in Microsoft Visual Basic.
.vda	See .tga.
.vp	Document file in Ventura Publisher.
.vrm	<ol style="list-style-type: none"> 1. See .vrml. 2. Source file in Visual ReXX.
.vrml	A 3-D graphics file in VRML.
.vst	Bitmap image file in Targa.
.vxd	Virtual device driver in Microsoft Windows.
.wab	E-mail file in Microsoft Outlook Express.
.wav	Sound file stored in waveform (WAV) audio format.
.wmf	Vector image file encoded as a Microsoft Windows Metafile.

Common File Extensions *continued*

<i>File Extension</i>	<i>Type of File</i>
.wp	Document file in Corel WordPerfect.
.wp6	Document file in Corel WordPerfect 6.x.
.wpd	<i>See</i> .wp.
.wpg	Graphic file in Corel WordPerfect.
.wps	Document file in Microsoft Works.
.wri	Document file in Microsoft Write.
.xls	Spreadsheet file in Microsoft Excel.
.z	UNIX file archive compressed with gzip.
.Z	UNIX file archive compressed with compress utility.
.zip	Archive file compressed in ZIP format with PKZIP or WinZip.
.zoo	Archive file compressed with zoo.

Appendix C

Instant Messaging Emoticons and Acronyms

Instant messaging, chat, and other Internet communications formats have led to a variety of shorthand indicators and clarifiers meant to enhance the user experience.

Emotags

Emotags were first used in e-mail and newsgroups to clarify a message for the reader. Typically, emotags consist of a word or words in brackets or parentheses, such as <joke>, and appear right after or both before and after the text they refer to.

Smileys

<i>Text</i>	<i>Meaning</i>
:~)	smile
(~:	left-handed smile
:o)	smile with a large nose (or clown smiley)
:)	smile with no nose
:~>	smirk (or wry smile)
:~}	wry smile (or leer)
:~t	unsmiley
:*)	just clowning around (or inebriated)
:~))))	extreme happiness (or sarcastic happiness)
:~D	very happy (or laughing)
(~D	laughing hard
:~) :~) :~)	loud guffaw
:~')	laughing and crying
%~)	amused (and possibly confused)
:~/	chagrined (or skeptical)
:~I	indifferent
:~)	touched (or ill with a cold)

Smileys

The most common emoticons are faces and expressions composed of standard keyboard punctuation marks and symbols, and which are viewed sideways. These are known as “smileys” in reference to the first emoticon, which represented a smile, such as : -). Smileys are indicators of the emotional “tone of voice” intended by the writer.

Smileys *continued*

Text	Meaning
:(sad (or bald and sad)
-(frown (or unhappy)
:c	very unhappy
:-(((extremely unhappy (or sarcastic unhappiness)
:<	forlorn
>:-(annoyed
:-[pouting
(:~& or %-(-	angry
>:~<	very angry
~:~(-	very angry (or fuming mad)
%-(or :/)	not amused
:-	expressionless
:- or :-(have an ordinary day
:e	disappointed
:-X	lips are sealed (or not saying a word)
:v	talking
:-I	hmmm
:-8(condescending stare
:-O	shouting (or shocked)
:-@	screaming
:-(or :'-(-	crying
~:~o	baby
]~>	devilish
):-)	impish
;~>	lewd
:-x	kiss
:*	ready for a kiss (or just ate something sour)
8-]	wow
:-J	tongue-in-cheek
:-&	tongue-tied (or biting tongue)
:p	no way! (or nyah nyah)
:~)	wink
'~)	one-eyed wink
:-7	wry statement (or tongue-in-cheek)
:- :-	déjà vu
?-(sorry, I don't know what went wrong (or black eye)
:-C	that's unbelievable! (or incredible!)
B-D	serves you right
:-B	drooling
:-*)	drunk

Smileys *continued*

Text	Meaning
:~9	licking lips
~p	yuck!
:~b	sticking out tongue
-]~:)[-	impressed
8~I or 8~	in suspense
~	excessively rigid
:~	obnoxious
~)	bored (or asleep)
~I	asleep
I^o	snoring
~O	yawning
:~"	whistling (or pursing lips)
:~s	incoherent statement
:~#	just said the wrong thing (or braces)
:~!	foot in mouth
:~() or :~D	big mouth
(:~\$ or :~(*)	ill
(:~) or :~^)	ill with a cold
:~R	ill with the flu
%~+ or %~+{	lost a fight
X~(unconscious (or dead)
<~:-)	duce
*~:o)	bozo
@~;-)	flirt
X~:-)	child
:~>)	big nose
&~:-)	curly hair (or girl smiley)
#~:-)	matted hair
8~:-)	wearing glasses
8:~:-)	glasses on forehead (or little girl, or hair in curlers)
B~:-)	wearing horn-rimmed glasses (or sunglasses)
B~	wearing cool sunglasses
O~:-)	angel
&8~	nerd
c~:-) or (:~:-)	bald
:~{	has a moustache
:~}) or :~)#	has a beard
:~Q or :~I	smoker
:~d~	heavy smoker
:~?	pipe smoker

Smileys *continued*

<i>Text</i>	<i>Meaning</i>
:-I	no smoking
:-) X	wearing a bow tie
{(:-)	wearing a toupee
:-{ }	lipstick
[:-)	stereo headphones
d :-o	hats off
~:-(has been flamed (or is on fire)
~~:-(has been flamed repeatedly
)	Cheshire cat
(:I	egghead
3:-o	cow
[:]	robot
M-)	see no evil
:X)	hear no evil
:-M	speak no evil
*8((:	strange
O+	female
O->	male
*(handshake offered
*)	handshake accepted
<{:~}	message in a bottle
(-:~)	putting heads together
[] or ()	hug given (name or initials can be included between the brackets)
((())	lots of hugs
((()):**	hugs and kisses
(:():)	Band-Aid (or comfort)
@->-	a rose
@->-	a long-stemmed rose
@==	atomic bomb
<'')))))-<	a fish
^	giggles

Alternate (Japanese) Smileys

Alternate smileys, which do not require users to tilt their heads sideways, were developed by Internet users in Japan

and are becoming more common worldwide. Some versions of these emoticons leave out the () brackets around the faces.

Alternate Smileys

<i>Text</i>	<i>Meaning</i>
(^_^)	male smiley
(^.^)	female smiley
(^L^)	happy
(-_-)	secret smile
(^o^)	laughing out loud
(^_^;)	laughing to cover nervousness
(^_^)/	waving hello
(;_;)/	waving good-bye
(^_~) or (^_-)	winking
(*^o^*) or (*^.^*)	exciting
\(^_^)/	joyful
(;_;) or (~~>.<~~)	crying
(>.<) or (>_<)	angry
(v_v)	expressionless
(^o^;>	excuse me?
(*^_^*)	blushing (or shy)
(^_^;;;)	embarrassed (or in a cold sweat)
(?_?)	confused (or wondering)
(!_!) or (o_o)	shocked
(*_*)	frightened (or in love)
(=_=)~	sleepy
(u_u)	sleeping
(@_@)	stunned
"\=o-o="	wearing glasses
m(_)m	humble bow of thanks or apology

Acronyms and Shorthand

The first emotional indicators in newsgroups and e-mail were acronyms designed to give readers clues to the attitude and intent of the sender. Acronyms also quickly

developed as keyboarding shortcuts. Use of acronyms is particularly prevalent in instant messaging, primarily to maintain the pace of real-time conversation.

Acronyms

<i>Text</i>	<i>Meaning</i>
AAMOF	as a matter of fact
AAR	at any rate
ADN	any day now
AFAIK	as far as I know
AFK	away from keyboard
AFKBRB	away from keyboard, be right back
ASAP	as soon as possible
A/S/L	age/sex/location
B2W	back to work
B4N (or BFN)	bye for now
BAK	back at keyboard
BBL	be back later
BBS	be back soon
BCNU	be seeing you
BF (or B/F)	boyfriend
BMN	but maybe not
BRB	be right back
BTDT	been there, done that
BTDTBTT	been there, done that, bought the tape
BTDTGTTS	been there, done that, got the t-shirt
BTDTGTTSAWIO	been there, done that, got the t-shirt, and wore it out
BTW	by the way
BYKT	but you knew that
CIO	cut it out
CMIW	correct me if I'm wrong
CU (or CYA)	see you
CUL (or CUL8R)	see you later
DIY	do it yourself
DYJHIW	don't you just hate it when
EAK	eating at keyboard
EOL	end of lecture
EOM	end of message
F2F (or FTF)	face to face
FAPP	for all practical purposes

Acronyms *continued*

<i>Text</i>	<i>Meaning</i>
FOFL (or FOTFL)	falling on the floor laughing
FTR	for the record
FWIW	for what it's worth
FYA	for your amusement
FYEO	for your eyes only
FYI	for your information
g (or <g>)	grin
G (or <G>)	big grin
G2G (or GTG)	got to go
GAL	get a life
GD&H	grinning, ducking, and hiding
GD&R	grinning, ducking, and running
GD&RVVF	grinning, ducking, and running, very, very fast
GF (or G/F)	girlfriend
GG	gotta go (or good game)
GIWIST	gee, I wish I said that
GMTA	great minds think alike
GoAT	go away, troll
HAK	hugs and kisses
HAGD	have a great day
HAND	have a nice day
HEH	a courtesy laugh
HHOS	ha-ha, only serious
HTH	hope this helps (or hope that helps)
IAE	in any event
HW	homework (or hardware)
IANAL	I am not a lawyer
IC	I see
ICBW	I could be wrong (or it could be worse)
IDTS	I don't think so
IINM	if I'm not mistaken
IIRC	if I recall correctly
IUC	if I understand correctly
IMCO	in my considered opinion
IME	in my experience
IMHO	in my humble opinion
IMNSHO	in my not-so-humble opinion
IMO	in my opinion

Acronyms *continued*

<i>Text</i>	<i>Meaning</i>
IOW	in other words
IRL	in real life
ISTM	it seems to me
ISWYM	I see what you mean
ITRW	in the real world
J (or <J>)	joking
JC	just chillin'
JIC	just in case
JK (or J/K)	just kidding (or that was a joke)
JTYWTK	just thought you wanted to know
JW	just wondering
K	okay
KWIM	know what I mean?
L (or <L>)	laughing
L8R	later
LJBF	let's just be friends
LOL	laughing out loud
LTNS	long time no see
MHBFY	my heart bleeds for you
MHOTY	my hat's off to you
MOTAS	member of the appropriate sex
MOTD	message of the day
MYOB	mind your own business
NBD	no big deal
NBIF	no basis in fact
NOYB	none of your business
NP	no problem
NRN	no response necessary (or no reply necessary)
OIC	oh, I see
OM	oh my (or old man, as in husband)
OOI	out of interest
OOTB	out of the box
OTL	out to lunch
OTOH	on the other hand
OTTH	on the third hand
PAW	parents are watching
PC	politically correct
PDA	public display of affection
PEST	please excuse slow typing

Acronyms *continued*

<i>Text</i>	<i>Meaning</i>
PI (or PIC)	politically incorrect
PKB (or P/K/B)	pot, kettle, black (or pot calling the kettle black)
PMBI	pardon my butting in
PMFJI	pardon me for jumping in
POS	parent over shoulder (or parents over shoulder)
POV	point of view
PPL	people
PTB	powers that be
R (or r)	are
REHI	re-hello (following a short time away) (or hi again)
RFC	request for comment
RL	real life
ROTFL	rolling on the floor laughing
ROTFLOL	rolling on the floor laughing out loud
RSN	real soon now
S (or <S>)	smile
SCNR	sorry, could not resist
SITD	still in the dark
SOP	standard operating procedure
SPMD	some people may differ
SUP	what's up?
TBE	to be expected
THX (or TX)	thanks
TIA	thanks in advance
TANJ	there ain't no justice
TIC	tongue-in-cheek
TPHB	the pointy-haired boss
TPTB	the powers that be
TTBOMK	to the best of my knowledge
TTFN	ta-ta for now
TTYL	talk to you later
TVM	thanks very much
TVMIA	thanks very much in advance
TYVMIA	thank you very much in advance
U	you
UW	you're welcome
VBG (or <VBG>)	very big grin
WB	welcome back
WCD	what's cookin' doc?

Acronyms *continued*

<i>Text</i>	<i>Meaning</i>
WHBT	we have been trolled
WOA	work of art
WRT	with regard to (or with respect to)
WTG	way to go
WTH	what the heck?
Y (or <Y>)	yawning
YHBT	you have been told (or you have been trolled)
YHBW	you have been warned
YHGMTPOTG	you have greatly misinterpreted the purpose of this group
YHM	you have mail
YMMV	your mileage may vary
YOYO	you're on your own
YWSYLS	you win some, you lose some

Appendix D

Internet Domains

Top-Level Domains: Organizational

<i>Domain</i>	<i>Type of Organization</i>
.aero	Air-transport industry
.biz	Businesses
.com	Commercial
.coop	Cooperatives
.edu	Educational
.gov	Nonmilitary agency, United States federal government
.info	Unrestricted use
.int	International organization
.mil	United States military
.museum	Museums
.name	Individuals
.net	Network provider
.org	Nonprofit organization
.pro	Professional workers

Top-Level Domains: Geographic

<i>Domain</i>	<i>Country/Region</i>
.ac	Ascension Island
.ad	Andorra
.ae	United Arab Emirates
.af	Afghanistan
.ag	Antigua and Barbuda
.ai	Anguilla
.al	Albania
.am	Armenia
.an	Netherlands Antilles
.ao	Angola
.aq	Antarctica
.ar	Argentina

Top-Level Domains: Geographic *continued*

<i>Domain</i>	<i>Country/Region</i>
.as	American Samoa
.at	Austria
.au	Australia
.aw	Aruba
.az	Azerbaijan
.ba	Bosnia and Herzegovina
.bb	Barbados
.bd	Bangladesh
.be	Belgium
.bf	Burkina Faso
.bg	Bulgaria
.bh	Bahrain
.bi	Burundi
.bj	Benin
.bm	Bermuda
.bn	Brunei
.bo	Bolivia
.br	Brazil
.bs	Bahamas, The
.bt	Bhutan
.bv	Bouvet Island
.bw	Botswana
.by	Belarus
.bz	Belize
.ca	Canada
.cc	Cocos (Keeling) Islands
.cd	Congo (DRC)
.cf	Central African Republic
.cg	Congo
.ch	Switzerland
.ci	Côte d'Ivoire
.ck	Cook Islands
.cl	Chile
.cm	Cameroon
.cn	China
.co	Colombia
.cr	Costa Rica
.cs	Serbia and Montenegro
.cu	Cuba
.cv	Cape Verde
.cx	Christmas Island

Top-Level Domains: Geographic *continued*

<i>Domain</i>	<i>Country/Region</i>
.cy	Cyprus
.cz	Czech Republic
.de	Germany
.dj	Djibouti
.dk	Denmark
.dm	Dominica
.do	Dominican Republic
.dz	Algeria
.ec	Ecuador
.ee	Estonia
.eg	Egypt
.er	Eritrea
.es	Spain
.et	Ethiopia
.fi	Finland
.fj	Fiji Islands
.fk	Falkland Islands (Islas Malvinas)
.fm	Micronesia
.fo	Faroe Islands
.fr	France
.ga	Gabon
.gd	Grenada
.ge	Georgia
.gf	French Guiana
.gg	Guernsey
.gh	Ghana
.gi	Gibraltar
.gl	Greenland
.gm	Gambia, The
.gn	Guinea
.gp	Guadeloupe
.gq	Equatorial Guinea
.gr	Greece
.gs	South Georgia and the South Sandwich Islands
.gt	Guatemala
.gu	Guam
.gw	Guinea-Bissau
.gy	Guyana
.hk	Hong Kong SAR
.hm	Heard Island and McDonald Islands

Top-Level Domains: Geographic *continued*

<i>Domain</i>	<i>Country/Region</i>
.hn	Honduras
.hr	Croatia
.ht	Haiti
.hu	Hungary
.id	Indonesia
.ie	Ireland
.il	Israel
.im	Man, Isle of
.in	India
.io	British Indian Ocean Territory
.iq	Iraq
.ir	Iran
.is	Iceland
.it	Italy
.je	Jersey
.jm	Jamaica
.jo	Jordan
.jp	Japan
.ke	Kenya
.kg	Kyrgyzstan
.kh	Cambodia
.ki	Kiribati
.km	Comoros
.kn	St. Kitts and Nevis
.kp	North Korea
.kr	Korea
.kw	Kuwait
.ky	Cayman Islands
.kz	Kazakhstan
.la	Laos
.lb	Lebanon
.lc	St. Lucia
.li	Liechtenstein
.lk	Sri Lanka
.lr	Liberia
.ls	Lesotho
.lt	Lithuania
.lu	Luxembourg
.lv	Latvia
.ly	Libya

Top-Level Domains: Geographic *continued****Domain*** ***Country/Region***

.ma	Morocco
.mc	Monaco
.md	Moldova
.mg	Madagascar
.mh	Marshall Islands
.mk	Macedonia, Former Yugoslav Republic of
.ml	Mali
.mm	Myanmar
.mn	Mongolia
.mo	Macau SAR
.mp	Northern Mariana Islands
.mq	Martinique
.mr	Mauritania
.ms	Montserrat
.mt	Malta
.mu	Mauritius
.mv	Maldives
.mw	Malawi
.mx	Mexico
.my	Malaysia
.mz	Mozambique
.na	Namibia
.nc	New Caledonia
.ne	Niger
.nf	Norfolk Island
.ng	Nigeria
.ni	Nicaragua
.nl	Netherlands, The
.no	Norway
.np	Nepal
.nr	Nauru
.nu	Niue
.nz	New Zealand
.om	Oman
.pa	Panama
.pe	Peru
.pf	French Polynesia
.pg	Papua New Guinea
.ph	Philippines
.pk	Pakistan

Top-Level Domains: Geographic *continued*

<i>Domain</i>	<i>Country/Region</i>
.pl	Poland
.pm	St. Pierre and Miquelon
.pn	Pitcairn Islands
.pr	Puerto Rico
.ps	Palestinian Authority
.pt	Portugal
.pw	Palau
.py	Paraguay
.qa	Qatar
.re	Reunion
.ro	Romania
.ru	Russia
.rw	Rwanda
.sa	Saudi Arabia
.sb	Solomon Islands
.sc	Seychelles
.sd	Sudan
.se	Sweden
.sg	Singapore
.sh	St. Helena
.si	Slovenia
.sj	Svalbard and Jan Mayen
.sk	Slovakia
.sl	Sierra Leone
.sm	San Marino
.sn	Senegal
.so	Somalia
.sr	Suriname
.st	São Tomé and Príncipe
.sv	El Salvador
.sy	Syria
.sz	Swaziland
.tc	Turks and Caicos Islands
.td	Chad
.tf	French Southern and Antarctic Lands
.tg	Togo
.th	Thailand
.tj	Tajikistan
.tk	Tokelau

Top-Level Domains: Geographic *continued*

<i>Domain</i>	<i>Country/Region</i>
.tm	Turkmenistan
.tn	Tunisia
.to	Tonga
.tp	East Timor
.tr	Turkey
.tt	Trinidad and Tobago
.tv	Tuvalu
.tw	Taiwan
.tz	Tanzania
.ua	Ukraine
.ug	Uganda
.uk	United Kingdom
.um	U.S. Minor Outlying Islands
.us	United States
.uy	Uruguay
.uz	Uzbekistan
.va	Vatican City
.vc	St. Vincent and the Grenadines
.ve	Venezuela
.vg	Virgin Islands, British
.vi	Virgin Islands
.vn	Vietnam
.vu	Vanuatu
.wf	Wallis and Futuna
.ws	Samoa
.ye	Yemen
.yt	Mayotte
.za	South Africa
.zm	Zambia
.zw	Zimbabwe

Appendix E

Numeric Equivalents

<i>Decimal (Base 10)</i>	<i>Hexadecimal (Base 16)</i>	<i>Octal (Base 8)</i>	<i>Binary (Base 2)</i>
1	01	01	0000001
2	02	02	0000010
3	03	03	0000011
4	04	04	0000100
5	05	05	0000101
6	06	06	0000110
7	07	07	0000111
8	08	10	0001000
9	09	11	0001001
10	0A	12	0001010
11	0B	13	0001011
12	0C	14	0001100
13	0D	15	0001101
14	0E	16	0001110
15	0F	17	0001111
16	10	20	0010000
17	11	21	0010001
18	12	22	0010010
19	13	23	0010011
20	14	24	0010100
21	15	25	0010101
22	16	26	0010110
23	17	27	0010111
24	18	30	0011000
25	19	31	0011001
26	1A	32	0011010
27	1B	33	0011011
28	1C	34	0011100
29	1D	35	0011101
30	1E	36	0011110
31	1F	37	0011111
32	20	40	0100000

Numeric Equivalents *continued*

<i>Decimal (Base 10)</i>	<i>Hexadecimal (Base 16)</i>	<i>Octal (Base 8)</i>	<i>Binary (Base 2)</i>
33	21	41	00100001
34	22	42	00100010
35	23	43	00100011
36	24	44	00100100
37	25	45	00100101
38	26	46	00100110
39	27	47	00100111
40	28	50	00101000
41	29	51	00101001
42	2A	52	00101010
43	2B	53	00101011
44	2C	54	00101100
45	2D	55	00101101
46	2E	56	00101110
47	2F	57	00101111
48	30	60	00110000
49	31	61	00110001
50	32	62	00110010
51	33	63	00110011
52	34	64	00110100
53	35	65	00110101
54	36	66	00110110
55	37	67	00110111
56	38	70	00111001
57	39	71	00111000
58	3A	72	00111010
59	3B	73	00111011
60	3C	74	00111100
61	3D	75	00111101
62	3E	76	00111110
63	3F	77	00111111
64	40	100	01000000
65	41	101	01000001
66	42	102	01000010
67	43	103	01000011
68	44	104	01000100
69	45	105	01000101
70	46	106	01000110
71	47	107	01000111

Numeric Equivalents *continued*

<i>Decimal (Base 10)</i>	<i>Hexadecimal (Base 16)</i>	<i>Octal (Base 8)</i>	<i>Binary (Base 2)</i>
72	48	110	01001000
73	49	111	01001001
74	4A	112	01001010
75	4B	113	01001011
76	4C	114	01001100
77	4D	115	01001101
78	4E	116	01001110
79	4F	117	01001111
80	50	120	01010000
81	51	121	01010001
82	52	122	01010010
83	53	123	01010011
84	54	124	01010100
85	55	125	01010101
86	56	126	01010110
87	57	127	01010111
88	58	130	01011000
89	59	131	01011001
90	5A	132	01011010
91	5B	133	01011011
92	5C	134	01011100
93	5D	135	01011101
94	5E	136	01011110
95	5F	137	01011111
96	60	140	01100000
97	61	141	01100001
98	62	142	01100010
99	63	143	01100011
100	64	144	01100100
101	65	145	01100101
102	66	146	01100110
103	67	147	01100111
104	68	150	01101000
105	69	151	01101001
106	6A	152	01101010
107	6B	153	01101011
108	6C	154	01101100
109	6D	155	01101101
110	6E	156	01101110
111	6F	157	01101111

Numeric Equivalents *continued*

<i>Decimal (Base 10)</i>	<i>Hexadecimal (Base 16)</i>	<i>Octal (Base 8)</i>	<i>Binary (Base 2)</i>
112	70	160	01110000
113	71	161	01110001
114	72	162	01110010
115	73	163	01110011
116	74	164	01110100
117	75	165	01110101
118	76	166	01110110
119	77	167	01110111
120	78	170	01111000
121	79	171	01111001
122	7A	172	01111010
123	7B	173	01111011
124	7C	174	01111100
125	7D	175	01111101
126	7E	176	01111110
127	7F	177	01111111
128	80	200	10000000
129	81	201	10000001
130	82	202	10000010
131	83	203	10000011
132	84	204	10000100
133	85	205	10000101
134	86	206	10000110
135	87	207	10000111
136	88	210	10001000
137	89	211	10001001
138	8A	212	10001010
139	8B	213	10001011
140	8C	214	10001100
141	8D	215	10001101
142	8E	216	10001110
143	8F	217	10001111
144	90	220	10010000
145	91	221	10010001
146	92	222	10010010
147	93	223	10010011
148	94	224	10010100
149	95	225	10010101
150	96	226	10010110

Numeric Equivalents *continued*

<i>Decimal (Base 10)</i>	<i>Hexadecimal (Base 16)</i>	<i>Octal (Base 8)</i>	<i>Binary (Base 2)</i>
151	97	227	10010111
152	98	230	10011000
153	99	231	10011001
154	9A	232	10011010
155	9B	233	10011011
156	9C	234	10011100
157	9D	235	10011101
158	9E	236	10011110
159	9F	237	10011111
160	A0	240	10100000
161	A1	241	10100001
162	A2	242	10100010
163	A3	243	10100011
164	A4	244	10100100
165	A5	245	10100101
166	A6	246	10100110
167	A7	247	10100111
168	A8	250	10101000
169	A9	251	10101001
170	AA	252	10101010
171	AB	253	10101011
172	AC	254	10101100
173	AD	255	10101101
174	AE	256	10101110
175	AF	257	10101111
176	B0	260	10110000
177	B1	261	10110001
178	B2	262	10110010
179	B3	263	10110011
180	B4	264	10110100
181	B5	265	10110101
182	B6	266	10110110
183	B7	267	10110111
184	B8	270	10111000
185	B9	271	10111001
186	BA	272	10111010
187	BB	273	10111011
188	BC	274	10111100
189	BD	275	10111101
190	BE	276	10111110

Numeric Equivalents *continued*

<i>Decimal (Base 10)</i>	<i>Hexadecimal (Base 16)</i>	<i>Octal (Base 8)</i>	<i>Binary (Base 2)</i>
191	BF	277	10111111
192	C0	300	11000000
193	C1	301	11000001
194	C2	302	11000010
195	C3	303	11000011
196	C4	304	11000100
197	C5	305	11000101
198	C6	306	11000110
199	C7	307	11000111
200	C8	310	11001000
201	C9	311	11001001
202	CA	312	11001010
203	CB	313	11001011
204	CC	314	11001100
205	CD	315	11001101
206	CE	316	11001110
207	CF	317	11001111
208	D0	320	11010000
209	D1	321	11010001
210	D2	322	11010010
211	D3	323	11010011
212	D4	324	11010100
213	D5	325	11010101
214	D6	326	11010110
215	D7	327	11010111
216	D8	330	11011000
217	D9	331	11011001
218	DA	332	11011010
219	DB	333	11011011
220	DC	334	11011100
221	DD	335	11011101
222	DE	336	11011110
223	DF	337	11011111
224	E0	340	11100000
225	E1	341	11100001
226	E2	342	11100010
227	E3	343	11100011
228	E4	344	11100100
229	E5	345	11100101

Numeric Equivalents *continued*

<i>Decimal (Base 10)</i>	<i>Hexadecimal (Base 16)</i>	<i>Octal (Base 8)</i>	<i>Binary (Base 2)</i>
230	E6	346	11100110
231	E7	347	11100111
232	E8	350	11101000
233	E9	351	11101001
234	EA	352	11101010
235	EB	353	11101011
236	EC	354	11101100
237	ED	355	11101101
238	EE	356	11101110
239	EF	357	11101111
240	F0	360	11110000
241	F1	361	11110001
242	F2	362	11110010
243	F3	363	11110011
244	F4	364	11110100
245	F5	365	11110101
246	F6	366	11110110
247	F7	367	11110111
248	F8	370	11111000
249	F9	371	11111001
250	FA	372	11111010
251	FB	373	11111011
252	FC	374	11111100
253	FD	375	11111101
254	FE	376	11111110
255	FF	377	11111111