

Under the Paperwork Reduction Act of 1995, no persons are required to respond to a collection of information unless it contains a valid OMB control number.

Application Data Sheet 37 CFR 1.76		Attorney Docket Number	1116-028C
		Application Number	
Title of Invention	NETWORK-ENABLED AUDIO DEVICE		
The application data sheet is part of the provisional or nonprovisional application for which it is being submitted. The following form contains the bibliographic data arranged in a format specified by the United States Patent and Trademark Office as outlined in 37 CFR 1.76. This document may be completed electronically and submitted to the Office in electronic format using the Electronic Filing System (EFS) or the document may be printed and included in a paper filed application.			

Secrecy Order 37 CFR 5.2

<input type="checkbox"/> Portions or all of the application associated with this Application Data Sheet may fall under a Secrecy Order pursuant to 37 CFR 5.2 (Paper filers only. Applications that fall under Secrecy Order may not be filed electronically.)

Applicant Information:

Applicant 1					<input type="button" value="Remove"/>
Applicant Authority <input checked="" type="radio"/> Inventor		<input type="radio"/> Legal Representative under 35 U.S.C. 117		<input type="radio"/> Party of Interest under 35 U.S.C. 118	
Prefix	Given Name	Middle Name	Family Name	Suffix	
	Safi		Qureshey		
Residence Information (Select One) <input checked="" type="radio"/> US Residency <input type="radio"/> Non US Residency <input type="radio"/> Active US Military Service					
City	Santa Ana	State/Province	CA	Country of Residence i	US
Citizenship under 37 CFR 1.41(b) i		US			
Mailing Address of Applicant:					
Address 1	11741 Skyline Drive				
Address 2					
City	Santa Ana	State/Province	CA		
Postal Code	92705	Countryi	US		
Applicant 2					<input type="button" value="Remove"/>
Applicant Authority <input checked="" type="radio"/> Inventor		<input type="radio"/> Legal Representative under 35 U.S.C. 117		<input type="radio"/> Party of Interest under 35 U.S.C. 118	
Prefix	Given Name	Middle Name	Family Name	Suffix	
	Daniel	D.	Sheppard		
Residence Information (Select One) <input checked="" type="radio"/> US Residency <input type="radio"/> Non US Residency <input type="radio"/> Active US Military Service					
City	Brea	State/Province	CA	Country of Residence i	US
Citizenship under 37 CFR 1.41(b) i		US			
Mailing Address of Applicant:					
Address 1	345 Hilltop Lane				
Address 2					
City	Brea	State/Province	CA		
Postal Code	92821	Countryi	US		
All Inventors Must Be Listed - Additional Inventor Information blocks may be generated within this form by selecting the Add button.					
					<input type="button" value="Add"/>

Correspondence Information:

Enter either Customer Number or complete the Correspondence Information section below. For further information see 37 CFR 1.33(a).
<input type="checkbox"/> An Address is being provided for the correspondence information of this application.

Application Data Sheet 37 CFR 1.76		Attorney Docket Number	1116-028C
		Application Number	
Title of Invention	NETWORK-ENABLED AUDIO DEVICE		
Customer Number	27820		
Email Address		<input type="button" value="Add Email"/>	<input type="button" value="Remove Email"/>

Application Information:

Title of the Invention	NETWORK-ENABLED AUDIO DEVICE		
Attorney Docket Number	1116-028C	Small Entity Status Claimed	<input type="checkbox"/>
Application Type	Nonprovisional		
Subject Matter	Utility		
Suggested Class (if any)		Sub Class (if any)	
Suggested Technology Center (if any)			
Total Number of Drawing Sheets (if any)	49	Suggested Figure for Publication (if any)	
Publication Information:			
<input type="checkbox"/> Request Early Publication (Fee required at time of Request 37 CFR 1.219)			
<input type="checkbox"/> Request Not to Publish. I hereby request that the attached application not be published under 35 U.S.C. 122(b) and certify that the invention disclosed in the attached application has not been and will not be the subject of an application filed in another country, or under a multilateral agreement, that requires publication at eighteen months after filing.			

Representative Information:

Representative information should be provided for all practitioners having a power of attorney in the application. Providing this information in the Application Data Sheet does not constitute a power of attorney in the application (see 37 CFR 1.32). Enter either Customer Number or complete the Representative Name section below. If both sections are completed the Customer Number will be used for the Representative Information during processing.			
Please Select One:	<input checked="" type="radio"/> Customer Number	<input type="radio"/> US Patent Practitioner	<input type="radio"/> US Representative (37 CFR 11.9)
Customer Number	27820		

Domestic Priority Information:

This section allows for the applicant to claim benefit under 35 U.S.C. 119(e), 120, 121, or 365(c). Providing this information in the application data sheet constitutes the specific reference required by 35 U.S.C. 119(e) or 120, and 37 CFR 1.78(a)(2) or CFR 1.78(a)(4), and need not otherwise be made part of the specification.			
Prior Application Status	Pending		<input type="button" value="Remove"/>
Application Number	Continuity Type	Prior Application Number	Filing Date (YYYY-MM-DD)
	Continuation of	09805470	2001-03-12
Prior Application Status	Abandoned		<input type="button" value="Remove"/>
Application Number	Continuity Type	Prior Application Number	Filing Date (YYYY-MM-DD)
09805470	Continuation in part of	09096703	1998-06-12

Under the Paperwork Reduction Act of 1995, no persons are required to respond to a collection of information unless it contains a valid OMB control number.

Application Data Sheet 37 CFR 1.76		Attorney Docket Number	1116-028C
		Application Number	
Title of Invention	NETWORK-ENABLED AUDIO DEVICE		
Prior Application Status	Expired	<input type="button" value="Remove"/>	
Application Number	Continuity Type	Prior Application Number	Filing Date (YYYY-MM-DD)
09805470	non provisional of	60246842	2000-11-08
Prior Application Status	Expired	<input type="button" value="Remove"/>	
Application Number	Continuity Type	Prior Application Number	Filing Date (YYYY-MM-DD)
09096703	non provisional of	60072127	1998-01-22
Additional Domestic Priority Data may be generated within this form by selecting the Add button.			<input type="button" value="Add"/>

Foreign Priority Information:

This section allows for the applicant to claim benefit of foreign priority and to identify any prior foreign application for which priority is not claimed. Providing this information in the application data sheet constitutes the claim for priority as required by 35 U.S.C. 119(b) and 37 CFR 1.55(a).

<input type="button" value="Remove"/>			
Application Number	Country ⁱ	Parent Filing Date (YYYY-MM-DD)	Priority Claimed
			<input checked="" type="radio"/> Yes <input type="radio"/> No
Additional Foreign Priority Data may be generated within this form by selecting the Add button.			<input type="button" value="Add"/>

Assignee Information:

Providing this information in the application data sheet does not substitute for compliance with any requirement of part 3 of Title 37 of the CFR to have an assignment recorded in the Office.

Assignee 1				<input type="button" value="Remove"/>
If the Assignee is an Organization check here. <input checked="" type="checkbox"/>				
Organization Name	Concert Technology Corporation			
Mailing Address Information:				
Address 1	2530 Meridian Parkway, Suite 300			
Address 2				
City	Durham	State/Province	NC	
Country ⁱ	US	Postal Code	27713	
Phone Number		Fax Number		
Email Address				
Additional Assignee Data may be generated within this form by selecting the Add button.				<input type="button" value="Add"/>

Signature:

A signature of the applicant or representative is required in accordance with 37 CFR 1.33 and 10.18. Please see 37 CFR 1.4(d) for the form of the signature.

Signature	/Benjamin S. Withrow/		Date (YYYY-MM-DD)	2006-11-27
First Name	Benjamin	Last Name	Withrow	Registration Number
			40876	

Under the Paperwork Reduction Act of 1995, no persons are required to respond to a collection of information unless it contains a valid OMB control number.

Application Data Sheet 37 CFR 1.76	Attorney Docket Number	1116-028C
	Application Number	
Title of Invention	NETWORK-ENABLED AUDIO DEVICE	

This collection of information is required by 37 CFR 1.76. The information is required to obtain or retain a benefit by the public which is to file (and by the USPTO to process) an application. Confidentiality is governed by 35 U.S.C. 122 and 37 CFR 1.14. This collection is estimated to take 23 minutes to complete, including gathering, preparing, and submitting the completed application data sheet form to the USPTO. Time will vary depending upon the individual case. Any comments on the amount of time you require to complete this form and/or suggestions for reducing this burden, should be sent to the Chief Information Officer, U.S. Patent and Trademark Office, U.S. Department of Commerce, P.O. Box 1450, Alexandria, VA 22313-1450. DO NOT SEND FEES OR COMPLETED FORMS TO THIS ADDRESS. **SEND TO: Commissioner for Patents, P.O. Box 1450, Alexandria, VA 22313-1450.**

Privacy Act Statement

The Privacy Act of 1974 (P.L. 93-579) requires that you be given certain information in connection with your submission of the attached form related to a patent application or patent. Accordingly, pursuant to the requirements of the Act, please be advised that: (1) the general authority for the collection of this information is 35 U.S.C. 2(b)(2); (2) furnishing of the information solicited is voluntary; and (3) the principal purpose for which the information is used by the U.S. Patent and Trademark Office is to process and/or examine your submission related to a patent application or patent. If you do not furnish the requested information, the U.S. Patent and Trademark Office may not be able to process and/or examine your submission, which may result in termination of proceedings or abandonment of the application or expiration of the patent.

The information provided by you in this form will be subject to the following routine uses:

1. The information on this form will be treated confidentially to the extent allowed under the Freedom of Information Act (5 U.S.C. 552) and the Privacy Act (5 U.S.C. 552a). Records from this system of records may be disclosed to the Department of Justice to determine whether the Freedom of Information Act requires disclosure of these records.
2. A record from this system of records may be disclosed, as a routine use, in the course of presenting evidence to a court, magistrate, or administrative tribunal, including disclosures to opposing counsel in the course of settlement negotiations.
3. A record in this system of records may be disclosed, as a routine use, to a Member of Congress submitting a request involving an individual, to whom the record pertains, when the individual has requested assistance from the Member with respect to the subject matter of the record.
4. A record in this system of records may be disclosed, as a routine use, to a contractor of the Agency having need for the information in order to perform a contract. Recipients of information shall be required to comply with the requirements of the Privacy Act of 1974, as amended, pursuant to 5 U.S.C. 552a(m).
5. A record related to an International Application filed under the Patent Cooperation Treaty in this system of records may be disclosed, as a routine use, to the International Bureau of the World Intellectual Property Organization, pursuant to the Patent Cooperation Treaty.
6. A record in this system of records may be disclosed, as a routine use, to another federal agency for purposes of National Security review (35 U.S.C. 181) and for review pursuant to the Atomic Energy Act (42 U.S.C. 218(c)).
7. A record from this system of records may be disclosed, as a routine use, to the Administrator, General Services, or his/her designee, during an inspection of records conducted by GSA as part of that agency's responsibility to recommend improvements in records management practices and programs, under authority of 44 U.S.C. 2904 and 2906. Such disclosure shall be made in accordance with the GSA regulations governing inspection of records for this purpose, and any other relevant (i.e., GSA or Commerce) directive. Such disclosure shall not be used to make determinations about individuals.
8. A record from this system of records may be disclosed, as a routine use, to the public after either publication of the application pursuant to 35 U.S.C. 122(b) or issuance of a patent pursuant to 35 U.S.C. 151. Further, a record may be disclosed, subject to the limitations of 37 CFR 1.14, as a routine use, to the public if the record was filed in an application which became abandoned or in which the proceedings were terminated and which application is referenced by either a published application, an application open to public inspections or an issued patent.
9. A record from this system of records may be disclosed, as a routine use, to a Federal, State, or local law enforcement agency, if the USPTO becomes aware of a violation or potential violation of law or regulation.

NETWORK-ENABLED AUDIO DEVICE

Related Applications

[0001] The present application is a continuation of U.S. Patent Application Serial No. 09/805,470, filed March 12, 2001, which is a continuation-in-part of U.S. Patent Application Serial No. 09/096,703, filed June 12, 1998, now abandoned, and which claims the benefit of U.S. Provisional Application No. 60/246,842, filed November 8, 2000. U.S. Patent Application Serial No. 09/096,703 also claims the benefit of U.S. Provisional Patent Application No. 60/072,127, filed January 22, 1998. The disclosures of these previous applications are hereby incorporated by reference in their entireties.

Background of the Invention

Field of the Invention

[0002] The present invention relates to the field of audio file transfers and, more particularly, relates to the field of management and distribution of audio files over a computer network such as the Internet.

Description of the Related Art

[0003] The Internet is a worldwide array of interconnected computers and information servers that allow anyone with a computer and access to the Internet to get information about virtually any subject 24 hours a day. For the average consumer, an Internet Service Provider (ISP) provides access to the Internet. ISPs such as CompuServe, Prodigy, and America On-Line, currently link over ten million users to the Internet. Users typically connect to the ISP by using standard telephone lines and a telephone modem. Cable modems that allow a user to connect to the ISP over cable television lines, and satellite connections to the Internet, are also available.

[0004] The Internet provides a wealth of information from stock reports to headline news. One of the newer services provided on the Internet is a streaming audio (e.g., RealAudio and MPEG audio) service. Streaming audio

services are often provided in connection with the World Wide Web (Web) and thus are often called Web radio broadcasts. With streaming audio, a user with a Personal Computer (PC), a sound card, and the necessary software can listen to audio programs from anywhere in the world. For example, Radio Prague provides daily Internet broadcasts from the Czech Republic. Listeners in the U.S. can listen to these Web radio broadcasts either in real time, or stored for later replay. Thus, unlike more traditional radio broadcasts where the listener must be within a reception area, Web radio broadcasts can be heard anywhere, so long as the listener has a connection to the Internet and the necessary computer hardware and software.

[0005] Unfortunately, even with the ever-decreasing cost of personal computers, the hardware and software needed to listen to a Web radio broadcast is beyond the financial means of many people. Even for those that can afford a personal computer, listening to a Web radio broadcast ties up the computer so that the user cannot use it for other purposes. Moreover, the use of a personal computer to receive streaming audio (e.g., Web radio broadcasts) requires a certain amount of computer literacy on the part of the user. The user must be able to install the Web Radio software, configure the Web Radio software to communicate with the ISP, and find the various Web radio broadcasts provided on the Web.

[0006] In addition to listening to Web radio broadcasts, users may wish to listen to audio files. With a group of PC's in a home and in a network, users can download songs from one PC to another or upload songs from one PC to another. However, users cannot play a song on one PC by using the controls of another PC. In addition, the users must purchase multiple PC's, which can be costly. Further, the user must be able to install the network connection and the appropriate software. Moreover, even if the user can afford to purchase multiple PC's and install the proper connection, the user would have difficulty playing music in addition to performing other tasks on the PC. For example, the Web radio broadcast may be interrupted. Also, a skip over parts of a song may result if the user is using a word processing

program at the same time as listening to music.

Summary of the Invention

[0007] The present invention solves these and other problems by providing a network-enabled audio device for listening to a variety of audio sources with substantially equal convenience. The network-enabled audio device has a visual display for providing audio source choices to a user. The visual display also provides functions for managing audio sources. User control buttons allow a user to choose an audio source to listen to. The menu buttons allow the user to choose functions for managing the audio sources. In one embodiment, there is also tuner circuitry for receiving radio frequency signals from radio broadcast stations. In one embodiment, a CD player allows the user to listen to CD's. In one embodiment, the network-enabled audio device also has one or more audio amplifiers and one or more loudspeakers operably connected to said audio amplifiers. In one embodiment, a modem is used for transmitting and receiving digital data over a communications network. One embodiment includes a data storage device.

[0008] A first software module is stored on the data storage device, and the software module is configured to decode compressed audio files into a playable (e.g. uncompressed) format. A second software module is also stored on the data storage device. The second software module is configured to use the modem to connect to an Internet service provider to receive assignments of playlists from a third software module. The playlists include references to audio from a variety of audio sources. The assignments provide information about the location of other web sites containing the audio sources. The second software module is configured to subsequently connect through an Internet service provider to web sites to download audio files.

[0009] A third software module is also stored on the data storage device. The third software module is configured to use the modem to connect to an Internet service provider to receive digitized audio broadcasts from the Internet service provider. The module is further configured to provide a select-

broadcast display to allow the user to selectably connect a program broadcast to the input of one or more audio amplifiers either from a local AM or FM radio station or from the world wide Web so that, to the user, reception of a broadcast from the World Wide Web is no more complicated than listening to a local FM or AM radio station.

[0010] One aspect of the present invention is a network-enabled audio device that allows a user to store files, to play standard audio CD's, to play MP3 encoded CDs, to record songs from CD's, to receive digitized radio broadcasts over the World Wide Web (Web), and to receive assignments of playlists of songs from other network-enabled audio devices. The network-enabled audio device provides the hardware and software to perform those functions without the need for expensive equipment. Optionally, a Local Area Network can be configured in place of, or in addition to, the Internet connection to facilitate assignments of playlists and other features. Without an Internet connection or other network connection, the network-enabled audio device can play standard audio CD's, can play MP3 encoded CD's, and can record CD's.

[0011] The network-enabled audio device provides a display device, such as a Liquid Crystal Display (LCD) that allows the user to select playlists of music much like a jukebox. The user can compose playlists from disk files, CD's, Internet streaming audio broadcasts, online music sites, and other audio sources. In one embodiment, the user can also compose playlists from links to AM/FM broadcasts. The user can also select a desired Web broadcast from a list of available Web broadcasts. In addition, the user can play standard audio CD's and MP3 encoded CD's and have access to local AM/FM stations. Further, the software, the user controls, and the display in the network-enabled audio device are operably configured and connected such that the user can listen to playlists that include CD's and other audio sources just as the user would choose a playlist in a jukebox. Thus, the network-enabled audio device provides people who are or are not comfortable with computers a way of taking music from various sources and putting it into one place for listening pleasure. In one embodiment, the Personal Computer (PC) is used to compose the playlists, but the user is able to

listen to playlists and other audio sources without using the PC.

[0012] In one embodiment, the network-enabled audio device is a low-cost tabletop box that connects to an AC power line and optionally to a phone line or to a local area network connection such as Ethernet. The device includes a display device, speakers, a control panel, a computer processor, stored software, a modem, an AM/FM tuner, and a CD player. Optionally, the device can include multiple computer processors or support computer processors. The user accesses the server site via a PC and the Internet. From the server site, the user obtains a list of the devices in his or her Internet Personal Audio Network (IPAN) and what songs are on those devices. The IPAN includes an IPAN server, an IPAN client, and IPAN software stored on the network-enabled audio device. In one embodiment, the IPAN client includes a standard web browser, an IPAN plug-in to the standard web browser, and an IPAN active tray software module. In one embodiment, any standard web browser may be used, but the IPAN client includes the IPAN plug-in and the IPAN active tray software module.

[0013] The IPAN client and the IPAN server store the name of the song and the associated Uniform Resource Locator (URL). The user can list multiple devices as being part of his or her IPAN. At a default time, such as for example 2 a.m., each device establishes a connection to an Internet Service Provider (ISP). The stored software module in each device connects to the server site home page, via the ISP, and inquires whether any songs or playlists have been assigned to the device. The user can bypass the default time for accessing the server and access the server by manually pressing one of the buttons.

[0014] In one embodiment, the network-enabled audio device has no disk for data storage space. Rather, a local area network (LAN) connection to a PC or other network-enabled audio device allows the use of disk space on another device. In one embodiment, the network-enabled audio device comprises speakers, an AC power line, and a network line. A home PC is connected to the network-enabled audio device through the network line. The network connection can be a Home Phoneline Networking Alliance (HPNA) network connection so that the connection may be done through existing phone lines in a home. Optionally, the

network connection can be an Ethernet connection. Multiple network-enabled audio devices can be connected to each other and ultimately to the PC through the network line.

[0015] In one embodiment, the network-enabled audio device does not have any storage space other than memory. This embodiment provides for a low-cost system that can play songs from playlists stored on the IPAN Manager or on the PC's storage space without having to store the audio files locally.

[0016] Another aspect of the present invention is a network-enabled component audio device system for listening to a variety of audio sources with substantially equal convenience. A visual display provides audio source choices to a user. The visual display also provides menu choices for managing audio sources to the user. The user control buttons allow the user to choose an audio source to listen to. The menu buttons allow the user to choose functions for managing the audio sources. The network-enabled component audio device has a CD player for listening to compact discs. A modem is used for transmitting and receiving digital data over a communications network. In one embodiment, a data storage device is provided.

[0017] A first software module is configured to decode compressed audio files. The first software module is stored on the data storage device. A second software module is configured to use the modem to connect to an Internet service provider to receive assignments of playlists from the second software module. The playlists include titles of audio from a variety of audio sources. The assignments provide information about the location of other web sites containing the audio sources. The software module is configured to connect through the ISP to the web sites to download the audio files.

[0018] In one embodiment, the network-enabled audio device is a component hardware device for an audio system. The network-enabled audio device provides an audio output to the audio system. The audio system provides amplifiers and loudspeakers. The network-enabled audio device includes an enclosure that connects to an AC power line, a network line, and the audio system. The network line is a computer data connection, such as, for example, a telephone line, a cable

line, an Ethernet line, a Token-Ring line, a twisted pair line, an infrared link, a radio frequency link, an IEEE 1394 FireWire line, etc. The network-enabled audio device includes a display device, a control panel, at least one computer processor, a stored software module, and a modem. In one embodiment, the network-enabled audio device connects to the IPAN server site.

[0019] Another aspect of the present invention is a method for assigning playlists of music from one electronic device to another. First, a network connection is used for transmitting and receiving digital data over a communication network to an Internet service provider. Next, the process provides a first software module to manage playlists of songs. The software module allows a user to compose playlists from a variety of audio sources. The software module allows a user to assign a playlist from a first device to a second device. Next, the process checks the second device's data storage space for songs listed on the assigned playlist. Next, the process accesses a server site to obtain locations of the web sites the first device downloaded its audio files from. The process then provides a second software module to connect to various web sites to download remaining songs needed for the playlist. The second software module connects if songs needed to form the playlist are not stored on the second device's data storage space. Finally, the process uploads files to the server from the first device and downloads files the second device if the second software module is unable to download a file from said web site.

Brief Description of the Drawings

[0020] The various novel features of the invention are illustrated in the figures listed below and described in the detailed description that follows.

[0021] Figure 1 is a perspective view of one embodiment of a tabletop intelligent radio apparatus.

[0022] Figure 2 is a block diagram of the functional elements of the intelligent radio apparatus.

[0023] Figure 3A shows a default display that appears while a Web broadcast is being received.

- [0024]** Figure 3B shows a menu display that allows the user to select one of the command and setup displays shown in Figures 3C-3E.
- [0025]** Figure 3C illustrates a select language display that allows a user to specify desired languages (e.g., English, French, etc.).
- [0026]** Figure 3D illustrates a display that allows a user to select a type of program material (e.g., news, sports, weather, etc.).
- [0027]** Figure 3E illustrates a display that allows a user to select various program broadcasts.
- [0028]** Figure 4 illustrates a data-entry display that the intelligent radio apparatus uses to allow the user to input alphanumeric text.
- [0029]** Figure 5 is a flowchart that illustrates operation of the intelligent radio apparatus.
- [0030]** Figure 6 is a flow graph that illustrates operation of the intelligent radio networked system.
- [0031]** Figure 6A illustrates the information management and data processing functions provided by a Web radio Web site (e.g., www.webradio.com) to produce a list of Web radio broadcast stations for the user.
- [0032]** Figure 6B illustrates a relationship between the Web radio Web site and other web sites that provide streaming audio programming.
- [0033]** Figure 7 is a perspective view of a tabletop intelligent radio tuner.
- [0034]** Figure 8 is a block diagram of the functional elements of the intelligent radio tuner shown in Figure 7.
- [0035]** Figure 9 is a block diagram of the functional elements of an embodiment of the intelligent radio that provides a remote playback capability.
- [0036]** Figure 10 is a block diagram of the functional elements of an embodiment of the intelligent radio that provides a remote access capability.
- [0037]** Figure 11 is a perspective view of one embodiment of the computing environment of a network-enabled audio device configuration.
- [0038]** Figure 12A is a perspective front view of one embodiment of the network enabled component audio device as shown in Figure 11 that integrates with a home stereo entertainment system.

- [0039]** Figure 12B is a perspective rear view of one embodiment of the network-enabled component audio device as shown in Figure 11 that integrates with a home stereo entertainment system.
- [0040]** Figures 13A is a perspective front view of one embodiment of a stand alone network-enabled audio device as shown in Figure 11.
- [0041]** Figure 13B is a perspective rear view of one embodiment of a stand alone network-enabled audio device as shown in Figure 11.
- [0042]** Figure 14 is a block diagram of the functional elements of the network-enabled audio device as shown in Figures 12A, 12B, 13A, and 13B.
- [0043]** Figure 15 is a block diagram illustrating the configuration between several network-enabled audio devices and a stereo web site as shown in Figure 11.
- [0044]** Figure 16 illustrates a process for connecting the components and setting up the software for the network-enabled audio device as shown in Figures 12A, 12B, 13A, and 13B.
- [0045]** Figure 17A shows a default display of the current playlists when the Internet Personal Area network (IPAN) manager software is started.
- [0046]** Figure 17B illustrates a display that allows the user to control the sound and perform other functions on the audio source.
- [0047]** Figure 17C illustrates the menus used to assign a playlist, as shown in Figure 17A, to another device.
- [0048]** Figure 17D illustrates the songs within a playlist and links to other devices that have the songs present on their hard disk space.
- [0049]** Figure 17E illustrates a schedule window that appears for a song (shown in Figure 17D) to be played at a particular time on a specific device.
- [0050]** Figure 17F illustrates the window that appears to allow the user to choose a default look and feel for the IPAN manager window, as shown in Figure 17A.
- [0051]** Figure 17G illustrates the window that appears to allow the user to choose other options and the look and feel for the IPAN manager window, as shown in Figure 17A.

- [0052]** Figure 17H illustrates the window that appears to allow the user to move audio files from one device to another device.
- [0053]** Figure 17I shows a display for allowing a user to add a device to the IPAN.
- [0054]** Figure 18A shows a default display of the network-enabled audio device, as shown in Figures 12A, 12B, 13A, and 13B.
- [0055]** Figure 18B shows a display for allowing a user to operate the radio functions of the network-enabled audio device, as shown in Figures 12A, 12B, 13A, and 13B.
- [0056]** Figure 18C shows a display for allowing a user to use preset radio stations of the network-enabled audio device, as shown in Figures 12A, 12B, 13A, and 13B.
- [0057]** Figure 18D shows a display for allowing a user to play a playlist stored on the network-enabled audio device, as shown in Figures 12A, 12B, 13A, and 13B.
- [0058]** Figure 18E shows a display for allowing a user to delete a song from a playlist stored on the network-enabled audio device, as shown in Figures 12A, 12B, 13A, and 13B.
- [0059]** Figure 18F shows a display allowing a user to play the songs from all the playlists stored on the network-enabled audio device as shown in Figures 12A, 12B, 13A, and 13B.
- [0060]** Figure 18G shows a display for allowing a user to collect information about a CD and copy a CD to the internal hard drive of the network-enabled audio device shown in Figures 12A, 12B, 13A, and 13B.
- [0061]** Figure 18H shows a display that allows a user to play and navigate through the audio stored on the CD.
- [0062]** Figure 19A is a flowchart showing the process for downloading audio files found when navigating the Internet.
- [0063]** Figure 19B is a flowchart showing the process for assigning playlists from one device to another.
- [0064]** Figure 19C, which comprises Figure 19C₁ and Figure 19C₂, is a flowchart of the process shown in Figure 19B that assigns playlists with

missing songs from one device to another.

[0065] Figure 20A shows a default display of the network-enabled audio device before the action button has been pressed, as shown in Figures 12A, 12B, 13A, and 13B.

[0066] Figure 20B shows a display of the menu items on the network-enabled audio device after the action button has been pressed.

[0067] Figure 20C shows a display of the menu items on the network-enabled audio device after the "music" menu item has been chosen.

[0068] Figure 20D shows a display of the menu items on the network-enabled audio device after the "albums" menu item has been chosen.

[0069] Figure 20E shows a display of the menu items on the network-enabled audio device after the menu item representing an album has been chosen.

[0070] Figure 20F shows a display of the menu items on the network-enabled audio device after the "buy" menu item has been chosen.

[0071] Figure 21 shows a display including an advertisement after the action button has been pressed on the network-enabled audio device.

[0072] In the figures, the first digit of any three-digit number generally indicates the number of the figure in which the element first appears. For example, an element with the reference number 502 first appears in Figure 5. Where four-digit reference numbers are used, the first two digits indicate the figure number.

Detailed Description

[0073] One aspect of the present invention is an intelligent radio device that allows a user to receive digitized radio broadcasts over the World Wide Web (Web). The intelligent radio provides the hardware and software necessary to receive digitized audio from the Web without the need for a personal computer or other expensive equipment. The intelligent radio provides a display device, such as a Liquid Crystal Display (LCD) that allows the user to select a desired Web broadcast from a list of available Web broadcasts.

The display also allows the user to select Web broadcasts in a particular language. The software, the user controls, and the display in the intelligent radio 100 are operably configured and connected such that a user can tune into a Web radio broadcast in a manner similar to the way a user would use the controls on a conventional radio to tune into an AM or FM radio station. Thus, the intelligent radio provides people who are not comfortable with computers, or who do not own or have access to a computer, an opportunity to listen to streaming audio information from the Internet.

[0074] In one embodiment, the intelligent radio is a low-cost tabletop box that connects to an AC power line and a phone line. The device includes a display device, speakers, a control panel, a computer processor, a stored software program, and a modem. The intelligent radio uses the modem to establish a telephone connection to an Internet Service Provider (ISP). The stored software program connects to a Web Radio home page, via the ISP, and downloads a list of Web radio station addresses. Alternatively, the user can enter a web address (e.g., a Uniform Resource Locator (URL)) to connect directly to a web page that provides audio broadcasts (instead of first connecting to the Web Radio home page). The user may use buttons on the control panel to scroll through the display and select a Web radio broadcast "station" for listening. When a station is selected, the stored software program connects to the station and begins to receive digitized audio data transmitted by the station. The intelligent radio converts the received data to analog audio and plays the audio on one or more loudspeakers.

[0075] In an alternate embodiment, the intelligent radio is a tuner that connects to an audio system such as a component stereo system. The tuner provides an audio output to the audio system. The audio system provides amplifiers and loudspeakers. The tuner comprises an enclosure that connects to an AC power line, a network line, and the audio system. The network line may be any type of computer data connection, including, for example, a telephone line, a cable line, an Ethernet line, a Token-Ring line, a twisted pair line, an infrared link, a radio frequency link, an IEEE-1394 FireWire line, etc. The tuner includes a display device, a control panel, a computer processor, a stored software program,

and a modem. The intelligent radio uses the modem to establish a telephone connection to an Internet Service Provider (ISP). The stored software program connects to a Web Radio home page, usually provided by the ISP, and downloads a list of Web radio stations. A user uses use buttons on the control panel (or remote control) to scroll through the display and select a Web radio broadcast "station" for listening. Alternatively, the user may use voice-activated commands to scroll through the display. When a station is selected, the stored software program connects to the station and begins to receive digitized audio data transmitted by the station. The intelligent radio converts the received data to analog audio, which is provided to the audio system.

[0076] Figure 1 illustrates one embodiment of a tabletop intelligent radio 100. The intelligent radio 100 is mounted in an enclosure 101 and connects to household AC power through a power cord 104 and to a communications network by a network cable 102. The network cable 102 may be a telephone line, a network cable, a cable TV cable, a connection to a wireless (e.g., satellite) unit, etc. For example, the communications network may use Iridium satellites developed by the Motorola Corp., Globalstar satellites developed by a consortium of European manufacturers which includes Aérospatiale and Alcatel, P21 satellites developed on a project financed by Inmarsat, or the Odyssey satellite system developed by a TRW consortium associated with Teleglobe/Canada.

[0077] User controls are mounted on the front of the enclosure 101 and include a combined on-off and volume control 110, a command button 121, a cursor control 116, a select button 118, a tuning control 114, and a button bar 120. The cursor control 116 provides up, down, left, and right movements of a cursor or other entity on a display device 112. The button bar 120 provides buttons to select an audio source, including, for example, "AM" radio, "FM" radio, "Web" radio, "Cassette", and "External" input. Also mounted on the front of the enclosure 101 is the display device 112, which provides information to the user. An optional cassette player/recorder 130 provides the capability to play and record audio cassettes. The intelligent radio 100 also includes a left stereo

speaker 106 and a right stereo speaker 108 that may be mounted in the enclosure 101 or in separate enclosures. A wireless remote 135 provides remote operation of the intelligent radio 100. In some embodiments, a microphone is provided as well. An output from the microphone is provided to an analog-to-digital converter to convert the analog microphone signal into digital data. The microphone may be placed in the intelligent radio 100, in the wireless remote 135, or both.

[0078] Figure 2 is a block diagram of the functional elements of the intelligent radio 100. The intelligent radio 100 comprises a Central Processor Unit (CPU) 202 that is used to run the intelligent radio software. The CPU 202 is connected to a random access memory 204, a data storage device 210, and a modem 206. The data storage device 210 may be any type of non-volatile data storage device, including, for example, a floppy disk drive, a hard disk drive, a flash memory, a CD-ROM, a DVD-ROM, a CMOS memory with battery backup, etc. The data storage device 210 provides storage for software programs used by the intelligent radio 100. The software stored on the data storage device 210 may be upgraded by downloading new software from the Web. The data storage device 210 may also provide storage for digitized audio material, such as recorded Web radio broadcasts, CD-Audio, etc. The modem 206 is connected to a communications network 230, shown as a Public Switched Telephone Network (PSTN), by the network cable 102. Although the communications network 230 is shown as a PSTN network, one skilled in the art will recognize that the network 230 may also be a cable television (CATV) network, a satellite network, or any other communications network. In one embodiment, the network 230 comprises both a Direct TV/PC satellite connection that provides information to the intelligent radio 100 at high speed (e.g., 400,000 bytes per second or more), and a PSTN network connection so the intelligent radio can upload information back to the ISP 232 (because many Direct TV/PC connections are only one-way). In yet another embodiment, the satellite network is a two-way satellite network that uses the satellite for both download and upload. In one embodiment, the satellite network uses the Iridium™ system developed, in part, by the Motorola Corp.

[0079] Optionally, a telephone 229 is connected to a first port of a codec 260. A second port of the codec 260 is provided to the CPU 202. The codec 260 provides digital-to-analog conversion and analog-to-digital conversion for the telephone 229. The codec 260 also provides standard telephone interface signals, such as a ringing signal, to the telephone 229, and telephone status conditions, such as receiver up or receiver down, to the CPU 202. In some embodiments, the codec 260 and the modem 206 may be combined as a telephone modem. The telephone 229 may be connected even when the network 230 is not a telephone network.

[0080] The modem 206 provides an interface between the CPU 202 and the communications network 230 and the operational characteristics of the modem 206 are determined by the type of communications network 230. Thus, if the network 230 is a PSTN network, then a telephone modem is used; if the network 230 is a CATV network, then a cable modem is used, etc. In a preferred embodiment, the modem 206 is integral to the intelligent radio 100. In other embodiments, the modem 206 is provided in a separate enclosure. An Internet Service Provider (ISP) 232 provides the user with a connection from the communications network 230 to the Web via the Internet 234. Note that Figure 2 shows functional elements, but not necessarily hardware configurations. Thus, for example, the modem 206 may be implemented in software on the CPU 202. The CPU 202 may be a Digital Signal Processor (DSP). The CPU 202 may comprise a single computer processor, or multiple computer processors. In one embodiment, the CPU 202 comprises two processors, a DSP and a general purpose microprocessor. In one embodiment, the modem 206 is provided in a plug-in module such that the intelligent radio can be configured for different types of computer networks by simply changing the modem plug-in to suit the type of network being used.

[0081] The CPU 202 provides data to the display device 112. The CPU 202 receives user inputs from the command button 121, the tuning control 114, the button bar 120, the select button 118, and the cursor control 116. The CPU 202 provides digitized audio samples to an input of a Digital-to-Analog Converter (DAC) 220.

The analog audio output of the DAC 220 is provided to an amplifier 222. In a preferred embodiment, the DAC 220 and the amplifier 222 are each two-channel devices, providing left and right stereo channels. A left channel output of the amplifier 222 is provided to the left channel speaker 106 and a right channel output of the amplifier 222 is provided to the right channel speaker 108. The volume control 110 controls the gain of the amplifier 222.

[0082] As shown in the preferred embodiment in Figure 2, the other optional audio sources such as the cassette device 130, an AM tuner 240, an FM tuner 242, and an external input 244 also provide inputs to the amplifier 222. Other optional audio sources may be provided, such as, for example, an audio CD, a DVD, a digital audio tape unit, etc. The CPU 202 controls the cassette device 130, the AM tuner 240, the FM tuner 242, and other optional audio sources. A line output from the amplifier 222 may also be provided to a record input of the cassette device 130.

[0083] As described above, the button bar 120 is used to select one of the audio sources. When the button bar 120 is set to "AM," the intelligent radio 100 operates in an AM radio mode. In the AM radio mode, an analog output from the AM tuner 240 is provided to the amplifier 222. Also in the AM radio mode, the display device 112 displays the frequency of an AM station selected by the AM tuner 240. The user may use the tuning control 114 to select a desired AM station. The AM mode is optional.

[0084] An analog output from a microphone 250 is provided to an analog input of an analog-to-digital converter 252. A digital output from the analog-to-digital converter 252 is provided to the CPU 202. The microphone 250 and converter 252 allow for voice commands to control the intelligent radio. The microphone 250 and converter 252 are optional. In some embodiments, a microphone is also placed in a wireless remote so that voice commands can be provided from the wireless remote.

[0085] When the button bar 120 is set to "FM," the intelligent radio 100 operates in an FM radio mode. In the FM radio mode, the analog audio output from the FM tuner is provided to the amplifier 222, and the display device 112

displays the frequency of the FM station selected by the FM tuner 242. The FM mode is also optional.

[0086] When the button bar 120 is set to "Cassette," the intelligent radio 100 operates in a cassette playback mode. In the cassette playback mode, analog output from the cassette player is provided to the amplifier 222, and the display device 112 displays information relating to the cassette playback. The cassette playback mode is also optional. The cassette device 130 may also optionally be configured to provide a record capability such that the cassette can be used to record audio information from any of the other modes. Thus, for example, the cassette can be used to record FM radio, AM radio, or Web radio broadcasts.

[0087] When the button bar 120 is set to "Web," the intelligent radio 100 operates in a Web Radio mode. In the Web Radio mode, the intelligent radio 100 uses the modem 206 to connect to the ISP 232. The ISP 232 provides a list of available Web broadcasts, and access to the Internet 234, so that the various Web broadcasts can be received by the intelligent radio 100. In the Web Radio mode, the display device 112 is used to select a Web broadcast and to provide information about the selected Web broadcast.

[0088] Figures 3A through 3E show various displays provided by the display device 112 while in the Web Radio mode. Figure 3A shows a default display 300 that appears while a Web broadcast is being received. Figure 3B shows a menu display that allows the user to select one of the command and setup displays shown in Figures 3C-3E.

[0089] The display 300, shown in Figure 3A, includes information about the Web broadcast including the type of broadcast (e.g., "Newscast"), the Web address (URL) of the source for the broadcast (e.g., <http://www.npr.org>), a description of the broadcast (e.g., "National Public Radio 1997"), a broadcast format (e.g., "Streaming RealAudio"), etc.

[0090] Figure 3B shows a menu display 320 that allows the user to access the various setup and control displays shown in Figures 3D-3E. The user activates the menu display 320 by pressing the command button 121. The display 320 provides a menu list 322 that lists the various other command

displays. The list 322 may provide: a "Tune Station" command for activating a tune-station display 340, shown in Figure 3E; a "Select Language" command for activating a select-language display 310, shown in Figure 3C; and a "Select List" command for activating a select-list display 322, shown in Figure 3D. The list 322 may also provide commands to activate other displays (not shown) such as "Setup," to initialize the intelligent radio, "Scan Stations," to get a new list of Web broadcast stations from the Internet 234, and "Define Station," to manually define a Web broadcast station not listed. The list 322 may also provide commands to activate other displays such as "Set Clock," and "Set Alarm," to provide optional clock and alarm clock modes for the display device 112.

[0091] The display 320 also provides a scroll bar 321 to allow the user to scroll through the list 322 and select an item (command) from the list. Scrolling may be accomplished by using either the cursor control 116 or the tuning control 114. The user uses the cursor control 116 or the tuning control 114 to highlight a desired menu item in the list 322, and then the user presses the select button 118 to select the highlighted menu item.

[0092] The select-language display 310, shown in Figure 3B, allows the user to elect to receive Web broadcasts in one or more selected languages. The display 310 provides a list of available languages 312 and a scroll bar 314 for scrolling through the list 312. Each item in the list 312 corresponds to a language (e.g., English, French, etc.) and each item is provided with a checkbox 313. If a checkbox 313 is checked, then the corresponding language is enabled. The display 310 also provides an OK button 315, a Cancel button 316, a Clear-All button 317, and a Select-All button 318. The Clear-All button 317 clears all of the checkboxes 313, and the Select-All button 318 checks all of the checkboxes 313. The user "presses" one of the buttons 315-318 by using the cursor control 116 to highlight a desired button and then pressing the select button 118 to "press" the highlighted button.

[0093] The select-list display 330, shown in Figure 3D, allows the user to select a preferred type of program material (e.g., Sports, Weather, News,

All, etc.). The display 330 includes a list 332 of program types and a scroll bar 331. The user uses the cursor control 116 or the tuning control 114 to highlight a desired program type from the list 332, and then the user presses the select button 118 to select the highlighted program type.

[0094] The select-broadcast display 340, shown in Figure 3E, allows the user to select a Web broadcast. The display 330 includes a list 342 of the available Web broadcasts having the proper language (as selected in the select language display 310) and the desired program type (as selected in the select-list display 331). The user uses the cursor control 116 or the tuning control 114 to highlight a desired broadcast from the list 342, and then the user presses the select button 118 to select the highlighted program type. Each item in the list 342 is provided with a checkbox 343. If the checkbox 343 is checked, then the corresponding broadcast is a preferred (or "fast-tune") broadcast. The user may scroll through the fast-tune broadcasts by using the tuning control 114 from the default display 300 shown in Figure 3A, without having to activate the select-broadcast display 340. This provides a convenient shortcut feature to allow the user to quickly tune to stations that the user regularly listens to.

[0095] Figure 4 illustrates a data-entry display 450 that allows the user to input alphanumeric text (e.g., the telephone number of the ISP 232 or a URL). The display 450 includes a text prompt 451 to prompt the user for the desired data. The display also includes an on-screen keyboard 452, a text display 453, an OK button 454 and a Cancel button 455. The user enters text by using the cursor control 118 to highlight a desired character on the on-screen keyboard 452 and then pressing the select button 118 to enter the highlighted character into the text display 453. The OK button 454 and the Cancel button 455 are "pressed" in the same fashion.

[0096] Figure 5 is a flowchart 500 that begins at a start block 501 and illustrates the Web Radio mode process. The process advances from the start block 501 to a decision block 502, where the process checks a status flag to determine whether or not the intelligent radio software needs to be initialized (setup). If setup is needed, then the process advances to a process block 504; otherwise, the

process jumps over the setup steps to a process block 514. In the process block 504, the process obtains a phone number for the desired ISP 232. The phone number may be obtained from a default phone number stored in the intelligent radio software, or by prompting the user through the data-entry display 450. Once the phone number has been obtained, the process advances to a process block 506, where the modem 206 dials the telephone number and establishes a modem connection with the ISP 232. Once the connection is established, the process advances to a process block 508 where the user establishes an account with the ISP 232.

[0097] In one embodiment, the user is prompted for a password that is stored on the data storage device 210 or entered using the data-entry display 450. Establishing an account may include other actions, such as creating a username for the user, changing the phone number used to access the ISP 232, and entering information about the user and the user's account. Once an account is established, the process advances to a process block 510 where a list of available Web radio broadcast stations is downloaded to the intelligent radio 100 from the ISP 232 and stored on the storage device 210. Lists of available languages and program types are also downloaded and stored on the storage device 210. Once the lists are downloaded, the process advances to a hang-up block 512 wherein the modem 206 terminates the network connection (e.g., hangs-up the phone). Upon hang-up, the setup process is complete, and the process advances to the process block 514.

[0098] In the process block 514, the modem dials the ISP 232 and then advances to a process block 516 where the intelligent radio 100 logs on to the user's account at the ISP 232. The hang-up, redial, and logon (blocks 512, 514, and 516, respectively) is desirable when using a PSTN, because the initial telephone call, placed in the block 506, is typically a long-distance call or a toll-free (e.g., a 1-800) call. By contrast, the telephone call placed in the block 514 is typically a local call. When using a non-PSTN network (e.g., a cable modem, a satellite network, etc.) then the hang-up, redial, and logon (blocks 512, 514, and 516, respectively) is typically omitted.

[0099] Once the user is logged on, the process advances to a process block 518 where the user selects (tunes) a Web radio broadcast station. Once a Web broadcast has been selected, the process advances to a process block 520 where the intelligent radio 100 receives the Web broadcast. The CPU 202 decodes and decompresses the received data as necessary and then sends the decompressed data to the DAC 220 where it is converted to an analog signal that is subsequently played on the speakers 106, 108. The process remains in the process block 520 while the user listens to the Web broadcast.

[0100] If the user tunes to a new Web broadcast station (e.g., by turning the tuning control 114 or by activating the select-broadcast display 340) then the process loops back to the process block 518, selects the new station, and returns to the process block 520.

[0101] Figure 6A illustrates the information management and data processing functions 600 provided by a Web Radio site 602 (e.g., www.webradio.com). Access to the Internet site 602 is made possible by the Internet access provided by the ISP 232. The Internet site 602 provides a list of Web radio broadcast stations for the user and optionally other value-added services that enhance the operation of the intelligent radio 100. For example, the Internet site 602 may provide a list of available program sources and streaming audio programming. The site 602 may also maintain user profile comprising a list of preferred Internet "broadcast stations." The site 602 also provides special download capabilities such that the user can download information and software into the intelligent radio. The site 602 also provides upload capabilities such that the user can upload information, such as preferences, etc., from the intelligent radio 100 to the site 602. For example, the site 602 can provide a customized list of stations for each user and voicemail capability. The site 602 may provide reformatting of streaming audio data into a format better suited for the intelligent radio.

[0102] In one embodiment, the site 602 also provides Web telephone capabilities to the intelligent radio 100, such that the user can use the intelligent radio as a telephone to talk to other users that are connected to the Internet. In one

embodiment of the Web telephone, the codec 260 is used to digitize speech from a microphone in the handset of the telephone 229. The digitized speech is sent over the network 230 to the ISP. The ISP forwards the digitized speech to a remote user. Similarly, the ISP provides digitized speech from the remote user to the intelligent radio. The intelligent radio uses the codec 260 to convert the digitized speech into analog signals that are played on the speakers 106 and 108 or a speaker in the handset of the telephone 229.

[0103] In yet another embodiment, the intelligent radio provides voice email in connection with the site 602. To receive email, text-to-voice software in the site 602 is used to convert email text into digitized voice data as words spoken in the user's desired language. The digitized voice data is provided to the intelligent radio where it is converted to an analog signal and played on the speakers 106 and 108 or a speaker in the handset of the telephone 229. To receive email, the user speaks into the microphone 250 or the microphone in the handset of the telephone 229 and the spoken words are converted into digitized speech by the intelligent radio. The intelligent radio sends the digitized speech to the site 602 where it is converted into email text and then emailed to the recipient. The software to convert speech to text and text to speech is provided in the site 602 in order to minimize the cost and complexity of the intelligent radio. Alternatively, the software to convert speech to text and text to speech is provided in the intelligent radio.

[0104] In one embodiment, the site 602 also provides special formatting and markup protocols that are tailored to the intelligent radio display 112. Most existing Internet sites are geared towards a computer or television and assume that a user has a large, high resolution, color monitor. Most existing Internet sites also assume that a user is accessing the site by using a Web browser such as Netscape Navigator™ or Microsoft Internet Explorer™. These browsers support high level protocols such as HyperText Markup Language (HTML). The display 112 may be relatively smaller, and relatively less capable than a traditional computer monitor. In some embodiments, the display 112 does not necessarily need all of the capabilities and complexity of HTML

and is thus better served by information that is formatted for the display 112 and that is expressed in a markup language that is suited to the needs of the intelligent radio 100, without the overhead and complexity of HTML.

[0105] When the user connects to the Internet site, information is passed along a first data stream to an account management block 604. The block 604 provides account management functions relating to the user's account with the ISP 232. The account management block passes data to a user preference block 606, which retrieves user profile information and user preferences specified by the user. Information regarding the user preferences may be stored by the ISP 232, or downloaded from the intelligent radio 100 as needed.

[0106] Information is also passed from the process block 602 along a second data stream to a program management block 608. The program management block 608 accesses a language variety database 610 to determine which languages are available, and a program variety database 612 to determine which types of programs are available. The program management block 608 also accesses program sources such as live broadcasts 620, archived broadcasts 624, stored music 626, and other streaming audio sources 622.

[0107] User profile information from the user preference block 606 and program data from the program management block 608 are provided to a program list block 616, which constructs a list of available Web programs (broadcasts) that fit the user's preferences. The list constructed in the block 616 is passed to the intelligent radio 100.

[0108] Figure 6B shows the conceptual relationship between the site 602 and other Web sites that supply streaming audio information, such as a site 630, a site 631, and a site 632. The Internet provides the ability to transfer data between any two of the sites 602, 630-632. The user connects, through the ISP 232, to the site 602. The site 602 provides links to the sites 630-632 through the programming lists provided by the site 602. If the user selects a streaming audio program from one of the sites 630-632, then the site 602 provides the necessary link to the selected site. In some embodiments, the site 602 provides the link information to the intelligent radio 100, and the intelligent radio

100 makes a "direct" connection to the selected site. In other embodiments, the site 602 links to the selected site, receives the streaming audio data, reformats the data if desired, and then sends the streaming audio data to the intelligent radio 100.

[0109] Figure 7 illustrates an embodiment of an intelligent radio tuner 700. The tuner 700 is mounted in an enclosure 701 and connects to household AC power through a power cord 104, to a network through a network cable 102, and to an audio system through an audio line 702. User controls are mounted on the front of the enclosure 701 and include an on-off switch 704, a command button 121, a cursor control 116, a select button 118, and a tuning control 114. The cursor control 116 provides up, down, left, and right movements of a cursor or other entity on a display device 112. Also mounted on the front of the enclosure 701 is the display device 112, which provides information to the user.

[0110] Figure 8 is a block diagram of the functional elements of the intelligent radio configured as a tuner 700. The tuner 700 comprises the Central Processor Unit (CPU) 202 that is used to run the intelligent radio software. The CPU 202 is connected to the random access memory 204, the data storage device 210, the modem 206, and the codec 260. The data storage device 210 may be any type of non-volatile data storage device, including, for example, a floppy disk drive, a hard disk drive, a flash memory, a CD-ROM, a DVD-ROM, a CMOS memory with battery backup, etc. The modem 206 is connected to a communications network 230, shown as a Public Switched Telephone Network (PSTN). Although the communications network 230 is shown as a PSTN network, one skilled in the art will recognize that the network 230 may also be a cable television (CATV) network, a satellite network, or any other communications network. The modem 206 provides an interface between the CPU 202 and the communications network 230 and the operational characteristics of the modem 206 are determined by the type of communications network 203. Thus, if the network 230 is a PSTN network, then a telephone modem is used; and if the network 230 is a CATV network, then a cable modem is used, etc. An Internet Service Provider (ISP) 232 provides

the user with a connection from the network 230 to the Web via the Internet 234.

[0111] The CPU 202 provides data to the display device 112. The CPU 202 receives user inputs from the command button 121, the tuning control 114, the select button 118, and the cursor control 116. The CPU 202 provides digitized audio samples to an input of a Digital-to-Analog Converter (DAC) 220. The analog audio output of the DAC 220 is provided to the audio output 702. In a preferred embodiment, the DAC 220 is a two-channel device, providing left and right stereo channels.

[0112] Figure 9 is a block diagram of the functional elements of an embodiment of an intelligent radio that provides for remote playback. Figure 9 shows a base unit 900 that is connected to the communications network 230. The base unit 900 receives streaming audio from the Web and transmits the audio information to a remote playback unit 902.

[0113] The base unit 900 is similar in most respects to the intelligent radio except that the amplifier 222, the loudspeakers 106 and 108, and the volume control 110 are not located in the base unit 900, but rather are located in the remote playback unit 902. In the base unit, the DAC 220, the cassette device 130, the AM tuner 240, the FM tuner 242, and the external input 244 are connected to a transmitter 904 rather than the amplifier 222. The transmitter 904 provides a transmitted signal to a receiver 906 in the remote unit 902. The receiver 906 provides an audio output to the amplifier 222.

[0114] The base unit 900 receives the streaming audio information from the Internet 234 and uses a transmission carrier to retransmit the audio information to one or more remote units 902. The transmitter 904 and the receiver 906 may use any form of communication for the transmission carrier, including radio frequency communication, infrared communication, ultrasonic communication, etc. In one embodiment, the transmitter 904 may be a low power FM (Frequency Modulation) transmitter compatible with standard FM broadcast bands, such that the remote playback unit 902 can be a standard FM transistor radio or a stereo receiver. In yet another embodiment, the transmitter 904 may be a low power AM (Amplitude Modulation) transmitter compatible with standard AM broadcast

bands, such that the remote playback unit 902 can be a standard AM transistor radio or a stereo receiver.

[0115] In other embodiments, the base unit 900 may also include an amplifier 222, loudspeakers 106 and 108, and a volume control 110 such that the base unit 900 can provide both playback of the audio information and transmission of the audio information to the remote unit 902.

[0116] Figure 10 is a block diagram of the functional elements of an embodiment of an intelligent radio that provides for remote access, comprising a base unit 1002 and an intelligent radio 1000. The base unit 1002 comprises a transceiver 1012 coupled to a modem 1011. The modem 1011 is connected to the communications network 230. The modem 1011 receives data from the ISP and provides the data to the transceiver 1012, which then transmits the data to a transceiver 1010 in the intelligent radio 1000. The transceiver 1010 transmits data from the intelligent radio 1000 to the transceiver 1012. The transceiver 1012 provides the data from the intelligent radio 1000 to the modem 1011, which sends the data to the ISP 232.

[0117] The intelligent radio 1000 is similar in most respects to the intelligent radio 100 shown in Figure 2, with the addition of the transceiver 1010. A data input/output port of the transceiver 1010 is provided to the processor 202 and a Radio Frequency (RF) input/output port of the transceiver 1010 is provided to an antenna. Also, in the intelligent radio 1000, the modem 206 is optional (because network communications are handled by the transceiver 1010 rather than the modem 206).

[0118] The transceivers 1010 and 1012 use any suitable means for communication, including, for example, optical communication, radio communication, etc. In a preferred embodiment, the transceivers 1010 and 1012 are radio transceivers that use spread-spectrum communication techniques at a frequency of approximately 2.4 GHz. The combination of the base unit 1002 and the intelligent radio 1000 provides a capability similar to that provided by a cordless telephone. The base unit 1002 can be located near a network connection point (e.g., a telephone outlet), and the intelligent radio 1000

can be conveniently placed anywhere within the range of the base unit 1002. The two-way communication link between the transceiver 1010 and the transceiver 1012 provides a cordless connection to the network 230.

[0119] In one embodiment, the intelligent radio, as shown in Figure 1, is a network-enabled audio device. Figure 11 illustrates one embodiment of the network-enabled audio device configured for use with other electronic devices. In one embodiment, the network-enabled audio device works in conjunction with a PC. With a network connection, software on a PC can be used to assign playlists of songs to the network-enabled audio device. Further, the network-enabled audio devices can be set to turn on at a certain time and play a playlist of music. In one embodiment, songs encompass a variety of audio sources including, but not limited to, audio files containing music and/or advertisements. Optionally, the network-enabled audio devices can turn on through an Internet connection as well. The front panel, including the user controls, can be disabled in order to prevent users from turning the device off when a playlist is scheduled.

[0120] In one embodiment, the network-enabled audio device records user activity and provides that information to a server for data mining purposes. For instance, a user's composition of a playlist including songs from The Beatles can be recorded by the network-enabled audio device and sent to a server tracking the number of users composing playlists including songs from The Beatles. Tracking information can then be provided to record companies interested in selling more Beatles MP3's to gauge consumer demand. In one embodiment, a button is provided for allowing the user to turn the logging feature on or off.

[0121] In Figure 11, an IPAN 1100 includes an IPAN server 1104, a PC IPAN client 1106, a network 1102, a device B 1108, a device A 1110, and user controls 1112. The PC IPAN client 1106 connects to the IPAN Server 1104 through the network 1102 (such as the Internet). The Device 1110 represents a network-enabled audio device, which connects at a default time to the IPAN server 1104. The user can optionally change the default time or can connect to the IPAN server

1104 at a desired time independent of the default time. The user can use the user controls 1112 on the Device 1110 to bypass the default time and connect to the server 1104 immediately. When the Device 1110 connects, the IPAN server 1104 may have a playlist for the Device 1110. The IPAN server 1104 downloads the playlist to the device 1110. The IPAN server 1104 checks to see what devices have the audio files listed in the playlist. The IPAN server 1104 maintains a list of URL's from which the device 1110 received audio files listed in the playlists. In one embodiment, the list of URL's is stored in a catalog. In one embodiment, the catalog also includes other information such as, for example, a list of available audio playback devices and their settings, scheduled audio playback, and/or commands for system synchronization. The Device 1110 attempts to connect to the URL's listed as the location from which the songs located on the Device's 1108 hard drive were retrieved from. If the URL's do not work and the song exists in the IPAN 1100, then the audio files are transferred from the Device 1108 to the Device 1110 by uploading the files from the Device 1108 the next time the Device 1108 connects. The next time the Device 1110 connects, it will download the list of files from the server. If the song does not exist in the IPAN, the Device 1110 attempts to download the song at intervals until the user deletes the song from the playlist or the song is added to the Device 1108. In one embodiment, for example, an empty cone will appear beside the song in the playlist that could not be downloaded. The user can delete the song in order to request a cease in the attempts to download, or the user can refrain from deleting the song from the playlist in order to request that further attempts be made to download the song. A request for further attempts in downloading the song results in further iterations of Device 1110 attempting to download the song from the broken URL followed by attempts to upload the song from Device 1108 when Device 1108 connects.

[0122] Figures 12A and 12B illustrate one embodiment of a network-enabled component audio device 1200. The device 1200 represents one embodiment of the intelligent radio 700. Figure 12A illustrates a front view of the network-enabled audio device 1200. The network-enabled audio device 1200

has user controls which are mounted on the front of an enclosure 1202 and include a power button 1204, a shuttle control 1214, an enter button 1216, menu buttons 1212, an action button 1210, and a CD-eject button 1222. On the shuttle control 1214, there is a right button 1264, a left button 1260, an up button 1262, and a down button 1266 for navigating through menus on the display 1230. An infrared port 1208 is mounted on the front of the enclosure 1202 to read signals from a remote control 1250. In one embodiment, the remote control includes buttons for volume, enter, navigation shuttle, action, power, CD eject, and five pre-set menu buttons. A CD player 1220 is also mounted on the front of the enclosure 1202 to play standard audio CD's or MP3 encoded CD's.

[0123] In one embodiment, the display 1230 has a menu bar to provide the user with options for listening to playlists, listening to the CD player, or listening to streaming audio. The shuttle control 1214 is used to scroll through the selections in a playlist. Each selection is highlighted as the shuttle control 1214 is pressed right 1264 or left 1260. When the user makes a choice, the enter button 1216 is pressed to signify that choice being made. If the user chooses the playlist option, a drop down menu is displayed in the display 1230 showing the available playlists. The user then uses the shuttle control 1214 to scroll through the playlists by pressing the up button 1262 or the down button 1266. Once the user chooses an audio source with the shuttle control 1214, the user can navigate and play the audio with the group of menu buttons 1212.

[0124] The group of menu buttons 1212 is context sensitive and will change function depending on the audio source. For example, in one embodiment, if the user selects the CD player 1220 as the audio source, then the first menu button in the group of menu buttons 1212 is used to play the CD while the second menu button is used to stop. In one embodiment, the bottom of the display 1230 changes according to the audio source determined by the user. If the user chooses to play CDs, a "play" icon appears above the first button in the group of menu buttons. In one embodiment, if the user chooses to listen to the AM/FM radio, a scan icon appears above the first button in the group of menu buttons 1212.

[0125] In addition to allowing the user to play files, the network-enabled audio device allows the user to play audio CD's on the CD player 1220. Further, the user can copy and encode songs off CD's in digital formats (known as "ripping") and compose playlists with those songs and other files and streaming audio.

[0126] The action button 1210 allows the user to request the latest news, albums, concerts and other information on artists. For example, if the user is listening to a streaming audio broadcast and does not know who the artist is, he or she can press the action button 1210 and receive information on the display 1230 identifying the artists, the name of the songs, interesting facts about the artist, etc. Optionally, the user can acquire similar information by pressing the action button when listening to a CD or a playlist. In one embodiment, the network-enabled audio device 1200 acquires this information by accessing the IPAN server 1104. The IPAN server 1104 then accesses its own database to search for the requested information. Optionally, the database is located on at least one different server than the IPAN server 1104. In one embodiment, if the information is not found, a sample of the song will be sent to another server to analyze the sample and report back to the IPAN server 1104 with the correct information.

[0127] Figure 12B illustrates a rear view of the network-enabled component audio device 1200. The network-enabled audio device 1200 connects to household AC power through a power cord 1268. The network-enabled audio device 1200 includes a phone jack 1250, an Ethernet port 1252, a line-in connector 1264 having left and right channels, a line-out connector 1262 having left and right channels, a microphone jack 1258, a headphone jack 1260, a TOS link 1256, and a USB port 1254.

[0128] In one embodiment, the phone jack 1250 can be used to either establish a modem connection to an ISP and/or to establish a LAN connection (e.g. Home Phone Network Alliance network connection). The Ethernet port 1252 can be used with an Ethernet cable to provide access to an Ethernet LAN. Optionally, the Ethernet port 1252 can be replaced or supplemented with other types of

connections to communications networks. A network cable provided to the Ethernet port 1252 can be a network cable, a cable TV cable, a connection to a wireless (e.g., satellite) unit, a power line, etc. For example, the communications network uses satellites developed by the Motorola Corp., Global Star satellites developed by a consortium of European manufacturers which includes Aérospatiale and Alcatel, P21 satellites developed on a project financed by Inmarsat, or the Odyssey satellite system developed by a TRW consortium associated with Teleglobe/Canada.

[0129] In one embodiment, the network-enabled audio device 1200 provides an audio output to an associated audio system. For high-speed interaction with other audio components, the digital out TOS link 1256 (also known as "Optic S/PDIF") is used for an optical connection to provide for the transfer of raw digital streams. Files can be transferred from the network-enabled audio device 1200 without a conversion from digital to analog signals. When the audio file reaches the associated audio system, such as for example a portable MP3 player, the digital audio stream is then converted to an analog stream within the associated audio system to enhance audio quality. The associated audio system provides for amplifiers and loudspeakers.

[0130] The line in connector 1264 is an analog line in from another device. The line out connector 1262 is an analog line out to standard left and right RCA-style connectors. The standard USB host connector 1254 allows downloading of music to portable MP3 players (in a host downloading to a slave relationship) and/or USB networking with a PC or other network-enabled audio device 1200 or 1300.

[0131] Figures 13A and 13B illustrate one embodiment of a tabletop network-enabled audio device 1300. Figure 13A illustrates a front view of the tabletop version of the network-enabled audio device 1300. As described in more detail below, the network-enabled audio device 1300 is similar to the network enabled audio device 1200 with the addition of extra features such as a radio, amplifier, and speakers. The network-enabled audio device 1300 has user controls which are mounted on the front of the enclosure 1302 and includes the power button 1204,

the shuttle control 1214, the enter button 1216, the menu buttons 1212, the action button 1210, the volume control 1316, and a CD eject button 1222. The shuttle control 1214 includes the right button 1264, the left button 1260, the up button 1262, and the down button 1266 for navigating through menus on the display 1230. The infrared port 1208 is mounted on the front of the enclosure 1302 to read signals from the remote control 1250. In one embodiment, the remote control includes buttons for volume, enter, navigation shuttle, action, power, CD eject, and five pre-set menu buttons. The CD player 1220 is also provided on the device 1300 to play standard audio CD's or MP3 encoded CD's. A right speaker 1303 and a left speaker 1303 are operably connected to the network-enabled audio device 1300.

[0132] In one embodiment, the group of menu buttons 1212 perform the same or similar functions as the group of menu buttons 1212 in the network-enabled component audio device 1200 illustrated in Figure 12 except that the display 1230 will illustrate an additional option of playing an AM/FM radio. Therefore, when the shuttle control 1214 is used to select the AM/FM radio audio source and the user presses the enter button 1216, the icons that reflect functions such as tuning, scanning, and other buttons used to navigate and manage an AM/FM audio source appear. If the user chooses to listen to the AM/FM radio, a scan icon appears above the first menu button 1212.

[0133] Figure 13B illustrates a rear view of the tabletop network-enabled audio device 1300. The network-enabled audio device 1300 connects to household AC power through the power cord 1268. The network-enabled audio device includes the phone jack 1250, the Ethernet port 1252, the line-in connector 1264 having left and right channels, the line-out connector 1262 having right and left channels, the microphone jack 1258, the headphone jack 1260, an AM/FM antenna port 1390, left and right speaker outputs 1392, and the USB port 1254.

[0134] In one embodiment, the network-enabled audio device 1300 has an AM/FM antenna port for connecting to an AM/FM antenna. The network enabled audio device 1300 includes an amplifier and loudspeakers 1303 (as will be described in Figure 14) which connect to the left and right speaker outputs 1350.

[0135] Figure 14 is a block diagram of the functional elements of the network-enabled audio devices 1200 and 1300. The network-enabled audio device 1300 typically includes the functional elements of the network-enabled audio device 1200. The network-enabled component audio device system 1300 includes an AM Tuner 1418, an FM tuner 1420, an amplifier 1422, and the speakers 1303. In one embodiment, the network-enabled audio device 1200 does not include the AM tuner 1418, the FM tuner 1420, the amplifier 1422, or the speakers 1303. A Central Processing Unit (CPU) 1402 and a CPU Support Chip 1406 are used to run the software on the network-enabled audio devices 1200 and 1300. In one embodiment, the CPU 1402 is a StrongARM SA-1110 manufactured by Intel, and the CPU Support Chip 1406 is a StrongARM SA-1111 manufactured by Intel. The network-enabled audio device 1200 includes a display 1408, a modem 1410, a memory card 1412, a data storage device 1414, a codec 1416, a CD player, a DAC 1470, a microphone 1480, a line-in port 1482, and a line out 1484. Further, the network-enabled audio device 1200 includes user controls, including a shuttle control 1214, a group of menu buttons 1212, an enter button 1204, and an action button 1210. The network-enabled audio device 1200 connects externally to a network 1428. The network 1428 is shown as a Public Switched Telephone Network (PSTN) 1428 that connects to an ISP 1429 which gives access to the Internet 1102. Through the Internet 1102, a user can access the server site 1104 and thereby access the server site IPAN software 1433.

[0136] In one embodiment the CPU 1402 communicates with the random access memory 1412, the telephone modem 1410, and the display 1408. The memory 1412 can be flash memory or a combination of flash memory and other types of memory. The memory 1412 can be volatile or non-volatile or a combination of volatile and non-volatile. The modem 1410 is connected to a communications network 1428, shown as a PSTN 1428. In one embodiment, the modem 1410 is also connected to an HPNA network. Although the communications network 1428 is shown as a PSTN network, one skilled in the art will recognize that the network 1428 can also be a cable television (CATV) network, a satellite network, or any other communications network. In one embodiment, the

network 1428 comprises both a Direct TV/PC satellite connection that provides information to the network-enabled audio device at high speed (e.g., 400,000 bytes per second or more), and a PSTN 1428 network connection so the intelligent radio can upload information back to the ISP 1429 (because many Direct TV/PC connections are only one-way). In yet another embodiment, the satellite network is a two-way satellite network that uses the satellite for both download and upload.

[0137] A port of the codec 1416 is provided to the CPU Support Chip 1406. In one embodiment, the codec is a Cirrus CS4299 audio codec. The codec 1416 provides analog-to-digital conversion for the microphone 1480 and for the line in 1482, and digital-to-analog conversion for the line out 1484. In some embodiments, the codec 1416 and the modem 1430 are combined as a telephone modem.

[0138] The modem 1410 provides an interface between the CPU 1402 and the communications network 1428 and the operational characteristics of the modem 1410 are determined by the type of communications network 1428. Thus, if the network 1428 is a PSTN network, then a telephone modem is used; if the network 1428 is a CATV network, then a cable modem is used, etc. In a preferred embodiment, the modem 1430 is integral to the network-enabled audio device. An Internet Service Provider (ISP) 1429 provides the user with a connection from the communications network 1428 to the Web via the Internet 1430. The server site 1104 can then be accessed, and the server site IPAN software 1433 can be used by the user to manage audio sources and devices. Note that Figure 14 shows functional elements, but not necessarily hardware configurations. Thus, for example, the modem 1410 can be implemented in software on the CPU 1402 or even on the CPU Support Chip 1406. The CPU 1402 is a single computer processor, or multiple computer processors. In one embodiment, the CPU 1402 comprises two processors, a Digital Signal Processor (DSP) and a general purpose microprocessor. In one embodiment, the modem 1410 is provided in a plug-in module such that the intelligent radio can be configured for different types of computer networks by simply changing the modem plug-in to suit the type of network being used.

[0139] Optionally, the microphone 1480 is connected to a second port of the codec 1416. An analog output from the microphone 1480 is provided to the codec 1416. A digital output from the codec 1416 is provided to the CPU 1402. The microphone 1480 allows for voice commands to control the network-enabled audio device. The microphone 1416 is optional. In one embodiment, a microphone (not shown) is also placed in a wireless remote so that voice commands can be provided from the wireless remote. Optionally, headphones can also be used.

[0140] The CPU 1402 provides data to the display device 1408. The CPU 1402 receives user inputs from the shuttle control 1214, the group of menu buttons 1212, the enter button 1202, and the action button 1210.

[0141] A system bus interface interconnects the CPU 1402 to the CPU Support Chip 1406. In one embodiment, the CPU Support Chip provides digitized audio samples to an input of the Digital-to-Analog Converter (DAC) 1470. The analog audio output of the DAC 1470 is provided to the amplifier 1422. In one embodiment, the DAC 1470 and the amplifier 1422 are each two-channel devices, providing left and right stereo channels. Channel outputs of the amplifier 1422 are provided to the speakers 1303. The volume control controls the gain of the amplifier 1422. In one embodiment, the amplifier and speakers are part of an external stereo system.

[0142] The CPU support chip 1406 is also operably connected to a CD player 1426 which outputs audio to the amplifier 1422 or an external amplification system. The CPU Support Chip 1406 or optionally the CPU 1402 also maintains software for managing the transfer of audio files from CD's to the network-enabled audio device's hard drive.

[0143] Figure 15 illustrates a configuration for assigning playlists and audio sources to a network-enabled audio device 1510 or other devices such as a PC 1508 from a network-enabled audio device 1520 or another device. Each network-enabled audio device 1510 has a storage space 1512 for network-enabled audio device IPAN software 1526, a playlist 1528, and associated URL's and songs within the playlist. Similarly, each network-

enabled audio device 1520 has a storage space 1522 for network-enabled audio device IPAN software 1526, a playlist 1528, and associated URL's and songs within the playlist. Each client PC 1508 has a storage space 1524 for client IPAN software 1532, a playlist 1534, and associated URL's and songs within the playlist. The server site 1104 includes server site IPAN software 1433, the playlist 1528 stored on the storage space 1522 of device 1510, the playlist 1530 stored on the storage space 1524 of the client PC 1508, and the playlist 1530 stored on the storage space 1522 of the device 1520. A storage space 1506 is provided to the server site 1104 for use in uploading and downloading audio files when URL's are broken. Storage space 1506 for the server site IPAN 1104 and other software programs can be stored externally or locally at the site.

[0144] Each network enabled audio device 1510 has storage space 1512 for a playlist 1528, which is a list of audio files and associated URL's of where the audio files were retrieved from. Optionally, the associated URL's can be archived for only file formats that are streaming audio or MP3. Multiple playlists can be stored on the storage space 1512. In addition to the playlist 1528, the actual audio files listed in the playlist are also stored in the storage space 1512. The audio files can be streaming audio, Windows Media Audio (WMA), and other audio formats. The network enabled audio device 1520 performs the same functions as the network enabled audio device 1510 with the storage space 1522, the playlist 1530, the network-enabled audio device IPAN software 1526, and songs and associated URL's.

[0145] The PC client 1508 has a storage space 1524 for a playlist 1534 and associated URL's and songs in the playlist. PC IPAN client software 1532 is also stored on the storage space 1524. The PC client 1508 includes a web browser (e.g., Microsoft Explorer, Netscape Navigator, etc.), an IPAN plug-in to the web browser, and an IPAN active tray software module.

[0146] The IPAN plug-in opens as soon as the web browser is opened. The IPAN plug-in affects the handling of links to MP3 files, streaming audio, and any other audio file type designated. Whenever a user selects, saves, or opens a file

in the web browser, the IPAN plug-in intercepts the normal processing of the web browser and will check to see if the file is an audio file. If the file is an audio file, the IPAN plug-in will allow the user to download the audio file to the IPAN 1100 now or to schedule the file for download at a later time. In either case, the URL can be added to the playlist. Further, the IPAN plug-in will periodically connect to the server site IPAN software 1433 to receive software upgrades or to upload updates of the audio files present on the client PC 1433.

[0147] The web browser can be used to connect to the server site 1104 and provide access to the server site IPAN software 1433. The IPAN active tray software module runs in the background when the PC client 1508 is turned on. Without the web browser being opened, the IPAN active tray software module can play audio files in playlists.

[0148] At the server site 1104, the user can access the server site IPAN software 1433 through a network connection to the server site IPAN 1104 and from the server site IPAN software 1433 the user can assign playlists to different devices such as the network-enabled audio device 1510, the network-enabled audio device 1520, or the client PC 1508. The user composes the playlists from the server site IPAN software 1433, but typically only stores the title of the song and the URL from which the song came. The playlists stored throughout the IPAN 1100 are also stored in the server site IPAN 1433. The user then has a master list of where all playlists are located. When the device 1510 connects to the server site IPAN 1104, a playlist is assigned to it. Within the playlist, the URL's indicate the location from which the audio files associated with the song titles in the playlist can be downloaded. The network-enabled audio device 1510 then proceeds to download the song from the given site specified by the URL to the disk space 1512 on the device 1510. If the site at the URL is not working, the server site IPAN software 1433 will upload the playlist from the disk space 1522 of another device 1520 the next time the second device 1520 connects to the network. The next time the original device 1510 calls in, it will download the playlist from the server site 1104.

[0149] Further, the server downloads software upgrades, if necessary, when

the device accesses the IPAN 1433. For example, if the disk space in a device that was supposed to have a playlist was accidentally erased, then the server site 1104 provides the URL's for sites to download the lost playlists. In addition, the server site 1104 downloads any other software used to enhance the communications between the server and the device. Software can also be downloaded to be used by the CPU 1402 or the Support Chip CPU 1406.

[0150] In one embodiment, there is no server site 1104. The PC IPAN client software 1532 stores the playlists that are located throughout the IPAN 1100. Through a network connection, the PC IPAN client software assigns playlists to devices 1510 and 1520.

[0151] Figure 16 illustrates the connection steps used when the user first sets up the network-enabled audio device. A user begins at process block 1601 by connecting the speakers and radio antennas to the back of the unit. The user also takes other preparatory measures such as plugging in the AC power cord and connecting a phone cable to a telephone jack. At the next process block 1602, the user can choose to begin listening to preloaded music without setting up any of the software by pressing the power button 1204 on the machine and pressing the "Listen Now/Setup Later" button on the first screen. The user can thus listen to preloaded music before even setting up the software for the network-enabled audio device. The process then advances to the next process block 1603 where the user can scroll through the playlists of preloaded music by using the shuttle control 1214 and the enter button 1216. At the next process block 1605, the user begins to set up the network-enabled audio device 1200 by inserting a setup CD into the CD player 1220. The process advances to process block 1606 where the user returns to the first screen and selects "Setup Now" in order to begin loading the PC IPAN client software 1532 on the network-enabled audio device 1200.

[0152] Figures 17A through 17I show various displays provided by the PC IPAN client software 1532 and the server site IPAN software 1433. In one embodiment, these displays are produced by web pages provided by the server and display on the user's PC in a web browser. Figure 17A illustrates a Playlist Manager window 1700 that appears when a user runs the PC IPAN client

software 1532 and the server site IPAN software 1433. The user-control buttons in the Playlist Manager window include a client feature control button 1702, an audio player window button 1704, a create new playlist button 1706, a delete button 1708, a schedule button 1710, a play button 1712, a scan hard drive button 1714, an add device button 1716, and a synchronize button 1718. Personal Audio Information Tabs 1726 allow the user to view classifications for audio such as by artist or playlist. The display playlist and song button 1740 provides access to audio and devices such as PC's, network-enabled audio devices 1200 and 1300, portable audio devices, etc. Access is provided as a tree control in the playlist window 1780. The playlist window 1780 displays playlists, the title window 1720 displays songs in the playlist, an arrow button 1760 provides for addition of songs to playlists, and an arrow button 1799 provides for deletion of songs from playlists.

[0153] The Client Feature control button 1702 allows the user to select a desired playlist or other audio source to listen to. The client feature control button also allows the user to control the look and feel of the window such as color and background designs ("skins") etc. The user clicks the play button 1712 to play a selection. To control the volume, shuffle, repeat, and other playback functions, the user clicks the audio player window button 1704. A new popup window appears with buttons for each of those functions. In addition to choosing a playlist, the user can compose a new playlist. The user clicks the new playlist button 1706 to create a new playlist by artist, album, or genre. The user can scan the PC's hard drive for music to incorporate into a playlist by clicking the scan button 1714. The user can also add a device to the IPAN 1433 by clicking the add device button 1716.

[0154] To help manage playlists and devices, the Playlist Manager 1700 provides personal audio information tabs 1726. The devices that can be managed include network-enabled audio devices 1200 and 1300, PC's, portable MP3 players, cell phones, etc. With the personal audio information tabs 1726, the user can view and manage the devices, playlists, and audio classifications by "All," "Playlist," "Album," "Artist," "Genre," "Books," or "Clips." The playlist

window 1780 lists the playlists selected by the personal audio information tabs 1726. The title window 1720 lists the songs in a playlist selected in the playlist window 1780. Songs are added to a playlist listed in the playlist window 1780 using the arrow button 1760 and removed from a playlist listed in the playlist window 1780 using the arrow button 1799. The user deletes audio files from the IPAN 1100 by selecting the file and pressing the delete button 1708. Further, the user can schedule playlists or streams to be heard at designated devices and at designated times by using the schedule button 1710. The user can synchronize with the server site IPAN 1433 by clicking the synchronize button 1718. Playlists are stored on the server site IPAN 1433 in addition to the PC IPAN client 1508 or device 1510. In other words, a playlist may have been updated at the server site IPAN 1433 by adding or deleting some songs in the playlist. The user can choose to have the same playlist with two different songs at the server site 1104 and on the device 1200 or 1300. But, if the user made the playlist at the server site IPAN 1433, the user presses the synchronize button 1718 so that the next time the device 1200 or 1300 connects, an updated playlist will be downloaded. To access a playlist or the playlists on a particular device, the user clicks the display button 1740.

[0155] Figure 17B illustrates the display of an audio player window 1792 that includes a previous track button 1782, a play button 1784, a stop button 1786, and a next track button 1790. The audio player window 1792 is invoked by pressing the audio player window button 1704. A volume indicator 1794 displays the current volume. The user can click on the volume indicator 1794 to drag it higher or lower to a different volume. The user can click the shuffle button 1796 to "randomize" the playlist as opposed to playing the playlist in the same order. Further, the user can press the repeat button 1798 in order to have continuous play as opposed to the playlist stopping when it runs out of songs to play. The playlists will typically start from the beginning.

[0156] Figure 17C illustrates the display of the audio player window 1700 showing popup menus that appear when the user attempts to assign a highlighted playlist to another device. After the user highlights a song, the user can

right-click on the song in order to have a popup menu 1761 appear with a variety of options such as "Load," "Play," "Blast To," "Copy To," "Make Available On," and "Delete." The user can choose the menu option of "Make Available On" to assign the playlist from one device to another, (e.g. from device 1510 to device 1520). The addition of the device 1510, the device 1520, a portable player, a PC, etc. to the IPAN 1100 will be discussed with reference to Figure 17I. Once the "Make Available On" option is chosen, another window 1762 appears with options of devices for the playlist to be assigned to. In Figure 17C, the playlist is assigned to "Living Room iRad-S" instead of "Office Desktop computer," "Portable Player," or "Home Desktop Computer."

[0157] Figure 17D illustrates one embodiment of how the list of songs in a playlist is displayed. A speaker icon 1762 is used to indicate a local audio file. In other words, the audio file is located on some storage space within one of the devices (e.g., a network enabled audio device 1200 or 1300, a PC, a portable player, etc.). A speaker outline icon 1763 indicates a link to an audio file located elsewhere on another device within the IPAN 1100. The link can be clicked in order to see what other devices, if any, the file is located on.

[0158] Figure 17E illustrates a scheduling window 1763 that opens in response to the pressing the schedule button 1710. The user can schedule playlists to be played at a particular time and on a particular device. The network-enabled audio device will automatically turn on at the scheduled time and play the given playlist. The user controls can be disabled in order to prevent a user at a remote location from changing the music scheduled to be played at the given time. Optionally, the user controls can be disabled in order to prevent the network-enabled audio device from being turned off. The scheduling window 1763 allows a user to highlight dates on a calendar and choose devices from menus to be played at a specific time. The user can also choose to interactively play the selected playlist on a day of the week at a particular time. For example, the user can choose to have a selected playlist played every Monday, Tuesday, Wednesday, Thursday, and Friday at 6 p.m.

[0159] Figure 17F illustrates a popup menu for selecting the default look and

feel ("skin") of the IPAN client 1508. The user accesses the "skin" option by pressing the client feature control button 1702 and the client feature control menu 1764 appears. After the user selects "skin" from the client feature control menu 1764, a "skin" menu 1765 appears to provide different "skin" options such as, for example, "Default," "Executive," "Space," "Sixties," and "Post Industrial." Figure 17G shows that the "skin" menu 1765 also provides a "Get More Skins" option to allow the user to see other "skins" besides the ones listed in the "skin" window 1765.

[0160] Figure 17H shows how the user can choose to "blast" a playlist of the existing audio files from a device, such as a portable player, and replace them with a new playlist in one easy process. In other words, the user can delete the existing audio files from a playlist without deleting the playlist name and substitute new audio files for the old audio files. After the user selects a song, the user right-clicks on the song to open a window 1766 with the option "Blast To." When the "Blast to" menu item is selected, a popup menu 1767 appears to provide the user with a list of devices that the music can be "Blasted" to. Devices such as the network-enabled audio devices 1200 and 1300, PC's, portable players, etc. can be "Blasted" to.

[0161] Figure 17I illustrates a pop up window 1779 for adding a device to the IPAN. A plurality of fields 1771-1774 and a plurality of fields 1775-1778 are provided to allow the user to enter information concerning the new device to be added. The user enters the name of the new device to be added in the field 1771; the serial number of the device in the field 1772; the device type of the new device in the field 1773, the connection point in the field 1774; the time to automatically download to the new device in the field 1775; the maximum time for download duration in the field 1776, and a folder for receiving files in the field 1778. In addition an OK button 1791 and a Cancel button 1792 are provided. Finally, there is a download box 1793 that is checked to have new files and updates automatically downloaded to the device when it is connected to the IPAN 1100. A device can become a dedicated MP3 server by downloading files to the device every time an audio file is downloaded to any other device.

[0162] The user selects the type of device in the field 1773 from a list of devices supported by the IPAN 1100. The user may have more than one type of device in the IPAN 1100. Therefore, the user can enter a name in the field 1771 and the serial number in the field 1772 to distinguish similar devices. If the user designates a portable device, the device which the portable device will be connected to is entered in the field 1774 to provide the IPAN with information about how to access the portable device. The download time is entered in the field 1775 to provide the IPAN with the time when the user would like the device to automatically download. The default time is set to early morning (e.g. between midnight and 5 a.m.) because that is the time when the least amount of people are on the telephone and the Internet. The download duration is entered into the field 1776 to provide a maximum time limit for download duration if desired. The default is unlimited, but the user can set a maximum time so that if the download is not finished within the time limit, the device signs off. Before signing off, the current task will be completed. In other words, if the maximum time is exceeded in the middle of downloading the third song in a download of ten songs, the task of downloading the third song will be completed. The download will continue where it left off upon initiation of the next download command. In the previous example, the download will continue at the fourth song. Finally, the server site IPAN software 1433 will automatically install downloaded files in a designated folder unless the user specifies a different location in the field 1778.

[0163] Figures 18A through 18H illustrate the use of the display 1800 on the network-enabled audio device. In Figure 18A, the screen display 1802 includes a "Radio" menu item 1804, a "Playlist" menu item 1806, a "Favorites" menu item 1808, a "Jukebox" menu item 1810, a "CD" menu item 1812, and an "Internet Radio" menu item 1814. Residing in the lower portion of the display 1800, the menu buttons 1821-1825 are in the group of menu buttons 1212 and are provided to correspond to icons 1841-1845 residing in the lower portion of the display 1800. Each one of the icons 1841-1845 represents a different function to be performed with respect to a selected audio source.

[0164] The user selects items from the screen display 1802 by using the shuttle

control 1214 and the enter button 1216. For example, to select the "CD" audio source, the user presses right shuttle control 1264 until the "CD" menu item is highlighted. The user then presses the enter button 1216. Once an audio source is selected, context sensitive icons 1841-1845 appear above the corresponding menu buttons 1821-1825. Depending on the chosen audio source, the icons 1841-1845 represent different functions.

[0165] Figure 18B illustrates the screen display 1802 when the audio source is an AM/FM radio, such as the AM/FM "Radio" menu item 1804. The menu item 1804 is highlighted to indicate that the AM/FM "Radio" audio source has been chosen. The menu buttons 1821-1825 change context to correspond to icons that represent functions related to the audio source selected. Because the AM/FM "Radio" audio source was selected, the menu buttons 1821-1825 change context to correspond to the icons for an AM/FM tuner. The icons 1841-1845 shown as, respectively, a play icon 1841 corresponding to a play function 1830, a scan next icon 1842 corresponding to a scan next function 1832, a scan previous icon 1843 corresponding to a scan next function 1834, a radio presets icon 1844 corresponding to a radio presets function 1836, and a stop icon 1845 corresponding to a stop function 1838. As further illustrated in Figure 18C, if the menu button 1823 corresponding to the icon 1844 representing the radio presets function 1836 is pressed, the menu buttons 1821-1825 change context to correspond to icons 1841-1845 which represent the choice of preset stations with each of the functions 1870-1874 corresponding to a different radio station. In one embodiment, the radio source menu option 1804 is omitted.

[0166] Figure 18D shows the screen display 1802 after the user has selected the Playlist menu item 1806. The menu buttons 1821-1825 are used to select from various playlist icons 1841-1845. The icons 1841-1845 shown as, respectively, a play icon 1841 corresponding to a play function 1875, a record icon 1842 corresponding to a record function 1876, an export icon 1843 corresponding to an export function 1877, and back to previous menu icon 1845 corresponding to a back to previous menu function 1878. The shuttle control 1214 and the enter button 1216 are used to select a song from the playlist in order to play. The

record function 1876 will record a playlist to the network-enabled audio device's storage device 1510. The export mode downloads the playlist to a portable player. After a song is chosen from a playlist in Figure 18D, Figure 18E shows the menu buttons 1821 and 1822 changing context to correspond to icons 1840 and 1841. The icons 1841 and 1842 are shown as, respectively, a delete icon 1841 corresponding to a delete function 1848 and a back to previous menu icon 1850 corresponding to a back to previous menu function 1850.

[0167] Figure 18F illustrates the Jukebox audio source 1810, which provides a listing of all the audio files stored on the hard drive 1512 of the network enabled audio device 1510 by Title, Artist, Album or Genre. The menu buttons 1821 and 1822 change contexts to correspond go icons 1840 and 1841. The icons 1841 and 1842 are shown as, respectively, a play icon 1849 corresponding to a play function 1849 and a back to previous menu icon 1851 corresponding to a back to previous menu function 1851.

[0168] Figure 18G illustrates the CD audio source 1812 being selected. The menu buttons 1821-1823 change context to correspond to icons 1841-1843. The icons 1841-1843 are shown as, respectively, a Name CD icon 1841 corresponding to a Name CD function 1852, a Record CD icon 1842 corresponding to a Record CD function 1854, and a back to previous menu icon 1843 corresponding to a back to previous menu function 1856. The Record CD function 1854 can be used to copy tracks from a CD to the hard drive 1512 for future use in playlists. The Name CD function 1852 is used to retrieve a title name for a track and other information via the Internet from a CD database site after the Record CD function 1854 has been used to copy the CD to the hard drive. In one embodiment, an online database is checked via the Internet.

[0169] In Figure 18H, when the CD player is being played, menu buttons 1821-1825 change context to correspond to icons 1841-1844. The icons 1841-1845 are shown as, respectively, a previous track icon 1841 corresponding to a previous track function 1892, a pause icon 1842 corresponding to a pause function 1894, a next track icon 1843 corresponding to a next track function 1896, and a stop icon 1844 corresponding to a stop play function 1898.

[0170] Figure 19A is a flowchart that illustrates an audio query process 1900 of the IPAN 1100. The audio query process 1900 begins at start block 1940 where the PC IPAN client software 1532 is opened. In one embodiment, a portion of the PC IPAN client software 1532 is part of the "active tray" so that when a user turns the PC 1508 on, the PC IPAN client software 1532 is opened. Further, a portion of the PC IPAN client software 1532 is part of the IPAN plug-in so that when an Internet or other network connection is established, the PC IPAN client software 1532 runs in the background to query whether to add an audio file found on the Internet to the server site IPAN 1104. The process advances to a process block 1942 where the user finds a desired audio file as addressed by a URL. The user can search the Internet for audio without having to access the web site associated with the server site 1502. In a decision block 1944, the user is asked, through a menu, if the file is to be downloaded. If the process advances to a process block 1948, the user has decided to download the file now and the playlist is added to the IPAN 1100. At a process block 1950, the file has been downloaded and is available for playing. If the user decides "NO" (i.e. to download the file at a later time or at the default time) the process advances to a process block 1946 to download the file at that default or more convenient time. The process then advances to a process block 1948 when the file is added to the IPAN 1100. The web site associated with the server site 1104 does not have to be opened. The PC IPAN client software 1532 will download the software to the hard drive of the PC 1508 and connect to the web site associated with the server site 1508 to upload the audio files. At the final process block 1950, the audio files will be available for playing.

[0171] Figure 19B is a flowchart 1900 that begins at start block 1902 and illustrates the assignment of playlists to devices. The process advances from the start block 1902 to a process block 1904 where the user logs into the server site IPAN 1433. The process advances to the next process block 1908 where the user assigns a playlist to a first device 1510. In one embodiment, the playlist is stored in an SQL database and accessed via active server pages. After the active server pages access the SQL database, the playlist is downloaded to the first device

1510. The process then advances to a decision block 1908 where the process checks to see if all the songs in the playlist are stored in the first device's hard drive 1512. If all the songs in the playlist are already on the first device 1510, the songs on device 1510 are catalogued as being present. If songs need to be downloaded, the server site IPAN 1433 forms a list of remaining songs. In the next process block 1910, the server site IPAN 1433 compares the list of remaining songs to its records of the songs present on the device 1520 to see if the device 1520 has some of the necessary songs to complete the playlist formation. If the second device 1520 does have some of the remaining songs, the URLs of those songs, which are stored on the Server site IPAN, are provided to the first device 1510. The remaining songs which the second device 1520 does not have are deleted from the list of remaining songs and do not become part of the playlist. In the next process block 1914, the first device 1510 will download the songs from the URLs provided to it by server site IPAN 1433. The first device 1510 downloads all of the remaining songs needed for the playlist from the second device's 1520 URL's, but if all the songs are not on the second device's 1520 playlist, the first device 1510 will either get them from another device or in the worst case compose a playlist from only the songs that could be retrieved.

[0172] In the decision block 1916, the process determines if any URLs are broken. If A is unable to download the files from the URLs, the server site IPAN 1433 will upload the files to the server site in process block 1920, store the files in the interim, and download the files to the first device 1510 in process block 1922 the next time the first device 1510 calls in. For instance, the first device 1510 can be located on the east coast, and the second device 1520 can be located on the west coast. The first device 1510 may be assigned a playlist that is stored on the disk drive 1522 of the second device 1520. When the first device connects (e.g., at 2 a.m.) to the server site IPAN 1433, the first device will receive the URL's for the location where the second device 1520 downloaded the audio files and now the first device 1510 can download the audio files. If the URLs are broken, the first device 1510 will disconnect. When the second device 1520 calls in three hours later at 2 a.m. Pacific Time, the server site IPAN 1433 will upload the audio files

to the server site 1104 and store the files on the disk space 1506. When the first device 1510 connects at 2 a.m. the following evening, the audio files will be ready to download from the server site 1104 to the first device 1510. The audio files will finally be stored on the disk space 1512.

[0173] At process block 1922, the songs that are present on the device 1510's storage space, the songs that have been downloaded from URL's to the device 1510, and the songs that have been uploaded to the device 1520 are catalogued in the IPAN 1100. In one embodiment, the songs are catalogued in the IPAN 1100 at the time that they are found. For instance, the songs that are on the device 1510's hard drive found at the process block 1908 can be catalogued in the IPAN 1100 at that time rather than at process block 1922. Further, the songs downloaded from URL's can be catalogued at process block 1916 or decision block 1916. Finally, the songs uploaded from the device 1520 can be catalogued at the time of uploading at process block 1918 or at the time of downloading at process block 1920. Optionally, delays in cataloguing can be used. In one embodiment, for example, the uploaded songs and the downloaded songs are all catalogued at process block 1920 whereas the songs present on the device 1510's storage space are catalogued at the decision block 1908.

[0174] Figure 19C is a flowchart 1980 that illustrates another embodiment of the process of flowchart 1900. In one embodiment, the flowchart 1980 has process and decision blocks that handle an assignment of a playlist that includes songs not present on the device 1510. The process advances from the start block 1902 through 1908 in the same fashion as the process in flowchart 1900. In contrast to the process in flowchart 1900, the process then advances to decision block 1990 rather than 1910. At decision block 1990, if songs need to be downloaded, the server site IPAN 1433 checks its records to see if the device 1520 has all the necessary songs on the list of remaining songs to complete the playlist formation. If the device 1520 has none or some but not all of the necessary songs, the process advances to a process block 1950. At the process block 1950, the necessary songs that are not present on the device 1520 are catalogued in the new playlist with empty cone icons next to those songs. Optionally, the icon can

be a symbol other than an empty cone. The playlist is not yet completely formed and will have additions of songs that are present on the device 1520 at a later point in the process. The process then advances to a process block 1952 and deletes songs that the device 1520 does not have from the list of remaining songs. The process then advances to decision block 1954 to determine if the list of remaining songs is empty. If the list of remaining songs is empty, then the process advances to process block 1922 where the songs present on the device 1510's storage space 1512 are catalogued in addition to the missing songs that are catalogued. In one embodiment, cataloguing does not include multiple entries for songs determined to be present at an earlier time. For instance, if a song is present on a device and is catalogued once as being present on the device, a multiple entry for the song being present on the device will not be made at a subsequent iteration of the process. If the list of remaining songs is not empty, the process advances to the process block 1912. At the process block 1912, the process in the flowchart 1980 proceeds in the same fashion as the process in flowchart 1900 until the process advances to the process block 1922. After all the songs (including the missing songs) are catalogued at the process block 1922, the process advances to the process block 1960 where the list of remaining songs is deleted. At the process block 1962, if the playlist does not contain any songs with an empty cone icon, the playlist is complete and the process advances to the end process block 1924. If the playlist contains any songs with an empty cone icon, the process advances to the decision block 1964 to allow the user to delete the missing songs. If the user deletes the missing songs, the playlist is complete, and the process advances to the end process block 1924. If the user decides not to delete the missing songs, a new list of remaining songs is created consisting of the missing songs not deleted by the user. The process then advances to the decision block 1990.

[0175] At the decision block 1990, if the device 1520 initially had all the remaining songs on the playlist, the process 1980 proceeds in the same fashion as the process 1900. In one embodiment, if the process advanced from the process block 1966 rather than 1908, the missing songs have been added to the storage

space 1522 of the device 1520 so that the playlist can now be complete. The process advances through iterations until all the songs present on the playlist are present on the storage space 1512 of the device 1510 or until the user deletes songs from playlist so that no missing songs are present. In one embodiment, the process advances from the process block 1966 to the decision block 1908 in order to check whether the missing songs have been added to the storage space 1512 of the device 1510 or the storage space 1522 of the device 1520 so that the playlist can now be complete.

[0176] In one embodiment, the IPAN 1100 includes a network connection so that the first device 1510 and the second device 1520 can have audio files downloaded from the first device 1510 to the second device 1520 almost instantaneously after the assignment of an audio file to the device 1510. For example, in a home network, the device 1510 does not need to connect to the Internet and can retrieve the necessary file through the network connection.

[0177] Figures 20A-20F illustrate the use of the action button 1210 on the network-enabled audio devices 1200 or 1300. Figure 20A illustrates the screen display 1802 before the action button 1210 has been pressed. In one embodiment, the action button 1210 can be pressed when an audio source (e.g. an audio source in MP3 file format) with an unidentified artist is playing. Optionally, the action button 1210 can be pressed when an audio source in MP3 file format with an identified artist is playing. Optionally, the action button 1210 can be pressed for audio sources such as, for example, streaming audio, files in WMA file format, CDs, etc. The menu buttons 1821-1825 represent the functions that can be performed on the given audio source before the action button 1210 is pressed. For an MP3 file, for example, the menu buttons 1821-1825 correspond to a "pause" function, a "next" function, a "previous" function, an "add favorites" function, and a "stop" function. After the action button 1210 is pressed, the menu buttons 1821-1825 change context to perform functions that provide additional information on the given audio source and artist. Further, after the action button 1210 is pressed, the artist will no longer be shown as "unknown" because the audio source will be uploaded to a server for analysis to determine the

identification of the artist. The server will download the identity of the artist in addition to other information concerning the audio source.

[0178] Figure 20B illustrates the screen display 1802 after the action button 1210 has been pressed. The "unknown" artist in Figure 20A has been determined to be "Moby," and the unidentified MP3 file has been identified as "Porcelain." The menu buttons 1821-1825 correspond to menu items that provide information on, or related to, the audio source. A title menu 2002 is provided to indicate the location in the directory of action button options that the user has chosen. If the user is at the beginning of the action button directory structure, the screen display 1802 illustrates the text "action" in the title menu 2002.

[0179] The menu buttons 1821-1825 correspond to the menu items "news," "music," "tour," "offers," and "done." By choosing the menu item "news," information will be presented to the user of current events regarding the artist and/or the given audio source. For instance, the "news" function can display Billboard top 40 information, clothing lines introduced by the artist, new albums, etc. The menu button 1822 corresponding to the "music" menu item provides the user access to other audio sources from a given artist. The menu button 1823 corresponding to the "tour" menu item allows the user to get up-to-date information on tours that the artist is going on. The menu 1824 corresponds to the "offers" menu item which allows the user to receive information on merchandise, promotional items, etc. for the given artist. The menu button 1825 corresponding to the "done" menu item allows a user to turn off the action button 1210.

[0180] Figure 20C illustrates the screen display 1802 after the menu item "music" has been chosen. The menu path 2204 lists "action" to indicate to the user that the menu title "music" 2202 was a menu item chosen from the menu items illustrated in the screen shot denoted by the menu title "action." The menu buttons 1821-1825 correspond to the menu items "albums," "similar," "samples," "back," and "done." If the user selects the "albums" menu item the user will be able to view a list of other albums by the artist of the audio source. In one embodiment, the server downloads the albums listing when the action button

1210 is pressed for the first time. Optionally, the server downloads additional information after the user selects one of the menu buttons 1821-1825. When the user presses the menu button 1822, the "similar" menu item is chosen and a listing of albums that are from a genre of music similar to that of the audio source or from artists that are in some way similar to the artist of the audio source is presented. If the "similar" menu item is performed on Moby and "Porcelain," a list of techno songs from Moby and/or techno songs from other artists can be presented. If the user presses the menu button 1823 corresponding to the "samples" menu item, audio samples from the artist will be presented. If the user presses the menu button 1824 corresponding to the "back" menu item, the location illustrated in the menu title is returned to. If the user presses the menu button 1825 corresponding to the "done" menu item, the action button 1210 is turned off.

[0181] Figure 20D illustrates the screen display 1802 after the menu item "albums" has been chosen. The menu path 2204 lists "action/music" to indicate to the user that the menu title "albums" 2202 was a menu item chosen from the menu items illustrated in the screen shot denoted by the menu title "music." The menu buttons 1821-1824 correspond to different albums for the given artist. Figure 20D illustrates four of Moby's albums: "Moby," "Ambience," "Everything is Wrong," and "Animal Rights." The menu button 1825 corresponds to the "done" function which allows the user to turn the action button 1210 off.

[0182] Figure 20E illustrates the screen display 1802 after the menu item "Ambient" is chosen on the screen display 1802 illustrated in Figure 20D. The menu path 2204 action/music/albums shows that "Ambient" was chosen from the menu title "albums" 2202. The menu item "buy" is chosen to purchase the album "Ambient." The menu item "download" is chosen to download the "Ambient" album. The menu item "listen" is pressed to allow the user to listen to the album. The menu item "back" allows the user to access the previous menu title. To reach the screen shot with the menu title "albums" from the menu title "Ambient," the user chooses the "back" menu

item. The user can turn the action button off by pressing the "done" menu item.

[0183] Figure 20F illustrates the screen display 1802 after the user determines to buy the album illustrated in Figure 20E. The menu path action/music/albums/buy indicates that the user chose the "buy" menu item in Figure 20E. The title menu 2202 "complete" is used at the end of the transaction. The menu item "buy" can be chosen to allow the user to complete the transaction. To reach the screen shot with the menu title "Ambient" from the menu title "Complete," the user chooses the "back" menu item. The menu button 1825 corresponds to the menu item "done" which allows the user to turn the action button 1210 off.

[0184] In Figure 20B, if the menu item "news" is chosen by the user, the subsequent screen will display the menu path "action," the menu title "news," and the menu items: "listen," "read," "log to myactions," "back," "done." If the user chooses the menu item "read," a subsequent screen displays the menu path "action/news," the menu title "read," and the menu items "log to myactions," "back," and "done." If the user chooses the menu item "log to myactions," information about a particular artist or a particular audio source will be stored in a log for future reference. The displayed menu path will be "action/news/to myactions," the menu title will be "complete," and the menu items will be "back" and "done."

[0185] If instead of reading the news, the user would like to listen to the "news," the "listen" menu item can be chosen in the screen displaying the "action" menu path and the "news" menu title. The next screen will display the "action/news" menu path and the "listen" menu title. The screen will also alert the user as to the status of the retrieval of the news. The menu items include "log to myactions," "back" and "done."

[0186] In Figure 20C, the user can choose the menu item "samples" so that the next screen displays the menu path "action/music," the menu title "samples," and the menu items which include different audio source samples. After the user chooses a sample from the menu items of samples, a screen displays the menu path "action/music/samples," the title menu "Ambient," and

the menu items "buy," "download," "listen," "back," and "done." If the user chooses to select the "buy" menu item, the next screen displays the menu path "action/music/samples/buy," the menu title "complete," and the menu items "back," and "done."

[0187] In Figure 20B, if the user decides to select the menu item "tour," the next screen will display the menu path "action," the menu title "tour," and the menu items "appearing," "log to myactions," "back," and "done." If the user selects the menu item "appearing," the next screen will display a location or locations of tours for the given artist. For example, when the user presses "tour" for "Moby," the screen can display "December 13, 2000 Verizon Amphitheater Irvine CA." The screen will also display the menu title "appearing" and the menu items "log to myactions," "back," and "done." If the user selects the "log to myactions" menu item, the next screen displays the menu path "action/tour/appearing," the menu title "complete" and the menu items "log to myactions," "back," and "done."

[0188] In Figure 20B, if the user selects the "offers" menu item, the next screen displays the menu path "action," the menu title "offers," and the menu items "merch," "special," "back," and "done." If the user selects the menu item "merch," the next screen displays the menu path "action/offers," the menu title "merchandise," and the menu items "item one," "item two," "item three," "back," and "done." If the user selects the menu item "item one," the next screen displays the menu path "action/offers/merchandise," "item one," and the menu items "buy," "log to myactions," "back," and "done." If the user selects "buy," the next screen displays the menu path "action/offers/merchandise/buy," the menu title "complete," and the menu items "buy," "back," and "done." The screen also displays the artist and the item selected. For example, the screen displaying "Moby, Item 1" indicates that the user bought Item 1 by Moby. If instead of buying Item 1, the user wishes to keep a log of Item 1 for future reference, the user can upload that future reference to a server. For instance, in the next screen, the menu path can be "action/offers/merchandise/to myaudioramp." The menu title is "complete,"

and the menu items are "back" and "done."

[0189] In Figure 20C, if the user decides to choose "similar" music, the next screen displays the menu path "action/music," the menu title "similar," and the menu items that include audio sources similar to that of the artist with the given audio source. Menu items that can appear on the screen for "Moby," for example, are "808 state," "air," "aphex," "back," and "done." If the user decides to select the menu item "808 state," the next screen displays the menu path "action/music/similar," the menu title "808 state," the menu items "buy," "download," "listen," "back," and "done." If the user decides to buy "808 state," the next screen displays the menu path "action/music/similar/buy," the menu title "complete," and the menu items "back" and "done."

[0190] In Figure 20C, if the user decides to select the menu item "samples," the next screen displays the menu path "action/music," the menu title "samples," and the menu items that include audio source samples of the given album. The menu items for "Moby" can include "Moby," "Ambient," "Everything is Wrong," "Animal Rights," and "done,"

[0191] In Figure 20C, if the user selects the menu item "similar," the next screen displays the menu path "action/music/similar," the menu title "listen," and the menu items "back" and "done." The user can also choose to download the similar music. The next screen displays the menu path "action/music/similar," the menu title "download," and the menu items "back" and "done."

[0192] In Figure 21, after the action button 1210 is pressed, the audio-enabled device 1200 or 1300 can at times play advertisements. For a Nike advertisement, the text "Nike" would be displayed on the first line of the screen. The text of the advertisement, such as "radio free Sydney, air max knukini offer," can be displayed underneath the "Nike" text. The menu title "action" 2002 is displayed and the menu items "buy," "log to myactions," "more info," "offers," and "done" are displayed. If the user decides to buy the products offered in the advertisement, the next screen displays the menu path "action/buy," the menu title "complete," the menu items "back" and "done," and the advertisements are displayed. If the user decides instead to store the offer for a future

reference, the menu path "action/to myaudioramp" is displayed in addition to the menu title "complete," and the menu items "back" and "done" are displayed. If the user wishes to receive more information, the "more info" menu item can be chosen. The menu path "action/more info," the menu title "more info," and the menu items "buy," "log to myactions," "offers," and "done" are displayed.

[0193] While the above description contains many specifics, these should not be construed as limitations on the scope of the invention, but rather as an exemplification of preferred embodiments thereof. The various user controls and buttons can be relocated, combined, reconfigured, etc. Most of the user controls and buttons can even be omitted entirely in favor of voice-activated commands. One skilled in the art will recognize that many of the various features, and capabilities described in connection with the intelligent radio 100, are also applicable to other embodiments as well, including the embodiments described in connection with Figures 7-10 and the network-enabled audio device in Figures 13A-21. One skilled in the art will also recognize that other embodiments are contemplated, including, for example, handheld intelligent radios, and intelligent radios for boats, cars, trucks, planes, and other vehicles, etc.

[0194] One skilled in the art will recognize that these features, and thus the scope of the present invention, should be interpreted in light of the following claims and any equivalents thereto.

Claims

1. An electronic device comprising:
 - a) a network interface enabling the electronic device to receive an Internet radio broadcast;
 - b) a system enabling playback of audio content from an additional content source; and
 - c) a control system associated with the network interface and the system enabling playback of audio content from the additional content source, and adapted to:
 - i) enable a user of the electronic device to select a desired mode of operation from a plurality of modes of operation comprising an Internet radio mode of operation and an additional content source mode of operation;
 - ii) receive and play the Internet radio broadcast when the desired mode of operation is the Internet radio mode of operation; and
 - iii) play the audio content from the additional content source when the desired mode of operation is the additional content source mode of operation.
2. The electronic device of claim 1 wherein the additional content source is broadcast radio.
3. The electronic device of claim 1 wherein the additional content source is an optical disc.
4. The electronic device of claim 1 wherein the additional content source is a playlist.
5. The electronic device of claim 1 further comprising a data storage device, wherein the additional content source is the data storage device.

6. The electronic device of claim 1 wherein the network interface is further adapted to communicatively couple the electronic device to a central system and the additional content source is a playlist assigned to the electronic device via the central system, and the control system is further adapted to:

- a) receive the playlist assigned to the electronic device from the central system, the playlist identifying a plurality of songs, wherein ones of the plurality of songs are not stored on the electronic device;
- b) receive information from the central system enabling the electronic device to obtain the ones of the plurality of songs from at least one remote source; and
- c) obtain the ones of the plurality of songs from the at least one remote source.

7. The electronic device of claim 1 wherein the control system is further adapted to:

- a) send a request to a remote server for supplemental information related to a song in real-time while the song is playing;
- b) receive the supplemental information from the remote server; and
- c) present the supplemental information to the user of the electronic device.

8. An electronic device comprising:

- a) a network interface enabling the electronic device to receive an Internet radio broadcast;
- b) a system enabling playback of audio content from a plurality of additional content sources; and
- c) a control system associated with the network interface and the system enabling playback of audio content from the plurality of additional content sources, and adapted to:

- i) enable a user of the electronic device to select a desired mode of operation from a plurality of modes of operation comprising an Internet radio mode of operation and a plurality of additional modes of operation each corresponding to one of the plurality of additional content sources;
- ii) receive and play the Internet radio broadcast when the desired mode of operation is the Internet radio mode of operation; and
- iii) play the audio content from one of the plurality of additional content sources when the desired mode of operation is a corresponding one of the plurality of additional modes of operations.

9. The electronic device of claim 8 wherein the plurality of additional content sources comprises at least two of a group consisting of: broadcast radio, an optical disc, a playlist, and a data storage device of the electronic device.

10. The electronic device of claim 8 wherein the network interface is further adapted to communicatively couple the electronic device to a central system and one of the plurality of additional content sources is a playlist assigned to the electronic device via the central system, and the control system is further adapted to:

- a) receive the playlist assigned to the electronic device from the central system, the playlist identifying a plurality of songs, wherein ones of the plurality of songs are not stored on the electronic device;
- b) receive information from the central system enabling the electronic device to obtain the ones of the plurality of songs from at least one remote source; and
- c) obtain the ones of the plurality of songs from the at least one remote source.

11. The electronic device of claim 8 wherein the control system is further adapted to:

- a) send a request to a remote server for supplemental information related to a song in real-time while the song is playing;
 - b) receive the supplemental information from the remote server; and
 - c) present the supplemental information to the user of the electronic device.
12. A method of operation for an electronic device comprising:
- a) enabling a user of the electronic device to select a desired mode of operation from a plurality of modes of operation comprising an Internet radio mode of operation and an additional content source mode of operation;
 - b) playing an Internet radio broadcast when the desired mode of operation is the Internet radio mode of operation; and
 - c) playing audio content from an additional content source when the desired mode of operation is the additional content source mode of operation.
13. The method of claim 12 wherein playing the audio content comprises:
- a) receiving audio content from a broadcast radio source; and
 - b) playing the audio content from the broadcast radio source.
14. The method of claim 12 wherein playing the audio content comprises:
- a) obtaining audio content from an optical disc; and
 - b) playing the audio content from the optical disc.
15. The method of claim 12 wherein playing the audio content comprises:
- a) obtaining audio content identified by a playlist; and
 - b) playing the audio content identified by the playlist.
16. The method of claim 12 wherein playing the audio content comprises:

- a) obtaining audio content from a data storage device of the electronic device; and
- b) playing the audio content from the data storage device.

17. The method of claim 12 wherein the additional content source is a playlist assigned to the electronic device via a central system, and the method further comprises:

- a) receiving the playlist assigned to the electronic device from the central system, the playlist identifying a plurality of songs, wherein ones of the plurality of songs are not stored on the electronic device;
- b) receiving information from the central system enabling the electronic device to obtain the ones of the plurality of songs from at least one remote source; and
- c) obtaining the ones of the plurality of songs from the at least one remote source.

18. The method of claim 12 further comprising:

- a) sending a request to a remote server for supplemental information related to a song in real-time while the song is playing;
- b) receiving the supplemental information from the remote server; and
- c) presenting the supplemental information to the user of the electronic device.

19. A method of operation for an electronic device comprising:

- a) enabling a user of the electronic device to select a desired mode of operation from a plurality of modes of operation comprising an Internet radio mode of operation and a plurality of additional modes of operation;
- b) playing an Internet radio broadcast when the desired mode of operation is the Internet radio mode of operation; and

c) playing audio content from one of the plurality of additional content sources when the desired mode of operation is a corresponding one of the plurality of additional modes of operations.

20. The method of claim 19 wherein the plurality of additional content sources comprises at least two of a group consisting of: broadcast radio, an optical disc, a playlist, and a data storage device of the electronic device.

Abstract of the Disclosure

A network-enabled audio device that provides a display device that allows the user to select playlists of music much like a jukebox is disclosed. The user can compose playlists from disk files, CD's, Internet streaming audio broadcasts, online music sites, and other audio sources. The user can also select a desired Web broadcast from a list of available Web broadcasts. In addition, the user can play standard audio CD's and MP3 encoded CD's and have access to local AM/FM stations. Further, the software, the user controls, and the display in the network-enabled audio device are operably configured and connected such that the user can listen to playlists that include CD's and other audio sources just as the user would choose a playlist in a jukebox. The user accesses a server site via a PC and the Internet. From the server site, the user obtains a list of the devices in his or her Internet Personal Audio Network (IPAN) and what songs are on those devices. The IPAN includes an IPAN server, an IPAN client, and IPAN software stored on the network-enabled audio device. Thus, the network-enabled audio device provides people who are or are not comfortable with computers a way of taking music from various sources and putting it into one place for listening pleasure. In one embodiment, the Personal Computer (PC) is used to compose the playlists, but the user is able to listen to playlists and other audio sources without using the PC.

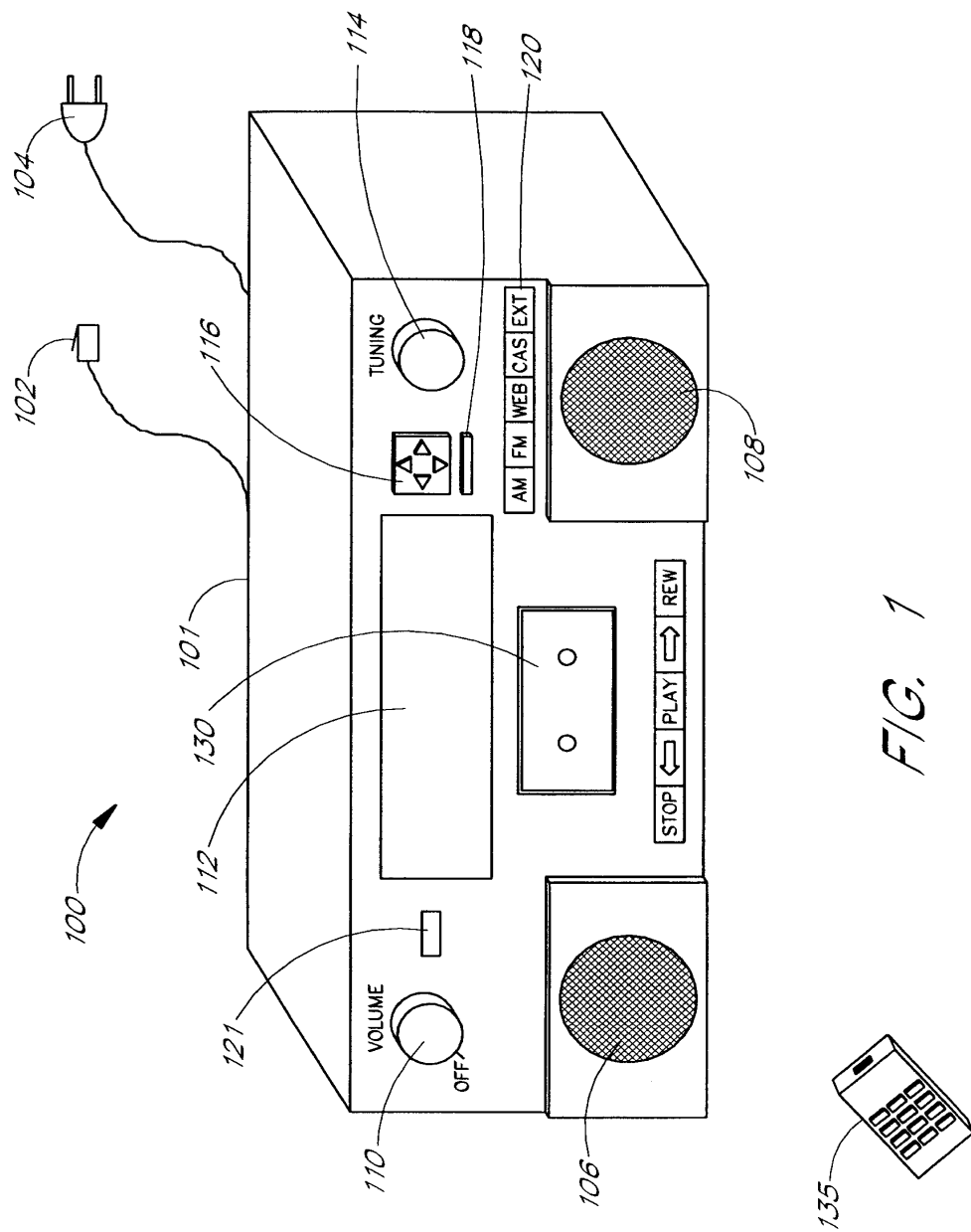

FIG. 1

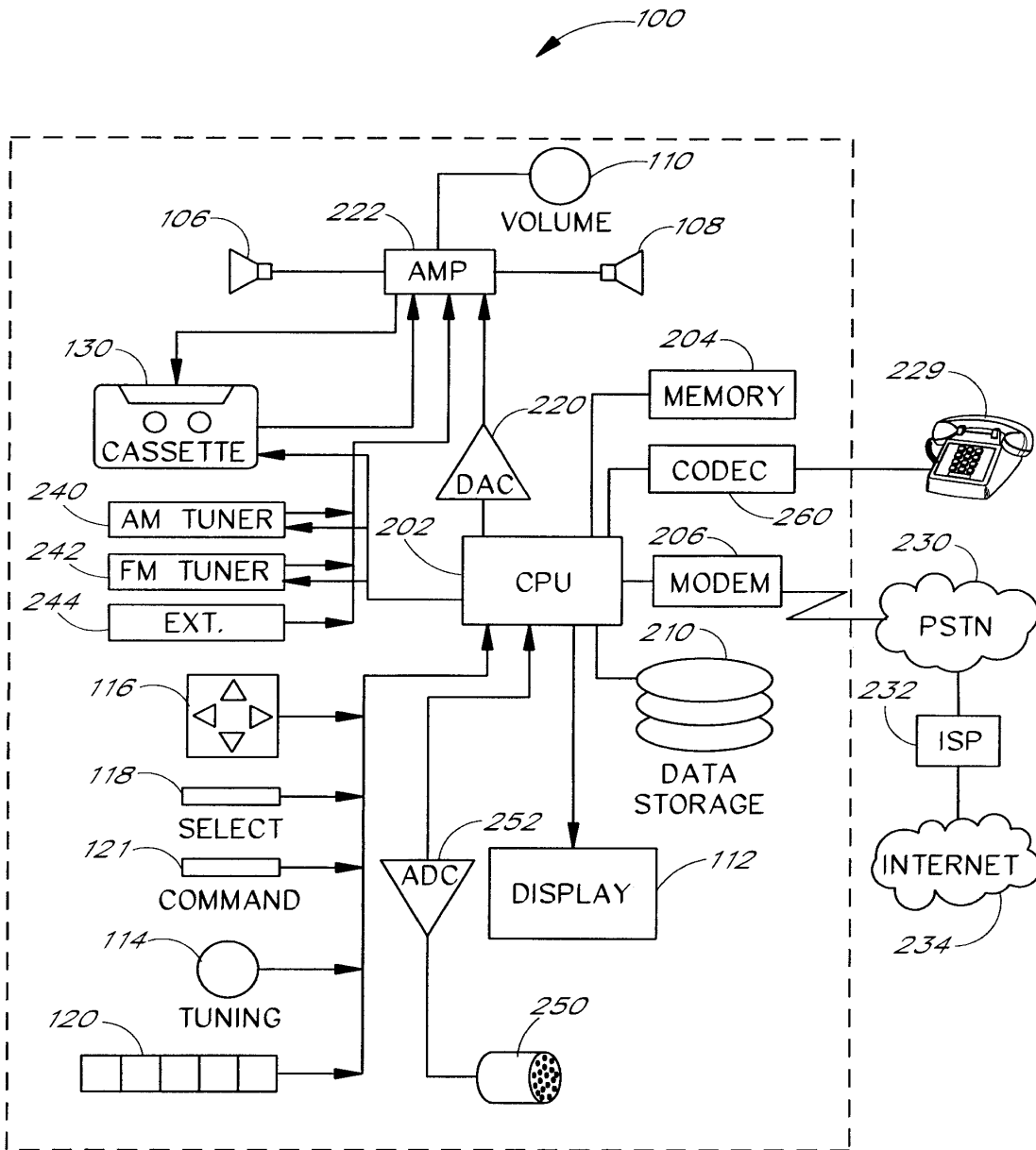

FIG. 2

300

Clip	pnm: //audio.npr.org/news.auto.ra
11:01 Newscast - 17-August-1997 http://www.npr.org/ National Public Radio 1997	
Status: Streaming RealAudio from audio.npr.org...	
Pre-recorded Net Bandwidth: 96% Ch. Rate 8000bps	

FIG. 3A

320

323

TUNE STATION

SET CLOCK

SET ALARM

SCAN STATIONS

SELECT LANGUAGES

DEFINE STATION

321

322

FIG. 3B

310

LANGUAGES

<p>313</p> <p><input checked="" type="checkbox"/> ENGLISH</p> <p><input type="checkbox"/> FRENCH</p> <p><input type="checkbox"/> GERMAN</p> <p style="text-align: right;">312</p>	<p>▲</p> <p>□</p> <p>▼</p> <p style="text-align: center;">314</p>	<p>315</p> <p style="border: 1px solid black; display: inline-block; padding: 2px;">OK</p> <p>316</p> <p style="border: 1px solid black; display: inline-block; padding: 2px;">CANCEL</p> <p>317</p> <p style="border: 1px solid black; display: inline-block; padding: 2px;">CLEAR ALL</p> <p>318</p> <p style="border: 1px solid black; display: inline-block; padding: 2px;">SELECT ALL</p>
-----------------------------------------------------------------------------------------------------------------------------------------------------------------------------------	-------------------------------------------------------------------	------------------------------------------------------------------------------------------------------------------------------------------------------------------------------------------------------------------------------------------------------------------------------------------------------------------------------------------------------------------------------------------------

FIG. 3C

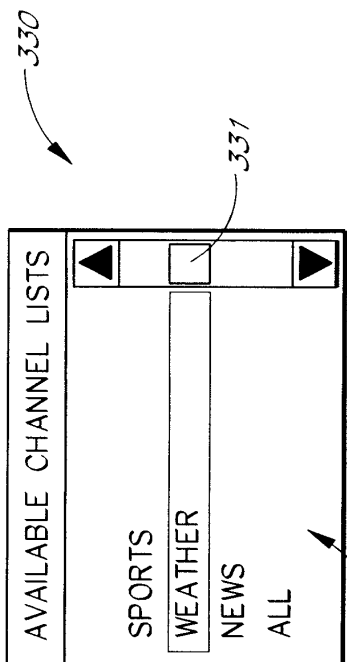

FIG. 3D

FIG. 3E

ID	Description	Address
<input type="checkbox"/>	ABC Hourly News	http://www.rbn.com/clg-bin/r.pl?swave/abc/wnews.ra
<input type="checkbox"/>	AirForce Radio News update	http://www.af.mil/news/radio/latest.ram
<input checked="" type="checkbox"/>	Citynews from around the w...	http://www.citynews.co.uk/
<input type="checkbox"/>	CounterSpin-weekly rt win...	http://www.webactive.com/webactive/content/cspin
<input type="checkbox"/>	The Daily Feed- Satire colu...	http://www.dailyfeed.com/Latest_Feed.html
<input type="checkbox"/>	Environmental Information...	http://www.webactive.com/webactive/audio/raconten
<input type="checkbox"/>	Earth and Sky daily update	http://www.earthsky.com/today ram
<input type="checkbox"/>	Iowa Agrigulture news	http://www.wagnews.com/features/news/ianews.html
<input type="checkbox"/>	Leeza's entertainment upda...	http://www.premrad.com/
<input type="checkbox"/>	Missouri Farm Report	http://www.agnews.com/audio/momr.ram

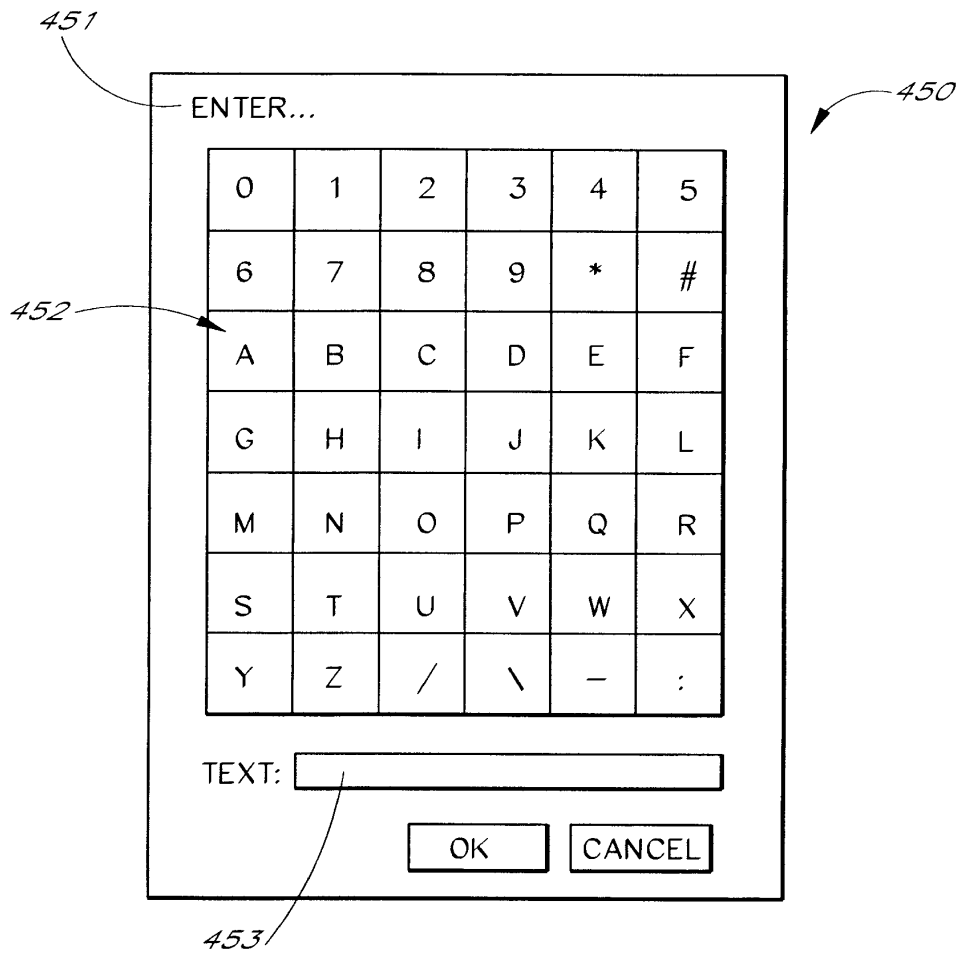

FIG. 4

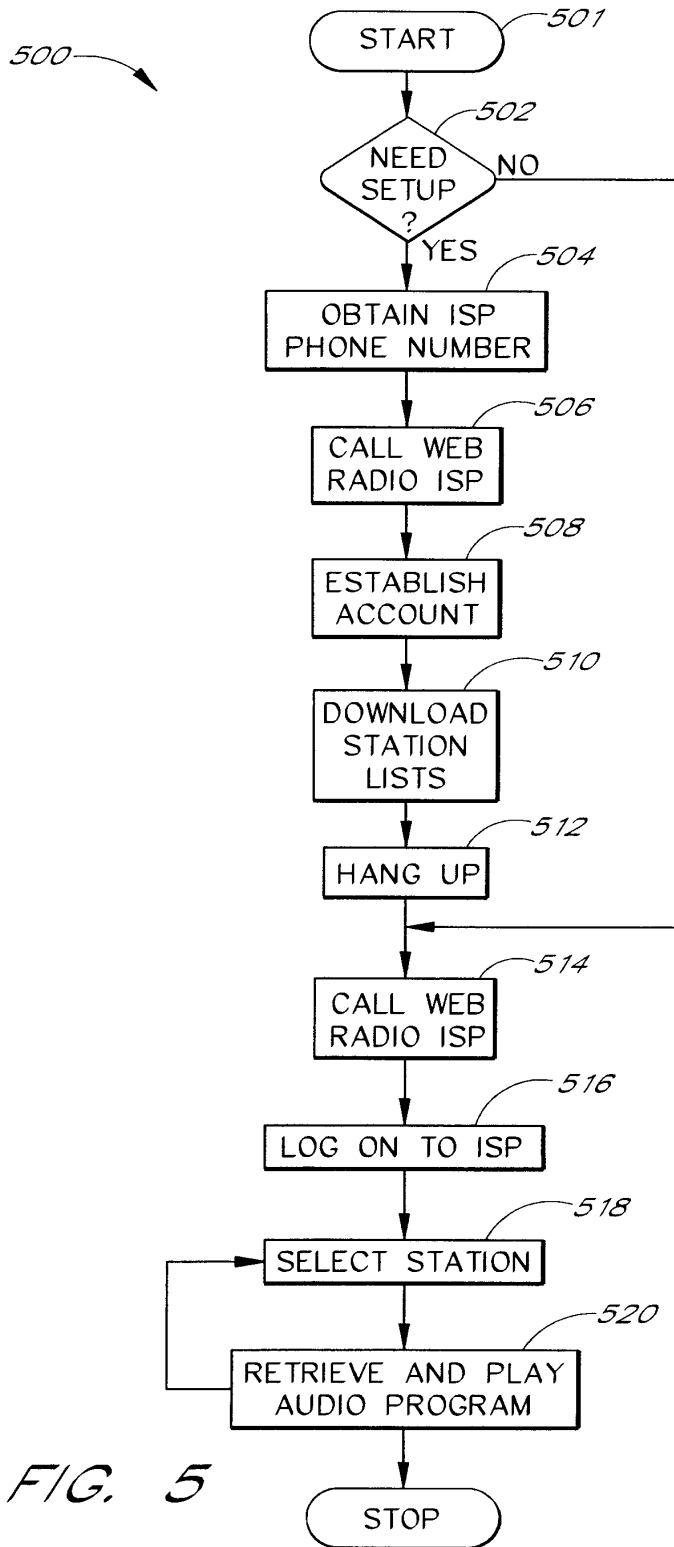

FIG. 5

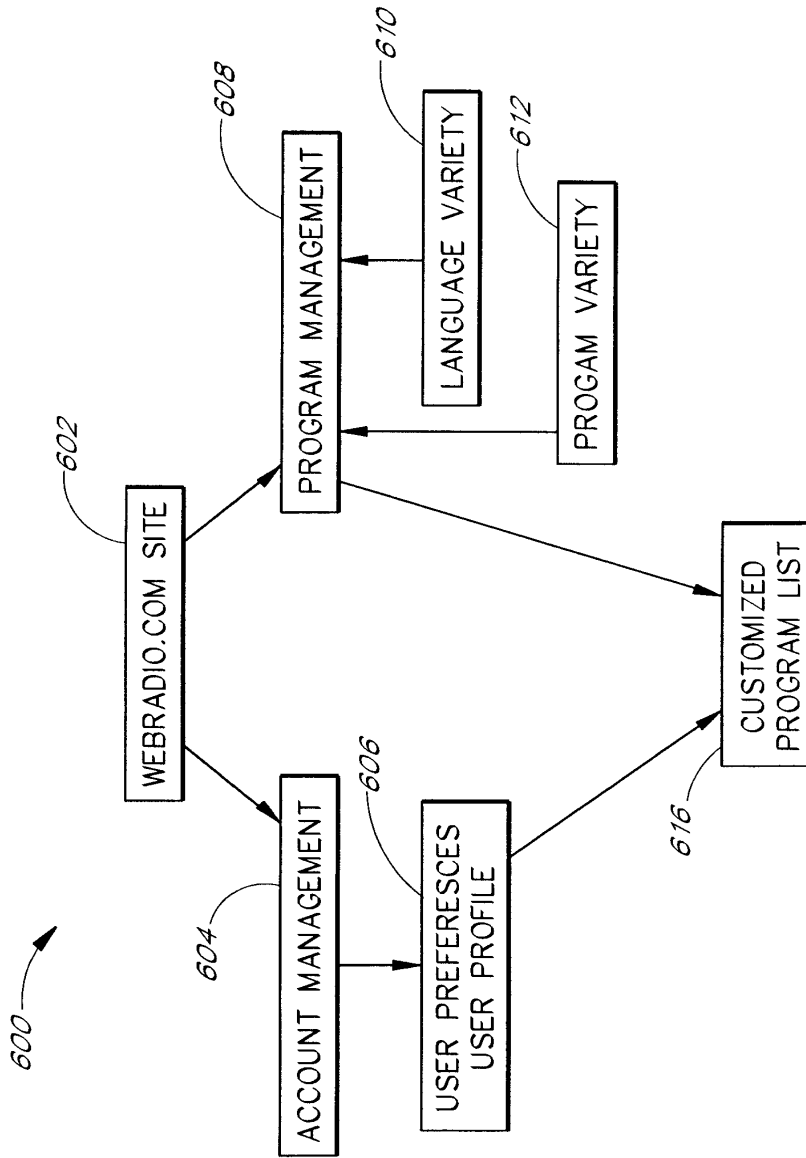

FIG. 6

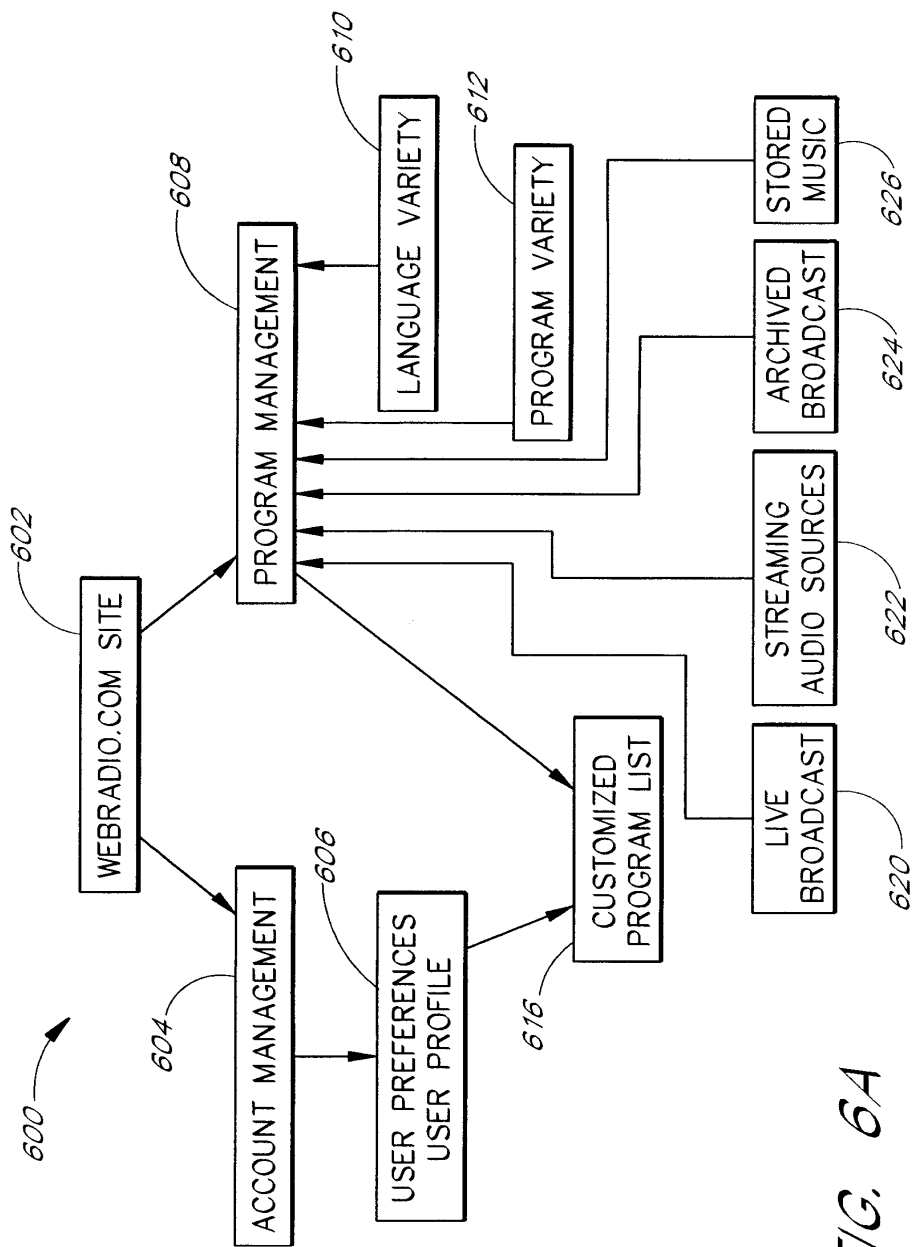

FIG. 6A

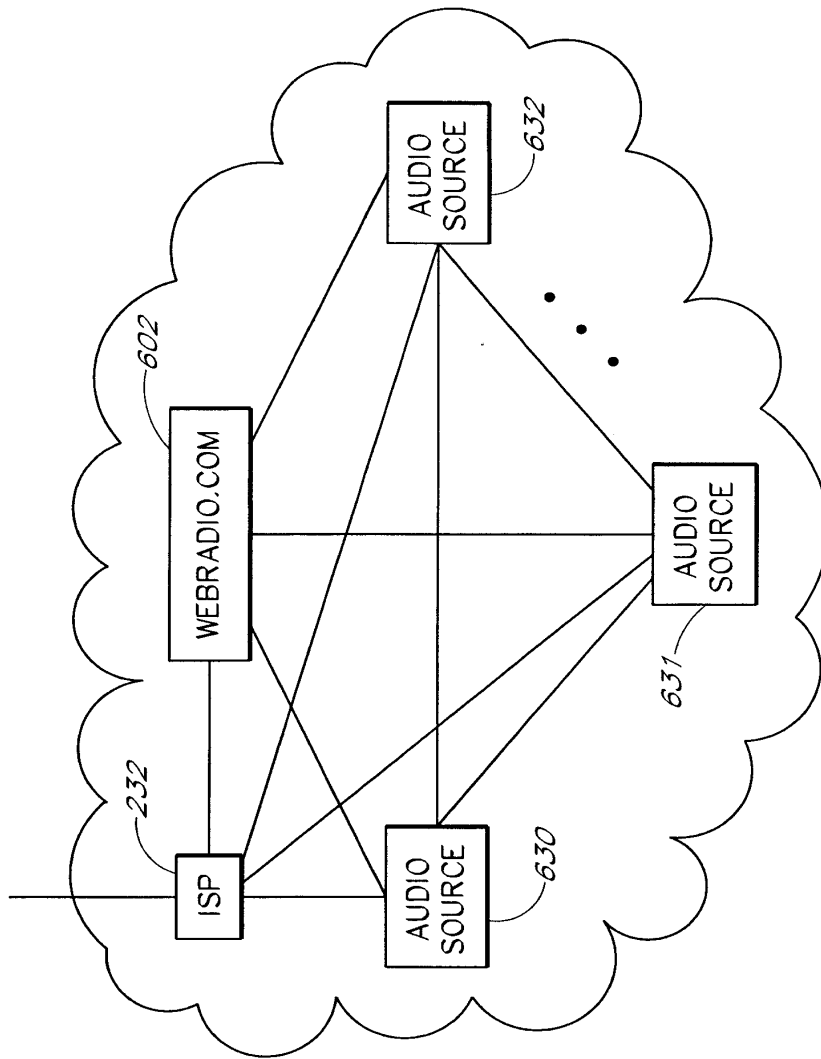

FIG. 6B

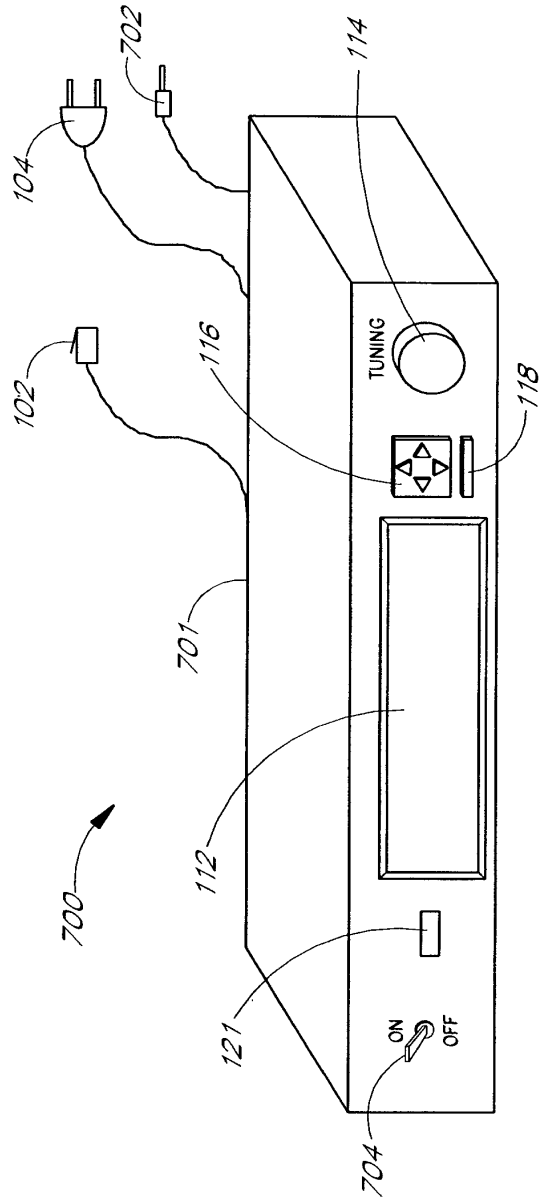

FIG. 7

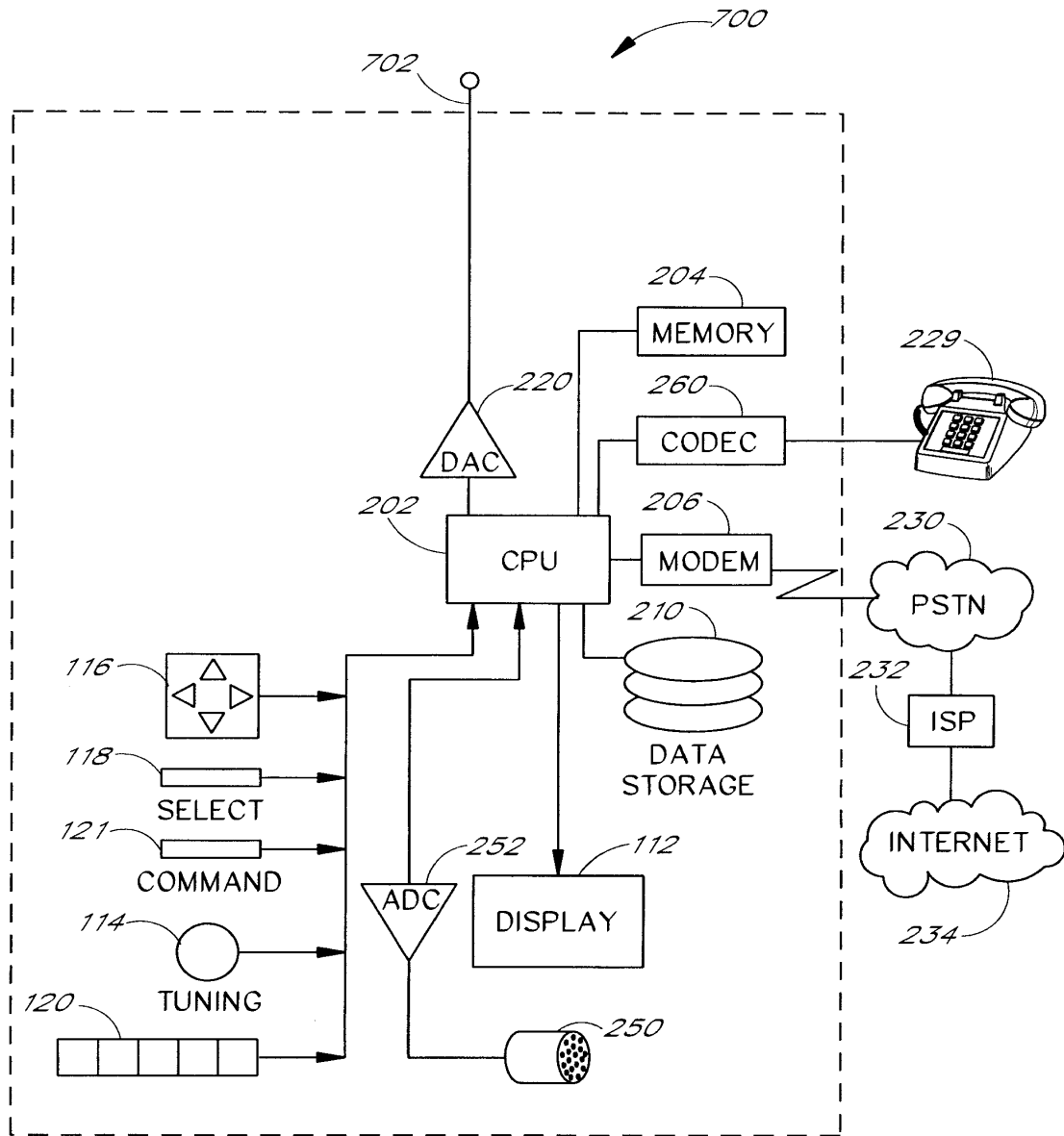

FIG. 8

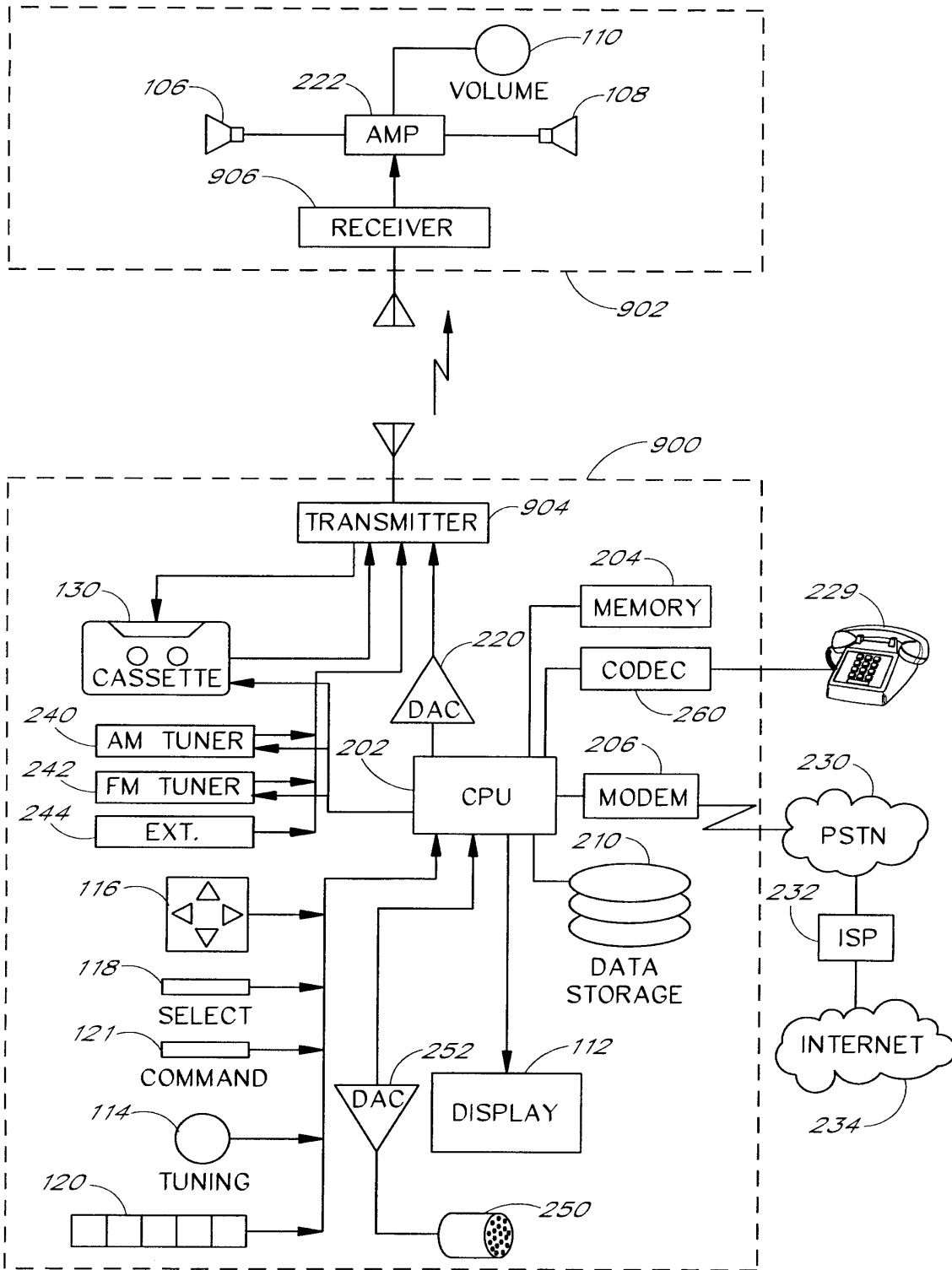

FIG. 9

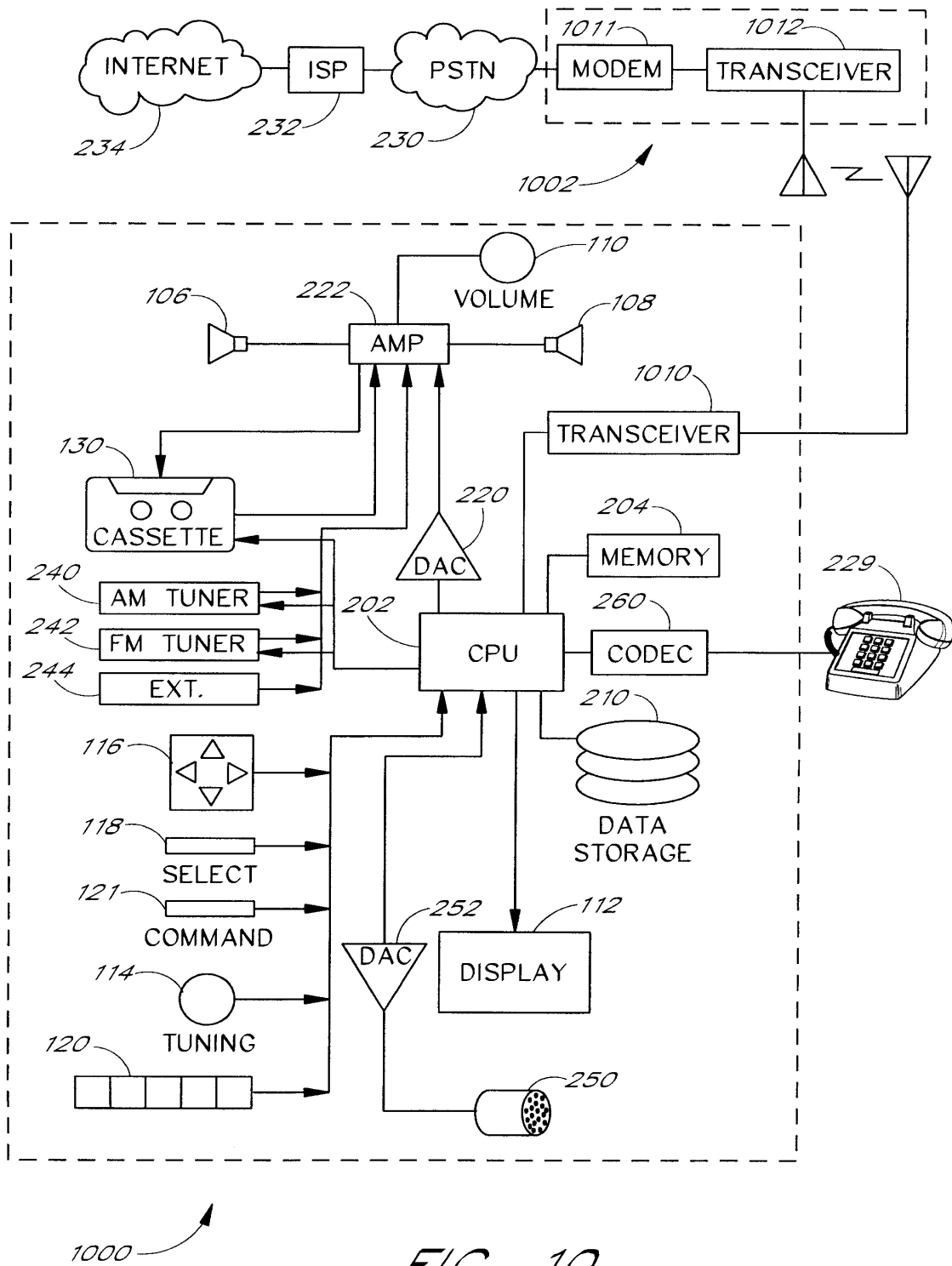

FIG. 10

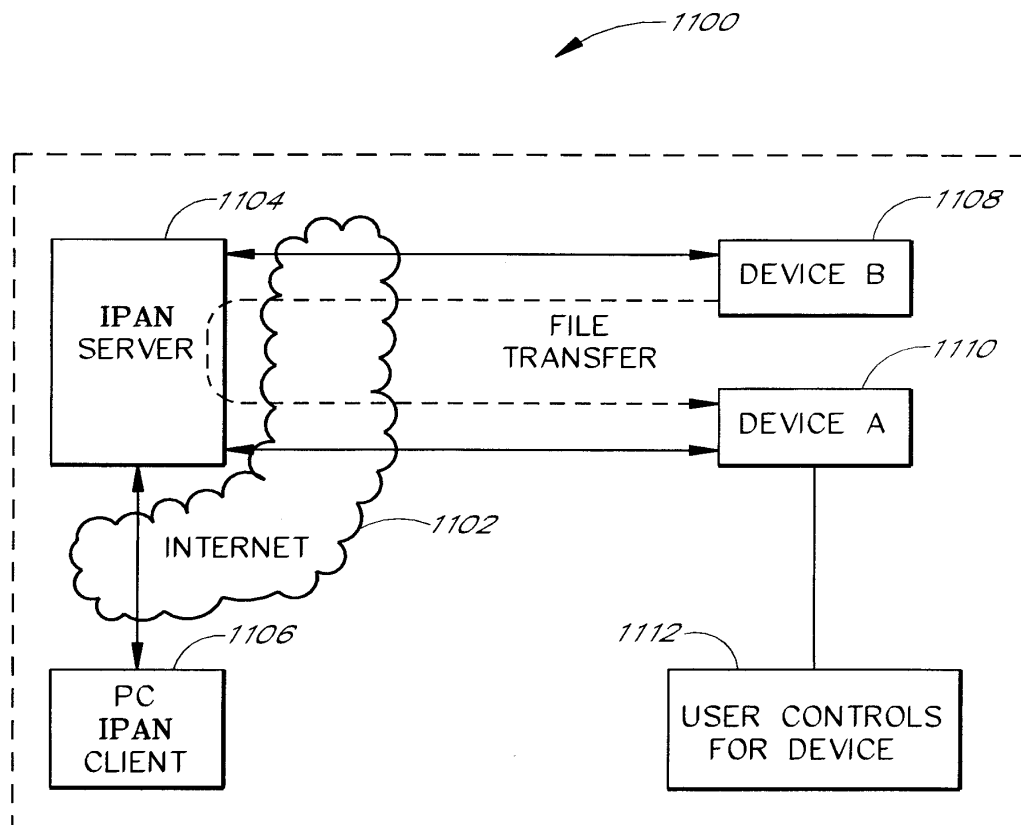

FIG. 11

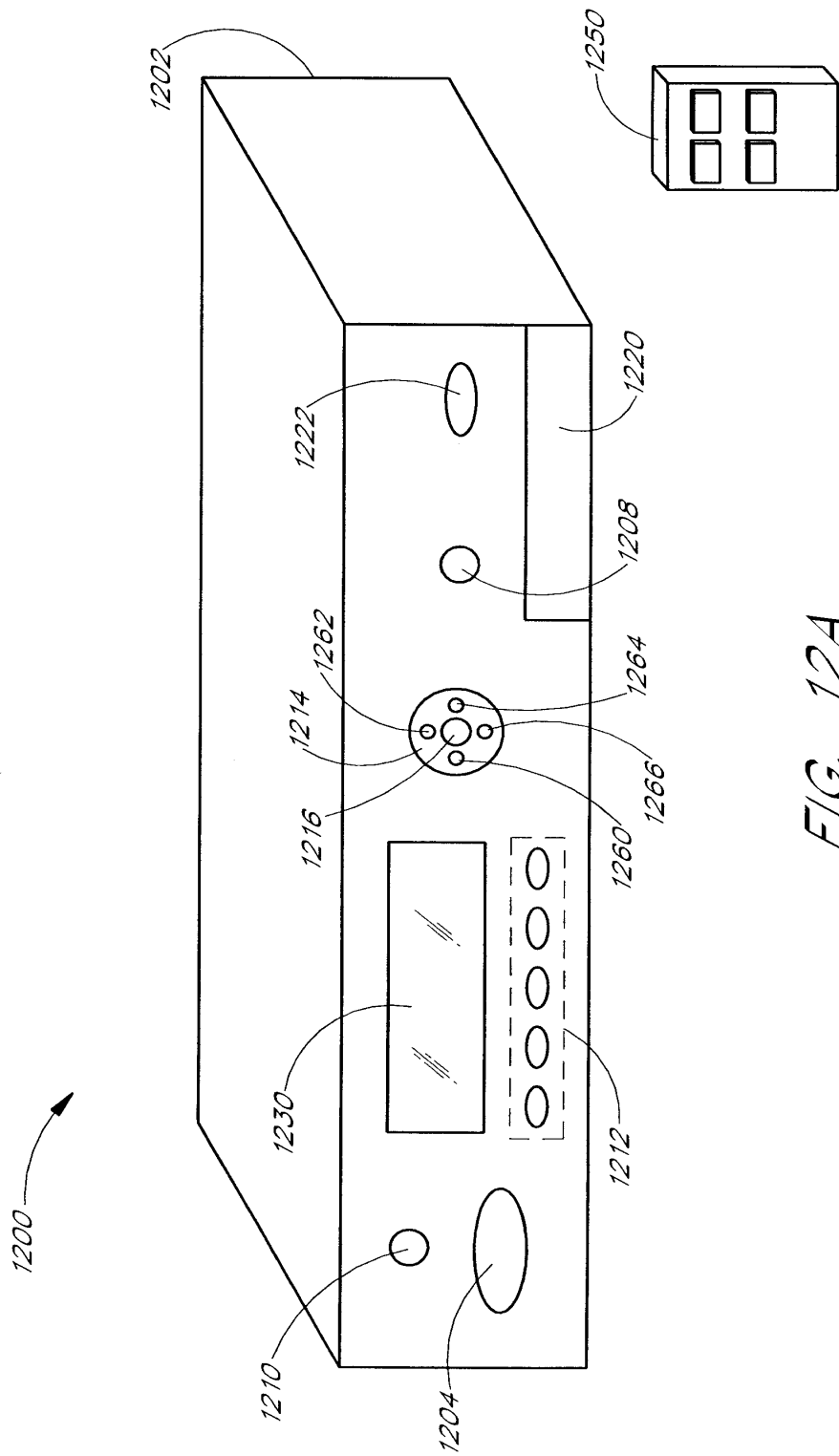

FIG. 12A

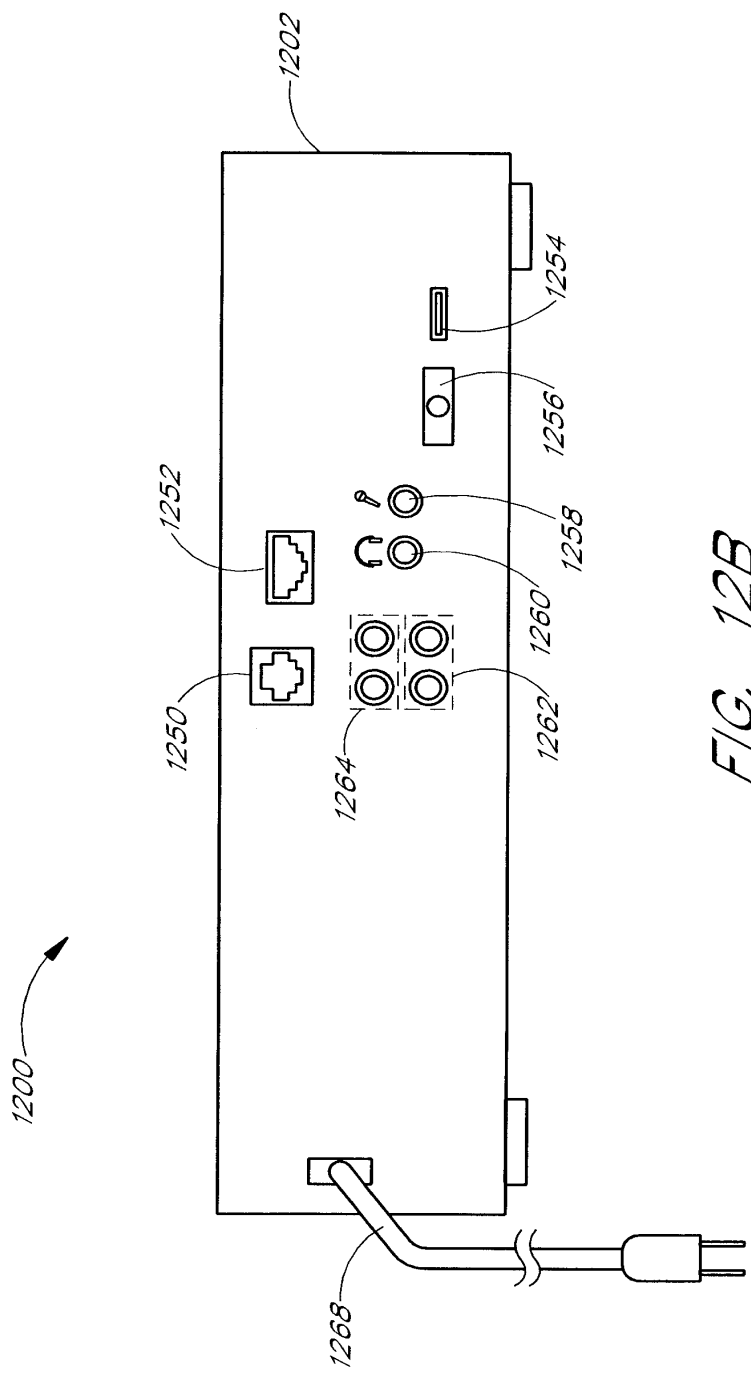

FIG. 12B

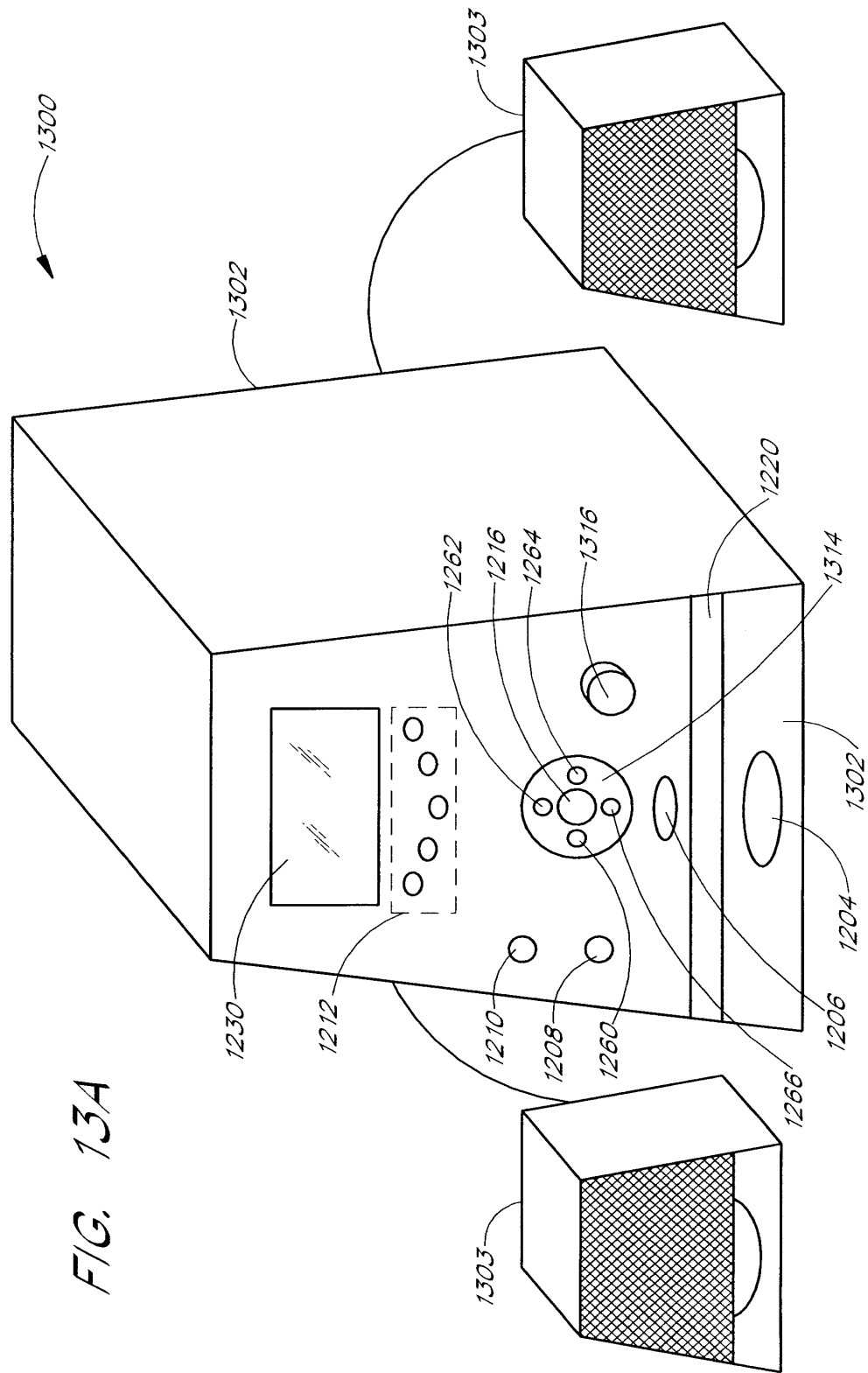

FIG. 13A

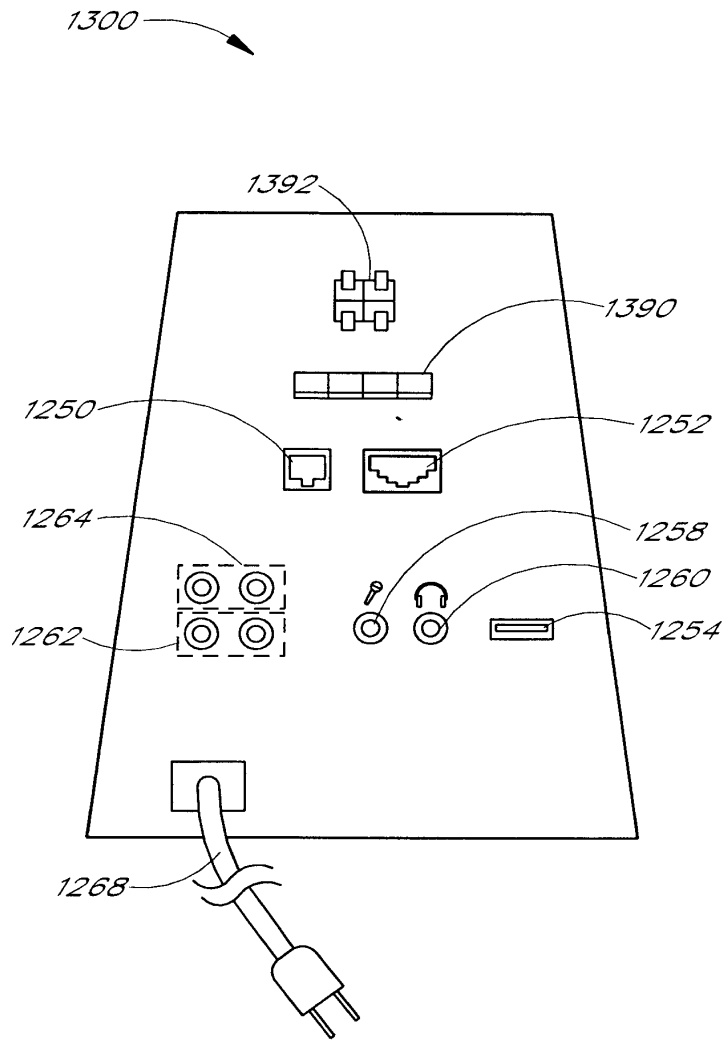

FIG. 13B

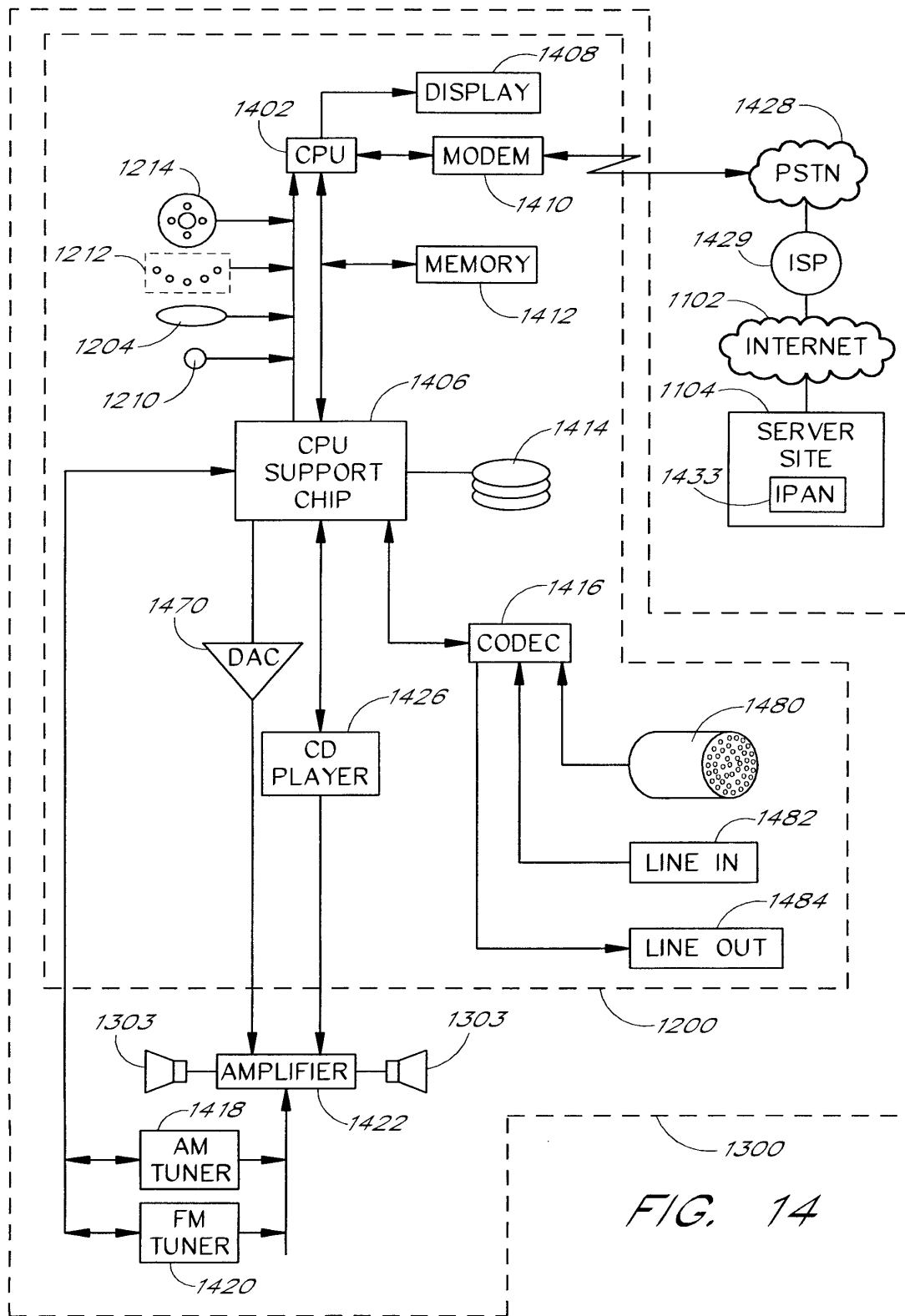

FIG. 14

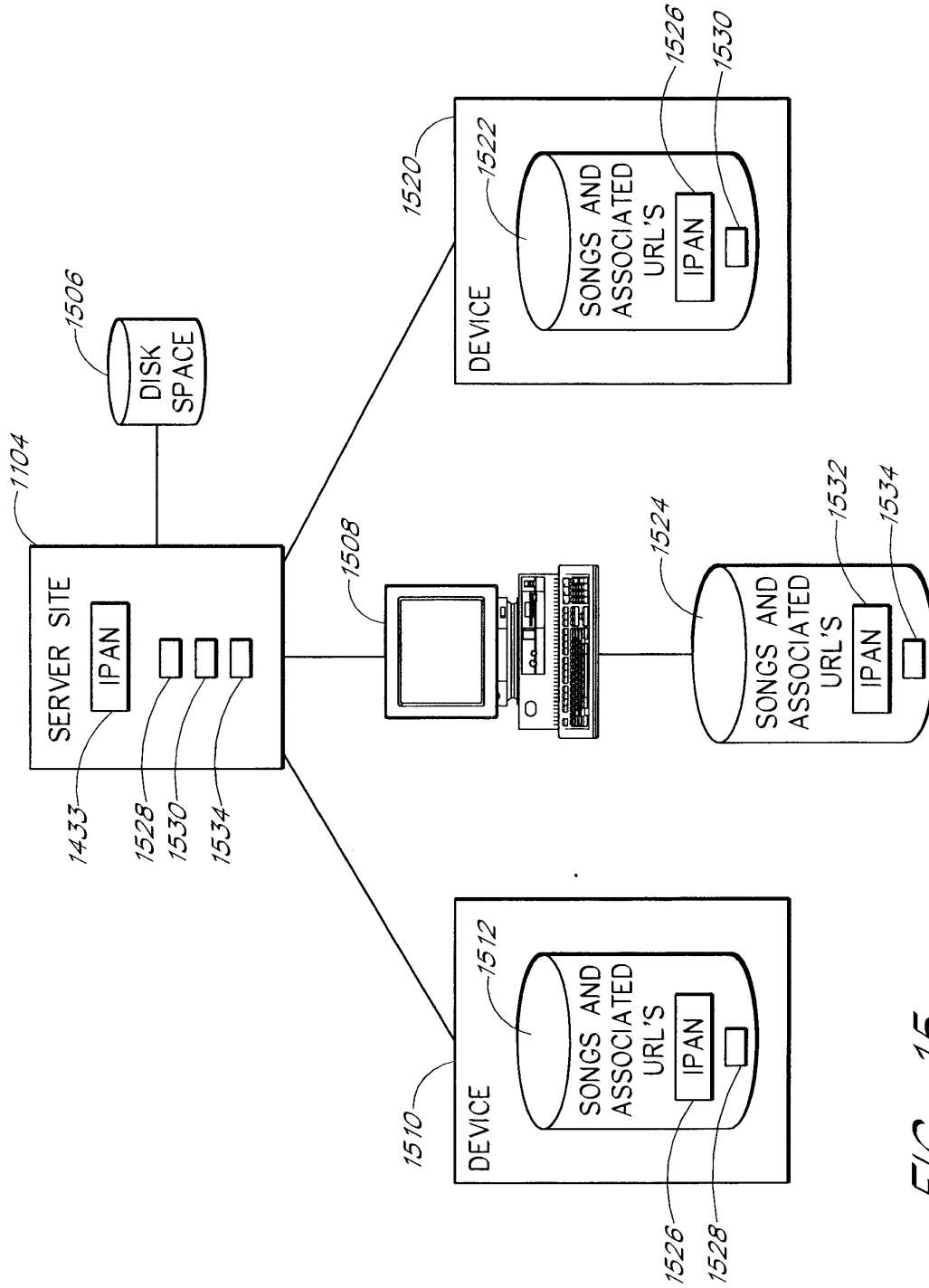

FIG. 15

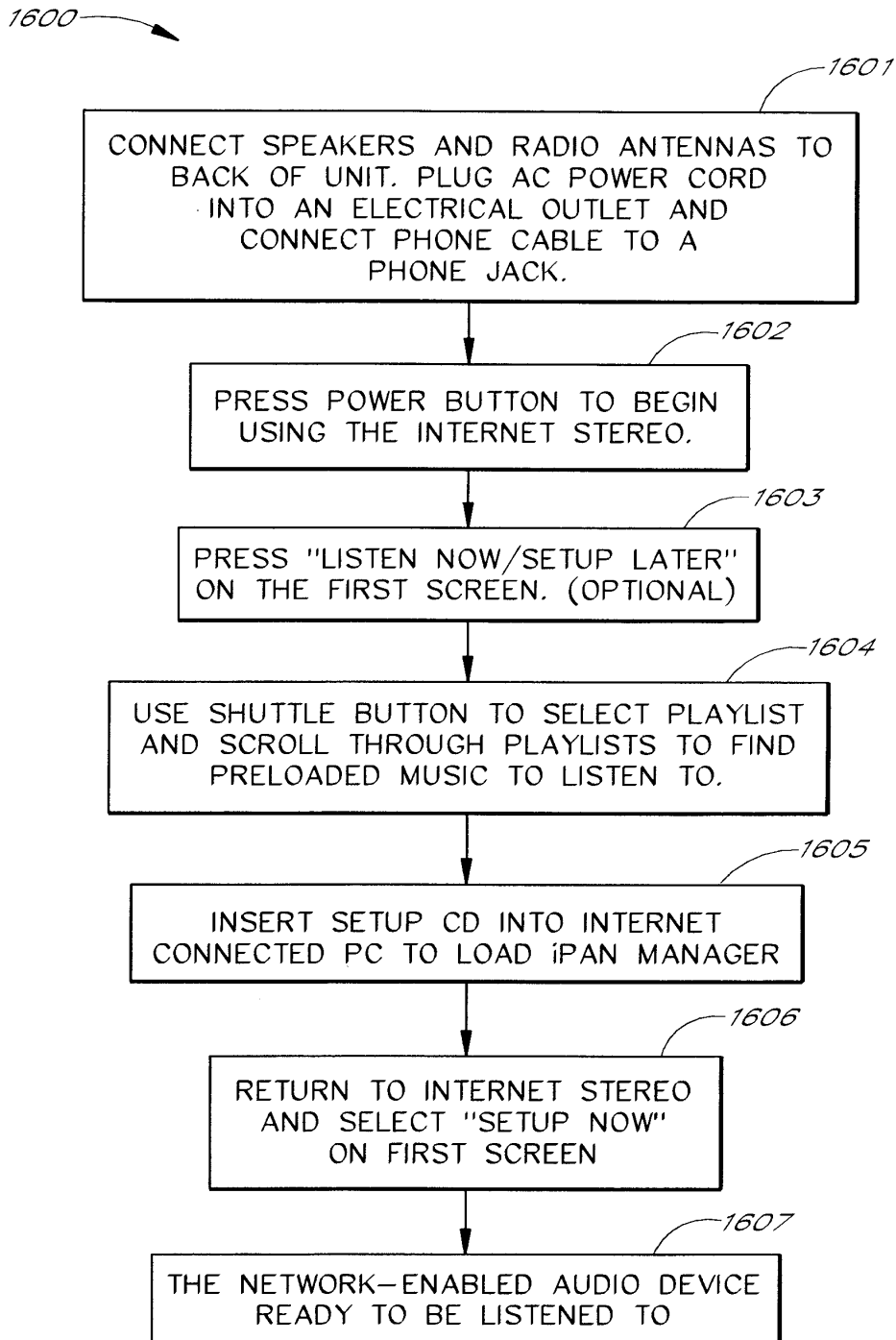

FIG. 16

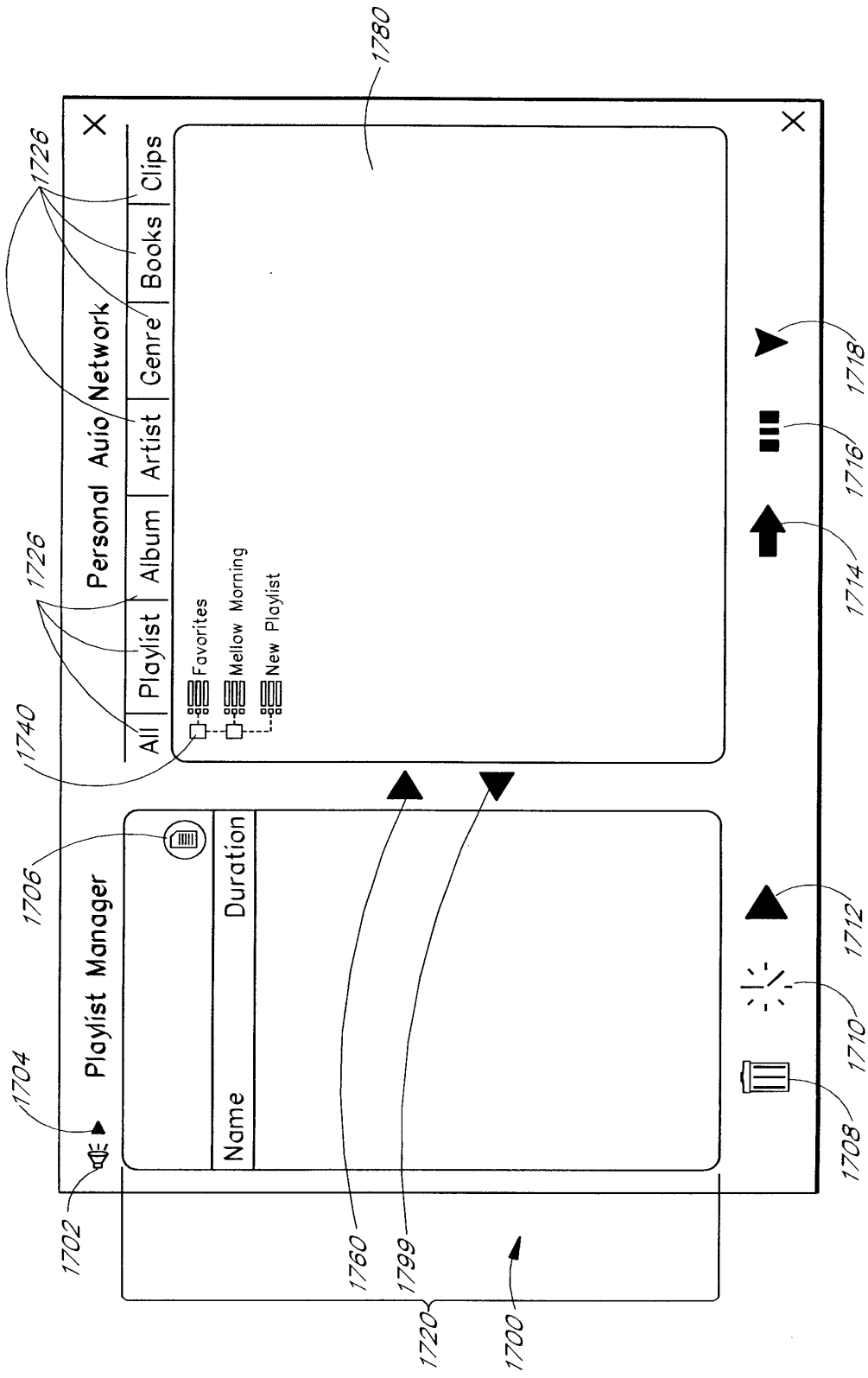

FIG. 17A

1792

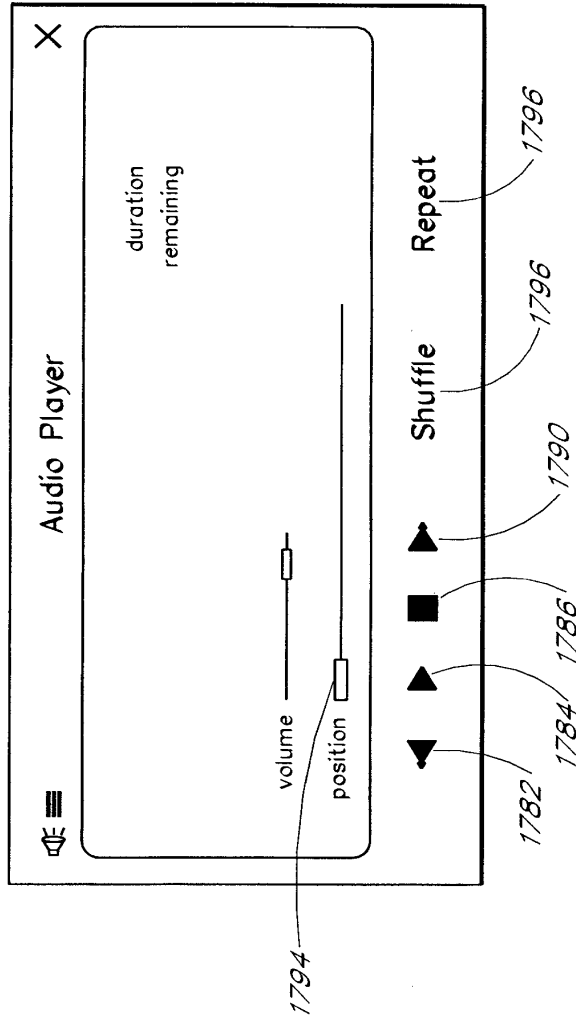

FIG. 17B

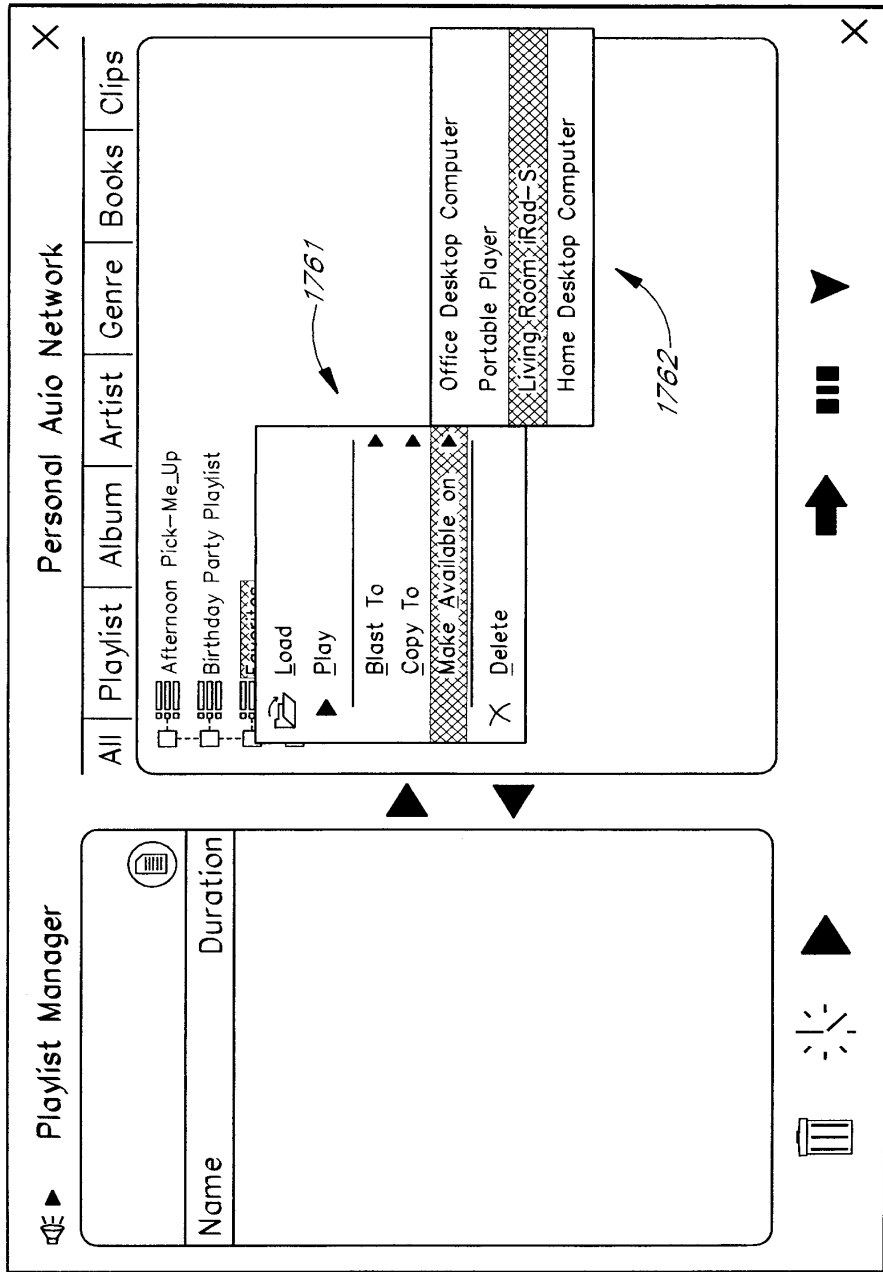

FIG. 17C

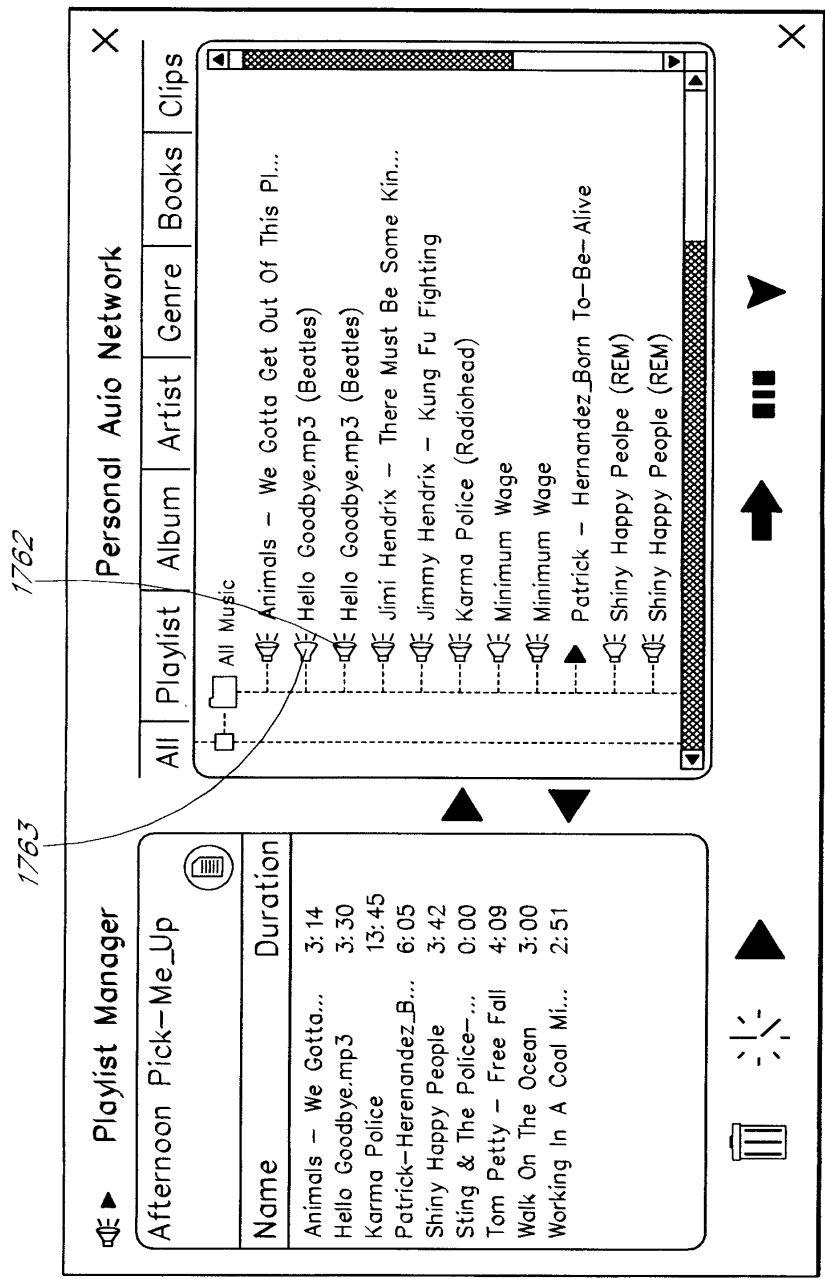

FIG. 17D

1763

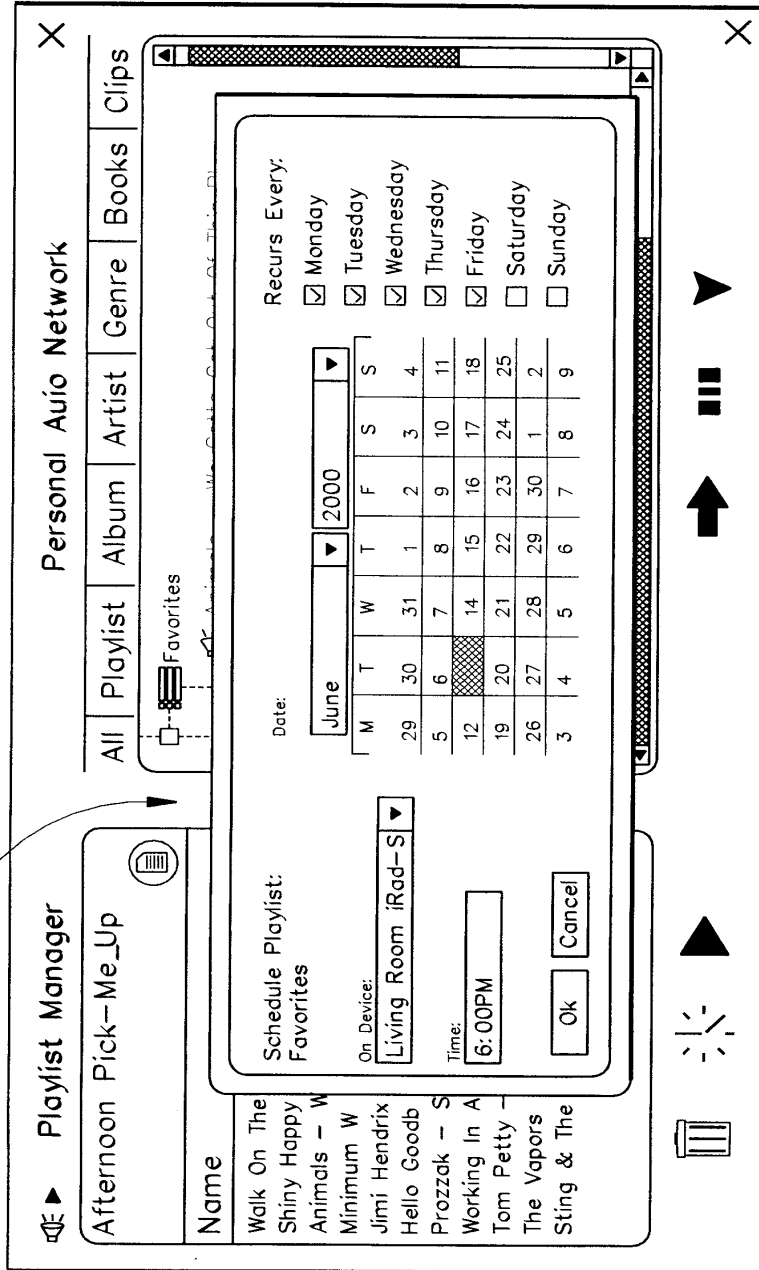

FIG. 17E

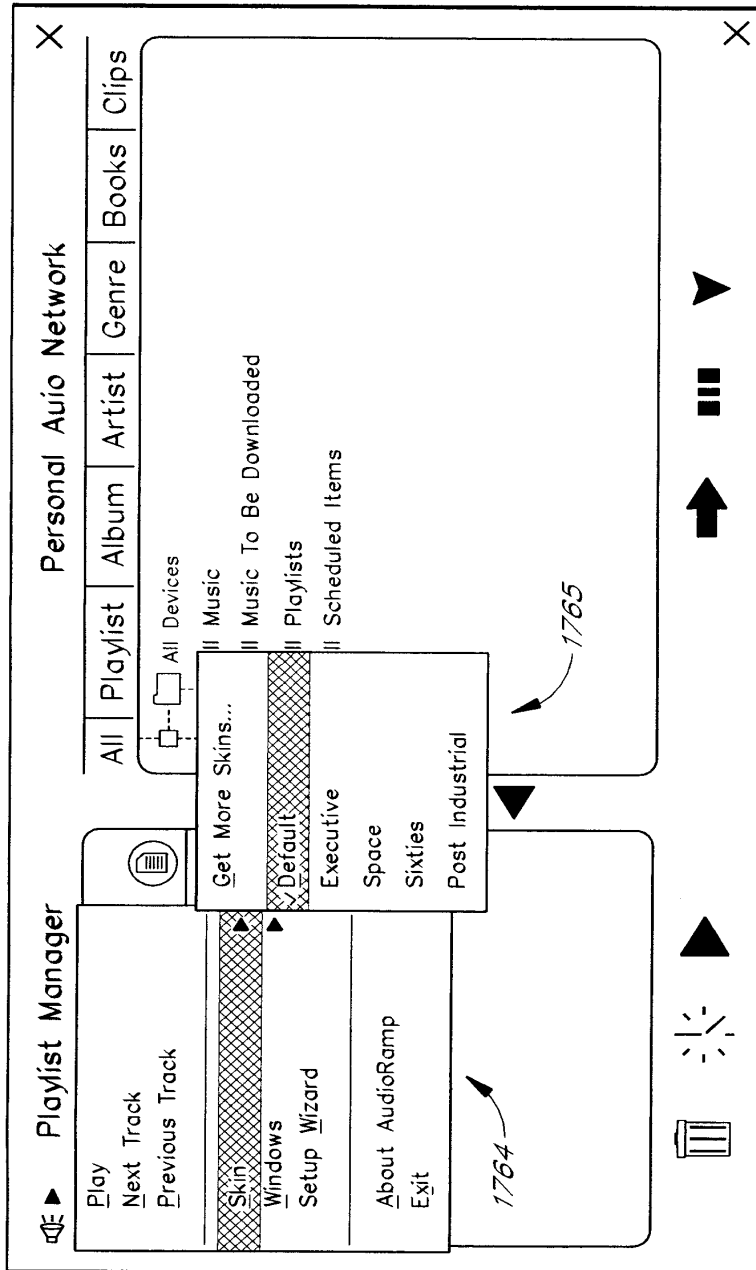

FIG. 17F

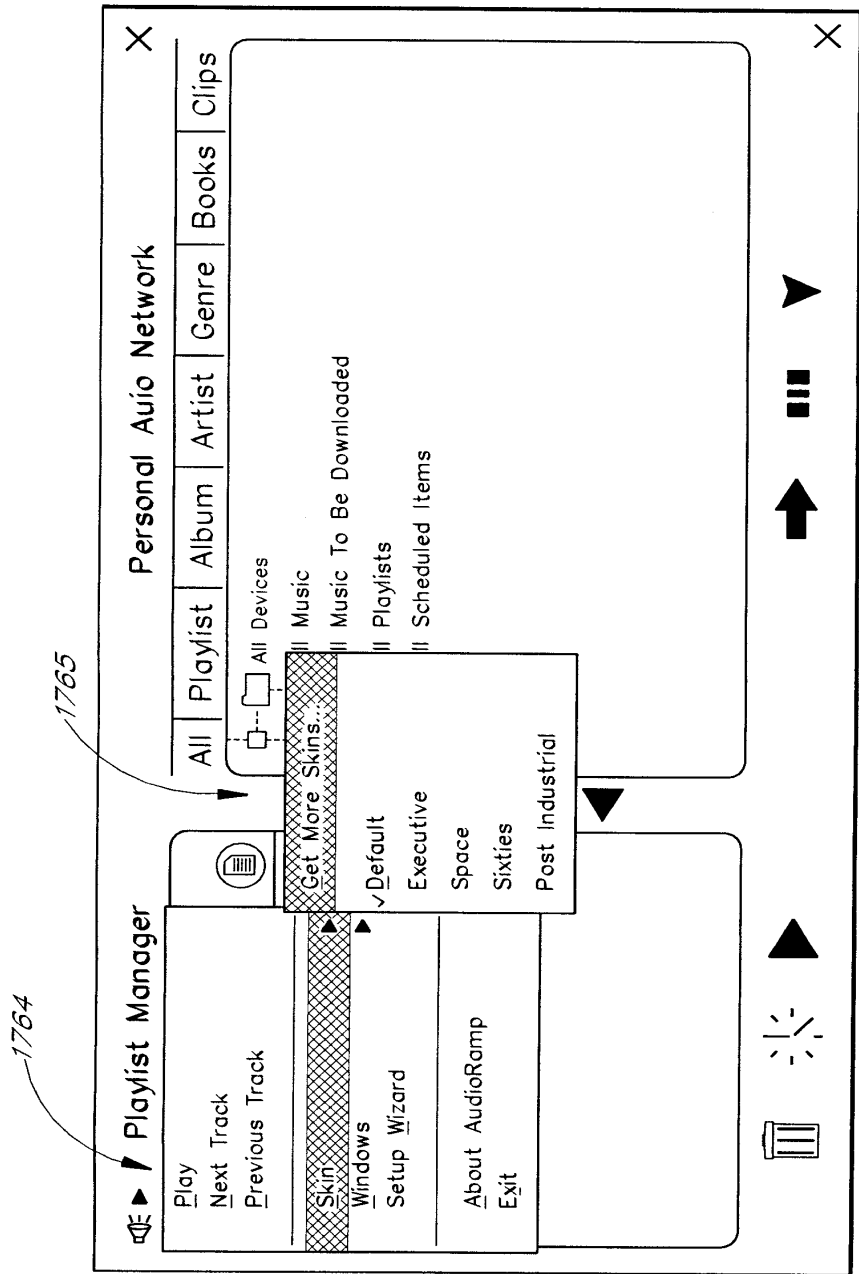

FIG. 17G

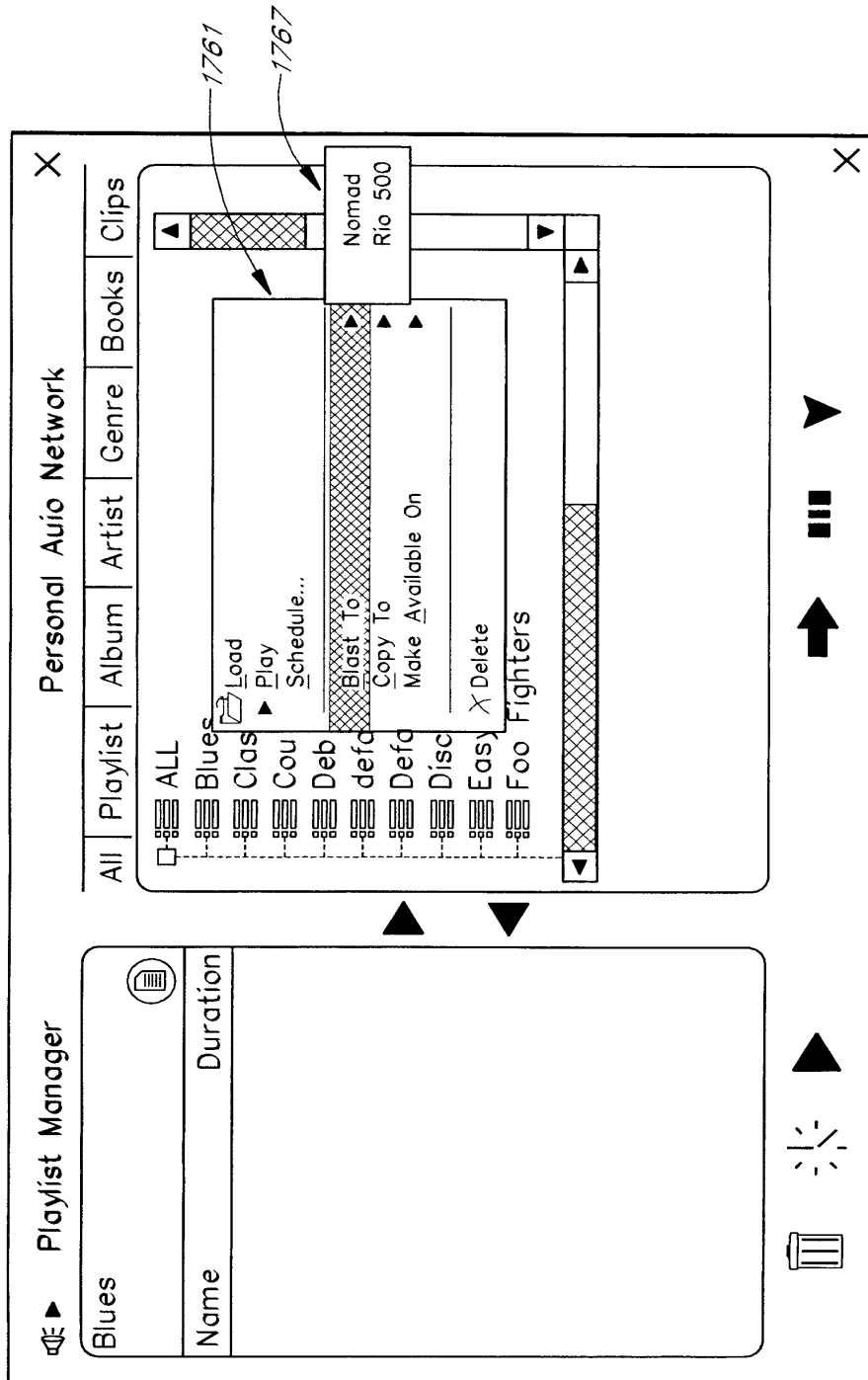

FIG. 17H

1793

1771 Name Portable Player

1772 Serial Number

1773 Device Type Diamond Rio PMP500

1774 Connected To My Personal Computer

Download to this device by default

1775 Download Time 1:00 AM

1776 Download Duration 1.00

1778 Download Folder C:\audio

1791 Ok

1792 Cancel

FIG. 171

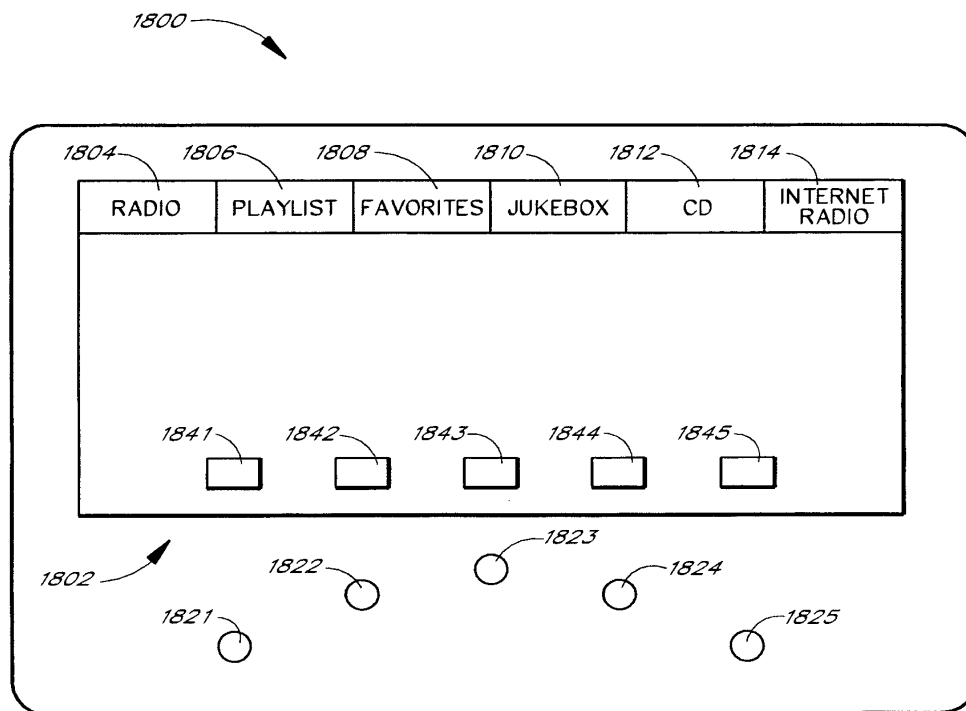

FIG. 18A

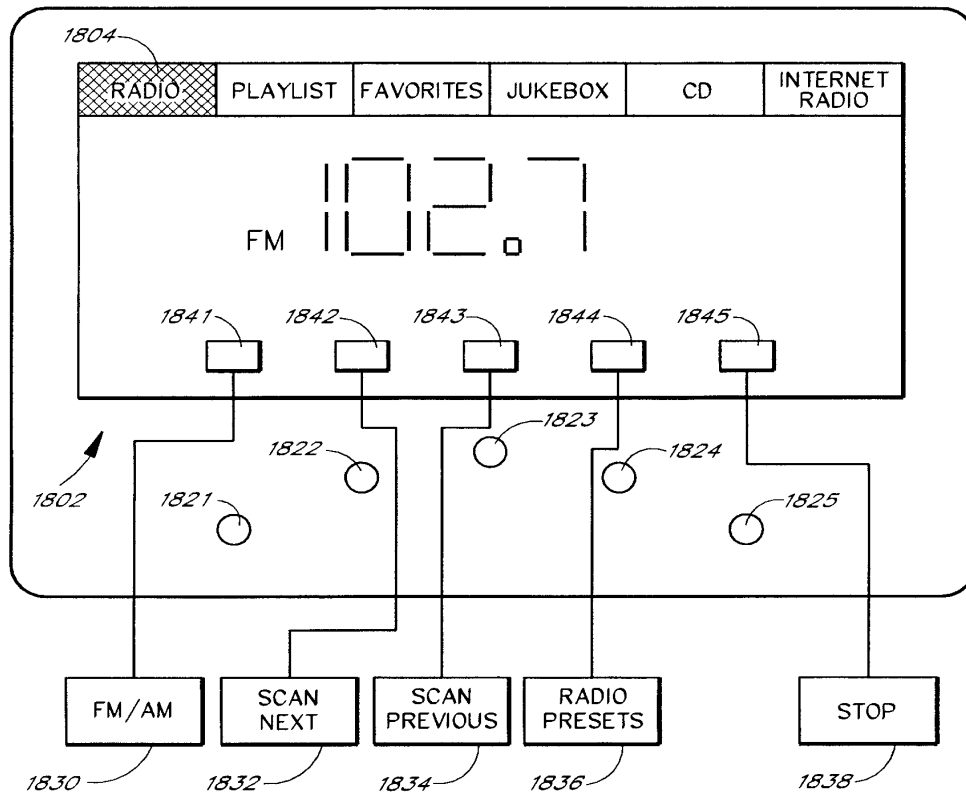

FIG. 18B

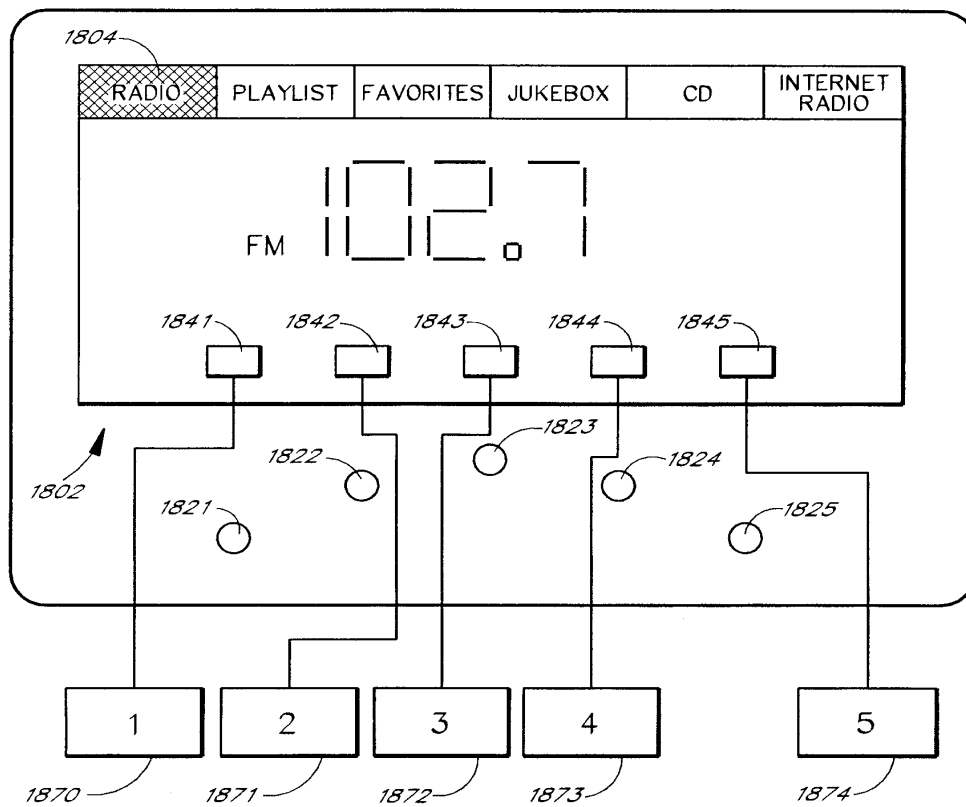

FIG. 18C

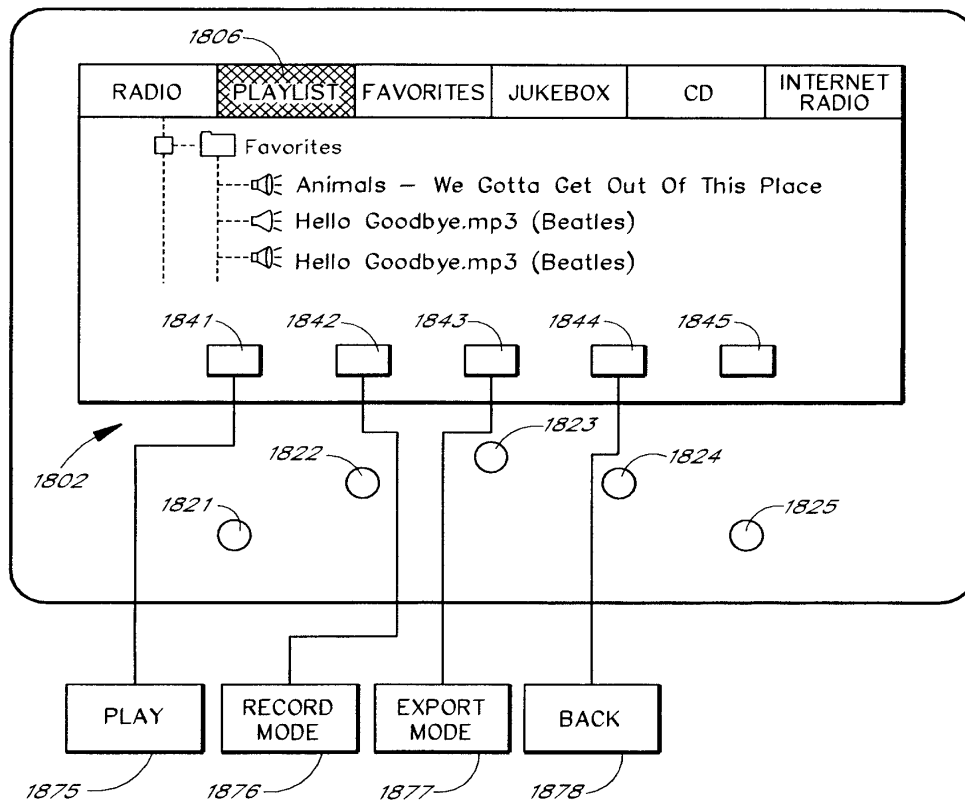

FIG. 18D

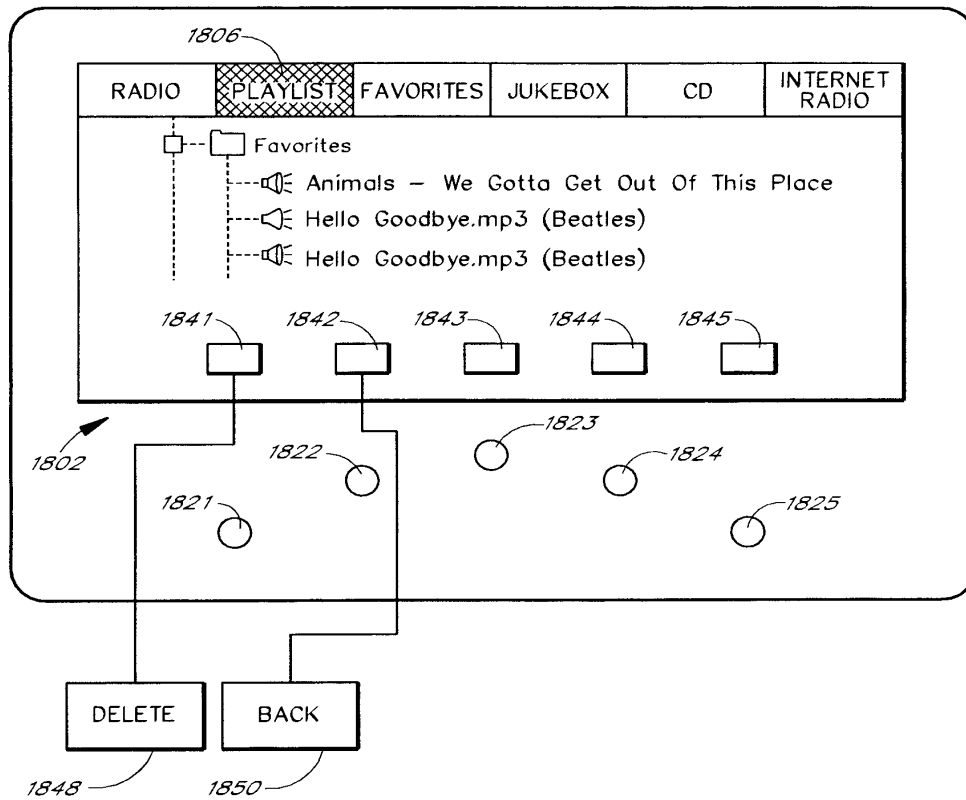

FIG. 18E

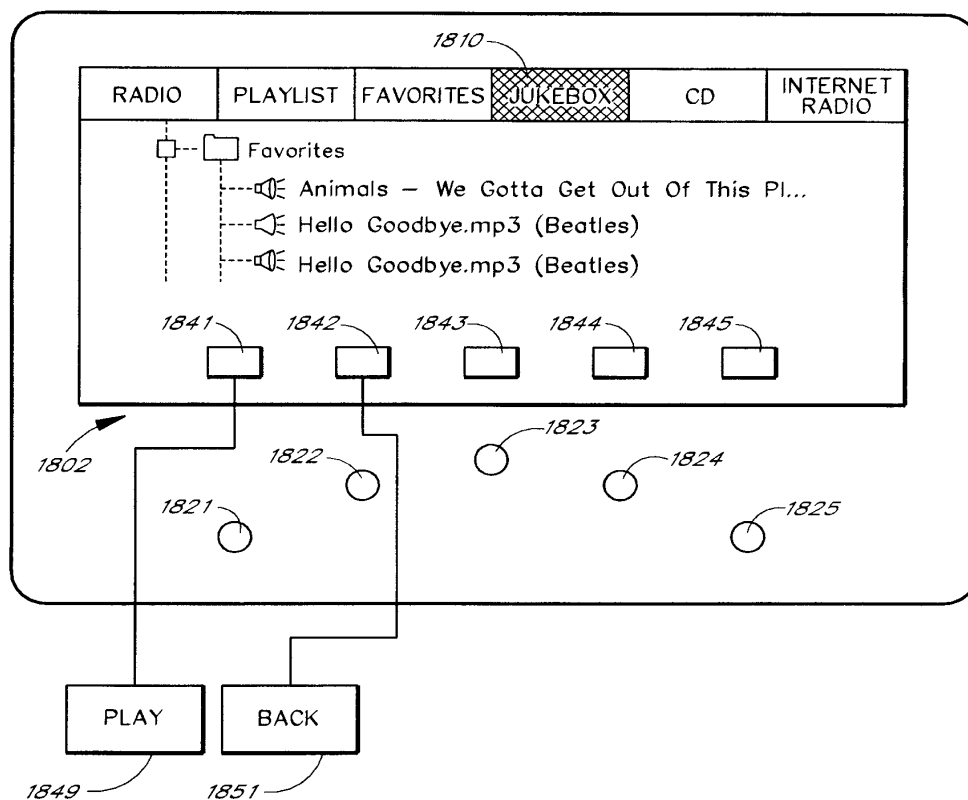

FIG. 18F

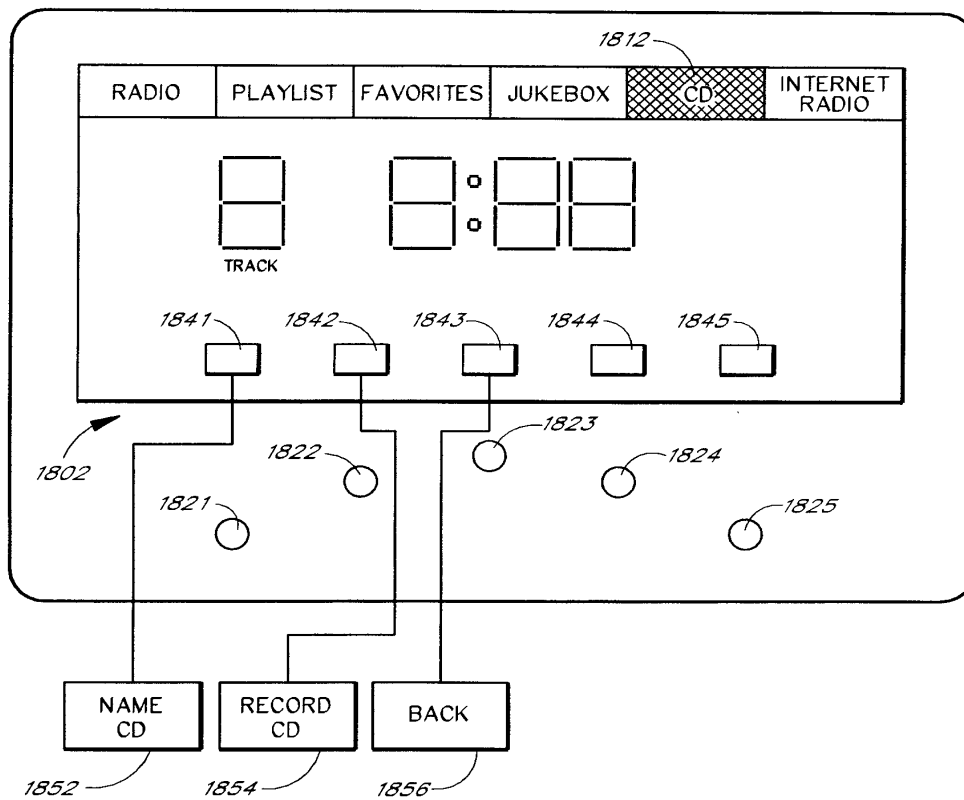

FIG. 18G

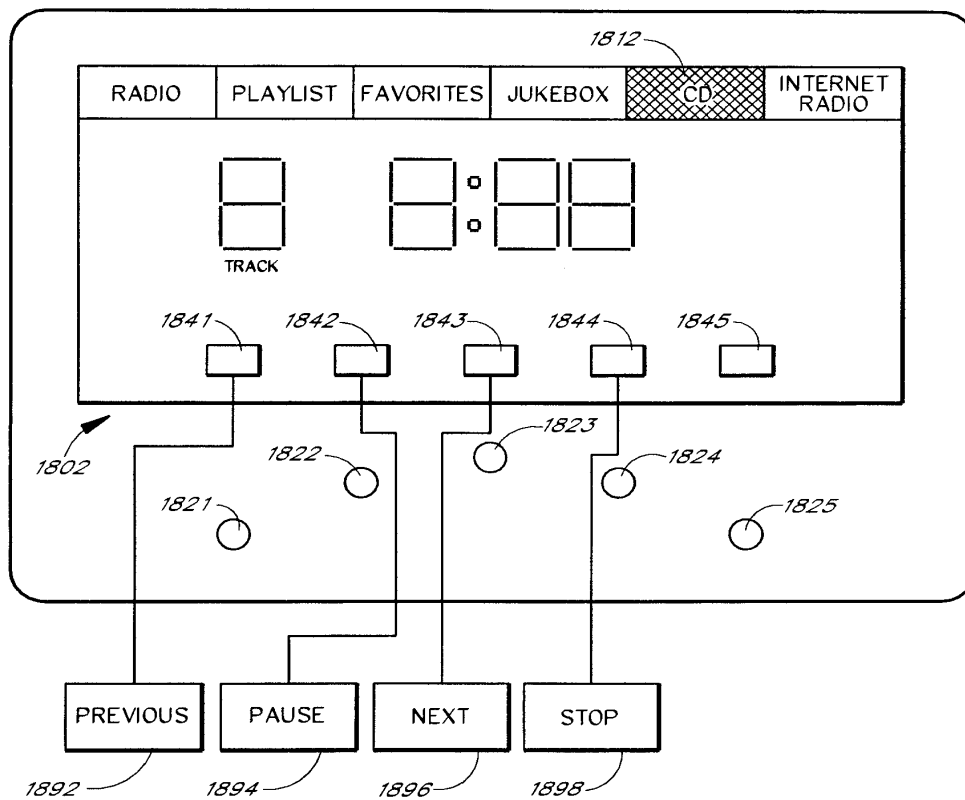

FIG. 18H

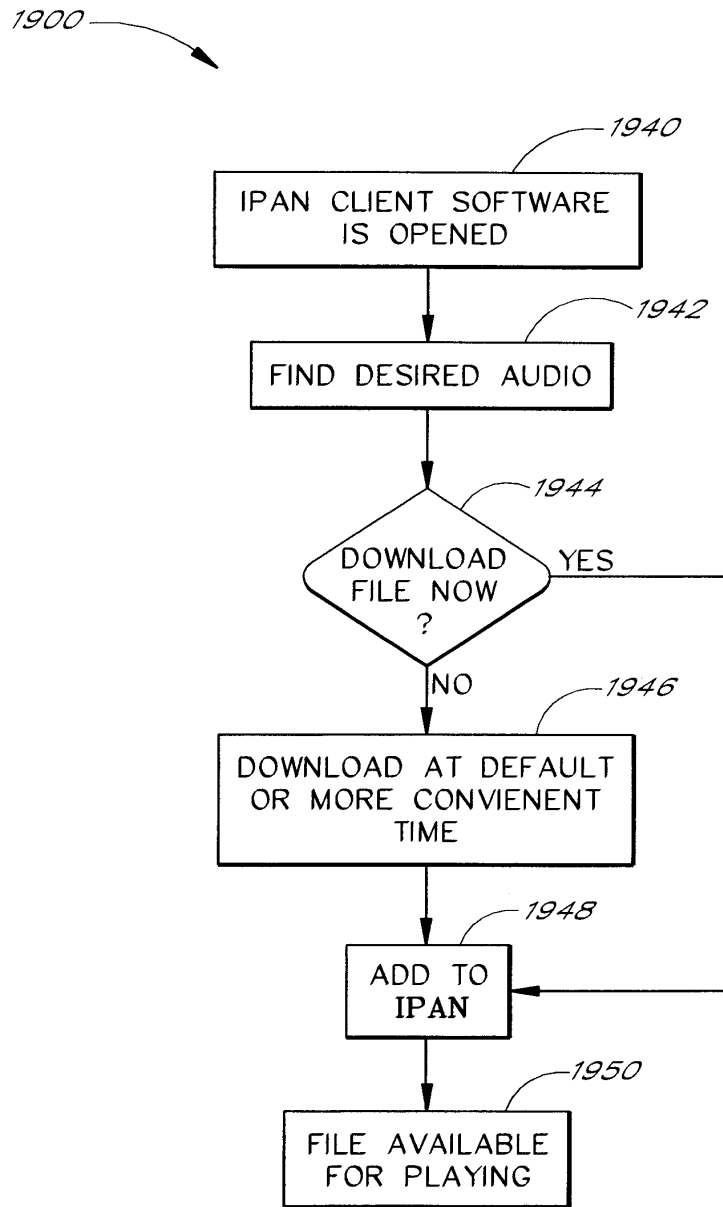

FIG. 19A

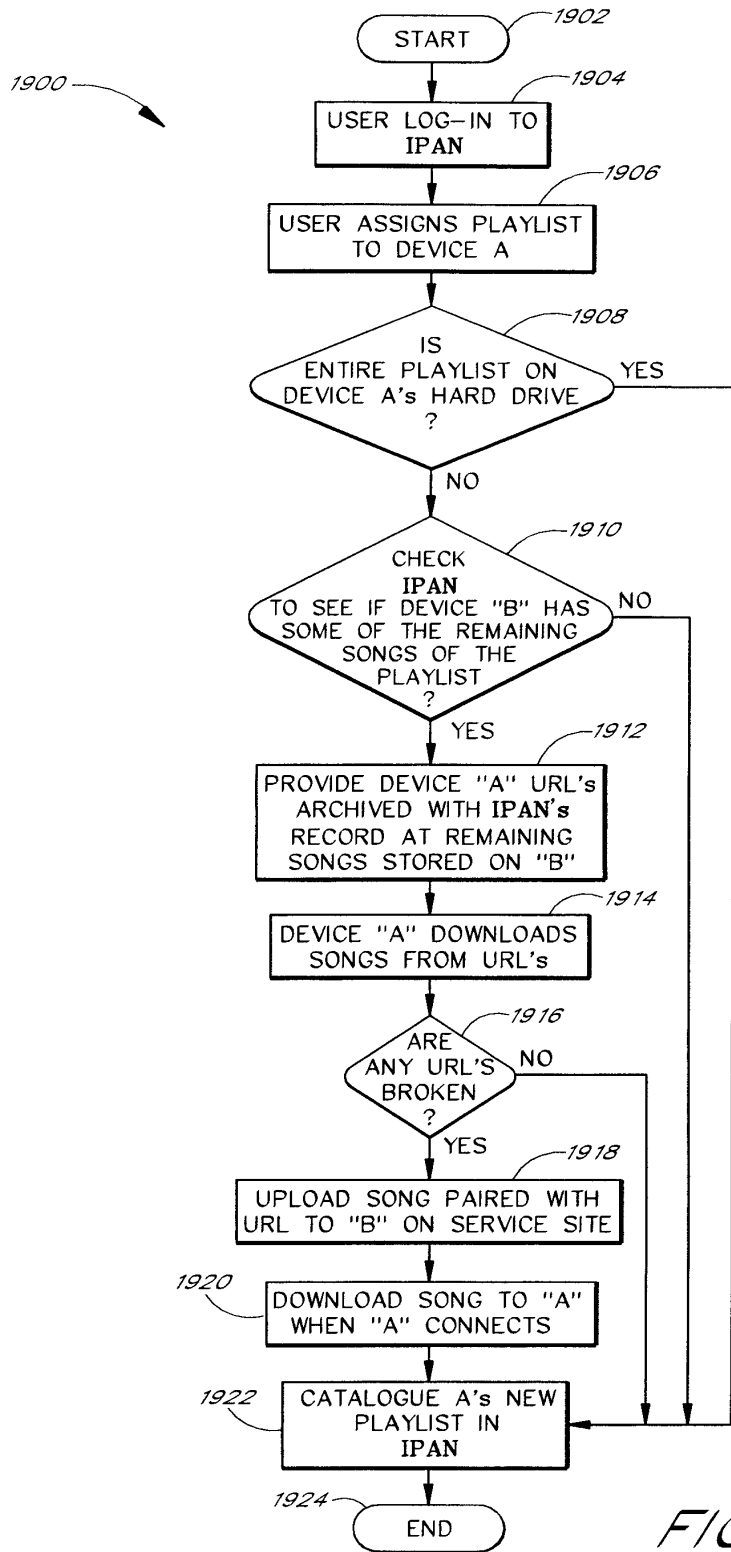

FIG. 19B

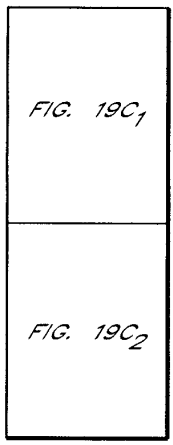
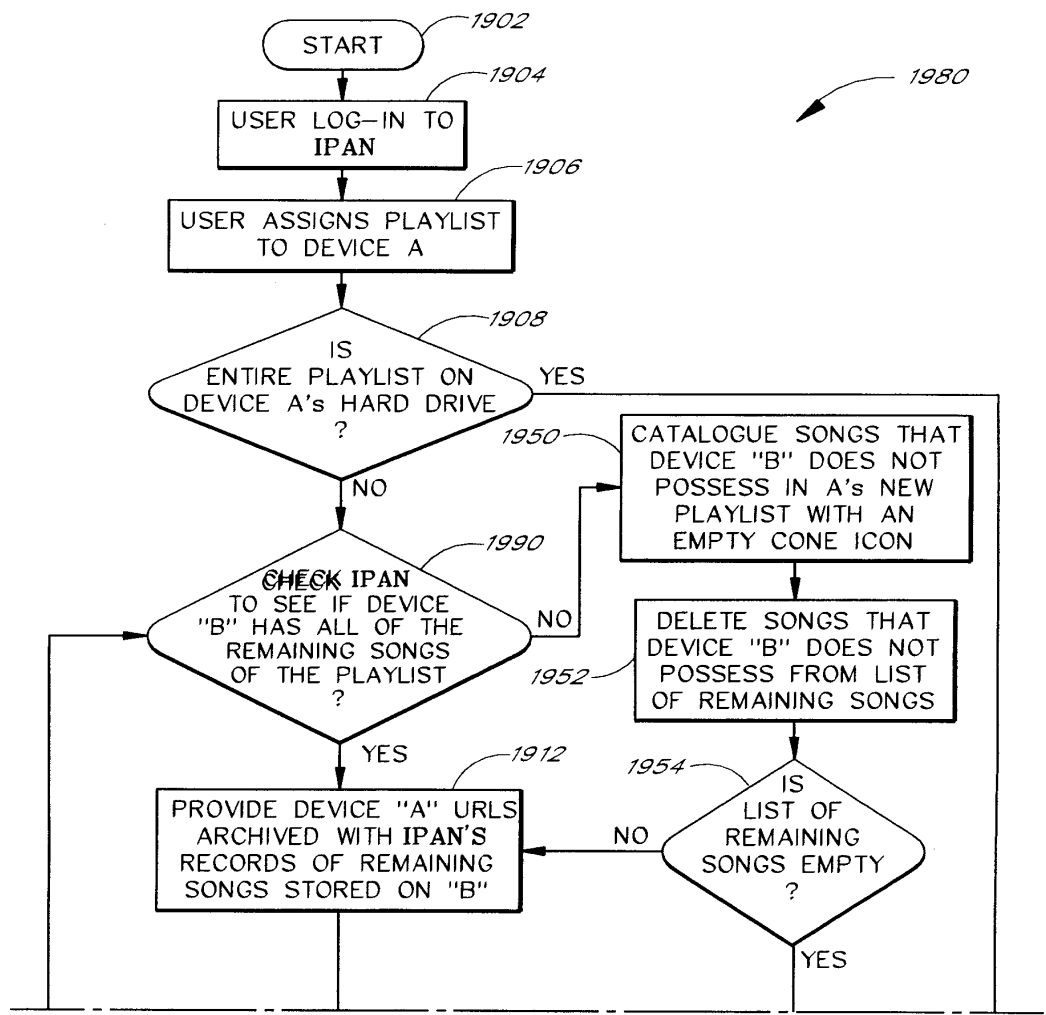

FIG. 19C

FIG. 19C₁



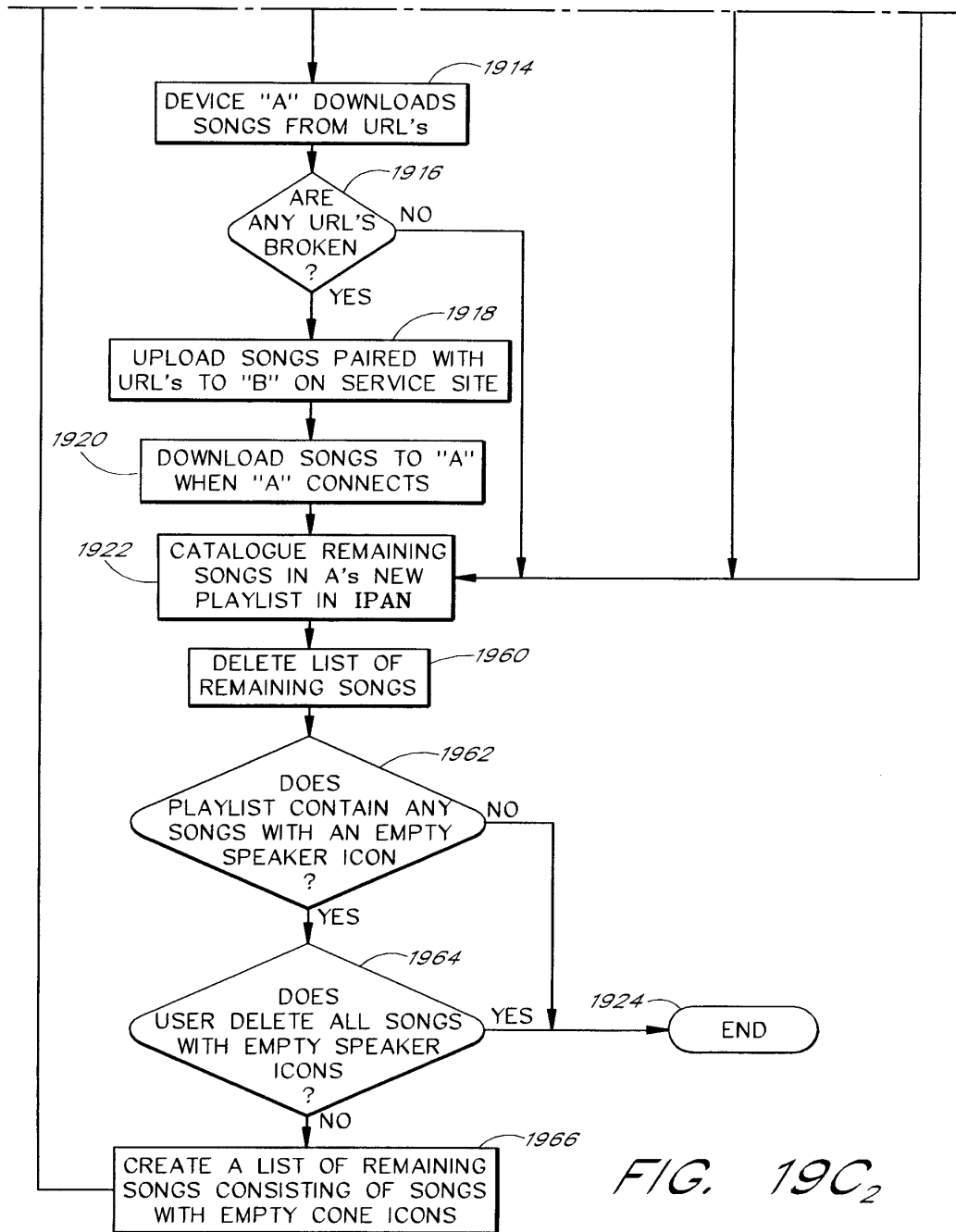

FIG. 19C₂

1802

Unknown
MP3
02:58 / 05:43
Pause Next Previous Add Stop
Favorites



FIG. 20A

1802

Porcelain

Moby, Play

MP3

Action

News Music Tour Offers Done

2002

- 1821
- 1822
- 1823
- 1824
- 1825

FIG. 20B

1802

Porcelain

Moby, Play

Action²⁰⁰⁴

Music²⁰⁰²

Albums Similar Samples Back Done

- 1821
- 1822
- 1823
- 1824
- 1825

FIG. 20C

1802

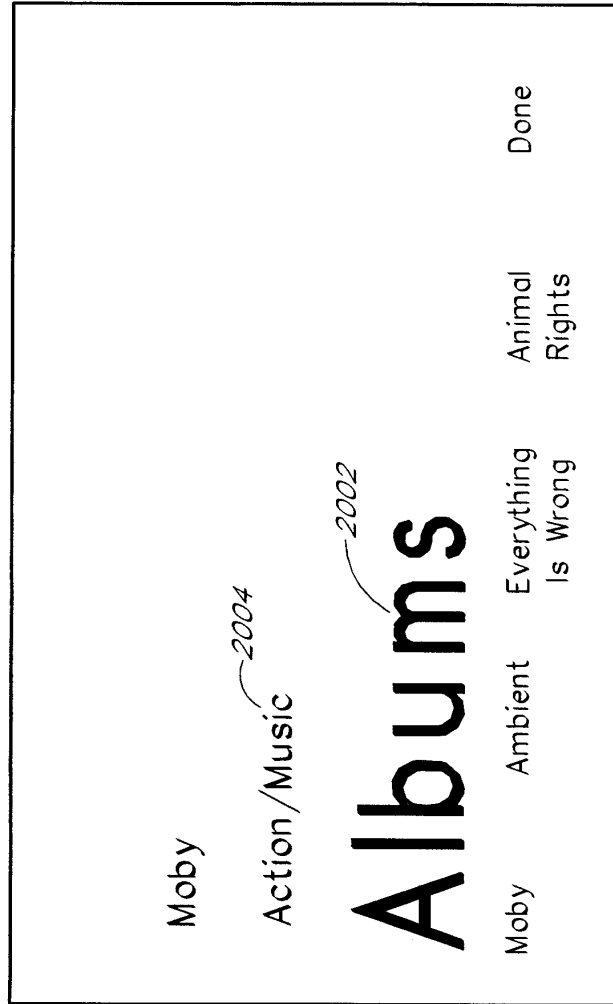

FIG. 20D

1802

Moby

Action/Music/Albums²⁰⁰⁴

Ambient²⁰⁰²

Buy Download Listen Back Done

- 1821
- 1822
- 1823
- 1824
- 1825

FIG. 20E

1802 →

Moby, Ambient
Action/Music/Albums/Buy²⁰⁰⁴
Complete²⁰⁰²
Buy Back Done

- 1821 ○
- 1822 ○
- 1823 ○
- 1824 ○
- 1825 ○

FIG. 20F

1802 →

Nike
Radio Free Sydney, Air Max Knukini Offer
MP3

Action

Buy Log to MyActions More Info Offers Done

2002

- 1821
- 1822
- 1823
- 1824
- 1825

FIG. 21

**DECLARATION - USA PATENT APPLICATION**

As a below named inventor, I hereby declare that:

My residence, post office address and citizenship are as stated below next to my name;

I believe I am an original, first and joint inventor of the subject matter which is claimed and for which a patent is sought on the invention entitled **NETWORK-ENABLED AUDIO DEVICE**; the specification of which was filed on **March 12, 2001** as Application Serial No. **09/805,470**.

I hereby state that I have reviewed and understand the contents of the above identified specification, including the claims, as amended by any amendment referred to above;

I acknowledge the duty to disclose information which is material to patentability as defined in Title 37, Code of Federal Regulations, § 1.56;

I hereby claim the benefit under Title 35, United States Codes § 119(e) of any United States provisional application(s) listed below.

Application No.: 60/246,842

Filing Date: November 8, 2000

I hereby claim the benefit under Title 35, United States Code, § 120 of any United States application(s) listed below, and insofar as the subject matter of each of the claims of this application is not disclosed in the prior United States application in the manner provided by the first paragraph of Title 35, United States Code § 112, I acknowledge the duty to disclose information which is material to patentability as defined in Title 37, Code of Federal Regulations, § 1.56, which became available between the filing date of the prior application and the national or PCT international filing date of this application:

Prior U.S.A. Application(s)

Application No.: 09/096,703

Filing Date: June 12, 1998 Status: Pending

I hereby declare that all statements made herein of my own knowledge are true and that all statements made on information and belief are believed to be true; and further that these statements were made with the knowledge that willful false statements and the like so made are punishable by fine or imprisonment, or both, under Section 1001 of Title 18 of the United States Code and that such willful, false statements may jeopardize the validity of the application or any patent issued thereon.

Full name of first inventor: **Safi Qureshey**

Inventor's signature _____

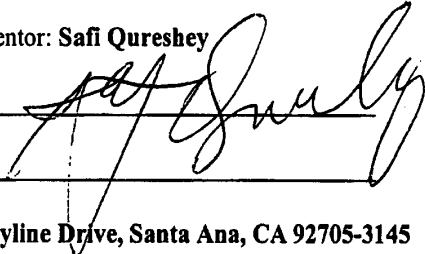

Date _____

Residence: **11741 Skyline Drive, Santa Ana, CA 92705-3145**

Citizenship: **United States**

Post Office Address: **Same**

Full name of second inventor: **Daniel D. Sheppard**

Inventor's signature _____

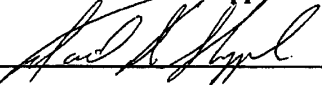

Date 7-10-01

Residence: **345 Hilltop Lane, Brea, CA 92821**

Citizenship: **United States**

Post Office Address: **Same**

Send Correspondence To:
KNOBBE, MARTENS, OLSON & BEAR, LLP
Customer No. 20,995

H:\DOCS\LWH\WH-5899.DOC:jk
062901

IN THE UNITED STATES PATENT AND TRADEMARK OFFICE

In re application of: Safi Qureshey et al.
Serial Number: 09/805,470
Filed: 03/12/2001
For: **NETWORK-ENABLED AUDIO DEVICE**

Examiner: Pablo N. Tran
Art Unit: 2618

Commissioner for Patents
PO Box 1450
Alexandria, VA 22313-1450

POWER OF ATTORNEY

Sir:

The undersigned, assignee of the entire interest in and to an application of Safi Qureshey et al. for U.S. Letters Patent for **NETWORK-ENABLED AUDIO DEVICE**, filed March 12, 2001, Application Serial Number 09/805,470 by an assignment document recorded with the United States Patent and Trademark Office at reel/frame 018354/0834, hereby appoints the firm of Withrow & Terranova, P.L.L.C., Customer No. 27820, comprising Benjamin S. Withrow, Reg. No. 40,876, Steven N. Terranova, Reg. No. 43,185, John R. Witcher, III, Reg. No. 39,877, Richard C. Bevins, Reg. No. 51,468, and Christopher B. Lee, Reg. No. 58,793, as my attorneys and/or agents with full power of substitution and revocation, to prosecute this application, to make alterations and amendments therein, to receive the patent, and to transact all business in the Patent and Trademark Office connected therewith.

Furthermore, in accordance with 37 CFR §3.73(b), the undersigned hereby states that the documentary evidence of a chain of title from the original owner to the assignee, i.e. assignment document referenced above, has been reviewed and the undersigned certifies that, to the best of assignee's knowledge and belief, title is in assignee who seeks to prosecute this application.

PLEASE ADDRESS ALL COMMUNICATIONS AND TELEPHONE CALLS TO:
WITHROW & TERRANOVA, P.L.L.C., P.O. BOX 1287, CARY, NORTH CAROLINA
27512, (919) 654-4520.

CONCERT TECHNOLOGY CORPORATION

BY: 
Hugh Svendsen
Chief Executive Officer

Date: 10/6/2006

File No.: 1116-028

Electronic Patent Application Fee Transmittal

Application Number:					
Filing Date:					
Title of Invention:	NETWORK-ENABLED AUDIO DEVICE				
First Named Inventor/Applicant Name:	Safi Qureshey				
Filer:	Benjamin Withrow/Kelly Farrow				
Attorney Docket Number:	1116-028C				
Filed as Large Entity					
Utility Filing Fees					
Description	Fee Code	Quantity	Amount	Sub-Total in USD(\$)	
Basic Filing:					
Utility application filing	1011	1	300	300	
Utility Search Fee	1111	1	500	500	
Utility Examination Fee	1311	1	200	200	
Pages:					
Claims:					
Independent claims in excess of 3	1201	1	200	200	
Miscellaneous-Filing:					
Petition:					

Description	Fee Code	Quantity	Amount	Sub-Total in USD(\$)
Patent-Appeals-and-Interference:				
Post-Allowance-and-Post-Issuance:				
Extension-of-Time:				
Miscellaneous:				
Total in USD (\$)				1200

Electronic Acknowledgement Receipt

EFS ID:	1333454
Application Number:	11563232
International Application Number:	
Confirmation Number:	1583
Title of Invention:	NETWORK-ENABLED AUDIO DEVICE
First Named Inventor/Applicant Name:	Safi Qureshey
Customer Number:	27820
Filer:	Benjamin Withrow/Kelly Farrow
Filer Authorized By:	Benjamin Withrow
Attorney Docket Number:	1116-028C
Receipt Date:	27-NOV-2006
Filing Date:	
Time Stamp:	10:29:25
Application Type:	Utility

Payment information:

Submitted with Payment	yes
Payment was successfully received in RAM	\$ 1200
RAM confirmation Number	348
Deposit Account	

File Listing:

Document Number	Document Description	File Name	File Size(Bytes)	Multi Part /.zip	Pages (if appl.)
-----------------	----------------------	-----------	------------------	------------------	------------------

1	Application Data Sheet	ADS.pdf	993757	no	5
Warnings:					
Information:					
2		1116-028C_Application.pdf	271296	yes	63
	Multipart Description/PDF files in .zip description				
	Document Description		Start	End	
	Specification		1	56	
	Claims		57	62	
	Abstract		63	63	
Warnings:					
Information:					
3	Drawings	1116-028C_Drawings.pdf	868773	no	49
Warnings:					
Information:					
4	Oath or Declaration filed	Declaration_As_Filed.pdf	72124	no	2
Warnings:					
Information:					
5	Power of Attorney	1116-028C_POA.pdf	52837	no	2
Warnings:					
Information:					
6	Fee Worksheet (PTO-875)	fee-info.pdf	8469	no	2
Warnings:					
Information:					
Total Files Size (in bytes):			2267256		

This Acknowledgement Receipt evidences receipt on the noted date by the USPTO of the indicated documents, characterized by the applicant, and including page counts, where applicable. It serves as evidence of receipt similar to a Post Card, as described in MPEP 503.

New Applications Under 35 U.S.C. 111

If a new application is being filed and the application includes the necessary components for a filing date (see 37 CFR 1.53(b)-(d) and MPEP 506), a Filing Receipt (37 CFR 1.54) will be issued in due course and the date shown on this Acknowledgement Receipt will establish the filing date of the application.

National Stage of an International Application under 35 U.S.C. 371

If a timely submission to enter the national stage of an international application is compliant with the conditions of 35 U.S.C. 371 and other applicable requirements a Form PCT/DO/EO/903 indicating acceptance of the application as a national stage submission under 35 U.S.C. 371 will be issued in addition to the Filing Receipt, in due course.

Under the Paperwork Reduction Act of 1995, no persons are required to respond to a collection of information unless it displays a valid OMB control number.

PATENT APPLICATION FEE DETERMINATION RECORD					11/563,232				
Substitute for Form PTO-875									
APPLICATION AS FILED – PART I					SMALL ENTITY		OTHER THAN SMALL ENTITY		
(Column 1)		(Column 2)			(Column 3)				
FOR	NUMBER FILED				RATE (\$)	FEE (\$)	RATE (\$)	FEE (\$)	
BASIC FEE (37 CFR 1.16(a), (b), or (c))								300	
SEARCH FEE (37 CFR 1.16(k), (l), or (m))								500	
EXAMINATION FEE (37 CFR 1.16(o), (p), or (q))								200	
TOTAL CLAIMS (37 CFR 1.16(i))	20	minus 20=			X\$25=		X\$50		
INDEPENDENT CLAIMS (37 CFR 1.16(h))	4	minus 3 =			X\$100=		X\$200=	200	
APPLICATION SIZE FEE (37 CFR 1.16(s))									
MULTIPLE DEPENDENT CLAIM PRESENT (37 CFR 1.16(j))					N/A		N/A		
					TOTAL		TOTAL	1200	
* If the difference in column 1 is less than zero, enter "0" in column 2.									
APPLICATION AS AMENDED – PART II					SMALL ENTITY		OTHER THAN SMALL ENTITY		
(Column 1)		(Column 2)		(Column 3)					
AMENDMENT A		CLAIMS REMAINING AFTER AMENDMENT		HIGHEST NUMBER PREVIOUSLY PAID FOR	PRESENT EXTRA	RATE (\$)	ADDITIONAL FEE (\$)	RATE (\$)	ADDITIONAL FEE (\$)
	Total (37 CFR 1.16(i))	*	Minus	**	=	X =		X =	
	Independent (37 CFR 1.16(h))	*	Minus	***	=	X =		X =	
	Application Size Fee (37 CFR 1.16(s))					N/A		N/A	
	FIRST PRESENTATION OF MULTIPLE DEPENDENT CLAIM (37 CFR 1.16(j))					TOTAL ADD'T FEE		TOTAL ADD'T FEE	
AMENDMENT B		CLAIMS REMAINING AFTER AMENDMENT		HIGHEST NUMBER PREVIOUSLY PAID FOR	PRESENT EXTRA	RATE (\$)	ADDITIONAL FEE (\$)	RATE (\$)	ADDITIONAL FEE (\$)
	Total (37 CFR 1.16(i))	*	Minus	**	=	X =		X =	
	Independent (37 CFR 1.16(h))	*	Minus	***	=	X =		X =	
	Application Size Fee (37 CFR 1.16(s))					N/A		N/A	
	FIRST PRESENTATION OF MULTIPLE DEPENDENT CLAIM (37 CFR 1.16(j))					TOTAL ADD'T FEE		TOTAL ADD'T FEE	
					TOTAL ADD'T FEE		TOTAL ADD'T FEE		
* If the entry in column 1 is less than the entry in column 2, write "0" in column 3.									
** If the "Highest Number Previously Paid For" IN THIS SPACE is less than 20, enter "20".									
*** If the "Highest Number Previously Paid For" IN THIS SPACE is less than 3, enter "3".									
The "Highest Number Previously Paid For" (Total or Independent) is the highest number found in the appropriate box in column 1.									

This collection of information is required by 37 CFR 1.16. The information is required to obtain or retain a benefit by the public which is to file (and by the USPTO to process) an application. Confidentiality is governed by 35 U.S.C. 122 and 37 CFR 1.14. This collection is estimated to take 12 minutes to complete including gathering, preparing, and submitting the completed application form to the USPTO. Time will vary depending upon the individual case. Any comment on the amount of time you require to complete this form and/or suggestions for reducing this burden, should be sent to the Chief Information Officer, U.S. Patent and Trademark Office, U.S. Department of Commerce, P.O. Box 1450, Alexandria, VA 22313-1450. DO NOT SEND FEES OR COMPLETED FORMS TO ADDRESS. **SEND TO: Commissioner for Patents, P.O. Box 1450, Alexandria, VA 22313-1450.**

If you need assistance in completing the form, call 1-800-PTO-9199 and select option 2.



UNITED STATES PATENT AND TRADEMARK OFFICE

UNITED STATES DEPARTMENT OF COMMERCE
United States Patent and Trademark Office
Address: COMMISSIONER FOR PATENTS
P.O. Box 1450
Alexandria, Virginia 22313-1450
www.uspto.gov

Table with 8 columns: APPLICATION NUMBER, FILING or 371(c) DATE, GRP ART UNIT, FIL FEE REC'D, ATTY. DOCKET NO, DRAWINGS, TOT CLAIMS, IND CLAIMS. Row 1: 11/563,232, 11/27/2006, 2623, 1200, 1116-028C, 49, 20, 4

CONFIRMATION NO. 1583

27820
WITHROW & TERRANOVA, P.L.L.C.
P.O. BOX 1287
CARY, NC27512

FILING RECEIPT

Date Mailed: 01/08/2007

Receipt is acknowledged of this regular Patent Application. It will be considered in its order and you will be notified as to the results of the examination. Be sure to provide the U.S. APPLICATION NUMBER, FILING DATE, NAME OF APPLICANT, and TITLE OF INVENTION when inquiring about this application. Fees transmitted by check or draft are subject to collection. Please verify the accuracy of the data presented on this receipt. If an error is noted on this Filing Receipt, please mail to the Commissioner for Patents P.O. Box 1450 Alexandria Va 22313-1450. Please provide a copy of this Filing Receipt with the changes noted thereon. If you received a "Notice to File Missing Parts" for this application, please submit any corrections to this Filing Receipt with your reply to the Notice. When the USPTO processes the reply to the Notice, the USPTO will generate another Filing Receipt incorporating the requested corrections (if appropriate).

Applicant(s)

Safi Qureshey, Santa Ana, CA;
Daniel D. Sheppard, Brea, CA;

Assignment For Published Patent Application

CONCERT TECHNOLOGY CORPORATION, Durham, NC

Power of Attorney: The patent practitioners associated with Customer Number 27820

Domestic Priority data as claimed by applicant

This application is a CON of 09/805,470 03/12/2001
which is a CIP of 09/096,703 06/12/1998 ABN
and claims benefit of 60/246,842 11/08/2000
and said 09/096,703 06/12/1998
claims benefit of 60/072,127 01/22/1998

Foreign Applications

If Required, Foreign Filing License Granted: 01/05/2007

The country code and number of your priority application, to be used for filing abroad under the Paris Convention, is US11/563,232

Projected Publication Date: 04/19/2007

Non-Publication Request: No

Early Publication Request: No

Title

NETWORK-ENABLED AUDIO DEVICE

Preliminary Class

725

PROTECTING YOUR INVENTION OUTSIDE THE UNITED STATES

Since the rights granted by a U.S. patent extend only throughout the territory of the United States and have no effect in a foreign country, an inventor who wishes patent protection in another country must apply for a patent in a specific country or in regional patent offices. Applicants may wish to consider the filing of an international application under the Patent Cooperation Treaty (PCT). An international (PCT) application generally has the same effect as a regular national patent application in each PCT-member country. The PCT process **simplifies** the filing of patent applications on the same invention in member countries, but **does not result** in a grant of "an international patent" and does not eliminate the need of applicants to file additional documents and fees in countries where patent protection is desired.

Almost every country has its own patent law, and a person desiring a patent in a particular country must make an application for patent in that country in accordance with its particular laws. Since the laws of many countries differ in various respects from the patent law of the United States, applicants are advised to seek guidance from specific foreign countries to ensure that patent rights are not lost prematurely.

Applicants also are advised that in the case of inventions made in the United States, the Director of the USPTO must issue a license before applicants can apply for a patent in a foreign country. The filing of a U.S. patent application serves as a request for a foreign filing license. The application's filing receipt contains further information and guidance as to the status of applicant's license for foreign filing.

Applicants may wish to consult the USPTO booklet, "General Information Concerning Patents" (specifically, the section entitled "Treaties and Foreign Patents") for more information on timeframes and deadlines for filing foreign patent applications. The guide is available either by contacting the USPTO Contact Center at 800-786-9199, or it can be viewed on the USPTO website at <http://www.uspto.gov/web/offices/pac/doc/general/index.html>.

For information on preventing theft of your intellectual property (patents, trademarks and copyrights), you may wish to consult the U.S. Government website, <http://www.stopfakes.gov>. Part of a Department of Commerce initiative, this website includes self-help "toolkits" giving innovators guidance on how to protect intellectual property in specific countries such as China, Korea and Mexico. For questions regarding patent enforcement issues, applicants may call the U.S. Government hotline at 1-866-999-HALT (1-866-999-4158).

LICENSE FOR FOREIGN FILING UNDER**Title 35, United States Code, Section 184****Title 37, Code of Federal Regulations, 5.11 & 5.15****GRANTED**

The applicant has been granted a license under 35 U.S.C. 184, if the phrase "IF REQUIRED, FOREIGN FILING LICENSE GRANTED" followed by a date appears on this form. Such licenses are issued in all applications where the conditions for issuance of a license have been met, regardless of whether or not a license may be required as set forth in 37 CFR 5.15. The scope and limitations of this license are set forth in 37 CFR 5.15(a) unless an earlier license has been issued under 37 CFR 5.15(b). The license is subject to revocation upon written notification. The date indicated is the effective date of the license, unless an earlier license of similar scope has been granted under 37 CFR 5.13 or 5.14.

This license is to be retained by the licensee and may be used at any time on or after the effective date thereof unless it is revoked. This license is automatically transferred to any related applications(s) filed under

37 CFR 1.53(d). This license is not retroactive.

The grant of a license does not in any way lessen the responsibility of a licensee for the security of the subject matter as imposed by any Government contract or the provisions of existing laws relating to espionage and the national security or the export of technical data. Licensees should apprise themselves of current regulations especially with respect to certain countries, of other agencies, particularly the Office of Defense Trade Controls, Department of State (with respect to Arms, Munitions and Implements of War (22 CFR 121-128)); the Bureau of Industry and Security, Department of Commerce (15 CFR parts 730-774); the Office of Foreign Assets Control, Department of Treasury (31 CFR Parts 500+) and the Department of Energy.

NOT GRANTED

No license under 35 U.S.C. 184 has been granted at this time, if the phrase "IF REQUIRED, FOREIGN FILING LICENSE GRANTED" DOES NOT appear on this form. Applicant may still petition for a license under 37 CFR 5.12, if a license is desired before the expiration of 6 months from the filing date of the application. If 6 months has lapsed from the filing date of this application and the licensee has not received any indication of a secrecy order under 35 U.S.C. 181, the licensee may foreign file the application pursuant to 37 CFR 5.15(b).



UNITED STATES PATENT AND TRADEMARK OFFICE

UNITED STATES DEPARTMENT OF COMMERCE
United States Patent and Trademark Office
Address: COMMISSIONER FOR PATENTS
P.O. Box 1450
Alexandria, Virginia 22313-1450
www.uspto.gov

APPLICATION NUMBER	FILING OR 371(c) DATE	FIRST NAMED APPLICANT	ATTY. DOCKET NO./TITLE
11/563,232	11/27/2006	Safi Qureshey	1116-028C

CONFIRMATION NO. 1583

27820
WITHROW & TERRANOVA, P.L.L.C.
100 REGENCY FOREST DRIVE
SUITE 160
CARY, NC27518

Title: NETWORK-ENABLED AUDIO DEVICE

Publication No. US-2007-0089132-A1

Publication Date: 04/19/2007

NOTICE OF PUBLICATION OF APPLICATION

The above-identified application will be electronically published as a patent application publication pursuant to 37 CFR 1.211, et seq. The patent application publication number and publication date are set forth above.

The publication may be accessed through the USPTO's publically available Searchable Databases via the Internet at www.uspto.gov. The direct link to access the publication is currently <http://www.uspto.gov/patft/>.

The publication process established by the Office does not provide for mailing a copy of the publication to applicant. A copy of the publication may be obtained from the Office upon payment of the appropriate fee set forth in 37 CFR 1.19(a)(1). Orders for copies of patent application publications are handled by the USPTO's Office of Public Records. The Office of Public Records can be reached by telephone at (703) 308-9726 or (800) 972-6382, by facsimile at (703) 305-8759, by mail addressed to the United States Patent and Trademark Office, Office of Public Records, Alexandria, VA 22313-1450 or via the Internet.

In addition, information on the status of the application, including the mailing date of Office actions and the dates of receipt of correspondence filed in the Office, may also be accessed via the Internet through the Patent Electronic Business Center at www.uspto.gov using the public side of the Patent Application Information and Retrieval (PAIR) system. The direct link to access this status information is currently <http://pair.uspto.gov/>. Prior to publication, such status information is confidential and may only be obtained by applicant using the private side of PAIR.

Further assistance in electronically accessing the publication, or about PAIR, is available by calling the Patent Electronic Business Center at 703-305-3028.

Pre-Grant Publication Division, 703-605-4283



UNITED STATES PATENT AND TRADEMARK OFFICE

UNITED STATES DEPARTMENT OF COMMERCE
United States Patent and Trademark Office
Address: COMMISSIONER FOR PATENTS
P.O. Box 1450
Alexandria, Virginia 22313-1450
www.uspto.gov

APPLICATION NUMBER	PATENT NUMBER	GROUP ART UNIT	FILE WRAPPER LOCATION
11/563,232		2623	

Correspondence Address / Fee Address Change

The following fields have been set to Customer Number 71739 on 06/26/2007

- Correspondence Address
- Maintenance Fee Address

The address of record for Customer Number 71739 is:
CONCERT TECHNOLOGY AND WITHROW & TERRANOVA
100 REGENCY FOREST DRIVE , SUITE 160
CARY,NC 27518

Under the Paperwork Reduction Act of 1995, no persons are required to respond to a collection of information unless it contains a valid OMB control number.

INFORMATION DISCLOSURE STATEMENT BY APPLICANT (Not for submission under 37 CFR 1.99)	Application Number	11563232
	Filing Date	2006-11-27
	First Named Inventor	Safi Qureshey et al.
	Art Unit	2623
	Examiner Name	TBA
	Attorney Docket Number	1116-028C

U.S. PATENTS							Remove
Examiner Initial*	Cite No	Patent Number	Kind Code ¹	Issue Date	Name of Patentee or Applicant of cited Document	Pages, Columns, Lines where Relevant Passages or Relevant Figures Appear	
	1	3291919		1966-12-13	Robitaille		
	2	4682370		1987-07-21	Matthews		
	3	4720873		1988-01-19	Goodman et al.		
	4	4920432		1990-04-24	Eggers et al.		
	5	5035438		1991-07-30	Cronquist		
	6	5119188		1992-06-02	McCalley et al.		
	7	5127003		1992-06-30	Doll, Jr. et al.		
	8	5129036		1992-07-07	Dean et al.		

INFORMATION DISCLOSURE STATEMENT BY APPLICANT (Not for submission under 37 CFR 1.99)	Application Number		11563232	
	Filing Date		2006-11-27	
	First Named Inventor	Safi Qureshey et al.		
	Art Unit		2623	
	Examiner Name	TBA		
	Attorney Docket Number		1116-028C	

	9	5168481		1992-12-01	Culbertson et al.	
	10	5189630		1993-02-23	Barstow et al.	
	11	5192999		1993-03-09	Graczyk et al.	
	12	5215466		1993-06-01	Rubio	
	13	5282028		1994-01-25	Johnson et al.	
	14	5305438		1994-04-19	MacKay et al.	
	15	5349678		1994-09-20	Morris et al.	
	16	5351276		1994-09-27	Doll, Jr. et al.	
	17	5414455		1995-05-09	Hooper et al.	
	18	5455570		1995-10-03	Cook et al.	
	19	5475835		1995-12-12	Hickey	

INFORMATION DISCLOSURE STATEMENT BY APPLICANT (Not for submission under 37 CFR 1.99)	Application Number		11563232	
	Filing Date		2006-11-27	
	First Named Inventor	Safi Qureshey et al.		
	Art Unit		2623	
	Examiner Name	TBA		
	Attorney Docket Number		1116-028C	

	20	5481535		1996-01-02	Hershey	
	21	5512935		1996-04-30	Majeti et al.	
	22	5526284		1996-06-11	Mankovitz	
	23	5534913		1996-07-09	Majeti et al.	
	24	5539635		1996-07-23	Larson, Jr.	
	25	5544161		1996-08-06	Bigham et al.	
	26	5557541		1996-09-17	Schulhof et al.	
	27	5568645		1996-10-22	Morris et al.	
	28	5570134		1996-10-29	Hong	
	29	5572442		1996-11-05	Schulhof et al.	
	30	5592511		1997-01-07	Schoen et al.	

INFORMATION DISCLOSURE STATEMENT BY APPLICANT (Not for submission under 37 CFR 1.99)	Application Number		11563232	
	Filing Date		2006-11-27	
	First Named Inventor	Safi Qureshey et al.		
	Art Unit		2623	
	Examiner Name	TBA		
	Attorney Docket Number		1116-028C	

	31	5617565		1997-04-01	Augenbraun et al.	
	32	5625608		1997-04-29	Grewe et al.	
	33	5629867		1997-05-13	Goldman	
	34	5636211		1997-06-03	Newlin et al.	
	35	5640193		1997-06-17	Wellner	
	36	5654886		1997-08-05	Zereski, Jr. et al.	
	37	5671436		1997-09-23	Morris et al.	
	38	5673322		1997-09-30	Pepe et al.	
	39	5684799		1997-11-04	Bigham et al.	
	40	5682525		1997-10-28	Bouve et al.	
	41	5740035		1998-04-14	Cohen et al.	

INFORMATION DISCLOSURE STATEMENT BY APPLICANT (Not for submission under 37 CFR 1.99)	Application Number	11563232
	Filing Date	2006-11-27
	First Named Inventor	Safi Qureshey et al.
	Art Unit	2623
	Examiner Name	TBA
	Attorney Docket Number	1116-028C

	42	5768527		1998-06-16	Zhu et al.	
	43	5809246		1998-09-15	Goldman	
	44	5812937		1998-09-22	Takahisa et al.	
	45	5818512		1998-10-06	Fuller	
	46	5819160		1998-10-06	Foladare et al.	
	47	5844893		1998-12-01	Gollnick et al.	
	48	5850340		1998-12-15	York	
	49	5857149		1999-01-05	Suzuki	
	50	5862171		1999-01-19	Mahany	

If you wish to add additional U.S. Patent citation information please click the Add button.

Add

U.S.PATENT APPLICATION PUBLICATIONS

Remove

Examiner Initial*	Cite No	Publication Number	Kind Code ¹	Publication Date	Name of Patentee or Applicant of cited Document	Pages, Columns, Lines where Relevant Passages or Relevant Figures Appear
-------------------	---------	--------------------	------------------------	------------------	-------------------------------------------------	--------------------------------------------------------------------------

INFORMATION DISCLOSURE STATEMENT BY APPLICANT (Not for submission under 37 CFR 1.99)	Application Number	11563232
	Filing Date	2006-11-27
	First Named Inventor	Safi Qureshey et al.
	Art Unit	2623
	Examiner Name	TBA
	Attorney Docket Number	1116-028C

1						
---	--	--	--	--	--	--

If you wish to add additional U.S. Published Application citation information please click the Add button.

FOREIGN PATENT DOCUMENTS

Examiner Initial*	Cite No	Foreign Document Number ³	Country Code ² j	Kind Code ⁴	Publication Date	Name of Patentee or Applicant of cited Document	Pages, Columns, Lines where Relevant Passages or Relevant Figures Appear	T ⁵
	1	2306869	GB	A	1997-07-05	Patrik Garten		<input checked="" type="checkbox"/>
	2	97/26601	WO	A2	1997-07-24	Philips Electronics N.V.		<input checked="" type="checkbox"/>

If you wish to add additional Foreign Patent Document citation information please click the Add button.

NON-PATENT LITERATURE DOCUMENTS

Examiner Initials*	Cite No	Include name of the author (in CAPITAL LETTERS), title of the article (when appropriate), title of the item (book, magazine, journal, serial, symposium, catalog, etc), date, pages(s), volume-issue number(s), publisher, city and/or country where published.	T ⁵
	1	"A Music Revolution ... SoundServer," imerge, 2 pages.	<input checked="" type="checkbox"/>
	2	"imerge Multi-room SoundServer Application note," Issue 1.1, August 2000, 9 pages.	<input checked="" type="checkbox"/>
	3	VERONICA HENDRICKS, "Imerge SoundServer," Techonline, http://www.techonline.com/scripts/tol.exe?TEMPLATE,top.ops&AREA,1&CONTENT,8988&NET,13&USER.todd_Bergeson@3com.com , Copyright 1999-2000 TechOnLine, Inc., printed September 22, 2000, 2 pages.	<input checked="" type="checkbox"/>
	4	"NPR : National Public Radio : News & Analysis, World, US, Music & Arts," http://www.npr.org , Copyright 2007 NPR, printed October 16, 2007, 7 pages.	<input checked="" type="checkbox"/>

INFORMATION DISCLOSURE STATEMENT BY APPLICANT (Not for submission under 37 CFR 1.99)	Application Number	11563232
	Filing Date	2006-11-27
	First Named Inventor	Safi Qureshey et al.
	Art Unit	2623
	Examiner Name	TBA
	Attorney Docket Number	1116-028C

5	"Webradio Com," http://www.webradio.com/eflp/web+radio/pid73231/D284974/C2243539 , Copyright 2007 www.webradio.com, printed October 16, 2007, 1 page.	<input checked="" type="checkbox"/>
6	"RCS Acquires Decision Inc.; Offers Complete Software Solution for Radio Station Programming Operations," Businesswire, February 9, 1993, Copyright 1995 Reuters Info. Svcs., 2 pages.	<input checked="" type="checkbox"/>
7	MARY WELLER, "Radio Station Software: Programmes That Meet Your Stations Needs," Music & Media, November 28, 1992, p. 11, Copyright 1995 Information Access Co., 3 pages.	<input checked="" type="checkbox"/>
8	CHRIS MCCONNELL, "The tapeless revolution comes to radio (disk-based radio broadcasting storage, production and editing systems)," Broadcasting & Cable, v124, n41, p. 77, October 10, 1994, Copyright 1995 Info Access Co., 4 pages.	<input checked="" type="checkbox"/>
9	"Blockbuster and IBM Announce New Multimedia Ventures," May 11, 1993, 2 pages.	<input checked="" type="checkbox"/>
10	"IBM Launches Business to Deploy Multimedia Applications and Services," January 20, 1993, 3 pages.	<input checked="" type="checkbox"/>
11	"The Not So Hard Disk," Wheatstone Corporation, 5 pages.	<input checked="" type="checkbox"/>
12	"Audio Switcher Model CCSW84-01," Computer Concepts Corp. Digital Commercial System, February 1991, 3 pages.	<input checked="" type="checkbox"/>
13	"DCS Live! Live Radio Just Got Easier," Computer Concepts Corporation, 1 page.	<input checked="" type="checkbox"/>
14	"DCS Overview," Computer Concepts Corporation, 1 page.	<input checked="" type="checkbox"/>
15	"The Computer Concepts Traffic System. You'll wonder how you managed without it," Computer Concepts Corporation, 1 page.	<input checked="" type="checkbox"/>

INFORMATION DISCLOSURE STATEMENT BY APPLICANT (Not for submission under 37 CFR 1.99)	Application Number	11563232
	Filing Date	2006-11-27
	First Named Inventor	Safi Qureshey et al.
	Art Unit	2623
	Examiner Name	TBA
	Attorney Docket Number	1116-028C

16	"Digital On-Air Studio System," January 31, 1994, Copyright format only 1997 Knight-Ridder Info., 1 page.	<input checked="" type="checkbox"/>
17	"Relatable's Open Source Audio Signature Solution, TRM," http://web.archive.org/web/20001117082600/http://www.relatable.com/tech/trm.html , copyright Relatable 2000, printed November 28, 2007, 2 pages.	<input checked="" type="checkbox"/>

If you wish to add additional non-patent literature document citation information please click the Add button

EXAMINER SIGNATURE

Examiner Signature		Date Considered	
--------------------	--	-----------------	--

*EXAMINER: Initial if reference considered, whether or not citation is in conformance with MPEP 609. Draw line through a citation if not in conformance and not considered. Include copy of this form with next communication to applicant.

¹ See Kind Codes of USPTO Patent Documents at www.USPTO.GOV or MPEP 901.04. ² Enter office that issued the document, by the two-letter code (WIPO Standard ST.3). ³ For Japanese patent documents, the indication of the year of the reign of the Emperor must precede the serial number of the patent document. ⁴ Kind of document by the appropriate symbols as indicated on the document under WIPO Standard ST.16 if possible. ⁵ Applicant is to place a check mark here if English language translation is attached.

INFORMATION DISCLOSURE STATEMENT BY APPLICANT (Not for submission under 37 CFR 1.99)	Application Number	11563232
	Filing Date	2006-11-27
	First Named Inventor	Safi Qureshey et al.
	Art Unit	2623
	Examiner Name	TBA
	Attorney Docket Number	1116-028C

CERTIFICATION STATEMENT

Please see 37 CFR 1.97 and 1.98 to make the appropriate selection(s):

That each item of information contained in the information disclosure statement was first cited in any communication from a foreign patent office in a counterpart foreign application not more than three months prior to the filing of the information disclosure statement. See 37 CFR 1.97(e)(1).

OR

That no item of information contained in the information disclosure statement was cited in a communication from a foreign patent office in a counterpart foreign application, and, to the knowledge of the person signing the certification after making reasonable inquiry, no item of information contained in the information disclosure statement was known to any individual designated in 37 CFR 1.56(c) more than three months prior to the filing of the information disclosure statement. See 37 CFR 1.97(e)(2).

See attached certification statement.

Fee set forth in 37 CFR 1.17 (p) has been submitted herewith.

None

SIGNATURE

A signature of the applicant or representative is required in accordance with CFR 1.33, 10.18. Please see CFR 1.4(d) for the form of the signature.

Signature	/Steven N. Terranova/	Date (YYYY-MM-DD)	2007-12-28
Name/Print	Steven N. Terranova	Registration Number	43,185

This collection of information is required by 37 CFR 1.97 and 1.98. The information is required to obtain or retain a benefit by the public which is to file (and by the USPTO to process) an application. Confidentiality is governed by 35 U.S.C. 122 and 37 CFR 1.14. This collection is estimated to take 1 hour to complete, including gathering, preparing and submitting the completed application form to the USPTO. Time will vary depending upon the individual case. Any comments on the amount of time you require to complete this form and/or suggestions for reducing this burden, should be sent to the Chief Information Officer, U.S. Patent and Trademark Office, U.S. Department of Commerce, P.O. Box 1450, Alexandria, VA 22313-1450. **DO NOT SEND FEES OR COMPLETED FORMS TO THIS ADDRESS. SEND TO: Commissioner for Patents, P.O. Box 1450, Alexandria, VA 22313-1450.**

Privacy Act Statement

The Privacy Act of 1974 (P.L. 93-579) requires that you be given certain information in connection with your submission of the attached form related to a patent application or patent. Accordingly, pursuant to the requirements of the Act, please be advised that: (1) the general authority for the collection of this information is 35 U.S.C. 2(b)(2); (2) furnishing of the information solicited is voluntary; and (3) the principal purpose for which the information is used by the U.S. Patent and Trademark Office is to process and/or examine your submission related to a patent application or patent. If you do not furnish the requested information, the U.S. Patent and Trademark Office may not be able to process and/or examine your submission, which may result in termination of proceedings or abandonment of the application or expiration of the patent.

The information provided by you in this form will be subject to the following routine uses:

1. The information on this form will be treated confidentially to the extent allowed under the Freedom of Information Act (5 U.S.C. 552) and the Privacy Act (5 U.S.C. 552a). Records from this system of records may be disclosed to the Department of Justice to determine whether the Freedom of Information Act requires disclosure of these records.
2. A record from this system of records may be disclosed, as a routine use, in the course of presenting evidence to a court, magistrate, or administrative tribunal, including disclosures to opposing counsel in the course of settlement negotiations.
3. A record in this system of records may be disclosed, as a routine use, to a Member of Congress submitting a request involving an individual, to whom the record pertains, when the individual has requested assistance from the Member with respect to the subject matter of the record.
4. A record in this system of records may be disclosed, as a routine use, to a contractor of the Agency having need for the information in order to perform a contract. Recipients of information shall be required to comply with the requirements of the Privacy Act of 1974, as amended, pursuant to 5 U.S.C. 552a(m).
5. A record related to an International Application filed under the Patent Cooperation Treaty in this system of records may be disclosed, as a routine use, to the International Bureau of the World Intellectual Property Organization, pursuant to the Patent Cooperation Treaty.
6. A record in this system of records may be disclosed, as a routine use, to another federal agency for purposes of National Security review (35 U.S.C. 181) and for review pursuant to the Atomic Energy Act (42 U.S.C. 218(c)).
7. A record from this system of records may be disclosed, as a routine use, to the Administrator, General Services, or his/her designee, during an inspection of records conducted by GSA as part of that agency's responsibility to recommend improvements in records management practices and programs, under authority of 44 U.S.C. 2904 and 2906. Such disclosure shall be made in accordance with the GSA regulations governing inspection of records for this purpose, and any other relevant (i.e., GSA or Commerce) directive. Such disclosure shall not be used to make determinations about individuals.
8. A record from this system of records may be disclosed, as a routine use, to the public after either publication of the application pursuant to 35 U.S.C. 122(b) or issuance of a patent pursuant to 35 U.S.C. 151. Further, a record may be disclosed, subject to the limitations of 37 CFR 1.14, as a routine use, to the public if the record was filed in an application which became abandoned or in which the proceedings were terminated and which application is referenced by either a published application, an application open to public inspections or an issued patent.
9. A record from this system of records may be disclosed, as a routine use, to a Federal, State, or local law enforcement agency, if the USPTO becomes aware of a violation or potential violation of law or regulation.

Under the Paperwork Reduction Act of 1995, no persons are required to respond to a collection of information unless it contains a valid OMB control number.

INFORMATION DISCLOSURE STATEMENT BY APPLICANT (Not for submission under 37 CFR 1.99)	Application Number	11563232
	Filing Date	2006-11-27
	First Named Inventor	Safi Qureshey et al.
	Art Unit	2623
	Examiner Name	TBA
	Attorney Docket Number	1116-028C

U.S. PATENTS							Remove
Examiner Initial*	Cite No	Patent Number	Kind Code ¹	Issue Date	Name of Patentee or Applicant of cited Document	Pages, Columns, Lines where Relevant Passages or Relevant Figures Appear	
	1	5870390		1999-02-09	Campanella		
	2	5873045		1999-02-16	Lee et al.		
	3	5880721		1999-03-09	Yen		
	4	5892536		1999-04-06	Logan et al.		
	5	5905865		1999-05-18	Palmer et al.		
	6	5918223		1999-06-29	Blum et al.		
	7	5943398		1999-08-24	Klein et al.		
	8	5948084		1999-09-07	Ha		

INFORMATION DISCLOSURE STATEMENT BY APPLICANT (Not for submission under 37 CFR 1.99)	Application Number		11563232	
	Filing Date		2006-11-27	
	First Named Inventor	Safi Qureshey et al.		
	Art Unit		2623	
	Examiner Name	TBA		
	Attorney Docket Number		1116-028C	

	9	5949492		1999-09-07	Mankovitz	
	10	5990868		1999-11-23	Frederick	
	11	5991693		1999-11-23	Zalewski	
	12	6005563		1999-12-21	White et al.	
	13	6012086		2000-01-04	Lowell	
	14	6014569		2000-01-11	Bottum	
	15	6035350		2000-03-07	Swamy et al.	
	16	6067562		2000-05-23	Goldman	
	17	6088455		2000-07-11	Logan et al.	
	18	6105060		2000-08-15	Rothblatt	
	19	6199076	B1	2001-03-06	Logan et al.	

INFORMATION DISCLOSURE STATEMENT BY APPLICANT (Not for submission under 37 CFR 1.99)	Application Number		11563232	
	Filing Date		2006-11-27	
	First Named Inventor	Safi Qureshey et al.		
	Art Unit		2623	
	Examiner Name	TBA		
	Attorney Docket Number		1116-028C	

	20	6204885	B1	2001-03-20	Kwoh	
	21	6226672	B1	2001-05-01	DeMartin et al.	
	22	6229621	B1	2001-05-08	Kulakowski et al.	
	23	6253069	B1	2001-06-26	Mankovitz	
	24	6295093	B1	2001-09-25	Park et al.	
	25	6295555	B1	2001-09-25	Goldman	
	26	6349329	B1	2002-02-19	Mackintosh et al.	
	27	6628928	B1	2003-09-30	Crosby et al.	
	28	6793142	B2	2004-09-21	Yap	
	29	6826283	B1	2004-11-30	Wheeler et al.	
If you wish to add additional U.S. Patent citation information please click the Add button.						<input type="button" value="Add"/>
U.S.PATENT APPLICATION PUBLICATIONS						<input type="button" value="Remove"/>

INFORMATION DISCLOSURE STATEMENT BY APPLICANT (Not for submission under 37 CFR 1.99)	Application Number	11563232
	Filing Date	2006-11-27
	First Named Inventor	Safi Qureshey et al.
	Art Unit	2623
	Examiner Name	TBA
	Attorney Docket Number	1116-028C

Examiner Initial*	Cite No	Publication Number	Kind Code ¹	Publication Date	Name of Patentee or Applicant of cited Document	Pages, Columns, Lines where Relevant Passages or Relevant Figures Appear
	1	20020002039	A1	2002-01-03	Qureshey et al.	
	2	20020072326	A1	2002-06-13	Qureshey et al.	
	3	20040121723	A1	2004-06-24	Poltorak	
	4	20060074808	A1	2006-04-06	Boesen	
	5	20060141962	A1	2006-06-29	Forbes et al.	
	6	20060156346	A1	2006-07-13	Kulakowski	
	7	20060171395	A1	2006-08-03	Deshpande	
	8	20060173825	A1	2006-08-03	Hess et al.	
	9	20060174348	A1	2006-08-03	Rhoads et al.	
	10	20060184960	A1	2006-08-17	Horton et al.	

INFORMATION DISCLOSURE STATEMENT BY APPLICANT (Not for submission under 37 CFR 1.99)	Application Number	11563232
	Filing Date	2006-11-27
	First Named Inventor	Safi Qureshey et al.
	Art Unit	2623
	Examiner Name	TBA
	Attorney Docket Number	1116-028C

11	20060218613	A1	2006-09-28	Bushnell	
12	20070089135	A1	2007-04-19	Qureshey et al.	
13	20070088804	A1	2007-04-19	Qureshey et al.	
14	20070180063	A1	2007-08-02	Qureshey et al.	

If you wish to add additional U.S. Published Application citation information please click the Add button.

FOREIGN PATENT DOCUMENTS

Examiner Initial*	Cite No	Foreign Document Number ³	Country Code ² j	Kind Code ⁴	Publication Date	Name of Patentee or Applicant of cited Document	Pages, Columns, Lines where Relevant Passages or Relevant Figures Appear	T ⁵
	1							<input type="checkbox"/>

If you wish to add additional Foreign Patent Document citation information please click the Add button.

NON-PATENT LITERATURE DOCUMENTS

Examiner Initials*	Cite No	Include name of the author (in CAPITAL LETTERS), title of the article (when appropriate), title of the item (book, magazine, journal, serial, symposium, catalog, etc), date, pages(s), volume-issue number(s), publisher, city and/or country where published.	T ⁵
	1		<input type="checkbox"/>

If you wish to add additional non-patent literature document citation information please click the Add button.

EXAMINER SIGNATURE

Examiner Signature		Date Considered	
--------------------	--	-----------------	--

*EXAMINER: Initial if reference considered, whether or not citation is in conformance with MPEP 609. Draw line through a citation if not in conformance and not considered. Include copy of this form with next communication to applicant.

INFORMATION DISCLOSURE STATEMENT BY APPLICANT (Not for submission under 37 CFR 1.99)	Application Number	11563232
	Filing Date	2006-11-27
	First Named Inventor	Safi Qureshey et al.
	Art Unit	2623
	Examiner Name	TBA
	Attorney Docket Number	1116-028C

¹ See Kind Codes of USPTO Patent Documents at www.USPTO.GOV or MPEP 901.04. ² Enter office that issued the document, by the two-letter code (WIPO Standard ST.3). ³ For Japanese patent documents, the indication of the year of the reign of the Emperor must precede the serial number of the patent document. ⁴ Kind of document by the appropriate symbols as indicated on the document under WIPO Standard ST.16 if possible. ⁵ Applicant is to place a check mark here if English language translation is attached.

INFORMATION DISCLOSURE STATEMENT BY APPLICANT (Not for submission under 37 CFR 1.99)	Application Number	11563232
	Filing Date	2006-11-27
	First Named Inventor	Safi Qureshey et al.
	Art Unit	2623
	Examiner Name	TBA
	Attorney Docket Number	1116-028C

CERTIFICATION STATEMENT

Please see 37 CFR 1.97 and 1.98 to make the appropriate selection(s):

That each item of information contained in the information disclosure statement was first cited in any communication from a foreign patent office in a counterpart foreign application not more than three months prior to the filing of the information disclosure statement. See 37 CFR 1.97(e)(1).

OR

That no item of information contained in the information disclosure statement was cited in a communication from a foreign patent office in a counterpart foreign application, and, to the knowledge of the person signing the certification after making reasonable inquiry, no item of information contained in the information disclosure statement was known to any individual designated in 37 CFR 1.56(c) more than three months prior to the filing of the information disclosure statement. See 37 CFR 1.97(e)(2).

See attached certification statement.

Fee set forth in 37 CFR 1.17 (p) has been submitted herewith.

None

SIGNATURE

A signature of the applicant or representative is required in accordance with CFR 1.33, 10.18. Please see CFR 1.4(d) for the form of the signature.

Signature	/Steven N. Terranova/	Date (YYYY-MM-DD)	2007-12-28
Name/Print	Steven N. Terranova	Registration Number	43,185

This collection of information is required by 37 CFR 1.97 and 1.98. The information is required to obtain or retain a benefit by the public which is to file (and by the USPTO to process) an application. Confidentiality is governed by 35 U.S.C. 122 and 37 CFR 1.14. This collection is estimated to take 1 hour to complete, including gathering, preparing and submitting the completed application form to the USPTO. Time will vary depending upon the individual case. Any comments on the amount of time you require to complete this form and/or suggestions for reducing this burden, should be sent to the Chief Information Officer, U.S. Patent and Trademark Office, U.S. Department of Commerce, P.O. Box 1450, Alexandria, VA 22313-1450. **DO NOT SEND FEES OR COMPLETED FORMS TO THIS ADDRESS. SEND TO: Commissioner for Patents, P.O. Box 1450, Alexandria, VA 22313-1450.**

Privacy Act Statement

The Privacy Act of 1974 (P.L. 93-579) requires that you be given certain information in connection with your submission of the attached form related to a patent application or patent. Accordingly, pursuant to the requirements of the Act, please be advised that: (1) the general authority for the collection of this information is 35 U.S.C. 2(b)(2); (2) furnishing of the information solicited is voluntary; and (3) the principal purpose for which the information is used by the U.S. Patent and Trademark Office is to process and/or examine your submission related to a patent application or patent. If you do not furnish the requested information, the U.S. Patent and Trademark Office may not be able to process and/or examine your submission, which may result in termination of proceedings or abandonment of the application or expiration of the patent.

The information provided by you in this form will be subject to the following routine uses:

1. The information on this form will be treated confidentially to the extent allowed under the Freedom of Information Act (5 U.S.C. 552) and the Privacy Act (5 U.S.C. 552a). Records from this system of records may be disclosed to the Department of Justice to determine whether the Freedom of Information Act requires disclosure of these records.
2. A record from this system of records may be disclosed, as a routine use, in the course of presenting evidence to a court, magistrate, or administrative tribunal, including disclosures to opposing counsel in the course of settlement negotiations.
3. A record in this system of records may be disclosed, as a routine use, to a Member of Congress submitting a request involving an individual, to whom the record pertains, when the individual has requested assistance from the Member with respect to the subject matter of the record.
4. A record in this system of records may be disclosed, as a routine use, to a contractor of the Agency having need for the information in order to perform a contract. Recipients of information shall be required to comply with the requirements of the Privacy Act of 1974, as amended, pursuant to 5 U.S.C. 552a(m).
5. A record related to an International Application filed under the Patent Cooperation Treaty in this system of records may be disclosed, as a routine use, to the International Bureau of the World Intellectual Property Organization, pursuant to the Patent Cooperation Treaty.
6. A record in this system of records may be disclosed, as a routine use, to another federal agency for purposes of National Security review (35 U.S.C. 181) and for review pursuant to the Atomic Energy Act (42 U.S.C. 218(c)).
7. A record from this system of records may be disclosed, as a routine use, to the Administrator, General Services, or his/her designee, during an inspection of records conducted by GSA as part of that agency's responsibility to recommend improvements in records management practices and programs, under authority of 44 U.S.C. 2904 and 2906. Such disclosure shall be made in accordance with the GSA regulations governing inspection of records for this purpose, and any other relevant (i.e., GSA or Commerce) directive. Such disclosure shall not be used to make determinations about individuals.
8. A record from this system of records may be disclosed, as a routine use, to the public after either publication of the application pursuant to 35 U.S.C. 122(b) or issuance of a patent pursuant to 35 U.S.C. 151. Further, a record may be disclosed, subject to the limitations of 37 CFR 1.14, as a routine use, to the public if the record was filed in an application which became abandoned or in which the proceedings were terminated and which application is referenced by either a published application, an application open to public inspections or an issued patent.
9. A record from this system of records may be disclosed, as a routine use, to a Federal, State, or local law enforcement agency, if the USPTO becomes aware of a violation or potential violation of law or regulation.

Electronic Acknowledgement Receipt

EFS ID:	2649716
Application Number:	11563232
International Application Number:	
Confirmation Number:	1583
Title of Invention:	NETWORK-ENABLED AUDIO DEVICE
First Named Inventor/Applicant Name:	Safi Qureshey
Customer Number:	71739
Filer:	Steven Terranova/Julie Smith
Filer Authorized By:	Steven Terranova
Attorney Docket Number:	1116-028C
Receipt Date:	28-DEC-2007
Filing Date:	27-NOV-2006
Time Stamp:	14:17:11
Application Type:	Utility under 35 USC 111(a)

Payment information:

Submitted with Payment	no
------------------------	----

File Listing:

Document Number	Document Description	File Name	File Size(Bytes) /Message Digest	Multi Part /.zip	Pages (if appl.)
1	Information Disclosure Statement (IDS) Filed	1116-028C_IDS.PDF	1217241 d0ad8bf15b93c8bd8046175e48c851bb a9536794	no	10

Warnings:

Information:

2	Foreign Reference	GB2306869.pdf	1008470 e82cbaa45c46018d6efd4eb7a46ffb086c5cle09	no	23
Warnings:					
Information:					
3	Foreign Reference	WO9726601.pdf	2126459 d7e86e31da5c7ece87dc14c09db22be0b51773a	no	41
Warnings:					
Information:					
4	NPL Documents	Audio_Switcher.pdf	511374 7ad137fbb80a88cde3d72971d4188ce2af50e722	no	3
Warnings:					
The page size in the PDF is too large. The pages should be 8.5 x 11 or A4. If this PDF is submitted, the pages will be resized upon entry into the Image File Wrapper and may affect subsequent processing					
Information:					
5	NPL Documents	Blockbuster_IBM_Press_Rel ease.pdf	521948 24a620d70d7193cbee68f4e7e431110a50dd0445	no	2
Warnings:					
The page size in the PDF is too large. The pages should be 8.5 x 11 or A4. If this PDF is submitted, the pages will be resized upon entry into the Image File Wrapper and may affect subsequent processing					
Information:					
6	NPL Documents	Computer_Concepts_Traffic. pdf	382810 e094d23a2b55d670363f8d2eb1095241a0becf6a	no	1
Warnings:					
The page size in the PDF is too large. The pages should be 8.5 x 11 or A4. If this PDF is submitted, the pages will be resized upon entry into the Image File Wrapper and may affect subsequent processing					
Information:					
7	NPL Documents	DCS_Live.pdf	273725 943cb2cb8c3242d6162849c0c8aab801f274b920	no	1
Warnings:					
The page size in the PDF is too large. The pages should be 8.5 x 11 or A4. If this PDF is submitted, the pages will be resized upon entry into the Image File Wrapper and may affect subsequent processing					
Information:					
8	NPL Documents	DCS_Overview.pdf	283880 9d1699e042be27b69c0b2ff1dc1e453f753ad204	no	1
Warnings:					
The page size in the PDF is too large. The pages should be 8.5 x 11 or A4. If this PDF is submitted, the pages will be resized upon entry into the Image File Wrapper and may affect subsequent processing					

Information:					
9	NPL Documents	Digital_On_Air.pdf	285999	no	1
			d9fc760fd03ed6180cc45ae349efc4e8d0fc3fb		
Warnings:					
The page size in the PDF is too large. The pages should be 8.5 x 11 or A4. If this PDF is submitted, the pages will be resized upon entry into the Image File Wrapper and may affect subsequent processing					
Information:					
10	NPL Documents	Hendricks_Imerge_SoundServer.pdf	82690	no	2
			67491a9b4eee0fef2e210e7df388891852a7713c		
Warnings:					
Information:					
11	NPL Documents	IBM_Press_Release.pdf	566681	no	3
			0f658cfe6b3f84f80cfa396d95bdee33bab840f		
Warnings:					
The page size in the PDF is too large. The pages should be 8.5 x 11 or A4. If this PDF is submitted, the pages will be resized upon entry into the Image File Wrapper and may affect subsequent processing					
Information:					
12	NPL Documents	Imerge_SoundServer.pdf	1090717	no	9
			5c6a7be2d97bcbf4189da612200d0ba78a48b165		
Warnings:					
Information:					
13	NPL Documents	McConnel_Tapeless_Revolution.pdf	1302517	no	4
			9faf5atda59731032886ebe6e05cde9cd9e0c47		
Warnings:					
The page size in the PDF is too large. The pages should be 8.5 x 11 or A4. If this PDF is submitted, the pages will be resized upon entry into the Image File Wrapper and may affect subsequent processing					
Information:					
14	NPL Documents	Music_Revolution.pdf	600560	no	2
			5baeaa2a9270fda3f5045b3bcbdd99c71efbd844b		
Warnings:					
Information:					
15	NPL Documents	npr.pdf	238942	no	7
			f175c7061a63393495c11ce563afd369d03a86fe		
Warnings:					
Information:					

16	NPL Documents	RCS_Acquires_Decision.pdf	520769 d5361162d72b80c2430ef0e1e4518518f210c581	no	2
Warnings:					
The page size in the PDF is too large. The pages should be 8.5 x 11 or A4. If this PDF is submitted, the pages will be resized upon entry into the Image File Wrapper and may affect subsequent processing					
Information:					
17	NPL Documents	Relatable.pdf	135768 a9d18da003c6b4c1d44d2d408aec2922611269	no	2
Warnings:					
Information:					
18	NPL Documents	webradio.pdf	240312 c6a392aadf01ec36c743e94d6a65efc762b58d8e	no	1
Warnings:					
Information:					
19	NPL Documents	Weller_Radio_Station_Software.pdf	791435 883d1ec67ebab295fc3b45526e1a2825d55593a3	no	3
Warnings:					
The page size in the PDF is too large. The pages should be 8.5 x 11 or A4. If this PDF is submitted, the pages will be resized upon entry into the Image File Wrapper and may affect subsequent processing					
Information:					
20	NPL Documents	Wheatstone_Hard_Disk.pdf	1887312 c350fd538ce844098a118813211e8cde3036db22	no	5
Warnings:					
The page size in the PDF is too large. The pages should be 8.5 x 11 or A4. If this PDF is submitted, the pages will be resized upon entry into the Image File Wrapper and may affect subsequent processing					
Information:					
21	Information Disclosure Statement (IDS) Filed	1116-028C_IDS_2.PDF	1032744 1a0d8b9fdecdb205f037124adaceedab2a0eed4	no	8
Warnings:					
Information:					
Total Files Size (in bytes):				15102353	

This Acknowledgement Receipt evidences receipt on the noted date by the USPTO of the indicated documents, characterized by the applicant, and including page counts, where applicable. It serves as evidence of receipt similar to a Post Card, as described in MPEP 503.

New Applications Under 35 U.S.C. 111

If a new application is being filed and the application includes the necessary components for a filing date (see 37 CFR 1.53(b)-(d) and MPEP 506), a Filing Receipt (37 CFR 1.54) will be issued in due course and the date shown on this Acknowledgement Receipt will establish the filing date of the application.

National Stage of an International Application under 35 U.S.C. 371

If a timely submission to enter the national stage of an international application is compliant with the conditions of 35 U.S.C. 371 and other applicable requirements a Form PCT/DO/EO/903 indicating acceptance of the application as a national stage submission under 35 U.S.C. 371 will be issued in addition to the Filing Receipt, in due course.

New International Application Filed with the USPTO as a Receiving Office

If a new international application is being filed and the international application includes the necessary components for an international filing date (see PCT Article 11 and MPEP 1810), a Notification of the International Application Number and of the International Filing Date (Form PCT/RO/105) will be issued in due course, subject to prescriptions concerning national security, and the date shown on this Acknowledgement Receipt will establish the international filing date of the application.

Under the Paperwork Reduction Act of 1995, no persons are required to respond to a collection of information unless it contains a valid OMB control number.

INFORMATION DISCLOSURE STATEMENT BY APPLICANT (Not for submission under 37 CFR 1.99)	Application Number	11563232
	Filing Date	2006-11-27
	First Named Inventor	Safi Qureshey et al.
	Art Unit	2623
	Examiner Name	TBA
	Attorney Docket Number	1116-028C

U.S. PATENTS							Remove
Examiner Initial*	Cite No	Patent Number	Kind Code ¹	Issue Date	Name of Patentee or Applicant of cited Document	Pages, Columns, Lines where Relevant Passages or Relevant Figures Appear	
	1	5191573		1993-03-02	Hair		
	2	5440336		1995-08-08	Buhro et al.		
	3	5583763		1996-12-10	Atcheson et al.		
	4	5594779		1997-01-14	Goodman		
	5	5727048		1998-03-10	Hiroshima et al.		
	6	5914941		1999-06-22	Janky		
	7	5930765		1999-07-27	Martin		
	8	5949877		1999-09-07	Traw et al.		

INFORMATION DISCLOSURE STATEMENT BY APPLICANT (Not for submission under 37 CFR 1.99)	Application Number	11563232
	Filing Date	2006-11-27
	First Named Inventor	Safi Qureshey et al.
	Art Unit	2623
	Examiner Name	TBA
	Attorney Docket Number	1116-028C

	9	5991737		1999-11-23	Chen	
	10	6233430	B1	2001-05-15	Helferich	
	11	6233682	B1	2001-05-15	Fritsch	
	12	6505160	B1	2003-01-07	Levy et al.	
	13	6721403	B1	2004-04-13	Mandalia	
	14	6782253	B1	2004-08-24	Shteyn et al.	
	15	6829475	B1	2004-12-07	Lee et al.	

If you wish to add additional U.S. Patent citation information please click the Add button.

U.S.PATENT APPLICATION PUBLICATIONS

Examiner Initial*	Cite No	Publication Number	Kind Code ¹	Publication Date	Name of Patentee or Applicant of cited Document	Pages, Columns, Lines where Relevant Passages or Relevant Figures Appear
	1	20020049037	A1	2002-04-25	Christensen et al.	

If you wish to add additional U.S. Published Application citation information please click the Add button.

FOREIGN PATENT DOCUMENTS

INFORMATION DISCLOSURE STATEMENT BY APPLICANT (Not for submission under 37 CFR 1.99)	Application Number	11563232
	Filing Date	2006-11-27
	First Named Inventor	Safi Qureshey et al.
	Art Unit	2623
	Examiner Name	TBA
	Attorney Docket Number	1116-028C

Examiner Initial*	Cite No	Foreign Document Number ³	Country Code ² j	Kind Code ⁴	Publication Date	Name of Patentee or Applicant of cited Document	Pages,Columns,Lines where Relevant Passages or Relevant Figures Appear	T ⁵
	1							<input type="checkbox"/>

If you wish to add additional Foreign Patent Document citation information please click the Add button

Add

NON-PATENT LITERATURE DOCUMENTS

Remove

Examiner Initials*	Cite No	Include name of the author (in CAPITAL LETTERS), title of the article (when appropriate), title of the item (book, magazine, journal, serial, symposium, catalog, etc), date, pages(s), volume-issue number(s), publisher, city and/or country where published.	T ⁵
	1		<input type="checkbox"/>

If you wish to add additional non-patent literature document citation information please click the Add button

Add

EXAMINER SIGNATURE

Examiner Signature		Date Considered	
--------------------	--	-----------------	--

*EXAMINER: Initial if reference considered, whether or not citation is in conformance with MPEP 609. Draw line through a citation if not in conformance and not considered. Include copy of this form with next communication to applicant.

¹ See Kind Codes of USPTO Patent Documents at www.USPTO.GOV or MPEP 901.04. ² Enter office that issued the document, by the two-letter code (WIPO Standard ST.3). ³ For Japanese patent documents, the indication of the year of the reign of the Emperor must precede the serial number of the patent document. ⁴ Kind of document by the appropriate symbols as indicated on the document under WIPO Standard ST.16 if possible. ⁵ Applicant is to place a check mark here if English language translation is attached.

INFORMATION DISCLOSURE STATEMENT BY APPLICANT (Not for submission under 37 CFR 1.99)	Application Number	11563232
	Filing Date	2006-11-27
	First Named Inventor	Safi Qureshey et al.
	Art Unit	2623
	Examiner Name	TBA
	Attorney Docket Number	1116-028C

CERTIFICATION STATEMENT

Please see 37 CFR 1.97 and 1.98 to make the appropriate selection(s):

That each item of information contained in the information disclosure statement was first cited in any communication from a foreign patent office in a counterpart foreign application not more than three months prior to the filing of the information disclosure statement. See 37 CFR 1.97(e)(1).

OR

That no item of information contained in the information disclosure statement was cited in a communication from a foreign patent office in a counterpart foreign application, and, to the knowledge of the person signing the certification after making reasonable inquiry, no item of information contained in the information disclosure statement was known to any individual designated in 37 CFR 1.56(c) more than three months prior to the filing of the information disclosure statement. See 37 CFR 1.97(e)(2).

See attached certification statement.

Fee set forth in 37 CFR 1.17 (p) has been submitted herewith.

None

SIGNATURE

A signature of the applicant or representative is required in accordance with CFR 1.33, 10.18. Please see CFR 1.4(d) for the form of the signature.

Signature	/R. Chad Bevins/	Date (YYYY-MM-DD)	2008-04-25
Name/Print	R. Chad Bevins	Registration Number	51468

This collection of information is required by 37 CFR 1.97 and 1.98. The information is required to obtain or retain a benefit by the public which is to file (and by the USPTO to process) an application. Confidentiality is governed by 35 U.S.C. 122 and 37 CFR 1.14. This collection is estimated to take 1 hour to complete, including gathering, preparing and submitting the completed application form to the USPTO. Time will vary depending upon the individual case. Any comments on the amount of time you require to complete this form and/or suggestions for reducing this burden, should be sent to the Chief Information Officer, U.S. Patent and Trademark Office, U.S. Department of Commerce, P.O. Box 1450, Alexandria, VA 22313-1450. **DO NOT SEND FEES OR COMPLETED FORMS TO THIS ADDRESS. SEND TO: Commissioner for Patents, P.O. Box 1450, Alexandria, VA 22313-1450.**

Privacy Act Statement

The Privacy Act of 1974 (P.L. 93-579) requires that you be given certain information in connection with your submission of the attached form related to a patent application or patent. Accordingly, pursuant to the requirements of the Act, please be advised that: (1) the general authority for the collection of this information is 35 U.S.C. 2(b)(2); (2) furnishing of the information solicited is voluntary; and (3) the principal purpose for which the information is used by the U.S. Patent and Trademark Office is to process and/or examine your submission related to a patent application or patent. If you do not furnish the requested information, the U.S. Patent and Trademark Office may not be able to process and/or examine your submission, which may result in termination of proceedings or abandonment of the application or expiration of the patent.

The information provided by you in this form will be subject to the following routine uses:

1. The information on this form will be treated confidentially to the extent allowed under the Freedom of Information Act (5 U.S.C. 552) and the Privacy Act (5 U.S.C. 552a). Records from this system of records may be disclosed to the Department of Justice to determine whether the Freedom of Information Act requires disclosure of these records.
2. A record from this system of records may be disclosed, as a routine use, in the course of presenting evidence to a court, magistrate, or administrative tribunal, including disclosures to opposing counsel in the course of settlement negotiations.
3. A record in this system of records may be disclosed, as a routine use, to a Member of Congress submitting a request involving an individual, to whom the record pertains, when the individual has requested assistance from the Member with respect to the subject matter of the record.
4. A record in this system of records may be disclosed, as a routine use, to a contractor of the Agency having need for the information in order to perform a contract. Recipients of information shall be required to comply with the requirements of the Privacy Act of 1974, as amended, pursuant to 5 U.S.C. 552a(m).
5. A record related to an International Application filed under the Patent Cooperation Treaty in this system of records may be disclosed, as a routine use, to the International Bureau of the World Intellectual Property Organization, pursuant to the Patent Cooperation Treaty.
6. A record in this system of records may be disclosed, as a routine use, to another federal agency for purposes of National Security review (35 U.S.C. 181) and for review pursuant to the Atomic Energy Act (42 U.S.C. 218(c)).
7. A record from this system of records may be disclosed, as a routine use, to the Administrator, General Services, or his/her designee, during an inspection of records conducted by GSA as part of that agency's responsibility to recommend improvements in records management practices and programs, under authority of 44 U.S.C. 2904 and 2906. Such disclosure shall be made in accordance with the GSA regulations governing inspection of records for this purpose, and any other relevant (i.e., GSA or Commerce) directive. Such disclosure shall not be used to make determinations about individuals.
8. A record from this system of records may be disclosed, as a routine use, to the public after either publication of the application pursuant to 35 U.S.C. 122(b) or issuance of a patent pursuant to 35 U.S.C. 151. Further, a record may be disclosed, subject to the limitations of 37 CFR 1.14, as a routine use, to the public if the record was filed in an application which became abandoned or in which the proceedings were terminated and which application is referenced by either a published application, an application open to public inspections or an issued patent.
9. A record from this system of records may be disclosed, as a routine use, to a Federal, State, or local law enforcement agency, if the USPTO becomes aware of a violation or potential violation of law or regulation.

Electronic Acknowledgement Receipt

EFS ID:	3207154
Application Number:	11563232
International Application Number:	
Confirmation Number:	1583
Title of Invention:	NETWORK-ENABLED AUDIO DEVICE
First Named Inventor/Applicant Name:	Safi Qureshey
Customer Number:	71739
Filer:	Benjamin Withrow/Kelly Farrow
Filer Authorized By:	Benjamin Withrow
Attorney Docket Number:	1116-028C
Receipt Date:	25-APR-2008
Filing Date:	27-NOV-2006
Time Stamp:	08:53:29
Application Type:	Utility under 35 USC 111(a)

Payment information:

Submitted with Payment	no
------------------------	----

File Listing:

Document Number	Document Description	File Name	File Size(Bytes) /Message Digest	Multi Part /.zip	Pages (if appl.)
1	Information Disclosure Statement (IDS) Filed	1116-028C_IDS_3.PDF	522181 <small>cdc0bb9766443e56dc99c56442552d4 236dbf63f</small>	no	5

Warnings:

Information:

This Acknowledgement Receipt evidences receipt on the noted date by the USPTO of the indicated documents, characterized by the applicant, and including page counts, where applicable. It serves as evidence of receipt similar to a Post Card, as described in MPEP 503.

New Applications Under 35 U.S.C. 111

If a new application is being filed and the application includes the necessary components for a filing date (see 37 CFR 1.53(b)-(d) and MPEP 506), a Filing Receipt (37 CFR 1.54) will be issued in due course and the date shown on this Acknowledgement Receipt will establish the filing date of the application.

National Stage of an International Application under 35 U.S.C. 371

If a timely submission to enter the national stage of an international application is compliant with the conditions of 35 U.S.C. 371 and other applicable requirements a Form PCT/DO/EO/903 indicating acceptance of the application as a national stage submission under 35 U.S.C. 371 will be issued in addition to the Filing Receipt, in due course.

New International Application Filed with the USPTO as a Receiving Office

If a new international application is being filed and the international application includes the necessary components for an international filing date (see PCT Article 11 and MPEP 1810), a Notification of the International Application Number and of the International Filing Date (Form PCT/RO/105) will be issued in due course, subject to prescriptions concerning national security, and the date shown on this Acknowledgement Receipt will establish the international filing date of the application.

INFORMATION DISCLOSURE STATEMENT BY APPLICANT (Not for submission under 37 CFR 1.99)	Application Number	11563232
	Filing Date	2006-11-27
	First Named Inventor	Safi Qureshey et al.
	Art Unit	2618
	Examiner Name	TBA
	Attorney Docket Number	1116-028C

U.S. PATENTS							Remove
Examiner Initial*	Cite No	Patent Number	Kind Code ¹	Issue Date	Name of Patentee or Applicant of cited Document	Pages, Columns, Lines where Relevant Passages or Relevant Figures Appear	
	1	5652841		1999-03-30	Nemirovsky et al.		
	2	6108686		2000-08-22	Williams, Jr.		
	3	6182128	B1	2001-01-30	Kelkar et al.		
	4	6349339	B1	2002-02-19	Williams		
	5	6473792	B1	2002-10-29	Yavitz et al.		
	6	6502194	B1	2002-12-31	Berman et al.		
	7	6600898	B1	2003-07-29	De Bonet et al.		
	8	6609096	B1	2003-08-19	De Bonet et al.		

INFORMATION DISCLOSURE STATEMENT BY APPLICANT (Not for submission under 37 CFR 1.99)	Application Number	11563232
	Filing Date	2006-11-27
	First Named Inventor	Safi Qureshey et al.
	Art Unit	2618
	Examiner Name	TBA
	Attorney Docket Number	1116-028C

	9	6647389	B1	2003-11-11	Fitch et al.	
	10	6925489	B1	2005-08-02	Curtin	
	11	6985694	B1	2006-01-10	De Bonet et al.	
	12	7010263	B1	2006-03-07	Patsiokas	
	13	7058694	B1	2006-06-06	De Bonet et al.	
	14	7212830	B2	2007-05-01	Tamaki et al.	
	15	5890152		1999-03-30	Rapaport et al.	

If you wish to add additional U.S. Patent citation information please click the Add button.

Add

U.S.PATENT APPLICATION PUBLICATIONS

Remove

Examiner Initial*	Cite No	Publication Number	Kind Code ¹	Publication Date	Name of Patentee or Applicant of cited Document	Pages, Columns, Lines where Relevant Passages or Relevant Figures Appear
	1	20060161621	A1	2006-07-20	Rosenberg	
	2	20060224971	A1	2006-10-05	Paulin et al.	

INFORMATION DISCLOSURE STATEMENT BY APPLICANT (Not for submission under 37 CFR 1.99)	Application Number	11563232
	Filing Date	2006-11-27
	First Named Inventor	Safi Qureshey et al.
	Art Unit	2618
	Examiner Name	TBA
	Attorney Docket Number	1116-028C

3	20060288074	A1	2006-12-21	Rosenberg	
4	20070220100	A1	2007-09-20	Rosenberg	
5	20070265979	A1	2007-11-15	Hangartner	

If you wish to add additional U.S. Published Application citation information please click the Add button.

FOREIGN PATENT DOCUMENTS

Examiner Initial*	Cite No	Foreign Document Number ³	Country Code ² j	Kind Code ⁴	Publication Date	Name of Patentee or Applicant of cited Document	Pages, Columns, Lines where Relevant Passages or Relevant Figures Appear	T ⁵
	1							<input type="checkbox"/>

If you wish to add additional Foreign Patent Document citation information please click the Add button.

NON-PATENT LITERATURE DOCUMENTS

Examiner Initials*	Cite No	Include name of the author (in CAPITAL LETTERS), title of the article (when appropriate), title of the item (book, magazine, journal, serial, symposium, catalog, etc), date, pages(s), volume-issue number(s), publisher, city and/or country where published.	T ⁵
	1		<input type="checkbox"/>

If you wish to add additional non-patent literature document citation information please click the Add button.

EXAMINER SIGNATURE

Examiner Signature		Date Considered	
--------------------	--	-----------------	--

*EXAMINER: Initial if reference considered, whether or not citation is in conformance with MPEP 609. Draw line through a citation if not in conformance and not considered. Include copy of this form with next communication to applicant.

INFORMATION DISCLOSURE STATEMENT BY APPLICANT (Not for submission under 37 CFR 1.99)	Application Number	11563232
	Filing Date	2006-11-27
	First Named Inventor	Safi Qureshey et al.
	Art Unit	2618
	Examiner Name	TBA
	Attorney Docket Number	1116-028C

¹ See Kind Codes of USPTO Patent Documents at www.USPTO.GOV or MPEP 901.04. ² Enter office that issued the document, by the two-letter code (WIPO Standard ST.3). ³ For Japanese patent documents, the indication of the year of the reign of the Emperor must precede the serial number of the patent document. ⁴ Kind of document by the appropriate symbols as indicated on the document under WIPO Standard ST.16 if possible. ⁵ Applicant is to place a check mark here if English language translation is attached.

INFORMATION DISCLOSURE STATEMENT BY APPLICANT (Not for submission under 37 CFR 1.99)	Application Number	11563232
	Filing Date	2006-11-27
	First Named Inventor	Safi Qureshey et al.
	Art Unit	2618
	Examiner Name	TBA
	Attorney Docket Number	1116-028C

CERTIFICATION STATEMENT

Please see 37 CFR 1.97 and 1.98 to make the appropriate selection(s):

That each item of information contained in the information disclosure statement was first cited in any communication from a foreign patent office in a counterpart foreign application not more than three months prior to the filing of the information disclosure statement. See 37 CFR 1.97(e)(1).

OR

That no item of information contained in the information disclosure statement was cited in a communication from a foreign patent office in a counterpart foreign application, and, to the knowledge of the person signing the certification after making reasonable inquiry, no item of information contained in the information disclosure statement was known to any individual designated in 37 CFR 1.56(c) more than three months prior to the filing of the information disclosure statement. See 37 CFR 1.97(e)(2).

See attached certification statement.

Fee set forth in 37 CFR 1.17 (p) has been submitted herewith.

None

SIGNATURE

A signature of the applicant or representative is required in accordance with CFR 1.33, 10.18. Please see CFR 1.4(d) for the form of the signature.

Signature	/R. Chad Bevins/	Date (YYYY-MM-DD)	2009-07-20
Name/Print	R. Chad Bevins	Registration Number	51468

This collection of information is required by 37 CFR 1.97 and 1.98. The information is required to obtain or retain a benefit by the public which is to file (and by the USPTO to process) an application. Confidentiality is governed by 35 U.S.C. 122 and 37 CFR 1.14. This collection is estimated to take 1 hour to complete, including gathering, preparing and submitting the completed application form to the USPTO. Time will vary depending upon the individual case. Any comments on the amount of time you require to complete this form and/or suggestions for reducing this burden, should be sent to the Chief Information Officer, U.S. Patent and Trademark Office, U.S. Department of Commerce, P.O. Box 1450, Alexandria, VA 22313-1450. **DO NOT SEND FEES OR COMPLETED FORMS TO THIS ADDRESS. SEND TO: Commissioner for Patents, P.O. Box 1450, Alexandria, VA 22313-1450.**

Privacy Act Statement

The Privacy Act of 1974 (P.L. 93-579) requires that you be given certain information in connection with your submission of the attached form related to a patent application or patent. Accordingly, pursuant to the requirements of the Act, please be advised that: (1) the general authority for the collection of this information is 35 U.S.C. 2(b)(2); (2) furnishing of the information solicited is voluntary; and (3) the principal purpose for which the information is used by the U.S. Patent and Trademark Office is to process and/or examine your submission related to a patent application or patent. If you do not furnish the requested information, the U.S. Patent and Trademark Office may not be able to process and/or examine your submission, which may result in termination of proceedings or abandonment of the application or expiration of the patent.

The information provided by you in this form will be subject to the following routine uses:

1. The information on this form will be treated confidentially to the extent allowed under the Freedom of Information Act (5 U.S.C. 552) and the Privacy Act (5 U.S.C. 552a). Records from this system of records may be disclosed to the Department of Justice to determine whether the Freedom of Information Act requires disclosure of these records.
2. A record from this system of records may be disclosed, as a routine use, in the course of presenting evidence to a court, magistrate, or administrative tribunal, including disclosures to opposing counsel in the course of settlement negotiations.
3. A record in this system of records may be disclosed, as a routine use, to a Member of Congress submitting a request involving an individual, to whom the record pertains, when the individual has requested assistance from the Member with respect to the subject matter of the record.
4. A record in this system of records may be disclosed, as a routine use, to a contractor of the Agency having need for the information in order to perform a contract. Recipients of information shall be required to comply with the requirements of the Privacy Act of 1974, as amended, pursuant to 5 U.S.C. 552a(m).
5. A record related to an International Application filed under the Patent Cooperation Treaty in this system of records may be disclosed, as a routine use, to the International Bureau of the World Intellectual Property Organization, pursuant to the Patent Cooperation Treaty.
6. A record in this system of records may be disclosed, as a routine use, to another federal agency for purposes of National Security review (35 U.S.C. 181) and for review pursuant to the Atomic Energy Act (42 U.S.C. 218(c)).
7. A record from this system of records may be disclosed, as a routine use, to the Administrator, General Services, or his/her designee, during an inspection of records conducted by GSA as part of that agency's responsibility to recommend improvements in records management practices and programs, under authority of 44 U.S.C. 2904 and 2906. Such disclosure shall be made in accordance with the GSA regulations governing inspection of records for this purpose, and any other relevant (i.e., GSA or Commerce) directive. Such disclosure shall not be used to make determinations about individuals.
8. A record from this system of records may be disclosed, as a routine use, to the public after either publication of the application pursuant to 35 U.S.C. 122(b) or issuance of a patent pursuant to 35 U.S.C. 151. Further, a record may be disclosed, subject to the limitations of 37 CFR 1.14, as a routine use, to the public if the record was filed in an application which became abandoned or in which the proceedings were terminated and which application is referenced by either a published application, an application open to public inspections or an issued patent.
9. A record from this system of records may be disclosed, as a routine use, to a Federal, State, or local law enforcement agency, if the USPTO becomes aware of a violation or potential violation of law or regulation.

Electronic Acknowledgement Receipt

EFS ID:	5731194
Application Number:	11563232
International Application Number:	
Confirmation Number:	1583
Title of Invention:	NETWORK-ENABLED AUDIO DEVICE
First Named Inventor/Applicant Name:	Safi Qureshey
Customer Number:	71739
Filer:	R. Chad Bevins/Julie Smith
Filer Authorized By:	R. Chad Bevins
Attorney Docket Number:	1116-028C
Receipt Date:	20-JUL-2009
Filing Date:	27-NOV-2006
Time Stamp:	14:07:24
Application Type:	Utility under 35 USC 111(a)

Payment information:

Submitted with Payment	no
------------------------	----

File Listing:

Document Number	Document Description	File Name	File Size(Bytes)/ Message Digest	Multi Part /.zip	Pages (if appl.)
1	Information Disclosure Statement (IDS) Filed (SB/08)	1116-028C_IDS_4.pdf	935379 <small>783f3763f25ed4b42d6734ee0c242e93804510bd</small>	no	6

Warnings:

Information:

This Acknowledgement Receipt evidences receipt on the noted date by the USPTO of the indicated documents, characterized by the applicant, and including page counts, where applicable. It serves as evidence of receipt similar to a Post Card, as described in MPEP 503.

New Applications Under 35 U.S.C. 111

If a new application is being filed and the application includes the necessary components for a filing date (see 37 CFR 1.53(b)-(d) and MPEP 506), a Filing Receipt (37 CFR 1.54) will be issued in due course and the date shown on this Acknowledgement Receipt will establish the filing date of the application.

National Stage of an International Application under 35 U.S.C. 371

If a timely submission to enter the national stage of an international application is compliant with the conditions of 35 U.S.C. 371 and other applicable requirements a Form PCT/DO/EO/903 indicating acceptance of the application as a national stage submission under 35 U.S.C. 371 will be issued in addition to the Filing Receipt, in due course.

New International Application Filed with the USPTO as a Receiving Office

If a new international application is being filed and the international application includes the necessary components for an international filing date (see PCT Article 11 and MPEP 1810), a Notification of the International Application Number and of the International Filing Date (Form PCT/RO/105) will be issued in due course, subject to prescriptions concerning national security, and the date shown on this Acknowledgement Receipt will establish the international filing date of the application.

INFORMATION DISCLOSURE STATEMENT BY APPLICANT (Not for submission under 37 CFR 1.99)	Application Number	11563232
	Filing Date	2006-11-27
	First Named Inventor	Safi Qureshey et al.
	Art Unit	2618
	Examiner Name	TBA
	Attorney Docket Number	1116-028C

U.S. PATENTS							Remove	
Examiner Initial*	Cite No	Patent Number	Kind Code ¹	Issue Date	Name of Patentee or Applicant of cited Document	Pages, Columns, Lines where Relevant Passages or Relevant Figures Appear		
	1	6701355	B1	2004-03-02	Brandt et al.			
If you wish to add additional U.S. Patent citation information please click the Add button.							Add	
U.S. PATENT APPLICATION PUBLICATIONS							Remove	
Examiner Initial*	Cite No	Publication Number	Kind Code ¹	Publication Date	Name of Patentee or Applicant of cited Document	Pages, Columns, Lines where Relevant Passages or Relevant Figures Appear		
	1							
If you wish to add additional U.S. Published Application citation information please click the Add button.							Add	
FOREIGN PATENT DOCUMENTS							Remove	
Examiner Initial*	Cite No	Foreign Document Number ³	Country Code ² j	Kind Code ⁴	Publication Date	Name of Patentee or Applicant of cited Document	Pages, Columns, Lines where Relevant Passages or Relevant Figures Appear	T ⁵
	1							<input type="checkbox"/>
If you wish to add additional Foreign Patent Document citation information please click the Add button							Add	
NON-PATENT LITERATURE DOCUMENTS							Remove	
Examiner Initials*	Cite No	Include name of the author (in CAPITAL LETTERS), title of the article (when appropriate), title of the item (book, magazine, journal, serial, symposium, catalog, etc), date, pages(s), volume-issue number(s), publisher, city and/or country where published.						T ⁵

INFORMATION DISCLOSURE STATEMENT BY APPLICANT (Not for submission under 37 CFR 1.99)	Application Number	11563232
	Filing Date	2006-11-27
	First Named Inventor	Safi Qureshey et al.
	Art Unit	2618
	Examiner Name	TBA
	Attorney Docket Number	1116-028C

1		<input type="checkbox"/>
---	--	--------------------------

If you wish to add additional non-patent literature document citation information please click the Add button

EXAMINER SIGNATURE

Examiner Signature		Date Considered	
--------------------	--	-----------------	--

*EXAMINER: Initial if reference considered, whether or not citation is in conformance with MPEP 609. Draw line through a citation if not in conformance and not considered. Include copy of this form with next communication to applicant.

¹ See Kind Codes of USPTO Patent Documents at www.USPTO.GOV or MPEP 901.04. ² Enter office that issued the document, by the two-letter code (WIPO Standard ST.3). ³ For Japanese patent documents, the indication of the year of the reign of the Emperor must precede the serial number of the patent document. ⁴ Kind of document by the appropriate symbols as indicated on the document under WIPO Standard ST.16 if possible. ⁵ Applicant is to place a check mark here if English language translation is attached.

INFORMATION DISCLOSURE STATEMENT BY APPLICANT (Not for submission under 37 CFR 1.99)	Application Number	11563232
	Filing Date	2006-11-27
	First Named Inventor	Safi Qureshey et al.
	Art Unit	2618
	Examiner Name	TBA
	Attorney Docket Number	1116-028C

CERTIFICATION STATEMENT

Please see 37 CFR 1.97 and 1.98 to make the appropriate selection(s):

That each item of information contained in the information disclosure statement was first cited in any communication from a foreign patent office in a counterpart foreign application not more than three months prior to the filing of the information disclosure statement. See 37 CFR 1.97(e)(1).

OR

That no item of information contained in the information disclosure statement was cited in a communication from a foreign patent office in a counterpart foreign application, and, to the knowledge of the person signing the certification after making reasonable inquiry, no item of information contained in the information disclosure statement was known to any individual designated in 37 CFR 1.56(c) more than three months prior to the filing of the information disclosure statement. See 37 CFR 1.97(e)(2).

See attached certification statement.

Fee set forth in 37 CFR 1.17 (p) has been submitted herewith.

None

SIGNATURE

A signature of the applicant or representative is required in accordance with CFR 1.33, 10.18. Please see CFR 1.4(d) for the form of the signature.

Signature	/R. Chad Bevins/	Date (YYYY-MM-DD)	2009-09-09
Name/Print	R. Chad Bevins	Registration Number	51,468

This collection of information is required by 37 CFR 1.97 and 1.98. The information is required to obtain or retain a benefit by the public which is to file (and by the USPTO to process) an application. Confidentiality is governed by 35 U.S.C. 122 and 37 CFR 1.14. This collection is estimated to take 1 hour to complete, including gathering, preparing and submitting the completed application form to the USPTO. Time will vary depending upon the individual case. Any comments on the amount of time you require to complete this form and/or suggestions for reducing this burden, should be sent to the Chief Information Officer, U.S. Patent and Trademark Office, U.S. Department of Commerce, P.O. Box 1450, Alexandria, VA 22313-1450. **DO NOT SEND FEES OR COMPLETED FORMS TO THIS ADDRESS. SEND TO: Commissioner for Patents, P.O. Box 1450, Alexandria, VA 22313-1450.**

Privacy Act Statement

The Privacy Act of 1974 (P.L. 93-579) requires that you be given certain information in connection with your submission of the attached form related to a patent application or patent. Accordingly, pursuant to the requirements of the Act, please be advised that: (1) the general authority for the collection of this information is 35 U.S.C. 2(b)(2); (2) furnishing of the information solicited is voluntary; and (3) the principal purpose for which the information is used by the U.S. Patent and Trademark Office is to process and/or examine your submission related to a patent application or patent. If you do not furnish the requested information, the U.S. Patent and Trademark Office may not be able to process and/or examine your submission, which may result in termination of proceedings or abandonment of the application or expiration of the patent.

The information provided by you in this form will be subject to the following routine uses:

1. The information on this form will be treated confidentially to the extent allowed under the Freedom of Information Act (5 U.S.C. 552) and the Privacy Act (5 U.S.C. 552a). Records from this system of records may be disclosed to the Department of Justice to determine whether the Freedom of Information Act requires disclosure of these records.
2. A record from this system of records may be disclosed, as a routine use, in the course of presenting evidence to a court, magistrate, or administrative tribunal, including disclosures to opposing counsel in the course of settlement negotiations.
3. A record in this system of records may be disclosed, as a routine use, to a Member of Congress submitting a request involving an individual, to whom the record pertains, when the individual has requested assistance from the Member with respect to the subject matter of the record.
4. A record in this system of records may be disclosed, as a routine use, to a contractor of the Agency having need for the information in order to perform a contract. Recipients of information shall be required to comply with the requirements of the Privacy Act of 1974, as amended, pursuant to 5 U.S.C. 552a(m).
5. A record related to an International Application filed under the Patent Cooperation Treaty in this system of records may be disclosed, as a routine use, to the International Bureau of the World Intellectual Property Organization, pursuant to the Patent Cooperation Treaty.
6. A record in this system of records may be disclosed, as a routine use, to another federal agency for purposes of National Security review (35 U.S.C. 181) and for review pursuant to the Atomic Energy Act (42 U.S.C. 218(c)).
7. A record from this system of records may be disclosed, as a routine use, to the Administrator, General Services, or his/her designee, during an inspection of records conducted by GSA as part of that agency's responsibility to recommend improvements in records management practices and programs, under authority of 44 U.S.C. 2904 and 2906. Such disclosure shall be made in accordance with the GSA regulations governing inspection of records for this purpose, and any other relevant (i.e., GSA or Commerce) directive. Such disclosure shall not be used to make determinations about individuals.
8. A record from this system of records may be disclosed, as a routine use, to the public after either publication of the application pursuant to 35 U.S.C. 122(b) or issuance of a patent pursuant to 35 U.S.C. 151. Further, a record may be disclosed, subject to the limitations of 37 CFR 1.14, as a routine use, to the public if the record was filed in an application which became abandoned or in which the proceedings were terminated and which application is referenced by either a published application, an application open to public inspections or an issued patent.
9. A record from this system of records may be disclosed, as a routine use, to a Federal, State, or local law enforcement agency, if the USPTO becomes aware of a violation or potential violation of law or regulation.

Electronic Acknowledgement Receipt

EFS ID:	6038471
Application Number:	11563232
International Application Number:	
Confirmation Number:	1583
Title of Invention:	NETWORK-ENABLED AUDIO DEVICE
First Named Inventor/Applicant Name:	Safi Qureshey
Customer Number:	71739
Filer:	R. Chad Bevins/Julie Smith
Filer Authorized By:	R. Chad Bevins
Attorney Docket Number:	1116-028C
Receipt Date:	09-SEP-2009
Filing Date:	27-NOV-2006
Time Stamp:	15:21:40
Application Type:	Utility under 35 USC 111(a)

Payment information:

Submitted with Payment	no
------------------------	----

File Listing:

Document Number	Document Description	File Name	File Size(Bytes)/ Message Digest	Multi Part /.zip	Pages (if appl.)
1	Information Disclosure Statement (IDS) Filed (SB/08)	1116-028C_IDS_5.PDF	762928 <small>45e236f297144a02931cbc90734d57ff0a8e2f22</small>	no	4

Warnings:

Information:

This Acknowledgement Receipt evidences receipt on the noted date by the USPTO of the indicated documents, characterized by the applicant, and including page counts, where applicable. It serves as evidence of receipt similar to a Post Card, as described in MPEP 503.

New Applications Under 35 U.S.C. 111

If a new application is being filed and the application includes the necessary components for a filing date (see 37 CFR 1.53(b)-(d) and MPEP 506), a Filing Receipt (37 CFR 1.54) will be issued in due course and the date shown on this Acknowledgement Receipt will establish the filing date of the application.

National Stage of an International Application under 35 U.S.C. 371

If a timely submission to enter the national stage of an international application is compliant with the conditions of 35 U.S.C. 371 and other applicable requirements a Form PCT/DO/EO/903 indicating acceptance of the application as a national stage submission under 35 U.S.C. 371 will be issued in addition to the Filing Receipt, in due course.

New International Application Filed with the USPTO as a Receiving Office

If a new international application is being filed and the international application includes the necessary components for an international filing date (see PCT Article 11 and MPEP 1810), a Notification of the International Application Number and of the International Filing Date (Form PCT/RO/105) will be issued in due course, subject to prescriptions concerning national security, and the date shown on this Acknowledgement Receipt will establish the international filing date of the application.

INFORMATION DISCLOSURE STATEMENT BY APPLICANT (Not for submission under 37 CFR 1.99)	Application Number	11563232
	Filing Date	2006-11-27
	First Named Inventor	Safi Qureshey et al.
	Art Unit	2618
	Examiner Name	TBA
	Attorney Docket Number	1116-028C

U.S. PATENTS							Remove	
Examiner Initial*	Cite No	Patent Number	Kind Code ¹	Issue Date	Name of Patentee or Applicant of cited Document	Pages, Columns, Lines where Relevant Passages or Relevant Figures Appear		
	1	5852610		1998-12-22	Olaniyan			
	2	5907831		1999-05-25	Lotvin et al.			
If you wish to add additional U.S. Patent citation information please click the Add button.							Add	
U.S. PATENT APPLICATION PUBLICATIONS							Remove	
Examiner Initial*	Cite No	Publication Number	Kind Code ¹	Publication Date	Name of Patentee or Applicant of cited Document	Pages, Columns, Lines where Relevant Passages or Relevant Figures Appear		
	1							
If you wish to add additional U.S. Published Application citation information please click the Add button.							Add	
FOREIGN PATENT DOCUMENTS							Remove	
Examiner Initial*	Cite No	Foreign Document Number ³	Country Code ² j	Kind Code ⁴	Publication Date	Name of Patentee or Applicant of cited Document	Pages, Columns, Lines where Relevant Passages or Relevant Figures Appear	T ⁵
	1							<input type="checkbox"/>
If you wish to add additional Foreign Patent Document citation information please click the Add button.							Add	
NON-PATENT LITERATURE DOCUMENTS							Remove	

INFORMATION DISCLOSURE STATEMENT BY APPLICANT (Not for submission under 37 CFR 1.99)	Application Number	11563232
	Filing Date	2006-11-27
	First Named Inventor	Safi Qureshey et al.
	Art Unit	2618
	Examiner Name	TBA
	Attorney Docket Number	1116-028C

Examiner Initials*	Cite No	Include name of the author (in CAPITAL LETTERS), title of the article (when appropriate), title of the item (book, magazine, journal, serial, symposium, catalog, etc), date, pages(s), volume-issue number(s), publisher, city and/or country where published.	T ⁵
	1		<input type="checkbox"/>

If you wish to add additional non-patent literature document citation information please click the Add button

EXAMINER SIGNATURE

Examiner Signature		Date Considered	
--------------------	--	-----------------	--

*EXAMINER: Initial if reference considered, whether or not citation is in conformance with MPEP 609. Draw line through a citation if not in conformance and not considered. Include copy of this form with next communication to applicant.

¹ See Kind Codes of USPTO Patent Documents at www.USPTO.GOV or MPEP 901.04. ² Enter office that issued the document, by the two-letter code (WIPO Standard ST.3). ³ For Japanese patent documents, the indication of the year of the reign of the Emperor must precede the serial number of the patent document. ⁴ Kind of document by the appropriate symbols as indicated on the document under WIPO Standard ST.16 if possible. ⁵ Applicant is to place a check mark here if English language translation is attached.

INFORMATION DISCLOSURE STATEMENT BY APPLICANT (Not for submission under 37 CFR 1.99)	Application Number	11563232
	Filing Date	2006-11-27
	First Named Inventor	Safi Qureshey et al.
	Art Unit	2618
	Examiner Name	TBA
	Attorney Docket Number	1116-028C

CERTIFICATION STATEMENT

Please see 37 CFR 1.97 and 1.98 to make the appropriate selection(s):

That each item of information contained in the information disclosure statement was first cited in any communication from a foreign patent office in a counterpart foreign application not more than three months prior to the filing of the information disclosure statement. See 37 CFR 1.97(e)(1).

OR

That no item of information contained in the information disclosure statement was cited in a communication from a foreign patent office in a counterpart foreign application, and, to the knowledge of the person signing the certification after making reasonable inquiry, no item of information contained in the information disclosure statement was known to any individual designated in 37 CFR 1.56(c) more than three months prior to the filing of the information disclosure statement. See 37 CFR 1.97(e)(2).

- See attached certification statement.
- Fee set forth in 37 CFR 1.17 (p) has been submitted herewith.
- None

SIGNATURE

A signature of the applicant or representative is required in accordance with CFR 1.33, 10.18. Please see CFR 1.4(d) for the form of the signature.

Signature	/R. Chad Bevins/	Date (YYYY-MM-DD)	2009-11-20
Name/Print	R. Chad Bevins	Registration Number	51,468

This collection of information is required by 37 CFR 1.97 and 1.98. The information is required to obtain or retain a benefit by the public which is to file (and by the USPTO to process) an application. Confidentiality is governed by 35 U.S.C. 122 and 37 CFR 1.14. This collection is estimated to take 1 hour to complete, including gathering, preparing and submitting the completed application form to the USPTO. Time will vary depending upon the individual case. Any comments on the amount of time you require to complete this form and/or suggestions for reducing this burden, should be sent to the Chief Information Officer, U.S. Patent and Trademark Office, U.S. Department of Commerce, P.O. Box 1450, Alexandria, VA 22313-1450. **DO NOT SEND FEES OR COMPLETED FORMS TO THIS ADDRESS. SEND TO: Commissioner for Patents, P.O. Box 1450, Alexandria, VA 22313-1450.**

Privacy Act Statement

The Privacy Act of 1974 (P.L. 93-579) requires that you be given certain information in connection with your submission of the attached form related to a patent application or patent. Accordingly, pursuant to the requirements of the Act, please be advised that: (1) the general authority for the collection of this information is 35 U.S.C. 2(b)(2); (2) furnishing of the information solicited is voluntary; and (3) the principal purpose for which the information is used by the U.S. Patent and Trademark Office is to process and/or examine your submission related to a patent application or patent. If you do not furnish the requested information, the U.S. Patent and Trademark Office may not be able to process and/or examine your submission, which may result in termination of proceedings or abandonment of the application or expiration of the patent.

The information provided by you in this form will be subject to the following routine uses:

1. The information on this form will be treated confidentially to the extent allowed under the Freedom of Information Act (5 U.S.C. 552) and the Privacy Act (5 U.S.C. 552a). Records from this system of records may be disclosed to the Department of Justice to determine whether the Freedom of Information Act requires disclosure of these records.
2. A record from this system of records may be disclosed, as a routine use, in the course of presenting evidence to a court, magistrate, or administrative tribunal, including disclosures to opposing counsel in the course of settlement negotiations.
3. A record in this system of records may be disclosed, as a routine use, to a Member of Congress submitting a request involving an individual, to whom the record pertains, when the individual has requested assistance from the Member with respect to the subject matter of the record.
4. A record in this system of records may be disclosed, as a routine use, to a contractor of the Agency having need for the information in order to perform a contract. Recipients of information shall be required to comply with the requirements of the Privacy Act of 1974, as amended, pursuant to 5 U.S.C. 552a(m).
5. A record related to an International Application filed under the Patent Cooperation Treaty in this system of records may be disclosed, as a routine use, to the International Bureau of the World Intellectual Property Organization, pursuant to the Patent Cooperation Treaty.
6. A record in this system of records may be disclosed, as a routine use, to another federal agency for purposes of National Security review (35 U.S.C. 181) and for review pursuant to the Atomic Energy Act (42 U.S.C. 218(c)).
7. A record from this system of records may be disclosed, as a routine use, to the Administrator, General Services, or his/her designee, during an inspection of records conducted by GSA as part of that agency's responsibility to recommend improvements in records management practices and programs, under authority of 44 U.S.C. 2904 and 2906. Such disclosure shall be made in accordance with the GSA regulations governing inspection of records for this purpose, and any other relevant (i.e., GSA or Commerce) directive. Such disclosure shall not be used to make determinations about individuals.
8. A record from this system of records may be disclosed, as a routine use, to the public after either publication of the application pursuant to 35 U.S.C. 122(b) or issuance of a patent pursuant to 35 U.S.C. 151. Further, a record may be disclosed, subject to the limitations of 37 CFR 1.14, as a routine use, to the public if the record was filed in an application which became abandoned or in which the proceedings were terminated and which application is referenced by either a published application, an application open to public inspections or an issued patent.
9. A record from this system of records may be disclosed, as a routine use, to a Federal, State, or local law enforcement agency, if the USPTO becomes aware of a violation or potential violation of law or regulation.

Electronic Acknowledgement Receipt

EFS ID:	6497744
Application Number:	11563232
International Application Number:	
Confirmation Number:	1583
Title of Invention:	NETWORK-ENABLED AUDIO DEVICE
First Named Inventor/Applicant Name:	Safi Qureshey
Customer Number:	71739
Filer:	R. Chad Bevins/Julie Smith
Filer Authorized By:	R. Chad Bevins
Attorney Docket Number:	1116-028C
Receipt Date:	20-NOV-2009
Filing Date:	27-NOV-2006
Time Stamp:	15:41:19
Application Type:	Utility under 35 USC 111(a)

Payment information:

Submitted with Payment	no
------------------------	----

File Listing:

Document Number	Document Description	File Name	File Size(Bytes)/ Message Digest	Multi Part /.zip	Pages (if appl.)
1	Information Disclosure Statement (IDS) Filed (SB/08)	1116-028C_IDS_6.PDF	770174 a38766ce2ab130dd8e5sec62942b56539f161d8f3	no	4

Warnings:

Information:

This Acknowledgement Receipt evidences receipt on the noted date by the USPTO of the indicated documents, characterized by the applicant, and including page counts, where applicable. It serves as evidence of receipt similar to a Post Card, as described in MPEP 503.

New Applications Under 35 U.S.C. 111

If a new application is being filed and the application includes the necessary components for a filing date (see 37 CFR 1.53(b)-(d) and MPEP 506), a Filing Receipt (37 CFR 1.54) will be issued in due course and the date shown on this Acknowledgement Receipt will establish the filing date of the application.

National Stage of an International Application under 35 U.S.C. 371

If a timely submission to enter the national stage of an international application is compliant with the conditions of 35 U.S.C. 371 and other applicable requirements a Form PCT/DO/EO/903 indicating acceptance of the application as a national stage submission under 35 U.S.C. 371 will be issued in addition to the Filing Receipt, in due course.

New International Application Filed with the USPTO as a Receiving Office

If a new international application is being filed and the international application includes the necessary components for an international filing date (see PCT Article 11 and MPEP 1810), a Notification of the International Application Number and of the International Filing Date (Form PCT/RO/105) will be issued in due course, subject to prescriptions concerning national security, and the date shown on this Acknowledgement Receipt will establish the international filing date of the application.

Under the Paperwork Reduction Act of 1995, no persons are required to respond to a collection of information unless it displays a valid OMB control number.

POWER OF ATTORNEY TO PROSECUTE APPLICATIONS BEFORE THE USPTO

I hereby revoke all previous powers of attorney given in the application identified in the attached statement under 37 CFR 3.73(b).

I hereby appoint:

 Practitioners associated with the Customer Number:

71739

OR

 Practitioner(s) named below (if more than ten patent practitioners are to be named, then a customer number must be used):

Name	Registration Number	Name	Registration Number

as attorney(s) or agent(s) to represent the undersigned before the United States Patent and Trademark Office (USPTO) in connection with any and all patent applications assigned only to the undersigned according to the USPTO assignment records or assignment documents attached to this form in accordance with 37 CFR 3.73(b).

Please change the correspondence address for the application identified in the attached statement under 37 CFR 3.73(b) to:

 The address associated with Customer Number:

71739

OR

<input type="checkbox"/> Firm or Individual Name			
Address			
City	State	Zip	
Country			
Telephone	Email		

Assignee Name and Address:
Horsham Enterprises, LLC.
1000 North West Street, Suite 1200
Wilmington, Delaware, 19801**A copy of this form, together with a statement under 37 CFR 3.73(b) (Form PTO/SB/96 or equivalent) is required to be filed in each application in which this form is used. The statement under 37 CFR 3.73(b) may be completed by one of the practitioners appointed in this form if the appointed practitioner is authorized to act on behalf of the assignee, and must identify the application in which this Power of Attorney is to be filed.****SIGNATURE of Assignee of Record**

The individual whose signature and title is supplied below is authorized to act on behalf of the assignee

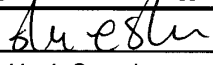
Signature		Date	6/11/2010
Name	Hugh Svendsen	Telephone	919-433-1845
Title	Member		

This collection of information is required by 37 CFR 1.31, 1.32 and 1.33. The information is required to obtain or retain a benefit by the public which is to file (and by the USPTO to process) an application. Confidentiality is governed by 35 U.S.C. 122 and 37 CFR 1.11 and 1.14. This collection is estimated to take 3 minutes to complete, including gathering, preparing, and submitting the completed application form to the USPTO. Time will vary depending upon the individual case. Any comments on the amount of time you require to complete this form and/or suggestions for reducing this burden, should be sent to the Chief Information Officer, U.S. Patent and Trademark Office, U.S. Department of Commerce, P.O. Box 1450, Alexandria, VA 22313-1450. DO NOT SEND FEES OR COMPLETED FORMS TO THIS ADDRESS. **SEND TO: Commissioner for Patents, P.O. Box 1450, Alexandria, VA 22313-1450.**

If you need assistance in completing the form, call 1-800-PTO-9199 and select option 2.

Under the Paperwork Reduction Act of 1995, no persons are required to respond to a collection of information unless it displays a valid OMB control number.

STATEMENT UNDER 37 CFR 3.73(b)

Applicant/Patent Owner: Horsham Enterprises, LLC

Application No./Patent No.: 11/563,232

Filed/Issue Date: 11/27/2006

Titled: NETWORK-ENABLED AUDIO DEVICE

Horsham Enterprises, LLC

, a limited liability company

(Name of Assignee)

(Type of Assignee, e.g., corporation, partnership, university, government agency, etc.)

states that it is:

- 1. the assignee of the entire right, title, and interest in;
- 2. an assignee of less than the entire right, title, and interest in (The extent (by percentage) of its ownership interest is _____ %); or
- 3. the assignee of an undivided interest in the entirety of (a complete assignment from one of the joint inventors was made)

the patent application/patent identified above, by virtue of either:

A. An assignment from the inventor(s) of the patent application/patent identified above. The assignment was recorded in the United States Patent and Trademark Office at Reel _____, Frame _____, or for which a copy therefore is attached.

OR

B. A chain of title from the inventor(s), of the patent application/patent identified above, to the current assignee as follows:

1. From: Safi Qureshey, Daniel D. Sheppard To: AudioRamp.com

The document was recorded in the United States Patent and Trademark Office at Reel 019135, Frame 0918, or for which a copy thereof is attached.

2. From: AudioRamp.com To: Knobbe, Martens, Olson & Bear LLP

The document was recorded in the United States Patent and Trademark Office at Reel 019135, Frame 0961, or for which a copy thereof is attached.

3. From: Knobbe, Martens, Olson & Bear LLP To: Concert Technology Corporation

The document was recorded in the United States Patent and Trademark Office at Reel 019135, Frame 0987, or for which a copy thereof is attached.

Additional documents in the chain of title are listed on a supplemental sheet(s).

As required by 37 CFR 3.73(b)(1)(i), the documentary evidence of the chain of title from the original owner to the assignee was, or concurrently is being, submitted for recordation pursuant to 37 CFR 3.11.

[NOTE: A separate copy (i.e., a true copy of the original assignment document(s)) must be submitted to Assignment Division in accordance with 37 CFR Part 3, to record the assignment in the records of the USPTO. See MPEP 302.08]

The undersigned (whose title is supplied below) is authorized to act on behalf of the assignee.

Signature

R. Chad Bevins

Printed or Typed Name

Date

7/30/2010
Attorney of Record

Title

This collection of information is required by 37 CFR 3.73(b). The information is required to obtain or retain a benefit by the public which is to file (and by the USPTO to process) an application. Confidentiality is governed by 35 U.S.C. 122 and 37 CFR 1.11 and 1.14. This collection is estimated to take 12 minutes to complete, including gathering, preparing, and submitting the completed application form to the USPTO. Time will vary depending upon the individual case. Any comments on the amount of time you require to complete this form and/or suggestions for reducing this burden, should be sent to the Chief Information Officer, U.S. Patent and Trademark Office, U.S. Department of Commerce, P.O. Box 1450, Alexandria, VA 22313-1450. DO NOT SEND FEES OR COMPLETED FORMS TO THIS ADDRESS. SEND TO: Commissioner for Patents, P.O. Box 1450, Alexandria, VA 22313-1450.

If you need assistance in completing the form, call 1-800-PTO-9199 and select option 2.

Statement Under 37 CFR 3.73(b) – Supplemental Sheet

4. From: Concert Technology Corporation To: ConPact, Inc.

The document was recorded in the United States Patent and Trademark Office at
Reel 019260 , Frame 0630 , or for which a copy thereof is attached.

5. From: ConPact, Inc. To: Horsham Enterprises, LLC

The document was recorded in the United States Patent and Trademark Office at
Reel 024606 , Frame 0327 , or for which a copy thereof is attached.

Electronic Acknowledgement Receipt

EFS ID:	8123239
Application Number:	11563232
International Application Number:	
Confirmation Number:	1583
Title of Invention:	NETWORK-ENABLED AUDIO DEVICE
First Named Inventor/Applicant Name:	Safi Qureshey
Customer Number:	71739
Filer:	R. Chad Bevins/Julie Smith
Filer Authorized By:	R. Chad Bevins
Attorney Docket Number:	1116-028C
Receipt Date:	30-JUL-2010
Filing Date:	27-NOV-2006
Time Stamp:	11:04:48
Application Type:	Utility under 35 USC 111(a)

Payment information:

Submitted with Payment	no
------------------------	----

File Listing:

Document Number	Document Description	File Name	File Size(Bytes)/ Message Digest	Multi Part /.zip	Pages (if appl.)
1	Power of Attorney	1116-028C_Horsham_POA.pdf	66808 a45c68d732ba060a7adb73aed1662e8f5727026e	no	1

Warnings:

Information:

2	Assignee showing of ownership per 37 CFR 3.73(b).	1116-028C_Statement_Under_3-73b.pdf	135011 144fe0541fbb17436cfc2700ff3aab136f6da34c	no	2
Warnings:					
Information:					
Total Files Size (in bytes):			201819		
<p>This Acknowledgement Receipt evidences receipt on the noted date by the USPTO of the indicated documents, characterized by the applicant, and including page counts, where applicable. It serves as evidence of receipt similar to a Post Card, as described in MPEP 503.</p> <p><u>New Applications Under 35 U.S.C. 111</u> If a new application is being filed and the application includes the necessary components for a filing date (see 37 CFR 1.53(b)-(d) and MPEP 506), a Filing Receipt (37 CFR 1.54) will be issued in due course and the date shown on this Acknowledgement Receipt will establish the filing date of the application.</p> <p><u>National Stage of an International Application under 35 U.S.C. 371</u> If a timely submission to enter the national stage of an international application is compliant with the conditions of 35 U.S.C. 371 and other applicable requirements a Form PCT/DO/EO/903 indicating acceptance of the application as a national stage submission under 35 U.S.C. 371 will be issued in addition to the Filing Receipt, in due course.</p> <p><u>New International Application Filed with the USPTO as a Receiving Office</u> If a new international application is being filed and the international application includes the necessary components for an international filing date (see PCT Article 11 and MPEP 1810), a Notification of the International Application Number and of the International Filing Date (Form PCT/RO/105) will be issued in due course, subject to prescriptions concerning national security, and the date shown on this Acknowledgement Receipt will establish the international filing date of the application.</p>					



UNITED STATES PATENT AND TRADEMARK OFFICE

UNITED STATES DEPARTMENT OF COMMERCE
United States Patent and Trademark Office
Address: COMMISSIONER FOR PATENTS
P.O. Box 1450
Alexandria, Virginia 22313-1450
www.uspto.gov

APPLICATION NUMBER	FILING OR 371(C) DATE	FIRST NAMED APPLICANT	ATTY. DOCKET NO./TITLE
11/563,232	11/27/2006	Safi Qureshey	1116-028C

CONFIRMATION NO. 1583

POA ACCEPTANCE LETTER

71739
WITHROW & TERRANOVA CT
100 REGENCY FOREST DRIVE , SUITE 160
CARY, NC 27518



Date Mailed: 08/06/2010

NOTICE OF ACCEPTANCE OF POWER OF ATTORNEY

This is in response to the Power of Attorney filed 07/30/2010.

The Power of Attorney in this application is accepted. Correspondence in this application will be mailed to the above address as provided by 37 CFR 1.33.

/snguyen/

Office of Data Management, Application Assistance Unit (571) 272-4000, or (571) 272-4200, or 1-888-786-0101



UNITED STATES PATENT AND TRADEMARK OFFICE

UNITED STATES DEPARTMENT OF COMMERCE
United States Patent and Trademark Office
Address: COMMISSIONER FOR PATENTS
P.O. Box 1450
Alexandria, Virginia 22313-1450
www.uspto.gov

APPLICATION NUMBER	FILING OR 371(C) DATE	FIRST NAMED APPLICANT	ATTY. DOCKET NO./TITLE
11/563,232	11/27/2006	Safi Qureshey	1116-028C

CONFIRMATION NO. 1583

POWER OF ATTORNEY NOTICE

71739
WITHROW & TERRANOVA CT
100 REGENCY FOREST DRIVE , SUITE 160
CARY, NC 27518



Date Mailed: 08/06/2010

NOTICE REGARDING CHANGE OF POWER OF ATTORNEY

This is in response to the Power of Attorney filed 07/30/2010.

- The Power of Attorney to you in this application has been revoked by the assignee who has intervned as provided by 37 CFR 3.71. Future correspondence will be mailed to the new address of record(37 CFR 1.33).

/snguyen/

Office of Data Management, Application Assistance Unit (571) 272-4000, or (571) 272-4200, or 1-888-786-0101

INFORMATION DISCLOSURE STATEMENT BY APPLICANT (Not for submission under 37 CFR 1.99)	Application Number		11563232
	Filing Date		2006-11-27
	First Named Inventor	Safi Qureshey et al.	
	Art Unit		2618
	Examiner Name	Pablo N. Tran	
	Attorney Docket Number		1116-028C

U.S. PATENTS							Remove
Examiner Initial*	Cite No	Patent Number	Kind Code ¹	Issue Date	Name of Patentee or Applicant of cited Document	Pages, Columns, Lines where Relevant Passages or Relevant Figures Appear	
	1	6662231	B1	2003-12-09	Drosset et al.		
	2	6741869	B1	2004-05-25	Lehr		
	3	6711622	B1	2004-03-23	Fuller et al.		
	4	7870088	B1	2011-01-11	Chen et al.		
	5	7856485	B2	2010-12-21	Prager et al.		
	6	7840691	B1	2010-11-23	De Bonet et al.		
	7	7797321	B2	2010-09-14	Martin et al.		
	8	7797272	B2	2010-09-14	Picker et al.		

INFORMATION DISCLOSURE STATEMENT BY APPLICANT (Not for submission under 37 CFR 1.99)	Application Number	11563232
	Filing Date	2006-11-27
	First Named Inventor	Safi Qureshey et al.
	Art Unit	2618
	Examiner Name	Pablo N. Tran
	Attorney Docket Number	1116-028C

9	7783722	B1	2010-08-24	Rosenberg et al.	
10	7711838	B1	2010-05-04	Boulter et al.	
11	7469283	B2	2008-12-23	Eyal et al.	
12	7139770	B2	2006-11-21	Nakase et al.	

If you wish to add additional U.S. Patent citation information please click the Add button.

U.S.PATENT APPLICATION PUBLICATIONS

Examiner Initial*	Cite No	Publication Number	Kind Code ¹	Publication Date	Name of Patentee or Applicant of cited Document	Pages, Columns, Lines where Relevant Passages or Relevant Figures Appear
	1	20090070267	A9	2009-03-12	Hangartner	
	2	20070283268	A1	2007-12-06	Berger et al.	

If you wish to add additional U.S. Published Application citation information please click the Add button.

FOREIGN PATENT DOCUMENTS

Examiner Initial*	Cite No	Foreign Document Number ³	Country Code ² j	Kind Code ⁴	Publication Date	Name of Patentee or Applicant of cited Document	Pages, Columns, Lines where Relevant Passages or Relevant Figures Appear	T ⁵
	1							<input type="checkbox"/>

If you wish to add additional Foreign Patent Document citation information please click the Add button

NON-PATENT LITERATURE DOCUMENTS

INFORMATION DISCLOSURE STATEMENT BY APPLICANT (Not for submission under 37 CFR 1.99)	Application Number	11563232
	Filing Date	2006-11-27
	First Named Inventor	Safi Qureshey et al.
	Art Unit	2618
	Examiner Name	Pablo N. Tran
	Attorney Docket Number	1116-028C

Examiner Initials*	Cite No	Include name of the author (in CAPITAL LETTERS), title of the article (when appropriate), title of the item (book, magazine, journal, serial, symposium, catalog, etc), date, pages(s), volume-issue number(s), publisher, city and/or country where published.	T ⁵
	1		<input type="checkbox"/>

If you wish to add additional non-patent literature document citation information please click the Add button

EXAMINER SIGNATURE

Examiner Signature	Date Considered
--------------------	-----------------

*EXAMINER: Initial if reference considered, whether or not citation is in conformance with MPEP 609. Draw line through a citation if not in conformance and not considered. Include copy of this form with next communication to applicant.

¹ See Kind Codes of USPTO Patent Documents at www.USPTO.GOV or MPEP 901.04. ² Enter office that issued the document, by the two-letter code (WIPO Standard ST.3). ³ For Japanese patent documents, the indication of the year of the reign of the Emperor must precede the serial number of the patent document. ⁴ Kind of document by the appropriate symbols as indicated on the document under WIPO Standard ST.16 if possible. ⁵ Applicant is to place a check mark here if English language translation is attached.

INFORMATION DISCLOSURE STATEMENT BY APPLICANT (Not for submission under 37 CFR 1.99)	Application Number	11563232
	Filing Date	2006-11-27
	First Named Inventor	Safi Qureshey et al.
	Art Unit	2618
	Examiner Name	Pablo N. Tran
	Attorney Docket Number	1116-028C

CERTIFICATION STATEMENT

Please see 37 CFR 1.97 and 1.98 to make the appropriate selection(s):

That each item of information contained in the information disclosure statement was first cited in any communication from a foreign patent office in a counterpart foreign application not more than three months prior to the filing of the information disclosure statement. See 37 CFR 1.97(e)(1).

OR

That no item of information contained in the information disclosure statement was cited in a communication from a foreign patent office in a counterpart foreign application, and, to the knowledge of the person signing the certification after making reasonable inquiry, no item of information contained in the information disclosure statement was known to any individual designated in 37 CFR 1.56(c) more than three months prior to the filing of the information disclosure statement. See 37 CFR 1.97(e)(2).

See attached certification statement.

The fee set forth in 37 CFR 1.17 (p) has been submitted herewith.

A certification statement is not submitted herewith.

SIGNATURE

A signature of the applicant or representative is required in accordance with CFR 1.33, 10.18. Please see CFR 1.4(d) for the form of the signature.

Signature	/R. Chad Bevins/	Date (YYYY-MM-DD)	2011-03-22
Name/Print	R. Chad Bevins	Registration Number	51468

This collection of information is required by 37 CFR 1.97 and 1.98. The information is required to obtain or retain a benefit by the public which is to file (and by the USPTO to process) an application. Confidentiality is governed by 35 U.S.C. 122 and 37 CFR 1.14. This collection is estimated to take 1 hour to complete, including gathering, preparing and submitting the completed application form to the USPTO. Time will vary depending upon the individual case. Any comments on the amount of time you require to complete this form and/or suggestions for reducing this burden, should be sent to the Chief Information Officer, U.S. Patent and Trademark Office, U.S. Department of Commerce, P.O. Box 1450, Alexandria, VA 22313-1450. **DO NOT SEND FEES OR COMPLETED FORMS TO THIS ADDRESS. SEND TO: Commissioner for Patents, P.O. Box 1450, Alexandria, VA 22313-1450.**

Privacy Act Statement

The Privacy Act of 1974 (P.L. 93-579) requires that you be given certain information in connection with your submission of the attached form related to a patent application or patent. Accordingly, pursuant to the requirements of the Act, please be advised that: (1) the general authority for the collection of this information is 35 U.S.C. 2(b)(2); (2) furnishing of the information solicited is voluntary; and (3) the principal purpose for which the information is used by the U.S. Patent and Trademark Office is to process and/or examine your submission related to a patent application or patent. If you do not furnish the requested information, the U.S. Patent and Trademark Office may not be able to process and/or examine your submission, which may result in termination of proceedings or abandonment of the application or expiration of the patent.

The information provided by you in this form will be subject to the following routine uses:

1. The information on this form will be treated confidentially to the extent allowed under the Freedom of Information Act (5 U.S.C. 552) and the Privacy Act (5 U.S.C. 552a). Records from this system of records may be disclosed to the Department of Justice to determine whether the Freedom of Information Act requires disclosure of these records.
2. A record from this system of records may be disclosed, as a routine use, in the course of presenting evidence to a court, magistrate, or administrative tribunal, including disclosures to opposing counsel in the course of settlement negotiations.
3. A record in this system of records may be disclosed, as a routine use, to a Member of Congress submitting a request involving an individual, to whom the record pertains, when the individual has requested assistance from the Member with respect to the subject matter of the record.
4. A record in this system of records may be disclosed, as a routine use, to a contractor of the Agency having need for the information in order to perform a contract. Recipients of information shall be required to comply with the requirements of the Privacy Act of 1974, as amended, pursuant to 5 U.S.C. 552a(m).
5. A record related to an International Application filed under the Patent Cooperation Treaty in this system of records may be disclosed, as a routine use, to the International Bureau of the World Intellectual Property Organization, pursuant to the Patent Cooperation Treaty.
6. A record in this system of records may be disclosed, as a routine use, to another federal agency for purposes of National Security review (35 U.S.C. 181) and for review pursuant to the Atomic Energy Act (42 U.S.C. 218(c)).
7. A record from this system of records may be disclosed, as a routine use, to the Administrator, General Services, or his/her designee, during an inspection of records conducted by GSA as part of that agency's responsibility to recommend improvements in records management practices and programs, under authority of 44 U.S.C. 2904 and 2906. Such disclosure shall be made in accordance with the GSA regulations governing inspection of records for this purpose, and any other relevant (i.e., GSA or Commerce) directive. Such disclosure shall not be used to make determinations about individuals.
8. A record from this system of records may be disclosed, as a routine use, to the public after either publication of the application pursuant to 35 U.S.C. 122(b) or issuance of a patent pursuant to 35 U.S.C. 151. Further, a record may be disclosed, subject to the limitations of 37 CFR 1.14, as a routine use, to the public if the record was filed in an application which became abandoned or in which the proceedings were terminated and which application is referenced by either a published application, an application open to public inspections or an issued patent.
9. A record from this system of records may be disclosed, as a routine use, to a Federal, State, or local law enforcement agency, if the USPTO becomes aware of a violation or potential violation of law or regulation.

Electronic Acknowledgement Receipt

EFS ID:	9710275
Application Number:	11563232
International Application Number:	
Confirmation Number:	1583
Title of Invention:	NETWORK-ENABLED AUDIO DEVICE
First Named Inventor/Applicant Name:	Safi Qureshey
Customer Number:	71739
Filer:	R. Chad Bevins/Julie Smith
Filer Authorized By:	R. Chad Bevins
Attorney Docket Number:	1116-028C
Receipt Date:	22-MAR-2011
Filing Date:	27-NOV-2006
Time Stamp:	14:08:18
Application Type:	Utility under 35 USC 111(a)

Payment information:

Submitted with Payment	no
------------------------	----

File Listing:

Document Number	Document Description	File Name	File Size(Bytes)/ Message Digest	Multi Part /.zip	Pages (if appl.)
1	Information Disclosure Statement (IDS) Filed (SB/08)	1116-028C_IDS_7.PDF	611981 <small>0121166957ed3428394b415308305836bc 568f39</small>	no	5

Warnings:

Information:

This Acknowledgement Receipt evidences receipt on the noted date by the USPTO of the indicated documents, characterized by the applicant, and including page counts, where applicable. It serves as evidence of receipt similar to a Post Card, as described in MPEP 503.

New Applications Under 35 U.S.C. 111

If a new application is being filed and the application includes the necessary components for a filing date (see 37 CFR 1.53(b)-(d) and MPEP 506), a Filing Receipt (37 CFR 1.54) will be issued in due course and the date shown on this Acknowledgement Receipt will establish the filing date of the application.

National Stage of an International Application under 35 U.S.C. 371

If a timely submission to enter the national stage of an international application is compliant with the conditions of 35 U.S.C. 371 and other applicable requirements a Form PCT/DO/EO/903 indicating acceptance of the application as a national stage submission under 35 U.S.C. 371 will be issued in addition to the Filing Receipt, in due course.

New International Application Filed with the USPTO as a Receiving Office

If a new international application is being filed and the international application includes the necessary components for an international filing date (see PCT Article 11 and MPEP 1810), a Notification of the International Application Number and of the International Filing Date (Form PCT/RO/105) will be issued in due course, subject to prescriptions concerning national security, and the date shown on this Acknowledgement Receipt will establish the international filing date of the application.

Application Number	Application/Control No.	Applicant(s)/Patent Under Reexamination
Document Code -		Internal Document – DO NOT MAIL

TERMINAL DISCLAIMER	<input type="checkbox"/> APPROVED	<input type="checkbox"/> DISAPPROVED
Date Filed:	This patent is subject to a Terminal Disclaimer	

Approved/Disapproved by:	

U.S. Patent and Trademark Office

<i>Index of Claims</i> 	Application/Control No. 11563232	Applicant(s)/Patent Under Reexamination QURESHEY ET AL.
	Examiner PABLO TRAN	Art Unit 2618

✓	Rejected	-	Cancelled	N	Non-Elected	A	Appeal
=	Allowed	÷	Restricted	I	Interference	O	Objected

Claims renumbered in the same order as presented by applicant
 CPA
 T.D.
 R.1.47

CLAIM		DATE							
Final	Original	05/22/2011							
	1	✓							
	2	✓							
	3	✓							
	4	✓							
	5	✓							
	6	✓							
	7	✓							
	8	✓							
	9	✓							
	10	✓							
	11	✓							
	12	✓							
	13	✓							
	14	✓							
	15	✓							
	16	✓							
	17	✓							
	18	✓							
	19	✓							
	20	✓							

INFORMATION DISCLOSURE STATEMENT BY APPLICANT (Not for submission under 37 CFR 1.99)	Application Number	11563232
	Filing Date	2006-11-27
	First Named Inventor	Safi Qureshey et al.
	Art Unit	2618
	Examiner Name	TBA
	Attorney Docket Number	1116-028C

U.S. PATENTS							Remove
Examiner Initial*	Cite No	Patent Number	Kind Code ¹	Issue Date	Name of Patentee or Applicant of cited Document	Pages, Columns, Lines where Relevant Passages or Relevant Figures Appear	
	1	5652841		1999-03-30	Nemirovsky et al.		
	2	6108686		2000-08-22	Williams, Jr.		
	3	6182128	B1	2001-01-30	Kelkar et al.		
	4	6349339	B1	2002-02-19	Williams		
	5	6473792	B1	2002-10-29	Yavitz et al.		
	6	6502194	B1	2002-12-31	Berman et al.		
	7	6600898	B1	2003-07-29	De Bonet et al.		
	8	6609096	B1	2003-08-19	De Bonet et al.		

ALL REFERENCES CONSIDERED EXCEPT WHERE LINED THROUGH. /PT/

INFORMATION DISCLOSURE STATEMENT BY APPLICANT (Not for submission under 37 CFR 1.99)	Application Number	11563232
	Filing Date	2006-11-27
	First Named Inventor	Safi Qureshey et al.
	Art Unit	2618
	Examiner Name	TBA
	Attorney Docket Number	1116-028C

9	6647389	B1	2003-11-11	Fitch et al.	
10	6925489	B1	2005-08-02	Curtin	
11	6985694	B1	2006-01-10	De Bonet et al.	
12	7010263	B1	2006-03-07	Patsiokas	
13	7058694	B1	2006-06-06	De Bonet et al.	
14	7212830	B2	2007-05-01	Tamaki et al.	
15	5890152		1999-03-30	Rapaport et al.	

If you wish to add additional U.S. Patent citation information please click the Add button.

Add

U.S.PATENT APPLICATION PUBLICATIONS

Remove

Examiner Initial*	Cite No	Publication Number	Kind Code ¹	Publication Date	Name of Patentee or Applicant of cited Document	Pages, Columns, Lines where Relevant Passages or Relevant Figures Appear
	1	20060161621	A1	2006-07-20	Rosenberg	
	2	20060224971	A1	2006-10-05	Paulin et al.	

ALL REFERENCES CONSIDERED EXCEPT WHERE LINED THROUGH. /PT/

EFS Web 2.1.10

INFORMATION DISCLOSURE STATEMENT BY APPLICANT (Not for submission under 37 CFR 1.99)	Application Number	11563232
	Filing Date	2006-11-27
	First Named Inventor	Safi Qureshey et al.
	Art Unit	2618
	Examiner Name	TBA
	Attorney Docket Number	1116-028C

3	20060288074	A1	2006-12-21	Rosenberg	
4	20070220100	A1	2007-09-20	Rosenberg	
5	20070265979	A1	2007-11-15	Hangartner	

If you wish to add additional U.S. Published Application citation information please click the Add button.

FOREIGN PATENT DOCUMENTS

Examiner Initial*	Cite No	Foreign Document Number ³	Country Code ² j	Kind Code ⁴	Publication Date	Name of Patentee or Applicant of cited Document	Pages, Columns, Lines where Relevant Passages or Relevant Figures Appear	T ⁵
	1							<input type="checkbox"/>

If you wish to add additional Foreign Patent Document citation information please click the Add button.

NON-PATENT LITERATURE DOCUMENTS

Examiner Initials*	Cite No	Include name of the author (in CAPITAL LETTERS), title of the article (when appropriate), title of the item (book, magazine, journal, serial, symposium, catalog, etc), date, pages(s), volume-issue number(s), publisher, city and/or country where published.	T ⁵
	1		<input type="checkbox"/>

If you wish to add additional non-patent literature document citation information please click the Add button.

EXAMINER SIGNATURE

Examiner Signature	/PT/	Date Considered	05/22/2011
--------------------	------	-----------------	------------

*EXAMINER: Initial if reference considered, whether or not citation is in conformance with MPEP 609. Draw line through a citation if not in conformance and not considered. Include copy of this form with next communication to applicant.

ALL REFERENCES CONSIDERED EXCEPT WHERE LINED THROUGH. /PT/

INFORMATION DISCLOSURE STATEMENT BY APPLICANT (Not for submission under 37 CFR 1.99)	Application Number	11563232
	Filing Date	2006-11-27
	First Named Inventor	Safi Qureshey et al.
	Art Unit	2618
	Examiner Name	TBA
	Attorney Docket Number	1116-028C

¹ See Kind Codes of USPTO Patent Documents at www.USPTO.GOV or MPEP 901.04. ² Enter office that issued the document, by the two-letter code (WIPO Standard ST.3). ³ For Japanese patent documents, the indication of the year of the reign of the Emperor must precede the serial number of the patent document. ⁴ Kind of document by the appropriate symbols as indicated on the document under WIPO Standard ST.16 if possible. ⁵ Applicant is to place a check mark here if English language translation is attached.

ALL REFERENCES CONSIDERED EXCEPT WHERE LINED THROUGH. /PT/

EFS Web 2.1.10

INFORMATION DISCLOSURE STATEMENT BY APPLICANT (Not for submission under 37 CFR 1.99)	Application Number	11563232
	Filing Date	2006-11-27
	First Named Inventor	Safi Qureshey et al.
	Art Unit	2618
	Examiner Name	TBA
	Attorney Docket Number	1116-028C

U.S. PATENTS								Remove
Examiner Initial*	Cite No	Patent Number	Kind Code ¹	Issue Date	Name of Patentee or Applicant of cited Document	Pages, Columns, Lines where Relevant Passages or Relevant Figures Appear		
	1	6701355	B1	2004-03-02	Brandt et al.			
If you wish to add additional U.S. Patent citation information please click the Add button.								Add
U.S. PATENT APPLICATION PUBLICATIONS								Remove
Examiner Initial*	Cite No	Publication Number	Kind Code ¹	Publication Date	Name of Patentee or Applicant of cited Document	Pages, Columns, Lines where Relevant Passages or Relevant Figures Appear		
	1							
If you wish to add additional U.S. Published Application citation information please click the Add button.								Add
FOREIGN PATENT DOCUMENTS								Remove
Examiner Initial*	Cite No	Foreign Document Number ³	Country Code ² j	Kind Code ⁴	Publication Date	Name of Patentee or Applicant of cited Document	Pages, Columns, Lines where Relevant Passages or Relevant Figures Appear	T ⁵
	1							<input type="checkbox"/>
If you wish to add additional Foreign Patent Document citation information please click the Add button.								Add
NON-PATENT LITERATURE DOCUMENTS								Remove
Examiner Initials*	Cite No	Include name of the author (in CAPITAL LETTERS), title of the article (when appropriate), title of the item (book, magazine, journal, serial, symposium, catalog, etc), date, pages(s), volume-issue number(s), publisher, city and/or country where published.						T ⁵

ALL REFERENCES CONSIDERED EXCEPT WHERE LINED THROUGH. /PT/

INFORMATION DISCLOSURE STATEMENT BY APPLICANT (Not for submission under 37 CFR 1.99)	Application Number	11563232
	Filing Date	2006-11-27
	First Named Inventor	Safi Qureshey et al.
	Art Unit	2618
	Examiner Name	TBA
	Attorney Docket Number	1116-028C

1		<input type="checkbox"/>
---	--	--------------------------

If you wish to add additional non-patent literature document citation information please click the Add button

EXAMINER SIGNATURE

Examiner Signature	/PT/	Date Considered	05/22/2011
--------------------	------	-----------------	------------

*EXAMINER: Initial if reference considered, whether or not citation is in conformance with MPEP 609. Draw line through a citation if not in conformance and not considered. Include copy of this form with next communication to applicant.

¹ See Kind Codes of USPTO Patent Documents at www.USPTO.GOV or MPEP 901.04. ² Enter office that issued the document, by the two-letter code (WIPO Standard ST.3). ³ For Japanese patent documents, the indication of the year of the reign of the Emperor must precede the serial number of the patent document. ⁴ Kind of document by the appropriate symbols as indicated on the document under WIPO Standard ST.16 if possible. ⁵ Applicant is to place a check mark here if English language translation is attached.

ALL REFERENCES CONSIDERED EXCEPT WHERE LINED THROUGH. /PT/

INFORMATION DISCLOSURE STATEMENT BY APPLICANT (Not for submission under 37 CFR 1.99)	Application Number	11563232
	Filing Date	2006-11-27
	First Named Inventor	Safi Qureshey et al.
	Art Unit	2618
	Examiner Name	TBA
	Attorney Docket Number	1116-028C

U.S. PATENTS							Remove	
Examiner Initial*	Cite No	Patent Number	Kind Code ¹	Issue Date	Name of Patentee or Applicant of cited Document	Pages, Columns, Lines where Relevant Passages or Relevant Figures Appear		
	1	5852610		1998-12-22	Olaniyan			
	2	5907831		1999-05-25	Lotvin et al.			
If you wish to add additional U.S. Patent citation information please click the Add button.							Add	
U.S. PATENT APPLICATION PUBLICATIONS							Remove	
Examiner Initial*	Cite No	Publication Number	Kind Code ¹	Publication Date	Name of Patentee or Applicant of cited Document	Pages, Columns, Lines where Relevant Passages or Relevant Figures Appear		
	1							
If you wish to add additional U.S. Published Application citation information please click the Add button.							Add	
FOREIGN PATENT DOCUMENTS							Remove	
Examiner Initial*	Cite No	Foreign Document Number ³	Country Code ² j	Kind Code ⁴	Publication Date	Name of Patentee or Applicant of cited Document	Pages, Columns, Lines where Relevant Passages or Relevant Figures Appear	T ⁵
	1							<input type="checkbox"/>
If you wish to add additional Foreign Patent Document citation information please click the Add button.							Add	
NON-PATENT LITERATURE DOCUMENTS							Remove	

ALL REFERENCES CONSIDERED EXCEPT WHERE LINED THROUGH. /PT/

INFORMATION DISCLOSURE STATEMENT BY APPLICANT (Not for submission under 37 CFR 1.99)	Application Number	11563232
	Filing Date	2006-11-27
	First Named Inventor	Safi Qureshey et al.
	Art Unit	2618
	Examiner Name	TBA
	Attorney Docket Number	1116-028C

Examiner Initials*	Cite No	Include name of the author (in CAPITAL LETTERS), title of the article (when appropriate), title of the item (book, magazine, journal, serial, symposium, catalog, etc), date, pages(s), volume-issue number(s), publisher, city and/or country where published.	T ⁵
	1		<input type="checkbox"/>

If you wish to add additional non-patent literature document citation information please click the Add button

EXAMINER SIGNATURE

Examiner Signature	/PT/	Date Considered	05/22/2011
--------------------	------	-----------------	------------

*EXAMINER: Initial if reference considered, whether or not citation is in conformance with MPEP 609. Draw line through a citation if not in conformance and not considered. Include copy of this form with next communication to applicant.

¹ See Kind Codes of USPTO Patent Documents at www.USPTO.GOV or MPEP 901.04. ² Enter office that issued the document, by the two-letter code (WIPO Standard ST.3). ³ For Japanese patent documents, the indication of the year of the reign of the Emperor must precede the serial number of the patent document. ⁴ Kind of document by the appropriate symbols as indicated on the document under WIPO Standard ST.16 if possible. ⁵ Applicant is to place a check mark here if English language translation is attached.

ALL REFERENCES CONSIDERED EXCEPT WHERE LINED THROUGH. /PT/

EFS Web 2.1.10

Under the Paperwork Reduction Act of 1995, no persons are required to respond to a collection of information unless it contains a valid OMB control number.

INFORMATION DISCLOSURE STATEMENT BY APPLICANT (Not for submission under 37 CFR 1.99)	Application Number	11563232
	Filing Date	2006-11-27
	First Named Inventor	Safi Qureshey et al.
	Art Unit	2623
	Examiner Name	TBA
	Attorney Docket Number	1116-028C

U.S. PATENTS							Remove
Examiner Initial*	Cite No	Patent Number	Kind Code ¹	Issue Date	Name of Patentee or Applicant of cited Document	Pages, Columns, Lines where Relevant Passages or Relevant Figures Appear	
	1	3291919		1966-12-13	Robitaille		
	2	4682370		1987-07-21	Matthews		
	3	4720873		1988-01-19	Goodman et al.		
	4	4920432		1990-04-24	Eggers et al.		
	5	5035438		1991-07-30	Cronquist		
	6	5119188		1992-06-02	McCalley et al.		
	7	5127003		1992-06-30	Doll, Jr. et al.		
	8	5129036		1992-07-07	Dean et al.		

ALL REFERENCES CONSIDERED EXCEPT WHERE LINED THROUGH. /PT/

EFS Web 2.0

INFORMATION DISCLOSURE STATEMENT BY APPLICANT (Not for submission under 37 CFR 1.99)	Application Number	11563232
	Filing Date	2006-11-27
	First Named Inventor	Safi Qureshey et al.
	Art Unit	2623
	Examiner Name	TBA
	Attorney Docket Number	1116-028C

	9	5168481		1992-12-01	Culbertson et al.	
	10	5189630		1993-02-23	Barstow et al.	
	11	5192999		1993-03-09	Graczyk et al.	
	12	5215466		1993-06-01	Rubio	
	13	5282028		1994-01-25	Johnson et al.	
	14	5305438		1994-04-19	MacKay et al.	
	15	5349678		1994-09-20	Morris et al.	
	16	5351276		1994-09-27	Doll, Jr. et al.	
	17	5414455		1995-05-09	Hooper et al.	
	18	5455570		1995-10-03	Cook et al.	
	19	5475835		1995-12-12	Hickey	

EFS Web 2.0
ALL REFERENCES CONSIDERED EXCEPT WHERE LINED THROUGH. /PT/

INFORMATION DISCLOSURE STATEMENT BY APPLICANT (Not for submission under 37 CFR 1.99)	Application Number	11563232
	Filing Date	2006-11-27
	First Named Inventor	Safi Qureshey et al.
	Art Unit	2623
	Examiner Name	TBA
	Attorney Docket Number	1116-028C

	20	5481535		1996-01-02	Hershey	
	21	5512935		1996-04-30	Majeti et al.	
	22	5526284		1996-06-11	Mankovitz	
	23	5534913		1996-07-09	Majeti et al.	
	24	5539635		1996-07-23	Larson, Jr.	
	25	5544161		1996-08-06	Bigham et al.	
	26	5557541		1996-09-17	Schulhof et al.	
	27	5568645		1996-10-22	Morris et al.	
	28	5570134		1996-10-29	Hong	
	29	5572442		1996-11-05	Schulhof et al.	
	30	5592511		1997-01-07	Schoen et al.	

FFS Web 2.0
ALL REFERENCES CONSIDERED EXCEPT WHERE LINED THROUGH. /PT/

INFORMATION DISCLOSURE STATEMENT BY APPLICANT (Not for submission under 37 CFR 1.99)	Application Number		11563232	
	Filing Date		2006-11-27	
	First Named Inventor	Safi Qureshey et al.		
	Art Unit		2623	
	Examiner Name	TBA		
	Attorney Docket Number		1116-028C	

	31	5617565		1997-04-01	Augenbraun et al.	
	32	5625608		1997-04-29	Grewe et al.	
	33	5629867		1997-05-13	Goldman	
	34	5636211		1997-06-03	Newlin et al.	
	35	5640193		1997-06-17	Wellner	
	36	5654886		1997-08-05	Zereski, Jr. et al.	
	37	5671436		1997-09-23	Morris et al.	
	38	5673322		1997-09-30	Pepe et al.	
	39	5684799		1997-11-04	Bigham et al.	
	40	5682525		1997-10-28	Bouve et al.	
	41	5740035		1998-04-14	Cohen et al.	

FFS Web 2.0
ALL REFERENCES CONSIDERED EXCEPT WHERE LINED THROUGH. /PT/

INFORMATION DISCLOSURE STATEMENT BY APPLICANT (Not for submission under 37 CFR 1.99)	Application Number	11563232
	Filing Date	2006-11-27
	First Named Inventor	Safi Qureshey et al.
	Art Unit	2623
	Examiner Name	TBA
	Attorney Docket Number	1116-028C

42	5768527		1998-06-16	Zhu et al.	
43	5809246		1998-09-15	Goldman	
44	5812937		1998-09-22	Takahisa et al.	
45	5818512		1998-10-06	Fuller	
46	5819160		1998-10-06	Foladare et al.	
47	5844893		1998-12-01	Gollnick et al.	
48	5850340		1998-12-15	York	
49	5857149		1999-01-05	Suzuki	
50	5862171		1999-01-19	Mahany	

If you wish to add additional U.S. Patent citation information please click the Add button.

Add

U.S.PATENT APPLICATION PUBLICATIONS

Remove

Examiner Initial*	Cite No	Publication Number	Kind Code ¹	Publication Date	Name of Patentee or Applicant of cited Document	Pages, Columns, Lines where Relevant Passages or Relevant Figures Appear
-------------------	---------	--------------------	------------------------	------------------	-------------------------------------------------	--------------------------------------------------------------------------

ALL REFERENCES CONSIDERED EXCEPT WHERE LINED THROUGH. /PT/
EFS Web 2.0

INFORMATION DISCLOSURE STATEMENT BY APPLICANT (Not for submission under 37 CFR 1.99)	Application Number	11563232
	Filing Date	2006-11-27
	First Named Inventor	Safi Qureshey et al.
	Art Unit	2623
	Examiner Name	TBA
	Attorney Docket Number	1116-028C

1						
---	--	--	--	--	--	--

If you wish to add additional U.S. Published Application citation information please click the Add button

FOREIGN PATENT DOCUMENTS

Examiner Initial*	Cite No	Foreign Document Number ³	Country Code ² j	Kind Code ⁴	Publication Date	Name of Patentee or Applicant of cited Document	Pages, Columns, Lines where Relevant Passages or Relevant Figures Appear	T ⁵
	1	2306869	GB	A	1997-07-05	Patrik Garten		<input checked="" type="checkbox"/>
	2	97/26601	WO	A2	1997-07-24	Philips Electronics N.V.		<input checked="" type="checkbox"/>

If you wish to add additional Foreign Patent Document citation information please click the Add button

NON-PATENT LITERATURE DOCUMENTS

Examiner Initials*	Cite No	Include name of the author (in CAPITAL LETTERS), title of the article (when appropriate), title of the item (book, magazine, journal, serial, symposium, catalog, etc), date, pages(s), volume-issue number(s), publisher, city and/or country where published.	T ⁵
	1	"A Music Revolution ... SoundServer," imerge, 2 pages.	<input checked="" type="checkbox"/>
	2	"imerge Multi-room SoundServer Application note," Issue 1.1, August 2000, 9 pages.	<input checked="" type="checkbox"/>
	3	VERONICA HENDRICKS, "Imerge SoundServer," Techonline, http://www.techonline.com/scripts/tol.exe?TEMPLATE,top.ops&AREA,1&CONTENT,8988&NET,13&USER.todd_Bergeson@3com.com , Copyright 1999-2000 TechOnLine, Inc., printed September 22, 2000, 2 pages.	<input checked="" type="checkbox"/>
	4	"NPR : National Public Radio : News & Analysis, World, US, Music & Arts," http://www.npr.org , Copyright 2007 NPR, printed October 16, 2007, 7 pages.	<input checked="" type="checkbox"/>

ALL REFERENCES CONSIDERED EXCEPT WHERE LINED THROUGH. /PT/

EFS Web 2.0

INFORMATION DISCLOSURE STATEMENT BY APPLICANT (Not for submission under 37 CFR 1.99)	Application Number	11563232
	Filing Date	2006-11-27
	First Named Inventor	Safi Qureshey et al.
	Art Unit	2623
	Examiner Name	TBA
	Attorney Docket Number	1116-028C

5	"Webradio Com," http://www.webradio.com/eflp/web+radio/pid73231/D284974/C2243539 , Copyright 2007 www.webradio.com, printed October 16, 2007, 1 page.	<input checked="" type="checkbox"/>
6	"RCS Acquires Decision Inc.; Offers Complete Software Solution for Radio Station Programming Operations," Businesswire, February 9, 1993, Copyright 1995 Reuters Info. Svcs., 2 pages.	<input checked="" type="checkbox"/>
7	MARY WELLER, "Radio Station Software: Programmes That Meet Your Stations Needs," Music & Media, November 28, 1992, p. 11, Copyright 1995 Information Access Co., 3 pages.	<input checked="" type="checkbox"/>
8	CHRIS MCCONNELL, "The tapeless revolution comes to radio (disk-based radio broadcasting storage, production and editing systems)," Broadcasting & Cable, v124, n41, p. 77, October 10, 1994, Copyright 1995 Info Access Co., 4 pages.	<input checked="" type="checkbox"/>
9	"Blockbuster and IBM Announce New Multimedia Ventures," May 11, 1993, 2 pages.	<input checked="" type="checkbox"/>
10	"IBM Launches Business to Deploy Multimedia Applications and Services," January 20, 1993, 3 pages.	<input checked="" type="checkbox"/>
11	"The Not So Hard Disk," Wheatstone Corporation, 5 pages.	<input checked="" type="checkbox"/>
12	"Audio Switcher Model CCSW84-01," Computer Concepts Corp. Digital Commercial System, February 1991, 3 pages.	<input checked="" type="checkbox"/>
13	"DCS Live! Live Radio Just Got Easier," Computer Concepts Corporation, 1 page.	<input checked="" type="checkbox"/>
14	"DCS Overview," Computer Concepts Corporation, 1 page.	<input checked="" type="checkbox"/>
15	"The Computer Concepts Traffic System. You'll wonder how you managed without it," Computer Concepts Corporation, 1 page.	<input checked="" type="checkbox"/>

FFS Web 2.0
ALL REFERENCES CONSIDERED EXCEPT WHERE LINED THROUGH. /PT/

INFORMATION DISCLOSURE STATEMENT BY APPLICANT (Not for submission under 37 CFR 1.99)	Application Number	11563232
	Filing Date	2006-11-27
	First Named Inventor	Safi Qureshey et al.
	Art Unit	2623
	Examiner Name	TBA
	Attorney Docket Number	1116-028C

16	"Digital On-Air Studio System," January 31, 1994, Copyright format only 1997 Knight-Ridder Info., 1 page.	<input checked="" type="checkbox"/>
17	"Relatable's Open Source Audio Signature Solution, TRM," http://web.archive.org/web/20001117082600/http://www.relatable.com/tech/trm.html , copyright Relatable 2000, printed November 28, 2007, 2 pages.	<input checked="" type="checkbox"/>

If you wish to add additional non-patent literature document citation information please click the Add button

EXAMINER SIGNATURE

Examiner Signature	/PT/	Date Considered	05/22/2011
--------------------	------	-----------------	------------

*EXAMINER: Initial if reference considered, whether or not citation is in conformance with MPEP 609. Draw line through a citation if not in conformance and not considered. Include copy of this form with next communication to applicant.

¹ See Kind Codes of USPTO Patent Documents at www.USPTO.GOV or MPEP 901.04. ² Enter office that issued the document, by the two-letter code (WIPO Standard ST.3). ³ For Japanese patent documents, the indication of the year of the reign of the Emperor must precede the serial number of the patent document. ⁴ Kind of document by the appropriate symbols as indicated on the document under WIPO Standard ST.16 if possible. ⁵ Applicant is to place a check mark here if English language translation is attached.

ALL REFERENCES CONSIDERED EXCEPT WHERE LINED THROUGH. /PT/

EFS Web 2.0

Under the Paperwork Reduction Act of 1995, no persons are required to respond to a collection of information unless it contains a valid OMB control number.

INFORMATION DISCLOSURE STATEMENT BY APPLICANT (Not for submission under 37 CFR 1.99)	Application Number	11563232
	Filing Date	2006-11-27
	First Named Inventor	Safi Qureshey et al.
	Art Unit	2623
	Examiner Name	TBA
	Attorney Docket Number	1116-028C

U.S. PATENTS							Remove
Examiner Initial*	Cite No	Patent Number	Kind Code ¹	Issue Date	Name of Patentee or Applicant of cited Document	Pages, Columns, Lines where Relevant Passages or Relevant Figures Appear	
	1	5870390		1999-02-09	Campanella		
	2	5873045		1999-02-16	Lee et al.		
	3	5880721		1999-03-09	Yen		
	4	5892536		1999-04-06	Logan et al.		
	5	5905865		1999-05-18	Palmer et al.		
	6	5918223		1999-06-29	Blum et al.		
	7	5943398		1999-08-24	Klein et al.		
	8	5948084		1999-09-07	Ha		

ALL REFERENCES CONSIDERED EXCEPT WHERE LINED THROUGH. /PT/

INFORMATION DISCLOSURE STATEMENT BY APPLICANT (Not for submission under 37 CFR 1.99)	Application Number		11563232	
	Filing Date		2006-11-27	
	First Named Inventor	Safi Qureshey et al.		
	Art Unit		2623	
	Examiner Name	TBA		
	Attorney Docket Number		1116-028C	

	9	5949492		1999-09-07	Mankovitz	
	10	5990868		1999-11-23	Frederick	
	11	5991693		1999-11-23	Zalewski	
	12	6005563		1999-12-21	White et al.	
	13	6012086		2000-01-04	Lowell	
	14	6014569		2000-01-11	Bottum	
	15	6035350		2000-03-07	Swamy et al.	
	16	6067562		2000-05-23	Goldman	
	17	6088455		2000-07-11	Logan et al.	
	18	6105060		2000-08-15	Rothblatt	
	19	6199076	B1	2001-03-06	Logan et al.	

EFS Web 2.0
ALL REFERENCES CONSIDERED EXCEPT WHERE LINED THROUGH. /PT/

INFORMATION DISCLOSURE STATEMENT BY APPLICANT (Not for submission under 37 CFR 1.99)	Application Number	11563232
	Filing Date	2006-11-27
	First Named Inventor	Safi Qureshey et al.
	Art Unit	2623
	Examiner Name	TBA
	Attorney Docket Number	1116-028C

	20	6204885	B1	2001-03-20	Kwoh	
	21	6226672	B1	2001-05-01	DeMartin et al.	
	22	6229621	B1	2001-05-08	Kulakowski et al.	
	23	6253069	B1	2001-06-26	Mankovitz	
	24	6295093	B1	2001-09-25	Park et al.	
	25	6295555	B1	2001-09-25	Goldman	
	26	6349329	B1	2002-02-19	Mackintosh et al.	
	27	6628928	B1	2003-09-30	Crosby et al.	
	28	6793142	B2	2004-09-21	Yap	
	29	6826283	B1	2004-11-30	Wheeler et al.	
If you wish to add additional U.S. Patent citation information please click the Add button.						<input type="button" value="Add"/>
U.S.PATENT APPLICATION PUBLICATIONS						<input type="button" value="Remove"/>

ALL REFERENCES CONSIDERED EXCEPT WHERE LINED THROUGH. /PT/

EFS Web 2.0

INFORMATION DISCLOSURE STATEMENT BY APPLICANT (Not for submission under 37 CFR 1.99)	Application Number	11563232
	Filing Date	2006-11-27
	First Named Inventor	Safi Qureshey et al.
	Art Unit	2623
	Examiner Name	TBA
	Attorney Docket Number	1116-028C

Examiner Initial*	Cite No	Publication Number	Kind Code ¹	Publication Date	Name of Patentee or Applicant of cited Document	Pages, Columns, Lines where Relevant Passages or Relevant Figures Appear
	1	20020002039	A1	2002-01-03	Qureshey et al.	
	2	20020072326	A1	2002-06-13	Qureshey et al.	
	3	20040121723	A1	2004-06-24	Poltorak	
	4	20060074808	A1	2006-04-06	Boesen	
	5	20060141962	A1	2006-06-29	Forbes et al.	
	6	20060156346	A1	2006-07-13	Kulakowski	
	7	20060171395	A1	2006-08-03	Deshpande	
	8	20060173825	A1	2006-08-03	Hess et al.	
	9	20060174348	A1	2006-08-03	Rhoads et al.	
	10	20060184960	A1	2006-08-17	Horton et al.	

FFS Web 2.0
ALL REFERENCES CONSIDERED EXCEPT WHERE LINED THROUGH. /PT/

INFORMATION DISCLOSURE STATEMENT BY APPLICANT (Not for submission under 37 CFR 1.99)	Application Number	11563232
	Filing Date	2006-11-27
	First Named Inventor	Safi Qureshey et al.
	Art Unit	2623
	Examiner Name	TBA
	Attorney Docket Number	1116-028C

11	20060218613	A1	2006-09-28	Bushnell	
12	20070089135	A1	2007-04-19	Qureshey et al.	
13	20070088804	A1	2007-04-19	Qureshey et al.	
14	20070180063	A1	2007-08-02	Qureshey et al.	

If you wish to add additional U.S. Published Application citation information please click the Add button.

FOREIGN PATENT DOCUMENTS

Examiner Initial*	Cite No	Foreign Document Number ³	Country Code ² j	Kind Code ⁴	Publication Date	Name of Patentee or Applicant of cited Document	Pages, Columns, Lines where Relevant Passages or Relevant Figures Appear	T ⁵
	1							<input type="checkbox"/>

If you wish to add additional Foreign Patent Document citation information please click the Add button.

NON-PATENT LITERATURE DOCUMENTS

Examiner Initials*	Cite No	Include name of the author (in CAPITAL LETTERS), title of the article (when appropriate), title of the item (book, magazine, journal, serial, symposium, catalog, etc), date, pages(s), volume-issue number(s), publisher, city and/or country where published.	T ⁵
	1		<input type="checkbox"/>

If you wish to add additional non-patent literature document citation information please click the Add button.

EXAMINER SIGNATURE

Examiner Signature	/PT/	Date Considered	05/22/2011
--------------------	------	-----------------	------------

*EXAMINER: Initial if reference considered, whether or not citation is in conformance with MPEP 609. Draw line through a citation if not in conformance and not considered. Include copy of this form with next communication to applicant.

ALL REFERENCES CONSIDERED EXCEPT WHERE LINED THROUGH. /PT/

EFS Web 2.0

INFORMATION DISCLOSURE STATEMENT BY APPLICANT (Not for submission under 37 CFR 1.99)	Application Number	11563232
	Filing Date	2006-11-27
	First Named Inventor	Safi Qureshey et al.
	Art Unit	2623
	Examiner Name	TBA
	Attorney Docket Number	1116-028C

¹ See Kind Codes of USPTO Patent Documents at www.USPTO.GOV or MPEP 901.04. ² Enter office that issued the document, by the two-letter code (WIPO Standard ST.3). ³ For Japanese patent documents, the indication of the year of the reign of the Emperor must precede the serial number of the patent document. ⁴ Kind of document by the appropriate symbols as indicated on the document under WIPO Standard ST.16 if possible. ⁵ Applicant is to place a check mark here if English language translation is attached.

ALL REFERENCES CONSIDERED EXCEPT WHERE LINED THROUGH. /PT/

EFS Web 2.0



UNITED STATES PATENT AND TRADEMARK OFFICE

UNITED STATES DEPARTMENT OF COMMERCE
United States Patent and Trademark Office
Address: COMMISSIONER FOR PATENTS
P.O. Box 1450
Alexandria, Virginia 22313-1450
www.uspto.gov

APPLICATION NO.	FILING DATE	FIRST NAMED INVENTOR	ATTORNEY DOCKET NO.	CONFIRMATION NO.
11/563,232	11/27/2006	Safi Qureshey	1116-028C	1583
71739	7590	05/23/2011	EXAMINER	
WITHROW & TERRANOVA CT 100 REGENCY FOREST DRIVE, SUITE 160 CARY, NC 27518			TRAN, PABLO N	
			ART UNIT	PAPER NUMBER
			2618	
			MAIL DATE	DELIVERY MODE
			05/23/2011	PAPER

Please find below and/or attached an Office communication concerning this application or proceeding.

The time period for reply, if any, is set in the attached communication.

Office Action Summary	Application No. 11/563,232	Applicant(s) QURESHEY ET AL.	
	Examiner PABLO TRAN	Art Unit 2618	

-- The MAILING DATE of this communication appears on the cover sheet with the correspondence address --

Period for Reply

A SHORTENED STATUTORY PERIOD FOR REPLY IS SET TO EXPIRE 3 MONTH(S) OR THIRTY (30) DAYS, WHICHEVER IS LONGER, FROM THE MAILING DATE OF THIS COMMUNICATION.

- Extensions of time may be available under the provisions of 37 CFR 1.136(a). In no event, however, may a reply be timely filed after SIX (6) MONTHS from the mailing date of this communication.
- If NO period for reply is specified above, the maximum statutory period will apply and will expire SIX (6) MONTHS from the mailing date of this communication.
- Failure to reply within the set or extended period for reply will, by statute, cause the application to become ABANDONED (35 U.S.C. § 133).
- Any reply received by the Office later than three months after the mailing date of this communication, even if timely filed, may reduce any earned patent term adjustment. See 37 CFR 1.704(b).

Status

- 1) Responsive to communication(s) filed on ____.
- 2a) This action is **FINAL**. 2b) This action is non-final.
- 3) Since this application is in condition for allowance except for formal matters, prosecution as to the merits is closed in accordance with the practice under *Ex parte Quayle*, 1935 C.D. 11, 453 O.G. 213.

Disposition of Claims

- 4) Claim(s) 1-20 is/are pending in the application.
4a) Of the above claim(s) ____ is/are withdrawn from consideration.
- 5) Claim(s) ____ is/are allowed.
- 6) Claim(s) 1-20 is/are rejected.
- 7) Claim(s) ____ is/are objected to.
- 8) Claim(s) ____ are subject to restriction and/or election requirement.

Application Papers

- 9) The specification is objected to by the Examiner.
- 10) The drawing(s) filed on ____ is/are: a) accepted or b) objected to by the Examiner.
Applicant may not request that any objection to the drawing(s) be held in abeyance. See 37 CFR 1.85(a).
Replacement drawing sheet(s) including the correction is required if the drawing(s) is objected to. See 37 CFR 1.121(d).
- 11) The oath or declaration is objected to by the Examiner. Note the attached Office Action or form PTO-152.

Priority under 35 U.S.C. § 119

- 12) Acknowledgment is made of a claim for foreign priority under 35 U.S.C. § 119(a)-(d) or (f).
a) All b) Some * c) None of:
1. Certified copies of the priority documents have been received.
2. Certified copies of the priority documents have been received in Application No. ____.
3. Copies of the certified copies of the priority documents have been received in this National Stage application from the International Bureau (PCT Rule 17.2(a)).
- * See the attached detailed Office action for a list of the certified copies not received.

Attachment(s)

- | | |
|-----------------------------------------------------------------------------------------------------------------------|-----------------------------------------------------------------------------------------|
| 1) <input checked="" type="checkbox"/> Notice of References Cited (PTO-892) | 4) <input type="checkbox"/> Interview Summary (PTO-413)
Paper No(s)/Mail Date. ____. |
| 2) <input type="checkbox"/> Notice of Draftsperson's Patent Drawing Review (PTO-948) | 5) <input type="checkbox"/> Notice of Informal Patent Application |
| 3) <input checked="" type="checkbox"/> Information Disclosure Statement(s) (PTO/SB/08)
Paper No(s)/Mail Date ____. | 6) <input type="checkbox"/> Other: ____. |

DETAILED ACTION

Double Patenting

1. The nonstatutory double patenting rejection is based on a judicially created doctrine grounded in public policy (a policy reflected in the statute) so as to prevent the unjustified or improper timewise extension of the “right to exclude” granted by a patent and to prevent possible harassment by multiple assignees. A nonstatutory obviousness-type double patenting rejection is appropriate where the conflicting claims are not identical, but at least one examined application claim is not patentably distinct from the reference claim(s) because the examined application claim is either anticipated by, or would have been obvious over, the reference claim(s). See, e.g., *In re Berg*, 140 F.3d 1428, 46 USPQ2d 1226 (Fed. Cir. 1998); *In re Goodman*, 11 F.3d 1046, 29 USPQ2d 2010 (Fed. Cir. 1993); *In re Longi*, 759 F.2d 887, 225 USPQ 645 (Fed. Cir. 1985); *In re Van Ornum*, 686 F.2d 937, 214 USPQ 761 (CCPA 1982); *In re Vogel*, 422 F.2d 438, 164 USPQ 619 (CCPA 1970); and *In re Thorington*, 418 F.2d 528, 163 USPQ 644 (CCPA 1969).

A timely filed terminal disclaimer in compliance with 37 CFR 1.321(c) or 1.321(d) may be used to overcome an actual or provisional rejection based on a nonstatutory double patenting ground provided the conflicting application or patent either is shown to be commonly owned with this application, or claims an invention made as a result of activities undertaken within the scope of a joint research agreement.

Effective January 1, 1994, a registered attorney or agent of record may sign a terminal disclaimer. A terminal disclaimer signed by the assignee must fully comply with 37 CFR 3.73(b).

2. Claims 1-20 are provisionally rejected on the ground of nonstatutory obviousness-type double patenting as being unpatentable over claims 1, 16, and 28 of copending Application No. 11/697833. Although the conflicting claims are not identical, they are not patentably distinct from each other because both applications disclose similar subject matter of an Internet radio broadcast apparatus enable the user to access an Internet radio site over a communication network.

This is a provisional obviousness-type double patenting rejection because the conflicting claims have not in fact been patented.

Claim Rejections - 35 USC § 102

3. The following is a quotation of the appropriate paragraphs of 35 U.S.C. 102 that form the basis for the rejections under this section made in this Office action:

A person shall be entitled to a patent unless –

(e) the invention was described in (1) an application for patent, published under section 122(b), by another filed in the United States before the invention by the applicant for patent or (2) a patent granted on an application for patent by another filed in the United States before the invention by the applicant for patent, except that an international application filed under the treaty defined in section 351(a) shall have the effects for purposes of this subsection of an application filed in the United States only if the international application designated the United States and was published under Article 21(2) of such treaty in the English language.

4. Claims 1-5, 7-9, 11-16, and 18-20 are rejected under 35 U.S.C. 102(e) as being anticipated by Mankovitz (US Pat No 5,949,492).

As per claims 1, 8, 12, and 19, Mankovitz discloses an electronic device comprising a network interface (see fig. 9/no. 707) enabling the electronic device to receive an Internet radio broadcast (fig. 64, col. 2/ln. 61-col. 3/ln. 57, col. 46/ln. 16-44); a system enabling playback of audio content from an additional content source and a control system associated with the network interface and the system enabling playback of audio content from the additional content source, and adapted to enable a user of the electronic device to select a desired mode of operation from a plurality of modes of operation comprising an Internet radio mode of operation and an additional content source mode of operation; receive and play the Internet radio broadcast when the desired mode of operation is the Internet radio mode of operation; and play the audio content from the additional content source when the desired mode of operation is the additional content source mode of operation (see fig. 8, fig. 9, col. 7/ln. 35-col. 4/ln. 19).

As per claims 7, 11, and 18, Mankovitz disclose the control system is further adapted to send a request to a remote server for supplemental information related to a song in real-time while the song is playing; receive the supplemental information from the remote server; and present the supplemental information to the user of the electronic device (see col. 2/ln. 61-col. 3/ln. 57).

As per claims 2-5, 9, 13-16, an 20, Mankovitz discloses the plurality of additional content sources comprises at least two of a group consisting of: broadcast radio (see col. 1/ln. 9-11), an optical disc (see col. 8/ln. 54-col. 9/ln. 35), a playlist (see col. 35/ln. 65-col. 36/ln. 21, col. 38/ln. 25-46), and a data storage device of the electronic device (see col. 8/ln. 54-col. 9/ln. 35).

Allowable Subject Matter

5. Claims 6, 10, and 17 are objected to as being dependent upon a rejected base claim, but would be allowable if rewritten in independent form including all of the limitations of the base claim and any intervening claims.

Conclusion

6. Any inquiry concerning this communication or earlier communications from the examiner should be directed to Pablo Tran whose telephone number is (571)272-7898. The examiner normal hours are 9:30 -5:00 (Monday-Friday). If attempts to reach the examiner by telephone are unsuccessful, the examiner's supervisor, Edward Urban, can be reached at (571)272-7899. The fax phone number for the organization where this application or proceeding is assigned is (571)273-8300.

7. Information regarding the status of an application may be obtained from the Patent Application Information Retrieval (PAIR) System. Status information for Published applications may be obtained from either Private PAIR or Public PAIR. Status information for unpublished applications is available through Private PAIR only. For more information about the PAIR system, see <http://pair-directauspto.gov>. Should You have questions on access to the Private PAIR system, contact the Electronic

Application/Control Number: 11/563,232

Page 6

Art Unit: 2618

Business Center (EBC) at 866-217-9197 (toll-free). If you would like assistance from a USPTO Customer Service Representative or access to the automated information system, call 800-786-9199 (in USA or CANADA) or 571-272-1000.

May 22, 2011

/P. T./

Primary Examiner, Art Unit 2618

Notice of References Cited	Application/Control No. 11/563,232	Applicant(s)/Patent Under Reexamination QURESHEY ET AL.	
	Examiner PABLO TRAN	Art Unit 2618	Page 1 of 1

U.S. PATENT DOCUMENTS

*	Document Number Country Code-Number-Kind Code	Date MM-YYYY	Name	Classification
*	A US-5,949,492	09-1999	Mankovitz, Roy J.	348/473
*	B US-2005/0044561	02-2005	McDonald, Russel	725/018
*	C US-2004/0255340	12-2004	Logan, James D.	725/145
*	D US-7,926,085	04-2011	Del Beccaro et al.	725/143
*	E US-7,917,932	03-2011	Krikorian, Jason G.	725/88
*	F US-7,917,645	03-2011	Ikezoye et al.	709/231
*	G US-7,856,485	12-2010	Prager et al.	709/219
	H US-			
	I US-			
	J US-			
	K US-			
	L US-			
	M US-			

FOREIGN PATENT DOCUMENTS

*	Document Number Country Code-Number-Kind Code	Date MM-YYYY	Country	Name	Classification
	N				
	O				
	P				
	Q				
	R				
	S				
	T				

NON-PATENT DOCUMENTS

*	Include as applicable: Author, Title Date, Publisher, Edition or Volume, Pertinent Pages)
U	
V	
W	
X	

*A copy of this reference is not being furnished with this Office action. (See MPEP § 707.05(a).)
Dates in MM-YYYY format are publication dates. Classifications may be US or foreign.

UNITED STATES PATENT AND TRADEMARK OFFICE

UNITED STATES DEPARTMENT OF COMMERCE
United States Patent and Trademark Office
 Address: COMMISSIONER FOR PATENTS
 P.O. Box 1450
 Alexandria, Virginia 22313-1450
 www.uspto.gov

BIB DATA SHEET
CONFIRMATION NO. 1583

SERIAL NUMBER	FILING or 371(c) DATE	CLASS	GROUP ART UNIT	ATTORNEY DOCKET NO.
11/563,232	11/27/2006	725	2618	1116-028C
APPLICANTS				
Safi Qureshey, Santa Ana, CA; Daniel D. Sheppard, Brea, CA;				
** CONTINUING DATA *****				
This application is a CON of 09/805,470 03/12/2001 ABN which is a CIP of 09/096,703 06/12/1998 ABN and claims benefit of 60/246,842 11/08/2000 and said 09/096,703 06/12/1998 claims benefit of 60/072,127 01/22/1998				
** FOREIGN APPLICATIONS *****				
** IF REQUIRED, FOREIGN FILING LICENSE GRANTED ** 01/05/2007				
Foreign Priority claimed <input type="checkbox"/> Yes <input checked="" type="checkbox"/> No		35 USC 119(a-d) conditions met <input type="checkbox"/> Yes <input checked="" type="checkbox"/> No		<input type="checkbox"/> Met after Allowance
Verified and Acknowledged	/PABLO N TRAN/ Examiner's Signature	Initials	STATE OR COUNTRY CA	SHEETS DRAWINGS 49
			TOTAL CLAIMS 20	INDEPENDENT CLAIMS 4
ADDRESS				
WITHROW & TERRANOVA CT 100 REGENCY FOREST DRIVE , SUITE 160 CARY, NC 27518 UNITED STATES				
TITLE				
NETWORK-ENABLED AUDIO DEVICE				
FILING FEE RECEIVED 1200	FEES: Authority has been given in Paper No. _____ to charge/credit DEPOSIT ACCOUNT No. _____ for following:			<input type="checkbox"/> All Fees
				<input type="checkbox"/> 1.16 Fees (Filing)
				<input type="checkbox"/> 1.17 Fees (Processing Ext. of time)
				<input type="checkbox"/> 1.18 Fees (Issue)
				<input type="checkbox"/> Other _____
				<input type="checkbox"/> Credit

EAST Search History

EAST Search History (Prior Art)

Ref #	Hits	Search Query	DBs	Default Operator	Plurals	Time Stamp
L6	86	"5949492"	US-PGPUB; USPAT; FPRS; EPO; JPO; DERWENT	OR	ON	2011/05/22 23:52
L7	86	L6	US-PGPUB; USPAT; FPRS; EPO; JPO; DERWENT	OR	ON	2011/05/22 23:52
L8	201	"6088455"	US-PGPUB; USPAT; FPRS; EPO; JPO; DERWENT	OR	ON	2011/05/22 23:52
L9	201	L8	US-PGPUB; USPAT; FPRS; EPO; JPO; DERWENT	OR	ON	2011/05/22 23:52
L10	286	L6 or L8	US-PGPUB; USPAT; FPRS; EPO; JPO; DERWENT	OR	ON	2011/05/22 23:52
L11	286	L10	US-PGPUB; USPAT; FPRS; EPO; JPO; DERWENT	OR	ON	2011/05/22 23:52
L12	191	L10 and radio and internet	US-PGPUB; USPAT; FPRS; EPO; JPO; DERWENT	OR	ON	2011/05/22 23:52
L13	191	L12	US-PGPUB; USPAT; FPRS; EPO; JPO; DERWENT	OR	ON	2011/05/22 23:52
L14	179	L12 and audio	US-PGPUB; USPAT; FPRS; EPO; JPO; DERWENT	OR	ON	2011/05/22 23:53
L15	179	L14	US-PGPUB; USPAT; FPRS; EPO; JPO; DERWENT	OR	ON	2011/05/22 23:53

L16	102	L14 and playback\$5	US-PGPUB; USPAT; FPRS; EPO; JPO; DERWENT	OR	ON	2011/05/22 23:53
L17	102	L16	US-PGPUB; USPAT; FPRS; EPO; JPO; DERWENT	OR	ON	2011/05/22 23:53
L18	102	L14 and (playback\$5 play?back\$5)	US-PGPUB; USPAT; FPRS; EPO; JPO; DERWENT	OR	ON	2011/05/22 23:53
L19	102	L18	US-PGPUB; USPAT; FPRS; EPO; JPO; DERWENT	OR	ON	2011/05/22 23:53
L20	106	L14 and (playback\$5 play?back\$5 (play adj back \$5))	US-PGPUB; USPAT; FPRS; EPO; JPO; DERWENT	OR	ON	2011/05/22 23:53
L21	106	L20	US-PGPUB; USPAT; FPRS; EPO; JPO; DERWENT	OR	ON	2011/05/22 23:53
L22	52	L20 and optical	US-PGPUB; USPAT; FPRS; EPO; JPO; DERWENT	OR	ON	2011/05/22 23:53
L23	52	L22	US-PGPUB; USPAT; FPRS; EPO; JPO; DERWENT	OR	ON	2011/05/22 23:53
L24	329122	"455"/ "3.02", "3.06".ccls.	US-PGPUB; USPAT; FPRS; EPO; JPO; DERWENT	OR	ON	2011/05/22 23:54

L25	1337050	"455"/ "142", "150.1", "151.1", "151.2", "154.1", "154.2", "158.1", "158.2", "158.4", "186.1", "344", "414.1", "414.3", "456.2", "556.1", "557". ccls.	US-PGPUB; USPAT; FPRS; EPO; JPO; DERWENT	OR	ON	2011/05/22 23:56
L26	4286631	24 or "35"	US-PGPUB; USPAT; FPRS; EPO; JPO; DERWENT	OR	ON	2011/05/22 23:56
L27	12998	26 and (broadcast near3 radio)	US-PGPUB; USPAT; FPRS; EPO; JPO; DERWENT	OR	ON	2011/05/22 23:56
L28	5066	26 and (internet near3 radio)	US-PGPUB; USPAT; FPRS; EPO; JPO; DERWENT	OR	ON	2011/05/22 23:56
L29	2972	28 and audio	US-PGPUB; USPAT; FPRS; EPO; JPO; DERWENT	OR	ON	2011/05/22 23:57
L30	1005	29 and (playback\$3 play?back\$3 (pay adj back \$3))	US-PGPUB; USPAT; FPRS; EPO; JPO; DERWENT	OR	ON	2011/05/22 23:58
L31	1055	29 and (playback\$3 play?back\$3 (play adj back \$3))	US-PGPUB; USPAT; FPRS; EPO; JPO; DERWENT	OR	ON	2011/05/22 23:58
L32	811	31 and list\$1	US-PGPUB; USPAT; FPRS; EPO; JPO; DERWENT	OR	ON	2011/05/22 23:58
L33	22	15 and 32	US-PGPUB; USPAT; FPRS; EPO; JPO; DERWENT	OR	ON	2011/05/22 23:59

5/ 22/ 11 11:59:39 PM

C:\ Documents and Settings\ ptran4\ My Documents\ EAST\ Workspaces\ 11999482.wsp

INFORMATION DISCLOSURE STATEMENT BY APPLICANT (Not for submission under 37 CFR 1.99)	Application Number	11563232
	Filing Date	2006-11-27
	First Named Inventor	Safi Qureshey et al.
	Art Unit	2618
	Examiner Name	Pablo N. Tran
	Attorney Docket Number	1116-028C

U.S. PATENTS							Remove
Examiner Initial*	Cite No	Patent Number	Kind Code ¹	Issue Date	Name of Patentee or Applicant of cited Document	Pages, Columns, Lines where Relevant Passages or Relevant Figures Appear	
	1	6662231	B1	2003-12-09	Drosset et al.		
	2	6741869	B1	2004-05-25	Lehr		
	3	6711622	B1	2004-03-23	Fuller et al.		
	4	7870088	B1	2011-01-11	Chen et al.		
	5	7856485	B2	2010-12-21	Prager et al.		
	6	7840691	B1	2010-11-23	De Bonet et al.		
	7	7797321	B2	2010-09-14	Martin et al.		
	8	7797272	B2	2010-09-14	Picker et al.		

ALL REFERENCES CONSIDERED EXCEPT WHERE LINED THROUGH. /PT/

INFORMATION DISCLOSURE STATEMENT BY APPLICANT (Not for submission under 37 CFR 1.99)	Application Number	11563232
	Filing Date	2006-11-27
	First Named Inventor	Safi Qureshey et al.
	Art Unit	2618
	Examiner Name	Pablo N. Tran
	Attorney Docket Number	1116-028C

9	7783722	B1	2010-08-24	Rosenberg et al.	
10	7711838	B1	2010-05-04	Boulter et al.	
11	7469283	B2	2008-12-23	Eyal et al.	
12	7139770	B2	2006-11-21	Nakase et al.	

If you wish to add additional U.S. Patent citation information please click the Add button.

U.S.PATENT APPLICATION PUBLICATIONS

Examiner Initial*	Cite No	Publication Number	Kind Code ¹	Publication Date	Name of Patentee or Applicant of cited Document	Pages, Columns, Lines where Relevant Passages or Relevant Figures Appear
	1	20090070267	A9	2009-03-12	Hangartner	
	2	20070283268	A1	2007-12-06	Berger et al.	

If you wish to add additional U.S. Published Application citation information please click the Add button.

FOREIGN PATENT DOCUMENTS

Examiner Initial*	Cite No	Foreign Document Number ³	Country Code ² j	Kind Code ⁴	Publication Date	Name of Patentee or Applicant of cited Document	Pages, Columns, Lines where Relevant Passages or Relevant Figures Appear	T ⁵
	1							<input type="checkbox"/>

If you wish to add additional Foreign Patent Document citation information please click the Add button

NON-PATENT LITERATURE DOCUMENTS

EFS Web 2.1.17
ALL REFERENCES CONSIDERED EXCEPT WHERE LINED THROUGH. /PT/

INFORMATION DISCLOSURE STATEMENT BY APPLICANT (Not for submission under 37 CFR 1.99)	Application Number	11563232
	Filing Date	2006-11-27
	First Named Inventor	Safi Qureshey et al.
	Art Unit	2618
	Examiner Name	Pablo N. Tran
	Attorney Docket Number	1116-028C

Examiner Initials*	Cite No	Include name of the author (in CAPITAL LETTERS), title of the article (when appropriate), title of the item (book, magazine, journal, serial, symposium, catalog, etc), date, pages(s), volume-issue number(s), publisher, city and/or country where published.	T ⁵
	1		<input type="checkbox"/>

If you wish to add additional non-patent literature document citation information please click the Add button

EXAMINER SIGNATURE

Examiner Signature	/PT/	Date Considered	05/22/2011
--------------------	------	-----------------	------------

*EXAMINER: Initial if reference considered, whether or not citation is in conformance with MPEP 609. Draw line through a citation if not in conformance and not considered. Include copy of this form with next communication to applicant.

¹ See Kind Codes of USPTO Patent Documents at www.USPTO.GOV or MPEP 901.04. ² Enter office that issued the document, by the two-letter code (WIPO Standard ST.3). ³ For Japanese patent documents, the indication of the year of the reign of the Emperor must precede the serial number of the patent document. ⁴ Kind of document by the appropriate symbols as indicated on the document under WIPO Standard ST.16 if possible. ⁵ Applicant is to place a check mark here if English language translation is attached.

ALL REFERENCES CONSIDERED EXCEPT WHERE LINED THROUGH. /PT/

Under the Paperwork Reduction Act of 1995, no persons are required to respond to a collection of information unless it contains a valid OMB control number.

INFORMATION DISCLOSURE STATEMENT BY APPLICANT (Not for submission under 37 CFR 1.99)	Application Number	11563232
	Filing Date	2006-11-27
	First Named Inventor	Safi Qureshey et al.
	Art Unit	2623
	Examiner Name	TBA
	Attorney Docket Number	1116-028C

U.S. PATENTS							Remove
Examiner Initial*	Cite No	Patent Number	Kind Code ¹	Issue Date	Name of Patentee or Applicant of cited Document	Pages, Columns, Lines where Relevant Passages or Relevant Figures Appear	
	1	5191573		1993-03-02	Hair		
	2	5440336		1995-08-08	Buhro et al.		
	3	5583763		1996-12-10	Atcheson et al.		
	4	5594779		1997-01-14	Goodman		
	5	5727048		1998-03-10	Hiroshima et al.		
	6	5914941		1999-06-22	Janky		
	7	5930765		1999-07-27	Martin		
	8	5949877		1999-09-07	Traw et al.		

ALL REFERENCES CONSIDERED EXCEPT WHERE LINED THROUGH. /PT/

EFS Web 2.0

INFORMATION DISCLOSURE STATEMENT BY APPLICANT (Not for submission under 37 CFR 1.99)	Application Number	11563232
	Filing Date	2006-11-27
	First Named Inventor	Safi Qureshey et al.
	Art Unit	2623
	Examiner Name	TBA
	Attorney Docket Number	1116-028C

9	5991737		1999-11-23	Chen	
10	6233430	B1	2001-05-15	Helferich	
11	6233682	B1	2001-05-15	Fritsch	
12	6505160	B1	2003-01-07	Levy et al.	
13	6721403	B1	2004-04-13	Mandalia	
14	6782253	B1	2004-08-24	Shteyn et al.	
15	6829475	B1	2004-12-07	Lee et al.	

If you wish to add additional U.S. Patent citation information please click the Add button.

Add

U.S.PATENT APPLICATION PUBLICATIONS

Remove

Examiner Initial*	Cite No	Publication Number	Kind Code ¹	Publication Date	Name of Patentee or Applicant of cited Document	Pages, Columns, Lines where Relevant Passages or Relevant Figures Appear
	1	20020049037	A1	2002-04-25	Christensen et al.	

If you wish to add additional U.S. Published Application citation information please click the Add button.

Add

FOREIGN PATENT DOCUMENTS

Remove

ALL REFERENCES CONSIDERED EXCEPT WHERE LINED THROUGH. /PT/

EFS Web 2.0

INFORMATION DISCLOSURE STATEMENT BY APPLICANT (Not for submission under 37 CFR 1.99)	Application Number	11563232
	Filing Date	2006-11-27
	First Named Inventor	Safi Qureshey et al.
	Art Unit	2623
	Examiner Name	TBA
	Attorney Docket Number	1116-028C

Examiner Initial*	Cite No	Foreign Document Number ³	Country Code ² j	Kind Code ⁴	Publication Date	Name of Patentee or Applicant of cited Document	Pages,Columns,Lines where Relevant Passages or Relevant Figures Appear	T ⁵
	1							<input type="checkbox"/>

If you wish to add additional Foreign Patent Document citation information please click the Add button

NON-PATENT LITERATURE DOCUMENTS

Examiner Initials*	Cite No	Include name of the author (in CAPITAL LETTERS), title of the article (when appropriate), title of the item (book, magazine, journal, serial, symposium, catalog, etc), date, pages(s), volume-issue number(s), publisher, city and/or country where published.	T ⁵
	1		<input type="checkbox"/>

If you wish to add additional non-patent literature document citation information please click the Add button

EXAMINER SIGNATURE

Examiner Signature	/PT/	Date Considered	05/22/2011
--------------------	------	-----------------	------------

*EXAMINER: Initial if reference considered, whether or not citation is in conformance with MPEP 609. Draw line through a citation if not in conformance and not considered. Include copy of this form with next communication to applicant.

¹ See Kind Codes of USPTO Patent Documents at www.USPTO.GOV or MPEP 901.04. ² Enter office that issued the document, by the two-letter code (WIPO Standard ST.3). ³ For Japanese patent documents, the indication of the year of the reign of the Emperor must precede the serial number of the patent document. ⁴ Kind of document by the appropriate symbols as indicated on the document under WIPO Standard ST.16 if possible. ⁵ Applicant is to place a check mark here if English language translation is attached.

ALL REFERENCES CONSIDERED EXCEPT WHERE LINED THROUGH. /PT/

Search Notes 	Application/Control No. 11563232	Applicant(s)/Patent Under Reexamination QURESHEY ET AL.
	Examiner PABLO TRAN	Art Unit 2618

SEARCHED

Class	Subclass	Date	Examiner
455	3.02, 3.06, 142, 150.1, 151.1, 151.2, 154.1, 154.2, 158.1, 158.2, 158.4, 186.1, 344, 414.1, 414.3, 456.2, 556.1, 557	5/22/11	PT
709	217, 219	5/22/11	PT
725	39, 45, 18	5/22/11	PT

SEARCH NOTES

Search Notes	Date	Examiner
East (us-pgpub, uspat, fprs, epo, jpo, derwent), WIPO	5/22/11	PT

INTERFERENCE SEARCH

Class	Subclass	Date	Examiner
	Interference texts searches	5/22/11	PT

	/P.T./ Primary Examiner.Art Unit 2618
--	------------------------------------------

INFORMATION DISCLOSURE STATEMENT BY APPLICANT (Not for submission under 37 CFR 1.99)	Application Number		11563232	
	Filing Date		2006-11-27	
	First Named Inventor	Safi Qureshey et al.		
	Art Unit	2618		
	Examiner Name	Pablo N. Tran		
	Attorney Docket Number	1116-028C		

U.S. PATENTS						Remove
Examiner Initial*	Cite No	Patent Number	Kind Code ¹	Issue Date	Name of Patentee or Applicant of cited Document	Pages, Columns, Lines where Relevant Passages or Relevant Figures Appear
	1	6507727	B1	2003-01-14	Henrick	
	2	6587127	B1	2003-07-01	Leeke et al.	
	3	6657116	B1	2003-12-02	Gunnerson	
	4	6192340	B1	2001-02-20	Abecassis	
	5	6248946	B1	2001-06-19	Dwek	
	6	7028082	B1	2006-04-11	Rosenberg et al.	
	7	6933433	B1	2005-08-23	Porteus et al.	
	8	7277955	B2	2007-10-02	Elliott	

INFORMATION DISCLOSURE STATEMENT BY APPLICANT (Not for submission under 37 CFR 1.99)	Application Number		11563232	
	Filing Date		2006-11-27	
	First Named Inventor	Safi Qureshey et al.		
	Art Unit	2618		
	Examiner Name	Pablo N. Tran		
	Attorney Docket Number	1116-028C		

	9	7187947	B1	2007-03-06	White et al.	
	10	6064379		2000-05-16	DeMoney	
	11	7472353	B1	2008-12-30	Wolff et al.	
	12	6982780	B2	2006-01-03	Morley et al.	
	13	7468934	B1	2008-12-23	Janik	
	14	7525289	B2	2009-04-28	Janik et al.	
	15	7652844	B2	2010-01-26	Edwards et al.	
	16	7660601	B2	2010-02-09	Janik et al.	
	17	7768234	B2	2010-08-03	Janik et al.	
	18	7786705	B2	2010-08-31	Janik et al.	
	19	7904579	B2	2011-03-08	Janik et al.	

INFORMATION DISCLOSURE STATEMENT BY APPLICANT (Not for submission under 37 CFR 1.99)	Application Number		11563232	
	Filing Date		2006-11-27	
	First Named Inventor	Safi Qureshey et al.		
	Art Unit		2618	
	Examiner Name	Pablo N. Tran		
	Attorney Docket Number		1116-028C	

	20	7920824	B2	2011-04-05	Janik et al.	
	21	5262875		1993-11-16	Mincer et al.	
	22	5440334		1995-08-08	Walters et al.	
	23	5710970		1998-01-20	Walters et al.	
	24	6389467	B1	2002-05-14	Eyal	
	25	6484199	B2	2002-11-19	Eyal	
	26	6519648	B1	2003-02-11	Eyal	
	27	6721741	B1	2004-04-13	Eyal et al.	
	28	6735628	B2	2004-05-11	Eyal	
	29	7010537	B2	2006-03-07	Eyal et al.	
	30	6725275	B2	2004-04-20	Eyal	

INFORMATION DISCLOSURE STATEMENT BY APPLICANT (Not for submission under 37 CFR 1.99)	Application Number	11563232
	Filing Date	2006-11-27
	First Named Inventor	Safi Qureshey et al.
	Art Unit	2618
	Examiner Name	Pablo N. Tran
	Attorney Docket Number	1116-028C

If you wish to add additional U.S. Patent citation information please click the Add button.						Add
U.S.PATENT APPLICATION PUBLICATIONS						Remove
Examiner Initial*	Cite No	Publication Number	Kind Code ¹	Publication Date	Name of Patentee or Applicant of cited Document	Pages, Columns, Lines where Relevant Passages or Relevant Figures Appear
	1	20020194260	A1	2002-12-19	Headley et al.	
	2	20030018799	A1	2003-01-23	Eyal	
	3	20020013852	A1	2002-01-31	Janik	
	4	20020138630	A1	2002-09-26	Solomon et al.	
	5	20030060157	A1	2003-03-27	Henrick	
	6	20020161858	A1	2002-10-31	Goldman	
	7	20030033420	A1	2003-02-13	Eyal et al.	
	8	20020023084	A1	2002-02-21	Eyal et al.	
	9	20020116476	A1	2002-08-22	Eyal et al.	
If you wish to add additional U.S. Published Application citation information please click the Add button.						Add

INFORMATION DISCLOSURE STATEMENT BY APPLICANT (Not for submission under 37 CFR 1.99)	Application Number		11563232	
	Filing Date		2006-11-27	
	First Named Inventor	Safi Qureshey et al.		
	Art Unit	2618		
	Examiner Name	Pablo N. Tran		
	Attorney Docket Number	1116-028C		

FOREIGN PATENT DOCUMENTS							Remove	
Examiner Initial*	Cite No	Foreign Document Number ³	Country Code ² j	Kind Code ⁴	Publication Date	Name of Patentee or Applicant of cited Document	Pages, Columns, Lines where Relevant Passages or Relevant Figures Appear	T ⁵
	1	0984584	EP	A1	2000-03-08	America Online, Inc.		<input type="checkbox"/>

If you wish to add additional Foreign Patent Document citation information please click the Add button **Add**

NON-PATENT LITERATURE DOCUMENTS				Remove
Examiner Initials*	Cite No	Include name of the author (in CAPITAL LETTERS), title of the article (when appropriate), title of the item (book, magazine, journal, serial, symposium, catalog, etc), date, pages(s), volume-issue number(s), publisher, city and/or country where published.		T ⁵
	1	KEVIN C. ALMEROETH ET AL., "An Alternative Paradigm for Scalable On-Demand Applications: Evaluating and Deploying the Interactive Multimedia Jukebox," IEEE Transactions on Knowledge and Data Engineering, Vol. 11, No. 4, July/August 1999, pages 658-672, copyright 1999 IEEE, 15 pages.		<input type="checkbox"/>

If you wish to add additional non-patent literature document citation information please click the Add button **Add**

EXAMINER SIGNATURE	
Examiner Signature	Date Considered

*EXAMINER: Initial if reference considered, whether or not citation is in conformance with MPEP 609. Draw line through a citation if not in conformance and not considered. Include copy of this form with next communication to applicant.

¹ See Kind Codes of USPTO Patent Documents at www.USPTO.GOV or MPEP 901.04. ² Enter office that issued the document, by the two-letter code (WIPO Standard ST.3). ³ For Japanese patent documents, the indication of the year of the reign of the Emperor must precede the serial number of the patent document. ⁴ Kind of document by the appropriate symbols as indicated on the document under WIPO Standard ST.16 if possible. ⁵ Applicant is to place a check mark here if English language translation is attached.

INFORMATION DISCLOSURE STATEMENT BY APPLICANT (Not for submission under 37 CFR 1.99)	Application Number	11563232
	Filing Date	2006-11-27
	First Named Inventor	Safi Qureshey et al.
	Art Unit	2618
	Examiner Name	Pablo N. Tran
	Attorney Docket Number	1116-028C

CERTIFICATION STATEMENT

Please see 37 CFR 1.97 and 1.98 to make the appropriate selection(s):

That each item of information contained in the information disclosure statement was first cited in any communication from a foreign patent office in a counterpart foreign application not more than three months prior to the filing of the information disclosure statement. See 37 CFR 1.97(e)(1).

OR

That no item of information contained in the information disclosure statement was cited in a communication from a foreign patent office in a counterpart foreign application, and, to the knowledge of the person signing the certification after making reasonable inquiry, no item of information contained in the information disclosure statement was known to any individual designated in 37 CFR 1.56(c) more than three months prior to the filing of the information disclosure statement. See 37 CFR 1.97(e)(2).

See attached certification statement.

The fee set forth in 37 CFR 1.17 (p) has been submitted herewith.

A certification statement is not submitted herewith.

SIGNATURE

A signature of the applicant or representative is required in accordance with CFR 1.33, 10.18. Please see CFR 1.4(d) for the form of the signature.

Signature	/R. Chad Bevins/	Date (YYYY-MM-DD)	2011-08-17
Name/Print	R. Chad Bevins	Registration Number	51468

This collection of information is required by 37 CFR 1.97 and 1.98. The information is required to obtain or retain a benefit by the public which is to file (and by the USPTO to process) an application. Confidentiality is governed by 35 U.S.C. 122 and 37 CFR 1.14. This collection is estimated to take 1 hour to complete, including gathering, preparing and submitting the completed application form to the USPTO. Time will vary depending upon the individual case. Any comments on the amount of time you require to complete this form and/or suggestions for reducing this burden, should be sent to the Chief Information Officer, U.S. Patent and Trademark Office, U.S. Department of Commerce, P.O. Box 1450, Alexandria, VA 22313-1450. **DO NOT SEND FEES OR COMPLETED FORMS TO THIS ADDRESS. SEND TO: Commissioner for Patents, P.O. Box 1450, Alexandria, VA 22313-1450.**

Privacy Act Statement

The Privacy Act of 1974 (P.L. 93-579) requires that you be given certain information in connection with your submission of the attached form related to a patent application or patent. Accordingly, pursuant to the requirements of the Act, please be advised that: (1) the general authority for the collection of this information is 35 U.S.C. 2(b)(2); (2) furnishing of the information solicited is voluntary; and (3) the principal purpose for which the information is used by the U.S. Patent and Trademark Office is to process and/or examine your submission related to a patent application or patent. If you do not furnish the requested information, the U.S. Patent and Trademark Office may not be able to process and/or examine your submission, which may result in termination of proceedings or abandonment of the application or expiration of the patent.

The information provided by you in this form will be subject to the following routine uses:

1. The information on this form will be treated confidentially to the extent allowed under the Freedom of Information Act (5 U.S.C. 552) and the Privacy Act (5 U.S.C. 552a). Records from this system of records may be disclosed to the Department of Justice to determine whether the Freedom of Information Act requires disclosure of these records.
2. A record from this system of records may be disclosed, as a routine use, in the course of presenting evidence to a court, magistrate, or administrative tribunal, including disclosures to opposing counsel in the course of settlement negotiations.
3. A record in this system of records may be disclosed, as a routine use, to a Member of Congress submitting a request involving an individual, to whom the record pertains, when the individual has requested assistance from the Member with respect to the subject matter of the record.
4. A record in this system of records may be disclosed, as a routine use, to a contractor of the Agency having need for the information in order to perform a contract. Recipients of information shall be required to comply with the requirements of the Privacy Act of 1974, as amended, pursuant to 5 U.S.C. 552a(m).
5. A record related to an International Application filed under the Patent Cooperation Treaty in this system of records may be disclosed, as a routine use, to the International Bureau of the World Intellectual Property Organization, pursuant to the Patent Cooperation Treaty.
6. A record in this system of records may be disclosed, as a routine use, to another federal agency for purposes of National Security review (35 U.S.C. 181) and for review pursuant to the Atomic Energy Act (42 U.S.C. 218(c)).
7. A record from this system of records may be disclosed, as a routine use, to the Administrator, General Services, or his/her designee, during an inspection of records conducted by GSA as part of that agency's responsibility to recommend improvements in records management practices and programs, under authority of 44 U.S.C. 2904 and 2906. Such disclosure shall be made in accordance with the GSA regulations governing inspection of records for this purpose, and any other relevant (i.e., GSA or Commerce) directive. Such disclosure shall not be used to make determinations about individuals.
8. A record from this system of records may be disclosed, as a routine use, to the public after either publication of the application pursuant to 35 U.S.C. 122(b) or issuance of a patent pursuant to 35 U.S.C. 151. Further, a record may be disclosed, subject to the limitations of 37 CFR 1.14, as a routine use, to the public if the record was filed in an application which became abandoned or in which the proceedings were terminated and which application is referenced by either a published application, an application open to public inspections or an issued patent.
9. A record from this system of records may be disclosed, as a routine use, to a Federal, State, or local law enforcement agency, if the USPTO becomes aware of a violation or potential violation of law or regulation.

(12) **EUROPEAN PATENT APPLICATION**

(43) Date of publication:
08.03.2000 Bulletin 2000/10

(51) Int Cl.7: **H04L 12/18, H04L 29/06**

(21) Application number: **99306950.9**

(22) Date of filing: **01.09.1999**

(84) Designated Contracting States:
AT BE CH CY DE DK ES FI FR GB GR IE IT LI LU
MC NL PT SE
 Designated Extension States:
AL LT LV MK RO SI

- **Enete, Noel**
Seal Beach, California 90740 (US)
- **Watson, Richard**
Austin, Texas 78751 (US)
- **Pai, Ashok**
Irvine, California 92612 (US)
- **Lippke, David**
Herndon, Virginia 20170 (US)

(30) Priority: **04.09.1998 US 148244**
18.03.1999 US 272673

(71) Applicant: **America Online, Inc.**
Dulles, VA 20166 (US)

(74) Representative: **Charig, Raymond Julian**
Eric Potter Clarkson,
Park View House,
58 The Ropewalk
Nottingham NG1 5DD (GB)

(72) Inventors:
 • **Lippert, Patrick**
Mission Viejo, California 92691 (US)

(54) **Internet multimedia broadcast system**

(57) A method and system for playback of live and pre-recorded multimedia data in real-time over a large scale communication network, such as the world-wide web. The invention allows a user connected to a specialized network to play back a multimedia broadcast. The invention includes a process that allows multimedia content to be created and scheduled as a playlist. The playlist data is compressed and transmitted to a host system as part of a capture protocol. The captured playlist data may then be "broadcast" to users. A user may choose a channel selection from a playlist, and cause the selected item to be downloaded and played back by means of a playback tool. The host system includes a

highly efficient distribution system that allows a large number of users accessing the host through Terminal Information Handlers to rapidly access one or more channels of multimedia data. The system architecture provides a "fan out" mechanism that includes a master broadcast process that accepts a multi-stream data flow and then distributes the multi-stream data flow to essentially every Terminal Information Handler accessible to the host. The load of providing data streams is thus spread among a large number of Terminal Information Handlers, reducing access latency and providing support for hundreds of thousands of users over a large scale communication network.

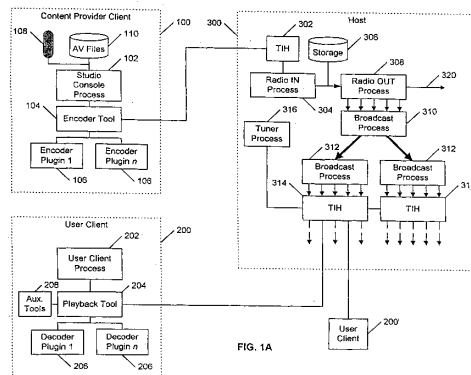

FIG. 1A

EP 0 984 584 A1

Description**TECHNICAL FIELD**

[0001] This invention relates to a method and system for playback of live and pre-recorded multimedia data in real-time over a large scale communication network, such as the world-wide web.

BACKGROUND

[0002] The world wide web, or Internet, is a large scale communication network that has become increasingly popular with users for accessing data from a huge variety of sources. Currently, a large percentage of users access the Internet through modems, typically having a data rate between about 33.6 Kbps and 14.4 Kbps. For data such as text or simple graphics, such speeds are adequate to enable a "web browsing" experience that most users find enjoyable. These data rates are also acceptable for transmittal and playback of multimedia data (*e.g.*, audio, video, still images, text, hyperlinks, *etc.*) in real-time if the data is highly compressed. Accordingly, a number of schemes have been implemented for allowing users to access and download compressed multimedia data streams for local decompression and playback.

[0003] One such approach for real-time multimedia data playback utilizes the Internet multicast protocol. Multicasting includes transmitting a communication from one site to a group of selected receivers (multicasting differs from broadcasting in that a broadcast is sent to everyone who has the equipment or connection to receive it). Under this scheme, a user initiates an action (*e.g.*, selection of a uniform resource locator - URL - address) that requests that a multimedia data stream be transmitted from a server to the user's client system, for decompression and playback by a software process executing on the client. The request causes the router to which the user is coupled to access special multicast Internet addresses. The requested data is then supplied to the user (or "subscriber") by means of a multicasting backbone (MBone), which is a network of special Internet sites that supports Internet Protocol multicasting for a limited number of users. MBone provides a faster technology than the Internet for transmitting real-time audio and video programs.

[0004] A disadvantage of Internet multicasting is that a multicast event (*e.g.*, a live radio show) can only effectively support several hundreds to a few thousands of users with uninterrupted data streams. Due to bandwidth constraints and the lack of guaranteed quality of service for the Internet, adding more users may cause objectionable pauses in content (*e.g.*, pauses in multimedia playback). Thus, for some events, Internet multicasting cannot meet user demand.

[0005] Accordingly, there is a need for an architecture that can provide for playback of live and pre-recorded

multimedia data in real-time over a large scale communication network, such as the world-wide web, for a large number of users, typically in the hundreds of thousands of users. The present invention provides a method and system for such an architecture.

SUMMARY

[0006] The preferred embodiment of the invention allows a user connected to a specialized network having a "Multimedia Broadcast" feature to play back a multimedia broadcast. One aspect of the invention includes a Studio Console Process executing on a content provider client system that allows multimedia content to be created and scheduled as a "playlist". The data comprising a playlist may be pre-recorded or live. The playlist data is compressed under the control of the Studio Console Process and transmitted to a host system as part of a "capture" protocol controlled by a "radio IN" process. The captured playlist data may then be "broadcast" to users who "tune in" to a "live multimedia show", or stored for later broadcast. (In this context, "broadcast" simply means transmittal of a data stream to a user who selects content to be played back on the user's client system).

[0007] A user may choose a "channel" selection from a playlist, and cause the selected item to be downloaded and played back by means of a "playback tool". The data stream corresponding to the selected item optionally may include embedded non-audio content, such as hypertext links to other forms, URLs to web pages, static images, video images, *etc.*

[0008] The host system includes a highly efficient distribution system that allows a large number of users accessing the host through Terminal Information Handlers to rapidly access one or more channels of audio data augmented by non-audio multimedia data. In particular, the inventive system architecture provides a "fan out" mechanism that includes a master broadcast process that accepts a multi-stream data flow from a "radio OUT" process and then distributes the multi-stream data flow to essentially every Terminal Information Handler accessible to the host. The load of providing data streams is thus spread among a large number of Terminal Information Handlers, reducing access latency to typically less than about 3 seconds, and providing support for hundreds of thousands of users over a large scale communication network such as the world-wide web.

[0009] In particular, in one aspect the invention includes a system for playback of live and pre-recorded multimedia data in real-time over a large scale communication network, including a computer system having a plurality of terminal information handlers for managing general information flow to and from a plurality of users; an output process for assembling multiple multimedia data streams for distribution; at least one broadcast process, in communication with the output process, for distributing the assembled multiple multimedia data

streams to each of the terminal information handlers; and a selector process, in communication with the terminal information handlers, for receiving a channel request from a user through an terminal information handler associated with the user, mapping the channel request to a corresponding one of the multiple multimedia data streams, and enabling transmission of the corresponding one multimedia data stream to the user through the associated terminal information handler. In another aspect, the invention includes a corresponding method.

[0010] The details of one or more embodiments of the invention are set forth in the accompanying drawings and the description below. Other features, objects, and advantages of the invention will be apparent from the description and drawings, and from the claims.

DESCRIPTION OF DRAWINGS

[0011] FIG. 1A is block diagram of the preferred embodiment of the invention.

[0012] FIG. 1B is block diagram of a portion of an alternative embodiment of the invention.

[0013] FIG. 2 is a "screen shot" of one embodiment of a graphical user interface (GUI) for defining a data stream within a studio console process in accordance with the invention.

[0014] FIG. 3 is a "screen shot" of one embodiment of a GUI for defining a playlist schedule within a studio console process in accordance with the invention.

[0015] FIG. 4 is a "screen shot" of one embodiment of a GUI for displaying playback information and allowing selection of a playback channel within a user client process in accordance with the invention.

[0016] FIG. 5A is a block diagram showing the client-host architecture for a capture session.

[0017] FIG. 5B is a data flow diagram showing the data flow for establishing a capture session.

[0018] FIG. 5C is a data flow diagram showing the data flow for recording during a capture session.

[0019] FIG. 5D is a data flow diagram showing the data flow for ending a capture session.

[0020] FIG. 6A is a data flow diagram showing the data flow architecture for playback of a multimedia data stream.

[0021] FIG. 6B is a data flow diagram showing the data flow for starting a playback session.

[0022] FIG. 6C is a data flow diagram showing the data flow for switching a playback channel.

[0023] FIG. 6D is a data flow diagram showing the data flow for ending a playback session.

[0024] Like reference numbers and designations in the various drawings indicate like elements.

DETAILED DESCRIPTION

Overview

[0025] The preferred embodiment of the invention allows a user connected to a specialized network having a "Radio" feature (*e.g.*, the America Online network) to play back an audio broadcast that may be augmented with non-audio multimedia data, such as video and still images, URLs, text fields, *etc.* One aspect of the invention includes a Studio Console Process executing on a content provider client system that allows such content to be created and scheduled.

[0026] For example, the Studio Console Process enables a content provider to schedule a week's worth of prerecorded content that changes daily. The content provider uses a form in the Studio Console Process to assemble a "playlist" for each day. If the content provider then needs to conduct a live event on the Radio system, the content provider uses the Studio Console Process to override any existing playlist. When the live event is completed, the playlist resumes as originally scheduled.

[0027] The data comprising a playlist may be pre-recorded or live. The playlist data is compressed under the control of the Studio Console Process and transmitted to a host system as part of a "capture" process. The captured playlist data may then be "broadcast" to users who "tune in" to a "live multimedia show", or stored for later broadcast. (In this context, "broadcast" simply means transmittal of a data stream to a user who selects content to be played back on the user's client system).

[0028] A user may initiate a form that displays available playlists for one or more "channels" of a host system, choose a selection from a playlist, and cause the selected item to be downloaded and played back by means of a "playback tool". The data stream corresponding to the selected item optionally may include embedded non-audio content, such as hypertext links to other forms, URLs to web pages, static images, or video images.

[0029] The host system includes a highly efficient distribution system that allows a large number of users to rapidly access one or more channels of audio data augmented by non-audio data. The latency of access - the time between a request for playback of a particular channel and commencement of playback on a user client - is typically less than about 3 seconds, compared to tens of seconds for many prior art systems.

System Architecture - Content Provider Client

[0030] FIG. 1A is block diagram of the preferred embodiment of the invention. Content to be broadcast is typically developed by a content provider utilizing a content provider client 100. A Studio Console Process 102 executes on the content provider client 100. The Studio Console Process 102 allows a content provider to define ("author") a play list data stream to be uploaded to a

host 300 during a "capture" session for "broadcast" to users selecting the channel assigned to the playlist. (Details of a capture session are described below.) The playlist data stream includes audio content and may include images or other data which may be inserted into the data stream as the data is being compressed. In the preferred embodiment, the Studio Console Process 102 communicates with a separate encoder tool 104 that responds to and carries out the directions of the content provider input by means of the Studio Console Process 102. In particular, the encoder tool 104 selects one of a plurality of encoder "plugins" 106 to perform necessary data compression of the multimedia content of the data stream. The encoder tool 104 also packages the compressed multimedia content into packets for transmission to the host 300. In the preferred embodiment, audio data is given priority over non-audio data to reduce the likelihood of any objectionable interruption in audio playback. In general, other types of data may be appended to audio packets as long as the total transmission packet (e.g., an Internet protocol packet) does not exceed a target bit rate (e.g., 10 Kbps).

[0031] Audio content may come from "live" sources to the content provider client 100, such as an input to a computer sound card from a microphone 108 or "line-in" source (e.g., an analog or digital audio playback device such as an audio tape or CD player), or a direct input to the computer from a direct digital connection (e.g., CDROM player). Alternatively, audio content may come from pre-recorded ("canned") sound files, such as WAV and ART files, located on storage media 110 accessible to the content provider client 100.

[0032] Similarly, images (still or video) may come from "live" sources to the content provider client 100, such as video cameras. Still images can be from standard file formats, including ART, BMP, GIF or JPG (JPEG) formats. In the preferred embodiment, all such formats are re-compressed into a single format (ART) for the broadcast data stream.

[0033] One aspect of the invention is that a content provider may change an encoder plugin 106 "on-the-fly" to accommodate different content inputs as such inputs change. For example, an encoder plugin 106 particularly well-suited for speech may be used for a time (for example, while a conductor is explaining a music piece about to be played), and then an encoder plugin 106 particularly well-suited for music may be switched in when the source material changes (for example, when the music piece is being played).

[0034] FIG. 2 is a "screen shot" of one embodiment of a graphical user interface (GUI) for defining a data stream within the Studio Console Process 102. The preferred content definition GUI for the Studio Console Process 102 includes controls that allow the content provider to do at least the following in "authoring" a playlist entry:

- Select an audio source 150 ("live" or "canned") for

a data stream.

- Define an audio target 152 for the data stream (e.g., a file name for storage on the content provider client 100 or on the host 300 for later broadcast, or a channel name for a live broadcast).
- Select an encoder 154 for compressing the audio source data stream. The list of available encoders allows selection of varying degrees of compression, depending on the desired final sound quality and the nature of the audio source material (e.g., speech generally can be compressed more than music). Examples of such encoders include those available from Voxware, Inc. of Princeton, NJ. For example, the Voxware VR12 Speech Codec requires a bit rate of only 1.5 Kbps for speech, while a music codec may require as much as 10 Kbps.
- Define a "stream name" 156, which is a name for the data stream that is delivered to a user's playback tool whenever playback is started for a particular virtual channel.
- Define a "stream description" 158 that provides a detailed description of the data stream that can be delivered to a user's playback tool on demand. For example, the description may contain rich-text - HTML formatted text that may contain font and color information tags.
- Define "caption text" 160, which is simple text that can appear within the data stream. In the preferred embodiment, when a playback tool receives a complete caption string, the caption string is forwarded to an auxiliary tool for display in a text field on a form, if the field exists. The caption text may be used for closed captioning or for other "headline" updates, and is preferably in "rich text format" (RTF). The caption text may also include hyperlinks.
- Select image data 162 that can be delivered appended to and interleaved with the audio data. The image data is inserted in the data stream wherever available space is found after the audio packets (a target bit rate for the data stream is set at authoring time) to expedite transfer to the client. When data is received at the playback tool, it is forwarded to an auxiliary tool for rendering. The original image data may be in any of a variety of formats, such as the well-known ART, BMP, GIF or JPG (JPEG) image formats, but is preferably transformed into a single multimedia ART format for broadcast. A number of images may be linked to form a "slide show". To save space in the data stream itself, a global ID reference to an image or video data may be delivered instead of an image itself. The global ID is passed by the user's playback tool to an aux-

iliary tool for rendering. This approach is useful if the referenced data resides on the client's system (*i.e.*, the data was downloaded previously). Video data can also be delivered appended to and interleaved with the audio data. As with image data, video data is inserted in the data stream wherever available space is found after the audio packets. However, a significant amount of bandwidth is required for video data, even for highly compressed video images, and thus should be limited for low-bandwidth users. When video data is received at the playback tool, it is forwarded to an auxiliary tool for rendering.

- Select or define URLs 164 that can be delivered appended to and interleaved with the audio data. When URLs are received at the playback tool, they forwarded to an auxiliary tool which attaches them to a button or image on a form (if one exists) displayed to the user. When the button or image is selected by the user, the attached URL is activated in conventional fashion.

[0035] The Studio Console Process 102 also may be used to schedule playlist content on a channel for an extended period of time. FIG. 3 is a "screen shot" of one embodiment of a GUI for defining a playlist schedule within the Studio Console Process 102. The preferred playlist definition GUI for the Studio Console Process 102 includes controls that allow the content provider to do at least the following in scheduling a playlist:

- Define a schedule 170 of start and stop times for each of a plurality of audio content files.
- Select a channel 172 on which multimedia content will be made available to users.
- Define a release date 174 for the playlist.
- Check the overall start and stop times 176 and file characteristics 178 for the playlist content.

System Architecture - User Client

[0036] FIG. 1A also shows a user client 200. In the preferred embodiment, a User Client Process 202 communicates through a playback tool 204 across a network (*e.g.*, the Internet) with the host 300 to access playlists and select a channel for playback. The User Client Process 202 responds to and carries out the directions of a user by means of the playback tool 204. In particular, the playback tool 204 selects one of a plurality of decoder plugins 206 to perform necessary data decompression of the multimedia content of a received data stream. The playback tool 204 also parses multimedia packets received from the host 300. In particular, the playback tool 204 processes all audio data internally, but forwards

all non-audio data to one or more auxiliary tools 208, each of which can manage and render such data.

[0037] In the preferred embodiment, while a data stream may contain all types of data, each particular calling form displayed by the User Client Process 202 notifies the auxiliary tools 208 of the data that pertain to the form. That way, different forms can have different presentations for the same data stream. For example, one small form may only have start and stop buttons for the audio portion of the stream with no image box. The auxiliary tools 208 would not try to render any accompanying image data. Another, larger form may have an image box that is updated by an auxiliary tool 208 whenever a new image appears in the data stream.

[0038] In the preferred embodiment, the user client process 202 provides the ability for a user to play back a particular playlist selection until a different channel is selected or the playback session is ended. Multimedia content may be delivered in a one-time transmission or may be continuously broadcast in a looping manner. In either event, the user is able to join an active broadcast at any point during its transmission.

[0039] FIG. 4 is a "screen shot" of one embodiment of a GUI for displaying playback information and allowing selection of a playback channel within the User Client Process 202. (Details of a playback session are described below.) The preferred playback GUI includes controls that allow the user to do at least the following:

- Display a playlist 400 of stream names for selectable data streams.
- Display a stream description 404 for a selected stream name.
- Display accompanying caption text 406.
- Display accompanying graphics 408.
- Display active link buttons 410 for accompanying URLs.
- Include other desired or convenient controls, such as a stop button 412. For example, if the user presses the stop button 412, the playback tool 204 should blank out the stream name, stream description, link button, and caption text. The playback tool 204 could also display a default name, such as "no station selected". The playback tool 204 may also cause a blank image sent to the appropriate auxiliary tool 208 if the user presses the stop button 412 while an image is being rendered. A standard graphic can be displayed instead.

System Architecture - Host Broadcast System Architecture

[0040] Referring to FIG. 1A, a playlist of multimedia

content generated by a content provider client 100 is transferred in conventional fashion over a network (*e.g.*, the Internet) to a host 300. The host 300 generally includes one or more "front-end" Terminal Information Handlers (TIH) 302 that manage general information flow to and from the host 300 for multiple users. For example, on the America Online network, each TIH 302 can manage about 63 concurrent users. A radio IN process 304 executing on the host 300 receives data from a content provider client 100 that is transmitted by means of "ri" (radio input) messages. The radio IN process 304 generally stores multimedia content as files in a storage device 306 that is accessible to the host 300 for later broadcast or for archiving of the multimedia content. However, the radio IN process 304 may also be used to directly transfer the received multimedia content to a radio OUT process 308 for broadcast to users requesting playback.

[0041] In accordance with a primary aspect of the invention, the radio OUT process 308 provides multiple data streams of multimedia content for access by users. In particular, the radio OUT process 308 may access multiple data streams from one or more storage devices 306, or accept "live" feeds of multimedia content from the radio IN process 304 (*e.g.*, a live interview or live reporting from the scene of a news event). Thus, the radio OUT process 308 gathers and assembles the data packets representing such multimedia content data streams into a "broader" multi-stream data flow.

[0042] In order to provide a highly efficient distribution system that allows a large number of users to rapidly access one or more channels of multimedia data, the inventive system architecture provides a "fan out" mechanism that includes a master broadcast process 312. The broadcast process 312 accepts the multi-stream data flow from the radio OUT process 310 and then distributes the multi-stream data flow (shown as thick arrows in FIG. 1A) along with instances of itself 312 to essentially every terminal information handler 314 accessible to the host 300. (Although only two instances of the broadcast process 312 and two TIHs 314 are shown, any number may be selected). Thus, the load of providing data streams is spread among a large number of Terminal Information Handlers 314.

[0043] For example, in the America Online network, one instance of each broadcast process would be distributed within an internal network to a "pod", each comprising a large number of individual servers. Coupled to each pod in a ring are multiple TIHs 314. Executing on each pod is an instance of the broadcast process 312, which circulates the multi-stream data flow among all TIHs within the pod. In this manner, any one channel of multimedia data stream within the multi-stream data flow is available for transmittal to a user requesting playback with very little delay. As noted above, in one embodiment of the invention, the access latency is typically less than about 3 seconds.

[0044] FIG. 1B is block diagram of a portion of an al-

ternative embodiment of the invention. In this embodiment, the Terminal Information Handlers are configured hierarchically. A multi-stream data flow from a broadcast process 350 is transmitted to a top-level terminal front end processor (TFEP) 352 of conventional design, which controls multiple TIHs 354. The TFEP 352 then re-transmits the multi-stream data flow to dependent TIHs 354, reducing data traffic within the overall system compared to the ring architecture referenced above. Multiple user clients 356 may then access selected channels of the multi-stream data flow through the TIHs 354.

[0045] Once the multi-stream data flow content is available in the TIHs 314, any channel of the multi-stream data flow is available for transmittal to a user requesting playback. To allow a user to select a particular channel, a tuner process 318 executing within the host 300 is coupled to each TIH 314. The tuner process 318 intercepts channel requests from users and commands the TIH 314 with which the user is in communication to deliver a particular multimedia data stream to that user from the multi-stream data flow. Thereafter, packets from that data stream are transmitted to the requesting user (see below for further discussion of playback sessions).

[0046] An additional function of the tuner process 318 is that it can "map" a channel name to a channel number. For internal efficiencies, each channel of the multi-stream data flow is given a channel number. However, it may be desirable to give one or more channel names to each channel number. Thus, channel "1" may be assigned the channel name of "The AOL Radio Hour" on one playback list form displayable to users for a particular time slot, but be assigned the channel name of "The Motley Fool" on the same or another playback list form for a different time slot. Accordingly, in the preferred embodiment, the tuner process 318 maintains a map of channel names to channel numbers. The tuner process 318 then maps an incoming channel name from a user's channel request to the corresponding channel number. That channel number is then used to select the corresponding data stream on the TIH 314 to transmit to the user.

[0047] The inventive architecture may also be used in conjunction with conventional Internet multicast systems by providing a connection 320 from the radio OUT process 308 to a multicast server system, in known fashion. This capability may be useful when a channel is expected to have a relatively small audience which would not tax the "fan out" characteristics of the multicast system. However, for large "fan out" needs, the inventive architecture provides the advantages noted above.

Capture Session

[0048] FIG. 5A is a block diagram showing the client-host architecture for a capture session. A content provider is provided with the Studio Console Process 102,

encoder tool 104, and encoder plugins 106 described above, which may be considered to be a single "capture tool" 502 executing on a content provider client 100. The capture tool 502 communicates with the host 300 over a network through a Send function 504, which takes care of the details of data transmission in known fashion. The host 300 communicates with the capture tool 502 through a Terminal Information Handler (TIH) 302, as described above. The capture process requires only one host process, the radio IN process 304, whose function is to receive data from a content provider that is transmitted by means of "ri" (radio input) messages. The radio IN process 304 stores multimedia content as files in a storage device 306 that are accessible to the host 300 for later broadcast. There are three phases of a capture session: Starting the capture session, Recording, and Ending the capture session.

[0049] For a live input (*e.g.*, a microphone capture), initiating a capture session will start recording, compressing the multimedia data using the selected encoder plugin 106, packetizing the compressed multimedia data as a data stream, and uploading the data stream to the host 300. Since the data is compressed and transmitted while the "live" data (*e.g.*, voice from a microphone) is being recorded, the author has no ability to edit and review the content. This option will most likely be used for unrehearsed content. For pre-recorded input (*e.g.*, a WAV file), initiating a capture session will start compressing the multimedia data using the selected encoder plugin 106, packetizing the compressed multimedia data as a data stream, and uploading the data stream to the host 300. Because the input data is file based, the author has the ability to edit and review content off-line before submitting it to the host 300.

[0050] FIG. 5B is a data flow diagram showing the data flow for establishing a capture session (the representation of the Send function 504 and TIH 302 from FIG. 5 have been omitted for clarity). To establish a capture session, the user invokes a "connect" function 506 in a form 508 of the capture tool 502, which uploads a CLIENT_CONNECT message 510 to the radio IN process 304 within the host 300. The radio IN process 304 returns the same message 512 to acknowledge that a connection has been established.

[0051] FIG. 5C is a data flow diagram showing the data flow for recording during a capture session. After the host 300 has been informed that the content provider client 100 will be sending data, the capture tool 502 initiates transfer of multimedia content with an "rc" (radio control) START_STREAM message 514. The radio IN process 304 returns the same message 516 to acknowledge the start of data transmission and opens 515 a file to store the data stream. The initialization message is then followed by "ri" (radio input) DATA messages 518-1 to 518-*n* from the capture tool 502. The DATA messages contain the audio data and any supplemental data appended to the audio data. At the end of the data stream, the capture tool 502 sends an "rc" (radio control)

END_STREAM message 520. The radio IN process 304 returns the same message 522 to acknowledge the end of data transmission and closes 523 the data file used to store the data stream.

[0052] FIG. 5D is a data flow diagram showing the data flow for ending a capture session. The capture session is stopped by closing the open form 508 of the capture tool 502 or by pressing the appropriate cancel control. When this happens, the capture tool 502 sends an "rc" (radio control) CLIENT_DISCONNECT message 524 to the radio IN process 304. The radio IN process 304 returns the same message 526 to acknowledge that the connection has been terminated. When this occurs, the capture tool 502 is shutdown by the content provider client 100.

Playback Session

[0053] FIG. 6A is a data flow diagram showing the data flow architecture for playback of a multimedia data stream. A user is provided with a user client process 202, playback tool 204, and decoder plugins 206 as described above, which may be considered to be a single "playback tool" executing on the user client 200. The playback tool includes a playback form 602 to accept user selection of a channel. The channel selected is communicated to the processes described above with respect to FIG. 1A, which may be considered to be a single "broadcast system" 604 from the user's perspective.

[0054] The broadcast system 604 manages the delivery of radio control messages ("rc") and radio broadcast ("rb") data to the user client 200 through a Terminal Information Handler, as described above. There are four phases of playback sessions: Start Playback, Playback, Switching Channels, and Ending Playback.

[0055] FIG. 6B is a data flow diagram showing the data flow for starting a playback session. To establish a playback session, the user uses the playback tool to download a selection form from the host 300. In particular, the broadcast system 604 will have initialized the playback form 602 with the available channels. A channel is selected from the playback form 602, and the playback tool notifies the broadcast system 604 of the selected channel through a CHANNEL_REQUEST command message 606.

[0056] Once the broadcast system 604 has been informed that the user client 200 has selected a particular radio channel for playback (*i.e.*, the tuner process 316 receives an "rw" token with a channel name), the broadcast system 604 initiates the broadcast with a "rc" (radio control) START_CMD message 608. This initialization message is immediately followed by "rb" (radio broadcast) data messages 610. The data messages 612 preferably alternate header information and multimedia data. In the preferred embodiment, an identical header token is repeated with every data transmission so that users can join in the broadcast at any particular moment.

The final "rb" data packet 614 transmitted contains an "end-of-file" (EOF) identifier. In the preferred embodiment, if the playback content loops, the first data header will be transmitted again, and the broadcast will restart. Otherwise, a special "rc" STOP_PLAY_0 message (not shown) is sent to shut down that particular channel.

[0057] FIG. 6C is a data flow diagram showing the data flow for switching a playback channel. The basic process is similar to the process described for FIG. 6B. However, when a program is playing, the user can request a different program using the playback form 602. The playback tool notifies the broadcast system 604 of the new selected channel through a channel request message 606'. The broadcast system 604 then initiates the new broadcast with a "rc" (radio control) START_CMD message 608'. This initialization message is immediately followed by "rb" (radio broadcast) data messages 610' for the new channel. Whenever a new channel is started, the stream name and stream description is sent to the appropriate auxiliary tool 208 for display if provided by the playback form 602.

[0058] FIG. 6D is a data flow diagram showing the data flow for ending a playback session. The playback session is stopped by closing the open playback form 602 or by pressing the appropriate cancel control. When this happens, a TERMINATE SESSION command message 616 is sent to the broadcast system 604 to force a STOP_PLAY_0 618 message to be sent back to the user client 200. When this occurs, the playback tool is shut-down.

Computer Implementation

[0059] The invention may be implemented in hardware or software, or a combination of both. However, preferably, the invention is implemented by means of a computer program executing on one or more programmable systems each comprising at least one processor, a data storage system (including volatile and non-volatile memory and/or storage elements), at least one input device, and at least one output device. Program code is applied to input data to perform the functions described herein and generate output information. The output information is applied to one or more output devices, in known fashion.

[0060] Each such program may be implemented in any desired computer language (including machine, assembly, high level procedural, or object oriented programming languages) to communicate with a computer system. In any case, the language may be a compiled or interpreted language.

[0061] Each such computer program is preferably stored on a storage media or device (*e.g.*, ROM or magnetic media) readable by a general or special purpose programmable computer, for configuring and operating the computer when the storage media or device is read by the computer to perform the procedures described herein. The inventive system may also be considered to

be implemented as a computer-readable storage medium, configured with a computer program, where the storage medium so configured causes a computer to operate in a specific and predefined manner to perform the functions described herein.

[0062] A number of embodiments of the present invention have been described. Nevertheless, it will be understood that various modifications may be made without departing from the spirit and scope of the invention. For example, while specific controls have been shown in FIGS. 2-4, other controls may be used to provide similar functionality. Further, while FIGS. 5A-5D and 6A-6D show preferred messaging and data flow protocols, other messaging and data flow protocols may be used to provide similar functionality. Accordingly, other embodiments are within the scope of the following claims.

Claims

1. A system for playback of live and pre-recorded multimedia data in real-time over a large scale communication network, including:
 - (a) a computer system having a plurality of terminal information handlers for managing general information flow to and from a plurality of users;
 - (b) an output process for assembling multiple multimedia data streams for distribution;
 - (c) at least one broadcast process, in communication with the output process, for distributing the assembled multiple multimedia data streams to each of the terminal information handlers; and
 - (d) a selector process, in communication with the terminal information handlers, for receiving a channel request from a user through an terminal information handler associated with the user, mapping the channel request to a corresponding one of the multiple multimedia data streams, and enabling transmission of the corresponding one multimedia data stream to the user through the associated terminal information handler.
2. The system of claim 1, further including an input process for receiving multimedia data streams for distribution.
3. The system of claim 1, further including at least one storage device for storing multimedia data streams for later transmission.
4. A method for playback of live and pre-recorded mul-

timedia data in real-time over a large scale communication network, including the steps of:

(a) providing a plurality of terminal information handlers for managing general information flow to and from a plurality of users; 5

(b) assembling multiple multimedia data streams for distribution; 10

(c) distributing the assembled multiple multimedia data streams to each of the terminal information handlers; and

(d) receiving a channel request from a user through an terminal information handler associated with the user, mapping the channel request to a corresponding one of the multiple multimedia data streams, and enabling transmission of the corresponding one multimedia data stream to the user through the associated terminal information handler. 15 20

5. The method of claim 4, further including the step of receiving multimedia data streams for distribution. 25

6. The method of claim 4, further including the step of storing multimedia data streams for later transmission. 30

30

35

40

45

50

55

9

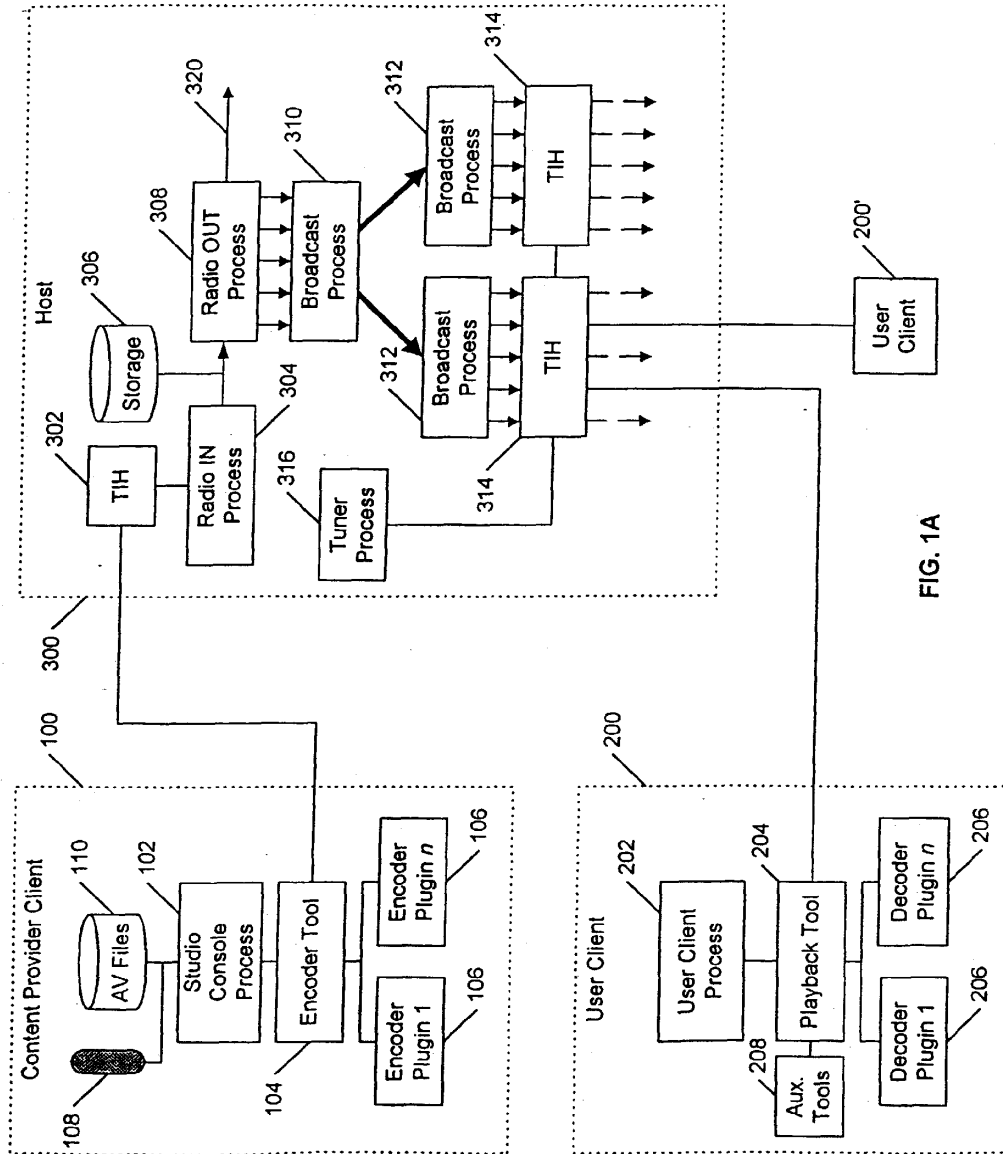
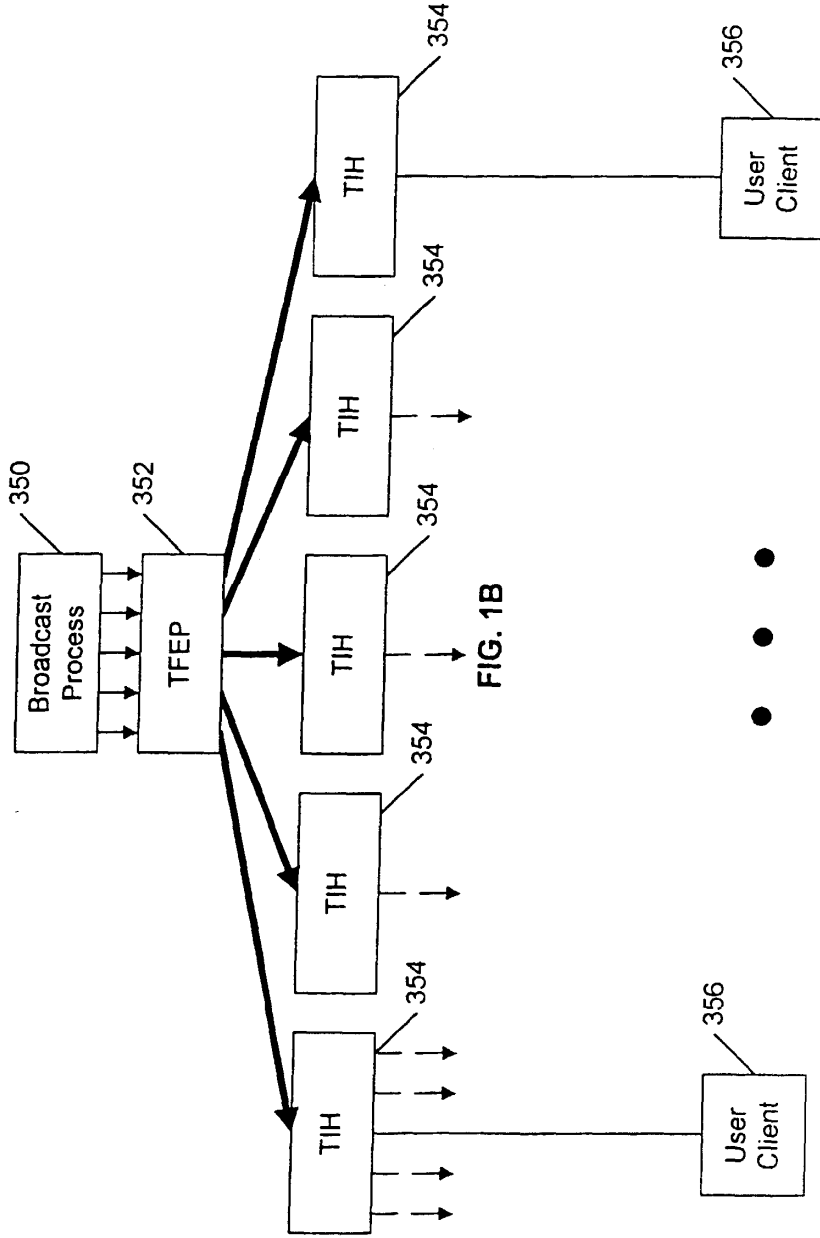

FIG. 1A



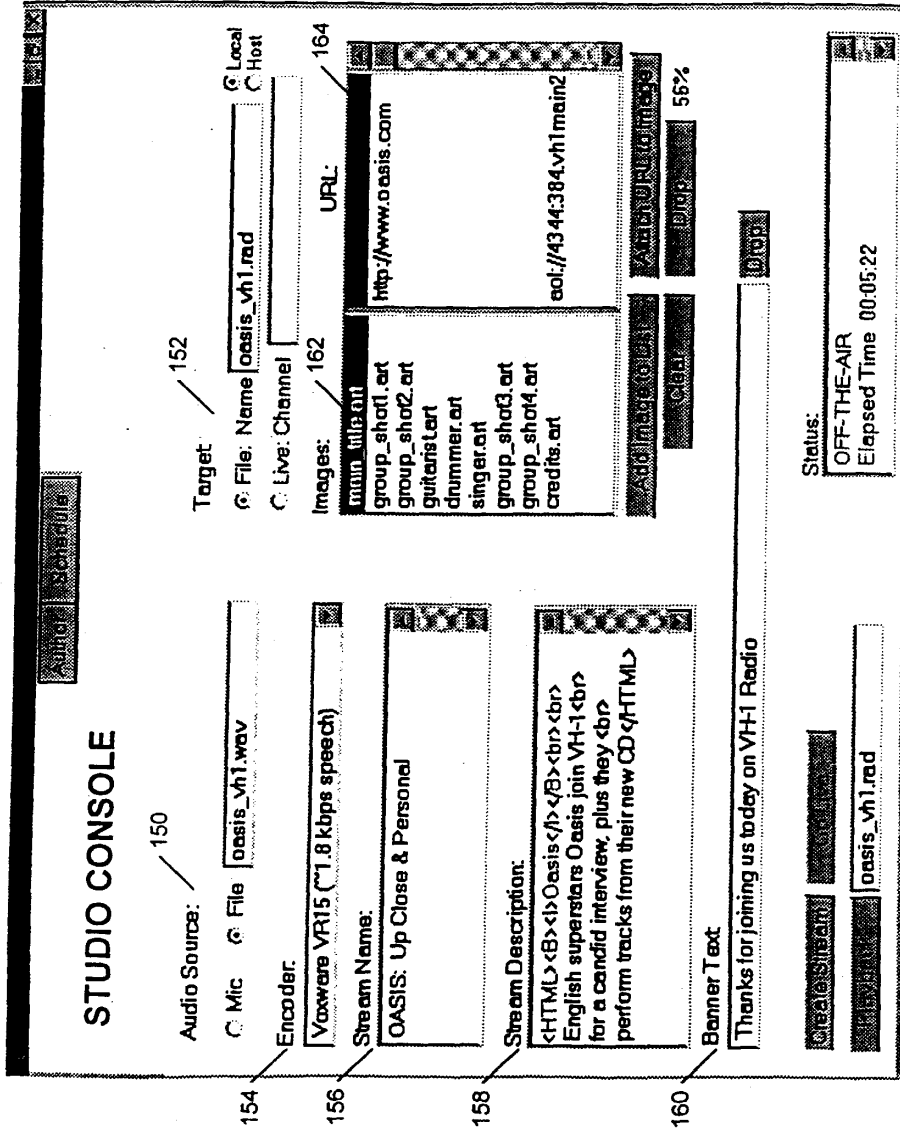

FIG. 2

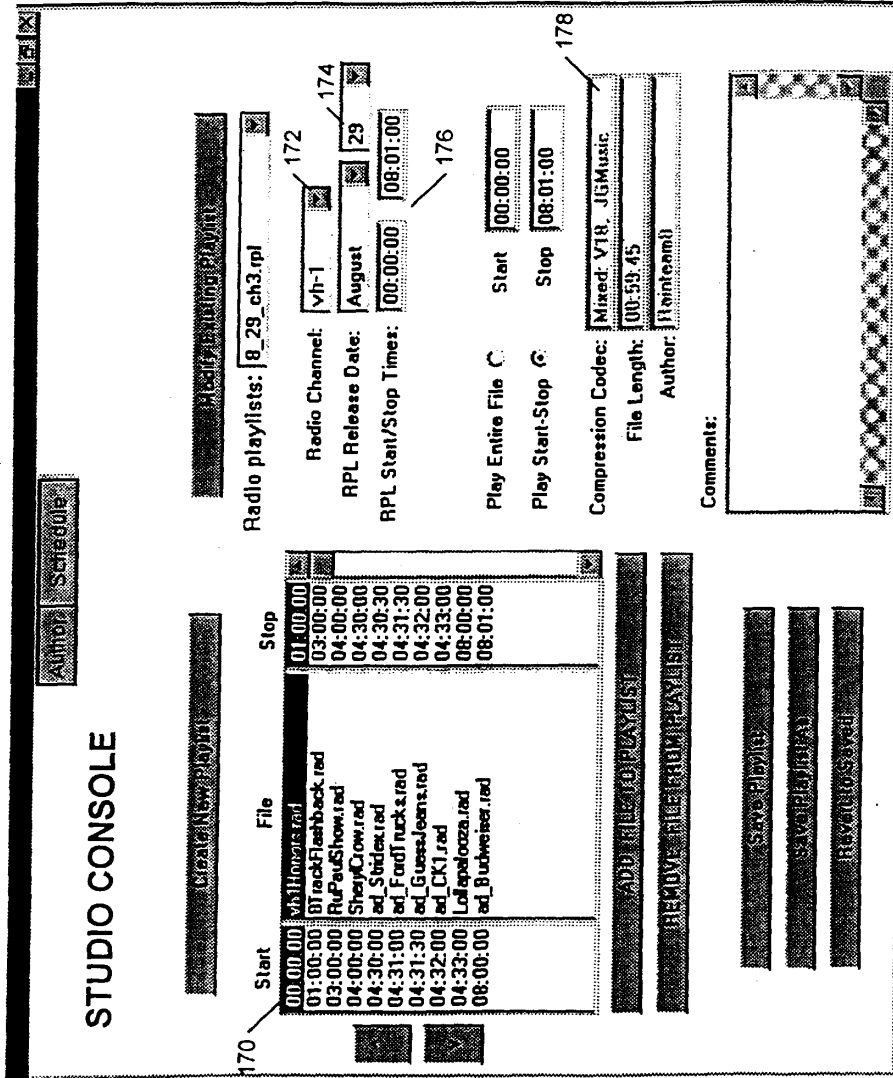

FIG. 3

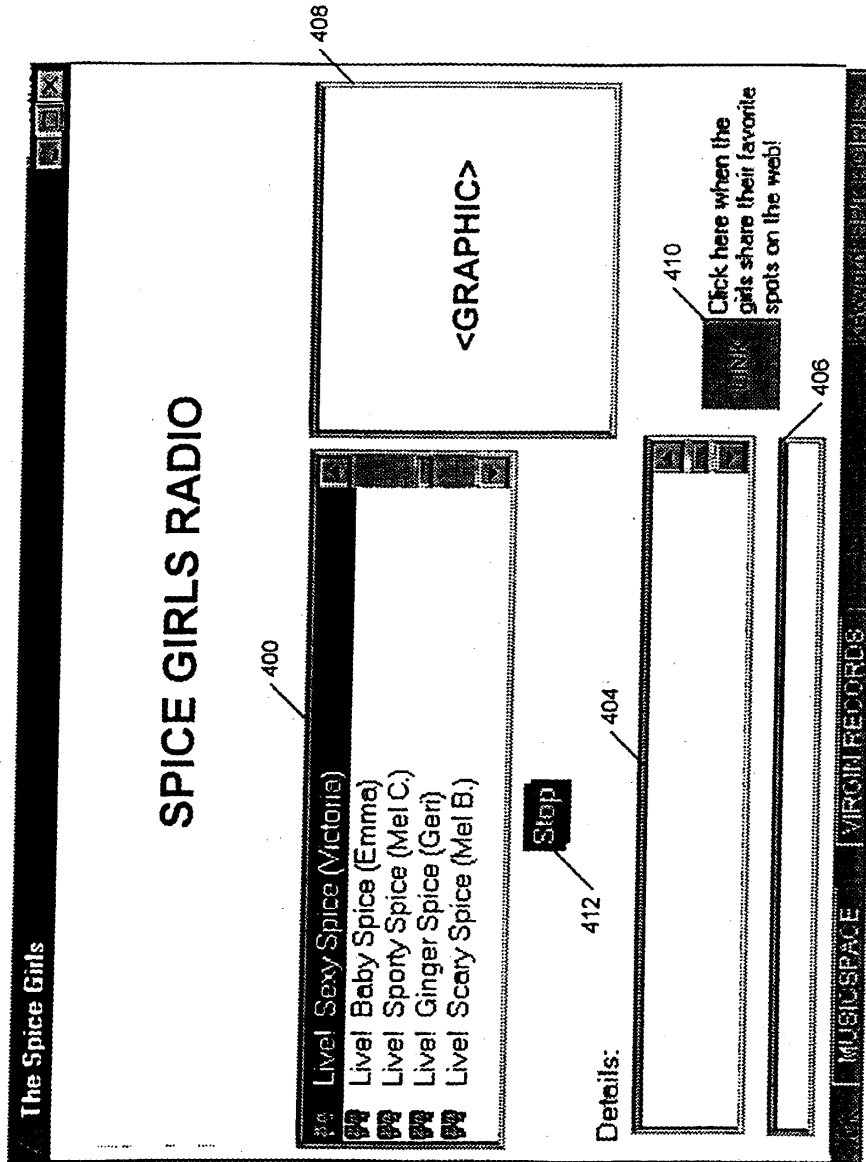

FIG. 4

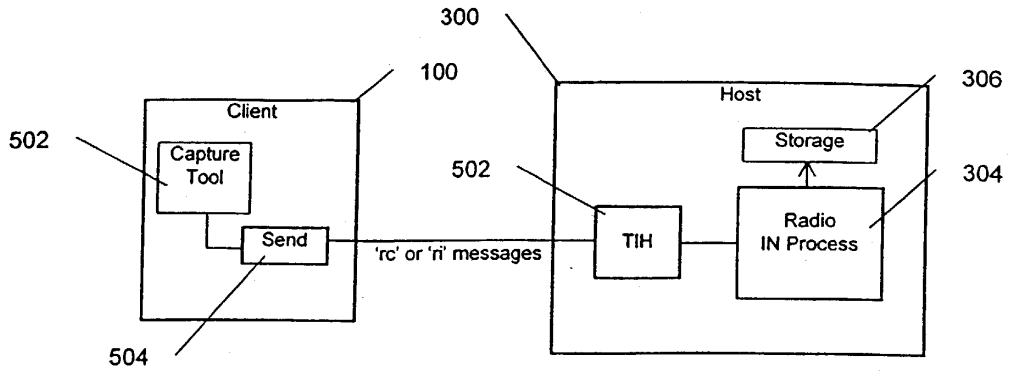

FIG. 5A

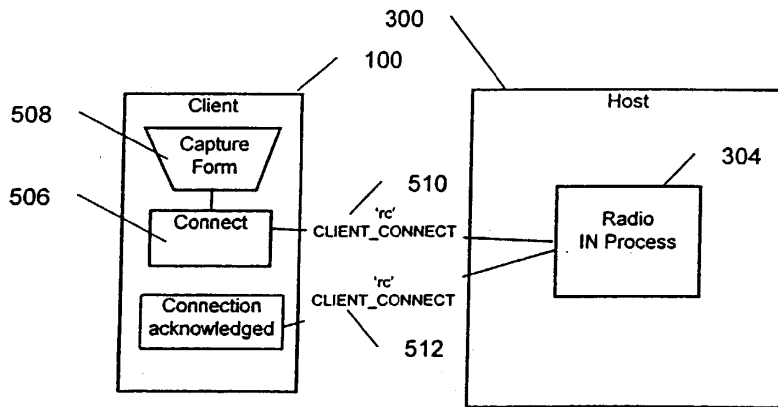

FIG. 5B

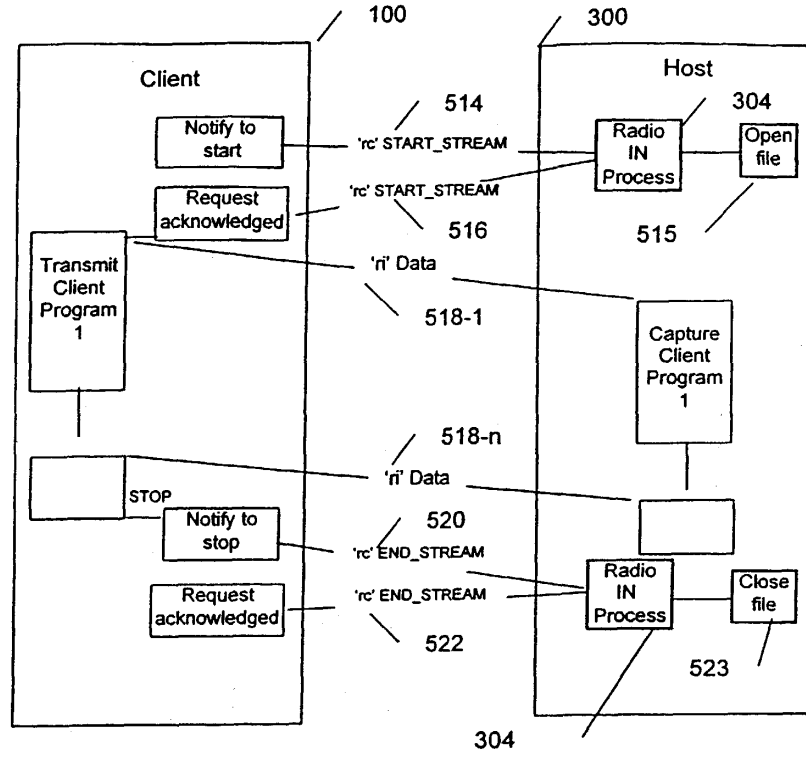

FIG. 5C

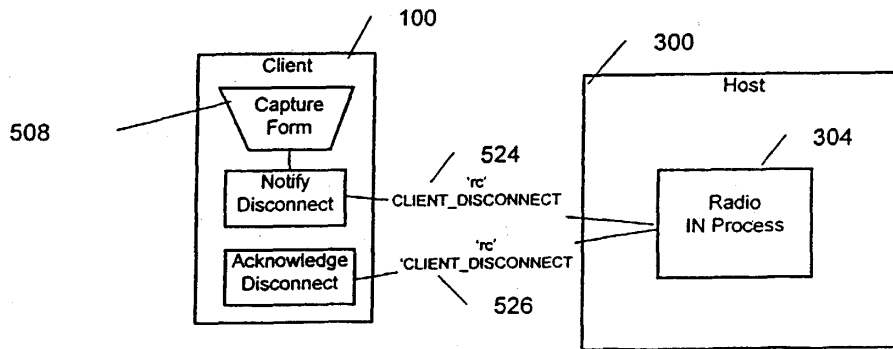

FIG. 5D

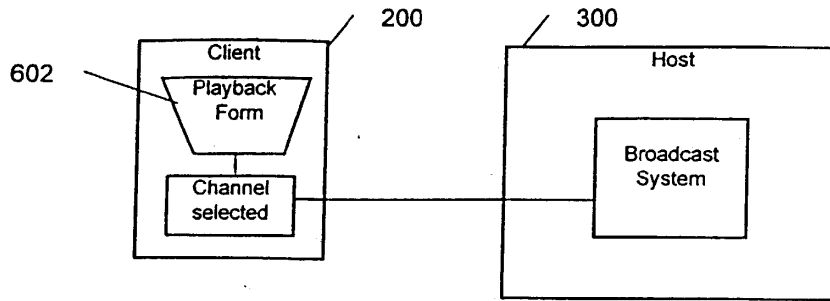

FIG. 6A

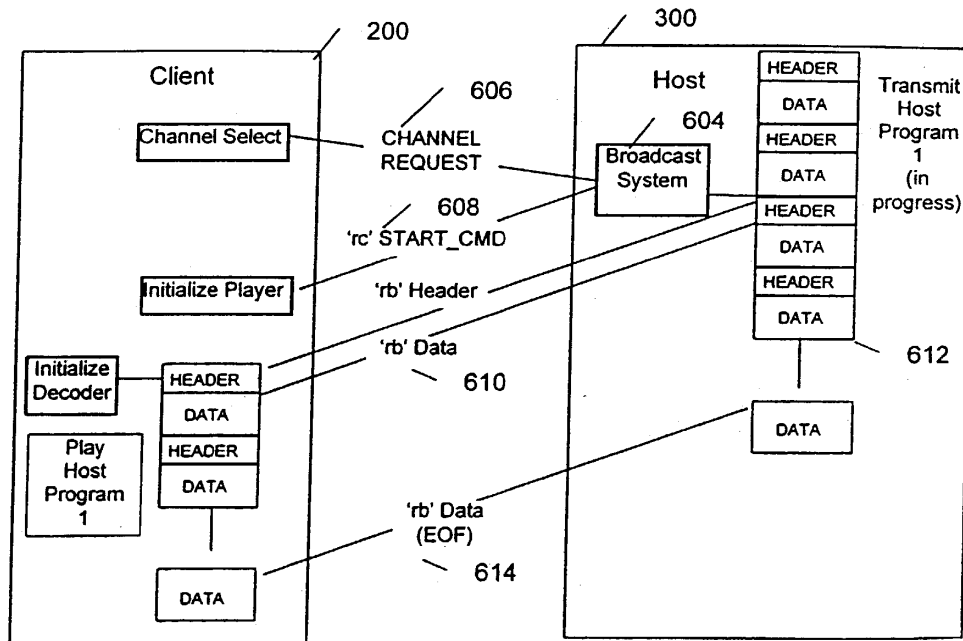

FIG. 6B

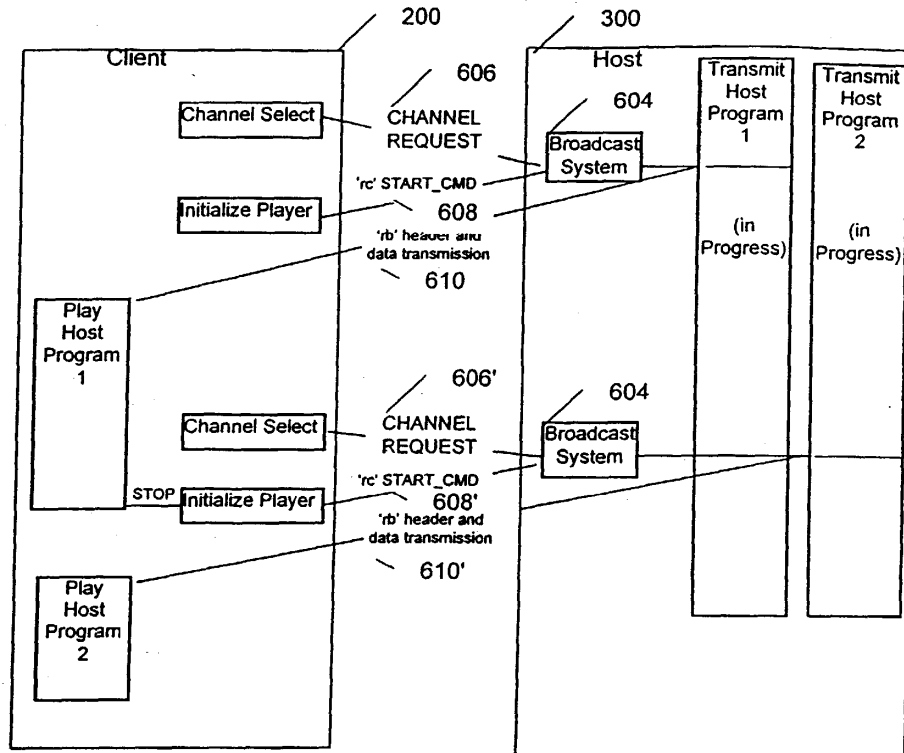

FIG. 6C

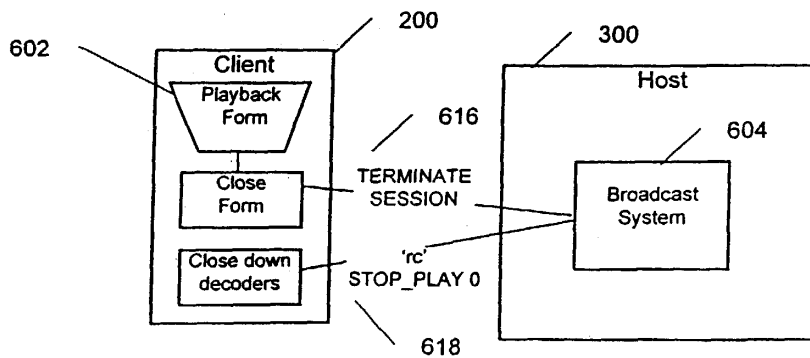

FIG. 6D



European Patent Office

EUROPEAN SEARCH REPORT

Application Number
EP 99 30 6950

DOCUMENTS CONSIDERED TO BE RELEVANT		
Category	Citation of document with indication, where appropriate, of relevant passages	Relevant to claim
X	US 5 778 187 A (BUTTERWORTH JAMES F ET AL) 7 July 1998 (1998-07-07) * abstract * * column 1, line 5 - line 15 * * column 3, line 4 - column 4, line 38 * * column 6, line 6 - line 21 * * column 17, line 4 - line 31 * * figure 18 *	1-6
X	US 5 557 724 A (KEMBEL JOHN ET AL) 17 September 1996 (1996-09-17) * abstract * * column 4, line 2 - line 60 * * column 8, line 1 - line 21 * * column 8, line 62 - column 9, line 6 * * column 10, line 53 - line 60 * * figures 1,3,15-18 *	1-6
		CLASSIFICATION OF THE APPLICATION (Int.Cl.7)
		H04L12/18 H04L29/06
		TECHNICAL FIELDS SEARCHED (Int.Cl.7)
		H04L
The present search report has been drawn up for all claims		
Place of search	Date of completion of the search	Examiner
THE HAGUE	17 December 1999	Poggio, F
CATEGORY OF CITED DOCUMENTS		
X : particularly relevant if taken alone Y : particularly relevant if combined with another document of the same category A : technological background O : non-written disclosure P : intermediate document T : theory or principle underlying the invention E : earlier patent document, but published on, or after the filing date D : document cited in the application L : document cited for other reasons & : member of the same patent family, corresponding document		

EPO FORM 1503 03.82 (F04C01)

**ANNEX TO THE EUROPEAN SEARCH REPORT
ON EUROPEAN PATENT APPLICATION NO.**

EP 99 30 6950

This annex lists the patent family members relating to the patent documents cited in the above-mentioned European search report. The members are as contained in the European Patent Office EDP file on
The European Patent Office is in no way liable for these particulars which are merely given for the purpose of information.

17-12-1999

Patent document cited in search report	Publication date	Patent family member(s)	Publication date
US 5778187 A	07-07-1998	AU 3002097 A WO 9742582 A US 5983005 A	26-11-1997 13-11-1997 09-11-1999
US 5557724 A	17-09-1996	NONE	

EPO FORM P0499

For more details about this annex : see Official Journal of the European Patent Office, No. 12/82

Electronic Patent Application Fee Transmittal

Application Number:	11563232
Filing Date:	27-Nov-2006
Title of Invention:	NETWORK-ENABLED AUDIO DEVICE
First Named Inventor/Applicant Name:	Safi Qureshey
Filer:	R. Chad Bevins/Julie Smith
Attorney Docket Number:	1116-028C

Filed as Large Entity

Utility under 35 USC 111(a) Filing Fees

Description	Fee Code	Quantity	Amount	Sub-Total in USD(\$)
Basic Filing:				
Pages:				
Claims:				
Miscellaneous-Filing:				
Petition:				
Patent-Appeals-and-Interference:				
Post-Allowance-and-Post-Issuance:				
Extension-of-Time:				

Description	Fee Code	Quantity	Amount	Sub-Total in USD(\$)
Miscellaneous:				
Submission- Information Disclosure Stmt	1806	1	180	180
Total in USD (\$)				180

Electronic Acknowledgement Receipt

EFS ID:	10755766
Application Number:	11563232
International Application Number:	
Confirmation Number:	1583
Title of Invention:	NETWORK-ENABLED AUDIO DEVICE
First Named Inventor/Applicant Name:	Safi Qureshey
Customer Number:	71739
Filer:	R. Chad Bevins/Julie Smith
Filer Authorized By:	R. Chad Bevins
Attorney Docket Number:	1116-028C
Receipt Date:	17-AUG-2011
Filing Date:	27-NOV-2006
Time Stamp:	14:10:42
Application Type:	Utility under 35 USC 111(a)

Payment information:

Submitted with Payment	yes
Payment Type	Credit Card
Payment was successfully received in RAM	\$180
RAM confirmation Number	372
Deposit Account	501732
Authorized User	BEVINS,R. CHAD

The Director of the USPTO is hereby authorized to charge indicated fees and credit any overpayment as follows:

Charge any Additional Fees required under 37 C.F.R. Section 1.21 (Miscellaneous fees and charges)

File Listing:					
Document Number	Document Description	File Name	File Size(Bytes)/ Message Digest	Multi Part /.zip	Pages (if appl.)
1	Transmittal Letter	1116-028C_IDS_Cover_Sheet_8-17-11.pdf	15870995 95085d59d24f0a401188aed7708a04a1880133cd	no	243
Warnings:					
Information:					
2	Information Disclosure Statement (IDS) Form (SB08)	1116-028C_IDS_8.PDF	612872 1dd50ef2a7086f6cb444e35f8664f50268de3e3c	no	7
Warnings:					
Information:					
3	Foreign Reference	EP0984584.pdf	359020 5f79245b0d5d9375a08dcd2b1737af4aa7d7b75f	no	20
Warnings:					
Information:					
4	Non Patent Literature	Kevin_Almeroth_Alternative_Paradigm.pdf	835722 f0c916b07c521fcf8a0a12fae52fd9cd1c764bcd	no	15
Warnings:					
Information:					
5	Fee Worksheet (SB06)	fee-info.pdf	30276 b8edfcf177cbee1110979b3b999f8d2d079fa002	no	2
Warnings:					
Information:					
Total Files Size (in bytes):			17708885		
<p>This Acknowledgement Receipt evidences receipt on the noted date by the USPTO of the indicated documents, characterized by the applicant, and including page counts, where applicable. It serves as evidence of receipt similar to a Post Card, as described in MPEP 503.</p> <p><u>New Applications Under 35 U.S.C. 111</u> If a new application is being filed and the application includes the necessary components for a filing date (see 37 CFR 1.53(b)-(d) and MPEP 506), a Filing Receipt (37 CFR 1.54) will be issued in due course and the date shown on this Acknowledgement Receipt will establish the filing date of the application.</p> <p><u>National Stage of an International Application under 35 U.S.C. 371</u> If a timely submission to enter the national stage of an international application is compliant with the conditions of 35 U.S.C. 371 and other applicable requirements a Form PCT/DO/EO/903 indicating acceptance of the application as a national stage submission under 35 U.S.C. 371 will be issued in addition to the Filing Receipt, in due course.</p> <p><u>New International Application Filed with the USPTO as a Receiving Office</u> If a new international application is being filed and the international application includes the necessary components for an international filing date (see PCT Article 11 and MPEP 1810), a Notification of the International Application Number and of the International Filing Date (Form PCT/RO/105) will be issued in due course, subject to prescriptions concerning national security, and the date shown on this Acknowledgement Receipt will establish the international filing date of the application.</p>					

IN THE UNITED STATES PATENT AND TRADEMARK OFFICE

In re Application: Safi Qureshey et al.
Serial No.: 11/563,232
Filed: 11/27/2006
Attorney Docket No. 1116-028C
For: **NETWORK-ENABLED AUDIO DEVICE**

Examiner: Pablo N. Tran
Art Unit: 2618

Mail Stop Amendment
Commissioner for Patents
PO Box 1450
Alexandria, VA 22313-1450

Sir:

SUPPLEMENTAL INFORMATION DISCLOSURE STATEMENT

In accordance with 37 C.F.R. 1.56, counsel wishes to make of record the attached additional items of information for the Examiner's consideration in connection with this application. Also enclosed is a form PTO/SB/08a for the Examiner's convenience in making such consideration of record. Inclusion herein of any particular item of information is not to be construed as an admission that same is prior art.

Attached as an appendix hereto are the following Office Actions from related applications:

From related U.S. Patent Application no. 09/805,470:

- Non-Final Rejection mailed April 7, 2004;
- Non-Final Rejection mailed October 19, 2005; and
- Final Rejection mailed July 27, 2006.

From related U.S. Patent Application no. 11/563,227:

- Non-Final Rejection mailed February 2, 2011; and
- Notice of Allowance mailed June 29, 2011.

From related U.S. Patent Application no. 11/563,230:

- Non-Final Rejection mailed March 5, 2009;

- Final Rejection mailed August 31, 2009;
- Advisory Action mailed December 23, 2009; and
- Examiner's Answer mailed June 10, 2010.

From related U.S. Patent Application no. 11/697,833:

- Non-Final Rejection mailed October 28, 2009;
- Final Rejection mailed May 12, 2010;
- Advisory Action mailed July 19, 2010;
- Non-Final Rejection mailed December 22, 2010; and
- Final Rejection mailed June 7, 2011.

Applicant includes herein the fee set forth in 37 C.F.R. § 1.17(p). The Director is hereby authorized to charge any additional fees that may be required, or credit any overpayment, to Deposit Account No. 50-1732.

Respectfully submitted,
WITHROW & TERRANOVA, P.L.L.C.

By:



R. Chad Bevens
Registration No. 51,468
100 Regency Forest Drive, Suite 160
Cary, NC 27518
Telephone: (919) 238-2300

Date: August 17, 2011
Attorney Docket: 1116-028C

IN THE UNITED STATES PATENT AND TRADEMARK OFFICE

In re Application of: Safi Qureshey et al.

Serial No. 11/563,232

Filed: 11/27/2006

Attorney Docket No. 1116-028C

For: **NETWORK-ENABLED AUDIO DEVICE**

Examiner: Pablo N. Tran

Art Unit: 2618

Mail Stop Amendment

Commissioner for Patents

PO Box 1450

Alexandria, VA 22313-1450

Sir:

RESPONSE TO THE OFFICE ACTION MAILED MAY 23, 2011

In response to the Office Action mailed May 23, 2011, Applicants offer the following amendments and remarks. Applicants enclose a payment in the amount of \$2,288.00 to cover the fee associated with the addition of 44 dependent claims. Applicants also enclose a payment in the amount of \$140.00 to cover the fee associated with a concurrently filed Terminal Disclaimer. If any additional fees are required in association with this response, the Director is hereby authorized to charge them to Deposit Account 50-1732, and consider this a petition therefor.

In the Title:

Please amend the title as follows:

NETWORK-ENABLED-AUDIO-DEVICE METHOD AND DEVICE FOR AN
INTERNET RADIO CAPABLE OF OBTAINING PLAYLIST CONTENT FROM A
CONTENT SERVER

In the Claims:

1. (Currently Amended) An electronic device comprising:
 - a) a network interface enabling the electronic device to receive an Internet radio broadcast and being further adapted to communicatively couple the electronic device to a central system;
 - b) a system enabling playback of audio content from ~~an additional content source~~ a playlist assigned to the electronic device via the central system; and
 - c) a control system associated with the network interface and the system enabling playback of the audio content indicated by the playlist ~~from the additional content source~~, and adapted to:
 - i) enable a user of the electronic device to select a desired mode of operation from a plurality of modes of operation comprising an Internet radio mode of operation and ~~an additional content source~~ a playlist mode of operation;
 - ii) receive and play the Internet radio broadcast when the desired mode of operation is the Internet radio mode of operation; and
 - iii) ~~play the audio content from the additional content source~~ when the desired mode of operation is the ~~additional content source~~ playlist mode of operation;
 - receive the playlist assigned to the electronic device from the central system, the playlist identifying a plurality of songs, wherein ones of the plurality of songs are not stored on the electronic device;
 - receive information from the central system enabling the electronic device to obtain the ones of the plurality of songs from at least one remote source;
 - obtain the ones of the plurality of songs from the at least one remote source;
 - and
 - play the audio content indicated by the playlist.
2. (Currently Amended) The electronic device of claim 1 wherein the control system is further adapted to enable playback from a ~~the additional content source~~ is broadcast radio source.

3. (Currently Amended) The electronic device of claim 1 wherein the control system is further adapted to enable playback from the additional content source is an optical disc.
4. (Cancelled)
5. (Currently Amended) The electronic device of claim 1 further comprising a data storage device, wherein the control system is further adapted to enable playback from the additional content source is the data storage device.
6. (Cancelled)
7. (Original) The electronic device of claim 1 wherein the control system is further adapted to:
 - a) send a request to a remote server for supplemental information related to a song in real-time while the song is playing;
 - b) receive the supplemental information from the remote server; and
 - c) present the supplemental information to the user of the electronic device.
8. (Currently Amended) An electronic device comprising:
 - a) a network interface enabling the electronic device to receive an Internet radio broadcast and being further adapted to communicatively couple the electronic device to a central system;
 - b) a system enabling playback of audio content from a plurality of additional content sources comprising a playlist assigned to the electronic device via the central system; and
 - c) a control system associated with the network interface and the system enabling playback of the audio content from the plurality of additional content sources, and adapted to:
 - i) enable a user of the electronic device to select a desired mode of operation from a plurality of modes of operation comprising an Internet radio mode of operation and a plurality of additional modes of operation each corresponding to one of the plurality of additional content sources;

- ii) receive and play the Internet radio broadcast when the desired mode of operation is the Internet radio mode of operation; and
- iii) play the audio content from one of the plurality of additional content sources when the desired mode of operation is a corresponding one of the plurality of additional modes of operations operation, where when in a playlist mode of operation, the control system is further adapted to:
 - receive the playlist assigned to the electronic device from the central system, the playlist identifying a plurality of songs, wherein ones of the plurality of songs are not stored on the electronic device;
 - receive information from the central system enabling the electronic device to obtain the ones of the plurality of songs from at least one remote source;
 - obtain the ones of the plurality of songs from the at least one remote source;
and
 - play the audio content indicated by the playlist.

9. (Currently Amended) The electronic device of claim 8 wherein the plurality of additional content sources further comprises ~~at least two of a group consisting of: broadcast radio, an optical disc, a playlist, and a data storage device~~ of the electronic device.

10. (Cancelled)

11. (Original) The electronic device of claim 8 wherein the control system is further adapted to:

- a) send a request to a remote server for supplemental information related to a song in real-time while the song is playing;
- b) receive the supplemental information from the remote server; and
- c) present the supplemental information to the user of the electronic device.

12. (Currently Amended) A method of operation for an electronic device comprising:
- a) enabling a user of the electronic device to select a desired mode of operation from a plurality of modes of operation comprising an Internet radio mode of operation and an ~~additional content source~~ a playlist mode of operation;
 - b) playing an Internet radio broadcast when the desired mode of operation is the Internet radio mode of operation; and
 - c) ~~playing audio content from an additional content source~~ when the desired mode of operation is the ~~additional content source~~ playlist mode of operation:
 - i) receiving a playlist assigned to the electronic device via a central system, the playlist identifying a plurality of songs, wherein ones of the plurality of songs are not stored on the electronic device;
 - ii) receiving information from the central system enabling the electronic device to obtain the ones of the plurality of songs from at least one remote source;
 - iii) obtaining the ones of the plurality of songs from the at least one remote source;
and
 - iv) playing audio content indicated by the playlist.
13. (Currently Amended) The method of claim 12 further comprising wherein playing the audio content comprises:
- a) receiving audio content from a broadcast radio source; and
 - b) playing the audio content from the broadcast radio source.
14. (Currently Amended) The method of claim 12 further comprising wherein playing the audio content comprises:
- a) obtaining audio content from an optical disc; and
 - b) playing the audio content from the optical disc.
15. (Cancelled)
16. (Currently Amended) The method of claim 12 further comprising wherein playing the audio content comprises:

- a) obtaining audio content from a data storage device of the electronic device; and
 - b) playing the audio content from the data storage device.
17. (Cancelled)
18. (Original) The method of claim 12 further comprising:
- a) sending a request to a remote server for supplemental information related to a song in real-time while the song is playing;
 - b) receiving the supplemental information from the remote server; and
 - c) presenting the supplemental information to the user of the electronic device.
19. (Cancelled)
20. (Cancelled)
21. (New) The electronic device of claim 1 wherein the control system is further adapted to provide an alarm clock mode.
22. (New) The electronic device of claim 8 wherein the control system is further adapted to provide an alarm clock mode.
23. (New) The method of claim 12 further including enabling the user to set an alarm.
24. (New) The electronic device of claim 1 wherein the control system is further adapted to: display a list of Internet radio broadcast stations.
25. (New) The electronic device of claim 8 wherein the control system is further adapted to: display a list of Internet radio broadcast stations.
26. (New) The method of claim 12 further comprising displaying a list of Internet radio broadcast stations.

27. (New) The electronic device of claim 1 wherein the control system is further adapted to: receive and display a recommended song.
28. (New) The electronic device of claim 27 wherein the control system is further adapted to: provide an option to listen to the recommended song.
29. (New) The electronic device of claim 27 wherein the control system is further adapted to: provide an option to purchase the recommended song.
30. (New) The electronic device of claim 8 wherein the control system is further adapted to: receive and display a recommended song.
31. (New) The electronic device of claim 30 wherein the control system is further adapted to: provide an option to listen to the recommended song.
32. (New) The electronic device of claim 30 wherein the control system is further adapted to: provide an option to purchase the recommended song.
33. (New) The method of claim 12 further comprising receiving and displaying a recommended song.
34. (New) The method of claim 33 further comprising providing an option to listen to the recommended song.
35. (New) The method of claim 33 further comprising providing an option to purchase the recommended song.
36. (New) The electronic device of claim 7 wherein the supplemental information comprises information enabling the user to listen to samples of a plurality of songs.

37. (New) The electronic device of claim 11 wherein the supplemental information comprises information enabling the user to listen to samples of a plurality of songs.
38. (New) The method of claim 18 wherein the supplemental information comprises information enabling the user to listen to samples of a plurality of songs.
39. (New) The electronic device of claim 1 further comprising a wireless transceiver communicatively coupled to the control system.
40. (New) The electronic device of claim 8 further comprising a wireless transceiver communicatively coupled to the control system.
41. (New) The method of claim 12 wherein obtaining the ones of the plurality of songs from the at least one remote source comprises receiving the ones of the plurality of songs from the at least one remote source via a wireless transceiver of the electronic device.
42. (New) The electronic device of claim 1 wherein the electronic device is further adapted to receive input from a wireless remote control having a navigation shuttle.
43. (New) The electronic device of claim 8 wherein the electronic device is further adapted to receive input from a wireless remote control having a navigation shuttle.
44. (New) The method of claim 12 further comprising:
receiving input from a wireless remote control that enables navigating the playlist.
45. (New) The electronic device of claim 8 wherein the system further enables playback from an optical disc.
46. (New) The method of claim 12 further comprising enabling playback from an optical disc.

47. (New) The electronic device of claim 8 wherein the plurality of additional content sources include a broadcast radio source.
48. (New) The electronic device of claim 8 wherein the plurality of additional content sources include an optical disc source.
49. (New) The electronic device of claim 1 wherein the control system is further adapted to:
enable the user of the electronic device to receive information on promotional items for the plurality of songs in the playlist.
50. (New) The electronic device of claim 8 wherein the control system is further adapted to:
enable the user of the electronic device to receive information on promotional items for the plurality of songs in the playlist.
51. (New) The method of claim 12 further comprising enabling the user of the electronic device to receive information on promotional items for the plurality of songs in the playlist.
52. (New) The electronic device of claim 1 wherein playback of the playlist when in the playlist mode of operation is triggered by at least one user settable schedule.
53. (New) The electronic device of claim 52 wherein there are a plurality of user settable schedules.
54. (New) The electronic device of claim 53 wherein at least one of the plurality of user settable schedules is specified by information that comprises a time of day.
55. (New) The electronic device of claim 54 wherein information that specifies the at least one of the plurality of user settable schedules further comprises a day of the week.

56. (New) The electronic device of claim 54 wherein information that specifies the at least one of the plurality of user settable schedules further comprises information that specifies a playlist.
57. (New) The electronic device of claim 8 wherein playback of the playlist when in the playlist mode of operation is triggered by at least one user settable schedule.
58. (New) The electronic device of claim 57 wherein there are a plurality of user settable schedules.
59. (New) The electronic device of claim 58 wherein at least one of the plurality of user settable schedules is specified by information that comprises a time of day.
60. (New) The electronic device of claim 59 wherein information that specifies the at least one of the plurality of user settable schedules further comprises a day of the week.
61. (New) The electronic device of claim 59 wherein information that specifies the at least one of the plurality of user settable schedules further comprises information that specifies a playlist.
62. (New) The method of claim 12 wherein playing the audio content indicated by the playlist when in the playlist mode of operation is triggered by at least one user settable schedule.
63. (New) The method of claim 62 wherein there are a plurality of user settable schedules.
64. (New) The method of claim 63 wherein at least one of the plurality of user settable schedules is specified by information that comprises a time of day.
65. (New) The method of claim 64 wherein information that specifies the at least one of the plurality of user settable schedules further comprises a day of the week.

66. (New) The method of claim 64 wherein information that specifies the at least one of the plurality of user settable schedules further comprises information that specifies a playlist.
67. (New) The electronic device of claim 1 further comprising at least one speaker.
68. (New) The electronic device of claim 8 further comprising at least one speaker.
69. (New) The method of claim 12 further comprising playing the audio content through at least one speaker.
70. (New) An electronic device comprising:
- a) a wireless transceiver communicatively coupling the electronic device to a base station, the wireless transceiver enabling the electronic device to receive an Internet radio broadcast and communicate with a central system;
 - b) a system enabling playback of audio content indicated by a playlist assigned to the electronic device via the central system;
 - c) a control system associated with the wireless transceiver and the system enabling playback of the audio content indicated by the playlist and adapted to:
 - i) enable a user of the electronic device to select a desired mode of operation from a plurality of modes of operation comprising an Internet radio mode of operation and a playlist mode of operation;
 - ii) receive and play the Internet radio broadcast when the desired mode of operation is the Internet radio mode of operation; and
 - iii) when the desired mode of operation is the playlist mode of operation:
 - receive the playlist assigned to the electronic device from the central system, the playlist identifying a plurality of songs, wherein ones of the plurality of songs are not stored on the electronic device;
 - receive information from the central system enabling the electronic device to obtain the ones of the plurality of songs from at least one remote source;
 - obtain the ones of the plurality of songs from the at least one remote source; and

- play the audio content indicated by the playlist.

71. (New) The electronic device of claim 70 wherein the control system is further adapted to provide an alarm clock mode.

REMARKS

Applicants have carefully reviewed the Office Action mailed May 23, 2011 and offer the following remarks to accompany the above amendments.

Status of the Claims

Claims 1-20 were previously pending. Claims 1-3, 5, 8, 9, 12-14, and 16 are amended herein. Claims 4, 6, 10, 15, 17, 19, and 20 are cancelled herein. Claims 21-71 are added herein. Accordingly, claims 1-3, 5, 7-9, 11-14, 16, 18, and 21-71 are pending.

Allowable Subject Matter

Applicants would like to thank the Examiner for indicating that claims 6, 10, and 17 would be allowable if rewritten in independent form. Applicants have amended claim 1 to include the subject matter of claim 6, amended claim 8 to include the subject matter of claim 10, and amended claim 12 to include the subject matter of claim 17. As such, claims 1, 8, and 12 are in condition for allowance.

Claims 2, 3, 5, 7, 9, 11, 13, 14, 16, and 18 depend directly or indirectly from claims 1, 8, or 12 and therefore are also in condition for allowance at least by virtue of their dependency from allowable base claims.

Double Patenting

Claims 1-20 were provisionally rejected on the grounds of non-statutory obviousness-type double patenting as being unpatentable over claims 1, 16, and 28 of co-pending U.S. Patent Application Serial No. 11/697,833. Applicants submit herewith a terminal disclaimer and respectfully request that this provisional rejection be withdrawn.

New Claims 21-71

Support for new claims 21-23 can be found in, for example, paragraph [0090] and Figure 3B of the Specification as originally filed. As such, no new matter has been added. Claims 21-23 depend from claims 1, 8, and 12 respectively and therefore are allowable at least by virtue of their dependency from allowable base claims.

Support for new claims 24-26 can be found in, for example, Figure 3E and the corresponding description found in the Specification as originally filed. As such, no new matter has been added. Claims 24-26 depend from claims 1, 8, and 12 respectively and therefore are allowable at least by virtue of their dependency from allowable base claims.

Support for new claims 27-38 can be found in, for example, Figures 20A-20F and the corresponding description found in the Specification as originally filed. As such, no new matter has been added. Claims 27-38 depend directly or indirectly from claims 1, 8, and 12 respectively and therefore are allowable at least by virtue of their dependency from allowable base claims.

Support for new claims 39-41 can be found in, for example, Figure 10 and the corresponding description found in the Specification as originally filed. As such, no new matter has been added. Claims 39-41 depend from claims 1, 8, and 12 respectively and therefore are allowable at least by virtue of their dependency from allowable base claims.

Support for new claims 42-44 can be found at, for example, paragraph [0122] of the Specification as originally filed. As such, no new matter has been added. Claims 42-44 depend from claims 1, 8, and 12 respectively and therefore are allowable at least by virtue of their dependency from allowable base claims.

Support for new claims 45 and 46 can be found at, for example, paragraph [0007] of the Specification as originally filed. As such, no new matter has been added. Claims 45 and 46 depend from claims 8 and 12 respectively and therefore are allowable at least by virtue of their dependency from allowable base claims.

Support for claims 47 and 48 can be found at, for example, Figure 1 and the corresponding description found in the Specification as originally filed. As such, no new matter has been added. Claims 47 and 48 depend from claim 8 and therefore are allowable at least by virtue of their dependency from an allowable base claim.

Support for claim 49-51 can be found at, for example, Figures 20A-20F and the corresponding description found in the Specification as originally filed. As such, no new matter has been added. Claims 49-51 depend from claims 1, 8, and 12 respectively and are therefore allowable at least by virtue of their dependency from allowable base claims.

Support for claims 52-66 can be found at, for example, paragraph [0158] and Figure 17E of the Specification as originally filed. As such, no new matter has been added. Claims 52-66

depend directly or indirectly from claims 1, 8, and 12 respectively and are therefore allowable at least by virtue of their dependency from allowable base claims.

Support for claims 67-69 can be found at, for example, Figure 1 and the corresponding description found in the Specification as originally filed. As such, no new matter has been added. Claims 67-69 depend from claims 1, 8, and 12 and therefore are allowable at least by virtue of their dependency from allowable base claims.

Claim 70 is similar to claim 1 except that the claimed electronic device includes a wireless transceiver. Support for claim 70 can be found in, for example, Figure 10 and the corresponding description found in the Specification as originally filed. Claim 70 includes subject matter similar to the allowable subject matter of claim 6 and, for at least this reason, is in condition for allowance.

Support for new claim 71 can be found in, for example, paragraph [0090] and Figure 3B of the Specification as originally filed. As such, no new matter has been added. Claim 71 depends from claim 70 and is therefore allowable at least by virtue of its dependency from an allowable base claim.

Conclusion

The present application is now in condition for allowance and such action is respectfully requested. The Examiner is encouraged to contact Applicants' representative regarding any remaining issues in an effort to expedite allowance and issuance of the present application.

Respectfully submitted,

WITHROW & TERRANOVA, P.L.L.C.

By:



R. Chad Bevins
Registration No. 51,468
100 Regency Forest Drive, Suite 160
Cary, NC 27518
Telephone: (919) 238-2300

Date: August 23, 2011
Attorney Docket: 1116-028C

Under the Paperwork Reduction Act of 1995, no persons are required to respond to a collection of information unless it displays a valid OMB control number.

TERMINAL DISCLAIMER TO OBTAIN A PROVISIONAL DOUBLE PATENTING REJECTION OVER A PENDING "REFERENCE" APPLICATION	Docket Number (Optional) 1116-028C
<p>In re Application of: Safi Qureshey et al.</p> <p>Application No.: 11/563,232</p> <p>Filed: 11/27/2006</p> <p>For: NETWORK-ENABLED AUDIO DEVICE</p> <p>The owner*, <u>Horsham Enterprises, LLC</u>, of <u>100</u> percent interest in the instant application hereby disclaims, except as provided below, the terminal part of the statutory term of any patent granted on the instant application which would extend beyond the expiration date of the full statutory term of any patent granted on pending reference Application Number <u>11/697,833</u>, filed on <u>4/09/2007</u>, as such term is defined in 35 U.S.C. 154 and 173, and as the term of any patent granted on said reference application may be shortened by any terminal disclaimer filed prior to the grant of any patent on the pending reference application. The owner hereby agrees that any patent so granted on the instant application shall be enforceable only for and during such period that it and any patent granted on the reference application are commonly owned. This agreement runs with any patent granted on the instant application and is binding upon the grantee, its successors or assigns.</p> <p>In making the above disclaimer, the owner does not disclaim the terminal part of any patent granted on the instant application that would extend to the expiration date of the full statutory term as defined in 35 U.S.C. 154 and 173 of any patent granted on said reference application, "as the term of any patent granted on said reference application may be shortened by any terminal disclaimer filed prior to the grant of any patent on the pending reference application," in the event that: any such patent: granted on the pending reference application: expires for failure to pay a maintenance fee, is held unenforceable, is found invalid by a court of competent jurisdiction, is statutorily disclaimed in whole or terminally disclaimed under 37 CFR 1.321, has all claims canceled by a reexamination certificate, is reissued, or is in any manner terminated prior to the expiration of its full statutory term as shortened by any terminal disclaimer filed prior to its grant.</p> <p>Check either box 1 or 2 below, if appropriate.</p> <p>1. <input type="checkbox"/> For submissions on behalf of a business/organization (e.g., corporation, partnership, university, government agency, etc.), the undersigned is empowered to act on behalf of the business/organization.</p> <p style="padding-left: 40px;">I hereby declare that all statements made herein of my own knowledge are true and that all statements made on information and belief are believed to be true; and further that these statements were made with the knowledge that willful false statements and the like so made are punishable by fine or imprisonment, or both, under Section 1001 of Title 18 of the United States Code and that such willful false statements may jeopardize the validity of the application or any patent issued thereon.</p> <p>2. <input checked="" type="checkbox"/> The undersigned is an attorney or agent of record. Reg. No. <u>51,468</u></p> <div style="text-align: center; margin-top: 20px;">  _____ Signature </div> <div style="text-align: right; margin-top: 10px;"> _____ August 23, 2011 Date </div> <div style="text-align: center; margin-top: 10px;"> R. Chad Bevins Typed or printed name </div> <div style="text-align: right; margin-top: 20px;"> _____ 919-238-2300 Telephone Number </div> <p><input checked="" type="checkbox"/> Terminal disclaimer fee under 37 CFR 1.20(d) is included.</p> <p style="text-align: center; font-weight: bold; margin-top: 20px;">WARNING: Information on this form may become public. Credit card information should not be included on this form. Provide credit card information and authorization on PTO-2038.</p> <p><small>*Statement under 37 CFR 3.73(b) is required if terminal disclaimer is signed by the assignee (owner). Form PTO/SB/96 may be used for making this statement. See MPEP § 324.</small></p>	

This collection of information is required by 37 CFR 1.321. The information is required to obtain or retain a benefit by the public which is to file (and by the USPTO to process) an application. Confidentiality is governed by 35 U.S.C. 122 and 37 CFR 1.11 and 1.14. This collection is estimated to take 12 minutes to complete, including gathering, preparing, and submitting the completed application form to the USPTO. Time will vary depending upon the individual case. Any comments on the amount of time you require to complete this form and/or suggestions for reducing this burden, should be sent to the Chief Information Officer, U.S. Patent and Trademark Office, U.S. Department of Commerce, P.O. Box 1450, Alexandria, VA 22313-1450. DO NOT SEND FEES OR COMPLETED FORMS TO THIS ADDRESS. SEND TO: Commissioner for Patents, P.O. Box 1450, Alexandria, VA 22313-1450.

If you need assistance in completing the form, call 1-800-PTO-9199 and select option 2.

Electronic Patent Application Fee Transmittal

Application Number:	11563232
Filing Date:	27-Nov-2006
Title of Invention:	NETWORK-ENABLED AUDIO DEVICE
First Named Inventor/Applicant Name:	Safi Qureshey
Filer:	R. Chad Bevins/Julie Smith
Attorney Docket Number:	1116-028C

Filed as Large Entity

Utility under 35 USC 111(a) Filing Fees

Description	Fee Code	Quantity	Amount	Sub-Total in USD(\$)
Basic Filing:				
Pages:				
Claims:				
Claims in excess of 20	1202	44	52	2288

Miscellaneous-Filing:

Petition:

Patent-Appeals-and-Interference:

Post-Allowance-and-Post-Issuance:

Extension-of-Time:

Description	Fee Code	Quantity	Amount	Sub-Total in USD(\$)
Miscellaneous:				
Statutory or terminal disclaimer	1814	1	140	140
Total in USD (\$)				2428

Electronic Acknowledgement Receipt

EFS ID:	10793954
Application Number:	11563232
International Application Number:	
Confirmation Number:	1583
Title of Invention:	NETWORK-ENABLED AUDIO DEVICE
First Named Inventor/Applicant Name:	Safi Qureshey
Customer Number:	71739
Filer:	R. Chad Bevins/Julie Smith
Filer Authorized By:	R. Chad Bevins
Attorney Docket Number:	1116-028C
Receipt Date:	23-AUG-2011
Filing Date:	27-NOV-2006
Time Stamp:	14:38:12
Application Type:	Utility under 35 USC 111(a)

Payment information:

Submitted with Payment	yes
Payment Type	Credit Card
Payment was successfully received in RAM	\$2428
RAM confirmation Number	10840
Deposit Account	501732
Authorized User	BEVINS,R. CHAD
The Director of the USPTO is hereby authorized to charge indicated fees and credit any overpayment as follows: Charge any Additional Fees required under 37 C.F.R. Section 1.21 (Miscellaneous fees and charges)	

File Listing:					
Document Number	Document Description	File Name	File Size(Bytes)/ Message Digest	Multi Part /.zip	Pages (if appl.)
1		1116-028C_Response_to_OA_ mailed_5-23-11.pdf	567397 d4bb8457adcbafcc95dffe17bdcac1fbb96fc723	yes	16
Multipart Description/PDF files in .zip description					
		Document Description	Start	End	
		Amendment/Req. Reconsideration-After Non-Final Reject	1	1	
		Specification	2	2	
		Claims	3	13	
		Applicant Arguments/Remarks Made in an Amendment	14	16	
Warnings:					
Information:					
2	Terminal Disclaimer Filed	1116-028C_Terminal_Disclaimer.pdf	75115 46a1086c1e483c1b49d7b05bb255a294af50455	no	1
Warnings:					
Information:					
3	Fee Worksheet (SB06)	fee-info.pdf	31969 c1ff78a2b3453b5b7fe9fc074ca3292e9843a921	no	2
Warnings:					
Information:					
Total Files Size (in bytes):			674481		

This Acknowledgement Receipt evidences receipt on the noted date by the USPTO of the indicated documents, characterized by the applicant, and including page counts, where applicable. It serves as evidence of receipt similar to a Post Card, as described in MPEP 503.

New Applications Under 35 U.S.C. 111

If a new application is being filed and the application includes the necessary components for a filing date (see 37 CFR 1.53(b)-(d) and MPEP 506), a Filing Receipt (37 CFR 1.54) will be issued in due course and the date shown on this Acknowledgement Receipt will establish the filing date of the application.

National Stage of an International Application under 35 U.S.C. 371

If a timely submission to enter the national stage of an international application is compliant with the conditions of 35 U.S.C. 371 and other applicable requirements a Form PCT/DO/EO/903 indicating acceptance of the application as a national stage submission under 35 U.S.C. 371 will be issued in addition to the Filing Receipt, in due course.

New International Application Filed with the USPTO as a Receiving Office

If a new international application is being filed and the international application includes the necessary components for an international filing date (see PCT Article 11 and MPEP 1810), a Notification of the International Application Number and of the International Filing Date (Form PCT/RO/105) will be issued in due course, subject to prescriptions concerning national security, and the date shown on this Acknowledgement Receipt will establish the international filing date of the application.

Under the Paperwork Reduction Act of 1995, no persons are required to respond to a collection of information unless it displays a valid OMB control number.

PATENT APPLICATION FEE DETERMINATION RECORD Substitute for Form PTO-875					Application or Docket Number 11/563,232	Filing Date 11/27/2006	<input type="checkbox"/> To be Mailed
APPLICATION AS FILED – PART I					OTHER THAN SMALL ENTITY		
(Column 1)		(Column 2)		SMALL ENTITY <input type="checkbox"/>		OR	
FOR	NUMBER FILED	NUMBER EXTRA	RATE (\$)	FEE (\$)	RATE (\$)	FEE (\$)	
<input type="checkbox"/> BASIC FEE <small>(37 CFR 1.16(a), (b), or (c))</small>	N/A	N/A	N/A		N/A		
<input type="checkbox"/> SEARCH FEE <small>(37 CFR 1.16(k), (j), or (m))</small>	N/A	N/A	N/A		N/A		
<input type="checkbox"/> EXAMINATION FEE <small>(37 CFR 1.16(o), (p), or (q))</small>	N/A	N/A	N/A		N/A		
TOTAL CLAIMS <small>(37 CFR 1.16(i))</small>	minus 20 =	*	X \$ =		OR	X \$ =	
INDEPENDENT CLAIMS <small>(37 CFR 1.16(h))</small>	minus 3 =	*	X \$ =		OR	X \$ =	
<input type="checkbox"/> APPLICATION SIZE FEE <small>(37 CFR 1.16(s))</small>	If the specification and drawings exceed 100 sheets of paper, the application size fee due is \$250 (\$125 for small entity) for each additional 50 sheets or fraction thereof. See 35 U.S.C. 41(a)(1)(G) and 37 CFR 1.16(s).						
<input type="checkbox"/> MULTIPLE DEPENDENT CLAIM PRESENT (37 CFR 1.16(j))							
* If the difference in column 1 is less than zero, enter "0" in column 2.							
APPLICATION AS AMENDED – PART II					OTHER THAN SMALL ENTITY		
(Column 1)		(Column 2)		SMALL ENTITY		OR	
AMENDMENT	DATE	CLAIMS REMAINING AFTER AMENDMENT	MINUS	HIGHEST NUMBER PREVIOUSLY PAID FOR	PRESENT EXTRA	RATE (\$)	ADDITIONAL FEE (\$)
	08/23/2011					X \$ =	OR
	Total (37 CFR 1.16(i))	* 64	Minus	** 20	= 44	X \$52=	2288
	Independent (37 CFR 1.16(h))	* 4	Minus	***4	= 0	X \$220=	0
<input type="checkbox"/> Application Size Fee (37 CFR 1.16(s))							
<input type="checkbox"/> FIRST PRESENTATION OF MULTIPLE DEPENDENT CLAIM (37 CFR 1.16(j))							
						TOTAL ADD'L FEE	OR
						TOTAL ADD'L FEE	2288
(Column 1)		(Column 2)		(Column 3)			
AMENDMENT	DATE	CLAIMS REMAINING AFTER AMENDMENT	MINUS	HIGHEST NUMBER PREVIOUSLY PAID FOR	PRESENT EXTRA	RATE (\$)	ADDITIONAL FEE (\$)
						X \$ =	OR
	Total (37 CFR 1.16(i))	*	Minus	**	=	X \$ =	OR
	Independent (37 CFR 1.16(h))	*	Minus	***	=	X \$ =	OR
<input type="checkbox"/> Application Size Fee (37 CFR 1.16(s))							
<input type="checkbox"/> FIRST PRESENTATION OF MULTIPLE DEPENDENT CLAIM (37 CFR 1.16(j))							
						TOTAL ADD'L FEE	OR
						TOTAL ADD'L FEE	
* If the entry in column 1 is less than the entry in column 2, write "0" in column 3.							
** If the "Highest Number Previously Paid For" IN THIS SPACE is less than 20, enter "20".							
*** If the "Highest Number Previously Paid For" IN THIS SPACE is less than 3, enter "3".							
The "Highest Number Previously Paid For" (Total or Independent) is the highest number found in the appropriate box in column 1.							

Legal Instrument Examiner:
/ROZENIA HARMON/

This collection of information is required by 37 CFR 1.16. The information is required to obtain or retain a benefit by the public which is to file (and by the USPTO to process) an application. Confidentiality is governed by 35 U.S.C. 122 and 37 CFR 1.14. This collection is estimated to take 12 minutes to complete, including gathering, preparing, and submitting the completed application form to the USPTO. Time will vary depending upon the individual case. Any comments on the amount of time you require to complete this form and/or suggestions for reducing this burden, should be sent to the Chief Information Officer, U.S. Patent and Trademark Office, U.S. Department of Commerce, P.O. Box 1450, Alexandria, VA 22313-1450. DO NOT SEND FEES OR COMPLETED FORMS TO THIS ADDRESS. **SEND TO: Commissioner for Patents, P.O. Box 1450, Alexandria, VA 22313-1450.**
 If you need assistance in completing the form, call 1-800-PTO-9199 and select option 2.

Application Number 	Application/Control No. 11/563,232	Applicant(s)/Patent under Reexamination QURESHEY ET AL.

Document Code - DISQ	Internal Document – DO NOT MAIL
-----------------------------	----------------------------------------

TERMINAL DISCLAIMER	<input checked="" type="checkbox"/> APPROVED	<input type="checkbox"/> DISAPPROVED
Date Filed : 8/23/11	This patent is subject to a Terminal Disclaimer	

Approved/Disapproved by:

jean proctor

U.S. Patent and Trademark Office



UNITED STATES PATENT AND TRADEMARK OFFICE

UNITED STATES DEPARTMENT OF COMMERCE
United States Patent and Trademark Office
Address: COMMISSIONER FOR PATENTS
P.O. Box 1450
Alexandria, Virginia 22313-1450
www.uspto.gov

NOTICE OF ALLOWANCE AND FEE(S) DUE

71739 7590 09/15/2011
WITHROW & TERRANOVA CT
100 REGENCY FOREST DRIVE, SUITE 160
CARY, NC 27518

EXAMINER
TRAN, PABLO N

ART UNIT PAPER NUMBER
2618

DATE MAILED: 09/15/2011

Table with 5 columns: APPLICATION NO., FILING DATE, FIRST NAMED INVENTOR, ATTORNEY DOCKET NO., CONFIRMATION NO.
11/563,232 11/27/2006 Safi Qureshey 1116-028C 1583

TITLE OF INVENTION: METHOD AND DEVICE FOR AN INTERNET RADIO CAPABLE OF OBTAINING PLAYLIST CONTENT FROM A CONTENT SERVER

Table with 7 columns: APPLN. TYPE, SMALL ENTITY, ISSUE FEE DUE, PUBLICATION FEE DUE, PREV. PAID ISSUE FEE, TOTAL FEE(S) DUE, DATE DUE
nonprovisional NO \$1510 \$300 \$0 \$1810 12/15/2011

THE APPLICATION IDENTIFIED ABOVE HAS BEEN EXAMINED AND IS ALLOWED FOR ISSUANCE AS A PATENT. PROSECUTION ON THE MERITS IS CLOSED. THIS NOTICE OF ALLOWANCE IS NOT A GRANT OF PATENT RIGHTS. THIS APPLICATION IS SUBJECT TO WITHDRAWAL FROM ISSUE AT THE INITIATIVE OF THE OFFICE OR UPON PETITION BY THE APPLICANT. SEE 37 CFR 1.313 AND MPEP 1308.

THE ISSUE FEE AND PUBLICATION FEE (IF REQUIRED) MUST BE PAID WITHIN THREE MONTHS FROM THE MAILING DATE OF THIS NOTICE OR THIS APPLICATION SHALL BE REGARDED AS ABANDONED. THIS STATUTORY PERIOD CANNOT BE EXTENDED. SEE 35 U.S.C. 151. THE ISSUE FEE DUE INDICATED ABOVE DOES NOT REFLECT A CREDIT FOR ANY PREVIOUSLY PAID ISSUE FEE IN THIS APPLICATION. IF AN ISSUE FEE HAS PREVIOUSLY BEEN PAID IN THIS APPLICATION (AS SHOWN ABOVE), THE RETURN OF PART B OF THIS FORM WILL BE CONSIDERED A REQUEST TO REAPPLY THE PREVIOUSLY PAID ISSUE FEE TOWARD THE ISSUE FEE NOW DUE.

HOW TO REPLY TO THIS NOTICE:

I. Review the SMALL ENTITY status shown above.

If the SMALL ENTITY is shown as YES, verify your current SMALL ENTITY status:

A. If the status is the same, pay the TOTAL FEE(S) DUE shown above.

B. If the status above is to be removed, check box 5b on Part B - Fee(s) Transmittal and pay the PUBLICATION FEE (if required) and twice the amount of the ISSUE FEE shown above, or

If the SMALL ENTITY is shown as NO:

A. Pay TOTAL FEE(S) DUE shown above, or

B. If applicant claimed SMALL ENTITY status before, or is now claiming SMALL ENTITY status, check box 5a on Part B - Fee(s) Transmittal and pay the PUBLICATION FEE (if required) and 1/2 the ISSUE FEE shown above.

II. PART B - FEE(S) TRANSMITTAL, or its equivalent, must be completed and returned to the United States Patent and Trademark Office (USPTO) with your ISSUE FEE and PUBLICATION FEE (if required). If you are charging the fee(s) to your deposit account, section "4b" of Part B - Fee(s) Transmittal should be completed and an extra copy of the form should be submitted. If an equivalent of Part B is filed, a request to reapply a previously paid issue fee must be clearly made, and delays in processing may occur due to the difficulty in recognizing the paper as an equivalent of Part B.

III. All communications regarding this application must give the application number. Please direct all communications prior to issuance to Mail Stop ISSUE FEE unless advised to the contrary.

IMPORTANT REMINDER: Utility patents issuing on applications filed on or after Dec. 12, 1980 may require payment of maintenance fees. It is patentee's responsibility to ensure timely payment of maintenance fees when due.

PART B - FEE(S) TRANSMITTAL

**Complete and send this form, together with applicable fee(s), to: Mail Mail Stop ISSUE FEE
 Commissioner for Patents
 P.O. Box 1450
 Alexandria, Virginia 22313-1450
 or Fax (571)-273-2885**

INSTRUCTIONS: This form should be used for transmitting the ISSUE FEE and PUBLICATION FEE (if required). Blocks 1 through 5 should be completed where appropriate. All further correspondence including the Patent, advance orders and notification of maintenance fees will be mailed to the current correspondence address as indicated unless corrected below or directed otherwise in Block 1, by (a) specifying a new correspondence address; and/or (b) indicating a separate "FEE ADDRESS" for maintenance fee notifications.

CURRENT CORRESPONDENCE ADDRESS (Note: Use Block 1 for any change of address)

71739 7590 09/15/2011
WITHROW & TERRANOVA CT
 100 REGENCY FOREST DRIVE , SUITE 160
 CARY, NC 27518

Note: A certificate of mailing can only be used for domestic mailings of the Fee(s) Transmittal. This certificate cannot be used for any other accompanying papers. Each additional paper, such as an assignment or formal drawing, must have its own certificate of mailing or transmission.

Certificate of Mailing or Transmission

I hereby certify that this Fee(s) Transmittal is being deposited with the United States Postal Service with sufficient postage for first class mail in an envelope addressed to the Mail Stop ISSUE FEE address above, or being facsimile transmitted to the USPTO (571) 273-2885, on the date indicated below.

(Depositor's name)
(Signature)
(Date)

APPLICATION NO.	FILING DATE	FIRST NAMED INVENTOR	ATTORNEY DOCKET NO.	CONFIRMATION NO.
-----------------	-------------	----------------------	---------------------	------------------

11/563,232 11/27/2006 Safi Qureshey 1116-028C 1583

TITLE OF INVENTION: METHOD AND DEVICE FOR AN INTERNET RADIO CAPABLE OF OBTAINING PLAYLIST CONTENT FROM A CONTENT SERVER

APPLN. TYPE	SMALL ENTITY	ISSUE FEE DUE	PUBLICATION FEE DUE	PREV. PAID ISSUE FEE	TOTAL FEE(S) DUE	DATE DUE
-------------	--------------	---------------	---------------------	----------------------	------------------	----------

nonprovisional NO \$1510 \$300 \$0 \$1810 12/15/2011

EXAMINER	ART UNIT	CLASS-SUBCLASS
----------	----------	----------------

TRAN, PABLO N 2618 725-034000

1. Change of correspondence address or indication of "Fee Address" (37 CFR 1.363).

- Change of correspondence address (or Change of Correspondence Address Form PTO/SB/122) attached.
- "Fee Address" indication (or "Fee Address" Indication form PTO/SB/47; Rev 03-02 or more recent) attached. **Use of a Customer Number is required.**

2. For printing on the patent front page, list

- (1) the names of up to 3 registered patent attorneys or agents OR, alternatively, 1 _____
- (2) the name of a single firm (having as a member a registered attorney or agent) and the names of up to 2 registered patent attorneys or agents. If no name is listed, no name will be printed. 2 _____
- 3 _____

3. ASSIGNEE NAME AND RESIDENCE DATA TO BE PRINTED ON THE PATENT (print or type)

PLEASE NOTE: Unless an assignee is identified below, no assignee data will appear on the patent. If an assignee is identified below, the document has been filed for recordation as set forth in 37 CFR 3.11. Completion of this form is NOT a substitute for filing an assignment.

(A) NAME OF ASSIGNEE (B) RESIDENCE: (CITY and STATE OR COUNTRY)

Please check the appropriate assignee category or categories (will not be printed on the patent) : Individual Corporation or other private group entity Government

4a. The following fee(s) are submitted:

- Issue Fee
- Publication Fee (No small entity discount permitted)
- Advance Order - # of Copies _____

4b. Payment of Fee(s): (**Please first reapply any previously paid issue fee shown above**)

- A check is enclosed.
- Payment by credit card. Form PTO-2038 is attached.
- The Director is hereby authorized to charge the required fee(s), any deficiency, or credit any overpayment, to Deposit Account Number _____ (enclose an extra copy of this form).

5. **Change in Entity Status** (from status indicated above)

- a. Applicant claims SMALL ENTITY status. See 37 CFR 1.27.
- b. Applicant is no longer claiming SMALL ENTITY status. See 37 CFR 1.27(g)(2).

NOTE: The Issue Fee and Publication Fee (if required) will not be accepted from anyone other than the applicant; a registered attorney or agent; or the assignee or other party in interest as shown by the records of the United States Patent and Trademark Office.

Authorized Signature _____ Date _____
 Typed or printed name _____ Registration No. _____

This collection of information is required by 37 CFR 1.311. The information is required to obtain or retain a benefit by the public which is to file (and by the USPTO to process) an application. Confidentiality is governed by 35 U.S.C. 122 and 37 CFR 1.14. This collection is estimated to take 12 minutes to complete, including gathering, preparing, and submitting the completed application form to the USPTO. Time will vary depending upon the individual case. Any comments on the amount of time you require to complete this form and/or suggestions for reducing this burden, should be sent to the Chief Information Officer, U.S. Patent and Trademark Office, U.S. Department of Commerce, P.O. Box 1450, Alexandria, Virginia 22313-1450. **DO NOT SEND FEES OR COMPLETED FORMS TO THIS ADDRESS. SEND TO: Commissioner for Patents, P.O. Box 1450, Alexandria, Virginia 22313-1450.**

Under the Paperwork Reduction Act of 1995, no persons are required to respond to a collection of information unless it displays a valid OMB control number.



UNITED STATES PATENT AND TRADEMARK OFFICE

UNITED STATES DEPARTMENT OF COMMERCE
United States Patent and Trademark Office
Address: COMMISSIONER FOR PATENTS
P.O. Box 1450
Alexandria, Virginia 22313-1450
www.uspto.gov

Table with 5 columns: APPLICATION NO., FILING DATE, FIRST NAMED INVENTOR, ATTORNEY DOCKET NO., CONFIRMATION NO.
Row 1: 11/563,232, 11/27/2006, Safi Qureshey, 1116-028C, 1583
Row 2: 71739, 7590, 09/15/2011, WITHROW & TERRANOVA CT, 100 REGENCY FOREST DRIVE, SUITE 160, CARY, NC 27518
Row 3: EXAMINER, TRAN, PABLO N
Row 4: ART UNIT, PAPER NUMBER, 2618
DATE MAILED: 09/15/2011

Determination of Patent Term Adjustment under 35 U.S.C. 154 (b)
(application filed on or after May 29, 2000)

The Patent Term Adjustment to date is 1212 day(s). If the issue fee is paid on the date that is three months after the mailing date of this notice and the patent issues on the Tuesday before the date that is 28 weeks (six and a half months) after the mailing date of this notice, the Patent Term Adjustment will be 1212 day(s).

If a Continued Prosecution Application (CPA) was filed in the above-identified application, the filing date that determines Patent Term Adjustment is the filing date of the most recent CPA.

Applicant will be able to obtain more detailed information by accessing the Patent Application Information Retrieval (PAIR) WEB site (http://pair.uspto.gov).

Any questions regarding the Patent Term Extension or Adjustment determination should be directed to the Office of Patent Legal Administration at (571)-272-7702. Questions relating to issue and publication fee payments should be directed to the Customer Service Center of the Office of Patent Publication at 1-(888)-786-0101 or (571)-272-4200.

Privacy Act Statement

The Privacy Act of 1974 (P.L. 93-579) requires that you be given certain information in connection with your submission of the attached form related to a patent application or patent. Accordingly, pursuant to the requirements of the Act, please be advised that: (1) the general authority for the collection of this information is 35 U.S.C. 2(b)(2); (2) furnishing of the information solicited is voluntary; and (3) the principal purpose for which the information is used by the U.S. Patent and Trademark Office is to process and/or examine your submission related to a patent application or patent. If you do not furnish the requested information, the U.S. Patent and Trademark Office may not be able to process and/or examine your submission, which may result in termination of proceedings or abandonment of the application or expiration of the patent.

The information provided by you in this form will be subject to the following routine uses:

1. The information on this form will be treated confidentially to the extent allowed under the Freedom of Information Act (5 U.S.C. 552) and the Privacy Act (5 U.S.C. 552a). Records from this system of records may be disclosed to the Department of Justice to determine whether disclosure of these records is required by the Freedom of Information Act.
2. A record from this system of records may be disclosed, as a routine use, in the course of presenting evidence to a court, magistrate, or administrative tribunal, including disclosures to opposing counsel in the course of settlement negotiations.
3. A record in this system of records may be disclosed, as a routine use, to a Member of Congress submitting a request involving an individual, to whom the record pertains, when the individual has requested assistance from the Member with respect to the subject matter of the record.
4. A record in this system of records may be disclosed, as a routine use, to a contractor of the Agency having need for the information in order to perform a contract. Recipients of information shall be required to comply with the requirements of the Privacy Act of 1974, as amended, pursuant to 5 U.S.C. 552a(m).
5. A record related to an International Application filed under the Patent Cooperation Treaty in this system of records may be disclosed, as a routine use, to the International Bureau of the World Intellectual Property Organization, pursuant to the Patent Cooperation Treaty.
6. A record in this system of records may be disclosed, as a routine use, to another federal agency for purposes of National Security review (35 U.S.C. 181) and for review pursuant to the Atomic Energy Act (42 U.S.C. 218(c)).
7. A record from this system of records may be disclosed, as a routine use, to the Administrator, General Services, or his/her designee, during an inspection of records conducted by GSA as part of that agency's responsibility to recommend improvements in records management practices and programs, under authority of 44 U.S.C. 2904 and 2906. Such disclosure shall be made in accordance with the GSA regulations governing inspection of records for this purpose, and any other relevant (i.e., GSA or Commerce) directive. Such disclosure shall not be used to make determinations about individuals.
8. A record from this system of records may be disclosed, as a routine use, to the public after either publication of the application pursuant to 35 U.S.C. 122(b) or issuance of a patent pursuant to 35 U.S.C. 151. Further, a record may be disclosed, subject to the limitations of 37 CFR 1.14, as a routine use, to the public if the record was filed in an application which became abandoned or in which the proceedings were terminated and which application is referenced by either a published application, an application open to public inspection or an issued patent.
9. A record from this system of records may be disclosed, as a routine use, to a Federal, State, or local law enforcement agency, if the USPTO becomes aware of a violation or potential violation of law or regulation.

Notice of Allowability	Application No.	Applicant(s)	
	11/563,232	QURESHEY ET AL.	
	Examiner	Art Unit	
	PABLO TRAN	2618	

-- The MAILING DATE of this communication appears on the cover sheet with the correspondence address--

All claims being allowable, PROSECUTION ON THE MERITS IS (OR REMAINS) CLOSED in this application. If not included herewith (or previously mailed), a Notice of Allowance (PTOL-85) or other appropriate communication will be mailed in due course. **THIS NOTICE OF ALLOWABILITY IS NOT A GRANT OF PATENT RIGHTS.** This application is subject to withdrawal from issue at the initiative of the Office or upon petition by the applicant. See 37 CFR 1.313 and MPEP 1308.

1. This communication is responsive to 08/23/11.
2. An election was made by the applicant in response to a restriction requirement set forth during the interview on ____; the restriction requirement and election have been incorporated into this action.
3. The allowed claim(s) is/are 1-3, 5, 7-9, 11-14, 16, 18, and 21-71 have been re-numbered 1-64.
4. Acknowledgment is made of a claim for foreign priority under 35 U.S.C. § 119(a)-(d) or (f).
 - a) All b) Some* c) None of the:
 1. Certified copies of the priority documents have been received.
 2. Certified copies of the priority documents have been received in Application No. ____.
 3. Copies of the certified copies of the priority documents have been received in this national stage application from the International Bureau (PCT Rule 17.2(a)).

* Certified copies not received: ____.

Applicant has THREE MONTHS FROM THE "MAILING DATE" of this communication to file a reply complying with the requirements noted below. Failure to timely comply will result in ABANDONMENT of this application.

THIS THREE-MONTH PERIOD IS NOT EXTENDABLE.

5. A SUBSTITUTE OATH OR DECLARATION must be submitted. Note the attached EXAMINER'S AMENDMENT or NOTICE OF INFORMAL PATENT APPLICATION (PTO-152) which gives reason(s) why the oath or declaration is deficient.
 6. CORRECTED DRAWINGS (as "replacement sheets") must be submitted.
 - (a) including changes required by the Notice of Draftsperson's Patent Drawing Review (PTO-948) attached
 - 1) hereto or 2) to Paper No./Mail Date ____.
 - (b) including changes required by the attached Examiner's Amendment / Comment or in the Office action of Paper No./Mail Date ____.
- Identifying indicia such as the application number (see 37 CFR 1.84(c)) should be written on the drawings in the front (not the back) of each sheet. Replacement sheet(s) should be labeled as such in the header according to 37 CFR 1.121(d).**
7. DEPOSIT OF and/or INFORMATION about the deposit of BIOLOGICAL MATERIAL must be submitted. Note the attached Examiner's comment regarding REQUIREMENT FOR THE DEPOSIT OF BIOLOGICAL MATERIAL.

Attachment(s)

- | | |
|-----------------------------------------------------------------------------------------------------------------------------------------------------------------------------------------------------------------------------------------------------------------------------------------------------------------------------------------------------------------------------------------------------------------------------------------------------------|----------------------------------------------------------------------------------------------------------------------------------------------------------------------------------------------------------------------------------------------------------------------------------------------------------------------------------------------------------------------------------------------------------------------------------|
| <ol style="list-style-type: none"> 1. <input type="checkbox"/> Notice of References Cited (PTO-892) 2. <input type="checkbox"/> Notice of Draftsperson's Patent Drawing Review (PTO-948) 3. <input checked="" type="checkbox"/> Information Disclosure Statements (PTO/SB/08), Paper No./Mail Date ____ 4. <input type="checkbox"/> Examiner's Comment Regarding Requirement for Deposit of Biological Material | <ol style="list-style-type: none"> 5. <input type="checkbox"/> Notice of Informal Patent Application 6. <input type="checkbox"/> Interview Summary (PTO-413), Paper No./Mail Date ____. 7. <input type="checkbox"/> Examiner's Amendment/Comment 8. <input checked="" type="checkbox"/> Examiner's Statement of Reasons for Allowance 9. <input type="checkbox"/> Other ____. |
|-----------------------------------------------------------------------------------------------------------------------------------------------------------------------------------------------------------------------------------------------------------------------------------------------------------------------------------------------------------------------------------------------------------------------------------------------------------|----------------------------------------------------------------------------------------------------------------------------------------------------------------------------------------------------------------------------------------------------------------------------------------------------------------------------------------------------------------------------------------------------------------------------------|

/Pablo N Tran/
Primary Examiner, Art Unit 2618

DETAILED ACTION

Allowable Subject Matter

1. The following is a statement of reasons for the indication of allowable subject matter:

The Applicant's response, filed on August 23, 2011, have placed the application in condition for allowance.

2. Any comments considered necessary by applicant must be submitted no later than the payment of the issue fee and, to avoid processing delays, should preferably accompany the issue fee. Such submissions should be clearly labeled "Comments on Statement of Reasons for Allowance."

Conclusion

3. Any inquiry concerning this communication or earlier communications from the examiner should be directed to Pablo Tran whose telephone number is (571)272-7898. The examiner normal hours are 9:30 -5:00 (Monday-Friday). If attempts to reach the examiner by telephone are unsuccessful, the examiner's supervisor, Edward Urban, can be reached at (571)272-7899. The fax phone number for the organization where this application or proceeding is assigned is (571)273-8300.
4. Information regarding the status of an application may be obtained from the Patent Application Information Retrieval (PAIR) System. Status information for

Art Unit: 2618

Published applications may be obtained from either Private PAIR or Public PAIR.

Status information for unpublished applications is available through Private PAIR only.

For more information about the PAIR system, see <http://pair-directauspto.gov>. Should

You have questions on access to the Private PAIR system, contact the Electronic

Business Center (EBC) at 866-217-9197 (toll-free). If you would like assistance from a

USPTO Customer Service Representative or access to the automated information

system, call 800-786-9199 (in USA or CANADA) or 571-272-1000.

September 10, 2011

/Pablo N Tran/

Primary Examiner, Art Unit 2618

Search Notes 	Application/Control No. 11563232	Applicant(s)/Patent Under Reexamination QURESHEY ET AL.
	Examiner PABLO TRAN	Art Unit 2618

SEARCHED			
Class	Subclass	Date	Examiner
455	3.02, 3.06, 142, 150.1, 151.1, 151.2, 154.1, 154.2, 158.1, 158.2, 158.4, 186.1, 344, 414.1, 414.3, 456.2, 556.1, 557	5/22/11	PT
709	217, 219	5/22/11	PT
725	39, 45, 18	5/22/11	PT

SEARCH NOTES		
Search Notes	Date	Examiner
East (us-pgpub, uspat, fprs, epo, jpo, derwent), WIPO	5/22/11	PT

INTERFERENCE SEARCH			
Class	Subclass	Date	Examiner
	Interference texts searches	5/22/11	PT

	/P.T./ Primary Examiner.Art Unit 2618
--	------------------------------------------

INFORMATION DISCLOSURE STATEMENT BY APPLICANT (Not for submission under 37 CFR 1.99)	Application Number	11563232
	Filing Date	2006-11-27
	First Named Inventor	Safi Qureshey et al.
	Art Unit	2618
	Examiner Name	Pablo N. Tran
	Attorney Docket Number	1116-028C

U.S. PATENTS						Remove
Examiner Initial*	Cite No	Patent Number	Kind Code ¹	Issue Date	Name of Patentee or Applicant of cited Document	Pages, Columns, Lines where Relevant Passages or Relevant Figures Appear
	1	6507727	B1	2003-01-14	Henrick	
	2	6587127	B1	2003-07-01	Leeke et al.	
	3	6657116	B1	2003-12-02	Gunnerson	
	4	6192340	B1	2001-02-20	Abecassis	
	5	6248946	B1	2001-06-19	Dwek	
	6	7028082	B1	2006-04-11	Rosenberg et al.	
	7	6933433	B1	2005-08-23	Porteus et al.	
	8	7277955	B2	2007-10-02	Elliott	

INFORMATION DISCLOSURE STATEMENT BY APPLICANT (Not for submission under 37 CFR 1.99)	Application Number	11563232
	Filing Date	2006-11-27
	First Named Inventor	Safi Qureshey et al.
	Art Unit	2618
	Examiner Name	Pablo N. Tran
	Attorney Docket Number	1116-028C

	9	7187947	B1	2007-03-06	White et al.	
	10	6064379		2000-05-16	DeMoney	
	11	7472353	B1	2008-12-30	Wolff et al.	
	12	6982780	B2	2006-01-03	Morley et al.	
	13	7468934	B1	2008-12-23	Janik	
	14	7525289	B2	2009-04-28	Janik et al.	
	15	7652844	B2	2010-01-26	Edwards et al.	
	16	7660601	B2	2010-02-09	Janik et al.	
	17	7768234	B2	2010-08-03	Janik et al.	
	18	7786705	B2	2010-08-31	Janik et al.	
	19	7904579	B2	2011-03-08	Janik et al.	

INFORMATION DISCLOSURE STATEMENT BY APPLICANT (Not for submission under 37 CFR 1.99)	Application Number	11563232
	Filing Date	2006-11-27
	First Named Inventor	Safi Qureshey et al.
	Art Unit	2618
	Examiner Name	Pablo N. Tran
	Attorney Docket Number	1116-028C

	20	7920824	B2	2011-04-05	Janik et al.	
	21	5262875		1993-11-16	Mincer et al.	
	22	5440334		1995-08-08	Walters et al.	
	23	5710970		1998-01-20	Walters et al.	
	24	6389467	B1	2002-05-14	Eyal	
	25	6484199	B2	2002-11-19	Eyal	
	26	6519648	B1	2003-02-11	Eyal	
	27	6721741	B1	2004-04-13	Eyal et al.	
	28	6735628	B2	2004-05-11	Eyal	
	29	7010537	B2	2006-03-07	Eyal et al.	
	30	6725275	B2	2004-04-20	Eyal	

INFORMATION DISCLOSURE STATEMENT BY APPLICANT (Not for submission under 37 CFR 1.99)	Application Number	11563232
	Filing Date	2006-11-27
	First Named Inventor	Safi Qureshey et al.
	Art Unit	2618
	Examiner Name	Pablo N. Tran
	Attorney Docket Number	1116-028C

If you wish to add additional U.S. Patent citation information please click the Add button.						Add
U.S.PATENT APPLICATION PUBLICATIONS						Remove
Examiner Initial*	Cite No	Publication Number	Kind Code ¹	Publication Date	Name of Patentee or Applicant of cited Document	Pages, Columns, Lines where Relevant Passages or Relevant Figures Appear
	1	20020194260	A1	2002-12-19	Headley et al.	
	2	20030018799	A1	2003-01-23	Eyal	
	3	20020013852	A1	2002-01-31	Janik	
	4	20020138630	A1	2002-09-26	Solomon et al.	
	5	20030060157	A1	2003-03-27	Henrick	
	6	20020161858	A1	2002-10-31	Goldman	
	7	20030033420	A1	2003-02-13	Eyal et al.	
	8	20020023084	A1	2002-02-21	Eyal et al.	
	9	20020116476	A1	2002-08-22	Eyal et al.	
If you wish to add additional U.S. Published Application citation information please click the Add button.						Add

INFORMATION DISCLOSURE STATEMENT BY APPLICANT (Not for submission under 37 CFR 1.99)	Application Number		11563232	
	Filing Date		2006-11-27	
	First Named Inventor	Safi Qureshey et al.		
	Art Unit	2618		
	Examiner Name	Pablo N. Tran		
	Attorney Docket Number	1116-028C		

FOREIGN PATENT DOCUMENTS							Remove	
Examiner Initial*	Cite No	Foreign Document Number ³	Country Code ² j	Kind Code ⁴	Publication Date	Name of Patentee or Applicant of cited Document	Pages, Columns, Lines where Relevant Passages or Relevant Figures Appear	T ⁵
	1	0984584	EP	A1	2000-03-08	America Online, Inc.		<input type="checkbox"/>

If you wish to add additional Foreign Patent Document citation information please click the Add button **Add**

NON-PATENT LITERATURE DOCUMENTS			Remove
Examiner Initials*	Cite No	Include name of the author (in CAPITAL LETTERS), title of the article (when appropriate), title of the item (book, magazine, journal, serial, symposium, catalog, etc), date, pages(s), volume-issue number(s), publisher, city and/or country where published.	T ⁵
	1	KEVIN C. ALMEROETH ET AL., "An Alternative Paradigm for Scalable On-Demand Applications: Evaluating and Deploying the Interactive Multimedia Jukebox," IEEE Transactions on Knowledge and Data Engineering, Vol. 11, No. 4, July/August 1999, pages 658-672, copyright 1999 IEEE, 15 pages.	<input type="checkbox"/>

If you wish to add additional non-patent literature document citation information please click the Add button **Add**

EXAMINER SIGNATURE			
Examiner Signature	/Pablo Tran/	Date Considered	09/11/2011

*EXAMINER: Initial if reference considered, whether or not citation is in conformance with MPEP 609. Draw line through a citation if not in conformance and not considered. Include copy of this form with next communication to applicant.

¹ See Kind Codes of USPTO Patent Documents at www.USPTO.GOV or MPEP 901.04. ² Enter office that issued the document, by the two-letter code (WIPO Standard ST.3). ³ For Japanese patent documents, the indication of the year of the reign of the Emperor must precede the serial number of the patent document. ⁴ Kind of document by the appropriate symbols as indicated on the document under WIPO Standard ST.16 if possible. ⁵ Applicant is to place a check mark here if English language translation is attached.

EAST Search History

EAST Search History (Prior Art)

Ref #	Hits	Search Query	DBs	Default Operator	Plurals	Time Stamp
L1	17065	455/3.02,3.06,142,150.1,151.1,151.2,154.1,154.2,158.1,158.2,158.4,186.1,344,414.1,414.3,456.2,556.1,557.ccls.	US- PGPUB; USPAT; FPRS; EPO; JPO; DERWENT	OR	OFF	2011/09/10: 12:14
L2	16737	709/217,219.ccls.	US- PGPUB; USPAT; FPRS; EPO; JPO; DERWENT	OR	OFF	2011/09/10: 12:14
L3	2360	725/39,45,18.ccls.	US- PGPUB; USPAT; FPRS; EPO; JPO; DERWENT	OR	OFF	2011/09/10: 12:14
L4	35840	1 or 2 or 3	US- PGPUB; USPAT; FPRS; EPO; JPO; DERWENT	OR	OFF	2011/09/10: 12:14
L5	23776	4 and internet	US- PGPUB; USPAT; FPRS; EPO; JPO; DERWENT	OR	ON	2011/09/10: 12:15
L6	650	5 and (playlist\$)	US- PGPUB; USPAT; FPRS; EPO; JPO; DERWENT	OR	ON	2011/09/10: 12:15
L7	435	6 and song	US- PGPUB; USPAT; FPRS; EPO; JPO; DERWENT	OR	ON	2011/09/10: 12:15
L8	279	7 and playback\$	US- PGPUB; USPAT; FPRS; EPO; JPO; DERWENT	OR	ON	2011/09/10: 12:16
L9	238	8 and radio	US- PGPUB; USPAT; FPRS; EPO; JPO; DERWENT	OR	ON	2011/09/10: 12:17
L10	236	9 and audio	US- PGPUB; USPAT; FPRS; EPO; JPO; DERWENT	OR	ON	2011/09/10: 12:19
L11	1	"11563232"	US- PGPUB; USPAT; FPRS; EPO; JPO; DERWENT	OR	ON	2011/09/10: 12:20
L12	1	10 and 11	US- PGPUB; USPAT; FPRS; EPO; JPO; DERWENT	OR	ON	2011/09/10: 12:20
L13	137	10 and ((assign\$ identif\$) with (list\$ playlist\$))	US- PGPUB; USPAT; FPRS;	OR	ON	2011/09/10: 12:21

EAST Search History

L14	62	13 and (internet\$ with radio)	EPO; JPO; DERWENT			
			US- PGPUB; USPAT; FPRS; EPO; JPO; DERWENT	OR	ON	2011/09/10; 12:21

9/10/2011 12:22:07 PM
 C:\Users\ptran4\Documents\EAST\Workspaces\11498011.wsp

Issue Classification 	Application/Control No. 11563232	Applicant(s)/Patent Under Reexamination QURESHEY ET AL.
	Examiner PABLO TRAN	Art Unit 2618

ORIGINAL						INTERNATIONAL CLASSIFICATION												
CLASS		SUBCLASS				CLAIMED					NON-CLAIMED							
455		344				H	0	5	K	11 / 00 (2006.01.01)								
CROSS REFERENCE(S)						G	0	6	F	15 / 16 (2006.01.01)								
						H	0	4	N	5 / 445 (2011.01.01)								
CLASS	SUBCLASS (ONE SUBCLASS PER BLOCK)																	
455	556.1	557	414.1	414.3														
709	217	219																
725	39	45																

Claims renumbered in the same order as presented by applicant
 CPA
 T.D.
 R.1.47

Final	Original	Final	Original	Final	Original	Final	Original	Final	Original	Final	Original	Final	Original	Final	Original
1	1		17	55	33	9	49	61	65						
2	2	53	18	56	34	30	50	62	66						
3	3		19	57	35	51	51	10	67						
4	4		20	12	36	16	52	31	68						
4	5	5	21	33	37	17	53	52	69						
	6	23	22	54	38	18	54	63	70						
11	7	46	23	7	39	19	55	64	71						
21	8	6	24	25	40	20	56								
22	9	24	25	48	41	37	57								
	10	47	26	8	42	38	58								
32	11	13	27	26	43	39	59								
42	12	14	28	49	44	40	60								
43	13	15	29	27	45	41	61								
44	14	34	30	50	46	58	62								
	15	35	31	28	47	59	63								
45	16	36	32	29	48	60	64								

NONE		Total Claims Allowed:	
		64	
(Assistant Examiner)	(Date)		
/PABLO TRAN/ Primary Examiner. Art Unit 2618	09/11/11	O.G. Print Claim(s)	O.G. Print Figure
(Primary Examiner)	(Date)	1	1

PART B - FEE(S) TRANSMITTAL

Complete and send this form, together with applicable fee(s), to: **Mail Stop ISSUE FEE**
Commissioner for Patents
P.O. Box 1450
Alexandria, Virginia 22313-1450
or Fax (571)-273-2885

INSTRUCTIONS: This form should be used for transmitting the ISSUE FEE and PUBLICATION FEE (if required). Blocks 1 through 5 should be completed where appropriate. All further correspondence including the Patent, advance orders and notification of maintenance fees will be mailed to the current correspondence address as indicated unless corrected below or directed otherwise in Block 1, by (a) specifying a new correspondence address; and/or (b) indicating a separate "FEE ADDRESS" for maintenance fee notifications.

CURRENT CORRESPONDENCE ADDRESS (Note: Use Block 1 for any change of address)

71739 7590 09/15/2011
WITHROW & TERRANOVA CT
100 REGENCY FOREST DRIVE, SUITE 160
CARY, NC 27518

Note: A certificate of mailing can only be used for domestic mailings of the Fee(s) Transmittal. This certificate cannot be used for any other accompanying papers. Each additional paper, such as an assignment or formal drawing, must have its own certificate of mailing or transmission.

Certificate of Mailing or Transmission
 I hereby certify that this Fee(s) Transmittal is being deposited with the United States Postal Service with sufficient postage for first class mail in an envelope addressed to the Mail Stop ISSUE FEE address above, or being facsimile transmitted to the USPTO (571) 273-2885, on the date indicated below.

_____ (Depositor's name)
_____ (Signature)
_____ (Date)

APPLICATION NO.	FILING DATE	FIRST NAMED INVENTOR	ATTORNEY DOCKET NO.	CONFIRMATION NO.
11/563,232	11/27/2006	Safi Qureshey	1116-028C	1583

TITLE OF INVENTION: METHOD AND DEVICE FOR AN INTERNET RADIO CAPABLE OF OBTAINING PLAYLIST CONTENT FROM A CONTENT SERVER

APPLN. TYPE	SMALL ENTITY	ISSUE FEE DUE	PUBLICATION FEE DUE	PREV. PAID ISSUE FEE	TOTAL FEE(S) DUE	DATE DUE
nonprovisional	NO	\$1510	\$300	\$0	\$1810	12/15/2011

EXAMINER	ART UNIT	CLASS-SUBCLASS
TRAN, PABLO N	2618	725-034000

1. Change of correspondence address or indication of "Fee Address" (37 CFR 1.363).

- Change of correspondence address (or Change of Correspondence Address form PTO/SB/122) attached.
 "Fee Address" indication (or "Fee Address" Indication form PTO/SB/47; Rev 03-02 or more recent) attached. Use of a Customer Number is required.

2. For printing on the patent front page, list

- (1) the names of up to 3 registered patent attorneys or agents OR, alternatively,
 (2) the name of a single firm (having as a member a registered attorney or agent) and the names of up to 2 registered patent attorneys or agents. If no name is listed, no name will be printed.

1. Withrow & Terranova, PLLC
 2. _____
 3. _____

3. ASSIGNEE NAME AND RESIDENCE DATA TO BE PRINTED ON THE PATENT (print or type)

PLEASE NOTE: Unless an assignee is identified below, no assignee data will appear on the patent. If an assignee is identified below, the document has been filed for recordation as set forth in 37 CFR 3.11. Completion of this form is NOT a substitute for filing an assignment.

(A) NAME OF ASSIGNEE

Horsham Enterprises, LLC

(B) RESIDENCE: (CITY and STATE OR COUNTRY)

Wilmington, Delaware

Please check the appropriate assignee category or categories (will not be printed on the patent): Individual Corporation or other private group entity Government

4a. The following fee(s) are submitted:

- Issue Fee
 Publication Fee (No small entity discount permitted)
 Advance Order - # of Copies _____

4b. Payment of Fee(s): (Please first reapply any previously paid issue fee shown above)

- A check is enclosed.
 Payment by credit card. Form PTO-2038 is attached.
 The Director is hereby authorized to charge the required fee(s), any deficiency, or credit any overpayment, to Deposit Account Number _____ (enclose an extra copy of this form).

5. Change in Entity Status (from status indicated above)

- a. Applicant claims SMALL ENTITY status. See 37 CFR 1.27. b. Applicant is no longer claiming SMALL ENTITY status. See 37 CFR 1.27(g)(2).

NOTE: The Issue Fee and Publication Fee (if required) will not be accepted from anyone other than the applicant; a registered attorney or agent; or the assignee or other party in interest as shown by the records of the United States Patent and Trademark Office.

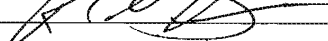
Authorized Signature 
 Typed or printed name R. Chad Bevins

Date September 16, 2011
 Registration No. 51,468

This collection of information is required by 37 CFR 1.311. The information is required to obtain or retain a benefit by the public which is to file (and by the USPTO to process) an application. Confidentiality is governed by 35 U.S.C. 122 and 37 CFR 1.14. This collection is estimated to take 12 minutes to complete, including gathering, preparing, and submitting the completed application form to the USPTO. Time will vary depending upon the individual case. Any comments on the amount of time you require to complete this form and/or suggestions for reducing this burden, should be sent to the Chief Information Officer, U.S. Patent and Trademark Office, U.S. Department of Commerce, P.O. Box 1450, Alexandria, Virginia 22313-1450. DO NOT SEND FEES OR COMPLETED FORMS TO THIS ADDRESS. SEND TO: Commissioner for Patents, P.O. Box 1450, Alexandria, Virginia 22313-1450.

Under the Paperwork Reduction Act of 1995, no persons are required to respond to a collection of information unless it displays a valid OMB control number.

Electronic Patent Application Fee Transmittal

Application Number:	11563232
Filing Date:	27-Nov-2006
Title of Invention:	METHOD AND DEVICE FOR AN INTERNET RADIO CAPABLE OF OBTAINING PLAYLIST CONTENT FROM A CONTENT SERVER
First Named Inventor/Applicant Name:	Safi Qureshey
Filer:	R. Chad Bevins/Julie Smith
Attorney Docket Number:	1116-028C

Filed as Large Entity

Utility under 35 USC 111(a) Filing Fees

Description	Fee Code	Quantity	Amount	Sub-Total in USD(\$)
Basic Filing:				
Pages:				
Claims:				
Miscellaneous-Filing:				
Petition:				
Patent-Appeals-and-Interference:				
Post-Allowance-and-Post-Issuance:				
Utility Appl issue fee	1501	1	1510	1510
Publ. Fee- early, voluntary, or normal	1504	1	300	300

Description	Fee Code	Quantity	Amount	Sub-Total in USD(\$)
Extension-of-Time:				
Miscellaneous:				
Total in USD (\$)				1810

Electronic Acknowledgement Receipt

EFS ID:	10968840
Application Number:	11563232
International Application Number:	
Confirmation Number:	1583
Title of Invention:	METHOD AND DEVICE FOR AN INTERNET RADIO CAPABLE OF OBTAINING PLAYLIST CONTENT FROM A CONTENT SERVER
First Named Inventor/Applicant Name:	Safi Qureshey
Customer Number:	71739
Filer:	R. Chad Bevins/Julie Smith
Filer Authorized By:	R. Chad Bevins
Attorney Docket Number:	1116-028C
Receipt Date:	16-SEP-2011
Filing Date:	27-NOV-2006
Time Stamp:	16:09:40
Application Type:	Utility under 35 USC 111(a)

Payment information:

Submitted with Payment	yes
Payment Type	Credit Card
Payment was successfully received in RAM	\$1810
RAM confirmation Number	2928
Deposit Account	501732
Authorized User	BEVINS,R. CHAD
<p>The Director of the USPTO is hereby authorized to charge indicated fees and credit any overpayment as follows:</p> <p style="padding-left: 40px;">Charge any Additional Fees required under 37 C.F.R. Section 1.20 (Post Issuance fees)</p> <p style="padding-left: 40px;">Charge any Additional Fees required under 37 C.F.R. Section 1.21 (Miscellaneous fees and charges)</p>	

File Listing:					
Document Number	Document Description	File Name	File Size(Bytes)/ Message Digest	Multi Part /.zip	Pages (if appl.)
1	Issue Fee Payment (PTO-85B)	1116-028C_Issue_Fee_Transmittal.pdf	88044 bb6325c38534bd9d6f74b0a97e6d60f7bd75ef5d	no	1
Warnings:					
Information:					
2	Fee Worksheet (SB06)	fee-info.pdf	32143 81ebede07caf252b0a1d1e01635cd0ef439840c6	no	2
Warnings:					
Information:					
Total Files Size (in bytes):			120187		
<p>This Acknowledgement Receipt evidences receipt on the noted date by the USPTO of the indicated documents, characterized by the applicant, and including page counts, where applicable. It serves as evidence of receipt similar to a Post Card, as described in MPEP 503.</p> <p><u>New Applications Under 35 U.S.C. 111</u> If a new application is being filed and the application includes the necessary components for a filing date (see 37 CFR 1.53(b)-(d) and MPEP 506), a Filing Receipt (37 CFR 1.54) will be issued in due course and the date shown on this Acknowledgement Receipt will establish the filing date of the application.</p> <p><u>National Stage of an International Application under 35 U.S.C. 371</u> If a timely submission to enter the national stage of an international application is compliant with the conditions of 35 U.S.C. 371 and other applicable requirements a Form PCT/DO/EO/903 indicating acceptance of the application as a national stage submission under 35 U.S.C. 371 will be issued in addition to the Filing Receipt, in due course.</p> <p><u>New International Application Filed with the USPTO as a Receiving Office</u> If a new international application is being filed and the international application includes the necessary components for an international filing date (see PCT Article 11 and MPEP 1810), a Notification of the International Application Number and of the International Filing Date (Form PCT/RO/105) will be issued in due course, subject to prescriptions concerning national security, and the date shown on this Acknowledgement Receipt will establish the international filing date of the application.</p>					



UNITED STATES PATENT AND TRADEMARK OFFICE

UNITED STATES DEPARTMENT OF COMMERCE
United States Patent and Trademark Office
Address: COMMISSIONER FOR PATENTS
P. O. Box 1450
Alexandria, Virginia 22313-1450
www.uspto.gov

APPLICATION NO.	ISSUE DATE	PATENT NO.	ATTORNEY DOCKET NO.	CONFIRMATION NO.
11/563,232	11/01/2011	8050652	1116-028C	1583

71739 7590 10/12/2011
WITHROW & TERRANOVA CT
100 REGENCY FOREST DRIVE , SUITE 160
CARY, NC 27518

ISSUE NOTIFICATION

The projected patent number and issue date are specified above.

Determination of Patent Term Adjustment under 35 U.S.C. 154 (b)
(application filed on or after May 29, 2000)

The Patent Term Adjustment is 1374 day(s). Any patent to issue from the above-identified application will include an indication of the adjustment on the front page.

If a Continued Prosecution Application (CPA) was filed in the above-identified application, the filing date that determines Patent Term Adjustment is the filing date of the most recent CPA.

Applicant will be able to obtain more detailed information by accessing the Patent Application Information Retrieval (PAIR) WEB site (<http://pair.uspto.gov>).

Any questions regarding the Patent Term Extension or Adjustment determination should be directed to the Office of Patent Legal Administration at (571)-272-7702. Questions relating to issue and publication fee payments should be directed to the Application Assistance Unit (AAU) of the Office of Data Management (ODM) at (571)-272-4200.

APPLICANT(s) (Please see PAIR WEB site <http://pair.uspto.gov> for additional applicants):

Safi Qureshey, Santa Ana, CA;
Daniel D. Sheppard, Brea, CA;

<p align="center">CHANGE OF CORRESPONDENCE ADDRESS <i>Patent</i></p> <p>Address to: Mail Stop Post Issue Commissioner for Patents P.O. Box 1450 Alexandria, VA 22313-1450</p>	Patent Number	6,050,652
	Issue Date	11/01/2011
	Application Number	11/563,232
	Filing Date	11/27/2006
	First Named Inventor	Safi Qureshey et al.
	Attorney Docket Number	1116-028C

Please change the Correspondence Address for the above-identified patent to:

The address associated with Customer Number:

OR

Firm or Individual Name

Address

City State ZIP

Country

Telephone Email

This form cannot be used to change the data associated with a Customer Number. To change the data associated with an existing Customer Number use "Request for Customer Number Data Change" (PTO/SB/124).

This form will not affect any "fee address" provided for the above-identified patent. To change a "fee address" use the "Fee Address Indication Form" (PTO/SB/47).

I am the:

Patentee.

Assignee of record of the entire interest. See 37 CFR 3.71. Statement under 37 CFR 3.73(b) is enclosed. (Form PTO/SB/96).

Attorney or agent of record. Registration Number 51468

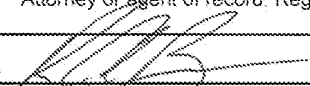
Signature 

Typed or Printed Name R. Chad Bevins

Date September 5, 2012 Telephone 919-238-2300

NOTE: Signatures of all the inventors or assignees of record of the entire interest or their representative(s) are required. Submit multiple forms if more than one signature is required, see below.

*Total of _____ forms are submitted.

This collection of information is required by 37 CFR 1.33. The information is required to obtain or retain a benefit by the public which is to file (and by the USPTO to process) an application. Confidentiality is governed by 35 U.S.C. 122 and 37 CFR 1.11 and 1.14. This collection is estimated to take 3 minutes to complete, including gathering, preparing, and submitting the completed application form to the USPTO. Time will vary depending upon the individual case. Any comments on the amount of time you require to complete this form and/or suggestions for reducing this burden, should be sent to the Chief Information Officer, U.S. Patent and Trademark Office, U.S. Department of Commerce, P.O. Box 1450, Alexandria, VA 22313-1450. DO NOT SEND FEES OR COMPLETED FORMS TO THIS ADDRESS. SEND TO: Mail Stop Post Issue, Commissioner for Patents, P.O. Box 1450, Alexandria, VA 22313-1450.

If you need assistance in completing the form, call 1-800-PTO-9199 and select option 2.

STATEMENT UNDER 37 CFR 3.73(b)

Applicant/Patent Owner: Safi Qureshey et al.

Application No./Patent No.: 8,050,652 Filed/Issue Date: 11/01/2011

Titled: **METHOD AND DEVICE FOR AN INTERNET RADIO CAPABLE OF OBTAINING PLAYLIST CONTENT FROM A CONTENT SERVER**

Black Hills Media, LLC, a limited liability corporation
(Name of Assignee) (Type of Assignee, e.g., corporation, partnership, university, government agency, etc.)

states that it is:

1. the assignee of the entire right, title, and interest in;
2. an assignee of less than the entire right, title, and interest in
(The extent (by percentage) of its ownership interest is _____ %); or
3. the assignee of an undivided interest in the entirety of (a complete assignment from one of the joint inventors was made) the patent application/patent identified above, by virtue of either:

A. An assignment from the inventor(s) of the patent application/patent identified above. The assignment was recorded in the United States Patent and Trademark Office at Reel _____, Frame _____, or for which a copy therefore is attached.

OR

B. A chain of title from the inventor(s), of the patent application/patent identified above, to the current assignee as follows:

1. From: Safi Qureshey and Daniel D. Shppard To: Audioramp.com

The document was recorded in the United States Patent and Trademark Office at
Reel 019135, Frame 0918, or for which a copy thereof is attached.

2. From: Audioramp.com To: Knobbe, Martens, Olson & Bear LLP

The document was recorded in the United States Patent and Trademark Office at
Reel 019135, Frame 0961, or for which a copy thereof is attached.

3. From: Knobbe, Martens, Olson & Bear LLP To: Concert Technology Corporation

The document was recorded in the United States Patent and Trademark Office at
Reel 019135, Frame 0987, or for which a copy thereof is attached.

Additional documents in the chain of title are listed on a supplemental sheet(s).

As required by 37 CFR 3.73(b)(1)(i), the documentary evidence of the chain of title from the original owner to the assignee was, or concurrently is being, submitted for recordation pursuant to 37 CFR 3.11.

[NOTE: A separate copy (i.e., a true copy of the original assignment document(s)) must be submitted to Assignment Division in accordance with 37 CFR Part 3, to record the assignment in the records of the USPTO. See MPEP 302.08]

The undersigned (whose title is supplied below) is authorized to act on behalf of the assignee.

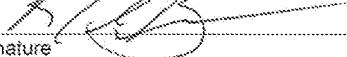
Signature

September 5, 2012
Date

R. Chad Bevins
Printed or Typed Name

Attorney of Record
Title

This collection of information is required by 37 CFR 3.73(b). The information is required to obtain or retain a benefit by the public which is to file (and by the USPTO to process) an application. Confidentiality is governed by 35 U.S.C. 122 and 37 CFR 1.11 and 1.14. This collection is estimated to take 12 minutes to complete, including gathering, preparing, and submitting the completed application form to the USPTO. Time will vary depending upon the individual case. Any comments on the amount of time you require to complete this form and/or suggestions for reducing this burden, should be sent to the Chief Information Officer, U.S. Patent and Trademark Office, U.S. Department of Commerce, P.O. Box 1450, Alexandria, VA 22313-1450. DO NOT SEND FEES OR COMPLETED FORMS TO THIS ADDRESS. SEND TO: Commissioner for Patents, P.O. Box 1450, Alexandria, VA 22313-1450.

If you need assistance in completing the form, call 1-800-PTO-9198 and select option 2.

Statement Under 37 CFR 3.73(b) – Supplemental Sheet

4. From: Concert Technology Corporation _____ To: ConPact, Inc. _____
The document was recorded in the United States Patent and Trademark Office at
Reel 019260 _____, Frame 0630 _____, or for which a copy thereof is attached.
5. From: ConPact, Inc. _____ To: Horsham Enterprises, LLC _____
The document was recorded in the United States Patent and Trademark Office at
Reel 024606 _____, Frame 0327 _____, or for which a copy thereof is attached.
6. From: Horsham Enterprises, LLC _____ To: Black Hills Media, LLC _____
The document was recorded in the United States Patent and Trademark Office at
Reel 028655 _____, Frame 0199 _____, or for which a copy thereof is attached.

Electronic Acknowledgement Receipt

EFS ID:	13666340
Application Number:	11563232
International Application Number:	
Confirmation Number:	1583
Title of Invention:	METHOD AND DEVICE FOR AN INTERNET RADIO CAPABLE OF OBTAINING PLAYLIST CONTENT FROM A CONTENT SERVER
First Named Inventor/Applicant Name:	Safi Qureshey
Customer Number:	71739
Filer:	R. Chad Bevins/Julie Smith
Filer Authorized By:	R. Chad Bevins
Attorney Docket Number:	1116-028C
Receipt Date:	05-SEP-2012
Filing Date:	27-NOV-2006
Time Stamp:	17:42:35
Application Type:	Utility under 35 USC 111(a)

Payment information:

Submitted with Payment	no
------------------------	----

File Listing:

Document Number	Document Description	File Name	File Size(Bytes)/ Message Digest	Multi Part /.zip	Pages (if appl.)
1	Power of Attorney	1116-028C_Black_Hills_Media_POA.pdf	139229 af63b0960767bdaa6efe38789defe5d0c21bd54d	no	1

Warnings:

Information:

2	Change of Address	1116-028C_Change_Correspondence_9-5-12.pdf	287782 a94fd4026ef9794857af77575c555b4a52385975	no	1
Warnings:					
Information:					
3	Assignee showing of ownership per 37 CFR 3.73(b).	1116-028C_Statement_Under_37CFR3-73b_9-5-12.pdf	352723 df1f1719775719500ded7799141ef987bd8c0916	no	2
Warnings:					
Information:					
Total Files Size (in bytes):				779734	
<p>This Acknowledgement Receipt evidences receipt on the noted date by the USPTO of the indicated documents, characterized by the applicant, and including page counts, where applicable. It serves as evidence of receipt similar to a Post Card, as described in MPEP 503.</p> <p><u>New Applications Under 35 U.S.C. 111</u> If a new application is being filed and the application includes the necessary components for a filing date (see 37 CFR 1.53(b)-(d) and MPEP 506), a Filing Receipt (37 CFR 1.54) will be issued in due course and the date shown on this Acknowledgement Receipt will establish the filing date of the application.</p> <p><u>National Stage of an International Application under 35 U.S.C. 371</u> If a timely submission to enter the national stage of an international application is compliant with the conditions of 35 U.S.C. 371 and other applicable requirements a Form PCT/DO/EO/903 indicating acceptance of the application as a national stage submission under 35 U.S.C. 371 will be issued in addition to the Filing Receipt, in due course.</p> <p><u>New International Application Filed with the USPTO as a Receiving Office</u> If a new international application is being filed and the international application includes the necessary components for an international filing date (see PCT Article 11 and MPEP 1810), a Notification of the International Application Number and of the International Filing Date (Form PCT/RO/105) will be issued in due course, subject to prescriptions concerning national security, and the date shown on this Acknowledgement Receipt will establish the international filing date of the application.</p>					

Under the Paperwork Reduction Act of 1995, no persons are required to respond to a collection of information unless it displays a valid OMB control number.

POWER OF ATTORNEY TO PROSECUTE APPLICATIONS BEFORE THE USPTO

I hereby revoke all previous powers of attorney given in the application identified in the attached statement under 37 CFR 3.73(b).

I hereby appoint:

Practitioners associated with the Customer Number:

71739

OR

Practitioner(s) named below (if more than ten patent practitioners are to be named, then a customer number must be used):

Name	Registration Number	Name	Registration Number

as attorney(s) or agent(s) to represent the undersigned before the United States Patent and Trademark Office (USPTO) in connection with any and all patent applications assigned only to the undersigned according to the USPTO assignment records or assignment documents attached to this form in accordance with 37 CFR 3.73(b).

Please change the correspondence address for the application identified in the attached statement under 37 CFR 3.73(b) to:

The address associated with Customer Number:

71739

OR

<input type="checkbox"/> Firm or Individual Name			
Address			
City	State	Zip	
Country			
Telephone	Email		

Assignee Name and Address:
 Black Hills Media, LLC
 1000 North West Street, Suite 1200
 Wilmington, DE 19801

A copy of this form, together with a statement under 37 CFR 3.73(b) (Form PTO/SB/96 or equivalent) is required to be filed in each application in which this form is used. The statement under 37 CFR 3.73(b) may be completed by one of the practitioners appointed in this form if the appointed practitioner is authorized to act on behalf of the assignee, and must identify the application in which this Power of Attorney is to be filed.

SIGNATURE of Assignee of Record

The individual whose signature and title is supplied below is authorized to act on behalf of the assignee

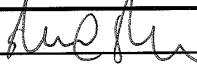
Signature		Date	7/30/2012
Name	Hugh Svendsen	Telephone	919-433-1845
Title	Member		

This collection of information is required by 37 CFR 1.31, 1.32 and 1.33. The information is required to obtain or retain a benefit by the public which is to file (and by the USPTO to process) an application. Confidentiality is governed by 35 U.S.C. 122 and 37 CFR 1.11 and 1.14. This collection is estimated to take 3 minutes to complete, including gathering, preparing, and submitting the completed application form to the USPTO. Time will vary depending upon the individual case. Any comments on the amount of time you require to complete this form and/or suggestions for reducing this burden, should be sent to the Chief Information Officer, U.S. Patent and Trademark Office, U.S. Department of Commerce, P.O. Box 1450, Alexandria, VA 22313-1450. DO NOT SEND FEES OR COMPLETED FORMS TO THIS ADDRESS. SEND TO: Commissioner for Patents, P.O. Box 1450, Alexandria, VA 22313-1450.

If you need assistance in completing the form, call 1-800-PTO-9199 and select option 2.



UNITED STATES PATENT AND TRADEMARK OFFICE

UNITED STATES DEPARTMENT OF COMMERCE
United States Patent and Trademark Office
Address: COMMISSIONER FOR PATENTS
P.O. Box 1450
Alexandria, Virginia 22313-1450
www.uspto.gov

APPLICATION NUMBER	FILING OR 371(C) DATE	FIRST NAMED APPLICANT	ATTY. DOCKET NO./TITLE
11/563,232	11/27/2006	Safi Qureshey	1116-028C

CONFIRMATION NO. 1583

POWER OF ATTORNEY NOTICE

71739
WITHROW & TERRANOVA CT
100 REGENCY FOREST DRIVE , SUITE 160
CARY, NC 27518



Date Mailed: 09/11/2012

NOTICE REGARDING CHANGE OF POWER OF ATTORNEY

This is in response to the Power of Attorney filed 07/30/2010.

- The Power of Attorney to you in this application has been revoked by the assignee who has intervned as provided by 37 CFR 3.71. Future correspondence will be mailed to the new address of record(37 CFR 1.33).

/snguyen/

Office of Data Management, Application Assistance Unit (571) 272-4000, or (571) 272-4200, or 1-888-786-0101



UNITED STATES PATENT AND TRADEMARK OFFICE

UNITED STATES DEPARTMENT OF COMMERCE
United States Patent and Trademark Office
Address: COMMISSIONER FOR PATENTS
P.O. Box 1450
Alexandria, Virginia 22313-1450
www.uspto.gov

APPLICATION NUMBER	FILING OR 371(C) DATE	FIRST NAMED APPLICANT	ATTY. DOCKET NO./TITLE
11/563,232	11/27/2006	Safi Qureshey	1116-028C

CONFIRMATION NO. 1583

POA ACCEPTANCE LETTER

71739
WITHROW & TERRANOVA CT
100 REGENCY FOREST DRIVE , SUITE 160
CARY, NC 27518



Date Mailed: 09/11/2012

NOTICE OF ACCEPTANCE OF POWER OF ATTORNEY

This is in response to the Power of Attorney filed 07/30/2010.

The Power of Attorney in this application is accepted. Correspondence in this application will be mailed to the above address as provided by 37 CFR 1.33.

/snguyen/

Office of Data Management, Application Assistance Unit (571) 272-4000, or (571) 272-4200, or 1-888-786-0101

AO 120 (Rev. 08/10)

TO: Mail Stop 8 Director of the U.S. Patent and Trademark Office P.O. Box 1450 Alexandria, VA 22313-1450	REPORT ON THE FILING OR DETERMINATION OF AN ACTION REGARDING A PATENT OR TRADEMARK
---------------------------------------------------------------------------------------------------------------------------------	----------------------------------------------------------------------------------------------------------------------------------------------------------

In Compliance with 35 U.S.C. § 290 and/or 15 U.S.C. § 1116 you are hereby advised that a court action has been filed in the U.S. District Court _____ for the District of Delaware _____ on the following
 Trademarks or Patents. (the patent action involves 35 U.S.C. § 292.);

DOCKET NO. 12-00637-RGA	DATE FILED 5/22/2012	U.S. DISTRICT COURT for the District of Delaware	
PLAINTIFF Black Hills Media, LLC		DEFENDANT Sonos, Inc.	
PATENT OR TRADEMARK NO.	DATE OF PATENT OR TRADEMARK	HOLDER OF PATENT OR TRADEMARK	
1 8,045,952	10/25/2011	Black Hills Media LLC	
2 8,050,652	11/1/2011	Black Hills Media LLC	
3 6,985,694	1/10/2006	Black Hills Media LLC	
4 7,742,740	6/22/2010	Black Hills Media LLC	
5 6,757,517	6/29/2004	Black Hills Media LLC	

cont'd on second page.

In the above—entitled case, the following patent(s)/ trademark(s) have been included:

DATE INCLUDED 9/11/2012	INCLUDED BY <input checked="" type="checkbox"/> Amendment <input type="checkbox"/> Answer <input type="checkbox"/> Cross Bill <input type="checkbox"/> Other Pleading		
PATENT OR TRADEMARK NO.	DATE OF PATENT OR TRADEMARK	HOLDER OF PATENT OR TRADEMARK	
1 6,108,686	8/22/2000	Black Hills Media LLC	
2 8,230,099	7/24/2012	Black Hills Media LLC	
3 8,214,873	7/3/2012	Black Hills Media LLC	
4			
5			

In the above—entitled case, the following decision has been rendered or judgement issued:

DECISION/JUDGEMENT

CLERK	(BY) DEPUTY CLERK	DATE
-------	-------------------	------

Copy 1—Upon initiation of action, mail this copy to Director Copy 3—Upon termination of action, mail this copy to Director
 Copy 2—Upon filing document adding patent(s), mail this copy to Director Copy 4—Case file copy

AO 120 (Rev. 08/10)

TO: Mail Stop 8 Director of the U.S. Patent and Trademark Office P.O. Box 1450 Alexandria, VA 22313-1450	REPORT ON THE FILING OR DETERMINATION OF AN ACTION REGARDING A PATENT OR TRADEMARK
---------------------------------------------------------------------------------------------------------------------------------	----------------------------------------------------------------------------------------------------------------------------------------------------------

In Compliance with 35 U.S.C. § 290 and/or 15 U.S.C. § 1116 you are hereby advised that a court action has been filed in the U.S. District Court _____ for the District of Delaware _____ on the following
 Trademarks or Patents. (the patent action involves 35 U.S.C. § 292.):

DOCKET NO. 12-00634-RGA	DATE FILED 5/22/0202	U.S. DISTRICT COURT for the District of Delaware	
PLAINTIFF Black Hills Media, LLC		DEFENDANT Pioneer Corporation	
PATENT OR TRADEMARK NO.	DATE OF PATENT OR TRADEMARK	HOLDER OF PATENT OR TRADEMARK	
1 8,045,952	10/25/2011	Black Hills Media LLC	
2 8,050,652	11/1/2011	Black Hills Media LLC	
3 6,985,694	1/10/2006	Black Hills Media LLC	
4			
5			

In the above—entitled case, the following patent(s)/ trademark(s) have been included:

DATE INCLUDED 9/12/2012	INCLUDED BY <input checked="" type="checkbox"/> Amendment <input type="checkbox"/> Answer <input type="checkbox"/> Cross Bill <input type="checkbox"/> Other Pleading		
PATENT OR TRADEMARK NO.	DATE OF PATENT OR TRADEMARK	HOLDER OF PATENT OR TRADEMARK	
1 6,108,686	8/22/0200	Black Hills Media LLC	
2 8,230,099	7/24/2012	Black Hills Media LLC	
3 8,214,873	7/2/2012	Black Hills Media LLC	
4			
5			

In the above—entitled case, the following decision has been rendered or judgement issued:

DECISION/JUDGEMENT

CLERK	(BY) DEPUTY CLERK	DATE
-------	-------------------	------

Copy 1—Upon initiation of action, mail this copy to Director Copy 3—Upon termination of action, mail this copy to Director
 Copy 2—Upon filing document adding patent(s), mail this copy to Director Copy 4—Case file copy

AO 120 (Rev. 08/10)

TO: Mail Stop 8 Director of the U.S. Patent and Trademark Office P.O. Box 1450 Alexandria, VA 22313-1450	REPORT ON THE FILING OR DETERMINATION OF AN ACTION REGARDING A PATENT OR TRADEMARK
---------------------------------------------------------------------------------------------------------------------------------	----------------------------------------------------------------------------------------------------------------------------------------------------------

In Compliance with 35 U.S.C. § 290 and/or 15 U.S.C. § 1116 you are hereby advised that a court action has been filed in the U.S. District Court _____ for the District of Delaware on the following
 Trademarks or Patents. (the patent action involves 35 U.S.C. § 292.):

DOCKET NO. 12-00635-RGA	DATE FILED 5/22/0202	U.S. DISTRICT COURT for the District of Delaware
PLAINTIFF Black Hills Media, LLC		DEFENDANT Yamaha Corporation of America
PATENT OR TRADEMARK NO.	DATE OF PATENT OR TRADEMARK	HOLDER OF PATENT OR TRADEMARK
1 8,045,952	10/25/2011	Black Hills Media LLC
2 8,050,652	11/1/2011	Black Hills Media LLC
3 6,985,694	1/10/2006	Black Hills Media LLC
4		
5		

In the above—entitled case, the following patent(s)/ trademark(s) have been included:

DATE INCLUDED 9/12/2012	INCLUDED BY <input checked="" type="checkbox"/> Amendment <input type="checkbox"/> Answer <input type="checkbox"/> Cross Bill <input type="checkbox"/> Other Pleading	
PATENT OR TRADEMARK NO.	DATE OF PATENT OR TRADEMARK	HOLDER OF PATENT OR TRADEMARK
1 6,108,686	8/22/0200	Black Hills Media LLC
2 8,230,099	7/24/2012	Black Hills Media LLC
3 8,214,873	7/2/2012	Black Hills Media LLC
4		
5		

In the above—entitled case, the following decision has been rendered or judgement issued:

DECISION/JUDGEMENT

CLERK	(BY) DEPUTY CLERK	DATE
-------	-------------------	------

Copy 1—Upon initiation of action, mail this copy to Director Copy 3—Upon termination of action, mail this copy to Director
 Copy 2—Upon filing document adding patent(s), mail this copy to Director Copy 4—Case file copy

AO 120 (Rev. 08/10)

TO: Mail Stop 8 Director of the U.S. Patent and Trademark Office P.O. Box 1450 Alexandria, VA 22313-1450	REPORT ON THE FILING OR DETERMINATION OF AN ACTION REGARDING A PATENT OR TRADEMARK
---------------------------------------------------------------------------------------------------------------------------------	----------------------------------------------------------------------------------------------------------------------------------------------------------

In Compliance with 35 U.S.C. § 290 and/or 15 U.S.C. § 1116 you are hereby advised that a court action has been filed in the U.S. District Court _____ for the District of Delaware _____ on the following
 Trademarks or Patents. (the patent action involves 35 U.S.C. § 292.);

DOCKET NO. 12-00636-RGA	DATE FILED 5/22/0202	U.S. DISTRICT COURT for the District of Delaware	
PLAINTIFF Black Hills Media, LLC		DEFENDANT Logitech International SA	
PATENT OR TRADEMARK NO.	DATE OF PATENT OR TRADEMARK	HOLDER OF PATENT OR TRADEMARK	
1 8,045,952	10/25/2011	Black Hills Media LLC	
2 8,050,652	11/1/2011	Black Hills Media LLC	
3 6,985,694	1/10/2006	Black Hills Media LLC	
4			
5			

In the above—entitled case, the following patent(s)/ trademark(s) have been included:

DATE INCLUDED 9/12/2012	INCLUDED BY <input checked="" type="checkbox"/> Amendment <input type="checkbox"/> Answer <input type="checkbox"/> Cross Bill <input type="checkbox"/> Other Pleading		
PATENT OR TRADEMARK NO.	DATE OF PATENT OR TRADEMARK	HOLDER OF PATENT OR TRADEMARK	
1 6,108,686	8/22/0200	Black Hills Media LLC	
2 8,230,099	7/24/2012	Black Hills Media LLC	
3 8,214,873	7/2/2012	Black Hills Media LLC	
4			
5			

In the above—entitled case, the following decision has been rendered or judgement issued:

DECISION/JUDGEMENT

CLERK	(BY) DEPUTY CLERK	DATE
-------	-------------------	------

Copy 1—Upon initiation of action, mail this copy to Director Copy 3—Upon termination of action, mail this copy to Director
 Copy 2—Upon filing document adding patent(s), mail this copy to Director Copy 4—Case file copy